

ALL ABOUT NEON SIGNS

NEWNES

# PRACTICAL MECHANICS



SEPTEMBER  
6<sup>D</sup>

*Building a*  
**FIVE-MINUTE  
FLYER—  
RUBBER  
DRIVEN!**

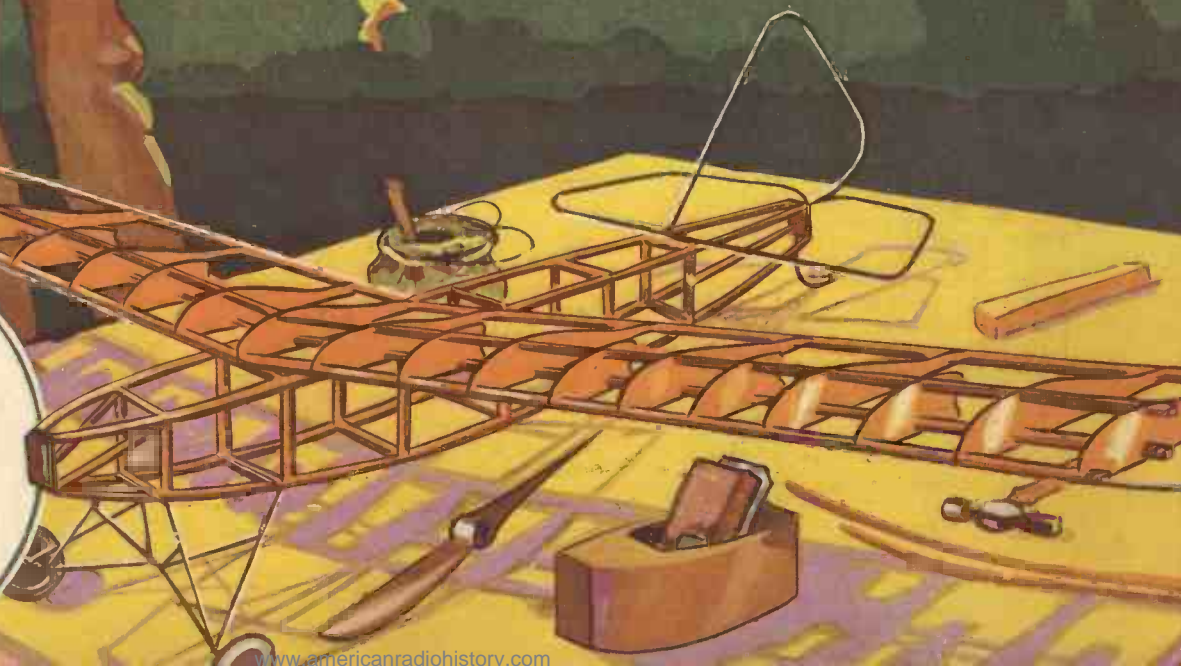



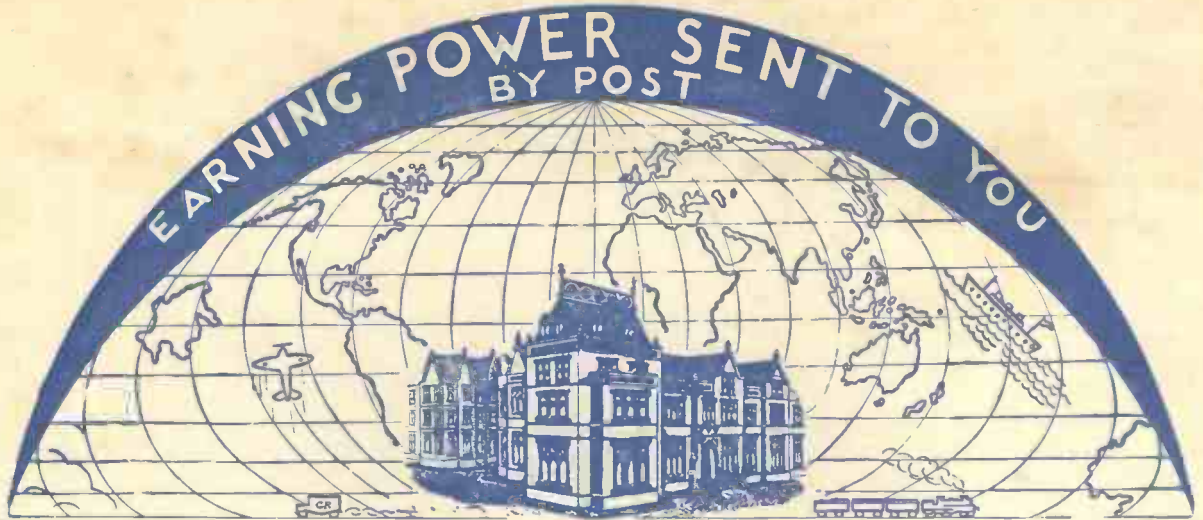

## Open Letter to Mr. Somebody and his Son

DEAR SIR,—The natural desire of most parents is to give their children a fair chance in life in the form of a good College Training, also there are many young men who would like to go to College but for some reason are not able to do so. Let us tell you here and now you can get a Complete College Training without having to go anywhere, and at a reasonable monthly fee for tuition. For well over 30 years we have been training students for all the Key positions, by post, in all parts of the world. Distance is nothing when you are studying by your own fireside.

The nature of our business makes us keep in touch with employment requirements, therefore we specialise in preparing students for the good positions which we know exist, and for all the worth-while examinations.

Write to us for FREE particulars of any subject which interests you, or if your career is not decided, write and tell us of your likes and dislikes, and we will give you practical advice as to the possibilities of a vocation and how to succeed in it.

You will be under no obligation whatever, it is our pleasure to help.

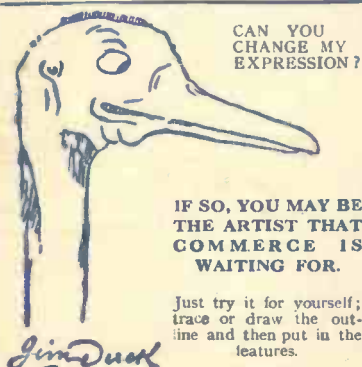

CAN YOU CHANGE MY EXPRESSION?

IF SO, YOU MAY BE THE ARTIST THAT COMMERCE IS WAITING FOR.

Just try it for yourself; trace or draw the outline and then put in the features.

*Jim Duck*

There are hundreds of openings in connection with Humorous Papers, Advertisement Drawing, Posters, Calendars, Catalogues, Textile Designs, Book Illustrations, etc. 60% of Commercial Art Work is done by "Free Lance Artists" who do their work at home and sell it to the highest bidder. Many Commercial Artists draw "retaining fees" from various sources, others prefer to work full-time employment or partnership arrangement. We teach you not only how to draw what is wanted but how to make buyers want what you draw. Many of our students who originally took up Commercial Art as a hobby have since turned it into a full-time paying profession with studio and staff of assistant artists; there is no limit to the possibilities. Let us send full particulars for a FREE TRIAL and details of our course for your inspection. You will be under no obligation whatever.

*Jim Duck*

Art Dept. 76.

## DO ANY OF THESE SUBJECTS INTEREST YOU?

Accountancy Examinations  
Advertising and Sales Management  
A.M.I. Fire E. Exam.  
Applied Mechanics  
Army Certificates  
Auctioneers & Estate Agents  
Aviation Engineering  
Banking  
Book-keeping  
Boilers and Modern Business Methods  
B.Sc. (Eng.)  
B.Sc. (Estate Management)  
Building, Architecture and Clerk of Works  
Cambridge Senior School Certificate  
Civil Engineering  
Civil Service  
All Commercial Subjects  
Commercial Art  
Concrete and Structural Engineering  
Draughtsmanship, all branches  
Engineering, all branches, subjects and exams.  
General Education  
G.P.O. Eng. Dept.  
Heating and Ventilating  
Industrial Chemistry  
Insurance  
Mathematics

Matriculation Metallurgy  
Mining, all subjects  
Mining, Electrical Engineering  
Motor Engineering  
Motor Trade  
Municipal and County Engineers  
Naval Architecture  
Pattern Making  
Police, Special Course  
Preceptors, College of Pumps and Pumping Machinery  
Radio Service Engineering  
Radio Communication  
Road Making and Maintenance  
Salesmanship I.S.M.A.  
Sanitation  
Secretarial Exams.  
Shipbuilding  
Shorthand (Pitman's)  
Structural Engineering  
Surveying  
Teachers of Handicrafts  
Telephony and Telegraphy  
Transport Inst. Exams.  
Weights and Measures Inspector  
Welding  
Wireless Telegraphy and Telephony  
Works Managers

If you do not see your own requirements above, write to us on any subject.

Also ask for our New Book (Free of Charge)  
**THE HUMAN MACHINE**  
Secrets of Success

## SIGNS of the TIMES

The Budget has restored  
**POLICE OPPORTUNITIES**  
The Air Force is to be increased  
**AVIATION must DEVELOP**  
Pay Cuts have been restored  
**CIVIL SERVICE**  
Suitable to both sexes. Ages 15½ to 24.  
**G.P.O. ENG. DEPT.**  
CUSTOMS AND EXCISE; INSP. OF TAXES, ETC. NO EXPERIENCE REQUIRED. OPEN EXAMS.

**MATRICULATION**  
There are many ways of commencing a career, but Matriculation is the jumping-off board for all the best ones.  
We prepare candidates for all  
**INSTITUTE EXAMS.**  
TECHNICAL, ACCOUNTANCY, SECRETARIAL, INSURANCE, ETC.  
**Engineers & Draughtsmen**  
All Branches — Employers are advertising for them.  
TELEPHONY, RADIO and MOTOR ENGINEERING are expanding rapidly. There are lots of vacancies. Our postal courses will make you eligible. Advice on all careers Free.

## IT IS THE PERSONAL TOUCH WHICH COUNTS IN POSTAL TUITION

**YOUNG MEN**  
Young men physically fit and whose careers are not definitely fixed should join the Police Force. We have special Courses for Entrance and Promotion. 1/- per week brings success. Full Particulars Free.  
Address:  
POLICE DEPT. 76.



Dept. 76. THE BENNETT COLLEGE. SHEFFIELD.

**ENGINEERS,**  
now is your chance to dig yourselves into a Key position and make your future solid. It needs Technical Training; we can give you that by post. Full particulars free.  
Dept. 76.





# PRACTICAL MECHANICS

Edited by F. J. Camm

VOL. III. No. 36  
SEPTEMBER  
1936

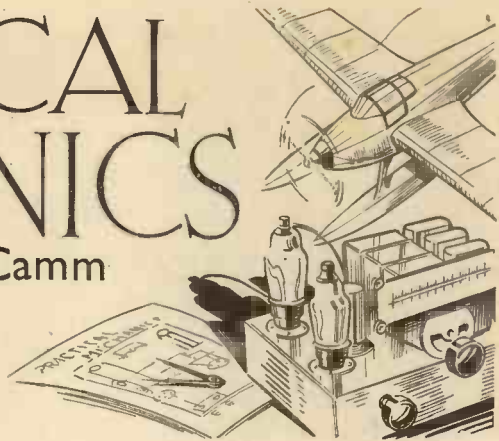

## The Treborough Bridge

THE Treborough Bridge system, linking the three New York suburbs of Bronx, Manhattan, and Queens, is now in use. The bridges took seven years to build and cost £12,500,000.

## An Up-to-date Destroyer

THE largest, fastest, and most heavily-armed destroyer built in this country, the *Grom*, built for the Polish Government by Messrs. J. Samuel White & Co., was recently launched at Cowes. The *Grom* is 374 ft. long by 37 ft.

## A "Flying Bedstead"

RECENTLY, at Hounslow Heath, Juan de la Cierva, the Spanish inventor, demonstrated his "flying bedstead," the newest type of autogiro. It rose thirty feet into the air without a take-off run.

## A New Record

THE world record for non-stop flights, set up by the French airmen, Codos and Rossi (5,567 miles, in 1933), has been broken, it is claimed, by three Soviet airmen flying a monoplane in a gigantic loop from Moscow to Nikolayevsk. The distance covered was 5,859 miles.

## A Mechanical "Heart"

A "HEART" invented by Colonel Lindbergh and Dr. A. Carrel, of the Rockefeller Institute, is said to be capable of infusing human and animal organs with perpetual life.

## A Trail-blazing Flight

TWO Russians recently started on a trail-blazing flight from San Francisco to Moscow by way of Alaska and Siberia. The distance is 10,000 miles, and they aim to establish a new mail route.

## A Magnet that Straightens Light

A MAGNET that keeps a chord of light straight is one of the interesting and practical marvels recently produced by the General Electric Co., Ltd.

"Osira" discharge tubes, which are well known in the lighting of many of our streets, have been adapted to floodlighting and large numbers have been installed for spectacular coloured-lighting effects.

These discharge lamps have no filament, but consist of a sausage-like glass tube containing two electrodes immersed in mercury vapour. The electric current passes from one electrode to the other, forming a cord of intensely luminous vapour about the thickness and length of an ordin-

## NOTES, NEWS, AND VIEWS

ary pencil, and giving a light of nearly 2,500 candle-power.

In flood-lighting projectors, this magnet is arranged to swing so that whatever the position of the projector, the magnet is always directly beneath the lamp.

## England Leads

THE number of air-mail letters from Britain to India last year was 10,500,000; in 1934 it was only 6,000,000. The Empire air-route mileage in 1935 was 53,291. America's was 52,461.

## A "Flying Flea" Record

THE first international trophy race for "Flying Fleas," held at Ramsgate recently, was won on handicap by M. E. Bret, of Cannes, France. With a time allowance of 4 min. 24 sec., he covered the 30-mile course at an average speed of 56½ m.p.h.

## New Postage Stamps

NEW postage stamps are shortly to be issued by postal authorities of the island of Curaçao, the Dutch colony in the West Indies.

## Speedy Battleships

NEW battleships which are to be built at Walker-on-Tyne and Birkenhead, will be, by a considerable margin, the fastest battleships ever built in this country. The unofficial estimate is 28 to 30 knots.

## SUBSCRIPTION RATES

Inland and Abroad, 7s. 6d. per annum

Canada - - 7s. per annum

Editorial and Advertisement Offices: "Practical Mechanics," George Newnes Ltd., 8-11 Southampton Street, Strand, W.C.2.

Registered at the G.P.O. for transmission by Canadian Magazine Post.

## Gas Masks Unnecessary

WE learn that an invention which may prove a great advance in protection against poison gas has been successfully tested in a Paris laboratory. A French scientist, M. Royer, has, by combining oxygen and carbon in a solid form and spraying the resultant mixture into an atmosphere impregnated with gas, succeeded in rendering the poison harmless.

## "Seeing" Your Voice

DR. H. HALL, of Cruft Laboratory, Harvard University, has invented a high-speed sound analyser which makes a photographic record on paper of the intensity and frequency of the different components present in a sound. A person can actually see a word that he has just spoken, and see the high- and low-frequency parts of the sound as he has pronounced it. The device will show the pictures of the different accents used by persons in different parts of the world.

## An Ultra-modern High-speed Train

A HIGH-SPEED all-aluminium train, in which all operations were controlled either automatically, or by the driver, was demonstrated some time ago on the B.M.T. subway system, New York City. The train lights were automatically operated by photo-electric cells; so that when a train entered or left a tunnel the lights were automatically turned on or off.

## A New Water Heater

A GERMAN firm have recently introduced a new water heater, which employs a fuel cartridge, for preparing a hot beverage and for heating a tin of food where a stove is not handy. It is light and can be carried in the pocket. Heat is supplied by compressed fuel, little larger than a coin; this is ignited by a piece of tinder, set off by a dry cell in the barrel. A single briquette of fuel will boil a pint of water in which the metal container is immersed, or heat a quart to a comfortable temperature. The unit is waterproof and easily cleaned.

## Bind Your Copies of "Practical Mechanics"

THE binding case for Volume III, complete with title page and index, is now ready and costs 3s. 6d. by post from the Publisher, George Newnes Ltd., 8-11 Southampton Street, Strand, London, W.C.2. The index can be obtained separately if desired for 7d. post free. All readers should have their copies of Volume III bound, and thus be able easily to refer to the contents by means of the fully cross-referenced index.



Full Constructional Details of a Fine All-Balsa Model, Which Has Been Tried, Tested, and Found Entirely Reliable and Consistent.

By F. J. CMM

# Building a Five-Minute Flier

**D**URING the past five years there has been a growing tendency to ignore the sturdy English system of model aircraft construction in which birch and spruce and proofed silk play a large part. In place of this system of construction we have substituted the American system in which small fittings are done away with and the structure is held together almost entirely by means of glue and dope.

Balsa is a wood of very low weight—weighing, in fact, only about one-third

the weight of cork. It is thus ideal for models intended for duration, and it enables, without a great increase in weight, a design to be adopted of a form which simulates the real thing.

### Advantages of Balsa

Although balsa is light but weak, it has the additional advantages that it is easily worked, quickly repaired, and requires the fewest tools for its manipulation. When a breakage does occur it is merely necessary to use a special glue on the two fractured parts

and place them together without a splice or binding of any sort. When dry, the broken part will be as strong as it was before breakage. Another advantage is that the model can be more quickly assembled than when fish-plates and sockets are used. In order to construct the model shown in the drawings and photographs you merely need an old safety-razor blade and a tube of the special glue sold for balsa construction, and a full-size blue print which is obtainable from the suppliers of the kit of parts, sold by the Model Aircraft Supplies Co., Ltd., 171, New Kent Road, London, S.E.1. This kit includes the necessary balsa already cut to section, a blue print, glue, wire, elastic, dope, lubricant, etc.

### Constructing the Fuselage

The first step is to construct the

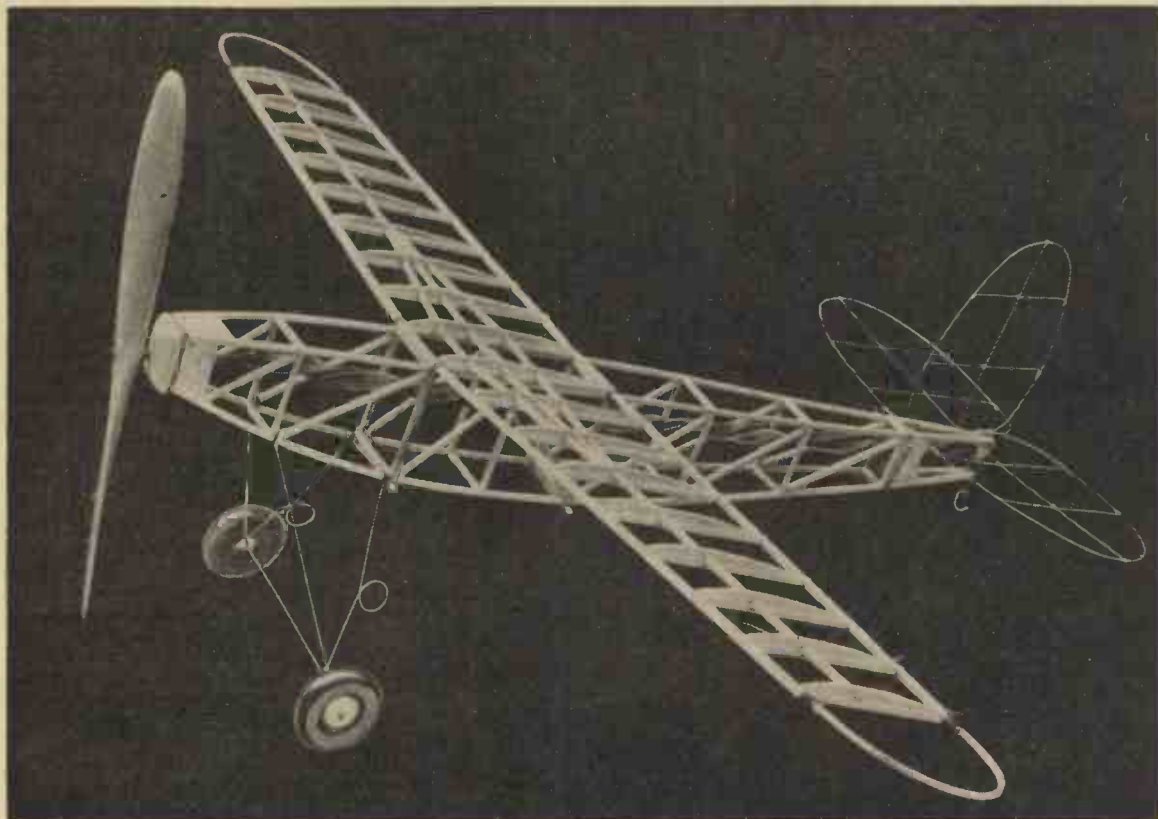

Photograph of the completed structure, without covering.



fuselage. Lay the blue print on a flat bench and pin it down. The longerons consist of  $\frac{1}{8}$ -in. square balsa, and the struts and diagonals are of the same section. Construct the two sides of the fuselage first by inserting pins along the lines of the side elevation drawing, and passing the various pieces of balsa accurately

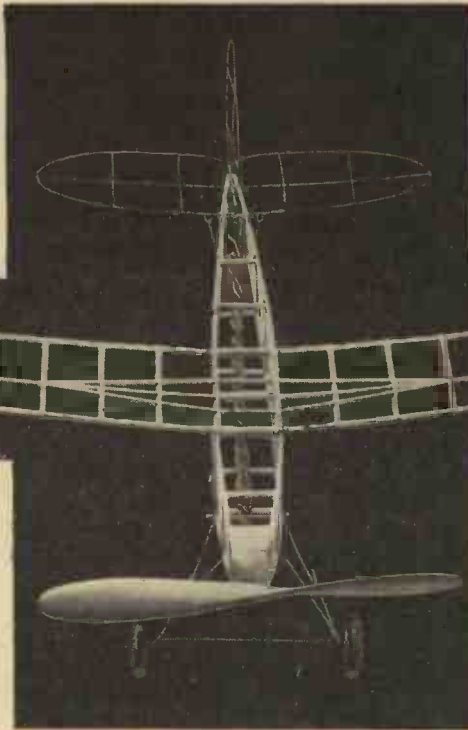

cut to length between them. Squeeze a little of the special glue on the contacting points and leave to dry for a couple of hours. Construct the other side in the same way, making sure when both sides are finished that each side is identical. There is no need to steam the balsa to the various curves; it will take on the correct form of its own accord. In each side at the nose and at the rear pieces of  $\frac{1}{8}$ -in. flat balsa are cut to box up the section for the nose block and for the tail support. A nose framing of  $\frac{1}{16}$ -in. three-ply is glued over the front to receive the balsa nose block through which passes the tubular brass bearing. With the two sides completed, stand them upright on the plan view of the fuselage and insert cross members Z, Z1, and Z2. These should be cut in pairs and thus be of identical lengths. If there is any discrepancy in the lengths the fuselage will not be square. When these members have been glued into position and the glue has set hard pull the sides in and join to the sternpost, taking care that both sides bend equally towards the centre line. The rear skid and rear elastic hook will, of course, be attached to the sternpost first.

*These two views indicate the simplicity of the construction and the attractive lines of the model.*

Scale Drawings appear on pages 665 and 666

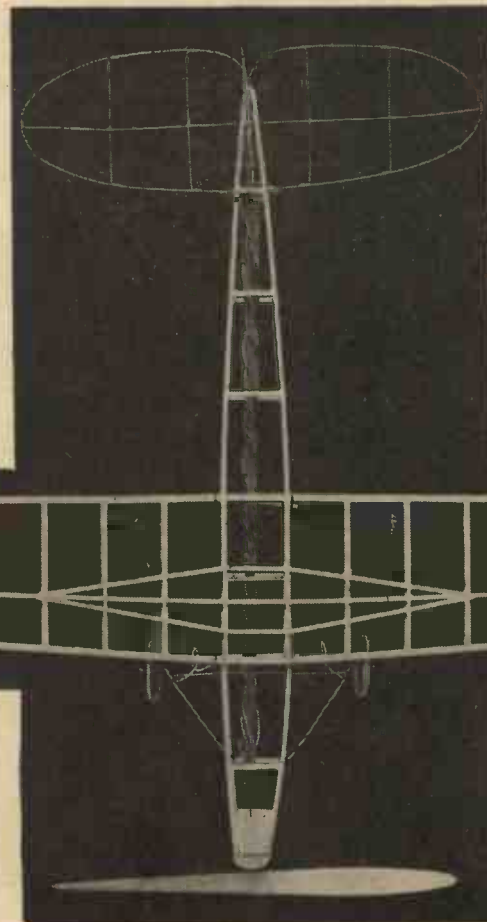

is glued into position. It is important to note that this has a downward angle in order to provide what is known as "down-thrust."

The nose block is cut by means of the razor blade from a solid block of balsa, and sandpapered to a more or less hemispherical form. It should fit the hole in the nose former per-

fectly. The propeller shaft is of 18 S.W.G. wire, and two cupped washers are placed between the propeller and the nose bush.

### The Undercarriage

In order that the model may be packed into a conveniently sized box, the chassis is made detachable. It is fixed to clips which are glued and bound in position. The front clips are made in one piece, and so are the rear clips. The undercarriage itself is made from 22-gauge wire, the joints being bound with florist's wire and soldered.

The chassis is of the sprung type, and the rear limbs have loops formed in them  $\frac{3}{4}$  in. in diameter. The chassis is in two pieces, consisting of the V members and the axle. The wheels may be made from plywood or balsa, or bought ready made.

### The Mainplane

The mainplane is made in a manner similar to that adopted for the fuselage, the various pieces of balsa being interposed between pins pushed through the blue print into the bench. The leading and trailing edges are made from  $\frac{3}{16}$ -in.  $\times$   $\frac{1}{8}$ -in. balsa, the mid-spars of  $\frac{1}{8}$ -in.  $\times$   $\frac{1}{8}$ -in.

balsa, and the wing tips from  $\frac{3}{32}$ -in.  $\times$   $\frac{3}{32}$ -in. birch. Notice that the latter are cut into the leading and trailing edges, being secured by glue and finally by binding when the wing is lifted. The wing section has a flat undersurface, and each rib is of T section. The root of the

### Bending the Sides

Next, pull in the two sides at the nose, gluing in the pieces of  $\frac{1}{8}$ -in. flat balsa top and bottom, and which should have been shaped to receive them. The intermediate struts can then be cut to exact length, after which the nose former



View of the uncovered wing, showing the swept-back leading edge.

T consists of a flat piece of balsa  $\frac{3}{16}$  in.  $\times$   $\frac{1}{8}$  in., and the upright part of  $\frac{1}{4}$  in.  $\times$   $\frac{1}{16}$  in. balsa. These upright portions are glued on and the camber is formed by glasspaper when the glue is dry. When the wing is completed remove the pins and lift, steaming the dihedral angle into the

bend to shape. Pin it down with drawing pins on the blue print, correcting the form of the curves and gluing the various members in position. The cross-pieces are of balsa  $\frac{1}{8}$  in.  $\times$   $\frac{1}{16}$  in. The fin is made in a similar way and joined to the tailplane.

#### Lubricating the Bearing and Elastic

Frequently oil the bearings with thick oil, or smear the spindle with vaseline. This will make a surprising difference to the running of the airscrew and the flying of the model, and will ensure that a minimum of power is lost in friction. The elastic should be lubricated at every fourth flight. Special lubricant is supplied with the kit, but if you run short you can make some yourself from 2 oz. of pure soft soap (green in colour) and a pennyworth of glycerine. Mix with an equal quantity of water and boil together.

#### Further Flying Hints

Do not wind the elastic to its full extent on the first flight. Give the airscrew (which is supplied finished) about 150 turns, and test the trim of the model. When this is correct, increase the turns to 200 and make any further adjustments to the trim, which may vary slightly as the turns are increased. Approach the maximum number of turns by increments of 50. Do not make extensive movements of the wing in order to trim it. Move the wing  $\frac{1}{8}$  in. at a time. For normal flying the fin should be set normal, when the model will fly in circles of large diameter, and climb. If straight flight is desired (it is almost impossible except by accident to get any single-screw model to fly exactly in a straight line) set the rear of the fin about  $\frac{1}{4}$  in. off centre line to counteract torque. The stability of the model is improved by bending up the tail flap about  $\frac{1}{8}$  in.

After the model has been flown a few times it will be noticed that the rubber skein has stretched. It should not be shortened, but during winding the nose block should be extended to take up the slack in the skein; the

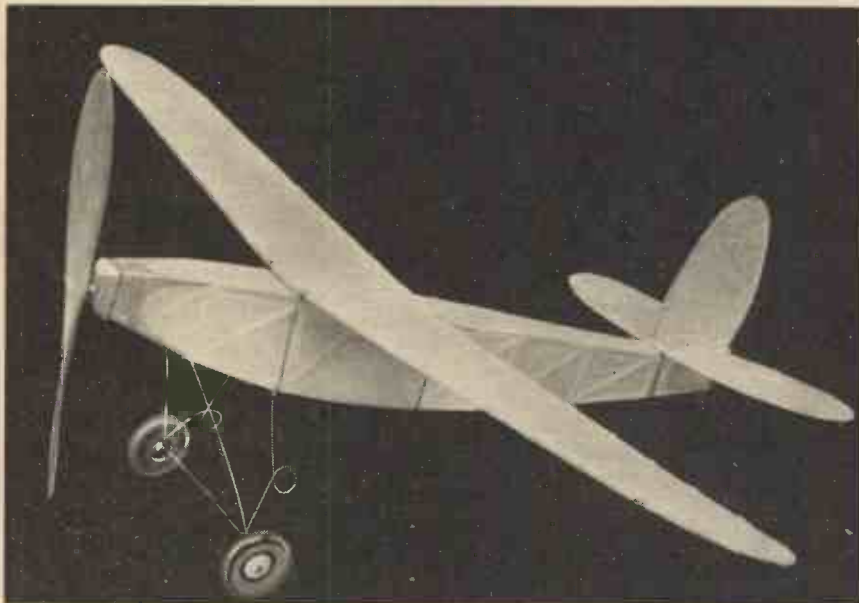

Illustration of the finished model.

spar at the point marked A to give  $1\frac{1}{2}$  in. rise at each wing tip. The dihedral must, of course, be equal on each side. If the spar cracks during the steaming process well cover the fractured part with glue. Place supporting blocks under the tip and pin the wing down in the centre. Next, glue the centre spars in position across the roots. The highest point of the camber is situated above the centre spar.

#### The Tailplane

This can be made either of birch or 22-gauge piano wire. I used the latter, but if you are reasonably skilled in the use of a jet of steam and can feel the precise moment when to effect the bend, birch may be used. Here again the blue print is used as a template. If wood is used the tailplane should be made in two halves from  $\frac{3}{32}$  in. square birch. Soak it in water for two hours, then steam it and

#### Flying

When the model is finished its appearance is improved if outlined in paint. The rubber motor consists of 8 strands of  $\frac{3}{16}$  in.  $\times$   $\frac{1}{32}$  in. elastic, and may be given 600 turns when lubricated. If the model climbs too steeply the wing should be placed farther back until it flies normally. If it tends to dive, move the wing forward.

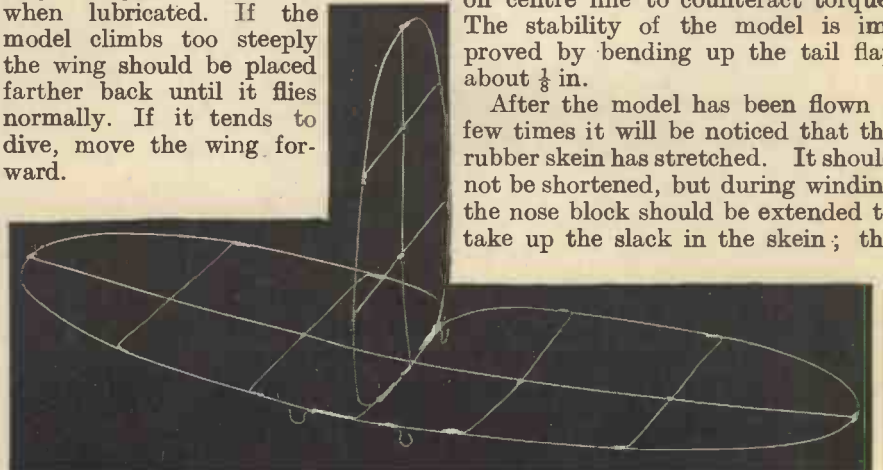

The wire tail and fin.





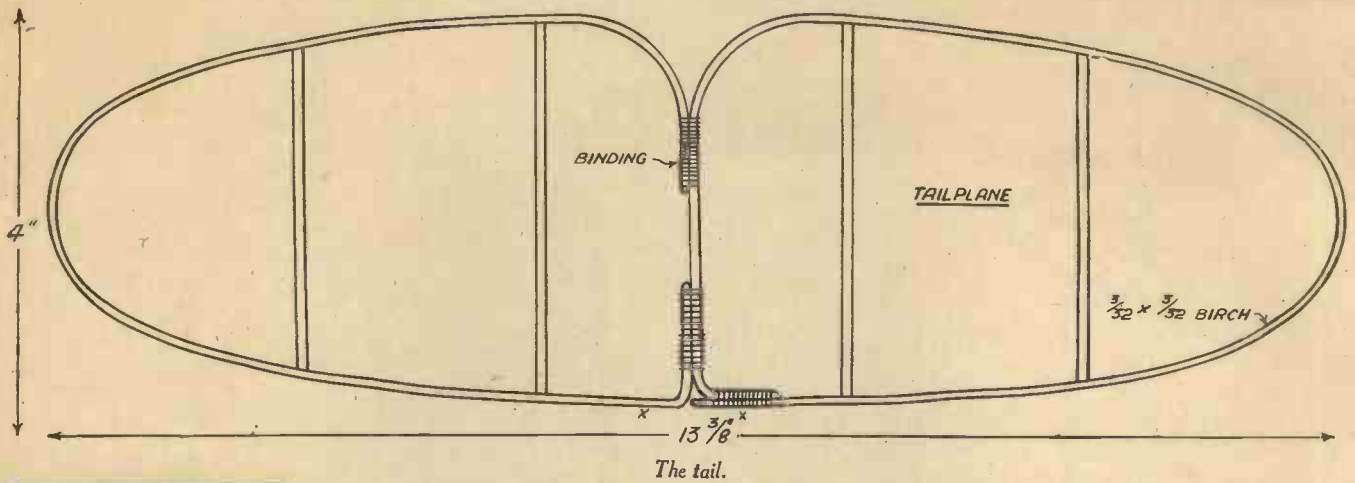

The tail.

latter may with advantage be stretched during the winding process if you can get an assist-

glide is a measure of efficiency. The gliding angle is extremely flat, although the duration of run of the propeller is less than a minute. The suppliers of the kit recommend 8 strands of  $\frac{3}{16}$ -in. flat strip elastic. Personally I found that only 6 strands with 1,000 turns gave a better result, although the climb was not so rapid

makers should direct their attention to the all-important problem of controlling the flight of the model. At present the flight of a model is very much like a bow drawn at a venture. You do not know where it is going to land. A simple mechanism working off the airscrew shaft could easily be devised and which, by means of a

reduction gear, operates the rudder so that the model flies on a Figure 8 course. Competitions for such flights were held before the war and quite successfully.

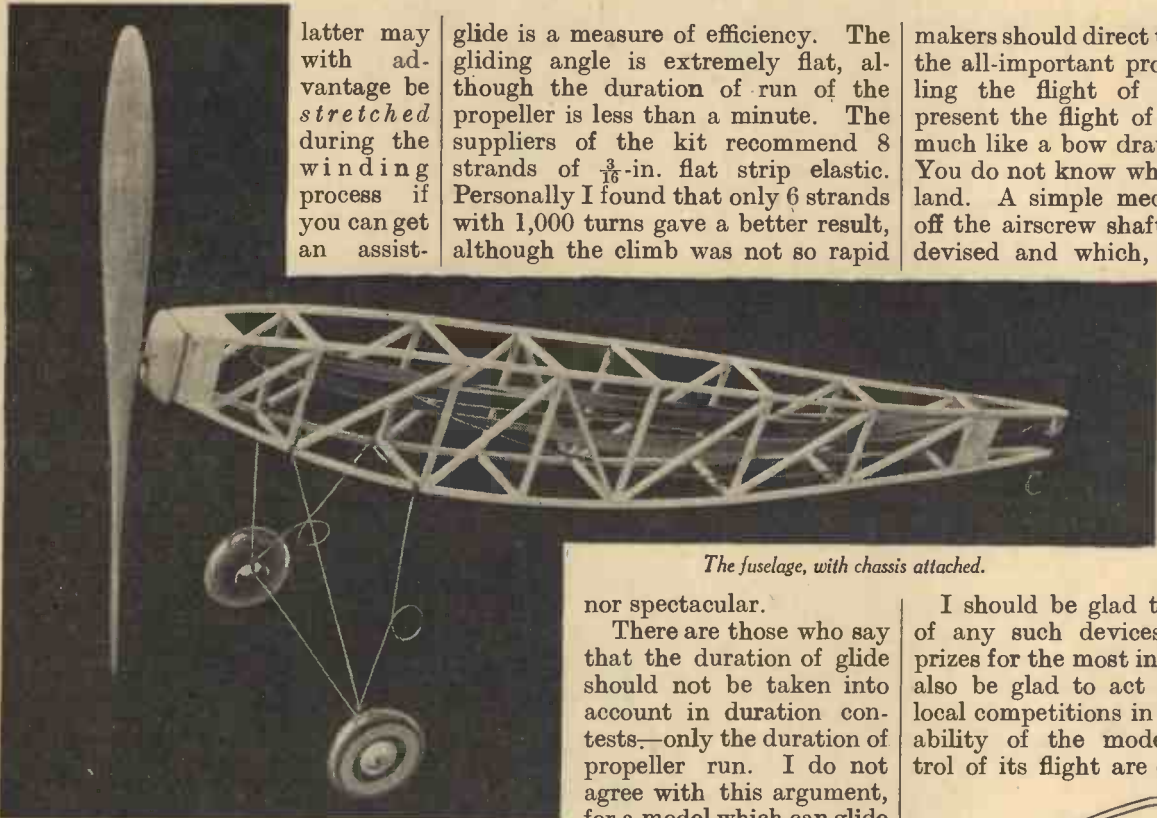

The fuselage, with chassis attached.

nor spectacular.

There are those who say that the duration of glide should not be taken into account in duration contests,—only the duration of propeller run. I do not agree with this argument, for a model which can glide

I should be glad to receive details of any such devices and to award prizes for the most ingenious. I shall also be glad to act as judge in any local competitions in which the steerability of the model and the control of its flight are deciding factors.

ant to hold the model while you pull on the skein and wind. It is claimed that more turns can be placed on a given skein in this way than if the skein is wound inert. I cannot vouch for the accuracy of this claim which emanates from America, but I can well believe it. You should carry some spare pieces of balsa, glue, and tissue to effect any small repairs necessary should the model come into contact with a fixed object whilst flying.

Under test I found this model to be a truly spectacular flier, consistently remaining in the air for more than five minutes, although the best part of this duration was due to glide. Still, it says a great deal for the efficiency of the model that it can glide for such a considerable time, for

for a number of minutes is certainly more efficient than one which drops like a brick when the airscrew stops. Unless the glide were taken into account the efficient model would be penalised and often beaten by the less efficient.

I do think, however, that the existing rule that models should only be timed whilst they are within the vision of the timekeeper (who is not permitted to follow the flight of the model) is wrong. The rule places competitors at the mercy of a timekeeper with poor eyesight, bad weather, and, also, should the competition take place on a dull day or in the evening the same timekeeper has less range of vision. No doubt, this rule will be subjected to discussion and modification in the future.

I am also of the opinion that model

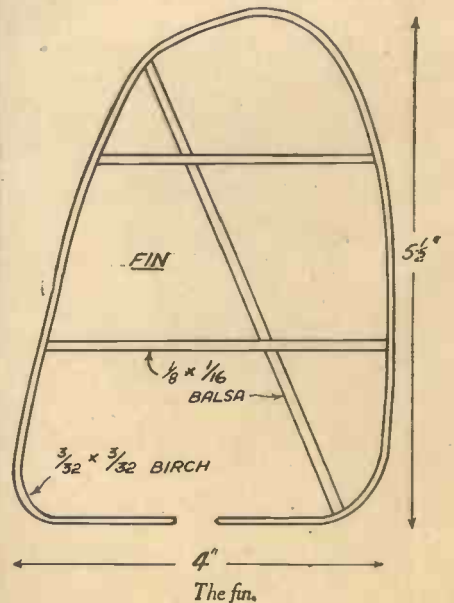

The fin.



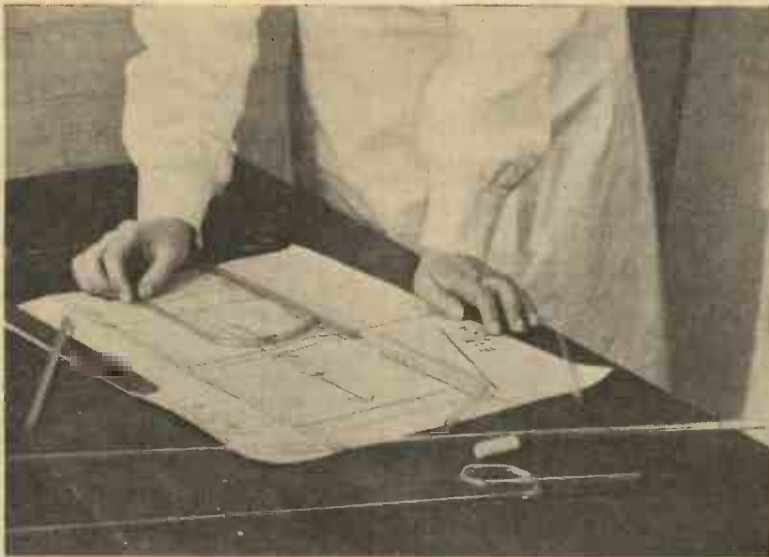

Neon letter-making. Measuring out from a full-scale drawing the necessary length of glass tubing for the construction of a section of a sign.

# NEON SIGNS

A Comprehensive Outline of the Nature, Construction, and Operation of Neon Advertising Signs, written non-technically and in straightforward language.

**D**ESPITE the fact that neon and its allied gases have been known for nearly 40 years, it is only since the Great War that the neon sign industry has arisen.

There are several reasons for this fact. For a considerable time after the discovery of neon, its electrical reactions and the commercial possibilities inherent in them were not realised. Again, it was not until 1907 that Georges Claude, a French physicist and inventor, made it possible to obtain the neon gases cheaply by means of the liquefaction of air.

The world's first neon sign was constructed in Paris in 1910 by the above-mentioned Georges Claude. Claude, naturally, held many master-patents concerned with the commercial manufacture of neon signs. These patent rights were rigorously guarded and is due, perhaps, to this fact, coupled, of course, with the intervention of the European War which dislocated all scientific commercial progress, that "neons" did not make their now universal appearance in the cities of civilisation more than a decade or two ago.

## How the Neon Works

The operating principle of the neon sign will no doubt be familiar to most readers of this journal. Neon gas at low pressure is contained in a glass tube and a high-potential alternating current is sent through the tube. Under the influence of the current, the neon gas glows vividly with its characteristic reddish-orange light, the neon glow filling the whole of the tube with a dense and uniformly-distributed mass of light.

Neon is not the only gas which has the property of glowing under the influence of a high-potential alternating current. Any gas, given suitable conditions, will emit a characteristic glow, and some of these gas-

glows are very beautiful, indeed. Unfortunately, however, only those gases belonging to what is now termed the group of "Rare Gases of the Atmosphere" are suitable for use in electrical signs and, of these gases, only three—neon, argon, and helium—have yet found commercial applica-

A bottle of neon. Although the gas is invisible and weighs but little, it is a most precious commodity. The quantity of neon in the bottle shown is sufficient to fill several large signs.



tion in sign making.

In the table on this page will be found a list of the rare gases of the atmosphere, together with a statement of their existing proportion in the atmosphere. Argon, it will be seen, is the most plentiful of all these rare gases. Neon comes next on the list, whilst the gas Xenon is excessively rare. Despite this latter fact, however, so efficient are becoming the methods of rare gas extraction from the atmosphere that we may look forward at a future time to signs filled with Xenon glowing brilliantly with a delicate sky-blue hue.

## The Rarest Gas

Xenon, the rarest of the rare gases, weight for weight is about four thousand times as dear as gold—even at the present-day high price of the latter. Even neon itself, when placed on this "gold standard," costs about a thousand pounds per ounce, which is many times the market price of gold. Fortunately for the electrical sign industry, these rare gases are not bought by weight, but are purchased by the sign-makers in litre-capacity glass bulbs, the

TABLE SHOWING AT A GLANCE THE RARE GASES OF THE ATMOSPHERE, THEIR RELATIVE PROPORTIONS IN THE EARTH'S ATMOSPHERE AND THEIR CHARACTERISTIC DISCHARGE GLOWS

Gas	Proportional Amount (by volume) in the Atmosphere	Electric-Discharge Glow
Argon	1 part in 106 parts of Air (equivalent to 0.93 per cent.)	Blue
Neon	1 part in 80,800 parts of air (equivalent to 0.001 per cent.)	Orange-Red
Helium	1 part in 245,300 parts of air	Yellow-White
Krypton	1 part in 20,000,000 parts of air	Lavender-White
Xenon	1 part in 70,000,000 parts of air	Sky-Blue

latter being filled with the rare gas at atmospheric pressure. Bought in this way, a litre of pure neon (sufficient to make many signs) costs about 35s. to £2. But, of course, the actual weight of a litre of neon is exceedingly small.

The three rare atmospheric gases, neon, argon and helium, together with mercury vapour, comprise the working elements of all present-day luminous tube signs, which, being all modelled on the pattern on the original neon discharge tubes, have now come to be termed "neon" signs, no matter whether they contain neon gas within them or not.

Commercial neon signs are obtainable, usually, in four brilliant colours and colour-shades, namely, red, yellow, green and blue. Pure neon gas gives the red colour. Blue glowing neon signs are usually filled with a gas composed of 80 per cent. of argon and

20 per cent. of neon, together with a proportion of mercury vapour. Argon, itself, glows with a blue colour, but its glow-efficiency is but poor. Hence, it is seldom used alone in the making of neon tubes. The 80 per cent. argon—20 per cent. neon mixture used in these blue-glow signs is termed the "carrier gas" in view of the fact that it carries the current before the mercury in the sign tube has become sufficiently heated up to form a glowing

now be appreciated by the reader, for, obviously, it would be impossible to lay down a hot piece of glass on a sheet of ordinary paper without the latter being charred.

The complete sign, or section of a sign, having been bent out of the glass tubing, electrodes are attached and small side-tubings are fused at convenient points into the glass sign. Through these the air is pumped out of the sign and neon or other

type of transformer is necessary, a transformer which will give an initially large current and which will, after the sign has once started, automatically reduce its output current. Such transformers, thanks to the ingenuity of electrical designers, are now readily obtainable. They are termed "high-leakage reactance transformers" and they are in use on all present-day signs of the neon type.

#### Careful Annealing

All the seals and bends of a neon sign tube must not only be adequately constructed, but they must be made as free as possible from internal strains in the glass by careful annealing. If this essential precaution is not taken, small cracks may develop in the glass of the tubes and, air thus gaining access to the interior of the tubes, the sign will immediately cease working.

Most of the trouble experienced with the operation of neon signs of all types has resulted from the tube electrodes. Owing to the considerably high working temperatures of a neon sign and aided, also, by the low gaseous pressure within the tubes, the electrodes of such signs gives rise to the phenomenon of "sputtering," whereby metallic particles are actually torn off the electrodes by the high-tension current and hurled against the inner glass walls of the tube. Not only does this effect, in time, deteriorate the electrodes of the sign, but, worse still, each sputtered particle of metal attaches itself to an atom of the neon gas and, embedding itself in the glass wall of the tube, very effectively removes the neon atom from its appointed sphere of action.

A neon sign, therefore, gradually undergoes an internal "cleaning-up" action, as a result of which, owing to the gradual removal of neon atoms from the free interior of the tube by the sputtered particles of electrode material, the sign eventually becomes so deficient in neon or its other gaseous element, that it refuses to function.

Thus it is that no neon sign can yet be guaranteed to function continually for more than eighteen months. Gradually, however, the electrode-sputtering difficulty inherent in all neon signs is being overcome, with the result that the future neon signs will very probably ultimately have at least as long a life as the present-day electric filament bulb.

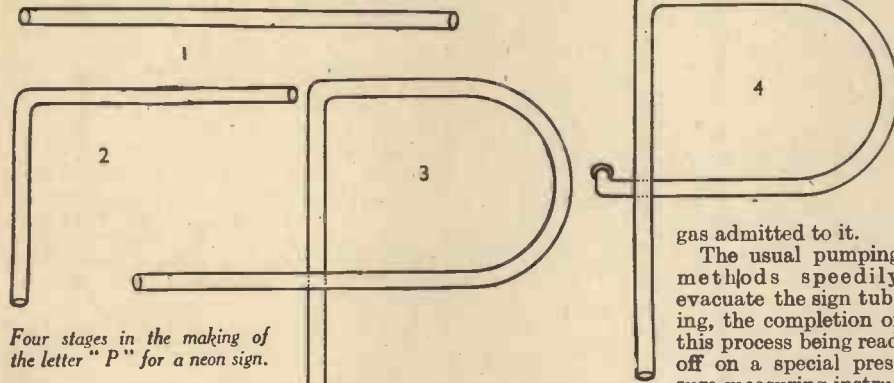

Four stages in the making of the letter "P" for a neon sign.

vapour. Once the mercury vapour in such signs has begun to glow, its vivid colour blends with the more subdued glow of the argon-neon carrier gas to produce the really beautiful blue which is now obtainable from such gas mixtures.

#### Green Signs

Green neon signs contain mercury and the argon-neon carrier glass. They are constructed from yellow glass, the latter removing the blue rays from the glow discharge and only permitting rays of more or less yellow-green colour to pass through. A green neon sign, therefore, is, in reality, a blue sign seen through yellow glass. Try viewing a blue neon sign through a sheet of yellow glass and you will obtain the characteristic colouration of a green neon sign.

Helium gas glows with a yellow or whitish-yellow light and, mixed with other rare gases, it is frequently used to produce the yellow glow of neon tubes. But helium is a high-resistance gas. It glows with difficulty and signs containing it usually require a more intense current to be forced through them.

The making of neon signs is a highly skilled task, calling not only for the highest practical qualifications in the art of glass-blowing but, in addition, extensive electrical knowledge.

#### Making the Lettering

When the design, shape, size and other details of a neon sign have been agreed upon, the actual lettering of the sign is drawn, full-size, on a length of non-combustible paper. Working from this paper "pattern," the neon glass-blower carefully bends out the letters of the required sign from lengths of perfectly clean glass tubing, special compressed air-fed bunsen-burner flames (or "fires," as they are termed in the industry) being employed.

Having heated and bent a length of glass tubing to the required form, the glass-blower lays it down over the "pattern" letter which has been drawn on the paper to see whether it exactly coincides with the latter. The use of non-combustible paper for drawing the neon sign "pattern" will

be appreciated by the reader, for, obviously, it would be impossible to lay down a hot piece of glass on a sheet of ordinary paper without the latter being charred. The complete sign, or section of a sign, having been bent out of the glass tubing, electrodes are attached and small side-tubings are fused at convenient points into the glass sign. Through these the air is pumped out of the sign and neon or other

#### Large Signs

The efficient fixing of large neon signs is not easy work. Owing to the high-tension current employed for the operation of the sign, each section of the wiring has to be most efficiently shock-proofed and insulated. Also, since the sign has to operate in all weathers, it is necessary to render it (in addition to the many sign-leads and connections) as weather-proof as possible.

The average neon sign is operated from an ordinary mains current supply, the latter being stepped-up in voltage by means of a transformer. It is rather important to note that a commercial neon sign is never operated on direct current. A sign could be thus operated at sufficiently high voltages, but the resulting glow would not be uniform. It would contain striae—alternate patches of light and darkness—and would, on this account alone, be quite ineffective.

Neon and its allied gases have a curious electrical characteristic. They take a relatively heavy current to start the glow, but the latter having once been begun, the tube will function on currents of a considerably lower order. Thus it is that for the operation of neon signs a very special

gas admitted to it.

The usual pumping methods speedily evacuate the sign tubing, the completion of this process being read off on a special pressure-measuring instru-

ment attached to the sign tubing, or to some part of the pumping apparatus. The neon container is then put into communication with the interior of the evacuated sign tubing, and, very carefully, the precious gas is "laddled" bit by bit into the sign. This handling of the invisible gas is effected ingeniously by means of a simple system of tap-turning. When the pressure-gauge connected up to the sign tubing registers an internal neon pressure of approximately 1 millimetre of mercury, the sign tubing is carefully sealed off. It is now internally complete and is thereupon handed over to the sign fixers and mounters.

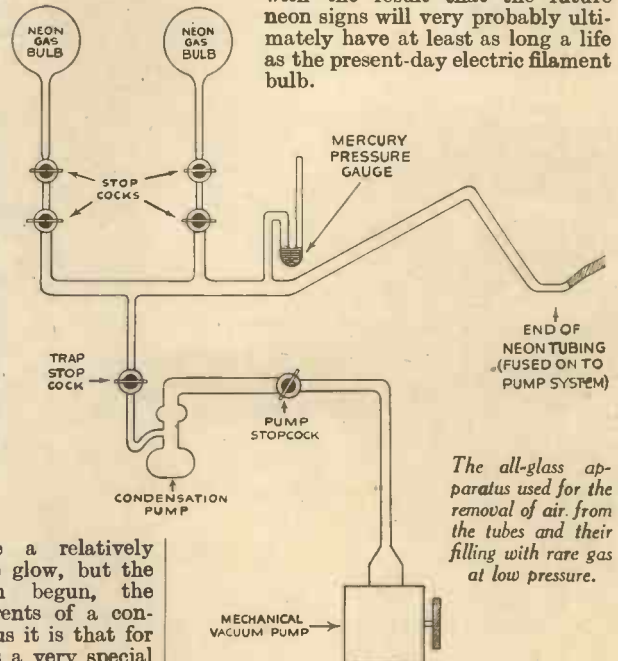

The all-glass apparatus used for the removal of air from the tubes and their filling with rare gas at low pressure.





Fig. 1.—One of the possible consequences of the break-up of the moon.

# HOW THE MOON WILL DISINTEGRATE

Sir James Jeans' Prediction of the Ultimate Break-up of the Moon

**T**HE moon is responsible for the greater part of the tides raised in the oceans of the earth; these, exerting a pull on the solid earth underneath, slow down its speed of rotation with the result that the day is continually lengthening. In Fig. 2, the tide-wave is shown diagrammatically as a white bulge on each side of the earth; actually this tidal swelling of the ocean does not amount to more than 3 ft. in mid-Atlantic though in places, due to land obstruction, it may, as in the Bay of Fundy, rise to 70 ft. This tidal undulation, due chiefly to the backward pull of the moon, acts as a brake upon the earth's rotation.

The tides will continue to act in this manner until the earth and moon are rotating and revolving in complete unison.

### Never See the Moon

When, if ever, that time arrives, the earth will continually turn the same face to the moon so that the inhabitants of one of the hemispheres of the earth will never see the moon at all, whilst the other side will be lighted by it every night. By this time the length of the day and month will be identical, each being equal to about forty-seven of our present days. It has been calculated that this state of things is likely to be attained after about 5,000 million years. After this, tidal friction will no longer operate in the sense of driving the moon further away from the earth. The joint effect of solar and lunar tides will be to slow down the

earth's rotation still further, the moon at the same time lessening its distance from the earth.



Fig. 2.—Showing the tide-wave diagrammatically as a white bulge on each side of the earth.

### The Moon Nearing the Earth

What will be the ultimate consequence of this? The moon has gradually come nearer to the earth until, as indicated, its distance is but little more than 12,000 miles from the earth instead of an average of 240,000 miles as at present. The tidal swelling will then be all on one side of the earth except for the small effect of solar action. The moon, the cause of this, will be permanently over this area, apex under apex, as both bodies slowly revolve. As observed from the earth, the moon would appear always in the same place in the sky, immense and menacing, while the planets, stars and sun passed on their apparent way. The growing nearness of the moon would, apart from raising a great permanent tide-bulge on the earth, also exercise a terrific strain upon the moon so as to produce a great tide-bulge on the moon, indicated diagrammatically on the drawing. A catastrophe would now be effecting, culminating in some such possible effect as indicated by Fig 1.

### Tiny Satellites

When the moon has finally, after unthinkable ages, been dragged down to within about 12,000 miles of the earth, the tides raised by the earth in the solid body of the moon will shatter the latter into fragments which will form tiny satellites revolving around the earth. Numerous fragments coming within the gravitational pull of the earth would fall as giant meteorites, raised to incandescence in their terrific speed through the earth's atmosphere,

might be expected to produce effects more or less similar to that produced by the fall of the great Tunguska meteorite of June 30th, 1908; and the great Meteor Crater in Arizona. A large portion of the moon would, it is believed, ultimately be resolved into small particles or even dust, which would be spread out as a vast ring encircling the earth in the same way as the particles of Saturn's rings revolve round Saturn.

#### A Striking Celestial Effect

Fig. 3 shows one of the most striking celestial effects such as could become possible in, say, the United States latitudes on a summer's night. The countless moonlets stretching as a luminous arch across the southern sky whilst the shadow cast by the earth upon it, corresponding to the shadow which may be seen of Saturn on its rings, would produce the great "bite" out of the luminous band shown in the picture. This great shadow would rise in the south-east, and reach the point indicated between 11 and 12 p.m., finally setting in the south-west. By day this lunar belt would more or less hide the sun for days or weeks, according to the density of its particles, whilst in the winter, instead of the bright luminous band, only a faintly lit or perhaps scarcely perceptible belt would be visible. The reason for this



Fig. 3.—The permanent "glory" following the disintegration of the moon.

is that the sun would then be shining upon the other side of its innumerable particles and only such light as penetrated would be visible together with such light as was

reflected from the radiant earth. This is, of course, supposing that there was any sunlight left, or the earth anything better than a dark frigid waste at that remote epoch.

**W**E reproduce below a photograph of an interesting steelwork contract which Messrs. Harland & Wolff Ltd., have on hand at Belfast, viz., the fabrication and erection of the steelwork for a new bridge at Durham Street, spanning the Great Northern Railway (1).

It will be of particular interest to mention that the new steelwork weighing approximately 300 tons, was erected in about thirty hours, all the work being done during the night to avoid any dislocation of the ordinary railway traffic.

The bridge as now erected consists of three spans of 42 ft., 57 ft. in centre, and 47 ft. 9 in., and the width has been increased

## IN THE WORLD OF SCIENCE

#### Tantalum

**TANTALUM** is the new semi-precious metal. It has been known for over a hundred years. At one time it was so scarce that it was classed amongst the rarest of metals, but the discovery of extensive deposits in Western Australia and of new methods of working it up have provided adequate supplies. It is somewhat akin to aluminium in its behaviour. Like aluminium, it is un-

probable that it will enjoy a vogue in the mounting of jewellery. Wireless experts will be interested to hear that in America an all-tantalum valve has been used, being a direct application of the important property tantalum possesses of completely absorbing the last traces of gases from vacuum tubes at low temperatures, and then as the temperature is raised it gives off the gas in quantity regulated by the temperature rise. The vacuum and sensitivity of tantalum valves are thus under special control. Another use is as a rectifying plate in transforming A.C. to D.C.

#### "Queen Mary's" Water Supply

**T**HE fresh water on the *Queen Mary* for domestic use and for make-up to her boilers is not supplied by evaporators as is the case in most sea-going vessels. Fresh water is taken on board at New York or Southampton sufficient to last her for her short run of four or five days. The water is stored in tanks forward of the engine room. Before use it is softened in a water-softening plant, and is then pumped to soft-water tanks ready for use.

Further forward still is another set of tanks which collect all the drainage and waste water from the ship. Pumps are installed which discharge these tanks into the sea.

#### Centrifugal Cast Concrete Girders

**A** RECENT German invention for the construction of concrete floors is a hollow centrifugally cast concrete girder. It replaces present method of construction with steel girders filled in with concrete or special tiles, and gives the same strength with use of less and cheaper material.

The girder is octagonal in external section with a cylindrical hollow centre. The girders thus pack against one another like the cells of a honey comb, leaving V-gaps between which are afterwards filled with triangular section hollow blocks.

Girders are cast in a high-speed rotating mould, in which the concrete is spun firmly on to the iron reinforcement. The outward centrifugal force throws the concrete firmly and evenly into the web of the reinforcement. When the concrete has set, the mould is unbolted and the girder is put on one side to cure.



The new bridge under construction at Durham Street, Belfast

to 65 feet overall. The main girders, fabricated in one piece and weighing about 30 tons each, run parallel with the station platforms and are supported on four built steel columns composing of six joists riveted together. These girders carry the roadway and parapet girders in the centre of the bridge, the ends being supported on reinforced concrete abutments,

tarnishable, and can be given a variety of lustres by anodic treatment. But it is harder and heavier and possesses the incredibly high melting-point of 3,000° C. It is being adopted by chemists in place of platinum vessels, for it is so inert to chemical attack that aqua regia leaves it undissolved. Its silvery lustre is superior if anything to that of platinum, and it is very



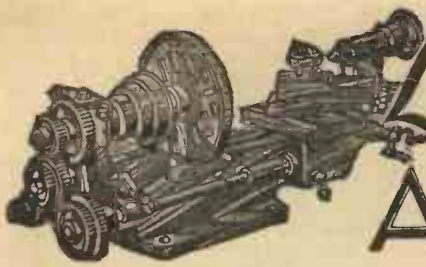

# Lathe Work FOR AMATEURS

## Dividing Attachment for a Lathe

WHEN a milling attachment is used in a lathe, its usefulness is considerably widened if there is a dividing mechanism for the lathe mandrel. For then the milling tool can be used for cutting hexagons, squares, wheel teeth, splines in shafts at regular intervals, etc.

A dividing attachment is shown in the accompanying drawings. Fig. 2 shows the dividing plate *A*, fitted to the lathe mandrel. The plate may be of brass, iron, or steel. Brass is easier to turn and drill, but iron or steel wears longer, and the dividing holes do not get worn and distorted on the more essential combinations such as sixes and fours and their multiples.

plate is used for chuck work, the usual chuck will hold the plate firm between the shoulder on the mandrel nose and the back face of the boss of the chuck back plate—exactly as in the case of the carrier-plate shown in the drawing.

To prevent the dividing plate moving round the mandrel nose, it is located by a projecting stud of cast steel, *F*. This is formed with a shoulder *F1* (see inset view), and is driven into the plate up to the shoulder, and the end riveted over in a countersink *G*. This stud fits into a hole in the face of the shoulder on the lathe mandrel, as shown in Fig. 2. To fit it, the hole for the reduced diameter of the pin is first drilled in the dividing plate, and then the plate is placed in position upon the mandrel nose and the hole in the mandrel is drilled using the plate as a templet, and the hole in the plate as a guide to the drill. The hole in the mandrel is then enlarged by a larger-sized drill to fit the full diameter of the locating stud *F*, and this hole should be deep enough to prevent the stud bottoming in it.

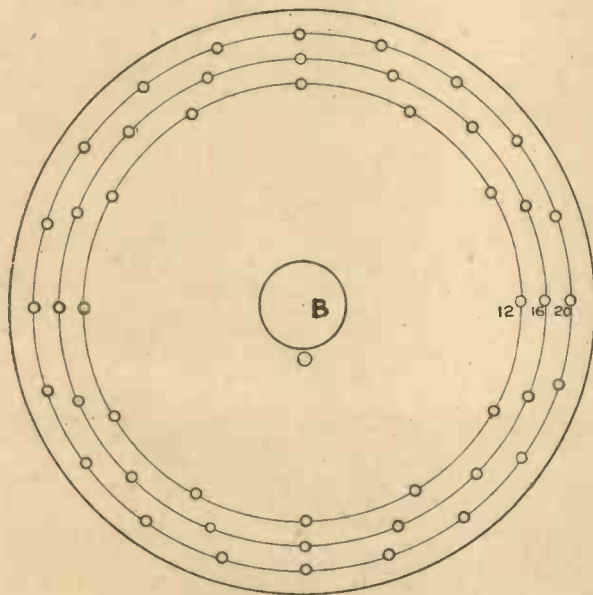

Fig. 1.—Details of the dividing plate.

The plate should be  $\frac{1}{4}$  in. or  $\frac{3}{8}$  in. thick, according to diameter. The latter should be as large as possible, providing it leaves space between its circumference and the bed of lathe to let the saddle come along full distance to the left.

### The Mandrel Attachment

The hole *B*, in the centre of the plate (Fig. 1) should be of a diameter exactly to fit the parallel portion of the lathe mandrel nose (*C*, Fig. 2) without shake. The mandrel is shown in part section in Fig. 2, so that the attachment can be seen. The plate *A* fits up close to the mandrel shoulder *D*, and it is held up by the carrier plate *E*, which is the usual fitting on the lathe. When the dividing

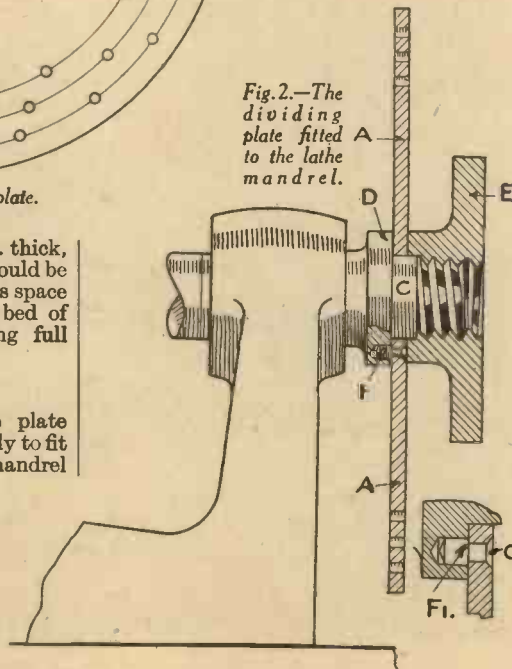
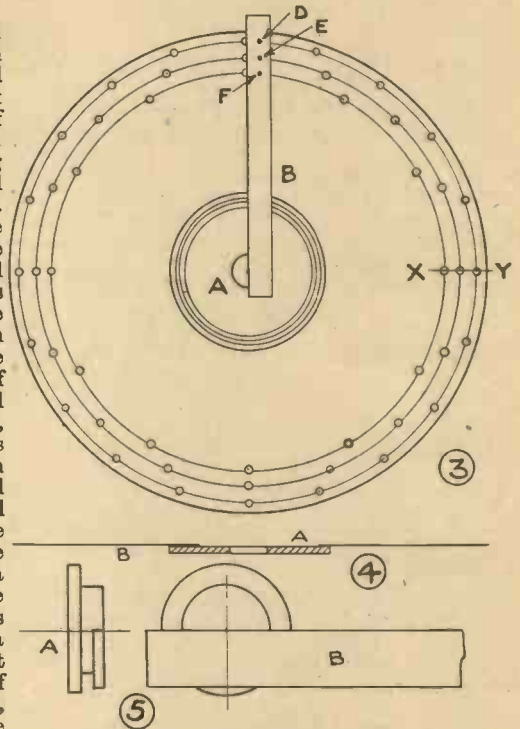

Fig. 2.—The dividing plate fitted to the lathe mandrel.

### Drilling the Plate

The plate *A* (Figs. 1 and 2) is bored out carefully under the drilling machine, or it can be screwed up to a face plate on the lathe mandrel and bored out. This may be the better way if it can be managed. The plate should be clamped to the face plate with packing behind the thickness of the lathe mandrel nose, so that the face plate, with the dividing plate, can be screwed off and offered up the other way round to see that it fits the parallel portion of the mandrel nose before taking it off the face plate. It is of the greatest importance that the plate should fit exactly on the parallel part *C* of the the mandrel nose.



Figs. 3 to 5.—Showing how to mark out the circles on the plate.

To divide the plate the following procedure should be followed.

The plate is fixed to the mandrel as it will be in use and, with a sharp V-tool, three (or more) rings are marked around it near the edge, as shown in Fig. 1. These circles should be very light but quite definite. It is on these circles that we are going to mark off our divisions 12-16-20 and so on. To do this with accuracy we lay out a much larger circle, say of sheet tin of good quality (Fig. 3), and we cut out a hole of a diameter just a little smaller than the diameter of our dividing plate. Then we sweat the tin plate to the face of the dividing plate, as shown in section in Fig. 4, where *A* is the dividing plate, and *B* is the tin plate. This tin plate should be cut round to a diameter of, say, 20 in. Then we fit a brass shouldered stud in the hole in the division plate so that it exactly fits it, and we cut a slot down the face of the stud and along half its diameter, and solder or sweat it to a straight edge for temporary use. The edge of the straight edge should come accurately across the centre of the stud as shown in Fig. 5, where *A* is a side view and *B* is a plan view of the straight edge. The stud is passed through from the underside of the division plate, and the straight edge sweated on above so that the straight edge can be rotated about the centre and will lie flat on the tin plate sheet. When we



have finished with it, it is unsoldered and removed, and the tin plate is unsoldered from the dividing plate.

Drilling three  $\frac{1}{8}$ -in. holes in the straight edge  $\frac{3}{8}$  in. apart (the nearest hole being  $9\frac{1}{2}$  in. from the stud which locates the straight edge), we can place a  $\frac{1}{8}$ -in. scribe in the holes and scribe three circles around the tin plate. These holes are shown at *D*, *E* and *F* in Fig. 3.

The tin-plate circles must be divided up with a pair of dividers, starting at the line *X*, *Y*. Great accuracy is essential, the dividers must be tight and have sharp points, and the divisions, as stepped round, should be accurately spaced on the eight scribed lines on the tin, be very lightly marked, and should finish again exactly on the line *X*, *Y*.

#### Reducing Error

The object of the big diameter marking is to reduce the amount of any error on the actual plate where the divisions will be much nearer together.

We can now use our straight edge for scribing fine radial lines which will pass exactly through the division lines on the large circles and across the small circles on the face of the actual division plate. The scribe should be sharp, hard, and have a long point. The straight edge should lie close to the surface and the line drawn close to the straight edge. In this way we can get a more accurate division than if we divided with the dividers directly on to the plate itself. Since our divisions are so

much wider, any slight inaccuracy at the big diameter will be reduced (in proportion) on the small plate.

At the points of intersection of the radial lines and the circles on the division plate fine centre-punch marks are made, taking care to mark only its proper divisions on each circle, since all the divisions will cross all the circles. It is best to mark alongside the intersections to be punched with a spot of red paint before punching.

Then with a very fine drill in the drill press and the plate held flat and square with the drill spindle the holes should be drilled very carefully, and of as small a diameter as can be handled accurately, i.e. without bending the drill and getting the hole out of square with the surface of the plate.

The holes should then be enlarged by a drill of a larger diameter to exactly  $\frac{1}{8}$  in.

diameter. Then the sharp corner at the front and back of the hole may be taken off (and only just taken off) with a rose countersink (not a flat countersink).

#### The Stop Spring

The stop pin and its spring support is shown in Fig. 6 at *A* and *B*. It is made of a fairly thick gauge spring steel  $\frac{3}{8}$  in. wide, and bent at right angles at the bottom and curved over into a ring at the top. At a distance equal to the height of the lathe centre above the bed, and measured from the bottom of the flat bent foot, a hole is drilled for the insertion of the pin *Z*. This pin has a shoulder at *P* and is riveted into the spring blade at the back. The forward end of the pin is made an accurate fit in the holes in the division plate. The spring should be such that the pin presses into the hole.

The device is screwed to the lathe bed by  $\frac{1}{8}$ -in. screws as shown, and may have to be set off slightly. To allow the pin to come in line with either of the three (or more) rows of holes, the spring is divided and hinged on the pivot *C*, so that the pin can be moved sideways. To keep it firm the two halves of the spring should normally be slightly curved against each other, and when the pivot-screw *C* is screwed up they will have enough friction upon each other to keep them firm. When not in use, the plate is removed from the mandrel, the spring stop from the lathe bed, and the holes for the two screws in the latter are filled with tallow to prevent grit getting in.

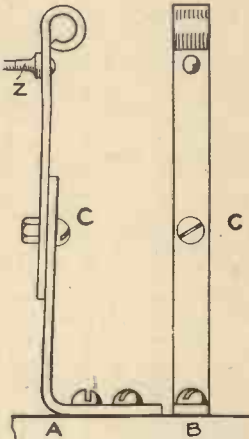

Fig. 6.—The stop pin and its spring support.

**W**HEN planning the new transmitting station for Northern Ireland, it was decided that the main supply of electrical energy should be drawn from the network of the public supply, and that a Diesel engine should be provided as a stand-by unit, in case of emergency such as a breakdown of the grid, which has occurred more than once in recent years. The Diesel engine finally selected was of Harland and Wolff's design and manufacture.

This engine is of the 4-stroke, trunk type, developing 570 B.H.P. at 330 revolutions per minute, and it is direct coupled to an alternator of 395 kW. of E.C.C. manufacture. The machine is of the 3-phase, 400-430 volts type, 50-cycles, complete with direct-coupled exciter.

The engine is of the totally-enclosed type as recently supplied for important stationary installations at home and abroad, and is in all essential respects similar to a large number which have been supplied for ship's auxiliary purposes on the larger types of passenger and cargo vessels.

#### Vibration and Noise

It will be appreciated that the power unit of a radio transmission station must, of necessity, reach a high standard in respect of the absence of vibration and noise, and these points were duly emphasised in the specification. In both respects the engine has given complete satisfaction to the B.B.C. Engineers.

Messrs. Harland and Wolff's contract also included the supply of accessories and piping, tanks, etc., some of which are described below. The engine jacket water is cooled by means of a Premier open type cooler, and the water is circulated by means of hot and cold motor-driven centrifugal pumps. Two fuel tanks of 40 tons each, arranged some distance from the building, have been supplied, and fuel is drawn from these by means of a motor-driven transfer pump to the 450 gallon fuel settling tank in the

### The B.B.C. Transmitting Station at Lisburn

engine house. From this tank the fuel gravitates to the centrifugal purifier, from which it is delivered to the 450 gallon clean oil tank and thence to a 125 gallon service tank in the engine room.

#### Starting the Engine

This is effected by compressed air at a

pressure of 360 lbs. per sq. inch, stored in a reservoir charged by means of a motor-driven Hamworthy compressor. The engine exhaust is led away overhead outside the building and downwards into a silencer, from which it is finally led to atmosphere by a vertical pipe a few feet higher than the roof. The complete equipment has been carried out on robust lines, with careful consideration to accessibility. The tests carried out on site under the supervision of the B.B.C. Engineers confirmed the low fuel consumption and close governing of the unit.

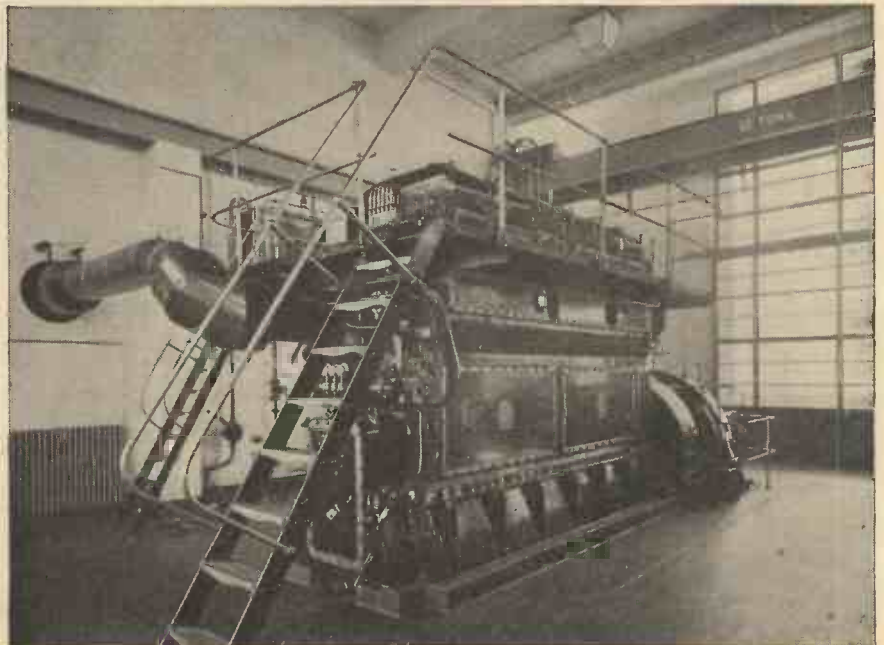

The Diesel engine installed at the transmitting station for Northern Ireland.



# MAKING A FULL-SIZE SAND YACHT

The Fine Sand Yacht illustrated below is Ideal for Use on the Sand. A Light Breeze will Operate it.

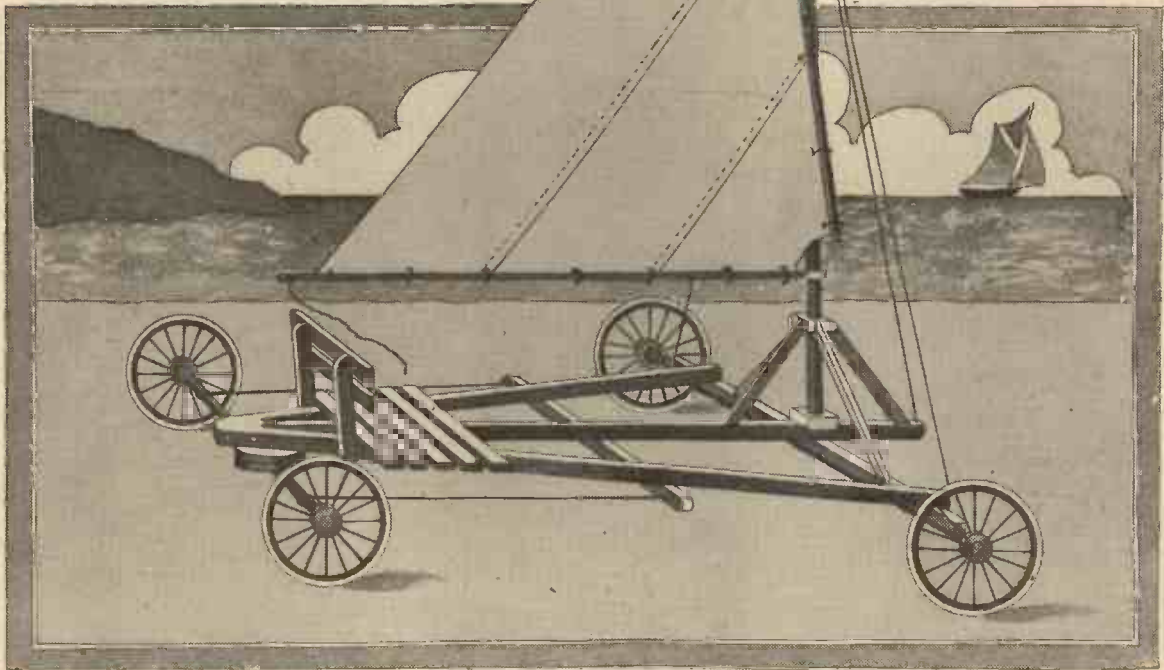

Fig. 1.—The finished sand yacht.

A SAND yacht is simple and inexpensive to build, and any amateur who is handy with tools will be able to make one without any trouble. Those living near or visiting the sea coast where there is a stretch of sands would be well repaid for building the yacht by the pleasure obtained from it, or those living inland will find it runs equally well on open moor or grassland. A single-seater yacht is illustrated, but it will be a very easy matter to increase the length and provide another seat, and also increase the sail area. The chassis, which is built of wood bolted together, is mounted on four wheels, the back pair are pivoted, and the yacht is steered with the feet, the footrest being also pivoted and attached to the back axle with two lengths of wire. The seat which is fitted over the back wheels is formed with battens nailed down to the chassis, and is provided with a backrest,

while the mast, which is fitted over the front wheels, drops into two blocks and is stayed with wires fitted between the top of the mast and the front and sides of the chassis. In a strong wind the yacht will be subject to some strain, and it is necessary to see that it is soundly built and that the material is free from knots.

### The Chassis

Figs. 2, 3, and 6 clearly show the chassis, and the method of its construction. Deal about 2 in. deep by 1½ in. thick in section will be quite suitable, the centre piece being 7 ft. long, two side pieces 6 ft. 2 in. long, and the head piece 3 ft. 6 in. long. The centre piece is first bolted to the head piece to stand exactly at right angles, while the side pieces are shaped to fit against the back end

of the centre piece, and are bolted to both the centre and head pieces.

A circular bearing measuring 8 in. diameter, and preferably of 1 in. hardwood, such as elm, is fixed under the back end of the chassis with the grain running from side to side. The blocks which carry the mast should also be of hardwood from 1 in. to 2 in. thick, the thicker the better.

### The Mast and Wheels

The mast may be of stout bamboo at least 6 ft. long, and holes are bored through the blocks to receive the mast. The bottom block is nailed or screwed to the centre piece of the chassis with the grain running from side to side, and the top block is supported and carried by four wooden stays of about 2 in. by 1 in. section fitted and nailed or screwed to the chassis and block.

Cycle or pram wheels not less than 1 ft.

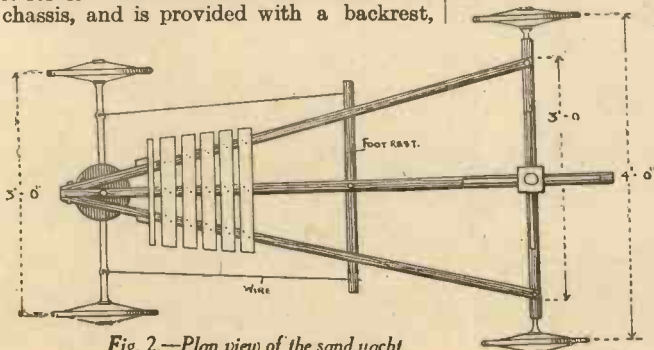

Fig. 2.—Plan view of the sand yacht.



Fig. 4.—Detail of the back axle.

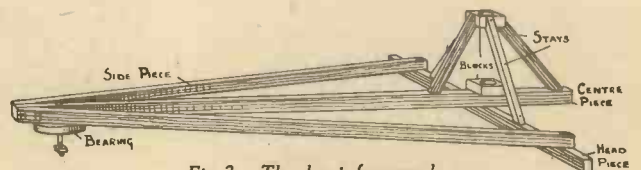

Fig. 3.—The chassis framework.

4 in. high should be used, and large tyres are desirable, as they will prevent the wheels from sinking in soft sand or soil. The front axle may be two arms bolted under the head piece, or in one length reaching from side to side. The back axle, which is shown in detail at Fig. 4, has a hardwood bearing similar to that which has been fitted to the chassis fixed to it with two bolts, and the axle is fitted with a long bolt which passes through the centre piece, the two hardwood bearings, and the axle itself. The bearings should be well greased.

**The Seat and Footrest**

Wedge-shaped blocks could be fitted over the side and centre pieces of the chassis to give a pitch to the seat, and the five battens which form it, and which are 1 ft. 6 in. long by 2 in. wide by 1 in. thick, are nailed or screwed over the blocks. The backrest is carried by two uprights 1 ft. 1 in. long by 2 in. wide by 1 in. thick, bolted to the side pieces of the chassis, and the rest is formed with two battens screwed to the uprights. The footrest is from 2 ft. 8 in. to 3 ft. long by 2 in. deep by 1½ in. thick, and is pivoted to the

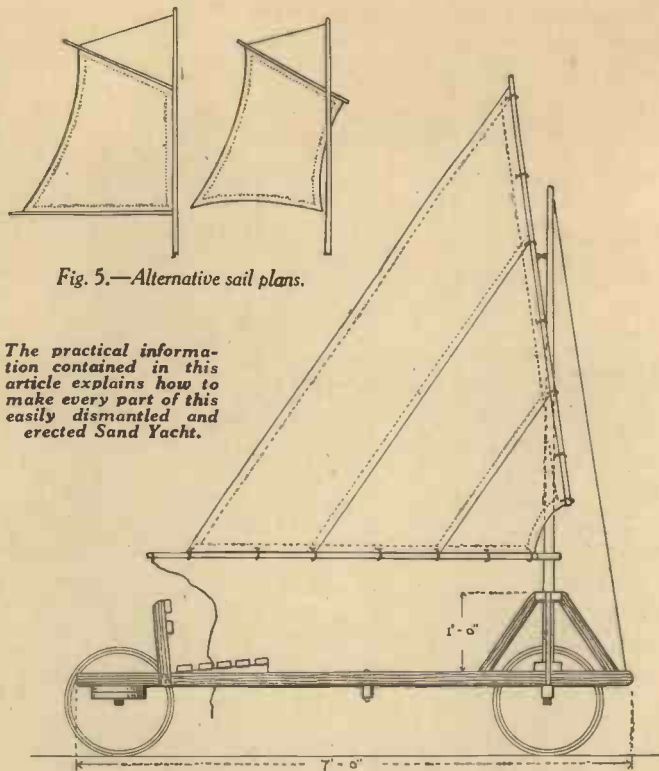

Fig. 5.—Alternative sail plans.

*The practical information contained in this article explains how to make every part of this easily dismantled and erected Sand Yacht.*

Fig. 6.—Side view of the sand yacht.

centre piece of the chassis with a bolt, a trial being made for the best individual position. It is then connected to the back axle with two stout wires, as shown in the plan, Fig. 2, holes being provided in the axle for this purpose.

**The Sail**

The type of sail shown in Fig. 1 is generally found to be most satisfactory, but either of those shown in Fig. 5 could be adopted if preferred. The material for the sail may be stout unbleached calico or light sail canvas. The sheets are lapped at least 1½ in. and double-stitched, and hems with thick cords inserted in them are turned around all the edges. The spar and boom may be of bamboo, and the sail is laced to them, eye-holes being provided in the hems of the latter for this purpose. The sail is hoisted with a pulley and rope fitted between the mast and spar, and, as before mentioned, the mast should be stayed to the chassis with wire guys.

On completion the yacht should be painted for the purpose of both preservation and appearance.

THE coil about to be described has the advantage of being simple to construct, is inexpensive, and has proved very efficient in use. Being comparatively small in size, makes it very suitable for use in model planes or speed boats where the space is somewhat limited. The magneto from which this coil was made, was of the "Blic" or "Dixie" type, and the armature is of the stationary pattern. Having obtained the magneto, the next stage is to carefully dismantle it, taking care not to damage the windings and insulation. The ends of the primary winding, that is the wires connected to the condenser having been unsoldered the armature core can be removed. If the revolving type of armature is used, it will be necessary to withdraw the ball-races and slip-ring. This exposes the screws securing the end pieces, and they can then be removed and the end pieces carefully levered off (see Fig. 1). It is as well to mention here that the ball-races are usually a tight fit, and if a drawer is not to hand, it is as well to borrow one, or failing this make one up as in Fig. 2. Having carefully removed the core, it will be seen that there are three wires for the connections. The thickest of these, that is the one that was connected to the slip-ring or high-tension distributor according to which type is being used, will be the spark plug connection, and the others will go to the battery and contact breaker respectively as illustrated in Fig. 3. A box will be required to enclose

**Constructing an Ignition Coil for Model Petrol Engines**

By H. W. ATTREE

the coil, not only to give a neat appearance, but to exclude moisture and prevent damage to the wires and insulation. This can be made from an old cigar box, the side pieces being neatly cut out and secured by small screws, cleaned up with sandpaper and then given a coat of varnish. Before the top is finally fixed, three terminals should be fitted and the connections soldered thereto. Wireless terminals are suitable for this purpose either the type with a knurled nut, or plug-in pattern; the latter are very convenient for easy attachment of the connections. To complete the job, it is as well to label the various

terminals to obviate confusion when connecting up to the engine and battery. If the coil is going to be used in a model aeroplane the wooden case could be dispensed with, also the terminals, and the connections extended and taken direct to the various points, thereby making a saving in weight. The coil described has worked well on 2, 4, or 6 volts, but was generally operated with a 4-volt hand-lamp battery and ran a 13 c.c. two-stroke engine up to 9,000 R.P.M. without difficulty, starting well at all times, which is largely due, no doubt, to the excellent spark at the plug.

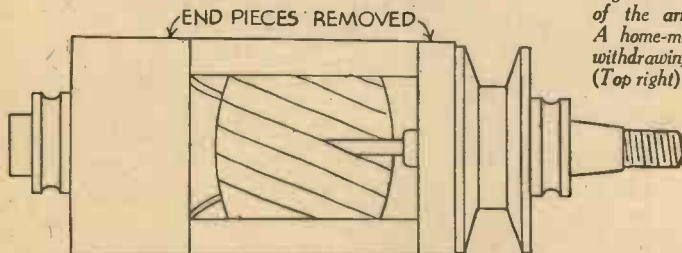

Figs. 1 to 3.—(Left) Details of the armature. (Right) A home-made drawer for withdrawing the ball-races. (Top right) The wiring plan.

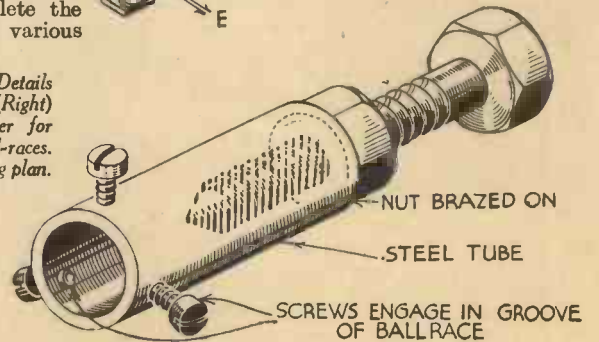
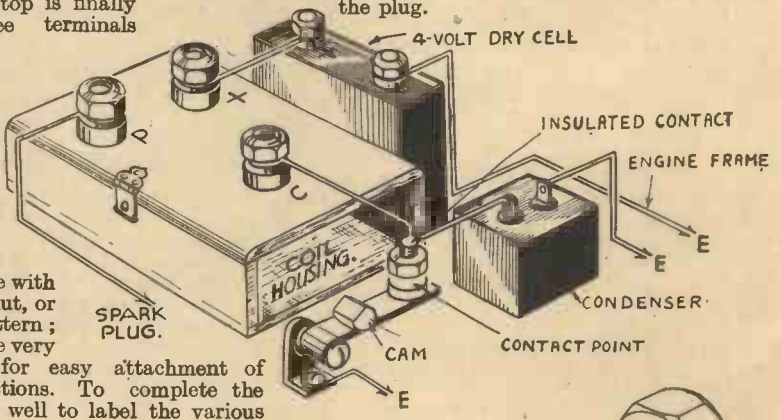



# Masters of Mechanics

## No. 13.—Gottlieb Daimler, the Pioneer of the Motor Car

**M**ARCH 17th, 1834, is an important date in the annals of motordom. For on it was born in the old-world and still semi-medieval village of Schörrndorf, in southern Germany, Gottlieb Daimler, the engineer, who, more than any other single individual, gave to the world the first practical petrol-driven motor car.

Daimler's life-history is no record of dazzling brilliance. True it is that the inventor was successful in most of his undertakings, yet the seeker after the sensational and what for some curious reason is termed the "romantic" in invention will look in vain for such characteristics in the career of

acquired a knowledge of precision tools and a habit of engineering accuracy which proved invaluable to him in after life and which, indeed, remained always with him.

Returning to Germany, young Daimler, after serving as foreman in one or two engineering works, became acquainted with Dr. Otto, the inventor of the four-stroke gas-engine. This was in the year 1863 and towards the end of the same year we find Gottlieb Daimler established as Otto's chief assistant, if not, indeed, as his engineering manager and right-hand man.

It is due to Daimler's inborn engineering gifts together with his practical training and experience that the now historic firm of Otto and Langen, gas-engine manufacturers, became so astonishingly successful. Daimler, however, at this period of his career, was content to remain in the background. Dr. Otto, the gas-engine theorist and his financial associate, Herr Langen, a wealthy Privy Councillor of Cologne, gathered all the honours which were showered upon the world's first successful gas-engines. Daimler did the work and he kept the Company organised and up to engineering "scratch."

### Manufacture of Gas-Engines

From Otto's early factory arose the *Gas*

*Motoren Fabrik*, a large gas-engine manufacturing concern of which Daimler became managing director. This Company let out its patents to the famous Crossley Brothers, of Manchester, in whose works Daimler showed a continual interest. Thus it was that British-built gas-engines, based upon the very latest designs of the Cologne factory of Otto and Langen, became known the world over and competed successfully with the German-produced engines.

In 1882 Daimler, who by this time had acquired a financial competence, announced his intention of retiring from active



Gottlieb Daimler.

participation in the *Gas Motoren Fabrik* and of devoting his leisure time to "a new hobby."

What this "new hobby" of Daimler's was the world soon knew. It was the designing and construction of a miniature gas-engine of the four-stroke type which, running on petrol vapour and air, would propel a light road-carriage and thus enable a road vehicle to travel along the roads just as a railway locomotive proceeded on its lines.

Daimler had a small workshop at Bad Cannstatt, near Stuttgart, in the Wurtemberg district of Southern Germany. In this experimental room after his retirement from the *Gas Motoren Fabrik* he spent most of his time attempting to produce the miniature petrol-engine which his mind had conceived.

Eventually, he met with his first success in the making of such engines, and in 1883 he obtained his first patent for a horizontal air-cooled gas-engine capable of being run on petroleum vapour.

### A Miniature Engine

Two years afterwards—in 1885—Daimler produced a much better miniature engine. It was of the single-cylinder



The first hooded car, the Daimler model of 1894. Its design marked an important advance in commercial car construction.

Daimler. Daimler's inventive success was due, mainly to his possession of a thorough grounding in the fundamental principles of engineering, to his practical skill in the machine shop, and, last but by no means least, to his keen preception of the enormous future possibility which awaited the coming of a petrol-driven light vehicle.

### His Early Life

Daimler was gifted mechanically. It is said that even when he was quite a small lad he could take a clock to pieces, repair it and reassemble the mechanism without any difficulty. During his school days, Daimler became keenly interested in the steam-engine and he determined to devote his life to steam engineering. At the age of nineteen he worked as an apprentice in an ammunition factory in Alsace, attending at regular intervals, the courses in engineering at the Polytechnic School at Stuttgart.

The next activity of the future inventor of the motor car was to go to England and to obtain a job at Manchester in the tool-making works of Joseph Whitworth & Co. Daimler remained in Whitworth's works for three years, and during his period there he



The first Daimler car, and, incidentally, the first four-wheeler. Constructed by Gottlieb Daimler in 1886. This photograph, taken some years after the construction of the car, shows Daimler in the rear seat. His son is at the tiller.



vertical type, and it was lighter and capable of running at a higher speed than any previous engine had done.

The year 1885 is really a memorable one, not only in the lifetime of Daimler, but also in the history of civilisation, for it saw the first attempts of Daimler to propel a road vehicle by means of his newly evolved petrol-engine.

Daimler's patent for his high-speed petrol-engine was granted on August 29th, 1885, and, on the following November 10th, we find the indefatigable inventor trying out in

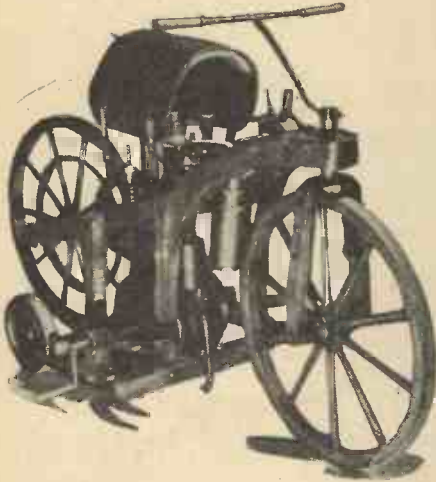

Daimler's "Motor Wheel." The world's first motor-propelled vehicle.

the streets of Bad Cannstatt a weird-looking contraption which he termed a "motor-wheel."

Opinions differ as to whether Daimler's "motor-wheel" ever successfully ran. There is no doubt, however, that it was made by Daimler's own hands and, more important still, that it constitutes the very first road-vehicle fitted with a petrol-engine. One and one only "motor-wheel" was made, for Daimler quickly lost his interest in the production of such crude cycle-like vehicles. Nevertheless, the vehicle was exhibited at the Paris Exhibition of 1889—more as a curiosity, perhaps, than anything else—and it was frequently on show in several of the German towns.

#### The "Motor-Wheel"

The photograph of this unique engineering "piece" accompanying this article shows the "motor-wheel" to comprise a vertical engine mounted in a low wooden cycle frame, the engine being started by means of a handle. As a matter of fact, the "motor-wheel" was not strictly a cycle, for, actually, it ran on four wheels. Two of these wheels, however, were nothing more than small stabilising wheels placed at opposite sides of the engine for the purpose of aiding the balance of the vehicle and counteracting to some extent the excessive vibration of the engine.

Whatever may be the precise truth concerning the working of Daimler's "motor-wheel" there is no doubt of the fact that it was not a success. Commercially, of course, it was never produced. As we have already remarked, Daimler lost interest in it. Other and greater plans for motor-propelled vehicles were in his mind.

In 1886, a German patent was granted to Gottlieb Daimler for a "wheeled vehicle to be propelled by a petrol motor and also an omnibus to run on rails with a motor placed in the centre of the omnibus."

Such, in the dry phraseology of the

German Patent Office, was the official but then unrecognised announcement of the birth of the motor car.

The world's first four-wheeled motor car was constructed by Daimler in 1886, soon after the granting of his master-patent. It contained a single-cylinder engine built in to a heavy wooden carriage which had been specially converted from a horse-drawn vehicle.

The first experimental trials of the new "horseless carriage" were made in the March of the following year. Little notice was taken of them. Daimler, perhaps, was regarded merely as a noisy nuisance and as an engineering fanatic, and certainly no dealer in horseflesh lost a wink of sleep over Daimler's novel creation.

#### A Tram-Vehicle

The motor-omnibus which is mentioned in Daimler's 1886 patent, underwent several elaborations and ultimately, but for only a short time, materialised as a miniature tram-vehicle running on a narrow-gauge line. It was shown at the International Exhibition held at Bremen, Germany, in 1889, where it attracted much attention. Motor cars, however, proved to be of more fundamental importance than motor tramways and it was to the production of the former vehicles that Daimler gave over the remainder of his life.

The first Daimler motor vehicle which proved to the world the vast possibilities inherent in the "horseless carriage" was the Daimler car of 1889. This had a twin-cylinder "V" engine—an utter novelty in those days—and its carriage-work was made lighter and improved in design. This vehicle was manufactured commercially in the new motor-vehicle works which Daimler founded, and its success, coupled with the slowly-increasing recognition of the petrol-propelled vehicle, led Daimler and his associates to produce still better vehicles.

It was at this period that Daimler busied himself with attempts at improving the carburetter, an invention of fundamental importance which he had made earlier on in his career.

Daimler's first carburetter was merely a metal chamber containing petrol across the surface of which air was sucked. Gradually, Daimler evolved a more satisfactory form of carburetter, having a petrol-saturated wick across which a current of air was drawn. Even this clumsy device proved more successful than the original forms of carburetter and nearly all of the earlier petrol-driven vehicles were equipped with some carburetter instrument of this type.

#### The 1894 Model

Perhaps the most radically improved of all Daimler's now historic cars was his 1894 model, which, in a way, was a masterpiece of invention. Quaint and almost fantastic as this vehicle appears to modern eyes, it nevertheless was considerably advanced in design, having electrical ignition, four-speed gear, hand-brake and various other "refinements." The electrical ignition, however, quickly gave way to the "hot-tube" type

of ignition (a red-hot platinum tube inserted into the cylinder wall, a small petrol lamp serving as the source of heat) it being found that the coil and battery type of electric ignition would not stand up to the jolting of the vehicle caused by its passing over the rough cobbled streets of the German towns.

The 1894 Daimler car developed some 6½ h.p. and it was sold to enthusiastic pioneers in considerable numbers.

This now-celebrated vehicle was, also, perhaps, the last of the Daimler models in which Daimler himself showed any overwhelming personal interest, for the great inventor was now ageing, and ill-health was beginning to assail him.

Daimler, however, had five sons and two of these—Paul and Adolf—carried on his pioneer work in the now rapidly expanding field of motor-vehicle design and production. The world was now becoming more and more motor-minded and Daimler père became increasingly content to relinquish his former multifarious activities and seek a well-earned rest in retirement and seclusion.

But Daimler's days were now well numbered. His ill-health increased and his life's end came on March 6th, 1900 at Bad Cannstatt, the town in which, fifteen years previously, he had built his first petrol-driven vehicle.

#### Daimler's Memory

To-day the grave of Gottlieb Daimler in the cemetery of Bad Cannstatt is honoured. Engineering organisations and various other learned Societies make pilgrimages to it and afterwards discourse ardently upon the pioneer engineering and inventive work of its occupant. The more ordinary mechanically minded individual, however, perpetuates the memory and tradition of Daimler in quite another way. In his interest for matters motoring he served in some small degree the same ends for which Daimler laboured. Therein lies the bond which, known or unknown, links up even the most humble of motor mechanics with the far-seeing and practical mind of Gottlieb Daimler, the world's pioneer master-mechanic of the motoring industry.

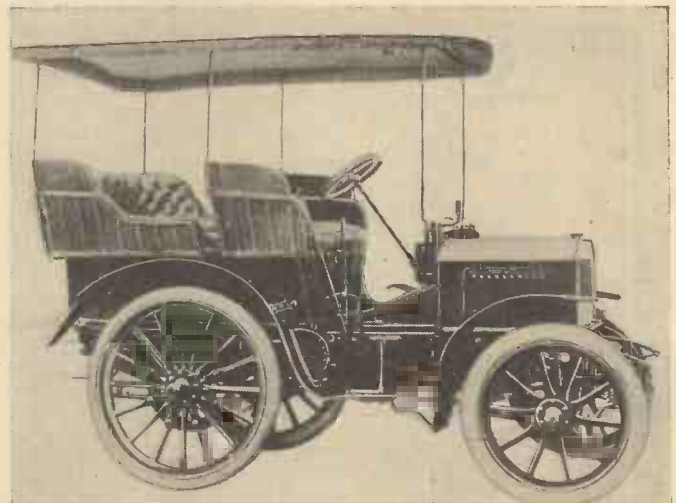

A later Daimler model, fitted with pneumatic tyres and wheel-steering.

This issue completes Volume 3. Binding cases and indexes are now ready. See page 661



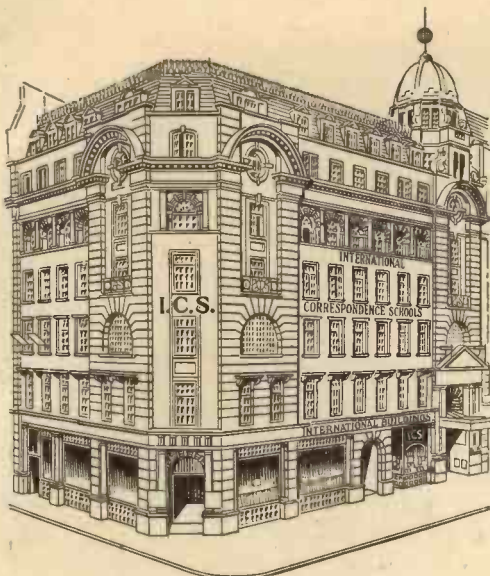

This is

**International Buildings**

Kingsway, London, Head Offices of the

**I. C. S.**

It is the centre from which radiates technical, commercial, and professional instruction that has been of great benefit to tens of thousands of ambitious people.

The I.C.S. is the greatest as well as the largest institution in the Empire devoted to spare-time training. Its prestige is unequalled. The Admiralty, Royal Air Force, Royal Army Service Corps, and other State Departments have entered into working arrangements with the I.C.S. for the training of men.

More than 1,000 I.C.S. text-books, prepared at International Buildings, are marvels of clearness, accuracy, and practical helpfulness.

There are 80 Instructors at Kingsway, many of them Associates, Members, or Fellows of their respective technical or professional bodies. All are specialists, and expert in giving the student individual attention throughout his Course of Study.

Among the 400 I.C.S. Courses there is one that can qualify YOU for Promotion and Better Pay.

# YOUR WORK AND YOUR PAY

The size of your salary is more or less in accordance with the measure of what you know and therefore can do. The more you know, the greater your pay.

Success—progress won by merit—depends on trained ability. Unless you have studied IN YOUR SPARE TIME, you have little chance of promotion, for knowledge that comes through everyday work is not enough.

You must know the principles underlying your work and be familiar with the many processes closely related to that work. *The one and only means of obtaining such knowledge is specialized study.*

No man need be without that extra efficiency which adds so much to his income, security and happiness. He can acquire it, on easy terms, by the simple I.C.S. method of teaching by post.

If you are in the early stages of your career and have not yet had a specialized training, you should start to get one without delay. Or perhaps you feel that your knowledge is a little out of date and ought to be modernized. In either case

**The International Correspondence Schools can help you.**

*Our expert advice on any matter concerning your work and your career is yours for the asking—free and without obligation. Let us send you a booklet dealing with the subject in which you are especially interested. It is packed with valuable information. All you have to do is mention your subject and, if you wish, tell us your problem or your difficulty. Write to us to-day or fill in and post the attached coupon. Your inquiry will be dealt with promptly. It may prove to be one of the most fortunate things you ever did.*

**COUPON FOR FREE BOOKLET**

**INTERNATIONAL CORRESPONDENCE SCHOOLS, LTD.; (Dept. 95), International Buildings, Kingsway, London, W.C.2**

Please send me your booklet containing full particulars of the Course of Correspondence Training before which I have marked **X**. I assume no obligation.

- |   |  |  |   |
|---|--|--|---|
| <input type="checkbox"/> Accountancy              | <input type="checkbox"/> Draughtsmanship           | <input type="checkbox"/> Mechanical Engineering      | <input type="checkbox"/> Surveying                    |
| <input type="checkbox"/> Advertising              | <input type="checkbox"/> Electrical Engineering    | <input type="checkbox"/> Mining Engineering          | <input type="checkbox"/> Telephone and Telegraph Eng. |
| <input type="checkbox"/> Aeronautical Engineering | <input type="checkbox"/> Engineering Shop Practice | <input type="checkbox"/> Motor Engineering           | <input type="checkbox"/> Textiles                     |
| <input type="checkbox"/> Air Conditioning         | <input type="checkbox"/> Fire Engineering          | <input type="checkbox"/> Pattern-making              | <input type="checkbox"/> Welding, Gas & Electric      |
| <input type="checkbox"/> Architecture             | <input type="checkbox"/> Garage Management         | <input type="checkbox"/> Plumbing                    | <input type="checkbox"/> Wireless Engineering         |
| <input type="checkbox"/> Boiler Engineering       | <input type="checkbox"/> Gas-Power Engineering     | <input type="checkbox"/> Radio Equipment & Servicing | <input type="checkbox"/> Woodworking                  |
| <input type="checkbox"/> Book-keeping             | <input type="checkbox"/> Heating & Ventilation     | <input type="checkbox"/> Sanitary Engineering        | <input type="checkbox"/> Works Management             |
| <input type="checkbox"/> Building                 | <input type="checkbox"/> Hydro-Electric            | <input type="checkbox"/> Scientific Management       |   |
| <input type="checkbox"/> Chemical Engineering     | <input type="checkbox"/> Marine Engineering        | <input type="checkbox"/> Sheet-Metal Working         |   |
| <input type="checkbox"/> Civil Engineering        | <input type="checkbox"/> Mechanical Drawing        | <input type="checkbox"/> Steam Engineering           |   |

**EXAMINATIONS**

Technical Institutions and Civil Service (G.P.O.). State which.....

NOTE.—If your subject is not on the above list, write it here .....

NAME..... AGE.....

ADDRESS.....

# FLYING MODELS! R.A.F. FIGHTERS REALLY TO SCALE

## BRISTOL BULLDOG

Wingspan 18 ins. Length 12½ ins. A most attractive kit which makes a model of great beauty and detail. Everything required is included: all balsa, tissue, printed insignia, wheels, cement, etc., etc., and clear plan which makes construction easy. Complete kit. (Right) Carriage paid .. **3/6**



## GLOSTER GAUNTLET

An exact ½-in. scale model. Wingspan 21 ins. Length 16½ ins. This model contains much fine detail and flies well. The kit is splendid value, and contains every item the constructor needs. Built by Comet's easy auto-line-up method. Clear full-size plan. Complete kit. (Left) Carriage paid .. **6/6**

## BRISTOL FIGHTER F2B

Wingspan 15 ins. Length 10 ins. A favourite Great War Plane. The model is a good flyer and a most faithful reproduction of the real plane. Wonderful value kit contains full-size plan, all balsa, tissue, wheels, insignia, cements, shaped flying prop, etc., etc. Moderately easy, but requires some experience. Complete kit. Carriage paid **2/-**



● Send 2 penny stamps for NEW catalogue showing many fine kits.

**SEND YOUR POSTAL ORDER NOW TO  
P. M. SWEETEN LTD.  
BANK HEY STREET  
BLACKPOOL**



Actual Photograph of Bond's British Permanent Way.

# THE CHEAPEST SUPER DETAIL PERMANENT WAY . . . .

IN ALL GAUGES  
FROM "OO" TO ¼"  
SCALE.

We illustrate above an ACTUAL PHOTOGRAPH of Bond's Super Detail Permanent Way; this is not an Artist's Impression, but a Photograph of the Model Rail and Chairs which Bond's supply. The Rail Sections faithfully reproduce the outline of the Full Size Rails, also the Model Chair—that of the Latest Standard Chair as standardised by the British Railway Companies.

If you want Super Detail for your Model Permanent Way, you can only get this with Bond's Super Detail Permanent Way Parts.

### PRICES STANDARD GAUGE "O" PARTS

Steel Rail, sheradised .. .. .	per yd. 2d., 1/6 doz. yds.
Brass Rail .. .. .	per yd. 4d., 3/9 doz. yds.
Cast Chairs, slide-on fit .. .. .	per 100 1/2.
Cast Chairs, for wooden keys .. .. .	per 100 1/2.
Keys .. .. .	per 100 6d.
Fishplates .. .. .	per doz. 3d.
Sleepers, stained correct colour .. .. .	per 100 2/-
Battens, ½" x 1" section .. .. .	per yd. 2d., 1/9 doz. yds.
Pins, approx. 1,000 .. .. .	6d. packet.
Track Gauge, special, with elec. chair jlg .. .. .	9d. each.

All Prices Plus Postage. For Prices of Gauge "OO," "1," ¼" Scale and ⅜" Scale, see General Catalogue, Price 6d. post free. It contains 180 pages, which illustrate all the requirements of the Model-maker, including a complete list of Tools and Materials.

**BOND'S O' EUSTON RD. LTD.**  
**254 EUSTON ROAD, LONDON, N.W.1**  
Telephone: Museum 7137      Established 1887

# LINDBERG 5 STAR KITS

\*\*\*\*\* KITS ARE THE LINDBERG DE LUXE LINE!



'BABY CYCLONE' PETROL ENGINES.

Send for List of Model Kits, Supplies and Engines.  
**NORTHERN MODEL AIRCRAFT COMPANY**  
(Dept. P.M.), 37a, FOUNTAIN STREET, MANCHESTER 2

HAWKER SUPER-FURY.  
Span 18½", Length 16".  
Weight 1½ ozs;  
Full of authentic detail. Working controls from cockpit. Metal covering from cockpit to spinner. Wheel pants, etc. Ready shaped Shock-absorbing Landing Gear. Complete with all dopes, etc. (Six bottles),  
Carr. paid (U.K.) **9/9** Overseas 2/6 Extra.  
Other 5 Star Kits:—  
MONOCOUBE .. 9/9  
RYAN S.T. .. 9/9  
BEECHCRAFT B.17L.  
DOUGLAS O.43.A.

# MSS VALUE KITS MSS

WE HAVE THE 'PICK' OF THE AMERICAN MARKETS

Kits and Supplies for all—Beginner or Expert Scale. Endurance and Petrol Fans. Of course all our Kits are complete, whether 2/- or 42/- they contain everything required—and everything means EVERYTHING. And they ALL fly, just arrived! Scientific "Miss America" 7-ft. GAS KIT. Price 45/-  
IMP KITS, 2/- 15-in. span, 5 models; 4/- 22-in. span, 6 models.  
SCIENTIFIC HI FLYERS - - - from 3/3 (20 in.) to 42/-  
BUNCH ENDURANCE - - - - - from 3/6 to 14/-  
IMP TORNADO MOTOR - - - - - 27/6 and 42/-  
BUNCH NEW "GWYN-AERO" PETROL MOTOR,  
6 cc. Complete, 87/6  
IMP "PAULOWNIA" Props and all Supplies at lowest prices.  
New Gas Model Accessories.

Send 2d. for 18-page Catalogue. Full of illustrations and useful hints.

**MODEL SUPPLY STORES**  
(Dept. P.M.), 46 Derby Road  
Prestwich, near Manchester



# BRITISH RECORDS held by models built with OUR MATERIALS

FUSELAGE MACHINES	
Rising off Ground .. .. .	9 mins. 50 secs.
Rising off Water .. .. .	1 min. 46 secs.
Hand Launched .. .. .	23 mins. 10 secs.

Our petrol engine model, "COMET," during 1935 entered 3 Competitions, won these awards:

- First Prize: B.M.A.S. Power Competition.
- First Prize: "Hallium" Power-Competition.
- Second Prize: S.M.A.E. Sir John Shelley Competition.

You can build this model, or the "Sky Rocket" which made the flight of 1935 (Cranborne to Isle of Wight: 35 miles!), from drawings or kits obtained from us.

The "COMET" 18-c.c. 2-stroke petrol engine is the finest on the market, its only fault being that it runs so well that a time switch is necessary if you don't want to lose your model!

Send 2d. stamp for lists, and become a satisfied customer of

**MODEL AIRCRAFT STORES**  
133 Richmond Park Road, BOURNEMOUTH

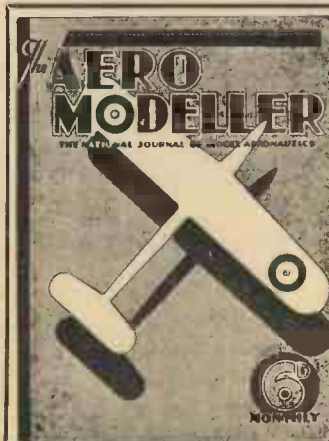

# The Leading Model Aviation Magazine

EVERY MONTH

- Models to Build
- News and Pictures
- Scale Plans
- Drawings
- Club Reports
- Authentic Articles
- Petrol Planes

From all Newsagents 6d. or The  
**Barron-Dean Publishing Co. LTD.**  
24-6 DEAN STREET, FETTER LANE, E.C.4.



# PETROL-DRIVEN LOW-WING MONOPLANE

*The Concluding Article on the Monocoque Fuselage Model*  
 By C. E. Bowden

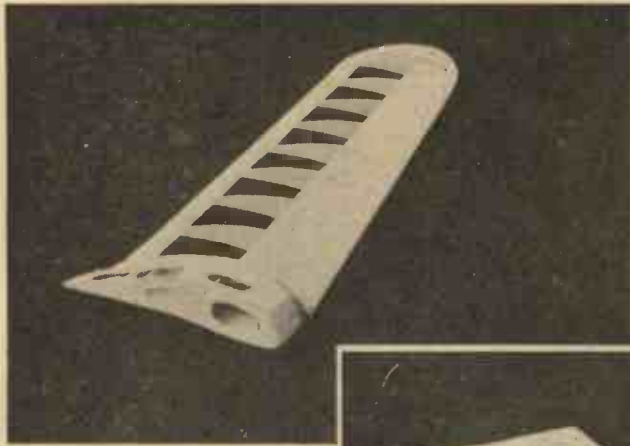

Fig. 17.—The left half of the wing uncovered. Notice the centre section and the sheet-balsa covered leading edge.

### The Engine and its Mounting

A PETROL model is not a success if it be a tractor model unless it has its engine so mounted that it can be knocked off in the event of a crash or bad landing. If this is not arranged for, damage will almost certainly follow, either to the fuselage or the engine.

On this model the Brown Junior engine is mounted on a cone of duralumin. The cone is hollow and has a backplate screwed into it. On the circular backplate, which by the way, is the same diameter as No. 1 former, there is a raised square of duralumin. This square fits into the square cut out from No. 1 former. The engine is therefore detachable in exactly the same way that the nosepiece of the normal rubber-driven model is detachable.

In this case there are two hooks on the outside circumference of the backplate of the cone mounting. There are also the two hooks of wire already mounted on the fuselage. Strong rubber bands wound between these hooks on either side of the fuselage keep the engine and its mounting hard up against the No. 1 nosepiece former, but it can be instantly detached by taking off the rubber bands, or it can be knocked out in the event of a crash. The rubber bands will obviously give before anything in the engine breaks.

### The Petrol Tank

It should be mentioned that the forward end of the duralumin cone is screwed into the crankcase of the Brown engine and kept from turning by a grub screw.

The Brown engine normally has the backplate of the crankcase screwed into the crankcase, so one merely has to take out this plate and screw in the cone. The cone is also used as a petrol tank which feeds to the special float-feed carburetter fitted.

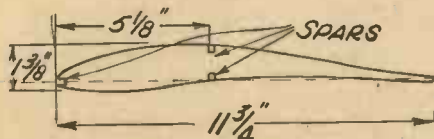

Fig. 20.—A Section of the tail plane at its largest rib.

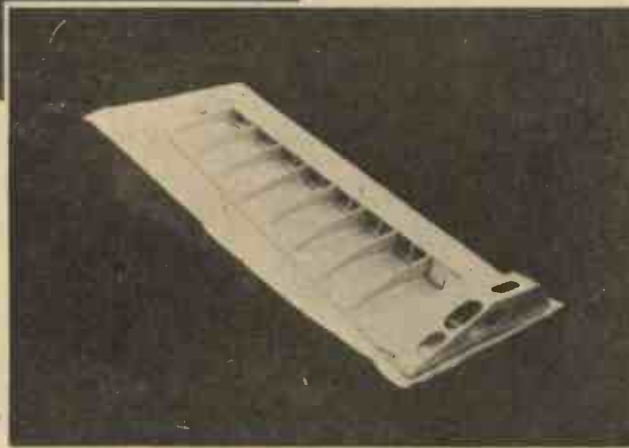

Fig. 18.—The right wing upon its bed on which it is constructed. Note centre section.

be in a position to make up this duralumin cone and may not have the facilities to get the work done. Then I suggest he does what I have done as an alternative method of mounting a Brown engine on a detachable mount. He should make up a pattern from 3-ply and send it to the Birmingham Aluminium Casting Co., Birmid Works, Smethwick, who will make him a few spare castings in *elektron* for a few shillings only. Thus he will always have spare engine mounts for other models.

*Elektron* is 40 per cent. lighter than normal aluminium alloy.

The pattern should be made up in the form of the bracket as shown in Fig. 21. The Brown engine and petrol tank can be kept in its normal upright position as received from the makers. It is merely bolted on to the casting. When making up the pattern from 1/4-in. thick 3-ply wood, glue can be used to make joints with a few very fine model aeroplane tacks. Make the pattern up to exactly fit the Brown engine and petrol-tank lugs and make the rear plate the exact size of No. 1 former with a raised square stuck on the back, so that there is a 1/4-in. deep square.

Do not let the thought of possible difficulties in connection with making a pattern deter you. This particular pattern is very simple indeed, and anyone should be able to make it who is capable of making a model aeroplane.

### The Tail Plane and Fin Unit

For this, Fig. 19 should be studied. A full-size drawing of the plan form of the tail plane should be made on paper and covered with greaseproof paper as in the case of the fuselage. The tail plane can then be built on a flat board. The tail plane has no hooks underneath, so that it can normally be kept on a flat board or floor when not in use, with weights on it so that it will not warp—an important point. It is kept in position on the model by elastic bands which pass over two small wooden pegs, 1/4 in. high, located on top of the leading edge and the width of the fuselage apart, whilst there are two similar pegs on top of



Fig. 19.—The tail plane and fin constructed as a unit.

the trailing edge to allow an elastic band to keep the rear of the tail down to the fuselage.

Two small pegs are also let into the fuselage and glued two or three inches in front of the leading edge of the tail plane and at the bottom of the fuselage. Thus the front elastic retaining bands are pulling the tail plane forward hard up against the fuselage where it drops down to the tail-plane platform.

The fin is built integral with the tail plane, and set exactly straight fore and aft, with the centre line of the fuselage.

The fin is composed of a 14 S.W.G. piano-wire outline. Balsa ribs of a streamline shape are inserted and stuck to the wire with aero glue. 1-m.m. thick balsa sheet is then used to fair the edges as shown in Fig. 19, which helps rigidity.

The tail plane itself is composed of balsa ribs and riblets. A 1/4-in. by 1/8-in. spruce leading edge is used. The same section spruce is used for the trailing edges. There are two main spars of 1/4-in. by 1/4-in. section in birch located one above the other. The tips of the tail plane are of 18 S.W.G. wire. Fig. 20 shows the section of the centre ribs. The tail plane, it will be observed from



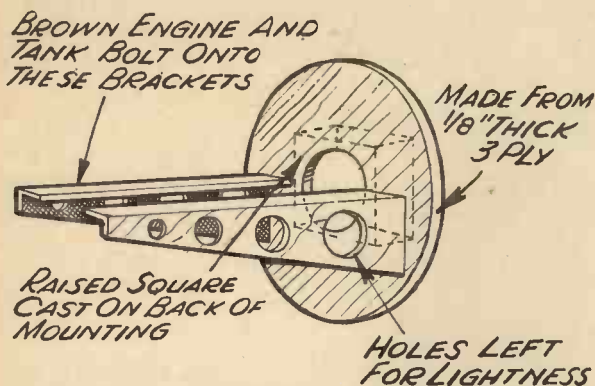

Fig. 21.—Alternative engine-mounting bracket. The method of constructing the pattern for casting.

Fig. 2 (June 1936 issue), is slightly tapered and it will also be noticed in Fig. 19 that the centre section and bottom of the fin are covered with 1-mm. thick balsa wood sheet. This adds to the rigid construction when the unit is covered and doped.

The whole tail plane and fin is then covered with damp Jap silk, doped with one coat of full-strength clean dope, and two of coloured dope. When covering the bottom of the tail plane the silk must be stitched to each rib in order to keep its slightly concave shape. The bottom should therefore be covered first. Kodak photopaste should be used to stick the silk down.

**The Main Plane**

This is made in two halves for the purpose of portability. Thus the 8-ft. span is divided into two 4-ft. lengths for the car or other means of transport (see Figs. 17 and 18).

It will be noticed that the plan form of the wing is a slight taper. The front elevation is also tapered, that is to say the centre is a thicker section than the tips. See Fig. 22 for wing sections. It has recently been found that highly tapered wings are unstable laterally, unless the tips are given a negative angle. On this model the slight taper has the same characteristics as a constant chord wing, i.e. the centre stalls first and the tips last. This is an important point for model work. It is therefore unnecessary to give the tips a negative angle on this model.

It will also be observed that the centre sections of the two half-wings are shaped to fit exactly into the cut-away portion of the fuselage, and the wing must take up the correct angle of incidence each time. The two half-wings butt up against each other. There are small 14 S.W.G. wire hooks located at leading edges, trailing edges, and at the bottom where the lower main spar is located. Thus the two halves, when erected, are bound to each other by means of these hooks and stout thread around the hooks. This thread is cut when the wing is taken apart.

The wing cannot part from the top because there are four large 14 S.W.G. piano-wire vertical hooks, two located along the leading edge at the width of the fuselage and two at the trailing edge at the width of the fuselage. Stout rubber bands are passed from these hooks to the vertical hooks that have already been fitted to the fuselage about half-way up. The upward tension on these hooks obviously tends to keep the top of the two wing halves

together, whilst the threaded hooks below keep the bottom together.

The advantage of this system is that there are no heavy stubs or pins that fit into each wing. They are unnecessary. Although the wing is perfectly rigid for flight, if the model should strike an unforeseen object the rubber bands almost invariably give without any damage being done to the wing.

The reader will see, by now that practically every component part of the model is detachable and held on by elastic bands. If these bands are arranged with just sufficient tension to keep the component parts rigid for flight, they will invariably give in the event of a possible crash. No end of irksome repairs are saved in this way.

The constructor should first of all make a full-sized plan drawing and front elevation drawing from the scale drawing, given earlier. It will then be a simple matter to make separate drawings of the intermediate ribs and riblets if the centre and largest rib are known and also the smallest rib. The heights of the intermediate ribs can be read off from the front elevation drawing. Fig. 19 shows the shape of the wing section and the dimensions of the largest and smallest rib.

Between the ribs there are riblets inserted. Thus we have the main ribs set  $4\frac{1}{8}$  in. apart, with a riblet spaced half-way between two main ribs. Refer again to Fig. 18 and you will just be able to see the rear of these riblets. It will also be observed that the two centre main ribs have  $\frac{1}{8}$ -in. thick balsa packing between the main spars. This is to form a sort of box girder.

The leading-edge spar is made from  $\frac{1}{8}$ -in. by  $\frac{1}{8}$ -in. spruce, and the trailing-edge spar is of a similar section spruce. The two main spars set one above the other (see Fig. 18) are of  $\frac{1}{8}$ -in. by  $\frac{1}{8}$ -in. birch.

The wing tips are made from 14 S.W.G. piano wire, bound at the ends to the leading and trailing edge by thread and glue. The tips have solid balsa wood inserts  $2\frac{1}{2}$  in. wide. These are glued into position and carved and sandpapered to a streamlined shape. They are very important as, besides looking well, they add enormously to the strength of the wings and prevent damage if a wing tip hits the ground during a cross-wind landing. They also prevent the dope distorting the wire tips (see Fig. 23).

I should have said that except for the two central ribs which are made from  $\frac{1}{8}$ -in thick

3-ply and fretted out for lightness, as can be seen in Fig. 18, all the rest of the ribs and riblets are made from  $\frac{1}{8}$ -in. thick balsa wood.

Having glued all the ribs into position with durofix glue, over the full-sized plan drawing, a strip of  $\frac{1}{8}$ -in. thick balsa wood and  $1\frac{1}{4}$  in. wide is glued under the trailing edge and the rear ends of the ribs. This gives strength to the trailing edge and weighs very little extra.

From the leading edge of the main spars sheet balsa wood  $\frac{1}{8}$ -in. thick is moulded round the wing both top and bottom. This gives a good "entry" to the wing and at the same time gives a sort of box girder effect and therefore great strength to the whole wing. This covering (see Fig. 17) is done with damp sheet balsa wood that has been soaked for a few minutes in hot water. It is then glued down to the ribs, and kept in position until dry by wrapping elastic around the wing.

The dihedral angle is placed into the wing halves where the No. 2 ribs are positioned. The main spars are steamed to the correct angles. In Fig. 18 the wooden bed or jig for

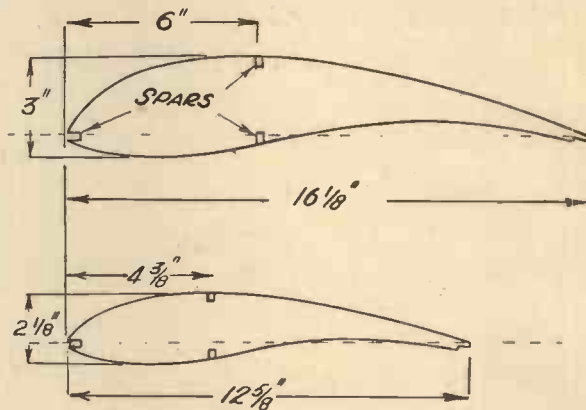

Fig. 22.—Section of main-plane ribs.

one half wing can just be seen with its paper plan on top and with the wing half on top of that. Now, having built the wing as described in its two halves, they should be covered with thin Jap silk. This must be well damped with water from a scent spray. The bottoms are covered first, and each rib has to be carefully stitched to the silk with thin thread. This is done to retain the highly concave shape under the wing. This shape is most important to retain. After this laborious job is completed the tops can be covered. Use photopaste as an adhesive. It is excellent, and far superior to any other adhesive when covering wings. If any mistake is made, the photopaste can be unstuck by application of water and the wrinkles smoothed out. Having covered the whole wing dope it with full-strength clear aeroplane dope, one coat. Let the wing halves set and dry on their beds with weights on them. This will prevent any warping of the wing whilst drying.

**The Control of Duration of Flight**

To my mind it is most essential to control the duration of flight of a petrol model, or damage will eventually be done to either the model or some unfortunate pedestrian.

It is difficult, however, to recommend the best method of control, owing to the fact that the reader may not consider himself sufficiently skilful with the alteration of a clock to tackle the same type of control I have fitted to the model under discussion.

A half-crown clock is taken out of its case and relieved of its escapement. Two

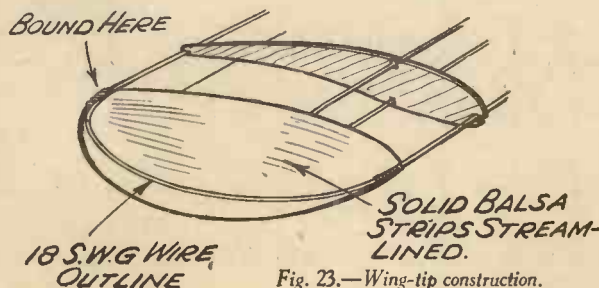

Fig. 23.—Wing-tip construction.



little air fans are soldered in position to act as an air brake and so regulate the speed at which the clock unwinds. The "innards" are then screwed on to a rectangular piece of 3-ply wood. Through this the main shaft of the clock protrudes and a pointer is soldered in position. A carefully graded "dial" is made on paper which is glued down to the 3-ply. This dial shows



Fig. 24.—The nose and fuselage, showing the cabin and dummy engine fairings to strengthen the nose where the low-wing "cutaway" is situated.

seconds run on its face, and is kept waterproof by covering with thin transparent celluloid. There are suitable electrical contacts on the 3-ply top as well, so that a small knife switch is broken by the pointer when it comes to zero. The two battery leads are connected to the knife switch. There is also a small brake lever which stops the pointer in any desired position that is set on the second time dial.

Thus, when ready for a flight the pointer is wound backwards by hand to the desired time for the flight, as shown on the dial. The brake is applied and the knife switch thrown into contact. Just as the model is released the brake lever is moved to "off" and the clock starts. When the pointer arrives at zero the knife switch is knocked open by the pointer and the ignition to the engine is switched off.

This clock device requires careful construction, and is fitted into a recess on the cabin, the construction of which will be explained under the next heading.

If the reader cannot undertake the construction of the clock he should use the simple device made from a photographic self-timer that I recently described in my small model biplane, "The Mouse," in PRACTICAL MECHANICS, January 1936. A copy of the back number should be obtained. This self-timer device is not so accurate, but serves its purpose provided the timing of the flight need not actually be made to within seconds. It is light and simple to construct.

#### Cabin and Fairings

In order to strengthen up the slender portion of the fuselage, where the cut-away portion for the low wing is located, a cabin and two dummy engine fairings made from solid blocks of balsa wood are fitted. These blocks of balsa wood, having been carved to shape and sandpapered, can then be hollowed out slightly with a gouge. They are then glued on to the top and sides of the fuselage forward, and then covered with silk and photopaste, doped and coloured. A recess is left in the top of the cabin to take the clock mechanism. It will be remembered that the battery wires from one side were brought up through the fuselage for the clock. It will be quite clear how to construct the shape of the cabin and

dummy engine fairings if the photographs of the nose of the model are studied (Fig. 24).

#### Flying Instructions

Throughout this article I have gone fairly deeply into the reasons why, etc., of the design, so that the constructor should be able to fly and build the model intelligently.

The best method I know of getting over the difficult and dangerous period of preliminary test flights is to first of all ensure that the model glides well and flat, by hand launching the model into a slight wind, and if the model is found nose heavy add a little weight to the tail. If it is tail heavy add a little weight to the nose. If the model obviously glides faster than it ought to, but glides fairly flat, then pack up the trailing edge of the tail plane a trifle only. If the model seems to be about correctly balanced by weight but tends to balloon up on the glide, then slightly pack up the leading edge of the tail plane. But it must be remembered that these tail alterations must be only very slight and the rest must be done on weight adjustment. Only experience will tell you just how much of each thing to do.

The design of the model described allows for the normal and correct incidences as shown in Fig. 2. Only slight alterations of the tail plane setting can be permitted, and if you have built the model correctly you will find that the C.G. comes out correctly. On the writer's model no alteration in weight distribution has been necessary. It

#### A NEW BOOK!

#### THE MODEL AIRCRAFT BOOK

By F. J. CANN

144 Large Pages, over 240 Illustrations,  
3s. 6d. net, by post, 4s. Contains In-  
structions for building petrol models and  
a Full-size Glider

was correctly calculated in the design. This comes to one by experience alone. The tail plane was found to require just a trifle of packing at the trailing edge. A strip of  $\frac{1}{8}$ -in. thick balsa made the model glide more slowly.

If the model glides correctly without the engine on and with the fin set straight as it should be, then a short power flight of ten seconds can be tried, and if the model will not take off with the engine *revving well*, then ease off the down thrust a degree or two by packing under the bottom of the detachable nosepiece. If, on the other hand, the nose goes up too much, give a shade more down thrust. If the model turns too quickly right or left give a shade of opposite thrust. The model should fly straight for the first twenty-five or thirty yards and then gently turn right-handed if the correct side thrust has been obtained. The angle of side thrust given in the sketch should about do the trick, but remember that your model may have a slight warp on one wing and this may necessitate an alteration of thrust line. But on no account must there be more than a *very slight* warp. If there is much and you take it up by altered thrust line to one side or the other, then when the power ceases the warped wing will take control and get the model into a bank and then a spin! Having got things going nicely on 10 seconds' flights, try 20 seconds and readjust slightly if necessary. After this, longer flights can be attempted.

It is dangerous to try flights that turn against torque. A slight turn with torque should be allowed.

The Brown Junior engine comes from the maker so that it runs anti-clockwise. It can be altered as explained in its instruction book to clockwise. I always alter mine to clockwise because I find it easier to swing the prop clockwise, as I am right-handed. Therefore the reader should remember that the offset of the thrust line that I have given for this model is for an engine revolving in a *clockwise* direction looking at the propeller from the front.

Try out your preliminary tests in very calm weather. The model described has been found to be exceptionally stable and a pleasantly slow flyer.

Remember the key to an undamaged model during its initial test flights is great patience in making the adjustments, which should only have to be very slight. Each flight being of a little longer duration as the owner gets the hang of his machine.



Fig. 25.—The model just taking off for a trial flight.



# THE HYDRAULIC RAM

By B. Joy.

The simplest—and one of the most interesting of Pumps.

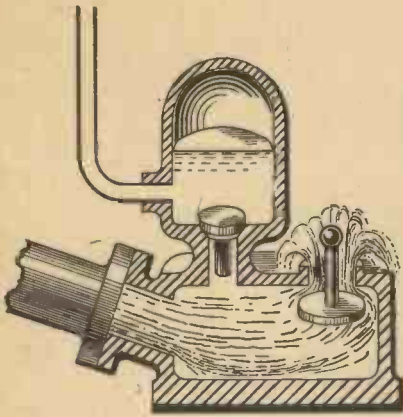

Fig. 1.—A section of a hydraulic ram showing part of the "drive" pipe and "dash" valve open.

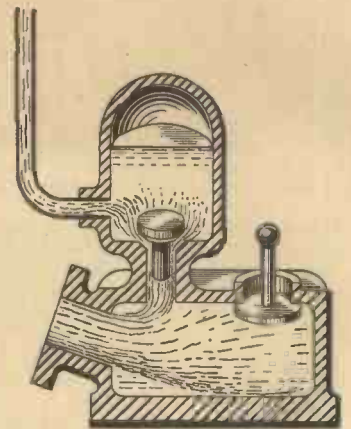

Fig. 2.—Showing the "dash" valve closed.

**M**OST people are acquainted with the rather objectionable noise generally known as "water-hammer." Occupiers of flats are particularly open to this annoyance—because, although the cause may be perfectly well known, no stop can be put to it save by the collaboration of some other adjacent flat occupier.

For example, "water-hammer" caused by a faulty tap in a ground floor flat may be just as unpleasant to an occupier of a top flat—indeed it may be more so. Now the principle which pertains to the wonderfully simple and regular action of the hydraulic ram is identical in every way with that which produces "water-hammer." Let us describe the action of the ram in full detail. Water flowing from a high level to a lower level is capable of exerting force. This fact has been made use of for many years—mainly by the adoption of the water-wheel. Such wheels have, of course, been applied to water raising—a force pump being driven from the shaft of the wheel. But as a simple means of *lifting* water by the force of *falling* water, the ram has no equal.

### Principle of Operation

Imagine a fairly copious supply of water flowing through a pipe of some considerable length to a discharge point, say, eight or ten feet lower in level. Now assume this flow of water to be *suddenly checked*—say by the closing of a valve—at the outlet end of the pipe. The water would have acquired a velocity in accordance with the difference of level causing the flow, and the result of the sudden checkage is a very *substantial rise of pressure* at the lower end of the pipe. The pressure rise indeed is sufficiently great to cause a *proportion* of the water to be forced up to a height many times greater than the original water level.

Thus, if a valve be opened and closed by hand under such conditions as have been described, a very simple water lifting device would be available—except that it would require the constant attention of a man or boy to operate the valve. It may seem a little surprising that actually no attendant is necessary, for the flow of water—which *closes* the valve under certain conditions—*opens* it again under certain other conditions.

Figs. 1 and 2 illustrate in a diagrammatic form sections of a hydraulic ram under some of the conditions above discussed.

A few details have been purposely simplified, or omitted, in order to render the operation of the machine clear. On the left-hand side of Fig. 1 is indicated a portion of the "drive" pipe conveying the water from the source of supply to the machine. This pipe may have a length of 30, 40 or

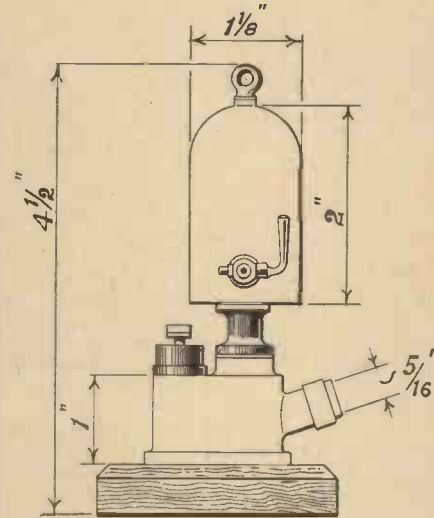

Fig. 3.—A detailed sketch showing the construction of a small hydraulic ram.

more feet. On the left-hand side of the same illustration is a delivery valve opening into an air-vessel, and from the air-vessel a rising main carries the water to a high-level tank. On the *right-hand* side of this figure is the "dash" valve—a valve of fairly large dimensions opening downwards, i.e. *towards* the direction of flow. The delivery valve is normally retained in a closed position by the pressure of water above it.

Referring again to Fig. 1 for the time being, water is presumed to be flowing along the "drive" pipe and discharging through the "dash" valve—which is open. When the flowing water has acquired a certain velocity it carries the valve with it on to its seat and sudden and complete closure of the outlet takes place. The whole of the energy of the water—with motion now checked—is converted into pressure sufficient to raise the delivery valve and pass water into the air-vessel. Conditions are now as shown by Fig. 2. The "dash" valve is closed, the delivery valve is open. The thrust of water into the air-vessel has brought about a balance of pressure, hence the delivery valve closes. Now occurs a somewhat unexpected event. The pipe-contained water having parted with most of its energy *rebounds*, much as will a steel bar if dropped endwise upon a hard floor. The rebound or "reflux" action is due partly to slight elasticity in the water itself, and partly to some elasticity of the walls of the retaining chamber. Whatever the cause, the re-flow of the water is sufficient to *drag open* the "dash" valve, through which the water once more

flows. And so the cycle of operations is repeated.

The speed of the machine, i.e. the number of openings and closings of the "dash" valve depends principally upon the *length* of the "drive" pipe, but upon other matters as well. The longer the drive pipe, the fewer the pulsations. On the other hand, the longer the drive pipe the greater the *pressure* when the water flow is checked.

### The Air-vessel

The air-vessel is a most important part of this machine, for by its aid the water in the rising main is kept moving continuously—instead of having to be put in motion every time the delivery valve opens. However, air-vessels that are constantly under pressure subsequently lose their efficiency. The air is slowly absorbed by the water. A number of ingenious little devices have been used to automatically make up for the air absorbed. The simplest consists merely of a minute hole drilled in the neck of the air-vessel immediately beneath the delivery valve. On the rebound of the water a little air is drawn in through the hole and on the next closing of the "dash" valve this air is forced past the delivery valve into the air-vessel.

"Dash" valves of many shapes and kinds have been used in the hydraulic ram. Some quite simple and direct, somewhat as suggested in the illustration, and others composed mainly, or entirely, of rubber. One ram uses a hinged door as a valve, while another has a series of large rubber "bands" surrounding a concave-sided hollow and perforated outlet. Sometimes an adjustable weight—with or without lever—is fitted for the main purpose of timing the closing of the valve.

With all its simplicity and economy—where a suitable water supply is available—the ram has one failing. It is a very noisy machine. The hammer blow delivered by the water when its free flow is suddenly checked, gives forth a noise which can be heard a great distance away. Like most mechanical noises—however caused—complete cure is difficult.

To the model-maker, the hydraulic ram is an easy piece of construction. The small ram illustrated in Fig. 3 was made by the writer without the use of special patterns or castings. This little machine worked exceedingly well, sometimes with a drive pipe about three feet in length only, and sometimes with a coiled pipe about three times this length. In operating such small models, copper, brass, "compo," or iron pipes may be used. If operated from a house-tap supply the water must first be run into a small tank.



# WORKSHOP SHAFTING

**I**n small workshops it is often desirable to rig up a line of shafting for driving two or three machine tools from a gas or oil engine, or an electric motor. The following method of constructing very efficient units for this job will save expense, since it is cheaper than buying cast-iron hangers or brackets, and the universal adjustment of the units provided makes them applicable

## Efficient Shafting for Driving two or three Machine Tools from an Electric Motor, etc.

to hold the bracket by light friction, and the block is fitted after with the remaining bolt or screw tightened up hard to ensure that the bracket does not move.

The bearing is a plain long hard brass or gun-metal casting turned and faced as shown in Fig. 2. It is bored out to the size of the shafting, which, for a small workshop, may be 1 in. in diameter. It is parallel at each end and  $1\frac{1}{2}$  in. in diameter and at the centre it is spherical-shaped, the maximum diameter being 2 in., as shown. This central spherical portion is important since it gives the bearing its location and allows of angular movement for lining-up, around the centre of the sphere at A.

### Details of the Strap

It is held to the bracket top plate B (Fig. 1) by a strap G, made of the same stock as at A in Fig. 3 to locate the spherical part of the bearing, but in this case the weight is taken by a recessed block which lies at the side of the strap—now the bottom. The adjustment of the bearing vertically is made by the slots in the depending member B of the hanger, and, when the final adjustment of the shaft horizontally has been made, there is inserted hard wood or metal blocks at D and E to ensure against

the bracket. These slots are  $\frac{3}{8}$ -in. wide full.

A sectional view of the strap G is shown separately in Fig. 3, and it will be seen that at A there is a spherical-shaped recess to correspond with the spherical portion on the journal bearing. The position of the spherical part of the bearing in this recess is shown in the strap section, and it will be seen that the length of one of the legs of the strap is not long enough to allow both straps to reach the bracket top. The result is that before the strap is tightened the bearing can take its own position and automatically locate itself; while tightening of the strap fixes it.

If the gap at Fig. 3 is  $\frac{1}{4}$  in. wide when one leg of the strap is bolted down, there will be enough spring in the top of the strap where it fits across the spherical part of the bearing to allow it to pull down in close contact with the top plate of the bracket holding the bearing firmly, the bottom of the spherical part of the bearing resting on the taper recessed block H made of  $\frac{3}{8}$ -in. plate on the top surface of the bracket.

### The Hanger

In Fig. 5 a hanger is shown. It is constructed on the same principles as the bracket shown in Fig. 1. The strap A is made exactly like strap G in the case of the bracket, and of the same dimensions and the same stock. There is the same recess as at A in Fig. 3 to locate the spherical part of the bearing, but in this case the weight is taken by a recessed block which lies at the side of the strap—now the bottom. The adjustment of the bearing vertically is made by the slots in the depending member B of the hanger, and, when the final adjustment of the shaft horizontally has been made, there is inserted hard wood or metal blocks at D and E to ensure against

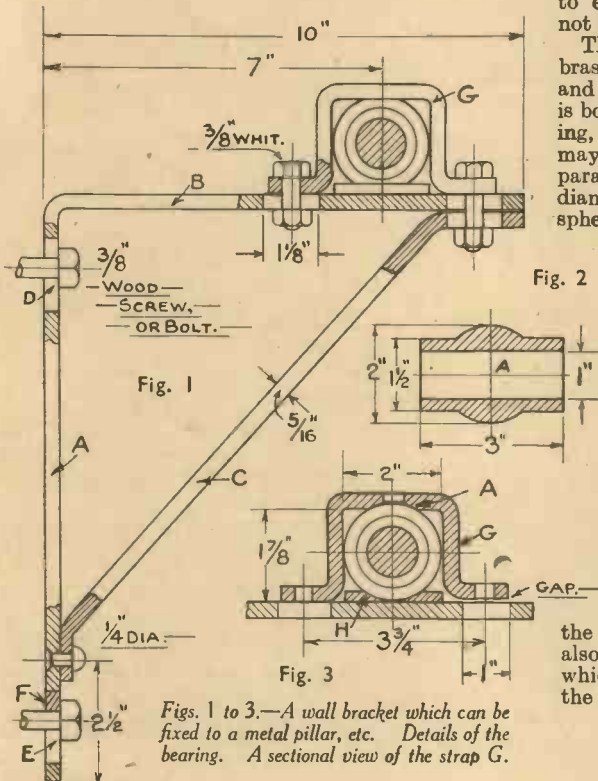

Figs. 1 to 3.—A wall bracket which can be fixed to a metal pillar, etc. Details of the bearing. A sectional view of the strap G.

in any position without extreme accuracy as to fixing of the brackets or hangers themselves. They allow for a wide range of adjustment after the actual brackets or hangers are bolted to walls, ceilings, or beams.

Fig. 1, shows a wall bracket which can, of course, be fixed to a metal pillar, stanchion, or post. The whole is made of  $1\frac{1}{2}$ -in. by  $\frac{3}{8}$ -in. flat iron bar, and the main bracket consists of a back and top plate A and B bent to a right angle, and a front strut C. The strut is attached to the ends of the back and top as shown.

### Adjusting Slots

The back plate has two slots D and E, by means of which it can be bolted (or screwed with coach screws) to the wall or other support. These slots allow of an adjustment of the bracket vertically within the range of the slots—i.e. the length of the slots less the diameter of the bolt or coach screw.

To prevent the bracket slipping should the holding bolt become loose, there is fitted a hardwood block F in the bottom slot E and between the top of the slot and bolt as shown. This block is fitted after the shaft has been aligned up; the nut or coach screw being removed, the bracket held up by the top fixing, and the block inserted and the nut, or coach screw, replaced.

Until the shaft is aligned horizontally, the fixing screws or nuts are only tightened

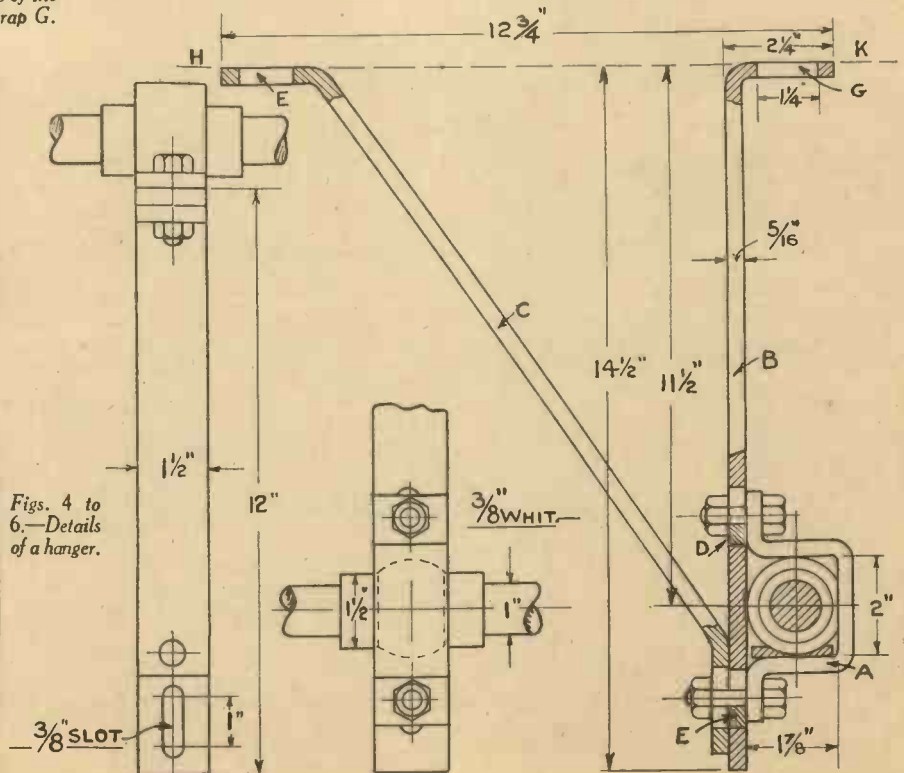

Figs. 4 to 6.—Details of a hanger.

# NEW LINES AND NEW LISTS

**CLIX**

**Now Ready for you**

Two entirely revised two-colour folders, in which new lines are illustrated and described in addition to the large range of perfect contact components for which Clix are renowned, are yours for a post-card request. Please ask for Folders "P.M."

**COMPONENTS FOR PERFECT CONTACT**

**STAND 82 RADIOLYMPIA**

# CLIX

**LECTRO LINX LIMITED**  
79a Rochester Row, London, S.W.1

the slight drop of the bearing should the nuts and bolts get loose.

### Longitudinal Adjustment

The longitudinal adjustment is made by slots *F* and *G* at the top ends of the depending member *B* and the strut *C* by means of the 1½-in. long slots by which it is bolted up.

It may be bolted up to a girder by a plate along the dotted line, *H-K* and a similar plate on the top of the girder, or it may be bolted or screwed up to a beam if the beam runs at right angles to the shafting, or to a thick board nailed or screwed up to two adjacent beams or floor joists.

In the case of both the bracket (Fig. 1) or the hanger (Fig. 5), the metal should be mild steel or good iron. The bends should be made with the metal red hot, and should not be sharper than the shapes shown on the drawings.

Holes for lubrication should be drilled each side of the spherical portion of the bearing bars (Fig. 2).

## Items of Interest

### The "Detectaray"

A PHOTO-ELECTRIC cell which has been recently placed on the market at the moderate cost of 5s. will undoubtedly appeal to those experimenters interested in such devices. The "Detectaray," as it is called, is extremely sensitive to the smallest variations in the colour or intensity of light. The current which is passed by the cell is so small that only very delicate instruments can successfully measure it, but by magnifying this current by means of a valve amplifier, quite large currents are available. In appearance the device is not unlike an ordinary two-pin electric plug. This shape was decided upon for easy methods of fitting; the inner portion of it contains a former treated with special chemicals, the connections being made at the plug pin points. The photo-electric cell also makes possible the automatic control of electric currents by variations of light.

### Lead-headed Wall Nails

IDEAL for holding all kinds of electrical and wireless leads, the nails shown below are fitted with lead heads. They will also prove ideal for holding rambling plants in position. The heads of the shanks project through the lead to receive hammer blows. A box containing twenty nails is obtainable for 9d. post free.

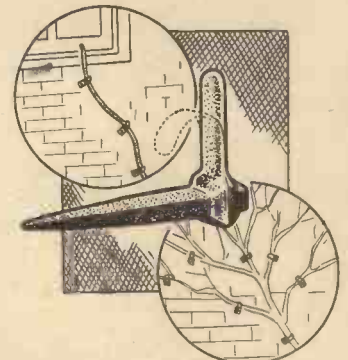

Lead-headed nails which can be put to a variety of uses.

## ELECTRADIX BARGAINS

**THE SUPERSEDER L.T. 2-V.** battery, rectified and smoothed, three tappings, lasts indefinitely. A boon. List 23 15s. New, guaranteed, 37/6.

**NEW STOCK OF CHARGERS.** H.T. & L.T., off A.C. Mains for 2 to 80 Cells. Certain money spinners at bargain prices. All sizes. State wants.

**EDISON STEEL CELLS.** We have some of these high-capacity discharge cells cheap up to 400 ampere hours.

**COIL TURN COUNTERS,** for checking the number of turns up to 9,999 on dial, soiled, 1/3 each.

**MOTOR INTERRUPTERS,** for converting any volts, D.C. to A.C., takes 12 V., 15/-.

**X-RAY TUBES.** Brand new, 7 bulb, 10/- each, packing and carriage 6/- extra.

**FLUORESCENT SCREENS,** Plate Holders 10 ins. and 15 ins., Coils cheap.

**VACUO RESISTERS,** wire ends, suitable where a 1-watt resistance is specified. 250,000 ohms, ½ meg., 1 meg., 2 meg. value in ohms, dd. each. Wire-wound 5 ohms strip, 6d.; 10 ohms, 7d.; 200 ohms, 1/-; Mica, 35 W., 150 ohms, 2/6.

A wonderful selection in our latest List 'P.M.', free for p.c.

**WESTON TABLE TEST SETS** in unused condition. Model 301, Moving Coil Weston Voltmeter 0-30, mounted flush in ebonite panel on table brackets, space at back for cell, five terminals and test key. Three Guinea Bargain at 18/6 to clear; limited number.

**TELEPHONES.** The cheapest tester is a pair of 2/9 Sullivan phones and a 6d. cell for any circuit. For short-wave sets Western Electric 2,000 ohms, 4/3 pair. Ericsson 4/6.

**CRYSTAL SETS** (for crystal-pure reception). Table type "A," 7/6. Double circuit type "B," 10/6.

**HOME RECORDING.** New Tracker Sets, geared drive with Cutter Head, Diamond Needle and Blanks. Bradford, 37/6; Felph, 27/6. Spare blanks, 4/- doz. Electric Gramo. Motors, powerful Panatone, 23 10s. Small types: Blue Flyer, 50/-; Facent, 45/-; H.M. Victor, 35/-.

**35 mm. FILM PROJECTORS.** "Williamson" & "Cine Chrome," with Lenses, etc., and Spools, Arc and Lantern, on floor pedestal, motor drive, 26 5s.

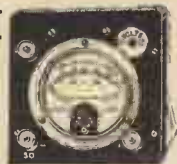

**ELECTRADIX RADIOS** 218 Upper Thames St., London, E.C.4

Telephone: Central 4611



## The PRACTICAL MECHANICS

# WIRELESS EXPERIMENTER

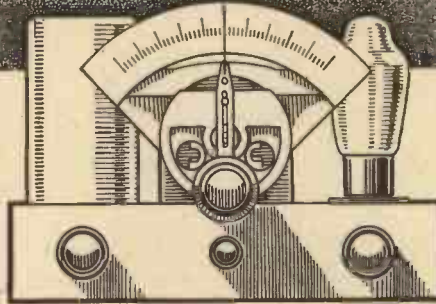

### THE "GNAT" MIDGET PORTABLE

An Ideal Lightweight Portable Receiver Suitable for Picnics, etc.

THE constructor will be pleased to note that the "Gnat" Midget Portable is built up on an aluminium chassis, and this may be obtained, ready drilled, from Messrs. Peto-Scott. Thus, the actual construction may be carried out simply with the aid of a pair of pliers and a screwdriver. On the grounds of simplicity this is a very important point, and although it should not be found a difficult task to drill a few holes in a chassis there are many constructors who will prefer to avoid this part of receiver construction on the grounds that it is uninteresting.

When the chassis and all the components have been obtained, the coil unit, the valve holders, and the three condensers must be mounted, and in this connection one or two precautions are to be observed. When placing the valve holders in position note carefully, in addition to the relative positions of the four- and five-pin holders, the positions of the large sockets on the holders. These are clearly indicated on the wiring plan by a heavier line and, when correctly placed, they should be attached by means of short bolts and nuts. Next, the three condensers which are attached to the front of the chassis are provided with connecting tags at the edges, and these may be turned down when received. Before fixing the condensers, bend these tags up and over the ends of the condenser so that there will be no risk of short-circuits against the metal surface of the chassis.

#### A Word of Warning

It is important here to reiterate our warning against a departure from the specified components. The condenser in the centre of the chassis edge,  $C_3$  on the wiring plan, is employed for reaction control, and an

examination of the circuit will show that this is actually inserted between H.T. positive and H.T. negative. The H.T. positive line is connected, via  $R_2$ , to the moving vanes of the condenser, and in many components these vanes are electrically connected to the control spindle. The mounting bush is in contact with the spindle, and thus when mounted on a metal chassis the moving vanes will be in contact with the chassis. This is connected to H.T. negative and, therefore, in the ordinary way, the H.T. supply would be short-circuited. The component specified for  $C_3$  is, however, of the type having the control spindle insu-

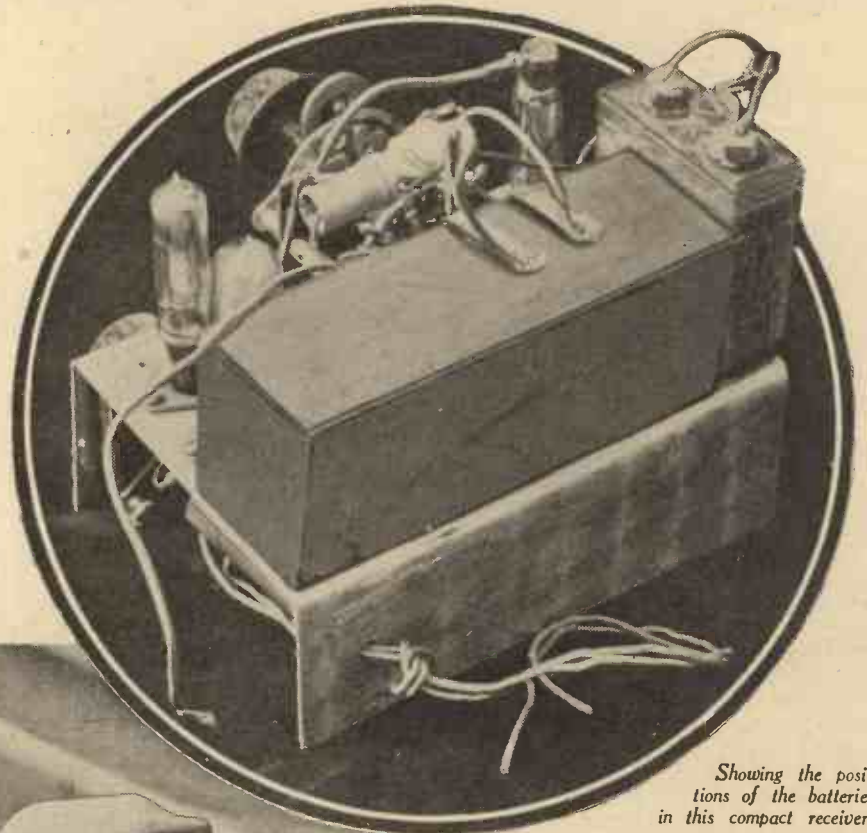

Showing the positions of the batteries in this compact receiver.



The "Gnat" is ideal for motorists, hikers, cyclists, campers—in fact, for all who follow outdoor pastimes.

lated from the moving vanes, and thus no special precautions are required, and the condenser may be mounted direct on the chassis. The two remaining condensers,  $C_1$  and  $C_2$ , have their moving vanes connected to earth, and this is carried out through the contact of the spindle and mounting bush, and thus no connection is shown to these points in the wiring plan.

#### The Coil Unit

The coil unit is provided, when supplied by the makers, with a number of coloured leads, and before mounting this on the necessary bracket it would be advisable to check the positions of the various leads and colours with the soldering lugs as shown on the wiring plan. Should there be any dis-



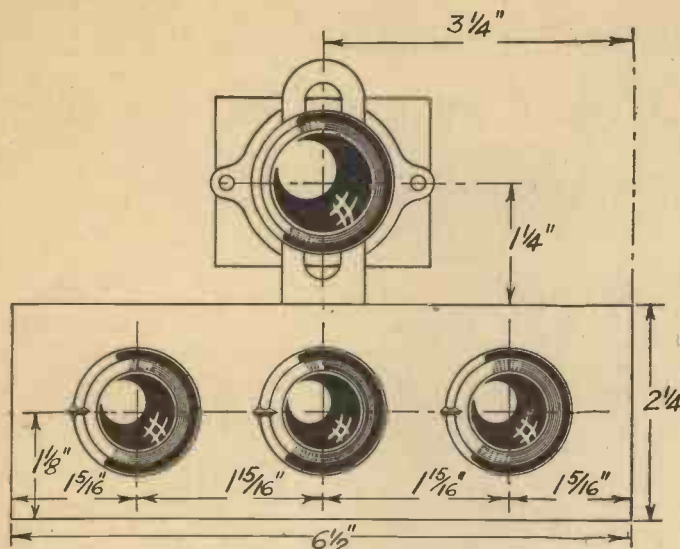

The front of chassis lay-out.

crepancy, the colours should be changed round so that they agree with the wiring plan, and thus at any future date, should it be necessary to make a check, the wiring plan will hold good. Before mounting the coil unit bare the end of the blue lead and solder this to the tag to which the black lead is attached, and to this same tag solder a length of ordinary flex for the H.T. negative connection. A length of ordinary connecting wire should then be joined to the same tag, and this should be connected to the top left-hand tag as shown in the wiring plan. Three additional lengths of flex are now connected to various tags on the coil unit for subsequent connection to L.T. negative, H.T. positive, and C<sub>2</sub> (the latter lead being marked "A" on the wiring plan). Now bolt down the mounting bracket and lock the coil unit into position, taking care not to damage the coil windings when handling it. Three of the coloured leads are passed through holes in the chassis, whilst the remaining leads are connected as shown in the wiring plan. It will be seen that the black lead is connected to the metal chassis, and as this is a common return for the H.T. negative feed and earth a good sound connection must be made, preferably by passing a bolt through a hole

in the chassis and anchoring the lead between a large washer and the surface of the chassis. Before making this connection clean the chassis round the hole to remove any grease which may be present and, if possible, well solder the end of the flexible lead to avoid poor contact due to fracture of the fine strands of wire or imperfect contact due to the flex "spreading" when the nut is tightened.

**Wiring**

Connection between the various parts should be carried out with the usual type of connecting wire

THE TOP AND UNDERNEATH CHASSIS WIRING PLAN OF THE "GNAT" MIDGET PORTABLE

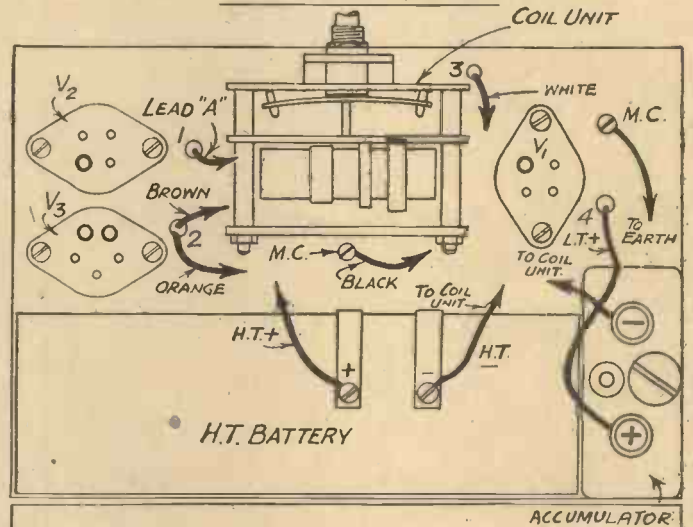
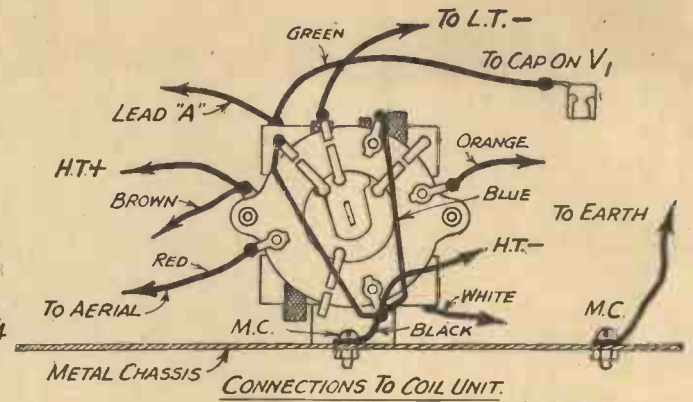

NOTE: "M.C." = CONNECTIONS TO METAL CHASSIS.

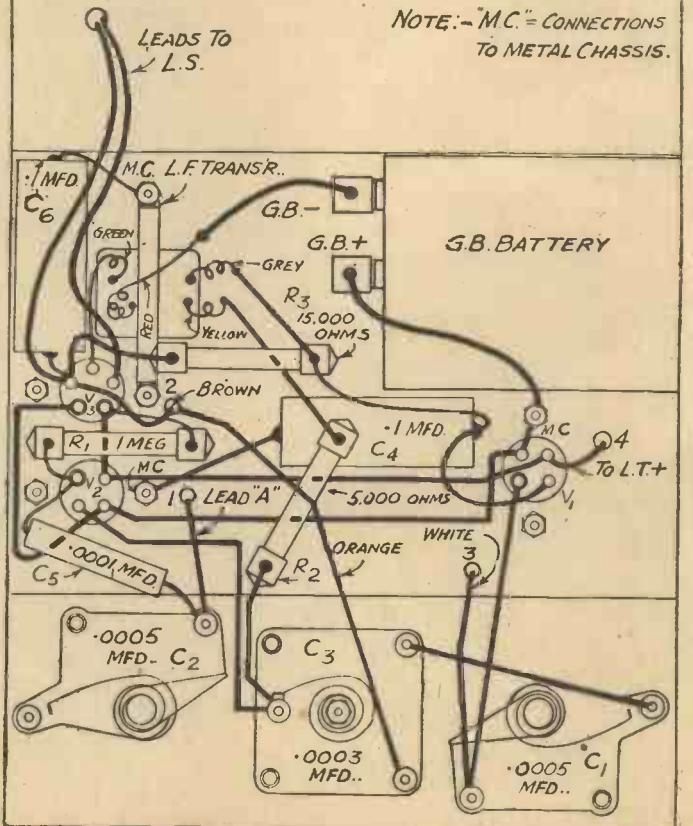

**LIST OF COMPONENTS**

- Special Tuning Coil Assembly (B.T.S.).
- Two .0005 mfd. Condensers (Compax) (Polar).
- One .0003 mfd. Differential Condenser (Polar).
- Three Tubular fixed Condensers, two .1 mfd., one .0001 mfd. (T.M.C.).
- Three fixed 1-watt Resistances, one 1 meg., one 15,000 ohms, one 5,000 ohms (Dubilier).
- One L.F. Transformer, type L.F. 33 (Bulgin).
- Three Midget-type Valve Holders, one 5-pin, two 4-pin (Clix).
- Two plugs, G.B. + and G.B. - (Clix).
- One Component Mounting Bracket (Peto-Scott).
- One Special Chassis (Peto-Scott).
- Three valves, one XSG, one XL, and one XY (Hivac).
- One 60-volt Battery, type X418 (Drydex).
- One 4 1/2-volt Battery, type X89 (Drydex).
- One 2-volt Accumulator, type Gel-cel. P.R.P.3. (Exide).
- One Midget Loud Speaker (W.B.).
- Wire, Nuts, Bolts, etc. (Peto-Scott).
- One special Carrying Case (Peto-Scott).
- Chassis with Valve Holders eyeletted in position, G.B. Battery Clip, etc. (Peto-Scott).—See Text.



# The ELECTRIC EYE

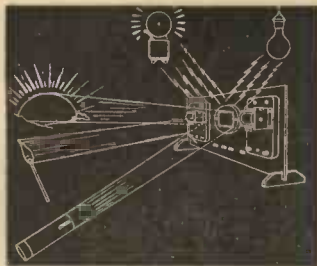

A device based on the principles of photo-electricity, which can be put to innumerable uses in the home. A beam of light shining on the sensitive plate of this ingenious apparatus will immediately turn on the Radio, start up Alarm Bells, etc., as soon as ray is broken. It can also be used in the opposite way, and automatically switch on the electric lights when darkness falls. Its unlimited scope for experiment will amaze old and young alike. The younger generation will derive endless entertainment from its possibilities; electric trains and all electrically driven toys can be controlled by this apparatus.

Write for illustrated brochure of this wonderful device

Selling at the very low price of **£1.60** post paid. Limited Supply only.

**DOUGLAS HOLT (Estd. 1919) LTD.**  
(Car and Radio Accessories)  
9 LITTLE TURNSTILE, LONDON, W.C.2

## ECONOMIC ELECTRIC CO. TWICKENHAM, LONDON, S.W.

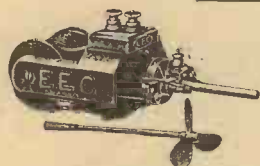

**THE NEW "MIDGET" MOTOR**  
The smallest and most powerful motor on the market.

Size: 3½ in. long, 1½ in. wide, 2½ in. high. Weight 7½ oz. Low centre makes it ideal for boat or loco. 4 VOLTS.

PRIOR: 5/6, post 4d.

Castings and materials 3/3, post paid.

Make your own Aero Petrol Engine. Set of castings and full scale working drawing 12/6, post 7d.

Castings are clean and drawings are complete key to construction. Weight complete 1½ lbs.



**G.P.O. TAPPERS**  
Substantial keys for practice use. An instrument, not a toy.  
6/6 post free. Buzzers 2/-, Sounder 9/6.

Our 70-page list contains a variety of small Mains Motors—Spark Coil material, Transformer Stamping, Wire, etc. Also over 500 other models for all purposes. Send for a copy now, 2d. post free.

# MIN AND MAX

When HIVAC produced their range of "MIDGET" type valves true Pocket Radio and Portable Receivers with loudspeakers were made possible.

In designing these valves, two essentials to true portable radio were never lost sight of. One was to reduce the size of the valves to the MINimum. The other was to bring up the performance to the MAXimum. In Hivac "MIDGET" valves, both these essentials were brought to a successful issue.

**TRULY PORTABLE RADIO IS NOW AN ACCOMPLISHED FACT— THANKS TO HIVAC "MIDGETS"**

Mr. F. J. CAMM specifies them for THE "GNAT"

XSG .... 15/6      XL .... 10/6      XY .... 15/6

Obtainable through all dealers.

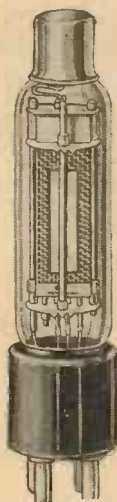

XSG Actual Size

Hivac Valve Guide and complete list "P.M." of "Midget" valves free on request.

# HIVAC

THE SCIENTIFIC VALVE

BRITISH MADE

STAND 26 OLYMPIA

HIGH VACUUM VALVE CO., LTD.  
113-117 Farringdon Road, London, E.C.1

# The essential link in Short-wave listening —Your Headphones



—they simply must be

# Ericsson

A short-wave set, however good, with poor 'phones is like a man with one ear. You simply cannot pull in the distant stations on any wavelength at decent strength, and short waves are tricky things.

So hook up Ericsson Telephones on your present set . . . you'll be pleasantly surprised at the wonderful difference they make. Their sensitivity is positively uncanny.

Three resistances— one price  
120, 2,000 and 4,000 ohms.

## 15/-

Sturdily built to stand up to the hardest wear, they retain their sensitivity, and rest very comfortably on the head over long spells. Buy a pair to-day and try for yourself.

At all good radio dealers. If you have any difficulty in procuring, write direct to:—

**ERICSSON TELEPHONES, Ltd.**  
67 - 73 Kingsway, London, W.C.2, Eng.

Telephone: 3271/3 Holborn.

# Ericsson

BRITISH SUPERSENSITIVE TELEPHONES





NEW INVENTIONS

The following information is specially supplied to "Practical Mechanics," by Messrs. Hughes & Young, Patent Agents, of 9 Warwick Court, High Holborn, London, W.C.1, who will be pleased to send readers mentioning this paper, a copy of their handbook, "How to Patent an Invention," free of charge.

Nose Appeal

AN old writer has called the five senses, the five Gateways of Knowledge. Hitherto, the enterprising salesman has used for the advertising of his wares Eye-Gate in the shape of print and pictures, and Ear-Gate by means of the radio. An inventor now proposes that Nose-Gate shall be utilised. His invention consists of apparatus to be worked in front of a shop and comprising a device similar to a flower sprayer. The idea is to spread around the odour of the goods which are for sale. For instance, coffee, Russian leather, and cooked dishes all have characteristic smells. And the public are to be lured to the shop by fragrance which they will at once associate with the merchandise. Consequently the factory will be stimulated by the olfactory.

Wrinkle to Prevent Wrinkles

A CELEBRATED French beauty of the past said that if she had had the designing of woman, she would have caused her wrinkles to appear only under her feet. Wrinkles or creases are unsightly not merely in the countenance but are considered to be undesirable in certain dress materials, such as silk, artificial silk, cotton, and linen. To make these materials resistant to creasing, a process has been devised and recently patented. It is claimed that the treatment makes for permanent smoothness.

The Cult of the Crease

WHILE upon the subject of the crease, I am moved to remark that, whereas normally a crease is regarded as a defect, there are occasions when it is "according to plan" as some of our former enemies used to say when they retired rapidly. I refer to the vertical crease in the leg covering of the immaculately attired beau. There has recently been patented a method of maintaining creases in trousers. This consists of applying to the folding line of the crease a non-stretchable tape, cord, or the like and stitching together the cloth of the trousers on the two sides of the folding line, together with the interposed tape, with invisible stitches.

Portable Refrigerator

THE holiday season, with its picnics, camping out, and travelling, makes appropriate the advent of an improved portable refrigerator. It is claimed for this device that it can be manufactured at low cost and that it requires comparatively little refrigerant. The invention is preferably formed with sides made of material capable of being folded and may be in the shape of a bag, the upper ends of the sides of which can be closed and folded over one another, in order to reduce the volume of the bag. The refrigerant container may be removable from the main container, and the refrigerant may be in the form of a solid or a solution of a suitable salt in water.

Anti-Noise Device

THE present is the age of noisome noise, which ranges from the deafening vibrations of the road drill to the nagging of the family jar. Ear plugs have not been

unknown in the past, but it is contended that recently devised ear fittings are an improvement upon these. Hitherto ear plugs have required to be tightly fitted into the inner auditory canal, causing discomfort to the user. The new device comprises a disc-like piece of soft rubber, preferably of the surgical variety and flesh coloured. It is of a shape and size to enable it yieldingly to fit and close the entrance to the auditory canal, without entering the canal. These ear fittings may be adapted to exclude not only noise but water from the ears, and so may be useful in bathing.

Expanding Bag

EVERY lady carries a handbag, but the dimensions do not permit of the carrying of other than small articles. There has just been patented a bag of this description which can be considerably expanded. The

interior of this handbag contains a rolled-up pouch which unfolds and forms an enlargement, converting it into a shopping bag.

Hop Picking by Machinery

AN improved machine for plucking hops has made its appearance. It comprises a plucker in the form of a comb-like device, having notches adapted to be engaged by only the thinner stems of the plants, which are in the immediate neighbourhood of the flower.

Prevention of Ice on Aircraft

MEANS have been devised for automatically preventing the formation of ice on aircraft. According to this invention, when ice-forming conditions prevail, the presence of ice releases a supply of anti-freezing agent. This device may be helpful to those who explore the altitudes of the stratosphere. DYNAMO.

CONSTRUCTORS OWE YOU A DEBT OF GRATITUDE—



says Mr. F. J. Camm.

W.B. Engineers are proud that an authority of Mr. Camm's standing should immediately and so emphatically endorse their opinion of the new 1937 Stentorian. Mr. Camm's message, reproduced below, gives sure proof that W.B. research in the past year has by no means been in vain:—

"Once again I can confirm the claims of your engineers to have enhanced even further the already enviable reputation which your speakers enjoy. The 1937 Stentorian, which I have submitted to a thorough test, represents a marked advance on your previous models. If anything, your claims are too modest, for my curves show a greater degree of frequency response at both ends of the register. Last year I asked, 'Can there be a better speaker?' Your 1937 Stentorian Speaker supplies the affirmative answer. All listeners, and particularly constructors, owe a debt of gratitude to the ind-fatigability of your research engineers."



You should hear this latest W.B. product. Like Mr. Camm, you will at once realise that here indeed is another milestone in loudspeaker progress.

To the understanding eye the curves reproduced here (taken from 1936 and 1937 Stentorian Senior models respectively) will convey more graphically than any words the great stride forward this new design represents. Each, in a commercial speaker, is a remarkable achievement; but a study of the 1937 type's improved top response, absence of harsh resonances, and remarkable levelness leaves no room for doubt as to the magnitude of this year's improvement. Whether you are building a new receiver or wish to revolutionise the performance of your present set—hear the 1937 Stentorian and know what 1937 reproduction can be!

SEE THEM AT RADIOLYMPIA STAND 66

1937 STENTORIAN PRICES.

Cabinet Models	Chassis Models
37 SC (Senior) . . . 63/-	37 S . . . . . 42/-
37 JC (Junior) . . . 49/6	37 J . . . . . 37/6
37 CC (Cadet) . . . 39/6	37 B . . . . . 23/6
37 BC (Baby) . . . 29/6	37 M . . . . . 17/6
Duplex . . . . . £6 6 0	EM/W . . . . . 70/-
	Duplex . . . . . 84/-

YOU MAY NOW BUY THE STENTORIAN SENIOR ON HIRE-PURCHASE FROM YOUR DEALER! ASK HIM!

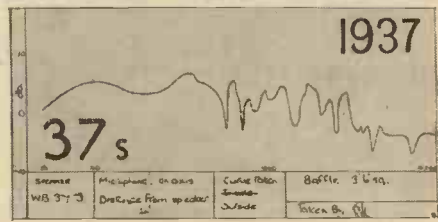

1937 STENTORIAN

WHITELEY ELECTRICAL RADIO CO. LTD., MANSFIELD, NOTTS  
Sole Agents in L.F.S.: Kelly & Shiel, Ltd., 47, Fleet Street, Dublin



Mr. A. A. Judge, at Wayne County Airport, after winning the Wakefield Cup.

# MODEL AERO TOPICS

Japanese tissue, thread, wire, cement, dope, etc. A useful booklet entitled *Helpful Hints for Model Building* is included with each kit. The same firm supplies kits for many other well-known models, and a fully illustrated catalogue is obtainable from them for 2d. It is well worth it. All of the models may be built without previous experience. The makers tell me that they will have a number of new kits available this December, including the New Hawker Fighter Hurricane, the Heston Phoenix, the Blackburn Shark, and the Gloster Gladiator. All of the models are flying models.



Mr. E. W. Twining, the first Wakefield Cup winner.

## Our Victorious Wakefield Team

AS briefly announced in last month's issue, members of the British Team which won the International Model Aeroplane Contest at Detroit, Michigan on July 3rd, and thus recaptured for England the Wakefield International Trophy, were entertained to dinner at the Monico by the generosity of Lord Wakefield. The British Team consisted of five youths and one man. The winner, Mr. A. A. Judge, lives at Clapham and is 17 years of age. At the dinner he was given a special replica of the Wakefield Cup. I would express the passing thought that it would have been a nice action to have invited the first winner of the first Wakefield Cup (many years before the war), Mr. E. W. Twining, one of the pioneers of model aeronautics in this country and one of the most versatile.



The Hawker Hind Model, made from a kit supplied by F. P. Sweeten.

## "The Model Aircraft Book."

The *Model Aircraft Book* has just been published from the offices of this journal at 3s. 6d. (by post 4s). Its contents are mainly devoted to the construction of petrol models, scale models, a full-size primary glider, and advanced rubber-driven models. The chapters include: A Petrol-driven Monoplane; A Petrol-driven Model Biplane; Power Units for Model Aircraft; The 1935 Wakefield Cup Winner; A Fuselage Model Biplane; A Lightweight Duration Monoplane; A Wing Flapping Model; Model Aeroplane Stability; Building Scale Models; and Building a Primary Glider. The book is bound in stiff board, printed in three colours, and measures no less than 7½ in. by 10 in. It is printed on art paper, contains 231 illustrations, and over 140 pages.

## WAKEFIELD CUP RESULTS

Held at Wayne County Airport, U.S.A., July 1st.

			1st Flight.	2nd Flight.	3rd Flight.	Average.
1st	A. A. Judge . . . . .	G. B.	3 m. 17 s.	2 m. 16-5 s.	1 m. 56-2 s.	4 m. 9-9 s.
2nd	R. Wriston . . . . .	U.S.A.	1 m. 40 s.	9 m. 15 s.	1 m. 13 s.	4 m. 2-6 s.
3rd	R. Copland . . . . .	G. B.	4 m. 35-2 s.	2 m. 10-9 s.	3 m. 25-2 s.	3 m. 23-6 s.
4th	D. Everett . . . . .	U.S.A.	2 m. 30 s.	3 m. 41-3 s.	2 m. 46-3 s.	2 m. 59-2 s.
5th	J. B. Allman . . . . .	G. B.	2 m. 30-8 s.	2 m. 29 s.	3 m. 10-1 s.	2 m. 43-3 s.
6th	G. Light . . . . .	U.S.A.	4 m. 43-8 s.	1 m. 53 s.	1 m. 23-5 s.	2 m. 40 s.
7th	D. Fairlie . . . . .	G. B.	2 m. 36-3 s.	3 m. 20 s.	1 m. 20-5 s.	2 m. 56 s.
8th	A. Vincere . . . . .	France	1 m. 32-5 s.	1 m. 27 s.	2 m. 28 s.	1 m. 49-1 s.

## "Baby Cyclone" Engine

Comet Aero Supplies, Barwell, Leicester, inform us that they have been appointed sole distributors for Great Britain of the "Baby Cyclone" Engine developed and manufactured by Aircraft Industries of Glendale, Cal., U.S.A. Stocks of engines and home-construction kits are now available and can be despatched by return. The Comet Aero Supplies have issued a leaflet illustrating the "Baby Cyclone" engine, and the interesting model which can be built from the kit. F.J.C.

I give above the result of the competition to 8 places.

## Realistic Models

The photograph in the centre of this page shows the Hawker Hind model built from a kit of parts supplied by F. P. Sweeten, Ltd., of 38 Bank Hey Street, Blackpool. The model realistically follows its prototype, and is of 18½-in. wing span, 14½-in. long, which is equivalent to a scale of ½ in. to the foot. The model includes dummy automatic slot control on the wing, pressure released tubes from tank, oil radiator, air scoop, bomb sight, etc. The kit includes all the balsa correctly cut to section, and with the shaped parts printed thereon so that they may easily be cut out, turned hardwood wheels, finished spinner, fibre prop. blades, and all



Four members of the Huntley Boys' School Model Aero Club. A model ornithopter built from instructions in "Practical Mechanics" is seen second from the right.



# The Latest in Railway Modelling



Fig. 1.—Track arrangement on the author's old West Midland Railway.

### Sidings and Junctions

There are really few railway modelers who can accurately model such an elementary feature as a siding. Indeed, the whole subject of the joining of one track to another is a most important one. Sidings and junctions embrace the whole realm of permanent-way problems and construction, ranging as they do from

By E. Beal

## This Month we Deal With the Problem of Sidings and Junctions

### Safety-points

It is one of the rules of civil engineering that every siding shall be so arranged that shunting operations upon it shall cause the least possible obstruction to passenger lines. Safety-points must be provided at every place where goods and mineral lines directly lead into main tracks, these safety-points being kept closed with a spring adjustment against the main line, being only operated

to stand upon it when at platforms. For example, the point shown in the photo of Laureceton Station (Fig. 10) is incorrect, and it will at once be seen why. This arrangement was a temporary expedient only, and has long been discarded. A passenger train standing at the station platform would, of course, be standing on this point, and thereby blocking the entire entrance and exit to the locomotive yard. A word is also necessary regarding the point-lever arrangements at a simple turnout. In

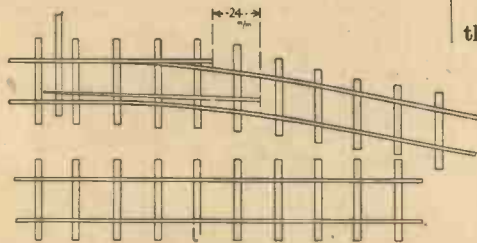

Fig. 2.—Dummy safety points.

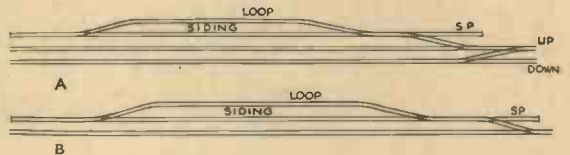

Fig. 3.—Factory sidings with safety points. A for double track and B for single track.

the matter of a simple turnout to a complicated system of burrowing and flying-junctions such as that at Camden Town, and even the simple feature known as a turnout has its own special details of accuracy and realistic procedure.

in an interlocking movement with the goods-line signal. Any single junction must be so placed as to avoid passenger trains requiring

strictly correct practice, where the turnout is situated on the main line between two stations, do not show a hand-operated lever.

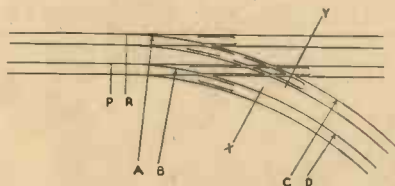

Fig. 4.—Diagram of a double junction.

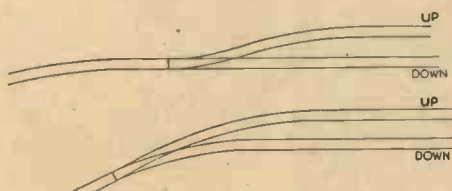

Fig. 5.—Double track junction with single track.



Fig. 6.—An incline from a burrowing-junction.

# THE TWINS

GO FROM STRENGTH TO STRENGTH!



The "Twin" Locomotive (Electric). Gauge "00." Price 14/6

**YOU** must own the BASSETT-LOWKE "Twin Trains"—truly the sensation of the Model Railway World in "00" gauge! We now have a full range in stock of this unique model railway—rail, points (hand or electric), crossings, coaches, vans, controllers, transformers, stations, engine sheds, signals, and, best of all, complete sets of Passenger and Goods Trains.

For gauge "0" railways write for F.B.12, Bassett-Lowke's new Free Folder in blue and black "LILLIPUTIAN POWER," which describes all the new gauge "0" popular model locomotives, including "The Princess Royal," "Flying Scotsman," and "Royal Scot." Send now.

The Passenger Set, complete with Engine, Tender, 3 Coaches, Controller, and Oval Track costs 40/-

The Goods Set, complete with Engine, Tender, 4 Wagons, Controller, and Oval Track costs 35/-

Gauge "00." 14 volts A.C. and 12 volts D.C.

Write at once for TT.12, the new BASSETT-LOWKE TWIN TRAIN RAILWAY BOOKLET, free.

**BASSETT-LOWKE LTD.**  
NORTHAMPTON

London: 112 High Holborn, W.C.1  
Manchester: 28 Corporation Street

## The 18th Annual MODEL ENGINEER EXHIBITION

ROYAL HORTICULTURAL HALL  
VINCENT SQUARE, WESTMINSTER  
SEPTEMBER 17th to 26th

11 a.m. to 9.30 p.m. daily

Admission 1s. 3d. (tax included)

A wonderful show of Engineering Models, Tools, and Workshop Equipment.

Locomotives, Marine and Stationary Engines. Steamers, Sailing Ships, Speed-boats, and Aeroplanes. A 72-ft. Passenger-carrying Railway Track operated by Steam Locomotives.

Working Model Railways in various gauges. Large Competition Model Section for Championship Cups, and Prizes.

Splendid Model Displays by the leading Model Engineering, Railway, Boat and Aeroplane Clubs and Societies.

*Something to interest every practical mechanic.*

ORGANISED BY:

**"THE MODEL ENGINEER"**  
13-16 Fisher Street, London, W.C.1

*A Real Motor-Driven  
Wood Planer  
for your  
Home  
Workshop*

SPECIALLY DESIGNED, COMPACT  
FULLY ADJUSTABLE MOTOR-DRIVEN  
4" PLANER BANISHES TEDIOUS HAND  
PLANING. 3 HIGH-SPEED STEEL KNIVES

**RIGID**

SMOOTH AND QUIET  
AT TOP SPEED

THE CHEAPEST PRACTICAL PLANER  
ON THE MARKET

PRICED WITHIN REACH OF  
EVERY HOME WORKER

It's **DRIVER** No. 525

*Send the coupon and know more*

**E. P. BARRUS, LTD.**  
35-37 UPPER THAMES ST., LONDON, E.C.4



SEND ME

**DRIVER**  
MOTOR-DRIVEN  
TOOLS CATALOGUE

MR. ....

(P.M.) .....

COUPON





Fig. 7.—A girder bridge for a flying-junction.

If a point-lever must be used, let it be concealed, or, better still, discard it in favour of a small dwarf lever-frame near the track-side, which will, at all events, suggest signal interlocking with the point. But the most important matter is that of safety-points, and it is such an invariable rule of real practice to install these at all places where sidings join the main line that the feature is fully worth inclusion in all model layouts. Even if the safety-points are not made to operate, it would be well to introduce a dummy type of catch-point. Fig. 2 gives a diagram suggestive of the form such a dummy might take. Sometimes this safety arrangement consists of a "dead-end" with a track and buffer stops in place of the catch-point, as shown in Fig. 3 A. There are very many railway modellers who imagine that the sole purpose of catch-points is to prevent runaway coaches and other vehicles from colliding with trains following on inclines.

**A Factory Siding**

The arrangement of a siding at a factory is often necessary at a point where fast running of trains on the main line must be allowed for. The plan Fig. 3 A is for a siding at a factory served by a double up and down main line. Here there arises an interesting problem for the designer and operator who desires to adhere strictly to real procedure. A crossover has to be installed in strict keeping with block-signalling requirements. The operating department would not use this crossover for the arrival and departure of trains from the "down" direction; these would be worked to and from the nearest goods depot. The modeller must decide for himself what shall be done about the crossing—whether it shall be installed simply as a scale feature or whether it shall be used, unrealistically, for the arrival and departure of down-line trains at the factory.

There will require to be a loop arrangement at the siding, so that main-line engines arriving with goods trains at the factory will not be trapped. This applies only to trains arriving from the down line. "Up" trains would back into the siding and locomotives leave without difficulty. "Down" trains would (after reversing) enter the siding engine first, and the locomotive would thereafter leave by the further point and loop. Fig. 3 B shows a similar siding arrangement for a single main line. In these plans SP represents safety-points.

more special requirements. The modelling of a double junction rarely receives due regard. It should be noticed that the two mouths of the points are never located directly opposite one another. This is due, in real practice, to the fact that the two points are arranged to the same radii, so

**A Double Junction**

When we pass from the single turnout to the double junction we are faced with even

at the same radius; curves C and D have a radius related to each other; and C and D are both at a sharper radius than A and

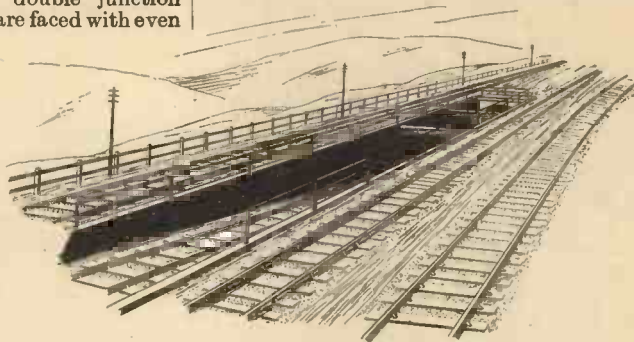

Fig. 8.—Sketch of a burrowing-junction.

B. The plan also indicates the necessary arrangement of the wing and check-rails.

It is also correct procedure to install a trailing crossover as near as possible to all double junctions, in keeping with block signalling requirements, and in order that trains may, if required, pass from, say, the up branch to the down main.

It is often necessary, especially on a model, to carry a double main line into a single line continuation, or vice versa. Fig. 5 gives two methods of doing this. The first method, though common, is bad, involving as it does a reverse curve for trains on the "up" road. Reverse curves should invariably be avoided if possible, and even on a crossover there should be a section of straight track between the two bends. The second method is far better, even if it involves the construction of a curved point, which in the sketch it does not.

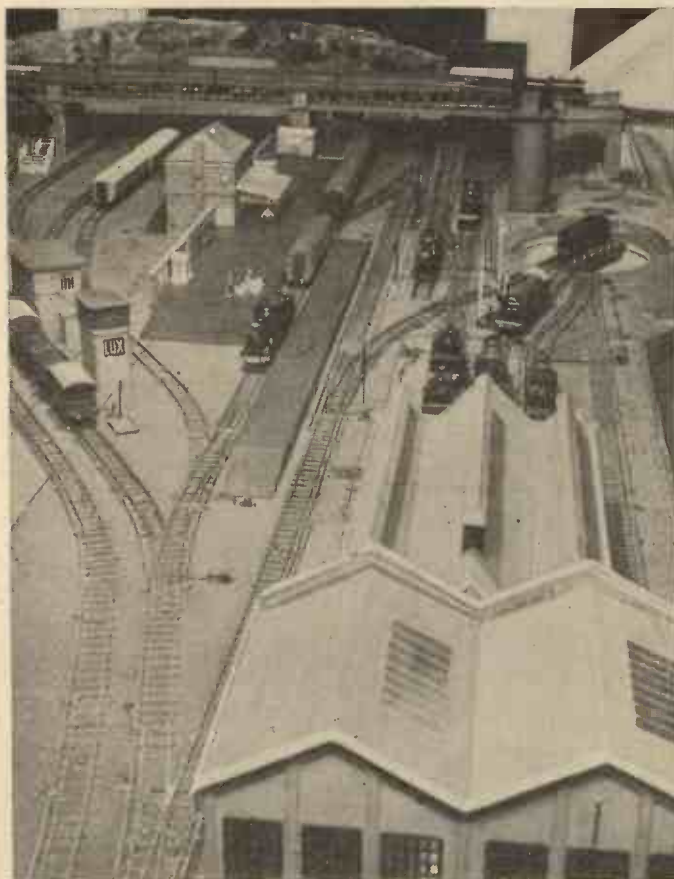

Fig. 10.—A wrongly placed turnout leading to an engine yard.

**A Flying-junction**

It is very often necessary, in model as well as real procedure, to arrange a double junction so that no train will require to cross the path of another train by way of a diamond crossing. This is done by introducing a flying- or a burrowing-junction, by means of which one of the tracks either is carried above the other or burrows beneath it. Whether the junction shall be "fly" or "burrow" is an important question, depending in real practice partly on the weight of the traffic. If the track involved in the question is to take heavy goods trains, it will, if other circumstances permit, be carried under the roads that are to take lighter passenger trains. If passenger trains are to take the branch, they will normally be carried up over the goods

(Continued on page 704)

that their frogs may be at the same angle. In model work this is a convenience in that it avoids running the point rods across the tracks so as to conflict with each other. The two curves of the points, then, are arranged at the same radii, this applying for the outer curve as far as the back crossing, and for the inner curve as far as the line X, or thereabouts (see Fig. 4). Thereafter the two curves are arranged at the properly decreasing radii. That is, in the plan, curves A and B are

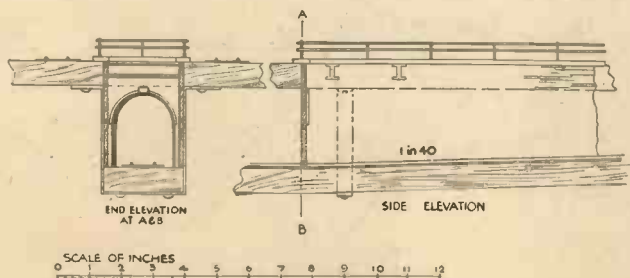

Fig. 9.—A design for a burrowing-junction.



# Experiments with Sand

**I**N order that the following experiments may prove successful, it is absolutely essential that the sand be perfectly dry. If it is damp the particles of sand will tend to cohere and thus ruin the experiments. To commence, thoroughly wash the sand to remove all saline matter, spread it out on a tray and well dry the sand in an oven. When dry, sift through a fine sieve to remove all coarse particles.

Obtain an ordinary funnel, place a finger over the hole in the bottom and fill with sand. Hold the funnel over a sheet of paper, remove the finger covering the hole and allow the sand to run out. It will be found that the sand flows out with great regularity, forming a cone-shaped heap on the paper, having an angle of 30 degrees as shown in Fig. 1. This is the critical angle at which sand will remain in a position of equilibrium. In Fig. 2, the only portion of the sand exerting a vertical pressure, is that contained within the cone P-S, the remainder of the sand pressing almost entirely against the sides of the vessel. The main pressure of the sand is therefore lateral and not vertical.

**The Unbroken Eggs.**  
Obtain a stout cylinder of some convenient material as shown in Fig 2, and place some eggs (E, F, G, H and N) and sand inside the cylinder. A block of wood should now be placed on top of the sand, and with a hammer, strike a heavy blow on the wooden disc. Upon removing the disc and sand, the eggs will be found unbroken.

Cut a large hole in the bottom of a wooden box, and paste a sheet of tissue paper over the hole. Fill the box with sand and it will then be found possible to lift the box without fear of the weight of the sand breaking the paper.

**An Experiment with Tins.**  
Construct three tin cans similar to those shown in vertical section in Fig. 3. A, B, and C are three spouts, soldered to opening

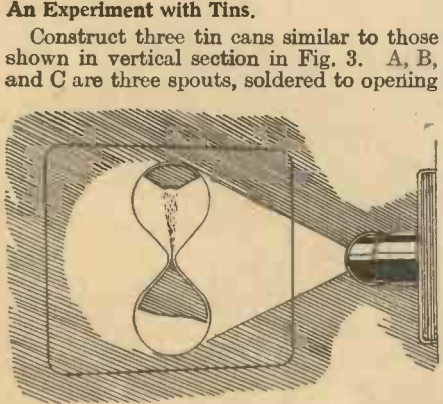

Fig. 4.—Making sand flow “up”

By V. E. JOHNSON, M.A.

## Simple Experiments that can be Performed with the Minimum of Apparatus

made in the tins, preferably large, say 1 in. in diameter. Cork or stop up the end of these spouts or tubes, they can be of rectangular section if you like. Fill or nearly fill the three vessels, on removing the stopper, the sand will flow out of one only—that with the spout inclined downwards, say, at an angle of 30 degrees, the critical angle. Even through this tube the sand will stop flowing when the sand forms a cone inside the vessel which corresponds with the lowest inside portion of the tube. Note the cone which the sand forms in flowing out. The fact that sand always forms this fixed conical form when in equilibrium, has many practical results, the most important of which perhaps is that in a cutting (such as the Suez Canal) or embankment, this angle must not be exceeded. In the case of a cutting the sand would simply roll off and fill up the hollow between.

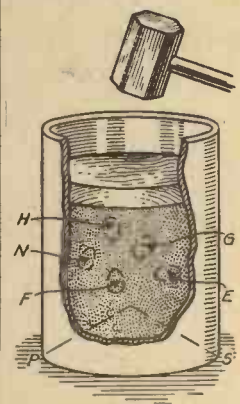

Fig. 2.—When eggs are placed in sand as shown and a wooden disc is placed on top, upon striking the disc the eggs will remain unbroken.

Repeat experiment 1, but place the funnel on some form of insulating support or hang it by silk cords or rubber and connect the same with an electrical influence machine. Work the machine and allow the sand to flow. Place a good size tray underneath the sand—which will be widely scattered, owing to the particles of sand being similarly charged electrically and repelling one another.

**A Phenomenon.**

Take an ordinary “sand glass” or egg boiler, a flattened one is best, put it in a magic lantern in the place of the ordinary lantern slide and focus it on the screen.

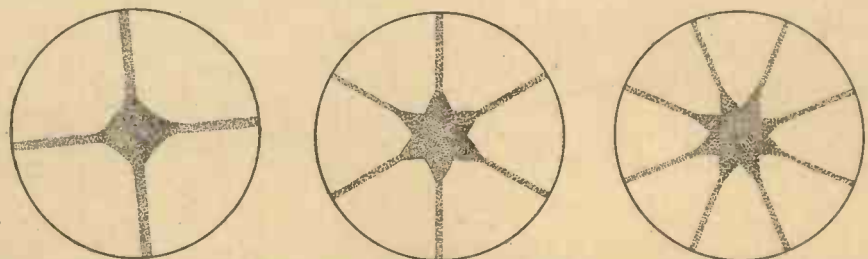

Fig. 5.—When sand is placed on a flat surface and the surface is vibrated, the sand will form paths as shown.

Since the picture on the screen is always an inverted one, the sand will appear to flow up instead of down, presenting the curious appearance shown in Fig. 4.

**Visible Sound or Chladni's Figures**

Take thin, square, round, and triangular flat plates of either very smooth wood, metal or glass, and support them on horizontal stands to which they are fixed at the centre or near the edges. The surface of the plates should be blackened. Sift some fine white sand carefully and evenly all over the plate. Next take a well-resined violin bow and draw it briskly across the edge. The sand is at once thrown into rapid movement by the vibration of the plate and will finally arrange itself in some perfectly regular figure, sometimes showing a beautiful stellar form and at others concentric circles or semicircles. In the case of a square plate, see Fig. 5, we have lines running parallel to the sides of the plate, or to the diagonals, intersecting in such a manner as to produce a check or chessboard pattern, the number of such patterns being almost

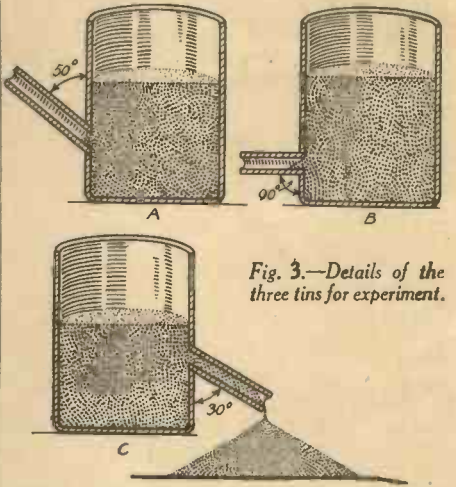

Fig. 3.—Details of the three tins for experiment.

infinite and depending by the points agitated and damped by placing the finger or fingers lightly on the edge of the plate and the shape, thickness and density of the plate. They depend very largely on the relative position of the bow and finger. These experiments can also be carried out on a drum or a sheet of smooth paper tightly stretched on a frame.

Instead of sand, powder of heliotrope may be used, in which case the figures may be transferred and retained by laying a sheet of damped paper over the designs.

One of the best ways to fix the plates is by screws covered with cork at the places on the plate where it is desired to have no vibration.





An Imperial Airways liner in the light from one of the new G.E.C. landing floodlights at Croydon Aerodrome.

## Making Flying Safe

IN the design, construction, and operation of commercial aircraft an ever-growing part is played by scientific experiment and research. Recently it was found necessary to make some special tests under the conditions of actual commercial operation, with wireless signalling between an air-liner in flight and ground stations. Arrangements were made for these experiments to be carried out from an air-liner of Imperial Airways flying on one of the ordinary scheduled services between London and Cologne, the experts taking part in the tests including officials of the National Physical Laboratory and of the Marconi Company.

### The Radio Department

The Radio Department of the National Physical Laboratory now has a special aeroplane at its disposal, in which experts are carrying out for the Air Ministry experiments in the guidance of air-liners by various methods of wireless equipment. Experiments are constantly in progress, also, between observers up in the air and research workers down on the ground. Aircraft with silenced engines, and with propellers revolving at slow tip-speeds, are flown at various heights and speeds above observing stations. This enables the noise they make, as heard on the ground, to be recorded by special sound-meters. And when engines are silenced, and the noise of propellers lessened, it becomes possible to obtain valuable data as to the sounds made by the air rush over hulls,

Below is Described  
Some of the Ingenious  
Devices Employed in  
Modern Aviation which  
are Speedily making  
Flying "Foolproof"

wings, and other surfaces. At the same time recording devices inside the aircraft are locating and "measuring" interior noises with a view to improvements in sound-deadening materials in hull structures, doors, and other fittings.

### Larger Air-liners

Air-liners are not only growing larger, but they are also flying faster. This is making it all the more necessary to study the drag, or resistance, which is set up when such structures are moving swiftly. Tests at the National Physical Laboratory emphasise the importance of employing smoothly finished surfaces, and of streamlining with the utmost care every part that is exposed to the rush of air. The attention now paid to such questions is illustrated by the external smoothness imparted to the metal hulls of the new Imperial Airways

flying-boats, and by the fact that such projections as direction-finding loop aerials will, when not in use, be withdrawn through a trap-door into the hull of these machines.

Air science concerns itself not only with aircraft, engines, and propellers, and with wireless equipment, but also with such questions as the improvement of airway lighting, and the simplification of the instruments which pilots use in navigation.

### Meteorological Services in South Africa

An improved system of wireless weather reporting has been established in South Africa. Twice a day the chief airports are furnished with reports from fifteen meteorological stations located at specially selected points throughout the Union. The reports from these stations are, in the first instance, communicated to main transmitting points at Germiston and Salisbury. Here, after they have been analysed, they are re-issued in the form of comprehensive twice-daily broadcasts.

### Refuelling at Penang

The progress of air transport at Penang is leading to the placing there of new petrol storage tanks. Three huge tanks, each weighing 11½ tons, are being installed. In addition to the twice-weekly service on the England-Australia route, an air mail is now in operation between Penang and Hong Kong which establishes connections at Penang with the air-liners on the main England-Australia service. The increased facilities for refuelling which are now being



provided at Penang are also in preparation for the impending use of the giant Imperial Airways flying-boats which carry first-class mails.

#### Long-range Wireless on the Empire Routes

In the operation of the Empire airways remarkable examples are sometimes forthcoming under favourable conditions of long-range wireless between air-liners in flight, and also between air-liners and ground stations. Not long ago Cairo received short-wave signals from an air-liner which was flying more than 1,000 miles away along the route to Cape Town. On another occasion two aircraft in flight on the African route were in wireless touch with each other while still approximately 2,000 miles apart. In yet another instance a machine flying across Africa established communication with a wireless station in England over a distance of roughly 4,000 miles.

Examples of an even longer range communication are sometimes forthcoming. An amateur in Cape Province, South Africa, succeeded in picking up short-wave messages from an air-liner flying 5,000 miles away between Alor Star and Singapore; while another machine on the Australia route established communication with Sydney while it was in flight at a point more than 5,000 miles from the receiving station.

#### Aids to Night Flying

To enable night-flying pilots on Karachi-Rangoon sections of the England-Australia service to locate their positions, air-beacons are being placed at points thirty to fifty miles apart along the route between aerodromes. These beacons stand 8 ft. high. They are 4 ft. in diameter, and are of  $1\frac{1}{2}$ -kilowatt rating. Each has a main optical system, surmounted by a red obstruction light fitting. As the beacon revolves Morse light signals are flashed skyward which indicate the precise location of the beacon on the route.

#### The "Magic" Eye

Those who have flown by Imperial Airways know that the reliability of the Company's air-liners is guaranteed by a system of maintenance and overhaul which leaves nothing to chance, and which, by a use of all the most up-to-date appliances, precludes any risk of human error. One of the most ingenious machines in the Company's engineering shops at the London air-port is a piece of apparatus which, in its sheer infallibility, proves superior to any method employed hitherto—microscopic or otherwise—in detecting the smallest flaw or crack in any component or part that is made of steel.

To see this machine at work—it is called the "Magna-Flux"—is to realise the strides now being made in preventing the failure while in operation of any working part that may be playing an essential role in—let us say for example—the accurate functioning of a modern aero engine. Every motor used by Imperial Airways comes into the shops for a complete overhaul after it has been in operation approximately six hundred hours—and it should be noted that these full overhauls are additional to the routine inspection and maintenance to which motors are subjected after every flight. As soon as the motor enters the shops for overhaul it is dismantled completely and every part cleaned and examined; and it is at this stage of the operations that the magnetic "eye" of the "Magna-Flux" is brought into play.

#### Magnetising Steel Parts

What this apparatus does first of all—and one has not space here to go into full details—is to magnetise any steel part that is to be examined. Then, immediately it has been removed from the magnetiser, the part has poured over it a liquid which is called a "detecting ink," and the actual composition of which is one of the secrets of the process. This liquid—to describe it in just general terms—takes the form of a spirit which has the property of evaporating very slowly, while contained in it is a specially prepared metallic powder. When this liquid is poured over a part that has come from the magnetiser, the effect is so magical that it makes one think of some clever conjuring trick.

#### A Tell-tale Line

Suppose, however, we take a typical instance. The operator hands you, before putting the apparatus into use, a small steel fitting. Actually it is a part from the oil-pump of one of the engines. "Can you see any crack or flaw in this?" he asks. You examine it keenly, turning it over and looking closely at every portion of its surface. Not the slightest sign of any flaw appears on the polished surface. To the eye it seems perfect. You hand it back to the operator. He switches on the electric current and magnetises the part. Then, after pouring over it some of the "detecting ink" already referred to, he hands the part back to you to examine again. And it is then that you realise that this machine does something impossible with human vision. For on the smooth and apparently unbroken surface of the steel there now appears a thin, black, tell-tale line. It is a tiny surface flaw which would have defied detection save by the use of this magnetic process. What has happened is that the magnetic flow through the part has been interrupted

by the existence of this crack. It has set up a resistance, although it is so small as to be invisible to the eye. And the result is that the metallic powder in the "detecting ink" which has been poured over the part is attracted or drawn to the point on the steel where the flaw exists. The sediment in the "ink" forms up and draws together on either side of the crack, revealing its position and size unmistakably; and there in that position the sediment or powder remains, clearly visible, even after the "ink" in which it has been contained has evaporated.

#### The Never-failing Eye

It is fascinating to examine some of the work which this apparatus is doing from day to day. Here is a gear-wheel. Apparently there is nothing wrong with it. But the operator draws your attention to some of the teeth; and here, when you look more closely, you see tell-tale streaks of black which indicate that flaws have just begun to develop. And that means that this gear-wheel, though at a glance one would have said it was perfectly sound, has been condemned and cast out, and will never be in service again. This work goes on all the time. Crankshafts, air-screw shafts, wheels, gears, oil-pump drives—all such parts as these, and others too numerous to mention, are subjected one by one to the magnetic "eye." The engine is the heart of the aeroplane, and what this process means is that when an engine has been re-assembled after one of its periodical overhauls, the fact is known beyond question—beyond any possibility of error—that its working parts are free from any potential source of failure. No tiny crack or symptom of undue wear, however minute it may be, can elude this never-failing eye.

It is ceaselessly on the alert.



Showing the bridge of the Imperial Airways Liner "Scylla."



# FREE!

## This IMPORTANT GUIDE to SUCCESSFUL ENGINEERING CAREERS

After months of intensive effort and research, we are pleased to announce that the 1936 edition of our Handbook, "ENGINEERING OPPORTUNITIES," is now out of the publishers' hands and ready for *free distribution*. Containing 268 pages of practical guidance, this book is, beyond argument, the finest and most complete handbook on Successful Engineering Careers ever compiled. It is a book that should be on the bookshelf of every person interested in engineering, whatever his age, position or experience.

The Handbook contains, among other intensely interesting matter, details of B.Sc., A.M.I.C.E., A.M.I.Mech.E., A.M.I.E.E., A.M.I.A.E., A.M.I.W.T., A.M.I.R.E., CIVIL SERVICE, and other important Engineering Examinations: outlines courses in all branches of CIVIL, MECHANICAL, ELECTRICAL, AUTOMOBILE, RADIO, TELEVISION and AERONAUTICAL ENGINEERING, BUILDING, GOVERNMENT EMPLOYMENT, etc., and outlines the unique advantages of our Employment Department.

**WE DEFINITELY GUARANTEE  
"NO PASS—NO FEE"**

If you are earning less than £10 per week you cannot afford to miss reading "ENGINEERING OPPORTUNITIES." In your own interests, we advise you to send for your copy of this enlightening guide to well-paid posts by filling in and posting the coupon NOW. There is no cost or obligation of any kind.

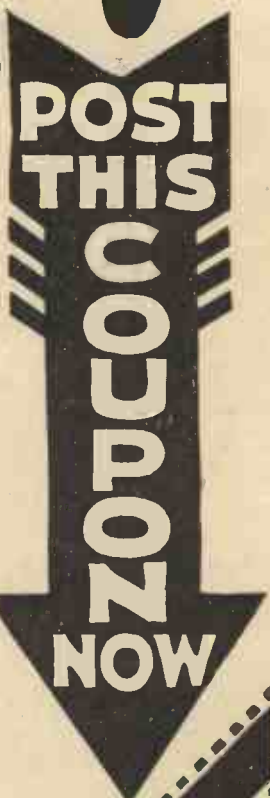

**BRITISH INSTITUTE OF  
ENGINEERING TECHNOLOGY**  
410, SHAKESPEARE HOUSE,  
17, 18 & 19, STRATFORD PLACE, LONDON, W.1.

TEAR OFF HERE  
**FREE COUPON**  
To B.I.E.T., 410, SHAKESPEARE HOUSE,  
17, 18 & 19, STRATFORD PLACE, LONDON, W.1.  
Please forward, free of cost or obligation of any kind, your  
268-page Handbook "ENGINEERING OPPORTUNITIES."  
NAME.....  
ADDRESS.....

# PRACTICAL PHOTOGRAPHY IN ALL ITS BRANCHES

# "PRACTICAL PHOTOGRAPHY

and

# Amateur Cinematography"

**B**OTH from practical and artistic considerations "Practical Photography and Amateur Cinematography" may be safely recommended as one of the best investments that the professional or amateur photographer can make.

The Experience of 80 Expert Contributors including:—

**HAROLD B. ABBOTT**, Author of "Motion Pictures with the Baby Cine."

**MARCUS ADAMS, F.R.P.S.** The Well-known London Child Photographer.

**J. E. ARCHIBALD**, Editor "Kodak Magazine."

**W. G. BRIGGS**, Managing Director, W. G. Briggs and Co., Ltd.

**J. H. BRIGHT**, Kodak, Ltd.

**Miss H. N. BROOKER**, In charge of Photographic Dept., Bloomsbury Trade School (L.C.C.)

**JOHN J. CURTIS**, Of Johnson and Sons, Manufacturing Chemists.

**W. L. DIXON**, Assistant Art Editor, "Daily Telegraph."

**F. R. NEWENS, F.R.P.S.** Lecturer and Specialist in Colour Photography.

**BERTRAM PARK**, Colour Photographs, Ltd., London.

**S. O. RAWLINGS, D.Sc., F.I.C., F.R.P.S.** Messrs. Ilford's Research Laboratory.

**W. J. SMITH, F.R.P.S. L.C.C.** School of Photo Engraving and Lithography.

**ALL THE STAPLE PROCESSES USED IN MODERN PHOTOGRAPHY AND CINEMATOGRAPHY.**

**TIME, LABOUR AND MONEY-SAVING ARTICLES AND EQUIPMENT.**

**14 SPECIAL PHOTOGRAVURE SUPPLEMENTS.**

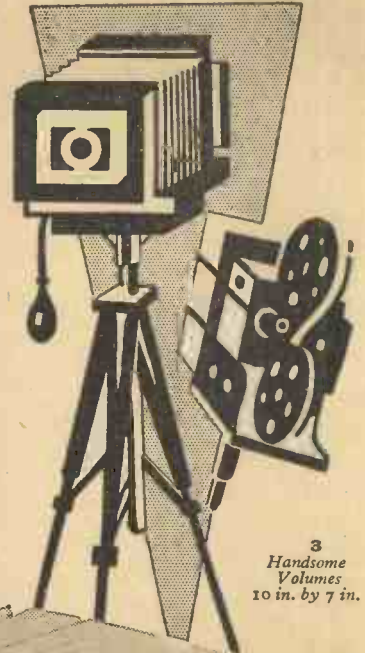

3 Handsome Volumes 10 in. by 7 in.

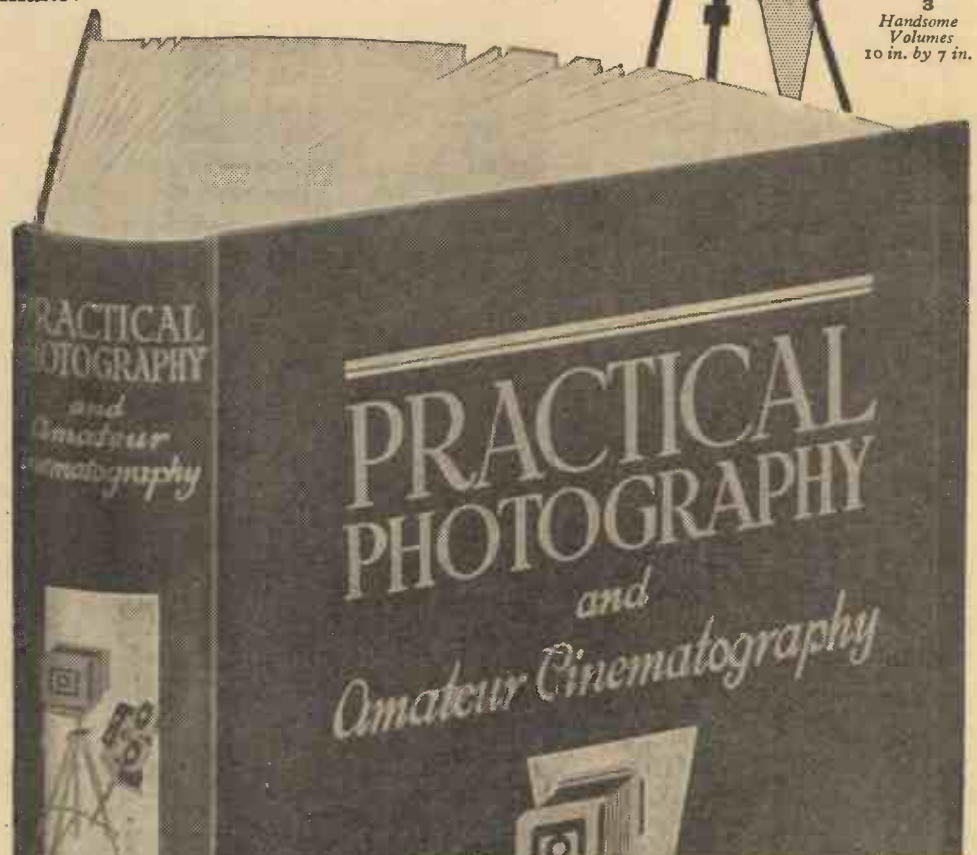

Send  
Coupon  
For **FREE**  
Descriptive  
Booklet

To the  
**HOME LIBRARY BOOK COMPANY**  
(George Newnes, Ltd.)  
8-11, Southampton Street, London, W.C.2

Please send me without any obligation to purchase, full particulars of "PRACTICAL PHOTOGRAPHY AND AMATEUR CINEMATOGRAPHY," and details of your scheme of Easy Payments with immediate delivery.

Name .....

Address .....

Sept. 36..... "PRACTICAL MECHANICS."

If you do not wish to cut your copy, send a postcard to address above, mentioning "PRACTICAL MECHANICS."





# THE AUTOMATIC MACHINE

**P**ROBABLY the earliest automatic machine of which any record exists was one in use by the ancient Romans which dispensed holy or perfumed water in exchange for a coin of the period.

It has at one time or another been proposed to dispense automatically all kinds of commodities in exchange for one or more coins, for instance, postage stamps, tickets, post cards, newspapers, towels, matches, chocolates, sweets, and other edible substances, cigarettes, cigars, perfumes and other liquids, gas and electric current.

One of the earliest inventions (1857) for a penny-in-the-slot machine was curiously enough for dispensing postage stamps. In this machine a strip of postage stamps was fed between a pair of rolls, one of which was driven by a spring and the protruding stamp was cut off by a knife. The penny in passing down a chute disengaged a detent from the spring roll.

## How the Automatic Post-card Machine Works

In 1876 a machine was patented for selling post cards or photographs, in which provision was made for receiving several

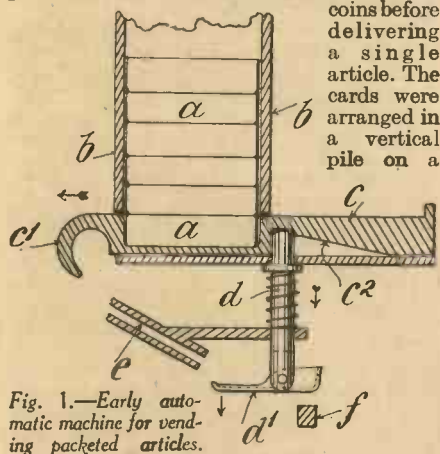

coins before delivering a single article. The cards were arranged in a vertical pile on a downward sloping ledge and fed forward against a fixed stop by a rolling weight at the back of the pile. The foremost card was prevented from falling down a delivery chute by a spring-controlled rod, operated from a snail cam wheel. This wheel was rotated by escapement gear set in motion by a weighted pendulum, which was caused to move by a coin striking its lower end, and the arrangement being such that a certain number of coins were necessary to vibrate the pendulum and so turn the cam wheel before the latter assumed such a position as to allow the rod to be retracted by its spring to release the card.

## Improving the Mechanism

In most, if not all, the early automatic

machines the weight of the coin was used as the means for freeing the locking mechanism by overbalancing a pivoted lever, but in 1876 a machine was patented in which the weight of the coin was not used for this purpose. In this machine, a closed casing was provided with a number of movable internal compartments, each of which contained the article to be sold. Access was obtained to one of the compartments by a door, the catch of which was freed by the coin mechanism in the following way: The coin falling down a chute was caught on the end of a pivoted lever, and opposite said end was

a spring-controlled push rod operable from the outside of the casing. On pushing the rod, its end engaged the coin and moved the lever, so that its other end operated to free a spring latch holding the door closed. This invention was also noteworthy in providing means for closing the coin slot during operation, and preventing the machine being operated by the use of a coin less than normal weight, the latter being accomplished by means of a weighted and pivoted lever, the one end of which projected into the coin slot, so that unless the coin was the proper weight it could not overbalance the lever and pass down the chute. This arrangement is now commonly employed in up-to-date machines.

**A Machine for Articles in Packets**  
In the annexed drawing, Fig. 1 shows the essentials of a machine about this period for selling matches and other packeted articles. The packeted articles (A) are piled one above the other in a casing (B), at the lower part of which is a slide (C), adapted to be withdrawn by a handle (C<sup>1</sup>). The slide (C) is formed at its front part with a recess or drawer to receive one of the articles (A) which are fed down by gravity. The under side of the slide (C) is formed with a notch and an inclined portion (C<sup>2</sup>) adapted to be engaged by the top end of a spring-controlled vertical sliding rod (D). To the lower end of the rod (D) is pivoted a coin pan (D<sup>1</sup>) adapted to receive a penny from the chute

## A Machine for Articles in Packets

movement and weight of the coin momentarily depresses the lever, causing its forward end to push up the slide (C) and with it the cigarette above it. The cigarette then rolls over the stop (B<sup>1</sup>) into a tray (B<sup>2</sup>) situated on the outside of the casing. In Fig. 3 is shown another method in which the coin is utilised to actually contact with the goods to deliver them. The packeted goods (A) are piled vertically in a casing (B), the lowermost one resting on side flanges (B<sup>1</sup>). A spring-controlled slidable push rod (C) is slotted at its inner end to receive a coin (X) as it emerges from a chute (E). On pressing in the rod (C), the top part of the coin engages the edge of the article and pushes it out into a delivery shoot (B<sup>2</sup>). At the end of the travel of the rod, the slot carrying the coin coincides with a slot (D) and falls through into a coin receptacle.

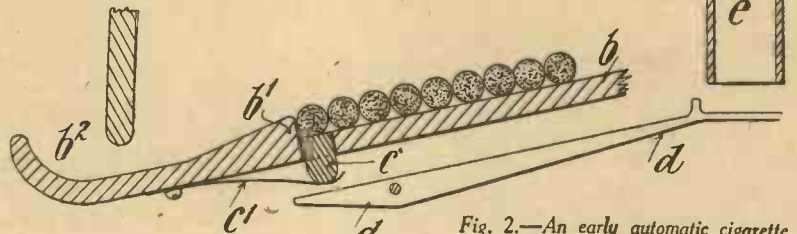

Fig. 2.—An early automatic cigarette machine.

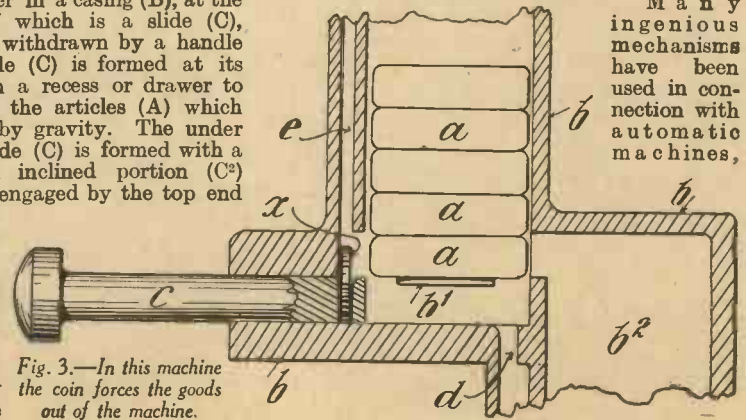

Fig. 3.—In this machine the coin forces the goods out of the machine.

(E). The weight of the penny is just sufficient to overcome the strength of the spring holding up the rod (D) and so moves it down, causing its upper end to become disengaged from the notch in the slide. On pulling out the slide (C) by its handle (C<sup>1</sup>), the article may be removed and the movement of the slide causes the rod, by contact with the incline (C<sup>2</sup>), to move still lower, whereupon the end of the pan (D<sup>1</sup>) engages with a fixed stop (F) which causes the pan to tilt and deposit the penny into a receptacle. On pushing home the slide, the rod, freed from the weight of the penny, is returned by its spring and re-engages or locks the slide in its original position ready for the machine to be again operated.

## The Cigarette Machine

Fig. 2 shows a machine of about the same period (1885) for delivering one cigarette at a time. The cigarettes are fed downwardly by gravity on an inclined plane (B) against a stop (B<sup>1</sup>). Below the cigarette in contact with the stop and working through a slot in the plane (B) is a transverse slide (C). This slide is held in its normal position shown by a leaf spring (C<sup>1</sup>). Underneath the plane (B) is pivoted a lever (D), the one end of which is immediately below the slide (C) and the other end is adapted to momentarily hold a coin passing down a chute (E). The

Many ingenious mechanisms have been used in connection with automatic machines,



varying with the objects in view, some so complicated as to be beyond the scope of the present article, for instance, the machine for automatically taking and delivering photographs, which machines by the way are not really a novelty, since in 1887 a patent was granted for a machine which automatically took, developed, and delivered a photograph in exchange for a coin. Automatic machines in which a series of photographs are displayed in rapid succession to give a kinematograph effect have long since been popular, and one of the earliest machines for displaying a single picture in return for a penny was patented in 1886. This machine comprised an eye slot opposite to which was the picture, and the eye slot was normally obscured by a shutter attached to a pivoted lever. The lever was overbalanced by the insertion of a penny, and, on rocking, moved the shutter away from the eye piece. On the lever reaching its lowest position, the penny was deposited into a receptacle, and in its upward movement, a pawl on the lever engaged a ratchet wheel which rotated a toothed wheel gearing with a pinion on which a fly was mounted so that the return movement of the lever was delayed.

#### The Weight of the Coin is Unimportant

As before mentioned, the majority of the early machines relied on the weight of the coin for operation, whereas now it is usual to employ the coin as a means for clutching together parts of the mechanism, for

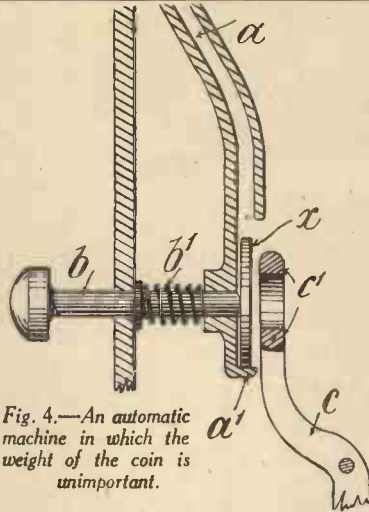

Fig. 4.—An automatic machine in which the weight of the coin is unimportant.

instance, in one such mechanism, see Fig. 4, the coin chute (A) terminated in a lip (A') to provide a temporary resting-place for the coin (X). A slidable rod (B) operating against a spring (B') had its inner end opposite the coin (X) in its temporary resting position, and opposite said end was fixed a lever (C) having a ring-shaped termination (C'). The other end of the lever was connected to any suitable mechanism for operating the locking means of the machine.

It will thus be seen that the end of the rod (B) was free to pass through the lever with-

out operating it unless the coin (X) formed an abutment; the coin after operating the lever (C) was pushed off the lip (A') into a coin receptacle. In other like mechanisms, the coin forms a connection either between two slotted ends of two aligned shafts or between two slotted discs.

In a recent machine of delivery of towels, the latter mechanism is employed. The towels are, without any wrapping or covering, piled one above the other, and on insertion of a coin, a handle, fixed on a spiked drum, can be rotated, so as to cause the spikes to engage the under surface of the lowermost towel of the pile and peel it off into a delivery chute.

#### How Bad Coins are Returned

In all present-day automatic vending machines, provision is made for obstructing the coin slot when the machine is emptied of the articles to be delivered, and many ingenious and varied mechanisms are employed to prevent the machines being operated unless the correct coin is inserted. This is of particular importance when the coin necessary to operate the machine is of a relatively high value, such as sixpences or shillings, for cigarette machines, gas meters, and like machines. To obviate a smaller coin than is intended to operate the machine it was usual in the earliest machines to make a hole in the coin chute fractionally smaller than the proper coin, so that a smaller coin on passing down the chute fell through the hole without causing the machine to operate.

**A**NYONE who has spilt methylated spirit or some such volatile liquid on his hand knows full well that, as the liquid evaporates, the hand becomes surprisingly cold.

The method of producing a cooling effect by the evaporation of a liquid is applied in most homes to-day without a full understanding of the phenomenon. The simple and effective earthenware coolers for butter or for milk are widely used, and depend for their efficacy on the fact that the constant evaporation of the water with which the porous earthenware is saturated, abstracts heat from the cooler and its contents.

#### Latent Heat

For a fuller understanding of this, it is necessary to appreciate the meaning of the term "latent heat." Normally, when heat is given to any substance its temperature rises. If however, that substance is in the process of changing from the solid to the liquid state, or from the liquid to the gaseous state, the temperature remains unchanged until the transformation is complete. Yet in order to produce this change of state, heat must be continually absorbed by the substance.

Since the presence of this heat fails to raise the temperature, it is known as latent heat. The term "latent" may be taken to signify hidden or dormant heat. Although it is absorbed by a substance changing state, this heat does not make itself evident until the reverse change of state occurs. For example, when a vapour turns back to a liquid or a liquid to a solid, the latent heat is given off again. This accounts for the comparative warmth which is sometimes noticed after a heavy fall of snow. The change from the state of vapour to solid is accompanied by the evolution of considerable heat.

During the change from the liquid to the gaseous state, the molecules of the substance are driven much further apart. To do this against the mutual attraction which they have for each other, energy is needed, and

## COOLING BY HEAT

By S. Boocock

this is supplied by the latent heat which the substance absorbs.

#### Some Practical Applications

When the thin film of water, which is spread throughout the pores of an earthenware butter cooler, evaporates, it absorbs the required latent heat from the cooler and its contents. The amount of heat absorbed in this way will be more readily appreciated if it is realised that it needs almost five and a half times as much heat to convert boiling water into steam at the same temperature, as it needs to raise the temperature of the same quantity of water from the freezing point to the boiling point.

The same principle is employed in keeping water cool in camp. A canvas water bag sweats, and the evaporation of the moisture

A simple experiment with ether.

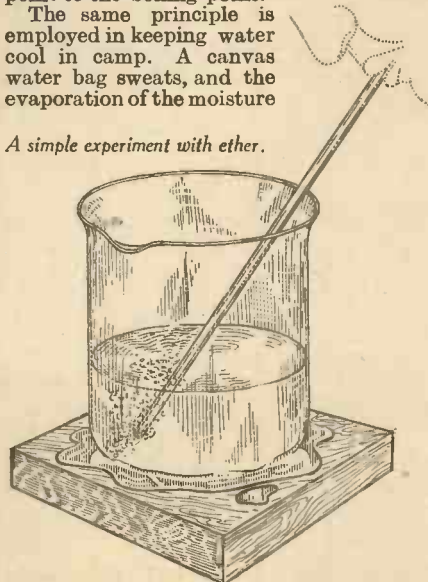

covering the bag keeps the contents cool.

The practice, sometimes adopted, of covering perishable food or a bottle of milk, for example, with a wet cloth having its ends in water is effective. The constant evaporation of the water from the pores of the cloth abstracts the necessary latent heat from the food, thus keeping it cool.

#### A Simple Experiment

To gain a clearer appreciation of the effect of rapid evaporation, obtain some ether and by evaporating it, freeze some water in the following manner. Pour a little water over a flat piece of wood and stand a thin, glass beaker on it. Partly fill the latter with ether, and by blowing into it with a glass tube, rapid evaporation will be obtained. The sides of the beaker will soon take on a misty appearance owing to the condensation of the water-vapour in the atmosphere, and finally, unless the bottom of the beaker is too thick, it will be found that the wood and the beaker have become frozen together.

Refrigeration in its many forms has for its basis the fact that when the molecules of a substance are caused to separate further, work must be done against their mutual attraction, and as before stated, this work is performed by the heat energy. For example, the evaporation of liquid air or liquid ammonia (not ammonia solution) will produce intense cold.

Another method of refrigeration is to allow a gas which is under considerable pressure, to expand by passing it into a region of low pressure. The expansion, that is the movement of the molecules away from each other, requires work to be done against their attractive forces. As in the case of evaporation, the energy for this is abstracted from neighbouring objects in the form of heat, thus cooling them.

It is interesting to note that the elaborate methods of refrigeration employed in ships' holds, butchers' shops, warehouses, etc., are identical in principle with the method of cooling milk by a cheap earthenware cover to fit over the bottle.



# Tools and Accessories For the Aero-Modellist

By D. A. Russell, A.I.Mech.E.

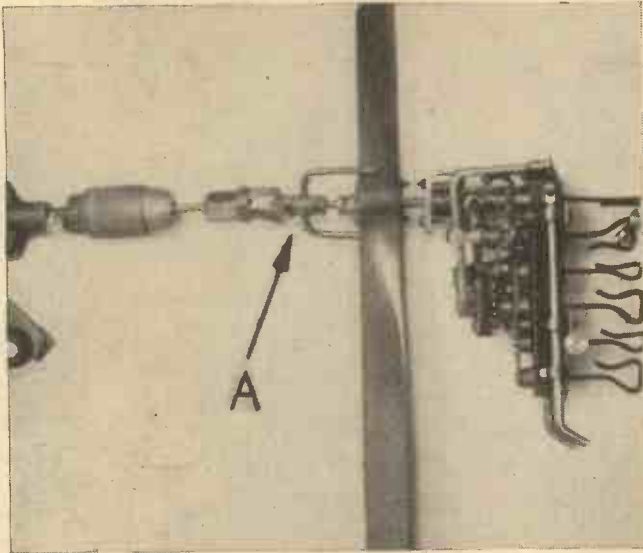

Fig. 1.—A side view of a 6-spindle unit described below.

IN the construction of medium and large-sized model aircraft, it is essential that the wooden framing of wings and fusilages should be nailed together; for not only are, say, one hundred  $\frac{1}{8}$ -in. nails lighter in weight than one hundred dabs of glue, but by their use a definite anchorage, under pressure, may be obtained.

The difficulty of handling very small nails is one which perhaps has discouraged their use by a certain number of aeromodellists—but with the aid of the tools here described rapid manipulation of nails of the smallest size can be accomplished with ease.

In Fig. 2 is a light tapered pair of pliers—the points of which have been turned up at an angle of 30 degrees. These are used for picking up and inserting nails into previously made holes, or for just “jabbing” them into the wood so that they stick. The sketch also shows how the nail is held in the pliers. To obtain a good grip, the nail must lie at right angles to the edge of jaws, and therefore the nose is bent up to enable the pliers to lie at an angle to the surface of the work, to give clearance for the operator’s fingers.

### Clinching Nails

The pliers shown in Fig. 4 are of a heavier type, and are used for clinching the nails up tight. As the ridges have been filed off the two gripping surfaces, no imprint is made on the wood being gripped. It will be found that the faces can only be parallel for one given gap opening; therefore it is advisable to have two pairs in use, one for a thickness of, say,  $\frac{1}{8}$  in. and the other for a thickness of  $\frac{1}{4}$  in. Reference to Fig. 4 will make this point clear.

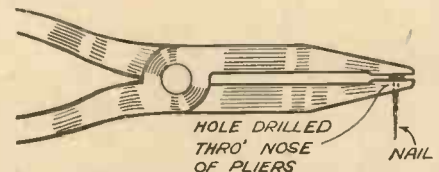

Fig. 3.—Pliers used for pushing long nails through a joint. The nail is pressed into place with the thumb, and pushed home with the pliers.

In Fig. 3 is shown pliers for pushing long nails through a joint, when it is intended that the end shall project through the wood and be turned over and clinched up by the pliers shown in Fig. 4.

A  $\frac{1}{8}$  in. diameter hole has been drilled through one jaw—allowing the end of the nail to pass through without being damaged.

It will be noticed that in each type of pliers used a “gap” has been formed between the two jaws, from the hinge to the

Fig. 2.—Pliers used for picking up and inserting nails into previously-made holes.

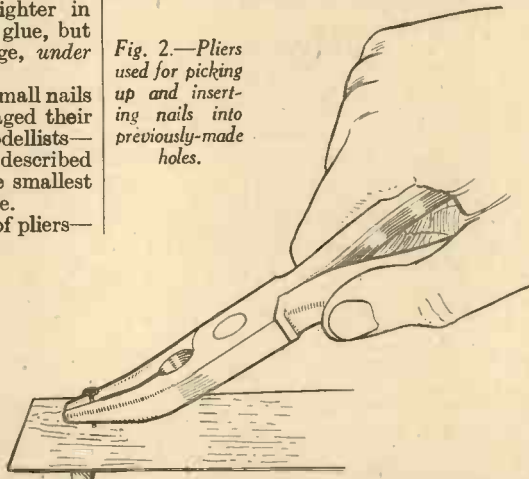

nose. In the case of the second pair, this has been done by grinding, and in the case of the two light pairs, by carefully heating and bending to shape.

The purpose of this gap is to allow the pliers to operate at some distance in from the edge of the material, and also to “form round” any intervening frame work, without damaging it, as shown in Fig. 5.

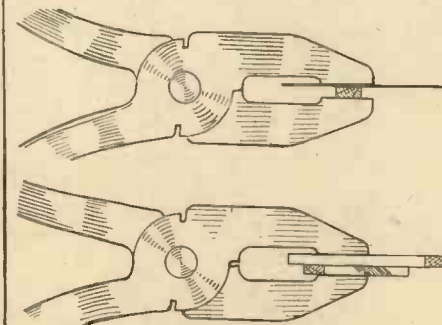

Fig. 4.—Pliers used for clinching nails up tight.

With the use of such tools it is possible to “nail” into strips of wood only  $\frac{1}{16}$  in. wide; and by clinching up tight with the second pair the heads of nails can be pressed flush into the surface of the wood, which cannot, of course, be done with a hammer.

### Multi-Spindle Motors

Rapid interchangeability of parts, such as gear-wheels, spindles, and airscrews, is a very useful feature in large multi-spindle motors, and by the introduction of certain parts all these features can be built into a very strong and easily made motor.

Fig. 1 shows a 6-spindle unit which incorporates ball thrust bearings to each spindle, and, in addition, roller bearings to the airscrew spindle, a dog clutch for holding the motor when wound up, and an automatic brake for stopping the motor as soon as the machine lands or hits an obstacle.

Six gear-wheels, at  $\frac{1}{2}$ -in. centres, are mounted between two bearing plates; the back plate being turned through a right angle, brought forward, and turned down to form a further bearing for the airscrew shaft. Each gear-wheel is mounted on a short length of spindle, into one end of which has been screwed and soldered a piece of bicycle spoke bent to form a hook.

The spindle is 0.156 in. diameter, and seven  $\frac{1}{8}$  in. diameter balls just fit round it, and are enclosed in a cage  $\frac{1}{2}$  in. wide, made from parting off a thin ring from a piece of tube.

At the forward end of the airscrew shaft, and fixed by means of bolts to the above-mentioned extension of the main motor frame, is fixed another cage— $\frac{1}{2}$  in. long. This contains seven silver steel rollers—a trifle under  $\frac{1}{2}$  in. long, which provide a suitable bearing to take the radial thrust of the airscrew.

Also on the airscrew shaft are two “dogs” forming a clutch, one dog being anchored to the shaft by the usual grub screw, the other being held between the jaws of a fork to which is fixed a lever, tensioned by a spring, so arranged to keep the dogs out of engagement. When the motor is wound up the dog clutch is engaged, and the side thrust imposed by the strain of the motor is sufficient to keep the dogs in engagement, thus holding the motor.

(Continued on page 704)

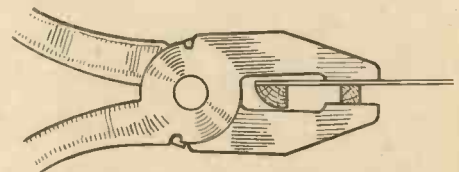

Fig. 5.—The gap between the jaws enables the pliers to operate over intervening framework.

# WIRELESS BOOKS



**Till September 30** In order to introduce our standard and popular wireless books to the widest possible public we are arranging, till September 30 only, to give away on the conditions stated at the foot of this advertisement copies of the famous humorous text-book on the subject, "Wireless for the Man-in-the-Moon," entirely free. Here is an opportunity of adding to your technical library a book of real permanent value from the practical man's point of view as well as one of the most delightful pieces of light literature in the field of Wireless. **FREE**

## FOR EVERY ENTHUSIAST

Below is a list of first-class and authoritative volumes on every phase of Wireless, detailed, comprehensive and up-to-date, and written by acknowledged experts. Many of these are already used for constant reference by the leading exponents both amateur and professional, but they have been designed and written to appeal to the man who knows nothing of the subject as well as the experienced "fan."

### WIRELESS CONSTRUCTOR'S ENCYCLOPEDIA

By F. J. CAMM (Editor of "Practical Wireless"). Third Edition.

5/- net, post free 5/6

Wireless Terms and Definitions stated and explained in concise, clear language by one of the best-known and most popular designers and writers of the day. Profusely illustrated. A veritable treasury of wireless knowledge and literally invaluable to all who are interested in the science whether as amateurs or experts.

### NEWNES' TELEVISION AND SHORT-WAVE HANDBOOK

By F. J. CAMM

Only 3/6 net, post free 4/-

EVERYTHING ABOUT—Drums, Mirror Screws, Scanning Discs and other Scanning Systems, Neon Lamps, the Cathode Ray Oscillograph. How to build Short-Wave Receivers; How to build Ultra-Short-Wave Receivers, straight and superhet. types.

### FIFTY TESTED WIRELESS CIRCUITS

By F. J. CAMM

2/6 net, post free 2/10

Modern circuits of practically every type of receiver from crystal to superhet. With diagrams and instructions for assembling and wiring, details of components and notes on operation.

### WIRELESS STEP BY STEP

By "DICTRON." Tenth Edition.

2/6 net, post free 2/10

The fact that this little handbook has reached its 10th edition is evidence of its undying popularity . . . and that again is convincing proof of its successful handling of the subject with which it deals.

**FREE**



**This Book** published at 2/6 net, will be sent free and post free to every purchaser of a book or books from the above list to the value of not less than 5/- net.

It is a book which no one interested in Wireless can fail to enjoy—mark your order "Mechanics Wireless Offer," and post without delay.

Book Department,  
**GEORGE NEWNES, LIMITED,**  
 8-11, Southampton Street, Strand,  
 London, W.C.2.

**TAKE THIS CHANCE NOW!**

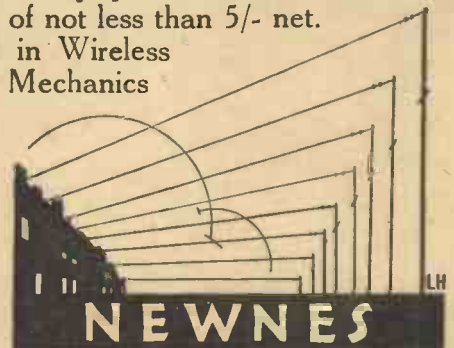

### THE OUTLINE OF WIRELESS

By RALPH STRANGER. Over 800 pages. Fully illustrated.

3/6 net, post free 9/3

*World-Radio*: "Step by step, line by line, precept by precept, it teaches you everything you want to know about wireless."

### THE ELEMENTS OF WIRELESS

By RALPH STRANGER

3/6 net, post free 3/11

The whole working of wireless receivers made clear to all.

### WIRELESS THE MODERN MAGIC CARPET

By RALPH STRANGER

3/6 net, post free 3/10

Instils information in an easy and pleasant manner.

### THE MATHEMATICS OF WIRELESS

By RALPH STRANGER

5/- net, post free 5/5

A simple introduction to arithmetic, algebra, geometry, trigonometry and calculus as they affect wireless calculations. 256 pages. Fully illustrated.

### DICTIONARY OF WIRELESS TERMS

By RALPH STRANGER

2/6 net, post free 2/10

A valuable synopsis of technical terms that everybody can understand.

"If you want a really gorgeous 'text-book,'" says the *Manchester Evening News*, "read **WIRELESS FOR THE MAN-IN-THE-MOON.**"

And writing about the same book and its authors, the *Midland Daily Telegraph* says, "They succeed in imparting a real knowledge about Wireless. It is both good fun and sound theory." Consult the above list and send in your order to-day.



# Hints ABOUT Hobbies

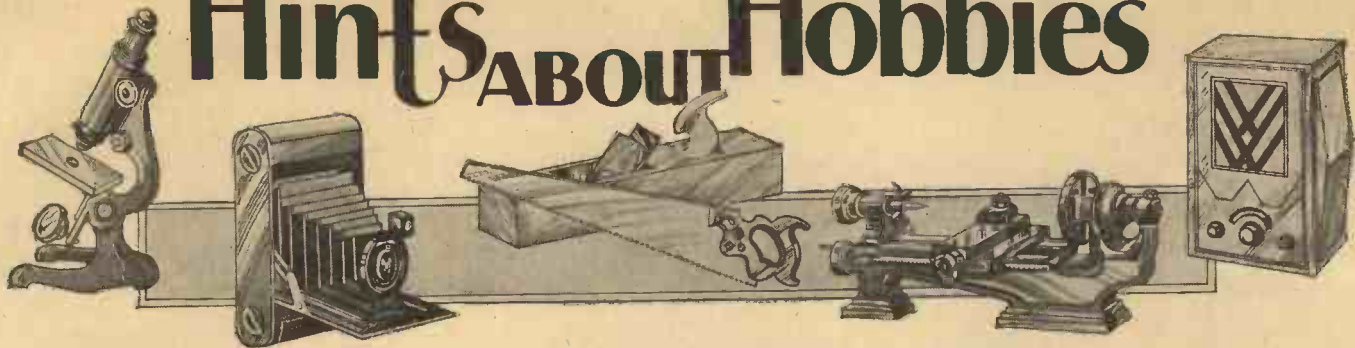

## A Useful Door Lock

A GOOD deal of attention is paid to the security of the majority of house front doors. Mortice locks and double-locking tumbler types being often standard fitments whilst the kitchenette or back door is rather neglected in this respect.

The drawing shows a method by which an ordinary slide bolt can be made quite secure.

Two holes are drilled into the slide of the lock so as to take a padlock. This prevents

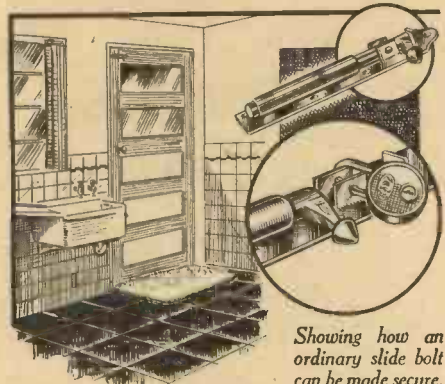

Showing how an ordinary slide bolt can be made secure.

the bolt being withdrawn unless the padlock is removed first. The padlock shown in the sketch can be obtained from a well-known store, price 6d.

## A Hammer Hint

THE addition to your claw hammer of a dome-shaped piece as shown in the accompanying sketch will add greatly to its efficiency when used as a nail extractor.

The dome may be of hardwood or metal (the end of an old bradawl handle will serve if the former is chosen), but for wearing qualities the writer recommends the metal dome piece.

This is obtained by sawing off the head of

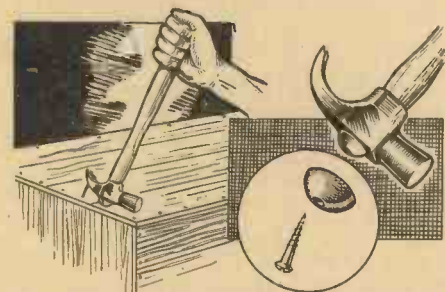

By fitting a dome-shaped piece of metal to the head of the hammer as shown it will add greatly to its efficiency as a nail extractor.

a round-headed carriage bolt and then drilling through the centre to take the fixing screw. R. Nold (Ilford).

## THAT HINT OF YOURS

Every reader of PRACTICAL MECHANICS must have originated some little dodge which would be of interest to other readers. Why not pass it on to us? For every item published on this page we will pay 5s. Address your envelope to "Hint," PRACTICAL MECHANICS, George Newnes Ltd., 8-11 Southampton Street, W.C. Put your name and address on every item. Please note that every hint sent in must be original.

## Sweeping a Chimney

A REALLY efficient chimney-sweeping set can be made out of 3-ply at a cost much below that of any marketed set. Obtain a piece of  $\frac{1}{8}$ -in. 3-ply, 3 ft. 6 in. or 4 ft. long and cut a number of 2½ in. strips from it to meet with your requirements.

A 9-in. lap should be allowed, and the ¼-in. bolt holes should be drilled 1½ ins. from the end of the strips, the two holes being 6 in. apart. Keep the drilling standard, in order to facilitate assembly.

A circular brush, such as may be purchased for 6d., is secured with wire to the end of one section and ¼-in. bolts 1 in. long (under head) are used for coupling the strips. G. W. Arnold (Essex).

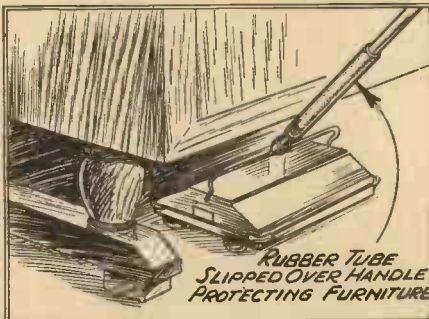

Protecting furniture from damage against knocks from a carpet sweeper.

## Protecting Furniture from Drainage

CONTINUAL knocking of the handle of a sweeper, broom, etc., against the edge of heavy furniture will soon disfigure it.

By slipping about 12 in. of rubber tube over the handles of all the cleaning implements in the house this little difficulty can be eliminated.

(T. H. Skinner (CityRd., E.C.1).)

## A Useful Lathe

A VERY useful lathe can be constructed from the hub and spindle of an old cycle front wheel. First remove all the spokes and clean and oil the hub thoroughly. Then mount the hub on a hollowed block of hardwood as shown in the drawing, securing it with nails through the lower spoke holes. Fix a small pulley on the left-hand side by means of the nut and washer, and screw a length of ¼-in. or 1-in. board to the bottom of the block. The board may be

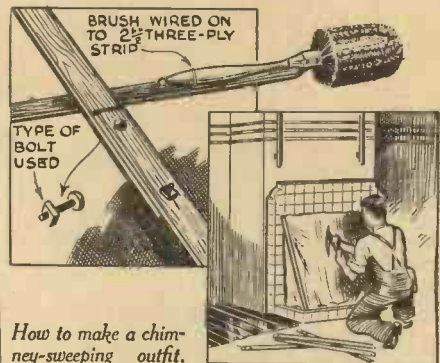

How to make a chimney-sweeping outfit.

any convenient length, as will be seen in the sketch. On the right-hand side of the spindle an emery wheel may be fitted by means of the nut and washer. The mechanical mind will readily be able to devise various chucks and contrivances for machining small parts. The spindle could be driven by means of a sewing-machine treadle, or by fixing a wheel under the bench and clamping the tool to the bench. If the board used is about 2 ft. long, and another block of wood with a long bolt passing through adapted for a tail stock, the whole makes a useful small lathe. The tail stock can be made movable by means of a bolt or thick wood screw passing through the board from underneath. Three

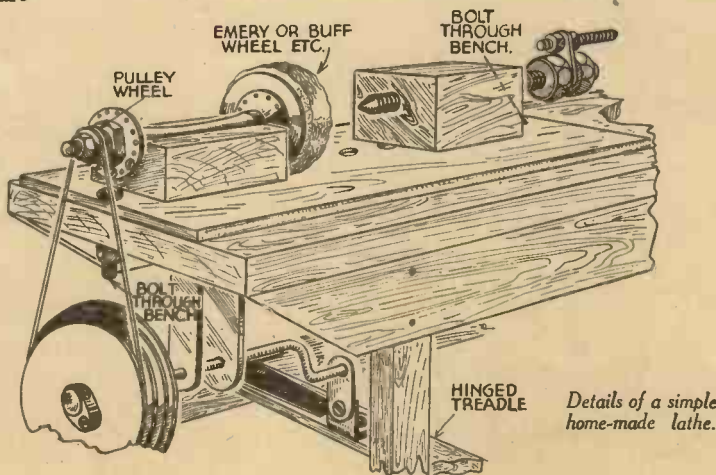

Details of a simple home-made lathe.



or four holes bored in the board gives different positions. A small tool rest completes the lathe. S. Wheatley (Kent).

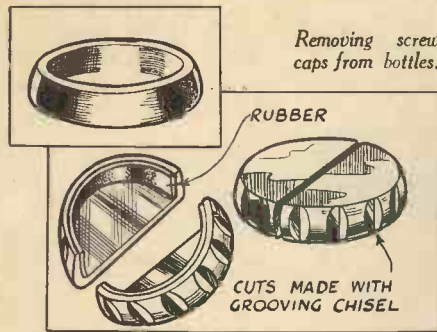

#### Removing Screw Caps from Bottles

**T**IGHT-fitting screw caps on bottles and jars are often the cause of much waste of time and sore fingers: in most cases the grip or milling on the cap is insufficient to obtain a really firm hold.

### THE LATEST IN RAILWAY MODELLING

(Continued from page 693)

tracks. But this arrangement does not always follow; passenger traffic may be much heavier and more frequent than a merely local goods traffic. In planning a model layout other determinants will, of course, influence the question; it will be largely a matter of convenience. But it may well be imagined that the flying- or burrowing-junction is a great help in model railway work, where space is always at a premium, and where distances between one place and another are necessarily short. It will also be clear that the subject involves the related one of gradients. In real practice a flying-junction demands a quite considerable length of track in order to secure the necessary rise; and this will also apply to a model. But there is a happy method of getting over this difficulty and of cutting off 50 per cent. of the length required. That is the very simple expedient of defiling the main lines and raising the branch, or vice versa. This means the difference in levels is divided equally, or proportionately if desired, between the main and branch lines. Nor does it follow that a flying-junction necessarily "flies." The one in the photo (Fig. 6) is an example on the West Midland Railway, in which the branch line certainly passes over the mains, but in which the main line takes the "burrowing" direction, the fly-over being on the level all the way.

A special form of bridge is brought into use for flying-junctions, as there is necessarily no space, particularly in a model, for a right-angular crossing. The bridge itself must therefore be set at a skew, and the sketch (Fig. 7) gives a very interesting example of such a bridge recently erected in which the design is somewhat unusual. The peculiar "unbalanced" appearance of the girders is here necessitated by the excessive angle of the skew. It will be noticed also that the wing-walls are considerably elongated on opposed sides of the earthworks. It should be the aim in planning such a fly-over in model layouts to keep the two tracks as closely parallel to one

The illustration shows a useful gadget which can be very easily made from a hardwood castor and an odd piece of rubber inner tube.

Cut a strip of the castor out so that the two halves form an oval when placed together. Next secure with rubber solution a strip of rubber inner tube inside each half and finally flute the outside of the castor with a grooving chisel.

#### A Soldering Hint

**I**HAVE taken up astronomy as my hobby, and in my free time I have built an 8-in. reflecting telescope. This work has required a great deal of soldering. Some of the joints were at very difficult reflex angles, and I found it most difficult to make the solder run evenly into the joint. I found a very good way, however, to overcome this difficulty. Clamp your soldering iron into a vice, then take a  $\frac{1}{4}$ -in. drill and make a shallow hole in the middle of the iron. Now, with a three-cornered file, file a V-shaped groove from the point of the iron to the edge of the hole. When using the iron

place the bar of solder in the shallow hole and it will be found that the solder will run

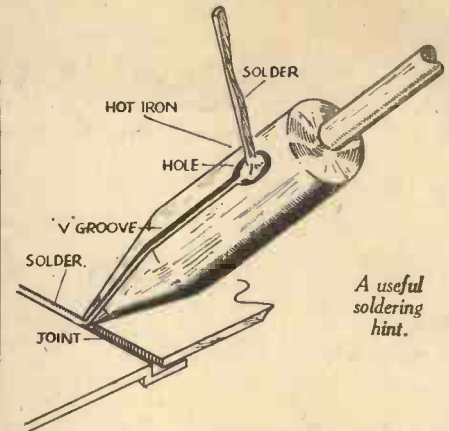

down the V-shaped groove into the joint (shown in the enclosed drawing). H. Goulding (Sussex).

another as possible, while allowing for the amount of space to give a clear run-way for vehicles passing under the bridge. Notice also the perpendicular abutments and sloped wing-walls according to practice. Concrete is very frequently used on new bridges of this type, girder-work, of course, being in steel.

There are all manner of arrangements for tracks at a flying-junction, according to the demands of the site and road-arrangements, and in model layouts there may be additional variations, according to the requirements of compactness and so forth. Fig. 11 makes clear some of these possibilities. And the introduction of a fly-over or burrow-under will be found useful and interesting in a score of situations, most especially where a pair of main-line roads diverge from a continuous run into a terminus station. Points and signals on a model lay-

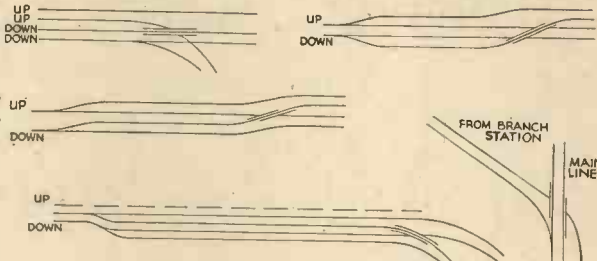

Fig. 11.—Arrangements of burrowing- and flying-junctions.

out should be avoided wherever possible; there are so many places at which they are essential, and this useful expedient may often make this avoidance practicable.

#### A Burrowing Crossing

Figs. 8 and 9 give an idea of the arrangements for a burrowing crossing. This type of defile would be necessary, say, in the case of a quadruple track in which the two "up" and the two "down" roads were adjacent to each other. The "up" branch would then pass underneath the "down" main, and would come up alongside the "down" branch at a point farther ahead, to which the latter here begins to turn out. A scaled drawing for the construction of such a tunnel is given in Fig. 7, and is very simple to construct. Here the baseboards consist of  $\frac{3}{4}$ -in. floor-boarding, in which a slot is cut for the incline. The defiling baseboard might be suspended on brackets formed by bending Meccano strips to shape and fixing

these in place with screws, the sides of the incline being boarded with fretwood covered with engineer's blue-brick paper. A similar portal would, of course, be required just on the other side of the crossing for the up-grade.

### TOOLS AND ACCESSORIES FOR THE AERO-MODELLIST

(Continued from page 701)

When ready for launching, a slight easing of the pressure allows the spring to disengage the clutch and release the motor.

The brake consists of two chain sprockets, arranged "back to back" on the fourth spindle from the top—which is longer than the other spindles. Ferodo is riveted to both sprockets—one of which is fixed to the spindles, and the other to the jaws of a fork and lever, similar to the dog clutch, but with a strong spring pulling the brake on. At the end of the brake-lever is a notch, which engages a lever from the landing gear. Before launching, the brake is pulled off and the lever engaged with the notch. Any shock due to landing or hitting an obstacle causes the lever to "trip" out of the notch, and the spring then pulls the brake on.

As the various grub-screws have not only to transmit drive but withstand the pull of the strands of rubber, they are all engaged with "countersinks" drilled in the various shafts.

Fig. 1 shows a side view of the unit, from which it will be noticed that a small chain sprocket is bolted to the front of the air-screw, thus enabling it to be securely fixed by the grub-screw to the shaft, the end of which is arranged to project beyond the sprocket and serve as a guide for the sleeve "A" of the universal joint of the winding gear.

This universal joint is made from  $\frac{3}{8}$  in. by  $\frac{1}{2}$  in. steel, the two U-shaped pieces being bolted to a collar. To one half of the joint is screwed and soldered a short length of steel rod which is engaged in the drill chuck, whilst to the other half is fixed the sleeve "A," through which passes the piece of rod bent to form the driving "prongs"—those, of course, being covered with rubber tubing when actually in use.

This simple arrangement provides an easily assembled winding gear with a ratio of 5 to 1.



## ARE YOU KEEN ON MODELLING ?

If so our "00" Gauge Scale Model Railways offer an entirely new sphere of interest, covering Trackwork, Rolling Stock, Locomotives; all types of Buildings, Bridges, and all Lineside Fittings, Electrical Sectioning, and Control of Trains—all this can be simply achieved at very reasonable cost.

Call, or write (sending 4d.), for our illustrated catalogue to :—

**HAMBLING'S** 26 Charing Cross Road, London, W.C.2  
TEM. BAR 4704

*A Screwdriver - a gimblet*



and the **Beacon** 456  
**CURTAIN RAIL**

is ready to hang your curtains

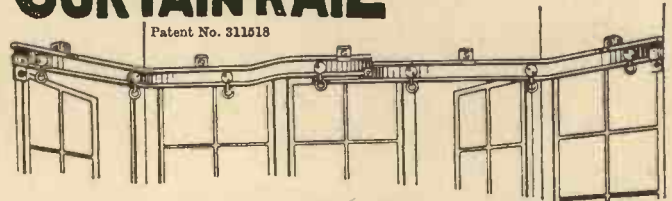

perfectly. Any handyman can erect. Fits all shapes of windows—square bays, round and oval.

Most fittings **SOLID CHUNKS OF BRASS** and whole system is a thoroughly sound job. Stands hardest wear—woodwork would have to give way first.

**IN FOUR QUALITIES.**  
Strong (Brass) ... 1/- ft.  
Light (Brass) ... 9d. ft.  
Steel (Rustproofed) ... 9d. ft.

White (Aluminium Alloy) ... 9d. ft.  
Complete with all fittings.

From all ironmongers. If any difficulty write for nearest stockist's name.

Beware imitations.

Any length cut to order

**SMITH AND DAVIS LIMITED**

8 TAMPED BRASSFOUNDERS  
HAMPTON ST., BIRMINGHAM

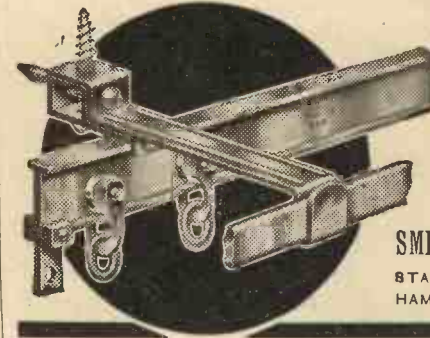

HE IS 35



AND LOOKS 60

HE IS 60



AND LOOKS 35

## BALDNESS BARS PROMOTION

### A MODERN MIRACLE

MEDICAL Science has at last discovered a simple method whereby the dormant hair follicles can be restored to **VIGOROUS LIFE**, enabling them to produce new and naturally coloured hair.

One delighted Client of 89½ who was bald for over 30 years reported that the "C.L.L." treatment produced a **FINE GROWTH OF NEW HAIR**. The ages of other equally grateful Clients range from 22 to 81. **MEDICALLY RECOMMENDED, £1,000 for denial.**

Write to-day for a copy of our Illustrated Book entitled "**HOW TO ACQUIRE PERFECT HAIR GROWTH.**" Post free privately from:—

**THE LABORATORIES (P.M.),**  
37 New Bond Street, London, W.1.

The **ONLY** cure in the world for Baldness endorsed by the Press and the **MEDICAL PROFESSION.**

## MICROSCOPES FOR ALL

### SPECIAL OFFER OF 4 MODELS

Each instrument has inclinable body, swing mirror, stage clips, and is nicely finished in Black Crystalline Enamel and bright Nickel Plating.

**SHARP DEFINITION IS OBTAINABLE and GOOD WORK CAN BE DONE**

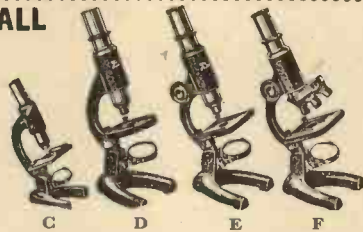

- |   |       |      |
|---|-------|------|
| Model C. Height 5½ in., sliding focus, magnification 25 × linear ..   | Price | 5/-  |
| Model D. Height 7 in., sliding focus, circular stage magnification 50 × linear ..   | Price | 9/6  |
| Model E. Height 7 in., rack and pinion focusing, magnification 50 × linear, square stage ..   | Price | 12/6 |
| Model F. Height 7 in., rack and pinion focusing, triple nose-piece, 3 lenses, magnifications 25 ×, 50 ×, 100 ×, in wood case, with set of Dissecting Instruments .. | Price | 30/- |

**IMMEDIATE DELIVERY FROM STOCK.**

**BROADHURST, CLARKSON & CO.**

Post Free in Great Britain.  
63 FARRINGTON ROAD,  
LONDON, E.C.1.

# engineering

Our **NEW ENGINEERING GUIDE** explains clearly how all the best jobs are secured. It shows how to obtain such money-making qualifications as A.M.I.C.E., A.M.I.Mech.E., A.M.I.W.T., A.F.R.Ae.S., etc. How to secure permanent, progressive and pensionable posts in the Government and Municipal Service, and describes numerous "Higher-pay Courses" in **CIVIL, ELECTRICAL, MECHANICAL, AUTO and AERO-ENGINEERING; TELEVISION, TALKIE-PICTURE WORK, etc.**

### SUCCESS—OR NO FEE

We definitely guarantee success. If you fail your examination, or if you are not satisfied in every way with our service, then your full tuition fee will be returned without question.

Write to-day for this remarkable publication and details of our employment service, etc.

**NATIONAL INSTITUTE OF ENGINEERING**  
(Dept. 29), Staple Inn Bldgs., High Holborn, London, W.C.1



## WIZARD POWER TOOLS

for the Cabinet Maker, Carpenter, Model Maker, etc.

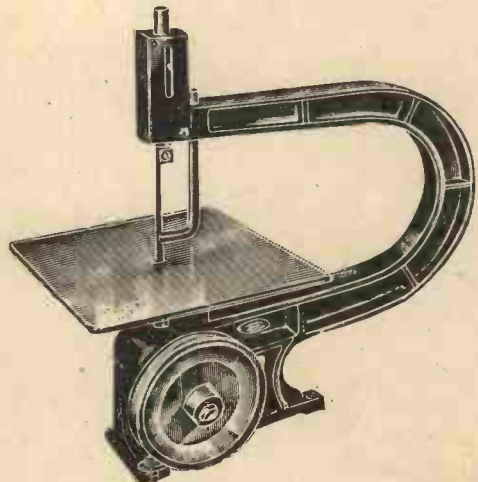

Illustration shows our No. 114 Jig Saw £4 5s.; Smaller Size £2 10s.

Write for illustrated priced catalogue No. 136C. of Jig Saws, Circular Saws, Band Saws, Lathes, Jointers, Shapers, Drill Presses, Grinders, Buffers, Sanders, Tools, and Accessories.

**WIZARD MACHINERY Co.**

13 VICTORIA ST., LONDON, S.W.1

Telephone: ABBEY 3018



# The LATEST NOVELTIES

The address of the makers of any device described below will be sent on application to the Editor, PRACTICAL MECHANICS, 8-11, Southampton St., Strand, W.O.2. Quote number at end of paragraph, and enclose 1d. stamp for the reply.

## For Amateur Photographers

If you are interested in self-photography, the device shown below can be fitted to cameras which are not already fitted with delayed-action devices. When fitted, it automatically presses the trigger and enables you to include yourself in the photograph. It is suitable for any Kodak camera fitted with a cable release. This "self-timer" as it is called, costs 6s. [197.]

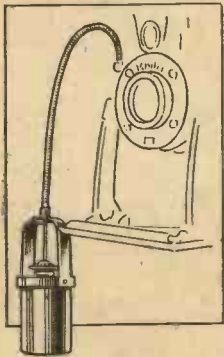

This device, when fitted to a camera, automatically presses the trigger and enables the photographer to include himself in the picture.

## The "Pifco" Rotameter

WIRELESS enthusiasts will no doubt be interested in the "Pifco" Rotameter, an efficient instrument suitable for testing out wireless apparatus. It is fitted with a moving-coil movement, has a resistance of no less than 500 ohms per volt, and, without any addition of external apparatus, it is capable of measuring resistances up to 200,000 ohms. Finished in black bakelite, complete with leads and fitted in a velvet-lined case, it costs £2 2s. [198.]

## An Electric Cooking Plate

AT the foot of this page is shown a small single-heat boiling-plate which can be used in a lighting circuit. It will be found most useful for boiling eggs, milk warming, etc. Due to its restricted size and loading, however, the plate is naturally not suitable for boiling large quantities of water. The device is finished in de luxe coloured porcelain enamel (mottled grey, green, primrose, or brown), and chromium plate. It is supplied complete with 6 ft. of three-core C.T.S. flex, is 4½ in. in diameter, and has a current loading of 450 watts. Priced at 17s. 6d. it will give 2½ hours' service for one penny. [199.]



This small electric single-heat boiling-plate is suitable for boiling eggs, milk, etc.

## Finding the Way

ONE of the keenest pleasures in travel is to always know by day or night the direction you are going. In connection with maps, a good compass adds much to enjoyment of a trip. In exploring nooks of the larger lakes and rivers, taking long hikes, making rough maps and sketches, a compass is invaluable. That shown on this page is suitable for installing in a car or boat and is extremely accurate. It is fitted with a special compensating neutraliser which counteracts the magnetic action of the

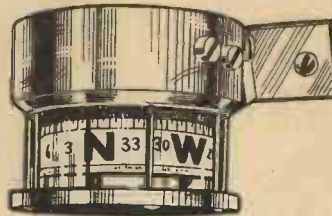

The Jones compass, which can be fitted to boat or car or can be carried in the pocket.

metal in the car. The figures on the compass are degrees, obtainable by adding a cipher to the figure that is given. North is 0°; east is 90°; south is 180°, and west is 270°. If the direction should be, for instance, the 24 mark near west, the direction would be 240°. The calibrations are five degrees each. The compass costs £3. [200.]

## A Weather Pillar

MOST readers know that air pressure, air temperature, air moisture, and the thereby resulting air currents (winds) produce the state of the weather, and cause the daily and even hourly changes. The weather pillar illustrated is a unique combination of instruments capable of measuring atmospheric changes in the air. A barometer is fitted in the base of the chromium-plate case and measures the air pressure. By means of an adjustable indicator the changes from one reading to another can be noted with accuracy. Arranged in a novel way in the

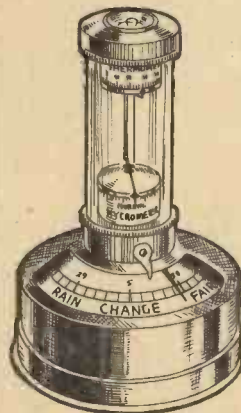

This weather pillar incorporates in its design, a barometer, thermometer, hygrometer, and a compass.

top part of the glass cylinder is a thermometer with a pointer to measure the air temperature.

A hygrometer is fitted in between these two to ascertain the amount of moisture in the air, and finally a compass is incorporated in the top of the pillar to determine the direction of the wind. A table is provided underneath the instrument, explaining the principal rules for determination of the coming weather. The "Luft" weather pillar, as it is called, costs 70s. [201.]

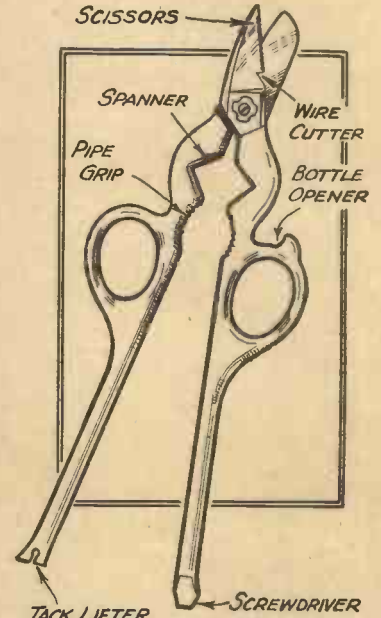

An ingenious pair of multi-purpose scissors.

## Multi-Purpose Scissors

FROM time to time in these pages, we have reviewed multi-purpose tools of various kinds. The sketch on this page shows an ingenious pair of scissors which unincorporates in its design, wire cutters, a spanner, a bottle opener, a pipe grip, a screwdriver, a tack lifter, and one blade has a serrated edge which enables the scissors to obtain a powerful grip. Made of Sheffield steel, the scissors are guaranteed hand ground and cost 5s. post free. [202.]

## Electric Towel Rails

THE towel rail illustrated below is finished in chromium plate and is fitted with a 200-watt tubular heater in a black vitreous enamel casing. It is supplied in two types—one for wall mounting and the other for floor mounting. The latter has a double rail at the top. An adequate guard is fitted over the heating element and each type is supplied complete with chromium-plated fixing screws. The wall pattern costs £2 18s., and the floor pattern £5 15s. At one penny per unit these rails can be used for five hours for one penny. [203.]

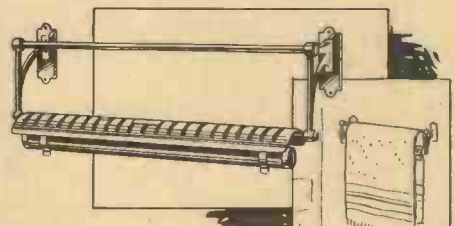

An electric towel rail.

(Continued on p. 709)



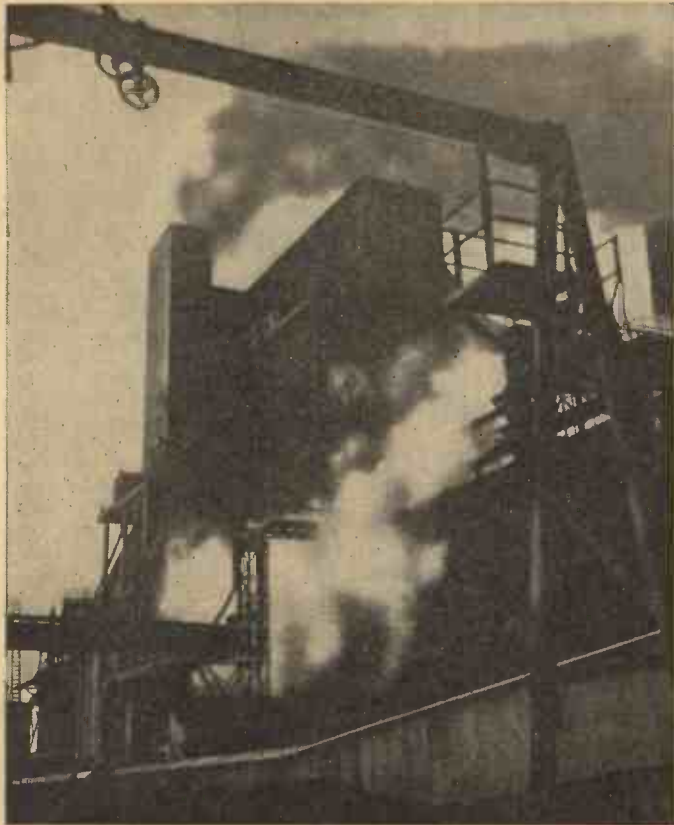

Where gas is obtained from coal.

# GAS LIGHTING

By A. MILLWARD

## Obtaining Lighting Gas from the Destructive Distillation of Coal

**L**IKE many other epoch-making inventions, the invention of lighting gas from the destructive distillation of coal is wholly a British invention.

Public attention was first directed to coal gas (carburetted hydrogen) by Thomas Sherley, or Shirley.

This discovery apparently remained dormant for about seventy years, until a letter addressed to Robert Boyle (the celebrated natural philosopher and chemist, author of *Boyle's Law of Gases* and who died in 1691) was published in the *Philosophical Transactions of the Royal Society* for 1739. This letter gave details of a series of experiments made by the Reverend John Clayton on the distillation of coal in a retort, showing how the inflammability of the evolved gases had been observed and how the gas had been actually collected and stored in bladders for considerable periods.

### First Use As Illuminant

The Reverend John Clayton, who was born in 1709 and died 1773, was the celebrated Jacobite divine. He was undoubtedly the first experimentally to use gas as an illuminant, gas distilled from coal, and was probably led to make his experiments by reason of a treatise entitled "Vegetable Staticks" by Dr. Stephen Hales.

About thirty years after the experiments of Clayton and Hales, we find Richard

Watson (1737-1816), who was afterwards Bishop of Llandaf in 1782, carrying out chemical researches and experimenting with carburetted hydrogen, which experiments, however, did not materially add to the sum of knowledge gained by the experiments of Clayton and Hales.

In 1787, Archibald Cochrane, ninth Earl of Dundonald, who was born in 1749 and died 1831, lit Culross Abbey with a gas he obtained from a coal-tar distillation process, but it was not until 1792 that William Murdock invented a practical method of gas illumination. William Murdock (afterwards known as Murdock in deference to the inability of the English to correctly pronounce the original spelling of his name) was born on August 21st, 1754 at Bello-mill at the junction of the Bello with the Lugar, near Old Cumnock, Ayrshire, not far from Auchinlech House, the home of James Boswell. His father, John Murdock, was a miller, farmer and mill-wright, being a mechanic or engineer of no mean order.

About this time (1777), a brother Scot, one James Watt, was attracting considerable public attention by his newly-invented "fire engine." Now as is known, Watt was originally in partnership with Dr. John Roebuck, a Birmingham physician, who had about 1760 formed the Carron Ironworks Company, and it was the Carron Ironworks that John Murdock employed for casting his gear wheels. In 1774, Roebuck was a

ruined man and Watt became a partner of Boulton, who owned the Soho Works at Birmingham, so that it is not surprising that young Murdock should be attracted to Birmingham and be desirous of entering the employment of Boulton and Watt.

### Murdock's Hat

Apparently Murdock, on arriving at the Soho Works, was interviewed by Boulton, who was not prepossessed by the appearance of Murdock, and he told him that the firm was not engaging new hands. When Boulton happened to notice Murdock's hat, however, which the shy and gawky lad was absent-mindedly twirling in his hands, it was so original that it aroused Boulton's curiosity, causing him to enquire what sort of a hat it was and where Murdock had obtained it. Murdock shyly explained it was made by him, being turned ovally from wood on a lathe which he had made. Boulton at once perceived that so ingenious a lad would probably be of service to his firm and so it happened that in 1777, at the age of twenty-three, Murdock entered the employment of Boulton and Watt at Soho Works, Birmingham, at the princely salary of 15s. per week. Murdock's ability was soon recognised, particularly by Watt, so much so that two years later, in 1779, he was sent by the firm to Cornwall to superintend the erection of Watt's engines for pumping the mines, and was the only



workman of the firm that could work amicably with the Cornish miners, particularly the "Captains," or the mine managers.

Murdock's almost-unparalleled loyalty and devotion to his firm, although only receiving 17s. per week when not employed at Birmingham, is borne out by the fact that when in Cornwall so highly was he appreciated by the mine owners that they offered him £1,000 per year to stay with them. It is not to the credit of either the firm, or to Watt, that such a conscientious, loyal and clever servant as Murdock proved to be, did not receive wages of more than £1 per week until he was forty-four years of age.

At Redruth in Cornwall, whilst in the employ of Boulton and Watt, Murdock carried out a series of experiments in distilling coal, which were so successful that in 1792 he was able to light his cottage and office with coal gas. He also constructed a portable gas lantern to light his way across the moors, for which purpose he fitted a bladder with a nozzle, filled the bladder with gas and expelled the gas through the nozzle, after lighting, by compressing the bladder under his arm in the manner of a bagpipe player.

#### A Prolific Inventor

Murdock was a prolific inventor and a mechanical genius, little inferior to his master, Watt. From 1781 to 1784 Murdock busied himself in his spare time in constructing several models of steam-propelled wheeled vehicles, from which circumstance he is credited in some quarters as being the inventor of the locomotive, but this is hardly consistent with fact. Murdock undoubtedly constructed and rode a steam tricycle in 1784 at Redruth. The actual tricycle was exhibited at the Exhibition of 1851 and is now in the Birmingham Art Gallery.

In connection with the above, it is worth noting that the "father of the locomotive," Richard Trevithick, who was the son of a Cornish mine "Captain," living near Redruth, when a boy of thirteen in 1784, often visited Murdock, and it is more than probable that the early steam tricycle of Murdock first aroused Trevithick's ambition to construct a passenger-carrying steam carriage, which he did at Redruth in 1801.

#### Watt's Vanity

Although Watt was an undoubted mechanical genius, he was vain and intolerant of the inventive abilities of others, which is fully borne out by his contempt for Matthew Wasborough, Moore, Patrick Miller, James Taylor and William Symington. Watt was undoubtedly jealous of Murdock's inventive ingenuity and knew of the experiments which Murdock was carrying out with his steam tricycle in 1781-1784, in which latter year Murdock was pressing Boulton and Watt to take him into partnership to manufacture his vehicles. In the same year, 1784, probably unknown to Murdock, Watt included in his Patent Specification for "improvements in steam engines," the specification of an engine to drive a wheeled carriage. Two years later, in 1786, Murdock wished to apply for a Patent for his steam carriage, at which suggestion Watt was extremely angry and wrote to his partner Boulton, asking him to make Murdock give up his experiments, as he, Watt, had already patented the idea "as well as words could do it" and was in fact, engaged in making "one of some size." With regard to this carriage, nothing further appears to be known and it is abundantly clear that Watt had nothing whatever to do with the subsequent success of the locomotive.

Murdock, early in 1781, invented the

"sun-and-planet" motion which was afterwards patented by Watt on October 25th, 1781. It may be that Watt, like many an employer-even to-day, considered that any invention of an employee *ipso facto* belonged to the employer. As Watt is always credited with the invention of the "sun-and-planet" motion, it may be worth while even at this late date to examine the position, and award the credit to whom it is due. It must not be forgotten that Murdock from his earliest years was conversant with toothed gearing, and it seems more than probable he suggested the motion to Watt at the time he was engaged in trying to overcome a rival's patent to the use of a crank in a steam engine. Although Watt included fully five ways of adapting a steam engine to drive a wheel, in his 1781 patent, yet the only one ever used was the sun-and-planet gear. Watt when taxed with not being the originator of this motion, replied that it was an old idea of his which had been "revived and executed by Murdock," but at a later date it is recorded by Samuel Smiles "at an interview which Mr. Parks had with Mr. Watt at Heathfield at which Murdock was present, Murdock spoke of the sun-and-planet motion as his own invention, which Watt did not contradict."

In 1785, Murdock married Ann Paynter, daughter of a mine "Captain," and lived at Cross Street, Redruth. In the same year, 1785, Murdock invented the first oscillating-cylinder engine, a model of which is now in the Science Museum at South Kensington. The actual engine was fitted in the *Endeavour* by Maudsley. He invented an iron cement (sal ammoniac and iron borings), which was extensively made and sold at the Soho Works, entirely displacing a cement attributed to Watt.

#### Numerous Patents

In subsequent years, he patented a paint, a double-D slide for steam engines, an air-blast engine, a pneumatic lift, transmission of parcels by compressed air, pneumatic bells, a steam gun, the manufacture of isinglass and a method of making stone pipes.

On a visit from Cornwall to the Soho Works in 1794, Murdock pressed Boulton and Watt to allow him to patent his invention, for the production and conduction of gas for illuminating purposes, but owing to the firm then being engaged in litigation in upholding Watt's steam-engine patent, they appeared to have lost faith in the protection afforded by a patent and the matter was shelved, so that this invention of Murdock was never patented.

The experiments by Murdock in coal gas lighting were laid aside for some years and revived in 1797, in which year he returned to his old home at Cumnock, where he started a foundry, erected gas making apparatus and publicly showed his invention. In the following year, 1798, he returned to Boulton and Watt and experimental apparatus was used to light the foundry of Boulton and Watt's Soho Works.

On Murdock's return to Birmingham in 1798, he was appointed general manager of the mechanical department of Boulton and Watt at a salary of £1,000 per annum, and although he was on the closest terms of friendship with both Boulton and Watt he did not become a partner of the firm until the business had passed to successors.

In 1802, the whole exterior of the Soho Works was lighted with gas in celebration of the Peace of Amiens (March 27th, 1802), and in the following year the foundry of Soho Works was regularly lighted with gas.

In 1805, the cotton mills of Messrs. Philips and Lee at Manchester were lighted

by gas from over 1,000 burners, and in the same year the Auldton Spinning Mills at Pollokshaws were also gas lighted. The gas was also used by certain tradesmen in Glasgow in the same year to light their shops.

#### Coal Gas Illumination

Some years previously (1801) a M. Le Blond or Le Bon, but probably Lebon, had carried out experiments in Paris on the dry distillation of wood, and with the gas so obtained, had lit up his house. These experiments became known to a Mr. Frederick Albert Wintzer or Winsor who was born in Brunswick in 1763. Winsor became keenly interested in Lebon's experiments and took active steps to introduce gas lighting on a commercial scale into this country, and subsequently in 1804, 1807, 1808 and 1809 obtained Patents in connection with the manufacture of coal gas.

In 1803, through F. A. Winsor's efforts the Lyceum Theatre, London, was experimentally lit with coal gas. Winsor was indefatigable in breaking down existing prejudices to the new form of illumination and trying to attract capital to finance his schemes, and in so doing, ran counter to William Murdock who rightly considered that the credit of the discovery of a practical form of coal gas lighting belonged to him.

In 1810, the first chartered gas company was formed, called "The Gas Light and Coke Company," the charter of which permitted the company to supply gas to any person within the cities of London and Westminster and the borough of Southwark. Pall Mall was lighted by gas on one side of the street in 1807, the other being lighted by oil. Mr. Ackermann's shop in the Strand was ablaze with gas before any gas company had been established.

In 1813, Westminster Bridge was first lighted with gas and whole streets of the Parish of St. Margarets, Westminster, were lit in the following year.

In 1815, the Guildhall was illuminated with gas.

In 1816, the use of gas became common in London, and in the same year, Murdock's house at Sycamore Hill had gas supplied to it through pipes connected with a large gas holder at the Soho Works.

#### First Gas Company

In 1817, the City of London Gas Company was formed, and the first Glasgow Gas Light Company was formed in the same year. The streets of Birmingham were not lighted by gas until 1826.

There was considerable prejudice against gas lighting in its early days and considerable ignorance displayed as to its nature, even by educated people, for it is said that the architects, when pipes were laid for lighting the House of Commons, gave instructions to workmen that the pipes should be fixed at a safe distance from the walls, the impression being that they must grow red hot as gas was transmitted through them.

In 1822, not less than a million sterling was invested in gas lighting, the system by that time being widely diffused over this country, Europe, America and the Colonies.

William Murdock retired from Boulton and Watt in 1830 and died on November 15th, 1839, at Sycamore Hill, an estate which he had purchased in 1815. He was buried in Handsworth Church beside the graves of Boulton and Watt.

Murdock had lived long enough to see with pride the universal prevalence of his invention, but without reaping any great pecuniary reward.



**'Still keep going when the rest have stopped'**

**Exide**

and

**Drydex**

**BATTERIES**

Obtainable from all reputable dealers and Exide Service Stations.

Exide Batteries, Exide Works, Clifton Junction, near Manchester. Also at London, Manchester, Birmingham, Bristol, Glasgow, Dublin and Belfast.

**LATEST NOVELTIES**

(Continued from page 706)

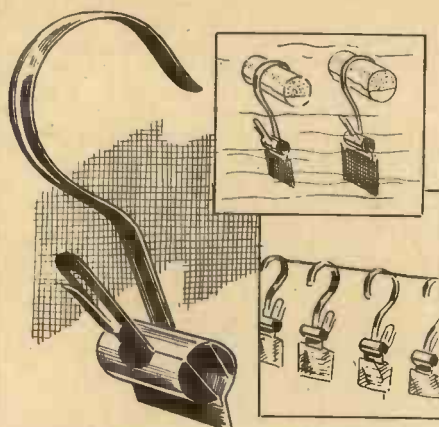

Photographic clips which will prove ideal for washing and drying prints.

**Film and Print Clips**

AMATEUR photographers who do their own printing, will no doubt be interested in the clips shown in the sketch which are ideal for drying and washing prints. As will be seen, a cork is placed in the loop of the clip and this acts as a float, thus enabling films and prints to be suspended in a tank. After washing, the cork can be removed and the clip may then be hung on a line as shown for drying the prints. A box containing twelve clips is obtainable for 1s. [204.]



By boiling eggs in the porcelain container shown, it is claimed that better flavour is obtained.

**A Novel Egg Boiler**

THE device shown below, which is a recent addition to the market, will be found ideal for boiling eggs. The egg is first broken and placed in the cup. Salt, pepper, and butter are added and the top is then firmly screwed down. The container is placed in boiling water and boiled as an ordinary egg. By boiling eggs in this manner much better flavour is obtained. The device is made of porcelain, and costs 2s. 9d. post free. [205.]

**LATHE WORK FOR AMATEURS**

By F. J. CAMM

96 Pages

1/- or 1/2 by post from Geo. Newnes Ltd., 8/11 Southampton Street, W.C.2.

**I intend to succeed!  
I have taken up  
PELMANISM**

"I intend to succeed!" How many people have said that—and for a time tried to act on it—and then slipped back into their old habit of "trusting to luck"! For intention alone isn't sufficient. YOU MUST KNOW HOW TO SUCCEED. YOU MUST HAVE HELP. Once you are on the right track, nothing can stop you, for success is born inside you. But first you must find the right track—and rid yourself of the drawbacks that are holding you back. That's why you need Pelmanism.

**TAKE UP PELMANISM!**

From the very first Pelman lesson, you will be training your powers of thought—your whole personality; learning to go in a straight line instead of in circles. If you're self-conscious, you'll be growing confident. If you're forgetful, you'll be acquiring a sure memory. And as your command of your talents grows, so will your enjoyment of life. You'll be "on top of life," not at its mercy.

The Pelman Course is for men and women in every walk of life—as half a million have already proved. It's simple to understand. It takes up only a spare half-hour a day. And you can start by forwarding a first small instalment. Don't put it off. It's worth a halfpenny stamp to learn more about it. Send the coupon now, to-day, for the interesting free 48-page book, "The Science of Success."

**WHAT PELMANISTS SAY:**

"I have regained almost complete self-confidence. My selling power is very much enhanced. My memory for details is much improved. I have learnt how to use my leisure to better advantage. I am happier."

SALESMAN (T.37177)

"I have derived great benefit, apart from improving my position, and rising within twelve months from 'second sales' to manager of a large tailoring concern with advancement of 200 per cent."

MANAGER (S.22154)

"Six months after studying your Course my salary was doubled. As time goes on I realise more and more that there is a harvest to be reaped through Pelmanism."

CLERK (D.23091.)

**GET THIS OFF TO-DAY!**

To the PELMAN INSTITUTE  
130 Pelman House, Bloomsbury Street,  
London, W.C.1.

Please send me free copy of "THE SCIENCE OF SUCCESS," together with particulars of the Correspondence Course in Pelmanism.

Name.....

Address.....

Occupation .....  
All Correspondence confidential

Pelman (Overseas) Institutes:  
PARIS, 80 Boulevard Haussmann. NEW YORK, 271 North Avenue, New Rochelle. MELBOURNE, 396 Flinders Lane. DURBAN, Natal Bank Chambers. DELHI, 10 Alipore Road. CALCUTTA, 102 Clive Street. AMSTERDAM, Damrak 68.

# THE "PRACTICAL MECHANICS" OUTBOARD SPEEDBOAT

**B**ELOW we show an illustration of the *Practical Mechanics* Outboard Speedboat, the construction of which was dealt with in our July and August issues. This attractive speedboat can be built for under £15, and will give endless pleasure.

The power unit is an Elto "Ace" Outboard Motor which can be fitted to the boat in two minutes. It costs £12 10s.

A set of blueprints, comprising three sheets, are obtainable from us at the moderate cost of 7s. 6d.



Showing the neat and attractive appearance of the "Practical Mechanics" Outboard Speedboat.

A midget named Timothy  
Trick  
Said "Fluxite is handy and  
quick ;  
The neat 'small space' set  
Is the outfit I get—  
And it costs only 'seven-  
and-a-kick'!"

See that FLUXITE is always by you—in the house—garage—workshop—wherever speedy soldering is needed. Used for 30 years in government works and by leading engineers and manufacturers. Of Ironmongers—in tins, 4d., 8d., 1/4 and 2/8. Ask to see the FLUXITE SMALL-SPACE SOLDERING SET—compact but substantial—complete with full instructions, 7/6. Write for Free Book on the ART OF "SOFT" SOLDERING and ask for Leaflet on CASE-HARDENING STEEL and TEMPERING TOOLS with FLUXITE.

TO CYCLISTS! Your wheels will NOT keep round and true unless the spokes are tied with fine wire at the crossings AND SOLDERED. This makes a much stronger wheel. It's simple—with FLUXITE—but IMPORTANT.

## THE FLUXITE GUN

is always ready to put Fluxite on the soldering job instantly. A little pressure places the right quantity on the right spot and one charging lasts for ages. Price 1/6.



ALL MECHANICS WILL HAVE

# FLUXITE

IT SIMPLIFIES ALL SOLDERING

FLUXITE Ltd., Dept. P.M., Dragon Works, Bermondsey St., S.E.1



## "CORREX" ROLL FILM DEVELOPING TANKS ARE THE BEST!

The "Correx" Roll Film Developing Tank represents the simplest, safest and most certain way of developing roll films. Any amateur using a "Correx" according to the simple instructions can be sure of obtaining properly developed negatives.

- "Correx" Tank for V.P. Films ... 25s. 0d.
- "Correx" Tank for 3½ x 2½ in. films ... 25s. 0d.
- "Correx" Tank for 4½ x 2½ in. films ... 30s. 0d.
- "Correx" Thermometer (Fahr.) ... 2s. 6d.
- "Correx" Developing Powders, 6 pairs ... 1s. 6d.

SANDS HUNTER & CO. LTD., 37 Bedford St., Strand, W.C.2

## HAVE YOU A RED NOSE?

Send a stamp to pay postage, and you will learn how to rid yourself of such a terrible affliction free of charge.

Address in confidence—

**P. TEMPLE, Specialist**

"Palace House," 128 Shaftesbury Avenue, W.1 (Est. 30 years.)

## BE TALL

Your Height increased in 14 days or money back. The amazing Stebbing System soon brings 3-5 inches

increase and new energy. The first, original and the one GENUINE GUARANTEED Height Increase System. Recommended by Health and Efficiency. Complete Course, 5/-, or Booklet free, privately.

STEBBING SYSTEM, Dept. M.P., 28, Dean Rd., London, W.1.

## A TWO-POINT LIGHTING CONTROL

ONE query that is regularly asked is "how can I wire up a lamp using two switches, so that the light may be con-

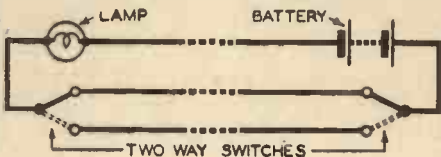

The circuit diagram.

trolled from either switch independent of the other?" A variation of this is "how can I connect a pear-push to the present system to control the light from the bed, and yet be independent of the other switch in the circuit?" The same circuit is used in both the above cases, and is known as two-point control. The advantage of this arrangement is that if a light is fixed above the stairs or in a long passage, with switches upstairs and down or at either end of the corridor, a person can put the light on at one point and off at the other.

The switches used must both be of the two-way type, and they are obtainable in both the tumbler pattern for wall mounting and the pear-push for flex.

To convert an existing single-point control to two-point control, strip the old system leaving only the lamp and ceiling rose. Extra material will be required, and this consists of two two-way switches and, for a bedroom, a three plate ceiling rose. Connections are made as in the sketch, but there is no objection to using the installed cable for the new system if convenient. It will probably be found easier however, if it is all rejected.

With a battery installation keep all wires short as possible, avoid joints and use as high voltage and as large a cable as convenient. No. 18 double-bell wire is suitable for most circuits. This does not mean that good results cannot be obtained from a 4.5 volt pocket lamp refl. and No. 260 C.C. wire. If you are in doubt "rig up" two switches from strips of sheet brass and instal with a 2.5 volt bulb.

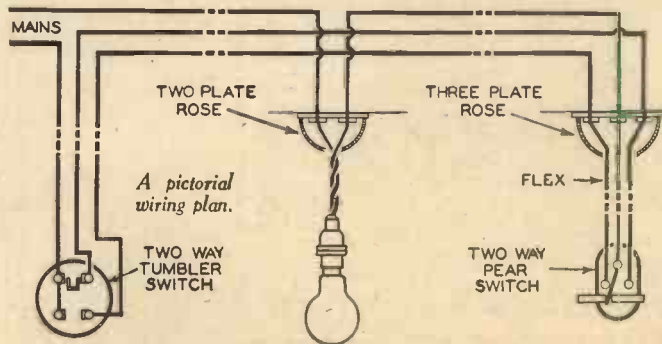

A pictorial wiring plan.



This book will answer your Queries

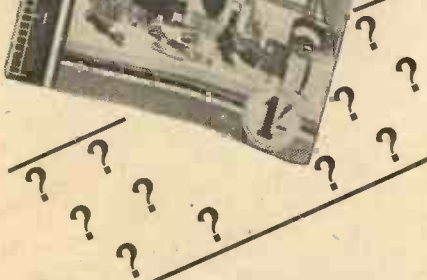

THE HANDYMAN'S ENQUIRE WITHIN costs only a shilling, but it may save you pounds in time and material. In 96 lavishly illustrated pages it gives a representative selection of all those hints and tips which have been proved after years and years of use. All of them represent information in common demand arranged for immediate reference at the precise moment the information is required. Owners of the book also have the benefit of a correspondence service for handymen, if any particular specialised information is unavailable in the book. It is only one of the famous Newnes Home Mechanic Series. All are equally practical, equally inexpensive, equally handy and essential to the modern man who makes things.

Here are some others in the series.

- THE HOME WOODWORKER
- MODEL BOAT BUILDING
- THE HANDYMAN'S ENQUIRE WITHIN
- TOY MAKING FOR AMATEURS
- 25 SIMPLE WORKING MODELS
- MOTOR CAR OVERHAUL AND UPKEEP
- ACCUMULATORS—CAR AND WIRELESS
- MODEL AEROPLANES AND AIRSHIPS
- POWER-DRIVEN MODEL AIRCRAFT
- SIMPLE ELECTRICAL APPARATUS
- LATHE WORK FOR AMATEURS
- HOUSE DECORATING AND PAINTING

Each 1/- net

From all booksellers, bookstalls and newsagents—or 1/2 each post free, from George Newnes Limited, 8-11, Southampton Street, Strand, London, W.C.2.

**NEWNES : LONDON**

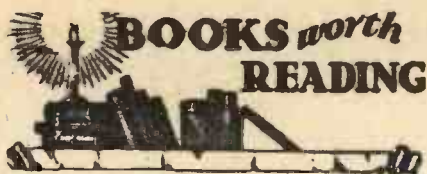

**A Model Engineering Handbook**

THE second edition of the 1935-6 Handbook issued by Bond's o' Euston Road is a veritable goldmine for the amateur mechanic or model maker. Originally issued years ago in the form of a simple catalogue of model railways and accessories this valuable book now includes every possible item for the mechanic, whether he carries out his constructional work on the kitchen table or in a fully-equipped machine shop. The first 86 pages are devoted to railways, ranging from complete outfits for the simplest OO or HO gauge to parts for passenger-carrying locomotives and rolling stock. In addition to the complete small-scale railways, every part may be obtained for the building of locomotives and rolling stock in all gauges.

The handbook also details all raw material for model work, as well as tools, lathes, drawing instruments, etc., and quite a few pages are devoted to boats, yachts, and fittings, and to electrical apparatus. There are 170 pages in the book, with a further 6 pages devoted to a complete index, and the price is 6d.

**THE "MODEL ENGINEER" EXHIBITION**

THE Annual "Model Engineer" Exhibition, now in its eighteenth year, will be again held at the Royal Horticultural Hall, Vincent Square, Westminster. It will be open daily, 11 a.m. to 9-30 p.m., from September 17th to the 26th inclusive. A splendid list of entries has been received for the Competition Section, in which Championship Cups, and medals and prizes are offered for the best exhibits. The models on view will include locomotives, marine and stationary engines, petrol motors, steamships, sailing ships, speedboats, and aeroplanes. A 72-ft. running track will be at work each day, operated by steam locomotives, and several electrically controlled model railways, in various gauges, will be shown working. A feature of the Show is the very complete display of lathes, machine tools, and workshop equipment of all kinds by the leading trade firms. The principal model engineering societies and clubs will also be represented by attractive exhibits of members' work.

It is an Exhibition which everybody with a workshop should certainly visit.

**REPLIES in BRIEF**

R. B. (N.13).—The engine you have would be quite unsuitable for the petrol-driven biplane. You would probably be able to use one of the designs given in *Power-driven Model Aircraft*, copy of which will be sent to you for 1s. 2d. by post.

R. R.—You omitted your name and address. There is no engine driven by springs; nor would it be practicable.

F. B. (Finchley).—We have no further details of the lathe.

**University Correspondence College**

Founder: WM. BRIGGS, LL.D., D.C.L., M.A., B.Sc.  
Principal: CECIL BRIGGS, M.A., M.C.

Students are prepared for

**MATRICULATION**

Intermediate and Degree

Examinations of London University

Founded in 1887 U.C.C. provides instruction by a staff of whole-time Specialist Tutors. Fees are extremely low, and payment by instalments may be arranged.

U.C.C. Successes at some London University Examinations during 1924-1935:—

MATRIC. (Ordinary)	INTER. Arts & Science	B.A. & B.Sc.
5,137	2,903	2,769

**Prospectus**

giving particulars of U.C.C. Courses, Tutors, Fees, etc., post free from the Registrar,  
**62 Burlington House, Cambridge**

*An Absorbing Hobby*

BUILDING A STUART MODEL IS AN ENGROSSING PASTIME, AND THE RESULT A CONTINUOUS PLEASURE



We Illustrate:

- STUART NO. 10.
- High Speed Steam Engine.
- Bore 3/4".
- Stroke 3/4".

Each set is quite complete—drawings and instructions are included.

If you have a lathe—

The rough castings	- - -	8/6
--------------------	-------	-----

If not—

Fully machined set	- - -	18/6
Ditto, with all holes drilled and tapped	- - -	25/-

This and many other Stuart engines are fully described in the 80-page CATALOGUE, 6d. post free.

WE HOPE TO SEE YOU AT OUR STAND NO. 18 AT THE MODEL ENGINEERING EXHIBITION.

**STUART TURNER LTD. HENLEY - ON - THAMES**



## Be a MAN that Women ADMIRE



Stebbing Pupil Collins

Now YOU can be the kind of MANLY MAN that women admire. Take up my world-famous 4-in-1 Course for building Body, Brain, Nerves and Will, practise my new Advanced methods for 30 days; if by that time you have not gained Robust Health, doubled physical and mental Strength, 10-25 ins. more muscle and 12-28 lbs. in weight—I WILL REFUND YOUR MONEY IN FULL. Thousands of testimonials, seen by leading Editors. The one complete all-round MAN-MAKING System. Complete Course 5/-, or send 2/6 now and 2/9 when satisfied. Sent privately under plain cover.—Lionel Stebbing, Stebbing Institute, 28 (MP-5), Dean Road, London, N.W.2.

## The DOSSETT Studio

SPECIALISTS IN TECHNICAL ILLUSTRATIONS

Write or 'phone us at HIGH HOLBORN HOUSE, HIGH HOLBORN, W.C.1.

Hol. 8688.

**The 'ADEPT' Bench Hand Shaper**

Price 22 - 17 - 6

Length of stroke of ram, 3 1/2 ins.; Length of cross travel of slide, 3 ins.; Size of Table, 4 1/2 ins. x 4 ins.; Rise and fall of Table, 2 ins.; Vertical feed of tool slide, 1 1/2 ins.; Maximum distance between tool and table, 3 ins.; Weight, 18 lb. Also the 'Adept' No. 2 H.L. Shaper, 64-in. stroke. Price 25 - 17 - 6.

Manufactured by F. W. PORTASS 83a Sellers Street, SHEFFIELD.

Machine Vice 10/-

## BECK'S CHEMISTRY

1 Flask 150 c.c.  
1 Beaker 100 c.c.  
1 Thistle Funnel  
3" Glass Tubing  
3 Test Tubes  
4" I.R. Tubing  
1 I.R. Cork

SPECIAL SAMPLE PARCEL

**2/6**

POST FREE

BECK (Scientific Dept. A), 60 High St. Stoke Newington, London, N.16.  
WRITE FOR FULL CATALOGUE—FREE !!!

## MAKE MORE MONEY

£3 to £6 weekly can be earned at home in a wonderful business of your own. No matter where you live you can commence to make money in your spare or whole time. No risk, canvassing or experience required. A wonderful opportunity for anyone wishing to add pounds to their income. Particulars, stamp.

**BALLARD, 71 Grace Road, LONDON, S.E.5**

## BLUSHING FREE

to all sufferers, particulars of a proved home treatment that quickly removes all embarrassment, and permanently cures blushing and flushing of the face and neck. Enclose stamp to pay postage to Mr. M. Temple (Specialist), "Palace House," 128 Shaftesbury Avenue (2nd Floor), London, W.1. (Est. 30 years.)

# Money Making IDEAS

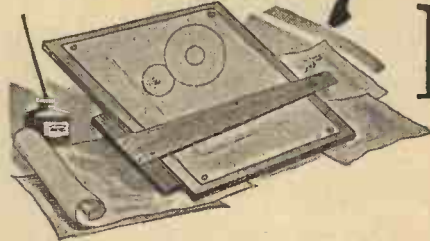

Advice by our Patents Expert

**A NOVEL BOOK-SHELF**

"IS there any market for a book-shelf which would keep books, no matter how few in number, upright. I hope the enclosed drawing will make my idea quite clear." (G. C., S.E.26.)

THE improved movable division for book shelves is not thought to have much, if any, commercial value. For one reason it is problematical if any protection could be obtained for such a device. The only possible way would be by patenting and it is not considered to have sufficient subject matter or invention to support a valid patent.

As the inventor is probably aware, it is quite well known to employ a weight, usually of a fancy or ornamental character, to retain a movable division in position, and further, in book rests, particularly for table or desk use, it has long since been usual to employ a fixed end attached to a shelf or tray provided with grooves in which runners, fixed to a movable end, are adapted to slide.

From the above, it will be seen that the only element of novelty in the proposed construction is the substitution of a spring for a weight, which is a well known mechanical equivalent.

**INDICATING CALLIPERS**

"I enclose a rough sketch of a pair of 'indicating callipers.' Can you tell me if this instrument has any commercial value. I can find no trace of any similar thing in the catalogues of various tool companies. I think it would have considerable market value." (G. S., Bristol, 7.)

THE improved indicating callipers are thought to be novel as far as we know and form fit subject matter for protection by Letters Patent. The inventor is advised to protect his invention by filing an Application for Patent with a Provisional Specification, which will give him protection for about twelve months. As soon as he has protected his invention, he should put it before firms interested in such tools, and during the twelve months he would probably be able to ascertain if the invention is likely to be commercially successful before incurring any great expense in protecting it.

**AN IMPROVED BALL COCK**

"PLEASE find enclosed drawings of an alteration I propose making in the construction of ball cocks used in plumbing systems to shut off a water supply as the level in a tank rises. The present type sometimes falls through the soldered seam in the copper ball corroding and becoming porous, thus admitting water to the ball and making it sink. My alteration, the drawings of which are, I believe, self explanatory, obviate this possibility, and would also lighten production costs of the article.

"I would be obliged if you would give me your opinion of this idea, as to whether it has any commercial value, if it would pass water company regulations, and if so, is it possible to protect it in any way." (N. G., Northumberland.)

THE proposed improvement relating to ball cocks is thought to be novel from personal knowledge and forms fit subject matter for protection by Letters Patent. The shape of the float, apart from its method of attachment, could also be registered as a Design which would be the least expensive way of obtaining protection but it would not cover any material alteration in the shape of the float. Provided the idea is novel it should have a distinct commercial value since the cost of production should be small.

Advice cannot be given as to whether the device would comply with various water companies regulations, but the information could be obtained on putting the invention before them, preferably after protection has been obtained.

**FRENCH-CHALKING CABLES**

"I HAVE thought of a device for french-chalking cables. The proposed tool would be cheap and simple to make as it only consists of four parts, i.e. one bakelite case, one small spring and two rubber plugs." (K. P., Finsbury, W.C.1.)

THE device for french-chalking cables is thought to be novel as far as we know, and forms fit subject matter for protection by Letters Patent.

It is ingenious and should be a practicable device and if properly marketed should meet with a certain measure of commercial success.

It would probably be advisable to protect the invention by filing an Application for Patent with a Provisional Specification, which is the least expensive way of obtaining protection for about twelve months, during which time it should be possible to ascertain if the invention is likely to be commercially successful.

**A MASCOT FOR CARS, ETC.**

"I HAVE devised an improved mascot for motor road vehicles, which incorporates a number of ingenious features. Can you tell me if it has any marketable value?" (J. S., Oxford.)

THE improved mascot for motor road vehicles is thought to be novel and forms fit subject matter for protection by Letters Patent. The only moving mascot for motor cars of which the writer has knowledge is the figure of a bird, the wings of which automatically flap up and down whilst the car is in motion.

The inventor is advised to file an Application for Patent with a Provisional Specification which will give him about twelve months' protection, during which time he should be able to ascertain if the invention is likely to be a commercial success.



PRACTICAL MECHANICS



Replies to Queries and Enquiries

If a postal reply is desired, a stamped addressed envelope must be enclosed. Every query and drawing which is sent must bear the name and address of the sender and be accompanied by the coupon appearing on page 111 of cover. Send your queries to the Editor, PRACTICAL MECHANICS, Geo. Newnes Ltd., 8-11 Southampton Street, Strand, London, W.C.2.

SPLITTING THE ATOM, BLOWLAMPS, ETC.

"(1) COULD you explain to me what force is released when the atom is split, and how could this force be utilised as a defensive or offensive weapon.

"(2) Which is the hottest, a gas bunsen burner flame or a paraffin blowlamp flame?

"(3) Could you describe, as simply as possible, how a paraffin blowlamp works.

"(4) Could you give me details of how to set a paraffin blowlamp in operation.

"(5) By what method is the heat of an oxy-acetylene flame discovered?

"(6) Could a boat be controlled by wireless by means of a spark coil as the transmitter, and a coherer and relay as the receiver?

"(7) About what is the range of an 1/4-in. spark transmitter?

"(8) Could you please inform on the following:

"(1) What is Tear Gas?

"(2) What is its composition, how is it made and for what is it used?

"(9) How could I make an experimental death ray by means of heat rays. Can one be made by means of ultra-short magnetic rays?

"I enclose free advice coupon and stamped address envelope." (W. S., Surrey.)

(1) THE energy which would be released if an atom could be split up fully is that energy which holds the component parts of the atom together. At the present time, one cannot tell exactly how this source of energy could be utilised if it were liberated. You may be quite sure, however, that if the atom's energy could be tapped satisfactorily, means of utilising it would soon be made available.

(2) The flame of a paraffin blowlamp is hotter than that of a bunsen burner.

(3) The ordinary paraffin blowlamp operates simply in virtue of the paraffin being vapourised by the heat of the nozzle and ejected from the lamp under considerable pressure.

(4) To set a paraffin blowlamp in operation fill the paraffin reservoir three-quarters full with paraffin oil, screw on the nozzle assembly and pour a little methylated spirits into the cup at the base of the nozzle. Ignite the spirits and allow the flame to heat up the nozzle of the lamp. When this is sufficiently heated, the vapourised paraffin will escape upon turning on the valve and it can be ignited by means of a match. Each make of paraffin blowlamp has its own peculiarities and conditions of operation. Hence it is impossible to give general instructions in detail for the operation of this class of lamp.

(5) The temperature of the oxy-acetylene flame is measured by allowing the flame to heat up either a specially constructed thermocouple which develops an electric

current proportional in strength to the heat of the flame, or by electrically measuring the strength of the heat-radiation given off by the flame.

(6) Yes, a boat could be controlled by the method you outline, although, by using a coherer as a detector of the radio waves, the boat's control would not be very satisfactory.

(7) About 20 yards, the exact range depending upon the exact transmitting circuit and conditions of transmission.

(8) "Tear Gas" is the name given to several chemical substances (usually liquids) which have the property of irritating the eyes. Benzyl bromide is one of the best-known tear "gases." It can be made by treating benzyl alcohol with sulphuric acid and bromide.

(9) You cannot make an experimental death ray for the simple reason that, strictly speaking, there is no such thing. Also, there are no such such things, as "ultra-short magnetic rays."

HOME RECORDING

"(1) HOW can I make a plastic substance (colour immaterial), which would remain soft for a few days and could then be baked to brittle hardness. I desire this to experiment on home recording.

"(2) Or alternatively, the name and address of a firm that retails a plastic substance of the above description. Can you inform me of the price (approx.) of the same." (H. M., Devon.)

WE are afraid that you will have difficulty in making or obtaining a plastic material having the characteristics you desire, particularly as such plastic material should be smooth and almost grainless in character for the use which you have in view.

Owing to your requirement for the material to be baked to a brittle hardness, waxes and wax-like materials are ruled out. The synthetic resins, such as bakelite, are obviously inapplicable since they require a process of heat and pressure moulding for their formation.

All things considered, we think that you would be served best in your experiments by using a marketed preparation known as "Pyruma cement." This is obtainable at most ironmongers at about 6d. per pound tin. Alternatively, it can be obtained from the manufacturers: Messrs. J. H. Sankey & Son, Ltd., The Hill, Ilford, Essex. This material remains plastic for two or three days and slowly dries hard, or if preferred, it can be baked dry. It should serve your purpose well, its only disadvantage being its slight graininess.

ELECTRON MULTIPLIER AND PHOTO-CELLS

"(1) IN the article on 'Electron Multipliers' in the April number, targets of

JUBILEE WORM DRIVE HOSE CLIPS



The long-life clip with the ever-tight grip

The Best Known For Radiator Joints, Air, Oil, and Water Hose Joints.

Largest sizes stop squeaking brakes.

Stocked by all Garages and Accessory Dealers

L. ROBINSON & CO., 25 London Chambers, GILLINGHAM, KENT.

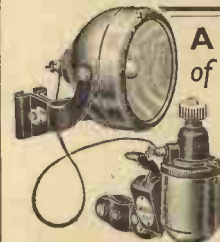

A NEW RANGE of "WILCO"

Cycle Dynamo Lighting Sets.

The New "Wilco" TORPEDO types are fitted with the famous "Wilco" ball-bearing dynamo with automatic voltage regulator which ensures a brilliant light at all riding speeds. Two bulbs controlled by improved rotary switch. Black and chromium finish.

SPECIAL OFFER. A few "Wilco" sets 15/9, as illustration, for 13/9 only. Model with Rear Lamp 18/9. The De-Luxe Model, all Chromium Plated 21/-.

From all dealers. If any difficulty order direct. 40-p. Catalogue "P.M.," 3d. post free.

L. WILKINSON 204 Lower Addcombe Road, CROYDON

WEBLEY AIR PISTOLS

Marvellously accurate for target practice.

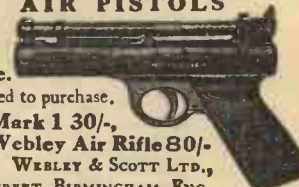

No license required to purchase.

Senior 45/-, Mark 1 30/-,

Junior 20/-, Webley Air Rifle 80/-

Write for List. WEBLEY & SCOTT LTD.,

106, WEAMAN STREET, BIRMINGHAM, ENG.

**Baker's SOLDERING FLUXES**

Sold in 6d. and 1/- tins at all Cycle Accessory Dealers, Tool Shops, Ironmongers, etc.

Write for your free copy "Joining of Metals" to

**SIR W. BURNETT & CO. LTD.** (CHEMICALS)  
GREAT WEST ROAD, Uxbridge, MIDDLESEX  
TELEPHONE: HOUNSLOW 0476

**INVENTORS!**

**VALUABLE GUIDE**  
General Advice Free. POST FREE 6d.

**CHATWIN & CO.** Est. 1880  
Regd., Patent, Design and Trade Mark Agents for all countries.

253 (D) Gray's Inn Road, London, W.C.1

**DON'T BE BULLIED**

Learn to fear no man. The BEST self-defence ever invented, namely, JIJITSU. Easy to learn. Send 2 penny stamps for SPLENDID ILLUSTRATED LESSONS. PHOTO ARTICLE, Testimonials and particulars, or P.O. 1/- for FIRST PART of my course You will be more than delighted. A Japanese Secret. Kill Fear Cure. Free to pupils.

Dept. P., Blenheim House, Bedford Lane, Fellingham, Middlesbrough.



mat silver coated with caesium oxide are mentioned. Can you tell me whether these are obtainable, and where?

"(2) What elements are used in the Photographic Photo-electric Exposure meters where no batteries are used." (W. J., East Sheen.)

(1) **T**HE Electron Multiplier, as described in the April issue of PRACTICAL MECHANICS, is not yet available as a commercial article. They are still being developed by the Radio Corporation of America from whom it might be possible to obtain one, although it is probable that even if they are willing to part with one at present they would ask a prohibitive price. It will probably be another year or so before they become commercial articles.

An example was acquired recently by the Science Museum, South Kensington—if you want to see it, it is on exhibition in the Radio Gallery.

(2) The sensitive element in the photo-electric type of exposure meter is a layer of cuprous oxide on a copper base. The copper forms one electrode and contact with the layer of cuprous oxide is made by dusting powdered graphite over the surface, a connection to the graphite being made by a ring of contact springs round the edge.

Manufacture of the cuprous oxide layer is accomplished by oxidising a sheet of copper in an electric furnace with an atmosphere of oxygen, but there are a great many "snags" in the process which make the construction of a successful cell by an amateur a matter of considerable difficulty.

**Photographs**

Will readers please note that when sending photographs for publication they should write their full name and address on the back of each photograph, as well as a description of the model?

**THE ECCENTRIC COAL TRUCK**

A Mechanical Acrobat which is installed at a British Radio Factory



The mechanical acrobat which automatically feeds coal to furnaces.

**C**OAL trucks that perform acrobatic feats are now permanently installed at the "His Master's Voice" factories at Hayes, Middlesex. For a considerable period, "His Master's Voice" have been seeking a solution to the problem of feeding, at regular intervals during the day, coal to the battery of hungry furnaces that help to provide some of the power required for the many processes in connection with the manufacture of "H.M.V." radio. To feed, by hand, over one hundred tons of coal, per day, to the furnaces would necessitate a considerable staff who would find it hard work to keep the required volume of coal on the move.

**Mechanical Acrobats**

The difficulty has now been overcome, and by an ingenious electrical apparatus, heavy trucks become mechanical acrobats, ready to shoot eleven tons of coal into a tip at the touch of a switch.

When the "H.M.V." factories are operating at peak, it often happens that a line of coal trucks extending for nearly a quarter of a mile, are required for the furnaces, and this is where the coal trucks perform eccentric antics. The trucks are shunted, one at a time, on to a steel bridge, lights flash, a switch is moved and the truck turns a complete somersault in the air. So ingenious is the lifting apparatus that the truck never leaves the rails, but, upside down, discharges its contents at the rate of four tons per minute into the tip. The coal shoots down a mammoth concrete funnel, whence it is brought by a conveyer belt to the furnaces.

The Eccentric Coal Truck is but another instance of the progressive methods employed at the "His Master's Voice" factories in connection with the manufacture of high grade radio instruments.

**THE HALLAM "NIPPER" AERO PETROL ENGINE**

6 c.c. Drives 12" propeller at 4,000 R.P.M.  
 TRACTION EFFORT, 16 to 18 ozs.  
 Engine complete with carburettor, contact-breaker and propeller ... .. Price £3 3s. 0d.  
 With tank, coil and condenser ... .. £4 0s. 0d.  
 Total weight of complete kit, 14 ozs.  
 4-oz. ignition coil, 18s. Set of castings and blue print, 10s. 6d.

Send for Hallam Engine Catalogue, Price 6d.

**J. HALLAM & SON ENGINEERS**  
 POOLE, DORSET, ENGLAND

**Engineers' Guide**

Bright Prospects and Big Pay Opportunities for the trained man

Write to-day for this great Guide which contains world's widest choice of home-study engineering courses—over 200—and shows how to obtain a recognised qualification such as A.M.I.Mech.E., A.M.I.E.E., A.P.R.Ae.S., etc. Mention branch, post or qualification that interests you, to THE TECHNOLOGICAL INSTITUTE OF GREAT BRITAIN, 123 Temple Bar House, London, E.C.4. (Founded 1917. 18,000 Successes.)



To Success

**The GRAYSON ENGINE**

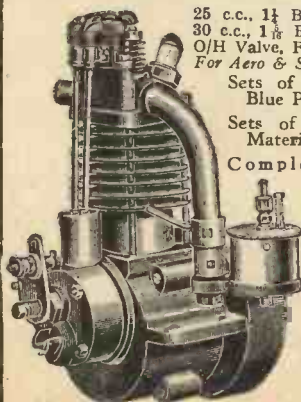

25 c.c., 1 1/2 Bore and Stroke;  
 30 c.c., 1 3/4 Bore and Stroke;  
 O/H Valve, Four Stroke.  
 For Aero & Speed Boat Work  
 Sets of Castings with Blue Print ... .. 12/6  
 Sets of Castings and Materials ... .. 25/-  
 Complete Standard Engine £7 5s.

We have now designed a new Grayson Air-cooled (finned) head interchangeable with standard model head at 1/8 each. Iron or Aluminium.

**The GRAYSPEC ENGINE**

15 c.c., Two Stroke 1 1/2 Bore, 1-in. Stroke.  
 For Model Aircraft and Marine Work.  
 Sets of Castings in Aluminium Alloy, for Aero or Marine Engines, complete with full-size blue print. 12/6 post free.

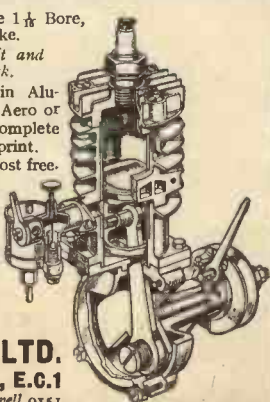

Finished Aero Engine, £3 17 6  
 Marine Model with fly-wheel £4 2 6  
 Propeller 15/- Fully Machined.

Catalogue P.M. 3d. post free.

**E. GRAY & SON LTD.**  
 18/20 Clerkenwell Rd., London, E.C.1  
 Established 1822 Telephone: Clerkenwell 0151

See these models at the Model Engineers' Exhibition from the 17th Sept. at Westminster Hall, Stands 10, 11 and 12

**THE WEBLEY SERVICE AIR RIFLE Mk II**

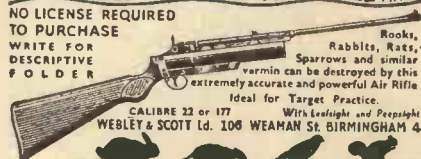

NO LICENSE REQUIRED TO PURCHASE  
 WRITE FOR DESCRIPTIVE FOLDER  
 Rabbits, Rats, Squirrels, Sparrows and similar vermin can be destroyed by this extremely accurate and powerful Air Rifle. Ideal for Target Practice.  
 CALIBRE 22 or 177 With Enslight and Peep Sight  
 WEBLEY & SCOTT Ltd. 106 WEAVER ST. BIRMINGHAM 4

When replying to Advertisements please mention PRACTICAL MECHANICS

**PRACTICAL HINTS ON PATENTS**

Sent free on application.

**THE IMPERIAL PATENT SERVICE**  
 First Avenue House, High Holborn, W.C.1.

Preliminary Consultation Free



# BUY, EXCHANGE OR SELL

Advertisements are accepted for these columns at 2d. per word (minimum 12 words at 2s.—advertisements of less than 12 words are charged at the minimum rate of 2s.), subject to a discount of 2½% for 6 consecutive monthly insertions or 5% for 12 consecutive monthly insertions. **TERMS:**—Cash with order. Cheques, Postal Orders, etc., should be made payable to George Newnes Ltd. *The Proprietors reserve the right to refuse or withdraw advertisements at their discretion.* All advertisements must be received on or before the 5th of the month preceding date of publication and should be addressed to the Advertisement Manager, "Practical Mechanics," George Newnes Ltd., 8-11 Southampton Street, Strand, W.C.2.

## CINEMATOGRAPHY

**ARTISTIC CINE FILMS.** Exclusive 9.5-mm. and 16-mm. productions. List Free. Projectors, Ciné-Cameras.—P. M. Dane, 64 Stanley Street, Liverpool, 1.

**CINEMATOGRAPH FILMS.** Standard size from 6d. 100 feet. Machines, Accessories. Sample Films 1/- and 2/6 post free. Catalogues free.—"Filmaries," 57 Lancaster Road, Leytonstone, E.11.

**WANTED** for prompt cash. Home Ciné-Cameras, projectors, films, accessories, microscopes, telescopes, binoculars, optical and mechanical goods. Mathematical and precision instruments. Small lathes. Modern cameras. Enlargers. Frank, 67 Saltmarket, Glasgow.

**MOVIES AT HOME.** How to make your own Cinema Projector. Particulars free. Moviescope (N), Pear Tree Green, Doddinghurst, Essex.

**"FILM-CRAFT."**—Here is a fascinating series of authoritative textbooks for everyone interested in the Cinema as the newest of the arts. The Filmcraft series, each 3s. 6d. net, includes volumes by Pudovkin, Adrien Brunel, G. E. Kendall, D. Charles Otley, Percy W. Harris. Each 3s. 9d. post free from George Newnes, Ltd., 8-11 Southampton Street, Strand, London, W.C.2.

## CLOCKS

**PRACTICAL MECHANICS SYNCHRONOUS ELECTRIC CLOCK** (July issue P.M.). We supply a complete kit of raw material, metal screws, wire, wheels, etc., less dial and case, for 21/- C.O.D., post free. This kit has the designer's approval. Glasgow and district readers may inspect the original clock in our showrooms. **FORBES BROTHERS, LTD.,** 52 Sauchiehall Street, Glasgow, C.2.

## ELECTRICAL

**USED GUARANTEED BARGAINS.** Electric motors from ¼ h.p. from 12/6. Electric drills ½ max. £1, also ¾ max., 27/6. Electric grinders, 16/-. Vacuum cleaners from 15/-.—A.C.R. Co., c/o Grout Service Garage, Ronalds Road, Holloway Road, N.7.

**ELECTRIC MOTORS, 1/10th & ¼ H.P. A.C. & D.C.** 200/240 volts. New and Second-hand from 35/- EASCO, 18 Brixton Road, S.W.9.

**SURPLUS ELECTRICAL** and Engineering Materials, low prices.—The London Electric Firm Croydon.

**ELECTRIC LIGHTING, 5/- a point;** progressive wiring diagrams and instructions, 6d., materials, wholesale prices; lists free.—P. Symax & Co., 263 Lichfield Road, Birmingham, 6.

## LITERATURE

**7,500** different American, English, Science, Mechanics, etc., Magazines. Parcels, Variety Samples and Catalogue, 1/7, 3/3.—P.M. Final, 15 Nashleigh Hill, Chesham, Bucks.

**GARDENS OF ENGLAND AND WALES.** Crown 8vo, 148 pp., 1s. net. New edition for 1936, illustrated and indexed list of gardens open to the public under the Queen's Institute Scheme.—Country Life, Ltd., 20 Tavistock Street, London, W.C.2.

## LITERATURE (continued)

**"SUNG BEFORE SIX,"** by Oliver Linden. Illustrated by Treyer Evans, 3s. 6d. net.—"This is a delightful book of verses, constituting the candid criticisms of a child on his parents, relatives, and those about him, and on life in general. They touch a very human chord, and are always amusing."—"Yorkshire Observer." Obtainable at all Booksellers and Newsagents.—George Newnes, Ltd., 8-11 Southampton Street, Strand, London, W.C.2.

**"A DOCTOR TALKS."**—The most fascinating medical book in the world. The human machine simply and entertainingly explained with 150 amusing sketches by Fouet. Of all Booksellers, 5s. net.—George Newnes, Ltd., 8-11 Southampton Street, Strand, London, W.C.2.

**"WIRELESS FOR THE MAN-IN-THE-MOON,"** by Coulombus and Decibel, 2s. 6d. net.—Writing about the book, the "Midland Daily Telegraph" says: "It is both good fun and sound theory."—At all Booksellers and Libraries, or from George Newnes, Ltd., 8-11 Southampton Street, Strand, London, W.C.2.

**MORE THRILLING THAN FICTION.**—Newnes' Wide World Library contains the finest true-life travel and adventure books, great literature and exhilarating reading. Each 2s. 6d. net from all Booksellers.—George Newnes, Ltd., 8-11 Southampton Street, Strand, London, W.C.2.

**WALKING TOURS AND HOSTELS OF BRITAIN,** by Sydney Moorhouse. Foolscap 8vo, with maps, 3s. 6d. net. The first comprehensive book covering 14 best districts of Britain with maps and information about routes, stopping places, etc. Officially recognised by the Youth Hostel Association. Ready this spring.—Country Life, Ltd., 20 Tavistock Street, London, W.C.2.

## THE "00" & "HO" GAUGE SPECIALIST

All interested in Model Railways should send two 1d. stamps for my latest list of specialities. My all-brass scale model permanent way is guaranteed, and the price is reasonable.

Latest addition—Fully equalised Coach Bogies, 3/6 per pair.

**GEORGE E. MELLOR**

**ALLANSON ROAD, RHOS-ON-SEA, N. WALES**

## MAGIC

**PERPLEXITIES AND TANTALISERS.**—"The Strand Problems Book" is the finest collection of puzzles of all kinds ever assembled, mathematical, geographical, literary—acrostics and codes, by W. T. Williams (Tantalus) and G. H. Savage. Only 2s. 6d. net, from all Booksellers.—George Newnes, Ltd., 8-11 Southampton Street, Strand, London, W.C.2.

## METAL WORK

**MAKE METAL TOYS.** Easy, profitable with "Success" moulds. Lists free. Complete trial mould, 1/6.—LEE'S, Bentinck Road, Nottingham.

## MODELS

**EVERYTHING FOR electrical rewinds** and repairs. Screws, nuts, and washers for model engineers. Lists free.—Lumen Electric Co., Litherland, Liverpool, 21.

**HALF-PRICE MODELS** like new. Catalogue 4½d. Model Exchange, 11 Friars Street, Ipswich.

## MODELS (continued)

**ARE YOU HANDY With Your Hands?**—If you like making and mending things you ought to know about the "Home Mechanic" Series of 18. Handbooks. They cover a wide field, from model and toy-making to motor-car upkeep and radio construction. Each is complete in itself and fully illustrated. Price 1s. each, or 1s. 2d. post free from George Newnes, Ltd., 8-11 Southampton Street, Strand, London, W.C.2.

**"WORKING MODELS and How to Make Them."** Edited by F. J. Camm, 3s. 6d.—This book will appeal to all who are handy with tools. Contains complete instructions for the making of every kind of working model. Each model has been actually constructed in accordance with the details given and subjected to stringent tests. The instructions and diagrams are so clear that even the most elaborate model can be built without fear of failure, 3s. 9d. post free from the publishers, George Newnes, Ltd., 8-11 Southampton Street, Strand, London, W.C.2.

**AN INVALUABLE Handbook. ACCUMULATORS.** Up to date, practical, dealing with every type of accumulator, methods of charging them at home, care and maintenance. This little book also explains how to erect a charging station. This is one of Newnes' Home Mechanic Books. Ask your Newsagent to show you other Titles in this Helpful Series, each 1s. net or 1s. 2d. post free from George Newnes, Ltd., 8-11 Southampton Street, Strand, London, W.C.2.

## MONEY-MAKING

**EXCELLENT MONEY-MAKING OPPORTUNITIES** constantly occurring, strongly recommended. Send stamped addressed envelope for free particulars.—Messrs. Green, 17 Church Lane, Hull.

## MUSICAL INSTRUMENTS

**BAND GUIDE.** Hints on the Bugle, Drum, Flute, Staff Parade formation, etc. Free, post paid—Potter's (Manufacturers), West Street, London, W.C.2.

## PATENTS

**REGINALD W. BARKER & CO.** (Established 1886), 56 Ludgate Hill, London, E.C.4.—Patent and Trade Mark Booklets Gratis.

**PROTECT YOUR IDEAS.** Free Advice, hand-book and consultations on patents and trade marks.—King's Patent Agency Limited (B. T. King, Patent Agent), 146a Queen Victoria Street, London, City E.161.

## PHOTOGRAPHY

**"PANTOGRAPHS"** make large accurate drawings from small photographs, printed drawings, etc., easily, 1/-, post free.—Cooke, 33 Hawthorn Road, Levenshulme, Manchester.

**£500** worth good, cheap Photo Material, Films, Plates, Cards, Papers, Chemicals, Catalogue and 4 Samples Free.—Hackett's Works, July Road, Liverpool 6.



# BUY, EXCHANGE OR SELL

## PHOTOGRAPHY (continued)

**DON'T TAKE RISKS.** Good developers mean good results. Our reliable stock developers keep twelve months after mixing. Satisfaction certain to amateurs and professionals. Best developer ever put on the market. Makes two pints strong developer. 6d. each, 6 for 2/3, 12 for 4/-. Post free.—Hackett's Works, July Road, Liverpool 6.

## SITUATIONS VACANT

**POST OFFICE ENGINEERING.** Good positions open to youths and men, age 17 to 30. Start £3 13s. weekly at age 17. Free details of vacancies from N.T.O. (Dept. 307), 335 High Holborn, W.C.1.

## RADIO MEN WANTED.

Messrs. Marconis anticipate requiring 200 Marine Wireless Operators in the next few months.  
**TRAINING PERIOD 8/12 MONTHS.**  
**APPOINTMENTS GUARANTEED.**  
**TRAINING FEE CAN BE PAID AFTER SECURING AN APPOINTMENT IF DESIRED.**  
**BRITAIN'S LEADING WIRELESS TRAINING CENTRE.**  
**COLLEGE ON SEA FRONT. BOARDERS ACCEPTED.**  
**WRITE FOR FULL PARTICULARS:**  
**WIRELESS COLLEGE,**  
**COLWYN BAY.**  
 Or London Representative, 4 WINTON AVENUE, N.11.

## TELEVISION

**TELEVISION.**—Newnes Television and Short-wave Handbook, by F. J. Camm, deals authoritatively with Scanning Systems (Drums, Mirror Screws, Discs, etc.), Neon Lamps, The Cathode-Ray Oscillograph, How to Build Short-wave and Ultra-short-wave Receivers. Fully illustrated. 3s. 6d. net. From your Bookseller.—George Newnes, Ltd., 8-11 Southampton Street, Strand, London, W.C.2.

## TOOLS

**GRAYSON'S** Glass-boring Outfits and Tube Cutters avoid risk.—Below.

**DRILLS,** Taps, Dies, Files, Chisels and Punches. Best quality at keenest prices.—Grayson & Company, 300 Campo Lane, Sheffield.

**3 Tons Bright Steel Wood Screws,** 1/2" to 3" long, a special quick clearance offer, 3 lb. assorted 2s. 6d.; very good value.—Below.

**Genuine "Crown" Lathe Chucks,** self centring, precision quality guaranteed accurate. Two sets hardened and ground steel jaws, 3", 2 1/2", 4", 2 9/16", 5", 3 1/2", 6", 4 1/2", 7 1/2", 5 1/2", 8", 6 1/2", 10 1/2", 8 1/2", 12", 10 1/2". Carriage paid.—Below.

**160 Large End Mills,** 1/2" to 1 1/2" diameter, clearing at 3 for 4s. 6d.; Nos. 2 and 3 Morse Taper Shank.—Below.

**120 Bundles Silver Steel,** 1/16" to 1/2" diameter, 16 assorted pieces, 13" long, 4s. bundle.—Below.

**Independent Chucks,** four reversible steel jaws, best quality, heavy engineers' pattern, 6", 4 1/2", 8", 5 1/2", 6d.; 10", 7 1/2", 6d.; 12", 9 1/2", 14", 10 1/2", 16", 12 1/2", 6d.—Below.

## FREE ADVICE BUREAU COUPON

This coupon is available until Sept. 30th, 1936, and must be attached to all letters containing queries.

PRACTICAL MECHANICS, SEPT., 1936

## TOOLS (continued)

**Independent Chucks,** amateur, light pattern, suitable for small Lathes, Four Reversible Jaws, Hardened and Ground. Fully guaranteed, complete with Key and Face Plate Bolts, 3", 18s. 6d.; 4", 24s.; 6", 32s. 6d. each.—Below.

**20 Only 1" Micrometers,** decimal equivalents marked on frame, usual price, 27s. 6d. each, an opportunity, 16s. 6d. each, all complete in plush-lined case.—Below.

**1" to 2" Micrometers,** 23s. 6d.; 2" to 3", 30s.; 3" to 4", 36s.; special quotation for full set High Class Micrometers, 0" to 6", complete on polished wood stand.—Below.

**Drilling and Milling Machine Vices,** a quantity for disposal at extremely low prices. Send for illustrated lists.—Below.

**500 Lathe Tool Holders,** 1/2" Square Shank, suitable for Lathes up to 4". Fitted with Super High-speed Tool, 1s. 9d. each, worth double.—Below.

**300 Boring Bar Tool Holders,** 1/2" Square Shank, 1/2" Round Adjustable Bar, 3s. 9d. each.—Below.

**150 Genuine Norton Grinding Wheels,** saucer shape, suitable for small tool and twist drill grinding, 1 1/2" dia., 1/2" thick, 1/2" hole, 1s. 6d. each, 15s. doz.; also 6" dia., 1/2" thick, 1/2" hole, 2s. 3d. each.—Below.

**30 Bundles Bright Mild Steel,** round, 1/2", 3/4", 1" dia. in 5' to 6' lengths, 10s. per bundle.—Below.

**600 High-speed Centre Drills,** three assorted sizes, small to medium, suitable for model makers, 1s. for three.—Below.

**3 Tons Best Sheffield Files,** Fats, Half Rounds, Square, Rounds, in rough and second cut sizes, 6", 8", 10", 12". This is a very special bargain offer, wonderful value, three dozen assorted, 10s.; also large files, 14", 16", 18", dozen assorted 8s. 6d., carr. forward.—Below.

**250 Bundles Bright Drawn Mild Steel,** approx. 5' length each piece, sizes 1/2", 5/32", 3/16", 7/32", 1/2", 9/32", 5/16", 1/2", 7/16", 1/2" round, 5s. 6d. per bundle of 50'; also Square Bright Steel, sizes 1/2", 3/16", 1/2", 5/16", 1/2", 7/16", 1/2", 5' lengths, 6s. bundle.—Below.

**5,000 Small Slitting Saws,** 1/2" dia., 1/32" thick, clear at 2s. per doz.—Below.

**2,000 Slitting Saws,** 2 1/2" dia., 1" hole, 1/64" to 1/2" thick, six assorted, 3s. 6d.—Below.

**1,300 Sets Hexagon Die-Nuts,** Sheffield made, Whitworth, B.S.F., also American thread, U.S.S. and S.A.E. suitable for Ford and other American cars 1/2", 5/16", 1/2", 7/16", 1/2", worth 7s. set, our clearing price, 2s. 9d. set; all the above four sets, 10s. lot.—Below.

**300 Drill Chucks,** takes to 1/2", three jaws. No. 1 Morse taper shank or 1/2" straight shank, 2s. 9d. each.—Below.

**500 Gross Tungsten Steel Hacksaw Blades,** 8", 9", 10", 12", 1s. 3d. per doz.; 12s. per gross; also Machine Blades, 12" x 1", 2s. doz.; 20s. gross; 14" x 1", 3s. doz.—Below.

**1,200 Best Quality Straight Shank End Mills,** standard sizes, 1/2", 1s. 3d.; 5/16", 1s. 4d.; 1/2", 1s. 6d.; 7/16", 1s. 9d.; 1/2", 2s. each. All right-hand, suitable for use in lathe.—Below.

**800 Sets 1" Circular Dies.** Screwing 1/2", 5/16", 3/8", 7/16", 1/2", Whitworth and B.S.F. Clearing at 2s. 9d. per set. Both sets 5s. Die stocks to suit 1s. 9d. each.—Below.

**5,000 Small Grinding Wheels,** suitable for Flexible Shaft use, etc., 1/2" to 1" diameter, assorted thicknesses, etc., brand new, unused, 2s. per dozen.—Below.

**60 Only, Genuine Norton Grinding Wheels,** suitable for general shop use, 9" dia., 1" wide, 1" hole, 4s. 9d. each, also few 1 1/2" wide; 5s. 9d. each.—Below.

**1,000 Fine Emery Wheels,** 2" to 4" dia., 1/2" hole, 1/2" to 1" thick, slightly used, but quite serviceable, 1s. 6d. per doz.—Below.

**10s. Orders Carriage Paid** except where stated otherwise, steel bars and files carriage extra.—J. Burke, 30 Trippet Lane, Sheffield.

## TRADE

**MANUFACTURING RUBBER COMPANY,** fully equipped, is desirous of utilising full capacity in winter season by producing additional lines. Particulars of requirements are invited by Peradin, Ltd., 7 Wormwood Street, London, E.C.2.

## WATCH MAKING

**WATCH AND CLOCK REPAIRS.** Everything for the watch, clock and model maker. Large stock of watches, clocks, and clock movements, etc. Wholesale prices. List 3d. BLAKISTON & CO., Ainsdale, Southport.

**WATCH, CLOCK AND JEWELLERY REPAIRS** a speciality. Materials, Tools, Invar Steel and wheel-cutting. Catalogue 6d. Shockproof Watches from 2/3. List 1 1/2d.—Young & Son, Material Dealers, Chippenham.

## WIRELESS

**SHORT WAVE** on a crystal set. Full building instructions and crystal, 1/2 post paid.—Radiomall, Tanworth-in-Arden, Warwickshire.

**FIFTY TESTED WIRELESS CIRCUITS,** by F. J. Camm, 2s. 6d.—This handbook contains every modern circuit, complete with instructions for assembling, component values, and notes on operation. 2s. 9d. post free from George Newnes, Ltd., 8-11 Southampton Street, Strand, London, W.C.2.

**"THE MATHEMATICS OF WIRELESS,"** by Ralph Stranger.—This book is essential to the amateur who wants to gain a further knowledge of the subject without loss of time—or temper! Fully illustrated, 256 pages. 5s. 3d. post free from George Newnes, Ltd., 8-11 Southampton Street, Strand, London, W.C.2.

**A DICTIONARY OF WIRELESS TERMS,** by Ralph Stranger. A Wireless Work of Reference that should be on the bookshelf of every keen amateur. Compiled by a master of lucidity, it gives the meanings of all Technical terms in general use. Price 2s. 6d. from all Booksellers and Newsagents.—George Newnes, Ltd., 8-11 Southampton Street, Strand, London, W.C.2.

**FOR THE RADIO ENTHUSIAST.**—"The Wireless Constructor's Encyclopedia," by F. J. Camm (Editor of "Practical and Amateur Wireless"), third edition. Compiled by one of the most accomplished designers and writers on the practical side of Wireless, it covers the whole field. A veritable Treasury of Wireless Knowledge. Price 5s., from all Booksellers and Newsagents.—George Newnes, Ltd., 8-11 Southampton Street, Strand, London, W.C.2.

**EVERYMAN'S WIRELESS BOOK,** by F. J. Camm, 3s. 6d. net. An invaluable book of reference explaining the operation, upkeep and overhaul of all types of wireless receiver. 200 illustrations. From all Booksellers and Newsagents.—George Newnes, Ltd., 8-11 Southampton Street, Strand, London, W.C.2.

## WOODWORK

**SELECTED MAHOGANY, ETC., FOR P.M. SPEED BOAT.**—Below.

**CABINET HARDWOODS,** Oak Mahogany, Ash, Whitewood, Ply-woods, etc. Lowest Prices. Send Cutting lists. Planing free. Speciality Prime Jan Oak, all thicknesses.—Wilfred Parr & Co., March Works, Lancaster Road, Leytonstone, E.11.



# FREE SERVICE FOR READERS

**R**EADERS requiring information concerning goods or services advertised in *PRACTICAL MECHANICS* should give names of Advertisers from whom particulars are desired. Any number of names may be included and we will obtain for you catalogues, lists, and any other information you may be wanting. **THERE IS NO CHARGE FOR THIS SERVICE.**

Readers desiring particulars from a number of Advertisers will, by this method, save time and postage. Half-penny stamp only is required if your envelope is left unsealed. If any Advertiser stipulates that stamps or postal orders are necessary before samples or catalogues are sent, please enclose the necessary amount with your instructions. You are cordially invited to make full use of this Service.

Post this to

**ADVERT. SERVICE DEPT.,**

PRACTICAL MECHANICS,

8-11 SOUTHAMPTON STREET,

STRAND, W.C.2

*Please obtain and send to me particulars from the Advertisers in your September issue whose names I give on list attached.*

Advertiser	Page No.	Information Required
------------	----------	----------------------

*Attach sheet of paper, with particulars, and your name and address (written in **BLOCK** letters), with date, to this announcement.*

# THRILLING EXPERIENCES IN THE AIR

"POPULAR FLYING," the National Aviation Magazine, contains every month most interesting true experiences of pilots, private and otherwise, in various parts of the world.

It contains war-time experiences of famous aces, and news of the latest aircraft. Throughout it is written without technicalities, in language everyone can understand.

Ask your newsagent to deliver this month's number—you will like it. Profusely illustrated.



*Special Contents of the September POPULAR FLYING include:—*

"WINGS OVER NORTHERN EUROPE" By Air to Scandinavia

AFTER RICHTHOFEN'S DEATH

An account of the subsequent history of the famous "Circus"

CHINA SPREADS HER WINGS

Flying in China to-day

UNDER THE HOOD

Blind Flying as taught in the United States

THE FIRST SOLO FLIGHT FROM THE PHILIPPINES TO CHINA

TOPICAL AND HISTORICAL AIR PICTURES

# THE SEPTEMBER POPULAR FLYING

At all Newsagents and Bookstalls monthly, or by post 7½d. direct from the Publisher, C. Arthur Pearson, Ltd., 18, Henrietta Street, London, W.C.2.

6<sup>d</sup>.

C. Arthur Pearson, Ltd.



# "One Week from To-night You'll See PROOF that I can make You a New Man!"

**NOTE: No other man in the world has ever DARED make such an offer!**

I GIVE MORE than "promises." I give PROOF! If you're sick and tired of half-baked ideas—if you really want a build like mine—then *one week*—just seven days—is all I need to prove I can give it to you!

You've got a body, man. Why not make it a real handsome *man's* body! There's NO good reason why you shouldn't have rippling cords of mighty muscle across your neck and shoulders. No reason at all why your chest shouldn't be strapping, big and husky like mine—your arms and legs powerful—your wind lasting—your vigour and pep 100%.

I used to be a sickly scarecrow weighing only 7 stones—a "laughing-stock" wherever I went. No fun. No friends. Right then I almost "fell" for some of these freak contraptions to make me "strong." But THEN—by the luckiest break of my life—I discovered *Dynamic Tension*.

## No Apparatus

Look at me now. You don't see any skinny, flabby, no-account bag of bones *here*, do you? This is what my remarkable secret has done for *my* body. Twice—against all-comers—I have won the title, "The World's Most Perfectly Developed Man." No wonder I've got no use for tricky apparatus that may strain your heart or other vital organs. I've found the *natural* way to build the husky, solid, fighting muscles that Nature means for you to have. And I've shown thousands of other fellows, many of them probably much worse off than you, how to develop themselves into champions MY way!

I'll give you clean-cut health *inside*, too—show you exactly how to get rid of constipation, poor digestion, bad breath, pimples and other weaknesses that are robbing you of the good times and the good things in life that can be yours.

Now make me PROVE I can do it. Let me send you the FREE Book that opens the door to *he-man living*. Just tell me where to send it. Use the coupon. There is no obligation. But be MAN enough to send the coupon NOW!



## CHARLES ATLAS

Dept. 10-J, Shell-Mex House, London, W.C.2.

I want the proof that your system of *Dynamic Tension* will make a NEW MAN of me. Send me your book *Everlasting Health & Strength* FREE.

NAME .....

(Please print or write plainly)

ADDRESS .....



## 48-Page Book FREE

It tells you all about my special *Dynamic Tension* method, and what it has done to make big-muscled men out of run-down specimens. It shows you, from actual photos, how I have developed my pupils to the same perfectly balanced proportions of my own physique. What my system did for me and these hundreds of others it can do for you too. Don't keep on being only half the man you CAN be! Find out what I can do for you. Where shall I send your copy of *Everlasting Health & Strength*? Put your name and address on the coupon, or a postcard, and post it to-day. CHARLES ATLAS, Dept. 10-J, Shell-Mex House, London, W.C.2.