

OUR £20 CAR - *and* HOW TO MAKE IT!

NEWNES

PRACTICAL MECHANICS

MARCH

6^D



Tax only £4



EARNING POWER SENT TO YOU
BY POST

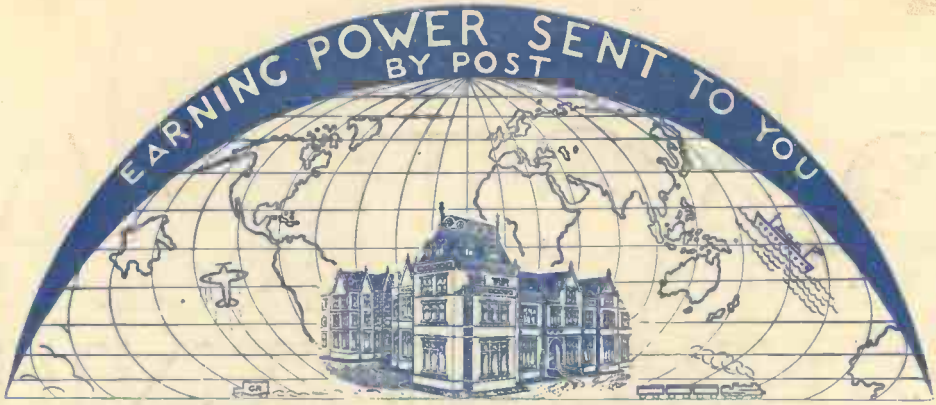

IT IS THE PERSONAL TOUCH WHICH COUNTS IN POSTAL TUITION

LET ME BE YOUR FATHER
35 YEARS' PRACTICAL EXPERIENCE

J. Bennett

Let us tell YOU how to make a success of the life before you - by using your spare evenings wisely and pleasantly

LET ME BE YOUR BIG BROTHER
15 YEARS HELPING HIM

J. Bennett

THE MOST SUCCESSFUL AND MOST PROGRESSIVE CORRESPONDENCE COLLEGE IN THE WORLD

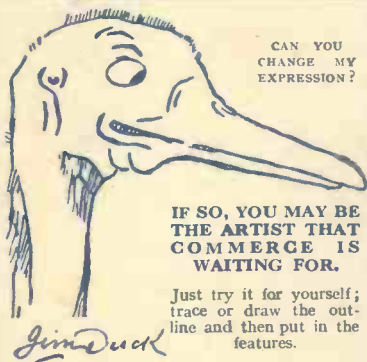

CAN YOU CHANGE MY EXPRESSION?

IF SO, YOU MAY BE THE ARTIST THAT COMMERCE IS WAITING FOR.

Just try it for yourself; trace or draw the outline and then put in the features.

Jim Duck

There are hundreds of openings in connection with Humorous Papers, Advertisement Drawing, Posters, Calendars, Catalogues, Textile Designs, Book Illustrations, etc. 60% of Commercial Art Work is done by "Free Lance Artists" who do their work at home and sell it to the highest bidders. Many Commercial Artists draw "retaining fees" from various sources, others prefer to work full-time employment or partnership arrangement. We teach you not only how to draw what is wanted but how to make buyers want what you draw. Many of our students who originally took up Commercial Art as a hobby have since turned it into a full-time paying profession with studio and staff of assistant artists; there is no limit to the possibilities. Let us send full particulars for a FREE TRIAL and details of our course for your inspection. You will be under no obligation whatever.

YOU CAN HAVE A COLLEGE TRAINING IN ALMOST ANY CAREER FOR A FEW SHILLINGS MONTHLY

- Accountancy Examinations
- Advertising and Sales Management
- A.M.I. Fire E. Exam.
- Applied Mechanics
- Army Certificates
- Auctioneers & Estate Agents
- Aviation Engineering
- Banking
- Book-keeping
- Bollers and Modern Business Methods
- B.Sc. (Eng.)
- B.Sc. (Estate Management)
- Building, Architecture and Clerk of Works
- Cambridge Senior School Certificate
- Civil Engineering
- Civil Service
- All Commercial Subjects
- Commercial Art
- Concrete and Structural Engineering
- Draughtsmanship, all branches
- Engineering, all branches, subjects and exams.
- General Education
- G.P.O. Eng. Dept.
- Heating and Ventilating
- Industrial Chemistry
- Insurance
- Mathematics

- Matriculation
- Metallurgy
- Mining, all subjects
- Mining, Electrical Engineering
- Motor Engineering
- Motor Trade
- Municipal and County Engineers
- Naval Architecture
- Pattern Making
- Police, Special Course
- Preceptors, College of Pumps and Pumping Machinery
- Radio Service Engineering
- Radio Communication
- Road Making and Maintenance
- Salesmanship
- Sanitation
- Secretarial Exams.
- Shorthand
- Shorthand (Pitman's)
- Structural Engineering
- Surveying
- Teachers of Handicrafts
- Telephony and Telegraphy
- Transport Inst. Exams.
- Weights and Measures Inspector
- Welding
- Wireless Telegraphy and Telephony
- Works Managers

If you do not see your own requirements above, write to us on any subject.

Also ask for our New Book (Free of Charge)
THE HUMAN MACHINE
Secrets of Success

SIGNS of the TIMES

The Budget has restored
POLICE OPPORTUNITIES
The Air Force is to be increased
AVIATION must DEVELOP

Pay Cuts have been restored
CIVIL SERVICE
Suitable to both sexes. Ages 15½ to 24.
G.P.O. ENG. DEPT.

CUSTOMS AND EXCISE; INSP. OF TAXES, ETC. NO EXPERIENCE REQUIRED. OPEN EXAMS.

MATRICULATION
There are many ways of commencing a career, but Matriculation is the jumping-off board for all the best ones.

We prepare candidates for all
INSTITUTE EXAMS.
TECHNICAL, ACCOUNTANCY, SECRETARIAL, INSURANCE, ETC.

Engineers & Draughtsmen
All Branches — Employers are advertising for them.

TELEPHONY, RADIO and MOTOR ENGINEERING are expanding rapidly. There are lots of vacancies. Our postal courses will make you eligible. Advice on all careers Free.

THE MAN DOES NOT GO FAR WHERE ACTION LAGS BEHIND DECISION

YOUNG MEN
Young men physically fit and whose careers are not definitely fixed should join the Police Force. We have special Courses for Entrance and Promotion. 1/- per week brings success. Full Particulars Free.
Address:
POLICE DEPT. 76.

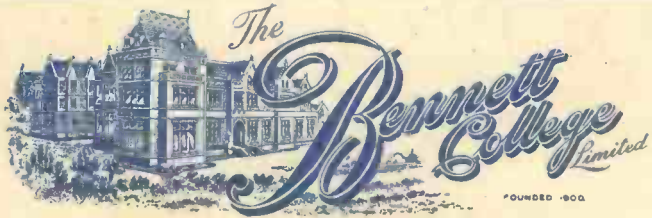

DEPT. 76, THE BENNETT COLLEGE, SHEFFIELD.

EVERY DEPARTMENT IS A COMPLETE COLLEGE.
EVERY STUDENT IS A CLASS TO HIMSELF.

Practical Mechanics

VOL. III. No. 30
MARCH
1936



Edited by F. J. CAMM

SUBSCRIPTION RATES :

Inland and Abroad, 7s. 6d. per annum
Canada - - 7s. per annum

Editorial and Advertisement Offices : "Practical Mechanics," George Newnes Ltd., 8-11 Southampton Street, Strand, W.C.2. Registered at the G.P.O. for transmission by Canadian Magazine Post.

Notes, News, and Views

A Lathe Which "Sees"

A NEW photo-electric lathe which can work to a complicated design without human aid, has been invented by a Russian engineer, according to the Taso Agency. With the aid of a photo-electric cell, the lathe can "see" any drawings that are placed in it, and shaping instruments are automatically adjusted.

The "Turbomotive"

THE first turbine-locomotive to be built by a British Railway Company, was recently taken out on a test run. The locomotive is now running on the L.M.S. Liverpool-London main line service.

Largest Diesel Engine

A 3,500 h.p. Diesel engine, the largest ever manufactured in Britain, is to be built at Stafford and Rugby, for Bermuda.

A New Monoplane

SIDE-BY-SIDE seating, and a speed of 100 m.p.h. with 33 m.p.g. are interesting features of the Praga monoplane which was recently tested out at Heston.

A Thames Tunnel

IT is hoped that the proposed tunnel under the Thames between Dartford and Purfleet will be started towards the end of the summer. The tunnel will take five years to build, and the original estimate of the cost, £3,000,000, is expected to be greatly reduced.

The Latest About Television

WHEN television is introduced on a large scale in this country, the B.B.C. will broadcast films, but at first this will not include dramas and comedies. The reason for this limitation is a clause in the proposed new contract which has just been drafted between film renters and exhibitors.

Four New Flying-Boats

WE learn that the Commonwealth Air Board is ordering four new flying-boats, with a range of 500 miles, for coastal patrol duties in North Australia and Papua.

Fastest Train in Japan

A NEW streamlined locomotive has just been completed at Kobe, Hyogo Prefecture, which will run on the Tokaido Line, connecting Tokyo with Osaka. It will do this 350-mile run in six hours.

Land Speed Record for Cars

AN attempt on Sir Malcolm Campbell's 301 m.p.h. land speed record, is to be made at Utah, by Lou Moore, U.S. racing motorist.

A Ship With Fins

SINCE it is not possible to straighten out the waves in the Channel, a device is to be tried out on a Southern Railway cross-Channel steamer, to prevent it from rolling when at sea. The device consists of two metal fins to be fitted on the sides of the steamer and controlled by a gyroscope on the bridge. The gyroscope remains level in spite of the rolling of the ship, and will operate the fins so that whenever there is the slightest tendency to roll, they will tend to keep the ship on an even keel.

A New Speed Plane

A NEW passenger plane, which, it is claimed, will break all records by conveying 10 passengers at a maximum speed of 254 m.p.h., was recently shown in Berlin. The new machine is a monoplane constructed entirely of light metal, and not only its landing wheels, but also its tail wheels, are retractable. It has twin engines, each of 600 h.p.

Holland's First Streamlined Locomotive

A NEW streamlined locomotive has been put into service by the Royal Dutch Railways.

"Heads" or "Tails"

A FORMULA which takes guess work out of coin-spinning and makes "heads I win, tails you lose" a certainty, has been revealed at the Imperial College of Science by Dr. G. F. C. Searle. The trick is worked by placing a penny in a small gadget and taking certain vertical measurements. Then, releasing a spring, you can make the coin always land "heads" or, if you wish, "tails"; it never fails. The gadget was invented to prove that the speed of an object is accelerated in its downward flight.

World's Largest Piece of Glass

PICKED workmen of the Corning Glass Works, New York, recently removed from its annealing oven, the world's largest piece of glass, the 200-in. mirror, or "eye" for the world's largest telescope.

Photographs Printed on the Wall

PHOTOGRAPHS can be printed directly on to the walls of a house by a process invented by Eugene Mollo. The process consists of an emulsion, with which surfaces are sensitised. The surface is sprayed with the emulsion and the photograph then printed by means of a projector. Developing, printing and fixing are all carried out by spraying.

London-Paris Record

THE Imperial Airways liner *Heracles* recently completed the 203-mile journey from Paris to London in 80 minutes flying time, at an average speed of 150 m.p.h. The previous record for machines of the *Heracles* class was 90 minutes.

Television in Germany

THE German high-definition television service, which was put out of action by the fire at the radio exhibition last August, is now in operation.

Pocket Wireless Sets

THE Watch Committee of the Maidstone Town Council are to consider providing the members of their Borough Police Force with pocket wireless sets.

A Coincidence

TWO aeroplanes, heading in opposite directions, recently passed and saluted each other in mid-Atlantic. It is believed to have been the first time that such a thing has happened.

The Third Dimension

IN a short film under the title of "Audio-scope," the amazing results of third dimension will be seen for the first time, on a large scale.

Luminous Cars

A FRENCH manufacturer of well-known cars, recently brought out models painted with a luminous compound—not radium, but one of the barium preparations which store up sunlight. Thus, safety will be promoted on the roads at night by higher visibility.

Austrian Railway Speed Car

A DOUBLE-ENDED motor car operated by internal combustion engines, is now operating between Vienna and the Polish frontier. Its speed is estimated at between 75 and 90 m.p.h.

OUR £20 CAR AND HOW TO MAKE IT!

The First Article of a Series Describing the Construction of an Ingenious, Simple and Well-designed Three-Wheeler, which May be Built for even less than £20. Its Annual Tax is Only £4, and it is Capable of 50 Miles an Hour. Petrol Consumption is over 65 Miles per Gallon, and it may be driven by any reader over 16 years of age! The Illustration Below Indicates its Really Attractive Lines. Any Unskilled Amateur Can Make it With Ordinary Tools.

If you have ever thought of the possibility of building for yourself a small runabout car, you have probably dismissed the idea as being outside the bounds of possibility for amateur construction, or as requiring a heavy initial outlay and the possession of tools and equipment usually associated with the factory. Therefore, I wish to disabuse your minds on these various points at the outset.

It is probably not known to many of my readers that several thousands of midget cars are built in America annually, and so intensely enthusiastic is the movement over there, that race meetings are held all over that vast country practically every night on the various dirt and hard tracks. There are hundreds of midget-car clubs in America and Canada, and a few in Australia, and the rules of membership and of the various midget-car competitions are firstly that the car must be amateur built, and, secondly, that the engine must not exceed a specified cubic capacity. Midget-car racing has become, in fact, a craze, and the sport bids fair to become popular in England.

Floodlit Racing Tracks

The American midget-car events draw enormous crowds, and after dark the tracks are floodlit. It is a fascinating sight to witness these tiny vehicles, most of which are capable of speeds of over 60 miles an hour, hurtling round the track and performing amazing evolutions demanding little of the skill which is required to drive more orthodox cars round Brooklands.

These tiny cars, however, are not built merely for racing purposes, and vast numbers of them are used for ordinary touring purposes. They have the great advantage, of course, of low taxation, require a minimum amount of garage space, are cheap to run (the petrol consumption is at least 65 miles to the gallon), are cleaner than motor cycles, and they have the added advantage of providing weather protection, which a motor cycle does not. They can also be used for touring along the narrow lanes and picturesque by-ways which would be impossible for larger cars, and above all, they are perfectly safe.

By F. J. Camm.



Note the Simplicity and Really Attractive Lines of this Fast Baby Car. You Can Build It!

Simple Construction

The greatest advantage, perhaps, is that they may be built for as small an amount as £15, depending upon the number of refinements which are fitted. Given a motor-cycle engine of the air-cooled type of from 250 c.c. to 600 c.c., a motor-cycle type of countershaft three-speed gearbox with integral clutch, and three wheels, and you have the material for building a midget car. The veriest amateur possesses the ability to construct one. Many years ago the cycle-car movement in England was extremely popular, and as with radio, there was a considerable number of amateurs who built

them. No doubt owing to the unreliability of early engines and the difficulty

of obtaining the requisite parts, the midget-car movement fell by the wayside. Nowadays, however, there is a plentiful supply of material. Motor-cycle engines of the required capacity can be picked up quite cheaply from garages and other firms who specialise in spare parts. So, too, can gearboxes, whilst the wheels can be purchased new for a very small sum.

Many years ago I designed a similar small car to that forming the subject of the present article and marketed it, and it proved extremely popular.

You require a motor-cycle engine of either the side or overhead valve type of not more than 350 c.c. for the design here given, and as 1 horse-power is approximately equivalent to 100 c.c. the power range required is from 2½ to 3½. If you fit a 2½ horse-power engine, the top speed would be an easy 40 miles an hour, whereas with a 350 c.c. engine the top speed would be in excess of 50 miles an hour. Naturally, the overhead-valve engines will be the faster.

Why a Three-Wheeler was Chosen

I will anticipate the reader's question of explaining why a three-wheeler has been chosen in preference to a four-wheeler. In the first place the legal definition of a three-wheeler is that it is a motor cycle! As such, it comes within the same taxation class as a motor cycle and sidecar. Secondly, it is cheaper to build, for the excellent reason that there are only three wheels and three tyres, instead of four wheels and four tyres, thirdly, the three-wheeler dispenses with the need for a differential gear. Fourthly, it is easier to build and has less

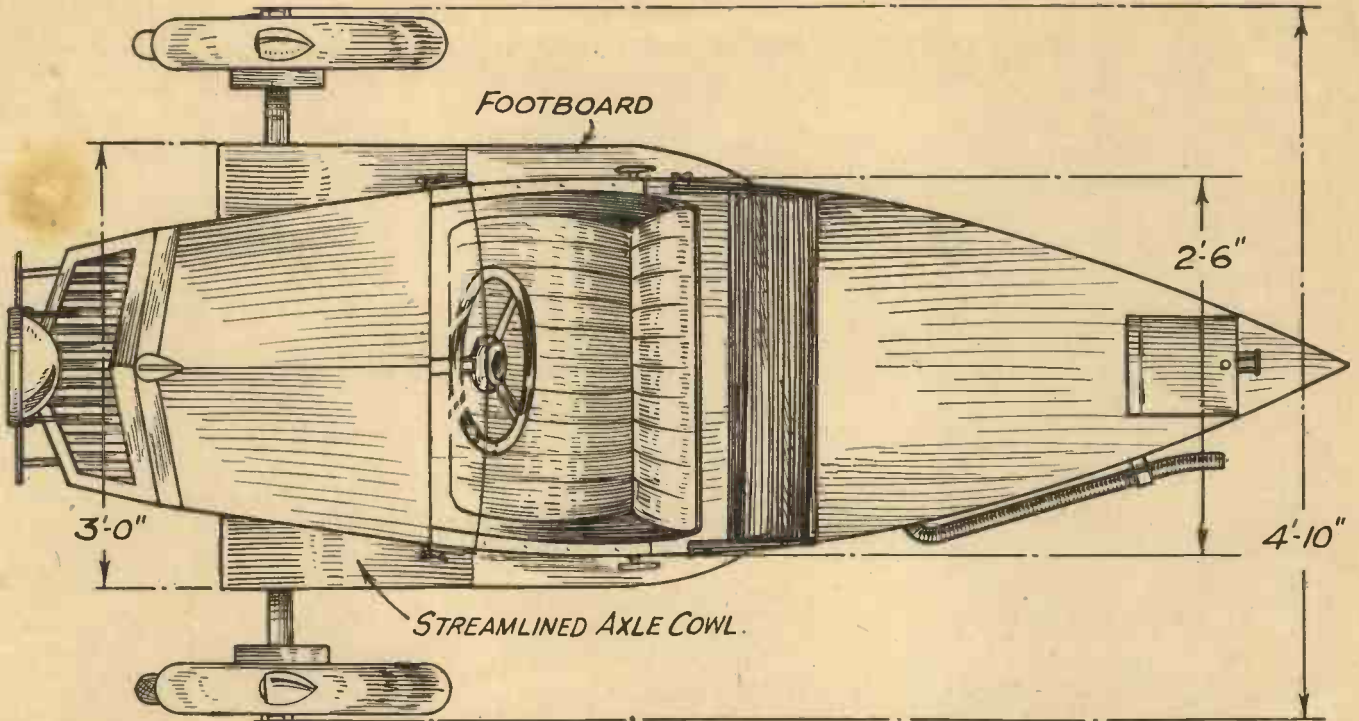

Fig. 1.—Plan View of the £20 Car!

working parts. The annual tax is £4 only. If you add to these advantages the fascination of building it, and finally of using it on the road you have the entire case for the tiny car.

Legal Requirements

In the absence of proved designs, the beginner may make expensive mistakes. There are the legal requirements, for example, which stipulate that brakes must apply to each wheel, and that there must be an independent hand-brake; the head lamps, in order to satisfy the Lighting Act, have to be mounted at a certain height from the ground and not more than a certain distance in from the extreme outside line of the vehicle. The number plates and the figures and letters thereon, must be to

legally prescribed dimensions, and a silencer must be fitted. The machine must not be noisy. Those are just a few of the legal requirements. The mechanical requirements

Detailed Blueprints will be issued for a Nominal Sum

are a little more detailed. We have to bear in mind the loading per horse-power so that the engine does not labour. The steering angle needs to be worked out for wheel clearance, and provision must be made for cooling the engine. The gear ratios must be carefully selected, so that the engine is enabled to rev. at its peak revolutions in order that it may develop maximum power.

The chassis must be free from whip, otherwise there would be frequent breaking of chains and undue wear on the transmission and tyres. The suspension system needs to be just right in order to absorb road shocks. The centre of gravity needs to be accurately disposed, so that the machine is stable and does not turn over, and the driver's seat needs to be disposed approximately midway between the two points of road support. Hence, the amateur who endeavours to design his own car finds this array of technical and legal considerations disconcerting.

The Problems Solved for You

In the design here presented the problems have been solved for you. Our £20 car complies with all of the legal requirements, and it is technically sound. In

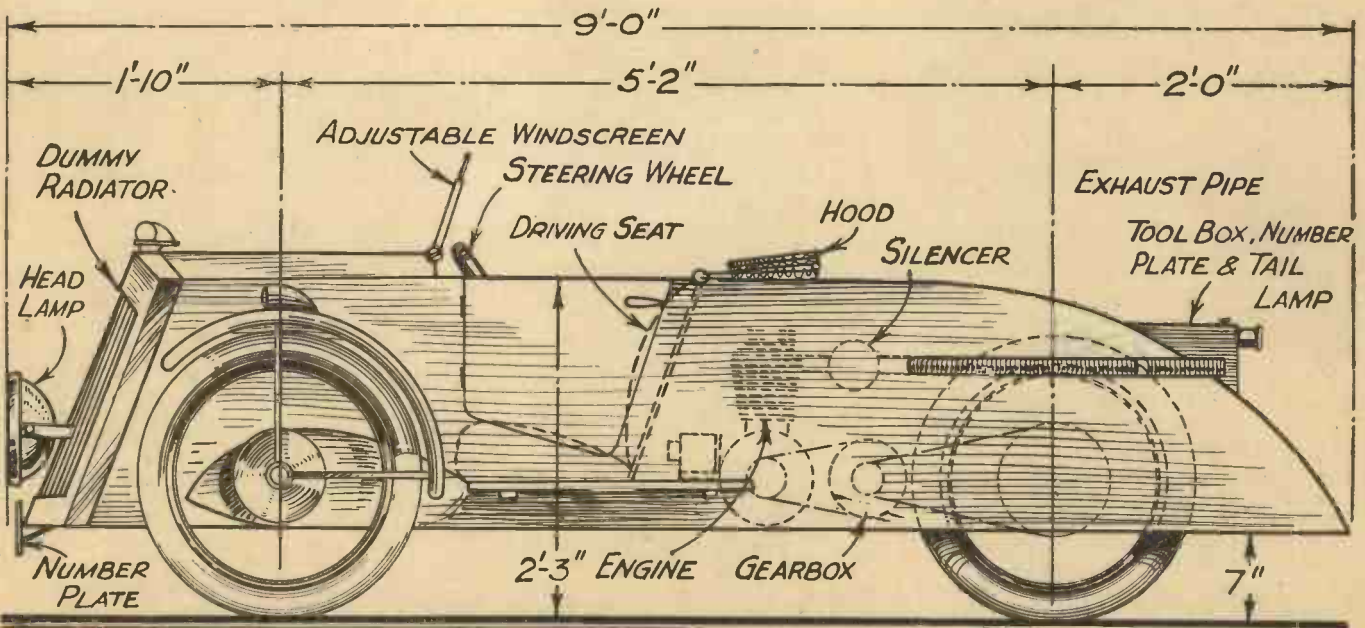

Fig. 2.—Side Elevation of the £20 Car.

later articles dealing with its construction I shall show you photographs of the various stages, and photographs of the car under test. Additionally, we shall sell detailed blueprints and an announcement will be made when they are ready. All of the constructional details, however, including dimensioned drawings will be given in this series, thus enabling the reader to build the car. The blueprints will be issued to those who are unaccustomed to laying out the various parts from scale drawings.

A Driving Licence

Another question which will arise in the mind of the reader who is under 17 years of age (the minimum age for which a driving licence for a car-owner is issued), is whether he is entitled to drive this three-wheeler within the meaning of the Act. Anyone over 16 years of age may drive a motor cycle, so the age limit is 16 years. If you are over 17 years of age, you will apply for a car-driving licence in the ordinary way. If you have not held a driving licence before, it will be necessary for you to pass the driving test; for details of this you must apply to the local County Council Offices, when a provisional driving licence will be issued to you. You will have to carry the "L" plate and be accompanied by an experienced driver. As, however, the latter can easily be accommodated pillion-passenger fashion, there is no difficulty here, although I recommend the beginner to teach himself to drive in private grounds. No doubt permission can be obtained locally for this.

Driving the Car

You will find that you will be able to drive the car within about five minutes, after you have become familiar with the operations of starting the engine, accelerating, changing gear, and braking. Actually it is much easier to drive than a motor cycle.

I shall confine my remarks this month to a general description of the design, so that the reader can collect together the necessary material. An inspection of the plan and side elevation, Figs. 1 and 2, indicate the racy lines of the body. The engine is mounted behind the driver's seat and the gearbox, of course, behind the engine. You will require any good second-hand motor-cycle engine of the type and power previously named, and a three-speed gearbox capable of transmitting the power of the selected engine. For example, you must not fit a gearbox from a 250 c.c. engine, if you are using a 350 c.c. engine, although it will be in order for you to use a gearbox which has been used in conjunction with a 350 c.c. engine on a 250 c.c. engine.

The Gearbox

The gearbox must be of the countershaft type with an integral clutch, and later I shall show how to calculate the size of sprocket required on the rear wheel in order to obtain the correct gear ratio. You will also require a silencer of the type fitted to 7 h.p. cars if you desire the engine to

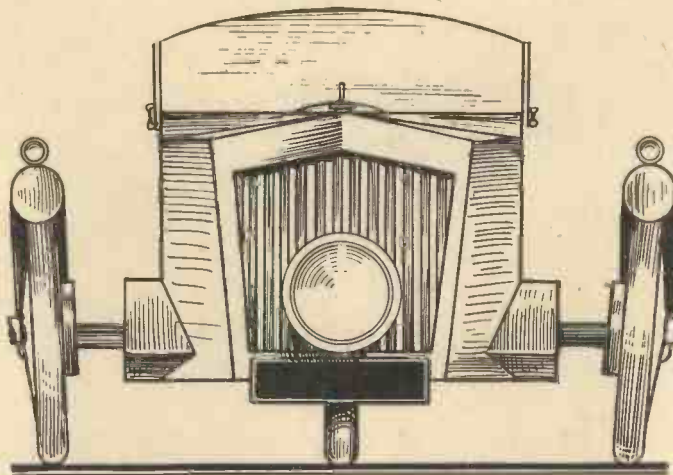

Fig. 3.—Front Elevation of the £20 Three-Wheeler.

be extremely silent, otherwise the ordinary motor-cycle style of gearbox will suit. I cannot, for obvious reasons, prepare designs suitable for all of the engines available, but as the only thing which is affected is the method of mounting, the reader will experience no difficulty in obviating this. The kick-starter will, of course, need to be extended by means of a piece of tube so that it protrudes outside the body. It will then be carried as a starting handle, and placed under the cushion of the driving seat when the car is started. The wheels are of the light motor-cycle type, having internal expanding

The Second Article on this Remarkable Car, Specially Designed for Readers of Practical Mechanics, will appear next month. Order your copy now!

brakes operated from a quick pedal, whilst the chassis and body consist of ash members and three-ply respectively.

The Car Controls

Car controls are used, that is to say, there are the usual three pedals, namely (from right to left facing the front of the car), accelerator, brake, and clutch. The steering wheel is centrally disposed, since this is a monocar and not intended for passenger-carrying owing to the low power. The radiator in front is, of course, a dummy; it is made by overlaying pieces of three-ply wood and picking it out in a different colour to that of the body colour. Two doors are fitted so that entry to the driving seat can be effected from either of the near or off side. A motor-cycle sidecar hood is used, whilst the mudguards are of the motor-cycle type.

These have the advantage that they move with the wheels, and thus do not throw mud when locked over as does an ordinary car.

Accessories Required

The windscreen is one of the Auster aeroplane as fitted to small aeroplanes and some sidecars, whilst the steering wheel is of the Blumel type. The tool-box, number-plate and tail-lamp are combined. Ackerman steering is used, enabling the car to be turned within a very sharp radius since the wheel base is only 5 ft. 2 in.

The overall length being only 9 ft., the car may thus be comfortably stored in the space normally required for a cycle and

sidecar. The total weight of the vehicle will be not more than 280 lb.

I have estimated that the total cost of the material will be approximately £18, and if the reader happens to strike bargains in his purchase of the various parts, it can be made for less than £10. For this particular car I have selected the Blackburn 350 c.c. side-valve engine, but, of course, the reader will endeavour to obtain from the sources mentioned, a second-hand car engine and gearbox.

Just a word about the petrol consumption; it will work out, with a 350 c.c. engine, at 65 miles per gallon at least, whilst the oil consumption should be in the neighbourhood of 2,000 miles to the gallon.

I shall, of course, be pleased to answer any questions which readers care to address to me provided that they enclose the Query Coupon and a stamped and addressed envelope. These queries should be confined to the present design, and I make the offer so that those readers who are able to follow the present illustrations and who wish to proceed with the work in advance of publication of the scale drawings next month, may be able to do so.

I want to make it clear, however, that I cannot, for obvious reasons, undertake to vary the design to suit individual needs. For example, some readers perhaps prefer to make a four-wheeler; I cannot undertake to prepare the many special diagrams which would be necessary to enable them to do so.

I shall be quite willing to advise readers regarding suitable engines, gearboxes and materials; to advise them on the lighting question and passing the driving tests. I shall also be pleased to indicate sources of supply for the various parts.

Here I would advise the reader to study the advertisement columns of papers like the *Practical Motorist* (3d. every Friday), particularly the Classified Advertisements. They may thus be able to pick up reliable second-hand gearboxes quite cheaply. A word of warning is necessary, however: make quite sure that any engine you purchase locally is in good condition, for it is just possible that some of the parts have been sold as spares, and the engine is therefore not complete. If the manufacture has been discontinued, you may experience difficulty in obtaining replacements and they will thus have to be specially made—which can be quite costly!



Tax only £4

Fig. 1.—A complete master frequency-meter and details of the dials.

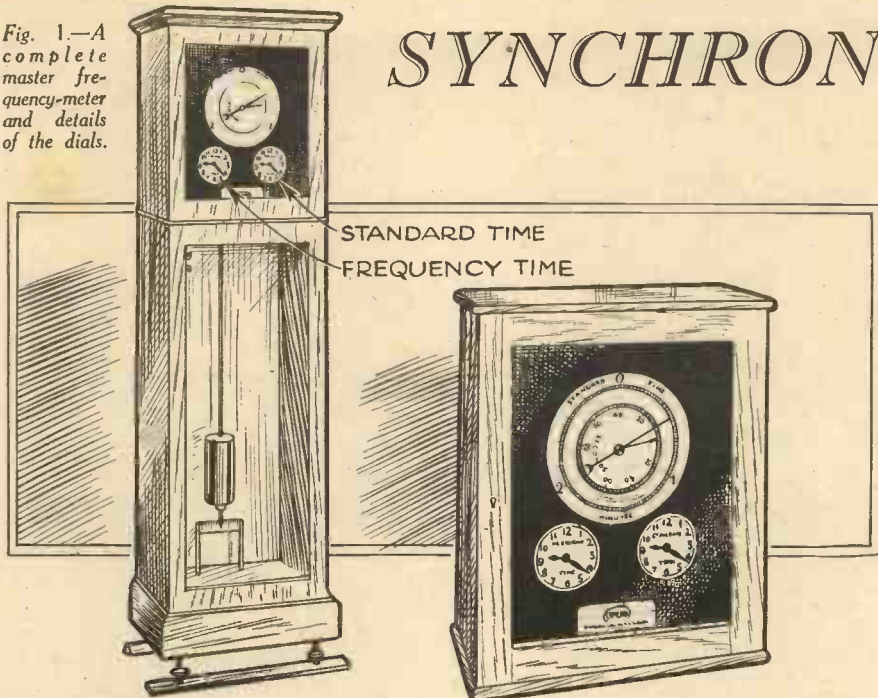

SYNCHRONOUS ELECTRIC MOTORS

the motor is 3,000 revs., hence the need for the reduction gearing. If an increased output is required, two or more rotor sections can be combined on the shaft, and the field increased to the necessary thickness. The shading coils consist of a copper band that encircles about half a pole. When the motor is switched on, the alternating current produces an alternating flux, which causes a heavy eddy current to circulate in the short-circuited shading coils. This causes a phase difference in the magnetism in the two portions of the pole face, that in the shaded part being behind, or lagging by about 50°, that in the non-shaded part. Hence, we have a rotating field, and the motor runs up to speed almost at once. Quite wide variations in the supply voltage do not affect the speed of the motor, but a small change in the frequency is at once apparent. Fig. 2 shows details of the Warren synchronous motor.

SMALL electric motors play a very important part in everyday domestic life. They drive all manner of light machinery, and operate cream separators, refrigerators, etc.

The most prominent type is the so-called "Universal Motor," or series commutator machine, which, being series wound, operates on both A.C. or D.C. circuits without any alteration. It has advantages both to the user and manufacturer of the appliance, the chief of which is its universal nature, since the maker can incorporate the same type of motor in all his articles.

Other motors are not very common in domestic circles, chiefly because of their higher initial cost coupled with the fact that they must be used only on A.C. The synchronous motor is met with in all forms of electric clocks, and timing and recording apparatus.

Controlled Frequency

Before dealing with A.C. clocks, it is necessary to describe how the frequency of the mains is controlled, and what is the advantage of a controlled frequency. Dealing with the last question first, it will be found that in generating practice when the load increases, it is usual to run up an extra plant to deal with this, and as there are generally two rush hours per day, some simple and efficient means of paralleling the alternators must be evolved. Before putting the second generator on the line, its voltage and frequency must be the same as that of the first. On the Grid, for economical operation, it is essential that generators at different stations must be able to share their load with other machines and stations during the rush hours. It is at once apparent that from the generating point of view, exact frequency control is essential. All timing apparatus, from workman's recorders to traffic lights, can be operated from the mains of standard frequency. In large works and factories, it is essential that the synchronous and induction motors run at a constant speed; in paper and flour mills and all other continuous operations, the constant speed factor is very important. In pumping and A.C.-D.C. generating sets, a variation

A Motor may be Kept at a Constant Speed by the Electric Supply which Drives it. This is the Principle of the Synchronous Motor which is the Subject of this Article

in speed causes a variation in the output or voltage; many similar instances could be cited.

The Warren Synchronous Motor

The heart of all frequency meters and control depends on the Warren synchronous motor, which is a tiny motor running at a high speed and developing about one millionth of a h.p. It consists of a laminated field of two poles, each of which is fitted with a shading coil. The armature, which runs on special bearings and is connected to a small gearbox running in an oil bath, consists of a ring of hard steel with one diametric spoke. The speed of

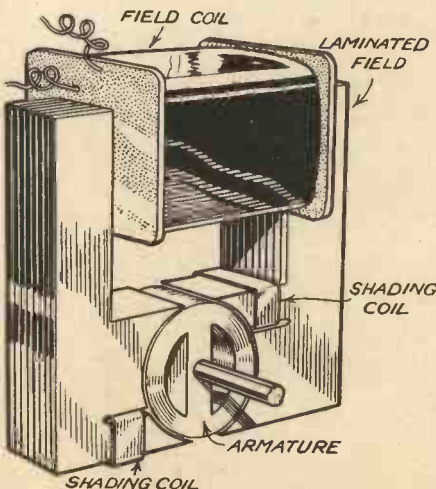

Fig. 2.—Details of the Warren synchronous motor.

The Master Frequency-meter

On the front of the master frequency-meter there are three faces. The large centre one has two dials, the outer is fixed, and the centre one revolves and has a small red pointer painted on it. Concentrically over the outer dial a larger finger revolves. Each dial is divided into seconds, and it takes three minutes for the fingers to make one complete revolution. The outer finger is controlled by a standard pendulum and shows standard time, while the inner disc shows frequency time. Both finger and disc are driven by the same Warren motor, but the finger has a synchronising wheel and slipping clutch mounted on the end of its shaft. This wheel has a certain number of teeth or indentations cut in its periphery, and into one of these, a small wheel is forced every thirty seconds by an electro-magnet. Thus, if the frequency time corresponds to the standard time, i.e. the large finger and disc rotate exactly together, then the small clutch will not slip. As soon as the frequency changes, however, the small wheel will not exactly fit the indentations, hence the clutch slips, and the variation is shown on the face. The standard pendulum is carefully compensated, and is driven by an electro-magnet working through a transformer and rectifier, from the mains. The smaller dials showing, respectively, standard time and frequency time, will, of course, show any large errors, and are used to check the instrument against the time signals (Fig. 1).

The master frequency-meter is mounted in the main control room. It is checked from Greenwich by the wireless "pips." In the control room there is a small receiving set which is switched on by a small synchronous motor a few moments before the pips are due, thus the shift engineer can always check up his instruments.

(To be continued)

TO AMERICA — UNDERGROUND

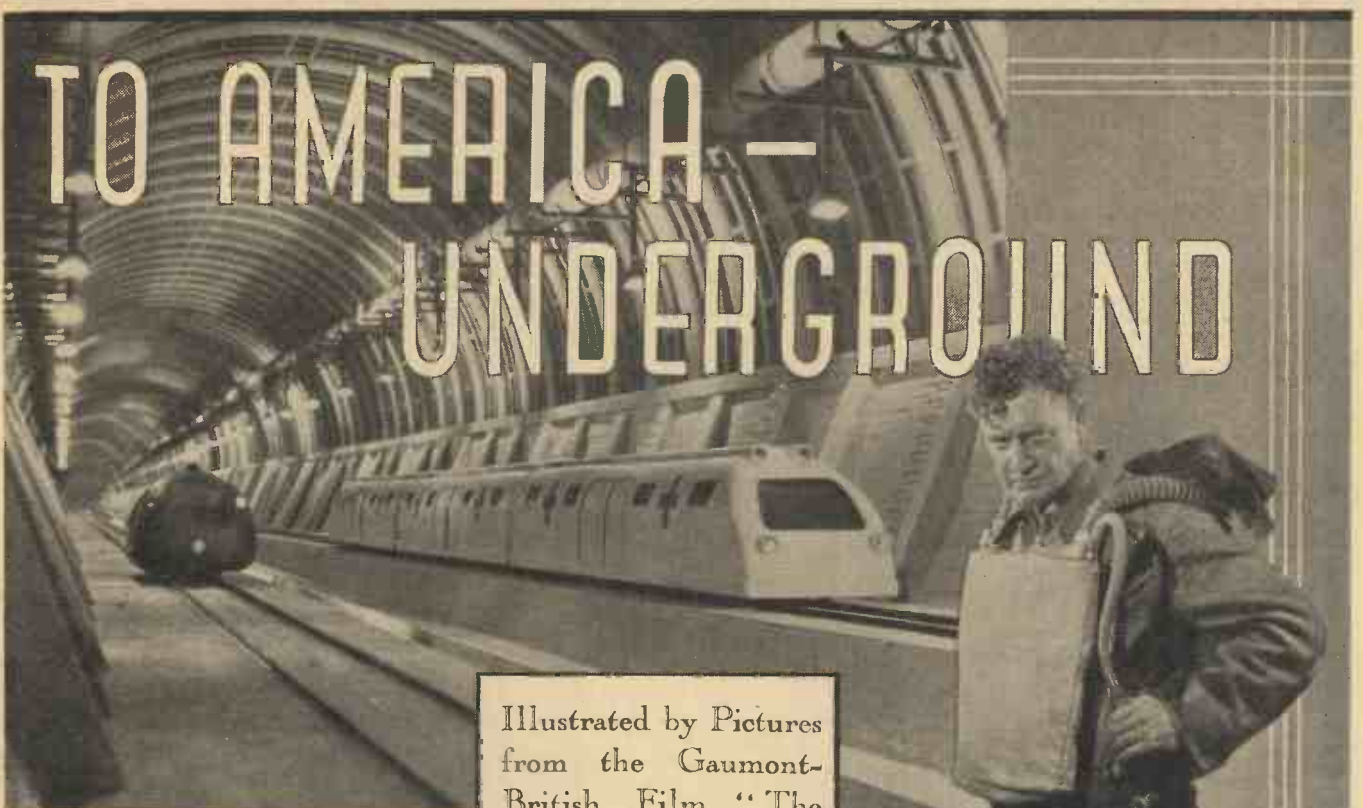

Illustrated by Pictures from the Gaumont-British Film "The Tunnel," this Article Discusses the Problems and Possibilities of Subterranean Transport Between London and New York

JUST imagine stopping a policeman in Trafalgar Square and asking him to direct you to the station for New York! At the moment it is—just imagination—but, after all, it is only imagination which has been responsible in the first place, for the locomotive, the motor-car, and the aeroplane! If Newton had been content to let the apple fall on his head without wondering why it should do so, and if Watt had watched the kettle boil without worrying just why the steam came out, we should probably still be living in an unscientific world. These two men were however, puzzled, and armed with only imagination, they set to work and solved their problems. When one considers the enormous strides which have been made in the realms of science and invention during

At one of the control boards. Note the television screen.



even the past twenty years, an Atlantic tunnel is surely not too fantastic a problem or too great a strain on our imagination.

The Simplon and Mersey Tunnels

Ever since the dawn of time, man has burrowed his way into the earth for one purpose or another, and the amazing accuracy and skill which have been displayed in contemporary workings such as the Simplon and the Mersey Tunnels, serve to show that even the most formidable tasks are not insurmountable.

Those readers who have seen the Gaumont-British film, "The Tunnel," will remember the truly impressive and convincing structural scenes which were shown. Although these sets were, of course, only built for the film, it must be realised that only by going about the job as if an actual Transatlantic tunnel was going to be built, was the amazing realism obtained. Kurt

Siodmak, who was responsible for the screen story, had treated the tunnel as a piece of real engineering, and although only based on imagination and without making any precise calculations in physics or mechanics, the germ of his scheme is of great interest and, who knows, may one day be the basis of an actual Transatlantic tunnel. Stranger things have happened, and it is interesting to note that Mr. Siodmak, in his film story "F.P.I.," visualised floating Atlantic aerodromes which are now actually in the experimental stages in America, and formed the text of an article which appeared in this magazine a few months ago.

3,000 Miles Long

The tunnel, as planned, would be roughly 3,000 miles long, and would follow a route from England to America via the Azores and Bermuda, with entrances at the two intermediate stations as well as at each end. The actual boring implement is really the only imaginative piece of apparatus used, and so feasible is it in theory, that one feels that it is only a matter of time before the drill will actually be in existence. Called the "Radium Drill," it is a huge radio-active boring machine, which is capable of reducing rock to liquid, without heat and consequent danger. The liquified slag is subsequently used, in part, to form a waterproof lining for the tunnel. Estimating the rate of progress at the rate of 2 ft. per minute, and assuming that the boring operations were carried out simultaneously from each end of the four locations, the tunnel could be completed in a few years. During construction it would be split up into sections, each in-

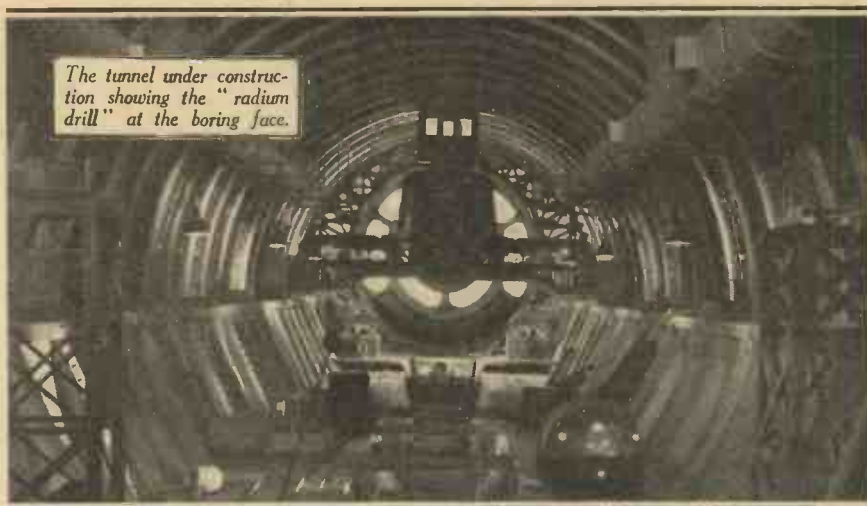

The tunnel under construction showing the "radium drill" at the boring face.

ulated from the other by air-tight doors, so that should any mishap occur at the boring face, that particular section could be cut off from the portion already constructed and thus localise any damage.

Four Train Tracks

The diameter of the tunnel would be sufficient for four train tracks to be laid, and in the space under these tracks an auxiliary and miniature tunnel could be constructed for carrying telegraphic cables.

The tunnel, having been completed, the question of atmosphere in it has to be considered. During operations air would,

of course, have to be pumped into the tunnel, but once completed, the situation changes. One of the primary objects of the tunnel is to expedite transport, and thus, if the air is exhausted from it and the trains run in a vast vacuum tube, their speed could be limitless. This may sound a fantastic statement, but Mr. Siodmak argues that although under normal, present-day conditions the human body cannot stand forward movement at speeds past a certain point, it is only true when movement is in an ordinary media offering resistance to moving bodies, such as air and water, and when movement is sudden. The train,

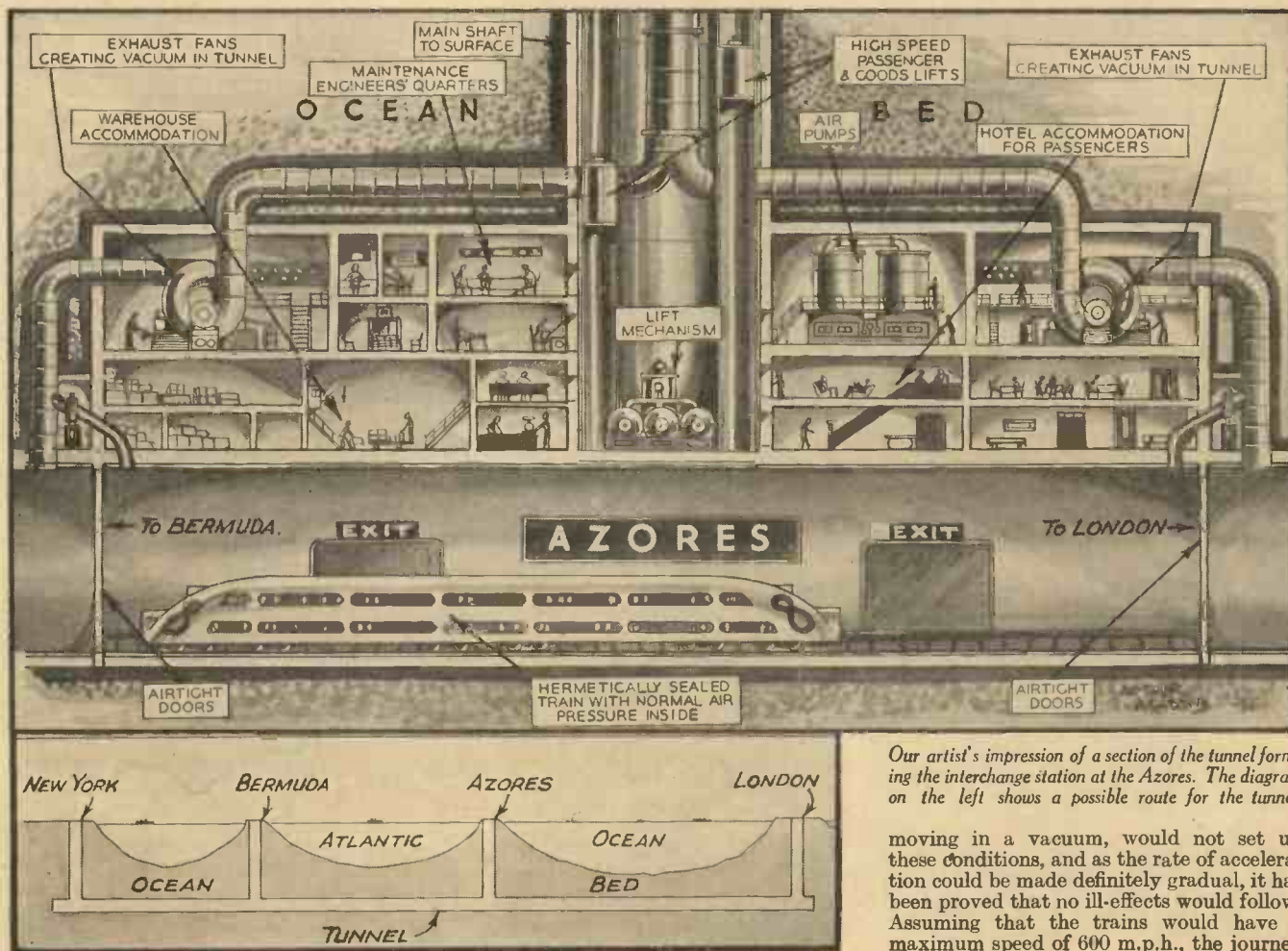

Our artist's impression of a section of the tunnel forming the interchange station at the Azores. The diagram on the left shows a possible route for the tunnel.

moving in a vacuum, would not set up these conditions, and as the rate of acceleration could be made definitely gradual, it has been proved that no ill-effects would follow. Assuming that the trains would have a maximum speed of 600 m.p.h., the journey

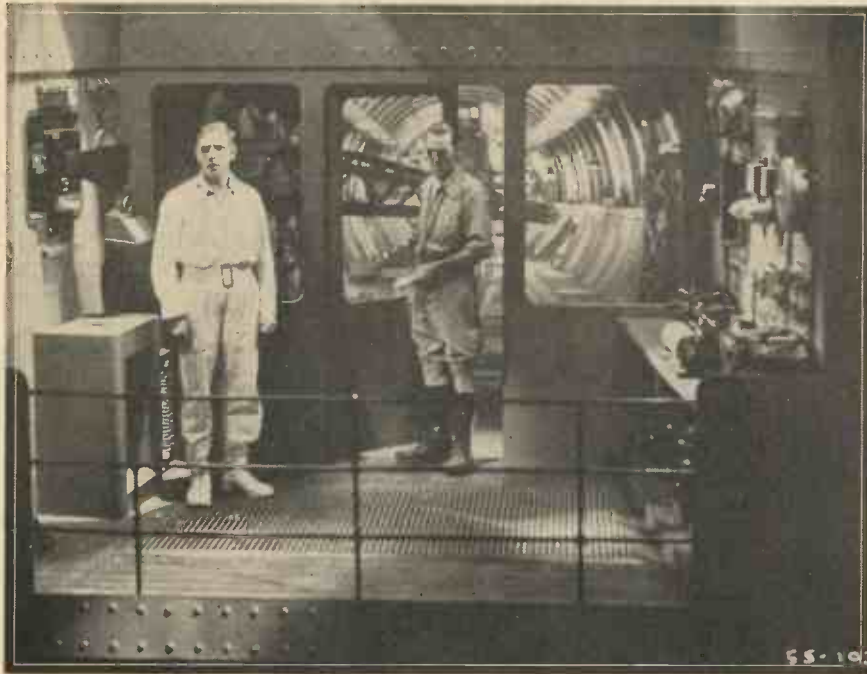

Inside the control cabin of the huge "radium drill" which ploughs its way through the tunnel.

from London to New York would occupy only about five hours.

Sealed Cars in a Vacuum

Using the tunnel as a vacuum, each train would naturally be a sealed car and would carry its own supply of synthetic atmosphere, but provision would, of course, have to be made for passengers entering or leaving the trains. We will assume that the

train has reached the Azores and passengers are to disembark. The section of the tunnel forming the Azores station would be capable of being atmospherically insulated from the rest of the tunnel by means of air-tight doors at each end. When the train had reached the station, these doors would close and the atmosphere in the station section equalised with that in the actual train. The train doors would now

be opened, the interchange of passengers effected, and they would again close. The air would now be pumped out of the station, and the air-tight doors opened, thus allowing the train to continue on its journey. A glance at the cross-sectional drawing will enable one to visualise this process more clearly. As will be seen, a miniature hotel would be built underground, and transport with the surface would be by means of high-speed lifts. Pumping plant would be accommodated, and auxiliary pumps placed at intervals in the main shaft.

Motive Power

The question of the motive power for the trains is one which suggests several alternatives, one of the most feasible of which is, perhaps, an electro-magnetic method. By this means the train is drawn by electro-magnetic force towards a magnet housed in the tunnel. As it approached, the train would cut-out this magnet by means of trip-switch gear, and bring the next magnet into operation. Thus the train would be drawn forward by the series of magnets and gain momentum. The acceleration by this method would be gradual. Perhaps, however, by the time that the actual tunnel is built, wireless transmission of power will be an accomplished fact. This would, of course, greatly simplify the motive problem, for power stations, built at each end of the tunnel would "broadcast" power, and receiving apparatus in the train would pick it up and utilise it for driving the motors of the train.

The advantages of such a tunnel are obvious, and although the project would be one of colossal magnitude, it is really more useful and feasible than the theory of rocket transport through the stratosphere. Not only is it possible to handle transport problems on a large scale, but weather conditions would not affect its services.

AN efficient and safe electric radiator which will work from the mains, can be made with a minimum of trouble. Fig. 1 shows the design of the heater. You will probably find the materials in your workshop, or you may buy them quite cheaply.

The heating element consists of high-resistance wire, wrapped on slate or asbestos. Nickel-chrome wire S.W.G. No. 32 will be found suitable, and has a resistance of 17.5 ohms per yard. The length of wire needed depends on the voltage of your supply, and the current you wish to use, and may be calculated simply by means of Ohm's law. Assuming that the voltage of your mains is 240, and that you wish to use a current of 2½ amperes, which is quite big enough for the ordinary lighting circuit, the required resistance of the wire will be found by putting these values in the formula: Ohms equals volts divided by amperes. Thus, 240 volts divided by 2½ amperes will give a value of 96 ohms for the resistance of the heater. On dividing this result by 17.5 ohms, the resistance per yard, we find that approximately 5½ yards of wire are needed.

The Heating Element

By means of a hacksaw, cut a piece of slate about 14 in. × 2 in. or 2½ in. Rub smooth with sandpaper, but discard the piece if it shows metallic streaks. Four holes are drilled, two at each end, to take wood screws and terminals respectively. This may be done with ordinary twist drills, but go slowly and avoid applying too much pressure. The slate must be dried thoroughly before use.

Make Your Own Electric Radiator

Now coil the wire into a thin spiral about ½ in. in diameter, by wrapping it tightly round a rod of the required thickness. The terminals should now be inserted in the slate, and the wire wrapped round and fixed to each terminal nut. Wrap the wire fairly tight, so that each loop of the spiral is separated from the next one. The tension will then keep the wire in place as it expands.

Assembling the Heater

Screw two wooden supports to the base, and fix the slate to these by means of two wood screws. See that the bare wire does not touch the wood as, should this be damp,

there will be no danger of shock. The reflector is a sheet of tin plate which is bent into a suitable shape, and screwed to the base. This reflector should pass beneath the heating element so as to reflect the radiations from the lower side. It may be made more rigid by fitting protecting bars of iron wire at the front of the radiator.

Connect a length of stout twin-flex to the terminals, and fix it to the baseboard by insulated staples. You may then connect up with the mains in the usual way by a plug or adapter.

Care must be taken to see that the wood or metal parts do not, in any position, come in contact with the bare wire. The heater will then be perfectly safe, since obviously a shock can only be obtained from this bare wire or the terminals, and if the radiator is carefully constructed they are efficiently insulated by the slate.

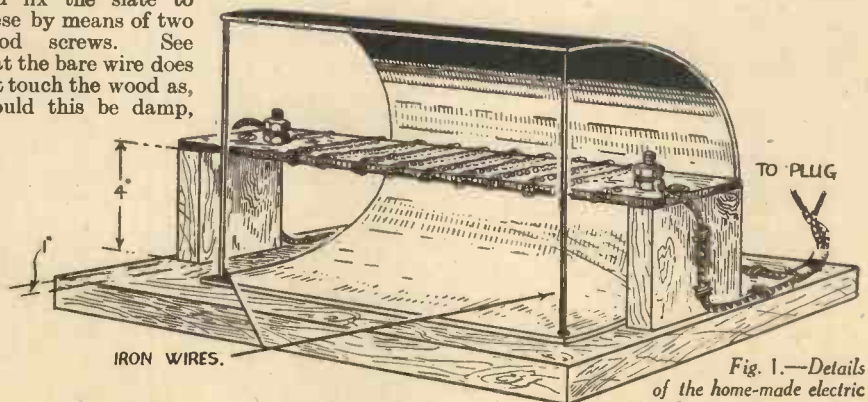

Fig. 1.—Details of the home-made electric radiator.

Domestic Refrigerators

In the Following Article is Outlined, and as far as Possible made Clear and Understandable, with Little or no Technicalities, the Principle, Theoretical and Practical, of a Refrigerating Machine



Figs. 1 and 2.—(Above) Showing the ice trays and ample food space in a modern domestic refrigerator; and (right) a small air-cooled refrigerator having a capacity of 1 cubic foot.

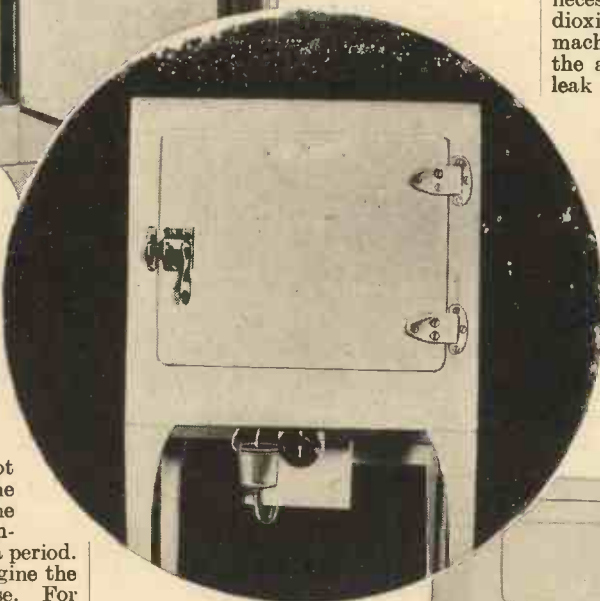

ton or compressed cork slabs, is tightly packed. This prevents the warm air outside entering the cooling chamber. The cooling chamber is built in two or more sections, the lower section being so constructed that shelves or trays may be fitted, on which are placed the foodstuffs to be preserved.

The upper chamber is used as the ice receptacle; necessary arrangements are

pays for itself in a very short period.

Mechanical refrigerators vary considerably, from the large ammonia ice-making plant (also used in large cold storages) to the small sulphur dioxide (chemical formula SO_2) machine (automatic) used in household delicatessens.

Ammonia Machines

The ammonia machine is rarely used in hotel kitchens, chiefly because hotel kitchens are nearly always situated on the ground floor and often in the basements, and any leak that may occur in the ammonia system, such as a burst pipe, leaky joint, gland, etc., would have disastrous results.

The most common type used—but not necessarily the most efficient—is the carbon dioxide (chemical formula CO_2). This machine has one distinct advantage over the ammonia plant, and that is that if a leak does occur in the system, no danger can ensue, the mixture being practically harmless. This, everyone will agree, is a great asset, especially when it can be fitted in any nook and corner.

In the smaller type of machine, such as for ice-cream making and storing, also the household delicatessen, the sulphur dioxide (chemical formula SO_2) is the most popular.

The cost of this machine is not high, running and maintenance costs being particularly low. The electrical consumption of these small machines is only about 10 units per month. They are automatic in

ONE of the most important, if not the most important machine used in a kitchen larder, is the cooling apparatus, or that which enables foodstuffs to be preserved for a period. Without it, it would be hard to imagine the many difficulties which would arise. For instance, all food would have to be bought daily, and bought in such a manner that none would be left at the end of the day, because all portions left—especially in the summer months—would have to be thrown away, as they would be unfit for consumption.

The ice-box and refrigerator have overcome all this worry, and, especially in the case of the refrigerator, food can be stored indefinitely, and the food will be just as good when it comes out of cold storage as the day it went in, providing it is properly stored at the correct temperature.

The Ice-box

In some of the small kitchen larders throughout the country, the old ice-box is still relied upon as a preserving medium, and in many of the remote country districts, it would be impossible for them to have anything else, there being no motive power and no means of driving a mechanical refrigerator.

An ice-box consists of a wooden box or cabinet, with a hinged lid or door. Between the outer walls and inner chamber an insulating material, such as silicate cot-

made for collecting the water from the melted ice by means of a drip-tray and draining-pipe, the latter being brought to a suitable position outside the cabinet. If this cabinet be kept tightly closed, the inside temperature will be reduced to about 35° to 40° F. While this system is good it is very costly—a medium-sized cabinet will use about 1 cwt. of ice in 24 hours.

This method of preserving foodstuffs would be most impracticable in a large hotel, not only from the point of view of cost but the amount of space that would be required for the ice portion, so mechanical refrigeration is resorted to as it is much better in every respect. The installation cost is the main cost, and the running and maintenance costs are not high. The machine

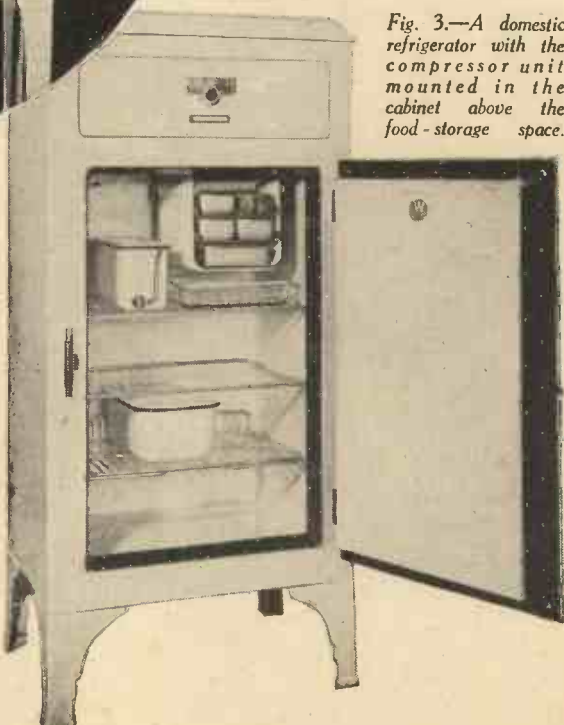

Fig. 3.—A domestic refrigerator with the compressor unit mounted in the cabinet above the food-storage space.

action, and when the automatic switch is properly set, will keep the temperature to within 5° - 8° of the setting. When installing this type of machine, great care must be exercised that there is plenty of ventilation, both from a running point of view and also a maintenance point. Often insufficient thought is given when choosing a site, and when the machine has to be overhauled it is found that the machine has to be moved to a better ventilated part of the building. This need not arise if care is exercised when installing. It is rather a good idea when it is not possible to have an out-building or well-ventilated room, to instal an electric-fan with reversing switch and necessary air-trunking attached, leading to the outside atmosphere, so that when the machine is running, cold air can be blown on to the machine, and when overhauling, the fan can be reversed to discharge any fumes outside.

The Principles of Mechanical Refrigeration

Refrigeration, no matter in which way it is carried out, is the transference of heat from one body to another, or from one substance to another. To explain, when a block of ice is placed into an ice-box the heat of the chamber, together with the heat of the contents, is transferred to the ice. In a mechanical refrigerator the heat of the cooling chamber and contents is transferred to the refrigerant, that is the ammonia, carbon dioxide or sulphur dioxide, whichever system may be used. Ice is comparatively hot to boiling ammonia at 25° below zero. When one thinks of a refrigerator one thinks of intense cold, yet heat is being supplied to the refrigerant to make it boil. The cooling chamber and contents supply the heat, and in giving up their heat, become cold.

To explain it more clearly, it will be necessary to detail the difference between heat and temperature. If heat is applied to a body, changes in its formation will take place, such as, if sufficient heat be applied to a metal it will change to a liquid. If heat be applied to a piece of ice it will melt, change from the solid to a liquid. If this heat is continued the water will boil. Its temperature then is 212° F. (atmospheric pressure), but no matter how much more heat is applied, it is impossible to raise its temperature above that point, but another change will take place in that the water will vapourise—turn to steam—that is the gaseous state.

It must be understood that heat can flow in one direction only, and that is from the warmer body or substance to the colder. If a vessel be tightly packed with ice, and in the centre of that ice pack is placed a vessel filled with water, say at 60° F., the ice being 32° F., the water being 60° F. will make the heat from the water flow to the ice. But it must be remembered that while this change is taking place, that is the heat leaving the water, the ice will not change its temperature from 32° F. until all the ice has melted, then and only then will the temperature of the melted ice commence to rise.

It has been stated that the temperature of boiling water is 212° F.—this is, of course, at atmospheric pressure. This boiling-point can be raised considerably. In a steam-boiler when the water is under pressure, and the pressure-gauge reads say 50 lb. per sq. inch, the temperature of that boiling water will be 298° F., and at 150 lb. per sq. inch it will be 363° F. Inversely, it can be made to boil at a much lower temperature than 212° F. If the pressure on the steam-gauge is reading 9 lb. (absolute pressure) per sq. inch (atmospheric pressure is 14.7 lb. per sq. inch) the boiling-point will be 170° F.

This also applies to all liquids, as they all have a maximum boiling-point at atmospheric pressure, a higher boiling-point under pressure, and a reduced boiling-point under vacuum.

Boiling-point of Liquids

The boiling-point of liquids varies considerably—ammonia will boil at 25° below zero, mercury at about 660° F., and sulphur dioxide at 14° F. It will now be quite clear to the reader that if a vessel is filled with ammonia and allowed to vapourise into the atmosphere, and a constant pressure is kept on the liquid (so that its boiling-point remains at the same temperature), the ammonia will draw heat from its surroundings, and that while under the same pressure its own temperature will not rise, and the objects or substances giving up their heat will naturally go cold. This condition could go on indefinitely (if there were sufficient ammonia in the vessel) until the substance supplying the heat to boil the ammonia, became the same temperature as that of the refrigerant, when the ammonia would stop boiling and refrigeration would cease.

This, of course, would not be possible

horizontal direction.) Fitted in the top of the piston is a non-return valve "A," so that when the motion is downward, the gas lifts the valve and passes through. On the return stroke, or when the piston is moving upwards, this valve "A" is forced on to its seating, and prevents the gas from again passing through the piston. By this means the gas is pushed onward. Above the piston, and bolted to the cylinder, is a valve plate and a non-return valve "B" working in the same direction as the piston-valve. This allows the gas to be forced through by the upward movement of the piston but allows none to pass back. This action is continuous and, as in some cases two pistons are connected to one crankshaft, the flow of gas is kept at a steady rate.

The gas is then forced through into the condenser. Between the condenser and the evaporator or boiler, a regulating-valve is fitted (expansion-valve or needle-valve) and a float-valve in the automatic type. This valve regulates the flow of the refrigerant into the evaporator or boiler. This will, of course, increase the pressure in the condenser, and in so doing raises its boiling-point, which is most essential. To bring the gas back to its liquid state, the heat

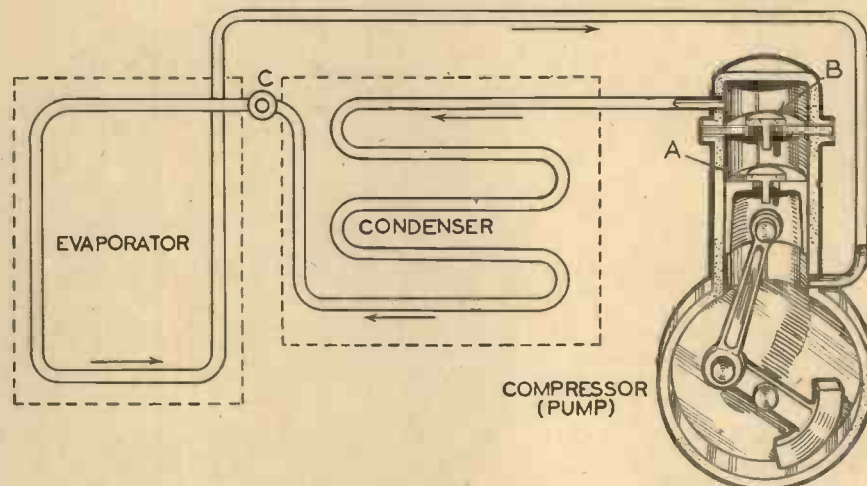

Fig. 4.—How the refrigerant is circulated.

under ordinary conditions, owing to the enormous amount of refrigerant that would be wasted. In refrigerating machines, it is used over and over again; it is boiled or vapourised, and then condensed or liquified, and so the process goes on.

It has already been explained that to vapourise or boil a liquid, heat must be added, but to alter its form and change it from its gaseous state to liquid state, the opposite is necessary—that is the heat must be extracted. This is done in either one of two ways.

The refrigerating machine is built in three separate units, (1) the pump, (2) the condenser, and (3) the evaporator or boiler. The pump is to circulate the refrigerant round the system, the condenser to extract the heat from the refrigerant and so liquify, and the evaporator or boiler to draw the heat from the surrounding objects or substances and so make them cold. Fig. 4 illustrates how the refrigerant is circulated.

The Inside Working

It will be seen from Fig. 4, that the pump is so constructed as to enable the piston or bucket to take a sliding, up-and-down motion. (In large machines they are made to work backwards and forwards in an

must be extracted. The methods adopted for extracting the heat, are either a circulation of cold water round the condenser, or a circulation of cold air round or through the condenser by an electric blower.

A Question of Temperature

If the atmospheric temperature around the condenser is 60° F., then it is necessary to raise the temperature of the refrigerant in the condenser to over 60° F. to be able to extract the heat. Also, if the temperature of the circulating water is 40° F., then it is only necessary to raise the temperature of the refrigerant to above 40° F. The pipe between the condenser and the evaporator, is termed "the liquid line."

The liquid is forced through the regulating valve at a steady pressure, and in passing into the evaporator expands and, having no pressure, its boiling-point is greatly reduced. After passing through the evaporator the refrigerant goes to the suction line of the pump; the process is thus continued.

After a running period, the temperature in the cooling chamber is reduced by reason of the refrigerant collecting the heat in the evaporator from the surrounding warm substances. The major portion of the gas being under pressure in the condenser, the evaporator has a minus pressure or vacuum.

WORLD FAMOUS FOUNTAINS



The Dragon Fountain, Versailles, believed to be the world's mightiest single jet.



The Griffon Fountain, Copenhagen, is a splendid modern example.

A FOUNTAIN is defined as an arrangement permitting water to gush into an ornamental bowl, or by which it is forced into high jets.

There are two principal kinds of fountains, the useful and the ornamental. The former are fountains provided in public streets or squares, from which people can draw water for domestic use. Such are still common in backward countries, but are being rapidly superseded by mains water supply laid on in dwelling-houses.

Ornamental fountains, which are used to beautify a street, garden, or public square still are popular, and have been built from the very earliest times. They are not only exceedingly beautiful objects, but in many cases represent a high degree of scientific and mechanical skill. This is especially the case with the very large and important fountains, which fling huge jets very high into the air, such as the fountains at Versailles, France, Aranjuez and Granada, Spain, and the great Buckingham Memorial at Chicago.

Some of these magnificent displays can almost be styled artificial geysers, or waterfalls.

Their Origin

The origin of the fountain is lost in the mists of antiquity, but it is certain that they were first made long before man had invented the water-pipe. Thus there is a Babylonian fountain, circa 3000 B.C., at Tello, the Lagash of antiquity, which is fed by a stone conduit. Layard, in his book on Nineveh, mentions an Assyrian example in a gorge of the river Gomel. This also is served by a stone channel and consists of a series of basins cut in the solid rock, and descending by steps to the stream.

It is certain that the ornamental fountain originated in a warm climate, and probably many centuries before Christ. In Greece and Rome, the commonest type had the water gushing from a grotesque human or animal mouth into a marble basin, but there were some which had a vertical jet. These are very beautiful, and also cool the air by spraying the water through the atmosphere, and consequently are much found in the



The Fountain, Rosenburg Square, Versailles.



Neptune Fountain, Bologna, Italy.

mansions of the great, or the palaces of kings. In Greece and Rome, main water supply was often laid on to the mansions of the rich, but humbler folk had to draw their supplies from a street fountain. The Greeks were very fond of handsome marble basins, having cut stone openings through which the water gushed. Of all Greek cities, Corinth was the richest in this respect, and its most famous example was dedicated to the nymph Pirene—whose tears for her sons slain by Artemis were held to be the mythical origin of the spring.

Public Fountains

Ancient Roman cities were well supplied with public fountains. In Pompeii we can still see some good examples in the main streets, and some splendid specimens of ornamental fountains in the courtyards of private houses. There is one magnificent example in a villa, which to-day is named after it. There is a large plunge bath of coloured marbles into which water gushes from two old men's mouths. A little cupid stands in the water, through which a jet of water is squirted into the air. A flight of marble steps permits the bather to descend into the pool; the whole effect is not only very beautiful, but represents a wonderful amount of mechanical skill when we remember it is two thousand years old. There are numerous public water-supply fountains in the streets. The Romans sometimes constructed gigantic ornamental fountains for the adornment of their cities. They were almost as large as temples, and were known as Nymphaea. One of the best examples now remaining is near the agora at Ephesus.

When Rome crashed, Europe went back to barbarism, and street fountains did not re-appear till the twelfth century, but thereafter progress was rapid, and many beautiful fountains which are still running date from the mediæval period. The Schöne Brunnen at Nuremberg is very charming, with its graceful gothic spirelet, and numerous statues.

Ornate Structures

With the cult for classical models in the Renaissance, many fine fountains were

designed. Some were exceedingly ornate, especially in Italy, where the most usual design consisted of a series of basins one above the other, but diminishing in size, and a lofty jet falling into the uppermost basin. Some of these are so elaborate that the water seems to be merely an afterthought; as, for instance, the Aqua Paola by Fontana (1600), and the Fountain of Tivoli, which was built from designs by Bernini in the eighteenth century. At the Villa D'este in the same Italian town, there is a most ingenious so-called "Water-Organ" or fountain, controlled by certain stones in the pavement. When certain of these are stepped on the water gushes out. This was a favourite joke in the Renaissance period, and there are many of these "secret fountains" which smother the unwary walker with jets of water when hidden stones are trodden on.

This was considered highly amusing by the *haut monde* of the period, and the guides play the joke on modern visitors to-day.

Many of these booby-traps are marvels of ingenuity; the idea is to make sure the unwary visitor is thoroughly soaked, and so the path is usually shut in by hedges, and the water-works begin when he is in the middle of a long alley way. Sometimes the jets are turned on by stepping on a paving stone, and in other cases there is a concealed tap which is operated by the practical joker.

One of the best examples of this kind known to me is in the gardens of the Palace at the Alhambra, where a very long path, shut in by hedges, connects two buildings. As you go along it appears perfectly normal, but when a tap is turned a long line of vertical spouts of water rise about 15 ft. into the air, and deluge the pathway.

"Les Grands Eaux"

The finest fountains in Europe are in France, Italy, and Spain. The most imposing spectacle of its kind in the world, can be seen on those days when "Les Grands Eaux" are showing in the gardens at Versailles, near Paris. The cost is so enormous that the water is only turned on for an hour at a time, on certain selected Sundays during the summer. Then at a given moment all the fountains in the grounds begin to spout in succession. There are 607 of them to-day, but originally (when first installed by Louis XIV), there were 1,400, and the cost was so ruinous, that the place was called "L'Abime des depenses," or the abyss of expense. There are twelve miles of underground pipes, and a display consumes six thousand million



The Palm Tree Fountain, Monreale, Sicily, which is believed to be the most graceful and artistic on earth.

cubic yards of water, which is used several times over, the fountains in the lower part of the grounds being worked by the overflow from those higher up.

The Basin of Apollo has one magnificent jet 60 ft. high, and three others of 47 ft., but the Bassin d'Enclade has an artificial geyser over 70 ft. high, and surrounded by a large number of smaller jets. The finest group is the Basin of Neptune with sixty-three large jets which plunge down into the pool in masses of creamy foam.

The largest jet of all is in the Dragon Basin, which hurls a mighty column of water 82 ft. into the air. It will be remembered that the shameful extravagance of the French kings was a main cause of the French Revolution, and it is satisfactory to notice that these fountains—constructed to amuse a pampered Court—now give pleasure

to millions of hard-working ordinary folk. When the fountains are playing, special trains are run, and the grounds are crowded.

Two of the most dignified and imposing fountains in the world are the wonderful pair that stand in front of St. Peter's Cathedral at Vatican City. The fountains are 45 ft. high, and hurl a jet more than a 100 ft. into the air. Unlike many Renaissance models of this kind, there is no extravagant detail, and the beauty of the lovely design is increased by its simplicity.

The Palm Tree Fountain

The fountains of Sicily are justly famous, and among them there is one which I believe to be the most graceful and artistic on earth. It is called the Palm Tree Fountain of Monreale, and is in the cloisters of Monreale Cathedral. The artist has chosen a palm tree as his model, with lofty trunk with zig-zag markings like the cut-off leaves on a date palm, and a circular crown from which issue a halo of jets of water, resembling palm fronds.

Spain and Portugal are very rich in fountains. Most of them are placed in the streets for domestic water-supply—since none is laid on to the smaller homes—but many of them are strikingly beautiful. One of the most picturesque works of this kind is the famed "Horses Fountain" at Santiago-de-Compostella, where four gigantic horses vomit a stream of water from their mouths, and busy housewives can be seen at all hours of the day filling their jugs and buckets. Maid-servants come too, and carry the large water-cans away on their heads, a trick learned from their Moorish ancestors.

The Moors, too, have left behind them in Spain some of the loveliest fountains ever made. In the old Moorish Palaces of long-dead Sheikhs or Sultans, we can see graceful marble fountains, and silvery pools, as in the Alhambra and the Alcazar. In the first-named palace is the Fountain of the Lions, perhaps the most celebrated of all these works of art.



(Left) The Neptune Fountain at Versailles is perhaps the most imposing group of spouts in the world, and (right) a picturesque fountain at Belem, Portugal.

A Model of a Tudor Ship

A Simple Model which, when Suitably Finished in Colours, has Considerable Decorative Value

Fig. 1.—This small Tudor ship is as interesting to make as it is attractive in appearance.

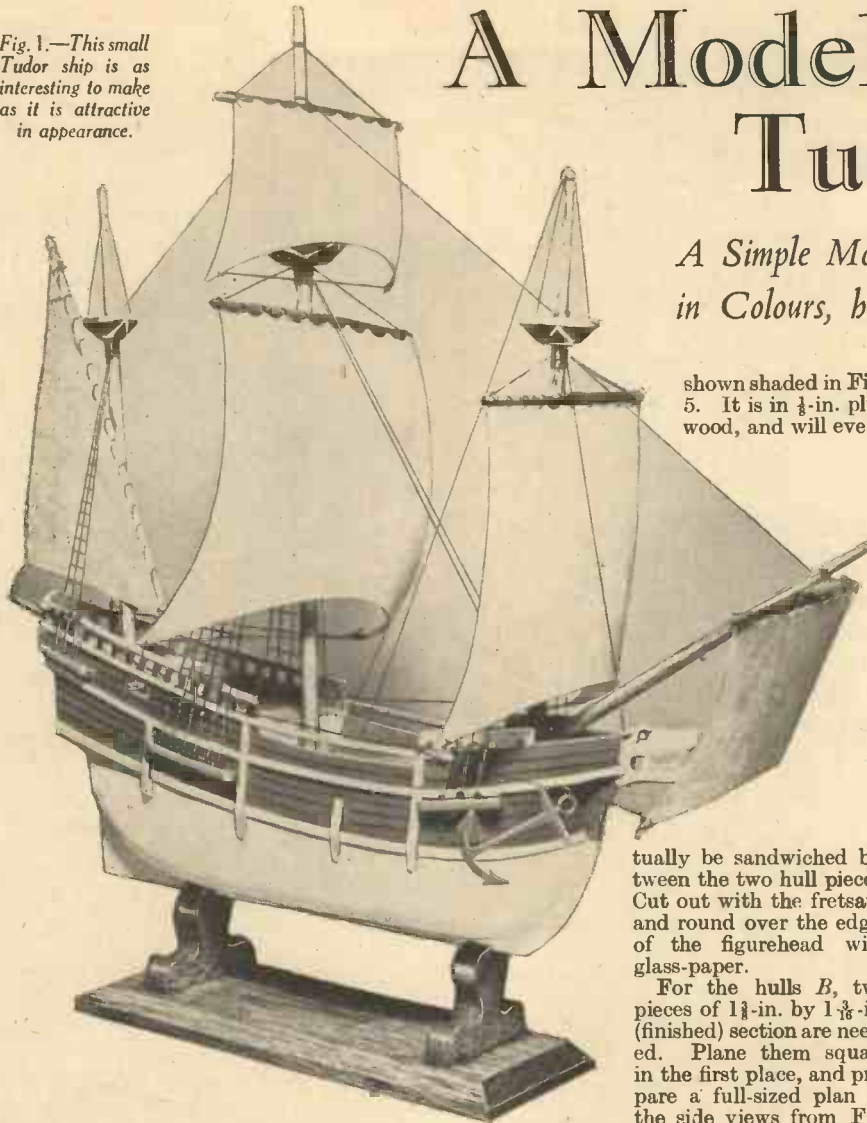

shown shaded in Fig. 5. It is in $\frac{1}{8}$ -in. plywood, and will even-

taken off to give the true shape when viewed from the front. The left-hand piece in Fig. 2 is shown at this squared-up stage, and that on the right shows the rounded shape partly produced, and being tested with a template.

This template is the reverse of the correct section amidships, and the line can be traced from the stern view. Form this centre shape first. The chisel can be used to remove the majority of the waste, the hull being held in the vice during the operation. Test frequently with the template, remembering that wood can always be removed easily, but cannot be replaced if too much is taken off.

Finishing the Hull

The shape towards bow and stern can continue in a gentle curve without lumps. View the hull from all directions, and take off a shaving where required. The wood

tually be sandwiched between the two hull pieces. Cut out with the fretsaw, and round over the edges of the figurehead with glass-paper.

For the hulls *B*, two pieces of $1\frac{1}{2}$ -in. by $1\frac{3}{8}$ -in. (finished) section are needed. Plane them square in the first place, and prepare a full-sized plan of the side views from Fig.

5. Transfer the plan on to opposite sides of each block, and the side view to the *inner* surface only. Take care that the bows of both tracings are always at the same end and are level. Note also that the two hulls are right and left hand.

The plan shaping is done in its entirety first. The fact that the shape has been marked out on two sides, enables the correct line to be maintained at both edges. Much of the waste can be sawn away. This is followed by vertical paring with the chisel, and the entire curve is finished off either with the spokeshave or wood file.

Now follows the elevation shaping. Put the hull in the vice and cut across with the chisel, keeping the latter square, and complete the whole curve. This will produce a shape which is correct in both plan and elevation, but the outer corner needs to be



Fig. 2.—Testing the shape of the hull with a template.

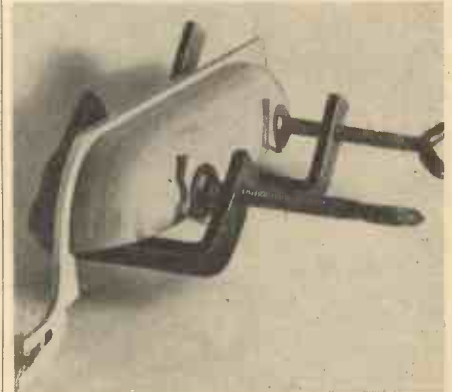

Fig. 3.—How the hull is glued to the keel.

file can follow. This should be worked with a sliding movement both along and across the shape, so that all chisel marks are taken out. A thorough glass-papering follows. The portion immediately adjoin-

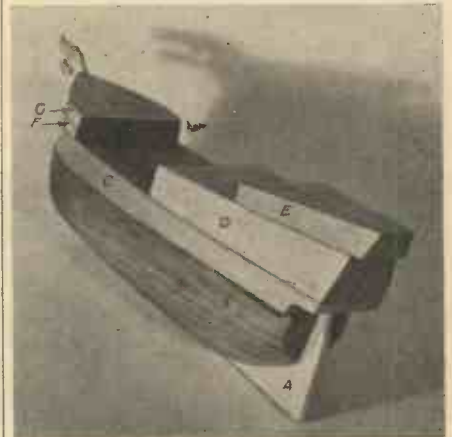

Fig. 4.—The superstructures glued to the hull.

THIS model represents the type of ship that was used for carrying merchandise during the time of Henry VIII. It is founded on a drawing made by Holbein in 1532, in which the crew are shown going about their various duties. Amongst them are several soldiers carrying pikes suggesting that the ship, even when engaged peacefully as a merchantman, would be prepared against attack. In emergency she would be pressed into service as a fighting ship.

As was invariably the case with Tudor ships, that shown in Fig. 1 is brightly finished with gay colours, thus making it a splendid subject for a model, because it has such decorative value. The hull is built up rather in the form of bread and butter, this being simpler than making it in a single piece, and it is just as satisfactory.

Practically any close-grained wood can be used. Satin walnut is quite satisfactory, or a good grade of pine. Common deal has the disadvantage of having hard and soft grain, and this is liable to show in the form of ridges as shrinkage takes place. Some hardwoods such as sycamore, are certainly close-grained, but they are so hard that the carving out is made difficult. For the keel $\frac{1}{8}$ -in. plywood is used, and for the bulwarks which are bent around the hull, $\frac{1}{8}$ -in. plywood answers well. Masts, spars and the stand, can be of oak.

The Main Hull

Begin by cutting out the keel piece *A*

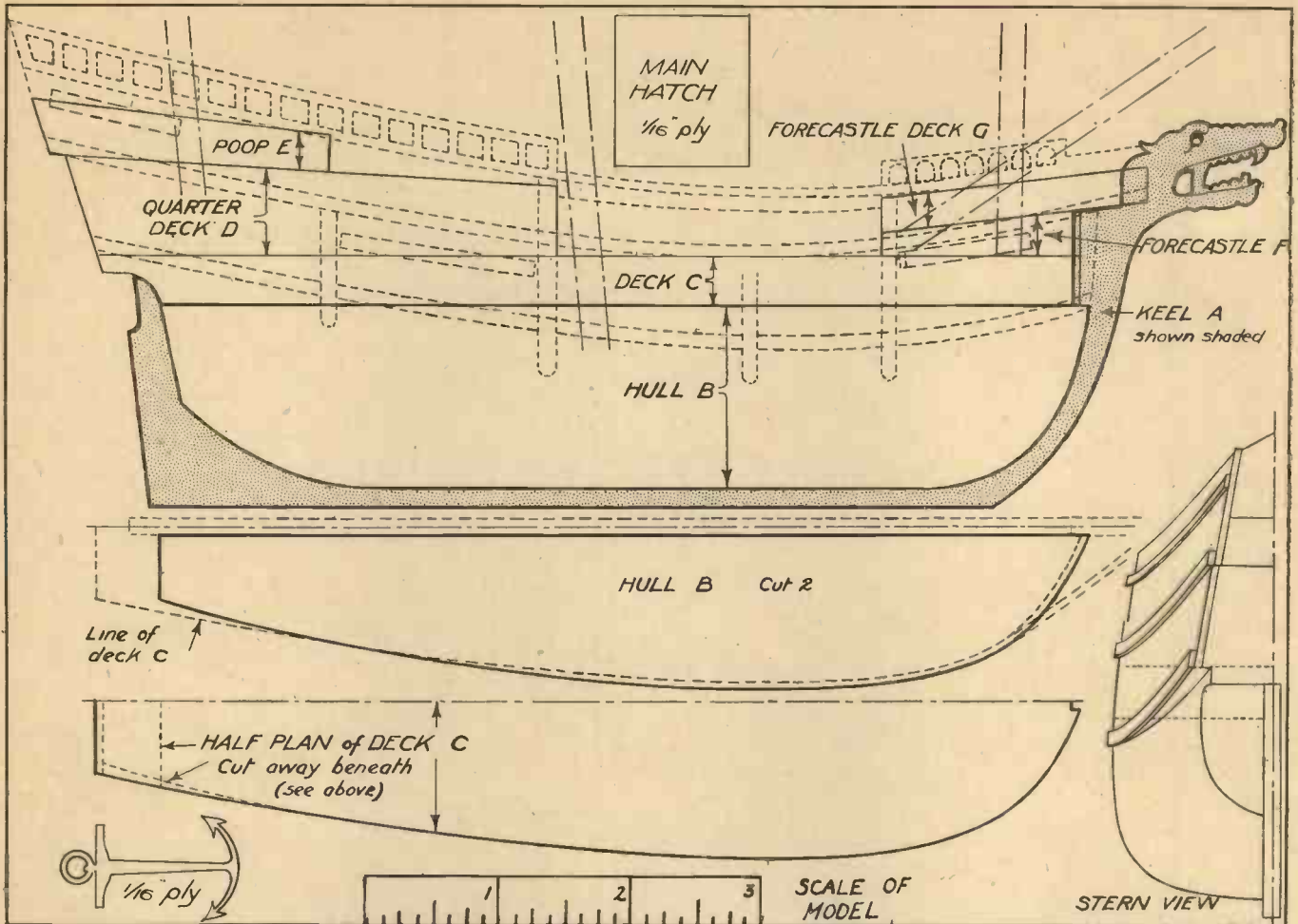

Fig. 5.—Constructional details of the hull, keel, etc.

ing the keel must be finished off true, because after gluing up, it would be extremely difficult to touch this portion. Towards the deck it is not so important, because a further smoothing down has to follow after the bulwarks are added.

It is now ready for gluing up. One or two nails can be driven through the keel into one hull piece, but this is not possible in the other. Instead, a nail can be driven in at an angle through the thin part of the hull. These nails serve to hold the parts in position, so that thumbscrews can be put on as in Fig. 3. Note the little blocks of wood under the cramps, to prevent damage to the surface.

The Superstructures

Begin with the deck C, one half of which is given in Fig. 5. Fold a piece of tracing paper and trace the shape, keeping the fold on the centre line. The opposite half of the shape is then traced directly from this. Transfer on to the wood ($\frac{3}{8}$ -in.), and cut out. It will be found that it stands in at the bow and right round until near the stern, where it projects. This is shown by the dotted line in the plan shape of the hull. This standing-in forms a rebate in which the bulwarks can be fitted, so that the whole thing is flush. The bulwarks project at the stern. At the underside, a hollowed-out shape is cut at the stern, so that it fits over the projecting rudder portion of the keel. The side shaping (see dotted line) is not cut until later. Fig. 4 shows the deck in position.

The various other superstructures are now cut out and glued on, as also shown in

Fig. 4. Certain of these have to be tapered in section (see side view in full-size design), and both the quarter deck and poop are taken off at an angle at the rear. If the stern view is examined, it will be seen that both quarter-deck and poop taper inwards towards the top ("tumble home" as it is called), and this shape is best worked after they have been fixed. If a bull-nose plane is available, this will prove very handy in working the shape. Alternatively, a wood file can be used.

At the bows, the forecastle does not taper, but rises vertically. Note that the forecastle deck is pointed and thus projects towards the beak. Before proceeding



Fig. 6.—Fitting the bulwark into place. Note how the cut at the bow enables it to fit against the forecastle and hull.

further, an imitation of the deck planking can be given, by drawing in a series of pencil lines.

The Bulwarks

These can both be fretted out at the same

time, by pinning together two pieces of $\frac{1}{8}$ -in. plywood. The grain must be upright. To save the tedious job of fretting out the holes, a $\frac{1}{8}$ -in. chisel can be used to cut them. The shaped ones at the bow can be bored in, and the bottom square, side cut with the chisel. If this method is adopted, the holes must be cut before the main outline is fretted, otherwise the grain may split away.

Fig. 6 shows the fixing. The cut at the bow enables the top part to bend along the forecastle deck, whilst the lower part can fit to the hull. Glue is used, and a few fine nails which are afterwards punched in, will hold down the plywood whilst it sets. Afterwards, the poop back can be added.

It is inevitable that a certain amount of unevenness will occur at the joint, and this can now be smoothed down. Where the bulwarks slope upwards towards the stern, the deck C can be cut away so that it is level with the hull. This is shown in the stern view, side view, and half plan of the deck.

Wales and Channels

For the wales, cut six pieces to the shape shown and fit them in the positions indicated by the dotted lines in the side view. The exact length can be measured from the actual hull, and they will bend easily one way or the other. The top wale is a trifle narrower than the others. Upright wales are also fixed in the positions shown, these again being in $\frac{1}{8}$ -in. ply. They can be bent right over the horizontal wales, and be fixed with glue and nails.

Coming now to the channels, fine holes

square, take off the corners to form an octagonal shape, and then round over. Afterwards, taper the ends where required. The foremast rises 7 in. above the deck, the mainmast $9\frac{1}{2}$ in., the mizzenmast $6\frac{1}{2}$ in., and the bowsprit $4\frac{1}{2}$ in. An extra length of about $\frac{1}{4}$ in. is needed in each, for recessing into the deck. Bore holes to take them, sloping the brace to give the required tilt to the masts, but do not glue till later. Sizes of the yards are given in Fig. 8.

These can be fixed either with a fine pin driven into the masts or they can be

lower hull is white or cream, and the bulwarks a mid-brown. Wales are picked out in yellow, and red and green are used to colour the handrailing, beak detail, and crows' nests. When dry (this is important), the whole is given a coat of clear cellulose lacquer.

Rigging and Sails

Begin with the main shrouds. Dealing with the mainmast, cut off 12 pieces of carpet thread (brown shade No. 50), each long enough to stretch from beneath the crow's nest to well below the channels. Remove the mast, put a coat of glue on the mast under the crow's nest, and lay the shrouds six to each side. When set, a piece of fine thread can be bound tightly round. Glue in the mast, and, threading two small glass beads on each shroud to form the dead eyes, pass the shrouds through their holes in the channels. Now fix the main stay from under the crow's nest to the base of the bowsprit, draw the shrouds taut, and tie them in pairs under the channels. A touch of glue on each knot prevents them from becoming undone. To hold the dead eyes in position, put a small dab of glue on each shroud, and raise the dead eyes to the required position.

Fig. 7 shows the remaining rigging and sail positions. The sails can be cut in lampshade vellum, to the sizes given in Fig. 8. The edges to be attached to the masts, can be scolloped out with a gouge or scissors as in Fig. 1. Fine thread laced through the ends will hold them to the yards, and dabs of glue along the edge will hold them in the centre. The free ends are roped to the rear bulwarks.

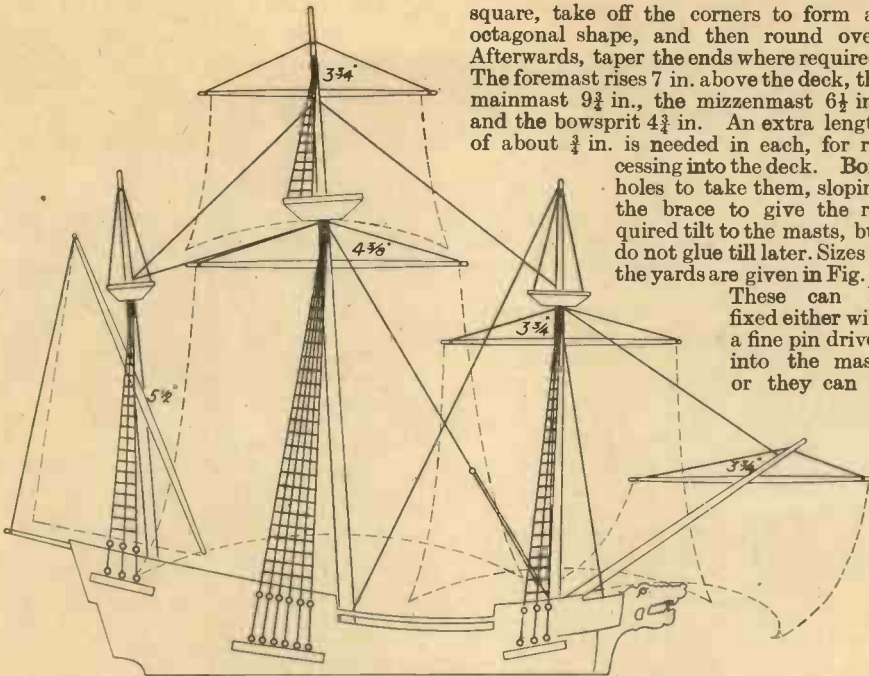

Fig. 7.—Details of the rigging and sails, and the sizes of the yards.

are drilled through these to take the shrouds, and at the ends, rather larger holes are made through the width to take the fixing screws (see dotted lines). The channels with curved edges, are fixed at the bow end.

bound on with fine thread. The crows' nests are fretted out, and the underside bevelled away. The centre holes are drilled before fretting out, their size being made to fit the masts.

Masts and Yards

These are cut in oak. Plane the wood

Poster or showcard colours are excellent for the purpose, as they are opaque and cover well. Two coats are advisable. The

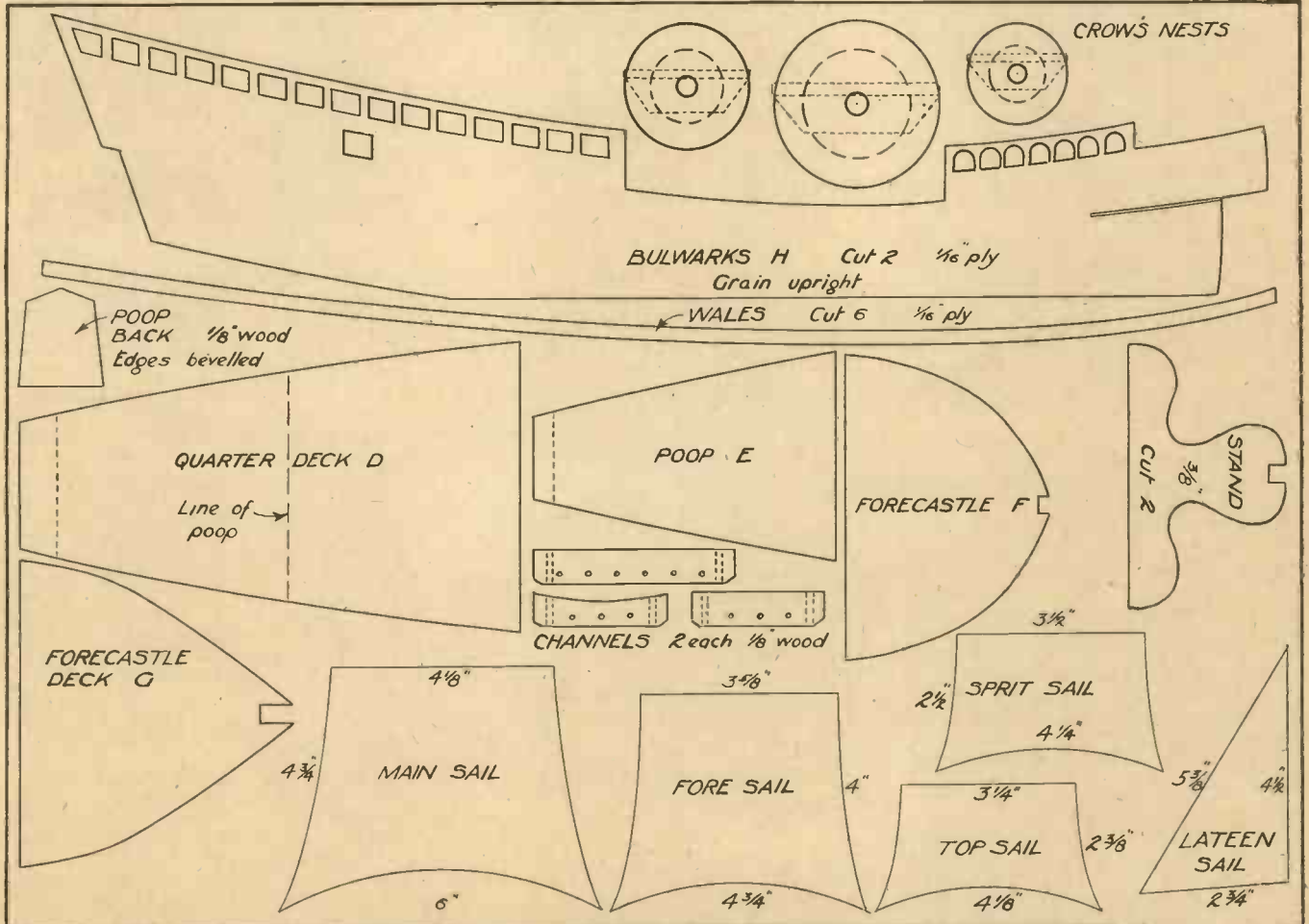
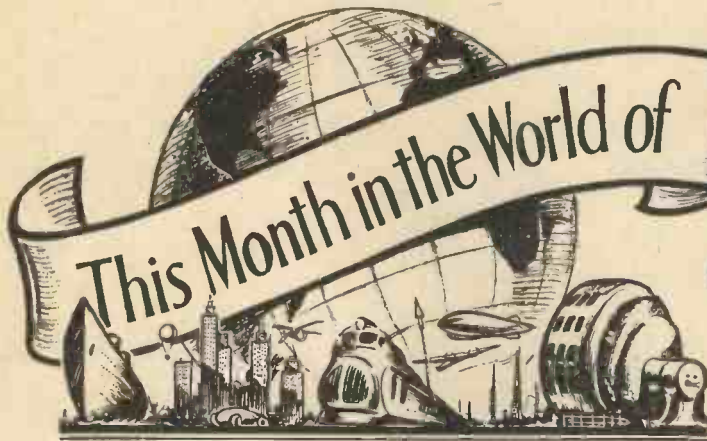

Fig. 8.—Constructional details of the bulwarks, superstructures, sails, etc.



Science,

New Laboratories

THE past few months has seen the opening of two new specialised laboratories, the Fire Officer's Testing Laboratory at Elstree, and the new London, Midland and Scottish Railway Laboratory at Derby. They represent the increasing importance of the relation of science to everyday life.

Fire Testing Laboratory

THE hazards of modern buildings from fire are great. Present day buildings are less inflammable than older types of structure, but their very size, and their rigid construction of steel and concrete, threatens collapse if they do take fire.

At Elstree one building is given over to the testing of building materials at high temperatures under load. Specially built gas-fired furnaces are installed for the purpose. There are separate types to deal with three main types of structural elements, a "floor" furnace, a "wall" furnace, and a "column" furnace.

The Floor and Wall Furnaces

FLOORING structures are built over the "floor" furnace. Gas burners play on the underside, while loads of iron weights are added on the top till the floor fails.

The "wall" furnace heats one side of a wall structure built into the frame of a hydraulic press. A load of 500 tons can be applied. Heating is from one side only. To make the test more stringent, water is sometimes hosed on to the cool side of the wall. The "column" furnace is similar, except that the built up column is completely surrounded by impinging gas burners.

"Foamed" Concrete

THE interior of the building naturally gets extremely hot. All operations are therefore conducted from a control room behind heat-resistant glass windows. Load indicators, and the leads of pyrometers indicating furnace temperatures, are brought into an instrument panel. A second building is given over to the testing of extinguishers and automatic sprays, and other fire fighting appliances. An interesting feature of the buildings is that it is constructed with the latest heat-resistant material known as "foamed" concrete, which is made from blast furnace slag.

The Train of the Future

THE object of the London Midland and Scottish Railway's Research Laboratory, which was opened last December, is to produce the perfect railway train which will give the highest speeds with maximum comforts at the lowest cost. In

Saving 1,000 h.p.

BOTH models have tufts of cotton-wool attached at various points, which show, as the wind rushes past, where the obstructions and resistances are. The research workers take as their basis of their stream-lining experiments, a speed of 100 m.p.h. At that speed, the stream-lined train requires only a quarter of the horsepower of the ordinary train, a saving of 1,000 h.p.

a special wind tunnel, the ideal stream-lined model is placed side by side with a model of an ordinary train.

railways are considerably modified, it is improbable that present railroad speeds can be increased much above their present limits. The problems of radius curves and maintenance of track, are too great.

Gas from Coal Mines

THE gasification of coal without mining, is a long dreamt of solution of the difficulties and dangers of coal mining. It has been tried in Russia on two disused coal mines. The method used is to cause a controlled explosion in the coal mine which sets the coal on fire, and air is then blown into the mine to keep it burning. Then steam is mixed in with the air to generate water gas from the burning products. So far, however, it has proved un-

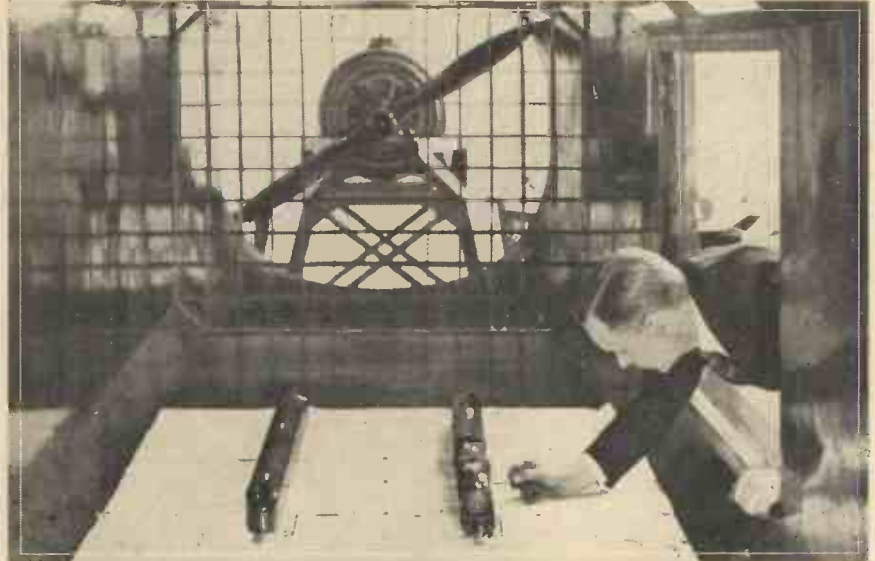

The large wind-tunnel built by the L.M.S. Railway at their new laboratory at Derby, for the purpose of streamlining experiments. The illustration shows a research engineer comparing air resistance of a standard and a streamlined train. In the background can be seen the tractor screw which provides an 80 m.p.h. wind, in the mouth of the tunnel.

A Year's Wear Produced in a Few Weeks

IN another part of the laboratory instruments produce the effects of a year's wear in a few weeks. They reproduce even the wear caused by passengers moving on the seats, and the rust of years on metal parts.

Grained Metal

THE number of coats of paint necessary for railway carriages has already been reduced from eighteen to eight. The scientists have also made a "cloth-paint," which gives to wood the soft "feel" of artificial silk or cotton, and have reproduced on metal the delicate grains of the rarest timber.

Rail-plane Trains

SERIOUS thought is being given to the development of rail-plane cars as a means of providing high-speed, long-distance transport. Unless the present

successful, as the gas coming off from the pithead contains over 60 per cent of nitrogen and carbon dioxide, both of which are useless incombustible gases. The calorific value, or heat producing quality of the gas, is only 120 British Thermal Units per cubic foot of gas. Ordinary gas-works coal-gas has a value of 500-600 British Thermal Units per cubic foot. Thus the results, so far, are very poor, but the experiments are, however, still being continued.

200 m.p.h.

THE suggestion is, a stream-lined car suspended from bogies, running on a single overhead rail. Motive power is to be provided by air-screws fore and aft, and speeds up to 200 m.p.h. are predicted. A few years ago the idea would have been thought futuristic. To-day, it seems the next step in the development of high-speed rail transport.

Invention & Progress

Silica Gel

A NOVEL drying agent in a convenient form, is provided by silica gel. This substance is identical in composition with quartz sand (SiO_2), but it is so prepared that it has a microscopic spongy structure which confers on it a remarkable power for absorbing water vapour from the air and other gases. It will absorb up to 30 per cent of its own weight of water vapour.

It has the appearance of small granules of dried, white gum, and does not change in the least either to eye or to touch when completely saturated with water. To give an indication of saturation, it is impregnated with cobalt nitrate, which, as is well known, changes from blue to pink when it absorbs water.

Desiccating Agent

BY heating up to 250-300° F., the gel can be dried, and its drying powers regenerated. It can thus be used over and over again. It finds a number of uses wherever storage away from damp and rust is required, as in storing tools, silver, and small metal parts, etc. It is a most convenient desiccating agent for the amateur chemist.

Bright Colours for Stream-lined Trains

THE coming of diesel-engined flyers and stream-lined trains, heralds a brighter era in rail-road finishes. In America, this movement is already in being. *Hiawatha*, stream-lined engine of the Chicago, Milwaukee, St. Paul and Pacific line is finished in black, grey, yellow, and maroon with gold lettering. The *Comet*, New York, New Haven and Hartford's stream-liner is an aluminium train finished in wide bands of blue and burnished

aluminium. The *Rebel*, of the Gulf, Mobile and Northern is aluminium banded with Chinese red. M1001, of Union Pacific, is finished in canary yellow. Colours are in cellulose lacquer, spray painted, which takes well on the smooth all welded carriage work. Bright colours not only attract travellers, but emphasize stream-line design.

A New Type of British 'Plane

IT is learned that a new type of aeroplane, in which a saving in structure weight of 35 to 40 per cent, with a consequent increase in load and range, is now in production in Britain. The machine, which is known as the Vickers' "Wellesley," is constructed on the "geodetic" principle; a new method invented by Mr. B. N. Wallis, who was the chief designer of the airship R 100. It can be used for both military and commercial aviation.

Telescopic Wings

ONE of the features of the machine is that it is possible also to design a telescopic wing, by which the span could be increased by sliding extensions at the right and left extremities. The left could thus be increased for the take-off, or greater speed attained when the extremities were withdrawn into the wing towards the body. This system is suitable for mass production, and on that basis would certainly be economical.

Proof Against Bullets

THE "geodetic" principle is based on a path taken between two points on the curved surface of a cylinder or globe. The frame of a wing or an aeroplane body, by this method, consists of a large number of members strictly placed on this principle, making up a comparatively light

web of metal crossing and recrossing, but leaving the wing or body hollow. So strong is the structure that it has retained the essential qualities even when parts have been damaged, as they might be, for example, by bullets. The complete absence of interior bracing makes it possible to carry inside the wing, fuel or stores, or in a very big deep-section wing, the passengers' cabins.

A New Type of Cruiser

RECENTLY launched at the Vickers-Armstrong yard at Walker-on-Tyne the *H.M.S. Newcastle*, the first of a class of eight large and powerful cruisers, is the largest British ship of this type to be launched for seven years. The *Newcastle* is 581 ft. long by 61 ft. 8 in., and will have turbine engines of 96,000 h.p. for a speed of 32 knots. She will carry her 6-in. guns in triple turrets and will have, besides, an anti-aircraft armament of eight 4-in. guns. Twenty-two smaller guns and eight torpedo tubes are to be mounted. Other equipment includes two aircraft and a catapult.

Boring for Water

AN artesian well nearly two miles deep, is to be sunk near Paris in the hope of finding a new water supply for the city.

A Map Tuning Dial

A RADIO set has recently been produced which "spotlights" on a map of Europe, the station to which it is tuned. As the tuning is altered, the name of the station from which the set is receiving at any moment, is automatically illuminated in its correct geographical position, on an illuminated map of Europe placed above the controls.



The Vickers "Wellesley" monoplane fitted with a Pegasus air-cooled engine. An order has been placed by the Air Ministry for a number of this new type of aircraft in which the system of "geodetic" construction is employed.

WHAT'S YOUR HOBBY?

—IS IT MOVIE-MAKING OR PHOTOGRAPHY?

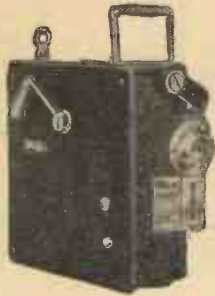

No matter which of the two it is, "CITY SALE" has all the apparatus necessary to make it a success. Expert advice free!

'CAMPRO'—The Camera that takes and shows movies

Can be run from the electric light or a small dry battery. Easy to use. Always ready for instant taking or projecting. Has F/3.5 lens and Garrard motor. **63/-**



FIRST EASY PAYMENT SECURES ANY PURCHASE

'ROLLEICORD' shows your picture full size and right way up on the ground glass screen. Takes 12 pictures on 3 1/2 x 2 1/8-exposure roll film for 1/-. Has F/4.5 Zeiss Triotar Lens and Compur Shutter. Yours for 27/5 and **£11.15.0** 8 more monthly payments.

CATALOGUES of NEW APPARATUS AND BARGAINS.—POST FREE

CITY SALE

and Exchange (1929) Ltd.
59-60 CHEAPSIDE, LONDON, E.C.2

FLYING SCALE MODELS



WARTIME BRITISH S.E.5A. 5/- Wingspan 13 1/2 in. Length 10 in.

An exact 1/4-in. scale model designed from the real plane in actual service. Every part that was on the real war bird is shown on this accurate flying model. Model builders who enjoy spending time in building exact replicas will find this kit

suits them splendidly. The full-size plan is a real joy, and shows guns, movable windscreen, insignia, rigging, shock-absorbing axle, etc., etc. The kit is complete, and includes everything needed, curved parts printed on selected sheet balsa, Japanese tissue, exact scale hardwood wheels, large bottles of balsa cement, tissue cement, silver dope and black dope for touch up. This model is a very good little flier. It is not difficult to make, and amply repays any extra time spent on it. Complete kit carriage paid for 5/-. (This kit cannot be sent abroad.)



PUSS MOTH 2/-

Wonderful flying scale model. Very clear full-size plan with full instructions. Kit includes shaped balsa flying prop and all else needed. Very good flier. Easy to build. Specially recommended for novices. Wingspan 16 in., length 12 in. AMAZING VALUE. Carriage paid for 2/-. (Postage abroad 9d. extra.) In these models the wings and fuselage are built up from strip balsa right on the full-size plan. Pins hold the strips in place until they have been cemented by the special quick-drying cement, which dries firm in one minute.

Send your Postal Order for a kit NOW

We guarantee you will be satisfied or your money refunded. If you live in a country district state your nearest Railway Station. Send two 1d. stamps for the most complete and beautifully illustrated flying scale model aeroplane catalogue in England. Sixteen pages showing 30 different models, 2/- to 25/6. Four new pages of very helpful hints for building. Also Balsa Wood and spare parts.

F. P. SWEETEN Ltd., Dept. P.M.

Bank Hey Street : BLACKPOOL

FLYING SCALE MODELS

YOU can easily build scale model Planes that really fly from our Kits—no special skill or tools required. Kits absolutely complete with full-sized plans and instructions, Balsa, Cement, Dope, Tissue, etc.

We are sole Agents for the most famous American Kits and Accessories—
SCIENTIFIC HI-FLYER KITS. BUNCH MODEL AIRPLANE CO. (Championship endurance Kits).

GENUINE "PAULOWNIA" PROPS. and IMP "TORNADO" MOTORS, etc.
Over 60 different Kits in stock of all Popular Models, such as
Fokker D7—Curtiss Fighter—Nieuport—Goshawk—Mr. Mulligan, etc.
20" span 3/3d. 25" span 6/6d.
All post free. All complete.

JUST ARRIVED—"SCIENTIFIC'S" NEW 1936 CATALOGUE. 20 pages full of illustrations and printed in three colours. Positively the most elaborate and complete Catalogue ever offered to the Aero-modellist. Secure your copy at once—yours—together with our full lists for a 3d. stamp. NOTE.—Owing to high cost of this Catalogue stamp must be enclosed.

MODEL SUPPLY STORES

(Dept. P), 46 Derby Road, PRESTWICH, Lancs.

REAL VALUE!

Send 1/6 Postal Order for a genuine 'LINDBERG' Kit of this fine 12-in. span FLYING SCALE MODEL Boeing P-26A Fighter Plane



Kit contains full-sized plan, instructions, printed balsa wood, insignias, cement, tissue, propeller, rubber, etc., etc. Simple to build and a fine flier!

Other types are:—
Hawker Super Fury, S.E.5., Sopwith Camel, Fairchild '24', U.S. Navy Racer, Fokker Triplane, Curtiss Goshawk. Only 1/6 each or 3 for 4/- carriage paid.

Photo of actual model! Not real plane. Also supplied in larger Super Detailed Kit—17 1/2-in. span, with working controls from cockpit, etc., etc., 12/9 carriage paid.
Other types: Span. Price
FOKKER D-VIII 15 1/2 in. 3/-
FAIRCHILD '22' 15 1/2 in. 3/9
BRISTOL FIGHTER 19 1/2 in. 6/6
SOPWITH CAMEL 20 in. 8/6
HAWKER S. FURY 18 1/2 in. 9/9

NORTHERN MODEL AIRCRAFT Co.
37a FOUNTAIN STREET, MANCHESTER 2.



EVERYTHING OPTICAL!

TELESCOPES—MICROSCOPES—BINOCULARS

SPECIAL OFFER of 50 Ships' Barometers, copper mount on oak, polished back. Post free EACH. A wonderful Bargain Offer, worth 25/- each. Each Barometer Guaranteed and British Made entirely. Send your Order now to avoid disappointment.

REPAIRS to any type of Optical Instrument—Lenses replaced.

Note Name and Address: **BROADHURST, CLARKSON & CO.** Telescope House, 63 FARRINGTON ROAD, London, E.C.1 (3 mins. from Farringdon St. Metro. Rly. Stn.)

"COMET" RIGHT ON TOP!

The "COMET" Petrol Engine Model 1935 Awards:—

- FIRST PRIZE: B.M.A.S. Power Competition at Cranborne.
- SECOND PRIZE: S.M.A.E. Sir John Shelley Competition at Fairley's Aerodrome.
- FIRST PRIZE: B.M.A.S. "Hallum" Competition at Cranborne. Mr. Brooks' Petrol Engine Model flew from Cranborne to the Isle of Wight, 35 miles as the crow flies!

Build one of these Models this winter, powered with the 18 c.c. COMET ENGINE

THE MODEL AIRCRAFT STORES

133 RICHMOND PARK ROAD, BOURNEMOUTH

Please send 2d. stamps for price lists.

Model Aero Topics

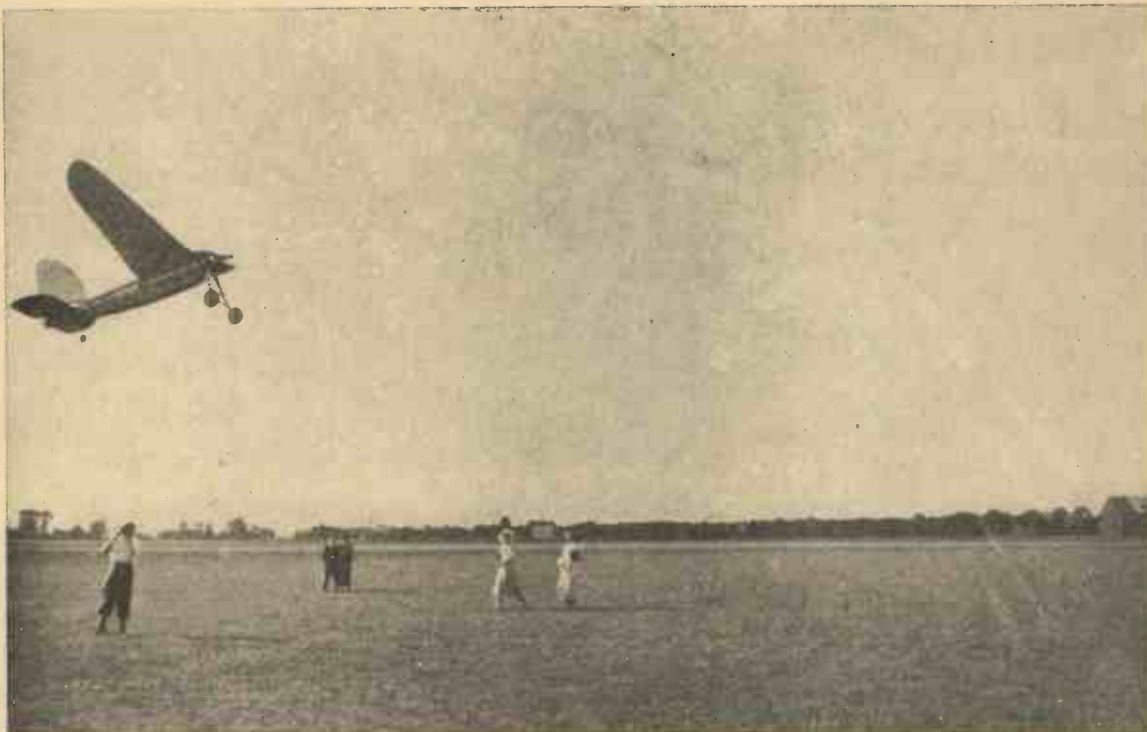

Capt. Bowden's Blue Dragon—just after taking off in 1934, when the machine established a record of 12 min. 48 sec.

Nonsense About Downthrust

I NOTICE a growing tendency on the part of some model makers to give a negative thrust-line to their models, that is to say, the thrust-line is not normal to the geometrical centre of the fuselage. I have not yet been able to discover what peculiar line of reason induces them to do this. I can understand such a method being adopted on a wrongly-designed model in an effort to reduce stalling tendency, but if a model is properly designed on paper, it is absurd to incline the thrust-line, and in any case the same effect could be obtained by altering the incidence of the wings. Perhaps some of the "experts" who talk so glibly about this sort of thing, might care to justify this whim. Unfortunately, beginners with petrol-driven models are copying this "idea" with disastrous results. I cannot too strongly recommend them not to do so.

A Thick-wing Section

ANOTHER so-called improvement, is to endeavour to make the model fly slowly by using a thick wing section with a fairly hefty lift/drag ratio. Here again, this merely advertises lack of knowledge and wrong design. With a petrol-driven model it merely indicates a too high crankshaft speed with a directly coupled airscrew. The wing loading and the wing section should be selected with the desired flying speed well in mind. If the loading is heavy, the model will fly fast. To fit a thick wing section to make it fly slowly, is patently ridiculous, since the same effect could be obtained, and more efficiently, by adopting a lighter wing loading. Thick wing sections are inefficient. I concede that with cantilever wings necessitating deep-section

By *F. J. Camm*

wing spars one must use a fairly thick wing section, but that is merely a necessary evil, since the most efficient wing would be that which has no thickness at all! I find a good deal of misconception exists in the minds of beginners on this subject. They think that because the Clark Y wing section is efficient on a full-size aeroplane, it must necessarily be so on a model.

A Rigid Unbraced Wing

THE full-size section is designed to effect the best compromise between lift, drag, and strength. If you want to make a rigid unbraced wing, you must use a deep wing section, and you endeavour to obtain the best lift/drag ratio in the circumstances. With a model, some of the problems which arise in full-size wing design vanish, and hence a new technique must be adopted. A wing section designed for a flying speed of 200 miles an hour is most inefficient at model speeds, and yet we find so-called "designers" recommend for models the Clark Y and other wing sections.

Many readers write to me on this point, and I have dealt with it in these pages many times before. I hope this paragraph finally disposes of the matter. Do not use a heavy loading for petrol-driven models, you are simply asking for crashes and damaged engines. Use the lightest loading possible—not more than 8 oz. to the square foot. Use a slow-running airscrew with as large a diameter as possible, fine pitch, and high-aspect ratio. Use the thinnest wing section you can, consistent

with strength and lift, and low-drag. Don't incline the thrust line, no matter what you may hear to the contrary.

Geared-down Airscrews

I HAVE had a fair amount of experience with the miniature petrol engines on the market. I have certainly tested most of them, and find that they all, for obvious reasons, develop their power at high revolutions. I am therefore surprised to find that very few experimenters have tried the effect of using a geared-down screw. It seems to me that an efficient airscrew cannot be designed for speeds of 3,000 to 6,000 revolutions per minute, for the percentage of slip must be extremely high. If the airscrew is designed for a practical efficiency of 70 per cent., the airscrew must be geared down, and I feel that most of the troubles with petrol-driven models are caused by airscrews which are running too fast. In order to let the airscrew revolve at its best speed, airscrews of perhaps only 12 in. in diameter and of 10 in. pitch are used. Little wonder, therefore, that the models stall, dive, and are unstable, both laterally and longitudinally. A very light gearing of 2-1 ratio can be made, and I advise its use.

Model Autogiros and Ornithopters

I AM interested to note that several successful flying model autogiros driven by elastic have been made, and I hope to be able to describe the construction of one of them next month. The best duration, up to the time of going to press, seems to be 18 seconds, but the models, I am assured, are most consistent flyers. The model aeroplane has developed and advanced considerably during the last three years, largely

I think, due to the efforts of Capt. Bowden with petrol-driven models. A branch which is still nebulous, is that concerned with flapping-wing models. Only one or two of these have been built, although I have described the construction of a successful one in some of my books. If any reader has made a successful flapping-wing model, I shall be glad if he will get into touch with me.

Cash for Readers

I SHALL be pleased to award prizes of 7s. 6d. for all photographs sent in by readers, and which I publish, showing either a model aeroplane on the ground or in the air. The photographs may indicate some new system of construction, some new gadget, a model just taking off or landing, in fact, any interesting photograph if clear and sharp, will suit. If you require the photograph returned, a stamped and addressed envelope should be enclosed. Every photograph must bear the name and address of the sender, and it is understood that the competitor has the right to submit the picture, and that copyright is not owned by someone else. Send your photographs with a cardboard stiffener to prevent damage in the post.

The "Baby Cyclone" Petrol Engine

THE manufacturers of the above engine, which I reviewed in the January issue, have kindly promised to let me have one for test. I understand that this engine will shortly be placed on the English market at a competitive price. The little "Brown Junior" engine still holds the field over here, and I have nothing but praise for it. Many readers have purchased them to fit into the petrol-model aeroplane described by me in recent issues. Blue prints for this model are still available at 7s. 6d. a set from the Publishers, Geo. Newnes, Ltd., 8/11 Southampton Street, Strand, W.C.2.



The immense size of some of the American "gas" models may be gauged from this photograph. In spite of their large size they weigh only about 3 lb. A light loading is used, and thus the models fly slowly.

A Propeller Tester

MAXIMUM propeller efficiency on model aircraft is very important, making all the difference between excellent or mediocre flights, and in some cases, deciding whether the machine flies at all. Among other factors, the size and the shape of the propeller is important. This may be small but having an exceptionally high rate of revolutions, thus giving the machine capabilities for a high altitude initial flight and a long glide, or large, resulting in a slower speed but extending flight under power. Another factor is propeller pitch. The more open the pitch the more "grip" the

blades will have, but resistance to rotation will also increase. The flatter the pitch, the faster will the propeller revolve, but non-productive slip will result if too flat. Where is the happy medium? Much of the experimental work necessary to find this out, can be done on the bench with the tester shown in Fig. 1. Essentially, the device registers the pull obtained with individual propellers, from which useful data can be obtained. The main portion is a dummy fuselage into which is fitted the rubber motive power in the usual manner. The fuselage should be of the same length as that of the plane to which the finished propeller will be fitted, so that the power obtained will be similar. This fuselage is carried on three more supports, sliding in three brass tubes soldered into brackets mounted on a baseboard. The wire slides and the tubes should be accurately mounted, to enable the fuselage to move forwards or backwards as easily as possible. The rear slide is continued to the rear, and is linked up, by another wire link, to the lower end of a long pointer. The pointer and the fuselage are drawn back by means of a spring which can be either of steel or elastic.

The Graph

THE readings are taken by winding up the motor to a similar number of turns which are obtained on the actual machine, and noting the position of the pointer on the scale. It is also necessary to take into account the time over which the propeller exerts a reasonable pull, and it is suggested that the pointer reading is taken every five seconds, and these readings converted into a graph as shown in Fig. 2. The curve C shows that a much longer flight can be expected from that propeller than A, in which, although more power is obtained during the first fifteen seconds, dies out much more rapidly. B shows a heavily pitched propeller which is far too heavy, as the rubber motor would be insufficient to drive it at its most efficient speed.

ACROSS COUNTRY



A fine view of the Bowden Drone low-wing petrol model just after taking off.

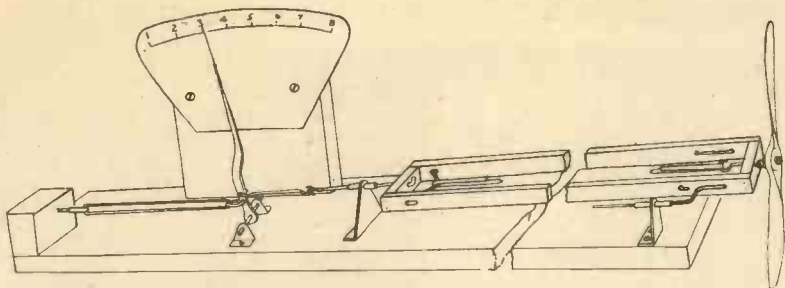

Fig. 1 (above).—The complete air-screw-testing apparatus.

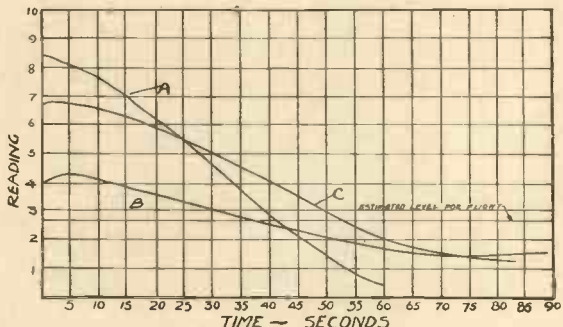

Fig. 2 (left).—Specimen graph from readings obtained with the apparatus.

A Model Ornithopter

HAVE all of the details of the Slinn Model Ornithopter which is, I believe, on sale in America. I have prepared working drawings and photographs, and shall publish these next month. Additionally, I have published, in *Hobbies New Annual*, details of my own successful model Ornithopter. I mention these facts so that any reader who wishes to experiment with flapping wing models will know the only sources of information.

The Wakefield Gold Challenge Cup Competition

ORD Wakefield has probably done more than any other man to encourage every branch of sport, and his name is famous throughout the world for the generous donations he has made to various branches of it. It is certain that England would be far behind other countries in motoring, aviation, cycling, and athletics were it not for the practical interest he evinces in the nation's welfare. Many years before the War, when aviation, and particularly model aviation, was followed by only a few enthusiasts who were looked upon as cranks, he donated to the then Kite and Model Aeroplane Association a splendid gold challenge cup which, excepting for the War years and for a period after the War, has been competed for annually. It was intended, of

course, originally that the cup should form the subject of a National Competition, but after the War the K.M.A.A. went out of existence and it was not until I raised the question of the many cups which had been donated, of which the Wakefield Challenge Cup was one, that anything was done to collect the cups together again. After my efforts and appeal in the columns of *Flight*, they were at last found and handed over to the S.M.A.E. It is to be regretted that the competitions for a few years were not national in character, but it gives me pleasure to relate that the organisation of the S.M.A.E. has been radically overhauled during the past month and the competitions will, in future, be on national lines.

THE
TWO STANDARD WORKS—
MODEL AEROPLANES
AND AIRSHIPS
POWER DRIVEN MODEL
AIRCRAFT

Each containing 96 pages and over 120 illustrations

1/- each or 1/2 by post from Geo. Newnes Ltd., 8-11 Southampton St., Strand, W.C.2.

IN AMERICA!

Financial Difficulties

HOWEVER, the point I wish to make was that the Wakefield Challenge Cup was won by the American team last year, and owing to lack of funds, it seemed, until the timely assistance of Lord Wakefield, that the S.M.A.E. would not be able to afford to send a British team over to America this year in an effort to win the Wakefield Cup back for England. The cost of sending a team to America is fairly heavy, and Lord Wakefield has generously subscribed the considerable sum of £200 towards the cost of the expedition. Additionally, Mr. Fairey has given £20, the Celson Dope Company £5, whilst financial assistance has also been promised by the Dunlop Rubber Company, the Balsa Wood Company, and many others.

Mr. Fairey is, of course, of the famous aircraft firm which bears his name, and before the War his name was equally famous as a successful competitor in model aircraft competitions. I do not know whether he ever won the Wakefield Cup, but it is my impression that he did so.

The First Winner

A NOTEWORTHY contributor to *PRACTICAL MECHANICS*, Mr. E. W. Twining, was, I believe, the first winner with a twin-screw T-frame Canard monoplane of distinctive design. Mr. E. W. Twining has been associated with models and model aircraft all his life, and is probably the most versatile of all modellers.

With the substantial funds now available I hope that the British team will have a successful visit, worthily uphold the traditions of British sport, and bring back the cup with them. I hope to be able to publish drawings and details of the winning design as soon after the competition as possible. One of the rules of the competition is that it must be competed for in the country of the present holder, and it is comforting to know that funds are now available to provide the opportunity of it being competed for over here next year.

Flying Scale Models

READERS may be interested to know that the Model Supply Stores, 46, Derby Road, Prestwich, are now the British agents for the Lawrence W. Brown Aircraft Co., Scientific Model Airplane Co., and Construct-a-Plane Co., of America. The sterling qualities and exclusive features of the kits manufactured by these firms are probably already well known to readers of this page, but for the first time they are able to obtain them in this country. Interested readers should write to the above firm for a copy of their latest catalogue which costs 3d.



The great enthusiasm in America for "gas" models is evidenced by these two photographs recently received.

NEW TWIN TRAIN SUPPLIES

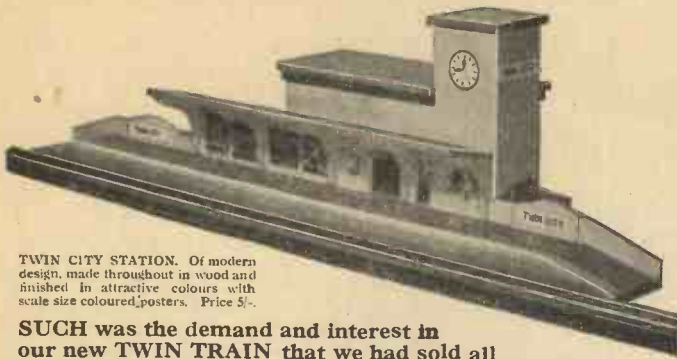

TWIN CITY STATION. Of modern design, made throughout in wood and finished in attractive colours with scale size coloured posters. Price 5/-.

SUCH was the demand and interest in our new TWIN TRAIN that we had sold all our available supplies before Christmas, but we are pleased to say new deliveries are now arriving, and we can supply accessories to add to existing layouts.

Never before has such value been offered in Model Railways. Look at these prices:—

- TWIN TRAIN TRACK. Mounted on plastic moulded base. Perfect Insulation. Straight or curved. Gauge "OO" 7 1/4 in. long, 9d. per length.
- POINTS. Hand-operated, price 5/- per pair. Electrically-operated, 12/- per pair.
- TWIN TRAIN WAGONS. With automatic couplings. From 8d. each upwards.

For complete details of this interesting innovation send for the Twin Train Folder, T.T.12.

NOTES OF INTEREST.

Our NEW Model Railway Catalogue is now published. New cover design. New range of models. Get your copy now. Ask for New A12. Price 6d. post free.
 New Track Booklet. Price 2d. "Laying Permanent Way." Useful for all model railway owners.
 Our New Ships Catalogue with new designs is now published. New range of models. S12, Price 6d. Get your copy now.

BASSETT-LOWKE LTD.

NORTHAMPTON, LONDON: 112 High Holborn, W.C.1.
 MANCHESTER: 28 Corporation Street.

RAILWAY MODELLING IN MINIATURE

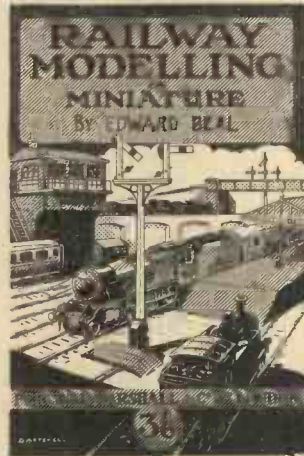

A practical handbook on the planning, building and operating of model railways, with special reference to OO & HO Gauges by **EDWARD BEAL**. Fully illustrated with 20 pages of photographs of model railways and innumerable drawings and 270 line drawings.

PRICE 3/6

Send postcard for 40-page Book List—post free

POST FREE 3/10

PERCIVAL MARSHALL & CO., Ltd.
 13-16N FISHER STREET, LONDON, W.C.1

LEARN BRITSU FOR SELF-DEFENCE



If you lack the means of protecting yourself against the attacks of bullies and others bigger than you are, learn Britsu—the wonderful new British system of self-defence. Britsu will give you the science and skill against which mere brute force is powerless.

What is BRITSU?

Britsu is a FULLY GUARANTEED modernised and perfected British system of self-defence based on the little-known centuries-old method of the East. Britsu offers you effective defence against ANY blow, kick or knife attack—ability to release from all holds around throat, body, arms, legs or wrists, either front or rear—power to render your assailant absolutely helpless by means of secret holds, locks and nerve and artery pinches.

STRENGTH NOT NEEDED You certainly do not need to be strong in order to become proficient in Britsu. It is really the weak man's defence against brute force. It is, however, admitted that the practice of Britsu forms one of the finest and most effective methods of acquiring and retaining muscular development and bodily fitness.

FREE INTERESTING BOOKLET

THE BRITSU INSTITUTE, 33 Greycoat Galleries, Greycoat Place, London, S.W.1.

Please send me full particulars of Britsu and your method of teaching the Art, together with details of your guarantee. It is understood that this request places me under no obligation whatever.

Name

Address

Post coupon to-day for free illustrated booklet which tells how you can learn Britsu at Home.

★ MERCO ★

The large range of MERCO products have made 100 gauge modelling possible. Send 1 1/2d. stamp for our lists and samples of the new Merco building papers. If you are interested in OO gauge you MUST have Mr. Ed. Beal's new book, "Railway Modelling in Miniature." It is full of constructional interest, Photos, Drawings, etc. We will send this by return for 3/6 post free.

MINIATURE EXHIBITION RAILWAYS CO.
 64 Watson Street, Dundee, Angus

NOTE: Readers in the London area should make a personal visit to HAMLINGS, 26 Charing Cross Road, W.C.2. Entrance opposite Charing Cross Road P.O.

UNIVERSAL MAINS A.C./D.C. MOTORS

A Universal (A.C./D.C.) Mains Motor as illus. Approx. 1/100 h.p. 200-250 v. 2,500 R.P.M. 15/-



1/40 h.p. 200-220 v. 2,850 R.P.M. Universal Motor with single-ended shaft. 35/-

New B.T.H. Universal Motor, 1/50 h.p. 100-250 v. 2,000 R.P.M. 50-100 cycles. May be run vertically or horizontally.

zontally. Silent running. Price with special sliding resistance, 30/- post free U.K.

INDUCTION MOTORS (A.C. ONLY) 200-250 v.
 1/25 h.p., with Shaft and Double-V Pulley, 2,000 R.P.M. 18/-.
 1/10 h.p., similar to above but larger and Single-V Pulley, 35/-.
 1/25 h.p., fitted with coarse and fine grinding wheels, 21/-.
 A.C. only Induction Fans, 200-250 v. Prices 15/6, 19/6, 35/-, 45/-.

Our 105-page Catalogue is interesting to all. 3d. post free.
GRAFTON ELECTRIC CO. (Dept. P),
 54 GRAFTON ST., TOTTENHAM COURT RD., LONDON, W.1

Adapting the Twin-Train Table Railway



IN his article in the December issue, Mr. W. J. Bassett-Lowke gave a full general description of this new miniature railway system. From this it will be gathered that, as it is now being sold to the public, the railway is essentially one—at any rate in its most simple form—which is intended for assembly on a dining-room table and after use, be packed up again. As may be gathered from the previous article, the scheme is capable of far greater possibilities by utilising the track for the planning of complete permanent layouts, such as the excellent ones designed by Mr. Beal and described in the January issue. In the following articles, it is proposed to go more fully into the technical details and, as far as possible, explain the complete system of working, following these details up with suggestions for adapting the locomotive mechanism to types of other engines having British outlines. Later designs and

By E. W. Twining Some Suggestions by the Author for Adapting the Mechanism of the Twin-Table Locomotive to Other Engines Having British Outlines

more wheels can possibly be added to the four already fitted on the engine, which, as may be recognised, to a great extent follows the outline of the German state rail-

way is too sharp to take even an ordinary 2-4-0 type engine with a rigid wheel base, whilst a 4-4-0, that is to say a four coupled bogie engine, would require a side play to the bogie considerably in excess of what is possible. Where, therefore, a permanent railway is to be laid down, it is strongly advocated that the minimum radius shall be not less than the 2 ft. to the outer rail as advocated by Mr. Beal, and in the more complicated wheel arrangements for locomotives, which will be described later, the curves will be schemed accordingly.

Scale of Model

It was found that the twin-train railway was not strictly the 00- but H0-gauge (H0 means "half 0" gauge, 0-gauge being 7 mm.). The gauge is of the track supposed to be 16.5 mm. although upon measuring this, it was found to be 16 mm. only. If the scale is H0, i.e. 3½ mm. to 1 ft., then the gauge of the track scales exactly 4 ft. 8½ in. and therefore the rail gauge should be taken as the scale of any model railway. On this scale, the height of the chimney and cab equals 14 ft., which accords very well with the German loading gauge. If the scale were taken to be 00, i.e. 4 mm. to the foot, the height of the chimney would only represent 12 ft. 3 in., which is not, of course, nearly high enough, and on the 4 mm. scale the gauge is only 4 ft.

ways. It was found by careful measurement that

the radius of the standard curves, measured to the outer rail, was 354 mm., approximately 14 in. Obviously, this

For utilising the mechanism to fit into casings having British locomotive outlines, it may be best to ignore the gauge and consider the scale to be 4 mm., because one is thus enabled to increase the height of the chimney, dome and cab roof, which may be necessary if it is wished to reproduce certain engines which have low boilers and

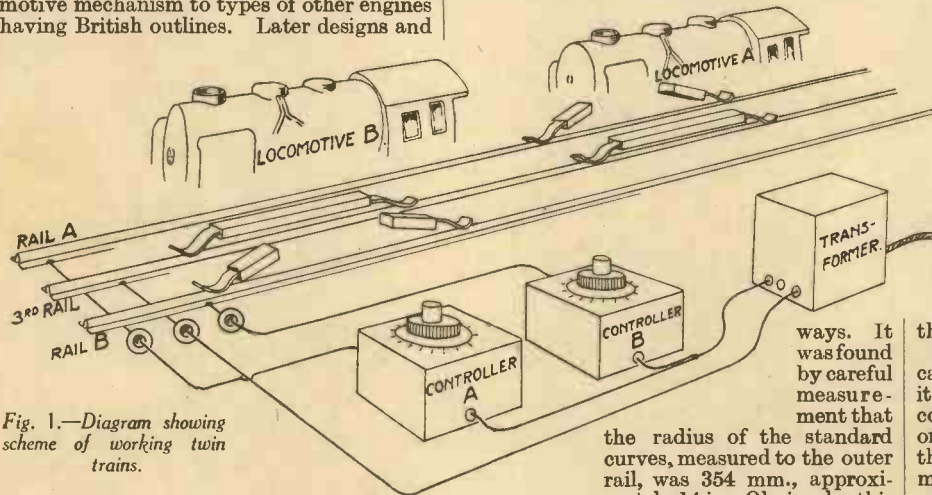

Fig. 1.—Diagram showing scheme of working twin trains.

drawings will be given for railway equipment such as signals, station buildings, tunnel fronts, etc., and one or two designs for locomotives in which the use of this electrical mechanism shall be incorporated for a larger scale, that is to say 0 gauge, having a width between the rails of 1¼ in.

Radius of Curves

Unfortunately, in this twin-train system as now manufactured, the radius of the curves is too small to allow of anything but a very limited wheel arrangement on the engines. Actually, very few

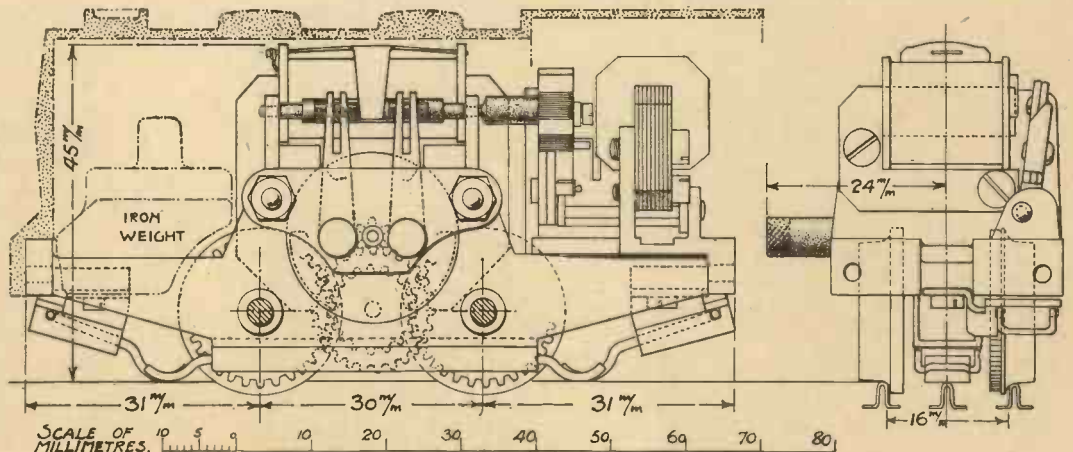

Fig. 2.—The locomotive mechanism, drawn full size.

long chimneys. The point is that the mechanism comes up so high, that there is a limit below which one cannot take the top of the boiler.

Twin-Train Working

Mr. Bassett-Lowke has already explained that not only the centre, which is generally known as the third rail, is insulated from the running rails, but these two outer rails are themselves insulated from each other and, in order to prevent these from being short-circuited, every wheel which rests upon one rail has to be insulated from those resting upon the other. It will be found that even between the driving wheels of the engine on opposite sides, there is no metallic connection. This feature is the essential one of the whole system, for it is only by means of it, that two trains can be independently operated upon the same track. The method adopted by the makers for preventing the train short-circuiting the track is the simple one of making all the wheels of every vehicle except the locomotive, of moulded plastic generally referred to as Bakelite. The engine wheels, however, are die-cast in metal with moulded plastic bushes fitting on to keys on the axle.

In order to make the system of working clear, a glance at Fig. 1 will show two locomotives standing upon, or running upon, the same track. Underneath these engines there are insulated brushes, or current collectors, rubbing upon the centre (third) rail. In addition to these there are other brushes which are not insulated, that is to say, they make metallic connection with the frame of the engine. Locomotive A has these latter brushes pressing upon the right-hand rail (right-hand in relation to the direction in which the engine is travelling chimney first); the other locomotive B has the brushes pressing on the left-hand rail. Suppose that both engines are required to stand on the track with their chimneys pointing the same way. If they were required to work chimney to chimney, or tender to tender, the brushes of both engines would be on either the right- or the left-hand side. The brushes, by the way, are so fixed by the makers that they are readily changed over from one side to the other.

When two trains are to be operated, two controllers are required, and these controllers should be connected up to the rails as shown in Fig. 1. Controller A has one side coupled to the transformer and the other to rail A; thus providing the necessary current for working locomotive A. Controller B is connected to the transformer and to rail B. Thus it will be seen that the movement of the two locomotives is entirely independent.

The Reversing Mechanism

Fitted to the controller is a milled knob or wheel which controls the speed of the trains, and a red knob or button by which reversing is effected. In Fig. 3 is shown, more or less diagrammatically, the essential parts of the electro-motor and reversing switch on the engine, and the electro-magnetic reversing gear which operates the

switch. If the reader is already the possessor of one of the engines, it is suggested that he removes the boiler by taking out the two screws at the back on either side of the tender-coupling, and unscrewing the two front buffers. He will then see the mechanical action of the four-armed star wheel brought about by the movement of the armature on the electro-magnet, and the cylindrical commutator revolved by the star wheel. It is these items which are shown in Fig. 3. *E* is the electro-magnet and *a* the armature of the same, reference to which has already been made. The star wheel is lettered *a*¹, *b*¹, *c*¹ and *d*¹. *A* is the armature of the motor, *B*¹ and *B*² are the brushes which rub on the commutator, and *C* and *F* is the field winding.

The parts *A*, *B*¹, *B*², *C* and *F*, are exactly like all other electric motors in general. It is interesting to note, however, that in an ordinary series-wound machine, i.e. one in which current passes through the field and armature windings one after the other, a change of direction of rotation can be effected by reversing the passage of the current through the winding of either the armature or the field coil; it does not matter which. This means that if a motor is running in a clockwise direction and you wish it to run anti-clockwise, the connections to the brushes or field winding can be changed over, both of which will have the effect of reversing direction.

In this little locomotive motor with which we are dealing, the makers have elected to change the passage of the current through the armature, and this is effected by the commutator *Rc*. In Fig. 3, diagram 1, it will be seen that this commutator is in such a position—note that point *a*¹ on the star wheel is at the top—that the current picked up from the third rail passes through the field winding *F*, the brush which is pressing on the sleeve *c* on *Rc*, the motor brush *B*¹, the armature, the brush *B*², the right-hand barrel *d* on *Rc*, the frame of the engine and down to one of the running rails. Note that the current, besides

passing through the motor via *Rc*, is also passing continuously through the electro-magnet *E*.

Supposing that the operator wishes to reverse the locomotive, he presses the red knob, see diagram 4, Fig. 3. This knob is spring loaded from underneath, and is held by the spring in the position in which it is shown. It will be seen that there is a barrel of insulation underneath the knob, with a brass band around it. In the up position, this band connects together two leaf springs through which all the current from the transformer to the running rails is passing. When the knob is pressed to the down position, the band passes beyond the range of contact with the leaf springs, and so the circuit to the locomotive is broken. This causes the armature *a* of the electro-magnet to fall away from the poles, since the magnet is no longer energised by coil *E*. Nothing further happens than that, except, of course, that current is also interrupted to the motor. When the knob is released, the armature *a* is again attracted to *E*. This brings a little paw into action which, engaging with the star wheel, causes the wheel to make one quarter of a revolution. Point *a*¹ on the wheel is therefore brought around to the position in which it is shown in diagram 2, Fig. 3. It will now be seen that the commutator *Rc* has turned an amount sufficient to bring the brushes *B*¹ and *B*² off of *c* and *d*, and they are now pressing upon the insulating material which separates the plates. In this position, current is prevented from passing to the motor although it is passing through *E*, and so the engine remains stationary. If now the operator presses the knob a second time, exactly the same thing happens to the electro-magnet, the releasing of the knob again causing current to flow. This time, however, when the star wheel and commutator make a further quarter revolution, plate *d* remains out of the circuit and a new plate *e* is brought into action (see diagram 3). The current passes downwards through *E*, still flowing,

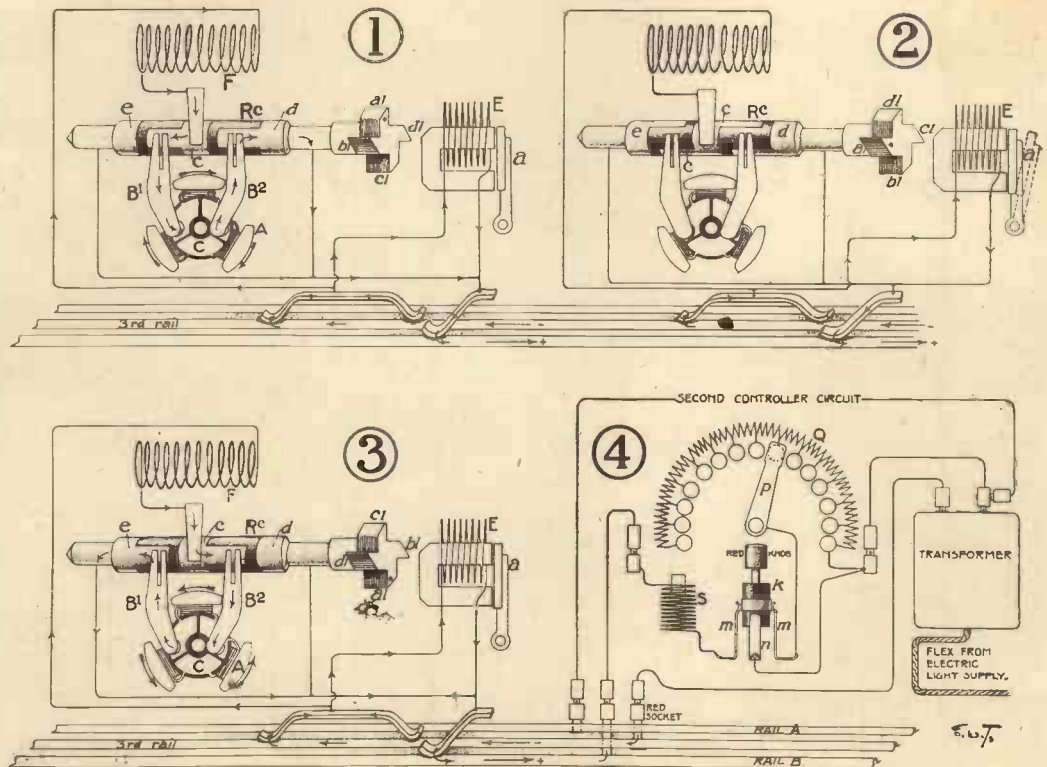

Fig. 3.—The locomotive mechanism and electrical circuits.

FREE!

This IMPORTANT GUIDE to SUCCESSFUL ENGINEERING CAREERS

After months of intensive effort and research, we are pleased to announce that the 1936 edition of our Handbook, "ENGINEERING OPPORTUNITIES," is now out of the publishers' hands and ready for free distribution.

Containing 268 pages of practical guidance, this book is, beyond argument, the finest and most complete handbook on Successful Engineering Careers ever compiled. It is a book that should be on the bookshelf of every person interested in engineering, whatever his age, position or experience.

The Handbook contains, among other intensely interesting matter, details of B.Sc., A.M.I.C.E., A.M.I.Mech.E., A.M.I.E.E., A.M.I.A.E., A.M.I.W.T., A.M.I.R.E., *CIVIL SERVICE, and other important Engineering Examinations; outlines courses in all branches of CIVIL, MECHANICAL, ELECTRICAL, AUTOMOBILE, RADIO, TELEVISION and AERONAUTICAL ENGINEERING, BUILDING, GOVERNMENT EMPLOYMENT, etc., and outlines the unique advantages of our Employment Department.

**WE DEFINITELY GUARANTEE
"NO PASS—NO FEE"**

If you are earning less than £10 per week you cannot afford to miss reading "ENGINEERING OPPORTUNITIES." In your own interests, we advise you to send for your copy of this enlightening guide to well-paid posts by filling in and posting the coupon NOW. There is no cost or obligation of any kind.

**BRITISH INSTITUTE OF
ENGINEERING TECHNOLOGY**

410 SHAKESPEARE HOUSE,
17, 18 & 19 STRATFORD PLACE, LONDON, W.1

**POST
THIS
COUPON
NOW**

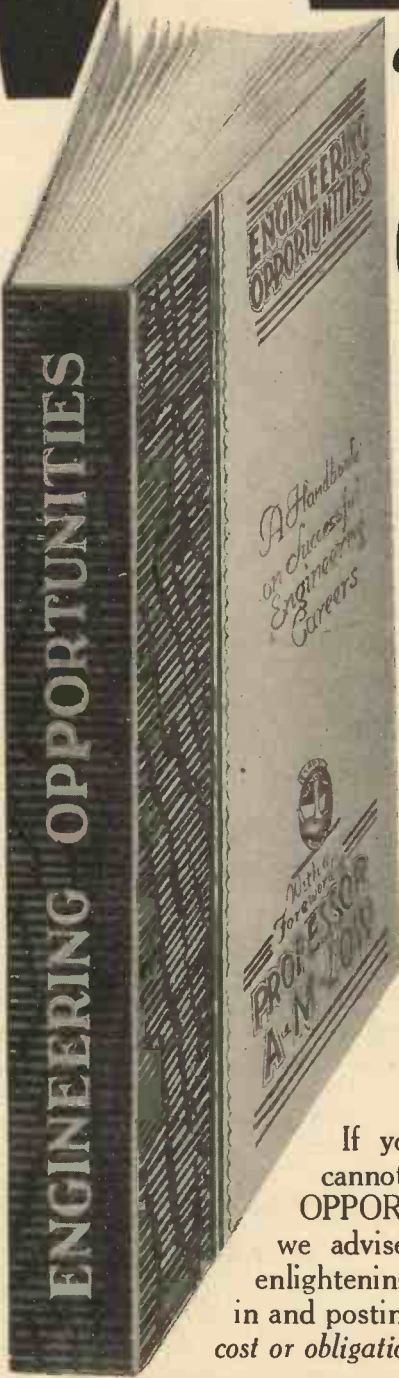

FREE COUPON
TEAR OFF HERE
To B.I.E.T., 410 SHAKESPEARE HOUSE,
17, 18 & 19 STRATFORD PLACE, LONDON, W.1
Please forward, free of cost or obligation of any kind, your
268-page Handbook "ENGINEERING OPPORTUNITIES."
NAME
ADDRESS

be it noted, in the same direction as before; then, turning right instead of left as it did in diagram 1, it passes down through brush B' , through the armature, up through brush B , through plate e and so back to the running rail. This cycle of changes, it will be seen, has had the effect of reversing the direction of rotation of the armature, such direction being indicated by arrows in diagrams 1 and 3 in Fig. 3.

The Controller

The circuits of one of the controllers is shown in diagram 4, Fig. 3. In connection with this, the function of the red knob has already been referred to, for reversing where k is the insulating cylinder with its brass band and m, m the switch leaves. Q is a series of resistance coils, each having ends which terminate on contact points or plates arranged in a semi-circle. Moving over these points is the control lever p , which is moved by a milled knob on the outside of the case. These coils and lever constitute the speed control, since, by moving the lever around over the contacts, the resistance in the circuit is varied, so reducing or increasing the amount of current passing to the motor. Besides these items, there is in the controller case, a solenoid S , which is a coil having a sliding soft-iron core inside of it. It will be seen that the whole of the current from the transformer to the motor passes through this coil. Operated by the sliding core, there is a trip mechanism—not shown in the sketch—which, when the coil S receives an excess of current, comes into operation and releases the red knob, so cutting off all current from the track and locomotive. Such an excess of current would be allowed to pass, were the resistance introduced in the circuit by the windings of the motor, and electro-magnet E cut out by a dead short-circuit across the running rails. During normal operation, the full amount of current which can be passed through the motor and coil E is insufficient to actuate the sliding core of S , but if a piece

of metal capable of causing a short circuit was inadvertently laid upon the track, then the coil S breaks the circuit and so protects the transformer from burning out or becoming overheated.

Besides the two switch leaves m, m , there is another leaf n at a slightly lower level. The object of this is not at first perfectly clear, but it will be seen that if the lever p were round to the left with a big resistance Q in the circuit and the current were broken by the operator pressing the red knob, there may not be a sufficient amount of

The Locomotive Mechanism

It is presumed that before anyone would attempt to design a body—by that is meant a dummy boiler, cab, etc.—for a different type of engine, he would need to make or have an exact outline of the mechanism which is to be contained within such body, and so in Fig. 2 is given an exact scale elevation showing the whole of the existing framing, collectors, wheels, motor and coil and mechanism of the reverser. This drawing, Fig. 2, is reproduced exactly full size. The dotted lines indicate the

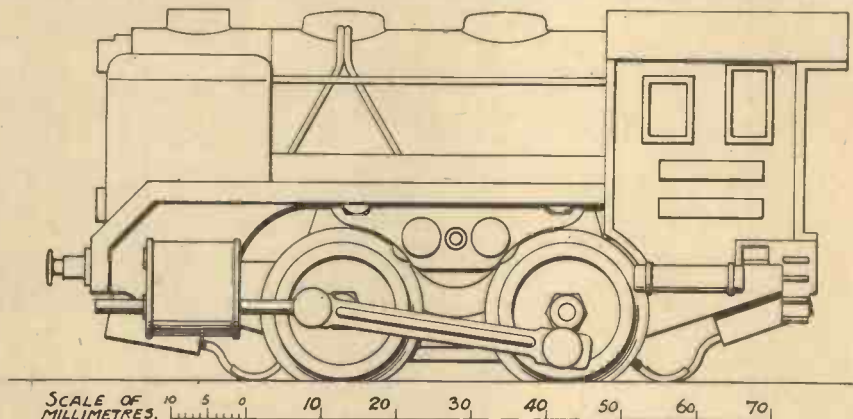

Fig. 4.—A side elevation of the locomotive drawn exactly full size.

current available for re-energising coil E on the engine and pulling up armature a . It will be noted, however, that the leaf n is connected straight to the transformer, so that when the band on k passes downwards and upwards, the latter being the movement of importance, there is a momentary rush of full voltage current through n to the left-hand leaf m , which is sufficient to ensure the operation of the electro-magnet of the locomotive. As indicated in the drawing, a second controller is connected on another circuit from the transformer leading to the other running rail.

outline of the existing German die-cast boiler and cab roof.

It is unfortunate, perhaps, that the reverser occupies so much space, especially in the width of the engine. So great is this that it is quite impossible to let any part of the boiler come further back than the star wheel and the reverser must, in every case, be enclosed in the cab. Two or three designs can be given which would certainly have a pleasing appearance and in Fig. 4, a full-size elevation of the German engine is shown.

(To be continued)

A New Electric Convector Heater

AN attractive and efficient electric convector heater finished in oxidised copper has just been introduced on the market by the General Electric Company. The heater incorporates low-temperature rod-type elements of circular shape fitted inside a series of specially designed ducts. Such an arrangement gives maximum convection: the warm air is directed in an outward and upward direction, and an even distribution is ensured throughout the area the convector is designed to cover. The body of the heater, with the exception of the grille, will be found to remain cool at all times, and thus may be placed close to walls, etc., with perfect safety and with immunity for the walls against discolouration.

The heating elements and electrical connections are inaccessible when the convector heater is in use, but with the removal of four screws in the base these can be withdrawn for replacement or adjustment whenever necessary. The elements are arranged for two-heat control by a switch at the side of the convector. With a loading of 1,500 watts, the dimensions of the convector are: width 16½ in., depth 8½ in., height 26½ in. The base is 18½ in. wide by 10½ in. deep, and the grille is 15 in. wide by 12 in. deep. The total weight is 37 lb. The convector is supplied complete



Showing the convector heater which is attractively finished in oxidised copper.

with 6 ft. of special heat-resisting flex. Such a heater is ideal for use where an unobtrusive source of heat is required. It is also an excellent auxiliary to tubular heaters in situations where wall space is too restricted to accommodate the necessary loading in the form of tubes.

ITEMS OF INTEREST

Turbo-alternator Facts

THE electricity supply for more than half Manchester is derived from a turbo-alternator at Barton power station which delivers 41,000 Kilowatts. It recently set up a record by running continuously for 124 days, and was restarted after a rest of only 8 hours. The rotor weighs nearly 100 tons and revolves at a speed of 1,500 r.p.m., while the speed of the blade tips on the largest wheel of the turbine is 550 miles per hour!

The "Normandie."

A MODEL of the world's largest liner, and the present holder of the Atlantic Blue Riband has just been acquired by the Science Museum. The model, which is over ten feet in length, conveys an excellent impression of the vessel's unorthodox design, with its rounded and streamlined upper works.

Masters of Mechanics

Nicolas Otto and the Rise of the Gas Engine

THE earliest gas engine was a primitive form of gun which fired a leaden bullet under the propelling influence of an explosion of gunpowder within its barrel. Then, during the seventeenth century, came a series of crude experiments which were made with the explosion of gunpowder rammed into barrels. The exploding powder was made to throw up an iron plate into the air. Afterwards, the barrel became a cast-iron cylinder and the iron plate a piston. Thus, incidentally, originated the piston and the cylinder. It was, however, found that steam was a much more controllable agent for the purpose of moving the piston within the cylinder, and so the steam engine emerged and ultimately became practicable, whilst the operating principle of the gas engine remained unthought of for years.

During the latter end of the eighteenth century and at the beginning of the nineteenth, several attempts to construct a working gas engine were made. R. Street, in 1794, for instance, S. Brown, in 1823, and a few other inventors all endeavoured to bring out an engine which would operate by the power of exploding gas. All such attempts, however, failed signally, and their lack of success, was mainly due to a non-appreciation on the part of the inventors of the theoretical principles upon which a true gas engine must work.

Lenoir's Engine

The first successfully working gas engine was not given to the world until 1860. In that year a naturalised Frenchman, although a Belgian by birth, one Etienne Lenoir by name, and an inventor and engineer by profession, was connected with a Company in Paris called *Société des Moteurs Lenoir*, which had been formed in the previous year, and the object of which was to manufacture for sale, an entirely new type of gas engine which Lenoir himself had invented.

Lenoir's master patent was taken out on January 24th, 1860. It was for an engine "dilated by the combustion of gas." During the following month, the inventor obtained a similar patent in England, and forthwith he commenced the manufacture of his engines.

Now, although Lenoir's engines, and particularly his later ones, worked smoothly and silently, they were extremely wasteful of fuel. They took six or seven times the amount of fuel to produce a given horsepower that a modern engine would consume and, moreover, they were extremely hot running. Large quantities of cooling water were required for the radiator systems, and, owing to the internal heat, the piston assembly quickly gave way and even melted under working conditions.

Lenoir's engine "dilated by the combustion of gas"—his patent reads very quaintly in these modern days—was hardly a true gas engine, but was more of a steam engine. When the piston halfway through mixture of gas it had sucked linder via the was exploded A non-return fitted to the in-the cylinder, and

steam engine. was about its stroke, the and air which into the cylinder inlet valve electrically. valve was let port of this preven-

ted the exploding charge from escaping backwards along the entrance conduit. The exploding gas, therefore, forced the piston along. The movement of the piston was conveyed to a flywheel by the usual crankshaft assembly. The momentum of the flywheel enabled the piston to make a return stroke within the cylinder, this stroke serving to expel the burnt gases from the engine via an exhaust valve. On the subsequent outward stroke of the piston, a fresh charge of mixture was drawn into the cylinder, and when, again, the piston had traversed half the cylinder's length, the mixture behind it was fired electrically, and so the cycle of operations proceeded.

Gas Version of the Steam Engine

Note carefully that Lenoir's engine did not compress the mixture and that, as previously mentioned, it was, in reality, a mere gas version of the steam engine, the exploding charge acting in a manner very analogous to a supply of steam suddenly injected into the cylinder.

Despite its many shortcomings, however, Lenoir's engine sold well, so great was the demand at that time for motive power. The first Lenoir engines were of two horse-powers—6 and 20. Within the space of three or four years, some four hundred of them were constructed at Lenoir's own works at Paris, whilst another hundred or so were manufactured by the Reading Iron Works in this country, which had a licence to work the Lenoir patents.

About this time, there rose up, again in France, one of the most curious geniuses which the modern world has ever seen. His name was Alphonse Beau de Rochas, and to the alertness and far-seeing perception of his mathematical and scientific mind is due not only the modern gas engine, but also the whole gamut of internal-combustion engines, great and small. Yet it is said that this Beau de Rochas, this somewhat mysterious French engineer, had no great liking for practical engineering, that he disliked experimentation and workshop

The first four-stroke gas engine built by Dr. Otto in 1876. Not only did it revolutionise the gas-engine industry but it paved the way also for the coming of the motor-car.

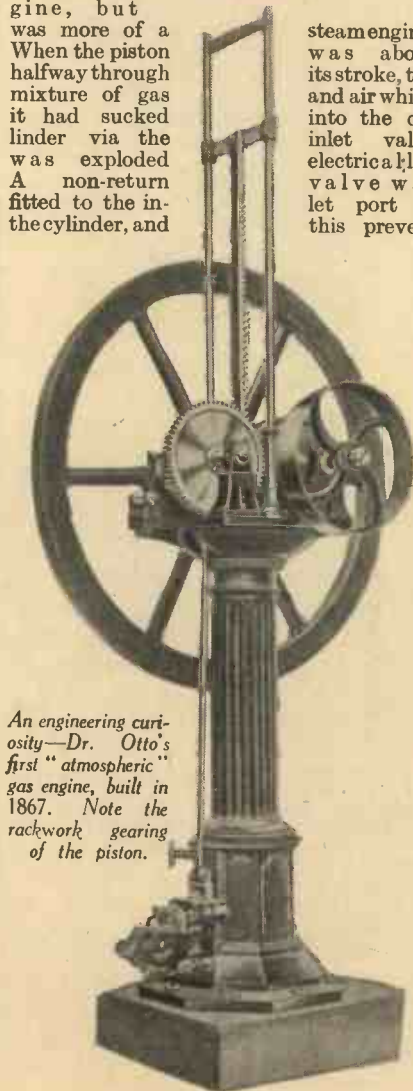
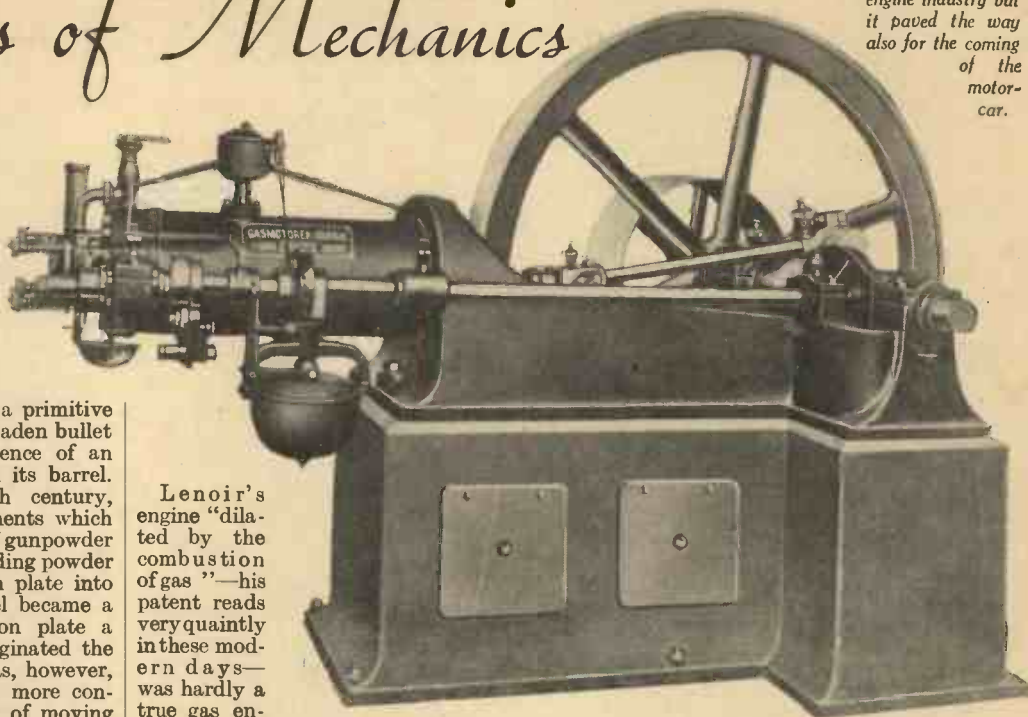

An engineering curiosity—Dr. Otto's first "atmospheric" gas engine, built in 1876. Note the rackwork gearing of the piston.

practice, and that he was ever content with the formulation of strange projects on paper rather than with the practical achievement of their conception.

In 1862, just when Lenoir's engines were obtaining much popularity, Beau de Rochas announced in a pamphlet, four conditions which would direct the operation of a more efficient gas engine than had ever, up to that time, been constructed. He even made his formulations the subject of a patent, the validity of which, however, was contested later on by Lenoir.

The Four-stroke Engine

According to Beau de Rochas, gas engine efficiency depends upon the following conditions being obtained:

1. The greatest possible pressure of gas at the beginning of the explosion within the cylinder.
2. The greatest possible degree of expansion of the combusting gases.
3. The maximum velocity of gaseous expansion within the cylinder.
4. The largest possible cylinder volume with the least possible cooling surface.

Having enunciated these principles, Beau de Rochas then proceeded to state that a gas engine could only work efficiently when its cycle of operations embodied four separate strokes of the piston, i.e., suction of the mixture into the cylinder, compression stroke of the piston whereby the mixture is compressed in the cylinder head, ignition stroke (the real power stroke) of the piston and, finally, the exhaust stroke, by virtue of which the waste products of combustion are efficiently swept out of the cylinder.

Thus came into being the first—and, incidentally, an entirely complete—conception of what we now term the "four-stroke engine." This cycle of operations, upon which nearly every internal combustion works, is still termed, theoretically, the Beau de Rochas cycle. Beau de Rochas, however, never attempted to put his fundamental cycle of operations into working practice. That practical feat was left to the ingenuity of others.

And now we come to the most famous name connected with the rise of the gas engine, to wit that of Dr. Nicolas August Otto, the man who made the first really commercially successful engine working by gas power.

Nicolas Otto was born at Holzhausen, in Germany, in 1832. His earlier education was meagre and he had little or no systematic scientific training. For a number of years he worked as a commercial traveller. Nevertheless, engineering was inborn in him and he began a spare-time study of gas engines when he was twenty-two years old. Lenoir's gas engine and its alleged success, urged Otto to further efforts in the construction of a working engine. He devised a gas engine, and had it made by a Cologne mechanic, but it was unsuccessful. Moreover, Otto was not a rich man and he found that experimental work in connection with engineering could be an exceedingly expensive pursuit. About the year 1863, Otto managed to interest in his experiments, a privy councillor of Cologne, named Langen. Herr Langen was struck with Otto's gas engine proposals, and he laid out money to bring about their practical achievement.

The Otto Engine

Eventually, after many trials and difficulties, Otto and his partner, Herr Langen, brought out a gas engine which differed radically from all previous engines of this nature. It operated strictly under the conditions which Beau de Rochas had laid down previously, its cycle of operations comprising the now well-known "four-stroke" cycle and also termed the "Otto cycle," although, in common fairness "Beau de Rochas" cycle should be the term used to denote this sequence of gas-engine operations.

In Otto's first working gas engine—the Otto "Atmospheric" engine—constructed in 1867—there was no compression of the gas. The piston was driven upwards within the cylinder by the force of the exploding charge and subsequently it descended under the influence of the external pressure of the

An early British-made Otto gas engine constructed by Crossley Bros., of Manchester. This also, was of the "atmospheric" type.

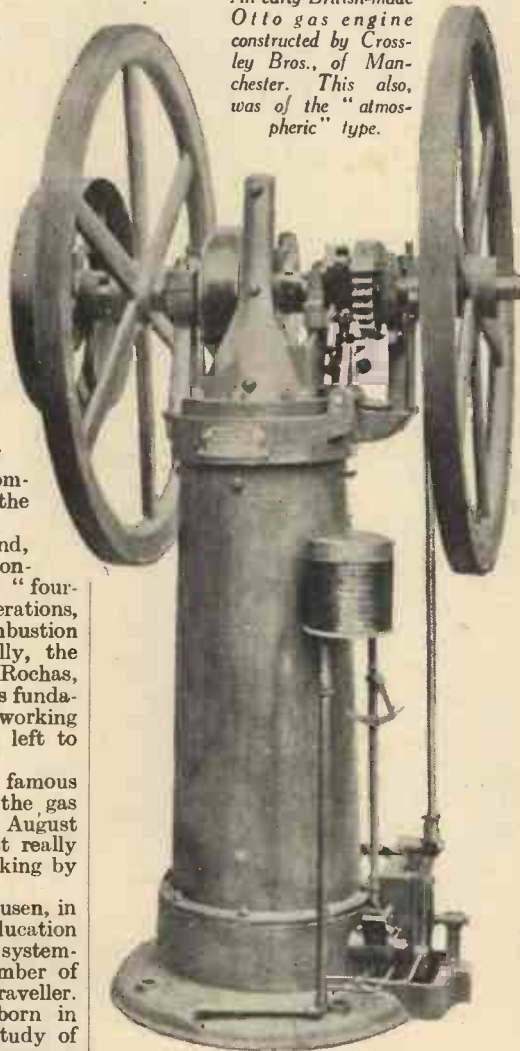

atmosphere. In descending, the piston operated a rackwork gear which revolved a driving wheel, and thus the engine's power was provided. The atmospheric engine was excessively noisy, erratic, and violent in its running.

It was not until nine years later—in 1876—that the world's first successful gas engine was produced by Otto working in conjunction with Langen. It has been previously remarked that this engine operated under the strict conditions set forth by Beau de Rochas. It was an engine which worked upon strictly scientific and truly mechanical principles. Beau de Rochas' four-stroke

principle was made practicable for the first time. Otto's engine sucked the gas mixture into the cylinder, compressed it, fired it, and ejected the burnt remains of the charge—all in a sequence of four strokes of the piston. At once, Otto halved and even more than halved the high fuel consumption of Lenoir's engines. The engine worked with reasonable silence—indeed, the inventor termed it his "Silent" engine—and its waste heat production was much less than that of the previous Lenoir engine. Quickly, therefore, Otto's "Silent" engine became a practicable engineering proposition. The demand for it grew and Otto found difficulty in obtaining the requisite capital necessary to establish a fresh extension of his factory. The relatively rich Langen, realizing the golden opportunity of the situation, opened his purse to its widest extent, and thereafter the firm of Otto and Langen leapt to fame as makers of silent, reliable, and successful gas engines.

The "Silent" Gas Engine

In England, the "Silent" gas engine was made by the Crossley Brothers, of Manchester, who were in close association with Dr. Otto through a great part of his period of experimentation. The Crossley engines, operating on the Otto principle, quickly became famous, and many of them constructed nearly half a century ago are still putting up a good performance in their various locations.

In 1886—less than ten years after Otto's first introduction of his "Silent" gas engine working on the four-stroke principle of Beau de Rochas, it was estimated that there were some 30,000 such engines in use in the world. Crossley's, of Manchester, had accounted for a goodly proportion of these engines, most of the remainder having been produced by Otto's own concern, the *Gas Motoren Fabrik*, of Germany, and by the *Compagnie Française des Moteurs à Gaz*, of Paris, which held the French patents.

In 1891—on the 26th of January, to be precise—Otto died. His decease took place at Cologne, and, curiously enough, little notice appeared to be taken of it at the time. In some strange way, Otto fell back into the obscurity from whence he had risen, and it was left for the famous Crossley Brothers to carry on his work.

Otto's Mechanic

When Otto found himself immersed in experimental work on the subject of the gas engine, he engaged a mechanic to assist him. Together they worked in a small shop at Deutz near Cologne, and it was largely due to the good workmanship and ingenuity of this mechanic that Otto's trial engines were a practical success.

Otto's original mechanic grew in status. Ultimately he became manager of the firm, and when he left it in 1882, he still retained a financial interest in it. But this mechanic of Otto's desired, as he said, to have greater time to pursue a "new hobby" and it was for that reason solely that he severed his working connection with Otto.

The "new hobby" which Otto's former mechanic wished to be free to follow up was nothing more nor less than the design and construction of a miniature engine working on Otto's principles but running at a higher speed and operating on petroleum and other liquid fuels instead of on gas.

And the name of Otto's mechanic was *Daimler*, a now very famous one in automobile engineering history, but the story of how he constructed the first motor-car will have to be reserved as fit subject-matter for a future article of this series.



The man with a family can soon SAVE POUNDS by doing all his own boot and shoe repairs. This book teaches how to make them as well as mend them.

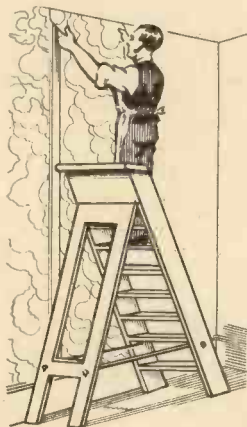

Are you your own landlord? If so, you cannot afford to be without this book a day longer. It teaches house repairs and decorations thoroughly.

The Chance of a Lifetime!

Specially Bound Edition of THE NEW AMATEUR MECHANIC

Edited by BERNARD E. JONES

4 Volumes—6,000 Working Drawings, Photos., etc.

This remarkable offer to readers of "Practical Mechanics" enables you to have full use of "The Amateur Mechanic" in your own home for one whole week. If you decide to purchase it after examination you may have it at a real BARGAIN PRICE, and on easy terms. Don't be too late for this great offer, as there is only a limited number of these sets available on such terms.

The Greatest Money-Saving Book Ever Published. Offered to You on Terms which CANNOT BE REPEATED

This is a book that will save you one hundred times its cost during the many years it will serve you. It shows how to do hundreds of useful jobs about the house or garden—from building a chicken house to doing your own brick work and concreting—from repairing water taps to laying linoleum. There are clear, straightforward instructions and 6,000 illustrations, so that even if you have had no previous experience whatever it is impossible to go wrong. Every householder, every man with a family, every young fellow who is keen on hobbies, every man anxious to make money in his spare time, should possess this fine work. At any rate, see it. It will cost you nothing.

Sent to your Home FREE on approval for 7 days

Below are just a few of the hundreds of jobs that "The Amateur Mechanic" teaches.

DO

- METALWORKING
- DISTEMPERING
- PAPERHANGING
- BRICKLAYING
- BRAZING AND RIVETING
- PANELLING WALLS

MAKE

- BOOTS AND SHOES
- GARDEN FURNITURE
- MODEL AIRSHIP
- WIRELESS SETS
- LEATHER SUITCASE

REPAIR

- FURNITURE
- CLOCKS AND WATCHES
- HOT WATER PIPES
- ELECTRIC BELLS AND LIGHTS
- LEAKY ROOFS AND WALLS
- BOOTS AND SHOES
- CHINA, MIRRORS
- MOTOR CYCLES

In this special edition the sections on wireless and television have been brought completely up to date

You Cannot Afford to Miss this Great Opportunity!

SEND TO-DAY!

Send for this BARGAIN PRICE Edition NOW—to-morrow may be too late! If you let this opportunity slip by, you may never have such a chance again, as the number of sets available under this great offer is strictly limited, and they are certain to be snapped up quickly. We will send the four volumes to you FREE on approval for seven days. At the end of this period you may either return them to us at our expense, or retain them at one half the original published price, for the low initial payment of

2/6

"Practical Mechanics" Free Examination Form (SPECIAL BARGAIN PRICE)

To THE WAVERLEY BOOK Co. Ltd., 96-97 Farrington Street, London, E.C.4.

Sirs,—Please send me, carriage paid, for Seven Days' Free Examination, "THE NEW AMATEUR MECHANIC," in four volumes specially bound in Full Pluvuisin. It is understood that I can examine the volumes for seven days from their receipt by me, and if I then do not wish to keep them, I may return them on the eighth day, and there the matter will end. If I decided to keep the work I will send you, on the eighth day, a confirmatory payment of 2s. 6d., and commencing thirty days thereafter, I will send ten further monthly payments of 3s. each, thus completing the special purchase price.

SPECIAL CASH PRICE WITHIN 8 DAYS IS 30/-

Name

Address

.....

Parents' signature

Occupation required if under 21.....

State if Householder..... Date.....

P.M.4. PLEASE FILL IN ALL PARTICULARS ASKED

CONSISTENT PERFORMANCE

Molybdenum wire is employed in the construction of Hivac grids because it possesses the exceptional quality of retaining its shape during changes of temperature. Sagging and warping which upset the characteristics are thereby eliminated; thus consistent performance is maintained and an exceptionally long working life guaranteed.

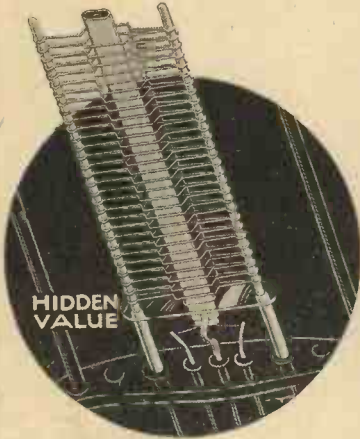

Specified for the
**A.C. MAINS
"ALL-WAVE 3"**

Hivac types:
AC/VP 13/6
AC/HL 9/6
Fit Hivac for consistent performance and save 25% on valve costs.

HIVAC VALVE GUIDE
"P.M." FREE.



BRITISH MADE by
High Vacuum Valve Co. Ltd., 113-117 Farringdon Road, London, E.C.1

CLIX "AIRSPRUNG" Chassis Mounting Valveholders

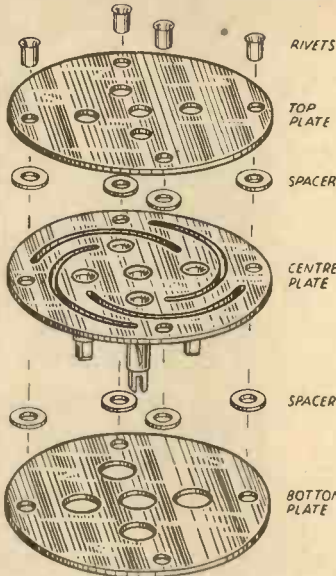

These are the only Non-Metal Antimicrophonic Chassis Mounting Valveholders obtainable with either Terminals or Soldering connections. The unique design of the "Airsprung" is clearly indicated by the illustrations.

The CLIX patented resilient sockets embrace the valve pins, both moving together as integral parts in contrast to the chafing movement resulting from badly designed pressed sockets or springs which cause microphonics.

With the absence of metal springs and the minimum amount of material employed, the sockets are practically air insulated, thus embodying the essentials of a valveholder that cannot be surpassed for use in receivers embodying ultra-short or short-wave circuits.

4-pin 1/2. 5-pin 1/3.
7-pin 1/4.

As Specified for the
"P.M." A.C. MAINS
"ALL-WAVE THREE"
Clix Folders "P.M." Free.

LECTRO LINX LIMITED,
79a ROCHESTER ROW, LONDON, S.W.1

PRECISION INSTRUMENTS

by J.B.

FOR THE "P.M. A.C. MAINS ALL-WAVE THREE"



The high regard held not only by the trade but also by the general public for J.B. components has patent proof in their consistent specification in "star" constructor receivers.

An addition to their many successes is the selection of the Baby Three (as illustrated), price 15/-, and two Baseboard Disc Drives, price 3/9 each, for the "A.C. Mains All-Wave Three" described in this issue.



POST THIS COUPON!

To **JACKSON BROTHERS (London)**
Ltd., 72 St. Thomas Street, S.E.1

Please send me a leaflet describing your components used in the "A.C. Mains All-Wave Three" in "Practical Mechanics," March issue.

Name

Address

OSTAR-GANZ

UNIVERSAL HIGH VOLTAGE VALVES

IMPROVE ANY SET

The recognised "Valves of the future" leaping into popularity owing to their unequalled performance—longer life—greater efficiency and cheaper consumption. A Valve for every purpose. NO Barretters, NO CUT DOWN Resistances, NO Mains Transformers required. Guaranteed for 6 months.

UNIVERSAL ALL WAVE KITS SETS AND RADIOGRAMS

Equal to a 1936 Model, which can be constructed without huge expense or experience. Construction enthusiasts demand the best—we have them in OSTAR-GANZ. Two examples of the exceptional KITS offered—Ostar-Ganz Universal 3-valve "All-wave" Receiver KIT 19-2,000 m., all wave changes on single switch, £7 10s., Ostar-Ganz Three Pentode 4-valve All Wave Receiver. Wave range 19-2,000 m., £9 9s. All KITS complete with the famous Ostar-Ganz Valves. Blueprint and Technical advice given FREE.

WHY SCRAP YOUR OLD SET?

when for a small outlay we can convert it (no matter what type or make) into a UNIVERSAL All Wave Model equal to sets of 1936 Construction.

Send to-day for full details of our KITS and AMPLIFIERS, from Dept. P.M. :-

EUGEN FORBAT

28-29 Southampton Street, Strand, W.C.2

Telephone: TEMple Bar 8608 and 4985.

BEFORE YOU DECIDE SEE HYVOLTSTAR

UNIVERSAL All Waves All Mains AC/DC Receivers. Acknowledged the most Advanced Radio on the market. The many new and exclusive features incorporated will greatly interest the technician. Working on 100 to 250 volts A.C. or D.C. without alteration. Covers all wave bands from 13-2,000 m. Push-pull output stage, providing undistorted output of 6/7 w. Adjustable selectivity. Automatic silent tuning. Extreme sensitivity. Automatic Volume Control and Fading Compensation on all wave bands, even on ultra-short waves. Two-speed tuning as easy on short waves as on medium or long.

Chassis Prices complete with Valves from 10/- gns. to 29 gns. Full details from Dept. P.M.

UNIVERSAL HIGH VOLTAGE RADIO, Ltd.
28-29 Southampton Street, Strand, W.C.2

Telephone: TEMple Bar 4985 and 8608.



ALL MODELS CAN BE
HAD ON APPROVAL

ALL RADIO
QUESTIONS
ANSWERED
FREE

Every Question
must be accom-
panied by the
Coupon on
page III of Cover

The PRACTICAL MECHANICS

Wireless Experimenter

WHEN dealing with receivers designed for use on the electric supply mains, it is to be expected that a little more care and thought must be expended in the construction. This is not only on account of the extra intricacy of the wiring, but it is very essential to guard against short circuits, or loose connections, which might lead not only to the destruction of one or more components, but might also lead to the user receiving a nasty shock. In all our mains apparatus great care is taken to so arrange the components and the wiring that there is very little risk of any such accident occurring, and, therefore, it is in the interests of the constructor to take care to duplicate not only the layout of the receiver but also the wiring. Do not, therefore, be tempted to improve upon our layout, or modify the position of any part because you think it will be better, as by so doing you may introduce some unforeseen trouble.

A reference to the illustrations and the wiring diagram will show that the receiver is very compact and there is little space to spare on the chassis. Therefore, before the construction is undertaken each part should be placed in its approximate position (as taken from the wiring

THE P.M. A.C. MAINS ALL-WAVE THREE

An Efficient All-wave Three-Valve Mains Receiver with a Tuning Control for Each Waveband

diagram, which is drawn to scale), and when each part is found to be correct, the screw holes or other points should be clearly indicated with a sharp-pointed instrument.

The Design

In view of the fact that it is desirable to enclose a mains receiver in a cabinet, so that no live wires may be touched whilst it is "On," it was thought necessary to place the wave-change switch on the front of the receiver. To do this without introducing

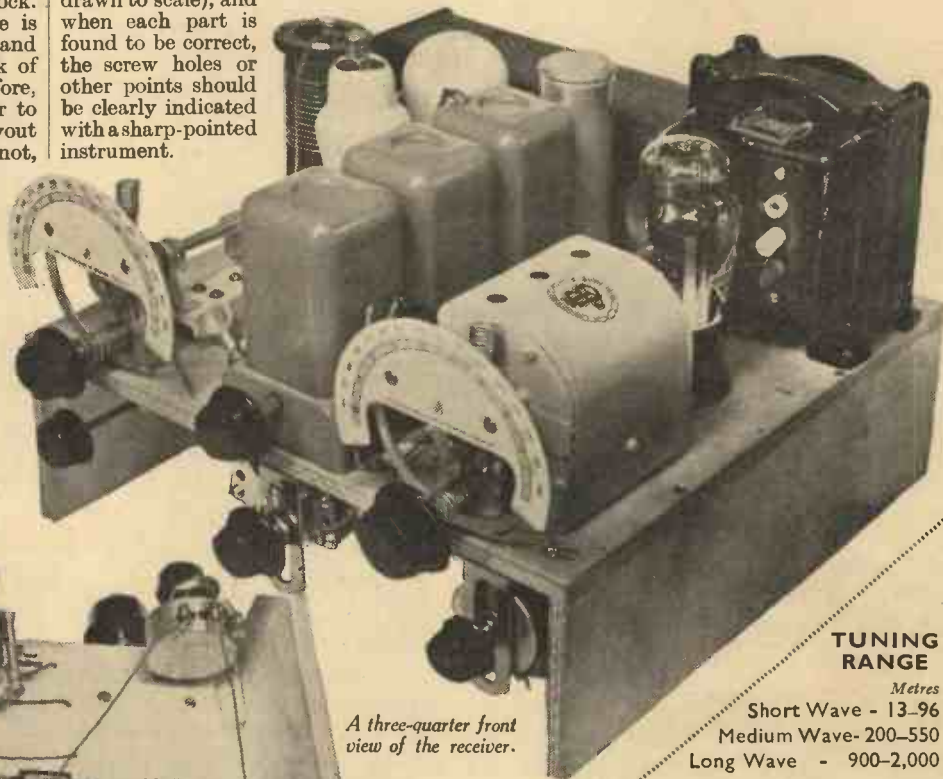

A three-quarter front view of the receiver.

TUNING RANGE

Metres
Short Wave - 13-96
Medium Wave - 200-550
Long Wave - 900-2,000

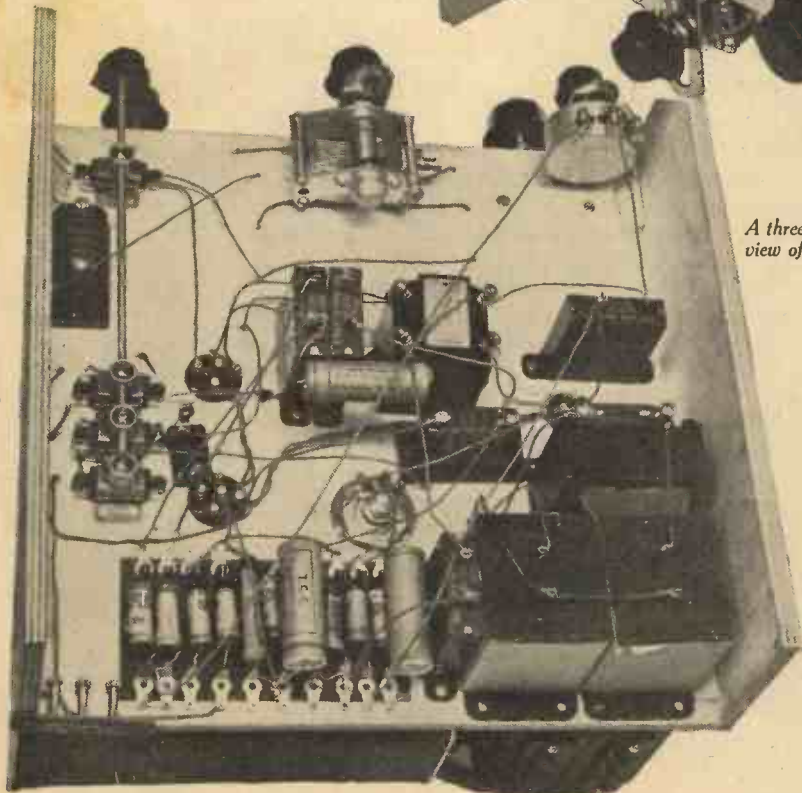

This below-chassis view will be of assistance in wiring up. The resistances on the group board may be seen in the foreground.

long leads we have employed the Bulgin switch which is operated through a rotary movement, and three of these are arranged in the most convenient position in the circuit, and a length of rod is passed through each and controlled from the front.

Certain readers dislike the straggly appearance which results from placing resistors in their exact position in the circuit, and in this receiver we have used a Bulgin resistance board so that all resistors may be placed in one spot in orderly array, and this both adds to the neatness of the finished receiver and simplifies wiring.

The Mains Section

In the mains supply section a metal rectifier has been used for the H.T. supply, and the mains transformer supplies, in addition to the H.T. voltages, the necessary heater supply for the three valves. A choke of ample rating is included for smoothing purposes, and the smoothing circuit is completed by an 8 mfd. electroly-

WEARITE

REGD. TRADE MARK

Q.R.T. COIL ASSEMBLY

specified for the "A.C. Mains All-Wave 3"

The complete unit as shown, comprising Q.R.T. Coil Units, spindle switches and knob. **22/6**

Also available as separate coil units (complete with switch and knob). Price 7/6.

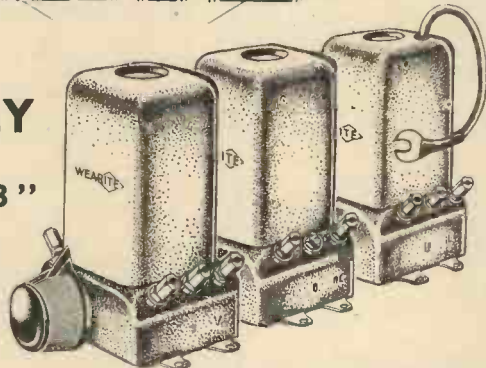

MODERNISE Your Set with this "UNIGEN" Universal Coil

Will bring your set up-to-date whatever the present circuit. Equally suitable for H.F. Aerial or Band Pass Tuning. Range 200-550 and 800-2,100 metres. **5/-**

To Messrs. Wright & Weaire Ltd. 740 High Rd., Tottenham, London, N.17

I am interested in your lists and would like you to send me a copy of those I have marked.

Name.....

A. Descriptive Booklet List M. 745.

Address.....

B. Special Booklet describing Test Apparatus.

C. Prints describing 7 approved circuits.

P.M.3.36

CA 8461

HEYBERD

MAINS TRANSFORMER Specified for the "ALL-WAVE THREE"

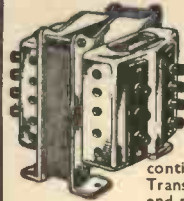

Heyberd Mains Transformers are well known for their trouble-free service, working continuously, under full load. These Transformers are fitted with special end plates, and coloured plugs and sockets for easy connection. **MODEL W.31. PRICE 29/-** Delivery from stock.

HEYBERD BATTERY CHARGERS AND RECTIFIER UNITS

These models incorporate all-metal parts. They are silent, clean designed for charging batteries or running model trains, and their running cost is less than a 40 watt house lamp.

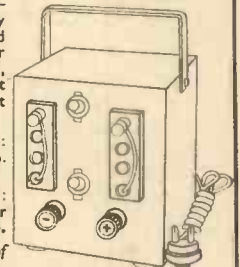

Model A.O.3. Output : 2, 6 or 12 volts at 1 amp. **PRICE 50/-**.

Model A.O.5. Output : 2, 6 or 12 volts at 1 or 2 amps. **PRICE 90/-**.

Send now for details of Heyberd Mains Transformers, Battery Chargers and Rectifier Units.

Mr.
Address

983/978 P.Mechs.

F. C. HEYBERD & Co., 10 FINSBURY STREET, LONDON, E.C.2

SPECIFIED

for the "A.C. Mains All-Wave Three."

TYPE H.T. 8
250 VOLT. 60 M/A
18/6

Once again the Westinghouse Metal Rectifier has been chosen to provide H.T. supply for this newest of sets. The reason is clear—operating on short waves shows up the weakness of a rectifier, as critical reaction is so sensitive to voltage fluctuation. As the steadiest possible output is essential, only a Westinghouse rectifier can be used with lasting satisfaction.

"The All-Metal Way, 1936" tells you why—and gives detailed information and diagrams of the applications of Westinghouse Metal Rectifiers and Westectors. Send for your copy to-day.



COUPON

Please send me a copy of "The All-Metal Way, 1936," for which I enclose 3d. in stamps.

WESTINGHOUSE BRAKE & SIGNAL Co. Ltd.
82 York Road, King's Cross, London, N.1.

Name.....

Address.....

Price 3d. March 1936

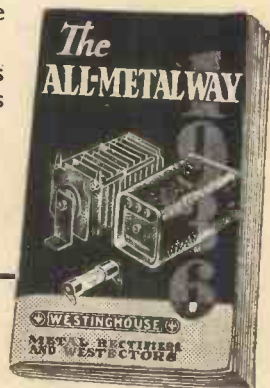

tic condenser. Electrolytics are also used for bias by-pass purposes, and thus, from all theoretical points of view, the circuit may be judged complete.

Starting Construction

Before starting the building of the receiver it is essential to get all the parts together, and this is to enable the exact position to be ascertained, although those who can transfer scale measurements may be able to reproduce the position from the scale wiring diagram on this page. The chassis must first be drilled for the electrolytics, and for this purpose a 1 1/4 in. hole should be drilled through three thicknesses of the plywood from the underside of the chassis, and a 3/4 in. hole should then be drilled through the centre of this hole from the top of the chassis. This arrangement is adopted in preference to using a metal bracket for the condensers, and it permits the large lock-nut to be screwed tightly on to the thread of the condenser.

Three 3/4 in. holes must also be drilled to accommodate the valveholders, and a slot must be cut on the top of the chassis so that the L.S. pick-up strip may be attached without the metal parts coming into contact with the metallised surface of the chassis. When attaching the valveholders, this

Wiring Diagram of the P.M. A.C. Mains Three.

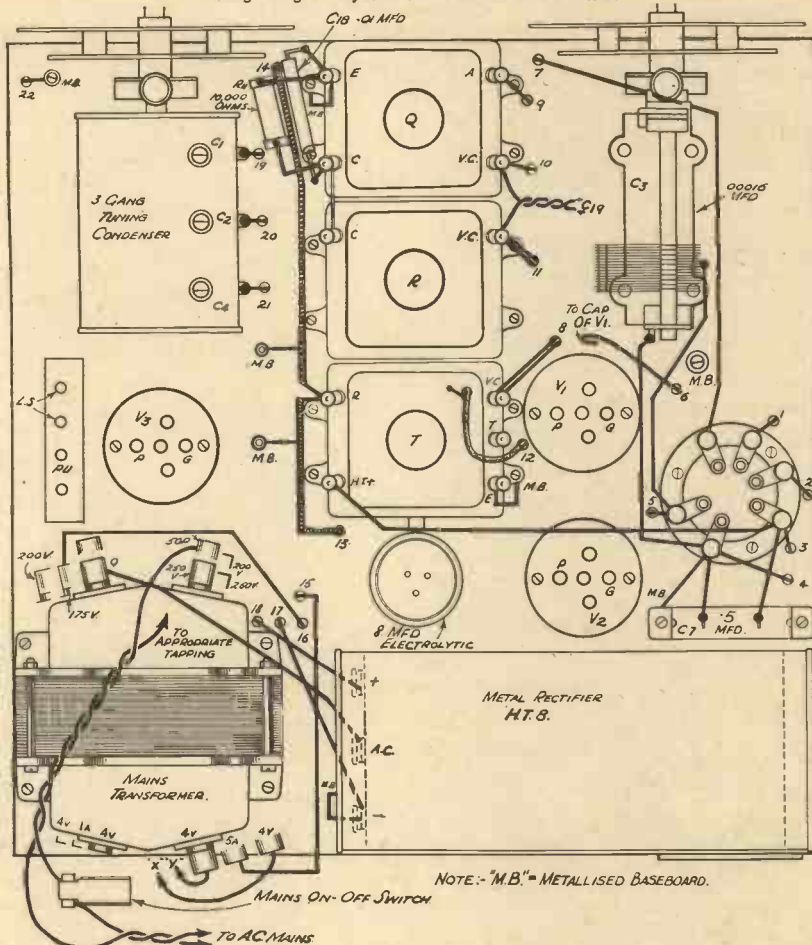

LIST OF COMPONENTS FOR THE P.M. A.C. MAINS ALL-WAVE THREE

COILS

- One set Three-gang, type WL-QRT (Wearite).
- One Short-wave Coil, type SPC with type SPB Base (B.T.S.).
- CONDENSERS (Variable)**
- One Three-gang, .0005 mfd. Baby Condenser with S.M. Dial C1, C2 and C4 (J.B.)
- One Single S.W., .00016 mfd. type EJ with S.M. dial (C3) (Polar).
- One Reaction .0002 mfd. type QJ, C5 (Polar).

CONDENSERS (Fixed)

- Four .5 mfd., type 65 (C6, C7, C8, C9)
- One 2 mfd., type C5 (C14)
- Three 25 mfd., 25-volt Electrolytics (C10, C11, C12) T.C.O.
- One .001 mfd., type M (C13)
- One .01 mfd., type M (C18)
- Two 4 mfd., type 84 (C15, C16)
- One 8 mfd., type 802 Electrolytic (C17)

RESISTANCES

- Two 50,000 ohms (R1, R2)
 - One 20,000 ohms (R3)
 - One 2,000 ohms (R4)
 - One 250 ohms (R5)
 - One .5 megohm (R6)
 - One 750 ohms (R7)
 - One 25,000 ohms (R8)
 - One 5,000 ohms (R9)
 - One 350 ohms (R10)
 - One 10,000 ohms (R11)
- Amplion 1-watt type.

CHOKES

- Two H.F., type HF3 (Bulgin).
- One 40H-60 m/A.L.F. (Premier).

VOLUME CONTROL

- One 5,000-ohm wire-wound Potentiometer (R12), (B.T.S.).

TRANSFORMERS

- One L.F., type DP21 (Varley).
- One Mains Transformer, type W31 (Heayberd).

SWITCHES

- One QMB on/off, type S80 (Bulgin).
- Four change-over, type S81 (S1, 2, 3, 4), (Bulgin).

RECTIFIER

- One Style H.T.S. (Westinghouse).

CHASSIS

- Metaplex, 12 in. by 12 in. with 3 1/4-in. runners (Peto-Scott).

VALVES

- One ACVP, and one ACHL (Hivac), and one PT41 (Cossor).

VALVEHOLDERS

- Three five-pin chassis type Airspring (Olix).

ACCESSORIES

- Four Component Brackets (Peto-Scott).
- One Ten-way Group Board (Bulgin).
- One 9 in. by 3/4 in. shaft (Bulgin).
- Two Terminal Strips, L.S.—P.U., A., E. (Olix).
- One Stentorian Senior Loudspeaker (W.B.).
- One Cabinet (Peto-Scott).

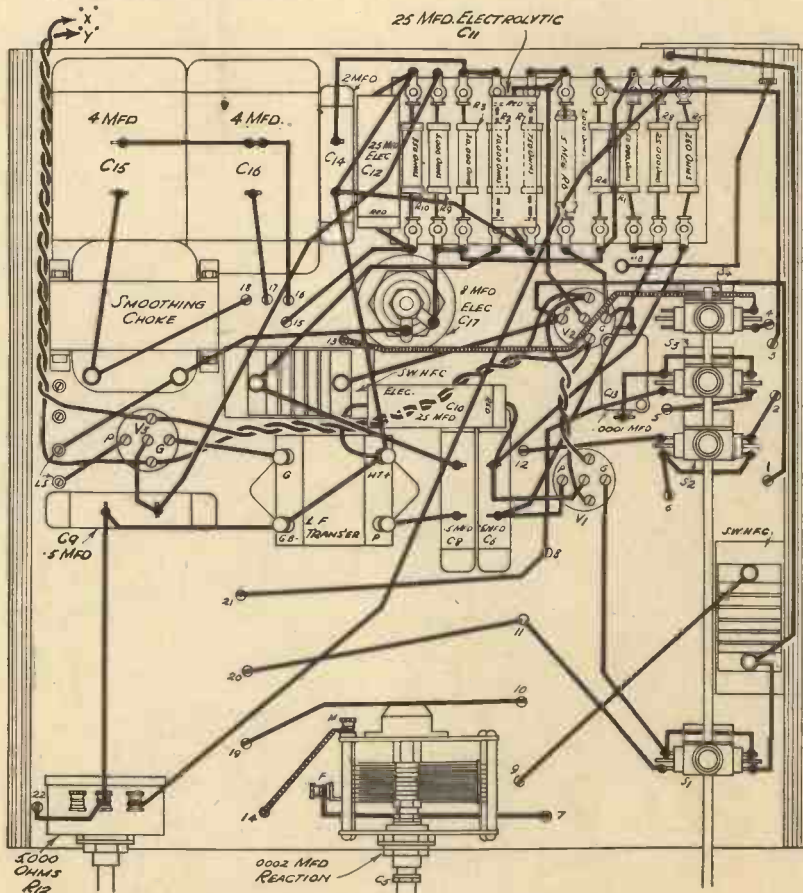

point must also receive attention, and in case of doubt it is worth while to scrape away the metal coating for a space slightly larger than the top of the valveholder. This point is mentioned as we have several times had receivers here which readers had failed to get in working order, and had found that the valveholder sockets were in contact with the top of the chassis.

Mounting the Parts

When all holes are drilled, the parts should be screwed down, mounting those on the underside of the chassis first, so that the receiver will rest flat on the bench or table. Before screwing the ganged switches in position the rod should be passed through them and each switch should be locked by means of the small grub-screw on the top of the moving knob. If this is not done you may find it impossible to push the rod through all the switches when they are attached.

Construction will be simplified if all the resistances are attached to the resistance board before it is screwed in position. When attaching the electrolytic condenser, make quite certain that the metallised surface of the chassis is intact round the fixing hole and lock the nut very tightly, as it is essential that the case of the condenser be joined to earth. If preferred, a short bare wire may be placed under the condenser before the nut is locked and this may be joined to the nearest earth point. This should not, however, be necessary if the above method of mounting is employed.

Note that the short-wave tuning condenser is raised slightly above the chassis surface so that the slow-motion drive may be balanced with the dial on the opposite side of the chassis. A piece of wood will serve for the purpose, or small lengths of ebonite tube may be cut as distance pieces. In view of the delicacy of this condenser, it is as well to leave this until all the remaining constructional work has been completed.

Wiring

The wiring is not difficult, and if a definite system is adopted it should be found no more difficult than in the case of an ordinary battery receiver. The heater circuit must, however, be wired with twin flex of suffi-

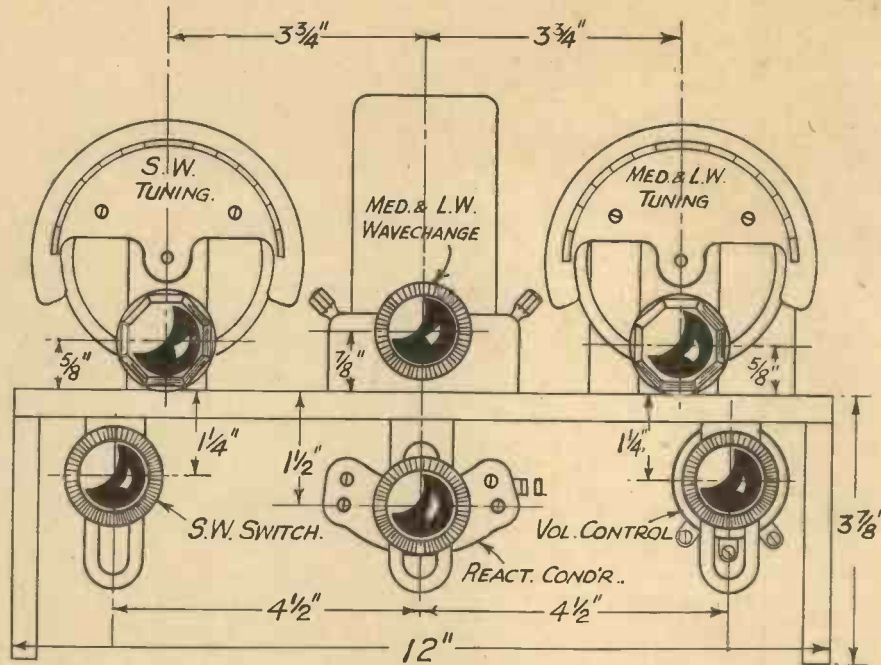

Drilling dimensions for the cabinet front.

cient thickness to avoid voltage loss. Do not use the cheap flex which is obtainable at certain stores, as this may prove unsatisfactory. You need only a short piece, and it will pay to get a good heavy lead, preferably that known as 70/36, as this will carry up to 8 amps at 4 volts without appreciable loss. The remainder of the wiring may be carried out with ordinary connecting wire, soldering where possible and making quite certain that all joints are really sound.

Earth Returns

There are only two other points which need emphasis on the constructional side. These concern the earth-return points which are carried out through the metallised coating of the chassis, and the screening of the reaction circuit. The latter is carried out by utilising the special screened cable sold for the purpose. This is a braided

material inside which is a length of systoflex. The ordinary wire as used for wiring the receiver is passed through this systoflex and the screening cut back at the end and wrapped to prevent contact with the wire inside. When the latter is attached to the respective terminals at the ends, a short length of bare wire should be wrapped round the screening and connected to the nearest earth point. Notice carefully that the wire inside the screening lead must not be allowed to come into contact with the braiding or earth connection. The points marked M.B. are firmly attached to the metallised surface of the chassis, preferably by soldering the wire to a tag and attaching this to the chassis with a round-head screw. The points marked M.B. on the underside of the chassis must be connected to bolts the heads of which make good contact with the upper surface of the chassis.

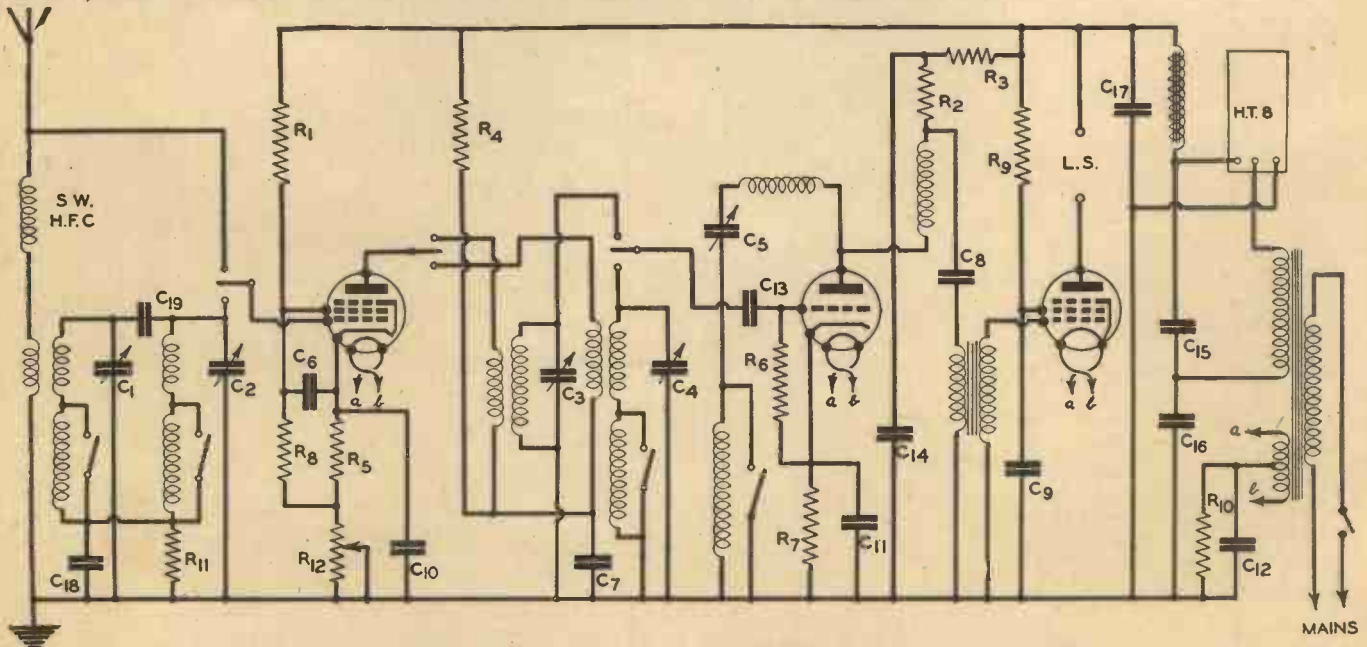

The circuit diagram of the P.M. A.C. Mains All-wave Three. The reference numbers are repeated on the list of Components on page 361.

A Screwdriver - a gimblet



and the **Beacon** 456 *is ready to hang your curtains*

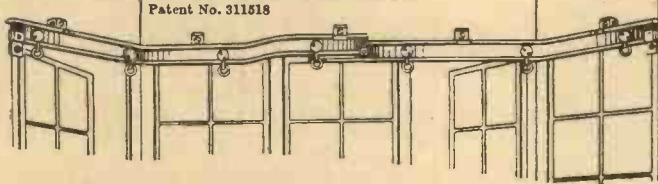

perfectly. Any handyman can erect. Fits all shapes of windows—square bays, round and oval.

Most fittings **SOLID CHUNKS OF BRASS** and whole system is a thoroughly sound job. Stands hardest wear—woodwork would have to give way first.

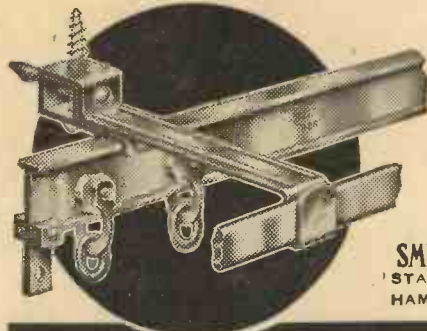

IN FOUR QUALITIES.
 Strong (Brass) ... 1/- ft.
 Light (Brass) ... 9d. ft.
 Steel (Rustproofed) ... 9d. ft.
 White (Aluminium Alloy)... ... 9d. ft.
 Complete with all fittings.
 From all ironmongers. If any difficulty write for nearest stockist's name.
 Beware imitations.
 Any length cut to order

SMITH AND DAVIS, LIMITED
 STAMPED BRASSFOUNDERS
 HAMPTON ST. BIRMINGHAM

A Really Portable ALL MAINS Set!

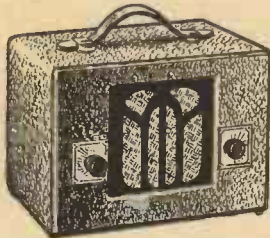

A.C. and D.C. 110-250 Volt. 5 Valves—Moving Coil—No Earth required—Self-contained Aerial—Long and Short Wave.

The latest thing from America, fine tone and excellent range. Attractively covered in washable Fabrikoid Leather in several colours, or in Polished Walnut Cabinet.

MEASURES 10" x 7" x 6" **SPECIAL PRICE £3.15**

Sent on 5 days' approval against cash. Satisfaction guaranteed or money refunded in full (less carriage charges).

Also **ELECTRIC SOLDERING IRONS**, any voltage AC/DC, 40 watt consumption, only 1/9. Better quality complete with wire stand 2/6. Send at once.

DOUGLAS HOLT (Car and Radio Accessories)
 Estd. (1919) Ltd. 9 Little Turnstile, Holborn, W.C.1.



Television is the coming boom in wireless—it will bring even greater prosperity to the industry and create many more opportunities for a career. Men who foresaw the broadcasting boom made good—be trained and prepared for this television boom which must follow as surely as night follows day.

At the **WIRELESS COLLEGE** students receive training in all the latest developments in all branches of the Wireless profession. Marine, Aircraft, Manufacturing, Designing, Experimenting, Sales and Service, etc. College on sea front. Write for free prospectus.

STUDENTS ACCEPTED AS BOARDERS. TRAINING FEE CAN BE PAID AFTER APPOINTMENT SECURED
The WIRELESS COLLEGE COLWYN BAY N. WALES



THE BRITISH LONG DISTANCE LISTENERS' CLUB

Join This Great New Organisation For Radio Enthusiasts

Amateur transmitters pioneered the short waves which have revolutionised broadcasting and made high-definition television possible. Why not join the growing band of short-wave and long-distance listeners who are getting so much enjoyment from short-wave receiving? Join the British Long Distance Listeners' Club and get a new thrill from radio. **MEMBERSHIP IS FREE.**

Advantages of Membership

- (1) No enrolment or membership fees.
- (2) Organisation centred in Great Britain.
- (3) Standardised log-books and verification sheets and badges available for members at reasonable prices.
- (4) Monthly report in "Wireless Magazine."
- (5) Interchange of ideas with fellow-members.
- (6) Members in same district placed in touch with one another when desired.
- (7) Special meetings and visits to be arranged.
- (8) Monthly problems for short-wave listeners.
- (9) Members' competitions and numerous other advantages to be announced.

SEND THIS ENROLMENT FORM TO
 The Secretary, B.L.D.L.C., 8-11 Southampton Street, Strand, London, W.C.2.

I wish to enrol my name as member of the British Long Distance Listeners' Club, it being clearly understood that no financial obligation is thus incurred. I am interested in long distance listening and *have a short-wave receiver have not

at present in use. I am specially interested in
 *Medium-wave
 *Short-wave listening.
 *Ultra-short-wave

Full Name.....
 (Block letters)

Address.....

P. Mech., March. *Strike out words not needed.

Working Model Steam Engines

Details of the Boiler Frontplate, Smokebox Door and Saddle, and Spirit Lamp are Given in this Seventh Article of the Series

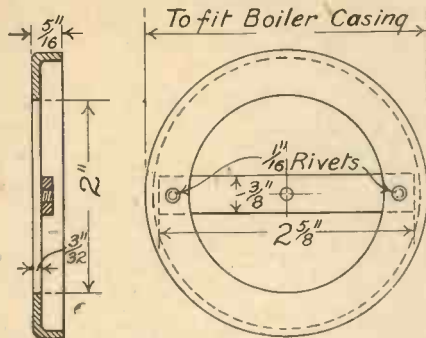

Fig. 18.—A section and front elevation of the boiler front.

THE next part to take in hand is the boiler frontplate, shown in Fig. 18, and this can be made from a light brass casting, or a boiler-end stamping. It must be carefully filed to be a good fit inside the end of the outer boiler casing.

The flange need not be more than 1/4 in. wide, and the central hole should be filed to 2 in. diameter. A piece of strip steel should now be cut to the dimensions given in Fig. 18, and this has to be riveted in position on the inside of the frontplate. The two holes to take the rivets should be countersunk on the outside of the casting, so that after riveting, the rivet heads can be filed flush. A central hole must be drilled and tapped out 1/8 in. Whit. to take the end of a steel screwed pin, which should be 5/8 in. long. This pin is for holding the smokebox door in position.

The boiler front can be fixed in position by means of four 3/8-in. screwed pins, screwed in through the outer casing into holes drilled in the flange of the plate. The holes for these pins should be drilled at equidistant spaces round the periphery of the boiler casing. For the smokebox door, a "dished" soft iron stamping can be used. The central hole should be drilled just large enough to allow the door to be slipped on to the screwed pin.

A small clamping handle can be fashioned out of a piece of 1/4 in. x 1/8 in. mild steel, to the size indicated in Fig. 19, a hole being drilled and tapped 1/8 in. Whit. for screwing on to the projecting end of the screwed pin.

Steam and Exhaust Pipes

The steam pipe connections are clearly shown in Fig. 6 and 11 (December and February issues). A piece of brass tubing 14 in. long will be required, and from this cut off a piece 4 in. long and bend one end to the union fitting which is clamped in place

by the union nut on the steam tap. Bend one end of the long piece of tubing, pass it through the outer boiler casing, between the water tubes, and push the other end through the hole made to receive it in the boiler backplate. Bend the projecting end of the tubing so that it joins up with the pipe from the steam tap, and then slip a short brass sleeve over the ends (as shown in Fig. 6) and solder the joints. To the other end of the tubing a union connecting piece is soldered, the other part of the union being soldered on to a short length of brass tubing which is screwed into the T-piece which connects up with the cylinder steam blocks.

of the saddle to the bedplate.

Now mark out the front plate D, using the rear one as a template, but do not mark out the part A, as this is not cut away from the front plate. After cutting out, lightly solder this plate to the other one and file down the rough edge till both plates coincide. Separate the plates and then proceed to cut out and file to shape two pieces B to the dimensions given, for forming the curved sides. After bending these to shape, cut out two more pieces C for the detachable

side plates and drill a 1/8-in. hole in each to clear the nuts on the cylinder pivot pins, and also drill four 3/8-in. holes where indicated.

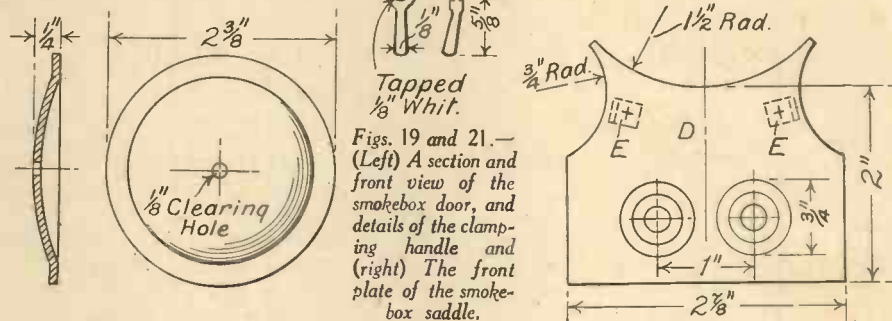

Figs. 19 and 21.—(Left) A section and front view of the smokebox door, and details of the clamping handle and (right) The front plate of the smokebox saddle.

For the exhaust pipes, two 2 1/2-in. lengths of brass tubing, 3/8 in. diameter, will be required, and one end of each should be threaded for a distance of 1/2 in., the other ends being tapped round with a light hammer to contract the orifices slightly. After this is done bend the pipes to the shape shown in Fig. 11, and screw them in position in the steam blocks.

The two curved side plates can now be clamped in position against the rear plate, and the joints well soldered on the inside. Next clamp the front plate in position, and solder two angle pieces, 1/4 in. wide, to the inside of the curved side pieces in the positions indicated at E, Figs. 21 and 22, so that the front faces of the angles touch the front plate.

Before removing the clamps, drill a 1/8-in. hole through each angle piece and front plate; the holes in the angle pieces being afterwards tapped to receive small fixing screws. Now place one of the side plates

Smokebox Saddle

This can be built up from sheet brass 3/4 in. thick, the sides and front being made detachable so that access can be had to the cylinders. Mark out the shape of the rear

plate to the dimensions given in Fig. 20, and after cutting out the plate with a sharp cold chisel, file down the rough edge carefully to the scribed outline. The part marked A has to be cut away to clear the cylinders. Two small brass angle pieces G can be soldered on to the plate in the position shown, to form feet for the back

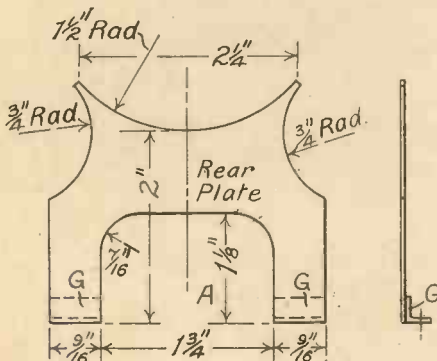

Fig. 20.—The various parts for forming the smokebox saddle.

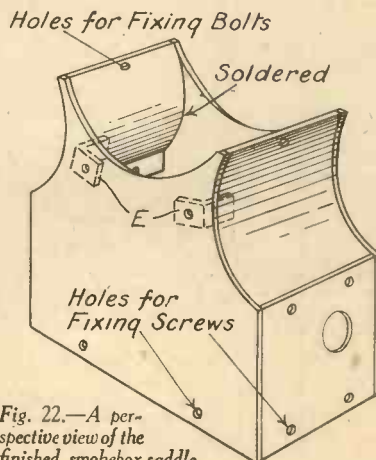

Fig. 22.—A perspective view of the finished smokebox saddle.

C in position, and mark the position of the two holes to be drilled near the bottom edge of the curved plate, B. Tap the holes to take $\frac{1}{16}$ -in. Whit. screws, and repeat the operation on the other curved plate.

Two "dummy" cylinder covers can be screwed on to the front plate D as shown, to give a more realistic appearance to the saddle.

The parts forming the saddle can be assembled in position on the bedplate and the holes carefully drilled and tapped in the bottom parts of the steam blocks for taking the fixing screws for the side plates. Two holes will also have to be tapped out in the bedplate to receive the screws for fixing the angle pieces G in position. For fixing the lower part of the front plate—a $1\frac{1}{2}$ -in. length of $\frac{1}{4}$ -in. angle brass can be soldered to the

saddle, as indicated in Fig. 22. The boiler back plate is held in position on the bedplate by means of a brass angle piece as shown in Figs. 1 and 6.

In order to protect the sides of the firebox from the heat of the lamp, the firebox may be lined with sheet asbestos held in place by a piece of tinfoil bent to shape and riveted to each side of the firebox by two or three rivets. The asbestos lining is indicated in Fig. 6.

Details of Spirit Lamp

The dimensions of the completed spirit lamp are given in Fig. 23. The reservoir can be made from tinfoil, about No. 22 gauge, the bottom and sides being formed from one piece cut to the shape and dimen-

supply pipe to pass through, and the centres of these holes should be $\frac{3}{8}$ in. from the bottom of the tubes. Each supply pipe consists of a $7\frac{1}{2}$ in. length of $\frac{3}{8}$ in. diameter brass tubing and on both sides of each tube small nicks H must be made with a small round file.

The wick tubes can now be slipped in position and soldered to the supply pipes, after which four discs can be cut out of a piece of sheet brass and filed till they just fit in the bottom ends of the wick tubes. Solder these discs in position, as at J, and then plug the ends of each supply pipe with a short piece of brass wire K soldered in.

Drip Tray

Before soldering the ends of the supply pipes in the reservoir the drip tray L must be made. For this a piece of tinfoil about 6 in. x 4 in. will be required, on which the developed shape of the tray can be marked out as shown in Fig. 25. After drilling the air inlet holes and those for the supply pipes, the front and the two sides of the tray can be bent up on the dotted lines and the joints soldered on the inside. Now push the supply pipes through the holes in the front of the tray till the wick tubes are in the position shown in Fig. 23. See that the supply pipes are quite parallel, and then solder them to the tray where they pass through the front plate.

The back plate M of the tray can now be bent up and soldered in position to the side plates. Having done this push the ends of the supply pipes through the holes

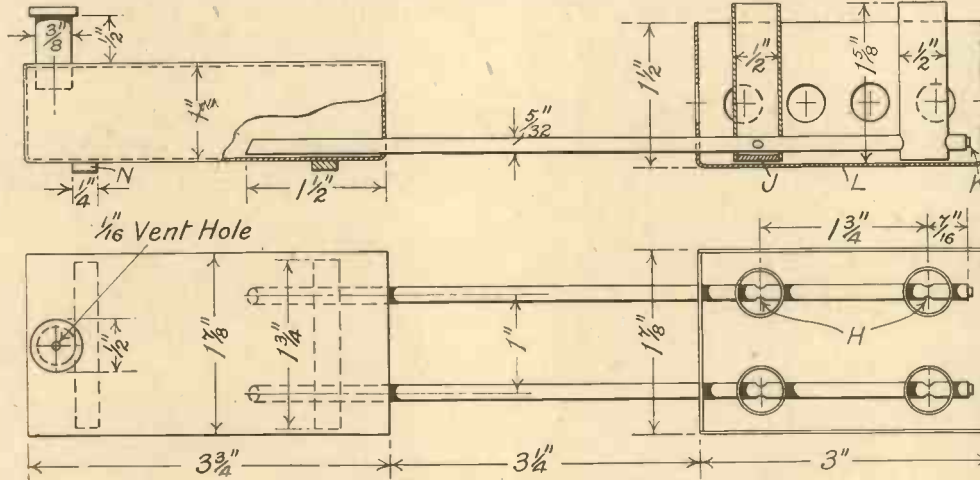

Fig. 23.—A part sectional elevation and plan of the spirit lamp.

bedplate between the steam blocks, and two holes drilled and tapped in it to take the fixing screws. The top part of the front plate is screwed to the two angle pieces E. Before finally fixing the front plate in position the steam pipe from the boiler must be coupled to the union piece between the cylinders.

Fixing the Boiler in Position

On referring to Figs. 1 and 6 (December issue), it will be seen that the bottom of the firebox has a flange at the sides and front, which is screwed down to the bedplate. This flange is composed of three lengths of $\frac{1}{2}$ in. brass angle, which can be riveted to the firebox casing with $\frac{1}{8}$ -in. copper wire rivets, after having the holes drilled to take the small screws for fixing the angles down on the bedplate. The holes in the latter can be carefully marked out after the boiler casing is bolted to the smokebox saddle. For this purpose two $\frac{3}{8}$ -in. bolts can be used, which pass through holes drilled near the top edges of the curved side plates of the

sions given in Fig. 24. After drilling the holes for the supply pipes, bend the sides up on the dotted lines and well solder the corner joints on the inside.

Top Plate

The top plate of the reservoir can also be made of tinfoil, and should be a push-fit in the top of the reservoir. A $\frac{3}{8}$ -in. hole must be drilled near one edge of the plate to take the filling tube, consisting of a $\frac{3}{4}$ -in. length of light brass tubing, which is soldered in position, leaving $\frac{1}{2}$ in. projecting above the top of the reservoir, as shown in Fig. 23. Do not solder the top plate in position till after the supply pipes are fixed in place.

For the wick tubes a piece of $\frac{1}{2}$ in. diameter light brass tubing about 7 in. long will be required. Cut off four pieces $1\frac{1}{2}$ in. long and file the ends square till each tube is exactly $1\frac{1}{8}$ in. long. Two $\frac{3}{32}$ -in. holes must now be drilled through each tube for the

in the rear plate of the reservoir, and when the latter and the front of the tray are the correct distance apart the ends of the supply pipes can be soldered to the bottom of the reservoir. The top plate of the reservoir should now be soldered in place, after which a small cap can be turned out of a piece of brass to fit in the top of the filling tube. Drill a $\frac{1}{16}$ -in. vent hole through the centre of the cap, as indicated in Fig. 23. This completes the spirit lamp with exception of the two packing strips N, which can be soldered to the bottom of the reservoir in the position shown.

Testing Under Steam

A little fine lubricating oil should be applied to all the working parts of the engine, and the flywheel given a number of turns to run the oil well into the bearings. The boiler can then be filled up to the top test

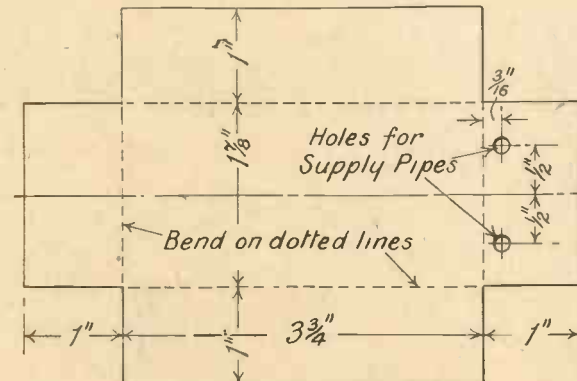

Figs. 24 & 25.—(Left) The tinplate blank for forming the bottom and sides of the lamp reservoir and (right) The shape of the metal plate for making the drip tray for the spirit lamp.

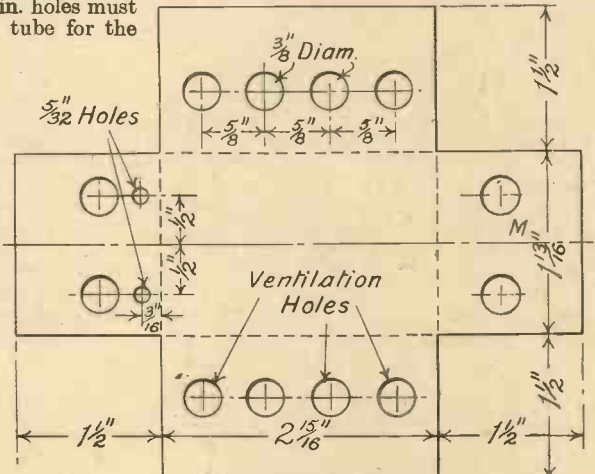

cock with hot water from a kettle, using a small tin funnel placed in the hole where the safety valve screws in. The top test cock should be kept open during this operation, while the bottom one should, of course, be shut off. When the water reaches the level of the top test cock, turn it off and screw down the safety valve, after adjusting the spring so that the valve can be raised comfortably by pressing the spring up with the finger.

The lamp reservoir can then be about half filled with methylated spirit and the wicks lighted. These should be of asbestos yarn. After three or four minutes have elapsed open the steam valve slightly to allow a little steam to enter the cylinders to warm them up, and give the flywheel a few turns with the hand to eject the small amount of water which will have formed in the cylinders. Now open the steam valve a little more, and if the cylinders and steam

blocks have been adjusted correctly, the engine should begin to run at a good speed. Slightly open the bottom test cock occasionally to try the level of the water, which should never be allowed to get below this level whilst the lamp is alight beneath the boiler, otherwise there would be a risk of running the solder.

Finally, the finished model can be left unpainted, the boiler casing and other parts being rubbed over occasionally.

A DESIGNOGRAPH is an instrument of precision, capable of automatically constructing any number of designs, which are mathematically correct. These designs can be made exquisitely beautiful, chiefly by an appropriate and harmonious blending of correct colours. Such an instrument, if correctly designed, does not become monotonous.

The designs made by this machine—no matter how constructed—are the result of the compounding of two or more separate motions, but, if more than two are employed, the results are too involved. Two of the simplest and best movements to combine, are a straight line and circle, and it is with these two that we are concerned in this article, i.e., a movement backwards and forwards in a straight line and round and round in a circle. In other words, cause a pen or pencil to move to and fro across, or partly across, a circular uniformly revolving disc covered with a sheet of paper. Such a movement will produce an extremely good design, provided the relative speeds are correctly adjusted.

The Result of Varying the Speeds

Suppose the recording disc (that on which the design is made) to be revolving quickly, the tracing pen will travel comparatively slowly across the recording disc, resulting in a spiral, which does not lend itself to a good design. Therefore, it is not advisable to rotate the recording disc quickly, in fact, the rotational speed should always be less than that of the designing wheel.

If we reverse the above procedure, an excellent design will be produced, with an interlacing and shading of colour which is quite unique.

One great advantage that a tracing formed by a stylographic pen has over one actuated by a pendulum or combination of pendulums, is that in the case of the former, the movement can be arrested at any moment and continued with a change of colour, which is impossible in the case of a pendulum.

Varying the Design

The most marked variations in design are produced in the following manner:

1. Variations in the relative speed of the moving parts.
2. Altering the position of the peg in the holder on the designing wheel, and changing the position of the wheel itself (by altering the holder only, you simply alter the size of the design, without altering its character).
3. The use of different coloured inks, a design in, say, red and green, having quite a different appearance to the same design in blue and orange.
4. By a skilful manipulation of different designs on the same piece of paper. When completed, the whole appearing as one design.

Reproducing the Same Design

There is, of course, no difficulty in immediately reproducing any design before the various parts have been moved, but

A Designograph

By V. E. Johnson, M.A.

having secured a design of some particularly interesting and beautiful character, it is an additional attraction to be able to reproduce it on some future occasion. Referring to the sketch of the designograph, it will be seen that the slot in the baseboard has a graduated ruler on both sides of it. Supposing we call the one on the left side *A*, and the other *B*, then $2\frac{1}{2}$ in. $A \times 3\frac{3}{8}$ in. *B* fixes the position of the movable block.

The position of the penholder, with respect to the end of the controlling rod, is easily measured, *R* meaning right side, and *L* left. The position of the designing wheel is fixed by the pointer on the protractor. There only remains to determine the position of the cords or belts. As an example, number the different pulleys on the various wheels, 1, 2, 3 in descending order of magnitude, remembering that *D*, the driver, has two sizes, *DW*, the designing wheel, three, and *RD*, the recording disc, one only. Thus *DIX* to *RD2*, and *DW3* to *RD* will give you the necessary information, *X* meaning that the straps are crossed. This same principle can be applied to any other type of designograph.

The Construction

The baseboard of the designograph measures 19 in. \times 21 in. \times 1 in., the four

legs are 3 in. high, and the slot in the baseboard is $7\frac{1}{2}$ in. long \times $\frac{1}{4}$ in. wide. The diameter of the recording disc is $10\frac{1}{2}$ in. and this disc contains five pulleys measuring 10 in., 9 in., 6 in., 5 in., and $2\frac{1}{2}$ in. respectively. The designing pulley is 10 in. in diameter, and is fitted with seven pulleys measuring $9\frac{1}{2}$ in., $8\frac{1}{2}$ in., $7\frac{1}{2}$ in., $6\frac{1}{2}$ in., 4 in., 3 in., and 2 in. in diameter and has two pulleys measuring 8 in. and $5\frac{1}{2}$ in. The brass sliding rod is $17\frac{1}{2}$ in. long and $\frac{1}{8}$ in. in diameter, and the flat connecting rod is 12 in. \times $\frac{3}{8}$ in. \times $\frac{1}{8}$ in. The length of the swivelling arm on which the designing pulley turns is 8 in., and the driving arm is $6\frac{1}{2}$ in. in length.

The Pen

An ordinary stylographic pen was used for the model illustrated, but for those who require great accuracy, glass pens should be used. These can be obtained from any scientific instrument makers, and require frequent cleaning, a good paper, and non-clogging ink. Ordinary pens can be used if desired, provided an extremely fine nib is used. The most satisfactory colours to commence with are scarlet, blue, green, violet, and a deep orange. A separate pen and filler must be used for each colour, and a fairly stiff paper for the designs.

LATHE WORK FOR AMATEURS

By F. J. CANN
96 Pages

1/- or 1/2 by post from Geo. Newnes
Ltd., 8/11 Southampton Street, W.C.2.

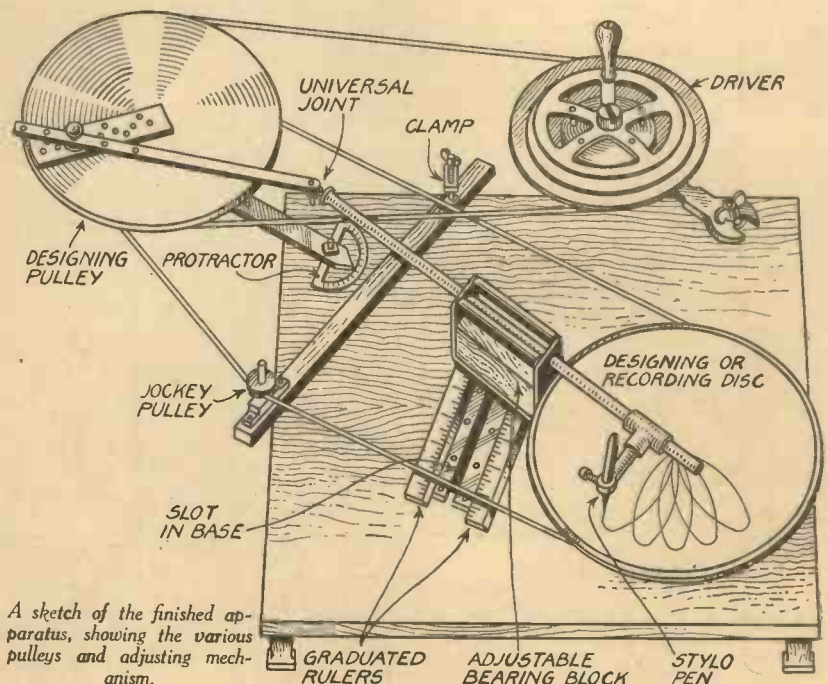

A sketch of the finished apparatus, showing the various pulleys and adjusting mechanism.

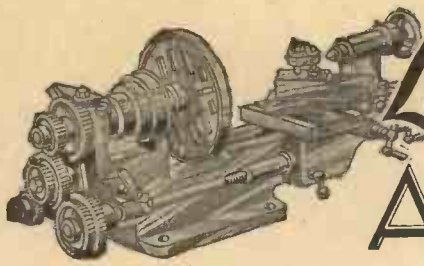

Lathe Work FOR AMATEURS

GRINDING OPERATIONS

By W. H. Deller

WHILE a centre lathe is primarily intended to be a machine for performing operations that are strictly regarded as turning, its general design is such that it may be easily adapted for use in other directions outside of this sphere.

The operation that is most akin to turning, is cylindrical grinding, and as a general rule, all turned work that is subsequently hardened should be finally ground. Other forms of grinding such as cutter and surface, can also be conveniently carried out on the lathe.

Frequently, the lack of facilities for carrying out such operations is the cause of a finished job falling short of perfection. Therefore it is proposed to deal with the adaptation of the lathe for grinding processes.

Extra Equipment Necessary

The extra equipment necessary to complete the conversion is really very little, and as to the question of outlay, the reader who is so disposed, may make the attachments for a fraction more than the bare cost of the material involved. Briefly, what is required is a driven spindle carrying a grinding wheel mounted on the tool platform in place of the usual turning tool. As may be imagined, a motor-driven unit specially made for the purpose, provides by far the simplest solution to the problem. Such electrically-driven self-contained "tool-post" grinders are to be had in great variety. These may be suitable for external or internal work, or a combination appropriate for both classes. The power of the motors fitted are usually of the order of 1/4-h.p., and therefore may be plugged into the lighting circuit. A small internal

grinding attachment of this description is seen fitted to the lathe in Fig. 1. The wheel spindle is removable by unscrewing the knurled collar on the necked portion of the casing, so that other spindles of different diameter or length may be substituted as required. A diagram of a combination attachment is shown in Fig. 2. Here the

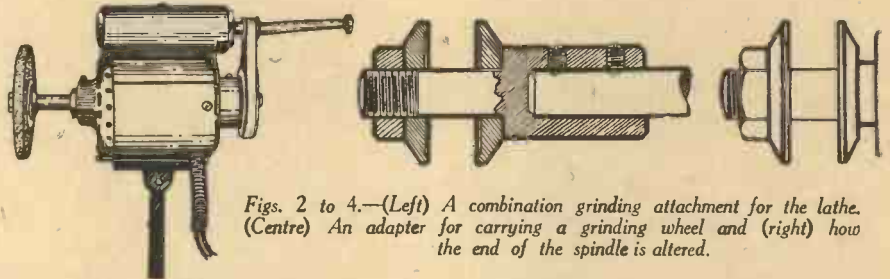

Figs. 2 to 4.—(Left) A combination grinding attachment for the lathe. (Centre) An adapter for carrying a grinding wheel and (right) how the end of the spindle is altered.

external wheel is driven at armature speed, and the internal spindle driven with an endless belt by a pulley at the opposite end of the armature spindle. The means provided for mounting in the tool post is so arranged, that the attachment is simply clamped in position with the spindle required nearest to the nose of the lathe. When the internal spindle is not in use, the belt should be slipped off so that the full power of the motor may be utilised to drive the large grinding wheel.

Converting an Existing Motor

An existing motor in the region of a 1/4-h.p. suitable for the mains current available, may be converted for use as a grinder providing that the armature is mounted

on substantial bearings. If the motor is a modern one, it will be fitted with ball bearings which is an advantage, but precautions should be taken to exclude the entry of grinding dust, as far as possible, into the bearings and inside of the motor.

The question of mounting the motor must first be considered, and probably the simplest way of so doing will be by fixing the motor to a baseplate. On account of bringing the armature spindle down to centre height, it may be necessary to remove the top slide of the "compound," and mount the baseplate directly on to the cross slide in substitution. While this will provide a rigid fixing and enable good work to be produced between the centres, it will not permit of taper grinding being carried out on work held in the chuck. As, however, most jobs may be tackled, this objection is not a serious one.

Having decided on the method of fixing the motor, the next step is to adapt the spindle to carry a grinding wheel. This can be done by making an adapter as shown in Fig. 3, or where the diameter and length of spindle will permit, by altering the end as shown in Fig. 4. The first

example affords the best method as the motor may still be used for other purposes. In making the adapter, it should first be roughed out and the hole bored to neatly fit the spindle. After fitting the grub screw or screws, the part is finished by turning on a true peg held by the screws. This should ensure that the extension runs perfectly true when in position. The internal grinding attachment may be



Fig. 5.—Details of a flexible shaft unit.

fitted at the front of the baseplate (so that it can be detached when not being used), and driven by a belt from a pulley fitted in place of the grinding wheel, or with a friction wheel in direct contact with a pulley so fitted.

Flexible Shaft Drive

Where the lathe is a small one, the dimensions of even the smallest motor giving sufficient power will be too great to permit mounting in the manner stated, and in such cases, an alternative method must needs be adopted. A flexible-shaft drive affords perhaps a simple solution as the actual grinding head can be got down to quite small proportions.

Where such a drive is contemplated, the actual flexible-shaft unit should, on account

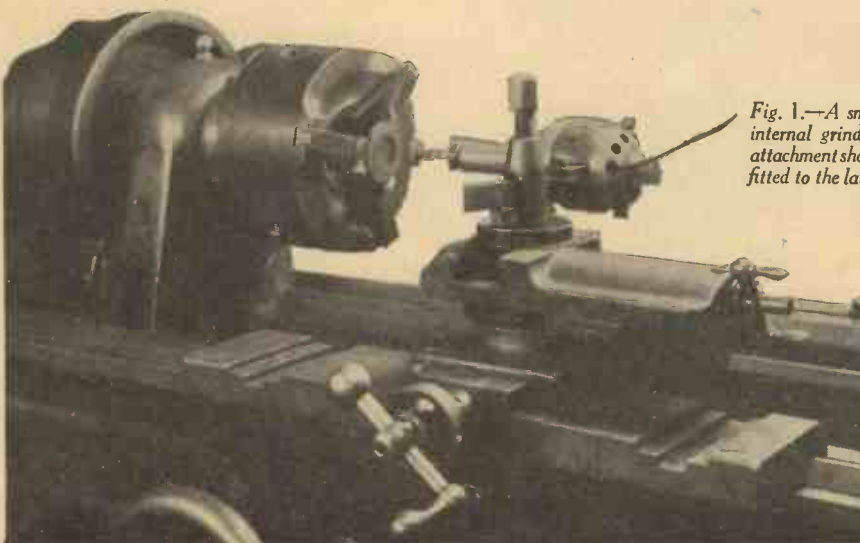

Fig. 1.—A small internal grinding attachment shown fitted to the lathe.

of the high speeds involved for internal grinding, be one that is fitted with ball races. A shaft unit of this description is illustrated in Fig. 5. The head shown separately is in this instance provided with a collet for gripping the shanks of small arbors carrying the appropriate wheels. It is better to avoid purchasing a head that is permanently fitted with a drill type of chuck, as this is not nearly good enough.

The head may, of course, be made on the lines of those shown later, in which case the shaft only needs to be considered, and there is no reason why, for light work, an old speedometer driving shaft and casing should not be pressed into service for the purpose (see Fig. 6). Where, however, one of the commercial types of flexible shaft units is to be used, it will be necessary to provide some means of holding the head portion in the tool holder. Alternative methods of so doing, and which will meet the requirements of most types of tool posts, are shown in Fig. 7. No actual dimensions can be given as these will depend upon the diameter of the grinding head, height from tool platform to centre, etc. Other details are made clear in the sketches.



Fig. 6.—For light work, an old speedometer driving shaft may be used.

The flexible shaft may be motor-driven direct or via countershaft to give a range of speeds above that of the motor, and if fitted in this manner, will form a valuable addition to the workshop equipment as its uses, apart from grinding, are numerous.



Fig. 7.—Alternative methods of holding the head portion of the flexible shaft in the tool holder.

Belt Driving from Countershaft

Although a more or less self-contained electrically-driven grinding head provides the most simple means of converting or adapting the lathe for grinding, the job can be accomplished by belt driving from a drum countershaft situated above the lathe as shown diagrammatically in Fig. 8.

The driving drum should extend to more than the maximum distance that the lathe will take between the centres, taking care to arrange it in such a position that the down belt will not be unduly tightened or slackened when the cross slide is moved. Where the drum cannot be mounted in

relation to a line through the lathe centres shown in Fig. 9, then a jockey pulley will need fitting to compensate belt tension; but this is a complication that is usually avoidable.

Belt-driven Grinding Heads

The reader who is desirous of doing a little grinding on the lathe, and intends making the head himself, will naturally

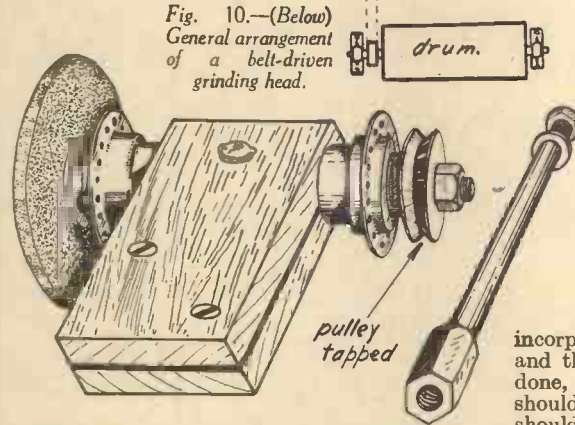

Fig. 10.—(Below) General arrangement of a belt-driven grinding head.

wish to achieve his aim with the minimum of trouble. A ball-bearing head, which will produce creditable work of small proportions, may, with very little trouble, be contrived from a front hub of a bicycle. Very little actual work, if any, is needed in the way of alterations. A round belt will transmit all the power that is required so that a vee pulley is all that is wanted to take the drive. The flanges may be reduced in diameter to below the spoke holes for the sake of appearance, but this is not really necessary.

A general arrangement of the head and method of mounting is shown in Fig. 10 together with an adapter and shaft for internal work.

Belt-driven External-Internal Attachment

A suitable design for making a belt-driven combination attachment is shown in Fig. 11. The external spindle is driven from a drum situated above the lathe in the manner previously explained. The pattern making involved is of the most simple nature, one pattern being required for the bracket and one for the friction pulley. As shown, the main spindle runs on ball bearings which can be on the lines indicated, or the design modified to

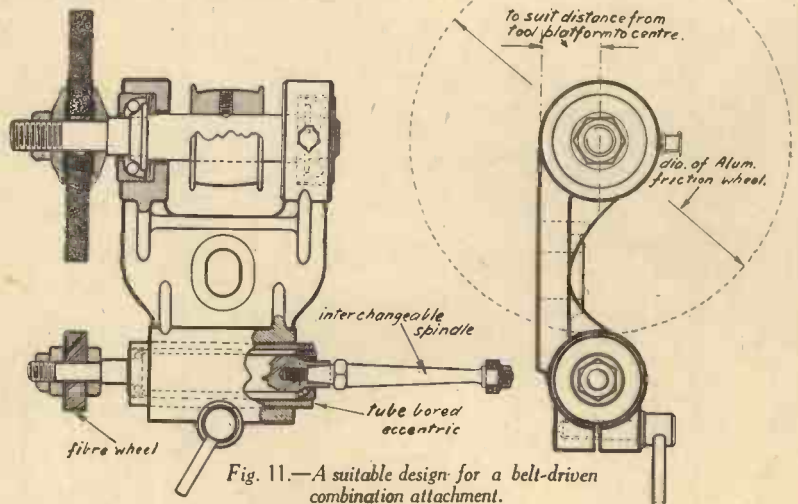

Fig. 11.—A suitable design for a belt-driven combination attachment.

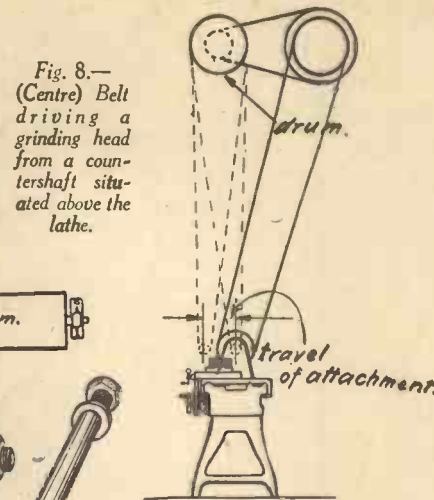

Fig. 8.—(Centre) Belt driving a grinding head from a countershaft situated above the lathe.

Fig. 9.—A jockey pulley fitted to compensate belt tension.

incorporate standard combined journal and thrust ball-races. Where this is done, the inner rings of the races should be made to butt against shoulders turned on the spindle at either end, and screwed caps fitted to effect adjustment to the outer rings. If the centre of the caps are bored to clear the shaft and a groove provided in each one to contain a felt ring, a good dust-proof bearing will result.

The spindle may, of course, be mounted on plain bearings, but to do this properly, the bearings require to be adjustable and also an adjustable thrust-plate is an absolute necessity, so that all things considered, the method shown or that suggested, forms the easiest way to go about the job. To bring the internal attachment into use, the grinding wheel is removed and the aluminium pulley substituted. The bracket is then swung round to bring this pulley nearest to the tailstock. It should be noted that the round body of the internal attachment is slightly eccentric in relationship to the spindle. This enables the body to be rotated, and thus bring the friction wheel to bear against the face of the pulley with the right degree of pressure before finally clamping into position. No dimensions are given on the drawings, as the attachment will have to be made to individual requirements.

EVERYTHING FOR THE FLYING FLEA

Complete Machines or Components in any stage of Construction

PERMAN POU ENGINES

Send stamped and addressed envelope for particulars to—

E. G. PERMAN & CO.

24-26 BROWNLOW MEWS,
GRAY'S INN ROAD, LONDON, W.C.1

ECONOMIC ELECTRIC CO. TWICKENHAM, LONDON, S.W.

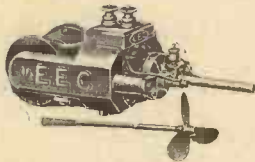

THE NEW "MIDGET" MOTOR
The smallest and most powerful motor on the market.
Size: 3 1/2 in. long, 1 1/2 in. wide, 2 1/2 in. high.
Weight 7 1/2 oz. Low centre makes it ideal for boat or loco. 4 VOLTS.
PRICE: 5/6, post 4d.
Castings and materials 3/3, post paid.



G.P.O. TAPPERS
Substantial keys for practice use. An instrument, not a toy.
6/6 post free. Buzzers 2/-, Sounder 9/6.

Our 70-page list contains a variety of small Mains Motors—Spark Coil material, Transformer Stamping, Wire, etc. Also over 500 other models for all purposes. Send for a copy now, 2d. post free.

"00" Gauge

Track Materials

We are the largest suppliers of all track parts and our prices are the lowest. Compare these prices

Correct section Brass rail, per 36" length 1 1/2d	1/6 per doz.
Single-track sleepers correct length	6d. " 100
Double "	8d. " "
Merco 3rd Rail Screw type chairs	6d. " doz.
Brass Slide on Fishplates	4d. " "
Ballast Felting for use under track to give ground effect per 36" length 1 1/2" wide	1d. per length.
Brass track pins for pinning track to baseboard	3d. " packet

Add 6d. postage on all orders for rail.

HAVE YOU read Mr. Beal's book covering all "00" gauge modelling? If not, send 3/6 plus 4d. postage now. We are known for our prompt despatch by return service.

HAMBLINGS, 26 Charing Cross Road, W.C.2

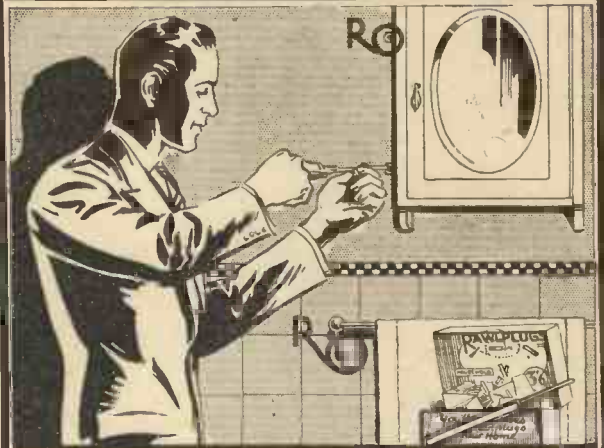

When You Use a Screw Use a RAWLPLUG 'too!

RAWLPLUGS Millions of Rawlplugs were used on such famous engineering jobs as the Mersey Tunnel, the Shannon Electricity scheme, Grid Systems and thousands of other jobs where reliable fixing work is of the utmost importance. Yet Rawlplugs are so simple to use that anybody can make neat firm fixtures with them in a few minutes—even if the user has had no previous experience. There is a Rawlplug for every size of screw. Every Electrician, Builder and Handyman should have a Rawlplug Outfit as part of his kit. Complete Outfits at 1/6, 3/6, and 5/6.

Rawlplug DUROFIX

This is the finest of all adhesives because it is unaffected either by heat or water. Crockery repaired with Durofix can be washed in hot water or baked in an oven. In addition, Durofix leaves no ugly stain at the join because it is colourless. Sportsmen will find it ideal for repairing the binding on cricket bats, golf clubs, etc. Once it has set, the moisture of the hands cannot make it tacky again. Sold in orange tubes, ready for use, at 6d. and 1/-.



Repairing Frayed ends of Electric Wire

Durofix will repair the frayed ends of electric wire covering, neatly and efficiently. Just put a little Durofix on the fingers and roll round the frayed ends. This ensures a neat finish and a permanent job.



Rawlplug PLASTIC WOOD Wood in Putty Form



This product is wood in putty form. It is pliable and can be moulded to any shape desired. It is invaluable for filling holes and cracks in all kinds of articles, and in addition it is a powerful adhesive. The craftsman also will find dozens of uses, such as designing moulding, model making and so on. When exposed to the air, Rawlplug Plastic Wood quickly hardens, and can be cut, planed, painted and varnished—just like ordinary wood. Sold in tubes at 6d. and 1/-, and in tins from 9d. upwards.

Write for illustrated literature of these and other Rawlplug Products. Free on request.

THE RAWLPLUG CO. LTD.
Rawlplug House, Cromwell Rd., London, S.W.7

B.194

GROUND ORGANISATION

*The Efficient Operation of a
of Disaster to a Minimum.*

mitted from the ground to air-liners in flight, thus keeping pilots in touch with any weather changes that may be in progress ahead of them along the routes they are following. In this way, should fog settle suddenly on an aerodrome for which he is steering, a pilot in flight can be warned of the fact by wireless, and advised to alter his course so as to alight at some alternative air-station where visibility is better.

Avoiding Risk of Collision

In times of bad visibility, the officer at Croydon can bring into play a system enabling him to exercise a special control by wireless over aircraft approaching or leaving the air-station, thus lessening any risk of collision. And in this connection it should be mentioned that air-liners outgoing and in-coming on the Continental routes, follow different courses, thus separating the main traffic lines.

Vital to the efficient operation of a modern airway is its system of wireless signalling, on the ground and in the air. Whenever flying conditions render such a course desirable, air-liner pilots can obtain wireless direction and position bearings from main air-stations. Such wireless guidance enables them to fly for long distances without seeing anything of landmarks below, and yet to maintain a perfectly accurate course; while wireless "homing" devices are now provided in aircraft which enable them, by picking up the signals sent out by transmitting stations, to steer directly towards such stations. The modern pilot is also aided in bad weather by such devices as turn-indicators, "automatic pilots," and artificial horizons—these enabling him to keep his machine on an even keel and steer an accurate course,



The London air-port, Croydon, floodlit at night.

THE fact that British air-lines now operate during all kinds of weather, with a reliability of just on 100 per cent., is mainly due to the skill of experienced pilots, to the dependability of multi-engined air-liners, and to the wonderful organisation which has been created in wireless, meteorology, and ground lighting. It is with the ground organisation of air transport that we propose to deal.

Take, for example, the equipment at a modern aerodrome such as the London air-port, Croydon.

Here one finds a spacious booking-hall and waiting-room for passengers, together with an adjoining hotel with restaurant and other accommodation. Departments are provided for dealing with mails and freight; also a Customs staff such as one would find at sea-ports. Air-liners pick up and set down their passengers at special arrival and departure platforms, while for taking-off and landing, they have a large and unobstructed aerodrome surface.

Big sheds, adjacent to the main buildings, provide housing for the air-liners not in flight. There are fully-equipped workshops for the overhaul and maintenance of aircraft and engines; while the flying personnel have their own pilots' room, where they assemble prior to, or after the completion of, their scheduled flights along the main air routes.

The Control Tower

The "brain" of the air-port is to be found in the control tower dominating the main buildings. Here is the traffic officer on duty; also the operators in charge of the wireless installation; while another important department is that of the meteorologists, who are constantly obtaining and distributing data as to weather conditions, along the airways between London and the Continent. This weather organisation not only receives frequent reports from a large number of ground stations, but pilotless balloons are sent up to secure information

as to wind-strength and direction; while reports are also available from the upper-air "soundings" made by aeroplanes sent up daily by the Air Ministry.

All such observations are plotted on weather maps, which the pilots of air-liners consult before they start their flights. At the same time, wireless messages are flashing constantly between the main air-ports of Europe, describing the conditions from hour to hour as to wind, cloud, and visibility.

Not only do such messages pass from station to station, but they are also trans-



A control officer plotting the position of an Imperial Airways liner on his map in the control tower at the air-port of London, Croydon.

OF THE MODERN AIRWAY

Modern Aerodrome is Largely Dependent on the Precautions Taken to Reduce the Risk Below is Described the many Ingenious Devices and Apparatus used in this Endeavour

when flying in such conditions as mist or fog rob him of any normal visual landmarks or horizon by which to correct the movements of his machine.



A night view of the new cone-type boundary light at Croydon Aerodrome.

Short-range Beams

The latest developments of airway wireless take the form of short-range beams, directed upward from an air-station, which guide an airman when he is coming in to land in fog. With these beams are incorporated special vertical rays that indicate to a pilot his varying height above the ground as he flies in down the main beam. Further developments with short-wave warning beams, may take the form of an apparatus fitted in an air-liner to warn the captain of the proximity of another machine when mist or fog reduce ordinary visibility.

Ever since civil aviation began, just over sixteen years ago, experts on marine lighting have been developing special ground lights and beacons for the guidance of aerial traffic. The brilliant red of the neon light, with its fog-piercing power, is used in a giant beacon at Croydon which pilots can see when they are still many miles distant. The aerodrome is also surrounded at night by red boundary-lights, while a special form of flood-light, throwing a low beam across the landing-ground, is capable of producing over a wide area an illumination almost equal to that of daylight.

Another special device, in which much ingenuity has been displayed, takes the form of an automatic device to tell an airman the direction and strength of the wind as he comes gliding down to land at a main or intermediate aerodrome. This takes the form of a large, illuminated, arrow-like structure which swings always head to wind, and along the top of which, coloured

lights can be mounted to indicate the strength of the wind.

Guiding Beacons

One of the problems in airway lighting has been the need to establish on hills or mountains, and at other remote points, powerful unattended guiding beacons which will function with a minimum of attention or overhaul. This has led to the employment, in automatic beacons, of a sun-valve or light-sensitive device which automatically sets a light going as soon as darkness begins to fall, and which extinguishes the light when daylight comes on the following morning. These automatic beacons, each flashing its distinctive signal, have now been brought to a high state of efficiency. Working automatically from gas-storage chambers, they will continue to light themselves up and put themselves out for a considerable period of time; and the mechanism is so ingenious that a beacon will, if necessary, automatically change its own gas mantles. Apart, in fact, from an occasional visit from an engineer to re-charge the gas cylinders, and give the machinery an overhaul, one of these air-lighthouses will look after itself for long periods without anyone having to go anywhere near it. Automatic electric beacons are also employed, operated by a small gas-engine plant which will run for long periods without attention.

The aerodrome beacon at Croydon is one of the most powerful in the world, and, on an average clear night, is visible over 60 miles away. It is of the red neon type, consisting of a number of neon tubes arranged in the form of a truncated cone on a metal framework. The beacon flashes a morse signal indicating the name of the aerodrome. The light source, although capable of being seen many miles away, is of low intrinsic brightness over a wide area, and does not dazzle pilots.

An Amplified Air-mail Scheme

The use of all such methods of airway lighting, both at air-stations and intermediate points, is now assuming a still greater significance in view of the decision to bring into operation, in 1937, an amplified air-mail scheme by which first-class letter mails, without any aerial surcharge, will be air-borne in bulk over the chief Empire routes. Under this new plan a fleet of larger and more powerful air-liners, already in construction for Imperial Airways, will operate by night as well as day, passengers being provided with sleeping-berths in addition to day saloons. All this will, of course, entail a considerable amplification not only of the flying equipment but also of wireless, meteorological, lighting services, and chains of guiding beacons stretching along thousands of miles of routes.

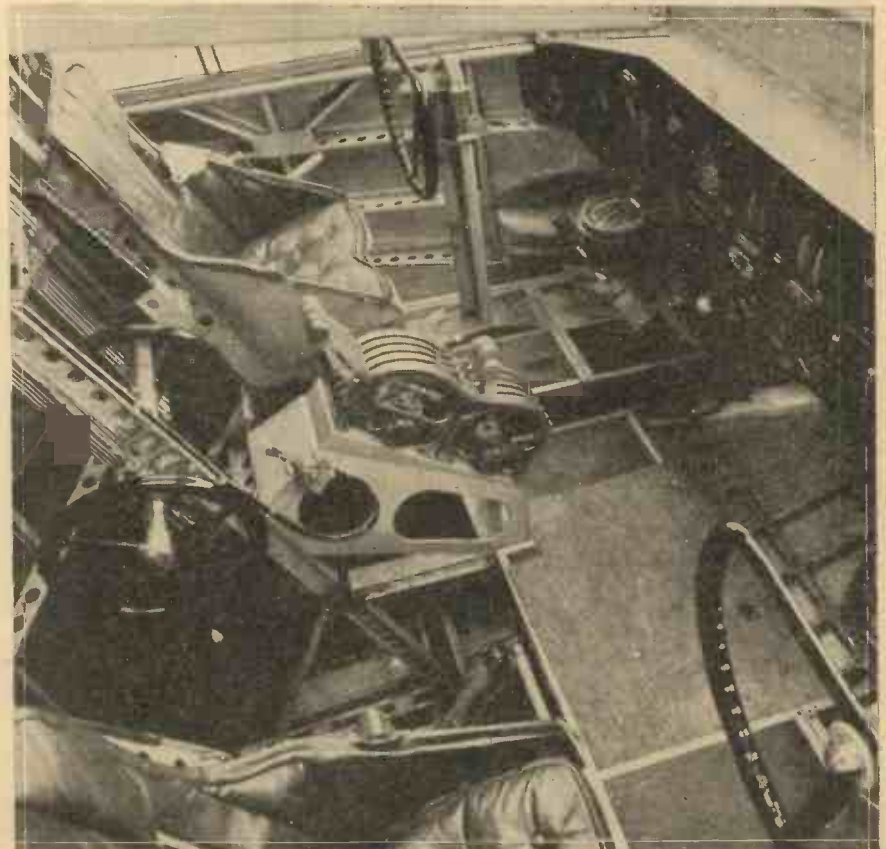

Showing the bridge of the Imperial Airways Liner "Scylla."

★ A GREAT OPPORTUNITY!

For Every Reader of
 "Practical Mechanics"
 An Invaluable New Work

THE "PRACTICAL CARPENTER AND JOINER"

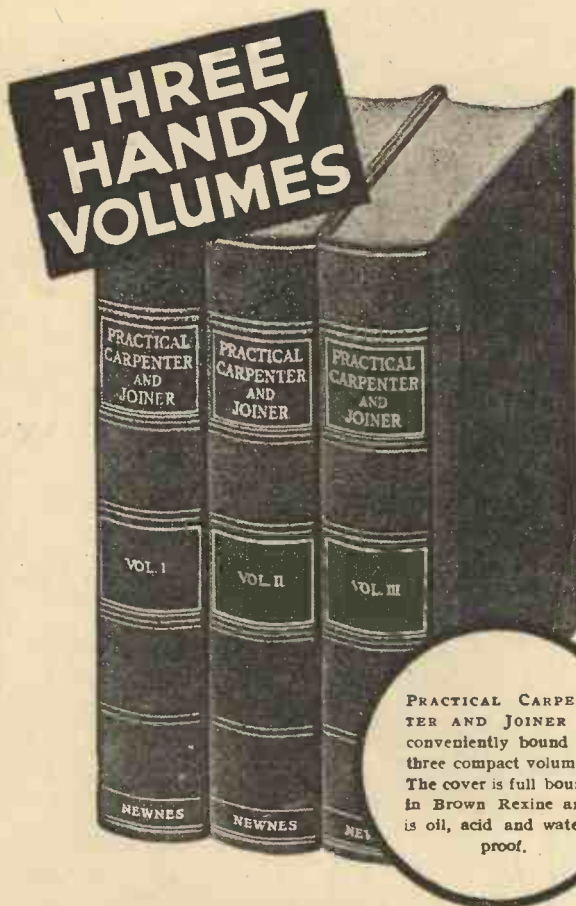

PRACTICAL CARPENTER AND JOINER is conveniently bound in three compact volumes. The cover is full bound in Brown Rexine and is oil, acid and water-proof.

Free ILLUSTRATED DESCRIPTIVE FOLDER

(SEE BELOW)

No obligation to Purchase

Prepared by over 30 Experts for the Man in the Trade

THE trade of Carpentry and Joinery is one which offers wonderful scope for advancement to the man who is prepared to use his brains as well as his hands in his everyday work.

PRACTICAL CARPENTER AND JOINER has been written purposely for those who want to get on by experts in every branch of the industry.

All the articles have been carefully planned in such a way that they place this experience at your disposal. In addition to fundamental principles, the work deals thoroughly with all applications—including work in the Joiners' Shop, Carpentry and Joinery as applied to Building Works, Doors, Windows, Floors, Roofs, Staircases and Handrailing, Forms, Mould and Shuttering for Concrete Work, Cradling and Bracketing, etc.

The work is equally important for reference purposes to Architects, Surveyors, Timber Merchants, Property Owners and others who are intimately connected with the Building and Woodworking Trades.

We have confidence that every reader who takes a pride in good craftsmanship will find "Practical Carpenter and Joiner" directly useful in his everyday work.

IMPORTANT TO YOU!

You may be an Architect, a Master Builder, a General Foreman, Machine Wood-worker, a Carpenter, or a Joiner, engaged in the shop or on building works. You may be an Apprentice or Improver in the industry. Whatever your status, we are confident you will find that the money you spend in purchasing this work is an investment you will never regret.

SEND TO-DAY FOR FREE FOLDER



Practical Contributors include:

- | | |
|---|-----------------------------|
| R. V. BOUGHTON, A.I.Struct.E. | F. E. DRURY, M.Sc. (Tech.). |
| J. AMBROSE DARTNALL, A.R.I.B.A., P.A.S.I. | H. GRISBROOK, A.M.C.T. |
| C. H. HANCOCK, F.B.I.O.C. | H. R. HUDSON. |
| A. TRYSTAN EDWARDS, A.R.I.B.A. | W. E. WEBB. |
| A. MORA. | E. GRISBROOK. |
| F. BURREN. | T. LINSTED. |
| E. H. IRELAND. | A. S. HOAD. |
| RUSSELL LATHAM. | T. W. TIDMARSH. |
| LLEWELLYN E. WILLIAMS, A.R.I.B.A. | J. S. TARTE. |
| C. H. HAYWARD. | H. G. PARKES. |
| H. J. BUTLER. | C. A. FARLEY, B.Sc. (Eng.). |
| A. B. SWALLOW, A.I.R.I. (Tech.). | A. SHELDON. |
| E. W. TWINING. | H. G. GILDART HICHISSON. |

Action Photographs and Drawings

The work contains more than a thousand illustrations and numerous useful charts and tables. All the action photographs have been taken in joiners' shops, machine wood-working shops, or on the actual building sites, under the supervision of practical men. Special charts have been prepared by experts. Every illustration has been included with a definite purpose. In constructional articles the illustrations enable the reader to see the whole of the process from the early stages to the finished job.

To THE HOME LIBRARY BOOK CO.
 (George Newnes, Ltd.)

8-11 Southampton St., Strand, London, W.C.2

Please send me free of all cost and with no obligation, the folder describing PRACTICAL CARPENTER AND JOINER, and particulars of the scheme whereby I shall be able to have the immediate use of the three volumes at an outlay of a few shillings per month.

Name.....

Address.....

Pract. Mech., 3/36

If you do not wish to cut your copy, send postcard mentioning "Practical Mechanics" to address above.

Woodworking for Beginners

Mortise (continued)

After being marked out, the mortise chisel which should have a blade exactly equal in width to the width of the mortise. The best way is to cut about half-way through the wood from one side, and then turn it over and cut across the grain at the ends of the mortise. The wood can then be turned back and the hole completed from the first side. An alternative method, which is rather better for the beginner, is to work half-way through the wood from each side. In any case it is of especial importance that the chisel should be held perfectly upright whilst cutting, and the wood should be placed on a solid piece of timber or on a bench hook.

There are two ways of cutting out the mortise, and both have their uses under different circumstances. The first, which is a great time saver, is to bore a few holes through the wood inside the lines marked out for the joint; after that the chiselling process is very much easier. Another way is to start in the centre of the joint; make a chisel cut by giving the tool a moderately heavy blow with a mallet, and then work backwards and forwards to each end of the joint. Cuts should be made every $\frac{1}{4}$ in. or so, when the waste wood can easily be removed. (See Fig. 23.)

Mortise Chisel.—See Chisels.

Mortise Gauge.—Also called a double marking gauge. This tool is similar to the ordinary marking gauge, but has two spurs which enable it to mark a pair of parallel lines which are also parallel to the edge or side of the wood. (See Fig. 18.) As the name implies, this tool is employed for marking out mortises. (See Gauges.)

Moulds.—There are various types of moulds, most of which can be made with a moulding plane of the kind briefly described under Planes. The most commonly used moulds are ogree, ovolo, scotia and bead; some of these are illustrated in Fig. 21 (shown last month).

Nail Punch.—Also called pin punch. This is similar in construction to a centre punch, but has a flat end instead of a point. Its purpose is for driving the heads of nails down below the surface of the wood. To prevent it slipping off the nail head, it should be held with the tip of the third finger close to the end; the finger then presses against the surface of the wood. (See Fig. 20, shown last month.)

Nailing.—This apparently very simple process demands a certain amount of care if good results are to be secured, especially when doing delicate work or dealing with thin wood. Nails should never be placed near the end of a piece of wood, or else splitting is almost sure to be caused. In every case it is advisable to make a hole through the piece of wood to be attached, to receive the nail; this avoids splitting and helps to keep the nail perfectly upright. (See Fig. 22, shown last month.)

A point which often puzzles the amateur wood-worker is what length nails should he use. A very good rule to follow is to use nails which are from two and a half to three times as long as the wood is thick.

Nails.—In various types, such as wire nails, floor brads, cut nails, oval nails, wire points, panel pins, escutcheon pins, etc. (See Fig. 19, shown last month.)

Northern Pine.—A useful soft-wood grown

Continued from Page 316 of Last Month's Issue

in the northern parts of Europe; it is commonly grown in Scotland, and for that reason often gets the name of Scotch pine. Another common name for the wood is yellow deal, whilst in the north of England it is generally called red deal. The wood is widely used for joinery purposes, since it is fairly free from knots, is easily worked, and takes a good finish when stained or varnished. It withstands exposure very well, and is thus widely used for roofing, doors, windows, and other building purposes. It is strong and durable.

The sapwood has a blueish tint and should always be avoided in purchasing, since it is not so durable nor easily worked; it is also absorbent and cannot be so easily varnished.

Notch.—A rectangular sinking made by sawing and chiselling. Notches are marked out by first measuring the length, squaring lines round the wood, and then gauging the depth. To cut out, the ends are first sawn down just to the gauge line, and if the notch is more than an inch or so long it is advisable to make other saw cuts at intervals to prevent splitting later.

Oilstones.—Used for sharpening edge tools such as chisels, plane irons, spokeshaves, etc. There are several kinds of oilstones, among which might be mentioned, Arkansas, Charnley Forest, Carborundum, and Turkey. All except Carborundum are "natural" stones quarried in different parts of the world; Carborundum is, however, a stone made by artificial processes.

Arkansas stone is white in colour, fine-grained, and of fairly even quality. It is useful for tools which require a very keen edge, but is too slow cutting for other purposes.

Charnley Forest stone is greenish-grey and cuts very slowly. It puts a very

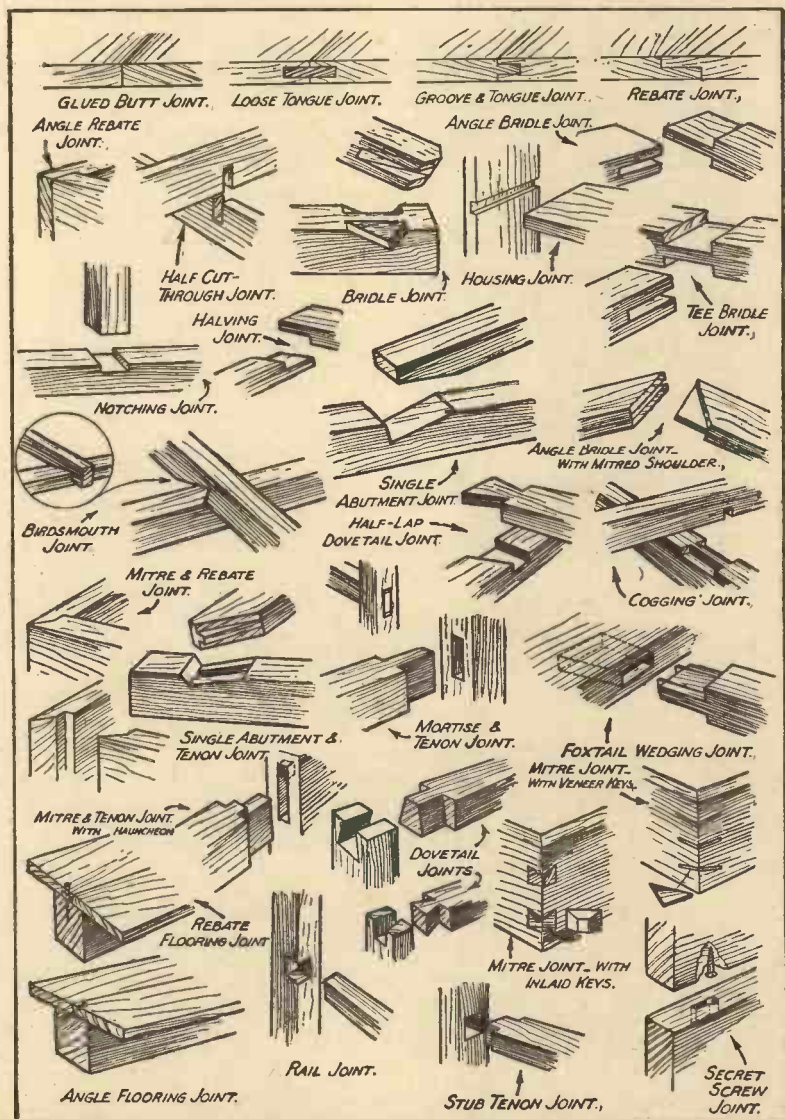

Fig. 23.—Various joints used in joinery and carpentry.

THE GLUE THAT GRIPS

Use

STE-FIX

A PURE VEGETABLE GLUE
ODOURLESS COLOURLESS

For Joinery, Fretwork, Leather, Model-making, Repairing Pottery, Glass-ware, etc., and for all purposes where a really powerful adhesive is required.

In Tubes 2d., 6d. and 9d.

Made by the Proprietors of

STEPHENS' INKS,
57 Aldersgate Street, E.C.1.

ALWAYS READY FOR USE

PLEASE SEND NOW FOR
THE STUART CATALOGUE NO. 3
6d. POST FREE

describing in 72 profusely illustrated pages the full range of Stuart products—**STEAM ENGINES and BOILERS, PUMPS, PETROL ENGINES, FITTINGS, SCREWS, DRILLS, MATERIALS, ETC.**



The "SUN"

Set of Castings and Parts . . . 12/6
Fully machined set 30/-
Finished, tested and painted 45/-

STUART TURNER LTD., HENLEY-ON-THAMES

Fig. 24.—A selection of planes : A, moulding plane (for making hollows); B and C, matching planes for forming tongues and grooves; D, bull-nose plane; E, smoothing plane;

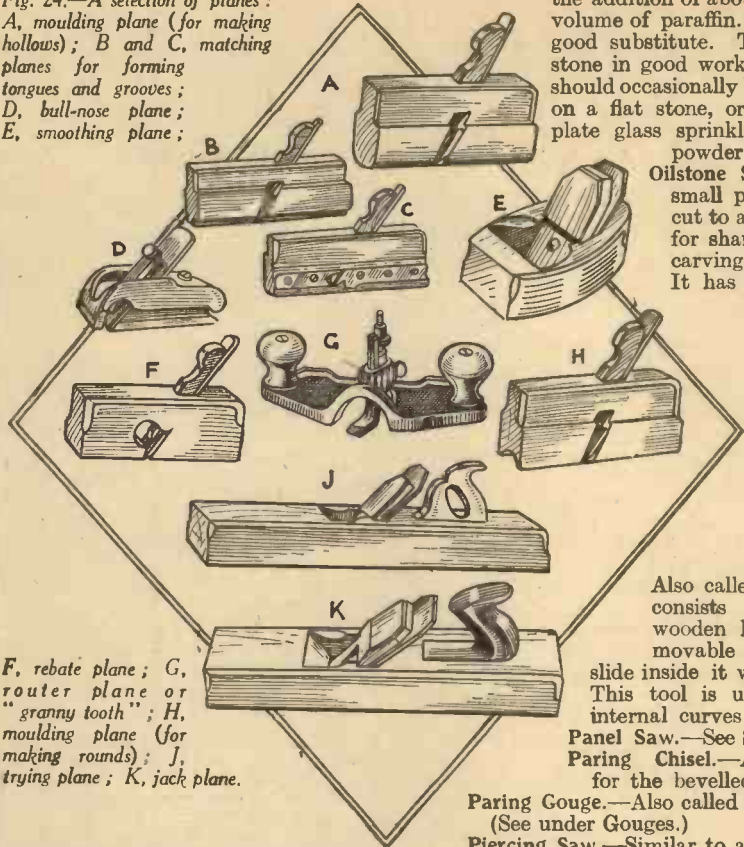

F, rebate plane; G, router plane or "granny tooth"; H, moulding plane (for making rounds); J, trying plane; K, jack plane.

fine edge on tools, and is thus useful as a finishing stone where tools are being used for delicate work.

Carborundum can be obtained in a variety of grades and is very quick cutting. It is not sufficiently fine to produce a very keen edge, and wears away rather quickly. When using this kind of stone it is advisable to finish off the work on a leather strop to remove "wire edges." Turkey stone varies immensely in different samples. Good samples are very fine grained and produce an excellent edge such as is required for a razor. It is



Fig. 25.—This sketch shows how pincers can be used without damaging the surface of the wood; a small wooden block is placed under them near to the head of the nail to be withdrawn.

greenish coloured, and the powder samples often show a streak of red or brown.

In using an oilstone it is important that the proper kind of oil should be employed. The best is generally considered to be neat's-foot, and this is often improved by

the addition of about one-tenth by volume of paraffin. Olive oil is a good substitute. To keep an oilstone in good working condition it should occasionally be rubbed down on a flat stone, or on a sheet of plate glass sprinkled with emery powder or sand.

Oilstone Slip.—This is a small piece of oilstone cut to a shape suitable for sharpening gouges, carving tools, bits, etc. It has two flat sides and two half-round edges; of the latter one is of smaller radius than the other. Slips are obtainable in various sizes.

Pad Saw.—Also called keyhole saw; consists of a turned wooden handle with removable blades which slide inside it when necessary. This tool is used for sawing internal curves and holes.

Panel Saw.—See Saws.
Paring Chisel.—Another name for the bevelled-edge chisel.

Paring Gouge.—Also called scribing gouge. (See under Gouges.)

Piercing Saw.—Similar to a small fret saw but fitted with a wider and stronger blade. It is generally used in metal working, but is also useful for making internal curves in thick wood or in stout ply-wood. Also called a coping saw.

Pincers.—The commonly known tool for extracting nails. It should always be employed as a lever and not merely for gripping nails so that they can be pulled out. (See Fig. 25.)

Planes.—Of various types, such as smoothing planes (short planes with beech-wood stock) used for cleaning off joints and dirty marks; jack planes, longer planes having beech stock from 10 to 14 in. long, and used for removing the initial roughness from wood and for truing up comparatively short lengths; trying planes, similar to jack planes but with longer stock, used for truing long pieces of timber; rebating planes, narrow planes, in which the mouth is open at one side so that the tool can be used in angles (or rebates); matching planes for making tongues, and moulding planes for forming moulds, beads, etc., on the edges of wood. In using planes of all types, weight must always be placed on the front at the beginning of the stroke, and gradually transferred to the back as the stroke proceeds. In other words, an attempt must be made to produce a "hollow" edge on the wood; this cannot actually be done due to the straightness of the sole.

When making a mould all round a rectangular piece of wood, it is best to deal with the ends first, so that any splitting at the corners will be removed when the edges are dealt with.

Reamer.—A kind of drill used for enlarging holes. It is tapered so that the end can easily be inserted in the existing holes. The type of reamer generally used for wood has a crescent-shaped cross section, so that it actually cuts instead of merely rubbing the material away.

(To be continued)

Money Making IDEAS

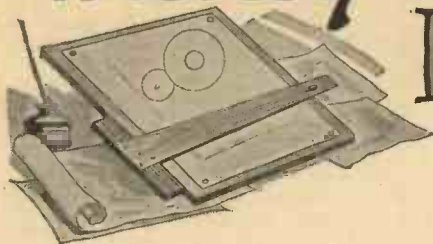

IMPROVING A ROLLER BLIND

"I WOULD greatly appreciate your opinion on the following idea of mine. As it is usual for the cord of a blind to slip round the spindle of the roller and jam the blind, I think this idea would alleviate this problem.

"A toothed wheel, fixed to the roller, is moved by another toothed wheel having a greater number of teeth. The spindle of the second wheel takes the cord, one winding for pulling up, the other winding for pulling down. The length of these windings will be small (about 3 in. or 4 in. each) depending on the ratio of the teeth. There would be no cord hanging from the centre of the blind, the cord in this case being at the side of the window. The whole idea could very easily be fitted to existing rollers as well as being fitted to new ones." (J. M., Fife).

THE improved roller blind is thought to be novel from personal knowledge, and so far as can be ascertained from the description would appear to form fit subject matter for protection by patent. A sketch and further particulars of the proposed arrangement should be furnished before a definite opinion can be given on the merits of the invention.

AN IMPROVED TAP VALVE

"CAN you advise me on the merits or otherwise of the invention described in the accompanying specification. I think this specification, together with the photographs enclosed, will make the idea perfectly clear." (J. P., Blackheath.)

THE improved valve of the screw-down type is ingenious and should be satisfactory in use. It is thought to be novel from personal knowledge and, if novel, should be a commercial success if properly marketed. The inventor, having obtained provisional protection for his invention, is advised to approach valve makers, and if the invention is not novel he will probably be soon advised of the fact. As the inventor is probably aware, the Patent Office do not make a search for novelty until after the complete specification has been filed, and it is presumed that no independent search for novelty has been made.

The following firms might be interested in the invention: F. H. Evans & Co., 138 Plashet Road, Upton Park, E.13; Kemp & Wright, Stratford Brass and Engineering Works, Junction Road, Stratford, E.15; The Winstone Engineering Co., 309-311 City Road, London, E.C.1; Frank Love, Ltd., XL House, Great Guildford Street, Southwark, S.E.1.

It is also presumed that the inventor has not had professional assistance in the drafting of his patent application, and should he require such assistance the Editor will be pleased to put him in touch with a reliable patent agent.

Advice by our Patents Expert

A DECARBONISING TOOL

"I ENCLOSE drawings of a device for facilitating the work of decarbonising a motor-car engine. Can you inform me as to its novelty, and if it is fit matter for taking out a patent." (E. D., Bucks.)

THE proposed tool for decarbonising internal-combustion engines is apparently an improved tool for grinding-in valves of such engines. As there has been a great number of patents obtained for such tools, it would be advisable to search through prior patent specifications relating to the subject matter before spending money in protecting the invention. If novel, it would appear to contain sufficient subject matter for a patent, but it is extremely doubtful if it would be possible to make a commercial success of the invention, because any patent which might be obtained at this date would necessarily be very restricted in its scope, and so might be readily overcome without infringing.

A NOVELTY FOR SMOKERS

"PLEASE give me your opinion regarding the enclosed idea. The advantages of such a combination, I am sure, would prove a great boon to all smokers of cigarettes, particularly lady smokers, who always desire compactness. The 'idea' could be modified to suit requirements." (G. C., nr. Blackburn.)

THE combined cigarette carton and book match carton may have advantages with a certain class of smoker, but even if novel, it is not considered that the mere sticking together of two cartons involves invention sufficient to support a patent. Owing to the difficulty in obtaining any adequate protection for the idea, it is not thought to have any commercial value, and a further drawback, which is probably insurmountable, is the difficulty in transporting matches which under carriage arrangements are classed as explosives.

AN AGRICULTURAL MACHINE

"IS there a machine already on the market for pulling and topping root crops? If not, where could I apply to take out a patent for this device? I should also like the names and addresses of firms who specialise in the manufacture of this type of machine." (T. F., Dublin.)

IT is thought that there are machines on the market for lifting root crops, as there have been a number of patents for such machines which a search amongst prior patent specifications would disclose. It may be possible to obtain a patent for the improved machine, if novel, but since no particulars are given it is not possible to give further advice. Applications for British patents are made at the Patent Office in London.

The International Harvester Company of Great Britain, Ltd., 259 City Road, London, E.C.1, would probably be interested in the invention.

TAKE UP PELMANISM

Sir John Foster Fraser's Appeal—How to Kill Depression and Morbid Thoughts

SIR JOHN FOSTER FRASER, F.R.G.S., the well-known author and special correspondent, is a great believer in the value of Pelmanism.

"Pelmanism is genuinely scientific," he says. "It brings swiftness to the young and brightens and sharpens the man who thinks decay is laying hold of him. It will not make the dunderhead into a statesman, but it will and does provide a plan whereby we can make the best of our qualities."

The Pelman Course contains the results of the latest Psychological discoveries and is fully explained in a book entitled "The Science of Success," a copy of which can be obtained free of cost, by every reader who writes for it to-day.

A course of Pelmanism brings out the mind's latent powers and develops them to the highest point of efficiency. It banishes such weaknesses and defects as:

- | | |
|-------------------|---------------------------|
| Depression | The "Inferiority Complex" |
| Shyness | Complex |
| Timidity | Inertia |
| Forgetfulness | Indecision |
| Boredom | Weakness of Will |
| The Worry Habit | Pessimism |
| Unnecessary Fears | Procrastination |
| Indefiniteness | Brain-Fag |
| Mind-Wandering | Morbid Thoughts |

which interfere with the effective working power of the mind, and in their place it develops strong, positive, vital qualities such as:

- | | |
|------------------|--------------------|
| —Concentration | —Organising Power |
| —Observation | —Directive Ability |
| —Perception | —Presence of Mind |
| —Optimism | —Courage |
| —Cheerfulness | —Self-Confidence |
| —Judgment | —Self-Control |
| —Initiative | —Tact |
| —Will-Power | —Reliability |
| —Decision | —Driving Force |
| —Originality | —Salesmanship |
| —Resourcefulness | —Business Acumen |
| | —A Reliable Memory |

In a sentence, Pelmanism enables you to live a fuller, richer, happier and more successful life.

Write to-day to

The Pelman Institute,
130 Pelman House, Bloomsbury Street,
London, W.C.1

and by return you will receive a free copy of "The Science of Success" containing full particulars of the Pelman Course and particulars enabling you to enrol on specially convenient terms.

Call or write for this free book to-day.

PELMAN (OVERSEAS) INSTITUTES

PARIS: 80 Boulevard Haussmann. NEW YORK: 271 North Avenue, New Rochelle. MELBOURNE: 396 Flinders Lane. JOHANNESBURG: P.O. Box 4928. DURBAN: Natal Bank Chambers (P.O. Box 1489). CALCUTTA: 102 Clive Street. Delhi: 10 Alipore Road. AMSTERDAM: Damrak 68.

BE MASTER OF YOUR MIND!

Two Books That Tell You

How to Exert Your Personality : How to Build Personal Power : How to Write Success from Failure

THE attainment of Psychological Power will CHANGE your outlook on everything affecting your personal interests and whole future—it will instruct you how to master and use your full mental powers—it will reveal to you the motives of others—and give you power, especially as affecting you and your interests.

Whoever you may be, you will be better for the perusal of these outstanding works.

Act Now Write for these vols.

PERSONALITY :

ITS NATURE, ITS OPERATION AND ITS DEVELOPMENT

AND

THE MASTERY OF MIND

5s. 4d. each post paid or the two vols. for 10s.

SOUND practical philosophy is the keynote to these books, which contain a complete system of mind-training, and show how you may lay the foundation of success, how YOU may "get there." There are essential principles of success—these books tell you them. There is a science of success—these books give it you. Chief of all, they make it plain that the secret to achievement is open to all.

Address all orders to :

THORSON'S PUBLISHERS Dept. 111 91 ST. MARTIN'S LANE, LONDON, W.C.2

Also obtainable at W. H. Smith's shops and all book-sellers. Complete Catalogue free on request.

BE TALLER THIS SPRING



With the aid of a box of CHALLONER'S Famous formula H.T.N. TABLETS

and easy system: well tried: harmless and safe. No strenuous exercises or old-fashioned appliances. *If one box is insufficient, we guarantee to supply a further box FREE of all charge.* E.H. (Sutton) writes: "Results beyond expectations and I am as pleased as Punch." Act NOW! Send 1½d. stamp for full particulars in sealed envelope. Sample 7½d. Book on height improvement 3d. P.O. or stamps only. Colonial Return Air Mail 1/- extra.

THE CHALLONER CO. (late of Bond St.) Department H65, Laboratory and Works: HYDE HEATH, AMERSHAM, BUCKS.

The **LATEST NOVELTIES**

The address of the makers of any device described below will be sent on application to the Editor, PRACTICAL MECHANICS, 8-11, Southampton St., Strand, W.C.2. Quote number at end of paragraph, and enclose 1d. stamp for the reply.

A Luminous Pencil

WE have dealt in these pages from time to time with various types of pen and pencil which have incorporated some novelty in their design. The latest addition in this respect is the luminous pencil shown below. It is self-propelling and repelling, and enables one to write in the dark. This is made possible by a bulb lighting up the head of the pencil, and thus throwing a light on to the paper upon which one desires to write. The current for the light is obtained from a small dry battery concealed in the handle of the pencil. This luminous novelty costs 8s. 6d., and refill batteries cost 4d. each. [179.]



A luminous pencil which throws sufficient light on to a sheet of paper, etc., to enable one to write in the dark.

An Electrically-Operated Door Lock

A DEVICE has recently been placed on the market whereby an ordinary lock as fixed to front doors, etc., can be opened at will from a distance by means of an electric push button.

It consists of an ordinary "Yale" type door lock, to which is attached a special electric unit, which, when the push button is pressed, withdraws the catch of the lock. If desired, a spiral spring can be fitted to the door, so that when the catch is released, the door will swing open a few inches indicating to the person outside that he may enter. As soon as the person pushes the door open, the special resetting cam resets the lock ready for closing again. The fitting of the electric unit does not interfere in any way with the ordinary action of the lock, which may be operated as usual if required, by means of either key or by turning the knob inside. The wiring required is very simple, and the push button which operates the lock may be mounted at any convenient place in the house.

Two or more buttons may be mounted in any position required, any one of which will operate the lock. The "Yale" type lock, electric unit and resetting cam, complete cost £3 10s. [180.]



A wireless novelty in which an A.C. D.C. receiver is housed in a globe of the world.

A Globe Wireless Set

A NOVEL type of wireless receiver is that shown in the illustration on this page. It consists of a globe of the world containing an all-electric A.C. or D.C. miniature wireless set. It is simple to operate and gives extremely good reception. It costs £7 7s. [181.]

An Ingenious Gas Lighter

WE show on this page a serviceable flint-operated gas lighter which is of simple construction, and is entirely fool-

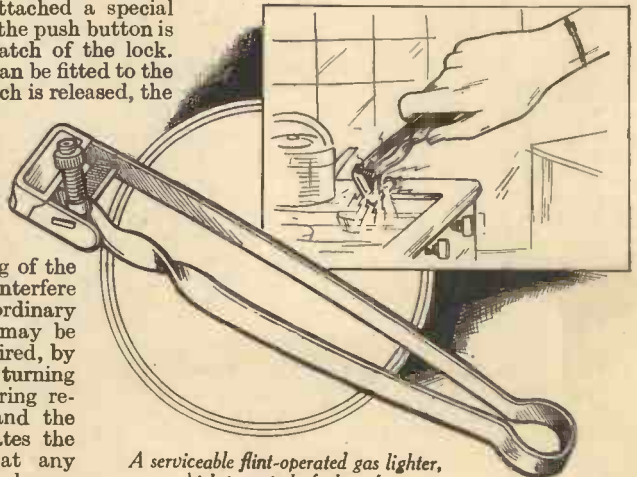

A serviceable flint-operated gas lighter, which is entirely foolproof.

proof. It is made of finest British steel, and is operated by pressing on the twisted side to which the flint is attached. It is guaranteed for one year and costs only 2s. 6d. A packet containing three spare flints is obtainable for 4d. [182.]

A Frost Predictor

THE sketch herewith shows a device for foretelling at a glance the coming of frost without the aid of tables. Frost is indicated when the wet-bulb column falls below the dry column, at sundown. The mercury tubes are fitted on a metal scale



This ingenious device enables one to foretell the coming of frost.



mounted on an oak back. This frost indicator should prove indispensable to gardeners, as it enables them to take suitable precautions to prevent the frost reaching their plants. It costs £1 10s. [183.]

A Compact Portable Receiver

WIRELESS enthusiasts will no doubt be interested in the midget portable wireless receiver shown on this page, which measures 6 in. x 4½ in. by 1½ in., and weighs less than 2 lb. It is considered to be one of the smallest self-contained 2-valve portable receivers ever produced, and is designed to work between the medium wavebands. It has a range of 50 to 100 miles, and is supplied with a single Ericsson telephone. The price of the receiver is £4 10s. [184.]

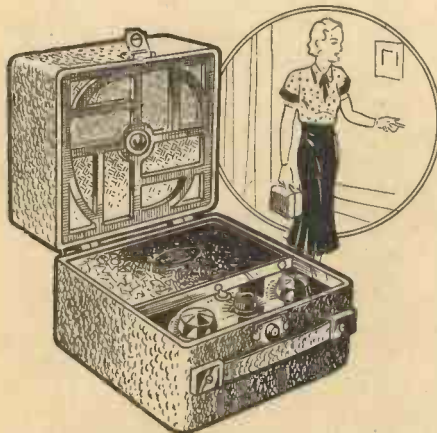

A midget portable wireless receiver which covers the medium wavebands and has a range of between 50 and 100 miles.

The Mistry Bird

THE mechanical bird shown on this page is a new and fascinating sport. You play the bird in the air by means of a steel rod and line, which is shown dismantled in the illustration. The wings revolve as the bird soars into the air, allowing it to rise to about 300 ft. The price complete with rod and line is 25s. [185.]

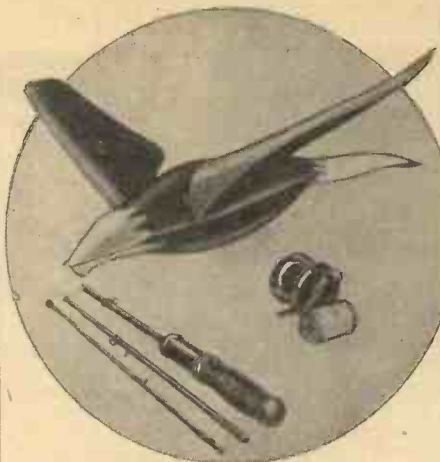

A mechanical bird which, when swept in the air with the rod and line shown, will rise to a height of 300 ft.

Knee Pads for Gardening

FOR really getting down to the job, these pads will be found ideal for the gardener. Strongly made of waterproof rubber-lined twill, padded with thick sponge rubber and reinforced with solid rubber facings on the outside, they are quickly

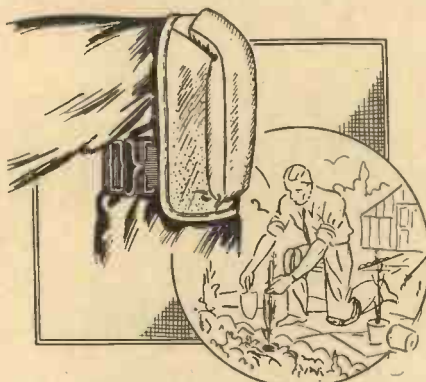

Solid rubber knee pads which enable one to kneel on hard and stony paths without experiencing any discomfort.

fitted and very comfortable in use. They enable one to kneel in luxury, on even the stoniest of stone paths and disperse with the worry of carrying a mat from place to place. They are obtainable for 4s. post free. [186.]

BOOK RECEIVED

"Everybody's Book of Aeroplanes." By R. Barnard Way. Price 1s. 6d. Published by Percival Marshall & Co., Ltd., 66 Farringdon Street, London, E.C.4.

THIS attractively illustrated book describes in detail, the principles of construction and flight, and how to identify notable machines of the day. The opening chapters deal with the early pioneers of flying, and the book goes on to describe why an aeroplane flies and how it is made. There is also a chapter on gliders and sailplanes. Although a fair number of foreign planes are described, the book gives most attention to British aeroplanes.

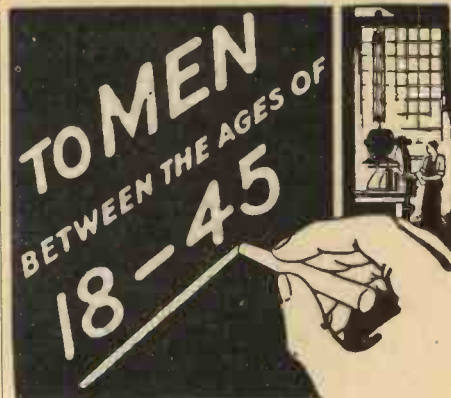

Things are happening to-day which vitally affect you!

If you are about 18, perhaps you are getting settled in your chosen work and already feeling the strain of competition for a better position. If you are in the 40's, your family responsibilities are near the peak, the necessity for money is tense—and younger men are challenging your job. And men of the ages between 18 and 45 face similar problems, in one form or another.

The most valuable employment security to-day is the security a man creates for himself—in himself! Through training, he is able to adapt himself to new conditions, to utilise experience without being handicapped by habit! He masters jobs and makes new jobs. He meets emergencies—and is not overwhelmed by them. And this is an age of emergencies.

For 45 years the International Correspondence Schools have helped thoughtful and ambitious men to acquire the training they need. To-day, with this need more urgent than ever, this world-famous institution offers greater opportunities than ever. Why not permit us to show you the way to greater security and larger earnings? Our expert advice is free. Write to-day.

.. COUPON FOR FREE BOOKLET ..

INTERNATIONAL CORRESPONDENCE SCHOOLS, LTD., Dept. 95, International Buildings, Kingsway, London, W.C.2.

Please send me your booklet containing full particulars of the Course of Correspondence Training before which I have marked X. I assume no obligation.

- Accountancy
- Advertising
- Aeronautical Engineering
- Architecture
- Bookkeeping
- Building
- Chemical Engineering
- Civil Engineering
- Draughtsmanship
- Electrical Engineering
- Engineering Design
- Marine Engineering
- Examinations, state which.....
- Mechanical Engineering
- Mining Engineering
- Motor Engineering
- Plumbing
- Radio
- Railway Equipment and Running
- Salesmanship
- Steam Engineering
- Textiles
- Woodworking

The I.C.S. teach wherever the post reaches and have a wide variety of courses of Study. If, therefore, your subject is not in the above list, write it here.

Name Age

Address

BECK'S CHEMISTRY

EQUIPMENT
APPARATUS AND CHEMICALS
FOR STUDENTS' LABORATORIES

SPECIAL PARCEL OF APPARATUS:

- 1 Flask, flat bottom, 150 c.c.; 1 Beaker, spouted, 100 c.c.; 3 Test Tubes, 4 in. x 1/2 in.; 1 Thistle Funnel, 20 cm.; 3 ft. Glass Tubing; 1 Rubber Cork, 2 holes; 4 inches Rubber Connection Tubing; 1 Glass Stirring Rod; 1936 Catalogue.

2/6
POST FREE

If this selection of apparatus is not what you require, write for 1936 CATALOGUE containing full details of other sets from 2/6 to 105/..

BECK (Scientific) 60 HIGH STREET, STOKE
Dept. A, NEWINGTON, LONDON, N.16

Booklet of Experiments 6d. (P.O.) post free.

Learn-To-Earn

MONEY-IN-SPARE-TIME

making Fancy Leather Goods. Tuition Free. Output purchased.

Write for Illustrated Booklet to

Box No. 127, The Melton Manufacturing Co., 265 Melton Road, LEICESTER.

Tobacco Habit

CONQUERED IN 3 DAYS



I offer a genuine guaranteed Remedy for tobacco or snuff habit. For either sex. It is unsafe and torturing to attempt to rid yourself of tobacco or snuff habit by suddenly stopping by will power; don't do it. By the Woods method you can give up tobacco and enjoy yourself a thousand times better while feeling always in robust health. My FREE book tells about the wonderful three days' method. Legions of testimonials. Inexpensive, reliable. Book on Tobacco and Snuff Habits sent in plain wrapper FREE on request. Write to-day. Don't delay. Address:

EDWARD J. WOODS, Ltd.,
167 Strand (788 TB), London, W.C.2.

Make More Money

£3 to £6 weekly can be earned at home in a wonderful business of your own. No matter where you live you can commence to make money in your spare or whole time. No risk, canvassing or experience required. A wonderful opportunity for anyone wishing to add pounds to their income. Particulars, stamp.

BALLARD, 71 Graces Rd., London, S. E. 5

WEBLEY AIR PISTOLS

Marvellously accurate for target practice.

No license required to purchase.

Senior 45/-. Mark 1 30/-. Junior 20/-. Webley Air Rifle 80/-

Write for List. **WEBLEY & SCOTT LTD.,**
WEAMAN STREET, BIRMINGHAM, ENG.

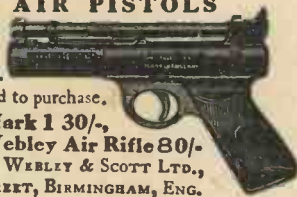

MAKE MONEY PICTURE FRAMING



Picture Framing, Tray-making, Craft Work, etc. Wonderful Wholesale Bargains in Mouldings, Beadings, Frets, Plys, Jacobean Legs, Table Tops, Corner and Tray Mouldings, Fine Art Pictures, New Chromium Beadings. Fully Illustrated Guide post free.

WATKINS PROVIDER
EXCHANGE WORKS, NEWPORT, MON.



A Review of the Latest Devices for the Amateur Mechanic. The address of the Makers of the Items mentioned can be had on application to the Editor. Please quote the number at the end of the paragraph.

The "Master Grip" Pipe Wrench

THE pipe wrench shown below is not a modification of an existing design, nor a combination of existing designs, but is an entirely new product with tremendous advantages over similar tools which are at present on the market. Carefully balanced, it has not a one-sided frame or loose head; its patent jaws ensure maximum grip and easy release. Adjustment is in the correct



The "Master Grip" pipe wrench which is fitted with interchangeable jaws. It is designed to give instant grip and release without slip.

place for one-handed operation, and the selective adjustment enables the tool to be used as a very large adjustable spanner for back nuts, etc. The head and the shank are of 45 carbon manganese steel, having tensile strength of 40/50 tons per sq. in. The pipe



A spanner with a ball-bearing adjustment. The body, which is of hydraulically drawn steel, is in one piece and virtually unbreakable. It is extended up behind the adjustable jaw, giving maximum support against spring.

wrench has a capacity of 1/2 in. to 2 1/2 in., and costs 16s. [150.]

A Spanner with Ball-bearing Adjustment

THE adjustable spanner shown in the illustrations on this page, one of which is a section through the tool, should prove extremely useful to the home mechanic. The adjustment mechanism, which is at the end of the handle, is ball-bearing, which is fully protected from dirt and grit; thus friction is practically eliminated and the spanner is enabled to obtain a vice-like grip. The jaws

are so arranged that they will take four sides of a hexagon nut, and the inside of the lower jaw is serrated to allow the spanner to grip, even if it is not tightened up. Designed for a variety of purposes, this tool will act as a small pipe wrench, vice or clamp, and can be used to remove split-pins, etc.; in fact, it does the work of a number of tools. The knurled handle, while free to rotate, remains attached to the body when the movable member is completely unscrewed and withdrawn. By reason of the presence of the ball-bearings, the releasing action is smooth and easy. It is obtainable at the following prices: 3 1/2 in., 3s. 6d. standard, 5s. chromium; 6 in., 5s. 6d. standard, 7s. 6d. chromium; 9 in., 8s. 6d. standard, 10s. 6d. chromium; or complete in a wallet 18s. 6d. standard, 24s. chromium. [151.]

Grinding of Curves

AT the coming Leipzig Spring Fair, March 1st-9th, 1936, there will be shown a handy implement, fitted with a flexible

shaft and a 1-h.p. motor. The grinding device is fitted to the hand-lever by a crossed crank. An indiarubber disc transfers the grinding force, so that the machine will adapt itself to any curvature. The disc does 3,000 r.p.m. The work done is guaranteed to be clean and as desired. The special advantage of the device is that by the clever way in which the joints have been arranged, and by the correct transmission of power, it will always respond to the slightest pressure of the hand. The working is elastic and free of vibrations.

A Small Compressor Plant

QUITE a number of readers will no doubt be interested in this efficient little compressor plant. It has a bore and stroke of 1.25 in., and all the bearings and piston are entirely self-lubricating and fire resisting. The simplicity of the design makes it eminently suitable for building into models with one or more cylinders, and for stage-by-stage experiments in higher compression. Being technically designed, the compressor

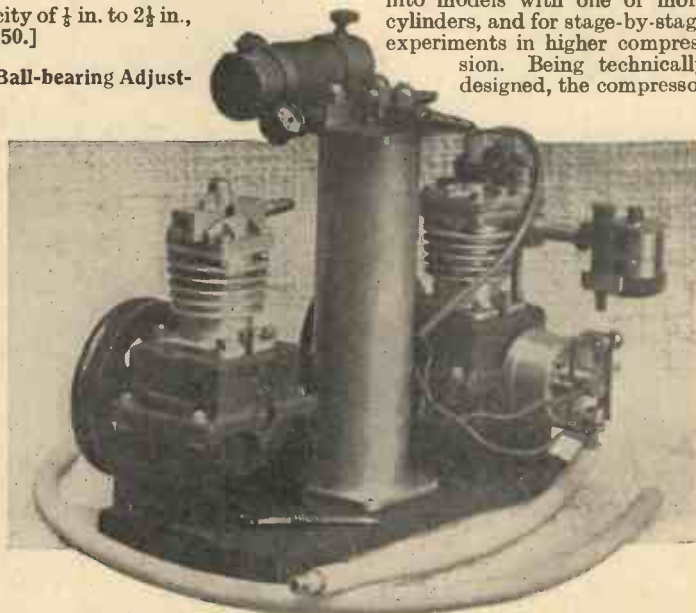

This compressor plant is suitable for direct coupling to an engine or motor. It is designed for a pressure of 100 lb. per sq. in. and for speeds up to about 1,250 r.p.m.

PATENTS, TRADE MARKS AND DESIGNS

FREE! ADVICE, HANDBOOK AND CONSULTATIONS

KINGS PATENT AGENCY LTD.

B. T. King, O.I.M.E., Patent Agent G.B., U.S.A. & Can. 146a Queen Victoria Street, LONDON, E.C.4

TELEGRAMS: GEOLGLOU, LONDON. TELEPHONE: CITY 6161.

PRACTICAL HINTS ON PATENTS

Sent free on application

THE IMPERIAL PATENT SERVICE First Avenue House, High Holborn, W.C.1.

Preliminary Consultation Free.

PATENTS, DESIGNS AND TRADE MARKS

A VALUABLE GUIDE ON INTERNATIONAL PROTECTION OF INVENTIONS. 100 Pages - Post Free, 6d. The TECHNICAL ADVERTISING AGENCY 253 (D) Gray's Inn Road, London, W.C.1

FROST & CO.

70 Old Compton St., London, W.1 Engineers, Tool and Model Makers. Models of all descriptions. Inventors, Scale and Advertising. Patterns, Castings, or Finished Parts, Small Stampings and Press Tools. Experimental and Repetition Work.

BLUSHING FREE

to all sufferers, particulars of a proved home treatment that quickly removes all embarrassment, and permanently cures blushing and flushing of the face and neck. Enclose stamp to pay postage to Mr. M. Temple (Specialist), "Palace House," 128 Shaftesbury Avenue (2nd Floor), London, W.1. (Est. 30 years.)

FOYLES Booksellers to the World

New and second-hand books on all technical subjects. Catalogues free on mentioning interests. 119-125 CHARING CROSS RD., LONDON, W.C.2 Telephone: Gerrard 5660 (12 lines).

BE TALL

Your Height increased in 14 days or money back. The amazing Stebbing System soon brings 3-5 inches increase and new energy. The first, original and the one GENUINE GUARANTEED Height Increase System. Recommended by Health and Efficiency. Complete Course, 5/-, or Booklet free, privately.

STEBBING SYSTEM, Dept. M.P., 28, Dean Rd., London, W.1.

VOICE

● Singers and Speakers, improve your voice fully 100% by scientific silent exercises. Gives increased range, volume and purity of tone. Stammering and all speech defects cured. Free Booklet.

PROF. REID, Wigmore Hall, (M) London, W.1

KEENEST PRICES for all Materials, Manufactured Parts and complete FLYING FLEAS. DUNSTABLE SAILPLANE CO., Luton Aerodrome, Barton, Beds.



An electric hair dryer which is absolutely shock proof and silent in operation.

can also be used for all commercial purposes, laboratories, and for experimental instructional work in technical schools and colleges. [152.]

A Streamline Hair Dryer

ABSOLUTELY shock proof and silent in operation, this electrically-driven hair dryer should appeal to all those readers who find drying their hair with a towel an extremely tedious task. It has a low power consumption, and is easy to handle. The mechanism is fitted into an unbreakable mottled enamel-finished case. The air inlet is at the back of the dryer, thereby rendering it impossible for hair to be drawn into the machine. It works from A.C. or D.C. supplies and costs 21s. [153.]

The "Record" Circular Plane

THE circular plane shown below will be found an extremely useful tool for the workshop. The steel face of the plane is anchored to the plane body in the centre, and adjusted by means of a screw controlling the two levers. It is fitted with toothed segment plates, which are graduated to provide for setting to correct radii. The plane is 10 in. long, has a 1 1/2-in. cutter and weighs 3 1/2 lb. It costs 26s. [155.]

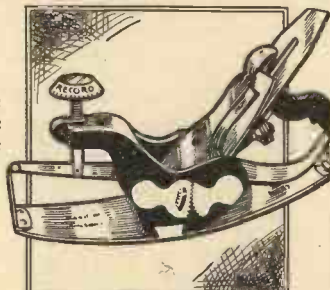

A new type of plane for the handyman.

BOOK RECEIVED

"Railway Modelling in Miniature." By Edward Beal. Price 3s. 6d. 133 pages. 270 illustrations. Published by Percival Marshall & Co., Ltd.

NO model-railway enthusiast should be without this new publication which deals in the main with the small HO and OO gauges. There are 133 pages devoted to all aspects of this interesting hobby, and the subjects covered will enable everyone to build the most comprehensive lay-out and to carry out all railway engineering practice in perfect detail.

The chapters deal with the merits of the small gauges, Track Work and Lay-out Design, Modelling Railway Buildings, Building and Equipment Designs, Rolling Stock and Motive Power, and conclude with some interesting and valuable details on scenic work.

The work is profusely illustrated in line and tone, and there is no difficulty in adapting many of the illustrations to gauge O. The majority of the working drawings are complete with a scale for use in either the OO or HO gauges, and it is only necessary to double the HO measurements in order to construct the item for use in gauge O.



"This crossword's a teaser," said Nell, "A word of seven letters, one's L, One's X—and the clue Is for 'joints firm and true,'" "That's FLUXITE," cried Dad, "sure as shootin'!"

See that FLUXITE is always by you—in the house—garage—workshop—wherever speedy soldering is needed. Used for 30 years in government works and by leading engineers and manufacturers. Of Ironmongers—in tins, 4d., 8d., 1/4 and 2/8. Ask to see the FLUXITE SMALL-SPACE SOLDERING SET—compact but substantial—complete with full instructions, 7/6.

Write for Free Book on the ART OF "SOFT" SOLDERING and ask for Leaflet on CASE-HARDENING STEEL and TEMPERING TOOLS with FLUXITE.

TO CYCLISTS! Your wheels will NOT keep round and true unless the spokes are tied with fine wire at the crossings AND SOLDERED. This makes a much stronger wheel. It's simple—with FLUXITE—but IMPORTANT.

THE FLUXITE GUN

is always ready to put Fluxite on the soldering job instantly. A little pressure places the right quantity on the right spot and one charging lasts for ages. Price 1/6.



ALL MECHANICS WILL HAVE FLUXITE IT SIMPLIFIES ALL SOLDERING FLUXITE Ltd., Dept. P.M., Dragon Works, Bermondsey St., S.E.1

Baker's SOLDERING FLUXES

Sold in 6d. and 1/- tins at all Cycle Accessory Dealers, Tool Shops, Ironmongers, etc. Write for your free copy "Joining of Metals" to

SIR Wm BURNETT & CO. LTD (CHEMICALS) GREAT WEST ROAD, ISLEWORTH MIDDLESEX TELEPHONE: HOUSLOW 0476

There are 101 uses for HAR BUTT'S Plasticine in the work-shop Plasticine, in 16 colours, 1s. per lb. Write for illustrated price lists to: Harbutt's Plasticine Ltd., 241 Bathampton, Bath.

ANGLE PLATES
(Fully Machined)

3" x 1 1/2" x 1 1/2"	2/-
3" x 2" x 1 1/2"	2/3
3" x 2" x 2"	2/6
3 1/2" x 2" x 2"	3/-
3 1/2" x 2 1/2" x 2"	4/-
4" x 2 1/2" x 2 1/2"	4/6
4" x 3" x 2 1/2"	4/9

Back Plates in Castings or Fitted at Extra Cost.

LATHE CARRIERS
1 1/2" 2" 1" 1 1/2" 2 1/2" 2 1/2"

FACE PLATE CLAMPS
2" 2 1/2" 3" 3 1/2" 4 1/2" length.
3d. 3 1/2d. 4d. 5d. 6d. each.
POST EXTRA.



E. GRAY & SON LTD.
18-20 Clerkenwell Road, London, E.C.1

NEW INVENTIONS

The following information is specially supplied to "Practical Mechanics," by Messrs. Hughes & Young, Patent Agents, of 9, Warwick Court, High Holborn, London, W.C.1, who will be pleased to send readers mentioning this paper, a copy of their handbook, "How to Patent an Invention," free of charge.

IN a column, for which I propose to write notes upon striking new inventions, it is appropriate that I should begin with a novel device relating to loose-leaf note-books. This comprises a back provided with a magnet, and the edge of each leaf is adapted to be retained by magnetic attraction. The inventor contends that this device is eminently convenient, as each leaf can be inserted or removed without disturbing its neighbours, and he claims that it is an improvement upon the ring system, in which the holding of the leaves depends upon two or three weak holes. The principle of this invention is applicable also to card folios and files.

Light on the Subject

SPEAKING of note-books, it is fitting to add that a tiny electric light bulb is now affixed to a loose-leaf note-book. This will facilitate the writing and reading of notes in the dark. A policeman on the highway at night, will find this device helpful.

Safety Thirst

THE turning over of a cup by a youngster is a frequent accident even in the best-regulated nurseries, which upsets both the drinking vessel and the nurse. To obviate this inconvenience, there has been devised an infant's safety cup, which renders the contents practically unspillable. The device consists of a resilient cap fitted over the top of the vessel, having at the edge an opening, at which point the child drinks. But should he knock over the cup, a flap prevents the liquid from escaping.

Flat Iron with Legs

THE industrious housewife will hail with delight an appliance which will reduce the annoyance of washing day. The object of this invention is to guard against the sad experience of placing a too hot iron upon material and burning it. There has recently been devised a flat iron furnished with legs, upon which it can stand when not being employed for ironing. The legs are brought into use by a slight pressure of the finger or thumb.

Overhead Garage Door

FROM the fertile brain of an American has emanated the idea of a garage door which opens outwardly and upwardly until it attains a horizontal position. Whether it formed part of the original design of the inventor, I cannot say, but such an arrangement will at least afford an extension of the roof.

Advertising on Rails

A RECENTLY accepted British patent application is for means to utilise the hand rails of escalators as a medium for advertisements, or for imparting information to passengers. For this purpose, the deviser proposes the use of a rubber, cellulose or other water-proof solution coated on its face with a clear varnish or lacquer, as a protection against dirt and defacement. This can be removed from the hand rail by a suitable solvent. If desired, the rail may be constructed hollow and a means of illumination placed within it.

BURNERD CHUCKS
(BRITISH MADE)

Small independent 4-jaw with steel bodies and reversible jaws, minimum weight and overhang, ideal for model, instrument and precision work, 3 1/2-in., 20s.; 4-in., 21s.; 4 1/2-in., 25s.

6-in. Independent Model with semi-steel body, suits Drummond 3 1/2-in. and 4-in., and larger lathes, 50s.

3-in. 3-jaw Lever Scroll Model with 2 sets jaws, 27s. 6d. Small overhang, light weight. Descriptive lists, with backplate prices, on request. All postages extra.

Obtainable from all tool dealers OR FROM

F. BURNERD & CO.
DRYBURGH ROAD, LONDON, S.W.15

FUN WITH YOUR RADIO

BROADCAST your own Jokes, Songs and Plays, or learn to Croon with the "HOME MIKE."

Just clip the "HOME MIKE" to your Set. Works on all Receivers.

No Alterations. Complete with Transformer. Great Entertainment Novelty—the Rage of the Season. Order at once to avoid disappointment. No Set complete without one.

Only **5/-**

Complete with instructions. Send P.O. or sent C.O.D. on receipt of p.c. or 'phone ROP 1800.



SCIENTIFIC SUPPLY STORES (Wireless) LTD.,
126 Newington Causeway, Elephant and Castle, Dept. ("M"), London, S.E.1.

GENUINE AND ONLY SUPER CHROMATIC MOUTH ORGAN

CASH PRICE 10/6 POST FREE SPECIAL TUTOR 1/- EXTRA
SMALLER MODEL 6/6 POST FREE

LARRY ADLER
The world's greatest Harmonica Player.

This superb HOHNER INSTRUMENT can be played in ANY Key (all 12 Keys) including all Sharps and Flats, exactly as your own Piano.

The world's BEST PIANO ACCORDIANS SUPPLIED. CASH OR EASY TERMS. SEND FOR ILLUSTRATED CATALOGUE TO:—
MODERN MUSIC STUDIO
High Holborn House (P.M.), 52 High Holborn, London, W.C.1



DON'T BE BULLIED

Learn to fear no man. The BEST self-defence ever invented, namely, **JUDO**. Easy to learn. Send 2 penny stamps for SPLENDID ILLUSTRATED LESSONS, Photo ARTICLE, Testimonials and particulars, or P.O. 1/- for FIRST PART of my course. You will be more than delighted.

Dept. P., Blenheim House, Bedford Lane, Fetham, Middlesex.



KEEP YOUR CHIN UP

DEVELOP AN UPRIGHT, GRACEFUL FIGURE. Breathe Better! Feel Better! LOOK BETTER! HARRISON'S ADJUSTABLE SHOULDER-BRACE

Keeps Your Chest Expanded, Head Up and Shoulders Squared, For Either Sex. State Size Chest.

2/6 From T. R. HARRISON, 6 Highfield Terrace, Art Silk SALTAIRE, YORKS. at 3/6. Money-Back Guarantee.



HAVE YOU A RED NOSE?

Send a stamp to pay postage, and you will learn how to rid yourself of such a terrible affliction free of charge.

Address in confidence—
P. TEMPLE, Specialist
"Palace House," 128 Shaftesbury Avenue, W.1 (Est. 30 years.)

The 'ADEPT' LATHE

11 in. centres, 6 in. between centres. With compound slide-rest, £14, or with hand-rest only, 12/6. Screw Tail Stock 5/- extra. Post 1/-.

THE SUPER ADEPT, 30/-.

F. W. PORTASS, 83a Sellers Street, SHEFFIELD.



MAN, READ THIS.

You, too, can be a manly man—I guarantee to give you 10-25 lbs. more muscle, 2-8 lbs. across your chest, 1-3 ins. on each arm, a splendid virile body, doubled strength, robust health, 12-28 lbs. increased weight—in 30 days or your money back.

World's record results from my 4-in-1 Course, the one complete all-around MAN-MAKING course which builds strength of Body, Brain, Nerve and Will. J. G. gains 40 1/2 lbs. all-round muscle, 6 1/2 ins. on chest, 12 lbs. weight, W. H. increases 30 lbs., 19 lbs. weight, J. B. gains 31 lbs., health, strength, vitality.

Testimony seen by Editors—thousands more. No apparatus. Recommended by "Health and Efficiency." For men aged 16-60. Complete 4-in-1 System costs not guineas, but only 5/- New intensive Course "How to Overcome Weakness and Build Virility" FREE if you enrol at once.

LIONEL STEBBING, STEBBING INSTITUTE,
Dept. O.P., 28 Dean Road, London, N.W.2.



"MOTODYNE" YOUR SPEED BOAT

Fit a "WILCO" Motodyne and adapt your clockwork boat to work by **ELECTRICITY.** This fine motor will work from a 4-volt flashlight battery and is carefully designed to give plenty of power. The square lugs save room and enable the propeller to work at the correct angle. Can also be used as a motor for model driving, or as a Dynamo, 7/9. Larger Model 11/6.

Post 6d. **7/9**

FREE LIGHT. The "Wilco" Transformer Lamp. Plugs into lamp socket. Input 200-250. Output 4 volts at 1/4 Amp. Complete with lamp and adaptor for using flex lead. Just the lamp for dark corners in workshops, sheds, etc. Current consumption negligible. Post 6d. Price **5/6**

New 40 page Catalogue "P.M." 3d. Post Free.

L. WILKINSON, 8 City Rd., London, E.C.



PRACTICAL MECHANICS

*Replies to
Queries and Enquiries*



If a postal reply is desired, a stamped addressed envelope must be enclosed. Every query and drawing which is sent must bear the name and address of the sender and cover. Send your queries to the Editor, PRACTICAL MECHANICS, Geo. Newnes Ltd., 8-11 Southampton Street, Strand, London, W.C.2.

SILVERING A MIRROR

"I WISH to silver two pieces of glass each 18 sq. in., one piece in black silver and the other in copper silver. Could you tell me what chemicals to use, and the best method of performing the task?" (W. R., Liverpool.)

THERE are several methods of silvering glass, and each method has its own advantages. The formalin method of silvering is about the best for most purposes. To work this method, take 20 or 25 grains of silver nitrate and dissolve it in about an ounce of distilled water. This represents the stock solution. It should be kept in the dark.

To make the silvering bath, take approximately 2 drachms of the above stock solution, and add liquid ammonia solution to it drop by drop until the white precipitate which first forms just dissolves. At this stage, add to the solution 2 oz. of distilled water.

In a separate vessel place 70 to 80 drops of commercial formalin solution (approximately 40 per cent. strength). Then pour into this vessel the silver solution to which the ammonia has been added, and finally pour the mixed solutions into a clean glass or porcelain vessel in order to ensure thorough mixing. The solution is now immediately poured over the glass to be silvered. A silver mirror is deposited almost immediately, after which the solution should be poured away, the mirror well rinsed in clean cold water, allowed to dry slowly and then varnished on the back.

Success in silvering is dependent upon the correct mixing of the solutions, and also upon the cleanliness of the glass surface. The glass to be silvered should, first of all, be washed with soap and water. It should then be rubbed down with a paste made of whiting and water, and finally it should be washed over with weak nitric acid, this treatment being followed by a thorough washing with distilled water in order to ensure the perfect cleanliness of the glass surface. The vessels used for the preparation of the silvering solution must also be perfectly clean. It would be advisable, moreover, for you to make a few preliminary trials at the silvering of small pieces of glass before you attempt the silvering of 18-sq. in. glasses.

By your terms "black" and "copper" silver, we believe that you imply the character of the backing which is usually placed on commercially silvered mirrors. These are usually electrolytically deposited layers of silver or copper, which are placed over the mirror layer of silver in order to protect the latter. They can be formed by placing the mirror in a silver or copper plating bath.

EXPERIMENTING WITH CARBON DIOXIDE

"AN interesting article in 'Practical Mechanics' has prompted me to perform an experiment for which I need the following data:

- "1. At what temperature does solid carbon dioxide evaporate at atmospheric pressure?
- "2. What would have to be the pressure upon it so that it would remain solid at 15° C.?
- "3. What is the density of solid carbon dioxide?" (R. T., Sussex.)

SOLID carbon dioxide evaporates at all temperatures above -78° C. under atmospheric pressure, its evaporation being slow. If, by this particular query, you wish to know the lowest temperature which can be produced by the evaporation of solid carbon dioxide, this is -110° C., this temperature being produced by the evaporation of a solution of solid carbon dioxide in ether under atmospheric pressure. Evaporated alone, solid carbon dioxide will lower the temperature of its surroundings to about -60 to -70° C.

At 15° C. carbon dioxide would not remain solid. Under pressure it would be converted into liquid carbon dioxide, which would require, at this temperature, a pressure of approximately 52 atmospheres to retain it in that state.

The density of solid carbon dioxide varies according to the physical condition in which it is prepared and, with the pure material, it has not been accurately determined. Write to Imperial Chemical Industries, Millbank, London, S.W.1, who will give you any density-determination figures which may have been made upon their solid carbon-dioxide product "Drikold."

OIL FROM PEPPERMINT LEAVES

"COULD you please tell me how to extract the essential oil out of peppermint leaves, etc.?" (H. L., nr. Huddersfield.)

TO obtain peppermint oil, collect the fresh leaves of the plant just before the flowers begin to open. Allow the leaves to dry in the air for three or four days, turning them over frequently. They are then placed in a still and heated up with water. Water and peppermint oil distil over, the latter being separated from the water and then redistilled. About 10 lb. of the pure oil are normally obtained from one ton of the leaves and flower tops.

Advisory Leaflet No. 98 of the Ministry of Agriculture and Fisheries deals with the subject of Peppermint, Its Cultivation and Distillation. It can be obtained, price 1½d. post paid, from H.M. Stationery Office, Adastral House, Kingsway, London, W.C.2.

21/- VALUE for 5'.
The 'UNIQUE' Slide Rule



ACCURACY GUARANTEED OTHER MODELS
Ten-inch Slide Rule in Polished Mahogany (British made), celluloid faced with log-log scale in addition to Scales A. B. C. and D. Flexible back. Aluminium framed, view free unbreakable cursor. Size of rule 11½ ins. x 1½ ins. Serviceable as 21/- model. Supplied with case and full instructions, including conversion Tables for Money Calculations. Price 5/- each (post 3d., 3 post free). 5-in. model 3/6 (postage 2d.). 10-in. Universal rule with additional Trig and Reciprocal Scales 6/6 (postage 3d. extra). **FREE GIFT** of a set of 12-in. Draughtsmen's Scales with each 10-in. rule. The TECHNICAL SUPPLY CO. (P.M.) Norfolk Hse., Garden Ave., Withdean, Brighton.



**SPECIALISTS IN
TECHNICAL
ILLUSTRATIONS**



Write or 'phone us at
**HIGH HOLBORN HOUSE,
HIGH HOLBORN, W.C.1.**
Hol. 8638.

"UNO" TRADE MARK
PEN STENCILS



for
Lettering

**POSTERS - SHOWCARDS - PRICE TICKETS
ENGINEERS' & ARCHITECTS' PLANS, ETC.**

OBTAINABLE FROM THE PATENTERS AND MANUFACTURERS—
A. WEST & PARTNERS, 36 BROADWAY, LONDON, S.W.1
AND ALL DRAWING OFFICE MATERIAL DEALERS.

DEFERRED TERMS ARRANGED



"IDEAL-LATHES"

3½ in. S.C.B.G. from £7/18/6. LISTS, Stamp please.
J. WILLIMOTT & SON, Neville's Factory, Chilwell, Notts.

Turn to Cover III for interesting information about advertisers' latest catalogues.

Engineers' Guide

Bright Prospects and
Big Pay Opportunities
for the trained man

Write to-day for this great Guide which contains world's widest choice of home-study engineering courses, and shows how to obtain a recognised Qualification such as A.M.I.Mech.E., A.M.I.E.E., A.F.R.Ae.S., etc. Mention branch, post or qualification that interests you, to THE TECHNOLOGICAL INSTITUTE OF GREAT BRITAIN, 123 Temple Bar House, London, E.C.4. (Founded 1917. 18,000 Successes.)



To Success

"DUPLEX TAILSTOCK" 3 1/4-in. B.G.S.C. LATHE

POINTS OF SUPERIORITY:

Weight (bench model) 85 lbs. Concentric adjusted bronze bearings. Ground mandrel and tailstock barrel. Multi-purpose tailstock. Compare with any other make, and judge for yourself. List stamp please.

WARD & POLLARD,
Engineers, Orchard Works,
Plumstead High St., London, S.E.18

JUBILEE WORM DRIVE HOSE CLIPS



THE FAMOUS H.J.B. VOICE

The long-life clip with
the ever-tight grip

The Best Known

For Radiator Joints,
Air, Oil, and Water
Hose Joints.

Large sizes stop squeaking
brakes.

Stocked by all Garages
and Accessory Dealers

L. ROBINSON & CO.,
25 London Chambers,
GILLINGHAM, KENT.

MICROPHONE

Never in the
history of Radio has
such value been offered
to the Public.

**H. J.
BENNETT**



Incorporating
Heayberd Transformer.
Voice and Song clearly
reproduced from any
receiver.

10/6 Post Free.
Trade Enquiries
Invited.
287 PENTONVILLE
ROAD, KING'S X.

*Phone: Terminus 4876.

REPLIES in BRIEF

E. A. M. (Oxhey).—It is not clear whether you require a 5 amp or a .5 amp resistance. For the former you will require 3 lb. of 20-gauge Eureka wire, and for the latter 1/2 oz. of 36-gauge Eureka wire. The former is suitable for operation on 180 volts at 5 amps, resistance being 36 ohms. In the latter case it would be 360.

R. B. (Littleborough).—It would be difficult to state exactly, without examining the apparatus, what caused the burner to fracture. It is most probable that the new voltage is too high, and hence the tube may be heating up faster than normal, or you may have been overloading the tube and heating the sealed-in wires. The trouble at the moment is caused by the crack, since there must be a vacuum in the tube, and it seems that this has failed. You will get a spark on starting, but this will flash out as the distance is too great. Your only plan is to return the bulb to the maker and see if it can be repaired.

A. J. C. (Co. Dublin).—The telephone would be quite suitable in the circumstances you name. Insulated wire must be used.

(P. S. Cornwall).—American whitewood may be used in place of Balsa.

No Name (Oldham).—When a rocket such as you suggest gets into space, internal pressure would tend to increase the volume. Your query is not clear.

W. J. B. (Manchester).—We hope to publish the article you require in an early issue.

R. J. B. (Hertford).—The circuit details are patented and you would therefore not be able to use it. Further information is probably obtainable from The Electronic Musical Development Co., 52 Bunhill Row, London, E.C.1.

T. M. (Waterford).—It is against our rules to publish addresses. If you will let us have a stamped addressed envelope, we shall be glad to send you the address of the manufacturers.

H. R. (Manchester).—We have several times described how to make shocking coils from electrical bells. The idea is as old as the proverbial hills. Devices such as you require, made from electrical bells, are described in *Simple Electrical Apparatus*, obtainable at 1s. from any bookstall, or by post 1s. 2d. from Geo. Newnes, Ltd., 8-11 Southampton Street, Strand, W.C. Many thanks for your suggestion.

S. D. (Navan).—You omitted to enclose a coupon or stamped addressed envelope. We recommend you to study the small handbook on the subject published by Messrs. Percival Marshall & Co., Ltd., 13 Fisher Street, London, W.C.1.

C. D. (Penge).—So called silver paper is usually aluminium, but it could be an alloy of tin, also pure tin and lead. Methods of making toy bombs were described in a past issue, a copy of which can be sent to you for 7d. We do not recommend making them in glass bulbs. The only papers which deal with the advertisements you require are the daily papers. Your coupon was out of date; you should be able to obtain the February number.

No Name (Scunthorpe).—You did not append your name, nor enclose a stamped addressed envelope. We do not publish addresses. Let us have your name and we shall be glad to trace the information you require.

FREE SERVICE FOR READERS

Readers requiring information concerning goods or services advertised in **PRACTICAL MECHANICS** should give names of Advertisers from whom particulars are desired. Any number of names may be included and we will obtain for you catalogues, lists, and any other information you may be wanting. **THERE IS NO CHARGE FOR THIS SERVICE.**

Readers desiring particulars from a number of Advertisers will, by this method, save time and postage. Half-penny stamp only is required if your envelope is left unsealed. If any Advertiser stipulates that stamps or postal orders are necessary before samples or catalogues are sent, please enclose the necessary amount with your instructions. You are cordially invited to make full use of this Service.

Post this to

ADVERT. SERVICE DEPT.,

PRACTICAL MECHANICS,
8-11 SOUTHAMPTON STREET,
STRAND, W.C.2

Please obtain and send to me particulars from the Advertisers in your March issue whose names I give on list attached.

Advertiser	Page No.	Information Required
------------	----------	----------------------

Attach sheet of paper, with particulars, and your name and address (written in **BLOCK** letters), with date, to this announcement.

BUY, EXCHANGE OR SELL

Advertisements are accepted for these columns at 2d. per word (minimum 12 words at 2s.—advertisements of less than 12 words are charged at the minimum rate of 2s.), subject to a discount of 2½% for 6 consecutive monthly insertions or 5% for 12 consecutive monthly insertions. **TERMS:**—Cash with order. Cheques, Postal Orders, etc., should be made payable to George Newnes Ltd. *The Proprietors reserve the right to refuse or withdraw advertisements at their discretion.* All advertisements must be received on or before the 5th of the month preceding date of publication and should be addressed to the Advertisement Manager, "Practical Mechanics," George Newnes Ltd., 8-11 Southampton Street, Strand, W.C.2.

CHEMICALS

A GARDEN IN A GLASS. Lagoon Chemical Garden Outfits, price 10½d. post free from Finch, 8 Brisbane St., Clayton-le-Moors, Accrington.

CINEMATOGRAPHY

FILMS, 35 mm. of every description, from 5s.—Baers, 178 Wardour Street, W.1.

ARTISTIC CINE FILMS. Exclusive 9.5 mm. and 16 mm. productions. List Free. Projectors, Cine Cameras.—P. M. Dane, 64 Stanley Street, Liverpool, 1.

WANTED FOR CASH home cine projectors, cameras, films, accessories, microscopes, telescopes, binoculars, optical and mechanical goods, precision tools, small lathes, enlargers. High-class modern cameras.—Frank, 67 Saltmarket, Glasgow.

CINEMATOGRAPH FILMS.—Standard size from 6d. 100 feet. Machines, Accessories. Sample Films, 1/- and 2/6 post free. Catalogues free.—"Filmaries," 57 Lancaster Road, Leytonstone, E.11.

MOVIES AT HOME. How to make your own Cinema Projector. Particulars free. Moviescope (N), Pear Tree Green, Dodinghurst, Essex.

CLOCK MOVEMENTS

CLOCK MOVEMENTS of every description ready for cases. Lists and hints on case making post free.—Needham, 25 Stratton Road, Manchester, 16.

ELECTRICAL

ELECTRIC MOTORS, DRILLS, GRINDERS, BATTERIES, all voltages, from 18/-. Lists free. Repair specialists.—EASCO, Electrical Service, 18 Brixton Road, S.W.9.

ELECTRIC MOTORS, second-hand, guaranteed, all sizes, low prices.—Geeco Ltd., 47 Pitt Street, Glasgow, C.2.

A.C. CHARGERS.—2 v. ½ amp, 9/-, 4 v., 10/6, 6 v., 12/6, 2 v. Trickle, 6/6, 4 v., 7/6, 6 v., 9/-. Post free. Limited number. A.C. and D.C. Chargers and Eliminators repaired. Send repairs for free quotation. A. T. Jenkins, 5 Sebastian Street, London, E.C.1.

SURPLUS ELECTRICAL and Engineering Materials, low prices.—The London Electric Firm, Croydon.

ELECTRIC MOTORS, A.C. and D.C., Pumps, Grinders, Drills, Air Compressors, Bandsaws, Lathes, Flex, Shafts, Paint Spray Equipment; list free. John P. Steel, Bingley.

ELECTRIC LIGHTING, 5/- a point; progressive wiring diagrams and instructions, 6d., materials, wholesale prices; lists free.—P. Symax & Co., 263 Lichfield Road, Birmingham, 6.

BARGAINS. Unrepeatable bankrupt stock of electrical apparatus. Vacuum cleaners, motors, commutator or induction, for driving 3" to 4" lathes, "Velocity" electric drills fitted with ¼" or ⅜" chucks, electric grinders, fires, ammeters, dynamos, etc. Stamp list. All well below half-price and guaranteed. Maxwell Electrical, c/o Grout Service Garage, Ronalds Road, N.7.

ENGINEERING

HIGH-CLASS LIGHT MECHANICAL WORK, Repairs, etc. Estimates free.—Lewis Gatenby, Engineer, 17 Thornton Lodge Road, Huddersfield.

AN ENGINEERS' LIBRARY for 8/6 post free. Fowler's Pocket Books 1936: Mechanics' and Machinists' 2/3, Mechanical Engineers' 3/3, Electrical Engineers' 3/3. Now ready.—Scientific Publishing Co., 53 New Bailey Street, Salford.

LIGHT ENGINEERING, EXPERIMENTAL, MODEL and Repair Work. Accuracy guaranteed. Estimates given.—Woodfall, Willowbrook Grove, Trafalgar Road, London, S.E.15.

ENGINES

ENGINES. BUILD Butler's ½-h.p. practical Model Petrol Engine. SET of Castings, 9/9. **INTERESTING** Catalogues 3d. **TAPS. YOUR** own stocks, dies, taps, ½ in. ⅝ in., ¾ in. and 3 taps, 12/-.—**WRITE** Profit-Sharing Works, Littleover, Derby.

LITERATURE

CALVERTS MECHANICS YEAR BOOK 1936. Over 190 Pages. Illustrated Workshop Hints and Calculations. 8d. post free.—Endsor & Co., 5 Bridge Street, Manchester.

MAGIC

PERPLEXITIES AND TANTALISERS.—"The Strand Problems Book" is the finest collection of puzzles of all kinds ever assembled, mathematical, geographical, literary—acrostics and codes, by W. T. Williams (Tantalus) and G. H. Savage. Only 2s. 6d. net, from all Booksellers.—George Newnes, Ltd., 8-11 Southampton Street, Strand, London, W.C.2.

METAL WORK

MAKE METAL TOYS. Easy, profitable with "Success" moulds. Lists free. Complete trial mould, 1/6.—LEE'S, Bentinck Road, Nottingham.

MISCELLANEOUS

TO STOP SMOKING, speedily, permanently, cheaply, as grateful thousands testify.—Carlton Chemical, Ltd., 203, Birmingham.

FREE FOUNTAIN PENS and large mail. 6d. P.O. for packing, etc.—Basil Dengate, 2 Pound Road, East Peckham, Kent.

STOP SMOKING.—Send 2/6 for complete treatment; immediate results guaranteed.—"Peacock," 752b Bury Road, Bolton.

BUILD YOUR OWN CARAVAN this Spring. Constructional blue-prints and easily assembled kits of parts for roomy lightweight caravan (four berth). Full particulars from Holland Coachcraft Ltd., 95 Bath Street, Glasgow, C.2.

HALLAM AERO. 13.5 cc., propeller, tank. Unused. Cost £4—£1 offers? 54 Broxbourne Road, Orpington, Kent.

MODELS

INVENTORS' MODELS, Experimental Work, Drawings, Patterns.—Bland, 105a Crawford Street, London, W.1.

STEEL TUBING, Seamless, ⅜ in. to 4½ in., ⅜ to ¾ in. thick. Please say lengths you cut to.—Cotes, Church Walk, Brentford, Middx.

BIRMINGHAM MODEL RAILWAY SUPPLIES. Agents for Leeds Model Co. Full range "00" rolling stock. Demonstrations, 18a Dale End.

"00" GAUGE BRASS TRACK, Points, Correct Section Rail, any radius, free samples, rail or sleepers separately. Send your enquiries to: T. & M. Products, 1 West Street, Leigh-on-Sea, Essex.

AN INVALUABLE Handbook. ACCUMULATORS. Up to date, practical, dealing with every type of accumulator, methods of charging them at home, care and maintenance. This little book also explains how to erect a charging station. This is one of Newnes' Home Mechanic Books. Ask your Newsgate to show you other titles in this helpful series. Obtainable at all Booksellers, 1s. each.—George Newnes, Ltd., 8-11 Southampton Street, Strand, London, W.C.2.

ARE YOU HANDY With Your Hands?—If you like making and mending things you ought to know about the "Home Mechanic" Series of 1s. Handbooks. They cover a wide field, from model and toy-making to motor-car upkeep and radio construction. Each is complete in itself and fully illustrated. Price 1s. each from all Booksellers and Newsgates (from whom a list of subjects can also be obtained).—George Newnes, Ltd., 8-11 Southampton Street, Strand, London, W.C.2.

"WORKING MODELS and How to Make Them." Edited by F. J. Camm, 3s. 6d.—This book will appeal to all who are handy with tools. Contains complete instructions for the making of every kind of working model. Each model has been actually constructed in accordance with the details given and subjected to stringent tests. The instructions and diagrams are so clear that even the most elaborate model can be built without fear of failure. Obtainable at all Booksellers and Newsgates.—George Newnes, Ltd., 8-11 Southampton Street, Strand, London, W.C.2.

MOTORING

THE PRACTICAL MOTORIST'S ENCYCLOPEDIA, by F. J. Camm. 3s. 6d. net. A lucid exposition of the principles, upkeep and repair of every part of the car. 442 illustrations. From book-sellers everywhere.—George Newnes, Ltd., 8-11 Southampton Street, Strand, London, W.C.2.

MUSICAL INSTRUMENTS

BAND GUIDE. Hints on the Bugle, Drum, Flute. Staff Parade formations, etc., Free, post paid.—Potter's (Manufacturers), West Street, London, W.C.2.

PATENTS

REGINALD W. BARKER & CO. (Established 1886), 56 Ludgate Hill, London, E.C.4. Patent and Trade Mark Booklets Gratis.

BUY, EXCHANGE OR SELL

PHOTOGRAPHY

£500 worth good, cheap Photo Material, Films, Plates, Cards, Papers, Chemicals. Catalogue and 4 Samples Free.—Hackett's Works, July Road, Liverpool 6.

POSTCARDS FROM ANY PHOTO. Time to finish, four days. 25 1/9; 50 3/-; 100 5/-; 500 17/-; 1,000 30/- . Enlargements 1/- . Samples and List Free.—Hackett's Works, July Road, Liverpool 6.

DON'T TAKE RISKS. Good developers mean good results. Our reliable stock developers keep two months after mixing. Satisfaction certain to amateurs and professionals. Best developer ever put on the market. Makes two pints strong developer. 6d. each. 6 for 2/3, 12 for 4/-. Post free.—Hackett's Works, July Road, Liverpool 6.

BRIGHTON. Over £4,000 value stocks. Bargains in plates, films, papers, mounts, etc. Lists free.—Kimber's (Largest mail-order photographic dealers in the world), 61 Grand Parade, Brighton.

"PANTOGRAPHS" make large accurate drawings from small photographs, printed drawings, etc., easily. 1s., post free.—Cooke, 33 Hawthorn Road, Levenshulme, Manchester.

PRINTING

PRINT YOUR OWN CARDS, STATIONERY, CIRCULARS, ETC. Save Money. Print for others. Make money. Presses 48/- . Complete Outfits 63/- up. Catalogue and Particulars free.—Kelsey Co. (Established 1872), Dept E.2, Meriden, Conn, U.S.A.

SITUATIONS VACANT

ENGINEERS—A REMARKABLE OFFER

Our new Engineering Guide explains clearly how all the best jobs are secured. It shows how to obtain such money-making qualifications as A.M.I.C.E., A.M.I.E.E., A.M.I.Mech.E., A.M.I.W.T., A.F.R.Ae.S., etc. How to secure permanent and progressive posts in the Government and Municipal Service; and describes numerous "Better-pay" courses in Civil, Electrical, Wireless, Auto and Aero, etc. Engineering. Write to-day for FREE copy of this Authoritative publication and details of our remarkable Guarantee of Success.—National Institute of Engineering (Dept. 5), Staple Inn Buildings, High Holborn, W.C.1.

STAMPS

FREE!! Twenty Unused Colonials, "Neurope," 1½d. Fifty for 9d.—G. H. Barnett, Limington, Somerset.

FOUR DIFFERENT QUEEN ASTRID MOURNING STAMPS 3d. Sanders, 90 Newlands Avenue, Southampton.

TELEVISION

TELEVISION.—Newnes Television and Short-wave Handbook, by F. J. Camm, deals authoritatively with Scanning Systems (Drums, Mirror Screws, Discs, etc.), Neon Lamps, The Cathode-Ray Oscillograph, How to Build Short-wave and Ultra-short-wave Receivers. Fully illustrated. 3s. 6d. net. From your Bookseller.—George Newnes, Ltd., 8-11 Southampton Street, Strand, London, W.C.2.

TOOLS

TOOLS UPON EASY PAYMENTS, Treadle Saw Benches £9 10 0. Power £3. Constructors' Saw Bench Fitments 12/6. Lathes 30/- . Compound Rests 15/- . Foot Treadles £2. Lists 2d. Brown Bros., Accrington.

3 Tons Best Sheffield Files, Flats, Half Rounds, Square, Rounds, in rough and second cut sizes 6", 8", 10", 12". This is a very special bargain offer, wonderful value, three dozen assorted, 10s.; also large files, 14", 16", 18", dozen assorted, 8s. 6d., carriage forward.—Below.

250 Bundles Bright Drawn Mild Steel, approx. 5' length each piece, sizes ½", 5/32", ¼", 7/32", ⅜", 9/32", ⅝", ⅞", 1" round, 5s. 6d. per bundle of 50'; also Square Bright Steel, sizes ½", ⅝", ⅞", 1", 1 ¼", 1 ½", 1 ¾", 2", 5' lengths, 6s.—Below.

5,000 Small Slitting Saws, ½" dia., 1/32" thick, clear at 2s. per doz.—Below.

2,000 Slitting Saws, 2 ½" diam., 1" hole, 1/64" to ¼" thick, six assorted, 3s. 6d.—Below.

1,300 Sets Hexagon Die-Nuts, Sheffield made, Whitworth, B.S.F., also American thread, U.S.S. and S.A.E. suitable for Ford and other American cars ½", ⅝", ⅞", 1", worth 7s. set, our clearing price, 2s. 9d. set; all the above four sets, 10s. lot.—Below.

120 Bundles Best Quality Silver Steel, round, ½" to 1", 16 standard sizes, 4s. per bundle.—Below.

250 Boxes Superfine Swiss Files, 1 doz. assorted shapes for high-class work, tool-making, etc., 4s. per box.—Below.

500 High Speed Tap Fluting Cutters, cuts taps ¼" to ½" dia. of cutters, 1 ½", ½" hole, 1s. 3d. each, three assorted, 3s. 3d., worth 6s. each; also larger Cutters, 2 ½" dia., ¾" hole, cut taps ½" to 1", 1s. 9d. each; three assorted, 4s. 6d.—Below.

250 Sets Feeler Gauges, 10 blades, long taper, 1 ½" to 25 thous., a very useful bargain, 1s. 9d. each.—Below.

300 Drill Chucks, takes to ½", three jaws. No. 1 Morse taper shank or ¼" straight shank, 2s. 9d. each.—Below.

140 Vee Blocks and Clamps, machined all over, very useful to model makers and machinists, 2s. 9d. each; 5s. pair.—Below.

24 Only, 1" Micrometers, lock-nut and ratchet stop, usual retail price 27s. 6d., all complete in plush lined case and guaranteed accurate, secure one now, 16s. 6d. each.—Below.

500 Gross Tungsten Steel Hackawood Blades, 8", 9", 10", 12", 1s. 3d. per doz.; 12s. per gross; also Machine Blades, 12" x 1", 2s. doz. 20s. gross; 14" x 1", 3s. doz.—Below.

1,000 Sets Hexagon Die-Nuts, C.E.I. Cycle Thread, ⅝", ⅞", 1", 1 ¼", 1 ½", 1 ¾", usual price 5s. 9d. set, clear at 2s. 3d. set.—Below.

1,200 Best Quality Straight Shank End Mills, standard sizes, ½", 1s. 3d.; ⅝", 1s. 4d.; ⅞", 1s. 6d.; 1", 1s. 9d.; 1 ¼", 2s. each. All right-hand, suitable for use in lathe.—Below.

800 Sets 1" Circular Dies. Screwing ¼", ⅝", ⅞", 1", 1 ¼" Whitworth and B.S.F. Clearing at 2s. 9d. per set. Both sets 5s. Die Stocks to suit 1s. 9d. each.—Below.

100 Boxes of Assorted Springs, approx. weight 3 lbs. From 300 to 600 springs. 3s. 6d. per box.—Below.

5,000 Tins Reliable Case-hardening Mixture, for use with ordinary fire, very effective, as used in several large Sheffield works, sample 1 lb. tins, 1s. 3d.; 2 lbs., 2s. 6d.; simple to use and guaranteed to give a glass hard surface to steel or iron, cash refunded if it fails to more than satisfy.—Below.

400 Lathe Tool Holders, ½" Square Shank, complete with super high speed tool. A very useful bargain, 1s. 9d. each.—Below.

TOOLS (continued)

350 Boring Tool Holders, ½" Square Shank, fitted with ¾" round boring bar, complete with high speed tool. These are a very good bargain. Actually worth 8s. 6d. each. Clearing at 3s. 9d. each.—Below.

60 Only, Genuine Norton Grinding Wheels, suitable for general shop use, 9" dia., 1" wide, 1" hole, 4s. 9d. each, also few 1 ½" wide 5s. 9d. each.—Below.

1,000 Fine Emery Wheels, 2" to 4" dia., ¾" hole, ½" to ¾" thick, slightly used, but quite serviceable, 1s. 6d. per doz.—Below.

5,000 Genuine Norton Grinding Wheels, 2 ½" dia., ¾" to 1" wide, ½" hole, three assorted 1s.; dozen assorted 3s.; six dozen 15s.; gross 25s.—Below.

10s. Orders Carriage Paid except where stated otherwise, steel bars and files carriage extra. J. Burke, 30 Trippet Lane, Sheffield.

GRAYSON'S combined Hand and Jumper Drill. Ideal for Electricians. 27/6 post free.—Below.

GLASS-BORING Outfits avoid risk.—Grayson & Company, 300 Campo Lane, Sheffield.

UNDER COST! 150 sets Highest Grade Lathe Tools.—Greenwood, Arncliffe Road, Southport.

MACKETT & CO. offer 5-in. S.C. Lathe and accessories, £9 15s., also 1-h.p. D.C. motor and fitments, £4 15s.—51 Millers Road, Brighton.

THE IDEAL JUNIOR 3-IN. LATHE. S C B G Comp Rest. Quick return to Saddle. Full divided Nut to apron. Illustrated List.—Willimott, Neville's Factory, Chilwell, Notts.

WIRELESS

SHORT WAVE on a crystal set. Full building instructions and crystal 1/2 post paid.—Radiomall, Tanworth-in-Arden, Warwickshire.

A DICTIONARY OF WIRELESS TERMS, by Ralph Stranger. A Wireless Work of Reference that should be on the bookshelf of every keen amateur. Compiled by a master of lucidity, it gives the meanings of all Technical terms in general use. Price 2s. 6d. from all Booksellers and Newsagents.—George Newnes, Ltd., 8-11 Southampton Street, Strand, London, W.C.2.

FOR THE RADIO ENTHUSIAST.—"The Wireless Constructor's Encyclopedia," by F. J. Camm (Editor of "Practical and Amateur Wireless"), third edition. Compiled by one of the most accomplished designers and writers on the practical side of Wireless, it covers the whole field. A veritable Treasury of Wireless Knowledge. Price 6s., from all Booksellers and Newsagents.—George Newnes, Ltd., 8-11 Southampton Street, Strand, London, W.C.2.

FIFTY TESTED WIRELESS CIRCUITS, by F. J. Camm, 2s. 6d.—This handbook contains every modern circuit, complete with instructions for assembling, component values, and notes on operation. Obtainable at all Booksellers and Newsagents.—George Newnes, Ltd., 8-11 Southampton Street, Strand, London, W.C.2.

"THE MATHEMATICS OF WIRELESS," by Ralph Stranger.—This book is essential to the amateur who wants to gain a further knowledge of the subject without loss of time—or temper! Fully illustrated, 256 pages. Price 6s., from all Booksellers and Newsagents.—George Newnes, Ltd., 8-11 Southampton Street, Strand, London, W.C.2.

WOODWORK

CABINET HARDWOODS, Oak, Mahogany, Ash, White-wood, Ply Woods, etc. Lowest Prices. Send Cutting lists. Planing free. Speciality prime Japan Oak, all thicknesses.—Wilfred Parr & Co., March Works, Lancaster Road, Leytonstone, E.11.

FREE

Beautiful
Coloured
Art Plate
of the
**VICKERS
"WELLESLEY"
MONOPLANE**

Special Contents of the MARCH issue—

WINGS OVER HAWAII. An Inter-Island Service.
COLONEL "BILLY" BISHOP, V.C.
His Career.

SABOTAGE IN THE BLUE?
Recent Air Mysteries in U.S.A.

MY MOST THRILLING FLIGHT.
By Captain Doyle.

BOMB-PROOF CITIES OF THE FUTURE.
Best Topical and Historical Air Pictures.

IN THE MARCH

POPULAR FLYING

The National Aviation Magazine

NOW ON SALE AT ALL NEWSAGENTS
AND BOOKSTALLS

6^{D.} MONTHLY

C. Arthur Pearson, Ltd.

EVERY READER WILL WANT IT

IN the annals of the British Throne, no sovereign has been held in greater affection than the late King. The love and esteem he commanded during his life will remain in the hearts of his people long after his death, and a memento of his glorious reign will be treasured in every home.

To-day a most beautiful memorial book, *The Life of King George V*, is published for our readers. It tells the story of his unstinted devotion to his subjects, of a reign that saw the world transformed.

Written in moving language, you will read of his boyhood, his youth as a sailor, the early death of the Duke of Clarence that made him heir-presumptive, his marriage to his cousin, then Princess May, and his accession to the throne.

Superbly illustrated on every page, the story unfolds through the years that brought Women's Suffrage, the World War, the Conquest of the Air, Talking Films and Radio, Speed, the Jubilee and the King's last illness.

"*The Life of King George V*" also includes most impressive photographs taken specially for this work at the funeral procession in London and Windsor.

You can obtain this magnificent all-photogravure record for only sixpence, at your newsagent's and bookstall. It is a complete pictorial panorama of a great and glorious reign.

A Rake-Brush for the Lawn

COMBINING the advantages of the brush and the rake, this handy garden

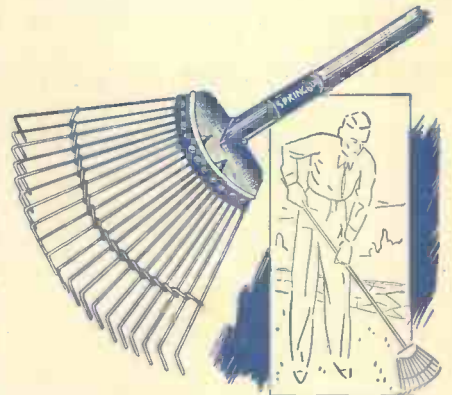

This device, known as a rake-brush, is suitable for weeding lawns and sweeping up dead leaves. It should prove an efficient tool for the gardener.

tool is a great ally in the better-lawns campaign. The flexible spring steel teeth cling closely to the ground, conform to the irregularities of the surface, and remove moss without disturbing the roots of the grass. For collecting up dead leaves and rubbish, this feather-weight tool will be found to be just the thing. Made in 40 in., 20 in., and 10 in. spans, they are supplied complete with handle for 15s., 5s. 6d., and 5s. respectively. They are sent carriage paid. [187.]

FREE ADVICE BUREAU
COUPON

This coupon is available until March 31st, 1936, and must be attached to all letters containing queries.
PRACTICAL MECHANICS, MARCH, 1936

The 7-STONE Weakling...

who became "The World's
Most Perfectly
Developed
Man"



**"I'll Prove to You in 7 days that
YOU, too, can be this NEW MAN!"**

—CHARLES ATLAS

WHEN I say I can make you into a man of giant-power and energy, I know what I'm talking about. I've seen my new system of body development, *Dynamic-Tension*, transform hundreds of weaker, punier men than you into Atlas Champions.

Take myself, for instance! I used to weigh only 7 stone. I was a sickly weakling. Then I discovered *Dynamic-Tension*. It gave me a body that twice won me the title "The World's Most Perfectly Developed Man." It'll work just as big a change in you, too! I'm so sure of it that I make you this amazing offer: At my own risk I'll give you **PROOF** in even the first 7 days that I can make you into this **NEW MAN**. I'll begin training you *on approval*. If you don't notice a marvellous change in yourself *within a week* you don't owe me a penny.

No "ifs," "ands" or "maybes." Just tell me where you want handsome steel-like muscles. Are you fat and flabby? Or skinny and gawky? Are you short-winded, peeps? Do you hold back and let others walk off with the prettiest girls, best jobs, etc.? Give me just 7 days! I'll **PROVE** to you that I can make you a healthy, confident, powerful **HE-MAN**.

Dynamic-Tension is an entirely **NATURAL** method. No mechanical gadgets to strain your heart and other vital organs. No pills, special foods or other unnatural, artificial contraptions. Only a few minutes of your spare time daily is enough to show amazing results—and it's actually fun! *Dynamic-Tension does the work.*

Send for **FREE BOOK**

Post the coupon right now for full details and I'll send you my illustrated book, "Everlasting Health and Strength." Tells all about my "*Dynamic-Tension*" method. Shows actual photographs of men I've made into Atlas Champions. Supplies the facts you need to know about *your* condition. It's a valuable book! And it's **FREE**. Send for your copy *to-day*. Post the coupon at once. **CHARLES ATLAS**, Dept. 10.C., Shell-Mex House, London, W.C.2.



AMAZING RESULTS IN ONE WEEK

"Here are the increases at the end of **ONE week**: Arm relaxed, $\frac{1}{2}$ in. more—forearm $\frac{1}{2}$ in.—chest, normal, 5 ins.—weight, 5 pounds gained—I feel healthier, stronger and more vital. I did not think that any course could do for me in a month what your course has done in only one week, and when I go out for a walk with my chest out and shoulders back my friends look at me with admiration. I owe it all to you." L.R.V., Nagpur, India.

CHARLES ATLAS, Dept. 10.C.,
Shell-Mex House, London, W.C.2

I want the proof that your system of "*Dynamic-Tension*" will make a New Man of me—give me a healthy, husky body and big muscular development. Send me your free book, "*Everlasting Health and Strength*." This request places me under no obligation.

Name.....
(Please print or write plainly)

Address.....

(Copyright © A 143.)