

M. Anderson

November 1991 • £1.50

PRACTICAL

ELECTRONICS

SCIENCE AND TECHNOLOGY

Screen play

Computer monitors for the 90s

Modem madness

Barry Fox on email

Radio rules

A new RSGB licence

CAD for real

Problems and pitfalls

How it works

Superhet radio

Data sheet

The NS32CG160

New tech roundup

Solar cells

Optical discs

In car navigation

In flight video

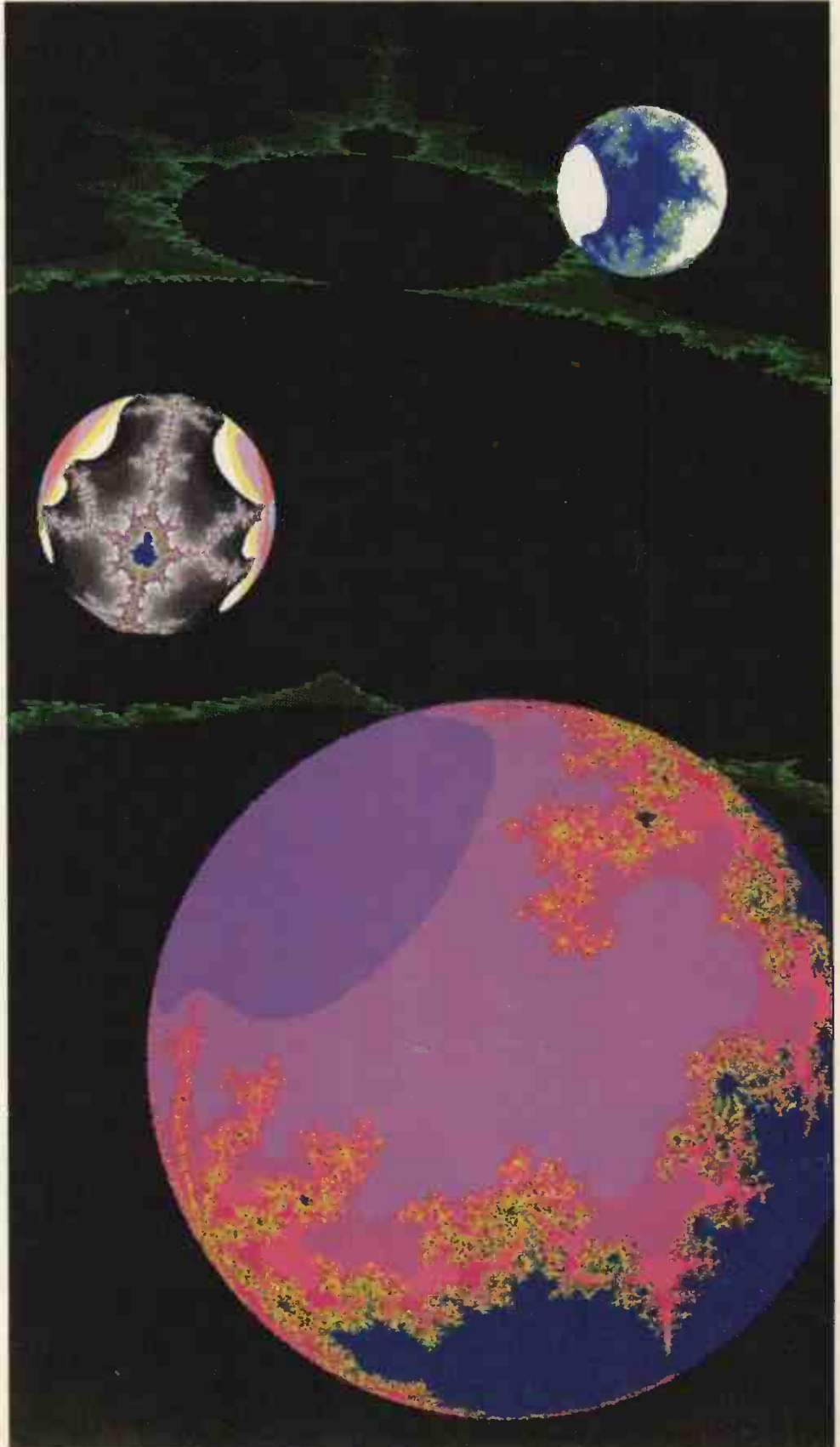

Take the Sensible Route!

BoardMaker is a powerful software tool which provides a convenient and fast method of designing printed circuit boards. Engineers worldwide have discovered that it provides an unparalleled price performance advantage over other PC-based and dedicated design systems by integrating sophisticated graphical editors and CAM outputs at an affordable price.

NEW VERSION

In the new version V2.40, full consideration has been given to allow designers to continue using their existing schematic capture package as a front end to BoardMaker. Even powerful facilities such as Top Down Modification, Component renumber and Back Annotation have been accommodated to provide overall design integrity between your schematic package and BoardMaker. Equally, powerful features are included to ensure that users who do not have schematic capture software can still take full advantage of BoardMaker's net capabilities.

BoardMaker V2.40 is a remarkable £295.00 (ex. carriage & VAT) and includes 3 months FREE software updates and full telephone technical support.

AUTOROUTER

BoardRouter is a new integrated gridless autoroute module which overcomes the limitations normally associated with autorouting. **YOU** specify the track width, via size and design rules for individual nets, BoardRouter then routes the board based on these settings in the same way you would route it yourself manually.

This ability allows you to autoroute mixed technology designs (SMD, analogue, digital, power switching etc) in **ONE PASS** while respecting **ALL** design rules.

GRIDLESS ROUTING

No worrying about whether tracks will fit between pins. If the track widths and clearances allow, BoardRouter will automatically place 1, 2 or even 3 tracks between pins.

FULLY-RE-ENTRANT

You can freely pre-route any tracks manually using BoardMaker prior to autorouting. Whilst autorouting you can pan and zoom to inspect the routes placed, interrupt it, manually modify the layout and resume autorouting.

BoardRouter is priced at £295.00, which includes 3 months FREE software updates and full telephone technical support. BoardMaker and BoardRouter can be bought together for only £495.00. (ex. carriage & VAT)



tsien

Tsien (UK) Limited
Cambridge Research Laboratories
181A Huntingdon Road
Cambridge CB3 0DJ UK
Tel 0223 277777
Fax 0223 277747

All trademarks acknowledged

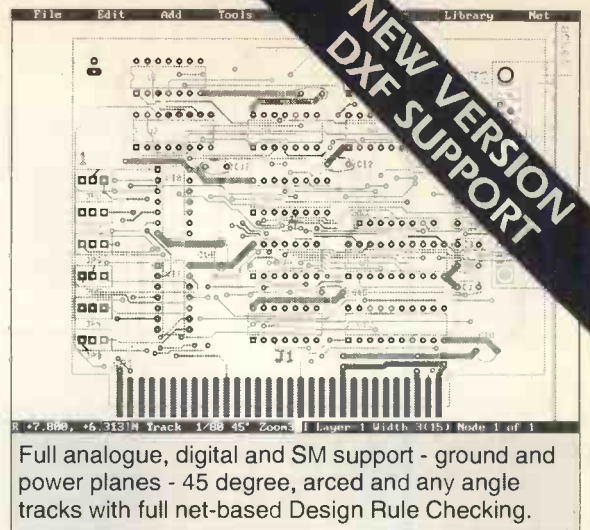

Full analogue, digital and SM support - ground and power planes - 45 degree, arced and any angle tracks with full net-based Design Rule Checking.

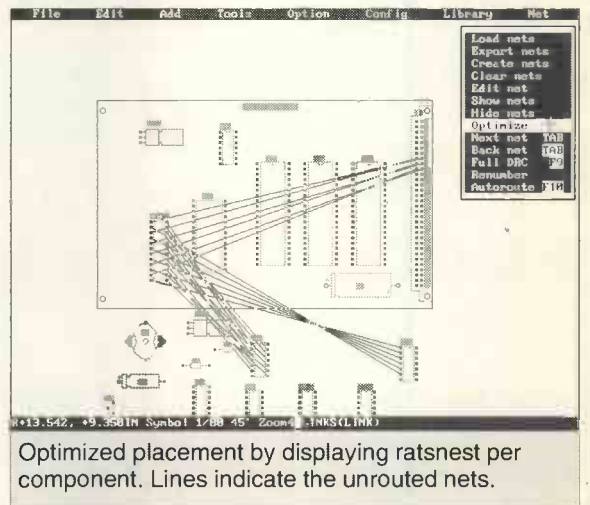

Optimized placement by displaying ratsnest per component. Lines indicate the unrouted nets.

HIGHLIGHTS

- Net list import from OrCAD, Schema etc.
- Graphical and manual netlist entry
- Top down modification for ECOs
- Forward and back annotation
- Component renumber
- Effortless manual routing
- Fully re-entrant gridless autorouting
- Simultaneously routes up to eight layers
- Powerful component placement tools
- Copper fill
- Curved tracks
- Extensive Design Rule Checking
- Full complement of CAM outputs
- Support and update service
- Reports generator
- Gerber, PostScript & DXF output
- Full SMD support

Don't just take our word for it. Call us today for a FREE Evaluation Pack and judge for yourself.



This month...

The bad thing about the British summer, apart from the weather of course, is that everyone goes on holiday. This means that even the best laid plans can go astray. In the next month box last month (if that makes any sense) I mentioned that we would be looking at the ION camera from Canon and the technology behind image scanners. Unfortunately, due to various people being on holiday, none of the items mentioned were available so we were unable to look at them – hopefully they will appear in the near future.

Having looked at a number of CAD systems over the past few months, PE seems to have gained something of a reputation for being a CAD Mag. As an alternative to a straight 'review' Andrew Armstrong describes some of the pitfalls that can be encountered when buying a CAD system. In practice, these can occur when buying almost any kind of software. As Andrew explains, the trick to avoiding them is to be aware they exist and not believe everything you're told without seeing it in action.

Our main feature this month concerns computer displays. As a demonstration of what is possible with the latest technology, the cover illustration was generated entirely on computer. It uses the well known Mandelbrot Set as the basis for the patterns with only the 'artistic' arrangement of the objects being left to the human touch.

Kenn Garroch, Editor

Next month...

Canon's S-50 Speakers

Adding a new dimension to sound

All I Want For Christmas

What are the best electronic gifts?

How It Works

Mains communications systems

Build It

Greenhouse monitor

Out on October 3

Features

- Technology Update 10
The latest in solar cells, optical discs and transistor technology
- The RSGB's New Licence 12
Radio expert Ian Poole describes how the radio waves are now available to everyone
- Computer Aided Design 16
Getting into CAD is not as straightforward as it may seem
- Computer Displays 25
Will LCDs replace CRTs? Paul Kennedy looks at the basic technology
- A Virtual Instrument 43
Jason Sumner plugs a card into his PC to turn it into a DMM

Build It

- PE Chronos 36
Putting together the display board
- Rain Gauge 45
Measure rainfall the professional way with Owen Bishop's pluviometer

Regulars

- Wavelengths 5
Help with old organ components and more on the MOSCODE amplifier
- Innovations 6
Westland's Merlin and the world's smallest desktop PC are in the news
- Silicon Valley 14
ADCs to beat all the records plus super powered i/o
- New Product Developments 20
In car navigation and the latest developments in airline entertainment
- How It Works 30
The Superheterodyne Radio
- Data Sheet 32
NS32CG160 32-bit processor featuring built in graphics commands
- Practical Components 34
Inductors
- Practical Technology 52
Barry Fox on the problems and pitfalls of international electronic mail
- Techniques 57
All you need to know about light detecting switches
- Barry Fox 62
3D-TV technologies abound, but are they any good?

Editor: Kenn Garroch Advertisement Manager: David Bonner Production Manager: Richard Milner Production Assistant: Dino Digioacchino Office Manager: Laura Esterman Publisher: Angelo Zgorelec
 • Practical Electronics Intra House 193 Uxbridge Road London W12 9RA Tel: 081-743 8888 Fax: 081-743 3062 Telecom Gold: 87: SQ0567 • Advertisements The Publishers of PE take reasonable precautions to ensure that advertisements published in the magazine are genuine, but cannot take any responsibility in respect of statements or claims made by advertisers. The Publishers also cannot accept any liability in respect of goods not being delivered or not working properly. © Intra Press 1991. Copyright in all drawings, photographs and articles published in PRACTICAL ELECTRONICS is fully protected, and reproduction or imitations in whole or in part are expressly forbidden. All reasonable precautions are taken by PRACTICAL ELECTRONICS to ensure that the advice and data given to readers is reliable. We cannot, however, guarantee it, and we cannot accept legal responsibility for it. Prices quoted are those current as we go to press. All material is accepted for publication on the express understanding that the contributor has the authority to permit us to do so. • Practical Electronics is typeset at Intra Press on Macintosh computers using Quark Xpress. Imagesetting by Pressgang. Reproduction by Circle Rule. Printing by Andover Press, St Ives plc. Distribution by Seymour Press • ISSN 0032-6372 •

REALISTIC®

PROGRAMMABLE

SCANNERS

A) Realistic PRO-37

Our Best! 200 channels. Hyper scan doubles the scanning speed. Covers: 68-88, 108-136.975 (AM), 137-174, 380-512, 806-960 MHz. Two speed scan and search. Two second scan delay, priority function, lockout key, keyboard lock. LCD display, switchable backlight. Earphone jack, belt clip, BNC aerial jack. Memory backup. Requires 6 "AA" batteries. 20-9138 £229.95

B) Realistic PRO-35.

100 channels. Covers: 68-88, 108-136.975 (AM), 137-174, 406-512 MHz. Two-second scan delay, lockout and search function. Priority channel, backlit LCD display. Memory backup. BNC aerial jack, belt clip, earphone jack. Complete with rechargeable ni-cad battery pack and AC adapter/charger. 20-9136 £179.95

C) Realistic PRO-41

10 channels. Covers: 68-88, 137-174, 406-512 MHz. LCD channel display, review key to display frequencies. Manual and scan modes. Three-second scan delay, keyboard lock switch. Memory backup. Requires 5 "AA" batteries.

20-9301 £99.95



Tandy®

ALL THE ACTION
AS IT HAPPENS!

InterTAN U.K. Ltd.,
Tandy Centre,
Leamore Lane, Walsall,
West Midlands. WS2 7PS
Tel: 0922-710000

Wavelengths

If you have any comments, suggestions, subjects you think should be aired, write to PE

On reading PE October issue page five, Wavelengths, Mr. F J Trowman requests help with an electronic organ problem. Might I suggest that he contacts the Electronic Organ Constructors Society, Trevor Hawkins, 23 Blenheim Road, St. Albans, Hertfordshire, AL1 4NS, Tel. 0727 57344. Send a self stamped addressed envelope if writing, the society publishes a very useful magazine a number of times a year.

D J Brown
Coventry
W Midlands

The society publishes its magazine four times a year and costs £1.50 to join plus £9.50 for a years membership.

Cover Bother

I have noticed that the cover of PE has been getting a lot more lively over the past few months. Actually, lively is rather an understatement where the October issue is concerned. What I would like to know is how they are produced. They are not photographs, as far as I can see, and for pieces of artwork, they are very precise. How is it done?

L Dobbs
Worthing
East Sussex

The September cover picture was drawn with a CAD art package on a Macintosh computer, in black and white. The colours were added with the aid of a process colour book and the image placed onto the DTP page layout along with the text and logos. The October picture was produced in a similar way but used a computer generated background. The current issue was also produced directly from a computer but using a fractal program. PE aims to be at the forefront of technology not just in its content but also in the way it is produced – apart from How It Works, pretty well all of the illustrations are drawn with a CAD system.

Cable On The Right Road

What's all this about cable TV not happening in the UK? (Barry Fox PE October 91). They have been digging the road up down my street for the past week and the signs say that the inconvenience is due to cable TV installation. In addition, there are now some pretty big poster ads going up trying to promote the thing. It looks as though cable is not as dead as it's supposed to be.

R J Clarke
London
SW4

What Diagram?

In your article about the MOSCODE amplifier in September's PE, I noticed a reference to a Fig. 5. I'm sure other reader's must have noticed that there isn't one so how about reprinting it as you obviously forgot it accidentally.

K Smith
Dover
Kent

Apologies for missing out the diagram. Unfortunately, it is impossible to put it in now as it is so big (a whole page). If anyone would like a copy please write to PE enclosing a SAE and marking your letter Amp Diagram. We'll get one to you as soon as possible.

More Moscode

Thank you for the interesting and informative project in the September PE. I'm referring to the high power amplifier design. I would like to get hold of a full kit of parts from Hobtek but you didn't print their telephone number. Could you help out?

L Ashby
Kings Lyn
Norfolk
*Hobtek can be contacted on
0903 726 083*

All Weather Video

After reading Barry Fox's "Video's In The Rain" in the September issue, I would like to make one point about video rental shops which he seems to have missed. A number of the films I hire are not shown on satellite and are unlikely to ever be shown. I won't be able to use any fancy simple button press to view them so I suppose I'll have to go out into the weather and borrow them.

J Brown
Manchester

As far as I know, BSkyB shows most of the new movies as soon as they are finished with the cinema circuit. Unfortunately, it may not show any minority interest films or those which were never really suitable for showing on the cinema or TV.

Intelligent Address

As a founder member of the recently formed Hyperdyne Synthetic Systems Group (primarily involved in the research and development of cyborg implants and whole android systems) and a long time admirer of your publication, I was very interested to see Neural Systems appear in your pages. I was especially interested in the NT404 NISP development package from Neural Technologies. I have endeavoured to find a company contact address or the distributor of the package, to no avail. Can you help?

Paul Benham
Derry
Northern Ireland

We've had a number of enquiries about this so an address is definitely called for. Neural Technologies can be contacted at:

*7a Lavant St
Petersfield
Hants
GU32 3EL
Tel. 0730 60256
Fax 0730 60466*

Innovations

This month, the Navy's new Merlin helicopter, the world's smallest PC and the future of science.



The Westland EH101 Merlin in its new rôle with the Navy.

On the 2nd November, the Secretary of State for Defence, the RT. Hon. Tom King MP announced that the British Navy's new helicopter, the Merlin, was to be the EH101 produced by Westland and Agusta in association with IBM.

The EH101 was originally designed by Westland and its Italian partner Agusta. After signing an agreement in 1979 to develop a helicopter to meet the demands of the 1990s, the EH101 has now flown 1220 hours with some 1290 mission flights. All of the major avionics and dynamics tests have been completed and the commitment from the British Government now means that production

can get underway.

All of the hardware for the machine will be built in Europe with 98% of the programme being placed with the UK and Italian manufacturers. IBM will be using its previous experience gained on similar programmes in the US where it developed advanced computer simulators, systems proving and operational trials of anti-submarine systems.

The EH101 is designed to be operated in one of three formats, Utility featuring a rear door, Heliliner seating up to 30 passengers and the Naval variant, now known as the Merlin. All three use advanced composite materials and sport three engines. The rotors are made from fibre reinforced and metal

components with each of the five blades having up to 35% increased efficiency compared to conventional blades.

On the electronics side, the active vibration control system uses a microprocessor controlled actuator to reduce airframe vibration by an average of 70%. The avionics uses digital databuses with an automatic flight control system offering autopilot and automatic stabilisation. The pilot operates the aircraft via high resolution CRT displays that provide information on a "need to know" basis.

Cable TV Stats

Anyone who has noticed the street being dug up outside their homes will

probably have realised that cable TV is here, or will be soon. Others may be unaware of the coming viewing revolution.

A survey commissioned by the Independent Television Commission (ITC) shows that awareness is on the rise with interest in subscribing expressed by nearly half (48%) of those questioned. 10% already subscribe and 38% say they would subscribe if the price were right. This is a slight improvement over the 43% interest announced a year ago.

The survey was based on a sample 1004 people and supplemented by a sample of 404 subscribers to cable or satellite who were asked about the services they receive. Only 67% of those

questioned had heard of cable TV compared with the 94% who had heard of new television channels.

The main reason given for not getting cable TV installed was usually the high cost. The next two most popular reasons were that those questioned didn't watch enough TV to make it worthwhile and that they were satisfied with the current services supplied by the mainstream broadcast channels, BBC, ITV and Channel 4. Adding value to the cable package proved to be something of a winner. Of those questioned, 34% said that they would be more likely to subscribe if a telephone service could be provided as well. The most appealing aspect of this service was a reduction in telephone bills with guaranteed fault repair in 4 hours, itemised bills and call waiting (knowing that another call is coming through) also quite popular.

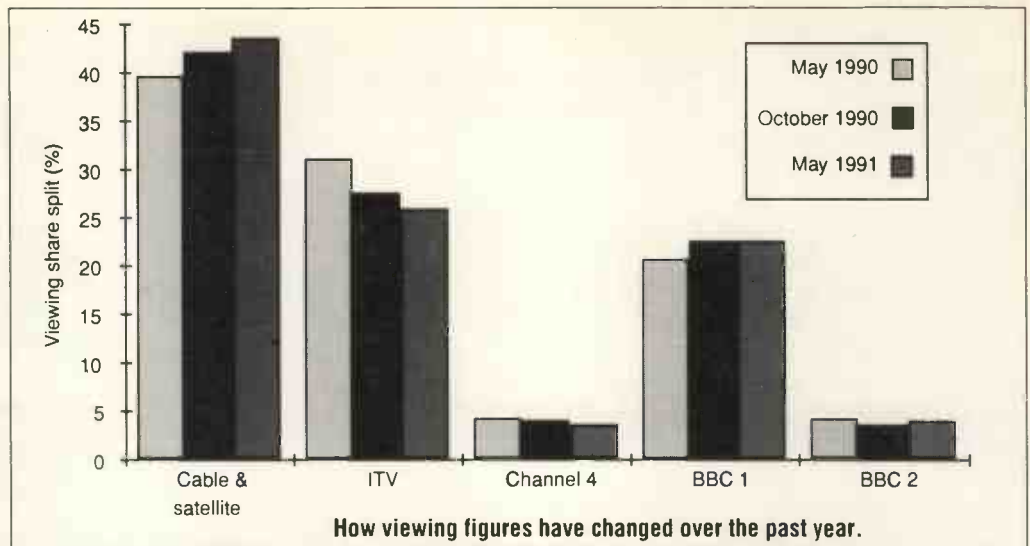

When asked about the 16 different television channels available on cable, only some of which are available on satellite, the top five were Discovery Channel (cable only) Sky Movies Plus, Sky News, The Movie Channel and CNN (cable only).

RM On The Move

Research Machines, makers of the Nimbus PC has just announced the launch of a range of

notebook computers. The RM NB100 is an 8086 based machine that is just over one inch thick and weighs 3.5lbs. It has a 1.44Mb, 3.5in floppy, 1Mb of RAM, a CGA compatible LCD (640 x 200 pixels) and MS-DOS on silicon disk. Priced at £599 it offers a relatively cheap entry into portable computing that is PC compatible.

The RM NB200 and RM NB220 are based on the popular 80286 microprocessor. With a

clock speed of 12MHz, 1.9in thick and weighing under 7lbs with 1Mb of memory and a double supertwist backlit VGA screen (640 x 480 with 32 grey levels) they are fully AT compatible. Expansion options include a VGA monitor, mouse port, serial and parallel interfaces, external keyboard connector, external diskette connector and bus port. Optional extras are a 20Mb hard disk (standard on the NB220)

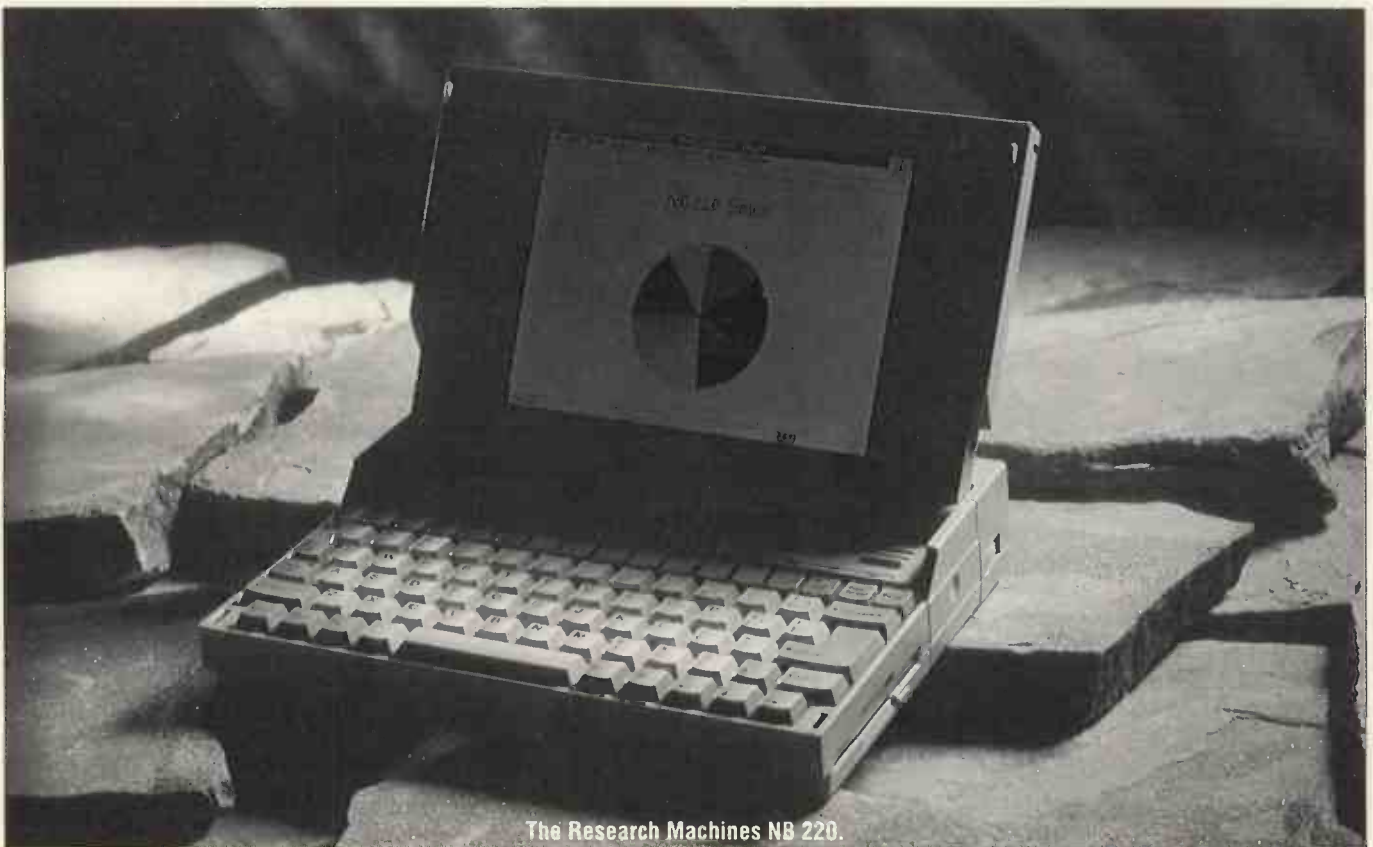

The Research Machines NB 220.

which is supplied complete with Windows version 3.

The top of the range, NB340 offers the same features as the NB200 but with an 80386SX processor and a 40Mb hard disk.

Prices start at £1199 (£949) for the NB200, £1499 (£1199) for the NB220 and £1699 (£1399) for the NB340 – figures in brackets are available to further and higher education purchasers.

RM's main market for the machines is hoped to be in the education area where it is already one of the leading PC suppliers. However, the current wide availability and performance competition from the many other companies producing laptops could mean that RM's current prices will have to fall.

Tiny PCs

The Tiny is the world's smallest desktop microcomputer measuring 210mm x 73mm x 133mm. Available in three

formats, the bottom of the range is the TC1 which sports a 10MHz V30, a single floppy disk drive, serial, parallel, games, mouse and video ports, 81 key keyboard, PAL modulator, CGA Hercules compatibility, DR-DOS 5 plus four pieces of bundled software, Mini Word, Banner programme, puzzle and clock, all for £299. The next machine up is the TC2 which has the same specifications as the TC1 but has an extra floppy drive and is priced at £349.

The top of the range is the TC3 which is the same as the TC1 and TC2 except that it has a 80286 running at 12MHz, 1Mb of memory, 3.5in floppy and 40Mb hard disk drives and is priced at £599.

The manufacturers, Tiny Computers, of 33 Ormside Way, Holmthorpe Industrial Estate, Redhill, Surrey, RH1 2LW, Tel. 0737 779511, also market a range of building block computers allowing OEMs to make up



The smallest desktop PC in the world.

machines with a choice of processors – 286, 386SX/DX and 486 – video cards and disk drives. Prices start at £249 for the 12MHz BB286 and rise to £999 for the BB486/25 cache.

Extending science coverage in print and broadcasting media, for example women's magazines, chat shows and soap operas.

Working with women's groups, recognising that public understanding of science issues are particularly pertinent to women.

Developing plans for a Science in Art Festival.

Continuing the Science Book Prizes, run jointly with the Science Museum and now in its second year of sponsorship by Rhône-Poulenc.

A booklet setting out these aims, COPUS Looks Forward: the next five years, is available free from Jill Nelson, COPUS Executive Committee c/o The Royal Society, 6 Carlton House Terrace, London SW1Y 5AG, Tel 071 839 5561 ext 226. ■

Public Science

Extending the understanding of science to the general public has been the aim of COPUS since its inception in 1985. The Committee on the Public Understanding of Science recently announced its latest five year plan in which it identifies the following challenges.

Persuading funding bodies to make public understanding of science a required and rewarded element in academic institutions.

Encouraging scientists and engineers to go on media training courses.

The most important addition you will make to your TOOLKIT

If electronics is your hobby or your livelihood there's no doubt about it. As *New Computer Express* said: "The Electronics Repair Manual is a complete reference in itself. On its own it would be worth the £44.95 asking price. The supplements that are already available and those planned make it an absolute necessity."

We couldn't have put it better ourselves.

The Manual contains over 800 pages packed with valuable information on the ins and outs of repairing and maintaining everything from your TV, Hi-Fi Amplifier, Radio and Video, right through to your Personal Computer. Information that's easy-to-follow, as each topic is lavishly illustrated and laid out with simple step-by-step instructions, backed up by a clear and comprehensive index.



Continual updating means you're never outpaced by technology. Every two or three months you'll receive supplements for your manual, guaranteeing that the **Electronics Repair Manual** remains the most comprehensive reference source available.

If you're involved in electronics, how can you be without it? To receive your copy on 10 days Free Approval, just complete the coupon below or ring FREEPHONE.



ORDER FORM – SEND NO MONEY

To: WEKA Publishing Limited **FREEPOST**
The Forum 74–80 Camden Street London NW1 1YW Tel: 071-388 8400

FREEPHONE 24hr Order Hotline. Use your credit card on 0800 289762

YES please send me immediately on 10 days free approval
THE ELECTRONICS REPAIR MANUAL

(Order No 12800). If I decide to keep the manual, I shall then pay **only £44.95** plus £5.50 postage and packing at the end of the 10 day approval period. I shall also receive the appropriate Updating Supplements throughout the year, priced at £22.00 plus £2.50 p&p. These are billed separately and can be discontinued at any time

(CAPITALS PLEASE)

NAME _____

ADDRESS _____

POSTCODE _____

SIGNATURE _____ AGE (if under 18) _____

OVERSEAS ORDERS

All overseas orders have to be prepaid but will be supplied under a Money-Back Guarantee of Satisfaction. If you are an overseas customer send no money at this stage, but return the complete order form. Upon receipt of this we will issue a pro-forma invoice for you to pay against. Payment must be made in sterling.

We reserve the right to alter the price and page extent of future supplements. You will be informed as and when any such decisions are made.

From time to time we will tell you about other companies' products and services, which we feel you might be interested in. Please tick here if you would prefer not to take part in this opportunity

WEKA GUARANTEE

You risk nothing by ordering today – as this title is covered by WEKA Publishing's Guarantee of Satisfaction. If for any reason it fails to match your expectations simply return it in perfect condition and you will owe us nothing.

E. Evans

E. Evans – Publisher



WEKA PUBLISHING GROUP
GERMANY · AUSTRIA · FRANCE · ITALY · USA · NETHERLANDS
SWITZERLAND · UNITED KINGDOM

401006

Looking Towards The Future

Ian Poole describes some of the latest advances in electronics technology with a look at a new solar cell design, high quality optical discs and microwave transistors.

The poor efficiency of solar cells has always been a problem making them useable in small and specialised applications. However recent work undertaken in Japan has brought the efficiency of their cells up to a new world record level of 16%. Furthermore it is hoped that in less than a year this might be improved to give efficiencies of around 18%. All of this has been achieved by using polycrystalline silicon coupled with some new techniques.

Normally it was found that a polycrystalline structure would only give a poor level of efficiency because of the many boundaries which existed within it. However by using a number of improvements this structure can now be used to its best advantage.

The first new feature is in the form of form grooves as shown in Fig. 1. Although these are produced mechanically they are just over 100 μm wide and 50 μm deep. By using these grooves the actual surface

area available for conversion is significantly increased. In addition to this the distance between the electrode and any point on the surface is reduced and this means that the internal resistance will be lower.

Another advantage of the grooves is that they reduce the reflectivity of the cell. In fact a major problem in any solar cell is that any light which is reflected cannot be converted into useful electrical energy.

The reflectivity of the cell is further reduced by the addition of a new layer. This is made up from magnesium fluoride and titanium oxide and is a great improvement over the traditional single layer as it absorbs more of the light spectrum.

A final improvement has been made by modifying the manufacturing techniques and reducing the size of the front electrode to 45% of the surface area. This gives a small but noticeable increase in the area which can actually collect the light.

Optical Discs

For some time the problem of low data rates in optical discs has been their major drawback. This appears to be an obstacle of the past now that Sony have introduced their new 3.5 inch erasable drive. This can store up to 128Mb in an erasable magneto-optical form and can access 120Mb from a pre-recorded optical disc of similar format to that of a conventional domestic compact disc.

In order to achieve this outstanding performance several advances have had to be made. The first is the new heads which are used. They are much smaller than any used on previous systems and can detect the polarity of the magneto-optical discs as well as the information in CD format on prerecorded discs.

The other major advance is in the use of a new chip set developed by AMD. It consists of an AM95C96 which has been developed specifically for optical disc control. However, the major speed increase has been achieved by the AM95C94, a specialised error detector. This new chip performs in hardware the specific error detection circuitry needed for optical discs. Previously this was all performed by software and was much slower. This new chip can now correct an erroneous byte in 10 μs where the previous software took 0.25 ms.

The disc spins at 3000 rpm giving a data transfer rate of 625 kb per second with a seek time (the time taken to reach a specific point on the disc) of 40 ms.

If prerecorded discs are required, Sony is able to make them up from a re-writable master.

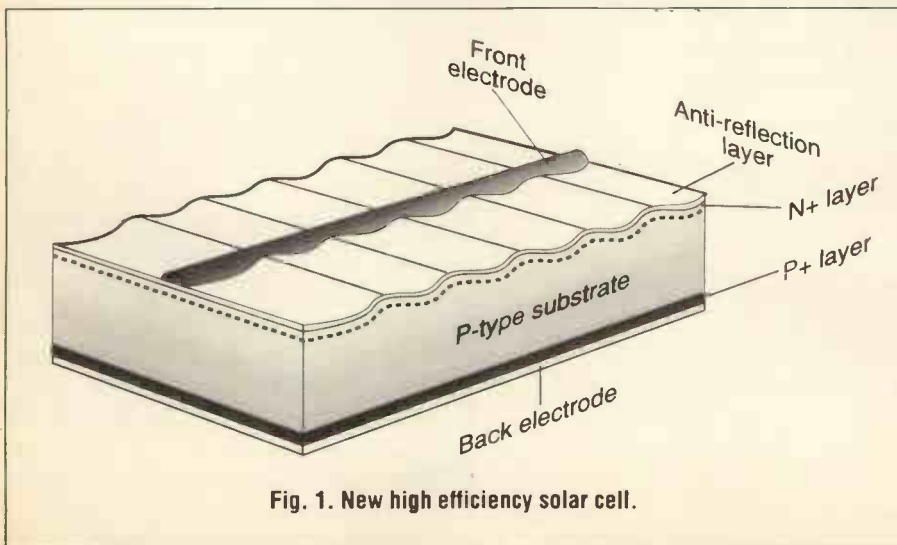

Fig. 1. New high efficiency solar cell.

Transistor Technology

In the past, Gallium arsenide was thought to be the best material for microwave semiconductor devices. A new type of transistor may be able to change all of this using silicon to take a step forwards in speed and power capabilities.

The new transistor has been developed in France by the Centre National d'Etudes des Telecommunications. The first samples of the device have a measured frequency of more than 26GHz and computer simulations have indicated that the same techniques can be used to obtain devices with frequencies up to about 100GHz. In addition to this the new transistor can handle currents of up to 100mA giving it a very respectable power handling capacity.

The new device is a form of VMOS FET called a Permeable Base Transistor (PBT). Although it is based around a conventional V structure, a number of alterations have been made as can be seen from Fig. 3.

In fact the basic concept was first used in the mid 1960s in the USA to make bipolar transistors. In these the base was replaced with a thin metallic film to give what was called a metal base transistor. However, the problem encountered in this design was that the electrons used to traverse the base as a result of their momentum and this drastically reduced the efficiency.

The solution was a discontinuous base and is applied in the PBT with remarkable results. However, the structure is rather unusual. The device is made from a piece of N+ silicon which has layers



Fig. 2. Sony's magneto-optical disc.

of N- and then N+ silicon grown onto it. Then a series of parallel grooves are etched through the top N+ epitaxial layer. After this a thin metal layer is deposited onto the upper surfaces of the silicon. On the tops of the fingers the metalisation acts as the source and in the bottom of the trenches it forms the gate. The underside of the fingers does not receive any metalisation with the result that there is good isolation between the gate and the source. In addition, the metalisation for both the gate and the source can be deposited at the same time and without any screening. This greatly simplifies the fabrication process.

The active region of the device occurs only around the edge of the

gate metalisation. As this area is very small (around 150Å) the active region is exceedingly small. The other dimensions of the device are also fairly small which enables the overall frequency response to be maintained.

Apart from the high frequency performance and the current capability there are a number of other advantages to this device. The first is the relative simplicity of the fabrication process. Although it does need several advanced techniques to be used, it should mean that the prices of PBTs ought to be very competitive when full production is reached.

The fact that silicon is used as opposed to gallium arsenide also brings some advantages. One is that the thermal conductivity of silicon is higher than GaAs, and this results in a comparatively high power device. The other arises from the fact that the bulk crystal defects in silicon are lower than in GaAs. This means that silicon is capable of giving a better noise performance.

Although these devices are still in the development stages, it should not be too long before they are seen in use. They are still likely to be expensive, but in view of their potential they should be cheaper than equivalent devices made by other means. ■

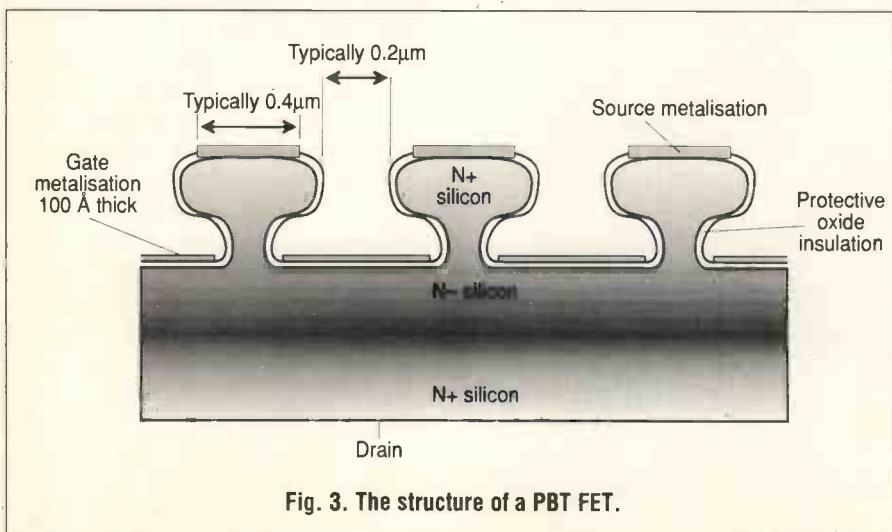

Fig. 3. The structure of a PBT FET.

A New Radio Novice Licence From The DTI

Ian Poole describes how, under a new scheme, gaining access to the radio waves is now easier and cheaper than ever before.

On July 25th 1991 seven young people received the first of a new type of amateur radio transmitting licence. The new licence is called the novice licence and was launched at the beginning of 1991. Its aim is to provide a new way into the hobby and it is intended for people of all ages, although it is particularly structured to encourage young people into amateur radio.

What Does It Offer?

The novice licences give access to a wide variety of bands and types of transmission as shown in Fig. 1. There are two classes of licence, Class A which gives access to all the novice bands, and class B which only allows operation on bands above 30 MHz. For both licences power limits are quite low at 3 watts RF output or 5 watts DC input to the final stage. Even so this is quite sufficient to make some

U.K. Novice Licence Bands

Frequency Band (MHz)	Types of Transmission Permitted
1.950 - 2.000	Morse, Telephony, RTTY, Data
3.565 - 3.585	Morse
10.130 - 10.140	Morse
21.100 - 21.149	Morse
28.100 - 28.190	Morse, RTTY, Data
28.300 - 28.500	Morse, Telephony
50.620 - 50.760	Data
51.250 - 51.750	Morse, Telephony, Data
433 - 435	Morse, Telephony, Data
1240 - 1325	Morse, Telephony, RTTY, Data, Facsimile, SSTV, FSTV
10 000 - 10 500	Morse, Telephony, RTTY, Data, Facsimile, SSTV, FSTV
Maximum power 3 Watts RF output or 5 Watts DC input.	

Figure 1

respectable contacts especially on the HF bands below 30 MHz where intercontinental contacts are quite possible if a good aerial is used.

There is plenty of scope for experimentation within the licence. There are no restrictions on having to buy factory made equipment. Indeed the training for the licence is set up to encourage home

construction. In addition to this a wide variety of modes of transmission are available - Morse, AM, FM, and SSB are all allowed as is data transmission. This is of particular interest because of the new packet radio transmissions which are being widely used by amateurs.

Obtaining The Licence

The object of the training for the new licence is to learn in a practical way. Candidates must satisfactorily complete a practical course run under the auspices of the Radio Society of Great Britain. It consists of a number of work sheets which are all designed to teach a particular aspect of electronics and radio. For example one work sheet may have a soldering task on it whilst another may be on making a contact. The course should take about 30 hours to complete so it is not particularly arduous. The assessment is carried out on a continuous basis and if one section is "failed" then this does not mean



Natasha Weir, callsign 2E1AAE, with her compact radio station (photo courtesy of RSGB).

that the whole course is failed.

Having successfully completed the course a 90 minute exam has to be passed. This is set by the City and Guilds but it is based on the practical course.

Having reached this far it is possible to obtain a class B licence. If a full class A novice licence is required then a simple morse test of 5 words a minute has to be passed. This too is organised by the R.S.G.B.

Bearing in mind the number of young candidates likely to be applying for the novice licence the cost is free to people under 21 years of age. However for older applicants the cost is £15, the same as the ordinary amateur radio licence.

Callsigns

A completely new set of callsigns have been started specifically for these licences. Unlike the standard system which starts with the letter G (e.g. G3YWX) the new novice callsigns start with the number 2. This is followed by a letter which indicates the country: E for England; M for Scotland; W for

Wales; I for Northern Ireland; D for the Isle of Man; U for Guernsey and J for Jersey. The next character is a numeral which denotes the class of licence. The numbers 0,2,3,4 indicate a class A licence whilst 1,5,6,7,8 indicate a class B licence. Following this are three letters which make the callsign unique and are issued in strict alphabetical sequence. For example a class B licence in Scotland might be 2M8CCN.

Where To Get It

A number of people have fought long and hard to have this new licence introduced. Now it has arrived there is the possibility of many more people being able to access the airwaves.

Information about the Novice Licence can be obtained free of charge by requesting a Novice Pack from the Radio Society of Great Britain, Lambda House, Cranbourne Road, Potters Bar, Herts, EN6 3JE.



Robert Cherry, call sign 2E1AAC, makes his first UK Novice contact (photo courtesy of the RSGB).

1991-1992

HENRY'S

ALL NEW COLOUR CATALOGUE

PLUS Test Instruments, Security, and Component Supplement

WITH £90.00 WORTH OF PURCHASE VOUCHERS

FREE and £2.00 OFF first purchase



To obtain Henry's new catalogue send envelope, minimum size C4 (12 3/4" x 9"), self addressed with £2.65 stamps affixed OR send £4 ch/po with request for catalogue, (Export £6) to the address below.

Also available for callers. Trade/Industry/Education. Attach notepaper request for FREE catalogue with trade price lists.

HENRY'S

OPEN 6 DAYS A WEEK

404 EDGWARE ROAD, LONDON, W2 1ED

Sales: 071-258 1831 Fax: 071-724 0322

Audio and Electronics Specialists

AROUND 350 PAGES COVERING

- Components
- Fans ■ Relays
- Public address
- Security ■ CCTV
- Test instruments
- Speakers ■ Disco
- Power supplies
- In car ■ Cables
- Inter comms
- CB ■ Tools etc.
- Accessories for TV-Video
- Telephones, Computer, Audio etc.

THROW AWAY YOUR EPROM BLOWER!

E-SYS 128

ADVANCED ROM INTERFACE AND EMULATION SYSTEM

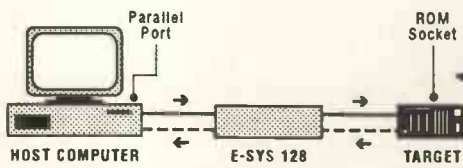

JUST £399 + VAT

E-Sys 128 links the parallel (Centronics) port of your computer to the ROM socket in the target machine quickly, efficiently, conveniently to mimic up to 128k of 8 bit ROM with a download of under two seconds (measured on 286 12MHz PC).

- Parallel input allows attachment to a wide variety of host computers.
- 32 pin header output replaces up to 128K ROM per socket
- Chain capability enables mimicking of multiples of 128K ROMs.
- True, fully portable ROM emulation provided by trickle charged Ni-Cd battery backup to enable E-Sys 128 to retain data even after the host and/or target is disconnected.
- Fast ROM emulation operating speed better than 100ns.
- Communication facility from target back to host to enable verification of data transfer.
- Target machine can relay data back to host during execution via pseudo RAM locations.

Order today and pay by cheque
Barclaycard or Access card
Free data sheet and technical description
Phone: (0235) 832939 Fax: (0235) 861039

21ST CENTURY ELECTRONICS

(a division of 21st Century Entertainment Ltd)

56B Milton Park Abingdon Oxfordshire OX14 4RX

COMING SOON!

E-SYS 1024
1Mbyte SYSTEM

TI, Exel And National Semiconductor

This month's valley looks at quick analogue to digital convertors, safety conscious EEPROMs and clever power drivers.

One of the penalties of high speed integrated circuits is usually high power consumption. This is especially true of "flash" analogue to digital convertors (ADC). Able to make 8-bit conversions at up to 20 million samples per second (MSPS), the ADC 0881 from National Semiconductor, featured in last month's valley is especially power hungry. An alternative, also from Nat Semi, is the ADC10662/4 which, although not quite as fast, offers a conversion of 10-bits in 466ns while dissipating only 235mW. Using a patented multi-step architecture, the chips are among the fastest of their type available.

Aimed at applications that require high speed with low power consumption, such as medical electronics, portable instrumentation, disk drives and high speed data-acquisition systems, the 10662 features two analogue input channels (with four on the 10664), is pin compatible with the older 10062 and operates from a single 5V supply. Analogue signals up to 250kHz can be digitised accurately without the need for an external sample/hold circuit.

Contact National Semiconductor, C/O Lorenz Minderer GmbH, Att: Mrs Humbert, Raiffeisenstraße 10, D-8016 Feldkirchen, Germany.

Safe EEPROM

Exel Microelectronics recently announced two new CMOS EEPROMs (Electrically Erasable Programmable Read Only Memory) featuring auto increment and Vcc

lockout plus low power consumption.

The lockout protection provides protection from inadvertent writes. In noisy environments, the electrical nature of the programming system in an EEPROM means that spikes in the power supplies and write data lines make the data unreliable. The XL93LC06 and 46 have built in supply voltage sensors which prohibit data alteration whenever the supply is below a safe value.

The auto increment feature allows the chips to output a continuous stream of data in response to a single read instruction. Normal EEPROMs need a read for each address which, in comparison, is slow, specially when a series of consecutive memory locations must be read.

The XL93LC06 has 256 bits of non-volatile memory arranged as 16 registers of 16 bits each. Operation is from a single 5V supply at a maximum of 2mA in active mode and 2µA in standby.

For more information contact

Exel Microelectronics PO Box 49038 San José CA 95161-9038 USA.

Intelligent Power

The TPIC2801 is an octal serial peripheral driver from Texas Instruments. Each output has a voltage capability of 30V at 1A with a current limit of 1.4A. The built in protection shuts the device down after an overload of 100µs and notification is available from the serial data output of any channels in trouble.

Available in a 15 pin kV power package, the TTL/CMOS compatible inputs reduce the number of connections needed to a microprocessor system by allowing the data at the output to be input serially.

The TPIC2801 is initially targeted at automotive and industrial systems but should find applications in any area where large drive power is needed.

For more information, contact TI, Freepost, Backhorse Road, London SE4 882. ■

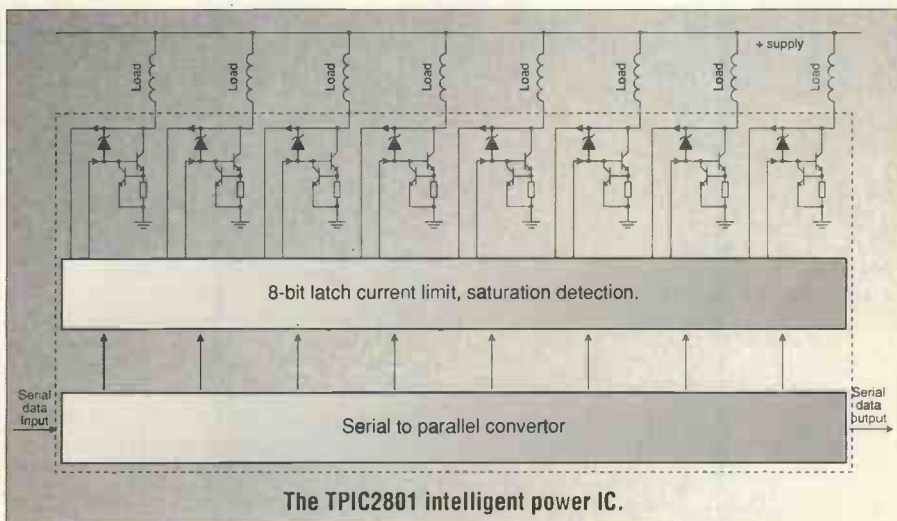

PSST...

Powerful Software Saves Time!

ANNOUNCING ISIS DESIGNER VERSION II

Our popular range of schematic capture products has been upgraded to give 'one button' integration to other CAD software. A special script language allows you to add your own options to the menus so that you can, for example, compile a netlist, convert it to the desired format and then invoke another DOS program all from one menu selection.

Other new features include full network compatibility, sophisticated support for PCB design including automatic property assignment and sheet global net properties, improved editing facilities, a full screen library maintenance tool and much more.

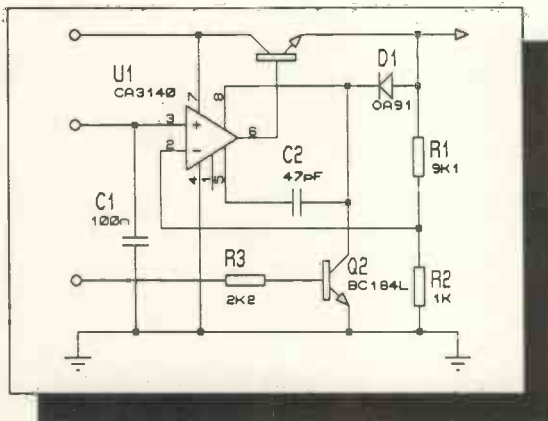

ISIS DESIGNER..... £275
ISIS DESIGNER+ £475

- Auto wire routing, dot placement and label generation.
- Powerful editing facilities.
- Object oriented 2D drawing with symbol library.
- Comprehensive device libraries provided.
- Device editor integral to main program.
- Output to dot matrix, pen plotters, lasers, POSTSCRIPT.
- Export to DTP packages in IMG, BMP, DXF or EPS formats.
- Multi-sheet and hierarchical designs held in one file.
- Netlist output to most popular EDA software.
- Bill of Materials and Electrical Rules Check reports.
- DESIGNER+ advanced features include hierarchical design, Automatic Annotation/Packaging, ASCII data import.

ARES - Advanced Routing

ARES £275

A netlist based, multi-layer PCB design package that can integrate with ISIS or other schematics software. Includes connectivity checker, design rule checker, power plane generator and automatic back-annotator.

ARES AUTOROUTE £475

Our new autorouter uses an advanced, multi-strategy algorithm to achieve very high completion rates, yet when driven from ISIS, there is remarkably little setting up to do - Package, Router-Strategy and DRC data can all be read from the netlist.

- Topological Route Editor (another Labcenter innovation)
- Unlimited user configurable pad, track and via styles.
- Full surface mount and metric support.
- 10 copper + 2 silk layers.
- 1 thou resolution.
- 30x30 inch max board size.
- Up to 5000 pins, 50000 trace segments using EMS RAM.
- Object oriented 2D drawing for silk screen graphics.
- Drivers for dot matrix, pen plotters, lasers, POSTSCRIPT, Photoplot (Gerber), NC drill (Excellon).
- Graphics export in IMG, BMP or EPS formats.

Budget Price CAD Software

ISIS SUPERSKETCH.....from only £69

Our highly popular schematic drawing program is still the only budget package designed specifically for drawing circuit diagrams. It has all the editing features of ISIS DESIGNER and our Graphical User Interface makes it exceptionally easy to learn and use.

Diagrams produced with SUPERSKETCH can be rendered on all common printers/plotters including POSTSCRIPT and graphics export to most DTP and Wordprocessing packages is also possible

An extended device library containing TTL, CMOS, Memory, Microprocessor and Analogue ICs is available for £30.

PCB IIonly £69

An exceptionally easy to use manual PCB drafting package offering most of the features of ARES but without the netlisting capabilities.

PCB II shares the same user interface as ISIS SUPERSKETCH and both packages plus the extended device library are available for just £149.

Labcenter
Electronics

COMBINATION PRICES

ISIS DESIGNER & ARES £495
ISIS DESIGNER & ARES AR £675
ISIS DESIGNER+ & ARES £675
ISIS DESIGNER+ & ARES AR £850
Prices Inc UK delivery, exc VAT.



Call for demo packs
Tel: 0274 542868
Fax: 0274 481078



14 Marriner's Drive, Bradford. BD9 4JT

A Second Look At CAD

When Andrew Armstrong took up PCB computer aided design in earnest he discovered that there were hidden pitfalls for the new user.

Three years ago I came to the conclusion that I needed computer-aided design (CAD) for printed circuit boards to continue my work in electronics design. I have little artistic talent and the increasing complexity of board designs coupled with shorter project timescales made it a matter of necessity rather than economics.

A brief survey of the market suggested that, other than buying a Sun or similar workstation and around £20,000-worth of software, a good alternative was a PC-compatible. The exact choice of computer was left until after I had decided on a software package, to make certain that the computer was adequate for the task.

Connectivity

I needed software which would allow me to draw a circuit diagram on the screen and transfer that information to the layout, so that the tracks would be forced to conform to the circuit diagram.

To transfer the design from schematic to layout, an intermediate stage – the netlist – is required. This is a complete list of all components present, and which pins are connected together. Normally, the program will not allow connection of component groups not joined on the schematic and will verify that all the required connections have been made.

One other important function is available: autorouting. A CAD package with automatic routing calculates the proper path of the connections as well as maintaining a list of what is connected to what. The first advice I had was that autorouting would be unlikely to

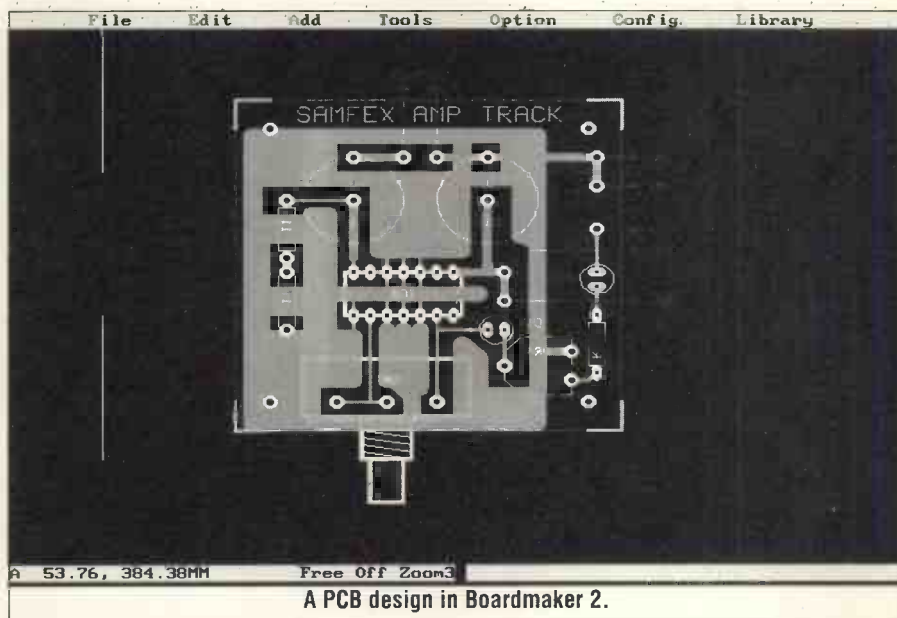

route the entire track layout, but would probably be able to do most it.

I reasoned that (for example) a 70% automatically routed board would be quicker to complete than one with no routing. It is interesting to note that a package which generates a netlist from the pin-to-pin layout connections can perform autorouting if a suitable software module is present. It does not matter that the netlist was not generated from a schematic.

In Practice

After visiting exhibitions, reading the literature and attending a number of demonstrations, I made my choice. In order to avoid biasing the reader either in favour of or against the package I bought, I shall use mythical names from now on. This is only meant to be a guide: it's no good if you don't do your own research! Anyway, I concluded that

RH Layout by Rhamphorynchus was the most suitable package in my price range. At the time, I expected to need pen-plotted or photo-plotted artwork for industrial design, and artwork produced on a dot-matrix printer for published projects. The specification of RHL stated that it would work with any Epson-compatible graphics printer. In possession of this information, I was set to buy it in the full confidence that it would drive my NEC P7 Plus, a 24-pin printer which emulates the Epson LQ850.

Unfortunately, I was wrong. Artwork printouts from RHL on this printer were approximately 30% expanded in height. What the specification meant was that RHL would drive Epson-compatible 9-pin printers.

The other snag was that, though RHL would provide a pen-plotted output, the pen-plotter had to be connected to the computer at the

time. It could not generate a file on disk for plotting by a bureau.

I was told that RHL V2 could generate HPGL files (Hewlett Packard Graphics Language, used by most pen-plotters) on disk, and that a 24-pin printer driver, though not currently available, was under development. On the point of buying RHL V1, I changed course and bought V2.

In the event, the 24-pin printer driver did not materialise, and my need for a disk-based pen-plot file lapsed for different reasons. I found that industrial design artwork was better photoplotted from a Gerber file on disk. The cost of photoplotting was similar to that of pen-plotting and the necessary photography.

User Friendly...

Meanwhile, expecting the 24 pin printer driver to be ready at any time, I set about learning to use the CAD package, with a couple of convenient small jobs to serve as an easy introduction.

All did not run smoothly. First of all, the mouse would not work. I had bought a Tulip computer with built-in mouse interface. The specification of the computer stated that the mouse was Microsoft compatible, and sure enough there was a genuine Microsoft chip on the motherboard. The CAD software, of course, was specified to work with Microsoft compatible mice, bus or serial types.

The man from Rhamphorynchus had the answer: "It won't work

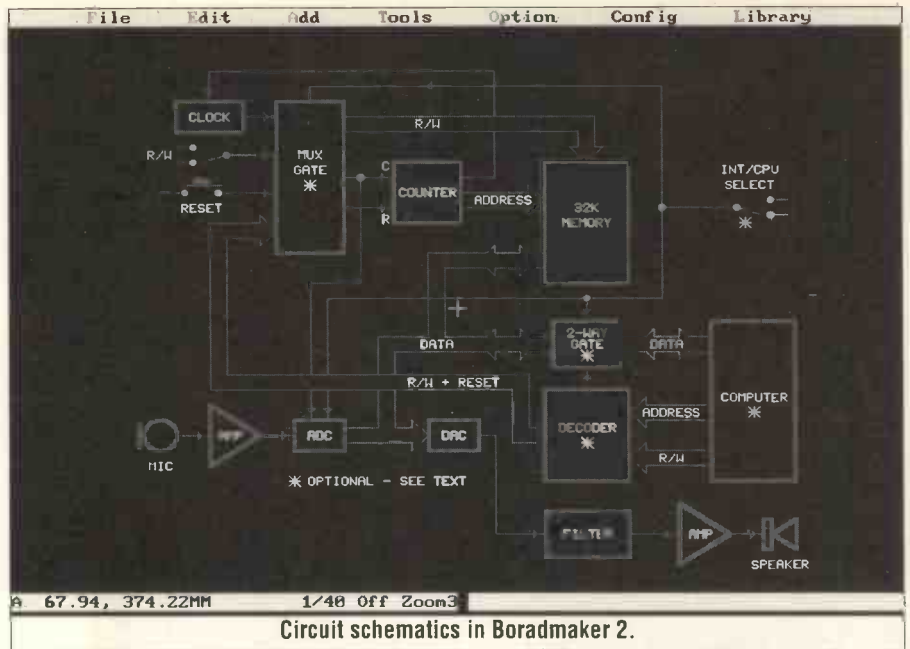

because your mouse interface is on the motherboard. If it was on a separate card, or if you used a serial mouse, then all would be well." It happened that the software was written to access the hardware directly, rather than using the computer's system or BIOS. Any item of hardware at a different address from that assumed by the programmers would not work. My Tulip mouse worked with every other piece of software I had tested – but that didn't alter the situation: I had to buy a new pointing device. Instead of a mouse I took the opportunity to buy a high quality trackerball – which I had intended to do, anyway, once I started earning money with software. Now it appeared as a startup cost.

The Marconi trackerball,

delivered by courier the next day, worked beautifully. That was when my troubles really started.

I had assumed that CAD software would be much like any other software package I had learned to use: do simple jobs with it initially, and learn advanced features gradually as they become relevant. I expected documentation which was poorly indexed, because this is the way of things with computer documentation, but I expected it to tell me everything about the software, eventually.

I found the reality frustrating. Perhaps infuriating would be a better word. I had never used a piece of fully industrial software before, nor anything so complex. Nothing worked in what I imagined to be the logical manner, and the manuals told me what to do, but not what the action was for.

For example, the manual might state that a function key would "enable closely spaced primitives". The same information appeared on the menu. What it actually meant would be something like this: "When drawing or modifying a component outline, it can be difficult to select the correct line from several in a small area. This function steps through each separate line in an area to permit selection of the correct one."

The people on the helpline at Rhamphorynchus UK were efficient and generally well-informed, and their help enabled me to make some progress. The tutorial book was also helpful. This put together the basic

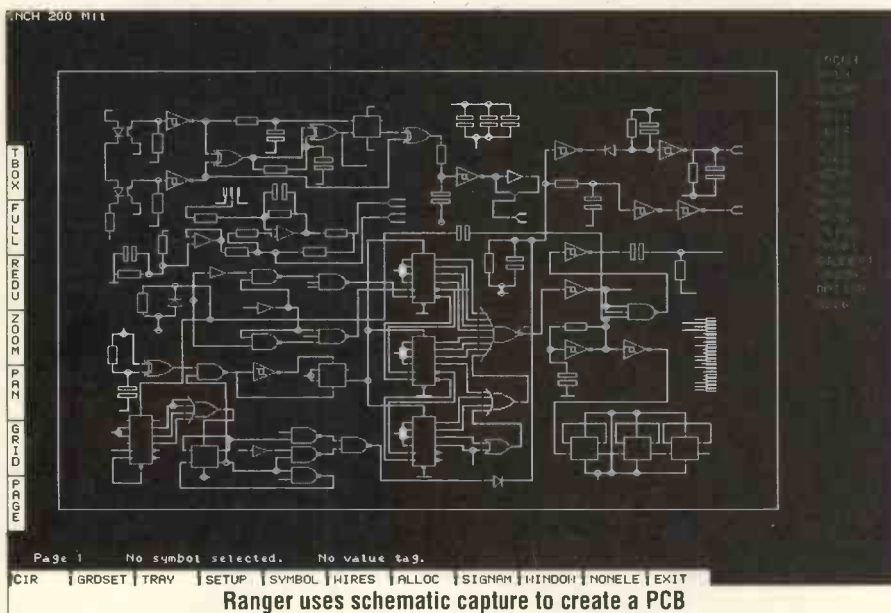

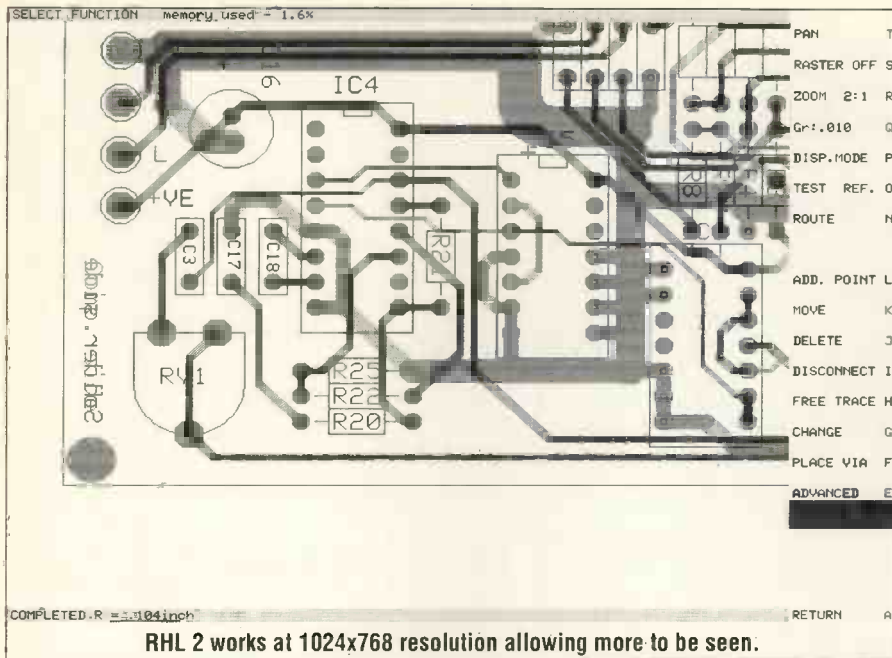

to impossible, except as a courtesy gesture, because the complexity of industrial software and the difficulty of matching the user's needs exactly to a proprietary package meant that normal grounds for return of goods and refund of payment are very difficult to establish. In the end, Rhamphorynchus offered me an upgrade to RH Layout V3 at a considerably reduced price. RHL3 included a 24 pin printer driver – and several other enhancements as well.

Reasoning that I could obtain no better offer and that even if I obtained a full refund I would have to spend several weeks learning to use a new software package – possibly an inferior one – I accepted. I made the condition that I would only accept delivery and pay for the software when it had been demonstrated to work correctly in all respects on my hardware. The demonstration showed that it did all work, and I upgraded to the top of the RH Layout range.

After learning to use RHL2, and discovering what I found difficult or unhelpful about it, I was pleasantly surprised by RHL3. No longer did I have to draw a schematic as a rats' nest and then add right-angle bends and junction points. No longer did wire or track routing have to be from pin to pin; joins could be made at any point along a connection. Several other aspects of use were improved and, though many of the principles of operation were similar to RHL2, the logic of the software was more

information needed to lay out a PCB, but it did not illustrate anything complex.

Various friends who design software offered me help to make sense of the package. "As user-friendly as a piranha in the bidet", one commented drily. She added that the software had been written as if for use by software programmers, rather than by engineers, and that if I approached it from a different point of view some logic would become apparent.

The 24 pin printer drive continued to be delayed and I had to borrow a 9 pin printer from a contact whenever I needed to make a printout – something of a nuisance.

Then, one day when I enquired, the suppliers had discovered that the printer driver for RHL2 was not being written, and would not be available. By this time I had learned to use the software fairly well, and did not want to change, so I suggested that I could be given the necessary information to write my own printer driver, or failing that to modify the parameter file for an existing driver to make a correctly scaled printout on my 24 pin printer in 9-pin (reduced resolution) mode.

My suppliers made enquiry to the overseas parent company and I was told that this information would be forthcoming. A delay was expected because the programmer was busy with a software update. Then he was on holiday. There was always a good reason for delay. The delay lengthened. Eventually they

came back to me with the news that the information would not be given to me – it was the proprietary property of the parent company, and they could not be expected to release it.

During our discussions the supplier had passed on the information that other RHL2 users had asked about a 24 pin printer driver. I now offered to write a printer driver and give the rights to the company, if they gave me the minimum information that would enable me to use my 24 pin printer, but they declined.

I was, by this time at, the end of my wits and I cast about for a solution. In the end I demanded a refund on the software. I had been advised that obtaining a refund from a software supplier was next

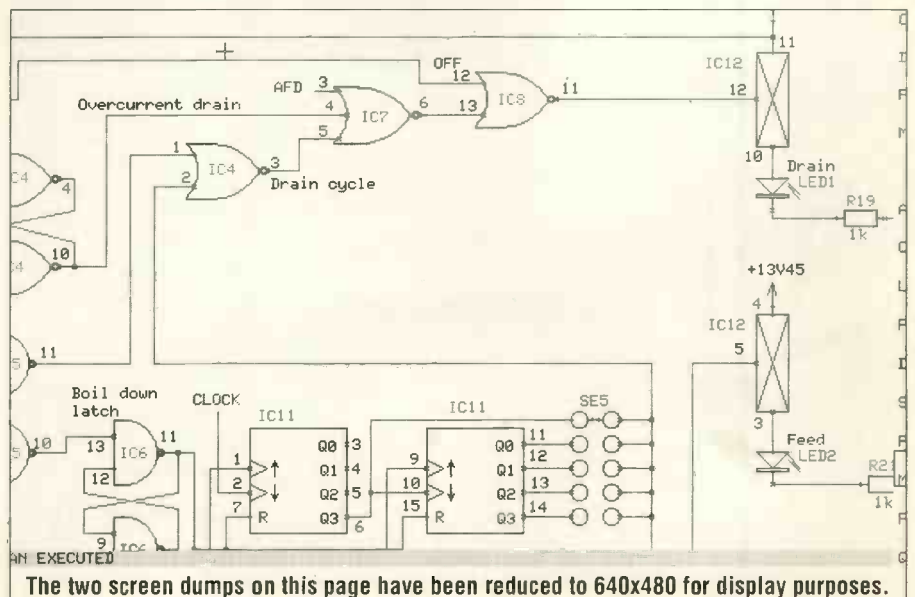

along the lines needed by an engineer rather than a software programmer.

Poorer but wiser, I now had a CAD package fully suitable for my needs.

In Use

Since buying CAD software I have designed ever more complex printed circuit boards, and have paid for annual upgrade packages which have increased the usefulness of the software steadily. Surface mount components are fully supported and "hot keys" permit more rapid switching between functions. I am told that a generic move function, which allows you to move whatever you click the cursor on, is planned. This would considerably speed the final tidying up of a layout. To return to using adhesive tapes and die-cut symbols would now seem like changing from a word processor to a quill pen.

So long as the circuit diagram is correct, it is possible to get a layout "right first time" to the extent that the resulting board could be substantially ready for manufacture.

Designing a board with CAD is quicker than designing it on paper, with the added advantage that once the design is done, plot files must be written to disk, taking perhaps half an hour.

The autorouter, which was most effective on boards consisting mainly of standard-size digital ICs, has gradually fallen behind current requirements. On a recent surface mount design, it declined to route any tracks, even in an area

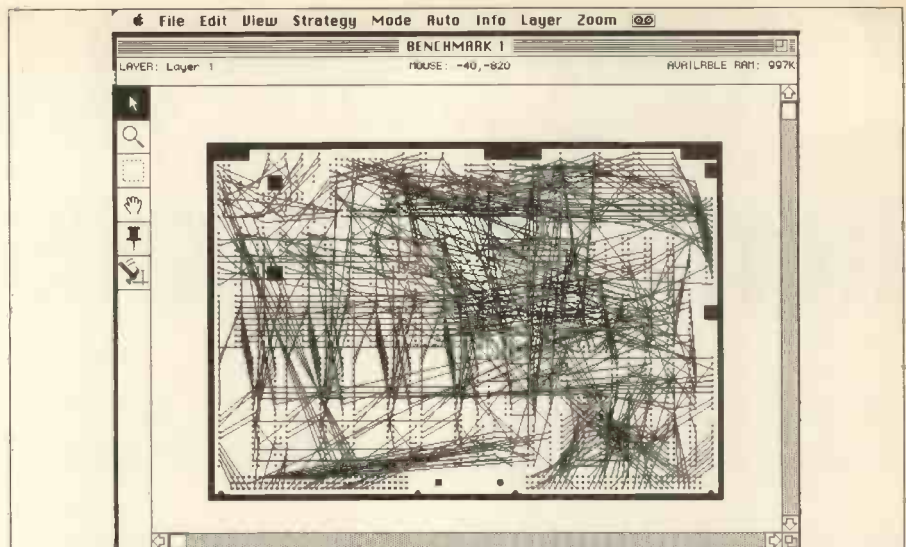

McCAD is a system available for the Macintosh

containing only digital ICs. "Board too complex," said the error message.

PCB autorouters now form a specialised field and Rhamphorynchus currently distributes an autorouter on behalf of another company. The router runs under Windows 3, and accepts information from RHL3 in a data export format. The top of the range autorouter package costs about the same as the full CAD package, to whit around £4000. The level 1 software for about £1100 looked good on demonstration, but I shall consider buying an autorouter only if I have a job which is not otherwise practicable.

Conclusion

CAD software proved to be a heavy investment, but it allows me to do work which I could not otherwise economically undertake. It is becoming a virtual necessity to use

some sort of CAD in electronics design.

Looking back, it might have been better if I had initially bought a low cost CAD package such as (had it been available at the time) the cheapest version of Boardmaker. This would have helped me to discover some of the questions I needed to ask about any CAD package before investing in a full-function one. Whether I would then have decided that a fully suitable package was too expensive for me, or gone ahead to look for such a one, it would have given me longer to survey the market and the market itself longer to develop to meet my need. I may then very well have chosen RHL3, spending more but avoiding some of the anguish with earlier versions of the package.

As for the quality of the package I am using, it is very high. I have heard claims that it is the best on the market in its price range, and that may be true. Certainly I can do all I need to with it, and so far it has been updated (for a substantial annual maintenance charge) to take account of developments in the field. Earth plane generation is easier, surface mount components are better supported, significant improvements have been added and minor snags resolved as they become obvious.

Getting into professional technology is a bit like placing savings in an investment fund or shares: it's a way of getting your money off you, and it is up to you to use your judgment to ensure that you get a reasonable return. If you do - everybody's happy. ■

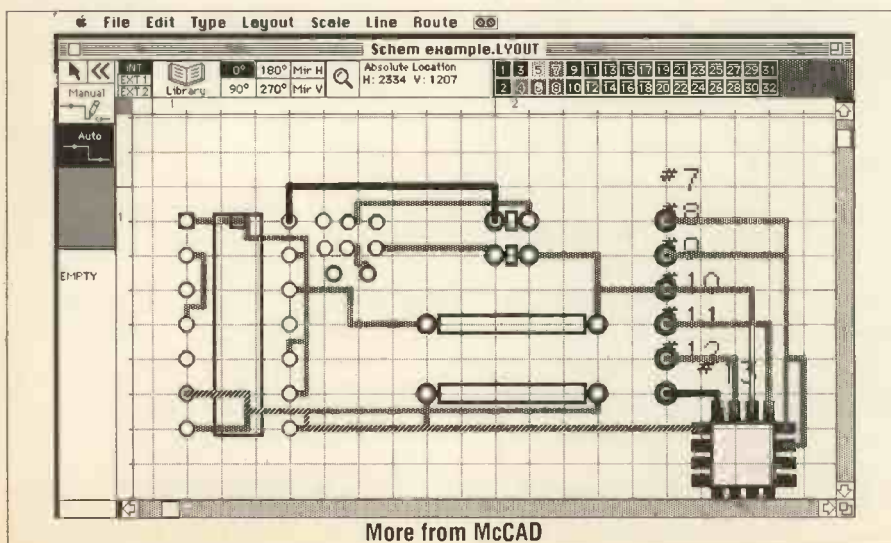

More from McCAD

Taking Control Of The Home Environment

Ian Burley's goodies this month include some in-flight entertainment, a new in-car navigation system for London and a house control system.

Interest in home automation and control has been riding very high in the US for several years. Unfortunately, not many practical advances have been made, though the Electronic Industries Association (EIA) in the US did formalise a set of home automation standards earlier this year.

Now we're beginning to see some progress. The Californian firm Group III Technologies Inc. has launched its SAMANTHA home automation system. SAMANTHA, believe it or not, is extracted from Security And MANagement Through Home Automation. The Samantha sales slogan is "The Lifestyle You Deserve at the Push of a Button."

Samantha's heart is a multi-buttoned unit looking at first glance like a trendy fax machine with its LCD display and telephone handset. It can't directly behave like a fax machine, but it can be adapted to act as an answering machine. In fact Samantha relies on the phone rather crucially. Through this link Samantha can monitor up to 15 rooms and many dozens of sensors and controllers as well as be accessible for re-programming or checking anywhere in the world where there's a phone.

The central unit, which is called a Personal Home Director (PHD), is basically a very very smart telephone. The PHD has an emergency call dialer, rechargeable battery back-up, audible synthesised context-sensitive help and 64 programmable macro sequences. Up to 15 rooms can be monitored and controlled by the PHD. In order to do this it must communicate with individual Room Directors via telephone

extensions. Each Room Director can be used as an intercom point, but more importantly they each act as a terminal to the PHD, which can be remotely controlled via the Room Director's compact keypad. Room Directors can also be fitted with an optional temperature sensor.

Once you've fitted Room Directors you can proceed to install a selection of sensors, sirens, and

appliance control modules. Where access to a phone socket is inconvenient, accessories are linked via radio.

Overall, Samantha can monitor the phone and be reprogrammed remotely from anywhere where another phone is available. It can control lighting, domestic appliances - including the central heating and monitor rooms for



SAMANTHA Security And MANagement Through Home Automatio

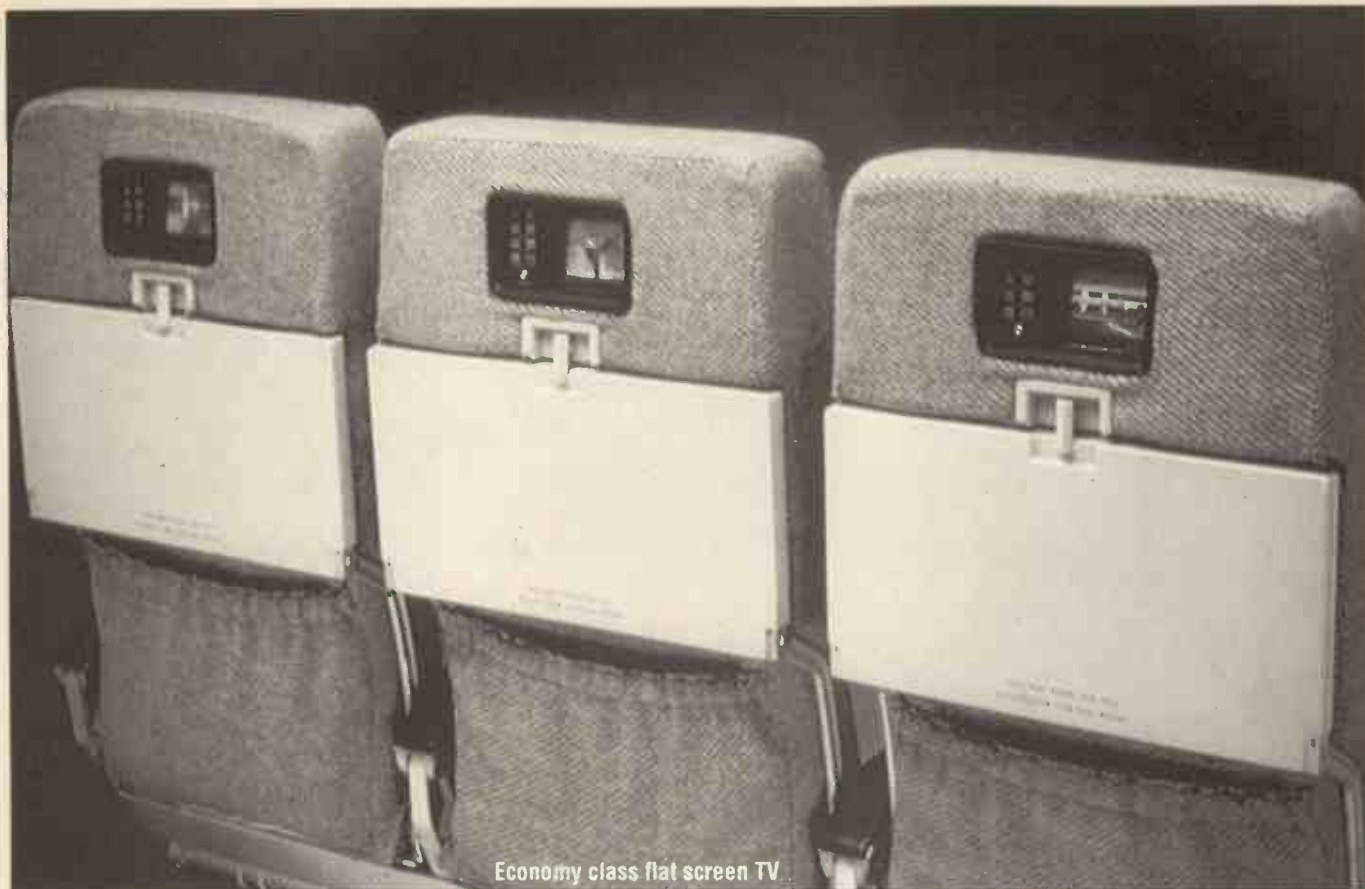

Economy class flat screen TV

security. It can dial out and alert the authorities, act as a paging system via the intercom facility. Samantha can remember pre-programmed memos and act as a very sophisticated alarm. It can even forward voice memos nominated phone numbers. And yes, there is a clock/calendar facility too! Some of the example applications suggested for Samantha include heating your morning coffee, keeping tabs on the kids (they can be required to enter a pass-code, say when they get back

from school), summoning the family for breakfast via the intercom, and so on.

It's difficult to evaluate such a system without getting one's hands on one, but the specifications make for interesting reading. How much does Samantha cost? A starter kit retails for \$1495 (£950). That may sound a lot, but isn't compared to dedicated alarm systems.

Group Three technologies is at 2125-B Madera Road, Simi Valley, CA 93065, Tel. (+44) 805 582 4410.

Fun In The Air

Virgin Atlantic has taken the very positive and forward thinking decision to abandon the old video projection system it and most other airlines have used for years to keep bored airline passengers reasonably occupied with the odd in-flight movie. The replacement is a personal LCD TV monitor, which can access a selection of channels, for every single passenger, including economy class. One of Virgin's 747s, the Shady Lady, flying the Boston or Newark New Jersey to Gatwick route, has already been fitted out with the new system, provided by Philips subsidiary, Airvision. First class passengers get a large, by LCD standards, six inch screen which is mounted on an adjustable arm from the seat arm-rest. Economy class passengers get either four or five inch screens which are mounted in the seat-back of the seat they face.

Reports received from people who have been lucky enough to fly the new Virgin plane are very encouraging. Picture quality is very good and the channel selection means you're not stuck with a movie everybody else has to put up with. Virgin's own research indicates that 96% of passengers



The Boss travels first class, of course.



The first class display offers an adjustable mount.

preferred the personal displays.

A selection channels are available ranging from a choice of movies to pop videos and a kid's

channel. The rest of Virgin's fleet of 747s will be refitted with the Airvision system by this time next year. So far Virgin is the only airline

to have committed to the new Airvision system, but Airvision's Pieter Souren expects orders to pick up once the recession is over.



Autoguide in action.

More Fun In The Air

Trialled on Qantas Airways and likely to be adopted by progressive airlines any time is the perfect accessory for the Airvision video network. It's a direct link into the plane's flight navigation computer. This system has been devised by Asinc Inc. in Tustin California and it's called the Airshow cabin Video Information System. It can answer those burning mid-flight questions like "How high are we?", "When will we arrive?", "Where are we?" and even "Where do I go to catch my connecting flight." The Airshow display is selectable as any normal inflight channel would be. The default display is a text-only read-out of information so:

Time to Destination	4:14
Wind Speed	53 km/h
Outside Air Temperature	-55'C
Wind Direction	240 deg
Distance to Destination	1,143 km
Altitude	10,820 m

The information displayed is real-time, but even more impressive is a colour map display which highlights nearby towns and cities and shows the plane's path over the last few hundred miles. The attitude of the plane symbol indicates its heading. You can watch the plane symbol turn in real time as the real thing manoeuvres on the runway for example. Three map resolutions are selectable to provide long distance, medium distance and a localised view of the region currently being over-flown. With the latter option you should be able to recognise coastal outlines and other major landmarks.

Besides real-time inflight data, Airshow can be patched into the destination airport's departure information system so you can see whether or not you're going to miss your connecting flight. It's even possible to select a map of the airport so you know exactly where to head for once you've arrived. Airlines are also able to incorporate their own custom graphics and ancillary information.

Although I haven't yet had the privilege of playing with an Airshow monitor just yet, I've managed to locate somebody who has. His opinion was that it was quite fascinating, though the net effect of staring at the display during the flight was to make it seem much longer than usual, which can't be very desirable on long-haul flights!

London Transport

The Department of Transport is at an advanced stage in negotiating a contract with GEC Marconi to provide London with an Autoguide system to shepherd hard-pressed motorists around the Capital's clogged traffic system. Autoguide would complement the existing Traffic Master system which is currently on offer to motorway users.

Autoguide has been in existence in prototype form since 1987. The idea is that car's are fitted with an electronic device which gathers information from either microwave or infra-red beacons at strategic places all over the capital within the M25 boundary. Another possibility is to use buried inductance loops,

though it's likely this method will be rejected on the grounds of cost and unreliability.

The beacons act as invisible electronic sign posts which the in-car computer can read. The beacons are connected via phone lines to a central master computer system. Besides the beacons there will traffic flow sensors which the central computers will rely on to make strategic decisions advising motorists which way to go. After last month's feature on Fuzzy Logic, this sounds like an ideal application of for that technology. The end result is that the in-car computer's simple LCD display will flash warnings of impending

problems and advise the driver to turn off his previously desired heading. A voice-synthesiser is another option.

The DoT is confident that once implemented, Autoguide could make a big impact on the Capital's chronic and worsening traffic flow problems. Trials of similar systems in Germany have not been so successful, but feeling is that London's road system is an ideal candidate for Autoguide. The target is to reduce the cost of the in-car unit to a price roughly comparable to a decent radio-cassette player. In the long run the system could save millions of pounds in wasted fuel and time. ■

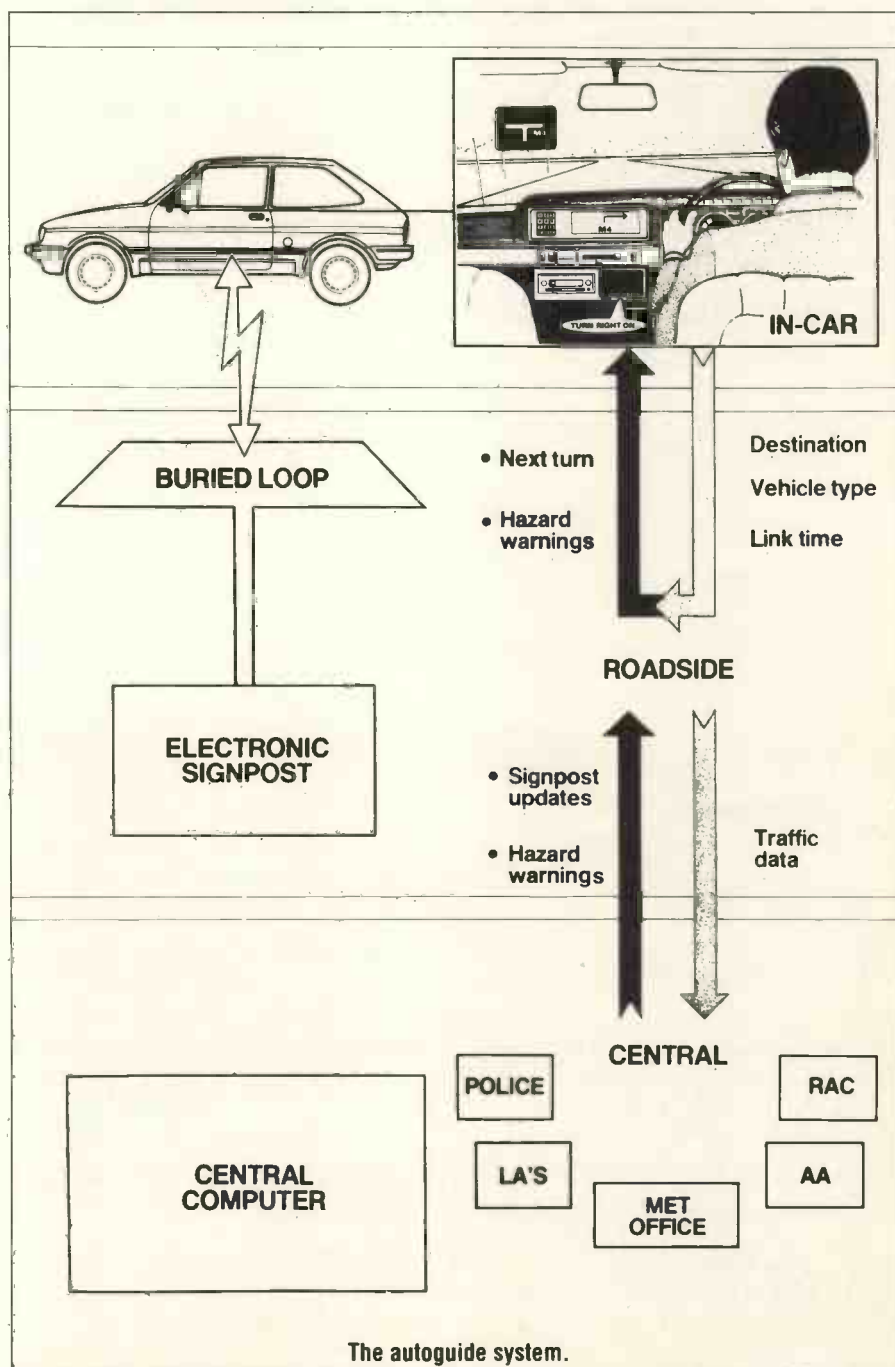

The autoguide system.

EASY-PC, SCHEMATIC and PCB CAD

Over 9000 Installations
in 50 Countries Worldwide!

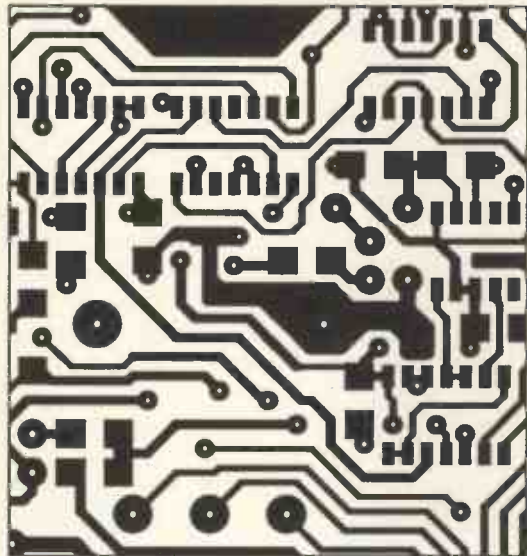

- Runs on:- PC/XT/AT/286/386/486 with Herc, CGA, EGA or VGA display.
- Design:- Single sided, Double sided and Multilayer boards.
- Provides Surface Mount support.
- Standard output includes Dot Matrix / Laser / Inkjet Printer, Pen Plotter, Photo-plotter and N.C. Drill.
- Superbly easy to use.
- Not copy protected.

Still Only £98.00!
Plus P&P+VAT

BRITISH DESIGN AWARD 1989

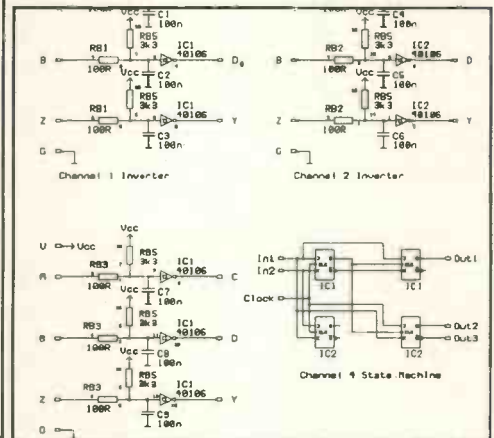

Options:

1000 piece Symbol Library £38, Gerber Import facility £98

DIGITAL SIMULATION PULSAR £195

SMITH CHART CAD Z-MATCH II £195

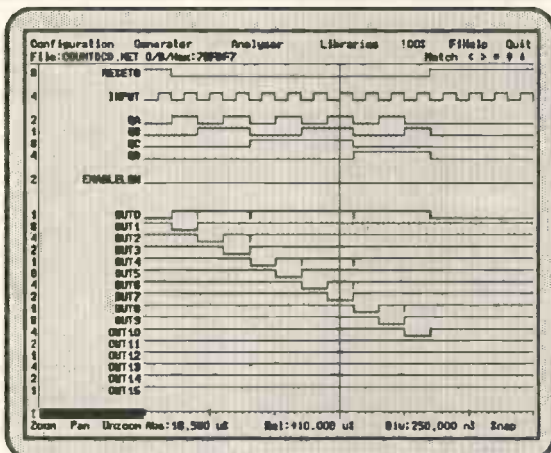

- At last! A full featured Digital Circuit Simulator for less than £1000!
- Pulsar allows you to test your designs without the need for expensive test equipment.
- Catch glitches down to a pico second per week!
- Includes 4000 Series CMOS and 74LS Libraries
- Runs on PC/XT/AT/286/386/486 with EGA or VGA.
- Not Copy protected.

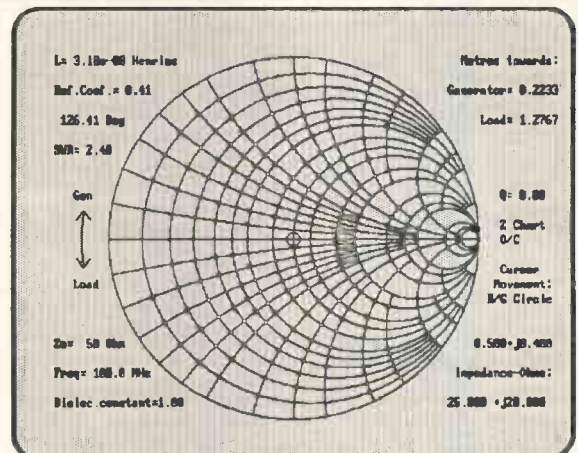

- Z-MATCH II simplifies RF matching and includes many more features than the standard Smith Chart.
- Handles transmission line transformers, stubs, discrete components, S Parameters etc.etc..
- Supplied with many worked examples.
- Superbly easy to learn and use.
- Runs on IBM PC/XT/AT/386/486, CGA, EGA, VGA.
- Not Copy protected.

For full information, Write, Phone or Fax:

Number One Systems Ltd.

REF: PE, HARDING WAY, ST. IVES, HUNTINGDON, CAMBS, ENGLAND, PE17 4WR.

Telephone: 0480 61778 (7 lines) Fax: 0480 494042

International: + 44 -480-61778, I'Fax: + 44-480-494042 ACCESS, AMEX, MASTERCARD, VISA Welcome.

The Electronics CAD Specialists

Refreshing The Silver Screen

Paul Kennedy explains the basics of computer displays from CRTs through gas plasma to the latest supertwist LCDs.

Probably the most obvious trend in the computer business is the movement towards smaller and more powerful machines. A number of technologies have been developed to allow this to happen, the most vital being the high resolution flat screen liquid crystal display.

The first computers used printers to display their results and many mainframes still use this method. However, to allow the machine to be used interactively in applications such as wordprocessors, spreadsheets, computer graphics, indeed, all of the things we now take for granted from computer, some sort of high speed display is needed.

The first, and still most common, form of output device is the VDU or visual display unit. This is basically a cathode ray tube that shows a matrix of characters in the, now familiar, row by column format. Early personal computers allowed

alpha-numeric characters only (A to Z and 0 to 9), possibly with upper case or possibly with an alternative graphics character set of lines and squares and pictures made up on an 8x8 pixel matrix – the pixel is the smallest picture element or dot on the screen (Fig. 1.), unfortunately, they couldn't be controlled individually. Fig. 2. shows how characters on a screen are made up from small squares which the viewer's eye joins together when seen from a distance. What can't be seen is the blurring effect caused by the phosphors which runs the characters together making any gaps invisible. The idea of a bit image screen was still in the future since most machines didn't have the memory or processing capabilities to deal with anything more sophisticated than a 40x25 or possibly 80x25 matrix. With the increase in memory capacity and the development of specialised graphics chips, computers

eventually developed rudimentary graphics capabilities. The advent of computer games which went through a huge development during the same period highlighted the new capabilities which included colour and increased resolution.

Memory To Screen

The computer image to be displayed is always held in memory somewhere. The format and method used to transfer it to the display vary from system to system. The commonest character only display system holds the 8-bit number of each character (0 to 255) in an contiguous area of RAM starting with the top left and moving down in lines from left to right until the bottom right is reached. For a 40x25 character screen this means 1000 bytes devoted to the screen. Fairly simple computer programs can be used to manipulate the memory allowing characters to be moved around on the display. To get a picture of the contents of the memory, the video system scans the appropriate area of memory converting each character number into an image, usually on an 8x8 dot matrix, which is then used to control brightness of the electron beam. The device which does all of the work is known as a CRTC or cathode ray tube controller and, at it simplest, transfers memory data to screen data. More sophisticated systems allow the shapes of the characters to be defined in RAM and hence altered. Graphics are also usually possible with 8-bits in memory being used to control eight pixels. This requires more memory since a display with 320 pixels by 200 lines,

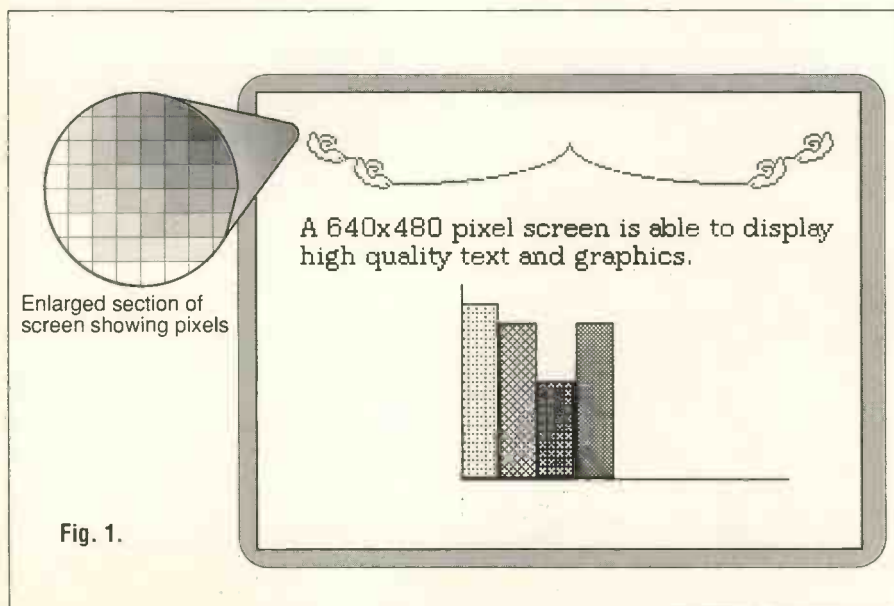

Fig. 1.

Liquid Crystal Displays

Early LCDs had a number of undesirable properties. They were slow, could only really be viewed from directly in front and had relatively low resolution. Despite this, they required very little power and were fairly robust.

The operation of an LCD is based upon effects produced by special materials which exist in a state between liquid and solid. The materials which exhibit this unusual state or phase are organic and have large rod-like molecules. A normal liquid has no order or symmetry in its makeup and individual elements are free to move and orientate as they like. In a crystalline solid, the opposite is true, there is a definite fixed structure. Liquid crystals exist in between these two and have a mix of the characteristics. The large molecules are free to rotate to a certain extent but also have an overall fixed structure.

Liquid crystals are sensitive to temperature, pressure, electric and magnetic fields, all of which affect their optical properties. The normal method of controlling the crystals is to use an electric field which acts across the material and causes light to be transmitted or polarised in different ways. There are actually three different types of liquid

crystal, nematic, smectic and cholesteric of which the first is the most common.

The twisted nematic structure is shown in Fig. a. This is set up by sandwiching the liquid crystal between two grooved plates, the top one at right angles to the bottom. In its normal, un-electrified, state it has a twist which rotates any light passing through it by 90°. When an electric field is applied, the crystals line up and the light passed straight through. To make this work as a light valve, two light polarisers are placed next to the plates with their polarisation directions the same as their adjacent plates. In its relaxed state, light passing through the back polariser will be rotated through 90° by the crystal to pass through the front polariser which is at right angles to that at the back. Applying an electric field untwists the crystal and removes the 90° polarisation and any light attempting to pass through the sandwich is blocked.

An LCD can operate in two main ways, by allowing light to enter from the front and reflect off a back layer and then exit back through the front. Alternatively, a backlight can be used with the crystal interrupting it where necessary.

To obtain a useable display, a

number of pixels (picture elements) must be defined and each must have individual control. There are a number of ways of achieving this. In theory, each pixel could have its own electrodes but any sizable display would require a vast number of connections. An alternative is to use a multiplex system where a row of pixels are serviced by a one single conductor and a column by another at right angles. By stepping through the rows in sequence and applying the column information, the number of connections is drastically reduced. The drawback of this is that the contrast gets worse with an increase in the number of pixels.

The advent of supertwist LCD technology a few years ago improved contrast and viewing angles, increased resolution and provided access to a number of grey levels. Displays that offer 640 x 480 pixels with 32 grey levels are now becoming commonplace on modern laptop portable computers.

A supertwist LCD, as its name implies, rotates the light by more than 90°. In fact it rotates it by about 30,000 degrees per millimetre. To make an display from this material, it is sandwiched between two very flat glass layers as well as the polarisers. By setting

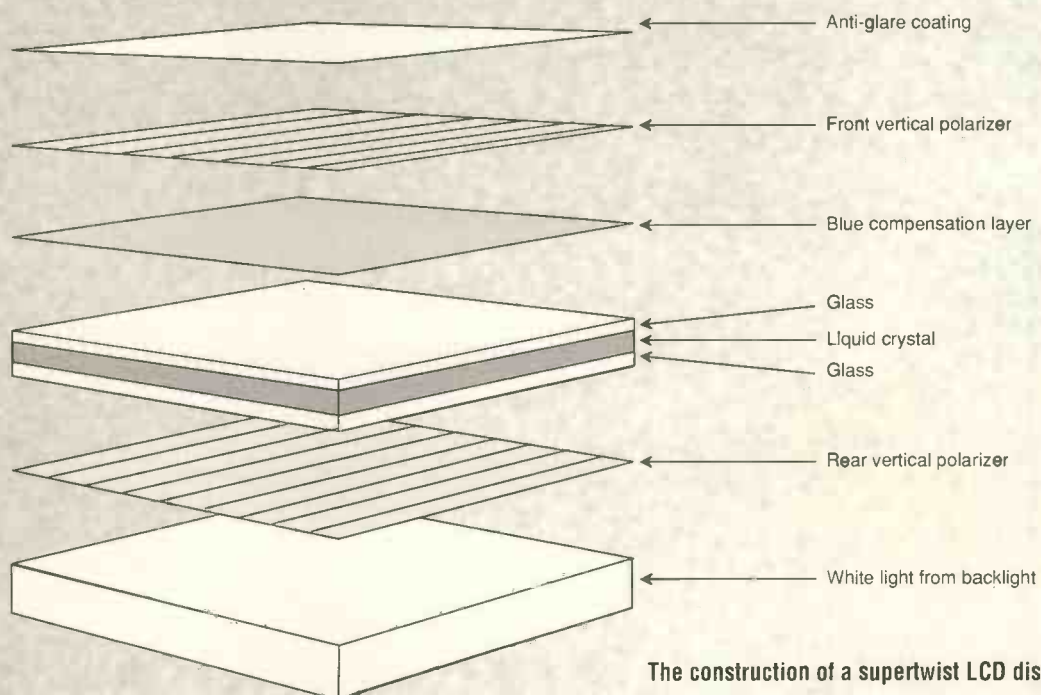

The construction of a supertwist LCD display.

the thickness of the crystal layer exactly, a net rotation of 90° can be set up. Unlike the twisted nematic display, the polarisers on each side of the crystal are the same way around. When an element is off, light enters the first polariser and is given a 90° twist. This goes to the final polariser and is not allowed through. Applying an electric field to the crystal untwists it removing the 90° twist so that it can pass straight through the front polariser. The net result is that an on pixel appears black and an off one white.

The main drawback with supertwist LCDs is that they don't affect the whole spectrum in the same way. Blue light is twisted by a different amount to the rest giving the whole display a bluish tinge. By using a crystal that affects blue more than other colours, this can be corrected to give a reasonable black and white image. During the scanning process, turning the pixels on and off at high speed produces different amounts of light transmission and gives the grey levels.

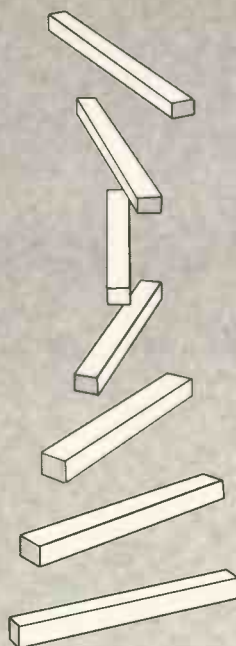

Fig a. A twisted nematic crystal.

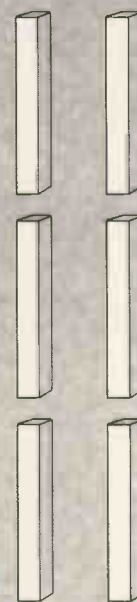

Fig. b. The twisted nematic under an electric field.

Gas Plasma

The nearest thing to a rival for the LCD is the gas plasma display. This uses the fact that in a low pressure gas, an electric current can be passed that excites the gas atoms and causes them to glow.

Normally gasses are relatively good insulators but when they are used at low pressures and with high voltages, breakdown of this insulation occurs and electrons will pass through. Each electron leaving the negative electrode or cathode hits a gas molecule which then becomes ionised and has enough energy to hit another gas atom causing an avalanche or negative particles to stream toward the anode. The excitation of the gas in this way causes it to glow with a colour that is characteristic of the gas used. The most efficient is neon which gives out orange light. The disadvantage of the system is that it requires about 100 to 200 volts to cause the discharge to start. However, low cost and high brightness means that they find many uses in applications where a CRT is too bulky, for example, luggable computers – these are generally designed to be used with the mains but transportable from location to location.

As with LCDs, a multiplexing system is used to address individual pixels or elements of the display. The simplest system uses a set of electrodes on the bottom of the

display at right angles to a set on the top with small cavities, in the position of each pixel, between the two – see illustration.

Turning on a cavity requires a voltage above a certain threshold level. By setting one of the electrodes to half of this value and then the other to the opposite half, only the cavity where they cross will have the full voltage and turn on. This means that an array of, for example, 10 x 10 pixels only needs 20 connections.

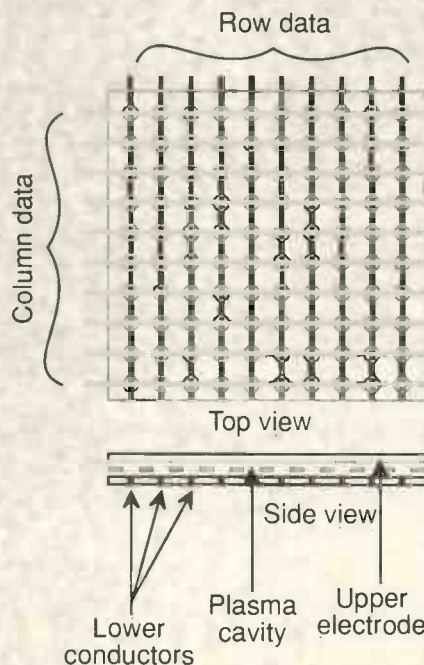

The operation of a gas plasma display.

The Cathode Ray Tube

The operation of the CRT was a fairly logical extension of early valve technology. A heater emits electrons which are attracted down the length of the tube to smash into the phosphors at the other end. The collisions generate photons of light which are emitted from the viewing end of the tube. The electrons can be constrained into a narrow beam by focussing coils and steered around the face of the tube either by more electric coils or by electrostatic plates. By scanning the stream of electrons across the face of the tube starting at the top left and tracing out horizontal lines until the bottom right is reached, a square picture of raster scan

image can be built up. As the beam moves across the tube, its intensity can be varied by altering the power to the heater causing the phosphors to emit more or less light, giving a monochrome image of varied levels.

To obtain colour, three phosphors are used, one for each of the primary colours, red, green and blue. By utilising three electron guns and steering the beam in the right way, a colour image can be built up.

To make sure that the electron beams hit the correct phosphors, a mask is used. This also determines the resolution or number of pixels that it is possible to display.

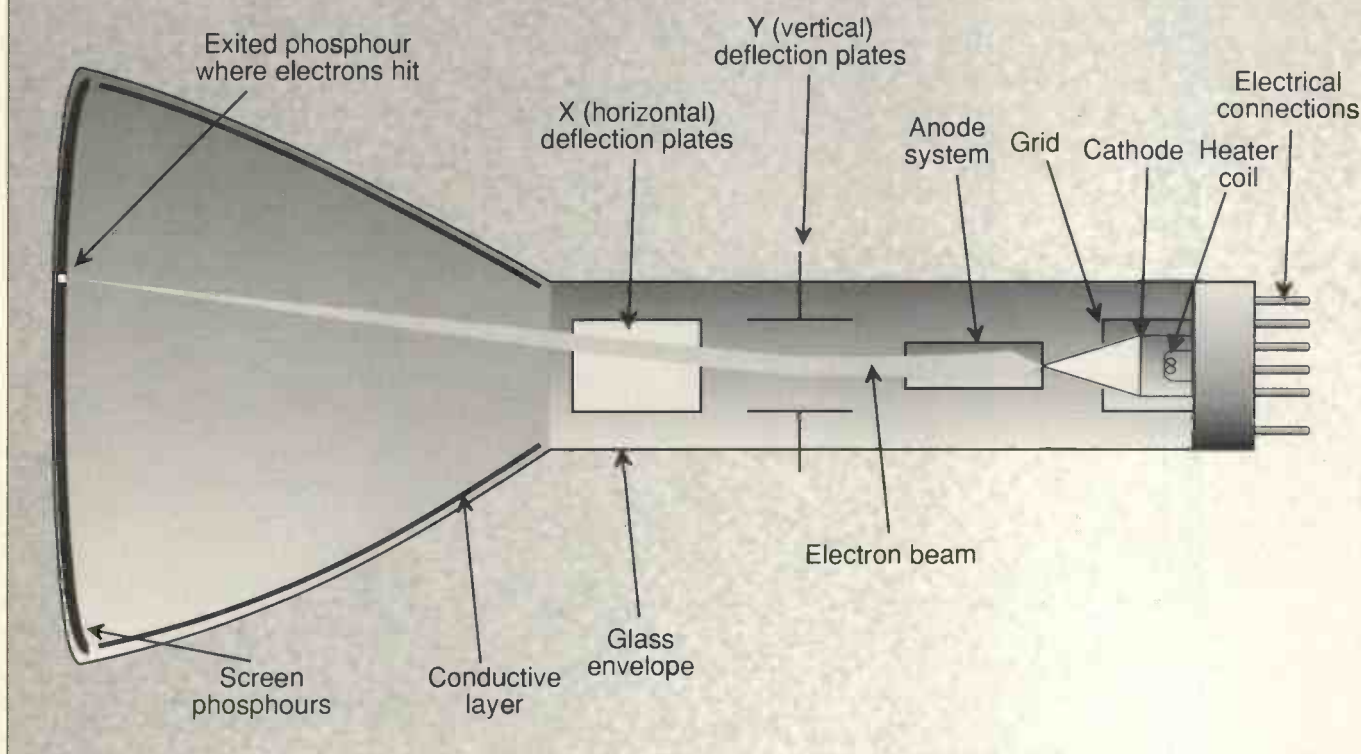

which is the same as 40 characters in 25 rows based on an 8x8 matrix, now requires 8000 bytes – 40 bytes gives 320 pixels and there are 200 rows. The addition of colour

increases the memory requirement yet again since additional information is needed. For example a 320 x 200 display with 16 colours requires 320 x 200 x 4 bits (the 4 bits

allow 16 colours to be defined) or 32000 bytes. Modern VGA (Video Graphics Array) displays used on IBM PCs and compatibles allow 640 x 480 with up to 256 colours and hence 300k or so of memory. There are other systems which allow fewer colours but select them from a large palette – super VGA provides 1024 x 768 x 256 colours selected from a palette of 256,000 – the picture on the front cover of the magazine give some idea of the quality possible.

The future of the computer display still lies with the CRT for the near future. However, the development of colour LCDs and other devices such as the Private Eye, which projects an image of the screen directly onto the retina of the eye, could see the dream of the badge sized super computer come true. ■

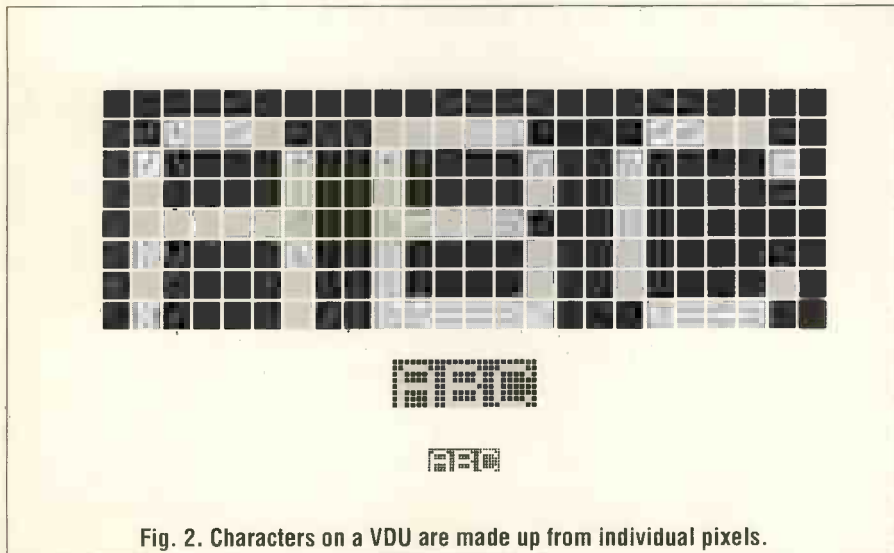

Fig. 2. Characters on a VDU are made up from individual pixels.

UNIDEN SATELLITE RECEIVER Brand new units (model 800B) £60.00 ref 60P4T also some 7007s also £60.00 ref 60P5T

SPECTRUM +2 COMPUTER Built in data recorder, 128K, psu and manuals £59.00 ref 59P4T

SPECTRUM +3 COMPUTER Built in disc drive, 128K, psu and manuals £79.00 ref 79P4T

AMSTRAD CPC464 COMPUTER No manuals but only £79.00 ref 79P5T

AMSTRAD CPC6128 COMPUTER Again no manuals but only £149.00 ref 149P4T

AMSTRAD GT65 Green screen monitor £49.00 ref 49P4T

AMSTRAD PORTABLE PC'S FROM £149 (PPC1512SD).

£179 (PPC1512DD), £179 (PPC1640SD), £209 (PPC1640DD), MODEMS £30 EXTRA. NO MANUALS OR PSU.

AMSTRAD PC BARGAIN!!!!!!

PC 1512DD COMPLETE WITH CGA COLOUR MONITOR, 2 DISC DRIVES, MANUALS ETC ONLY £249.00 REF 249P4T

HIGH POWER CAR SPEAKERS. Stereo pair output 100w each. 4ohm impedance and consisting of 6 1/2" woofer 2" mid range and 1" tweeter. Ideal to work with the amplifier described above. Price per pair £30.00 Order ref 30P7T.

2KV 500 WATT TRANSFORMERS Suitable for high voltage experiments or as a spare for a microwave oven etc. 250V AC input. £10.00 ref 10P93T

MICROWAVE CONTROL PANEL. Mains operated, with touch switches. Complete with 4 digit display, digital clock, and 2 relay outputs one for power and one for pulsed power (programmable). Ideal for all sorts of precision timer applications etc. £6.00 ref 6P18T

FIBRE OPTIC CABLE. Stranded optical fibres sheathed in black PVC. Five metre length £7.00 ref 7P29T

12V SOLAR CELL. 200mA output ideal for trickle charging etc. 300 mm square. Our price £15.00 ref 15P42T

PASSIVE INFRA-RED MOTION SENSOR. Complete with daylight sensor, adjustable lights on timer (8 secs -15 mins), 50' range with a 90 deg coverage. Manual override facility. Complete with wall brackets, bulb holders etc. Brand new and guaranteed. £25.00 ref 25P24T.

Pack of two PAR38 bulbs for above unit £12.00 ref 12P43T

VIDEO SENDER UNIT Transmit both audio and video signals from either a video camera, video recorder or computer to any standard TV set within a 100' range (tune TV to a spare channel).

12v DC op. £15.00 ref 15P39T Suitable mains adaptor £5.00 ref 5P191T

FM TRANSMITTER housed in a standard working 13A adapter (bug is mains driven). £26.00 ref 26P2T

MINIATURE RADIO TRANSCEIVERS A pair of walkie talkies with a range of up to 2 kilometres. Units measure 22x52x155mm. Complete with cases. £30.00 ref 30P12T

FM CORDLESS MICROPHONE. Small hand held unit with a 500' range! 2 transmit power levels reqs PP3 battery. Tuneable to any FM receiver. Our price £15 ref 15P42AT

10 BAND COMMUNICATIONS RECEIVER. 7 short bands, FM, AM and LWDX/local switch, tuning 'eye' mains or battery. Complete with shoulder strap and mains lead **NOW ONLY £19.00!! REF 19P14T.**

WHISPER 2000 LISTENING AID. Enables you to hear sounds that would otherwise be inaudible. Complete with headphones. Cased. £5.00 ref 5P179T.

CAR STEREO AND FM RADIO. Low cost stereo system giving 5 watts per channel. Signal to noise ratio better than 45db, wow and flutter less than .35%. Neg earth. £25.00 ref 25P21T.

LOW COST WALKIE TALKIES. Pair of battery operated units with a range of about 150'. Our price £8.00 a pair ref 8P50T

7 CHANNEL GRAPHIC EQUALIZER. plus a 60 watt power amp! 20-21KHz 4-8R 12-14v DC negative earth. Cased. £25 ref 25P14T.

NICAD BATTERIES. Brand new top quality. 4 x AA's £4.00 ref 4P44T. 2 x C's £4.00 ref 4P73T. 4 x D's £9.00 ref 9P12T. 1 x PP3 £6.00 ref 6P35T

TOWERS INTERNATIONAL TRANSISTOR SELECTOR GUIDE. The ultimate equivalents book. Latest edition £20.00 ref 20P32T.

CABLE TIES. 142mm x 3.2mm white nylon pack of 100 £3.00 ref 3P104T. Bumper pack of 1,000 ties £14.00 ref 14P6T

VIDEO AND AUDIO MONITORING SYSTEM

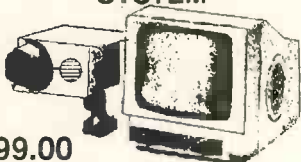

£99.00

Brand new units consisting of a camera, 14cm monitor, 70 metres of cable, AC adaptor, mounting bracket and owners manual. 240V AC or 12v DC operation complete with built in 2 way intercom. £99.00 ref 99P2T.

1991 CATALOGUE AVAILABLE NOW IF YOU DO NOT HAVE A COPY PLEASE REQUEST ONE WHEN ORDERING OR SEND US A 6"x9" SAE FOR A FREE COPY.

GEIGER COUNTER KIT. Complete with tube, PCB and all components to build a battery operated geiger counter. £39.00 ref 39P1T

FM BUG KIT. New design with PCB embedded coil. Transmits to any FM radio. 9v battery req'd. £5.00 ref 5P158T

FM BUG Built and tested superior 9v operation £14.00 ref 14P3T

COMPOSITE VIDEO KITS. These convert composite video into separate H sync, V sync and video. 12v DC. £8.00 ref 8P39T.

SINCLAIR C5 MOTORS 12v 29A (full load) 3300 rpm 6"x4" 1/4"

O/P shaft. New. £20.00 ref 20P22T.

As above but with fitted 4 to 1 inline reduction box (800rpm) and toothed nylon belt drive cog £40.00 ref 40P8T.

SINCLAIR C5 WHEELS 13" or 16" dia including treaded tyre and inner tube. Wheels are black, spoked one piece poly carbonate. 13" wheel £6.00 ref 6P20. 16" wheel £6.00 ref 6P21T.

ELECTRONIC SPEED CONTROL KIT for C5 motor. PCB and all components to build a speed controller (0-95% of speed). Uses pulse width modulation. £17.00 ref 17P3T.

SOLAR POWERED NICAD CHARGER. Charges 4 AA nicads in 8 hours. Brand new and cased £6.00 ref 6P3T.

MOSFETS FOR POWER AMPLIFIERS ETC. 100 watt mosfet pair 25J99 and 25K343 £4.00 a pair with pin out into ref 4P51T. Also available is a 25K413 and a 25J118 at £4.00 ref 4P42T.

12 VOLT BRUSHLESS FAN 1/2" square brand new ideal for boat, car, caravan etc. £5.00 ref 5P206T.

ACORN DATA RECORDER ALF503 Made for BBC computer but suitable for others. Includes mains adaptor, leads and book. £15.00 ref 15P43T

VIDEO TAPES. Three hour superior quality tapes made under licence from the famous JVC company. Pack of 10 tapes £20.00 ref 20P20T.

PHILIPS LASER. 2MW HELIUM NEON LASER TUBE. BRAND NEW FULL SPEC £40.00 REF 40P10T. MAINS POWER SUPPLY KIT £20.00 REF 20P33T READY BUILT AND TESTED LASER IN ONE CASE £75.00 REF 75P4T.

SOLDER 22SWG Gresin cored solder on a 1/2kg reel. Top quality. £4.00 a reel ref 4P70T.

600 WATT HEATERS Ideal for air or liquid, will not corrode, lasts for years. coil type construction 3"x2" mounted on a 4" dia metal plate for easy fixing. £3.00 ea ref 3P78T or 4 for £10.00 ref 10P76T.

TIME AND TEMPERATURE MODULE A clock, digital thermometer (Celsius and Fahrenheit (0-160 deg F) programmable too hot and too cold alarms. Runs for at least a year on one AA battery. £9.00 ref 9P5T.

Remote temperature probe for above unit £3.00 ref 3P60T

GEARBOX KITS Ideal for models etc. Contains 18 gears (2 of each size) 4x50mm axes and a powerful 9-12v motor. All the gears etc are push fit. £3.00 for complete kit ref 3P93T.

ELECTRONIC TICKET MACHINES These units contain a magnetic card reader, two matrix printers, motors, sensors and loads of electronic components etc. (12"x12"x7") Good value at £12.00 ref 12P28T.

JOYSTICKS Brand new with 2 fire buttons and suction feet these units can be modified for most computers by changing the connector etc. Price is 2 for £5.00 ref 5P174T.

GAS POWERED SOLDERING IRON AND BLOW TORCH Top quality tool with interchangeable heads and metal body. Fully adjustable, runs on lighter gas. £10.00 ref 10P130T

of 10 51/4" DSSD £5.00 ref 5P168T.

SONIC CONTROLLED MOTOR One click to start, two click to reverse direction, 3 click to stop! £3.00 each ref 3P137T.

FRESNEL MAGNIFYING LENS 83 x 52mm £1.00 ref BD827T.

LCD DISPLAY. 4 1/2 digits supplied with connection data £3.00 ref 3P77T or 5 for £10.00 ref 10P78T.

ALARM TRANSMITTERS. No data available but nicely made complex transmitters 9v operation. £4.00 each ref 4P81T.

100M REEL OF WHITE BELL WIRE figure 8 pattern ideal for intercoms, door bells etc £3.00 a reel ref 3P107T.

TRANSMITTER RECEIVER SYSTEM Originally made for nurse call systems they consist of a pendant style transmitter and a receiver with telescopic aerial 12v, 80 different channels. £12.00 ref 12P26T

CLAP LIGHT. This device turns on a lamp at a finger 'snap' etc. nicely cased with built in battery operated light. Ideal bedside light etc. £4.00 each ref 4P82T.

ELECTRONIC DIPSTICK KIT. Contains all you need to build an electronic device to give a 10 level liquid indicator. £5.00 (ex case) ref 5P194T.

UNIVERSAL BATTERY CHARGER. Takes AA's, C's D's and PP3 nicads. Holds up to 5 batteries at once. New and cased, mains operated. £6.00 ref 6P36T.

ONE THOUSAND CABLE TIES! 75mm x 2.4mm white nylon cable ties only £5.00 ref 5P181T.

PC MODEMS 1200/75 baud modems designed to plug into a PC complete with manual but no software £18.00 ref 18P12T

ASTEC SWITCHED MODE POWER SUPPLY 80mm x 165mm (PCB size) gives +5 at 3.75A, +12 at 1.5A, -12 at 0.4A. Brand new £12.00 ref 12P39T

VENTILATED CASE FOR ABOVE PSU with IEC filtered socket and power switch. £5.00 ref 5P190T.

IN CAR POWER SUPPLY. Plugs into cigar socket and gives 3, 4, 5, 6, 7, 5, 9, and 12v outputs at 800mA. Complete with universal spider plug. £5.00 ref 5P167T.

CUSTOMER RETURNED switched mode power supplies. Mixed type, good for spares or repair. £2.00 each ref 2P292T.

DRILL OPERATED PUMP. Fits any drill and is self priming. £3.00 ref 3P140T.

PERSONAL ATTACK ALARM. Complete with built in torch and vanity mirror. Pocket sized, req's 3 AA batteries. £3.00 ref 3P135T

POWERFUL SOLAR CELL 1AMP .45 VOLT only £5.00 ref 5P192T (other sizes available in catalogue).

SOLAR PROJECT KIT. Consists of a solar cell, special DC motor, plastic fan and turntables etc plus a 20 page book on solar energy! Price is £8.00 ref 8P51T.

RESISTOR PACK. 10 x 50 values (500 resistors) all 1/4 watt 2% metal film. £5.00 ref 5P170T.

CAPACITOR PACK 1. 100 assorted non electrolytic capacitors £2.00 ref 2P286T.

CAPACITOR PACK 2. 40 assorted electrolytic capacitors £2.00 ref 2P287T.

QUICK CUPPA? 12v immersion heater with lead and cigar lighter plug £3.00 ref 3P92T.

LED PACK. 50 red leds, 50 green leds and 50 yellow leds all 5mm £8.00 ref 8P52T

FERRARI TESTAROSSA. A true 2 channel radio controlled car with forward, reverse, 2 gears plus turbo. Working headlights. £22.00 ref 22P6T.

ULTRASONIC WIRELESS ALARM SYSTEM two units, one a sensor which plugs into a 13A socket in the area you wish to protect. The other, a central alarm unit plugs into any other socket elsewhere in the building. When the sensor is triggered (by body movement etc) the alarm sounds. Adjustable sensitivity. Price per pair £20.00 ref 20P34T. Additional sensors (max 5 per alarm unit) £11.00 ref 11P6T.

WASHING MACHINE PUMP. Mains operated new pump. Not self priming £5.00 ref 5P18T.

IBM PRINTER LEAD. (D25 to centronics plug) 2 metre parallel. £5.00 ref 5P186T.

COPPER CLAD STRIP BOARD 17" x 4" of .1" pitch "vero" board. £4.00 a sheet ref 4P62T or 2 sheets for £7.00 ref 7P22T.

STRIP BOARD CUTTING TOOL. £2.00 ref 2P352T.

3 1/2" disc drive. 720K capacity made by NEC £60.00 ref 60P2T

TV LOUDSPEAKERS. 5 watt magnetically screened 4 ohm 55 x 125mm. £3.00 a pair ref 3P109T.

SPEAKER GRILLS set of 3 matching grills of different diameters. 2 packs for £2.00 (6 grills) ref 2P364T

50 METRES OF MAINS CABLE £3.00 2 core black precut in convenient 2 m lengths. Ideal for repairs and projects. ref 3P91T

4 CORE SCREENED AUDIO CABLE 24 METRES £2.00

Pre-cut into convenient 1.2 m lengths Ref 2P365T

TWEETERS 2 1/4" DIA 8 ohm mounted on a smart metal plate for easy fixing £2.00 ref 2P366T

COMPUTER MICE Originally made for Future PC's but can be adapted for other machines. Swiss made £8.00 ref 8P57T. Atari ST conversion kit £2.00 ref 2P362T.

6 1/2" 20 WATT SPEAKER Built in tweeter 4 ohm £5.00 ref 5P205T

5" x 3" 16 OHM SPEAKER 3 for £1.00!! ref CD213T

ADJUSTABLE SPEAKER BRACKETS Ideal for mounting speakers on internal or external corners, uneven surfaces etc. 2 for £5.00 ref 5P207T

PIR LIGHT SWITCH Replaces a standard light switch in seconds light operates when anybody comes within detection range (4m) and stays on for an adjustable time (15 secs to 15 mins). Complete with daylight sensor. Unit also functions as a dimmer switch! 200 watt max. Not suitable for fluorescents. £14.00 ref 14P10T

2 MEG DISC DRIVES 3 1/2" disc drives made by Sony housed in a 5 1/4" frame 1.2 meg formatted. £66.00 ref 66P1T.

CUSTOMER RETURNED 2 channel full function radio controlled cars only £8.00 ref 8P200T

WINDUP SOLAR POWERED RADIO! FM/AM radio takes NICAD batteries complete with hand charger and solar panel 14P200T

240 WATT RMS AMP KIT Stereo 30-0-30 psu required £40.00 ref 40P200T

300 WATT RMS MONO AMP KIT £55.00 Psu required ref 55P200T

ALARM PIR SENSORS Standard 12v alarm type sensor will interface to most alarm panels. £16.00 ref 16P200T

ALARM PANELS 2 zone cased keypad entry, entry exit time delay etc. £18.00 ref 18P200T

35MM CAMERAS Customer returned units with built in flash and 28mm lens 2 for £8.00 ref 8P200T

STEAM ENGINE Standard Mamod 1332 engine complete with boiler piston etc £30

How It Works...

Supersonic Heterodyne

Radio expert Ian Poole describes the operation of the humble radio receiver with illustrations by Derek Gooding.

The transistor radio has to be one of the most common pieces of electronic equipment around the home. There is usually more than one in each household and they range from the very cheapest Medium Wave only sets all the way up to Hi-Fi tuners costing several hundreds of pounds. As well as being an integral part of everyday life, the transistor radio is also one of the oldest electronic gadgets in constant use.

Back In The War

Virtually all radios operate using a technique known as superhet. This word is derived from the term supersonic heterodyne which was introduced when the principle was first invented around the end of the First World War.

From the name it can be imagined that the system involves the beating or heterodyning of two high frequency signals. More specifically, the principle is based around the fact that when two signals are brought together in a non-linear electronic circuit then two further signals are produced which are at frequencies equal to the sum and the difference of the original two.

Mixing It Up

Looking at the operation of the receiver, the radio signal enters a circuit called a mixer where it interferes and "beats" with another signal from the local oscillator within the radio. The output from the mixer is then passed into an intermediate frequency or IF stage.

This consists of a series of fixed frequency filters and amplifiers. To give an example of the operation of the system, imagine that the local oscillator is running at 2.0MHz and the IF filter has a frequency of 0.5MHz. In this situation it will be possible for signals at 2.5MHz and 1.5MHz to be converted down to the frequency of the filter. In order to prevent signals on the two different frequencies from entering the filter some tuning is added to the radio frequency stages of the receiver.

Once the signal reaches the intermediate frequency stages it is amplified and filtered. The next step is called demodulation and involves recovering the audio from the radio frequency signal. In the case of amplitude modulation this can be done quite simply using a diode and a few other components.

All that remains is for the audio signal to be amplified so that it can be used to drive a loudspeaker or a pair of earphones.

Inside The Box

In virtually all transistor portable radios a ferrite rod aerial is provided to pick up Medium (525kHz to 1605kHz) and Long Wave (150kHz to 285kHz) transmissions. This type of aerial is relatively efficient for its size and being small it can be fitted into the case of the radio. Essentially it consists of a tuned coil wound around a length of ferrite. As the pickup coil is tuned it acts as the RF tuning for the receiver. For FM a separate extendable aerial has to be used as ferrite rod aeriels do not operate up to the frequencies used for FM (47MHz to 216MHz).

On the circuit board for the receiver there will be a main tuning capacitor. This has two sections to it. One for tuning the ferrite rod aerial coil and the other to tune the local oscillator. These two functions have to be carried out simultaneously, otherwise the oscillator and the RF tuning will not "track" together and they will be tuned to different frequencies. There are also two small preset adjusters on this capacitor. One for each section.

In addition to the tuning capacitor there is also a coil for the oscillator. This is housed in a screening can. In most cases the actual circuit for the oscillator and mixer is all based around a single transistor. Whilst this may not seem to lead to the best performance it is normally quite sufficient for domestic radios.

The IF amplifier will have tuned coils to give it selectivity. Generally the frequency of this amplifier will be around 455 kHz for AM and 10.7 MHz for FM. These coils will all be adjustable so that the amplifier can be tuned for the optimum results.

The detector normally consists of a single diode. From here the signal is passed to the volume control and then into the audio amplifier. In many cases the audio stages will only use transistors. If this is the case then the two output transistors can usually be identified by the fact that they are larger or mounted on a heatsink. Alternatively if an integrated circuit is used then it will usually have some form of heatsink arrangement. In some cases it may even use the copper on the printed circuit board ■

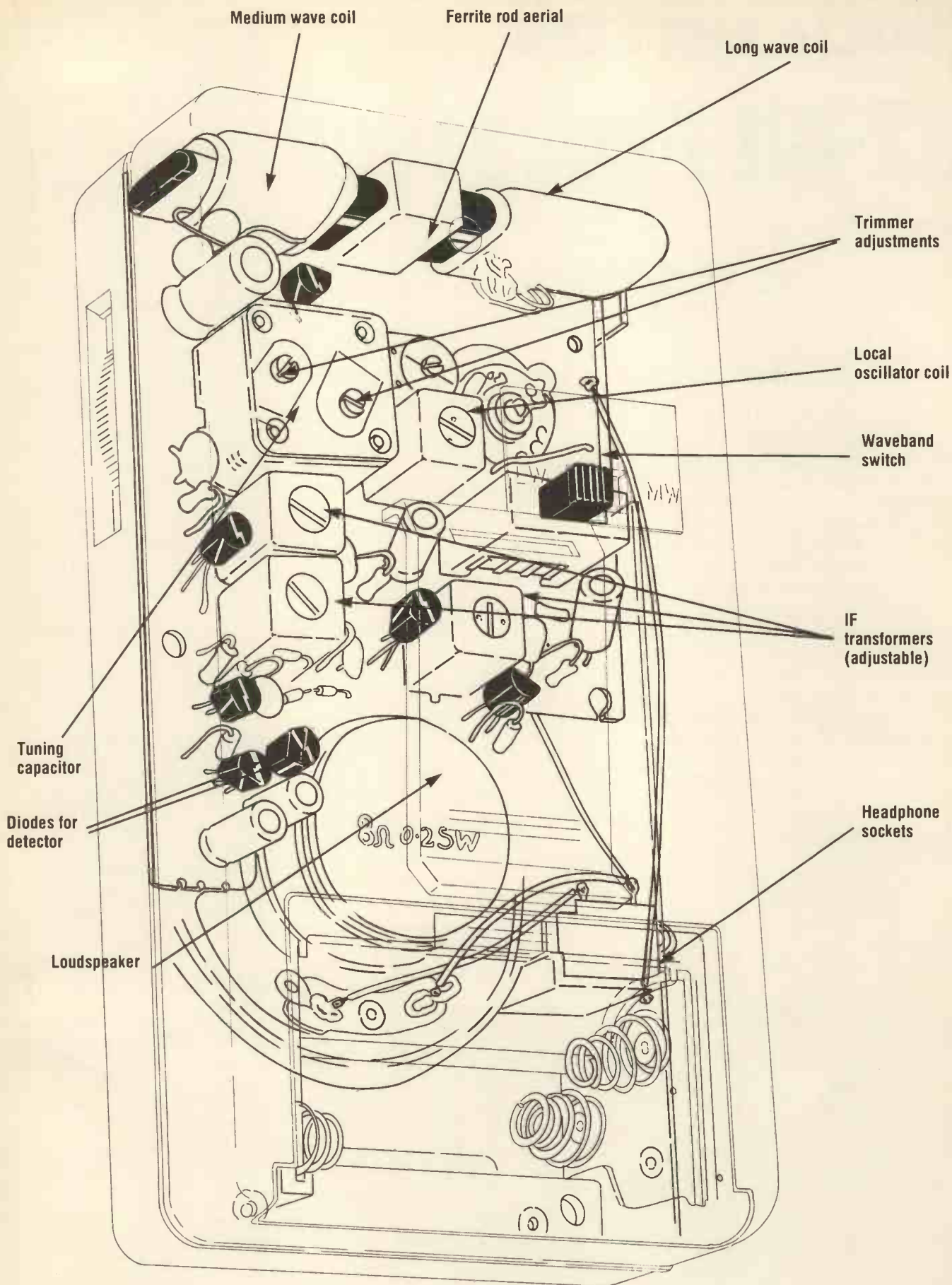

NS32CG160

32-Bit Processor

The NS32CG160 is one of National Semiconductors' Embedded System Processors aimed at office imaging peripherals. Featuring a 16Mb linear external address space and 16-bit external data bus, the chip incorporates a 32-bit arithmetic logic unit, instruction pipelining, an eight byte prefetch queue and a 16 x 16 bit hardware multiplier. Special attention has been given to graphics support with on chip bit block image transfer (BITBLT) which allows images to be manipulated at the processor level with a subsequent increase in speed. There are 18 dedicated graphics instructions as well as full support for floating point calculations via the NS32x81 coprocessors.

Built into the chip are a clock generator, three 16-bit timers, two DMA channels, 15 levels of interrupts and a power save system.

The architecture provides five main data types; bit, binary coded decimal, bytes, words and double words as well as facilities for array processing.

Image Transfer

BITBLT operations are used to move rectangular blocks of data around the memory area and hence any display device in use. There are seven instructions associated with the transfer, six being executed internally and one operating in conjunction with

an external BITBLT processing unit (BPU). The general purpose registers are loaded with information about the source and destination of the block to be moved, the base addresses, shift amounts, height, masks, warps and width.

Since memory is usually byte aligned it isn't possible to directly transfer data from one bit position to another - the bits usually relate to pixel positions. The get around this, the shift value is used to align to the word boundary where necessary. Unfortunately, the layout of memory doesn't directly correspond to the layout of a screen or printout and the warp value is needed to define the distance between two lines of the image in memory (in bits). The base address tells the processor where the image starts and the height and width tell it the size.

As well as simply moving bit images around, various processing operations can be executed. The logical functions AND, OR and XOR are performed on the source and destination data with the result being placed at the destination.

BITBLTs are useful in most computer graphics operations from simply printing characters onto the screen or drawing lines, to moving overlapping windows and filling areas. ■

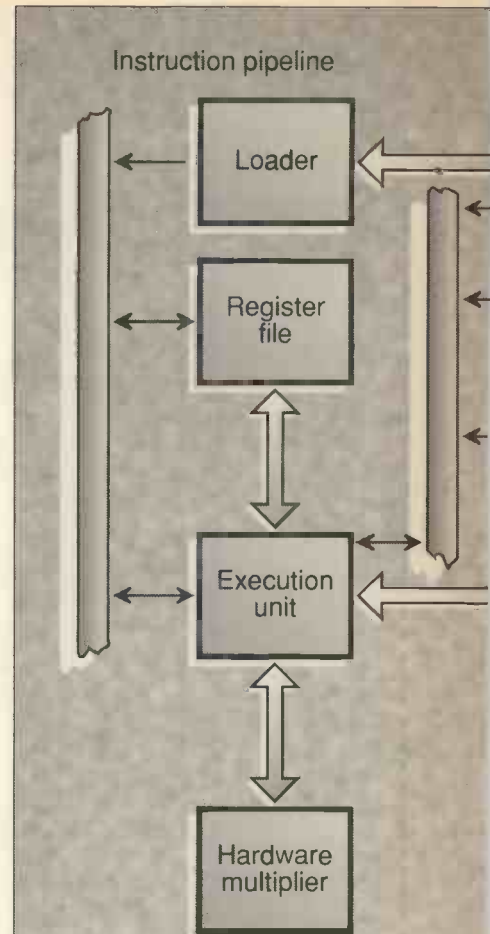

Block diagram of th

Instruction set

MOVES	Move a value
MOVQs	Move signed 4-bit constant
MOVMS	Move multiple
MOVZBW	Move with zero extension
MOVZID	Move with zero extension
MOVXBW	Move with sign extension
MOVXsD	Move with sign extension
ADDR	Move effective address
ADDs	Add
ADDQs	Add signed 4-bit constant
ADDCs	Add with carry
SUBs	Subtract
SUBCs	Subtract with borrow
NEGs	2s complement negate
ABSs	Get absolute value
MULs	Multiply
QUOs	Divide rounding to zero
REMs	Remainder from QUO
DIVs	Divide rounding down
MODs	Modulus
MEIs	Multiply and extend integer
DEIs	Divide, extend integer
ADDPs	Add BCD
SUBPs	Subtract BCD
CMPs	Compare
CMPQs	Compare quick
CMPMs	Compare multiple
ANDs	Logical AND
ORs	Logical OR

BITBLT Operation No.	Operation performed.
0	0
1	source AND destination
2	source AND - destination
3	source
4	-source AND destination
5	destination
6	source exclusive OR destination
7	source OR destination
8	-source AND -destination
9	source exclusive NOR destination
10	-destination
11	source OR -destination
12	-source
13	-source OR destination
14	-source OR -destination
15	1

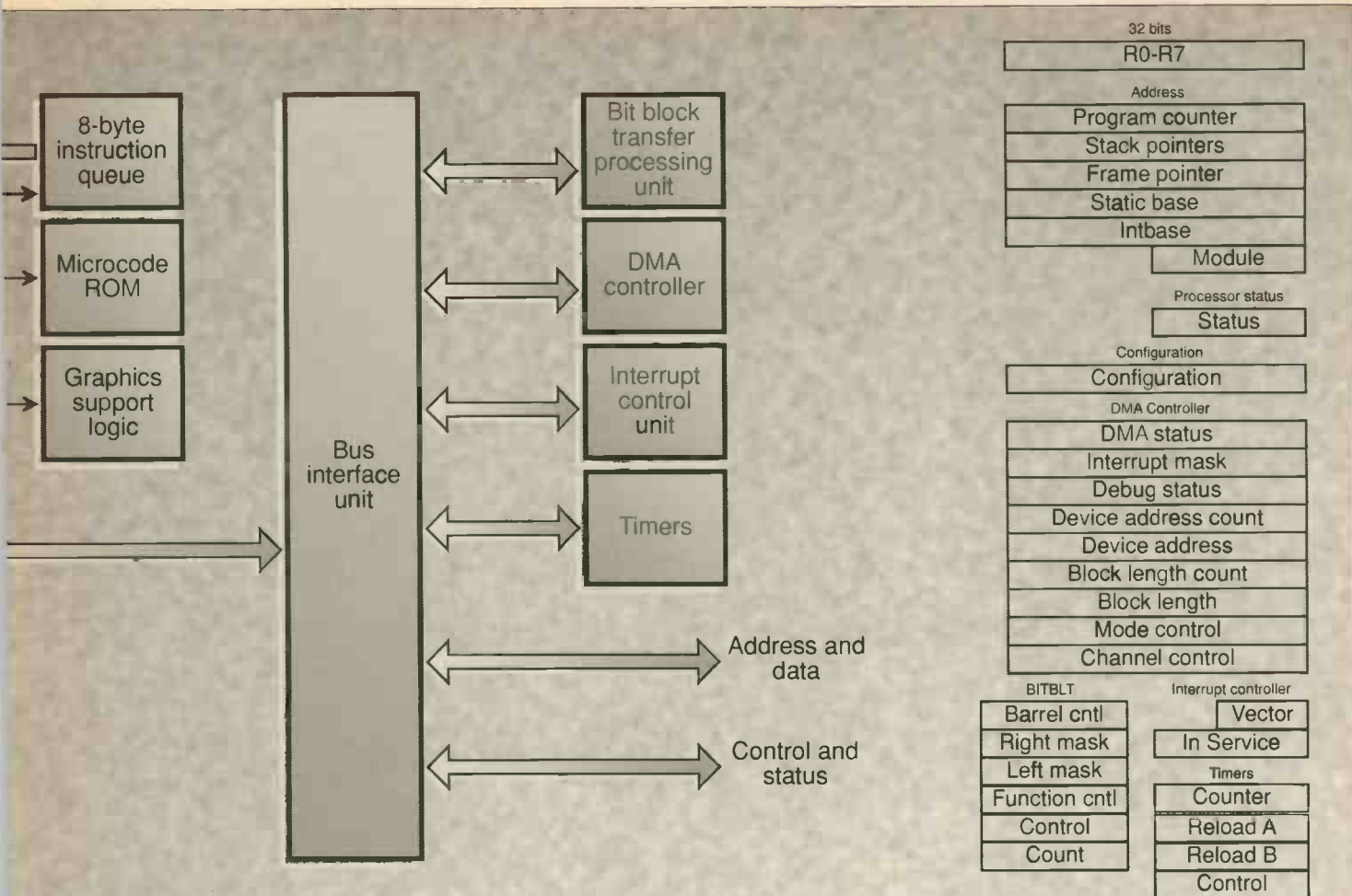

NS32CG160.

Internal registers.

BICs	Clear selected bits	FLAG	Flag trap	POLYn	Polynomial step
XORs	Logical exclusive OR	BPT	Breakpoint trap	DOTn	Dot product
COMs	Complement all bits	ENTER	Save regs and set stack	SCALBn	Binary scale
NOTs	Boolean complement	EXIT	Restore and reclaim stack	LOGBn	Binary log
Scnds	Save condition code	RET	Return from subroutine	NOP	Do nothing
LSHs	Logical shift left or right	RXP	Return from ext procedure	WAIT	Wait for interrupt
ASHs	Arithmetic shift left or right	RETTY	Return from trap	BBOR	Bit Align Block Transfer OR
ROTs	Rotate left or right	RETI	Return from interrupt	BBAND	BABT AND
EXTs	Extract bit field	SAVE	Save general purpose regs	BBFOR	BABT Fast OR
INSs	Insert bit field	RESTORE	Restore general regs	BBXOX	BABT XOR
EXTSs	Extract bit field	LPRs	Load dedicated register	BBSTOD	BAB source to dest
INSSs	Insert bit field	SPRs	Save dedicated register	BITWT	Bit aligned word transfer
CVTP	Convert to bit field pointer	ADJSPs	Adjust stack pointer	EXTBLT	External BABT
CHECKS	Index bounds check	BISPSRs	Set bits in status reg	MOVMPs	Move multiple pattern
INDEXs	Recursive indexing	BICPSRs	Clear selected status bits	TBITS	Test bit string
MOVSS	Move string	SETCFG	Set configuration register	SBITS	Set bit string
MOVST	Move and translate string	MOVn	Move FP value	SBITPS	Set bit perpendicular string
CMPSS	Compare strings	MOVLn	Move and shorten	TBITs	Test bit
CMPST	Compare and translate	MOVEFL	Move and lengthen	SBITs	Test and set bit
SKPSS	Skip over string	MOVSn	Convert int to std or long	SBITIs	Test and set bit interlocked
SKPST	Skip translating until/while	ROUNDs	Round to integer	CBITs	Test and clear bit
JUMP	Jump	TRUNCns	Truncate to integer	IBITs	Test and invert bit
BR	Branch relative	FLOORns	Convert to largest integer	FFSs	Find first set bit
Bcond	Conditional branch	ADDn	Add floating	s determines the integer length B = byte, W = word, D = double word. n determines the floating point length, F = standard floating, L = long floating.	
CASEs	Multiway branch	SUBn	Subtract floating		
ACBs	Add 4-bit const bra if NZ	DIVn	Divide floating		
JSR	Jump to subroutine	CMPn	Compare floating		
BSR	Branch to subroutine	NEGn	Negate floating		
CXP	Call external procedure	ABSn	Get absolute value		
CXPD	Call external with descriptor	LFSR	Load FSR		
SVC	Supervisor call	SFSR	Store FSR		

Practical Components: The Inductor

Inductors can be ranked with resistors and capacitors as the simplest of electronic components.

Inductors are found in many applications in electronics and especially in alternating current circuits. The way in which they react to varying currents is important in filters and tuned circuits.

The action of an inductor comes from the interaction between electrons and magnetic fields.

The Discovery

Induction first demonstrated by Michael Faraday (1791 – 1867) in 1831. He also laid the foundations for the idea of magnetic lines of force later developed by James Clerk Maxwell into classical field theory.

Joseph Henry (1797 – 1878), a US physicist discovered induction

and self induction but was pre-empted by Faraday who published his results first. Eventually Henry was honoured by having the unit of inductance H named after him.

A circuit has an inductance of one H if the current which flows through it changes at one amp per second and produces an electromotive force of one volt.

How It Works

The magnetic field f cutting through the coil at right angles to the front area is equal to the flux B times the area A :

$$f = BA$$

The electromotive force (EMF) E generated in the coil is depends upon the number of turns, N , and the changing magnetic field with time df/dt :

$$E = -Ndf/dt$$

From Ampere's law the magnetic flux or field strength B is defined as a constant c times the current I . c depends on the size, shape and number of turns of the coil. So:

$$B = cI$$

The interesting point about a coil is that changing the magnetic field within it generates an EMF and hence current in the coil. Running a changing current through a coil generates a magnetic field. So, a changing current generates a changing field which generates a changing current. The two currents are opposite so that the coil or inductor resists a changing current. From the above equations, substituting BA for f in $E = -Ndf/dt$ and assuming A is constant:

$$E = -ANdB/dt$$

Substituting cI for B and since c is constant, this now becomes:

$$E = -AcNdI/dt$$

Grouping the constants together as L , the inductance:

$$E = -LdI/dt$$

L is therefore dependent upon the number of turns, area and dimensions of the coil, all of which are constant for any particular device – L is measured in Henries (H).

What this all boils down to is

that the EMF, or voltage, generated by a coil is dependent on the changing current and the inductance. For slow current changes, the EMF is small. For a very fast changes, it can be pretty large. A practical example is when switching off a HiFi. A thump may be heard from the loudspeakers as the current in the coils collapses very quickly. Many modern amplifiers turn off slowly to avoid this happening.

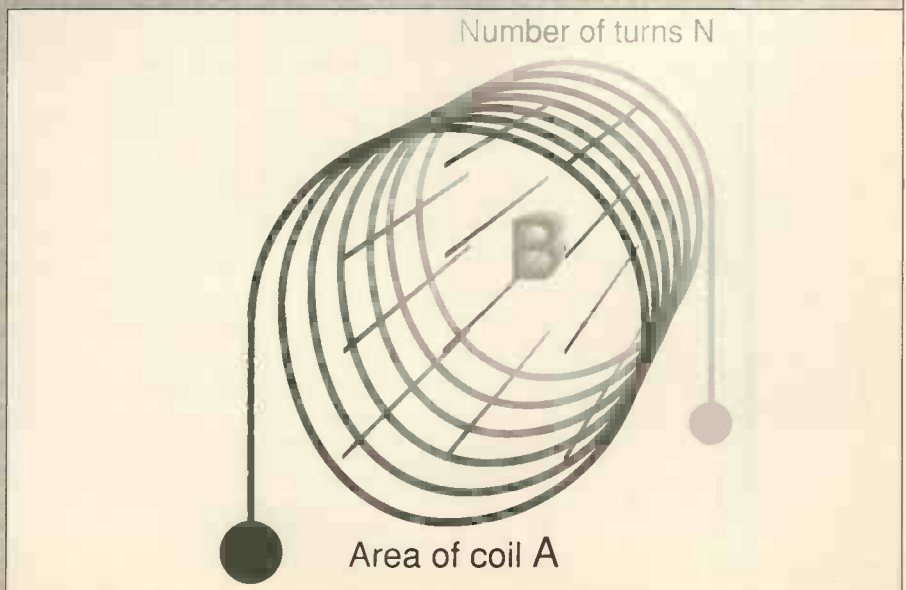

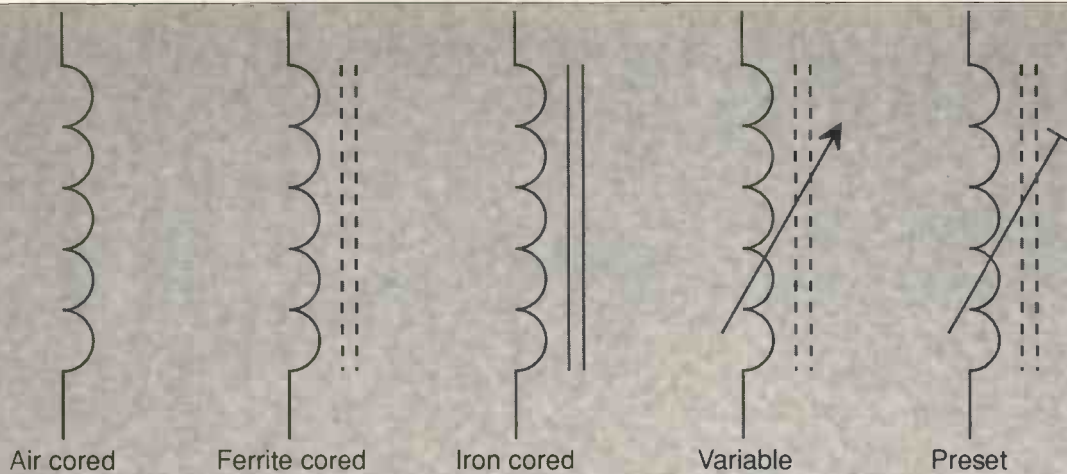

Glossary

Choke – a device used to impede the flow of alternating current or pulsed direct current, including spikes, by means of self inductance.

Core – magnetic material placed within a coil to intensify the magnetic field and alter the inductance.

Core loss – heat produced in a core by eddy currents induced into the material. It can be minimised by making the core from ferrite.

Ferrite – a compound of iron (ferric) oxides and ceramic material. They retain their magnetic properties but are poor conductors of electricity.

Former – a non-reactive, insulating support, usually made from ceramic,

card or plastic, around which a coil is wound.

Passing a current through a coil of wire generates a magnetic field. This magnetic field creates a current that is in the opposite direction to the original current.

Inductance depends on the number of turns in a coil, its shape, dimensions and whether any metal is near it. The latter effect is used to make variable inductances. A rod of ferrite is placed inside a coil with a screw fitting so that it can be inserted and withdrawn to change the inductance.

In electronic circuits, the two main uses for inductors are in filters and tuned circuits. Since an inductor resists changes in current and resists them more at high frequencies, putting the inductor in a series circuit gives a low pass filter. In parallel it forms a high pass filter since low frequencies pass through the inductor rather than the load. It is interesting to note that this is the opposite to the operation of a capacitor. ■

card or plastic, around which a coil is wound.

Henry – H, the measure of inductance. One H is present when one volt is produced by a varying current of one amp. Named after Joseph Henry an early researcher in the field of magnetic theory.

Induct – introduce formally into possession hence inductor, one who inducts.

Inductance – the property of a circuit which opposes any change to the existing current level.

Q – the ratio of the reactance of an inductor to its effective series resistance at a given frequency.

Reactance – the opposition offered by a coil measured in ohms.

Turns – a number of complete loops of wire.

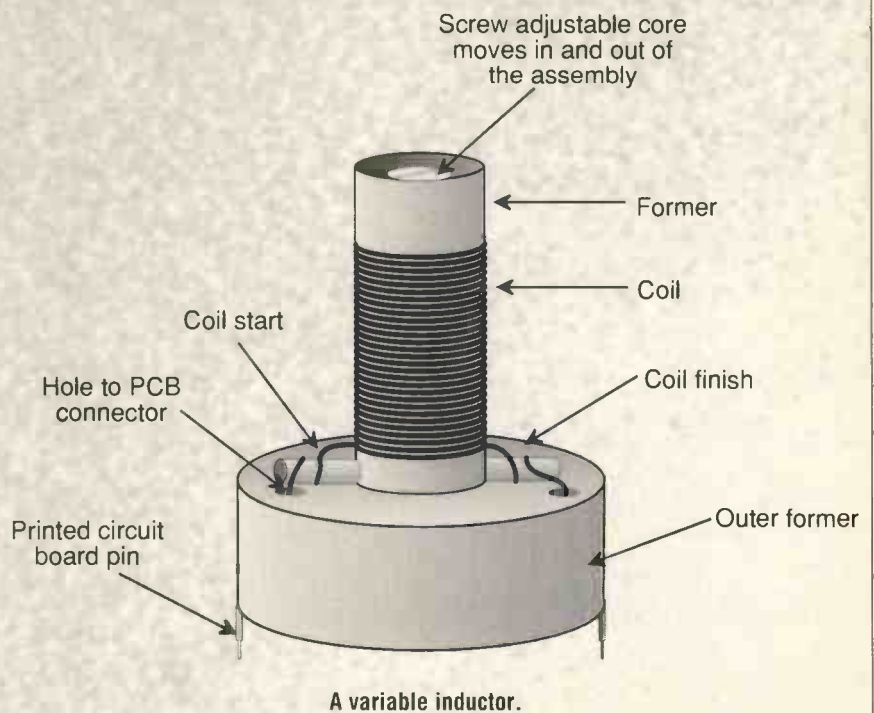
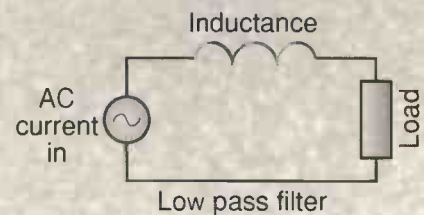
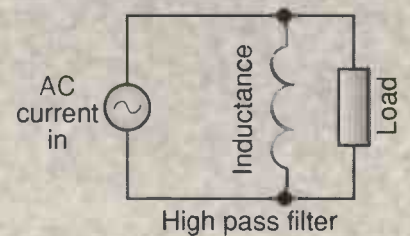

PE Chronos...

Building The Display

The Universal Counter Timer gets its output section this month as Anthony Smith describes how to build and test the display board.

This month we'll examine the remaining display board section, and then build and check out the board itself. The first circuit of interest, shown in Fig. 1, is primarily intended to drive the function and units LEDs, although its secondary purpose is to generate several control signals required by the main circuits.

IC27 is a 4-to-16 line decoder which converts the binary code at inputs S0, S1, S2, and S3 into the corresponding decimal equivalent at any of the sixteen outputs numbered O0 to O16. The outputs are active high, and are buffered by the sixteen invertors of IC49, IC50 and IC51 to provide the required to illuminate one of the sixteen function LEDs (D64 to D79 inclusive).

IC27 is driven by the four binary-coded function lines, F0 to F3, generated the function selection circuit described last month. For instance, we select function 11 such that the binary code is 1010; IC27 decodes this input, and drives the corresponding decimal output, O11 (pin 20), high (all other outputs remain low). As a result, function LED 11 (D74) is illuminated to indicate the choice of function.

Units LEDs

As well as driving the function LEDs, the decimal outputs of IC27 are used in many other ways, particularly to illuminate the units LEDs. Table 12 lists the unit LED appropriate for a particular function, or group of functions.

Under normal conditions, functions 1 and 2 (frequency A and B) indicate frequency in kHz units; however, when the high resolution

frequency (HRF) mode is selected, the units must be changed to Hz to cater for the increased resolution. Note, also, that function 4 (frequency ration A/B) and function 8 (units A) both make dimensionless measurements, and thus require no units indication.

Driving the MHz LED is straightforward: O3 of IC27 is simply buffered by IC54e which can sink enough to illuminate D60 whenever function 3 is selected. (The 4514, being a standard CMOS device, cannot sink or source enough current to illuminate a standard LED; hence, the outputs be buffered by the more powerful HCMOS devices).

Driving the remaining units LEDs is a slightly more complicated task. Consider, for example, the us LED: this must be illuminated whenever one of functions 5,6,7,9, or 10 is selected. Thus, we require a signal described in logic terms as (5+6+7+9+10). This is achieved in two steps. Firstly, decimal outputs O7, O9, O10 are used to drive inverter IC51c via diodes D46, D45, and D44, respectively. (The diodes, along with R106, act as a simple diode-resistor logic or network).

Thus, the output of the inverter is (bar all 7+9+10), that is, it is low whenever function 7 or 9 or 10 is selected. This output is used as control signal for the main board, and is also used to drive IC51d, such that the output of this inverter is (7+9+10). By combining this signal with the outputs O5 and O6 using the diode-resistor network of D41, D42, D43 and R107, we generate the (5+6+7+9+10) signal required to drive the us LED (D59).

The seconds LED (D58) is driven in a similar manner. Outputs O11 to

O16 are configured in another diode-resistor network using diodes D49 to D54, such that the output of IC52 goes low and illuminates D58 whenever function 11,12,13,14,15, or 16 is selected. The output is further inverted by IC54d to provide another control signal for the main board, namely (11+12+13+14+15+16).

The kHz LED (D61) must be illuminated whenever function 1 or 2 is selected, but must be swapped for the Hz LED (D62) is HRF is selected. This function can be selected either by operating S13 or by a logic high level from the external bus.

With the HRF function off, the output of AND gate IC57b is low, the output of IC54a is high and D62 is reverse biased. Consequently,, whenever function 1 or 2 is selected, the input to IC54b is driven high via diode D48 or D47, its output goes low and the kHz LED becomes forward biased.

If HRF is selected no, IC54a output goes low, removing the forward bias from the kHz LED which is thus extinguished. D62, however, now becomes forward biased and is illuminated, indicating that the reading is now in Hz. At the same time, the high level from IC57b is transmitted to the main board via terminal R. This signal is used to bring the frequency multiplier into play.

Reset Circuit

The remaining sections of the display board are shown in Fig. 2. Gates IC57c and IC57d form the reset circuit which is active low and output to the main board via terminal S. Resets occur at power up, the operation of SW15, a signal input to SK9, a signal from the

Fig. 1. LED driver circuit.

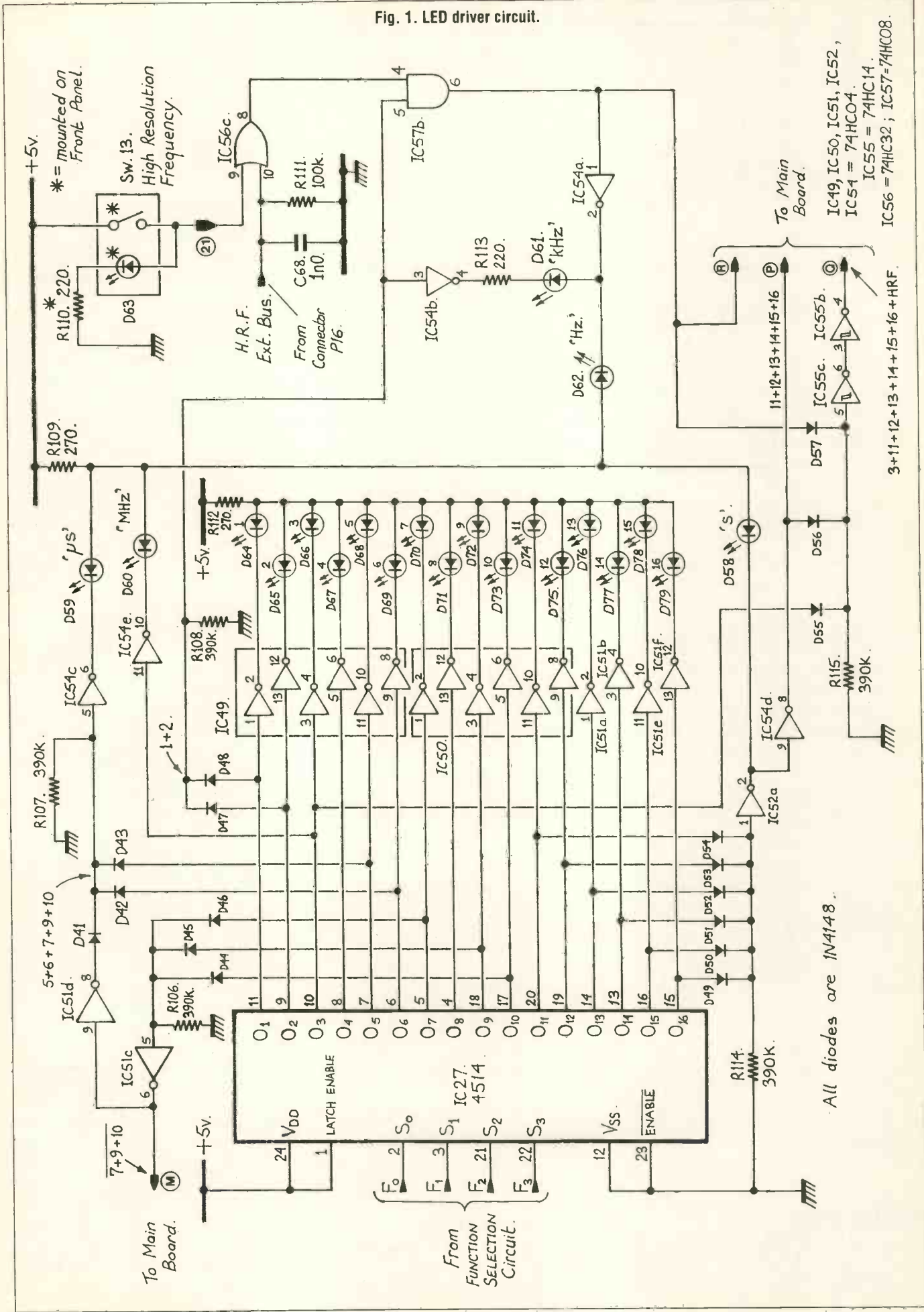

All diodes are 1N4148.

IC-49, IC50, IC51, IC52,
IC54 = 74HC04.
IC55 = 74HC14.
IC56 = 74HC32 ; IC57 = 74HC08.

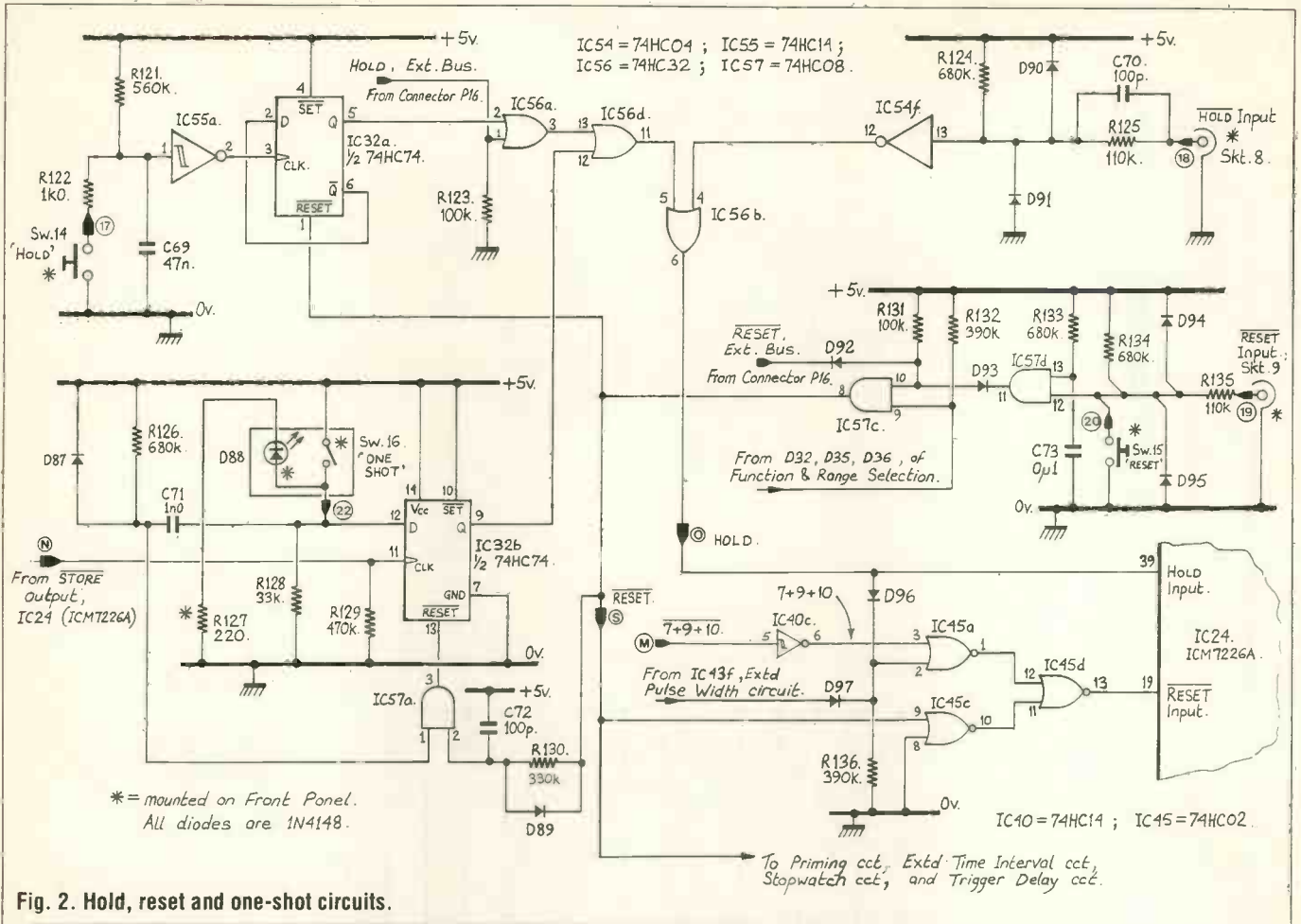

Fig. 2. Hold, reset and one-shot circuits.

external bus and by a change of function or range.

Note that diodes D94 and D95 provide protective clamping at the gate input to guard against overloads.

On the main board, the reset signal is fed to the bar RESET input of the ICM7226A (IC24) via the NOR gate in IC45. At the same time it is also fed to other circuits on the main board, namely the priming, extended time interval, stopwatch and trigger delay circuits.

As with Reset, the Hold operation can be activated in a number of ways. Pressing the front panel switch, a signal from the external bus and a signal at the hold input are all valid methods.

When using SW14, a toggle action is used that allows the user to operate in a "hands free" way with a further press of the button releasing the hold.

In The Hold

There are many instances when it is desirable that hold be asserted immediately after a measurement

has been completed so that further measurements (which may happen very quickly) do not change the reading. This kind of operation is provided by the one-shot or single-event circuit based around flip-flop IC32b.

In the lower left hand corner of Fig. 2, the bar STORE signal from the 7226A is fed to the clock of a flip-flop so that its rising edge transfers the logic level at D to Q. When SW16 is open, the D input is held low by R12 and Q is therefore also held low. However, when D is pulled high on the next bar STORE sets Q high and latches hold, capturing the last measurement. Getting out of this hold condition requires switching the one-shot off or activating the master reset.

Display connections

Fig. 3 shows how the digit drivers and segment outputs from the 7226A are connected to the displays. Note that although the dp (decimal point) output is shown connected to the dp pin of display eight, this is only really true of

displays 1 to 87. For display eight, the decimal point is actually replaced by the overflow LED, D31.

The component layout for the display board is shown in Fig. 4. As with the input board and the main board, construction begins by checking both sides of the PCB for short circuits, broken tracks, missing tracks, and so on.

The first step is to insert the through board links and solder them into place on both sides of the board. Next come the diodes and resistors, again making sure to solder on both sides of the board. IC58 and IC59 follow and don't use sockets. They should be soldered to the ground plane where appropriate.

The IC sockets go in next, but don't have their chips inserted, and are followed by the capacitors - take care with the polarity of C108.

The connector plugs P12 to P17 should be inserted next, remember that they are mounted on the rear of the board and are soldered on the component side. At the same time, solder the nine veropins into place - these two are located on the rear of the board.

Soldering the LEDs into place requires a little patience as they must be located at the correct height above the board – all other components should not extend more than 1/2in above the front surface.

The simplest way to install the LEDs is to make use of the front panel as a guide. Firstly, screw the four 1/2in spacers to each corner of the board. Next, insert the sixteen function LEDs (D64 to D79), the four range LEDs (D83 to D86), the five units LEDs (D59 to D62), the gate LED (D22) and the overflow LED (D3). Remember the function, range and units LEDs are standard red 3mm types, the gate a standard green 5mm and the overflow a high brightness 3mm red.

Take great care to locate the LEDs the right way around – the anodes are marked with an 'a' in Fig.4. Next, gently push the LEDs towards the board so that they extend no more than 1/2in above the surface. Now, screw the board to the front panel and push each LED slightly away from the board so that each one locates into its allocated hole in the panel.

The LEDs should now be that the correct height above the board from the panel and can be soldered on the rear side. When this is done, unscrew the board from the panel and solder the LEDs on the component side. Take care during this procedure not to force the LEDs at all, don't bend the leads excessively and don't stress the solder joints.

With all the LEDs in place, the board should look something like Fig.5. The final step is to solder the miniature display-test pushbutton, SW17) into place using two short lengths of thin wire.

Checking It Out

The first step is to check the current taken by the VHF section (channel C). Temporarily connect the 0V and 5V terminals of P17 to the corresponding terminals of P11 on the main board. Fig. 6 shows the connections to be made to the rear of the display board. Don't yet make any connections except those to P17.

Connect an ammeter set to the 100mA range in series with the 5V line between P11 and P17. Do not yet insert any ICs in the display

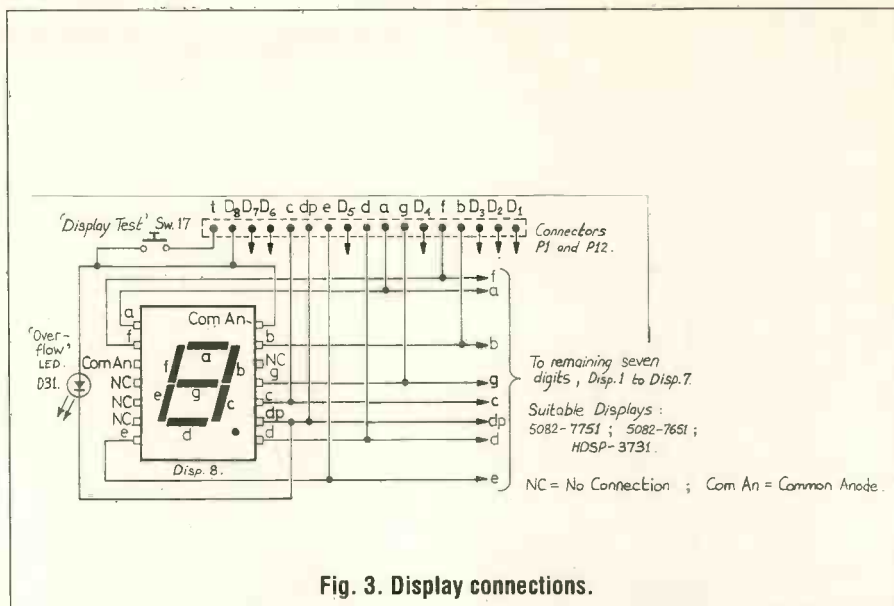

Fig. 3. Display connections.

board or the main board sockets.

Switch the mains power and note the current. This should be in the region of 50mA. Check for faults around IC58 and IC59 if the current is higher than this. Turn off the main power.

Temporarily connect all the switches to the display board as shown in Fig. 6. The 5V and 0V main board terminals are those located next to P11 – it is not necessary to connect the input board to the main board during these tests.

The display board ICs can now be inserted as shown in the component layout of Fig. 4. Take care with orientation and remember that all the chips are CMOS devices. The seven segment displays can now be inserted although they are not required by for the following tests.

With the ammeter still in place, switch on the mains power and observe the current – it should not be more than 70mA to 80mA. If excessive current is being drawn, quickly check the temperature of the ICs. If no faults are found on the board itself, check the temporary switch connections.

If the current reading is acceptable, operate the illuminated switches: the current should rise by 20mA or so.

Now turn off the switches, turn off the mains power and remove the ammeter. Replace the temporary supply connections with a 2-way ribbon cable link between connectors P11 and P17 – the link should be about 12cm long. No other connections should be made

to the main board.

Function Checks

Switch on the mains power again. The function 1 LED (D64) and the kHz LED (D61) should come on. If some other function or units LED lights up, check C67 and R100 at the reset input of IC26.

Now check that SW11 and SW12 can be used to step up and down through the functions one at a time. If this operation causes one or more functions to be skipped, check the switch debounce circuits.

While stepping through the functions, use a voltmeter or logic probe to check that the correct binary sequence is being output at terminals B, C, D and E of connector P14.

Now select function 1 and monitor terminals Q and R of connector P15; they should both be low. Turn on SW13 (HRF) and check that the units LED changes from kHz to Hz, at the same time, both terminals Q and R should go high. Repeat this procedure with function two selected.

Turn off SW13 and select function 1 or 2. Check that HRF can be selected by taking high the HRF input terminal of connector P16.

Remove the high level from P16 and connect the voltmeter or logic probe to terminal M of P14. Now observe the logic level at terminal P of connector P15; this should be high only for functions 11 to 16. Check, next, the level at terminal Q. This should go high whenever function 3 or 11 to 16 are selected.

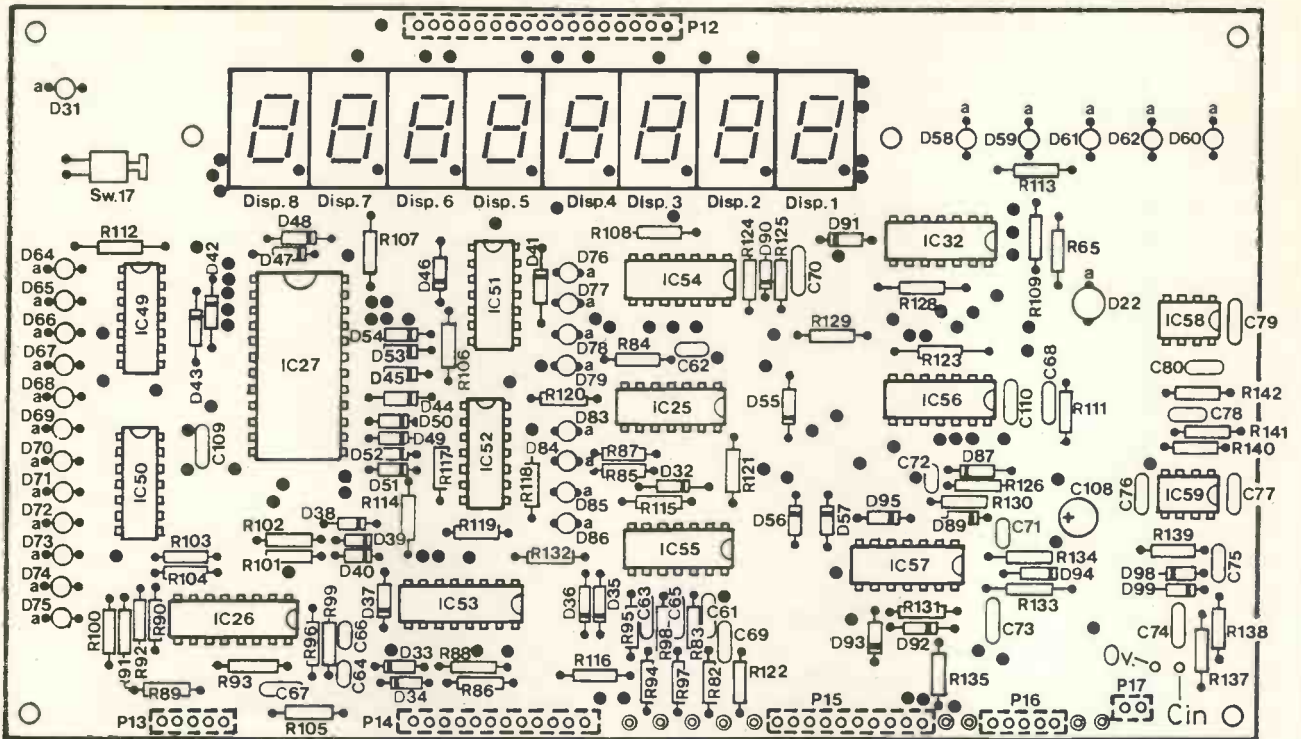

● = Link through board, (100). ⊙ = Veropin terminal on rear of board.
 Connectors P12 to P17 mounted on rear of board. a = anode of LEDs.
Fig. 4. Display board component overlay.

Checks On Reset

With reference to Fig 2, connect a logic probe to terminal S of P15 and press the reset switch. The level at S should go low. Now temporarily take the reset input low by connecting vero pin 19 to 0V. S should again be low. Remove the low level from the input and apply it to the external bus reset connector P16. S should go low again. Finally, pressing the range and function select switches also makes S go low.

The power up reset can be checked by observing the Q outputs of flip-flops IC32a (at pin 5) and at IC32b (at pin 9). turn off the power,

wait ten seconds, then switch on again. The Q outputs should both be low - checking this five to ten times proves that the outputs never go high. Check R133 and C73 if this isn't the case.

Hold On

Monitor terminal O of connector P15; it should be low. Now press the hold button SW14 and output O should latch high. Press the button again and the output should return to its original low level.

By waiting until the timebase circuit has been built and tested, the

10MHz clock signal itself can be used to check channel C. Solder a resistor (say 1k) to the inner core of the co-axial cable connected to the channel input. The, connect this resistor to the 5V clock squarewave at terminal 2 (main board).

The resistor and 50Ω input impedance of the channel attenuate the signal such that the actual peak input amplitude is given by:

$$\text{input amplitude} = 5 \times 50 / (50 + R)$$
 volts.

where R is the resistor value. By increasing the value of R in suitable steps, there will come a point where the prescaler will not function correctly. At this point, the input amplitude measured on the oscilloscope or calculated as above, is the sensitivity of the channel for squarewaves at 10MHz.

Note that although this test provides a rough value for the channel sensitivity, it is only really intended to check the basic operation of the VHF amplifier and prescaler.

This completes all the tests on the display board - the temporary leads should be left in place as they will be needed to check the display in conjunction with the main board in the next instalment. ■

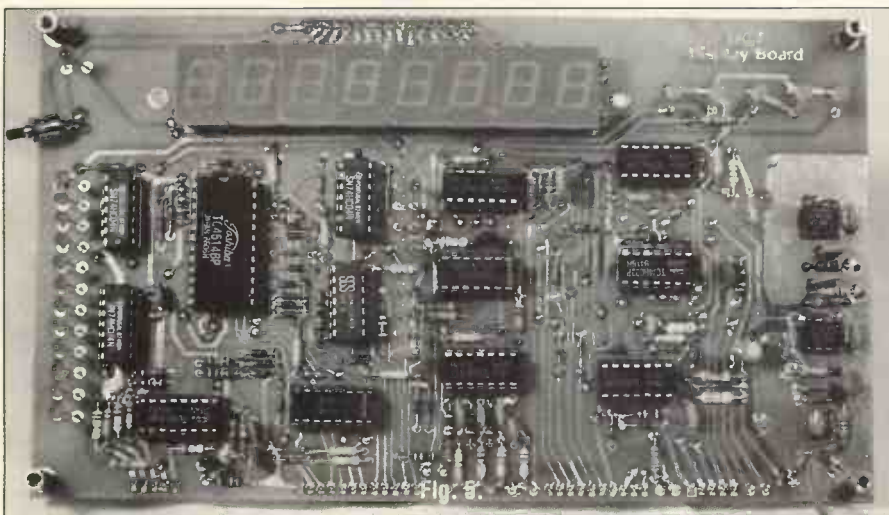

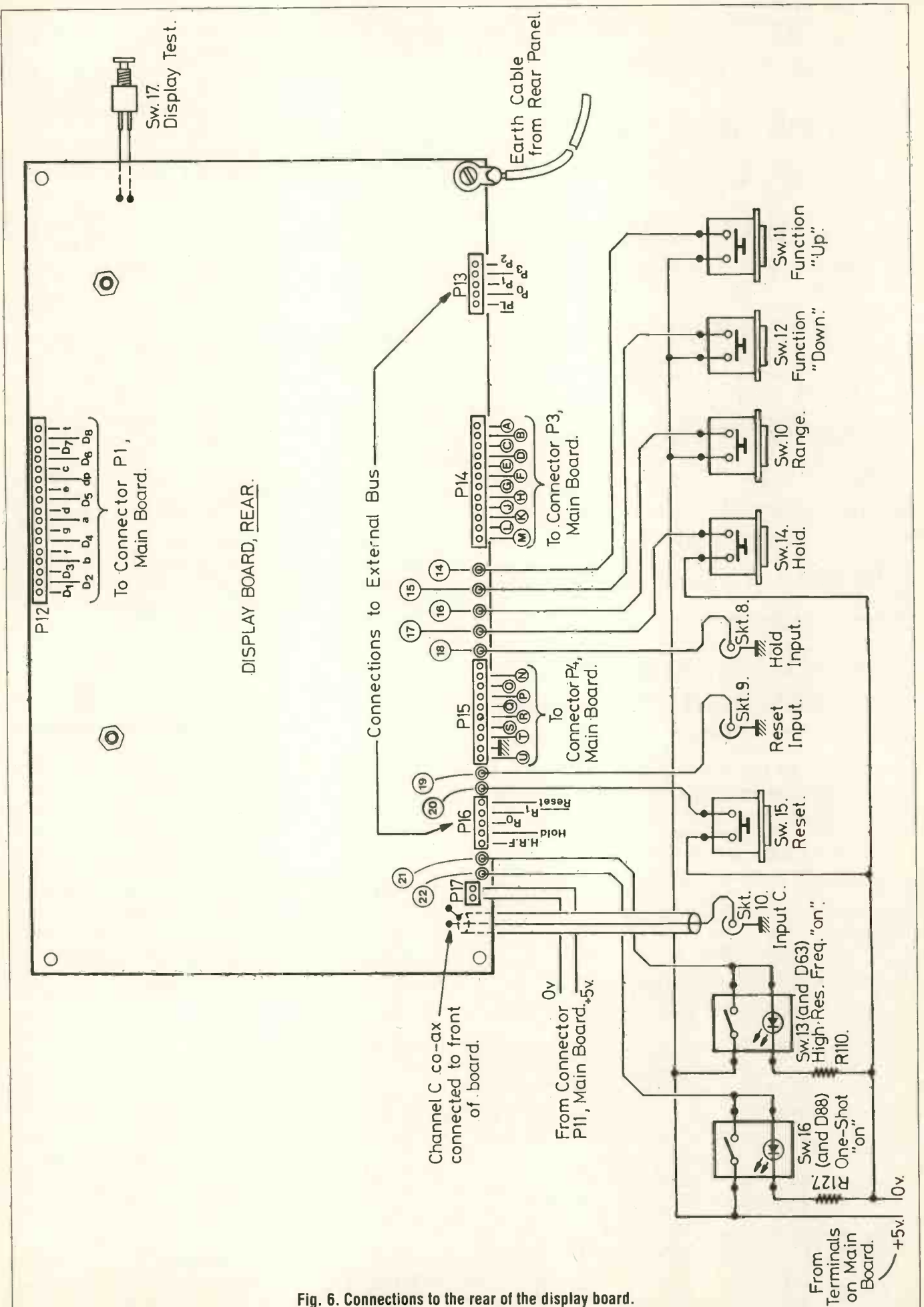

Fig. 6. Connections to the rear of the display board.

OMNI ELECTRONICS

stock a wide range of electronic components at

**174 Dalkeith Road
Edinburgh
EH16 5DX**

TEL: 031 667 2611

Open Monday to Thursday
9:15am – 6:00pm
Friday 9:15am – 5:00pm
Saturday 9:30am – 5:00pm

1990/91 catalogue costs £1.50
contains vouchers to use against
purchases

Do you have your copy yet?

The ONE STOP Component Shop



▶ **Massive Stocks**

▶ **Old & New Technology**

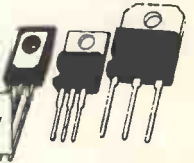

▶ **Latest Japanese
Semi-conductors
& Transistors
Available**

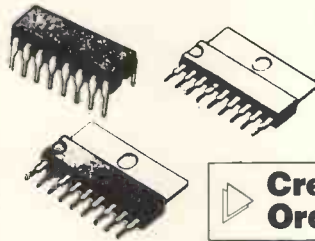

▶ **Credit Card Telephone
Orders a Speciality**

**CRICKLEWOOD
ELECTRONICS**



Tel: 081 4520161 & 081 4500995
40 Cricklewood Broadway, London NW2 3ET

Fax: 081 2081441 - Telex: 914977 CRICKEL G

EPROM PROGRAMMER OR UNIVERSAL PROGRAMMING SYSTEM FOR YOUR PC? From Low Cost EPROM PROGRAMMER

The model 160 programs virtually every EPROM and costs £195 + VAT
To UNIVERSAL PROGRAMMING SYSTEM

The Model 200AP programs EPROMs, serial and parallel EEPROMs, Flash memories, Micro-processors and controllers, PALs, GALs and Bi-polar PROMs and costs £345 + VAT (adapters where required from £75).

This includes all the 8751 and 8748 families, the PIC microcontrollers, Z8s and EPROM Emulators. Nearly 900 devices in all.

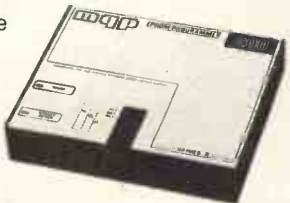

New devices are constantly being added – ask if you want any programmable device added to our list

All our programmers are designed, manufactured and supported by us in the UK.

Programming times are faster than most of our competitors, e.g. using the parallel port of your PC they program 2764s in 4 seconds and take less than one minute to blank check, program and verify 1 Megabit Flash Memories (and this time includes download time).

We also sell Gang Programmers, EPROM Emulators and Erasers and a universal cross-assembler for IBM PCs and compatibles

Write or phone today for Free Information Pack:
Phone: (0666) 825146 Fax: (0666) 825141



**MQP Electronics Ltd., Park Road Centre
Malmesbury, Wiltshire SN16 0BX UK**



Scandinavian customers please contact:	Digitron A/S, Alesund Norway	Phone 071-45 890 Fax 071-45 453
German customers please contact:	Synatron GmbH, Grabmann B. Munchen Germany	Phone 089/4602071 Fax 089/4605661

Interak 1 SINGLE BOARD COMPUTER

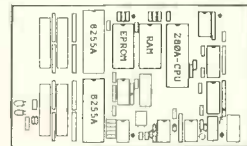

"SBC-1"

£17.50
+ 50p P&P
+ VAT

A computer doesn't *have* to look like you'd expect a computer to look. It doesn't *have* to have a keyboard and a screen and floppy disks and so on.

The SBC-1 has the bare minimum of chips a Z80 computer can have and still be a computer: A 4 MHz Z80-CPU chip, an EPROM chip (up to 32K), a static RAM chip (up to 32K) and a pair of 8255A I/O (input/output) chips giving 48 individual lines to wobble up and down. There are one or two additional "glue" chips included, but these are simple "74LS" or "HC" parts.

A star feature is that no special or custom chips (ie PALs, ULAs, ASICs etc) are used — and thus there are no secrets. The Z80A is the fastest and best established of all the 8-bit microprocessors — possibly the cheapest too!

Although no serial interface is included, it is easy for a Z80A to wobble one bit up or down at the appropriate rate — the cost is a few pence worth of code in the program: why buy hardware when software will do?

Applications already identified include: Magnetic Card reader, mini printer interface, printer buffer, push button keypad, LCD alphanumeric panel interface, 40-zone security interface for auto sending of security alarms, code converter (eg IBM PC keyboard codes to regular ASCII), real time clock (with plug in module), automatic horticultural irrigation controller.

By disabling the on-board Z80A-CPU this card will plug into our Interak 1 CPM Plus disk-based development system, so if you don't fancy hand-assembling Z80 machine code you don't have to!

The idea is (if you are a manufacturer) you buy just one development system and then turn out the cheap SBC-1 systems by the hundred. If you are really lazy we can write the program for you and assemble the SBC-1 cards so you can get on with manufacturing your product, leaving all your control problems to us.

Greenbank

For more details write or phone us:
**Greenbank Electronics, Dept PE11 460 New Chester Road, Rock
Ferry, Birkenhead, Merseyside. L42 2AE. Tel: 051-645 3391.**

VIP

A Virtual Instrument

Jason Sumner plugs another board into his PC and explores the latest in Digital Multi-meters – but, is it all there?

Nearly everyone with an interest in Electronics now has access to a computer of some sort. Possibly to most popular is the IBM PC compatible machine for which there is a whole host of useful software, from CAD packages to circuit simulators. The latest addition to this list is the digital multi-meter. No longer is this confined to a small box with a small display and, sometimes, relatively few functions. The DMM VIP (Virtual Instrument) is a board that plugs into the expansion slot of the PC/XT/AT/386 with software that provides all of the functions needed on the average DMM but using the computer as a display and storage system.

All of the usual functions are catered for, DC, AC volts up to 300V, DC, AC current up to 2A, resistance up to 20M Ω , capacitance up to 2 μ F and dBm up to \pm 55dB. All of the controls are accessed via the mouse pointer with the various buttons being pressed by simply pointing and clicking. The main readout is a 4.5 digit LED with the addition of a chart recorder offering eight pens.

On switching on and booting up, the system can be auto-calibrated with the settings being stored in an on-board EEPROM. In practice, these are set-up at the factory so calibration should not have to be performed very often. Selecting the various functions is quick and easy although there is quite a lot of room for on-line improvement with the addition of a help system – other DMMs have to make do with a short book, the VIP could have scored some extra brownie points by putting all of this on-line. Anyone who has used a

DMM before will not have any trouble using the VIP, apart, perhaps, from the chart recorder. The user interface for this is a little confusing and the minimum sample rate of half a second rather slow, especially when the hardware is capable of taking samples at 25 times a second.

On starting up the chart recorder a file name is requested using a rather badly designed dialogue system – an improvement would have been to list current log files and be able to add to them. Other improvements would have been the ability to activate the log at particular times in fact, the software could have provided a wide range of additions not normally available on a DMM.

The probes connect to the card at the back of the PC which, for most users who have the main PC box on their desks, should prove to be no trouble. However, some

people keep their machines on the floor with just the monitor and keyboard on the desk top – the probe leads are 1.5m long which may just be enough. Some form of extension box with a protected connection to the computer and shorter leads would have made the whole thing a bit neater though, perhaps, defeated the object of an all in one system somewhat.

As it stands the VIP simply emulates a basic DMM and, apart from the data logging system, provides no particularly clever extras. At the price of £499 excluding VAT, a little more could have been expected. As it is, much better value can be had by buying a stand alone DMM at a far lower price.

For more information contact Global Specialities, Rackery Lane, Llay, Wrexham, Clwyd, LL12 OPB, Tel. 0978 853920, Fax 0978 854 564. ■

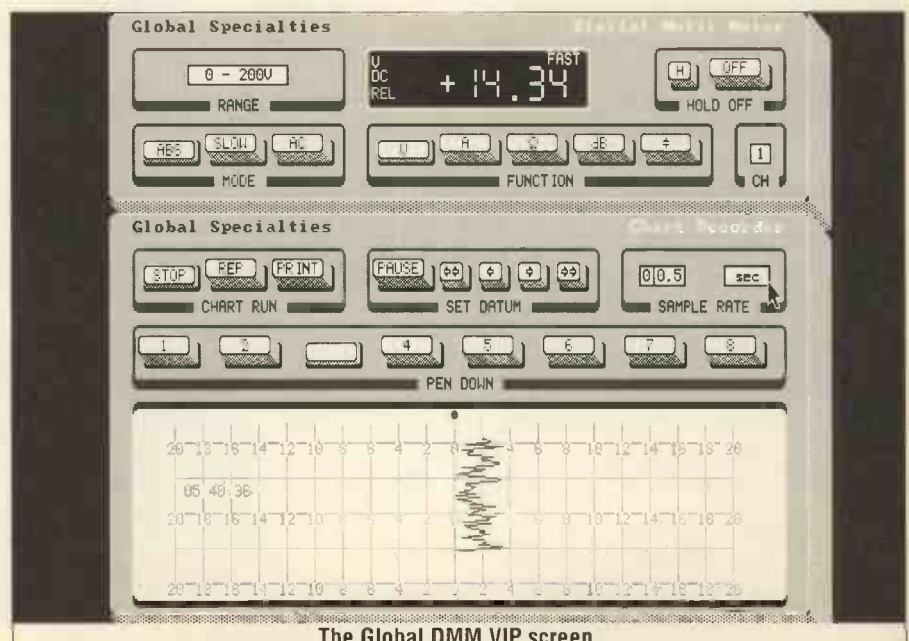

VARIABLE VOLTAGE TRANSFORMERS

INPUT 220/240V AC 50/60
OUTPUT 0-260V

	Price	P&P
0.5KVA 2.5 amp max	£29.00	£3.75 (£38.48 inc VAT)
1KVA 5 amp max	£37.40	£4.25 (£48.94 inc VAT)
2KVA 10 amp max	£54.00	£5.48 (£69.89 inc VAT)
3KVA 15 amp max	£71.50	£6.24 (£91.34 inc VAT)
5KVA 25 amp max	£126.50	

(Carriage on request)
Buy direct from the Importers. Keenest prices in the country

COMPREHENSIVE RANGE OF TRANSFORMERS-LT-ISOLATION & AUTO
(110-240V Auto transfer either cased with American socket and mains lead or open frame type. Available for immediate delivery.

ULTRA VIOLET BLACK LIGHT FLOURESCENT TUBES
4h 40 watt £10.44 (callers only) (£12.27 inc VAT)
2h 20 watt £7.44 + £1.25 p&p (£10.21 inc VAT)
13in 8 watt £5.80 + 75p p&p (£6.52 inc VAT)
12in 8 watt £4.80 + 75p p&p (£5.24 inc VAT)
9in 6 watt £3.96 + 50p p&p (£5.24 inc VAT)
6in 4 watt £3.96 + 50p p&p (£5.24 inc VAT)

230V AC BALLAST KIT
For either 6in, 9in or 12in tubes £5.50 + 55p p&p (£7.11 inc VAT)
For 13in tubes £6.00 + 75p p&p (£7.93 inc VAT)

400 WATT UV LAMP
Only £34.00 + £2.50 p&p (£42.89 inc VAT)
175 WATT SELF BALLASTED BLACK LIGHT MERCURY BULBS
Available with BC or EC fitting. Price inc VAT & p&p £20.27

12 VOLT BILGE PUMPS
Buy direct from the importers
500 GPH 15ft head 3 amp £16.36
1750 GPH 15ft head 9 amp £26.65
PRICES INCLUDE P&P & VAT

EPROM ERASURE KIT
Build your own EPROM ERASURE for a fraction of the price of a made-up unit kit of parts less case includes 12in 8 watt 2537 Angstrom Tube Ballast unit, pair of bi-pin leads, neon indicator, on/off switch, safety microswitch and circuit £14.00 + £2.00 p&p (£18.80 inc VAT)

SUPER HY-LIGHT STROBE KIT
Designed for Disco, Theatrical use etc.
Approx 16 joules. Adjustable speed £48.00 + £2.00 p&p (£58.75 inc VAT)
Case and reflector £22.00 + £2.00 p&p (£28.20 inc VAT).
SAE for further details including Hy-Light and industrial Strobe Kits.

"BOFFINS SPECIAL" - UNIQUE OFFER

Surplus Precision Medical Unit, internally in excellent condition. Designed primarily to eject a precise controllable amount of fluid from a medical syringe (latter not supplied). Contains the following removable components: Dual Micro Processor Boards and EPROMS. Escap Precision 12V DC Motor with 300.1 Gear Box and optical encoder coupled to a precision threaded drive mechanism. Mains supply with 12 x 1.5V Ni-Cad A.A. cells back-up. L.C.O. Digital read-out 17mm high with legends. Audible warning.

These are sold for the dismantling of the exceptional quality components. Regret no Circuits available. Ridiculously low price: £16.00 + £4.00 p&p (£23.50 incl VAT).

WIDE RANGE OF XENON FLASH TUBES

Write/Phone your enquiries

GIANT BLOWER EXTRACTOR UNIT
Twin output centrifugal blower 1 HP. 240V AC motor, output approx. 3800 c.f.m. Size: Length 100cm; height 27cm; Depth 26cm. Fixing plate 106 x 33cm. Price £125 + VAT. Ex-warehouse.

TORIN CENTRIFUGAL BLOWER
230V AC, 2,800 RPM, 0.9 amp, 130mm diameter, impeller outlet 63 x 37mm, overall size 195 x 160 x 150mm, long. Price £17.50 + £2.50 p&p (£23.50 inc. VAT)

SHADED POLE GEAR MOTORS
In the following sizes: 3RPM, 12 RMP, 80 RPM, 160 RPM. 110V AC or 240V AC with capacitors (supplied). Price inc VAT & p&p £14.86

GEARED MOTORS
71 RPM 20lb inch torque reversible 115V AC input including capacitor and transformer for 240V AC operation. Price inc VAT & p&p £23.50.

SOLID STATE HEAT UNIT
Input 230/240V AC. Output approx 15KV. Producing 10mm spark. Built-in 10 sec timer. Easily modified for 20 sec, 30 sec to continuous. Designed for boiler ignition. Dozens of uses in the field of physics and electronics. eg supplying neon or argon tubes etc. Price less case £6.50 - £1.00 p&p (£11.16 inc VAT) NMS

HEAVY DUTY MOTOR
Crouzet 115V/230V AC heavy duty 1RPM motor. Anticlockwise type 82/015. Size 68mm, diameter x 55mm long. Shaft 6mm diameter x 20mm long. Price inc VAT & p&p £18.86.

RHEOSTAT
50W 2 ohm 5 amp ceramic power rheostat, price inc VAT & p&p £10.61

MICROSWITCH
Pye 15 amp changeover lever microswitch, type S171. Brand new, price 5 for £7.05 inc VAT & p&p

NMS = NEW MANUF SURPLUS
R&T = RECONDITIONED AND TESTED

We have the widest choice of used oscilloscopes in the country

Tektronix 2445 Four Trace 150MHz Dual TB	£1200
Tektronix 485 Dual Trace 350MHz	£1000
Tektronix 2225 Dual Trace 50MHz Delay Sweep	£600
Tektronix 2215 Dual Trace 60MHz Delay Sweep	£450
Tektronix 475 Dual Trace 200MHz Delay Sweep	£550
Tektronix 465 Dual Trace 100MHz Delay Sweep	£450
Schlumberger-Enertec 5218 Three Trace 200MHz Delay Sweep	£550
Schlumberger-Enertec 5220 Dual Trace 100MHz Delay Sweep	£400
Philips PM3217 Dual Trace 50MHz Delay Sweep	£400
Hitachi V650F Dual Trace 60MHz Delay Sweep	£450
Hitachi V352F Dual Trace 35MHz	£250
Hitachi V212 Dual Trace 20MHz	£250
Leader 1020 Dual Trace 20MHz	£260
Trio CS1022 Dual Trace 20MHz	£225
Gould OS1100 Dual Trace 10MHz TV Trig	£160
Gould OS300 20MHz Dual Trace 2mV/cm. Small lightweight now only	£215

Far better than some of the New Rubbish available!

Scopex 14015 Dual Trace 15MHz	£150
Gould 1421 Digital Storage Dual Trace 20MHz	£650
Gould 1425 Digital Storage Dual Trace 20MHz	£650
Tektronix 434 Dual Trace 25MHz Tube Storage	£250

THIS IS JUST A SAMPLE - MANY OTHERS AVAILABLE

Racal/Dana Wideband Level Meter 5002	£1000
Racal/Dana Synthesised Sig Gen 10KHz-104MHz	£750
Racal/Dana (AIM) LCR Detachable 8341	£350
Wayne Kerr LCR Meter 4210	£500
Wayne Kerr Automatic Component Bridge 8605	£450
Wayne Kerr Universal RF Bridge 8602	£150
Wayne Kerr Component Tester 8424	£125
Farnell Synthesised Oscillator DSG1 0.0001Hz - 99.99KHz	£275
Farnell Automatic Mod Meter AMM	£250
Bradley Oscilloscope Calibrator 192 with Cal Cent	£800
Marconi TF2008 AMFM 10KHz-310MHz Sig Gen	£400
Marconi TF2015 AMFM 10-520MHz Sig Gen with TF2171	£400
Marconi TF2015 without Synchroniser TF2171	£250
Marconi TF2016 AMFM 10KHz-120MHz Sig Gen with TF2173	£350
Marconi TF2016 without Synchroniser TF2173	£175

Used Equipment - With 30 days guarantee. Manuals supplied if possible.
This is a VERY SMALL SAMPLE OF STOCK, SAE or Telephone for lists. Please check availability before ordering. Carriage on all units £16. VAT to be added to Total of Goods and Carriage.



STEWART OF READING

110 WYKEHAM ROAD, READING, BERKSHIRE RG6 1PL

Telephone: (0734) 268041 Fax: (0734) 351896 Callers Welcome 9am-5.30pm Mon-Fri (until 8pm Thurs)



SERVICE TRADING CO
57 BRIDGMAN ROAD, CHISWICK, LONDON W4 5BB
081-995 1560
ACCOUNT CUSTOMERS MIN. ORDER £10

MAKE YOUR INTERESTS PAY!

Over the past 100 years more than 9 million students throughout the world have found it worth their while! An ICS home-study course can help you get a better job, make more money and have more fun out of life! ICS has over 90 years experience in home-study courses and is the largest correspondence school in the world. You learn at your own pace, when and where you want under the guidance of expert 'personal' tutors. Find out how we can help YOU. Post or phone today for your FREE INFORMATION PACK on the course of your choice. (Tick one box only)

Electronics	<input type="checkbox"/>	TV, Video & Hi-Fi Servicing	<input type="checkbox"/>
Basic Electronic Engineering (City & Guilds)	<input type="checkbox"/>	Refrigeration & Air Conditioning	<input type="checkbox"/>
Electrical Engineering	<input type="checkbox"/>	Car Mechanics	<input type="checkbox"/>
Electrical Contracting/Installation	<input type="checkbox"/>	Computer Programming	<input type="checkbox"/>

GCSE/GCE/SCE over 40 examination subjects to choose from

Name _____ Address _____

ICS International Correspondence Schools, EDS111 312/314 High Street, Sutton, Surrey SM1 1PR
Telephone: 081-643 9568 or 041-221 2926 (24 hours)

ESR

Suppliers of an extensive range of top quality electronic components, accessories and hardware

Books • PCB Production Aids • Test Equipment
Tools • Self Assemble Electronic Products

NEW 1991 COLOUR CATALOGUE
£1.00
Includes P&P

ESR Electronic Components Tel: 091 251 4363
Station Road, Cullercoates
Tyne & Wear NE30 4PQ Fax: 091 252 2296

Schools, colleges and trade enquiries welcome
OPEN: Mon-Fri 8:30-5:00 Sat 10:00-5:00

TUTORKIT MICROELECTRONICS TUTORS

Logic Tutors
OP Amp Tutors
I.C. Patchboards
GCSE Units
Computer Interfaces

Prices from
£35.00 PLUS VAT

Including instruction manual and patch leads

*used by hundreds of schools in U.K. and overseas.

TUTORKIT PRODUCTS
(Div of Limrose Electronics Ltd)
Llay Industrial Estate
Wrexham, Clwyd, U.K.
LL12 0TU. Tel 0978 852285 Fax 0978 855556 Overseas distributors wanted

Counting The Rain Drops As They Fall

There may not have been very much rain this summer but things are certainly looking wetter this autumn. Own Bishop's latest gadget finds out just how much.

Call it udometer, pluviometer or just a common-or-garden rain gauge, the traditional instrument for measuring precipitation has not changed for hundreds of years. Even the ancient Romans had them. Rain (plus snow or hail, after they have melted) is collected in a wide-mouthed funnel and later poured into a measuring cylinder. The cross-sectional area of the cylinder is usually one-tenth that of the open end of the funnel. This increases the sensitivity of the technique, since the easily measurable depth of 1mm of water in the cylinder is equivalent to only 0.1mm of rainfall.

The funnel and cylinder rain gauge is inexpensive and simple to use but has the disadvantage that its operation is essentially manual. There is no easy way to automate it.

Recording gauges have been designed which weigh the water instead of measuring its volume, but these instruments tend to be mechanically complex. Nowadays two main techniques are used, the tilting bucket and the drop counter. This project is an example of the tilting bucket technique. The mechanical parts of it are relatively simple to construct and the electronics requires only a counter and its associated logic. The circuit can easily be placed under computer control and can be read remotely.

A rain gauge should be able to measure with a precision of 0.1mm or less. A day of typical light rain produces five to ten millimetres. If the gauge is to be read daily it must be able to accumulate at least the 25mm of rain which can fall during a single day of heavy rain.

Automatic Rain Gauge

As rain falls it accumulates in a small balanced container, referred to as the bucket. When the amount of water in the bucket reaches a given level, the bucket tilts over and empties itself. An electronic circuit counts the number of times the bucket empties during a given period, usually 24 hours. From this data the amount of rainfall in millimetres can be worked out.

This project has the feature of automatically and remotely recording the count at a pre-set time. The rainfall day begins at 9am (see box), a convenient hour for the professional meteorologist just starting a day's work at the station. For the amateur, who probably has to leave home before 9am, this can be an awkward time. To get around this, the gauge registers the 9 o'clock reading,

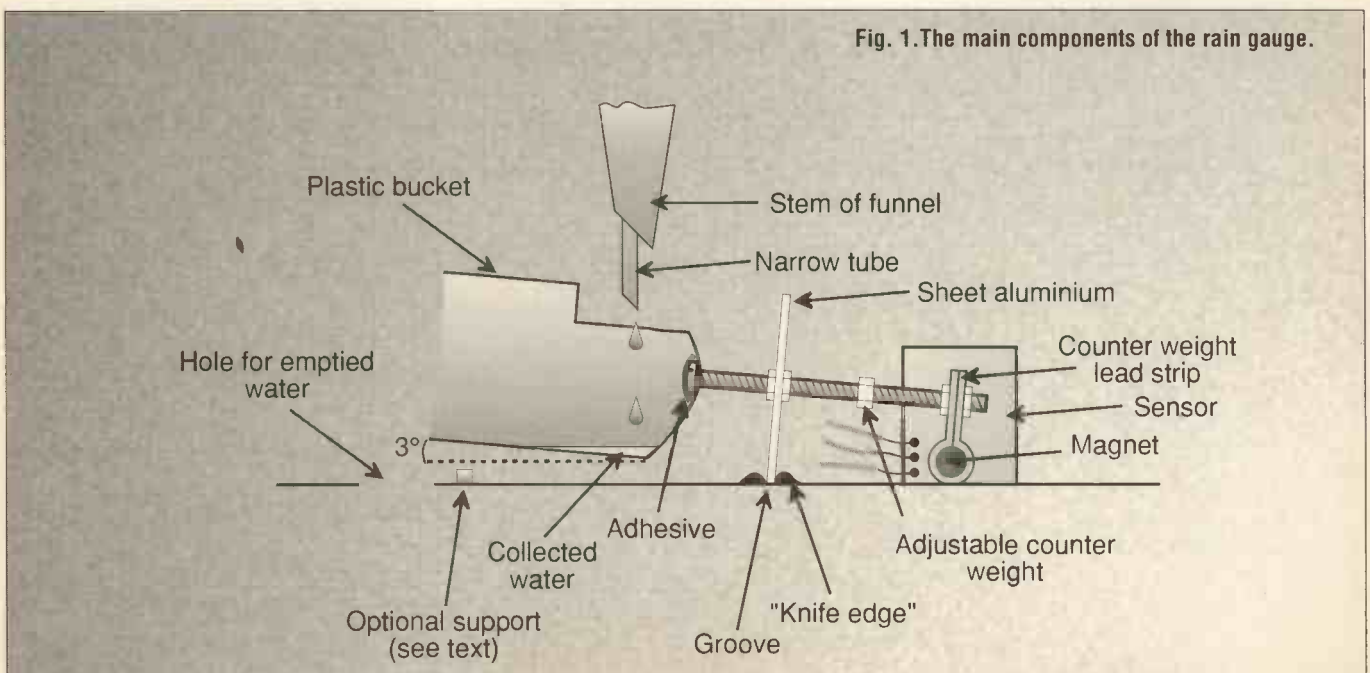

holding it until the user has the opportunity or the inclination to attend to it. In the meantime it continues to count the bucketfuls of rain that have fallen since the beginning of the current period. Moreover, the display unit can be located indoors, so there is no need to get wet when taking a reading.

How it works

Fig 1 shows the bucket mechanism. Rain is collected in a wide-mouthed funnel in order to obtain a sufficient quantity to measure. It runs into the bucket which has a counterweight to tilt it back at an angle of about 3°. The mechanism is pivoted on a "knife-edge" located in a groove in the wall of the enclosure. As the bucket fills, the water extends further toward its mouth and eventually overcomes the counterweight. The mechanism tilts, the water gushes out of the bucket and drains away. As soon as the bucket empties, the counterweight restores it to its tilted-back position.

Kicking The Bucket

There is scope for ingenuity in designing and building this part of the project. The essential points are:

- Use plastic for all parts that are likely to come into contact with water. The bolt-head inside the bucket is protected by coating it with adhesive or some other water-proof compound.
- The bucket tilts back at a very shallow angle, about 3°, but tilts forward at a slightly greater angle (about 5°).
- The mechanism must swing

freely, which is why a knife-edge suspension is preferred. Although this is referred to technically as a knife-edge, it is simply a rectangle of sheet aluminium.

- The knife-edge is below the centre of mass of the assembly, so as to give it unstable equilibrium when pivoting.
- The distance between the knife-edge and the centre of mass of the counterweight is less than that between the knife-edge and the centre of mass of the bucket. This allows a relatively small mass of water to overcome the moment of the counterweight.
- If the bucket enclosure has walls, a groove is incised in the wall; the knife edge fits loosely in the groove. If the enclosure has grooves moulded into its walls, use one of these but block the ends of the groove with strips of plastic to prevent the knife-edge from sliding sideways.
- Some means of finely adjusting the counter-weighting is essential; use a large nut that may be turned to move it along the rod; bend the counterweight (easy if it is made of sheet lead); move the knife-edge along the rod.
- It may be necessary to have a support to prevent the bucket tilting too far forward when emptying, otherwise it may not return to the tilted-back position.

- The enclosure must be firmly mounted to avoid shaking by wind.
- The jet is positioned so that it delivers the rainwater cleanly into the bucket, whether the bucket is tilted forward or backward.
- The tube from the funnel must be partly blocked or fitted with a screw-clip (aquarium aerator clip) to restrict the maximum dripping rate to 3 drops per second. Otherwise the tilted bucket may never have a chance to return to the tilted-back position during a heavy rainstorm.
- Usually the magnet supplied with the Hall effect device has its south-seeking pole marked with a spot of paint. This end should be directed away from the sensitive area (the dimpled surface) of the device.

The smaller the volume of water delivered at each tilting, the greater the precision of the gauge. The bucket of the prototype delivers 3.3 cm³ each time, which is a suitably small amount.

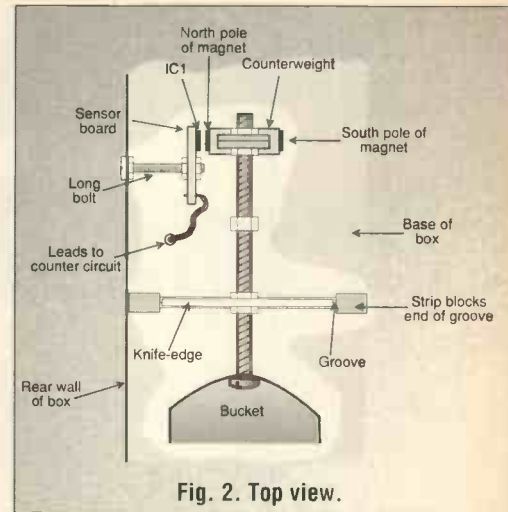

Fig. 2. Top view.

Through The funnel

This is made from two large plastic kitchen funnels. A single funnel will do, provided it is of the correct diameter. The alternative is to cut the rim from a second funnel and glue this upside down to the mouth of the first funnel (Fig 3). This reduces the likelihood of rain from surrounding areas splashing in during heavy storms. It also makes it easier to give the collecting area the correct radius. Before cutting the second funnel calculate what R should be, as explained under "Calibration".

Alarm Call

Ready-built alarm clock modules are available fairly cheaply but it is more economical to make use of a digital alarm clock that has begun to show signs of wear. All too often the battery contacts are the first part to become unreliable and the clock is relegated to the scrap box.

The clock is removed from its case and bolted to a piece of stripboard. The old battery spring contacts (unreliable) are cut off and wires soldered directly to the clock's PCB (printed circuit board). The control push-buttons (also unreliable and very fiddly) are replaced by PCB-mounting push-buttons. It requires a certain amount of close examination of the clock's PCB to work out where to make the new connections. The original push-buttons are conductive pads that make contact between pairs of copper areas on the PCB. With a fine-tipped soldering iron, there is no difficulty in soldering connecting wires directly to these areas. Not all of

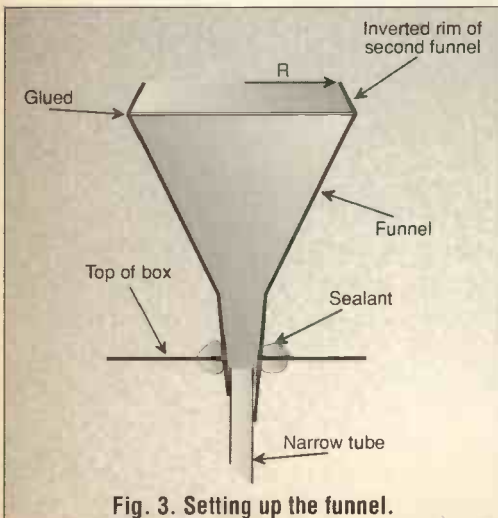

Fig. 3. Setting up the funnel.

Calibration

First establish the amount of water delivered by the bucket each time it empties. Call this $V \text{ mm}^3$. One way to do this is to slowly pour 100cm^3 of water into the funnel and record the count registered so that $V=100000/\text{count}$.

Now decide on what rainfall (depth in millimetres) is to be represented by this one count. A suitable quantity is 0.1mm, which means the gauge can record up to 25.5mm between readings (see box on binary). This is the maximum likely to fall in one day, expect in very rainy areas. If you live in such an area, 0.2mm would also be a suitable, though less precise, amount.

Given 0.1 mm of rainfall as the unit amount, the area A (in mm^2) of the top of the funnel is to be A and since the volume of water collected (V) is to represent 0.1mm then the unit amount is $V/0.1$.

Since the area of a circle $A = \pi R^2$

so $A/\pi=R^2$ and

$$R=\sqrt{A/\pi}$$

therefore $R = \sqrt{(V/0.1\pi)}$

and $R = 1.78\sqrt{V}$

As an example, if $V = 3300\text{mm}^3$, as in the prototype then $R = 1.78\sqrt{3300} = 102\text{mm}$. The inverted funnel on top of the upright funnel is cut away to give an aperture of exactly 102mm radius.

the original controls are retained; for example, rain gauges to not need to snooze. The controls for advancing hours and minutes are retained and the slider switch for "set clock" or "set alarm" replaced with a single button

The clock was originally powered by two button cells, connected to give a split supply of $\pm 1.35\text{V}$. This is obtained by using a potential divider, as in Fig 4. For use on a 5V supply R14 would be better replaced by a $18\text{k}\Omega$ resistor.

The alarm signal is a square wave, amplitude about $\pm 1\text{V}$ with a frequency of about 1kHz and lasts for 4 minutes. The value of R18 is chosen to bias TR1 into its on state in the absence of a signal from the clock. When the signal is present, its negative-going excursions turn the transistor off repeatedly, giving a series of high pulses, the first of which triggers the flip-flop (IC5c/IC5d). The rest are ignored. Capacitor C3 serves as a low-pass filter to remove any voltage spikes

from the signal that would prevent spurious or false triggering.

This account of interfacing the clock to the gauge applies to one particular model of clock. Others may need different treatment, for example, the hours and minutes buttons may have to be connected to the 0V rail, not the positive rail. However a little thought and experimentation will usually show what must be done.

Circuit construction

The circuit requires about 30mA of power and, since it is intended for operation 24 hours a day, a 6V DC (direct current) mains adaptor is ideal. An alternative would be to use four industrial D-type nickel-cadmium rechargeable batteries, which would last for about a week, especially if the LEDs are switched off in between readings. A small (1Ah) lead acid battery would last even longer. I

Fig 5 shows the layout of components of the display unit on the PCB which is shown in Fig 8. For normal operation link 1 and links 3 to 5 are connected as shown, as are the unnumbered links. Link 0 is connected to the 0V rail; omit the terminal pin at B and simply insert a wire link at that point. If a clock with high-pulse triggering is used, insert a terminal pin at B, and wire the clock output to it; also connect link 2, but not link 1.

If connection to a microcomputer is not contemplated, socket SKT1 can be left out. If a micro is to be used, wire a switch in place of link 4, or possibly omit the LEDs and the commoned resistors R2 to R9.

The LEDs specified are a special low-current type, pre-assembled in

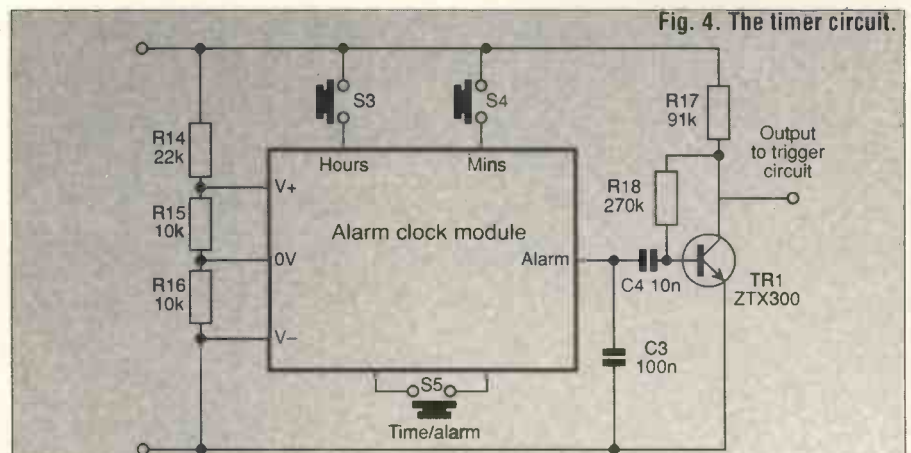

Fig. 4. The timer circuit.

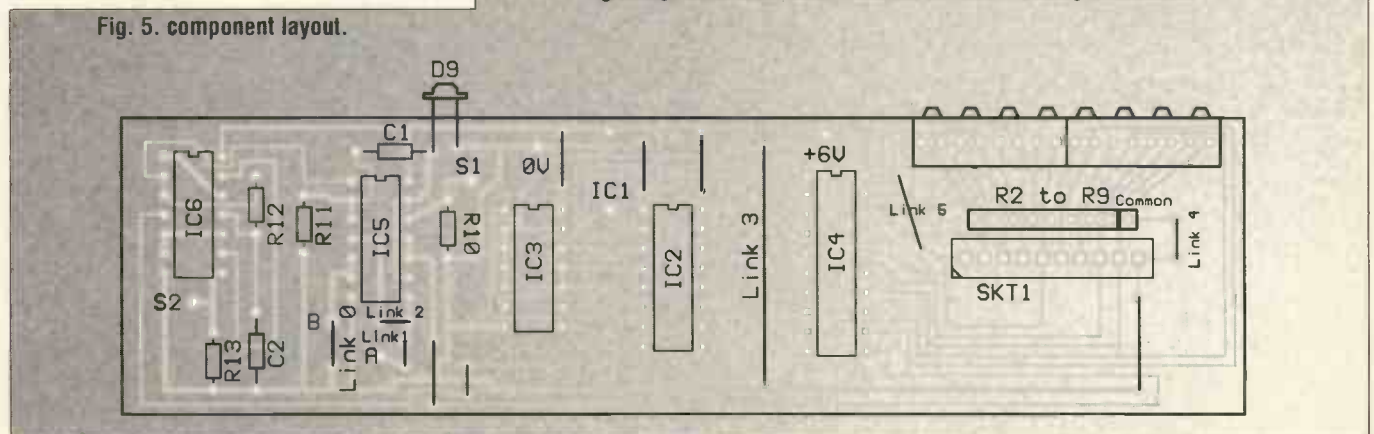

Fig. 5. component layout.

The Electronics

The counterweight of the bucket has a small magnet attached to it. A Hall-effect sensor is located so that it detects the field of the magnet when the sensor is in its tilted-back position. In this state the output of the sensor (Fig 6, IC1) at pin 1 is close to 0V. While the bucket is emptying the magnet is moved away from the sensor, the output of which rises to about 6V. As the mechanism tilts back again the output falls, causing the first counter of IC2 to increment by one.

IC2 has two counters IC2a and IC2b cascaded together. IC3 acts as a 4-input AND gate incrementing IC2b whenever the output of IC2a changes from 15 (= 1111 in binary) back to zero. Thus IC2 can register counts from zero up to 255. This 8-bit binary output goes to IC6 which contains eight D-type latches. When the enable input (pin 11) is high, the output of the latches follows their inputs. When the enable input goes low the outputs are saved or latched. These are 3-state outputs; in Fig 6 the control input (pin 1) is shown connected to 0V, which makes the outputs behave normally. When an output is high the LED (light emitting diode) connected to it is lit and the total count can be read as an 8-bit binary number. However, if pin 1 is made high,

the outputs go into a high-impedance state, that is to say they are in effect disconnected from the LEDs. More important, they are disconnected from the 10-way socket SKT1, making it feasible for this socket to be directly connected to the data bus of a microcomputer.

The latches are normally under the control of a clock, which can be either a ready-built clock module or, as in the prototype, the "works" of an old digital alarm clock adapted for the purpose. At 9 am each day (or at any other time for which the alarm is set) a high pulse from the clock sets the flip-flop, IC5c/IC4d. There is also an inverting gate provided by IC4b for use should the clock module be one which generates a logic low pulse at alarm time. When the flip-flop is set, the output at pin 10 goes low. This makes the enable input of IC4 low so that the count is latched and held until someone comes to read it. At the same time the output at pin 13 goes high, supplying current to the flashing LED. This indicates that the display shows the latched reading, not the current reading. In the meantime, the count in IC2 has been reset to zero and is subsequently incremented if it is raining, but this does not affect the output of IC3. After the

latched reading has been taken, the flip-flop is reset by pressing S1. From then on the display shows the current count held in IC2.

Another effect of setting the flip-flop is that a high pulse is passed to IC5a, which inverts it and sends a low pulse to IC6a. IC6a and IC6d are connected as a pulse generator which produces a high pulse on a rising edge, that is, at the end of the pulse from IC5a. IC6c and IC6b OR this high pulse with a possible high pulse produced if the reset button S2 is pressed. The output of IC6b is a high-going pulse which resets the counters. Thus the counters are reset either at the alarm time or when S2 is pressed. The output of IC6b is a high-going pulse which resets the counters. Thus the counters are reset either at the alarm time or when S2 is pressed. The purpose of the delay introduced by C1, R11 and IC5a is to allow time for the count to be latched into IC4 before IC2 is reset.

The sensor (IC1) is mounted on a small piece of strip-board (Fig 7). This is held in position by a long bolt mounted in the rear of the box. The IC (integrated circuit) should be close to the north-seeking end of the magnet when the bucket mechanism is tilted back (Fig 2).

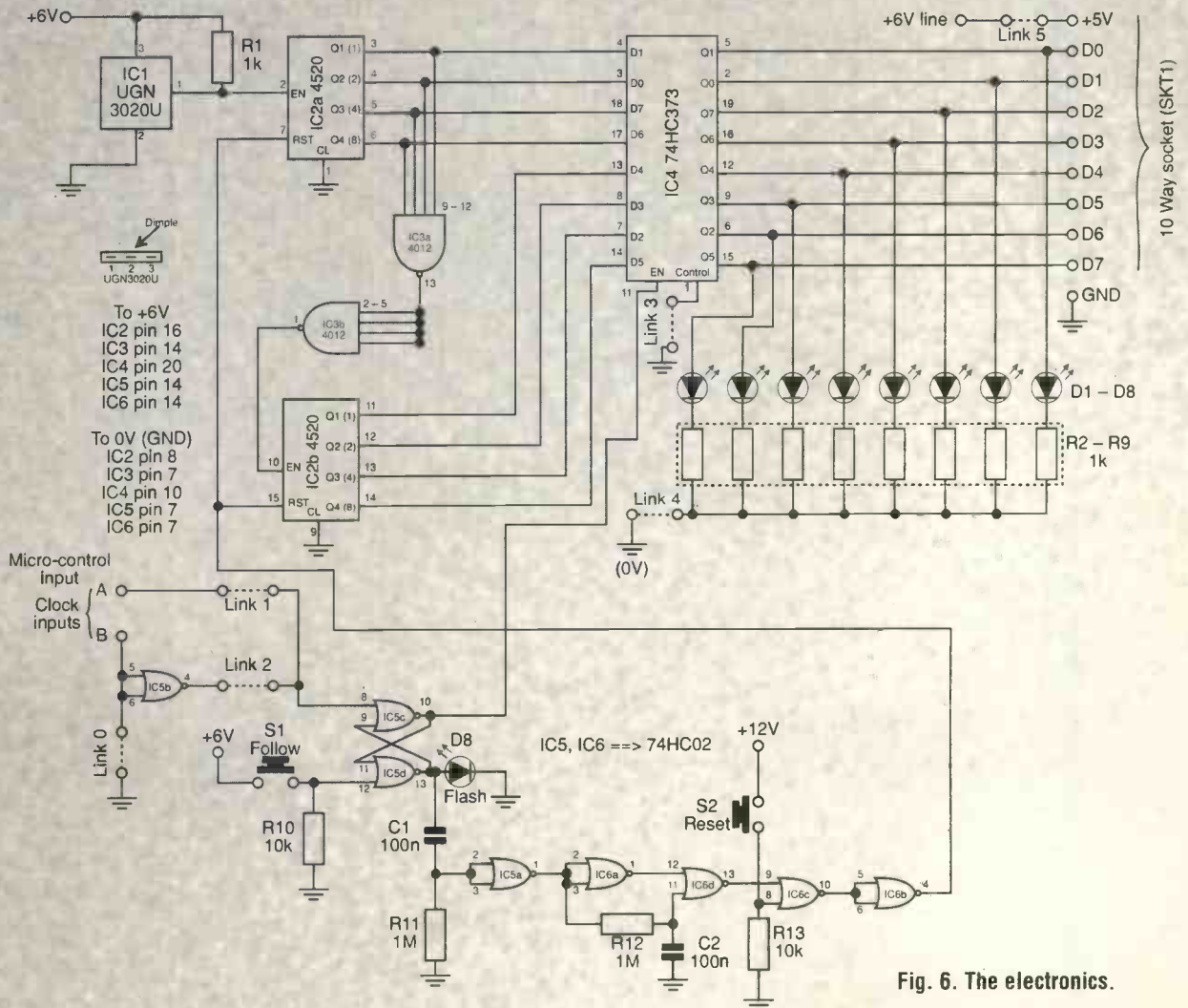

Fig. 6. The electronics.

Rainfall records

Regular recording of rainfall has been established in Britain for over 200 years. The first gauge in use as long ago as 1675. By the mid 19th century the British Rainfall Organisation had established a network which has now grown to over 7000 recording stations scattered throughout the country. It is the densest routine observational network in the world.

Recording rainfall has a purpose different from that which is usually associated with weather measurements. Wind direction and strength, temperature and changing barometric pressure are the basis of the nightly TV weather forecasts. Rainfall records on the other hand have no immediate bearing on what the weather will be like tomorrow. Instead they are used in long range prediction and statistics.

The collected data can be processed in a variety of ways, monthly, seasonal and annual totals and averages. There is also the matter of rainfall distribution throughout the country. Several industries, including the tourist industry are dependent on this. Statisticians work on the data to establish its variability, or more appropriately the reliability, or rainfall in a given area, vital knowledge for farmers, the river authorities and those who manage the domestic water supplies. Other derived data includes the average lengths of sequences of wet and dry days, the typical duration of rain showers, the number of showers per day, and the number of showers

lasting longer than a given period of time.

The official rainfall day begins at 9am. This is the time at which gauges are officially emptied, the reading taken and the water container replaced under the funnel to collect its share of the new day's deluge. With continuously recording gauges such as the bucket gauge and drop counter a more useful range of data is obtainable. It is such equipment which makes it practicable to collect such data as shower length, the number of showers per day and other short-term information. To reduce this data to a form in which it is more easily comprehended a few terms need to be defined, such as exactly what is meant by "a rainy day".

A rainy spell requires 15 or more consecutive days each with 0.2mm or more, while an officially wet spell must have at least 1mm on each of those days. Conversely, a dry spell has 15 or more consecutive days with less than 1mm of rain, and there must be less than 0.2mm of each of those days to make it an absolute drought.

Although a rainfall measurement has no immediate predictive value, rainfall and temperature are the two main indicators of climatic change. Examination of records make it possible to discern patterns and trends. This can be of great economic importance, particularly in areas of the World where the successive failure of the annual monsoons can bring about widespread starvation. In Britain, rainfall reached a peak in the nineteenth-thirties. Since then it declined until, in 1974, we experienced the worst

drought of this century. The production of hay and silage fell to only 60% of normal, and other crops were similarly affected. Britain was once a land of light but frequent rain, an almost ideal climate for the farmer. The current trend seems to be toward long dry spells punctuated by periods of violent storms. Farmers suffer while tourists are delighted. Fortunately this is mainly a matter of the distribution of rainfall in time. The total annual rainfall is only a little less than it was before, so our reservoirs remain full.

The past thirty years has seen a decline in the westerlies blowing across the North Atlantic, bringing rain to Britain and Western Europe. As a result of this the total rainfall has declined slightly in Western Europe. In Britain there has also been a change in distribution. In western areas of Britain much of the rainfall is precipitated as the moisture-laden westerlies are pushed up over the higher regions of Cornwall, Devon, Wales, the Scottish Highlands and the Pennines (orographic). The decline in westerlies has therefore reduced rainfall in western regions, while eastern areas of Britain remain relatively unaffected.

Such are the trends that statistical examination of rainfall data has made apparent. Whether these are on-going tendencies which may become more extreme, or whether they are part of long natural cycles that may yet reverse, or whether the trends may be diverted because of new factors such as the Greenhouse Effect, is still a matter of conjecture.

blocks of four and in series with a 1Kohm resistor they take only 4mA each. Note that the flashing LED is intended to operate on the full supply voltage and does not require

the usual series resistor.

The PCB is intended to fit vertically in slots in the side of the box. The LEDs are on the upper edge of the board, directed upward when the board is vertical. They lie just below a circular hole and a slit cut in the lid of the box. The two push-buttons, and other switches, if fitted, are mounted on the lid. The strip-board bearing the clock module is bolted to the bottom of

the box. If preferred, the clock can be mounted on the lid with apertures cut to allow the display to be viewed and the clock push-buttons to be reached. This entails the use of a larger box and more work in cutting the holes.

In The Field

The collector unit must be located in the open so that the funnel is

Fig. 7. The sensor board.

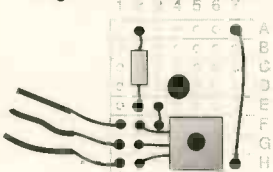
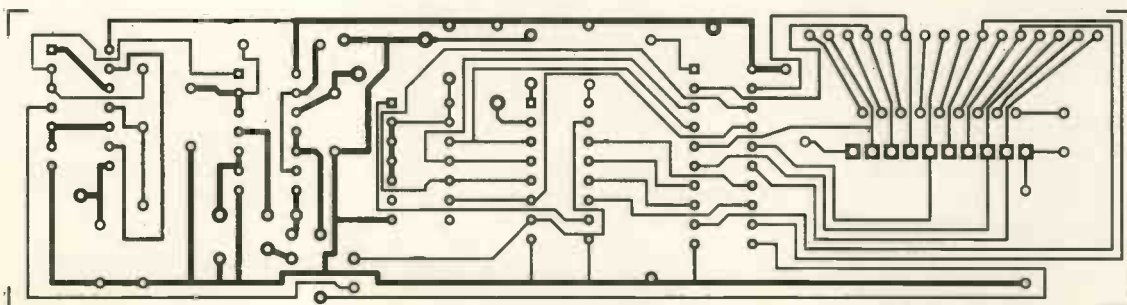

Fig. 8 PCB tracks.



The Hall effect

If a current is passing through a slice of semiconductor material and there is a magnetic field at right angles to the direction of the current, the charge carriers (electrons) of the current are deflected in a direction at right angles to both current and field. This is an example of Fleming's left-hand motor rule, but applied to electrons instead of to a coil of wire carrying a current. The result is to produce a higher density of electrons on one side of the slice than on the other. In other words, a potential difference appears across it. This is the Hall effect, which occurs in all conductors but is only easily measurable in semiconductors.

A Hall effect device includes the slice in which the effect occurs together with an integrated circuit to detect the voltage change and to produce a corresponding output. Different types of Hall effect device have different kinds of output. Linear devices produce an analogue

output voltage which varies in polarity with the direction of the magnetic field and varies in magnitude in proportion to the field strength (the magnetic flux density). Other devices have a switched output, which is either high (close to the supply voltage) or low (close to 0V). In some of these the switch is turned on when the magnetic flux density exceeds a given amount (+25mT (Tesla) in a typical device). It requires a field of opposite direction (-25mT) to turn it off. In the device used in this project the field is effective only if it is positive (entering from the dimpled side) and exceeds a given value, +22mT. A magnetic field below +16.5mT turns it off. A reversed field has no effect, however strong.

Hall effect devices have many applications as proximity detectors, as in this project, and are used in contact-less bounce-free switches.

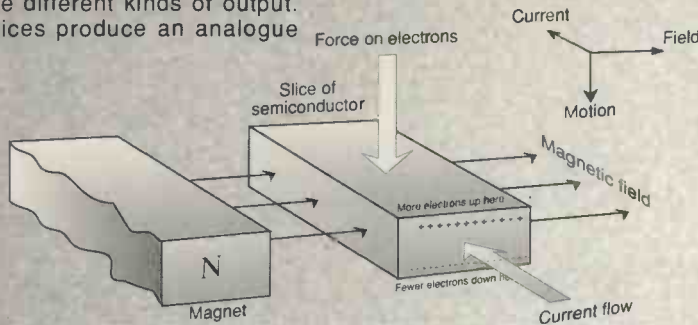

On The Links

The circuit board (Fig 5) has a number of links which allow the gauge to be operated in various ways:

Link 0 is used to connect the inputs of IC5b to a low logic level, if that gate is not to be used.

Link 1 is used if the clock produces a high alarm pulse. It can be replaced by a switch to isolate the clock if the gauge is to be controlled by a microcomputer.

Link 2 is connected instead of Link 1 to allow the use of IC5b to invert a low-going alarm pulse.

Link 3 normally connects the control input of IC3 to 0V, but can be used to put this function under the control of a microcomputer.

Link 4, if disconnected, disables the display. It can be left open or replaced by a switch. This is an option for economising in current, or for when the 10-way socket is connected to the data bus of a micro. If the socket is connected to the user port of a micro, it is not usually necessary to disable the display.

Link 5 is normally open but is connected if the circuit is to be powered from the +5V supply of a micro. Note that the 10-way socket also has a 0V connection to the 0V (ground) rail of the micro, which is essential for proper operation of the interface.

exposed to rain from all directions. It is also a good idea not to expose it to strong winds and situations where excessive run-off from trees or from blocked gutters may occasionally fall into the funnel. The enclosure can be bolted or screwed to a stout vertical post to hold it firm in the wind and to allow the measured water to drain

freely away. The funnel may require a supporting bracket to hold it in place and to reduce wind vibration.

A 3-core cable passes through a hole in the bottom of the collector box and is taken indoors or to a nearby shed or greenhouse where the counter hardware is situated. A cable several metres long may be

used as there is little risk of it picking up interference. Terminate the cable with a plug or plugs to fit SKT2-4.

Before bolting the lid on the collector box, check that the bucket is operating properly. Also check that no more than 2 or 3 drops per second fall into the bucket. ■

Components

(Excluding those required for the clock module)

Resistors

(carbon 0.125W or metal film 0.6W, 5%, unless otherwise specified)

R1 1k
R2-R9 1k, 8 commoned resistors (1 off)
R10, R13 10k (2 off)
R11, R12 1M (2 off)

Capacitors

C1, C2 100nF polyester (2 off)

Semiconductors

D1-D8 PCB mounting LEDs, low current type, red (Electromail stock no. 590-036)(2 x quad LEDs)

D9 Flashing LED

Integrated circuits

IC1 UGN3020U Hall effect IC switch (Electromail stock no. 307-446)

IC2 4520 CMOS dual synchronous divide-by-16 counter

IC3 4012 CMOS dual 4-input NAND gate

IC4 74HC373 CMOS octal 3-state latch

IC5, IC6 74HC02 CMOS quadruple 2-input NOR gate (2 off)

Miscellaneous

S1, S2 panel-mounting push-to-make push-buttons

SKT1 10-way printed circuit connector (Electromail stock no. 488-359) (optional)

SKT2-4 1mm Plugs and sockets, panel-mounting (3 off)

20-way DIL socket

16-way DIL socket

14-way DIL sockets (4 off)

enclosure for collector unit, ABS or metal box, approx 200mm x 110mm x 60mm

enclosure for counter unit, ABS box approx. 150mm x 80mm x 50mm (Electromail stock no. 508-936 fits the PCB)

printed circuit board

stripboard, for clock module and a small scrap for mounting IC1

1mm terminal pins (12 off)

Large plastic funnel (1 or 2 off)

Materials for making bucket, nuts, bolts, plastic tubing etc

Fig. 9. How to connect everything up.

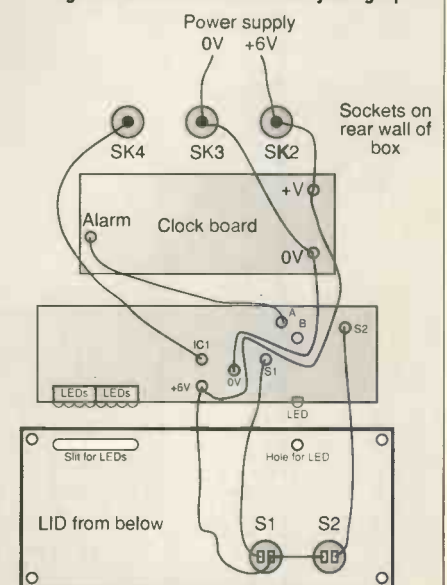

SURVEILLANCE PROFESSIONAL QUALITY KITS

No. 1 for Kits

Whether your requirement for surveillance equipment is amateur, professional or you are just fascinated by this unique area of electronics SUMA DESIGNS has a kit to fit the bill. We have been designing electronic surveillance equipment for over 12 years and you can be sure that all of our kits are very well tried, tested and proven and come complete with full instructions, circuit diagrams, assembly details and all high quality components including fibreglass PCB. Unless otherwise stated all transmitters are tuneable and can be received on an ordinary VHF FM radio.

UTX Ultra-miniature Room Transmitter

Smallest room transmitter kit in the world! Incredible 10mm x 20mm including mic. 3-12V operation. 500m range.....£16.45

MTX Micro-miniature Room Transmitter

Best-selling micro-miniature Room Transmitter
Just 17mm x 17mm including mic. 3-12V operation. 1000m range.....£13.45

STX High-performance Room Transmitter

Hi performance transmitter with a buffered output stage for greater stability and range. Measures 22mm x 22mm including mic. 6-12V operation, 1500m range.....£15.45

VT500 High-power Room Transmitter

Powerful 250mW output providing excellent range and performance. Size 20mm x 40mm. 9-12V operation. 3000m range.....£16.45

VXT Voice Activated Transmitter

Triggers only when sounds are detected. Very low standby current. Variable sensitivity and delay with LED indicator. Size 20mm x 67mm. 9V operation. 1000m range...£19.45

HVX400 Mains Powered Room Transmitter

Connects directly to 240V AC supply for long-term monitoring. Size 30mm x 35mm. 500m range.....£19.45

SCRX Subcarrier Scrambled Room Transmitter

Scrambled output from this transmitter cannot be monitored without the SCDM decoder connected to the receiver. Size 20mm x 67mm. 9V operation. 100m range.....£22.95

SCLX Subcarrier Telephone Transmitter

Connects to telephone line anywhere, requires no batteries. Output scrambled so requires SCDM connected to receiver. Size 32mm x 37mm. 1000m range.....£23.95

SCDM Subcarrier Decoder Unit for SCRX

Connects to receiver earphone socket and provides decoded audio output to headphones. Size 32mm x 70mm. 9-12V operation.....£22.95

ATR2 Micro Size Telephone Recording Interface

Connects between telephone line (anywhere) and cassette recorder. Switches tape automatically as phone is used. All conversations recorded. Size 16mm x 32mm. Powered from line.....£13.45

UTLX Ultra-miniature Telephone Transmitter

Smallest telephone transmitter kit available. Incredible size of 1mm x 20mm! Connects to line (anywhere) and switches on and off with phone use. All conversation transmitted. Powered from line. 500m range.....£15.95

TLX700 Micro-miniature Telephone Transmitter

Best-selling telephone transmitter. Being 20mm x 20mm it is easier to assemble than UTLX. Connects to line (anywhere) and switches on and off with phone use. All conversations transmitted. Powered from line. 1000m range.....£13.45

STLX High-performance Telephone Transmitter

High performance transmitter with buffered output stage providing excellent stability and performance. Connects to line (anywhere) and switches on and off with phone use. All conversations transmitted. Powered from line. Size 22mm x 22mm. 1500m range.....£16.45

TKX900 Signalling/Tracking Transmitter

Transmits a continuous stream of audio pulses with variable tone and rate. Ideal for signalling or tracking purposes. High power output giving range up to 3000m. Size 25mm x 63mm. 9V operation.....£22.95

CD400 Pocket Bug Detector/Locator

LED and piezo bleeper pulse slowly, rate of pulse and pitch of tone increase as you approach signal. Gain control allows pinpointing of source. Size 45mm x 54mm. 9V operation.....£30.95

CD600 Professional Bug Detector/Locator

Multicolour readout of signal strength with variable rate bleeper and variable sensitivity used to detect and locate hidden transmitters. Switch to AUDIO CONFORM mode to distinguish between localised bug transmission and normal legitimate signals such as pagers, cellular, taxis etc. Size 70mm x 100mm. 9V operation.....£50.95

QTX180 Crystal Controlled Room Transmitter

Narrow band FM transmitter for the ultimate in privacy. Operates on 180 MHz and requires the use of a scanner receiver or our QRX180 kit (see catalogue). Size 20mm x 67mm. 9V operation. 1000m range.....£40.95

QLX180 Crystal Controlled Telephone Transmitter

As per QTX180 but connects to telephone line to monitor both sides of conversations. 20mm x 67mm. 9V operation. 1000m range.....£40.95

QSX180 Line Powered Crystal Controlled Phone Transmitter

As per QLX180 but draws power requirements from line. No batteries required. Size 32mm x 37mm. Range 500m.....£35.95

QRX180 Crystal Controlled FM Receiver

For monitoring any of the 'Q' range transmitters. High sensitivity unit. All RF section supplied as a pre-built and aligned module ready to connect on board so no difficulty setting up. Output to headphones. 60mm x 75mm. 9V operation.....£60.95

A build-up service is available on all our kits if required.

UK customers please send cheques, POs or registered cash. Please add £1.50 per order for P&P. Goods despatched ASAP allowing for cheque clearance. Overseas customers send sterling bank draft and add £5.00 per order for shipment. Credit card orders welcomed on 0827 714476.

OUR LATEST CATALOGUE CONTAINING MANY MORE NEW SURVEILLANCE KITS NOW AVAILABLE. SEND TWO FIRST CLASS STAMPS OR OVERSEAS SEND TWO IRCs.

★★★★ Specials ★★★★★

DLTX/DLRX Radio Control Switch

Remote control anything around your home or garden, outside lights, alarms, paging system etc. System consists of a small VHF transmitter with digital encoder and receiver unit with decoder and relay output, momentary or alternate, 8-way di1 switches on both boards set your own unique security code. TX size 45mm x 45mm. RX size 35mm x 90mm. Both 9V operation. Range up to 200m.

Complete System (2 kits).....£50.95
Individual Transmitter DLTX.....£19.95
Individual Receiver DLRX.....£37.95

MBX-1 Hi-Fi Micro Broadcaster

Not technically a surveillance device but a great idea! Connects to the headphone output of your Hi-Fi, tape or CD and transmits Hi-Fi quality to a nearby radio. Listen to your favourite music anywhere around the house, garden, in the bath or in the garage and you don't have to put up with the DJ's choice and boring waffle. Size 27mm x 60mm. 9V operation. 250m range.....£20.95

**SUMA
DESIGNS**

**THE WORKSHOPS, 95 MAIN ROAD,
BAXTERLEY. NEAR ATHERSTONE,
WARWICKSHIRE CV9 2LE**



0827 714476

Comms, Computers And Cock-ups

Barry Fox has used portable communications systems all over the world and if his experiences are anything to go by, there is room for a great deal of improvement.

Over the last ten years I have travelled a lot, carrying a portable computer with the intention of sending back news and articles to magazines for which I write. Some of these magazines provide direct access to their editorial computer system by telephone line; others are connected to an electronic mail system, such as Telecom Gold or Mercury Link 7500.

I have used a whole string of computers (from Tandy 100 through budget Toshiba to luggable Dell) in Europe, North America and the Far East, with all kinds of modems (both acoustic and hard wired, electronic mail and fax) running at data speeds from 300 to 2400 baud.

There is only one thing I can say with certainty, and that is that no two communications situations are ever alike. It has only very occasionally been easy and is usually a very difficult and frustrating waste of time.

Many portables gobble power so rapidly that you cannot run them off batteries for much more than an



All this colour portable from Toshiba needs is reliable communications.

hour. The paper specification may promise longer, but only on minimum memory capacity and with no add-ons, for example an internal modem.

Nicad cells become progressively less retentive if you

do what the instruction books specifically warn against, but what everybody has to do in practice – top up half-charged cells.

Not all PCs have a multi-voltage charger. My Tosh doesn't, so I have to carry an extra transformer to cope with both 240 and 110 volt supplies.

I use an external modem (to save drain on the PC batteries) and this too needs either its own mains adaptor or spare batteries. The modem will often switch itself on in a suitcase during travel and flatten the cells.

Some hotel phones in North America now have a socket on the side for direct connection of a modem. Elsewhere, especially in Europe, everything possible is done to deter connection. Phone plugs vary in size and wiring from



The Cambridge Z88 is ideal for some portable applications.

country to country. Often the best bet is an omnipurpose modem lead with crocodile clips on the end. Take the telephone or wall junction box apart and play trial and error games to find the hot wires.

Many hotels (for example in Japan and the US) now have switchboards with non-standard dialling tones which an auto-dialling modem will refuse to recognise. The trick here is to dial 9 (or 0) manually, then quickly start the communication software running and hang up as the modem grabs the public system dial tone.

The latest spoiler in the USA is to route long distance calls through a friendly AT&T operator. He or she interrupts the dialled number to ask for the hotel room or credit card number. This defeats the auto dial modem. It makes sending faxes from a PC virtually impossible because the fax modem will need to set up the call and exchange handshakes before sending the text.

The most simple, bomb-proof, approach to email (Electronic Mail) transmission is to use an acoustic modem or coupler. You dial the host number manually, listen for the modem reply tone and then put the handset in the rubber cups of the acoustic unit. Even this failed on me once in an American hotel which had mock-antique phones which would not fit the cups.

Telecoms people will tell you

Recently I vowed never again to carry a PC and suitcase full of electronic gizmos...



not to try and phone long distance to a modem, but instead hook into a local packet switched network (like Tymnet or Telenet in the USA and Japan). This lets you dial a local host number, which acts as a node into the international packet network and provides a data ride back to the UK and into the electronic mail services.

For many years red tape made this very difficult, with travellers obliged to negotiate expensive password PSS deals before leaving home. Now the UK electronic mail services have made arrangements with some foreign data services, which let travellers call a foreign node with billing following later on the UK service. These have been very poorly advertised and not all countries have PSS nodes with back-home billing arrangements.

Remember to check on the host node numbers and what comms standard they use. Better still get a number for a foreign helpline; the host numbers have a nasty habit of changing.

The host modems may be auto-sensing and self-adjust to the speed of the calling modem. Or they may be of fixed speed, with different telephone numbers for different speeds. Odd things can happen when two auto-sensing modems try to talk to each other. They lock on at different speeds on different attempts.

Whereas the 1200 and 2400 baud standards for Bell (USA and elsewhere) and CCITT (Europe and other elsewhere) are close enough to match (usually), the 300 baud

Bell and CCITT standards are completely incompatible. From bitter experience I must advise that, if humanly possible, travellers should find out the number of the host modems in the cities they are visiting and then try making long distance calls from the UK to the remote modems to check connection. It is always far easier, and cheaper, to struggle with mismatched modems from your own home or office phone, than from the bedside phone of a far-off hotel when you have just crawled in off a long haul flight and are dog tired and jet lagged.

Be warned, incidentally, that some of the PSS helplines (even in business conscious North America) only work weekday office hours. If you arrive ill-prepared on a Friday night you may not be able to make any connection until Monday morning.

Recently I vowed never again to carry a PC and suitcase full of the electronic gizmos which may or may not successfully connect it to a phone line. Security checks at airports harden this resolve. But doubtless I shall keep on trying just once more.

What I do know for sure is that next time I see an advert which tells us all how easy it is to communicate on the move, I shall lodge a complaint with the Advertising Standards Authority, to see how the advertiser justifies the claim. Nobody should be allowed to write such twaddle unless they have actually tried it for themselves. ■

Practical Electronics Classified Ads

Reach thousands of serious electronic and computer enthusiasts – advertise in PE Classified pages:
 Rates 20p (plus 4p VAT) per word or £8.50 (plus £1.49 VAT) per column cm. All classified advertisements must be pre-paid. Send your copy, with remittance payable to Intra Press, (Payment by Visa or Access accepted – ads may be phoned in) to:

**Practical Electronics, Intra House, 193 Uxbridge Road, London W12 9RA.
 Tel: 081-743-8888. Fax: 081-743-3062**

Education

Start training now for the following courses.

- Telecomms Tech C&G 271
- Radio Amateur Licence C&G
- Microprocessor
- Introduction to Television

Send for our brochure - without obligation or telephone us on 06267 79398 (Ref: PE11/91) Name.....

Radio & Telecommunications Correspondence School,
 12 Moor View Drive, Teignmouth, Devon TQ14 9UN

BTEC ELECTRONICS TECHNICIAN FULL-TIME TRAINING

THOSE ELIGIBLE CAN APPLY FOR E.T. GRANT SUPPORT AN EQUAL OPPORTUNITIES PROGRAMME

O.N.C. H.N.C. O.N.D.

Next Course Commences 6th June 1992

FULL PROSPECTUS FROM

LONDON ELECTRONICS COLLEGE (DEPT. EE) 20 PENYVERN ROAD EARLS COURT, LONDON SW5 9SU TEL 071-373 8721

Retailers

MANCHESTER

THE ELECTRONICS SHOP

We stock a large range of electronic components, test equipment, telephone accessories, computer accessories, microphones, speakers, discolorighting, mixers, meters, stills, so call in and have a look around.

29 Hanging Ditch, Manchester M4 3ES
 Telephone: 061-834-1185
 Fax: 061-833-2969

Support your local electronics specialist!

Retailers

Project your retail image here!



Phone David Bonner for details on 081-743-8888

LONDON N WEST

CRICKLEWOOD ELECTRONICS

One of the largest ranges of components in the UK!

40 Cricklewood Broadway,
 LONDON NW2 3ET

Tel: 081-450 0995/452 0161

SOUTH COAST



Cooke International

"We stock used scopes, signal generators, power supplies, power meters, DVMs, oscillators, attenuators, test equipment. Much more available, visit our s/r room and bargain store. Prices from £5 upwards!"

Send SAE for lists

Contact: Cooke International, Unit Four Fordingbridge Site, Main Road, Barnham Bognor Regis, West Sussex PO22 0EB
 Tel: 0243 545111 Fax: 0243 542457

"Open: Mon - Fri 9am - 5pm or phone"

Computer Parts

CAMBRIDGE COMPUTER SCIENCE LIMITED

3.5" 720K Diskette Drives	£39.00 each
10MByte Winchester, used, 3 months Wty.	£42.00 each
5.25" Disk Drives, 80TK, DSDD	£34.00 each
5.25" Disk Drives, 80 TK, DSDD Used, No Wty	£15.00 each
<small>(The £15.00 drives are sold on a strictly "as is" basis)</small>	
5.25" Disks, DDDD, 48tp, boxes of 10	£3.00/box
Lookable diskette boxes for 80"3.5" or 100"5.25" (state which)	£5.99 each
Small sized diskette boxes (lockable)	40"3.5" £4.75, 50"5.25" £4.99 each
Printer stands (suit 8-/132 cols) Basic £2.99, or with paper catcher	£10.99 each
Digital multimeter, 14 ranges, incl leads & manual	£16.00 each
Apricot Disk drive PSU	£10.00 each
5V @ 6A PAU	£4.80 each
SV @ 10A PSU	£6.40 each
Nicads AA £0.89, C £1.99, D £2.09, PP3 £4.99, Universal charger	£5.99 each
74LS TTL, pick and mix, buy 10 or more for	£0.12 each
Types available: '00 '02 '04 '08 '10 '11 '12 '13 '14 '15 '20 '21 '26 '27 '30 '32 '33 '37 '38 '42 '74 '83 '85 '86 '96 '107 '109 '122 '125 '132 '136 '138 '139 '145 '151 '153 '157 '158 '160 '162 '163 '164 '165 '174 '181 '193 '240 '253 '257 '260 '298 '353 '365 '366 '373 '385 '390 '399 '670 '682	
27128 EPROMS (Ex equipment)	£1.20 each or £5.00/5
256K Byte DRAM Modules, removed from equipment	£6.00 each
62256-10 NV 32KByte SRAM	£5.00 each
8K Byte NV RAM chips £3.00 each	£10.00 four
Range of Aluminium and plastic project boxes (ask for list)	
Prices include postage. Add 50p (plus VAT) to orders below £5.00	
All items new unless stated. Add 17.5% VAT to all prices.	
Send an SAE for our latest list or for more info.	
Dept PE, 374 Milton Road, Cambridge, CB4 1SU	
Tel: 0223 424602, 0831 430496 or 0831 430552 (Mail order only)	

Manufacturers Original Spares

For Amstrad, Atari, Commodore and Sinclair computers.

Many TV, VCR & Audio Parts also available - Send S.A.E. or Phone 0452 526883 for a 'Price and Availability' on your requirements	
Atari YM2149F 'Sound' Chip (ST)	£10.02
Commodore 906114 'PLA' Chip (C64/C)	£9.24
Sinclair ZX8302 'ULA' Chip (QL)	£10.75
Membranes: QL-£7.95 Spec. 48K-£4.50 +/-128K-£7.99	
Amstrad Original Service Manual (CPC464 + Monitors)	£8.49
ditto Original Service Manual (PCW8526/8512)	£13.89
Chips: PEGA1A-£32.72 TEA2000-£4.49 AY38912-£5.74	
Sanyo/Fisher VCR Belt Kit VTC6500/VBS3500	£2.49
Hitachi Replacement Video Head VT1 1/14/33/34	£26.10
Toshiba Power Transformer (22224100) ST-U2	£9.99
Ferguson Tuner Control Door 3v35/36/38/39	£1.95
The above is just a very small sample of our stock. For a Catalogue please send 50p CHQ./Stamps/3xIRC's etc. Please add 95p (UK) P & P to above orders. All items subject to availability.	

**MARAPET (PEM) 1 Hornbeam Mews, Gloucester GL2 0UE
 MAIL ORDER ONLY TEL: 0452 526883**

Miscellaneous

AMPLIFIERS

A range of 300 watt self assembly amplifiers for sale
£45.00 each + £2.50 P&P

Also: Range of speaker drive units and other amplifiers

Call: Andy on (0273) 681257

Miscellaneous

UNIVERSAL PROGRAMMER HI-Lo ALL-03 £295

Take advantage of Asian low labour cost!

- ★ Texas Instrument approved. Good quality.
- ★ PC based, programs stored into 5 diskettes.
- ★ Program most MPU, PLD, EPROM, EEPROM, BPROM.
- ★ Adaptors for PLCC devices are available.
- ★ 1 year guarantee. Money back if not satisfied.
- ★ Price includes postage but not VAT.

Write for free catalogue and price list.

Active Action Industrial Ltd
Rm 1307, Wing Tuck Coml Ctr.
177-183 Wing Lok Street
Hong Kong

SOLVE CROSSWORD PUZZLES BY COMPUTER

X-SOLVE

Have 3 letters of a 15 letter word?

An anagram with a 3 word solution??

Then X-SOLVE the ANSWER

This £30 package for your IBM PC or compat. has 41,000+ solutions that have appeared before in crosswords and learns more as you meet them.

Try it for FREE

Details: X-SOLVE, PO Box 16, St. Albans,
Herts. AL1 5JG.

Tel: 0727-835703 6am-11.30pm

CATALOGUE £1.00 + 25P&P

Resistor Pack 85 different E12 values + zero ohm link total content	
1000 resistors	£8.95
LEDs 3mm or 5mm red/green	6p each. Yellow 11p each.
Cable ties 1p each £5.95/1,000 £49.50 per 10,000	
Stepping motor 4 phase 12V 7.5' step 50 ohms	£8.95
SA A1027 stepping motor driver chip	£3.95
FM Transmitter kit good quality sound	£8.60
High quality photo resist copper clad epoxy glass boards	
Dimensions single sided double sided	
3x4 inches £ 0.95 £1.07	
4x8 inches £ 2.40 £2.68	
6x12 inches £ 5.37 -	
12x12 inches £10.66 -	

Special Offers

Computer Grade Capacitors with screw terminals 38000µf 20V	£2.50
8700µf 10V £1.95, 68000µf 15V £2.95, 10000µf 16V	£1.50
7 segment Common anode led display 12mm	£0.45
LM2931A T5.0 Low drop out 5V regulator T0220 package	£0.85
BS250 P channel MOSFET £0.45, BC559 transistor	£3.95 per 100
74LS05 hex inverter £10.00 per 100, used 8748 Microcontroller	£3.50
Stereo LW/MW/FM Tuner pre-amp assembly complete with volume/tone controls and tuning scale Brand new in maker's carton	£6.95, faulty £3.50
Circuit etc. for above £0.50.	
Hour counter (used) 7 digit mains 240V AC 50Hz	£1.45
LCD display 16 digit 7x5 dots dot matrix	£2.50
Qwerty keyboard 58 key good quality switches new	£5.00
Qwerty keyboard with serial output, no data	£5.00.

Wide range of CMOS TTL 74HC 74F Linear transistors kits capacitors, resistors tools etc always in stock.
Please add 95p towards P&P - VAT Included

JPG Electronics 276 - 278 Chatsworth Road
Chesterfield S40 2BH
Access/Visa orders (0246) 211202. Callers welcome

Surplus

TURN YOUR SURPLUS

ICS transistors etc into cash, immediate settlement. WE welcome the opportunity to quote for complete factory clearance.

Contact:

COLES-HARDING & CO.,
103 South Brink, Wisbech, Cambs.

ESTABLISHED 15 YEARS

Tel: 0945 584188 - Fax: 0945 588844

Recycle your old projects and generate useful cash from spare components

Components

High Stability Resistors

Carbon Film Resistors 0.56R to 10MΩ E24 series 1/4W - 1p
100 off per value - 75p. 1000 off in even hundreds per value - £6.00
Metal Film 1/4W 10R0 to 1MΩ E12 series 5% - 2p. 1% E24 series - 3p
Mixed metal/carbon film 1/2W E24 series 1R0 to 10MΩ - 1.12p
Mixed metal/carbon film 1W 4R7 to 10MΩ E12 series - 5p

BC107/8/9 - 12p. BC182, BC183, BC184, BC212 & L versions - 10p
BFY50.51 & 52 - 20p. 2N3055 - 50p. TIP31A,32A - 25p. TIP, 41,42 - 40p
Tantalum bead electrolytics subminiature (MfDs/Volts)

0.125, 0.22/25, 0.47/25, 1.0/25, 2.2/25, 3.3/16, 3.3/20, 4.7/16 - 14p. 3.3/25, 4.7/25, 4.7/35 - 15p. 8.8/18, 8.8/35 - 16p. 10/16, 20/25 - 20p. 10/35, 22/16, 33/10, 47/10 - 30p. 100/6 - 30p. 100/16 - 50p. 220/6 - 60p

Aluminium Electrolytics (MfDs/Volts)
150, 2.2/50, 4.7/50, 10/16, 10/25, 10/50 - 5p. 22/16, 22/25, 22/50, 47/16, 47/25, 47/50 - 6p. 100/16, 100/25 - 7p. 100/50 - 12p. 220/16 - 8p. 220/25, 220/50 - 10p. 470/16, 470/25 - 11p. 1000/16 - 15p. 1000/25 - 16p. 2200/25 - 22p

Miniature Polyester Capacitors 250V Wkg. Vertical Mounting
.01, .015, .022, .033, .047, .068 - 4p. 0.1 - 5p. 0.15, 0.22 - 6p
Mylar Capacitors 100V Wkg. Vertical Mounting E12 Series
1000p to 8200p - 3p. 0.01 to 0.68 - 4p. 0.1 - 5p. 0.15, 0.22 - 6p

Subm. Ceramic Plate 100V Wkg. E12 Series Vertical Mounting
2% IP8 to 47P - 3p. 56P to 330P - 4p. 10%, 390P to 4700P - 4p
Plate/disc ceramic 50V. Wkg. Vertical Mount. E12 series 1P0 to 1000P & E6 series 1500P to 47000P - 2p. 0.1 - 3p

Polystyrene Capacitors 63V Wkg. E12 Series Axial Mounting
10P to 820P - 4p. 1000P to 10,000 - 5p. 12,000P - 6p

Diodes
Zener diodes E24 series 3V3 to 33V 400mW - 8p. 1 watt - 12p. 1N4148 - 2p. 1N4001 - 3p. 1N4002 - 3.5p. 1N4007 - 5p. 1N5404 - 14p. OA91 - 8p. AA143 - 10p. W005 - 20p. W01 - 25p. BYX10 - 6p

L.E.D.s Red, Green & Yellow 3mm & 5mm - 10p 8mm - 35p
20mm bases 0.15A to 10A quick blow - 5p. 0.1A to 5A Anti Surge - 8p
High Speed diodes 0.8mm, 1.0mm, 1.3mm, 1.5mm, 2mm - 30p
"Expo" Reliant drilling machines 12V d.c. with improved 3jaw chuck - £7.00
Nicas AA - 90p. HP11 - £2. HP2 - £2.20. PP3 - £5 Universal chargers for all above batteries - £6.50

Glass reed switches with single pole make contacts - 6p. Magnets - 12p. 0.1" stripboard 2.5" X 1" 9 rows 27 holes - 25p. 3.75" X 2.5" 24 rows 37 holes - 70p. Ionsars list price £16.95 7 year guarantee - £12.00. Jack plugs 2.5mm X 3.5mm - 14p. Sockets panel mtg - 10p
All prices VAT inclusive. Postage 30P (free over £5)

THE C.R. SUPPLY CO.
127 Chesterfield Road,
Sheffield S8 0RN.
Tel: 0742 557771

Classifieds can be a TIGHT SQUEEZE

Give your ad room to
breathe
in our

DISPLAY PAGES

Contact David Bonner
on

081-743 8888

Large selection of interesting components at very competitive prices.

Large S.A.E. for lists to AGS Electronics, Unit 2, Haxter Close, Bellver Ind. Estate, Plymouth, Devon PL6 7DD. Tel: 0752-767738.

SURPLUS/REDUNDANT ELECTRONICS COMPONENTS WANTED

ICs - Tuners - Transistors - Valves - Diodes etc - any quantity considered - immediate payment.

ADM ELECTRONICS SUPPLIES

Tel 0827 873311 Fax: 0827 874835

Surveillance

Suma Designs sell top quality surveillance equipment. See our display ad in this issue

Kits, Plans, Assembled Units, Surveillance Microtransmitters, Phone Recording Switches, Trackers, Defence /Protection Circuits, Plus much more. Send 2 x 22p stamps for lists, or tel. 05436 76477 24hrs. Everything for the budding 007. ACE(PE). 53 Woodland Way, Burntwood, Staffs. WS7 8UP.

Surveillance devices, lasers, Tesla coils, scramblers, ultrasonic and many more, over 150 designs. Send SAE to: Plancentre, Old Wharf, Dynock Road, Ledbury HR8 2HS for free list.

SPY BOOKS - Interested in espionage, counter-surveillance, personal freedom or investigation? Do you seek information that some people feel should remain secret or unpublished? Send large S.A.E PO BOX 2072, London NW10 0NZ

NEW VHF MICROTRANSMITTER KIT, tuneable 80-135 MHz, 500 metre range, sensitive electret microphone, high quality PCB. SPECIAL OFFER complete kit ONLY £5.95, assembled and ready to use £9.95 post free. Access orders telephone 021 411 1821. Cheques/ P.O.'s to: Quantek Electronics Ltd, (Dept P.E.), 45a Station Road, Northfield, Birmingham, B31 3TE

73 AMATEUR RADIO TODAY

Broaden your horizons.

Subscribe to the world's leading Radio Ham magazine. European rates for surface and air mail available on request from:

73 Amateur Radio Today
PO Box 50330
Boulder
CO.
80321-0330
USA

Techniques

This month Andrew Armstrong scrutinises light activated switches.

DR Clark of Plymouth writes to ask whether PE has recently published a design for a light activated switch, to switch on a lamp at dusk and switch it off at dawn.

No, we have not published such a design recently, so here are a couple of circuits which should be suitable.

The circuit shown in Fig. 1 is the simplest approach to this problem. A photo conductive cell is used to short out the gate drive to a triac when the cell is illuminated. Because the resistance of the cell, an ORP12, varies with illumination rather than changing abruptly at a particular light level, the lamp will fade in and out rather than switching abruptly.

The choice of component values in this circuit is dictated by the maximum rated dissipation of the ORP12. This photo conductive cell is rated at 250mW maximum dissipation so R1 is chosen to provide the maximum triggering current consistent with not exceeding the maximum dissipation of the ORP12.

Diacs generally trigger at approximately 30V and that the

maximum dissipation in the ORP12 occurs at a voltage just below that which will cause the diac to trigger. R2 and C1 present a short time constant and cause minimal attenuation of the 50Hz waveform so that the voltage on the ORP12 to cause triggering is only just over 30V peak. Assuming that the mains is an exact 240V sinewave, and that the diac triggers at exactly 30V, the voltage across the ORP12 at the trigger point will be 31.4V peak. This corresponds with 22.019V RMS, and occurs when the resistance of the ORP12 is 3.33k. At voltages in excess of 22V RMS, the diac will fire at some stage during the cycle, which will remove the triggering current from R1 and hence reduce the dissipation of the ORP12.

To calculate the dissipation in the ORP12, we need to know its resistance at the point at which the maximum AC voltage is applied to it. We then use the formula V^2/R . Taking the values given above, the maximum dissipation in the ORP12 (which only occurs at one specific light level) is 145mW. This is safely below the maximum rated dissipation of 250mW.

In order to make sure that a

sufficient trigger pulse is applied to the triac, C1 is chosen to be as high a value as possible consistent with the requirements above. Clearly, if it has too high a value, the time constant of R2 and C1 will be long enough to delay the triac triggering at maximum brightness. As a further measure to ensure proper triggering, a triac with a guaranteed 5mA gate trigger current and a low holding current is chosen. This particular triac is almost uniquely suitable for the job and, because it is rated at 4A RMS, it could switch a lamp load of almost a kilowatt.

A snubber network is provided to protect the triac from the effects of mains spikes and because the controller will pass through a phase controlled region, a filter choke and a class x capacitor are provided to prevent interference from being radiated into the mains. The choke should be made by winding 50 turns of 0.8 mm diameter wire on an iron dust core type T94-40 (available from Cirkit).

The necessity to filter the output detracts from what would be a very simple circuit, making it worthwhile to consider the design shown in Fig.2.

Fig. 1. A simple approach.

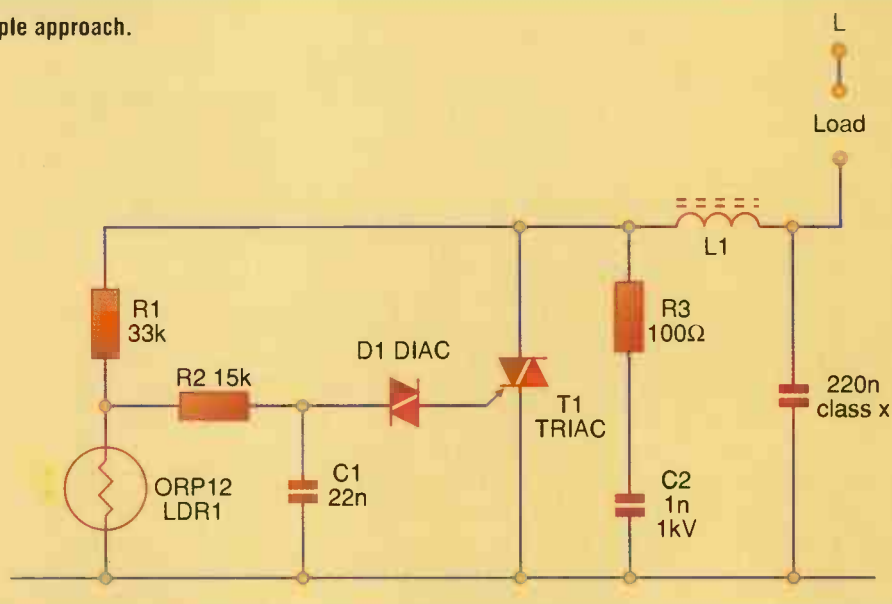

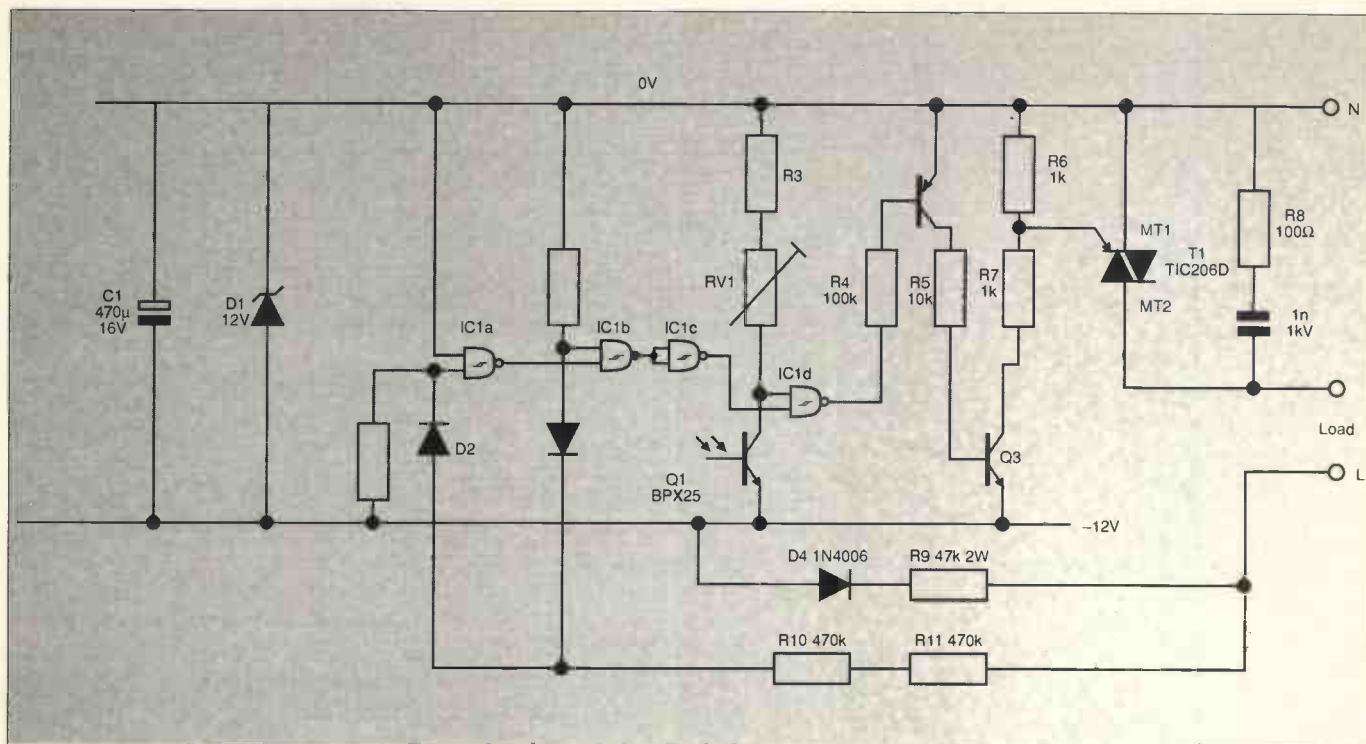

Zero Level Triggering

In this design, a -12V power supply is generated by means of a mains dropper resistor and a high-voltage diode. The triac is triggered by pulses from this negative power supply. A negative supply is used because most triacs trigger better with negative gate drive than with positive drive. Some types of triac are not specified to trigger at all if the gate drive is positive and the voltage on MT2 is negative. The TIC 206D is rated to trigger with 5mA of gate drive in quadrants 1 to 3, while in quadrant 4 (positive gate drive, negative voltage on MT2) it needs 10mA.

In the design shown in Fig.2, the power supply voltage is set by the 12V zener D1, and smoothed by C1. Clearly, there will be some ripple on this supply, but that does not matter in this application.

The DC current available for the power supply is not, as you might think, half the RMS current which would flow in R9 if D4 were not present. It is in fact $V_{peak}/\pi \cdot R$, for reasons which can only satisfactorily be explained by calculus – and which would be superfluous to the purposes of this article.

Taking into account that some current must flow in D1, 2mA is enough to power the active circuitry. The CMOS IC itself draws very little current, so 2mA is available to be shared between the

current through the photo-transistor, and triggering pulses for the triac.

IC1a and IC1b are used to generate a short trigger pulse at around the mains zero crossing. Assuming for the moment that the VPX25 is not illuminated: if the mains voltage is at 0V, then the output of IC1a is at logic 1, and therefore both inputs of IC1b are at logic 1, which switches the output of IC1b to logic 0. IC1c is connected as an inverter, so its output goes to logic 1. Because Q1 is not illuminated, both inputs of IC1d are at logic 1, so the output of IC1d is at logic 0. This switches on Q2, which switches on Q3, which triggers the triac T1.

During positive mains half cycles, while the voltage is high enough to bias pin 2 of IC1a to above its switching threshold, the output of IC1a goes to logic 0, which propagates through to provide logic 0 on the output of IC1c. This forces the output of IC1d to logic 1, which switches off the triggering current to T1. During negative half cycles, while there is enough voltage to pull pin 6 of IC1b below the switching threshold, the output of IC1b goes to logic 1, which propagates through to switch off the trigger current as above.

So long as the voltage of pin 12 of IC1d remains above the switching threshold, trigger pulses will be generated around the mains

zero crossings. A trigger current of approximately 11mA flows. This is more than enough to trigger a triac, so the triggering is clean. The duration of the triggering pulses is short enough to draw less than 0.5mA average from the power supply. It is this technique of circuitry which keeps the dissipation in R9 to acceptable levels (approximately 600mW).

Two resistors are used in series to supply signal to the CMOS gates so that the breakdown of one resistor alone would not destroy the circuitry. While one resistor would normally be sufficient, the level of mains spike generated by a fluorescent light switching on or off can be sufficient to cause a normal spiral cut film resistor to break down across the turns.

If Q1 is illuminated sufficiently to pull the voltage in pin 12 of IC1d below the switching threshold, then the output is forced to logic 1 and trigger pulses are no longer generated, so the lamp remains off.

Whichever circuit is used, the photodetector must be mounted in such a way that it does not receive enough illumination from the lamp which the circuit controls to switch off the lamp. It is normally sufficient to use a small piece of opaque plastic to shield the photodetector from the lamp while allowing daylight to fall upon it.

Subscribe to

PRACTICAL **ELECTRONICS**

SCIENCE AND TECHNOLOGY

Every month we bring you the best coverage of the modern technical world.

Innovations has all the news of the latest developments, technical features explain the detail behind the glittering facade of technology, while writers such as Barry Fox, Technology Journalist of the Year and Ian Burley, Editor of BT's Prestel Micronet consumer section, analyse the growing role of electronics in everyday life. Finally, for those of you who want personal hands-on experience of design and construction, our projects offer entry level designs and advanced challenges.

A 12-month subscription is only £18 (UK), £22 (surface mail) or £39 (air mail). Concessionary rates also available. Order by credit card on 081 743 8888.

Subscribe today and book your place in the electronic future.



Send to:
Intra Press, Intra House, 193 Uxbridge Road, London W12 9RA.
Make cheques/postal orders payable to Intra Press in £ sterling.
Please subscribe me to Practical Electronics for 12 months,
starting with the issue.
I enclose a cheque/postal order/banker's draft for £.....

Name
Address
Town
County
Post Code.....
Or: Please charge my VISA/Mastercard
Number
Expiry date.....

Subscription rates:

UK post - £18, Overseas surface mail - £22, overseas airmail - £39.

Discount rates:

UK BAEC/Educational concession- £16.20, Overseas BAEC/Educational concession - £19.80 (surface mail only available)

Please enclose proof of BAEC membership or educational status.

PRACTICAL ELECTRONICS

SCIENCE AND TECHNOLOGY

Looking back over the past 25 years, PE has made some very accurate predictions.

November 1966

In his editorial this month 25 years ago, the editor explained that without Avionics, modern airliners would be virtually impossible. At this time, all-weather landing systems were not common and, prophetically, he looked forward to the time when they would be. Looking further ahead, the editorial went on to say that the only solution to safe supersonic transport would be to relinquish control to the "free electron". Before the introduction of microprocessor systems and the difficulties involved in proving them to be fault free, this must have seemed an attractive idea. However, as the Shuttle and Airbus have proved, life is never that simple.

1976

The Semiconductor Update section in this issue featured the SC/MP from National Semiconductor. As the author predicted, this device was set to take the constructor market by storm. SC/MP stands for Simple Cost-effective Micro-Processor. It had 46 instructions with an 8-bit bus and was available in a number of kits enabling people to get to grips with the coming revolution in electronics. The SC/MP or Scamp as it was known has now faded into the mists of time. However, it should be remembered as the chip which fired the imagination of thousands of enthusiasts.

1981

Not all predictions come true, usually because they are based on false assumptions. The Robots feature in this issue made it clear that automation could be used to replace a lot of jobs in manufacturing industries. While true to some extent, there has never been a wholesale move towards robotics, probably because they have, so far, been unable to replace the incredible flexibility and adaptiveness that is innate in a human being. One day, perhaps, we will all be able to put our feet up and leave everything to our mechanical servants – on the other hand, will we want to?

1986

The final prediction in this column comes from BT who, in 1986, said that it would have replaced half of its old electromechanical exchanges for new digital ones by the end of the decade. This actually happened on 20th June 1991 when it converted its 3319th exchange. If it carries on at the same rate, it will have finished the lot by about the year 2000, a year full of celebrations ■



NATIONAL
COLLEGE OF
TECHNOLOGY

DISTANCE LEARNING COURSES

The National College of Technology offer a range of packaged learning short courses for study at home or in an industrial training environment which carry national BTEC awards. Study can commence at any time and at any level, enabling you to create a study routine to fit around existing commitments.

Courses on offer include:

Analogue Electronics
Digital Electronics
Fibre/Optoelectronics
Programmable Logic Controllers

Tutor support and BTEC certification are available as options with no travelling or college attendance required. These very popular courses which are ideal for vocational training contain workbooks, audio cassette lecturers, PCBs, instruments, tools, components and leads as necessary to support the theoretical and practical training. Whether you are a newcomer to electronics or have some experience and simply need an update or certifications, there is probably a distance learning course for you. Write or telephone for details to:

National College of Technology
NCT Ltd. PO Box 11, Wendover, Bucks
Tel: (0296) 624270

Advertising Index

21st Century Elec.....13	Labcenter.....15
73 Amateur Radio.....55	Limrose.....44
Active Action.....55	London Elec. Coll.....54
ADM.....55	Maplin.....OBC
AGS.....55	Marapet.....54
Astrofest 92.....61	MQP.....42
BK Electronics.....IBC	NCT.....60
Bull Electrical.....29	Number One Systems.....24
Cambridge Comp Sci.....54	Omni.....42
Coles Harding.....55	Radio & Tele. Schl.....54
CR Supply Co.....55	Service Trading Co.....44
Cricklewood.....42	Stewart of Reading.....44
Electronics Shop.....54	Suma Designs.....51
ESR.....44	Tandy.....4
Greenbank.....42	Tsien (UK).....IFC
Henry's Audio.....13	Weka Publishing.....9
Intl. Corr. School.....44	X-Solve.....55
JPG Electronics.....55	



The Universe comes to London

A Two Day Conference and Exhibition

Speakers Include:

Doctor Patrick Moore,

CBE, Editor-in-Chief, Astronomy Now

Professor Arnold Wolfendale,

Astronomer Royal

Professor Sir Bernard Lovell,

Jodrell Bank, University of Manchester

Professor Malcolm Longair,

Cavendish Laboratory, Cambridge University

Professor Peter Willmore,

Department of Space Sciences, Birmingham University

Professor Tony McDonnell,

Head of Unit for Space Sciences, University of
Kent at Canterbury

Professor Andrew Lyne,

University of Manchester

Doctor Heather Couper

Leif Robinson,

Editor, Sky & Telescope

Doctor John Mason,

Deputy Editor, Astronomy Now

The Venue:

Royal Borough of Kensington Town Hall
Hornton Street, London W8 7NX ENGLAND
Friday 14th - Saturday 15th February 1992

Sponsored by:

Astronomy Now



For details of how to exhibit contact the organisers:
Peter Hail & Associates Limited
Suite 75, 49 Hallam Street, London,
W1N 5LN ENGLAND
Telephone: 071-580 2104
Fax: 071-323 3891

For a copy of the Conference Programme, details
of special accommodation packages,
and how to apply for tickets, write to:
The 1992 European AstroFest (Tickets)
Intra House, 193 Uxbridge Road,
London W12 9RA ENGLAND

3D TV...

Not A Pretty Sight

Barry Fox Itaks a good look at the variety of three dimensional television systems and, after examining all the angles, is not terribly impressed.

Over the years I have grown weary of 3D TV and video systems.

In Japan, Toshiba sells a 3D VHS camcorder and playback system. This works like the 3D variant of JVC's now defunct VHD video disc system. It displays left and right images alternately to the left and right eyes. The viewer wears electronically switched LCD shutter spectacles. The result is depth but nasty flicker. It would be even worse in Europe where the display frame rate is less, 25 Hz for PAL instead of 30 Hz for NTSC.

Anaglyph systems separate the left and right images by displaying them in different colours. The viewer wears differently coloured spectacles and sees depth in tinged monochrome or oddly balanced colour.

Colour fringe systems, like Aspex, Vivitar's Q-DOS, and the system used by the Sun newspaper recently for Page 3 models, add colour to the edges of moving or out-of-focus objects. Again the viewer wears coloured spectacles. There is less depth but the fringing is less offensive to people without spectacles.

Polarizing systems, with two superimposed pictures viewed through polarizing sunglasses, give colour and depth, but dimmer images because half the light is lost.

The much hyped Deep Vision claimed 3D without spectacles. Grand talk about decoders disguised nothing more exotic than a vertical strip pattern over a TV screen which was supposed to give 3D to viewers without spectacles. In reality it gave a blurred picture with very little depth. Deep Vision seems mercifully to have disappeared without trace – despite



talk of being "in the shops by (last) Christmas".

Anyone in Europe with a satellite dish pointed at the Astra satellite can tune into German channel RTL-Plus and watch the first European demonstrations of another 3D TV system called Nuoptix.

Nuoptix relies on the Pulfrich effect, many times re-discovered over the years. The Pulfrich effect is the optical equivalent of artificial stereo. If the same sound is heard by both ears but the sound to one ear is artificially delayed, the brain is fooled into perceiving a spread of sound instead of a point source. If the same image is seen by both eyes, but the image available to one eye is artificially dimmed, the brain takes longer to process it. If the image is moving, the brain registers different perspectives for each eye and is fooled into perceiving depth.

Recently John Christian, who works for telecommunications giant GPT, won a £3,000 pounds prize in the BP/Nat West new technology awards for yet another 3D system.

A conventional camcorder sits on a mount with the lens poking into a box which has two lenses poking out of the side. These lenses are spaced apart by 50% wider than human eyes and thus "see" slightly exaggerated left and right eye images. These images fall on two mirrors in the box which turn the images through 90 degrees. The optics also reduce the images in size so that the tape records two upended images, of half normal size, side by side.

When the tape is played back, the image displayed on a TV screen is of course the same non-standard pair of upended half-size pictures, side by side. There are two ways of getting 3D from this image pair.

One is to project the image (Christian uses a Sharp LCD projector) through a mirror box which works in the opposite way to the camcorder mirror box. It turns the two images through 90 degrees and superimposes them on screen. The projected light for each image is passed through a polarizing filter. So a viewer wearing polarizing spectacles sees 3D, but with smaller and dimmer pictures than 2-D.

The other way is to display the image pairs on a conventional TV screen and look through a viewing box. This acts like a pair of binoculars, turning the images through 90 degrees and "feeding" one to the viewer's left eye and one to the viewer's right eye. In this case there is no need to wear spectacles. But it is a very awkward way to watch TV.

Christian's prize-winning system may entertain hobbyists but, sorry, it does nothing for me. ■

OMP POWER AMPLIFIER MODULES-TURNABLES-DIMMERS-LOUDSPEAKERS-19 INCH STEREO RACK AMPLIFIERS

OMP POWER AMPLIFIER MODULES Supplied ready built and tested.
OMP POWER AMPLIFIER MODULES Now enjoy a world-wide reputation for quality, reliability and performance at a realistic price. Four models available to suit the needs of the professional and hobby market i.e. Industry, Leisure, Instrumental and Hi-Fi etc. When comparing prices. NOTE all models include Toroidal power supply, Integral heat sink Glass fibre PCB and Drive circuits to power compatible Vu meter. Open and short circuit proof.

THOUSANDS OF MODULES PURCHASED BY PROFESSIONAL USERS

OMP100 Mk 11 Bi-Polar Output power 110 watts R.M.S. into 4 ohms, Frequency Response 15Hz - 30KHz - 3dB, T.H.D. 0.01%, S.N.R. -118dB, Sens. for Max. output 500mV at 10K, Size 355 x 115x65mm. **PRICE £33.99 + £3.00 P&P.**

NEW SERIES II MOS-FET MODULES
OMP/MF 100 Mos-Fet Output power 110 watts R.M.S. into 4 ohms, Frequency Response 1Hz - 100KHz - 3dB, Damping Factor, >300, Slew Rate 45V uS, T.H.D. Typical 0.002%, Input Sensitivity 500mV, S.N.R. -125dB, Size 300 x 123 x 60mm. **PRICE £39.99 + £3.00 P&P.**

OMP/MF200 Mos-Fet Output power 200 watts R.M.S. into 4 ohms, Frequency Response 1Hz - 100KHz - 3dB, Damping Factor >300, Slew Rate 50V uS, T.H.D. Typical 0.001%, Input Sensitivity 500mV, S.N.R. -130dB, Size 300 x 155 x 100mm. **PRICE £62.99 + £3.50 P&P.**

OMP/MF300 Mos-Fet Output power 300 watts R.M.S. into 4 ohms, Frequency Response 1Hz - 100KHz - 3dB, Damping Factor >300, Slew Rate 60V uS, T.H.D. Typical 0.0008%, Input Sensitivity 500mV, S.N.R. -130dB, Size 330 x 175 x 100mm. **PRICE £79.99 + £4.50 P&P.**

NOTE— MOS-FET MODULES ARE AVAILABLE IN TWO VERSIONS. STANDARD INPUT SENS. 500mV BAND WIDTH 100KHz. REC. PROFESSIONAL EQUIPMENT COMPATIBLE. INPUT SENS. 775mV BAND WIDTH 50KHz. ORDER STANDARD OR PEC.
 Vu METER Compatible with our four amplifiers detailed above. A very accurate visual display employing 11 L.E.D. diodes (7 green, 4 red) plus an additional on/off indicator. Sophisticated logic control circuits for very fast rise and decay times. Tough moulded plastic case, with tinted acrylic front. Size 84 x 27 x 45mm. **PRICE £8.50 + 50p P&P.**

LOUDSPEAKERS

LARGE SELECTION OF SPECIALIST LOUDSPEAKERS AVAILABLE, INCLUDING CABINET FITTINGS, SPEAKER GRILLES, CROSS-OVERS AND HIGH POWER, HIGH FREQUENCY BULLETS AND HORNS, LARGE S.A.E. (30p STAMPED) FOR COMPLETE LIST.

McKENZIE:— INSTRUMENTS, P.A., DISCO, ETC.
ALL MCKENZIE UNITS 8 OHMS IMPEDENCE
 8" 100 WATT C8100GPM GEN. PURPOSE LEAD GUITAR, EXCELLENT MID, DISCO. RES. FREQ. 80Hz FREQ. RESP. TO 14KHz SENS. 99dB. **PRICE £28.59 + £2.00 P&P.**
 10" 100 WATT C10100GP GUITAR, VOICE, ORGAN, KEYBOARD, DISCO, EXCELLENT MID. RES. FREQ. 70Hz FREQ. RESP. TO 6KHz SENS. 100dB. **PRICE £34.70 + £2.50 P&P.**
 10" 200 WATT C10200GP GUITAR, KEYBOARD, DISCO, EXCELLENT HIGH POWER MID. RES. FREQ. 45Hz FREQ. RESP. TO 7KHz SENS. 103dB. **PRICE £47.48 + £2.50 P&P.**
 12" 100 WATT C12100GP HIGH POWER GEN. PURPOSE LEAD GUITAR, DISCO. RES. FREQ. 45Hz FREQ. RESP. TO 7KHz SENS. 98dB. **PRICE £36.66 + £3.50 P&P.**
 12" 100 WATT C12100TC TWIN CONE HIGH POWER WIDE RESPONSE, P.A. VOICE, DISCO. RES. FREQ. 45Hz FREQ. RESP. TO 14KHz SENS. 100dB. **PRICE £37.63 + £3.50 P&P.**
 12" 200 WATT C12200B HIGH POWER BASS, KEYBOARDS, DISCO, P.A. RES. FREQ. 40Hz FREQ. RESP. TO 7KHz SENS. 100dB. **PRICE £64.17 + £3.50 P&P.**
 12" 300 WATT C12300GP HIGH POWER BASS LEAD GUITAR, KEYBOARDS, DISCO, ETC. RES. FREQ. 45Hz FREQ. RESP. TO 5KHz SENS. 100dB. **PRICE £85.79 + £3.50 P&P.**
 15" 100 WATT C15100BS BASS GUITAR, LOW FREQUENCY, P.A., DISCO. RES. FREQ. 40Hz FREQ. RESP. TO 5KHz SENS. 98dB. **PRICE £53.70 + £4.00 P&P.**
 15" 200 WATT C15200BS VERY HIGH POWER BASS. RES. FREQ. 40Hz FREQ. RESP. TO 4KHz SENS. 99dB. **PRICE £73.26 + £4.00 P&P.**
 15" 250 WATT C15250BS VERY HIGH POWER BASS. RES. FREQ. 40Hz FREQ. RESP. TO 4KHz SENS. 99dB. **PRICE £80.53 + £4.50 P&P.**
 15" 400 WATT C15400BS VERY HIGH POWER, LOW FREQUENCY BASS. RES. FREQ. 40Hz FREQ. RESP. TO 4KHz SENS. 102dB. **PRICE £94.12 + £4.50 P&P.**
 18" 400 WATT C18400BS EXTREMELY HIGH POWER, LOW FREQUENCY BASS. RES. FREQ. 27Hz FREQ. RESP. TO 3KHz SENS. 99dB. **PRICE £167.85 + £5.00 P&P.**

EARBENDERS:— HI-FI, STUDIO, IN-CAR, ETC.
ALL EARBENDER UNITS 8 OHMS EXCEPT EB8-50 AND EB10-50 DUAL 4 AND 8 OHM. BASS, SINGLE CONE, HIGH COMPLIANCE, ROLLED FOAM SURROUND
 8" 50 WATT EB8-50 DUAL IMPEDENCE, TAPPED 4 OHM BASS, HI-FI, IN-CAR. RES. FREQ. 40Hz FREQ. RESP. TO 7KHz SENS. 97dB. **PRICE £8.90 + £2.00 P&P.**
 10" 50 WATT EB10-50 DUAL IMPEDENCE, TAPPED 4 OHM BASS, HI-FI, IN-CAR. RES. FREQ. 40Hz FREQ. RESP. TO 5KHz SENS. 99dB. **PRICE £12.00 + £2.50 P&P.**
 10" 100 WATT EB10-100 BASS, HI-FI, STUDIO. RES. FREQ. 35Hz FREQ. RESP. TO 3KHz SENS. 96dB. **PRICE £27.50 + £3.50 P&P.**
 12" 60 WATT EB12-60 BASS, HI-FI, STUDIO. RES. FREQ. 28Hz FREQ. RESP. TO 3KHz SENS. 92dB. **PRICE £21.00 + £3.00 P&P.**
 12" 100 WATT EB12-100 BASS, STUDIO, HI-FI, EXCELLENT DISCO. RES. FREQ. 26Hz FREQ. RESP. TO 3KHz SENS. 93dB. **PRICE £32.00 + £3.50 P&P.**
FULL RANGE TWIN CONE, HIGH COMPLIANCE, ROLLED SURROUND
 5 1/2" 60 WATT EB5-60TC (TWIN CONE) HI-FI, MULTI-ARRAY DISCO ETC. RES. FREQ. 63Hz FREQ. RESP. TO 20KHz SENS. 92dB. **PRICE £9.99 + £1.50 P&P.**
 6 1/2" 60 WATT EB6-60TC (TWIN CONE) HI-FI, MULTI-ARRAY DISCO ETC. RES. FREQ. 38Hz FREQ. RESP. TO 20KHz SENS. 94dB. **PRICE £10.99 + £1.50 P&P.**
 8" 60 WATT EB8-60TC (TWIN CONE) HI-FI, MULTI-ARRAY DISCO ETC. RES. FREQ. 40Hz FREQ. RESP. TO 18KHz SENS. 89dB. **PRICE £12.99 + £1.50 P&P.**
 10" 60 WATT EB10-60TC (TWIN CONE) HI-FI, MULTI-ARRAY DISCO ETC. RES. FREQ. 35Hz FREQ. RESP. TO 12KHz SENS. 86dB. **PRICE £16.49 + £2.00 P&P.**

TRANSMITTER HOBBY KITS

PROVEN TRANSMITTER DESIGNS INCLUDING GLASS FIBRE PRINTED CIRCUIT BOARD AND HIGH QUALITY COMPONENTS COMPLETE WITH CIRCUIT AND INSTRUCTIONS
 3W FM TRANSMITTER 80-108MHz VARICAP CONTROLLED PROFESSIONAL PERFORMANCE. RANGE UP TO 3 MILES. SIZE 38 x 123mm SUPPLY 12V @ 0.5AMP. **PRICE £14.49 + £1.00 P&P.**
 FM MICRO TRANSMITTER (BUG) 100-108MHz VARICAP TUNED COMPLETE WITH VERY SENSITIVE MIC. RANGE 100-300m. SIZE 55 x 46mm SUPPLY 9V BATT. PRICE **£8.62 + £1.00 P&P.**

POSTAL CHARGES PER ORDER £1.00 MINIMUM. OFFICIAL ORDERS WELCOME FROM SCHOOLS, COLLEGES, GOVT. BODIES ETC. PRICES INCLUSIVE OF V.A.T. SALES COUNTER. VISA ACCESS ACCEPTED BY POST, PHONE OR FAX.

* PRICES INCLUDE V.A.T. * PROMPT DELIVERIES * FRIENDLY SERVICE * LARGE S.A.E. 30p STAMPED FOR CURRENT LIST.

OMP VARISPEED TURNTABLE CHASSIS



★ MANUAL ARM ★ STEEL CHASSIS ★ ELECTRONIC SPEED CONTROL 33 & 45 ★ VARI PITCH CONTROL ★ HIGH TORQUE SERVO DRIVEN DC MOTOR ★ TRANSISTOR SCREWS ★ 12 DIE CAST PLATTER ★ NEON STROBE ★ CALIBRATED BAL WEIGHT ★ REMOVABLE HEAD SHELL ★ CARTRIDGE FIXINGS ★ CUE LEVER ★ POWER 220-240V 50/60Hz ★ 390-305mm ★ SUPPLIED WITH MOUNTING CUT-OUT TEMPLATE
PRICE £59.99 + £3.50 P&P.

OPTIONAL MAGNETIC CARTRIDGES
STANTON AL500 PRICE £16.99 + 50p P&P
GOLDRING G850 PRICE £6.99 + 50p P&P

OMP MOS-FET POWER AMPLIFIERS, HIGH POWER, TWO CHANNEL 19 INCH RACK THOUSANDS PURCHASED BY PROFESSIONAL USERS



NEW MXF SERIES OF POWER AMPLIFIERS
 THREE MODELS:— **MXF200** (100w + 100w)
MXF400 (200w + 200w) **MXF600** (300w + 300w)
 All power ratings R.M.S. into 4 ohms

FEATURES: ★ Independent power supplies with two Toroidal Transformers ★ Twin L.E.D. Vu meters ★ Rotary indexed level controls ★ Illuminated on/off switch ★ XLR connectors ★ Standard 776mV inputs ★ Open and short circuit proof ★ Latest Mos-Fets for stress free power delivery into virtually any load ★ High slew rate ★ Very low distortion ★ Aluminium cases ★ MXF600 Fan Cooled with D.C. Loudspeaker and Thermal Protection
USED THE WORLD OVER IN CLUBS, PUBS, CINEMAS, DISCOS ETC.

SIZES:— MXF 200 W19" x H3 1/2" (2U) x D11"
 MXF 400 W19" x H5 1/2" (3U) x D12"
 MXF 600 W19" x H5 1/2" (3U) x D13"
PRICES: **MXF200 £171.35**
MXF400 £228.85
MXF600 £322.00
SECURICOR DELIVERY £12.00 EACH



OMP LINNET LOUDSPEAKERS

THE VERY BEST IN QUALITY AND VALUE
 MADE ESPECIALLY TO SUIT TODAY'S NEED FOR COMPACTNESS WITH HIGH OUTPUT SOUND LEVELS FINISHED IN HARDWEARING BLACK VYNIDE WITH PROTECTIVE CORNERS, GRILLE AND CARRYING HANDLE INCORPORATES 12" DRIVER PLUS HIGH FREQ. HORN FOR FULL FREQ. RANGE 45Hz-20KHz BOTH MODELS 8 OHM. SIZE H18" x W15" x D12"
CHOICE OF TWO MODELS
POWER RATINGS QUOTED IN WATTS RMS FOR EACH CABINET
OMP 12-100 (100W 100dB) PRICE £159.99 PER PAIR
OMP 12-200 (200W 102dB) PRICE £209.99 PER PAIR
SECURICOR DEL.— £12.00 PER PAIR

OMP SLIDE DIMMER 1K WATT & 2.5K WATT

CONTROL S LOADS UP TO 1KW & 2.5KW SUITABLE FOR RESISTIVE AND INDUCTIVE LOADS. BACK ANODISED CASE. READY FLUSH MOUNTED THROUGH PANEL. CABINET FINISH. ADVANCED FEATURES INCLUDE—
 • FULL 65mm SI IDF TRAVEL
 • NFON MONITOR INDICATOR
 • FLASH OVERRIDE BUTTON
 • HIGH & LOW LEVEL PRESETS
 • FULL VY SUPPRESSED TO RS 800
SIZES: 1KW H128 x W40 x D55mm
 2.5KW H128 x W76 x D79mm
PRICES:— 1K WATT £15.99
2.5K WATT £24.99 + 60p P&P

PIEZO ELECTRIC TWEETERS—MOTOROLA

PIEZO ELECTRIC TWEETERS — MOTOROLA
 Join the Piezo revolution. The low dynamic mass (no voice coil) of a Piezo tweeter produces an improved transient response with a lower distortion level than ordinary dynamic tweeters. As a crossover is not required these units can be added to existing speaker systems of up to 100 watts (more if 2 put in series). **FREE EXPLANATORY LEAFLETS SUPPLIED WITH EACH TWEETER.**

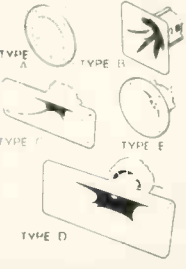

'TYPE A' (KSN2036A) 3" round with protective wire mesh. Ideal for bookshelf and medium sized Hi-fi speakers. Price £4.90 each + 50p P&P
'TYPE B' (KSN1005A) 3 1/2" super horn. For general purpose speakers, disco and P.A. systems etc. Price £5.00 each + 50p P&P
'TYPE C' (KSN6016A) 2" x 5" wide dispersion horn. For quality Hi-fi systems and quality discos etc. Price £6.99 each + 50p P&P
'TYPE D' (KSN1025A) 2" x 6" wide dispersion horn. Upper frequency response retained extending down to mid range (2KHz). Suitable for high quality Hi-fi systems and quality discos. Price £9.99 each + 50p P&P
'TYPE E' (KSN1038A) 3 3/4" horn tweeter with attractive silver finish. Suitable for Hi-fi monitor systems etc. Price £5.99 each + 50p P&P
LEVEL CONTROL Combines on a recessed mounting plate, level control and cabinet input jack socket. 85 x 85mm. Price £3.99 + 50p P&P

STEREO DISCO MIXER

STEREO DISCO MIXER with 2 x 5 band L & R graphic equalisers and twin 10 segment L.E.D. Vu Meters. Many outstanding features 5 inputs with individual ladders providing a useful combination of the following—
 3 Turntables (Mag) 3 Mics. 4 Line including CD plus Mic with talk over switch Headphone Monitor. Pan Pot L & R. Master Output controls. Output 775mV. Size 360 x 280 x 90mm. Supply 220-240V.
Price £134.99 — £4.00 P&P



B. K. ELECTRONICS Dept PE
 UNIT 5, COMET WAY, SOUTHEND-ON-SEA, ESSEX, SS2 6TR.
 TEL: 0702-527572 FAX: 0702-420243

1992 BUYER'S GUIDE TO ELECTRONIC COMPONENTS

Maplin

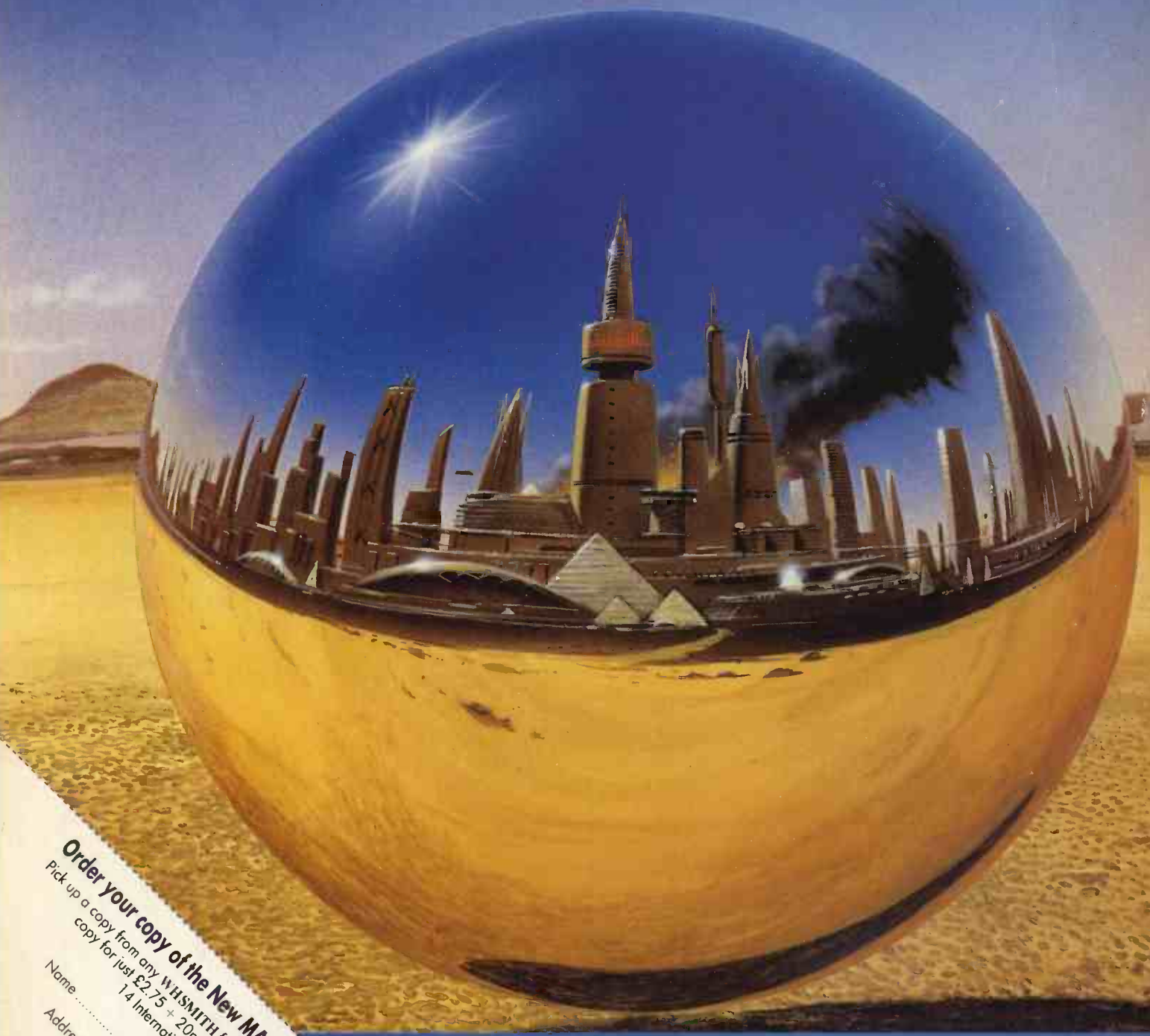

Order your copy of the New MAPLIN Catalogue on sale NOW!
Pick up a copy from any WHSMITH for just £2.75 or post this coupon now to receive your copy for just £2.75 + 20p p&p. If you live outside the U.K. send £4.85 or 14 International Reply Coupons. I enclose £2.95.

Name
Address
Post Code

Send to Maplin Electronics,
P.O. Box 3, Rayleigh,
Essex SS6 8LR.
PE92

Over 600 product packed pages with
more than 600 brand new products
On sale now, only £2.75

Available from all branches of WHSMITH and
Maplin shops nationwide. Hundreds of new products
at super low prices

64