

**PRACTICAL**

DECEMBER 1990 • £1.50

# ELECTRONICS

SCIENCE AND TECHNOLOGY

**UP TO  
£2000 to be  
GIVEN AWAY!**  
see page 61  
for details

## EASY PC

Reviewing a superb  
award-winning pcb  
cad system

## MICRO- CONTROLLING A ROBOT CAR

How to put your mini-  
mobiles under automatic  
control

## A CASE FOR TECHNOLOGY

Making the right choice of  
case to protect your project

**HOME-BASE**  
Kodak's CD-ROM  
breakthrough  
revolutionises  
your photography



MICRONTA®

# MULTI TESTERS

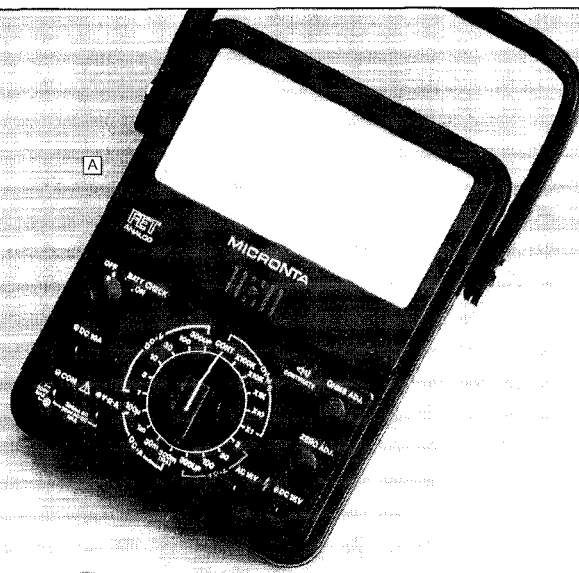

A

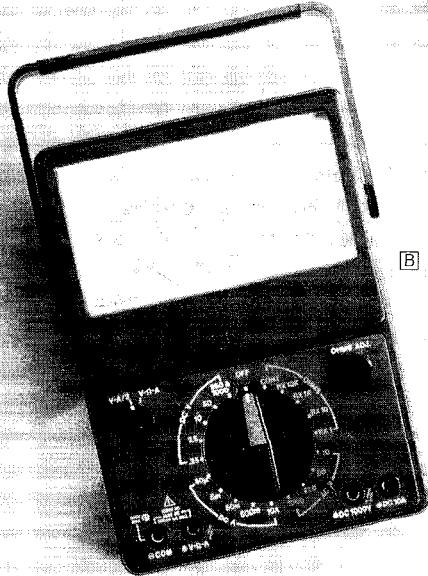

B



C



D



E

**A FET-Input Multitester.** 10-meg input sensitivity. Continuity sounder. Measures 1000V AC/DC, 10A DC current, 100 megohms resistance and -20 to +62 decibels. Requires one 9v, one "C" battery.  
22-220 ..... £39.95

**B Range-Doubler.** 50K DC sensitivity, continuity sounder. Measures: 1000V DC/AC, 10A DC current, 20 megohms resistance and -20 to +62 decibels. Requires one 9v, one "AA" battery.  
22-214 ..... £29.95

**C Fold-Up 25-Range.** 20K DC sensitivity. Measures 1000V AC/DC, 300mA DC current, 2 megohms resistance and -20 to +62 decibels. Requires "AA" battery.  
22-211 ..... £24.95

**D 18-Range.** 20K DC sensitivity. measures to 1000 volts DC, 1000 volts AC, 250mA DC current. Resistance to 2 megohms. Requires "AA" battery.  
22-201 ..... £17.95

**E 2K Pocket Multitester.** Measures to 1000 AC/DC. DC current to 150 mA. 100K resistance. Requires "AA" battery.  
22-7212 ..... £9.95

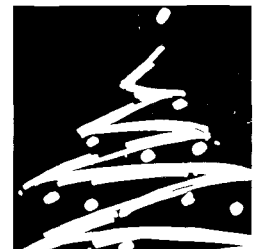

# Tandy

Accurate Every Time!

Over 500 Tandy Stores And Dealerships Nationwide. See Yellow Pages For Address Of Store Nearest You.

InterTAN U.K. Ltd., Tandy Centre, Leamore Lane, Walsall, West Midlands. WS2 7PS Tel:0922 710000

# PRACTICAL ELECTRONICS

VOL 26 NO 12

DECEMBER 1990

## CONTENTS

### £2000 TO GIVE AWAY!

Enter our monthly draw and you too could let us pay for your purchases .61

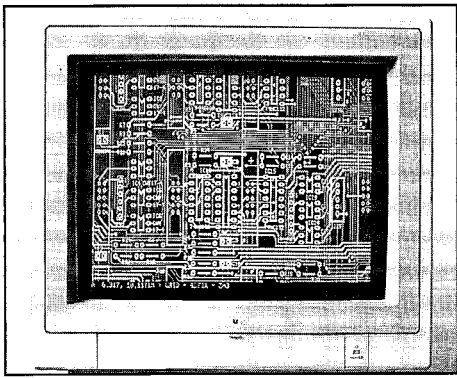

Page 17 ▲ Page 32 ▼



Page 41 ▼

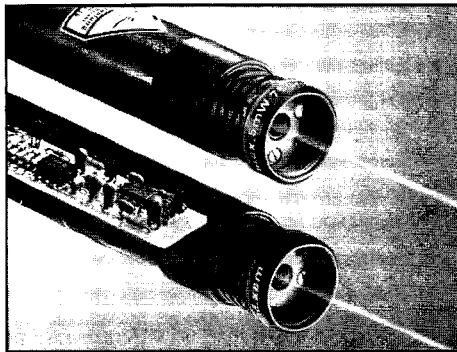

## NEXT MONTH

### WORKING SECURITY

Any PE reader loves the challenge of getting things working: usually we tell you how to construct and complete a brand new equipment design, but next month we look at another aspect – how to find the fault in something that should be working but isn't! Security is another subject that has wide appeal, particularly when it comes to property protection: we've a really superb car alarm system that we shall tell you how to build and install.

And with stereo tv now widely on-air, we'll be telling you how the Nicam system works.

★ WE'RE SYSTEMATICALLY WORKING TO SECURE YOUR INTEREST IN OUR JANUARY 1991 ISSUE

★ ON SALE FROM FRIDAY DECEMBER 7TH



## CONSTRUCTIONAL PROJECTS

**MICROCONTROLLING THE ROBOT CAR** by Alan Pickard .....12  
Don't keep your mini-mobiles on a short-leashed computer link, give them independent freedom by installing a 6502 microcontroller.

**BIKE COMPUTER - PART TWO** by John Becker .....23  
Tailoring the software to personalise our micro-cyclo to suit your cycle and checking out the multi-mode screen monitor.

**8748 PROGRAMMING ADAPTOR** by Kevin Browne .....29  
By overwhelming demand: an add-on unit allowing 8748-type microcontroller chips to be programmed on the popular Eprom Poly-Programmer.

## SPECIAL FEATURES

**EASY-PC PCB CAD** by John Becker .....17  
The British Design Award-winning computer aided pcb software system is given a thorough going-over and gains another praising convert.

**A CASE FOR TECHNOLOGY** by Desmond Harvey .....26  
An authoritative guide to boxing for all reasons: the criteria to consider, the options available, and the state of enclosure technology.

**HOME-BASE** by Ian Burley .....36  
Kodak's new Photo-CD system is set to revolutionise still-photography, putting prints on tv as readily as in your hand.

**LASERS - PART TWO** by Mike Sanders .....41  
Examining how semiconductor lasers work, turning electrical energy into coherent light with properties governed by grooves.

**BASIC ELECTRONICS - PART TWELVE** by Owen Bishop .....49  
More on opamps and how they can be used for addition, subtraction, differentiation and integration. Plus another module to build.

**HISTORY OF TECHNOLOGY - MORSE** by Ian Poole .....53  
Currently renowned for his invention of the morse code, Morse may eventually be best remembered as the foremost American artist.

## REGULAR FEATURES

**EDITORIAL** by John Becker - Converted to CAD .....9  
**LEADING EDGE** by Barry Fox - Standardising CT2 .....8  
**SPACEWATCH** by Dr Patrick Moore - Mars under-foot .....47  
**INDUSTRY NOTEBOOK** by Tom Ivali - High tech hewers .....57  
**TRACK FEEDBACK** - Readers' letters, and a few answers .....35

**ANNUAL INDEX 1990** - Your master guide to PE for the year .....32  
**NEWS AND MARKETPLACE** - what's new in electronics .....4  
**SPECIAL SUBS OFFER** - FREE binders for PE subscribers .....10  
**HOW TO DO IT** - the route to better board building .....48  
**PCB SERVICE** - professional PCBs for PE Projects .....52  
**ARMCHAIR BOOKSHOP** - haven for practical bookworms .....58  
**ADVERTISERS' INDEX** - locating favourite stockists .....62

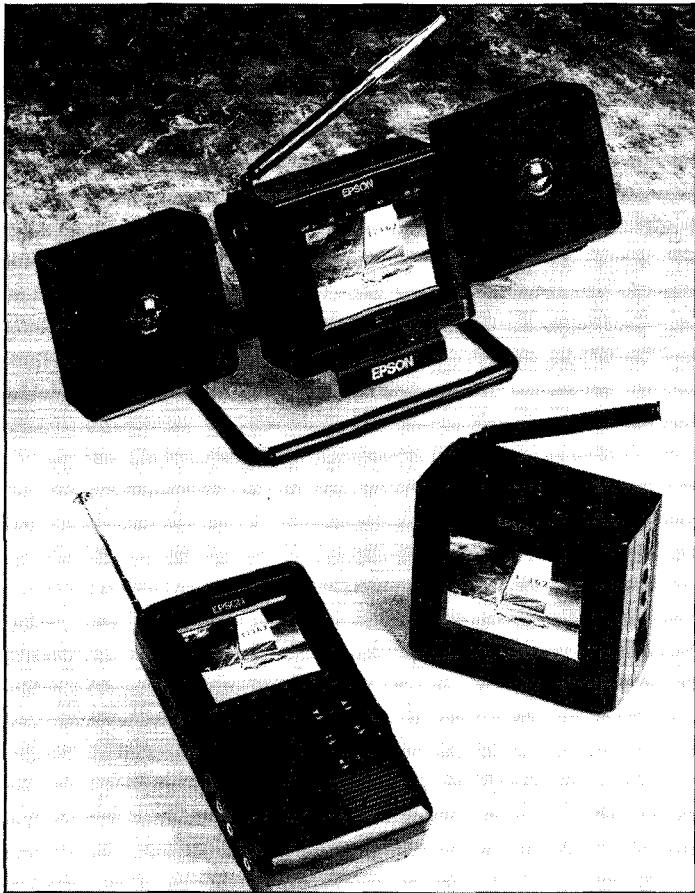

## SAM-PACKED

**E**pson are a new entrant to the home entertainment market but should certainly make their impact felt with their new family of colour lcd mini tvs. The tvs are the first consumer electronics product to take advantage of Epson's leading-edge liquid crystal display

technology, originally developed for portable computer systems.

Using Epson's proprietary SAM (super active matrix) image system, the tvs provide a picture quality, say Epson, far superior to other small screen lcd tvs available. The SAM system packs a much higher density

## INNOVATIVE SIG GENS

**M**arconi's innovative 2030 series of signal generators are now available from the IR Group. Packed with features designed to improve productivity and simplify measurement, the signal generators have frequency ranges extending from 10kHz to 1.35GHz (2030) and up to 2.7GHz (2031).

The series incorporates a backlit dot-matrix lcd panel which shows all parameter values simultaneously, giving complete information on the generator's settings and measurements. Full modulation covering am, fm and phase is fitted as standard to handle all types of receivers. Comprehensive modulation modes allow complete flexibility giving up to four independent modulation channels to simplify testing ssb and narrow band radio equipment.

Further details can be obtained from Peter Melvin, IR Group, Dorcan House, Meadfield Road, Langley, Slough, SL3 8AL. Tel: 0753 580000.

## SYSTEM X BILLION

**B**ritish Telecom and GEC Plessey Telecommunications (GPT) have reached an agreement for the supply of System X electronic exchanges. The agreement is potentially worth nearly £1 billion and covers the period up to March 1992.

BT has already placed orders under the agreement, which will add a further 2.7 million lines to the company's rapidly growing network of local System X digital exchanges. This will mean more than 14 million lines will be available on digital local exchanges by the end of the financial year.

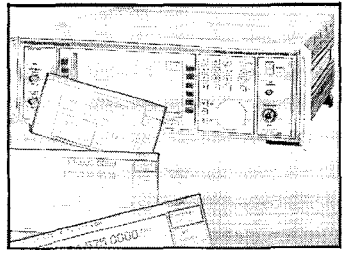

of pixels into each screen, giving a wider viewing angle, sharper image and brighter colours.

TV channel separation is via a touch-button auto tuning system, which scans to locate an acceptable signal for a station. Other simple controls allow for sound level, brightness and channel identification. The tvs can also be connected through a jack socket to a video camera or video cassette

recorder.

Epson's portable lcd tvs are available from a wide number of independent hifi and tv dealers nationwide, as well as Harrods and stores in the House of Fraser chain.

For further information on distribution contact Veda Products Ltd, Unit 31F, Parsonage Farm, Stansted, Essex, CM24 8TY. Tel: 0279 812645.

## ARTIFICIAL MAN

What will people think of next? An artificial human being is about to be designed to help in the testing of radio pagers! Radio Frequency Investigation Ltd have won the £60,000 contract from a consortium comprising the DTI, British Telecom, UKPOA and a number of manufacturers. The consortium was formed to address the problem of specifying the sensitivity of radio pagers, in terms of the minimum electromagnetic field strength required for triggering, when the effects of the electrical characteristics of the human body are difficult to estimate.

There are three standard techniques for measuring the required field strength: testing the apparatus in isolation; testing it on a person; and testing it on a 'salt man', a 15m high plastic cylinder filled with salt water, which is supposed to simulate the electromagnetic profile of a human.

However, all three techniques have drawbacks. Testing in isolation makes no allowance for the effects of the human body on the operation of the pager. Variations between people make the testing of pagers in situ problematic, as it is difficult to find an electrically average person! The use of the 'salt man' at least provides consistency, but the apparatus is impractical and does not generally simulate a human response.

BT currently tests pagers on people, and initiated the forming of the consortium to analyse and quantify the extent of variations in human electrical parameters, and then use this information as a starting point for the creation of a representative artificial human.

RFI is using consultants ITIC to carry out the background research, and will then design the artificial human based on these findings.

"We are approaching this project without any preconceived

opinions of what the outcome will look like," says RFI director Stephen Kirk. "We will go back to the fundamental physics of the problem and work towards a solution.

"It may be that we need only to simulate the electrical properties of the skin; alternatively, we may have to take into consideration the parameters of the whole body. One

thing is certain, however: the artificial human being must not be so heavy that a forklift truck is required to move it!"

For more information contact Stephen Kirk, Radio Frequency Investigation Ltd, Ewhurst Park, Ramsdell, Basingstoke, Hants, RG26 5RQ. Tel: 0256 851193.

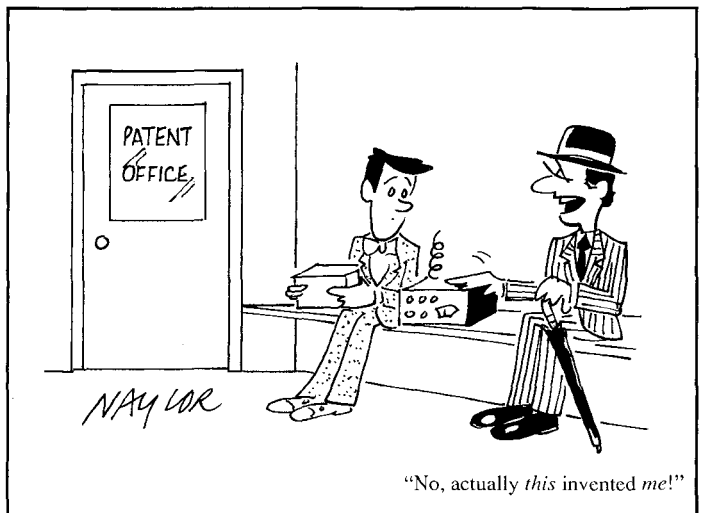

## CAMCORDING AMSTRAD

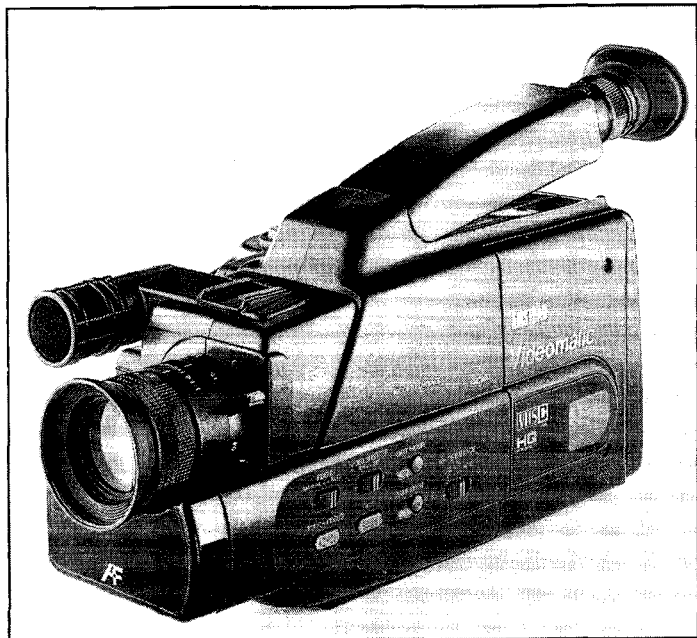

**B**y the time you read this Amstrad's new high specification camcorder should be in your shops. The introduction of the sub-£500 Videomatic VMC200 completes Amstrad's 1990 leisure product range and follows last year's success of the company's first camcorder, the VMC100. The latter machine proved to be the

UK's best selling model with a 27% market share.

Commenting on the introduction, Malcolm Miller, Amstrad Group Sales and Marketing Director said: "We have pursued a programme of leisure product launches throughout this year and to date have introduced a new mesh satellite dish with

integrated receiver/decoder, three vcr machines, including the Double-Decker model, a Fidelity branded 20-inch tv and the new three-model range of Amstrad games machines."

The VMC200 has been designed in the UK and is made in Japan by Amstrad subcontractors. It retails at £499 including vat.

**For more information contact your local Amstrad stockist, or Nick Hewer, Michael Joyce Consultants Ltd, 19 Garrick Street, London WC2E 9BB. Tel: 071-836 6801.**

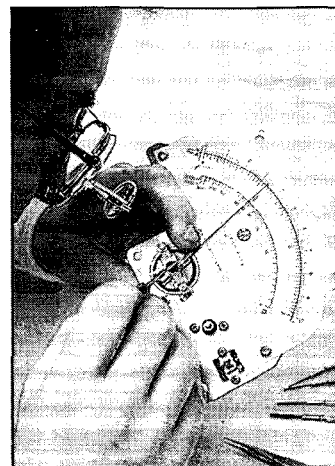

## QUALIFIED REPAIRS

**A**lpha Electronics have sent us a brochure about their repair, test and measurement service. The service operates to BS5750 and the company employs fully qualified engineers, and uses manufacturers' spare parts and components. The repairs are fully guaranteed for six months and are normally carried out within seven to ten working days. A local pick up and delivery service is available in many areas. Alpha maintain and repair all types of instrumentation both electrical and electronic, oscilloscopes up to 150MHz bandwidth, all types of multimeters, both analogue and digital, as well as specialist electrical test sets.

Alpha comment that ideally instruments should be checked at

regular intervals of 3, 6 or 12 months depending on the type and application. Even if you don't need strict accuracy in your test instruments, you'll certainly find benefit from the company's repair service: we can all be a bit clumsy occasionally. (I was recently, very: carelessly putting several thousand dc volts into a digital meter incapable of handling such tension. It died of course. In this instance, beyond economical resurrection - as dead as a Monty Python parrot!)

**If your equipment's worth caring for, contact Alpha Electronics Ltd, Unit 5, Linstock Trading Estate, Wigan Road, Atherton, Manchester, M29 0QA. Tel: 0942 873434.**

## CATALOGUE

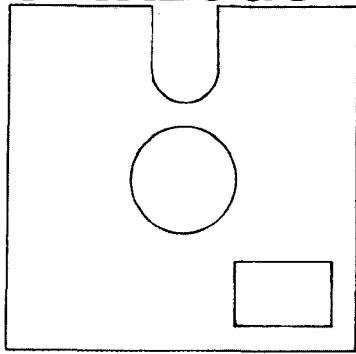

## DATABASE

Our browse through recently received literature

**Maplin's 1991 'Buyer's Guide to Electronic Components'** has thumped down heavily onto my desk. It's a massive catalogue of over 600 pages and is, I'm told, **the biggest and best ever**. Nearly a quarter of a million copies have been produced! In his introduction, Doug Simmons says that you'll notice some major changes in this catalogue and that they all represent part of Maplin's Grand Plan to further improve the service and product selection in line with customer requests. I have never had the opportunity to buy from Maplin since my own purchases are made from Trade suppliers. Consequently I am unable to judge what changes have been made, though the selective use of red colour tints throughout the catalogue appears to be new. Doug says that there are hundreds of new items to look out for, and that you'll find a great new range of in-car stereos and speakers,

improved cable stocks, a new range of torches and some brilliant tools. As ever, this is certainly a **catalogue which covers most matters electronic**, and should be on any constructor's book shelf. It is priced at £2.45 (plus 50p if posted) and is available from any of **Maplin's nationwide shops**, or direct from their head office, **PO Box 3, Rayleigh, Essex, SS6 2BR**. Tel: 0702 554161.

**Phonosonics'** latest catalist has benefitted from being reset on a DTP system and is free to anyone who requests one via their ansafone service or sends a medium sized stamped addressed envelope. **The company specialise in the sale of selected PE projects**, and have been doing so for nearly 20 years. Among their recent additions are the *Tele-Scope*, *Scope Expander* and *Morse Decoder*, all of which projects have been of great interest to readers. There are **currently around 40 interesting projects listed**, and the range is constantly being extended. **Phonosonics**, Dept PE, Unit P, 8 Finucane Drive, Orpington, Kent, BR5 4ED. Tel: 0689 37821.

**Greenweld's 1991 132-page electronic components catalogue** can hardly have escaped your attention since it's being given away free with this issue of PE! Do make a point of studying it carefully and keeping it close by you in the workshop. **It has a wealth of different products at good prices** and will help you to enjoy electronics even more. Further copies of the catalogue can be bought for £1.50 direct from **Greenweld Electronics Ltd**, 27 Park Road, Southampton, SO1 3TB. Tel: 0703 236363.

**Sarm's** catalogue proves the point that the size of a company's range should not always be judged by the size of its advert. This catalogue is over 90 A4 pages long and has a **large range of components** relating to many aspects of hobbyist electronic construction. Apart from hardware, such as cable accessories, connectors, potentiometers and switches, there is a large selection of **semiconductors including surface mount devices**, plus other essential components such as capacitors, resistors and optoelectronic products. The catalogue costs £1.80 and is available from **Sarm Digital**, 13 Pearle Street, Macclesfield, Cheshire, SK10 2AL. Tel: 0625 613710.

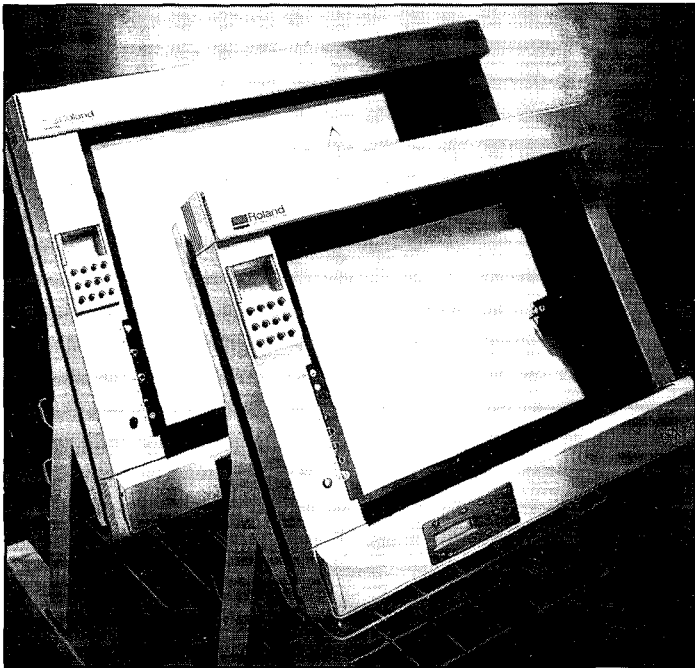

## HIGH PLOTTING

**N**umber One Systems, whose Easy-PC pcd cad system is reviewed in this issue have introduced a range of high accuracy plotters which use aerospace technology.

The range covers the latest Roland-DG large-format flat-bed plotters. Good engineering design features prominently in the DPX series. The base plates are constructed in a durable aluminium honeycomb, a technology pioneered in the aerospace industry where light weight and rigidity are of prime importance. This super-rigid base,

together with the stretch-free kevlar drive belt, seven times stronger than steel, leads to a plotter with an astonishing accuracy. Even across the full A1 size of the DPX3500, absolute accuracy is maintained to within 0.1mm with a repeatability better than 0.5mm. The smaller A2 sized DPX2500 also benefits from the same pin-point precision.

**For more information contact Roger Wareham, Technical Director, Number One Systems Ltd, Harding Way, Somersham Road, St Ives, Cambs, PE17 4WR. Tel: 0480 61778.**

## CARRYING THE TORCH



**A** new mini gas torch introduced by Maplin will satisfy even professional users. It is a compact and sturdy butane (gas lighter fuel) powered blow-lamp style gas flame torch. Incorporating push-button piezo-electric ignition, the torch is just the job for engineering, jewellery and model making work.

The flame is adjustable and reaches a temperature of 1300°C (2370°F). An adjustable collar varies the amount of air drawn into the burner head, and this provides control of flame temperature. The gas tank holds up to 26g of fuel. Refilling is by means of standard lighter fuel available from newsagents and tobacconists.

JL98G is the torch's order code number, and it costs £19.95 including vat.

A micro-mini gas torch is also available, under code number JL97F, and costing only £5.95 including vat.

For more information see Maplin's new 1991 catalogue, or contact any of their nationwide shops, or the head office at PO Box 3, Rayleigh, Essex, SS6 8LR. Tel: 0702 554161.

If you are organising any event to do with electronics, big or small, drop us a line,

**Please note** : Some events listed here may be trade or restricted category only. Also, we cannot guarantee information accuracy, so check details with the organisers before setting out.

**Nov 6-8.** Total Solutions. NEC Birmingham. 0799 26699.

**Nov 27.** Installation and Maintenance of Security Equipment. IEEE symposium. National Motorcycle Museum, Solihull. 071-836 3357.

**Dec 9.** SATRO (Science And Technology Regional Organisation) 4th annual show for computer and science enthusiasts. Aberdeen Music Hall. 0224 273161.

### 1991

**Mar 19-21.** Nepcon Europe and Electronics International (formerly British Electronics Week). NEC, Birmingham. 0799 26699.

**April 17-18.** Laboratory Manchester. Windsor Hall, G-Mex Centre, Manchester. 0799 26699.

**May 15-16.** Laboratory Scotland. Scottish Exhibition Centre, Glasgow. 0799 26699.

### IEE FARADAY LECTURES 1990-91

Presented by the Universities of Bath and Sussex.

**1990:** Oct 17 Brighton. Oct 30 Edinburgh. Nov 7 Liverpool. Nov 13 Middlesborough. Nov 21 Manchester. Nov 27 Reading. Dec 4 Coventry. Dec 12 Ipswich.

**1991:** Jan 15 Exeter. Jan 22 Swansea. Jan 29 Southampton. Feb 5-7 London. Feb 12 Hanley, Stoke-on-Trent. Feb 27 Nottingham. Mar 6 Sheffield. Mar 13-14 Bath.

For free tickets and further information contact (enclosing SAE) The Faraday Officer, IEE, Michael Faraday House, Six Hills Way, Stevenage, Herts, SG1 2AY.

### MICROPROCESSOR TRAINING COURSES

In conjunction with Colchester Institute, Flight Electronics is offering a range of intensive four-day microprocessor courses. Contact: Suzanne Kittow, Flight Electronics Ltd, Flight House, Ascupart Street, Southampton SO1 1LU. Tel: 0703 22721.

## LIFETIME GIFT

There's much food for thought in B&R Electrical's leaflet about their PowerBreaker RCD safety adaptor. It comments that for the diy enthusiast Christmas inevitably involves receiving a stocking which is strangely shaped like a powerdrill, or a beautifully wrapped present the shape of a hedge trimmer. "Why not surprise them this year with a safety adaptor shaped gift?" ask B&R. "A winner at the 'I wonder what it could be stage?', it may save a life sooner than you think."

The PowerBreaker safety RCD adaptor is a device that provides added protection against the risk of electrocution. Unlike a fuse or standard circuit breaker, which is designed only to protect the electrical appliance and its wiring, an RCD (residual current device) protects the user by automatically cutting the power before you get a serious shock.

B&R ask us to consider the antics of the diy person about the home and believe that the gift of an RCD could well prove to be the gift of life. We agree.

PowerBreaker RCDs are available as handy adaptors and also as protected 13 amp plugs and single or twin wall sockets. The adaptor is a compact RCD which simply plugs in, requiring no additional wiring.

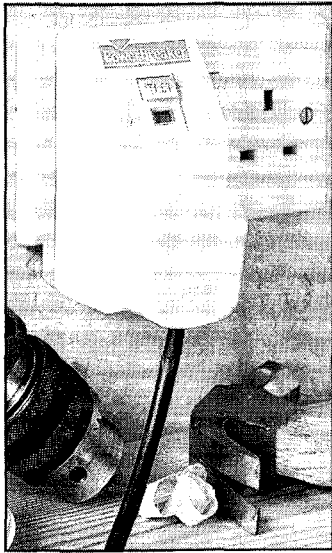

This makes it ideal for moving around the home to use with any potentially hazardous electrical appliance, such as the kettle, iron, toaster or computer.

PowerBreaker is readily available from high street stores such as Woolworth, Boots and Argos, as well as Texas, B&Q and Payless with prices starting from around £20.

**For further information contact Jon Zammett, Media Counsel Ltd, 15/17 Huntsworth News, London NW1 6DD. Tel: 071-402 2272.**

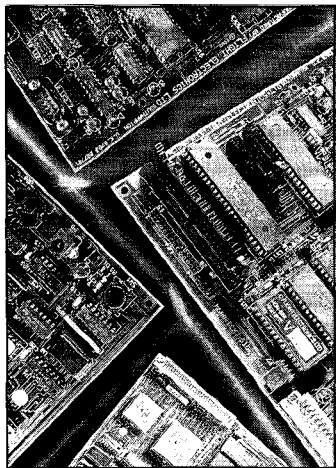

## 32-BIT TEACH IN

Commissioned by Motorola, Flight Electronics have introduced a 68020 evaluation module. The Flight-020 is a purpose built training/evaluation system designed to teach students everything they need to know about 32-bit technology.

Based on Motorola's MC68020 microprocessor, the 020 features a multilayer pcb and custom designed integrated circuits. Despite its advanced features, say Flight, the 020 is as simple to use as the company's flagship 68K training system.

An added benefit is the object code compatibility with earlier members of the M68000 family. This means that programs written for the

Flight 68K system are compatible with the new 020 system. The capability to directly address four gigabytes of memory makes the 020 a powerful and effective teaching tool.

**For further information contact Suzanne Kittow, Flight Electronics Ltd, Flight House, Ascupart Street, Southampton, SO1 1LU. Tel: 0703 227721.**

## BAEC EXPANDING

It's good to read in the British Amateur Electronics Club's latest newsletter that their membership is again increasing. This is due in part, says Chairman Herbert Howard, to the recent publicity PE has given to the club's activities. Thanks, Herbert, for your kind comments.

I am always pleased to publicise this worthwhile club and I recommend it to anyone who wishes to share the companionship and experience of others interested in electronics. The regular newsletter is a good source of information too. By being a member of BAEC you can also benefit from a reduced subscription rate to PE, see page 10.

Herbert - where's your address in the newsletter? I've had to look it up from file!

**For more information contact Herbert Howard, BAEC, 41 Thingwall Park, Fishponds, Bristol, BS16 2AJ.**

## CHIP COUNT

### 6805 FAMILY ADDITION

STC Electronic Services has announced the introduction of an extended range of Motorola microcomputers. The MC68HC05B6 HCMOS 8-bit microcomputer is a member of Motorola's MC68HC05 family of low cost single chip microcomputers. It contains an on-chip oscillator, cpu, ram, rom, eeprom, a/d converter, pulse length modulated outputs, i/o, serial communications interface, timer system and watchdog.

The fully static design allows operation at frequencies down to dc so further reducing the already low power consumption to just a few microamps. Power consumption reduction may also be implemented using low power mode instructions. When the processor executes the Stop, Wait or Slow instructions, selected internal operations are turned off.

The internal 16-bit timer is similar to the MC6801 timer and incorporates a 16-bit free running counter. The serial communications interface system is similar to the MC68HC05C4 but offers an enhanced capability including transmitter clocks allowing synchronous transmissions and separate baud rate selection for transmitter and receiver.

Other hardware features include a security bit for eeprom contents, external timer and serial communication interface interrupts, and external interrupt enable.

Software features are similar to the MC6800 and allow efficient use of program space, versatile interrupt handling, addressing modes and memory mapped i/o.

It is a chip that should be investigated by those devoted to microprocessor control. I did in fact, make tentative enquiries about it back in June when I saw it listed in my latest edition of the Motorola microcontroller data book. I was considering it as a candidate for use in the *Bike Computer*. At that time I was told that it was not yet available, but would be released at around £50. The data book states that the eeprom is 256 bytes and the ram is 176 bytes. Emulator and non-eeprom versions are available.

## AD2X250 A/D CONVERTER

I include this chip purely for interest because of its price since most of you will be expecting to pay less than £10 for your a/d converters.

Arcom's AD2X250 is a unique 12-bit a/d converter which provides two channels operating at 250K samples per second, or a single leaved channel operating at 500K samples per second. This exceptional speed provides a foundation for many mechanical, structural, biological and general laboratory data acquisition applications. The converter is in fact a module board rather than a single chip and has other facilities associated with it, but even so the price tag of £495 may leave some of you a trifle stunned.

## FASTER 20MHZ Z80 CPU

A new Zilog 20MHz Z80 cpu has become available through Celdis. The Z84C0020 is claimed to be twice as fast as any other 8-bit microprocessor and has a peak execution time of 5 mips.

Normally, if users want to increase system performance, they would either need to redesign the system using a 16/32-bit processor or use RISC architecture - which are both expensive alternatives. The new device, however, can simply be inserted into a current system board with a suitable circuit, allowing the system to run at twice its original speed. The 20MHz unit is fully code compatible with Z80 architecture and allows users to retain their software.

## SOURCE DATA

**Arcom Control Systems Ltd**, Unit 8, Clifton Road, Cambridge, CB1 4WH. Tel: 0223 411200.

**Celdis**, 37 Loverock Road, Reading, Berks, RG3 1ED. Tel: 0734 585171.

**STC**: Debbie Titchner, Design Support Group, STC Electronic Services, Edinburgh Way, Harlow, Essex, CM20 2DF. Tel: 0279 451444.

**T**he second generation cordless telephone, CT2 is the first domestic telecommunications system to transmit and receive digital speech. So far all telephones, whether fixed or mobile, have carried speech as an analogue signal, even though the control signals in a cellular system are digital. Full digitisation is what allows the system to work with public base stations or Telepoints, which recognise identification codes from each handset and bill calls made to the user's home or office.

### CLEVER BUT CONFUSING

The CT2 technology is clever, which makes it even more of a pity that the industry has shot itself in the foot by creating a mish mash of standards which confuses the public.

Early radio phone systems used one radio channel for both sides of the conversation (send and receive) and the callers had to say "over" when they finished speaking and switch to receive. Today's cellular phone systems avoid this by using a separate radio

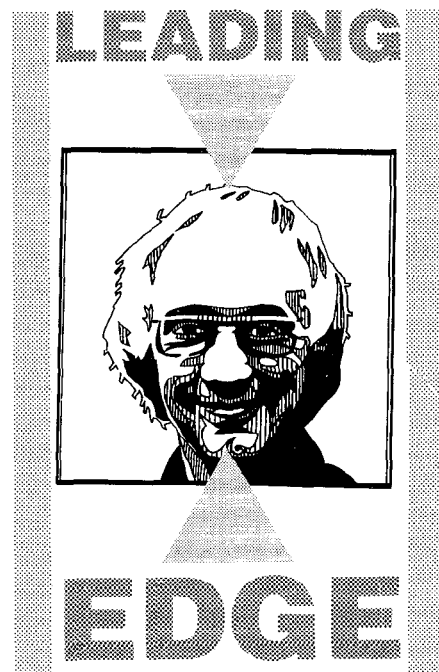

1375) now specifies the ping pong patterns so that all handsets conforming to the standard are compatible.

In March, telecoms administrations in France, Belgium, West Germany, Spain, Portugal, Italy, Finland and Holland signed a Memorandum of Understanding to adopt the CAI as a European standard. They agreed that by 1993 there will be Telepoint services in all major cities, main railway stations and main airports with the same phone usable in all countries.

### ROYALTY FREE

STC, BT, Ferranti, Shaye, Orbitel, Mercury and GPT have pooled all their patents on CAI technology. These patents can be used, royalty free, in any country that adopts the CAI standard. Bell Atlantic Mobile Systems will soon begin trials with CAI equipment, made by GPT, in the US.

The plan is for pan-European handsets to have a slot for a smart card which stores identification codes that authorise its

# STANDARDISING CT2

channel for each side of the conversation. But obviously this is wasteful of radio spectrum. CT2 plays a clever trick to cram both sides of the conversation (send and receive) onto the same radio channel.

I suspect few people understand the trick because the technical description put out by GPT (the telecoms company making CAI CT2 equipment) is probably the most confusing and garbled document I have ever seen. It only makes sense if you already understand what it is trying to say.

### DATA COMPRESSION

This is that the handset first converts speech into the form now standard for telecommunications, linear PCM word tunnings at 64 kilobits/second. Again using standard telecoms techniques, the handset now compresses the data stream into a continuous stream of ADPCM bits running at 32 kb/s.

The handset then chops the ADPCM conversation into short segments and transmits each segment at twice its normal speed, ie 64 kbit/s. The handset at each end does this so each is alternately sending and receiving bursts of double speed code. The bursts are interleaved, so that the radio channel carries a continuous 64 kb/s stream of data, which continually reverses direction, in ping pong fashion.

A buffer in each handset takes in each incoming double speed burst and clocks it out again at half speed. This reconstitutes the 32 kb/s stream which is expanded to 64 kb/s words and converted into an analogue signal. So each caller hears what appears to be

BY BARRY FOX  
Winner of the UK  
Technology Press Award

**Yet again multiple standards are out of line with public acceptability - this time in the CT2 telephone network. Will CA1 provide a universal answer?**

seamless speech.

All CT2 systems work with 40 radio channels, each 100 kHz wide, in the uhf radio band between 864-868 MHz. But the CT2 systems currently on the market use different ping pong patterns, and are thus incompatible. This happened because the DTI set only a very loose standard when it released frequencies for CT2 use.

### TRIPLE SYSTEMS

And this is why there are now three different and incompatible handset and Telepoint services, Mercury's Callpoint, BT's Phonepoint and Ferranti's Zonephone. Small wonder that sales of CT2 handsets have been pitifully small.

Too late, the DTI called for a common standard. The Common Air Interface (defined by the DTI's Performance Specification MPT

operation with public base stations in each CAI country, with calls billed to the user's home or office account.

In the UK, all providers of public CT2 services are obliged to conform with the CAI standard from January 1991. This means that the three consortia currently offering a CT2 service with their own proprietary and mutually incompatible technology, will have to install a second set of base station equipment at each Telepoint. Each Telepoint will then provide users with a choice of service, CAI for owners of new handsets and proprietary (Phonepoint, Callpoint and Zonephone) for owners of existing handsets.

The fourth licensed Telepoint provider in the UK, BYPS Communications (a consortium formed by Barclays, Philips and Shell) took a considered decision not to launch a service until CAI equipment was ready. British manufacturer company GPT (formed from the merger of GEC and Plessey telecoms divisions) took a policy decision to manufacture only CAI hardware. Starting this autumn GPT will supply around 2500 Telepoint base stations to each of the existing three CT2 operators, and a similar number to BYPS.

### PACKAGE DEALS

GPT's General Manager, Barry Turnbull, is blunt about the mistakes made by the existing Telepoint operators. The original plan for CT2 was to sell a package of home base station and handset for use as a secure domestic cordless telephone.

*Continued on page 14* ➔



**Y**ou've no doubt noticed that all the printed circuit boards that I've designed for PE over the years have been done in the traditional manner - manually. This has entailed the slightly laborious, but enjoyable, task of physically placing black self-adhesive pads and tapes down onto drafting film, cutting and shaping as required.

It is a very acceptable method, but it has its drawbacks. The pads and tapes are quite expensive and usually it's not practical to re-use them. It can also be tricky to make significant modifications to a pcb layout once you are well under way with it - even more so once it's completed.

Many times I've thought about obtaining a computer-aided pcb design program to run on my Amstrad 1640, an IBM-PC compatible machine, but was deterred by the thought that it could take weeks to learn - time that I could ill-afford. Consequently, I stuck with tapes and pads, in the belief that it was quicker in the short-term. How mistaken I was!

The final straws for me were the pcbs for the *Tele-Scope* (PE Sept 90) and the current *Bike Computer*. Having taped-up the *Tele-Scope* pcb I recognised a way in which I could lose two chips from the original design. But this would require an awful lot of retaping - which at first I resisted. However, having seen this

## PRACTICAL ELECTRONICS



### CONVERTED TO CAD

more economical route, I felt compelled to follow it. Vast lengths of tracks were stripped off, ic pads removed, and others painstakingly relaid in their place. It took the best part of a day.

Then, while working on the *Bike Computer*, I found I'd run out of dill ic pads which have tracks going between them, and this microcontroller board needed inter-pad tracking. Being too impatient to reorder and wait for the pads to arrive, I started out on an alternative taping method: working three-times life size instead of the usual double-size. In this way I was able to use in-stock

component pads for each ic pin hole and run 0.1 inch tracking between without too much trimming of pads or tracks. It worked out ok, though I had to then photographically reduce the image by more than my 'studio' is really set up for.

Enough is enough, I thought, let's look into pcb cad packages.

Knowing that Number One Systems regularly advertise in PE a pcb cad package which runs on IBM PCs and compatibles, I gave their Managing Director, Adrian Espin, a call and had a chat with him. He kindly sent me a copy of *Easy-PC*. It's fantastic!

It arrived on a Friday and I began examining its demo program early evening. Not long before midnight I'd progressed to the full software and, just for the hell of it, had already redesigned most of the *Bike Computer* main pcb. By the end of the weekend I had done a couple of other pcb layouts, a fair bit of circuit diagramming, and designed a few extra layout and diagram symbols. It was child's play!

When I think of the hours of manual padding and tracking I needn't have done in the past, I am horrified. There is no need to think that pcb cad is difficult, or expensive. It's not if you choose the right package, as I most certainly did with *Easy-PC*. Read the full review!

#### THE EDITOR

Editor:

**John Becker**

Sub-Editor:

**Henry Armstrong**

Technical Illustrator:

**Derek Gooding**

Group Advertisement Manager:

**Jacqueline Barlow**

Advertisement Executive:

**David Bonner**

Production Editor:

**Richard Milner**

Office Manager:

**Wendy Cooper**

Office Secretary:

**Wendy Rhodes**

Publisher:

**Angelo Zgorelec**

Practical Electronics,  
Intra House, 193 Uxbridge Road,  
London W12 9RA  
Tel: 081-743 8888  
Telecom Gold: 87: SQQ567  
Fax: 081-743 3062

#### Readers' Enquiries

All editorial correspondence should be addressed to the editor and **any letters requiring a reply should be accompanied by a stamped addressed envelope, or equivalent payment.**

We regret that lengthy technical enquiries cannot be answered over the phone.

#### Advertisements

The Publishers of PE take reasonable precautions to ensure that advertisements published in the magazine are genuine, but we cannot take any responsibility in respect of statements or claims made by advertisers. The Publishers also cannot accept any liability in respect of goods not being delivered or not working properly.

© Intra Press 1990. Copyright in all drawings, photographs and articles published in PRACTICAL ELECTRONICS is fully protected, and reproduction or imitations in whole or in part are expressly forbidden. All reasonable precautions are taken by PRACTICAL ELECTRONICS to ensure that the advice and data given to readers is reliable. We cannot, however, guarantee it, and we cannot accept legal responsibility for it. Prices quoted are those current as we go to press. All material is accepted for publication on the express understanding that the contributor has the authority to permit us to do so. **ISSN 0032-6372**

#### PE Services

**SUBSCRIPTIONS** - Annual subscription rates are £18.00 for the U.K. or £22.00 overseas (Air mail overseas is £39.00). Please send your cheques (payable to Intra Press), payment by Visa or Access also accepted, to: Practical Electronics, Subscription Dept., P.O. Box 500, Leicester LE99 0AA. Telephone: 0858 410510 (ask for Practical Electronics Subscriptions).

**BACK ISSUES** - We still have a limited number of the back issues from the last three years available (Certain issues from earlier years are also available, but check before ordering). Price £1.75 - overseas £2.25 (inclusive of postage). Orders should be sent to our editorial address.

**BINDERS** - to hold 12 issues of PE are also available from our editorial address. Price £5.95 (overseas £6.95 - surface mail). Post included.

**BOOK SERVICE** - see the Book Service advertisement in the magazine.

**PCB SERVICE** - details inside.

**Cover Photo:**  
**Easy-PC - Number One Systems**

# SPECIAL SUBS OFFER!

## SUBSCRIBE AND BE GIFTED!

TAKE OUT 12 MONTHS' SUBSCRIPTION TO PE AND CHOOSE A GIFT:

★ A FREE BINDER TO HOLD 12 COPIES OF PE WORTH £5.95

OR

★ A FREE 300 PAGE BOOK "INTERNATIONAL TRANSISTOR EQUIVALENTS GUIDE" WORTH £3.95

EXTRA SPECIAL OFFER TO STUDENTS, TEACHERS AND BAEC\* MEMBERS SAVE 10% AND RECEIVE THE GIFT OF YOUR CHOICE!

(\*British Amateur Electronics Club)

## PRACTICAL ELECTRONICS



If you already subscribe to PE you can take advantage of this special offer by extending your existing subscription - please advise your current subscription number or say from which month you want your subs to run.

Yes please PE, put me on course to a hi-tech future: Enrol me on your priority subscription list and send me 12 issues and my free gift for the following special price:

### UK readers

£18

£16.20 (student/teacher/BAEC)

### Overseas Readers

£22

£19.80 (student/teacher/BAEC)

Proof of my student/teacher/BAEC status is attached (e.g. headed notepaper etc.).

I wish my subs to start from the earliest possible issue

I wish to extend my existing subscription for a further 12 months commencing with the issue dated

As my free gift I would like to receive:

The Binder .....

The Transistor Equivalents Guide .....

Please send my monthly copy of PE to:

Name and address .....

.....

.....

Post Code .....

I enclose a cheque / postal order .....

Please charge to my Access / Visa card number

Send this form (or a photocopy of it) to:  
Practical Electronics Subscriptions, 193  
Uxbridge Road, London W12 9RA

## COMPUTER ICs

80C31 MICRO	£2
P8749H MICRO	£5
BBC MICRO PARTS	
SN76489AN	£3
VIDEO ULA 201647	£10ea 10+ £8
6845 CRT	£5
6522 PIA	£3
DM88LS120	£4.50
AY3-1015D UART	£2.50
8086 processor ex-equipment	£2
USED 41256-15	£1.50
USED 4164-15 ex-equipment	£1
9 x 41256-15 SIMM MODULE NEW	£10
8 x 4164 SIP MODULE NEW	£8
HD 146818 CLOCK IC	£2
2864 EEPROM	£3
27128A 250ns EPROM USED £1.50 NEW £2 100+ £1.50	
FLOPPY DISC CONTROLLER CHIPS 1771	£16ea
68000-8 PROCESSOR NEW	£5
HD63484-B	£5
ALL USED EPROMS ERASED AND BLANK CHECKED CAN BE PROGRAMMED IF DESIRED.	
2716-45 USED	£2 100/£1
2732-45 USED	£2 100/£1
2764-30 USED	£2 100/£1.60
27C256-30 USED	£2
27C512 USED (ALSO 27512)	£3.00
1702 EPROM EX EQPT	£5
2114 EX EQPT 60p 4116 EX EQPT	70p
6264-128k static ram	£3.00
62256-12 32K static Ram	£7.00
2532 EPROM USED	£2
4416 RAM	£3.00
USED 4416-15 RAM	£2
USED 41464-15	£5

## REGULATORS

LM317T PLASTIC TO220 variable	£1
LM317 METAL	£2.20
7812 METAL 12V 1A	£1
7805/12/15/24V plastic	35p 100+ 20p 1000+ 15p
7905/12/15/24 plastic	35p 100+ 20p 1000+ 15p
CA3085 T099 variable reg	2/£1
LM338 5A VARIABLE	£5

## CRYSTAL OSCILLATOR

1.8342 £1 each 1M, 1.8432M, 4M, 16M	£1.50 each
-------------------------------------	------------

## CRYSTALS

2.77 MHz/4.000 MHz/4.9152MHz 20MHz 49.504MHz, 6M, 16.568M	£1 each
---	---------

## TRANSISTORS

BC107, BCY70 PREFORMED LEADS	
full spec	£1 £4/100 £30/1000
BC557, BC548B, BC238C, BC308B	30/£1 £3.50/100
<b>POWER TRANSISTORS</b>	
N POWER FET IRF531	3/£1
P POWER FET IRF531	2/£1
2SC1520 sim BF259	3/£1 100/£22
TIP141/2 £1 ea TIP112/125/42B	2/£1
TIP35B TIP35C	£1.50
SE9301 100V 10A DARL. SIM TIP121	2/£1
2N3055 EX EQPT TESTED	4/£1
PLASTIC 3055 OR 2955 equiv 50p	100/£35
2N3773 NPN 25A 160V £1.80	10/£16

## QUARTZ HALOGEN LAMPS

A1/216 24V 150 WATTS	£2.25
H1 12V 50W (CAR SPOT)	£1.50
14 WAY ZIF SKT	£1
TEXT TOOL single in line 32 way. Can be ganged (coupling supplied) for use with any dual in line devices.	2/£2
28 WAY TEXT TOOL ZIF SOCKET EX NEW EQUIPMENT	£2.50

## CAPACITORS COMPUTER GRADE

3300uF 350V SIC SAFCO FELSIC 037	£6(£1.50)
2200uF 160V SIC SAFCO FELSIC CO38	£4(£1.20)
24,000uF 50V	£2 (1.30)

## TURNS COUNTING DIALS

all for 0.25" shaft	
10 turn dial 21 mm dia. fits 3mm spindle	£2
10 turn digital dial (3 digits) for 3mm or 6mm shaft	£3.50
10 turn clock face dial for 6mm spindle	£4

## MISCELLANEOUS

LM335Z T092 TEMPERATURE SENSOR 10mV/DEGREE C	£1 ea
<b>SLOPING FRONT PLASTIC CASE 225 x 215 x 76mm</b>	
76mm WITH ALL FRONT PANEL 200 x 130mm	£3.30
HUMIDITY SWITCH ADJUSTABLE	£2
WIRE ENDED FUSES 0.25A	30/£1
<b>NEW ULTRASONIC TRANSDUCERS 40kHz</b>	£2/pair
12 CORE CABLE 7.02mm OVERALL SCREEN	70p/METRE
OP AMP LM10CLN	£2.90
<b>BNC 50 OHM SCREENED CHASSIS SOCKET</b>	3/£1
<b>BNC TO CROC CLIPS LEAD 1 metre</b>	£1
LEMAG EARTH LEAKAGE TRIP 35A 30mA trip	£9.00
AMERICAN CHASSIS 2/3 pin SOCKET	2/£1
USED 3 1/2" FLOPPY DISCS D/S 720K	50p 10/£4
<b>TO-220 HEAT SINK sim RS 403-162</b>	10/£2.50
<b>SMALL MICROWAVE DIODES AEI DC1028A</b>	2/£1

## D.I.L. SWITCHES 10 WAY £1 8 WAY 80p 4/5/6 WAY ... 50p

180 volt 1 watt ZENERS also 12v & 75v	20/£1
VN10LM 60V 1/2A 50hm TO-92 mosfet	4/£1 100/£20
MIN GLASS NEONS	10/£1
MINIATURE CO-AX FREE PLUG RS 456-071	2/£1
MINIATURE CO-AX FREE SKT. RS 456-273	2/£1.50
DIL REED RELAY 2 POLE n/o CONTACTS	£1
PCB WITH 2N2646 UNIUNION with 12v 4 POLE RELAY	£1
400m 0.5w thick film resistors (yes four hundred megohms)	4/£1
STRAIN GAUGES 40 ohm Foil type polyester backed balco grid alloy	£1.50 ea 10+ £1
ELECTRET MICROPHONE INSERT	£0.90
Linear Hall effect IC Micro Switch no 613 SS4 sim RS 304-267	£2.90 100+ £1.50
HALL EFFECT IC UGS3040 + MAGNET	£1
OSCILLOSCOPE PROBE SWITCHED X1 X10	£10
CHEAP PHONO PLUGS	100/£2 1000/£18
1 pole 12 way rotary switch	4/£1
AUDIO ICS LM380 LM386	£1 ea LM324
555 TIMER 5/£1 741 OP AMP	5/£1
ZN14 AM RADIO CHIP	80p
COAX PLUGS nice ones	4/£1
COAX BACK TO BACK JOINERS	3/£1
4 x 4 MEMBRANE KEYBOARD	£1.50
15,000uF 40V	£2.50 (£1.25)

1.25" PANEL FUSEHOLDERS	3/£1
CHROMED STEEL HINGES 14.5 x 1" OPEN	£1 each
12v 1.2w small wire ended lamps fit AUDI VW TR7 SAAB	
VOLVO	10/£1
12V MES LAMPS	10/£1
STEREO CASSETTE HEAD	£2
MONO CASS. HEAD £1 ERASE HEAD	50p
THERMAL CUT OUTS 50 77 85 120°C	£1 ea
THERMAL FUSE 121°C 240V 15A 220°C	5/£1
TRANSISTOR MOUNTING PADS TO-5/TO-18	£3/1000
TO-3 TRANSISTOR COVERS	10/£1
STICK ON CABINET FEET	30/£1
PCB PINS FIT 0 1" VERO	200/£1
TO-220 micas + bushes	10/50p 100/£2
TO-3 micas + bushes	15/£1
PTFE min screened cable	10m/£1
Large heat shrink sleeving pack	£2
CERAMIC FILTERS 6M/9M/10.7M	50p 100/£20
I/C chassis plug rfi filter 10A	£3
Potentiometers short spindles values 2k5 10k 25k 1m	
2M5 lin	5/£1
500k lin 500k log	4/£1
40Khz ULTRASONIC TRANSDUCERS EX-EQPT NO DATA	
OMRON 12V GZV DIL RELAY 2 POLE CHANGEOVER	2/£1
SCART CONNECTOR	£1
BZV48C12 WIRE ENDED 12V 7WATT ZENER 17K STOCK	5/£1
3M/SCOTCH FLEX 50 WAY ROUND JACKETED FLAT CABLE 3659/50 (50 WAY IDC RIBBON WITH FOIL AND BRAID SCREENS, ROUND SECTION WITH BLACK PVC OUTER) £1. METRE, 100' REEL	£65 (1.50)
FANS 240V 120mm	£5 (1.50)
(OTHER VOLTAGE/SIZES USUALLY AVAILABLE)	
MOULDED INDUCTOR 470UH SIZE OF 1W RES	8/£1

## DIODES AND RECTIFIERS

1N4148	100/£1.50
1N4004/SD4 1A 300V	100/£3
1N5401 3A 100V	10/£1
BA158 1A 400V fast recovery	100/£3
BA159 1A 1000V fast recovery	100/£4
120V 35A STUD	65p
BY127 1200V 1.2A	10/£1
BY254 800V 3A	8/£1
BY255 1300V 3A	6/£1
6A 100V SIMILAR MR751	4/£1
1A 800V BRIDGE RECTIFIER	4/£1
4A 100V BRIDGE	3/£1
6A 100V BRIDGE	2/£1
8A 200V BRIDGE	2/£1.35
10A 200V BRIDGE	£1.50
25A 200V BRIDGE £2	10/£18
25A 400V BRIDGE £2.50	10/£22

## SCRs

PULSE TRANSFORMERS 1.1 + 1	£1.25
2P4M EQUIV C106D	3/£1
MCR72-6 10A 600V SCR	£1
35A 600V STUD SCR	£2
TICV106D 800mA 400V SCR	3/£1 100/£15
MEU21 PROG. UNIUNION	3/£1

## TRIACS

BT 137-600 8A TO-220	2/£1
BT138-600 12A TO-220	70p
MEU21 PROG. UNIUNION	3/£1
NEC TRIAC AC08F 8A 600V TO220	5/£2 100/£30
TXAL225 8A 400V 5mA GATE 2/	£1 100/£35
3TA08-400 8A 400V 5mA GATE ISOL TAB	£1
CA3059 0 VOLTAGE SWITCH	£1 each

## DIACS 4/£1

## CONNECTORS

D25 IDC SOCKET FUJITSU	£2
34 way card edge IDC CONNECTOR (disk drive type)	£1.25
CENTRONICS 36 WAY IDC PLUG	£2.50
CENTRONICS 36 WAY IDC SKT	£4.00
BBC TO CENTRONICS PRINTER LEAD 1.5M	£3.00
CENTRONICS 36 WAY PLUG SOLDER TYPE	£4
USED CENTRONICS 36W PLUG + SKT	£3

## USED D CONNECTORS price per pair

D9 60p, D15 £1.50, D25 £2, D37 £2, D50 £3.50 covers 50p ea.	
---	--

## WIRE WOUND RESISTORS

W21 or sim 2.5W 10 of one value	£1
R10 OR15 OR22 2R0 4R7 5R0 5R6 8R2 10R 12R 15R 18R 20R	£1
22R 27R 33R 47R 56R 62R 91R 120R 180R 390R 430R 470R	
680R 820R 910R 1K15 1K2 1K5 1K8 2K4 2K7 3K3 3K0 5K0	
4 FOR £1	
W22 or sim 6W 7 OF ONE VALUE	£1
R47 R62 1R0 1R5 1R8 3R3 6R8 9R1 12R 20R 24R 27R 33R 51R	£1
56R 62R 68R 100R 120R 180R 220R 390R 560R 820R 910R 1K0	
1K2 1K5 1K8 2K2 2K7 3K3 3K9 4K7 8K2 10k 15k 16k 20k	

## CRYSTAL OSCILLATORS

1.8342 £1 each 1M, 1.8432M, 4M, 16M	£1.50
1.000M 4M000 6M000 10M000 12M000 15M000 16M000	
18M000 20M000 24M000 25M000 32M000 40M000 £1.50	
0.512M 1M8432 2M4576 4M0936 5M3936 8M064 12M228	
16M384 16M485 17M280 17M408 29M4912 44M44 £1.25	

## PHOTO DEVICES

SLOTTED OPTO-SWITCH OPCOA OPB815	£1.30
2N5777	50p
TIL81 PHOTO TRANSISTOR	£1
TIL38 INFRA RED LED	5/£1
4N25, OP12252 OPTO ISOLATOR	80p
PHOTO DIODE 50p	6/£2
MEL12 (PHOTO DARLINGTON BASE n/c)	50p
4 DIGIT LED 7 SEG. DL4770	£1
LEDs RED 3 or 5mm 12/£1	100/£6
LEDs GREEN OR YELLOW 10/£1	100/£6.50
LEDs ASSORTED RD/GN/YW + INFRA/RED	200/£5
FLASHING RED LED 5mm 50p	100/£40
HI BRIGHTNESS LEDS COX24 RED	5/£1

## STC NTC BEAD THERMISTORS

G22 220R, G13 1K, G23 2K, G24 20K, G54 50K, G25 200K, RES	
@ 20°C DIRECTLY HEATED TYPE	£1 ea
FS22BW NTC BEAD INSIDE END OF 1" GLASS PROBE	
@ 20°C 200R	£1 ea
A13 DIRECTLY HEATED BEAD THERMISTOR 1k res. Ideal for audio Wien Bridge Oscillator	£2 ea

## CERMET MULTI TURN PRESETS 3/4"

10R 20R 100R 200R 250R 500R 2K 2K2 2K5 5K 10K 47K	
50K 100K 200K 500K 2M2	50p each

## IC SOCKETS

6 pin 15/£1 8 pin 12/£1 14/16 pin 10/£1 18/20 pin 7/£1,	
22/24/28 pin 4/£1 40 pin 30p	

## SOLID STATE RELAYS

40A 250V AC SOLID STATE RELAYS	£18
--------------------------------	-----

## POLYESTER/POLYCARB CAPS

100n, 220n, 63v 5mm	20/£1 100/£3
1n/3n/5n/6n/2n/10n 1% 63v 10mm	100/£6
10n/15n/22n/33n/47n/68n 10mm rad	100/£3.50
100n 250v radial 10mm	100/£3
100n 600v sprague axial 10/£1	100/£6 (£1)
2u2 160v RAD 22mm, 2u2 100v RAD 15mm	100/£10
10n/33n/47n 250v ac x rated 15mm	10/£1
470n 250v ac x rated rad	4/£1
1U 600V MIXED DIELECTRIC	50p ea.
1u0 100v RAD 15mm, 1u0 22mm RAD	£6/100
2U2 250V PMT CAPS. STOCK 6K	£20/100

## RF BITS

MINIATURE CO-AX 50Ω URM95	100m/£12
TRIMMER CAPS ALL	4/50p
SMALL 5p 2 pin mounting 5mm centres	
SMALL MULLARD 2 to 22pF	4/50p
SMALL MULLARD 5 to 50pF	4/50p
larger type grey 2 to 25pF black 15 to 90pF	
TRANSISTORS 2N4427	60p
FEED THRU CERAMIC CAPS 1000pF	10/£1
MICROWAVE X BAND GUNN OSCILLATOR 9 TO 11GHz EX- EQUIPMENT (DOPPLER SHIFT MICROWAVE MODULE)	£9.50

## MINIATURE RELAYS Suitable for RF

5 volt coil 1 pole changeover	£1
5 volt coil 2 pole changeover	£1
12 volt coil 1 pole changeover	£1

## MONOLITHIC CERAMIC CAPICITORS

10n 50v 2.5mm	100/£4.50
100n 50v 2.5mm or 5mm	100/£6
100n ax short leads	100/£3
100n ax long leads	100/£6
100n 50v dil package 0.3" rad	£10/100

## STEPPER MOTORS

7.5 DEGREES PER STEP 2 12 volt windings	£4
---	----

# KEYTRONICS

TEL. 0279-505543  
FAX. 0279-757656

P O BOX 634

BISHOPS STORTFORD

HERTFORDSHIRE CM23 2RX

## MAIL ORDER ONLY

MIN CASH ORDER £3.00 OFFICIAL ORDERS WELCOME  
UNIVERSITIES COLLEGES SCHOOLS GOVT. DEPARTMENTS  
MIN. ACCOUNT ORDER £10.00  
P&P AS SHOWN IN BRACKETS (HEAVY) ITEMS  
65p OTHERWISE (LIGHT) ITEMS

**ADD 15% VAT TO TOTAL  
ELECTRONIC COMPONENTS  
BOUGHT FOR CASH**







NIKAM CONTROLLER

The microcontroller board contains a 65C02 CPU and 65C22 VIA (both low power consumption), 2K cmos ram and 2K monitor eprom. There is also a further 2K memory area which can be fitted with 2K ram while developing programs. This ram can eventually be replaced with an eprom for specific 'on board' operating programs. The monitor eprom can be removed and a dedicated program in eprom will autostart on power up.

TERMINAL PROGRAM

The program shown in Listing 1 enables the BBC micro to communicate with the 6502 microcontroller. The BBC effectively becomes a terminal or vdu to the Nikam system. A further program is supplied with the system for downloading the contents of ram into the Nikam ram.

The Nikam microcontroller board and motherboard are available separately from Nikam assembled and tested with a very comprehensive and well written user manual.

The manual includes full circuits, layouts, memory map, etc.

Bare boards are also available and various other items and interfaces which can be used in conjunction with the system.

Nikam Electronics Ltd. are at: 25 Suffolk Drive, Lacey Green, Wilmslow, Cheshire, SK9 4DE.

APPLICATION PROGRAMS

In previous articles various test program

Fig. 2. Various configurations of microcontroller and Microbes 3/4/5.

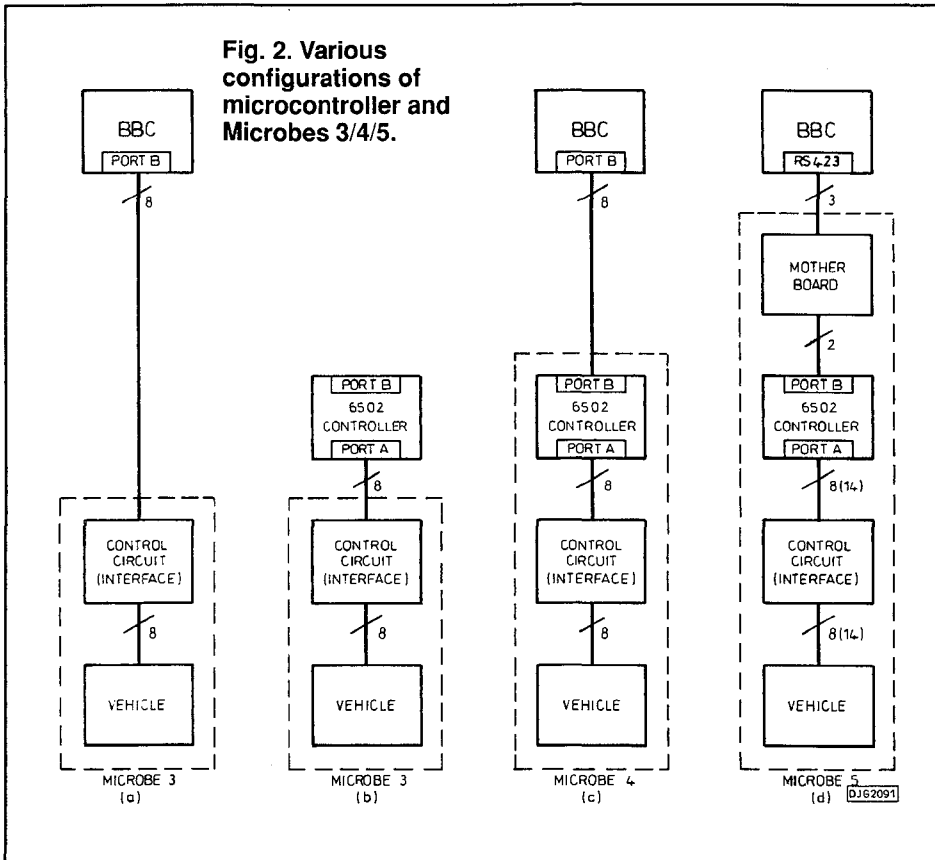

The Microbe 3 interface board can be wired to these pins, and six additional lines are available for control purposes. Thus Microbe 5 has a total of 14 i/o lines available. The specification of Microbe 5 can be summarised as follows:

- control by on-board (6502) cpu system;
- total of 14 (parallel) input/output lines;

- optional serial connection to BBC micro via RS423;
- facility for receiving downloaded machine code programs held in ram/BBC cassette or disk system;
- benefit of BBC assembler for program development.

Fig. 3. (Left) BBC RS423 to Microbe 4 connections to enable serial downloading of programs. Fig. 4. (Right). Nikam controller system connection details.

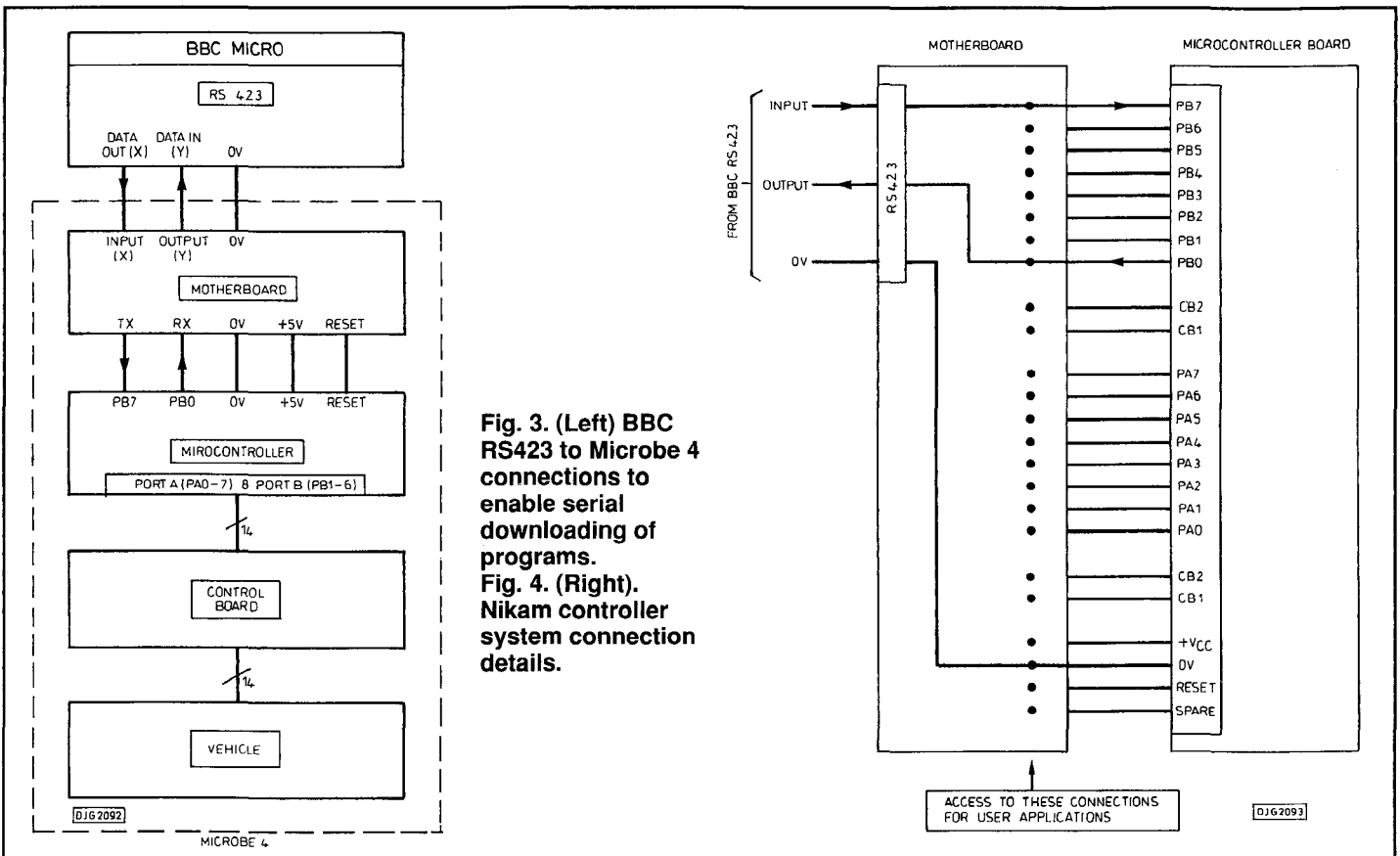

```

10 REM TERMINAL
15 REM NIKAM
20 MODE 7
30 REM TRANSMIT 2400 BAUD
40 *FX 8,5
50 REM RECEIVE 2400 BAUD
60 *FX 7,5
70 REM TAB TO ESCAPE
80 *FX 220,09
90 st%=&FE08 : REM STATUS REGISTER
100 trx%=&FE09 : REM TRANSMIT/RECEIVE
110 IF(?st% AND 1) = 1 PRINT CHR$(?trx%);
120 a$=INKEY$(0): IF a$<>" " ?trx% = ASCa$
130 GOTO 110

```

### Listing 1. Program to convert BBC micro into NIKAM VDU

modules were written in Basic, resulting in the final menu-driven program.

For microcontroller applications, these modules and any additional ones, will need to be written in machine code.

The Basic/assembler program in Listing 2 gives an indication of what is required.

LINES: 50-60 set Port BO-6 O/P, PB7 I/P  
70-80 put 'stop' hex code in data register

```

90 jump to delay subroutine at 160-220
100-110 put 'forward' hex code in data register
120 jump to delay subroutine
130-140 put 'stop' hex code in data register

```

This simple program can be extended to provide the 'RS' part of the earlier test routine 'FSRS' written in Basic. In its present form the program drives the motor forward briefly and then stops.

This program uses the assembler from within BBC Basic. When run, the program is assembled into machine code (see Listing 3 next month). Thus the block of machine code from &1500-1525 inclusive must be transferred into Nikam ram.

The assembled machine code program is run on the BBC via CALL &1500, but on the Nikam it is run from the appropriate start address in ram, eg 4000 hex, by use of the control character G (command G), ie 4000G followed by RETURN (BBC keyboard).

Thus a control program can be written, debugged and assembled using BBC Basic/assembler and when the final code is transferred to Nikam ram, can be run on the Nikam. (A fast loader program is provided in the Nikam manual for downloading).

Programs for the Nikam cannot of course make use of the BBC operating system routines

```

10 REM FSRS
20 P%=&1500
30 CLS
40 [
50 LDA £&7F
60 STA &FE62
70 LDA £&05
80 STA &FE60
90 JSR &151B
100 LDA £&0F
110 STA &FE60
120 JSR &151B
130 LDA £&05
140 STA &FE60
150 RTS
160 LDY £&FF
170 .LOOP1 LDX £&FF
180 .LOOP2 DEX
190 BNE LOOP 2
200 DEY
210 BNE LOOP1
220 RTS
230 ]

```

### Listing 2. BBC assembly language program to provide motor action

and labels are also inapplicable. Labels may be used initially when writing programs, but must be replaced by addresses to make them work on the Nikam. In other words, programs must be completely portable.

*Continued next month.*

PE

## LEADING EDGE

→ *Continued from page 8.*

The owner would then have the option to sign on to a public base station, Telepoint, service. Instead of adopting this logical approach BT, Mercury and Ferranti all started to sell handsets on their own, at around £200 each, making commercial success dependent on the availability of public base stations.

"And they have simply peppered them around the country, for hand-set owners to stumble on by chance," says Turnbull. "They should have done a deal with a chainstore and advertise that every branch has a Telepoint."

The current situation is absurdly confusing. Owners of handsets must find the right one of the three types of Telepoint which will work with their handset. Some locations, such as Post Offices, have now installed three different Telepoints, each with its own identifying sign. Next year they will have a CAI sign too.

Critical mass, for any public service, believes GPT, is around 20,000 Telepoint base stations. Until then, people will not think it is worthwhile buying a handset and signing onto a Telepoint service.

## HOME TRUTHS

Says Turnbull, "I was on the CAI committee with the other CT2 service providers, and I begged them not to launch with proprietary equipment. But they did. It's absolutely crazy. What's on the market now is already obsolete. I certainly wouldn't advise anyone to buy it, unless of course they want to

use it only in the home with a home base station and are happy to be tied to one specific manufacturer's system. The beauty of CAI is that one manufacturer's handset will work with another's base station and so on".

The burning question now is whether the coherence offered by CAI will restore confidence lost in CT2 by its false start, or whether CT2 will be overtaken by new mobile technologies and become the first telecoms technology (other than BT's Prestel viewdata and Electronic Yellow Pages, probably) to rate as a flop.

There are two new mobile phone

technologies due soon, a digital version of existing cellular phones and a pocket phone system, called Personal Communications Network. A PCN handset will look a lot like a CT2 handset, but will be able to receive calls on the move as well as make them.

Says Tim Lowry, GPT's director of mobile systems, "I am willing to lay a bet that the delays on PCN will be far longer than the delays on CAI".

In the meantime will GPT please find someone who understands CAI/CT2, and can write English, to re-write its technical brochure.

PE

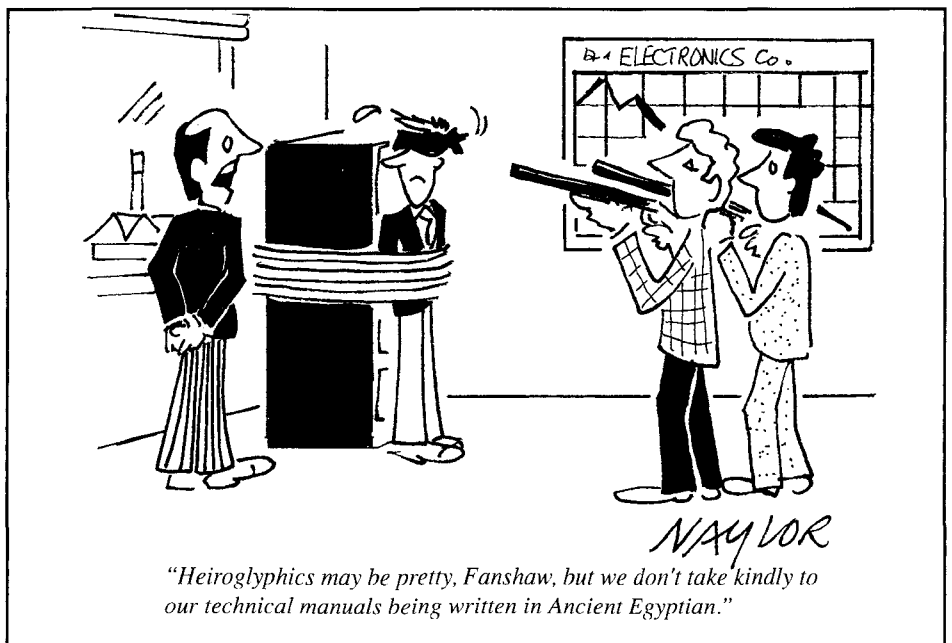

*"Hieroglyphics may be pretty, Fanshaw, but we don't take kindly to our technical manuals being written in Ancient Egyptian."*

# AGEA & G ELECTRONICS

ELECTRONIC COMPONENTS MAIL ORDER COMPANY.

1990 COMPONENTS CATALOGUE IS AVAILABLE NOW.

**FREE** entry to win an ultraviolet exposure Unit Value £ 200.

Have you send for your copy yet ?

Electronic Components at the right prices.

- FAST SERVICE
- LOW PRICES
- LARGE DISCOUNTS

Competition ends  
31 Dec 1990.

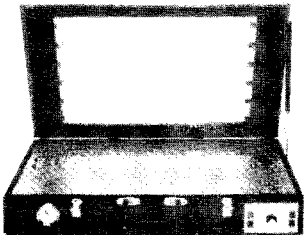

0.5" ORANGE DUAL LED DISPLAY

Value £ 2.00 absolutely free !!!

Simply complete and return the order form below and we will send your free gift.

PLEASE SEND A COPY OF THE A & G ELECTRONICS CATALOGUE AT £1.00 (REFUNDABLE WITH MY FIRST ORDER) AND MY FREE GIFT TO:

NAME .....

ADDRESS .....

I HAVE ENCLOSED £ .... Tick box to enter the competition.

A & G ELECTRONICS LTD.

Free Post ,100 Park Avenue ,

London E 6 2BR. (No Stamp Required)

TEL : 081-552 2386 Fax : 081 - 519 3419.

# The business ends that mean business

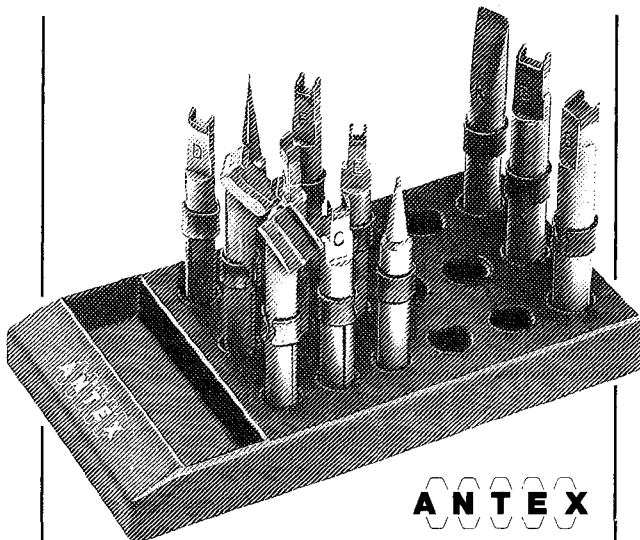

**ANTEX**

The Antex range of soldering irons and soldering stations have a well-deserved reputation throughout every industry where high quality soldered joints mean the difference between product success and failure.

But equally important are the business end components. The bits themselves.

Antex offer a comprehensive range of SMT de-soldering bits to fit Antex CS; TCS; XSTC; and XSD soldering irons, as well as all the irons in their new industrial range – A245, A545 and A718.

They are available singly or in packs of 12 with a tray.

The bit tray itself is also available separately (and takes most competitive bits).

The entire range is available from leading electronics distributors.

**Remember. Antex quality means good business.**

## TWO GREAT HOBBIES

ONLY  
£129.00  
INC VAT



## ...IN ONE GREAT KIT!

The K5000 Metal Detector Kit combines the challenge of DIY Electronics assembly with the reward and excitement of discovering Britain's buried past.

**THE KIT** — simplified assembly techniques require little technical knowledge and no complex electronic test equipment. All stages of assembly covered in a detailed 36 page manual.

**THE DETECTOR** — features Analytical Discrimination & Ground Exclusion, backed by the proven pedigree of C-Scope, Europe's leading detector manufacturer.

Ask at your local Hobby/Electronics shop or contact:—

**CSCOPE**

C-Scope International Ltd., Dept. PE  
Wotton Road, Ashford, Kent TN23 2LN.  
Telephone: 0233 629181.

Coupon to: Antex (Electronics) Limited  
2 Westbridge Industrial Estate  
Tavistock, Devon PL19 8DE

Please send me full details of the Antex range of soldering bits and trays.  (Please tick)

I am also interested in the complete range of Antex soldering products.  (Please tick)

Name \_\_\_\_\_ Position \_\_\_\_\_

Organisation \_\_\_\_\_

Address \_\_\_\_\_

PE3

For Super Schematics....

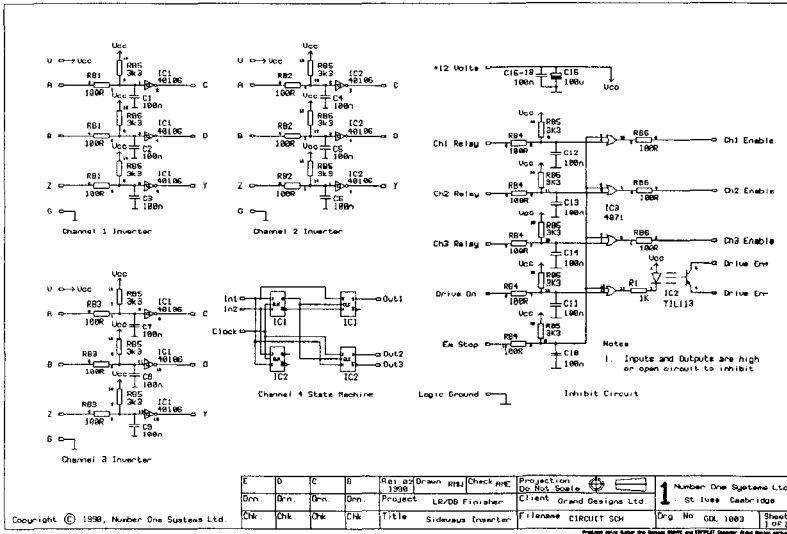

Still Only £98!!

BRITISH DESIGN AWARD 1989

- Runs on:- PC/XT/AT/386/486 with CGA EGA VGA.
- Design:- Single sided, Double sided and Multilayer boards.
- Provides Surface Mount support.
- Standard output includes Dot Matrix printer, Laser Printer, Pen Plotter, Photo-plotter and N.C. Drill.
- Superbly EASY to use.

.....and Perfect PCB's

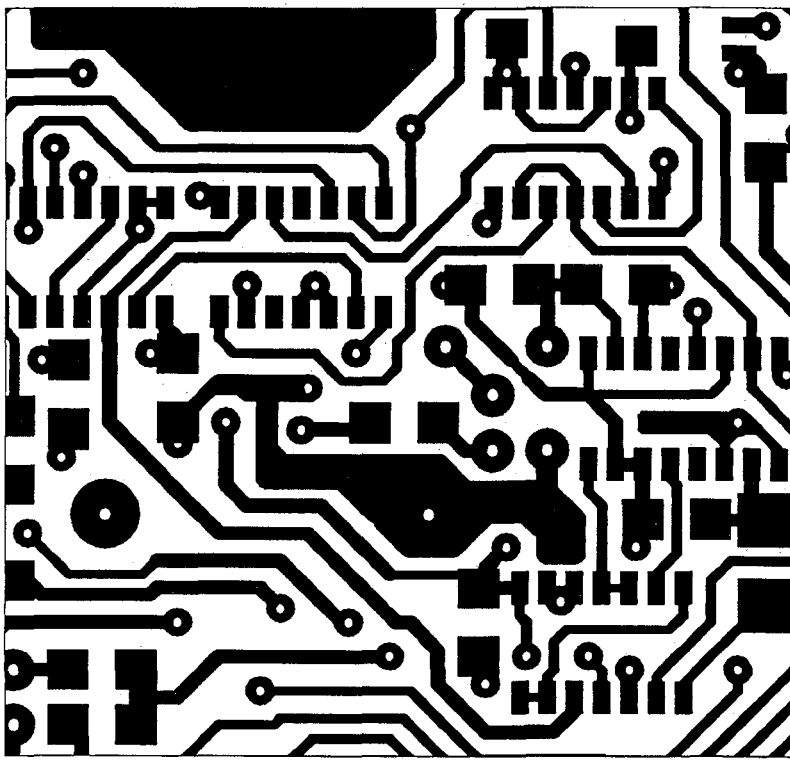

- Over 5000 installations in over 50 countries worldwide.
- Over 500 installations in Universities, Colleges etc.

Use Award Winning EASY-PC

NEW VERSION - LASER PRINTER SUPPORT!

Write ,Phone or Fax for full details:-  
**Number One Systems Ltd.** **I** **The CAD Specialists**  
 REF: PE, HARDING WAY, SOMERSHAM ROAD, ST.IVES, HUNTINGDON, CAMBS, PE17 4WR, ENGLAND.  
 Telephone: 0480 61778 (6 lines) Fax: 0480 494042 ACCESS, AMEX, MASTERCARD, VISA Welcome.





In the Editorial this month I say how reluctant I was to become involved in learning a pcb computer aided design program because I believed that it would be a time-consuming operation. But having made the decision to acquire a cad package I was amazed at how wrong my assumption had been. The *Easy-PC* system really is easy to learn and use.

*Easy-PC* is the brain-child of Number One Systems Ltd and is written for use on an IBM PC, XT, AT, PC386 or equivalent computer, including the Amstrad 1512 or 1640, and having a CGA, EGA or VGA monitor screen. A minimum of 512K of ram is required. It has been designed specifically for printed circuit board design, for producing circuit diagrams and all the associated schematic symbols. An extensive library of symbols is included with the system and it is extremely easy to add more symbols. You can also readily produce line drawings of a non-electronic nature and complete with textual captions.

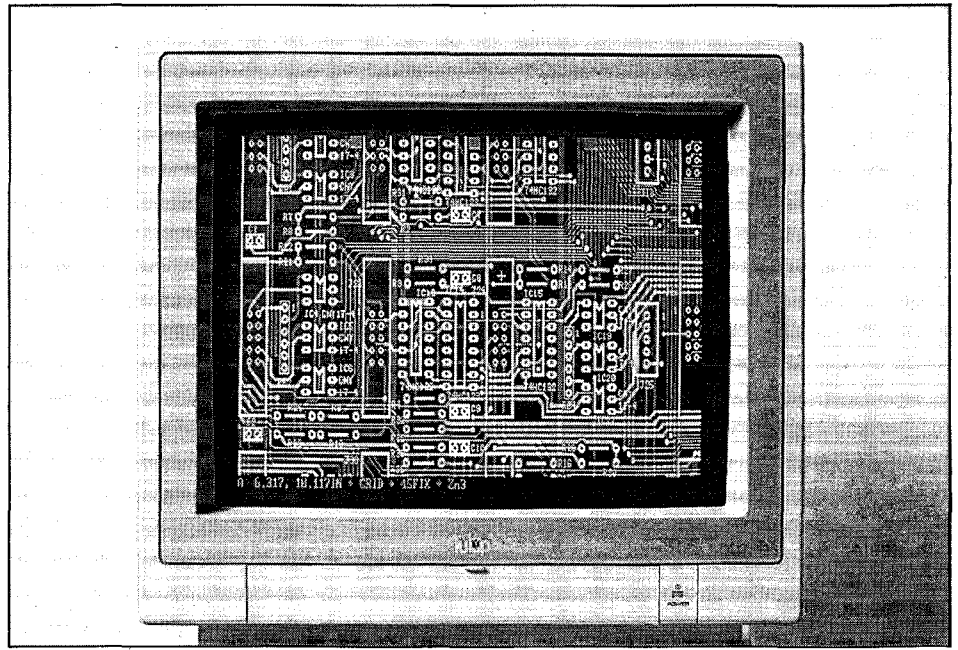

# EASY-PC PCD CAD

## MAIN FEATURES

- \* Complete pcb and circuit diagram design facilities.
- \* Exceptionally high speed operation.
- \* Excellent 'what you see is what you get' (wysiwyg!) screen display.
- \* Multilayer boards with up to eight track layers, top and bottom silk screen overlay details, drilling template and solder resists.
- \* Selective viewing of any combination of layers.
- \* Maximum board size 17 x 17 inches (430 x 430 mm).
- \* Up to 1500 ics per board.
- \* Up to 5000 tracks with up to 12000 segments.
- \* Up to 4000 pads in addition to those in ics.
- \* Up to 100 different symbols per board.
- \* Up to 6000 text characters in circuit diagrams.
- \* Choice of 128 track widths from 0.002 to over 0.5 inch, though limited to a maximum of eight widths per board.
- \* Choice of 128 different pad sizes from 0.002 to over 0.5 inch, though limited to 16 sizes per board.

**John Becker examines Number One Systems' computer-aided pcb design package and is highly impressed.**

- \* Choice of 8 pad shapes including circular, oval, square, rectangular, edge connector.
- \* Choice of different pad hole sizes including no hole.
- \* Excellent track editing facilities. Existing tracks can be modified anywhere along their length for both route and width.
- \* Screen grid overlay at 0.1 inch, with snap positioning to 0.1, 0.05, 0.025 inch, plus free-

hand positioning off-grid to a nominal resolution of 0.002 inch.

- \* Auto-via facility providing interconnections between pcb layers.
- \* Repeat, move, rotate, mirror and erase operations, for individual items or complete blocks.
- \* Rubber-banding operation, allowing blocks to be moved while retaining track connections.
- \* Automatic track angle setting of 45° or 90° plus free-hand.
- \* Extensive libraries of symbols with the ability to modify and create new symbols.
- \* Reference mode with re-locatable origin for accurate positioning of symbols or blocks.
- \* Auto-save prompt, settable to user-selected time intervals.
- \* Sophisticated back-up file operating system to maintain disc data protection even in event of power failure while saving.
- \* Print-out scales at 1/4, 1/2, 1, 2 or 4 times life size.
- \* Print-outs to 9 or 24-pin dot matrix printers.
- \* Camera-ready artwork can be produced on HPGL, pen plotters or Gerber photo-plotters.
- \* Drilling plot output compatible with NC standard drilling machines.

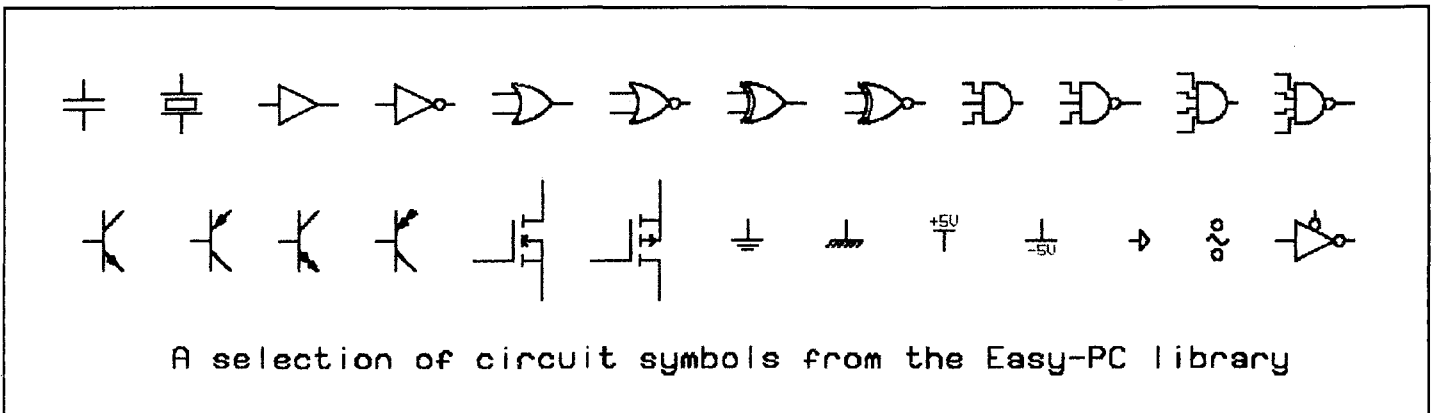

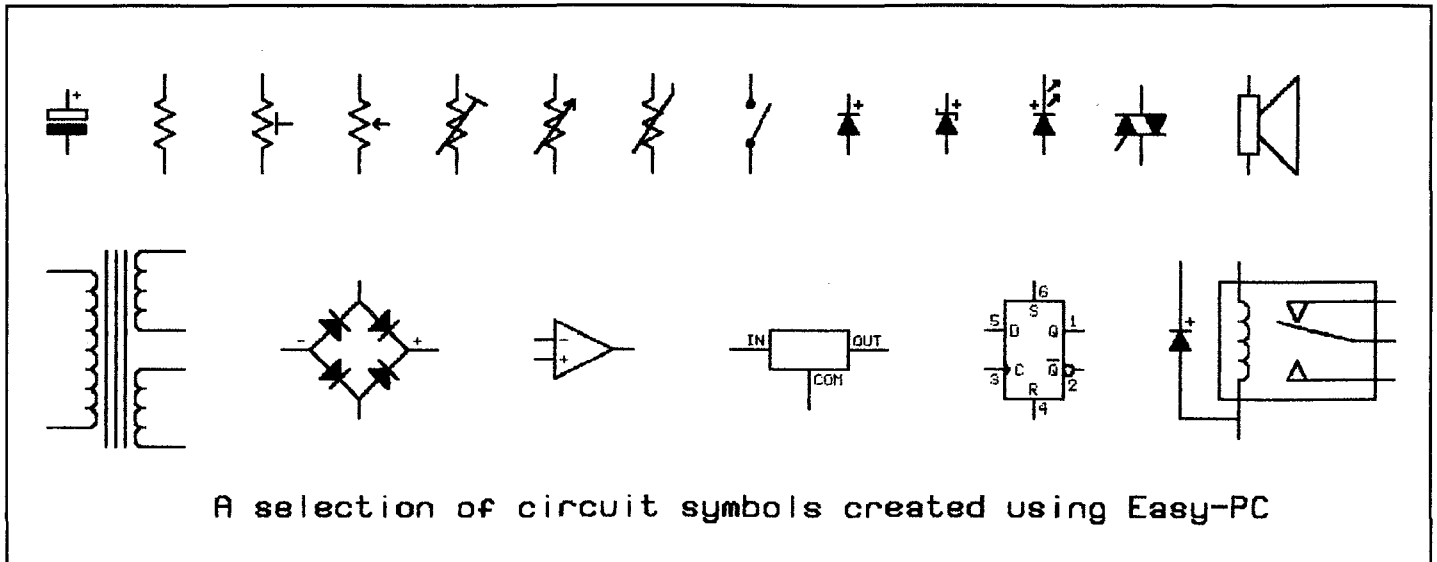

\* Functions selectable via pop-down menus or single keystroke commands.

\* Mouse or keyboard control of screen cursor positioning.

\* Quick and easy to learn and use.

### ON ARRIVAL

Easy-PC is supplied on both 5.25in and 3.5in discs, both sizes automatically being sent in the same package. The single 3.5in disc contains all the program and library files. The same data is split between two 5.25in discs. You use whichever disc size suits your machine and ignore the other.

Additionally supplied with my own package was a 5.25in demo disc complete with its own mini-manual. The demo disc contained a full implementation of the Easy-PC program with a few, largely minor, exceptions. The principal exceptions are that you can't save anything onto disc nor can you produce output for NC Drill, pen plotter or photoplotter. Most of the other Easy-PC functions, though, are included and it was a useful exercise to work through the examples in the 14 page manual before moving on to the full system.

The instructional manual for the full system is supplied in a strong ring binder. It is nicely presented, containing a clear contents page, a good index, information on installing the program onto your computer (extremely simple, involving little more than copying the discs onto hard disc or back-up floppies), and then a lengthy tutorial which takes you step by step through all the capabilities of Easy-PC. At the end of the manual is a section of useful hints and tips, plus a list of the symbols in the library, presented in words and also as pictures of the symbols themselves. The manual is well written, though was perhaps a bit economical on some descriptions of how the program operates. However, re-reading those passages once I was more familiar with the program made the meanings clear.

### BASIC OPERATION

Once the program has been installed on your machine, each time you run it you are first presented with the system logo, followed by a 5-option menu. This gives you choice of designing/editing a pcb layout or circuit diagram, or creating/editing a pcb or circuit

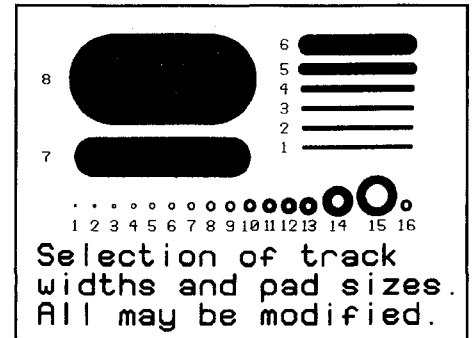

symbol, or of quitting the program. A suggested improvement at this point would be the inclusion of a screen statement advising which of the four program modes has been selected since in each mode the initial screen appearances are identical.

In many ways each of the four program modes are similar in use (though the program adopts a slightly different filing routine for each mode): it is basically only a matter of selecting the required pad or line options and then moving the mouse or cursor control keys to position or draw the detail you want. If you make a mistake it is very easy to delete or modify the detail. One nice touch is that a 'ghost-image' is retained on screen following deletion, enabling you see where the data had been. The 'ghost-image' disappears when the display is panned or the zoom mode changed.

Pads, lines, text or library symbols can be selected by using the pop down menus, first positioning the cursor over one of 'pads' displayed on the top of the screen. The respective menu then pops down and the desired option can be selected by moving the cursor over it and pressing Enter on the keyboard or mouse. Once the option has been selected, the menu disappears and the program then remains in that mode until another option is selected.

The combined use of the Function and selected other keys can achieve the same effect.

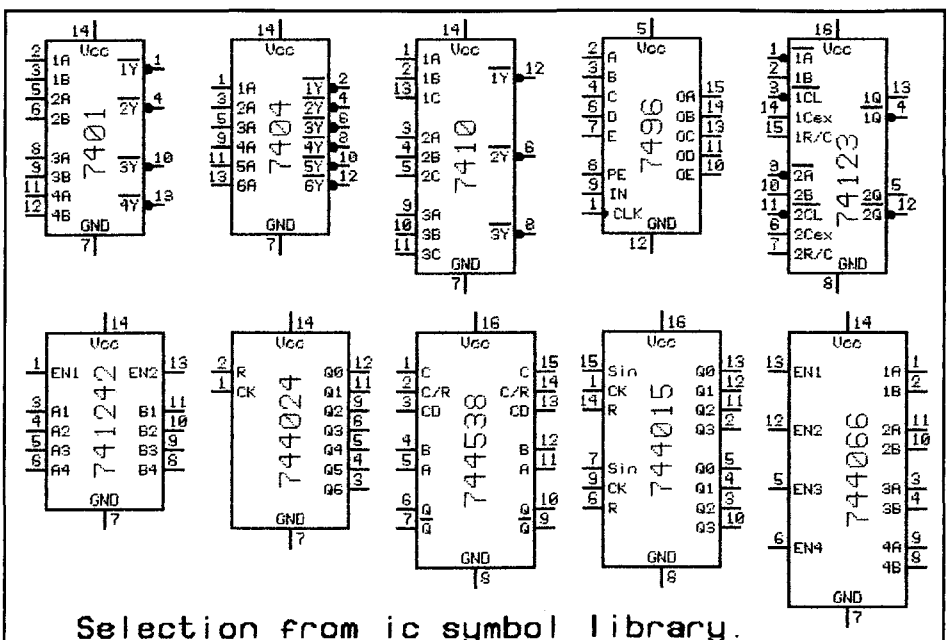
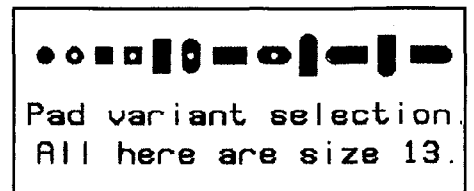

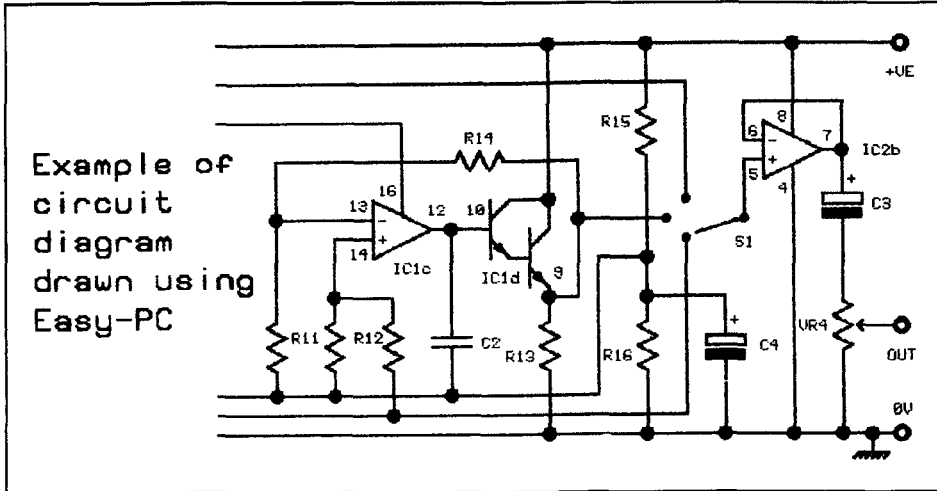

Example of circuit diagram drawn using Easy-PC

The combinations are very easy to remember, many of them simply being the initial letter of the mode required. I found that I quickly learned the coding and that its use provides a very fast change from one mode to another. The Function key selection in particular is logically thought out and with practice my fingers now readily find the correct key without actually looking at it.

By and large, the entire drawing operations are a simple combination of two-handed control, the right hand moving the mouse to position the cursor, and the left hand selecting the mode keys. The right hand also controls several other operations as well, just by pressing one or other of the two mouse keys.

The widths and sizes of pads, tracks and texts can be selected direct from the keyboard, simply by keying in a width or size number. The width or size of pads and lines that these numbers call up can be changed by prior setting of a user-option table, though in practice I have so far found little need to change the default options immediately available at switch-on.

When drawing lines you have a 'rubberbanding' option available. Having set the start point of a line, moving the cursor causes the line to follow it so that you can see precisely where to route it, placing route-changing nodes where you want. Rubberbanding may be switched off if you prefer so that you simply click the mouse at the start and end positions of the line you want drawn, the line appearing after the second click. I prefer the rubberbanding to be on continuously.

All layouts, diagrams and symbols can have text included with them, and all the characters on the keyboard are available.

An extremely useful 'interrogation' facility has been included. By putting the program into any of the four edit modes and then pressing the + key a screen display tells you full details about the nearest function relating to the mode, covering width, size, shape, variant or name, as appropriate.

### LIBRARIES

Symbols have been split into several library files. Those most likely to be used regularly are stored in the library to which the computer defaults at switch on. To access the other libraries you just change the screen prompt entry. The libraries have directories, in text form, which can be displayed on screen in response to pop-down menu or keystroke command. Regrettably you have to remember the name of the symbol you want since you cannot call it up until the directory display has been removed from screen. Accessing via mouse-controlled highlight selection on the screen directory would be a real advantage here. So too would the inclusion of a 'sort' facility to put the symbol names into alphabetical order.

On the current version of *Easy-PC* there are over 400 symbols available, mainly relating to digital ic varieties. Although the selection is good, it could be improved by extending it to cover more of the digital ics in current use, plus the inclusion of a linear ic library as well. However, symbols are so easy to create that the limitation is very minor. Number One Systems tell me that they intend to extend the libraries in due course.

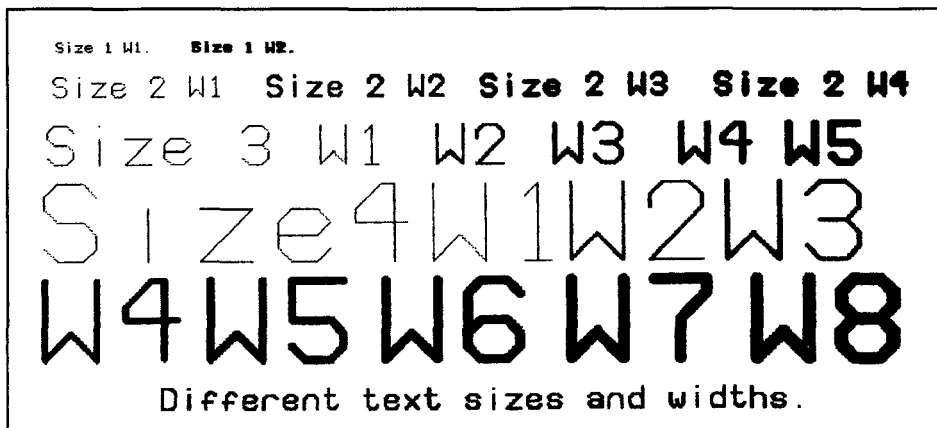

One aspect I do not like is that when modifying a library symbol it is necessary to either give the symbol a new name or to erase the old symbol before saving the new one. I changed several symbols to make them closer in style to that used in PE and preferred to keep the original name. By having to erase the old name first I felt in danger of making an error, with the resultant possibility of losing the symbol entirely. Certainly I could then reload the original symbol from the master disc, but I would prefer to have had a potentially less-hazardous modifying routine available.

### GLOBAL CHANGE

An interesting point came up after I had made several symbol changes. I had already designed some pcbs before changing the symbols. Reloading the pcb designs following the library changes, I was surprised to see that the pcbs still showed the original symbols. After some experimentation I found that if I first loaded the changed symbols onto a 'new' screen format, and then 'merged' the pcb design into another area of the same format, all the original symbols in question were automatically changed to the new ones. The 'side line' symbols could then be deleted and the pcb layout re-saved. Next time it was loaded the pcb showed the correct new symbols. It was in effect the equivalent of a 'global change' facility which I found very useful. It also gave an interesting insight into the program's architecture.

### ROTATION

The orientation of texts and symbols can be easily changed, allowing them to run horizontally, vertically, upside down, back-to-front and so on. All orientations are related to 90° steps and you cannot rotate text or symbols to other angles. It could be useful in some instances to be able to orientate them in steps of 45° angles. Ideally, a full 360° rotation through 1° steps would make the system an even more versatile package for general non-electronic drawing creation.

A very useful line function available is the automatic circle drawing facility. This allows you to draw a line to the radius length you want and then let the program produce a circle from it. The circle consists of many discrete nodes and it is then possible to selectively delete some nodes so that arcs and semi-circles etc can be produced.

### BLOCK MODE

One function I really like is the two-mode block-move facility. This allows you to select an area which you want to move and then to reposition it anywhere else on the screen. In one mode just the main detail within the block is moved (though detail which crosses the block boundaries may also be carried along). In the other mode a rubber-banding function comes into play so that any lines extending outside the block follow it to its new position, automatically being rerouted, shortened or lengthened as

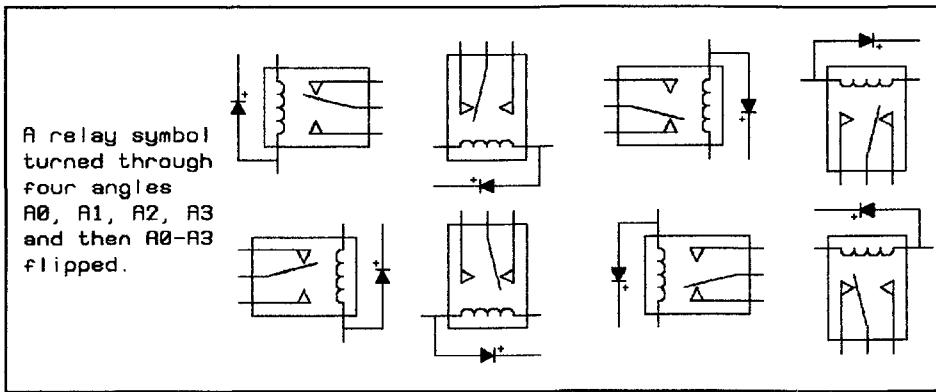

A relay symbol turned through four angles A0, A1, A2, A3 and then A0-A3 flipped.

Angle 0	Angle 1	Angle 2	Angle 3
Angle 0	Angle 1	Angle 2	Angle 3
Text at all four angles, with flipping.			

reserved for pad and line details. The top layer (Layer 0) is used for component overlay symbols and textual information. The lowest layer (Layer 9) allows you to put further text on the back of the pcb, and you can tell the program to make this a mirror image so that it appears correct when you turn over the actual manufactured pcb.

For single-sided pcbs you would use Layers 0, 1 and 9. With double-sided pcbs you can use any of the remaining layers for the second side, but would probably use Layer 2 or 8.

You can select which layers you want to see on screen at any one time, from nil to all. The same option applies when printing out to a printer or plotter. This is a vital facility when printing, and is a highly useful option when designing on screen. On screen you can set the layers to appear as different colours, and within certain restrictions can specify in which colours you want to see them. Usually I work with the layers in a combination of white, red and blue.

Although text and lines will only appear on the layers which you specify for them, pads

needed. This is especially useful if you wish, for example, to make space for additional components. It also allows you to compress or expand the layout once it is otherwise complete. It may sometimes be necessary to redraw some lines to make their routings more aesthetically pleasing, but what a time-saver this option is!

The block mode function can also be used to change the entire orientation of a selected block, in the same way that text can - upside-down, vertically, flipped back-to-front, etc. You can also cause the entire block to be repeated at another area on the screen. This is a real boon when a pcb consists of several sections in which

the symbol and tracking details are identical - there's no need to draw each section individually. It's equally useful with circuit diagram drawing as well.

Use of the block mode also allows you to selectively print parts of a layout or circuit.

## LAYERS

There are ten layers on which you can place your pcb design details, allowing not only single-sided pcbs to be drawn, but double-sided and multi-layer boards as well. Eight layers are

**Top left: combined track, pad, symbol and text layout – this was in red and white on the screen with good visual separation. Bottom left: Symbol and text separation. All symbols were designed using Easy-PC facilities. Top right: reverse side track view. Bottom Right: pads only separation, suitable for solder-resist requirements.**

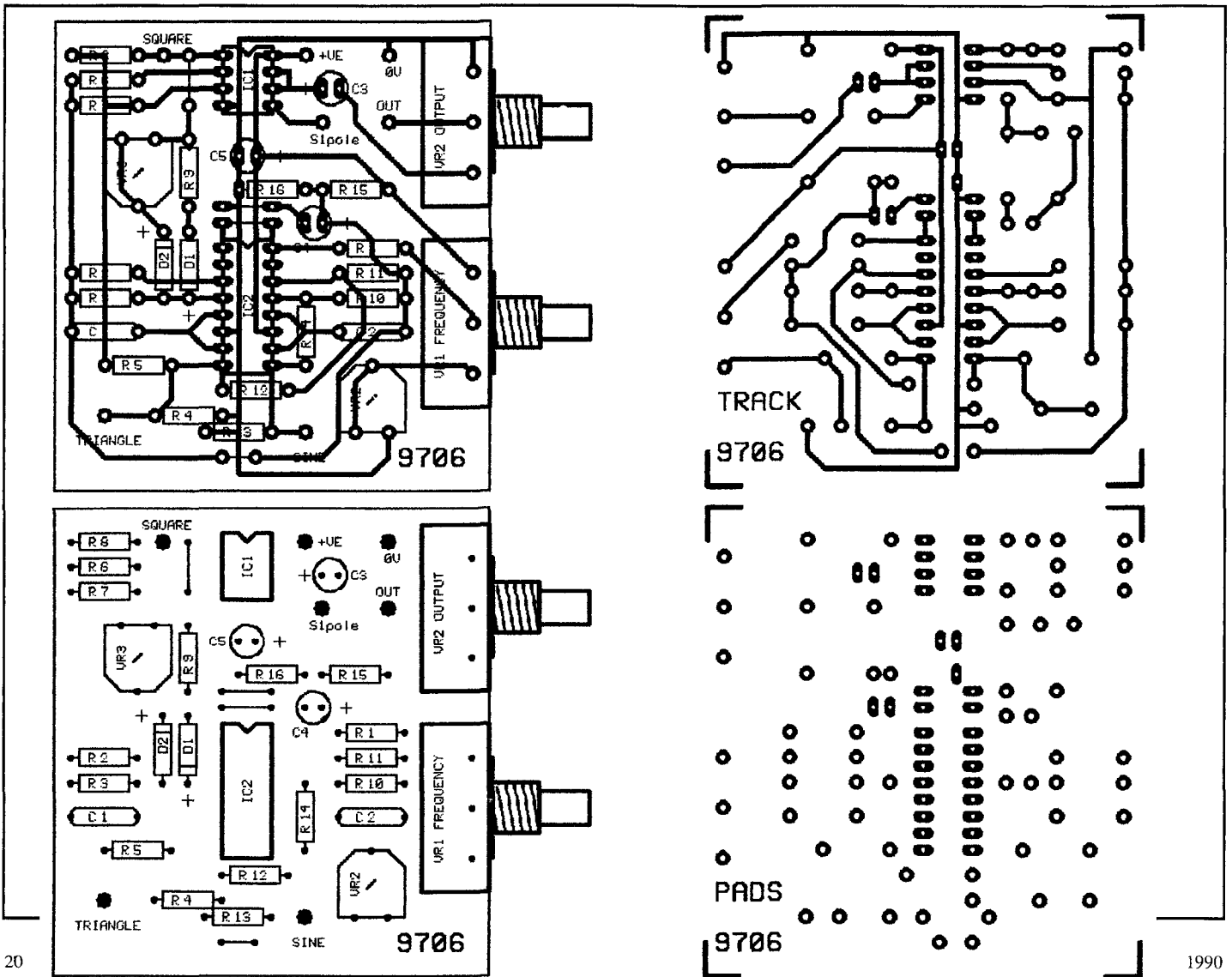

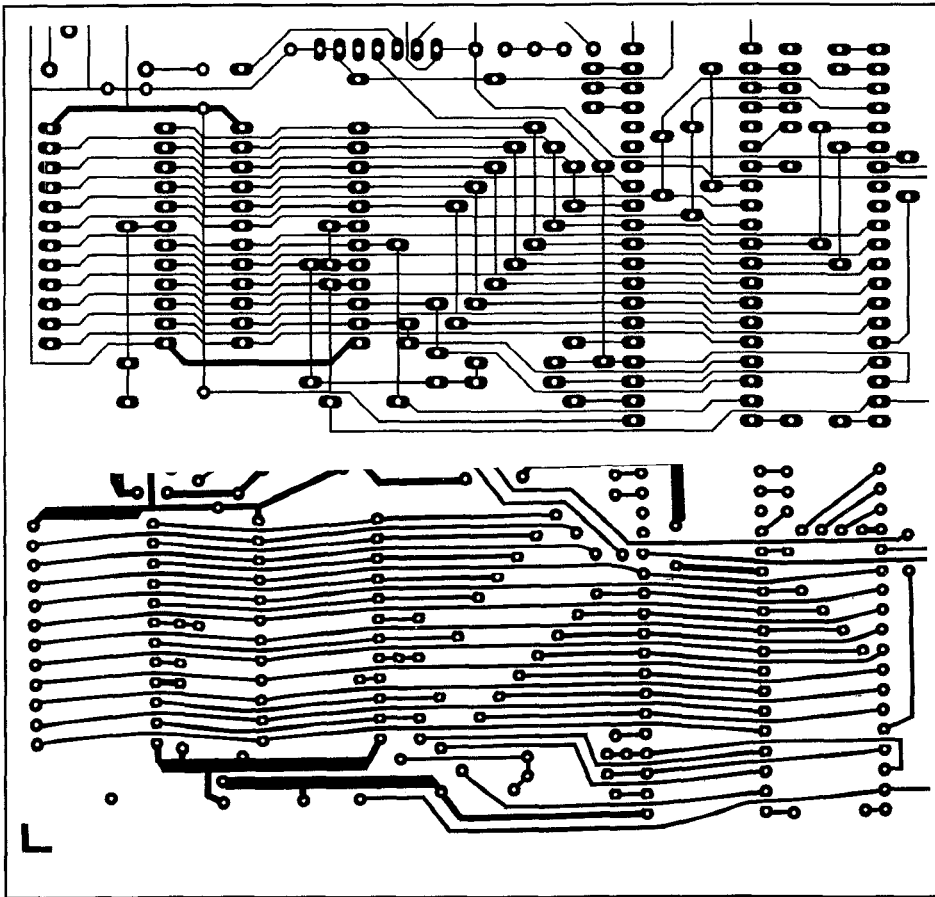

**Top: part of the Bike Computer main pcb redesigned on Easy-PC. On screen the main tracks are in red, the pads in white and the vertical links in blue. This part was done in far less time than it took to traditionally tape the original (though not fully completed) the equivalent section of which is reproduced below it.**

placed on any one of Layers 1 to 8 will automatically be copied to the other seven designated layers. Component symbols can only be placed on Layer 0.

When designing layout symbols, the line and text data is automatically allocated to Layer 0, though pad data will subsequently appear on all Layers 1 to 8.

Circuit diagram details are confined to a single layer which cannot be changed.

## PAN, ZOOM AND GRID

You can view your design at any one of seven magnifications. On the Amstrad 1640, Zoom 4 roughly corresponds to a life-size view. Zoom 1 shows the largest image, eight times that of Zoom 4. Zoom 7 shows the entire 17 x 17 inch layout area. At all zoom sizes you can pan the data in all directions across the screen.

A dotted grid can be switched on or off screen thus facilitating data positioning. Its scale varies with the zoom magnification, though is always related to 0.1 inch steps, except with Zoom 7 when no grid is shown. You can select a grid 'snap' mode which allows you to position the cursor close to a required point and then to let the program 'snap' it to the exact point, making for extremely precise positioning. The 'snap' can be set for scales of 1/4, 1/2 or 1 grid position, or for free-hand.

Another 'snap' function allows the cursor to be placed some greater distance away from a pad, line, symbol or text display. On pressing an

edit key, the cursor jumps straight to the nearest node of the display function selected. This is a great advantage when, for example, you want to delete or modify pads in a given area. Each time you press the Pad-edit key, the cursor jumps to the nearest pad, allowing you to make the necessary changes. This is another good time-saver. The 'snap' distance can be varied via the user-options menu.

In addition to the grid reference there is a separate sizing option which can be set for metric or imperial measurement. The initial starting reference point can be set to zero at any time allowing accurate size and distance measurements to be made.

## REPEAT MODES

Once you have selected a line, pad, text or symbol mode, the program stays in that mode until told to change. For example, you can select a particular pad size and shape, and constantly repeat it wherever you want across the design simply by clicking the mouse once at each point. The same too with line widths; it will stay in that width until another mode is selected. Text and symbol modes work slightly differently. You stay in the mode, but each time you click the mouse you then enter the text you want, or say which symbol you want brought on screen. If you want to repeat text or symbols you enter edit mode with the cursor over the text or symbol in question, move the cursor to the new position, and press R to repeat it.

## PRINTING

There are numerous printing options, allowing selection of scale size, choice of layers, choice of quality including draft, normal and bold. You can selectively print parts of a drawing, using the block function command, and you can reorientate the drawing to allow drawings wider than the paper width to be printed vertically, for example.

I use the program with a 24-pin printer (an Epson LQ550, which cost around £310) but it can be used with 9-pin printers instead. It can also be used with pen and photo plotters though I have no experience of these.

For prototyping purposes I print out life-size onto ordinary fan-fold paper, make a good photocopy of the print and spray it with a transparentiser. It is then placed in contact with photo-sensitive copper-clad pcb laminate and exposed in an ultraviolet unit, following which it is developed and etched in the usual way. (I had hoped to use the fan-fold print direct, but the ink image runs when sprayed with transparentiser!)

## HIGHLY BENEFICIAL

There are several peripheral but highly useful functions that this excellent program can perform as well, though space prevents their inclusion here.

*Easy-PC* has really opened my eyes to the value and operational simplicity of pcb cad. Although I still have many pounds worth of conventional pcb design pads and tracks, I doubt that I shall ever have occasion to use them again. The program has revolutionised my pcb and circuit diagram design facilities. No wonder the system won the 1989 British Design Award.

A further advantage of this cad package is the benefits you will experience from the helpful attitude of its designers. Number One Systems recognise how important it is that their customers should be absolutely satisfied with their products. They stress that if anyone has a problem or a query concerning *Easy-PC*, or any of the company's other software products, then they can ask for advice as many times as they like. Such an attitude is a breath of fresh air. (I know of one cad software company that restricts purchasers to only three queries unless consultation fees have been paid.) Whether you are a commercial pcb designer, or a hobbyist producing just the occasional layout, you will benefit greatly from this software.

I hope that I have whetted your appetite to find out more about *Easy-PC*. If so, give Number One Systems a call and obtain a free copy of their demo disc. (Tell them I told you to call!) They will even allow you to copy the demo as many times as you want and pass the copies around your friends. I am sure that having played with the demo for a while you'll not be able to resist buying the complete program. It costs only £98 and is worth every penny of it!

**Number One Systems** are at Harding Way, Somersham Road, St Ives, Huntingdon, Cambs, PE17 4WR. Tel: 0480 61778.

## ONE POUND PACKS

All packs are £1 each. Note the figure on the extreme left of the pack ref number and the next figure is the quantity of items in the pack, finally a short description.

- BD2 5 13A spurs provide a fused outlet to a ring main where devices such as a clock must not be switched off.
- BD9 2 6V 1A mains transformers upright mounting with fixing clamps.
- BD13 12 30 watt reed switches, it's surprising what you can make with these - burglar alarms, secret switches, relay, etc., etc.
- BD22 2 25 watt loudspeaker two unit crossovers.
- BD30 2 Nicad constant current chargers adapt to charge almost any nicad battery.
- BD32 2 Humidity switches, as the air becomes damper the membrane stretches and operates a microswitch.
- BD42 5 13A rocker switch three tags so on/off, or change over with centre off.
- BD45 1 24hr time switch, ex-Electricity Board, automatically adjust for lengthening and shortening day, original cost £40 each.
- BD49 5 Neon valves, with series resistor, these make good night lights.
- BD56 1 Mini uniselector, one use is for an electric jigsaw puzzle, we give circuit diagram for this. One pulse into motor, moves switch through one pole.
- BD67 1 Suck or blow operated pressure switch, or it can be operated by any low pressure variation such as water level in water tanks.
- BD103A 1 6V 750mA power supply, nicely cased with mains input and 6V output leads.
- BD120 2 Stripper boards, each contains a 400V 2A bridge rectifier and 14 other diodes and rectifiers as well as dozens of condensers, etc.
- BD128 10 Very fine drills for pcb boards etc. Normal cost about 80p each.
- BD132 2 Plastic boxes approx 3in cube with square hole through top so ideal for interrupted beam switch.
- BD134 10 Motors for model aeroplanes, spin to start so needs no switch.
- BD137 6.5" 4 Ohm speaker, 10 Watt rating.
- BD139 6 Microphone inserts - magnetic 400 ohm also act as speakers.
- BD148 4 Reed relay kits, you get 16 reed switches and 4 coil sets with notes on making c/o relays and other gadgets.
- BD149 6 Safety cover for 13A sockets - prevent those inquisitive little fingers getting nasty shocks.
- BD180 6 Neon indicators in panel mounting holders with lens.
- BD193 6 5 amp 3 pin flush mounting sockets make a low cost disco panel.
- BD199 1 Mains solenoid, very powerful, has 1in pull or could push if modified.
- BD201 8 Keyboard switches - made for computers but have many other applications.
- BD211 1 Electric clock, mains operated, put this in a box and you need never be late.
- BD221 5 12V alarms, make a noise about as loud as a car horn. Slightly soiled but OK.
- BD252 1 Panostat, controls output of boiling ring from simmer up boil.
- BD259 50 Leads with push-on 1/4in tags - a must for hook-ups - mains connections etc.
- BD263 2 Oblong push switches for bell or chimes, these can mains up to 5 amps so could be foot switch if fitted into pattress.
- BD268 1 Mini 1 watt amp for record player. Will also change speed of record player motor.
- BD305 1 Tubular dynamic mic with optional table rest.
- BD653 2 Miniature driver transformers. Ref. T44, 20k to 1k centre tapped.
- BD548 2 3.5V relays each with 2 pairs changeover contacts.
- BD667 2 4.7 uf non-polarised block capacitors, pcb mounting.
- There are over 1,000 items in our One Pound Pack List. If you want a complete copy please request this when ordering.
- GEIGER COUNTER KIT includes tube, PCB and all components to make a 9v counter £39. Ref 39P1
- PERSONAL STEREO'S Again customer returns but complete and with stereo headphones a bargain at only £3.00 each. Our ref 3P83.
- MAINS OPERATED MICROWAVE CONTROL PANEL with Touch switches. This unit has a 4 digit display with a built in clock and 2 relay outputs - one for power and 1 for pulsed power level. Could be used for all sorts of timer control applications. Only £6.00. Our ref 6P18.
- EQUIPMENT WALL MOUNT Multiangle for speakers etc. £3 each ref 3P72.
- SUB-MIN TOGGLE SWITCH Body size 8mm x 4mm x 7mm SBDT with chrome dolly fixing nuts. 3 for £1. Order ref BD649.
- COPPER CLAD PANEL for making PCB. Size approx 12in long x 8.5in wide. Double-sided on fibreglass middle which is quite thick (about 1/16in) so this would support quite heavy components and could even form a chassis to hold a mains transformer, etc. Price £1 each. Our ref BD683.
- MAINS FANS Brand new, snail type. Approx. 6" x 4" approx. 70W only £5.00. Ref. 5P166.
- REAL POWER AMPLIFIER for your car, it has 150 watts output. Frequency response 20hz to 20Khz and signal to noise ratio better than 60dB. Has built in short circuit protection and adjustable input level to suit your existing car stereo, so needs no pre-amp. Works into speakers ref. 30P7 described below. A real bargain at only £57.50. Order ref: 57P1.

## POWERFUL IONISER

Generates approx. 10 times more IONS than the ET1 and similar circuits. Will refresh your home, office, workroom etc. Makes you feel better and work harder - a complete mains operated kit, case included £18.00 + £2 p.p. Our ref 18P2.

REAL POWER CAR SPEAKERS. Stereo pair output 100W each. 4-Ohm impedance and consisting of 6.5in woofer, 2in mid range and 1in tweeter. Ideal to work with the amplifier described above. Price per pair £30.00. Order ref: 30P7.

VIDEO TAPES These are three hour tapes of superior quality, made under licence from the famous JVC Company. Offered at only £3 each. Our ref 3P63. Or 5 for £11. Our ref 11P3. Or for the really big user 10 for £20. Our ref 20P20.

ELECTRONIC SPACESHIP. Sound and impact controlled, responds to claps and shouts and reverses when it hits anything. Kits with really detailed instructions. Ideal present for budding young electrician. A youngster should be able to assemble but you may have to help with the soldering of the components on the pcb. Complete kit £10. Our ref. 10P81.

COMPOSITE VIDEO KITS. These convert composite video into separate H sync, V sync and video. Price £8.00. Our ref 8P39.

12" HIGH RESOLUTION MONITOR Amber screen, beautifully cased for free standing, needs only a 12v 1.5 amp supply. Technical data is on its way but we understand these are TTL input. Brand new in makers' cartons. Price: £22.00. Order ref: 22P2.

3.5in FLOPPY DRIVES We still have two models in stock: Single sided, 80 track, by Chiron. This is in the manufacturers metal case with leads and IDC connectors. Price £40, reference 40P1. Also a double sided, 80 track, by NEC. This is uncased. Price £60, reference 60P2. Both are brand new. Insured delivery £3 on each or both.

YUASHA LEAD ACID BATTERIES 6V 10A. Superb Value at only £9.00 REF 9P9H or 2 for £15.00 ref 15P37.

VERY POWERFUL 12 VOLT MOTORS. 1/3rd Horsepower. Made to drive the Sinclair C5 electric car but adaptable to power a go-kart, a mower, a rail car, model railway, etc. Brand new. Price £20 + £2 postage. Our ref. 20P22.

SINCLAIR C5 WHEELS. Set of 4 wheels with inner tubes and tyres. 2 13" dia. front wheels and 2 16" dia. rear wheels. Brand new, £6 each, 13" Ref 6P10, 16" Ref 16P11.

C5 GEARED MOTOR, 800 RPM. £40.00.

ELECTRONIC SPEED CONTROL KIT Suitable for controlling our powerful 12v motors. Price £17.00. Ref. 17P3 (heatsink required).

ORGAN MASTER is a three octave musical keyboard. It is beautifully made, has full size (piano size) keys, has gold plated contacts and is complete with ribbon cable and edge connector. Can be used with many computers, request information sheet. Brand new, only £15 plus £3 postage. Our ref 15P15.

## PHILIPS LASER

This is helium-neon and has a power rating of 2mW. Completely safe as long as you do not look directly into the beam when eye damage could result. Brand new, full spec. £35 plus £3 insured delivery. Mains operated power supply for this tube gives 8kv striking and 1.25kv at 5mA running. Complete kit with case £15.

## SOLDER

22-fwg 60/40 resin cored solder 1/2 kg reel. Top quality. £4.00. Ref 4P70.

HIGH RESOLUTION MONITOR. 9in black and white, used Philips tube M24/306W. Made up in a lacquered frame and has open sides. Made for use with OPD computer but suitable for most others. Brand new. £20 plus £5 post. Our ref 20P26.

12 VOLT BRUSHLESS FAN. Japanese made. The popular square shape (4.5in x 4.5in x 1.75in). The electronically run fans not only consume very little current but also they do not cause interference as the brush type motors do. Ideal for cooling computers, etc., or for a caravan. £8 each. Our ref 8P26.

MINI MONO AMP on p.c.b. size 4in x 2in (app.)

Fitted Volume control and a hole for a tone control should you require it. The amplifier has three transistors and we estimate the output to be 3W rms. More technical data will be included with amp. Brand new, perfect condition, offered at the very low price of £1.15 each, or 13 for £12.00.

JOYSTICKS for BBC, Atari, Dragon Commodore, etc. All £5.00 each. All brand new, state which required.

SUB-MIN PUSH SWITCHES Not much bigger than a plastic transistor but double pole PCB mounting. 3 for £1.00. Our ref BD688.

AA CELLS Probably the most popular of the rechargeable NICAD types. 4 for £4.00. Our ref. 4P44.

20 WATT 4 OHM SPEAKER With built in tweeter. Really well made unit which has the power and the quality for hi-fi 6.5in dia. Price £5.00. Our ref. 5P155 or 10 for £40.00 ref. 40P7.

MINI RADIO MODULE Only 2in square with ferrite aerial and solid dia. tuner with own knob. It is superhet and operates from a PP3 battery and would drive a crystal headphone. Price £1.00. Our ref. BD716.

BULGIN MAINS PLUG AND SOCKET The old and faithful 3 pin with screw terminals. The plug is panel mounted and the socket is cable mounted. 2 pairs for £1.00 or 4 plugs or 4 sockets for £1.00. Our ref. POPULAR ITEMS - MANY NEW THIS MONTHBD715, BD715P, or BD715S.

POPULAR ITEMS - MANY NEW THIS MONTH MICROPHONE Low cost hand held dynamic microphone with on/off switch in handle. Lead terminates in 1.35mm and 1.25mm plug. Only £1.00. Ref. BD711.

MOSFETS FOR POWER AMPLIFIERS AND HIGH CURRENT DEVICES 140v 100watt pair made by Hitachi. Also available in H pack ref 2SJ99 and 2SK343 £4.00 a pair. Ref 4P51.

TIME AND TEMPERATURE LCD MODULE A 12 hour clock a Celsius and Fahrenheit thermometer a too hot alarm and a too cold alarm. Approx

50x20mm with 12.7mm digits. Requires 1AA battery and a few switches. Comes with full data and diagram. Price £9.00. Our ref. 9P5.

REMOTE TEMPERATURE PROBE FOR ABOVE £3.00. Our ref. 3P60. 25 WATT STEREO AMPLIFIER IC STK043. With the addition of a handful of components you can build a 25 watt stereo amplifier. Supplied with a circuit diagram. £4.00 REF 4P69.

600 WATT AIR OR LIQUID MAINS HEATER Small coil heater made for heating air or liquids. Will not corrode, lasts for years. Case size 3in x 2in mounted on a metal plate for easy fixing. 4in dia. Price £3.00. Ref. 3P78 or 4 for £10.0. Our ref. 10P76.

EX-EQUIPMENT SWITCHED MODE POWER SUPPLIES Various makes and specs but generally +5, +12V ideal bench supply. Only £3.00. Our ref 8P36.

ACORN DATA RECORDER Made for the Electron or BBC computer but suitable for others. Includes mains adaptor, leads and book. £12.00. Ref. 12P15.

NEW PIR SENSORS Infra red movement sensors will switch up to 1000w mains. UK made, 12 month manufacturers warranty, 15-20m range with a 3-10mm timer, adjustable wall bracket. Only £25.00. Ref. 25P16.

MAINS FANS 80mm square silent mains fans ideal for equipment cooling where space is at a premium. They give quite a good draught and use about 12 watts. £9.00 ref 9P10.

13 MEMORY PUSHBUTTON TELEPHONES These are customer returns and sold as seen. They are complete and may need slight attention. Price £8.00 Ref 8P20 or 2 for £10.00 Ref 10P77 BT approved.

MINIATURE DOT MATRIX PRINTERS. These are 24 column 5v and similar to the one sold by Radio Spares for £46.00. You can have one for £10 ref 12P32.

MYLAR CONE SPEAKERS. These 85mm square 35ohm 2 watt speakers are ideal for outside use as they are virtually waterproof. £1.00 each ref BD903.

BBC JOYSTICK INTERFACE Converts a BBC joystick port to an Atari type port. Price £2.00. Our ref 2P26.

TELEPHONE EXTENSION LEAD 5m phone extension lead with plug on one end, socket on the other. White. Price £3.00. Our ref. 3P70 or 10 leads for only £19.00. Ref. 19P2.

LCD DISPLAY 4.5in digits supplied with connection data £3.00. Ref. 3P77 or 5 for £10. Ref. 10P78.

CROSS OVER NETWORK 8 Ohm 3 way, for tweeter midrange and woofer nicely cased with connections marked. Only £2.00. Our ref. 2P255 or 10 for £15.00. Ref. 15P32.

BASE STATION MICROPHONE Top quality unidirectional electret condenser mic 600r impedance sensitivity 16-30mV. 500ohm output. Complete with mic stand bracket. £15.00. Ref. 15P33.

MICROPHONE STAND Very heavy chromed metal stand magnetic base 4in high. £3.00 if ordered with above mic. Our ref. 3P81.

SOLAR POWERED NICAD CHARGER 4 Nicad AA battery charger. Charges 4 batteries in 2 hours. Price £5.00. Our ref. 6P3.

MAINS SOLDERING IRON Price £3.00. Our ref. 3P65.

SOLDERING ROV STAND Price £3.00. Our ref. 3P66.

CAR IONIZER KIT Improve the air in your car, clears smoke and helps prevent fatigue. Case req. Price £12.00. Our ref. 12P8.

NEW FM BUG KIT New design with PCB embedded coil 9v operation. Priced at £5.00. Our ref. 5P158.

NEW PANEL METERS 50UA movement with three different scales that are brought into view with a lever. Price only £3.00. Ref. 3P81.

STROBE LIGHTS Fit a standard Edison screw light fitting 240V 40 watt. Flash rate available in yellow, green. Complete with socket. Price £1.00 each. Ref. 10P80 (state colour required).

METAL PROJECT BOX ideal for battery charger, power supply etc. Sprayed grey size 8in x 4in x 4.5in. Louvered for ventilation. Price £3.00. Ref. 3P75.

TV SOUND DECODER Nicely cased, mains powered with 2 channels. Will drive a small speaker directly or could be fed into a HiFi system etc. £12.00 each. Ref 12P22.

2KV 500 WATT MAINS TRANSFORMER Suitable for high voltage experiments or as a spare for a microwave oven etc. £10.00 Ref 10P93.

STC SWITCHED MODE POWER SUPPLY 220v operation giving 5V at 2A+24 at 0.25A +12 at 0.15A and -5V at 0.4A. £12.00 each. Ref 12P27.

PC STYLE CASES 18" x 18" x 6" Complete with fan and glow illuminated power switch and IEC filtered power input plug. Priced at only £15.00. Ref 15P38.

PC POWER SUPPLIES Brand new with built in fan and power switch on the back +5 -5 +12 -12 150 Watt made by Attec £25.00 each. Ref 25P18.

BOSCHERT SWITCHED MODE POWER SUPPLIES +5 at 15A, +12 at 2A +24 at 2A 220V or 110V input. Brand new and guaranteed. Retail price is £180! Ours £20. Ref 20P33.

BUSH RADIO MIDSPEAKERS Pair of 4 ohm nicely cased loudspeakers approx 14" high complete with speaker leads and plugs. Price for a pair is £5.00. Ref. 5P14.

MAGNETIC CARD READERS These units contain a magnetic card reader, TWO matrix printer assemblies, electronic counter, motors, speaker, lots of optical sensors and lots of electronics components. £12.00 each. Ref. 12P28.

MODEMS Brand new units made by GEC they appear to be dial up, microprocessor controlled, auto answer, auto speed sensing, mains powered and cased. We do not have any data on these units so we are unable to offer any assistance with these units. £16.00 each. Ref. 16P6.

AZTEC SWITCHED MODE POWER SUPPLIES Cased power supplies with on/off switch and IEC input plug. Case size 180mm x 135mm x 65mm. 220V in, 5V at 3.75A, +12V at 1.5A, -12V at 0.4A. £12.00 each. Ref 12P30.

PERSONAL STEREO'S WITH FM RADIOS Customer returned units with stereo cassette, FM Radio and stereo headphone. £6. Ref 6P34.

## BULL ELECTRICAL

Dept. PE 250 PORTLAND ROAD, HOVE, BRIGHTON, SUSSEX BN3 5QT.

MAIL ORDER TERMS: Cash, PO or cheque with order. Please add £2.50 service charge. Monthly account orders accepted from schools and public companies. Access and B/Card orders accepted - minimum £5. Phone (0273) 203500. Fax: (0273) 20377.

1990 CATALOGUE NOW AVAILABLE. PLEASE SEND 6" x 9" SAE FOR FREE COPY!



**T**he accuracy of your soldering is of prime importance on the main pcb (it is at any time, but especially so here). Tracking runs between many of the chip pins on the board and it is essential that you check really hard that none of your solder joints allow solder to bridge between the pins and the tracks. Use a powerful close-up magnifying glass to check each and every joint.

**LCD, KEYPAD AND BOX**

Figs 11 and 12 last month showed the connections to the lcd module and the keypad. Keep the wiring between these and the pcbs neat and reasonably short. Cable ties may be used to group the wires into neat harnesses but don't put too many wires into each harness otherwise bending them to fit into the case will be tricky.

The main pcb has been designed to fit snugly into the bottom of the box, though you may need to clip off the corners of the pcb to avoid the box corners. The power saver pcb sits above the main board in the box.

In Fig. 12 last month reference is made to an

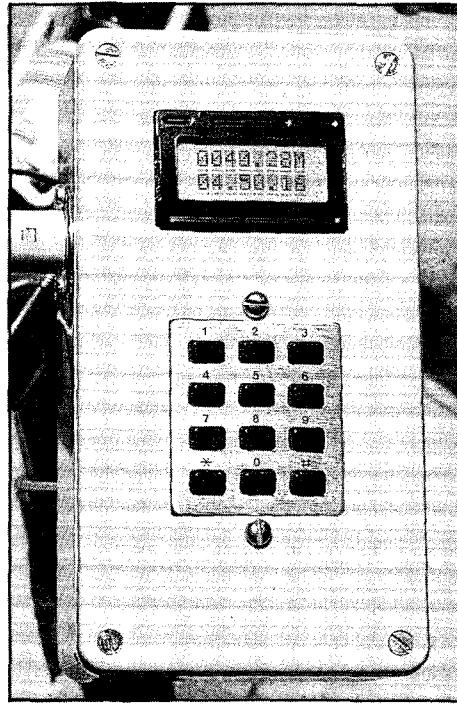

**HEX DUMP CONTINUED**

478	C4	0B	F0	0E	C0	01	D0	0F
480	A5	FF	C9	06	90	04	A5	0C
488	F0	05	A9	2E	20	63	44	60
490	00	00	00	00	00	00	00	00
498	20	00	46	86	06	A2	4E	8E
4A0	0C	20	A8	4A	4A	4A	4A	05
4A8	06	8D	01	20	A9	4C	8D	0C
4B0	20	98	29	0F	A2	4E	8E	0C
4B8	20	05	06	8D	01	20	A6	06
4C0	A9	4C	8D	0C	20	A0	00	60
4C8	00	00	00	00	00	00	00	00
4D0	00	00	00	00	00	00	00	00
4D8	00	00	00	00	00	00	00	00
4E0	00	00	00	00	00	00	00	00
4E8	A2	04	BD	50	47	95	C0	CA
4F0	D0	F8	F0	0A	A2	04	BD	58
4F8	47	95	C0	CA	D0	F8	A9	03
500	85	A0	EA	EA	EA	EA	EA	EA
508	EA	EA	A5	11	29	0F	F0	1C
510	85	A1	A9	04	85	1A	A5	1A
518	A8	B9	40	47	AA	B9	C0	00
520	A8	20	00	42	C6	1A	D0	EE
528	C6	A1	D0	E6	C6	A0	F0	1B
530	18	A2	04	18	66	10	66	11
538	CA	D0	F8	A2	04	18	26	C4

# BIKE COMPUTER

inverter. This is an additional unit that can be bought for use with the lcd module to provide backlighting of the display. Its use was covered in the LCD Module article of PE May 90. It is not necessary to use it with the Bike Computer.

**SOFTWARE**

Most of the hex code for the eprom was given last month. The remainder is shown in here. Before you key in hex lines 700 onwards you must calculate a few parameters relating to wheel size. You must also decide which security alarm code number you want to use, and as to whether you ought to change the alarm message in screen line 2. The latter first:

Hex line 7E8 holds the code which causes the lcd to show the words "ALARM ON" on screen line 1. Translate the hex numbers into decimal and will see that it is the Ascii code: hex 41 = Ascii 65 = A (as understood by the lcd). If you object to the statement for line 2 as held by hex line 7F0 (which I'll leave you to translate for yourself!) you can either invent your own 8-character message, or set the screen line blank by filling each position on hex line 7F0 with '20' (Ascii 32).

The alarm code number is held in hex line 7E0. As listed it is just '1234'. You may enter any 4-number code here using any of the numbers 1 to 7 (0, 8 and 9 are not acceptable).

Hex lines 720, 728, 750 and 758 are the ones which need changing to suit your wheel size. They hold the look-up data used by the program to work out distance factors in relation to wheel turns and time. The numbers shown in the four lines are those for a wheel diameter of 27 inches. The calculation required for other diameters is too complicated to explain here and

## Part two. In which John Becker discusses aspects of the software listing and tells you what to expect when checking out.

the Basic program overleaf should be used. If you have difficulty working out the numbers for your wheel diameter, tell me its size, enclose an sae, and I'll send you the numbers.

The program gives you the choice of entering your wheel size in inches or centimetres. It then makes the calculations and prints out on your computer screen the entire contents for each of the four lines. You then simply substitute those numbers for the ones shown in the hex listing. (The Basic program listing may need to be slightly corrected to match the dialect of your computer.)

Note that although I said in last month's introduction that the unit may be used with any wheel diameter, the largest practical diameter that can have data entered on these lines is 34.8 inches (88.4 cms). (Looking through Halford's bike catalogue the range of wheel sizes appears to be from 12.5in to 27.56in, 31.75cm to 70 cm). The bike computer could be used with larger wheel sizes, but further changes would need to be made to the program, partly relating to

540	26	C3	26	C2	26	C1	CA	D0
548	F4	F0	BF	A5	19	F0	00	A2
550	09	B5	50	95	80	CA	D0	F9
558	A9	00	85	19	60	00	00	00
560	A2	00	0E	00	20	A9	90	8D
568	01	20	8D	02	20	A9	BF	8D
570	03	20	A0	14	E8	D0	FD	C8
578	D0	FD	A9	33	20	9B	44	A2
580	00	A0	0A	E8	D0	FD	C8	D0
588	FA	20	9B	44	A2	00	E8	D0
590	FD	A9	32	20	9B	44	A9	2C
598	20	98	44	A9	06	20	98	44
5A0	A9	02	20	98	44	A9	0C	20
5A8	98	44	A9	01	20	98	44	A9
5B0	CC	8D	0E	20	A9	24	8D	04
5B8	20	A9	F4	8D	05	20	A2	00
5C0	BD	00	07	DD	E0	47	D0	07
5C8	E8	E0	04	90	F3	F0	15	A2
5D0	00	BD	E0	47	9D	00	07	E8
5D8	E0	04	90	F3	A9	00	AA	95
5E0	00	E8	D0	FB	A9	02	85	FF
5E8	20	40	46	A9	00	8D	10	07
5F0	8D	11	07	8D	12	07	4C	00
5F8	40	00	00	00	00	00	00	00
600	A8	A9	B0	8D	03	20	A9	80
608	8D	01	20	A9	4E	8D	0C	20
610	AD	01	20	29	08	D0	F9	A9
618	4C	8D	0C	20	A9	4E	8D	0C
620	20	A9	BF	8D	03	20	98	60
628	00	00	00	00	00	00	00	00
630	00	00	00	00	00	00	00	00
638	00	00	00	00	00	00	00	00
640	A6	1B	F0	1C	A2	00	A9	02
648	20	98	44	A5	FF	C9	02	F0
650	0B	C9	05	B0	07	A2	00	A9
658	18	20	98	44	A2	00	86	1B
660	60	00	00	00	00	00	00	00
668	00	00	00	00	00	00	00	00
670	A5	A8	85	10	A5	A9	85	11
678	60	A5	17	85	10	A5	18	85
680	11	60	00	00	00	00	00	00
688	00	00	00	00	00	00	00	00
690	A2	01	86	1B	D0	42	AD	00

```

698 20 29 7F C9 7F F0 05 CD
6A0 15 07 D0 07 8D 15 07 D0
6A8 ED F0 EB 8D 15 07 20 00
6B0 44 E6 FF A5 FF AE 12 07
6B8 DD 00 07 D0 17 EE 12 07
6C0 AE 12 07 E0 04 90 0D A9
6C8 00 8D 10 07 8D 01 20 A9
6D0 02 85 FF 60 A0 00 84 1B
6D8 20 40 46 8D 13 07 AD 13
6E0 07 A2 10 09 40 20 98 44
6E8 A2 FF 8E 03 20 A2 00 8E
6F0 01 20 E8 D0 FD AD 00 20
6F8 29 7F C9 7F D0 F7 F0 96
700 00 49 28 29 FD FE B8 B9
708 F7 F8 00 00 00 00 00
710 00 77 78 79 00 00 00
718 00 00 00 00 00 00 00
720 00 01 13 39 13 39 21 55
728 21 55 00 00 00 00 00
730 00 02 77 78 00 00 00
738 00 00 00 00 00 00 00
740 00 56 57 58 59 00 00
748 00 86 87 88 89 00 00
750 00 00 48 19 48 00 00
758 00 00 77 56 22 00 00
760 00 00 00 00 00 00 00
768 00 00 00 00 00 00 00
770 25 55 85 95 FA 67 B5 55
778 85 95 F4 67 47 74 00 00
780 FF FF FF FF FF 00 FF FF
788 FF FF FF 00 FF FF 00 00
790 00 40 00 40 00 40 00
798 00 40 00 40 00 40 00
7A0 44 56 5E 25 4D 20 44 56
7A8 5E 25 4B 20 52 74 20 20
7B0 4D 4D 4D 4D 20 20 4B 4B
7B8 4B 4B 20 20 76 20 00 00
7C0 00 00 00 00 00 00 00
7C8 00 00 00 00 00 00 00
7D0 00 00 00 00 00 00 00
7D8 00 00 00 00 00 00 00
7E0 01 02 03 04 00 00 00
7E8 41 4C 41 52 4D 20 4F 4E
7F0 50 49 53 53 20 4F 46 46
7F8 00 00 60 45 00 00 60 45

```

decimal point position controlling factors. I regret that neither I nor PE can offer advice on that.

If you are using an eeprom to store the hex code, once you have established that the program is working you might prefer to entirely reprogram it in order to set the master stores for miles and kilometres back to zero. It's not necessary to do so: just remember that the first few miles/kms on the 'clock' were experimental!

## POWER SUPPLY

Strictly speaking the unit requires a 5V power supply. This can be supplied from a 9V battery via a 7805 5V regulator ic. There is a drawback with using this method in that the 7805 itself consumes battery power, probably as much as 10mA. If you feel that this extra drain is too much, shortening the battery's useful life, you could instead power the unit from a 6V battery without a regulator ic. You must ensure, though, that 6V is not exceeded.

My own unit is powered by a small 6V 1 amp/hour dryfit battery (approx 2 x 1.6 x 2 inches) but I have inserted a 1N4001 diode in series with the positive line to drop the voltage

```

100 REM WHEEL - BIKE COMPUTER FACTORS CALCULATION
110 PRINT:PRINT"1 WHEEL DIAMETER IN INCHES (MAX 34.8)
120 PRINT:PRINT"2 WHEEL DIAMETER IN CMS (MAX 88.4)
130 PRINT:INPUT"WHICH MEASUREMENT TYPE";W$:W=VAL(W$):IFW<1ANDW<2THEN130
140 PRINT:INPUT"DIAMETER";D(W):IFW=1THEND(2)=D(1)*2.54:GOTO160
150 D(1)=D(2)/2.54
160 P=3.14159265:M(1)=63360:M(2)=1000:REM π, INCHES/MILE, CM/KM
170 J(1)=10000:J(2)=100:K(1)=1000:K(2)=10:REM INTEGER CORRECTION FACTORS
180 FORA=1TO2
190 C=D(A)*P:REM WHEEL CIRCUMFERENCE
200 R=M(A)/C:REM REVS PER MILE/KM
210 F=1000/R:REM PARTS PER THOUSAND
220 H=F*3600:REM HOURS CONVERSION
240 F=INT((F*J(A)+5)/10):H=INT((H*K(A)+5)/10):REM INTEGER CORRECTIONS
260 F$=STR$(F):IFLEFT$(F$,1)=" "THENF$=MID$(F$,2)
270 F$=RIGHT$("0000"+F$,4)
280 F(A)=LEFT$(F$,2)+" "+MID$(F$,3,2)+" "
290 H$=STR$(H):IFLEFT$(H$,1)=" "THENH$=MID$(H$,2)
300 H$=RIGHT$("000000"+H$,6)
310 H(A)=LEFT$(H$,2)+" "+MID$(H$,3,2)+" "+MID$(H$,5,2)+" "
320 NEXTA :PRINT:PRINT"DIAMETER = "D(1)"INCHES "D(2)"CMS"
330 PRINT"HEX LINE 730 = 00 01 "+F$(1)+F$(1)+F$(2)
340 PRINT"HEX LINE 738 = "+F$(2)+"00 00 00 00 00 00"
350 PRINT"HEX LINE 750 = 00 00 "+H$(1)+"00 00 00
360 PRINT"HEX LINE 758 = 00 00 "+H$(2)+"00 00 00"

```

## Program for calculating different wheel size factors.

by about 0.7V, thus keeping the voltage below 6V. The battery is kept in the saddlebag in a small protective plastic box.

## CHECKING OUT

Before you put everything into the box and mount it on the bike, check out its operation. Providing the eeprom is correctly programmed and your soldering is satisfactory, the unit should work first time. If it doesn't, recheck your work. It is highly unlikely that the components will be at fault if you have bought them from a good supplier.

For checking, it is best if you power the unit from a stabilised 5V power supply rather than from a battery.

At switch on, the processor goes through a brief routine setting up parameters for the lcd module. You will probably see the screen first display a dark band at the top, then clear, followed by a series of digits appearing across both lines. (You may need to adjust the brilliance control VR1 before you can see anything on the screen). At this moment the unit is in Mode 3 with line 1 showing total miles travelled and line 2 showing elapsed hours, minutes and seconds. Line 1 should read 0000.00M ('M' indicating Miles) and Line 2 should first read 00.00.00 but then be seen to increment at one second intervals.

Press key 6 on the keypad. Now in Mode 6, line 2 should show the same time, and line 1 should now read 0000.00K ('K' indicating Kilometres).

Key 1 puts the screen into distance and speed mode for miles, line 1 reading 000.00DM (Distance, Miles), and line 2 reading 000.00VM (Velocity, Miles). Key 4 switches over to distance and speed in kilometres, at this time reading 000.00DK and 000.00VK. Keys 2 and 5 put the unit into peak and average speed modes for miles and kilometres respectively. You should see 000.00^M and 000.00%M in mode 2 and 000.00^K and 000.00%K in mode 5. The ^ symbol indicates peak, and % indicates average.

Key 7 brings up the display showing the total revolutions that the wheel has turned and the elapsed time as decimal hours, both since last

being reset. Line 1 should read 000000Rv (Rv meaning Revs). The numbers in line 2 will depend on the elapsed time since you switched on but could at this moment probably show 0000.01t (t indicating decimal hours mode). In this mode, the decimal places show the minutes and seconds as a decimal of one hour, for example 30 minutes will be shown as 0000.50t.

Now monitor pin 6 of the opamp IC9 with a voltmeter and set VR2 midway. Move the magnet closely past the sensor chip and note that the voltage reading changes as the magnet passes it. The change will vary in amplitude depending on which face of the magnet is towards the top of the sensor. Mark this face and when finally mounting the magnet and sensor on the bike make sure that this surface and the top of the sensor ic face each other. Now monitor IC6c pin 3 and adjust VR2 until the meter shows the output changing fully between 0V and 5V as the magnet passes. It does not matter whether the output is high or low in the absence of the magnet, as long as the opposite state occurs when the magnet is closest. When the unit is mounted on the bike, VR2 should be adjusted so that the logic change occurs reliably when the wheel rotates.

Having established that the sensor is functioning, look at the screen, still in Mode 7. The figures in line 1 should have incremented by one each time the sensor was triggered. Move the magnet past the sensor and watch the count changing.

Next check out the reset function. To minimise the risk of accidental resetting, two keys need to be pressed simultaneously, keys 1 and 7. Pressing them resets all measurements back to zero except for the total miles/kilometres since the unit was first put into service.

## NEXT MONTH

In part three there will be a bit more on testing, and I'll look at the alarm and mounting options. I'll also briefly examine how the unit can be used as a general-purpose microcontroller.

PE



# GEM TECH

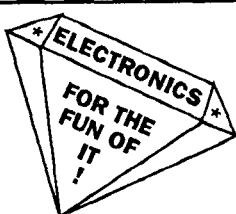

## DIY KIT MODULES

All with pcbs and step by step instructions

SCOPE TRACE DOUBLER	£12.50
DIGITAL SIGNAL GEN	£16.95
AUDIO SIGNAL GEN	£17.50
ROBOT VOX MODULE	£19.50
MULTIPLE SIRENS	£16.95
TIME SWITCH	£10.95
ENTRY ALARM CONTROLLER	£15.95
FROST ALARM	£10.80
CAR ALARM	£19.95
GEIGER COUNTER	£58.30
3-CHAN SOUND-TO-LIGHT CONTROL	£37.95
3-CHANNEL LIGHT SEQUENCER	£32.95

**ALL PRICES INCLUDE VAT. P&P ONLY £1.00 PER ITEM**

## MORE KITS IN FREE CATALOGUE

PLUS TOOLS, BOOKS, PCB MAKING EQUIPMENT, TEST GEAR AND MORE DETAILS

## SPECIAL TOOL KIT OFFER

One each of: mains soldering iron, soldering iron stand, solder pack, solda-mop, side cutters, snipe head pliers, neon screwdriver, modelling screwdrivers set of 6, wire stripper

LIST PRICE £20.97  
SPECIAL OFFER  
**ONLY £17.80**

## GEM-TECH

DEPT PE11, UNIT J,  
8 FINUCANE DRIVE,  
ORPINGTON, KENT, BR5 4ED.  
24-HR ANSAPHONE  
TEL 0689 37821

# Electroparts

TV, Video · Electronic Spares · Import & Export

342 Pinner Road, North Harrow  
Middlesex HA14 LB

Tel: 081-472 5778 / 081-861 4286 · Fax: 081-861 4271

Super Service  
Competitive Prices  
Speedy Delivery

Credit Card  
Orders Welcome



Integrated circuits

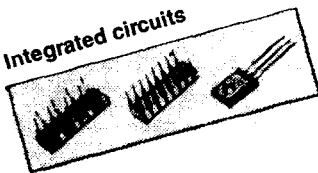

Transistors

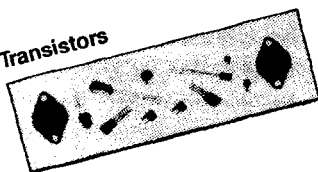

Crystals

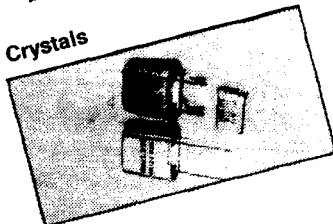

Valves

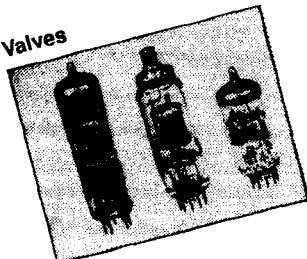

Varicap tuners

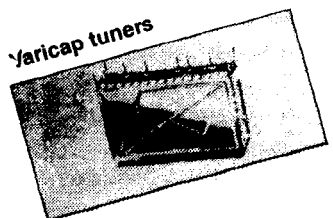

For  
Quality Components  
&  
Fast Service

Please phone or write for catalogue. Enclosing 30p A4 SAE.



Whether your requirement for surveillance equipment is amateur, professional or you are just fascinated by this unique area of electronics SUMA DESIGNS has a kit to fit the bill. We have been designing electronic surveillance equipment for over 12 years and you can be sure that all of our kits are very well tried, tested and proven and come complete with full instructions, circuit diagrams, assembly details and all high quality components including fibreglass PCB. Unless otherwise stated all transmitters are tuneable and can be received on an ordinary VHF FM radio.

UTX Ultra-miniature Room Transmitter. Smallest room transmitter kit in the world! Incredible 10mm x 20mm including mic. 3-12V operation. 500m range.....£14.95

MTX Micro-miniature Room Transmitter. Best-selling micro-miniature room transmitter. Just 17mm x 17mm including mic. 3-12V operation. 1000m range.....£12.95

STX High Performance Room Transmitter. High performance transmitter with a buffered output stage for greater stability and range. 22mm x 22mm including mic. 6-12V operation. 1500m range.....£15.95

VT500 High-Power Room Transmitter. Powerful 250mW output providing excellent range and performance. Size 20mm x 40mm. 9-12V operation. 3000m range.....£15.95

VXT Voice Activated Room Transmitter. Triggers only when sounds are detected. Very low standby current, variable sensitivity and delay with led indicator. Size 20mm x 67mm, 9V operation, 1000m range.....£18.95

QTX180 Crystal Controlled Room Transmitter. Narrow band FM transmitter for the ultimate in privacy. Operates on 180 MHz and requires the use of a scanner receiver or our QRX180 kit (see catalogue). Size 20mm x 67mm. 9V operation. 100m range.....£39.95

SCRX Subcarrier Scrambled Room Transmitter. Scrambled output from this transmitter cannot be monitored without the SCDM decoder connected to receiver. Size 20mm x 67mm, 9V operation, 1000m range.....£21.95

SCDM Subcarrier Decoder Unit for SCRX. Connects to receiver earphone socket and provides decoded audio output to headphones. Size 32mm x 70mm. 9-12V operation.....£21.95

HVX400 Mains Powered Room Transmitter. Connects directly to 240V AC supply for long term monitoring. Size 30mm x 35mm. 500m range.....£18.95

ATR2 Micro Size Telephone Recording Interface. Connects between telephone line (anywhere) and cassette recorder. Switches tape automatically as phone is used. All conversations recorded. Size 16mm x 32mm. Powered from line.....£12.95

UTLX Ultra-Miniature Telephone Transmitter. Smallest telephone transmitter kit available. Incredible size of 10mm x 20mm! Connects to line (anywhere) and switches on and off with phone use. All conversation transmitted. Powered from line. 500m range.....£14.95

TLX700 Micro-Miniature Telephone Transmitter. Best-selling telephone transmitter. Being 20mm x 20mm it is easier to assemble than UTLX. Connects to line (anywhere) and switches on and off with phone use. All conversations transmitted. Powered from line. 1000m range.....£12.95

STLX High-Performance Telephone Transmitter. High power transmitter with buffered output stage providing excellent stability and performance. Connects to line (anywhere) and switches on and off with phone use. All conversations transmitted. Powered from line. 1500m range.....£15.95

TKX900 Signalling/Tracking Transmitter. Transmits a continuous stream of audio pulses with variable tone and rate. Ideal for signalling or tracking purposes. High power output giving range up to 3000m. Size 25mm x 63mm. 9V operation.....£21.95

CD600 Professional Bug Detector/Locator. Multicolour readout of signal strength with variable rate bleeper and variable sensitivity used to detect and locate hidden transmitters. Switch to AUDIO CONFIRM mode to distinguish between localised bug transmission and normal legitimate signals such as pagers, cellular, taxis etc. Size 70mm x 100mm. 9V operation.....£49.95

### ★★★ SPECIAL ★★★

DLTX/DLRX Radio Control Switch. Remote control anything around your home or garden, outside lights, alarms, paging system etc. System consists of a small VHF transmitter with digital encoder and receiver unit with decoder and relay output, momentary or alternate, 8-way dil switches on both boards set your unique security code. TX size 45mm x 45mm, RX size 35mm x 90mm. Both 9V operation. Range up to 200m. Complete System (2 kits).....£49.95  
Individual Transmitter DLTX.....£18.95  
Individual Receiver DLRX.....£36.95

A build-up service is available on all our kits if required.

UK customers please send cheques, POs or registered cash. Please add £1.50 per order for P&P. Goods despatched ASAP allowing for cheque clearance. Overseas customers send sterling bank draft and add £5.00 per order for shipment. Credit card orders welcomed on 0827 714476.

OUR LATEST CATALOGUE CONTAINING MANY MORE NEW SURVEILLANCE KITS NOW AVAILABLE. SEND TWO 20P STAMPS OR OVERSEAS SEND TWO IRC'S.

## SUMA DESIGNS

The Workshops  
95 Main Road, Baxterley,  
Nr. Atherstone, Warwickshire CV9 2LE



Tel: 0827 714476

**T**he simple electronic enclosure has come a long way in the past few years. New materials, new designs, new codes of protection have all been introduced to cater for the needs of the professional electronic engineer. The advantages are clear. Enclosure technology today is an increasingly sophisticated science. But with the host of choices and specifications available, how does the amateur electronics enthusiast choose the right product for his needs?

## EXPANDING MARKET

As more and more industries enter the electronics era, the enclosure market is expanding. Today's product is being used in a host of new applications and new environments. The medical field is just one example. The environmental monitoring industry is another.

The result of this expanding marketplace is an increasing versatility in the design of enclosures. They now have to be highly adaptable - a property which has to be an

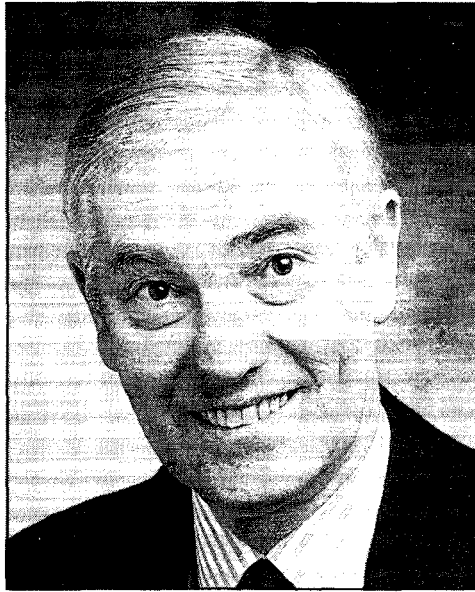

**Desmond Harvey is the Managing Director of Bopla UK Ltd, the UK subsidiary of one of Europe's largest enclosure manufacturers.**

today's product. Styled in high impact polystyrene, it signals the move away from traditional metal and is at once stronger and more attractive.

The light grey enclosure is highly adaptable to many applications. It can be used free standing or wall-mounted and it makes a comfortable enclosure for hand-held instruments. Moulded in two halves, the case is screwed together from below and is just the right size for a standard Eurocard. Moulded bosses in the base will also take a pcb or chassis and if required a suitably-sized pcb can be sandwiched firmly between the two case halves with no screws needed.

Cases are available with moulded-in ventilation louvres in the top and base, or with a neoprene O-ring seal providing protection to IP54. A further option is the provision of removable end panels in aluminium or plastic for extra flexibility.

There have been many extensions to the standard design for small instrument cases. Element from Bopla is typical. It is made from two interlocking sections with the advantage that when the upper section is removed

# A CASE FOR TECHNOLOGY

advantage to any amateur without the funds, the time, or the required numbers to order custom-built designs to suit his needs.

The demise of the well established general purpose housings - known generically as the 'Verobox', but manufactured by many companies - is a reflection of this need. Today there are a host of alternatives to the small electronics enclosure which dominated the market for so long.

The Elegant case from Bopla is one such alternative which typifies the properties of

**Desmond Harvey looks at the current state of enclosure technology, discussing the options available and examining the criteria for making the right choice.**

components can be installed quickly and conveniently into the lower section. Again the cases are moulded in high impact polystyrene, and come in a choice of sizes and colours. Various accessories add to the versatility of the case, ranging from wall mounting metal brackets, to handles to either carry the case or support it at an angle. Dual purpose plastic clips provide an instant snap-on lid.

## DESK TOPS

Moving on to look at larger, desk top enclosures, here there has been a similar revolution with the emergence of many new modular designs. These are generally based on a few basic parts which can be made up into many different case combinations to suit individual needs. The result is an off-the-shelf enclosure which can be tailor-made to suit your needs.

Bopla's Combi-Card is one example which comprises four main components; a front section, one or more centre sections, a rear section and a set of tie bars to connect all the pieces. These can be assembled into literally thousands of case combinations to suit a variety of needs with no tooling at all. Among the variations are rear sections incorporating terminal housing compartments for such things as connectors.

Matching tongue and grooves with a neoprene gasket on each section ensure the IP65 seal is maintained for all enclosure combinations.

**Left, the Elegant range of enclosures.**

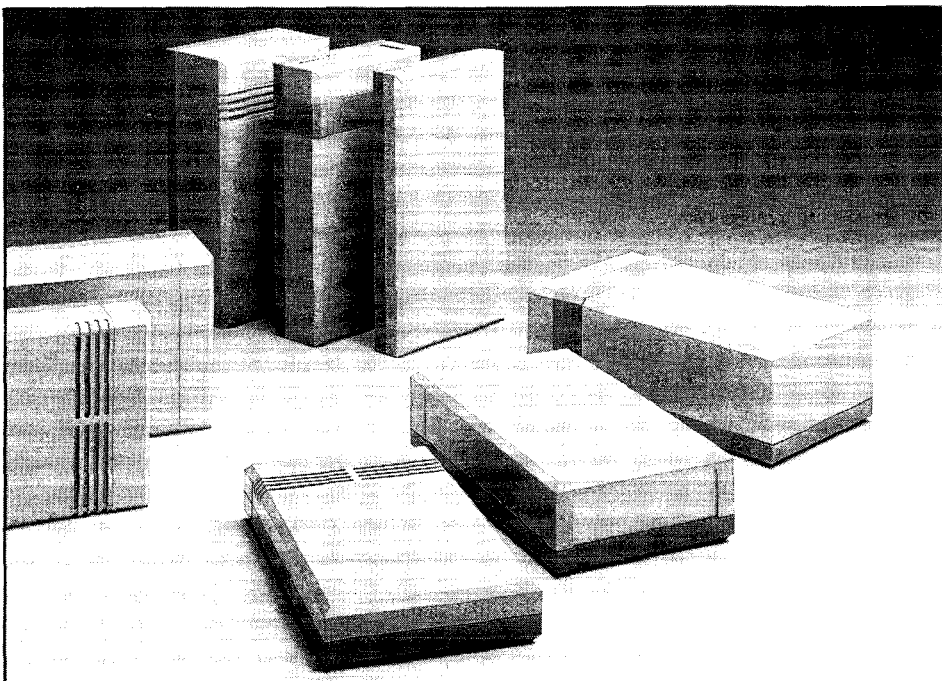

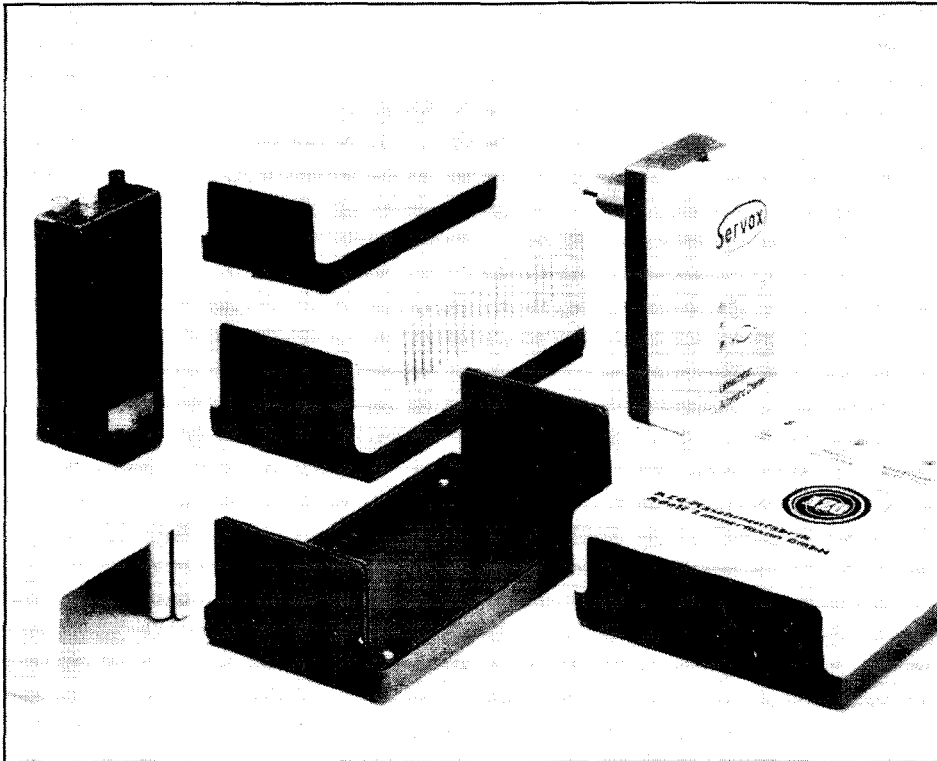

The Element range offers ideal enclosures for small instruments and electronic components.

Accessories such as carrying handles, card frame components and wall mounting brackets increase the flexibility of the product and make it suitable for a whole range of applications.

Look out for these enclosures and seek the advice of your enclosure supplier in the early stages of designing your product if possible. In many instances he will be able to point you to the right enclosure which can be adapted to your proposed design. It can save a lot of time and energy seeking out the enclosure which is right for your needs after you have designed your product.

Today's enclosures are certainly becoming increasingly 'user friendly' in their design. Take card frames and card guides for example. It used to be almost impossible to remove card guides from within their frame without damaging the guide and making it unusable.

New products on the marketplace are equipped with guides which can be easily snapped from the narrowest of spaces without any damage at all.

## PROTECTION

So much for the design and construction of the enclosure. What about the degrees of protection which today's products afford? This is after all their main function.

Many of today's enclosures are made of plastic. How has this developed over the years and how effective is it in protecting the product against physical impact?

The answer is it can be very effective. With the demise of metal enclosures has come the rapid development of new plastics to meet as many parameters as possible. The aforementioned high impact polystyrene is one example.

Within the range of plastics there are many

qualities: low cost, light weight, strength, colour, clarity and ease of cleaning. Not all the virtues will be found in one type, but increasing technology is enabling the development of multi-property plastics. Demand for lightweight resilience, for example, has seen the development of new plastic to take greater pressure. Polytan is a recent illustration. This blend of polystyrene and ABS combines high strength and durability with good flow characteristics.

New flame retardant materials have been developed to meet the demands of applications in hazardous environments. Do beware though, flame retardant material is usually non-standard so minimum quantities are still required in this material.

Materials have been designed to withstand ultraviolet light, oil, acid and alkali - although it is worth remembering that a plastic which stands up to oil may not stand up to alkali.

## DRAWBACKS

Plastic can have its drawbacks of course. The problem of RFI and EMI interference is one example. It is a subject which warrants an entirely separate feature. All I would say here is that if you anticipate problems of interference there are cost-effective methods of screening against it.

If you are working on very large racks and cabinets, cost can be reduced by screening only certain components.

This is a growing trend. The problematic circuit board for example can be isolated from its surroundings by using a screened module. This relatively inexpensive method isolates the transmissions from the board.

A series of circuit boards can be enclosed in desk-mounted cases which can then be screened. And a series of card frames can be housed in a

fully screened enclosure.

These can be treated using a number of materials. For maximum attenuation you must know the frequency level which your equipment emits. You also need to know how much heat is being produced because when ventilation is introduced into the cabinet, its screening performance will be impaired and a higher specification level may be needed.

Different results can obviously be obtained by using different metals. Electroless nickel deposits are the economic alternative for smaller quantities. Your enclosure manufacturer should, however, be able to guide you around many of the problems in achieving correct and cost-effective enclosures.

## DUST AND MOISTURE

From protection against RFI, to protection against dust and moisture: if you are installing your enclosure in dusty, corrosive and wet atmospheres you need to be sure that you achieve the correct level of sealing.

The IP (or International Protection) Codes give basic guidelines as to what sealing a particular enclosure affords. Many of today's smaller enclosures are sealed to IP44 and can be upgraded to IP65. But what exactly does this mean? A brief description follows, but for a more detailed definition, see sections three and four of BS5490:1977.

The first digit covers protection against penetration from the entire spectrum of solid objects - from tiny specks of dust to hands and tools. At the lowest of seven levels (0) no protection is offered, either of the equipment itself from damage by intrusion or of a person contacting live or moving parts. At the highest level (6) there should be no entry of dust. Level 5 permits limited ingress of dust (no harmful deposit).

The same applies to the second digit which covers the degree of protection against the entry of water. Again limited ingress is permitted as long as it is not harmful. Protection is gauged on a progressive scale 0 to 8. For example, number 1 indicates that dripping water should have no harmful effect and number 8 that the equipment is suitable for submersion in water. Level 6 seals against low pressure hoses from any angles, but will permit limited ingress as long as it is not harmful.

It is important to note here that higher ratings do not necessarily mean greater suitability. For example IP55 or IP65 are not a universal answer for outdoor applications. Here sharp drops in temperature can cause condensation to form within an unventilated case. This may in time short-circuit the components within it. So, while the introduction of a ventilator and a drain plug may reduce the rating, it would be a far superior choice for outside use.

## MINIATURISATION

Then there is increasing change in electronic design which is having its effect. Component miniaturisation is one prominent example.

Today's electronic components are constantly decreasing in size. This means that it is possible to

The IP Scale	2nd numeral: Degree of protection with respect to harmful ingress of water								
	0	1	2	3	4	5	6	7	8
1st numeral: Degree of protection with respect to persons and solid objects	Non protected	Protected against dripping water	Protected against dripping water of +/- 15° angle	Protected against spraying water of +/- 60° angle	Protected against splashing water	Protected against water jets	Protected against heavy seas	Protected against immersion	Protected against submersion
Non protected 0	IP00	IP01	IP02						
Protected against solid objects greater than ø50mm 1	IP10	IP11	IP12	IP13					
Protected against solid objects greater than ø12mm 2	IP20	IP21	IP22	IP23					
Protected against solid objects greater than ø2.5mm 3	IP30	IP31	IP32	IP33	IP34				
Protected against solid objects greater than ø1.0mm 4	IP40	IP41	IP42	IP43	IP44	IP45	IP46		
Dust protected Depression 200mm water column Max air flow 80x volume of encl. 5					IP54	IP55	IP56		
Dust tight Same test procedure 6						IP65	IP66	IP67	IP68

pack more parts within the housing. The enclosure must be well ventilated to dissipate any heat generated by this increased volume of equipment. Again, while ventilation may lower the IP rating, experts would argue that it is a far superior choice.

There can be many factors which need to be considered when choosing the right enclosure for your job. But it doesn't have to be that complicated. Today's enclosures are designed to offer tailor made solutions to any individual need. For the amateur electronics constructor this offers obvious advantages. Make sure, however, that when you choose your enclosure you ask yourself these simple questions:

- Where will it be situated?
- Will it be subject to physical impact?
- What about dust and moisture?
- Does it need ventilating?

Will it be subject to RFI, EMI interference?

Finally, always approach your enclosure supplier for his advice. With the right advice and information you should be able to choose a product from the vast range which is now available and which is ideal for your application.

Tel: 0908 221166.

#### RFI SCREENING

ERA TECHNOLOGY LTD, Cleeve Road, Leatherhead, Surrey, KT22 7SA. Tel: 0372 374151.

### INFORMATION

Bopla Ltd, 29 Faraday Road, Aylesbury, Bucks, HP19 3RY. Tel: 0296 399999.

#### PLASTICS

Valerie James, THE BRITISH PLASTICS FEDERATION, 5 Belgrave Square, London, SW1X 8PD. Tel: 071-235 9483.

#### IP CODES

BSI, Linford Wood, Milton Keynes, MK14 6LE.

### INFORMATION ON ENCLOSURE SUPPLIERS

Alan Jackson, GAMBICA, The Association for the Instrumentation, Control and Automation Industry in the UK, Leicester House, 8 Leicester Street, London, WC2 H7BN. Tel: 071-437 0678.

Extracts from BS 5490 : 1977 (1985) are reproduced with the permission of BSI. Complete copies of the BS can be obtained by post from BSI Sales, Linford Wood, Milton Keynes, MK14 6LE. Tel: 0908 220022.

PE

# TUTORKIT MICROELECTRONICS TUTORS

Logic Tutors  
OP Amp Tutors  
I.C. Patchboards  
GCSE Units  
Computer Interfaces

Prices from

£30.00  
PLUS VAT

Including instruction manual and patch leads

\*used by hundreds of schools in U.K. and overseas.

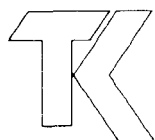
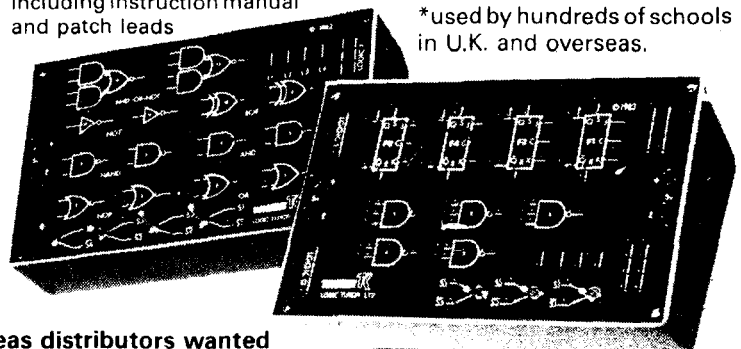

**TUTORKIT PRODUCTS**  
(Div of Limrose Electronics Ltd)  
Llay Industrial Estate  
Wrexham, Clwyd, U.K.  
LL12 0TU. Tel 0978 852285

Overseas distributors wanted



This article describes the construction and operation of an adaptor to program the internal eeprom of 8748/8749 series microcontrollers. The adaptor is designed to be used in conjunction with the Eeprom Poly-Programmer Project published in PE May and June 90.

**MICROCONTROLLER CHIPS**

Microcontroller chips are complete microprocessor systems, consisting of ram (random access memory), rom (read only memory), cpu (central processing unit) and i/o (input and output ports) all contained in one integrated circuit. In order to use a microcontroller for a particular project application the internal rom must be programmed with software instructions (an operating program), specific to the task required from the microcontroller.

The 8748/8749 microcontroller's internal rom is of the eeprom type (erasable

**Kevin Browne  
shows you how to  
program an 8748  
with an 8748 (plus  
the Eeprom Poly-  
Programmer!)**

**ADAPTOR OPERATION**

A complete circuit diagram of the programming adaptor is shown in Fig. 3.

The microcontroller to be programmed is plugged into socket SK1 on the adaptor pcb. The adaptor is then plugged into the eeprom socket of the poly-programmer unit. The 5V

taken from the auxiliary outputs of the Programmer (SK103).

To program an 8748/8749, three high voltage control signals are required. The programming voltage supply 'vdd' is taken directly from the programmer's 'V1' supply. D2 is required to maintain this input at 5 volts during address and data input, and during the verification sequence. The programming mode enable signal 'EA' is an 18 volt supply, again taken directly from the programmer, this time however, the 'V2' supply. This 18 volt supply is also used via the switching arrangement of transistors TR2 and TR3 to provide a 'PROG' pulse. The control of this pulse is taken from the 'PP' output of the programmer.

**CONSTRUCTION**

The programming adaptor consists of two pcbs. The upper pcb holds the majority of the components, and assembly is straightforward.

**8748 PROGRAMMING  
ADAPTOR**

programmable rom). It is programmed by applying a 21 volt pulse to fuse the data into the rom, in a similar way to standard eeprom chips. Erasure of the stored data is achieved by exposing the chip to ultra-violet light for approximately 20 minutes. Fig. 1 shows the pin-outs, and Fig. 2 shows the procedure for programming the internal rom of an 8748/8749 microcontroller.

supply to operate the microcontroller is taken from the same unit.

A 3.14 MHz crystal provides the clock frequency for the operation of the cpu. It is essential that the internal clock of the microcontroller is operating before programming is attempted otherwise the microcontroller will be irreparably damaged. To provide a visual check that the internal clock is operating the 'ALE' signal from pin 11 is used, via C1 and TR1 to light LED 1.

The address and data lines for the microcontroller are taken direct from the Programmer's socket address and data lines. The two control lines 'TO' and 'RESET' are

The lower pcb holds only the 28 way dil header, PL104. This plug should be carefully soldered to the copper side of the pcb. Next, the two pcbs should be wired together as stated below. Using a short length of ribbon cable the two auxiliary control leads C0 and C1 should be wired to the 16-way dil header PL103. Finally, after a careful check of both pcbs for stray solder splashes, the two boards can be fastened together using four 6BA nuts and bolts, with 0.25 inch spacers between the two pcbs. (Fig. 8).

R6 should be soldered to the back of the pcb between TR2 collector and +5V tracks.

**TESTING**

Before attempting to program a microcontroller it is advisable to check as far as possible the operation of the programming adaptor. To do this, insert the adaptor into the programmer's eeprom socket, connect plug PL103 to programmer socket SK103 and insert two 16-pin dil headers in the sockets SK101 and SK102 correctly strapped as shown in Fig.6. Adjust the programmer's voltage supplies V1 and V2 to 21V and 18V respectively. Next, the Basic program, or an adaption of it, should be run. Stop the program after each step and check the correct conditions are present on the microcontroller socket (SK1).

**OPERATION AND USE**

The adaptor is designed to program both the 8748 (1024 byte eeprom) microcontroller, and the larger 8749 (2048 byte) version. Care must

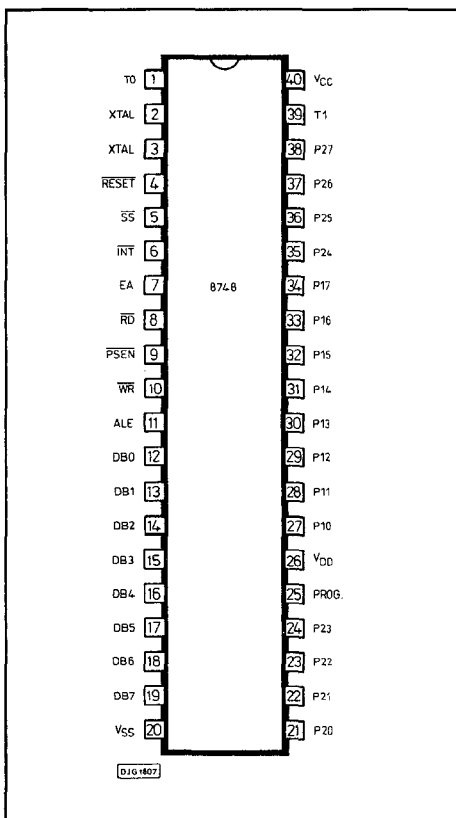

Fig. 1 (Left). 8748/8749 Micro-controller pin-outs.

Fig. 2 (below). 8748/8749 program and verify sequence.

1. Initial conditions required VDD=5V, Clock input (3-4MHz), RESET=0V, TO=5V, EA=5V
2. TO=0V – select programming mode.
3. EA=18V – activate programming mode.
4. Address applied to BUS and P20-P22
5. RESET=5V – latch address.
6. Data applied to BUS.
7. VDD=21V – programming power.
8. PROG=18V – 50ms programming pulse.
9. VDD=5V
10. TO=5V – select verify mode.
11. Read data on BUS and verify.
12. TO=0V
13. RESET=0V
14. Repeat from step 4 until finished.
15. EA=5V – de-activate programming mode.

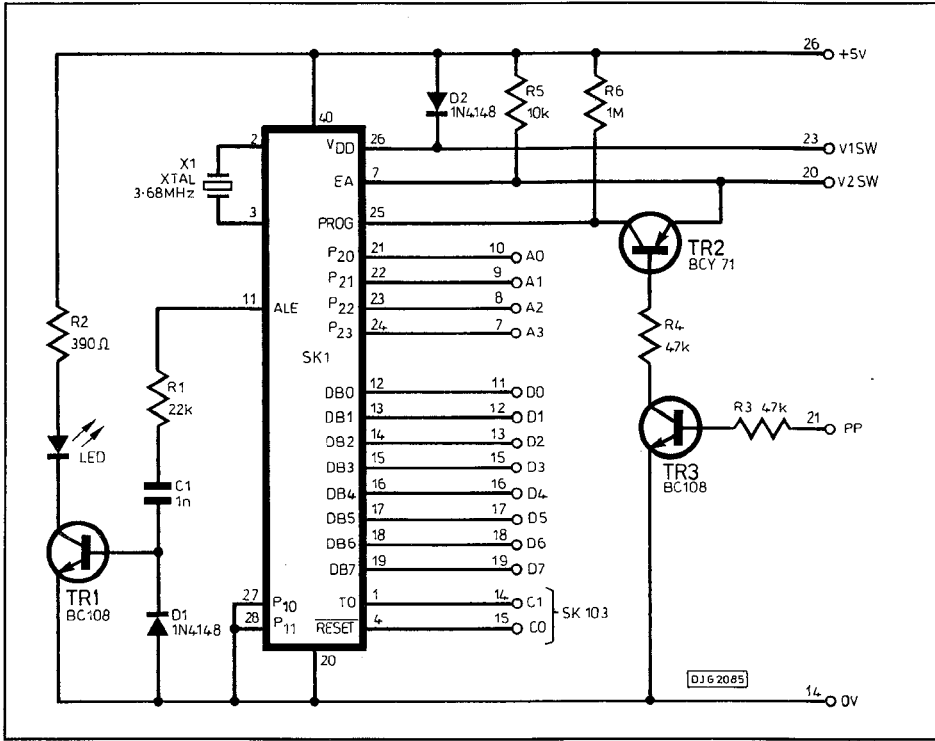

Fig. 3. Circuit diagram of the programming adaptor.

be taken to insert the microcontrollers correctly, and to check that the green 'ALE' led is lit before, during and after programming.

### WIRING DETAILS

PL104 Use  
pin

- 7 Hi address bit P23
- 8 Hi address bit P22
- 9 Hi address bit P21
- 10 Hi address bit P20
- 11 Data/lo address bit 0
- 12 Data/lo address bit 1
- 13 Data/lo address bit 2
- 14 0 volt supply
- 15 Data/lo address bit 3
- 16 Data/lo address bit 4
- 17 Data/lo address bit 5
- 18 Data/lo address bit 6
- 19 Data/lo address bit 7
- 20 18V EA/PROG supply.
- 21 5V PP program pulse.
- 23 21V VDD supply.
- 26 5 volt supply.

PL103  
pin  
14 C1 aux control 'TO' lead  
15 C0 aux control 'RESET' lead

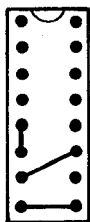

PL 101

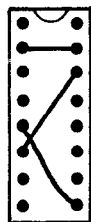

PL 102

DJG 2087

### BASIC PROGRAM

```
10 REM 8748 programming
20 LET prog = 50000 : LET error = 0
```

```
100 CLS
120 PRINT "8748 Programming"
130 INPUT "8748 Start Address ? ";adr
140 INPUT "No of bytes ? ";byte
150 LET byte = byte - 1
```

```
200 REM format RS232 I/F
210 FORMAT "b", 1200
```

```
220 OPEN #4;"b"
```

```
500 REM main program
510 PRINT #4;"c" : PRINT #4;"k02"
520 INPUT "Is 'ALE' LED lit (Y/N) ?";q$
530 IF q$ <> "y" THEN STOP
540 PRINT #4;"k00" : PRINT #4;"T"
```

```
600 REM program loop
610 FOR x = 0 TO byte
620 LET adrhi = INT (aqr/256)
630 LET adrlo = adr - (256 *adrhi)
640 PRINT #4;"e"
650 PRINT #4;"i";CHR$ (adrhi) : PRINT #4;"j";CHR$ (adrlo)
660 PRINT #4;"k01"
670 PRINT #4;"j";CHR$ (PEEK (PROG+x))
680 PRINT #4;"h20" : PRINT #4;"P32" : PRINT #4;"h00"
690 PRINT #4;"d" : PRINT #4;"k03"
700 PRINT #4;"J" : INPUT #4;a$
710 GOSUB 2000
720 IF data <> PEEK (prog+x) THEN LET error = error + 1
730 LET adr = adr + 1
740 PRINT #4;"k01" : PRINT #4;"k00"
750 NEXT x
800 REM programming finished
```

```
810 Print #4;"R" : Print #4;"k02"
820 PRINT "Program Finished",,,,
830 PRINT error;"ERRORS"
840 CLOSE #4
850 STOP
```

```
2000 REM hex to dec conversion
2010 LET d$ = "0123456789ABCDEF" : LET data = 0
2020 FOR y = 1 TO 2
2030 FOR z = 1 TO 16
```

Fig. 4. (centre) PCB layout details for the adaptor circuit.

Fig. 5 (right) PCB layout for the 28-pin DIL header PL104.

Fig. 6. (left) DIL header wiring for the main poly-programmer.

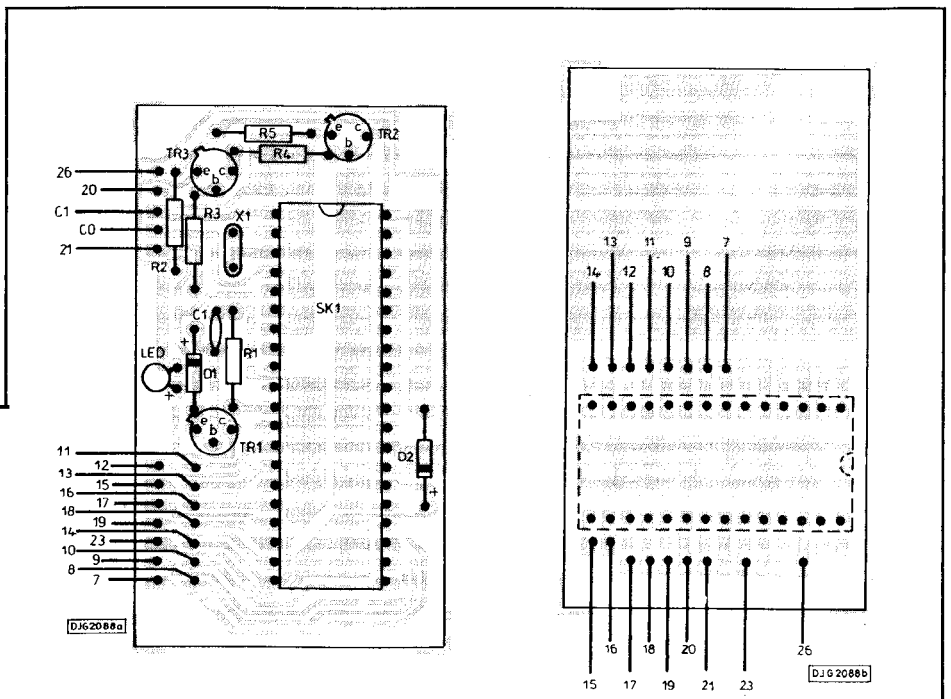



```
2040 IF a$(y) <> d$(z) THEN NEXT z
2050 LET data = 16*data + (z-1)
2060 NEXT y
2070 RETURN
```

NB. The Basic program was written for a Sinclair Spectrum 48K

C/R is automatically sent by Spectrum software at the end of a 'PRINT' statement.

'prog' is the address in Spectrum ram where data destined for the 8748 eprom is stored.

COMPONENTS	
<b>RESISTORS</b>	
R1	22k
R2	390Ω
R3,R4	47k (2 off)
R5	10k
R6	1M
<b>SEMICONDUCTORS</b>	
D1,D2	1N914 or 1N4148 (2 off)
TR1,TR3	BC108 (2 off)
TR2	BCY71
LED1	GREEN 5mm
<b>CAPACITORS</b>	
C1	1N Ceramic
<b>MISCELLANEOUS</b>	
XTAL1	3.68MHz,
SK1	40 pin zif,
PL101-PL103	16 pin dil header (3 off)
PL104	28 pin dil header
6BA nut/ bolts	(4 off)
0.25 inch spacers	(4 off)
printed circuit boards	

Fig. 7. PCB foil patterns

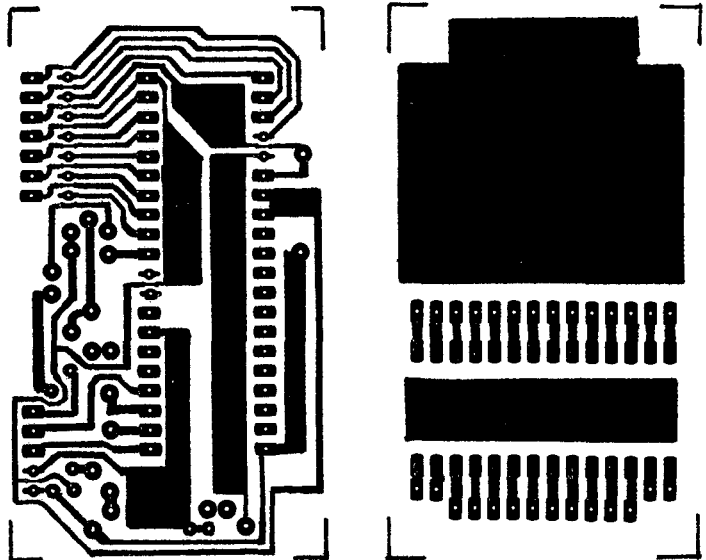
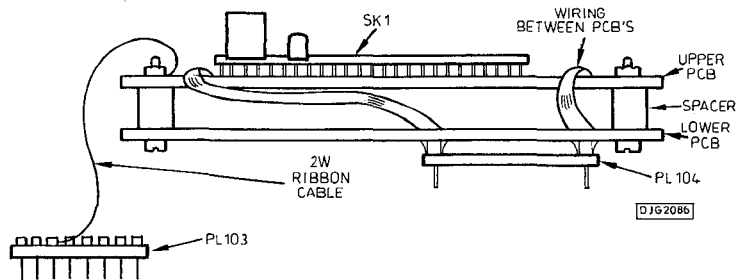

Fig. 8. Mounting assembly details.



## 286 Motherboard from £99

286-12	£99	286-16	£130
386sx-16	£260	386-20	£430
386-25	£470	386-33	P.O.A.
486	P.O.A.		

**Build your own 286-12Mhz from £350, include keyboard, 1M RAM and monitor.**

Desktop case+PSU (£100); Keyboard (£45); AT multi I/O card with FDD and IDE controller (£55); monitor (£65); 1.2M Floppy drive (£52).

### Options

Tower case (£150); 16 bit 1024x768 16 colour VGA card (£110);  
VGA Colour monitor :-640x480 (£230); 1024x768 (£270);  
Multisync (£310)

Hard disk 20M (£145); 40M (£190); 100M (£399) and many more.  
Floppy drive 1.44M (£45); 1.2M (£52)

DRAM	256x9	£60	1Mx9	£70
SIMM	256x9	£60	1Mx9	£70

Tel:- 0279 641119 ext 207; Open Mon-Fir 9:00-5:30 Sat by appointment

**CACHE**  
SYSTEMS LIMITED



Unit 7, Latton Bush Business Centre, Harlow Essex CM18 7BH

# HENRY'S

## ELECTRONICS DISTRIBUTORS

FOR TRADE, INDUSTRY,  
EXPORT, EDUCATION  
AND ALL  
HOBBYISTS

LARGE  
RANGE OF  
ELECTRONIC  
COMPONENTS  
IN STOCK!!!

AUDIO, TV,  
VIDEO,  
TELEPHONE  
& COMPUTER  
ACCESSORIES

Two Car Parks  
Nearby

A COMPLETE RANGE OF  
CATALOGUES, COVERING  
THE VAST HENRY'S STOCK

TEST INSTRUMENTS SAE 38p Includes 'Scopes, Counters,  
PSU's, Dmms, Generators, TV/Video, Clamps, Insulation,  
Temperature, Logic plus much more (UK's largest in stock range).

SECURITY SAE 32p Home, Office, Shop, Store etc. Alarms  
and Alarm Systems, CCTV, Doorphones, PIR Indoor/Outdoor,  
TV/Video, and Telephone Accessories, Intercomms.

COMPONENTS SAE 32p Tools, Service Aids, Components,  
Computer Accessories, Semiconductors etc.

COLOUR CATALOGUE SAE £2.00 Huge Range of Audio,  
Test, In Car, PA, Disco Equipment plus Leads, Plugs etc.

PUBLIC ADDRESS (SAE 28p) Disco, PA, Speakers etc.

COMMUNICATIONS (SAE 28p) CB Radio, Scanners etc.

TRADE/INDUSTRY/EDUCATION Write or fax for your  
FREE (UK only) CATALOGUES with Trade Prices  
(Export Send £5)

RETAIL MAIL ORDER Send SAE min. Size A4 with  
Stamp as Indicated (UK). Complete set with colour  
catalogue send PO/Chq (no SAE) £3.00 Export £5.00

**HENRY'S**  
AUDIO ELECTRONICS

404 EDGWARE ROAD  
LONDON W2 1ED

Instruments/PA/Audio 071-724 3564  
Security/Communications/CCTV 071-724 0323  
Components 071-723 1008  
Trade/Education/Export 071-258 1831  
Account facilities available Fax: 071-724 0322



ALL CATALOGUES  
CONTAIN PURCHASE  
VOUCHERS WORTH

**£90**

OPEN 6 DAYS A WEEK FOR CALLERS AND TELEPHONE ORDERS

FOR RETAIL MAIL ORDER ONLY

# INDEX

JANUARY 1990 TO DECEMBER 1990

## VOLUME 26

# Constructional Projects

**8748 Programming Adaptor** by Kevin Browne. Allows 8748 microcontroller chips to be programmed by the Eprom Poly-Programmer. **December**

**AC Motor Control** by Andrew Armstrong. An *Ask PE* solution to providing variable speed control for ac motors up to 2kW. **July**

**AF Octave Measurer** by Joe Chamberlain. Sophisticated multi-octave audio frequency analyser and test display unit. **August-October**

**Bargraph Tachometer** by Chris Walker. Three chips and 20 leds display revs and help you look after your car's welfare. **January**

**Basic Electronics** by Owen Bishop. Tutorial features with practical constructional experiments. Ideal for GCSE and other students of electronics.

**Part one** - Electricity. **January**

**Part two** - Resistance. **February**

**Part three** - Resistance, capacitance and inductance. **March**

**Part four** - Semiconductors. **April**

**Part five** - Photo diodes, leds and zeners. **May**

**Part six** - Transistors. **June**

**Part seven** - More on transistors. **July**

**Part eight** - Amplifiers. **August**

**Part nine** - Phototransistors, thyristors and jfets. **September**

**Part ten** - Current and voltage control. **October**

**Part eleven** - Opamps. **November**

**Part twelve** - more on opamps **December**

**Baud Rate Converter** by Robert MacFarlane. For use on the serial port of IBM PCs and clones. **June**

**Bike Alarm** by Chris Brown. Chris's bike's alright Jack, with a jack to thwart the hijack! A simple deterrent to push-bike thieves. **January**

**Bike Computer** by John Becker. Displays details of your push-bike trips. Also usable as general purpose 6502 microcontroller board. **November, December**

**Chiptester** by Dave Raynor. Excellently designed unit for testing most digital chips in conjunction with BBC computer. **October, November**

**Circuit Breaker** by Steve Bailey. Experimenter's power line protection circuit that does not require fuses. **June**

**Desk Thermometer** by Owen Bishop. Uses led bargraph to digitally display temperatures from 0°C to 39°C. **September**

**Eprom Poly-Programmer** by Kevin Browne. Microprocessor controlled programmer for a wide variety of eprom types. **May, June**

**Eeprom Programmers** by Malcolm Harvey. Two inexpensive projects to open the port to successful microprocessor control programming.

**Part one** - hex keypad version, with hex code display. **January**

**Part two** - simple hex switch version with led readout. **February**

**Flasher Alarm** by Paul Benton. Audibly reminds forgetful car drivers that the indicators are still flashing. **September**

**Ingenuity Unlimited.** Occasional series in which enthusiastic readers share their handy project design ideas.

**Car Burglar Alarm** by M.S. McNich. **February**

**Hex Keyboard** by M.H.S. Bukhari. **February**

**Low Battery Warning** by Nigel Chaffery. **March**

**RF Operated Relay** by Paul Benton. **February**

**Voltage Trimming** by B. Balet. **March**

**In-Situ Nicad Charger** by Dave May. Allows recharging of nicad batteries without removal from their apparatus. **November**

**Intermittent Wiper** by Andrew Armstrong. An *Ask PE* answer to providing a car with intermittent windscreen wiper control. **June**

**Message Maker** by John Becker. Using the Sanyo LCM570 intelligent lcd display module, provides computerised or eeprom controlled message making. Includes Basic software examples. **June**

**Microncontrolling the Robot Car** by Alan Pickard. Giving the April-June robot car an independent controller. **December**

**Mock Stereo and Equaliser** by John Becker. How to turn your mono music into simulated stereo, and add a 3-channel equaliser. **February**

**Modem** by Kevin Kirk. High quality, modest cost, hi-tech comms link suitable for use with virtually any computer. **February**

**Morse Decoder** by John Becker. An alphanumeric lcd module to decode and display morse messages from any source. **July**

**Motor Speed Control** by Andrew Armstrong. An *Ask PE* answer to powering golf trolleys and other dc motorised machines. **March**

**PC Interfacing** by Robert Penfold. How the IBM PC and its clones can be readily interfaced for external control and monitoring. **April**

**Radio Clock** by John Becker. Analogue and digital electronics combine to pluck time and calendar data from the airwaves.

**Part one** - receiver and pulse detector. **March**

**Part two** - decoding and display circuit. **April**

**Part three** - software control options. **May**

**Remote Powered Microphones** by Vivian Capel. How to obtain better service from Electret microphones. **July**

**Robot Car Building** by Alan Pickard. Circuits, controls and experimental software for controlling a variety of motorised mobiles.

**Part one** - basic operation. **April**

**Part two** - peripherals and software procedures. **May**

**Part three** - further software and implementation details. **June**

**Scope Expander** by John Becker. Provides your scope with at least eight traces, plus 64K digital storage. **August, September**

**Slave Flash** by Chris Brown. Principally for use with an existing photographic flash gun but has other functions too. **February**

**Sound Operated Switch** by Paul Benton. Causes the voice of a caller at the door to automatically turn on the porch light. **October**

**Tele-Scope** by John Becker. Turns your tv into a 2MHz oscilloscope. No internal mods to tv required. **September, October**

**Voltage Probe** by Stephen Bailey. Uses led bargraph to show what's happening in analogue and digital circuits. **August**

## Competitions

**25th Anniversary Competition** (Nov 89) - results **February**, answers **March**

**Robot Builder's Bonanza** - competition **April**, results **July**



# Special Features

**A Case For Technology** by Desmond Harvey. Examining the current state of enclosure technology. **December**

**Artificial Intelligence** by Richard Mishra. Explaining the basic concepts of AI and the goals aimed at by researchers. **April**

**Blanket Coverage** by Wayne Green. Our American correspondent warns us that electric blankets may radiate more than warmth. **May**

**Cellular Radio** by Mike Sanders. Examining the principles upon which this public mobile radio system operates. **August**

**Christmas Crossword** by Anthony H. Smith. Gives your festive brain something to digest. **January**, answers **February**

**Computers** by Mike Sanders. From Ascii to Zilog, this is the story of how and why a computer works. **February-April**

**Diy PCs** by Robert Penfold. Authoritative advice on assembling your own IBM PC compatible computer. **July**

**Easy-PC Review** by John Becker. Report on an excellent pcb cad program for IBM pcs and compatibles. **December**

**HF Radio** by Mike Sanders. A clear explanation of the hows and whys of radio reception.

**Part six** - RF and IF stage design, filters and detectors.

**January**

**History of Technology** by Ian Poole. Compact biographies of famous researchers who considerably advanced our technological progress.

Edison

Faraday

Hertz

**September**

**November**

**July**

Maxwell

Morse

Ohm

**August**

**December**

**October**

**Hi-Teching Trams** by Neil Harding. How electronic technology was used to bring an ancient tram system under automatic control. **March**

**Home Data Systems** by Wayne Green. Speculation by our American correspondent on the future for cd-rom data bases. **September**

**Intelligent LCD Modules** by John Becker. In-depth examination of Sanyo's LCM series of alphanumeric led modules. **May**

**Lasers** by Mike Sanders. A detailed examination of their history, properties, functions and varieties. **November, December**

**Mobile Radio** by Mike Sanders. The history and technology of the comms system that is equally at home in vehicles or your pocket. **July**

**Polyline Metering** by Robert Redding. A revolutionary method by which household meters may be remotely monitored. **October**

**Radio Pagers** by Mike Sanders. Examining the technology behind these economic users of the overcrowded radio spectrum. **September**

**Resistors in Parallel** by Joe Chamberlain. A handy ready-reckoner workshop-wall guide for calculating resistance values. **January**

**Space TV** by Frank Mendacio. Could tv repeats be infinitely time-warped across eternity, as this cautionary parable suggests? **April**

**UCT Performance** by Anthony H. Smith. What to look for in counter-timers, how the sophistication is achieved, and how to judge the value.

**January, February**

# Leading Edge Features

**Why Digital Phones?** by Tom Ivall. Examining the principles behind the incoming digital public mobile phone systems. **November**

Barry Fox takes a monthly look at the technology behind the news.

CD Video. **February, March**

Cellular Eavesdropping. **January**

Consuming Japanese. **May**

Electronic Yellow Pages. **November**

Insecure Cells.

Jet Line Gripping.

Mapping Perspective.

Radio Data Systems.

Radio Linking.

Standardising CT2

Squaring up to Japan.

**July**

**August**

**September**

**October**

**June**

**December**

**April**

# Industry Notebook Features

Tom Ivall's monthly comments on the electronics industry and the implications for some of its activities.

A Boost from the ERM. **October**

Cardboard and Cuckoo City. **June**

Challenge and Choice. **April**

Cooperation in Competition. **January**

Electrons and Photons. **May**

Greenhouse Electronics.

High Tech Hewers

New European Electronics.

Satellited and Letter-boxed.

St Cecilia Electronica.

The Megacellphone.

Two Cultures Revisited.

**September**

**December**

**March**

**August**

**November**

**July**

**February**

# Regular Features

**Editorial** by John Becker. Monthly views and comments from the Editor.

**Home-Base.** Monthly series highlighting new consumer electronic goods and services. Commenced April, by John Becker, thereafter by Ian Burley.

**Spacewatch** by Dr Patrick Moore CBE. Monthly series of astronomy and space reports.

**Catalogue Database.** Monthly reviews of catalogues received.

**Chipcount.** Monthly look at selected new chips.

**Events Diary.** Monthly list of forthcoming exhibitions and conferences.

**News and Marketplace.** Monthly series detailing new products and services.

**Track Feedback.** Frequent series expressing your views, and offering a few replies.

# Bookmark

## Books reviewed during 1990

**101 Optoelectrical Projects.** Delton T. Horn. Tab Books. **April**  
**Basic Electronics Theory - 3rd Edition.** Delton T. Horn. Tab. **April**  
**A Beginners' Guide to Modern Electronic Components.** R.A. Penfold. Babani. **October**  
**A Concise Introduction to dBASE.** J.W. Penfold. Babani. **July**  
**A Concise Introduction to GEM.** J.W. Penfold. Babani. **July**  
**A Concise Introduction to Lotus 1-2-3.** N. Kantaris. Babani. **July**  
**A Concise Introduction to OS/2.** N. Kantaris. Babani. **July**  
**A Concise Introduction to Word Perfect.** R.A. Penfold. Babani. **July**  
**Advanced BASIC Scientific Subroutines.** B.V. Cordingly and D.J. Chamund. Macmillan. **September**  
**Analog Electronics.** Ian Hickman. Heinemann Newnes. **November**  
**An Introduction to Amateur Radio.** I.D. Poole. Babani. **August**  
**An Introduction to VHF/UHF for Radio Amateurs.** I.D. Poole. Babani. **October**  
**Build Your Own Universal Computer Interface.** Bruce Chubb. Tab Books. **September**  
**Computer Engineers Pocket Book - 2nd Edition.** Michael Tooley. Heinemann Newnes. **June**  
**Digital Audio Projects.** R.A. Penfold. Babani. **August**  
**Digital Electronics Projects for Beginners.** Owen Bishop. PC Publishing. **November**  
**Electronic Display Devices.** Shoichi Matsumoto. John Wiley and Sons. **September**  
**Electronic Engineering Semiconductors and Devices - 2nd Edition.** John Allison. McGraw-Hill. **November**  
**Electronic Engineers Reference Book - 6th Edition.** F.F. Mazda. Butterworth. **April**  
**Fault Diagnosis of Digital Circuits.** V.N. Yarmolik. John Wiley and Sons. **November**  
**From Atoms to Amperes.** F.A. Wilson. Babani. **July**  
**Fundamentals of Pattern Recognition.** Monique Pavel. Marcel Dekker Inc. **April**  
**Getting the Most from Your PC's Hard Disk.** J.W. Penfold. Babani. **November**  
**How to Expand, Modernise and Repair PCs and Compatibles.** R.A. Penfold. Babani. **October**  
**How to Use Oscilloscopes and Other Test Equipment.** R.A. Penfold. Babani. **August**  
**Learning Electronics - Theory and Experiments with Computer-aided Instruction for the Apple/IBM.** R. Jesse Phagan and Bill Spalding. Tab Books. **June**  
**Learning to Program in C.** N. Kantaris. Babani. **July**  
**Master Handbook of IC Circuits - 2nd Edition.** Delton T. Horn. Tab Books. **April**  
**Microprocessor Pocket Book.** Steve Money. Heinemann. **June**  
**More Advanced MIDI Projects.** R.A. Penfold. Babani. **August**  
**More Advanced Test Equipment Construction.** R.A. Penfold.

Babani. **August**  
**More Advanced Uses of the Multimeter.** R.A. Penfold. Babani. **August**  
**Op-Amp Circuits Manual.** R.M. Marston. Heinemann. **September**  
**Optoelectronic Line Transmission - An Introduction to Fibre Optics.** R.L. Tricker. Heinemann Newnes. **October**  
**Passive Components - A User's Guide.** I.R. Sinclair. Heinemann Newnes. **October**  
**Power Control Circuits Manual.** R.M. Marston. Heinemann Newnes. **November**  
**Practical Digital Control.** A.M. Zikic. Ellis Horwood. **September**  
**Practical Transformer Design Handbook - 2nd Edition.** Eric Lowden. Tab Professional. **April**  
**Programming in QuickBASIC.** N. Kantaris. Babani. **October**  
**Radio and Electronics Engineer's Pocket Book - 18th Edition.** Keith Brindley. Heinemann Newnes. **June**  
**Semicon International Semiconductor Index - 8th Edition.** Semicon Indexes. **June**  
**Simple Short Wave Receiver Construction.** R.A. Penfold. Babani. **November**  
**Test Equipment Construction.** R.A. Penfold. Babani. **August**  
**Troubleshooting and Repairing VCRs.** Gordon McComb. Tab Books. **September**

## Publishers' Addresses

**Bernard Babani (Publishing) Ltd,** The Grampians, Shepherds Bush Road, London W6 7NF. Tel: 081-603 2581.  
**Butterworth & Co (Publishers) Ltd,** Borough Green, Sevenoaks, Kent, TN15 8PH. Tel: 0732 884587  
**Ellis Horwood** books are distributed by Halsted Press, a division of John Wiley and Sons.  
**Heinemann Professional Publishing,** Halley Court, Jordan Hill, Oxford, OX2 8EJ. Tel: 0865 311366.  
**John Wiley and Sons,** Baffins Lane, Chichester, West Sussex, PO19 1UD. Tel: 0243 779777.  
**Macmillan Education Ltd,** Houndmills, Basingstoke, Hants, RG21 2XS. Tel: 0526 29242.  
**McGraw-Hill Book Company (UK) Ltd,** Shoppenhangers Road, Maidenhead, Berks, SL6 2QL. Tel: 0628 23432.  
**Marcel Dekker Inc,** 270 Maddison Avenue, New York, NY 10016, USA.  
**PC Publishing,** 4 Brook Street, Tonbridge, Kent, TN9 2PJ. Tel: 0732 770893.  
**Semicon Indexes,** PO Box 470, Lee, London SE12 8AF. Tel: 081-852 2309.  
**Tab Books** are now imported by **McGraw-Hill.** (John Wiley & Sons no longer handle them).

## Summary Points

**Circuit Breaker** (Jun 90) Fig 3, C1 at top right should be C12, and D4 polarity should be reversed.  
**Eprom Poly-Programmer** (Jun 90) Fig 14 is incorrectly shown as a mirror image and should be flipped over.  
**Eeprom Programmer** (Jan 90) Fig 4, IC5 pin 4 also goes to IC2 pins 3 and 15. Fig 10, The link to IC3 pin 21/R6 should go to IC3 pin 20,

arrow 14 then goes on IC3 pin 21.  
**Modem** (Feb 90) Supplementary sheet of author's clarifications on a number of arising points is available (first issued April). Send sae.  
**Video AGC** (Dec 89) Fig 2, second TR1 is TR2. Fig 4, reverse positions of R1 and R2.

PE



**KNOWLEDGE AND THE LAW**

Dear Sir,

I am impelled to put fingers to keyboard to express my strong disagreement with your stated attitudes in reply to a letter in the *Track Feedback* column of June 90, entitled *Lawful*.

You say that it is your strict policy not to publish projects which fall outside the law or are otherwise socially unacceptable. Later you say that to publish information about the coding of satellite broadcasting would be tantamount to inciting readers to commit theft.

The new technologies have given manufacturers and publishers the opportunity to add coding techniques onto their products in order to restrict availability and so improve their profit potential. I for one would not grudge them their profits as many of their works are of a very high standard. But it is their responsibility to protect their products.

In addition, the use of radio waves for broadcasting is restricted, albeit rather excessively for reasons of availability. So too is designing equipment to connect to the BT phone network which can conceivably present a risk to other users, not least the engineers.

I take issue with you, however, in your stated aim to assist these people, not for your commendable public spirited attitudes but because of the stifling of the dissemination of knowledge which will result.

This is an offence against what I suggest should be the main objective of your magazine. Only by free unfettered access to information can development of new methods and discoveries be made. This is equally true of manufacturers who design sophisticated copy protection for their products.

The most disturbing question posed by your statement is how many well written and presented articles and projects have you rejected for publication for fear of offending someone's monopoly of some area of knowledge.

I cannot fault your insistence against infringing the law even when the law is an ass. But to make what amounts to moral judgments on the suitability of knowledge for publishing is I suggest comparable to book burning. This is not in keeping with the image of PE, or indeed the British Press.

A.G.H. Donnachaidh,  
Portsmouth, Hants.

*I am in whole-hearted agreement with you on the right to disseminate knowledge, and of the need for magazines like PE, and the Press in general to ensure that the world at large is kept informed.*

*This was not the point under question in my reply. The hobbyist*

**TRACK FEEDBACK**

*electronics magazine to which I referred had published Part One of a constructional project whose sole purpose was to decode certain satellite transmissions which were intended for use only by those who had paid for the right to decode them. Those responsible for the transmissions saw Part One and apparently believed that this project would enable people to decode the signals without paying for the ability. In keeping with your belief that it was their responsibility to protect their products, they acted accordingly.*

*I am informed from a reliable source that the magazine issue containing Part Two of the project had already gone to press and that copies were in the Distributor's warehouse when an injunction against the issue was served. The Distributors refused to send the issue out to newsagents. In such a situation a magazine has two choices, to abandon that issue and lose enormous amount of money (as well as upsetting readers and advertisers), or to reprint with suitable amendments. In this instance I understand that the cover was redesigned to remove reference to the decoder, and that the pages containing the project were replaced by other subject matter.*

*Can you honestly say that as Editor I should put PE into such a situation by attempting to publish projects that ignore legal requirements? Unlike some national newspapers which can afford to publish and be damned to the legal costs, we cannot. I would be perfectly happy to publish information on how, in this instance, the decoding system works, but I would not publish a diy project which could carry out that decoding. There are many ways in which knowledge can and should be circulated, but it must be done in such a way that enables a magazine to survive in the harsh world of commercial realities. I do not condone censorship, but common-sense must be used when judging what should or should not be published.*

Ed.

**TELE-SCOPY**

Dear Mr Becker,

In response to your speculation as to whether the PE Tele-Scope project was the first of its kind to be published (PE Sept 90), I would like

to inform you of a classified ad in an old copy of (censored) magazine. The ad in the September 81 issue read as follows:

*Convert any tv into large screen oscilloscope. External unit plugs into aerial socket. Circuit and plans, send SAE to ...*

Admittedly this was not a constructional project published by a hobby magazine, so your project may well be a first. Unfortunately I did not reply to the advert, so I do not know how well (if at all) the design worked. Assuming that the design did work, the technology we've been waiting for was with us nine years ago!

I can only assume that the PE project is superior due to newer and faster ics, and has a better specification. Hopefully a Tele-Scope will be part of my test gear sometime in the near future.

D.Brook, Mill Hill, London NW7.

*You are the only reader who has responded to my query, so my belief that PE had a First with the Tele-Scope is re-affirmed.*

Ed.

**MEMORABLE PINNING**

Dear Ed,

Having read the article in PE Aug 90, the *Scope Expander*, I think I may have found an error.

Referring to Fig.4 on page 14, the pin out for IC7, the sram 6116 memory ic, does not agree with the manufacturer's pin out. I have consulted two sources for the pin outs for this ic and they both give the same information, hence, is the pin out in your circuit a misprint?

G.C.Hadley, Lillington, Warks.

*You have raised an interesting point which I should have referred to in the text. The pin out numbering is according to my allocation of their use, not the manufacturer's. Although a standard convention exists in which data and address pins are given consistent numbering, this convention does not always need to be adhered to.*

*In the Scope Expander it did not matter in which order I used the data and address pins, provided I remained consistent within the logic of my own design. Purely for my ease of track routing in the designing of the pcb, I routed the data and address*

*lines from their respective sources to the most convenient pins of the memory. For example, the line I have allocated for D0 through IC10 is taken to memory pin 11. This line is still used as D0 at the memory, and is labelled as such, even though the manufacturer's data quotes this pin as being their D2. It is the use of the lines which determines their notation in this application. There are many situations in which this principle can be applied.*

Ed.

**PRIME SIGN**

Dear John,

I very much admire your dedicated work for PE, both past and present. I do wish you good health and many more inspiring years working as the Editor. It is good to see the quality increasing, which is a great reflection on your own dedication to the Journal.

I would be honoured if you would write back to me, albeit briefly, as a small contribution to my extensive and unusual collection of autographed letters.

With best wishes to you, and to PE. I wish you every future success in your own particular field of research work.

Peter W. Ladkin, Erdington, Birmingham.

*Another 'First' - I've never been autograph hunted before, except by those wanting to sell me something! I was unable to resist YOUR request.*

Ed.

**MULTIPLES**

Dear Sir,

I want to construct the PC Multiport project which appeared in PE April 89; are photocopies of the pcb track layouts still available?

As a reader of 25 years standing I would like to convey my appreciation for the years of pleasure PE has brought me and trust that today's youngsters are finding the pages of PE as rewarding as I have.

Bob Welch, Mount Vernon, Glasgow.

*Yes, we can still supply photocopies of this layout though you may find it difficult to reproduce for yourself as it is double-sided with some quite fine tracking. Perhaps, though, you intend using a pcb cad system to assist you - they are well worth obtaining if you do much pcb design work, as I have recently learned to my benefit.*

*Thanks for your kind wishes. Like yourself, I have gained much through PE over the years and try to encourage others to as well.*

Ed.



# HOME-BASE

**Ian Burley reports that Kodak has made an incredible breakthrough that should excite photographers of all calibres and revolutionise the way in which our snapped images are stored for posterity. He's news on other interesting matters too.**

**A**n important announcement from Kodak could mean that in about two years time we might be collecting our 35mm photos from the chemist stored on a special compact disc. Kodak has unveiled the results of a project in conjunction with Philips and Sun Microsystems, called Photo CD, which retains the use of conventional 35mm photographic film but stores images captured by film on CD ROM (compact disc read only memory). Prints from these Photo CDs are completely produced via a digital printing process using a specially developed thermal printer which replaces the old and messy liquid chemical processing method. Quality promises to be very high and Kodak will sell Philips produced CD players capable of displaying Photo CD pictures on a tv screen. Photo CD compatibility could well joint other emerging CD based formats like cd-i as a necessary feature of tomorrow's multimedia CD players, which will of course play ordinary music CDs as well.

If Kodak gets it right, present day 35mm camera technology will be preserved indefinitely despite recent advances in all-digital camera technology like Canon's Ion still video system and the equivalent Sony Mavica (see Barry Fox, Electronic Snapshots, PE October 1989).

**Top photo:** The Kodak Photo CD will be housed in an attractive "jewel case" similar to those used in the audio industry. The case will contain an index print displaying all images recorded on the Photo CD. Each image is numbered showing its sequential position on the roll and on the disc.

**Right Photo:** Users of personal computers and workstations can access images from Kodak Photo CDs using any CD ROM XA (extended architecture) input device. The CD ROM XA technology was jointly developed by Microsoft, Philips and Sony as an industry standard to integrate audio and images into computing applications. Because of its compatibility with this standard, Photo CD can be used with virtually any type of computer adhering to common industry standards.

Photographic enthusiasts have enjoyed many benefits from the advances in digital electronics over the last decade with ultra-responsive and pre-programmed metering systems and auto-focus features, yet the industry has been struggling to compete with the ever growing popularity of video cameras and other electronic leisure products. You only have to look in the average high street to realise that dedicated camera shops are becoming increasingly rare and even the high-street chains now devote less space to decent examples of 35mm camera technology.

## EVOLUTION

Meanwhile, solid state electronic camera technology has been evolving steadily from video-camera beginnings. Canon and Sony share a still-video camera system based around a tiny 2.5 inch floppy disc capable of storing up to 50 shots - one Sony camera even offers a sound recording feature. The resulting photos can be displayed on a tv screen

instantly or printed out using an expensive thermal colour printer. The picture quality is fine for display on tv, but no better than a cheap 110 pocket camera when printed and it's unlikely that anybody would want to enlarge the prints.

Conventional camera technology based around good old silver halide photographic film is certainly not threatened by still-video camera technology at this point. There are prototype electronic cameras offering around a million pixels of resolution, but that is only around one twentieth that of today's refined 35mm format photographic film emulsions. No doubt compact electronic cameras will offer equivalent reproduction quality in a few years time, probably with the help of advanced computer-aided image enhancement techniques and exciting new image sensing hardware, but it will probably be considerably later before affordable mass-produced cameras of this type will be generally available. Even today's low-resolution still video cameras from Canon and Sony cost around £500 a go.





*Eastman Kodak's new photographic system – jointly developed with Philips – scans 35mm film images and writes them on compact discs. These pictures can then be played back on television with the new Kodak Photo CD players. The players can accommodate current audio CDs and will play new Photo CDs allowing consumers to view high quality photographic images on television. A full function remote control unit will operate all video and audio features.*

### HOW DOES IT WORK?

Photo CD is compatible with both colours negative and transparency films. Once you have finished your film it's sent off for processing as usual. There are no changes to the conventional chemical processing techniques up to the point that the negatives or slides have been successfully processed. From here on it's completely different. Instead of the films being used to expose traditional photographic paper in order to produce ordinary prints, the films are digitized and eventually written to a compact disc. A very high resolution digitizer has been developed by Kodak to capture images containing 18 million pixels.

The scanner mechanism has a triple parallel linear ccd (charge-coupled device) array capable of capturing 2048 pixels at very high speed. Kodak says each resulting image is 18 megabytes big, which suggests a 256 colour palette per pixel. The digital picture file is then passed to a Sun Microsystems Sparcstation computer which corrects image colour and density and the picture data is then compressed. Up to 100 images can be stored on a single Photo CD, suggesting a compressed size of about 6 megabytes per picture. To put this into perspective, even the highest density personal computer floppy discs currently in widespread use will only be able to store less than a quarter of one compressed image! At this stage the compressed pictures are written to a blank cd via a disc writer jointly developed by Kodak and Philips.

When you end up collecting your finished Photo CD it will be supplied in a conventional cd album case but where an inlay card would be

found on a music cd, there will be an index file of the pictures contained in the cd printed in miniature. Hopefully without excessive optimism, Kodak claims a Photo CD made from a 24 exposure film will cost below £9. That's not bad considering how much today's music cds cost.

### MAKING PRINTS

What about getting some prints made? You will still be able to use the negatives or slides originally produced to make conventional prints, but Kodak has developed a new high-resolution thermal printer to produce comparable quality colour prints. The example 10 inch print I was shown was very acceptable and nobody I showed it to thought it was anything other than a conventionally produced print. What is not yet known is exactly how competitive these thermal prints will be price-wise. However the Photo CD does offer advantages in this department - it will be possible to digitally enhance or edit Photo CD images and scratched or damaged negatives should be a thing of the past, just as scratched and crackly lps are now banished to the past by music cds.

### MASSIVE INVESTMENT

Of course, Kodak has massive long-term investments in its film manufacturing and conventional photo-finishing industries. The beauty of Photo CD is that it preserves industry commitment to conventional film while bringing Kodak film into the electronic age. Even the colour thermal print system will be complementary rather than competitive with

conventional photo-finishing at first. Kodak should undergo a smooth and balanced transformation from old chemical processing techniques to its new electronic methods. Photo CDs themselves, if successful, should be around for a very long time. Even when digital image capturing overtakes film technology in the future, Photo CD will remain compatible.

Photo CD won't be commercially available until 1992, but it looks well worth waiting for, unlike Kodak's last experiment with discs in the early eighties - the unloved small format pocket disc camera which produced worse pictures than even 110 pocket cameras. What a difference a decade makes.

### CALLER ID PROGRESS

Caller ID, the ability to identify who is ringing your phone through a small display on the panel on the phone - before you even pick up the receiver, is one clear case where "freedom of speech" must give way to "freedom from speech," according to one journalist in the States. However, there is much opposition to the new technology which is slowly being introduced at selected sites around the USA. Functions possible through Caller ID include automatic callback, call trace, selective call forwarding or distinctive ringing.

In an attempt to pacify the anti-Caller ID lobby, selective blocking has been offered by some phone companies. The recipient's phone Caller ID display can be blocked on a call by call basis by dialling a special code number before the actual phone number. A US West spokesman said that in trials only half the callers used blocking even once, and that nobody blocked their number with every call. US West

**Below:** To produce Photo CDs, photofinishers will use the Kodak Photo CD Transfer Station consisting of five components; a high resolution film scanner, a computer workstation, image processing software, a Photo CD writer, and a thermal printer. The entire photofinishing system will be available from Kodak in mid 1992.

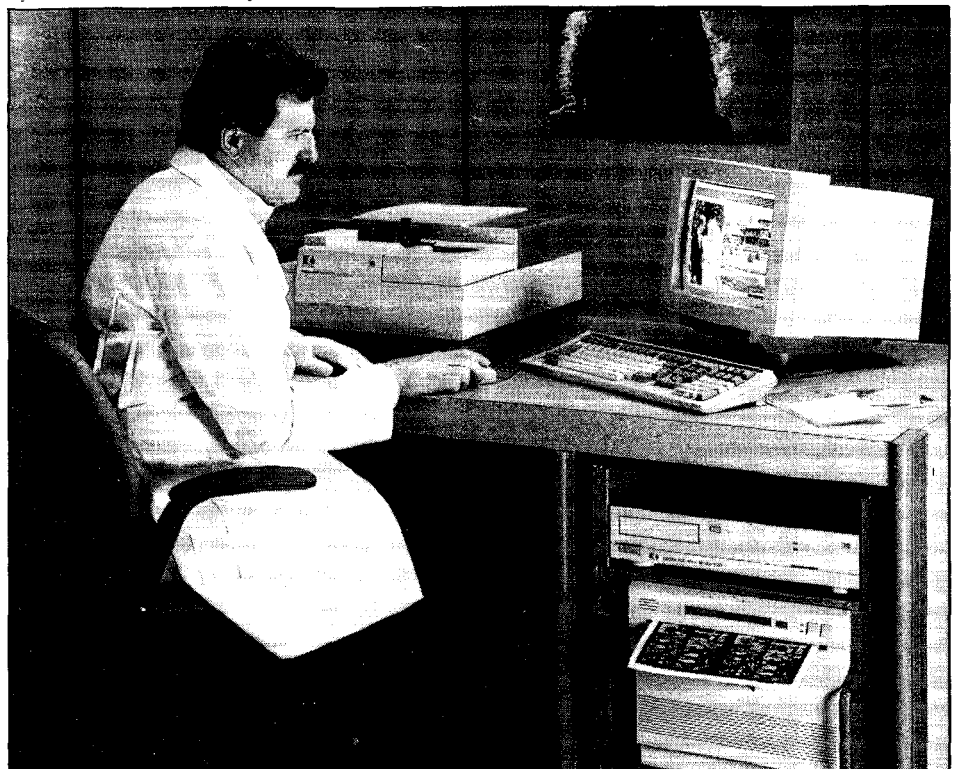

**Current Photographic Process**

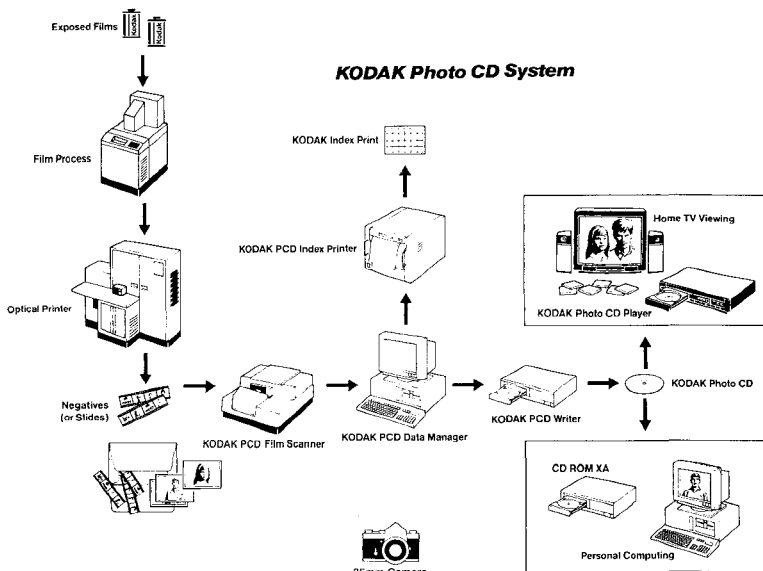

**KODAK Photo CD System**

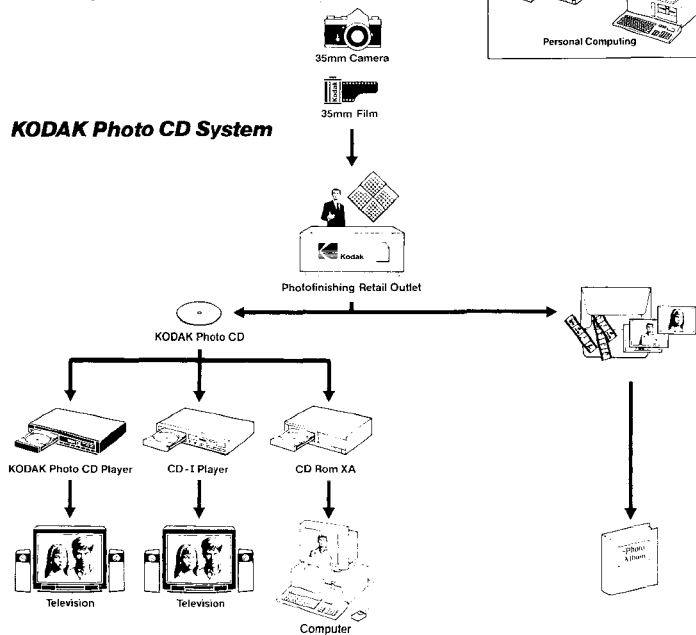

**Left:** Progress flow charts showing the current photographic system and the new Kodak Photo CD system.

became the first local carrier to offer Caller ID service with free optional blocking. The offering was made as part of a five-month trial of several new call management services aimed at small businesses.

BellSouth has applied to offer Caller ID in five states, without blocking, but only Tennessee has said yes. In North Carolina an attorney general has even suggested that Caller ID contravenes state phone-tapping regulations. In conservative Pennsylvania all applications to introduce Caller ID in any form have been blocked. There are problems in the all-important state of California and it now looks increasingly likely that the federal government will be brought in to settle the issue of Caller ID on a national level once and for all. Meanwhile, there don't appear to be any signs that Caller ID will be introduced in the UK just yet, though other value added services like call diverting, call waiting, outgoing call barring and conference calling are now being introduced here with the opening of new digital System X exchanges. To find out about these services ring Freephone Star Services.

**TELEPOINT OFF TO A POOR START**

Despite a steady increase in the number of Telepoint cordless phone public base stations successfully installed all over the country, there is little evidence that very many people are using them. About a year after the first Telepoint hand sets were introduced and 20 months since the four Telepoint service providers were licensed by the Department of Trade and Industry, a recent report in the *Sunday Times* indicated that there are only about 5,000 users. In fact there are probably as many public base station as there are users. To put it mildly, Telepoint has not been a rip-roaring success.

However, all is not doom and gloom. Telepoint dealers I have spoken to agreed that sales had been very disappointing though one dealer had cultivated a niche market selling to offices where the digital cordless phones are used as mobile desk phones in conjunction with a personal base station connected to the office PBX. In fact GPT, makers of the so-far unlaunched Rabbit BYPS phone, have produced a customized version of their Telepoint phone for office use. The cordless office PBX revolution is just around the corner.

Exports are going very well, too. Shaye Communications has announced that it has manufactured over 50,000 of its Forum

**Left:** If only you could see the 10x8 inch colour original of this photo you would be amazed at its quality. The original is a high quality thermal print reproduced using the Kodak Photo CD system. A 35mm Kodak Ektar negative was scanned and the digital image recorded on a Photo CD. The image information stored on the Photo CD was then sent to a Kodak XL7700 thermal printer. The Kodak XL7700 is currently available.





Telepoint phones, with 40% ending up overseas. One wonders where the 60% supposedly sold here have ended up. Meanwhile there is huge interest in Telepoint in Hong Kong, where 600,000 people already use electronic pagers. A combined Telepoint phone and numeric pager would appear to be a nice alternative to a cellular phone. But another problem is that Telepoint phones are still very expensive at about £200 plus vat. A personal base station doubles the price. Now if they started making the thing in Hong Kong... Perhaps that's what Sir Clive Sinclair, a founder director of Shaye Communications, wants to happen. When I asked him for some comments on the depressing news about Telepoint's first year, he cheerfully replied that things would get better; the prices of hand sets would drop to more affordable levels but in the mean time the priority was to get as many public base stations installed. Stop at any major motorway service station and you will be able to spot the vertical one metre Telepoint base station antennae. Seeing a Little Chef restaurant bristling with antennae from all four telepoint operators, BT Phonepoint, Mercury Callpoint, Ferranti ZonePhone and BYPS Rabbit, was quite amusing when I realised what they were.

It's my feeling that if Telepoint is to be a viable proposition it will have to take off next year. Hardware prices will have to halve and some sensible way of contacting a Telepoint user will have to be encouraged, a pager built in for example. Industry experts are already talking about Telepoint Plus, an enhancement to the Telepoint system which will enable reception of

incoming calls from public base stations, but it would appear that these improvements are far from imminent. I've said it before and I have to repeat; I'm a fan of the technology, but Telepoint is not good value enough even for me - a self-confessed gadget freak.

### AMIGA CDTV DELAYED

Commodore's much hyped CDTV (Commodore Dynamic Total Vision) multimedia player won't be on sale this Christmas as had been promised. The CDTV was originally launched at the Summer Consumer Electronics Show in Chicago back in June. At that time, confident Commodore spokespersons talked of a Christmas sell-out for the £700 supposed cd-i basher. In reality, the CDTV is far from finished and there was no realistic prospect of getting it into the shops for Christmas. Even if it had made the deadlines, there would be few if any software products on cd for it. The closest we've got to seeing the CDTV over here in the UK was at the recent Computer Entertainment Show at Earls Court, but Commodore's very low key exhibit consisted of just the one CDTV player in a perspex cabinet.

However, there is realistic talk of a February or March date for initial CDTV shipments. By that time, Commodore hopes there will be around 30 discs available including a world atlas, an illustrated Bible, the complete and illustrated works of Shakespeare, and a dictionary. None of these are exactly innovative

and indeed they're based on existing books. There will be some specially produced discs, however, including one on personal health topics. At least Commodore expects the discs to retail for rather less than existing cd roms which can cost from anything around £100 upwards.

Although the CDTV is based on Commodore Amiga computer internals housed in a conventional looking cd player case, Commodore isn't pushing its computer abilities. There is a feeling that association with personal computers will put potential, techno-phobe, buyers off. But that won't prevent ambitious users from buying keyboard and mouse add-ons to bring the CDTV up to full Amiga personal computer spec.

As for CDTV's prospects against its main rival, cd-i (compact disc interactive), it's now clear that CDTV won't have full screen motion video and even its part screen animation is detectably jerky. This is because the CDTV relies on software driven animation. The Philips cd-i system uses customized 68000 based processor technology from Motorola and although full screen motion video isn't quite ready yet, it promises to be quite good. The nuts and bolts of it is that cd-i will be technically superior but later than CDTV. My feeling is that cd-i will become the de facto home multimedia standard, so exactly where Commodore's CDTV will fit in remains to be seen.

PE

*Ian Burley is Deputy Editor of Micronet, an on-line computer and technology magazine published on Prestel by British Telecom.*

## C.A.D. SOFTWARE MADE EASY

### ISIS SUPERSKETCH

ISIS SUPERSKETCH is a purpose designed program for drawing circuit diagrams. Our Graphical User Interface and Intelligent Diagram Editor combine to leave all other budget packages far behind in this application. For example, you can draw a wire from pin to pin in just 4 mouse operations: point at first pin, click, point at second pin, click. The wire autorouter does the rest.

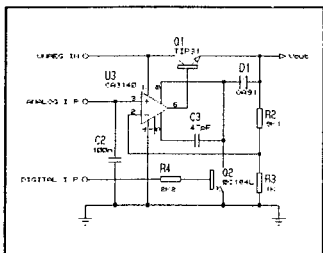

- Auto wire routing.
- Auto dot placement.
- Auto name generator.
- Powerful editing facilities.
- Object oriented 2D drawing with symbol library.
- Comprehensive device libraries available.
- Output to dot matrix, pen plotters, lasers, POSTSCRIPT.
- Export to DTP packages in IMG or DXF formats.

### PCB II

PCB II is a new state of the art manual PCB layout package sharing the same Graphical User Interface as ISIS SUPERSKETCH. It also features Topological Route Editing which is easy to learn and yet stunningly powerful... our demo disk will reveal all!

For a limited period only, we are offering ISIS SUPERSKETCH (Extended library) and PCB II for just £149 - can you afford not to join the CAD revolution?

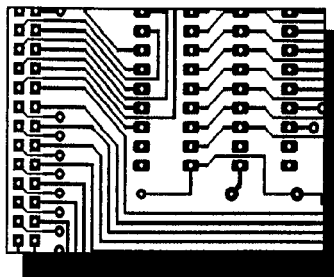

- Topological Route Editor
- Unlimited user configurable pad, track and via styles.
- Full surface mount support.
- 2 copper + 2 silk layers.
- 1 thou resolution.
- 30x30 inch max board size.
- Object oriented 2D drawing for silk screen graphics.
- Drivers for dot matrix, pen plotters, lasers, POSTSCRIPT, gerber, etc. etc..

**Labcenter**  
Electronics

#### PRICES

SUPERSKETCH (Basic Library) ..... £69  
 SUPERSKETCH (Extended Library) ..... £99  
 PCB II ..... £69  
 SUPERSKETCH (Ext Lib) + PCB II ..... £149  
 OTHER S/W & H/W ..... CALL



Call for demo disks today - 0274 542868.



14 Marriner's Drive, Bradford, BD9 4JT

TTLs			74LS SERIES			LINEAR ICs			CPUs			RAMs			CRYSTALS			INTERFACES ICs			
7400	0.16	74LS00	0.10	74LS445	1.50	4555	0.26	ADC0808	11.00	LM1830	2.50	TDA2004	2.40	68B09	10.00	2016-150	4.00	32.768KHz	1.00	AD561J	20.00
7401	0.30	74LS02	0.10	74LS465	2.78	4556	0.33	AD7910DC	15.00	LM1871	3.00	TDA2006	3.00	68B09E	10.00	1.00 MHz	2.70	1.00 MHz	2.70	AD7581	15.00
7402	0.16	74LS03	0.10	74LS467	2.78	4557	1.36	AV3	80.10	LM1872	2.00	TDA2020	3.20	8035	3.50	1.8432 MHz	2.25	1.8432 MHz	2.25	ADC0808	11.00
7403	0.18	74LS04	0.10	74LS468	2.78	4558	1.08	AV3-8910	4.50	LM1886	6.00	TDA2030	2.50	8039	3.50	2.111A-35	5.00	2.00 MHz	2.25	AM25S10	3.50
7404	0.18	74LS05	0.10	74LS469	2.78	4559	1.53	AV3-8910	4.50	LM1889	4.50	TDA2030	2.50	8039	3.50	2114	1.50	2.45760 MHz	3.75	AM25S25	3.50
7405	0.14	74LS08	0.10	74LS470	2.78	4560	2.48	CA3019A	1.00	LM1897	3.50	TDA2030	2.50	8039	3.50	2114-3	2.50	3.12 MHz	3.75	AM25S50	3.50
7406	0.30	74LS09	0.10	74LS471	2.78	4561	2.48	CA3028A	1.00	LM1917	4.50	TDA2030	2.50	8039	3.50	2114-3	2.50	3.276 MHz	1.50	AM25S50	3.50
7407	0.30	74LS10	0.10	74LS472	2.78	4562	1.70	CA3036	1.00	LM1932	3.50	TDA2030	2.50	8039	3.50	2114-3	2.50	3.5795 MHz	1.50	AM25S50	3.50
7408	0.11	74LS11	0.10	74LS473	2.78	4563	0.57	CA3039	2.22	LM1939	3.50	TDA2030	2.50	8039	3.50	2114-3	2.50	4.00 MHz	1.50	AM25S50	3.50
7409	0.30	74LS12	0.10	74LS474	2.78	4564	0.27	CA3060	3.50	LM1939	3.50	TDA2030	2.50	8039	3.50	2114-3	2.50	4.194 MHz	1.50	AM25S50	3.50
7410	0.13	74LS13	0.18	74LS475	2.78	4565	0.37	CA3090E	0.95	LM1934	3.50	TDA2030	2.50	8039	3.50	2114-3	2.50	4.43 MHz	1.50	AM25S50	3.50
7411	0.30	74LS14	0.22	74LS476	2.78	4566	1.28	CA3090E	0.95	LM1934	3.50	TDA2030	2.50	8039	3.50	2114-3	2.50	4.698 MHz	2.50	AM25S50	3.50
7412	0.30	74LS15	0.22	74LS477	2.78	4567	1.70	CA3090E	0.95	LM1934	3.50	TDA2030	2.50	8039	3.50	2114-3	2.50	4.952 MHz	2.50	AM25S50	3.50
7413	0.27	74LS16	0.12	74LS478	2.78	4568	0.86	CA3090AO	3.75	LM1934	3.50	TDA2030	2.50	8039	3.50	2114-3	2.50	5.000 MHz	1.50	AM25S50	3.50
7414	0.28	74LS17	0.12	74LS479	2.78	4569	1.44	CA3130E	1.00	LM1934	3.50	TDA2030	2.50	8039	3.50	2114-3	2.50	5.068	1.75	AM25S50	3.50
7415	0.33	74LS18	0.12	74LS480	2.78	4570	2.00	CA3130T	1.20	LM1934	3.50	TDA2030	2.50	8039	3.50	2114-3	2.50	6.00 MHz	1.40	AM25S50	3.50
7416	0.30	74LS19	0.12	74LS481	2.78	4571	2.00	CA3140	0.45	LM1934	3.50	TDA2030	2.50	8039	3.50	2114-3	2.50	6.144 MHz	1.40	AM25S50	3.50
7417	0.30	74LS20	0.12	74LS482	2.78	4572	2.48	CA3140T	1.00	LM1934	3.50	TDA2030	2.50	8039	3.50	2114-3	2.50	7.00 MHz	1.50	AM25S50	3.50
7418	0.20	74LS21	0.12	74LS483	2.78	4573	4.40	CA3146	2.25	LM1934	3.50	TDA2030	2.50	8039	3.50	2114-3	2.50	7.168 MHz	1.50	AM25S50	3.50
7419	0.36	74LS22	0.12	74LS484	2.78	4574	4.40	CA3160E	1.50	LM1934	3.50	TDA2030	2.50	8039	3.50	2114-3	2.50	8.00 MHz	1.50	AM25S50	3.50
7420	0.36	74LS23	0.12	74LS485	2.78	4575	4.40	CA3161E	2.00	LM1934	3.50	TDA2030	2.50	8039	3.50	2114-3	2.50	8.967 MHz	1.75	AM25S50	3.50
7421	0.36	74LS24	0.12	74LS486	2.78	4576	4.40	CA3162E	2.00	LM1934	3.50	TDA2030	2.50	8039	3.50	2114-3	2.50	10.00 MHz	1.75	AM25S50	3.50
7422	0.36	74LS25	0.12	74LS487	2.78	4577	4.40	CA3190E	2.70	LM1934	3.50	TDA2030	2.50	8039	3.50	2114-3	2.50	10.50 MHz	2.50	AM25S50	3.50
7423	0.36	74LS26	0.12	74LS488	2.78	4578	4.40	CA3240E	1.45	LM1934	3.50	TDA2030	2.50	8039	3.50	2114-3	2.50	10.70 MHz	1.50	AM25S50	3.50
7424	0.36	74LS27	0.12	74LS489	2.78	4579	4.40	CA3240E	1.45	LM1934	3.50	TDA2030	2.50	8039	3.50	2114-3	2.50	11.00 MHz	3.00	AM25S50	3.50
7425	0.36	74LS28	0.12	74LS490	2.78	4580	4.40	CA3240E	1.45	LM1934	3.50	TDA2030	2.50	8039	3.50	2114-3	2.50	12.00 MHz	1.50	AM25S50	3.50
7426	0.36	74LS29	0.12	74LS491	2.78	4581	4.40	CA3240E	1.45	LM1934	3.50	TDA2030	2.50	8039	3.50	2114-3	2.50	14.318 MHz	1.60	AM25S50	3.50
7427	0.36	74LS30	0.12	74LS492	2.78	4582	4.40	CA3240E	1.45	LM1934	3.50	TDA2030	2.50	8039	3.50	2114-3	2.50	14.318 MHz	1.60	AM25S50	3.50
7428	0.36	74LS31	0.12	74LS493	2.78	4583	4.40	CA3240E	1.45	LM1934	3.50	TDA2030	2.50	8039	3.50	2114-3	2.50	14.318 MHz	1.60	AM25S50	3.50
7429	0.36	74LS32	0.12	74LS494	2.78	4584	4.40	CA3240E	1.45	LM1934	3.50	TDA2030	2.50	8039	3.50	2114-3	2.50	14.318 MHz	1.60	AM25S50	3.50
7430	0.36	74LS33	0.12	74LS495	2.78	4585	4.40	CA3240E	1.45	LM1934	3.50	TDA2030	2.50	8039	3.50	2114-3	2.50	14.318 MHz	1.60	AM25S50	3.50
7431	0.36	74LS34	0.12	74LS496	2.78	4586	4.40	CA3240E	1.45	LM1934	3.50	TDA2030	2.50	8039	3.50	2114-3	2.50	14.318 MHz	1.60	AM25S50	3.50
7432	0.36	74LS35	0.12	74LS497	2.78	4587	4.40	CA3240E	1.45	LM1934	3.50	TDA2030	2.50	8039	3.50	2114-3	2.50	14.318 MHz	1.60	AM25S50	3.50
7433	0.36	74LS36	0.12	74LS498	2.78	4588	4.40	CA3240E	1.45	LM1934	3.50	TDA2030	2.50	8039	3.50	2114-3	2.50	14.318 MHz	1.60	AM25S50	3.50
7434	0.36	74LS37	0.12	74LS499	2.78	4589	4.40	CA3240E	1.45	LM1934	3.50	TDA2030	2.50	8039	3.50	2114-3	2.50	14.318 MHz	1.60	AM25S50	3.50
7435	0.36	74LS38	0.12	74LS500	2.78	4590	4.40	CA3240E	1.45	LM1934	3.50	TDA2030	2.50	8039	3.50	2114-3	2.50	14.318 MHz	1.60	AM25S50	3.50
7436	0.36	74LS39	0.12	74LS501	2.78	4591	4.40	CA3240E	1.45	LM1934	3.50	TDA2030	2.50	8039	3.50	2114-3	2.50	14.318 MHz	1.60	AM25S50	3.50
7437	0.36	74LS40	0.12	74LS502	2.78	4592	4.40	CA3240E	1.45	LM1934	3.50	TDA2030	2.50	8039	3.50	2114-3	2.50	14.318 MHz	1.60	AM25S50	3.50
7438	0.36	74LS41	0.12	74LS503	2.78	4593	4.40	CA3240E	1.45	LM1934	3.50	TDA2030	2.50	8039	3.50	2114-3	2.50	14.318 MHz	1.60	AM25S50	3.50
7439	0.36	74LS42	0.12	74LS504	2.78	4594	4.40	CA3240E	1.45	LM1934	3.50	TDA2030	2.50	8039	3.50	2114-3	2.50	14.318 MHz	1.60	AM25S50	3.50
7440	0.36	74LS43	0.12	74LS505	2.78	4595	4.40	CA3240E	1.45	LM1934	3.50	TDA2030	2.50	8039	3.50	2114-3	2.50	14.318 MHz	1.60	AM25S50	3.50
7441	0.36	74LS44	0.12	74LS506	2.78	4596	4.40	CA3240E	1.45	LM1934	3.50	TDA2030	2.50	8039	3.50	2114-3	2.50	14.318 MHz	1.60	AM25S50	3.50
7442	0.36	74LS45	0.12	74LS507	2.78	4597	4.40	CA3240E	1.45	LM1934	3.50	TDA2030	2.50	8039	3.50	2114-3	2.50	14.318 MHz	1.60	AM25S50	3.50
7443	0.36	74LS46	0.12	74LS508	2.78	4598	4.40	CA3240E	1.45	LM1934	3.50	TDA2030	2.50	8039	3.50	2114-3	2.50	14.318 MHz	1.60	AM25S50	3.50
7444	0.36	74LS47	0.12	74LS509	2.78	4599	4.40	CA3240E	1.45	LM1934	3.50	TDA2030	2.50	8039	3.50	2114-3	2.50	14.318 MHz	1.60	AM25S50	3.50
7445	0.36	74LS48	0.12	74LS510	2.78	4600	4.40	CA3240E	1.45	LM1934	3.50	TDA2030	2.50	8039	3.50	2114-3	2.50	14.318 MHz	1.60	AM25S50	3.50
7446	0.36	74LS49	0.12	74LS511	2.78	4601	4.40	CA3240E	1.45	LM1934	3.50	TDA2030	2.50	8039	3.50	2114-3	2.50	14.318 MHz	1.60	AM25S50	3.50
7447	0.36	74LS50	0.12	74LS512	2.78	4602	4.40	CA3240E	1.45	LM1934	3.50	TDA2030	2.50	8039	3.50	2114-3	2.50	14.318 MHz	1.60	AM25S50	3.50
7448	0.36	74LS51	0.12	74LS513	2.78	4603	4.40	CA3240E	1.45	LM1934	3.50	TDA2030	2.50	8039	3.50	2114-3	2.50	14.318 MHz	1.60	AM25S50	3.50
7449	0.36	74LS52	0.12	74LS514	2.78	4604	4.40	CA3240E	1.45	LM1934	3.50	TDA2030	2.50	8039	3.50	2114-3	2.50	14.318 MHz	1.60	AM25S50	3.50
7450	0.36	74LS53	0.12	74LS515	2.78	4605	4.40	CA3240E	1.45	LM1934	3.50	TDA2030	2.50	8039	3.50	2114-3	2.50	14.318 MHz	1.60	AM25S50	3.50
7451	0.36	74LS54	0.12	74LS516	2.78	4606	4.40	CA3240E	1.45	LM1934	3.50	TDA2030	2.50	8039	3.50	2114-3	2.50	14.318 MHz	1.60	AM25S50	3.50
7452	0.36	74LS55	0.12	74LS517	2.78	4607	4.40	CA3240E	1.45	LM1934	3.50	TDA2030	2.50	8039	3.50	2114-3	2.50	14.318 MHz	1.60	AM25S50	3.50
7453	0.36	74LS56	0.12	74LS518	2.78	4608	4.40	CA3240E	1.45	LM1934	3.50	TDA2030	2.50	8039	3.50	2114-3	2.50	14.318 MHz	1.60	AM25S50	3.50
7454	0.36	74LS57	0.12	74LS519	2.78	4609	4.40	CA3240E	1.45	LM1934	3.50	TDA2030	2.50	8039	3.50	2114-3	2.50	14.318 MHz	1.60	AM25S50	3.50
7455	0.36	74LS58	0.12	74LS520	2.78	4610	4.40	CA3240E	1.45	LM1934	3.50	TDA2030	2.50	8039	3.50	2114-3	2.50</				





Last month, we looked at how a vast technology had developed for the research and manufacture of semiconductor lasers for the optical fibre industry. Part one also mentioned how certain techniques could be applied to pulsed lasers in order to release the energy at a given instant to produce a higher peak power than would normally be achieved.

Such techniques include Q switching, cavity dumping and mode locking. These will be explored briefly before moving on to the development and manufacture of semiconductor lasers.

### HIGH ENERGY PULSES

An optical resonator can be interrupted in such a way that population inversion can proceed with no feedback, or very little feedback, to cause lasing. Then, when the population inversion has reached a high level, the interruption is removed so that the laser can emit a short, high power pulse.

The devices used are mechanical choppers and rotating mirrors for pulses of the order of 0.001 sec. For pulses of the order of  $10^{-6}$ s, acousto-optic modulators are used and Pockels and Kerr cells used for pulses of the order of

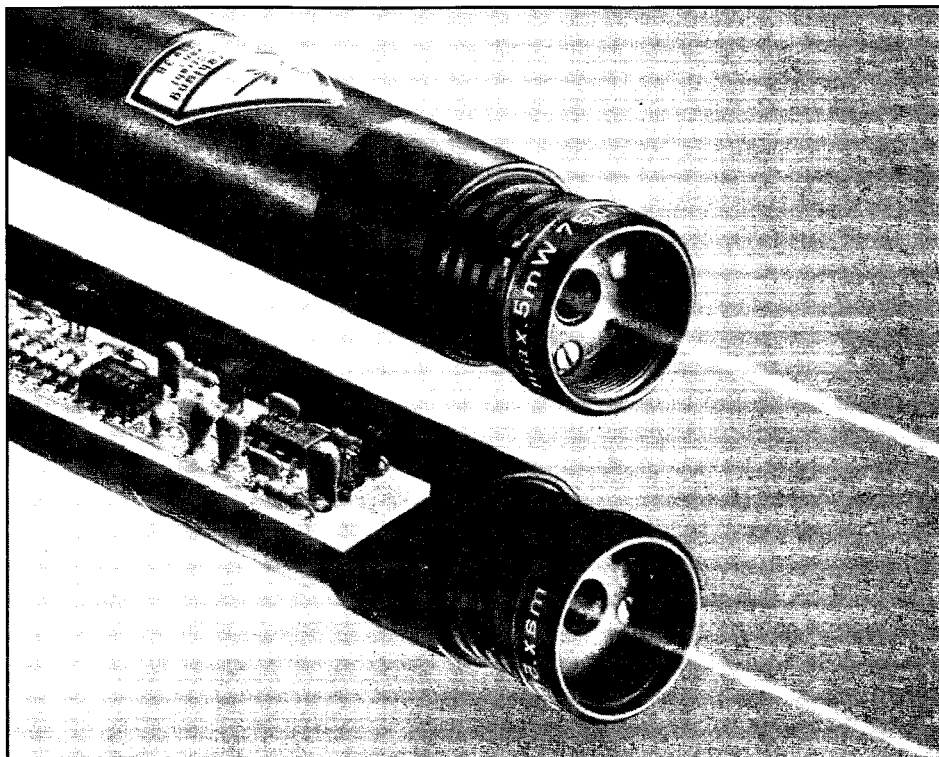

Diode lasers – photograph kindly supplied by Spindler and Hoyer.

# LASERS

$10^{-9}$ s. Acousto-optic modulators and Pockels and Kerr cells will be dealt with later.

The Q switches get their name from the Q value of a resonator and is defined as:

$$Q = 2\pi \frac{\text{energy stored}}{\text{energy lost per cycle}}$$

Cavity dumping does not provide the high power pulses that Q switching provides but is useful in instances where the laser cannot be subjected to Q switching. One of the reasons that a laser may not be Q switched is when the laser is not in the lasing state for a sufficient length of time.

Such a technique is used with dye lasers where the energy is allowed to build up with 100% feedback in a cavity. At a given instant the feedback is reduced to a low value and a high energy pulse is emitted.

A cavity is a physical cavity as with klystrons and microwave devices employing metal tubes ("plumbing") or a semiconductor chip in the case of semiconductor lasers. Further, the cavity in semiconductor lasers may be altered by the geometry or the doping of the material in order to restrict the amplification of light to that region, ie, the cavity.

Lasers operate in different modes both along the axis as well as across the cavity. Particularly with the wide band lasers, the modes of the different frequencies oscillate independently and therefore their phase relationships are random. If the modes can be locked together, then the modes can be put in step with each other which results in very short pulses of one pico second or less with very

## Part Two. Mike Sanders reflects on how in semiconductor lasers, the use of holes, grooves and cavities proves that absence makes the light grow stronger.

high power.

A popular technique is to use a saturable absorber such as an organic dye which absorbs the radiation in the cavity until all the modes are locked. When all the dye molecules have been excited, the dye is saturated and becomes

transparent for a fraction of a second allowing some of the energy to escape.

Using this method as many as one thousand modes can be locked in both continuous wave and pulsed lasers. The length of the dye cell is chosen so that the correct conditions are provided for saturation, (Fig.1).

### LIGHT EMITTING DIODES

The basic difference between a light emitting diode (led) and laser is that the laser has to be stimulated but the light emitting diode is spontaneous. This can be appreciated better from the characteristic curves.

Fig.2 shows the characteristic graph of a laser. As the drive current is increased, a threshold is reached when the optical output suddenly increases. By contrast, Fig.3 shows the characteristic curve for a light emitting diode which shows that the emission is fairly linear.

Since the graph of the laser is not linear it is unsuitable for analogue signals since these would distort. However, it is quite suitable for digital on-off keying.

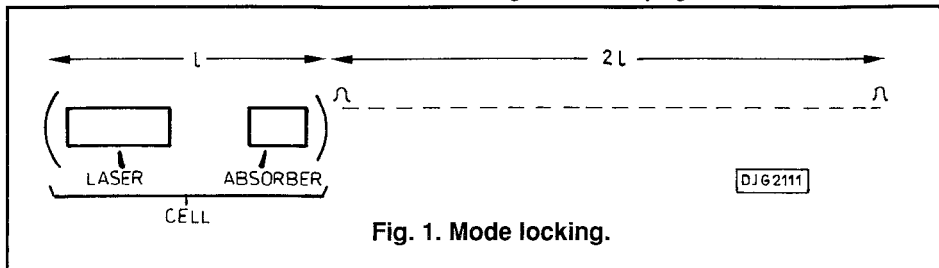

Fig. 1. Mode locking.

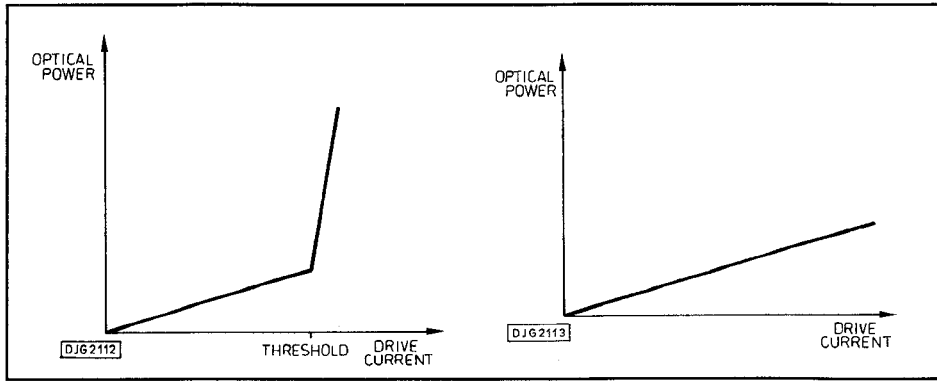

Fig. 2 and 3. Laser and led characteristic graphs.

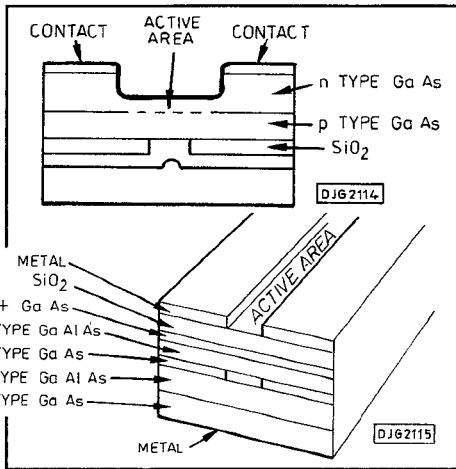

Fig. 4. and 5. Burrus and edge light emitting diodes.

Light emitting diodes operate in the infra red range for communications over optical fibre. The preferred wavelengths are  $0.85\mu\text{m}$  and  $0.95\mu\text{m}$  because of fibre characteristics as we shall see later.

Leds can have a well etched into them so that emitted energy is not lost. The wells are typically  $50\mu\text{m}$  in diameter to accommodate a  $50\mu\text{m}$  diameter optical fibre. Such leds are called Burrus diodes or high radiance light emitting diodes. (Fig.4).

In order to concentrate as well as guide the energy, edge light emitting diodes are constructed as shown in Fig.5. These approximate towards laser semiconductors in construction.

The refractive index of the stripe on top is uniform in order to produce a linear output. The stripe also acts as a waveguide and confines the edge emission so that it is sufficiently concentrated.

## SEMICONDUCTOR LASERS

As we have been looking at energy levels and energy bands, let us take another quick look at the differences between insulators, conductors and semiconductors. This is best done by looking at a diagram. Fig. 6 shows the band diagram for a conductor, insulator and semiconductor.

In the conductor the highest occupied band is partly filled. Surprisingly, in the insulator, the highest occupied band is also completely filled but the gap to the next band is wide, much wider than that in the conductor. In a semiconductor the highest occupied band is also completely filled as in an insulator but the gap to the next higher band is narrow, much narrower than that of a conductor.

A simple diode laser would consist of a p-n junction to form the laser cavity, also called the Fabry-Perot cavity. The end mirrors are plane (flat), parallel, partially reflecting mirrors to provide positive feedback.

Diode lasers are about  $250\mu\text{m} \times 50\mu\text{m}$  in size and emit several watts in pulses ranging from 100ns to 200ns. In the  $0.9\mu\text{m}$  wavelength several milliwatts average output is available for optical fibre communication, pollution detection and control, infra red illumination and pattern recognition.

The light is emitted parallel to the diode junction in lasers as opposed to perpendicularly to the junction as in most leds. There are about twenty known semiconductor materials from which diode lasers can be fabricated. These can emit from  $0.33\mu\text{m}$  to  $40\mu\text{m}$  in wavelength.

For wavelengths below  $0.8\mu\text{m}$ , electron beam excitation is used and above this wavelength, injection current is used. Fig.7 shows a simple p-n junction diode laser with drive current applied.

Fig.8 shows the energy band which offers opposition to migration across the junction in the unbiased state. When the drive current is applied, migration is much easier and light energy of frequency proportionate to the band gap is emitted. The contacts to the anode and substrate, (Fig.7), are usually gold plated for good conduction.

Diodes with the same semiconductor material on both sides of the junction are called homojunction lasers, but in a homojunction laser, at high currents, it is difficult to confine the holes and electrons to the junction for maximum combination.

In order to assist this process a third semiconductor such as gallium arsenide is applied to the p-n junction. The refractive index of this third layer is higher than the two neighbouring layers and therefore acts as a waveguide.

Since holes and electrons are confined to

Fig. 7. (Below). Diode laser. Fig. 8. (Right). Energy bands unbiased and forward biased respectively.

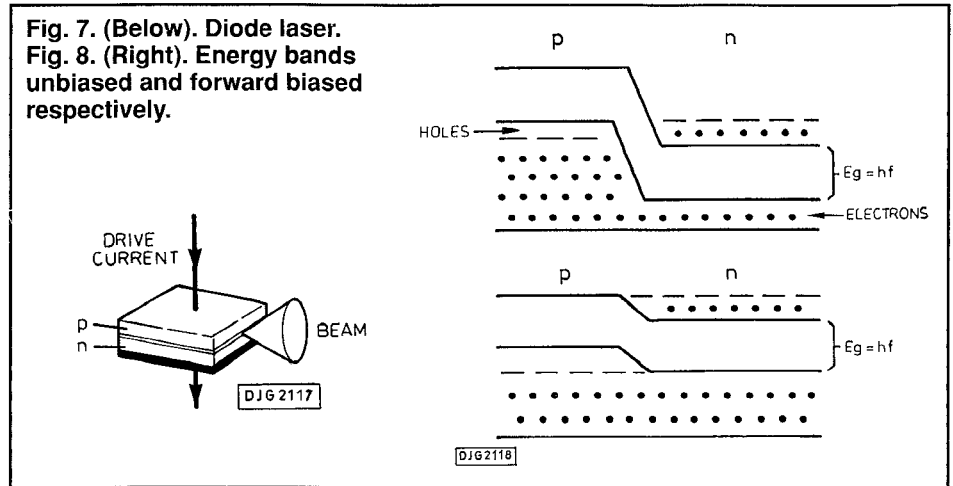
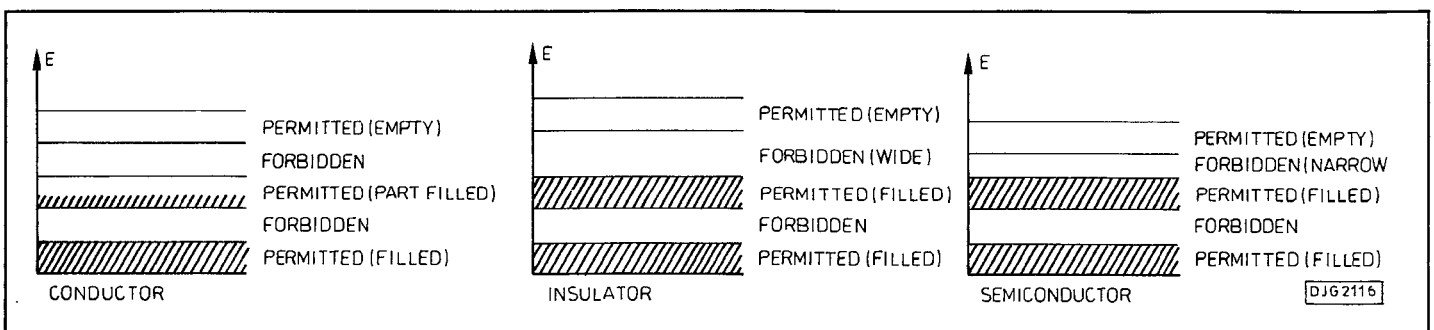

Fig. 6. Conductors, insulators and semiconductors.





this layer most of the lasing takes place here and this is now the Fabry-Perot cavity. Since the junction now has two dissimilar materials, this laser is called a heterojunction laser.

The laser cavity can be confined even further by making the electrical contact a narrow stripe and by including a cladding material of a different refractive index on each side of the active region to act as a lateral waveguide.

In this respect the geometry of the stripe laser is similar to that of the edge light emitting diode with one major difference. In the laser the stripe extends over the whole length of the chip, whereas it does not in the edge light emitting diode.

The purpose of placing a stripe over the laser is to permit feedback and hence laser action. Since the stripe does not cover the whole chip in the edge light emitting diode, the region without the stripe is an absorption region. Since light is absorbed here, there is no feedback, hence no lasing.

The minimum current required to produce lasing is called the threshold current and because of the heterojunction as well as the stripe, the amount of current is less than it would be without these refinements. The width of the stripe is typically 5µm to 20µm.

New versions of the gallium arsenide laser use double heterojunctions, (Fig.9), with stripe geometry. The double heterojunctions now refer to the junctions between gallium arsenide (GaAs) and the gallium aluminium arsenide (GaAlAs). This large optical cavity reduces the current density, hence the risk of damage from a large radiation field in the chip, is also reduced.

Fig. 9. Double heterodyne junction laser.

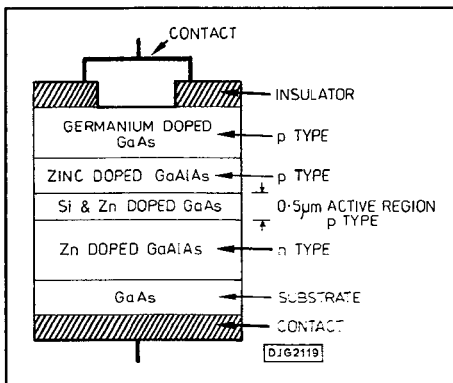

Gallium aluminium arsenide has poor thermal conductivity compared to gallium arsenide and the stripe contact improves the heat conduction from the active region. Since the active region is limited to a narrow stripe, lateral heat conduction takes place in the gallium arsenide and the rise in temperature of the active region is reduced.

The energy gap is wider in gallium aluminium arsenide than it is in the gallium arsenide, (Fig. 10), causing both holes and electrons to be reflected back into the active gallium arsenide region. This reduces the current density required to produce lasing.

In addition, the difference in refractive index between gallium arsenide and gallium aluminium arsenide causes light travelling at angles to the axis of the cavity to be reflected back into the active region. Both these factors mean that a smaller current density of the

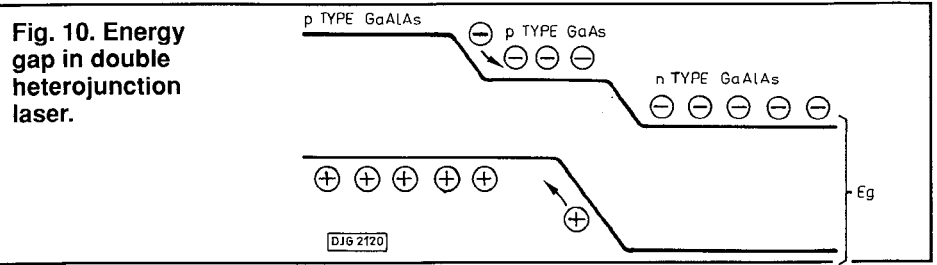

order of 1000A per square centimetre is sufficient to produce lasing.

This allows devices to be operated continuous-wave at room temperature. A typical output is 5mW with a 10 year life. Large optical cavity devices composed of two heterojunctions are called double heterojunction lasers and have cavities tens of micrometers wide instead of the 1µm of a homojunction. This reduces the risk of damage to the crystal from radiation. In spite of these measures the efficiency of a semiconductor laser at room temperature is about 4%.

The wavelength can be adjusted from 0.84µm to about 0.95µm by varying the quantity of aluminium. The active region below the stripe contains 5% aluminium and the other regions contain about 35% aluminium. This also helps the laser chip expand from the heat generated and presents it from cracking.

Stimulated emission in lasers produces a purer wavelength compared to spontaneous emission in light emitting diodes. This is because a photon emitted in a laser meets an electron and another photon of the same wavelength is emitted. Therefore the linewidth in a laser is much narrower, about 1nm compared to 20nm in light emitting diodes.

Because of the purer frequency in lasers a much wider communications bandwidth can be obtained (Fig. 11a). Compared to this, suppose there are two frequencies in the led emission, then modulating them with the same bandwidth as the laser will lead to overlapping sidebands (Fig. 11b).

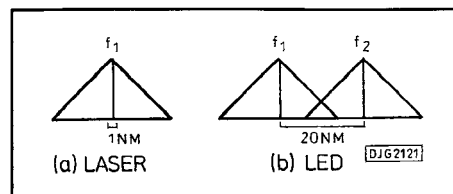

Fig. 11. Communications bandwidth.

As a result of this large bandwidth and the fact that lasers lend themselves to rapid on-off switching they are ideal for telecommunications over optical fibre and can transmit quite high data rates. Currently, 565 Mbit/s is quite common and laboratory experiments have yielded 2.4 Gbit/s, the limitations being as much on the fibre as the laser itself.

Obviously the purer the frequency, to the exclusion of other frequencies, the wider the bandwidth that is available from the laser. Also less energy needs to be coupled in and out of the device since all the energy is concentrated into a single carrier.

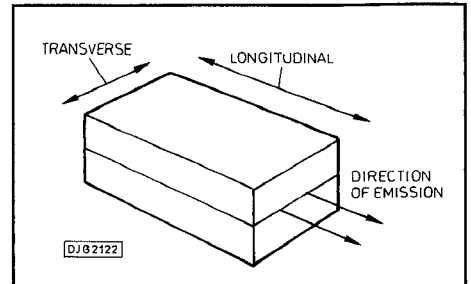

Fig. 12. Transverse and longitudinal modes.

### TRANSVERSE AND LONGITUDINAL MODES

At this point it would be useful to explain modes. A single frequency laser is not the same thing as a single mode laser. A single mode laser emits only the fundamental in the transverse mode but has several longitudinal modes.

The terms transverse and longitudinal, (Fig.12), do not refer to the electric field of the laser light but to the components of the light wave oscillating across the transverse or longitudinal directions of the laser cavity. The transverse mode is also called the spatial or lateral mode.

The fundamental transverse mode is a sine shaped wave, (Fig. 13), in which the peak of half a wavelength fits across the laser cavity. The waveform is said to have a Gaussian distribution, ie, peak power concentrated in the middle and dying off at the edges.

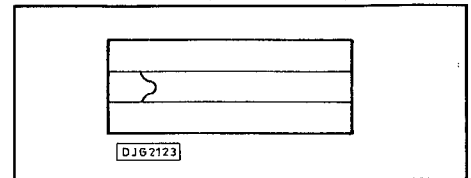
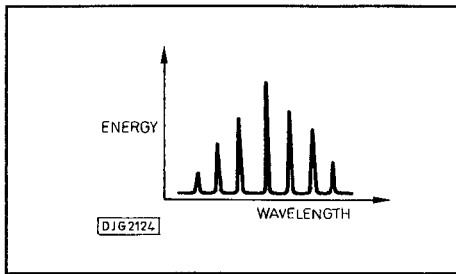

Fig. 13. Fundamental mode.

Modes with more than one peak are higher order transverse modes and produce a broader beam with the energy distributed across several peaks. As we have seen before, the higher modes can be eliminated by manufacturing lasers with a narrow enough active region so as to accommodate only the fundamental mode, (Fig. 13).

We have seen that spectral purity is a relative term. How pure is pure? A laser may be pure compared to say a light bulb, but the laser itself emits light over a range of about 100 Angstroms (1A = 1<sup>-10</sup> metre). Resonance between the end mirrors will reinforce and therefore amplify those frequencies with a whole number of wavelengths between the end mirrors.



**Fig. 14. Longitudinal mode.**

The result is a central line with about a dozen spectral lines spaced 2 Angstroms to 10 Angstroms apart, (Fig.14). Therefore there is one transverse mode but several longitudinal modes. If the laser can be restricted to one transverse and one longitudinal mode, a single frequency laser is obtained.

The obvious question must be asked. Is it not possible to design a filter so as to extract the desired mode? The answer is no, for two reasons. It is very difficult to design a filter with a narrow enough bandpass so that wavelengths only a few Angstroms away would be rejected.

But suppose it were possible to design a narrow band filter, the second hurdle is partition noise. A semiconductor laser is a coupled oscillator which resonates in several longitudinal modes. It can be compared to two pendulums joined by a spring.

If the pendulums are caused to swing, they will swing together some of the time, and at other times, only one will swing since the other will have transferred all its energy to the first. Therefore, although the whole coupled system shares the total available energy, this share is not equal and can in fact go down to zero for either pendulum.

The same thing happens with longitudinal modes in a laser with the energy coupled and transferred between the wavelengths. All the energy is shared between the wavelengths but at any given moment one wavelength could have more, or less energy than the others.

Therefore if one were to succeed in partitioning (filtering) one of the wavelengths it would suffer from partition noise. That is, it would be intense at times and silent at other times. Clearly, this is totally unsuitable for communications purposes and the only acceptable alternative is to construct the laser so that it emits a single frequency that is also stable.

There are four known methods of obtaining a single frequency:

- i) coupled cavities
- ii) frequency selective feedback
- iii) injection locking
- iv) geometry controlled lasers

## COUPLED CAVITY LASERS

The basic principle is that light travelling in an additional cavity causes radiation to be strengthened provided that wavelength exists in both the main cavity as well as the additional cavity.

One method of creating an additional cavity is to place an external mirror opposite

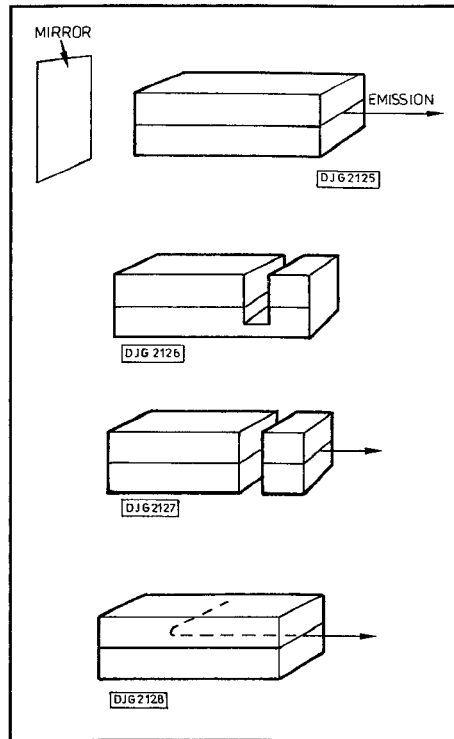

**Fig. 15 (top). External mirror.**

**Fig. 16. Grooved coupled cavity laser.**

**Fig. 17. Cleaved coupled cavity.**

**Fig. 18. Integrated reflective interference.**

the crystal mirror on the laser, (Fig. 15). The mirror may be flat but in practice is slightly concave to focus the energy back into the laser cavity. The external cavity can be fine tuned by temperature controlling the position of the mirror with a resistance heater.

Another method is to manufacture a two section laser, (Fig. 16), called a grooved coupled cavity laser. One section is the source of light and the other is the reflective element (etalon) and modulator. The first experimenters etched a groove one micrometer wide and used electrical contacts to each section. They managed to obtain single frequency pulses shorter than one nanosecond and tuned the wavelength by varying the current to the reflective element.

Instead of cutting a groove, the laser diode can be cleaved completely to form a cleaved coupled cavity (C<sup>3</sup>), (Fig. 17). The laser crystal is in unequal pieces and the shorter one is used as a frequency modulator.

When a current is applied to the modulator its refractive index changes. This alters the effective optical length and restricts the longitudinal mode to the required wavelength.

A separate cavity can be created without cleaving the laser crystal entirely. This is realised in the integrated reflective interference laser, (Fig. 18). Two straight segments are joined by a curved segment and this curved segment acts as reflective element between the two straight segments.

Altering the propagation characteristics like this causes the longitudinal modes to interfere with each other. Therefore only the wavelength that is amplified in both straight segments is radiated.

## FREQUENCY SELECTIVE FEEDBACK LASERS

Coupled cavity lasers force the device to operate at a single wavelength. The wavelength can also be tuned slightly by adjusting the current or temperature. However, the desired frequency cannot be selected by a diffraction grating whereas in the frequency selective feedback laser, the required frequency can be extracted by a diffraction grating.

If the grating is placed outside the laser, (Fig. 19), to form an external cavity, it acts as an external mirror. It can be fitted so that the grooves face the laser with the correct interval to reinforce the desired wavelength. Using this technique, spectral lines as narrow as 10<sup>-6</sup> Angstrom have been obtained. This is a thousand times narrower than the emission from a free running single mode laser.

The distributed Bragg reflector, (Fig. 20), is a complex version of the external grating. Instead of end mirrors, the distributed Bragg reflector has a grating at each end of the diode. This grating is in the plane of the active region.

If the period of the grating is half the wavelength of the required emission or a multiple of half wavelengths, the light is reflected backwards. This is the Bragg condition. The diffraction grating therefore acts as a frequency selective mirror which reflects back into the laser cavity those frequencies which satisfy the Bragg condition and bypasses the others.

A variation of the Bragg reflector is the distributed feedback laser, (Fig. 21), where the grating is fabricated directly above or below the laser cavity and is therefore inside the crystal. Once again the end faces do not determine the limits of the laser cavity. Instead, the wavelength that is reinforced is decided by the period of the grating.

**Fig. 19. External grating.**

**Fig. 20. Distributed Bragg reflector.**

**Fig. 21. Distributed feedback laser.**

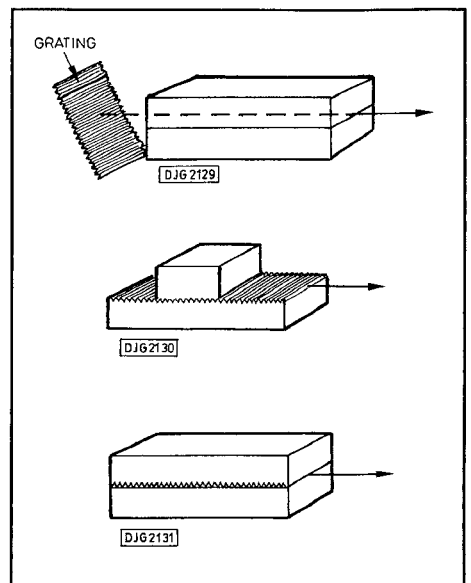

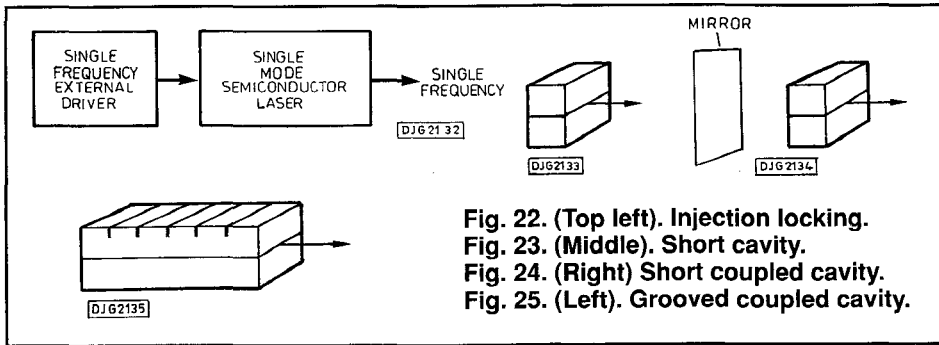

Fig. 22. (Top left). Injection locking.  
 Fig. 23. (Middle). Short cavity.  
 Fig. 24. (Right) Short coupled cavity.  
 Fig. 25. (Left). Grooved coupled cavity.

## INJECTION LOCKING

Injection locking was dealt with under techniques for producing short, peak power pulses and will only be dealt with briefly here. In the technique for producing a short, peak power pulse a dye absorber was used.

The technique for enhancing a single frequency uses a single frequency external source to drive the single mode laser, (Fig. 22). The external driver is of low power and does not have to be a semiconductor laser.

## GEOMETRY CONTROLLED LASERS

The main technique in geometry controlled lasers that has been found useful is that of a short cavity (Fig. 23). As before a single mode laser is used but the cavity is only about 50µm

which is a sixth of the usual laser cavity.

The adjacent longitudinal modes are then spaced about 20 Angstroms apart instead of only a few Angstroms. In addition the single frequency can be assisted by highly reflective coatings on the laser mirrors.

There are also many hybrid designs involving a combination of the above techniques. For instance a fixed external mirror can be combined with a short coupled cavity, (Fig.24). A bit rate of 2 Gbit/s has been obtained at a wavelength of 1.55µm using this technique.

Another hybrid technique combines the idea of a distributed feedback laser with the grooved coupled cavity laser, (Fig.25). In this multi section design the whole laser cavity has shallow grooves spaced about 40µm apart.

The purpose of producing a single frequency laser is to transmit a wider bandwidth than would otherwise be possible. Therefore, whilst each of the above methods will emit a continuous pure wavelength they can become

unstable when the drive current to the laser is modulated. The most common type of instability is mode hopping, that is, hopping from one longitudinal mode to another.

Each of the above techniques has its own problems of manufacture and operation. For instance the distributed feedback type needs an exact grating to be grown within the layers of the semiconductor. These lasers have been tested over 2000 hours of continuous operation using a wide range of current and temperature and their performance has not deteriorated.

The problem with the external mirror laser is to select and maintain the correct distance between laser and mirror in order to provide the required wavelength.

The cleaved coupled cavity is easy to manufacture since it involves cutting the chip into two pieces and attaching wires to each piece. But it is sensitive to changes in temperature and current.

Injection locked lasers can be operated stably and with good purity reducing the line width from 0.1 Angstrom to less than 10<sup>-4</sup> Angstrom. But they tend to be bulky since the driving laser could be a helium-neon laser.

In the next part we shall look at applications of lasers together with methods of manufacturing this important twentieth century tool.

Spindler and Hoyer UK Ltd, who kindly provided the photos for this series, are at 14 Tonbridge Chambers, Pembury Road, Tonbridge, Kent, TN9 2HZ. Tel 0732 770800.

PE

## MAKE YOUR INTERESTS PAY!

Over the past 100 years more than 9 million students throughout the world have found it worth their while! An ICS home-study course can help you get a better job, make more money and have more fun out of life! ICS has over 90 years experience in home-study courses and is the largest correspondence school in the world. You learn at your own pace, when and where you want under the guidance of expert 'personal' tutors. Find out how we can help YOU. Post or phone today for your **FREE INFORMATION PACK** on the course of your choice. (Tick one box only!)

Electronics	<input type="checkbox"/>	TV, Video & Hi-Fi Servicing	<input type="checkbox"/>
Basic Electronic Engineering (City & Guilds)	<input type="checkbox"/>	Refrigeration & Air Conditioning	<input type="checkbox"/>
Electrical Engineering	<input type="checkbox"/>	Car Mechanics	<input type="checkbox"/>
Electrical Contracting/Installation	<input type="checkbox"/>	Computer Programming	<input type="checkbox"/>
GCSE/GCE/SCE over 40 examination subjects to choose from			<input type="checkbox"/>

Name \_\_\_\_\_ Address \_\_\_\_\_



International Correspondence Schools, Dept. EDS80, 312/314 High Street, Sutton, Surrey SM1 1PR. Telephone: 081-643 9568 or 041-221 2926 (24 hours)

### Manufacturers Original Spares

Available for many makes of TV, Video & Audio equipment. Also Sinclair, Amstrad, Commodore & Atari Computers. Write (Encl. SAE Please) or Phone 0452 26883 for a 'Price & Availability' on your requirements.

	6526 CIA (C64/C/C128)	£10.86
	8565 VIC	£23.48
	8580 R5 (C64C)	£13.98
Commodore	8701 CLK.GEN. (C64/C128)	£ 7.56
&	901225 CHA.ROM (C64/C)	£ 6.37
Atari	901226 BAS.ROM (C64/C)	£ 9.21
Chips	906114 PLAN (C64/C)	£ 5.73
	PC900 PHOTOCOUPLER (ST)	£ 3.07
	CNY65 PHOTOCOUPLER (ST)	£4.64
	6C001E ULA (Spec.48K/+)	£15.99
Sinclair	7C001 ULA (Spec.128K/+2)	£16.99
&	UM1233 MODULATOR (Spec./QL)	£ 4.75
Amstrad	Spectrum Membranes (48K)-£4.50 (128K/+)	£ 7.90
Spares	Original Service Manual (PCW8256/8512)	£13.59
	PEGA1A (84pin)-£42.72 TEA2000-£4.04 MAB8049 (QL)	£ 5.96
	CPC464 Service Manual	£8.49
	CPC664 Service Manual	£13.49

For Catalogue/Lists please send 44p stamps/cheq./2xIRC's etc.

MAIL ORDER ONLY. Please add 95p (UK) P & P to above orders.

MARAPET (PEM) 1 Hornbeam Mews, Gloucester GL2 0UE



NATIONAL COLLEGE OF TECHNOLOGY

## Packaged Short Courses

The National College of Technology (NCT Ltd) offers a range of packaged short courses in analogue electronics, digital electronics & fibres, optoelectronics & programmable logic controllers for study at home or at work. The advantages are that you may,

- commence at any time
- work at your own pace
- have a tutor (optional)

and there is no travelling involved. BTEC certificates are available subject to the conditions of the award. These highly popular packed courses contain workbooks, a cassette tape, circuit board and components necessary to provide both theoretical and practical training.

Whether you are a newcomer to electronics or have some experience and simply need updating, there is probably a packaged short course ready for you. Write or telephone for details, quoting Practical Electronics, to:

**NCT Ltd, Bicester Hall**  
**5 London Road, Bicester**  
**Oxon OX6 7BU**

or telephone (0296) 613067 Ext. 202

Component Catalogue still valid into 1991

# CRICKLEWOOD ELECTRONICS



## 90'S DECADE COMPONENT CATALOGUE

- ONE OF THE LARGEST RANGES OF COMPONENTS IN THE UK
- FAST AND EFFICIENT SAME DAY PERSONAL SERVICE
- VERY COMPETITIVE PRICE; QUANTITY DISCOUNTS AVAILABLE
- DISCOUNT VOUCHERS INCLUDED
- NO MINIMUM ORDER

CRICKLEWOOD SUPPLY MOST OF THE COMPONENTS FOR P.E. PROJECTS. 13,000 STOCKLINES (MANY UNOBTAINABLE ELSEWHERE) PLEASE PHONE US FOR YOUR SPECIFIC NEEDS.

FILL IN THE COUPON AND POST IT WITH YOUR CHEQUE, PO ETC FOR £1.50 TO RECEIVE YOUR CRICKLEWOOD ELECTRONICS CATALOGUE AND VOUCHERS WHICH YOU CAN USE AGAINST YOUR NEXT PURCHASE

**Cricklewood Electronics Ltd**  
40 CRICKLEWOOD BROADWAY, LONDON, NW2 3ET  
Tel: 081-450 0995/452 0161  
Fax: 081-208 1441 Telex: 914977

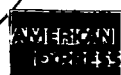

TELEPHONE ORDERS OUR SPECIALITY

### CRICKLEWOOD ELECTRONICS COMPONENTS CATALOGUES

PLEASE SEND ..... COPIES OF THE CRICKLEWOOD ELECTRONICS CATALOGUE AT £1.50 TO:

NAME .....

ADDRESS .....

.....

.....

.....

Remittance enclosed £.....

# Astronomy Now

## Britain's leading astronomical magazine

### Astronomy Now



### In the December issue:

- Volcanoes on Io ○
- The Case Against Astrology ○
- Aldebaran – Red Eye of Taurus ○
- ○ ○

plus: News Update - The Night Sky - Picture Gallery and more...

**December issue on sale soon - price £1.50!**



**T**he "space news" this month is a mixture of the good and the bad. Magellan, the space-craft which is orbiting Venus, is sending back excellent results, and showing that Venus is an even more intriguing place than we had believed - I will have more to say about it in the near future. Galileo, on its way to Jupiter, is showing some alarming eccentricities - but so did Voyager 2, soon after its launch in 1977, and we all remember the superb views which it sent back from the outer planets!

**HST MIRROR**

The cause of the problems with the Hubble Space Telescope have now been identified. They arose from a faulty piece of testing equipment, which resulted in the main mirror being given the wrong figure. One must admit that it is hard to understand how such a mistake can have passed unnoticed, particularly since it was, by conventional standards, very large - but we must now make the best of the situation.

Suggestions of bringing the telescope down for repair have been discounted; it would be too risky, particularly in view of all the problems with the Shuttle. The main mirror cannot be put right. Therefore, the only chance seems to be to send up new auxiliary equipment which has 'built-in' errors to compensate for the error in the main mirror. This may be possible; time will tell. Meanwhile, some good results are being obtained, and of course the telescope will be supreme in the ultra-violet range, because the ultra-violet radiation from space cannot penetrate through to the Earth's surface. So perhaps the best verdict at the moment is to say that the telescope is a partial success - even though we have to admit, sadly, that it could have been and should have been so much better.

**SPACE**

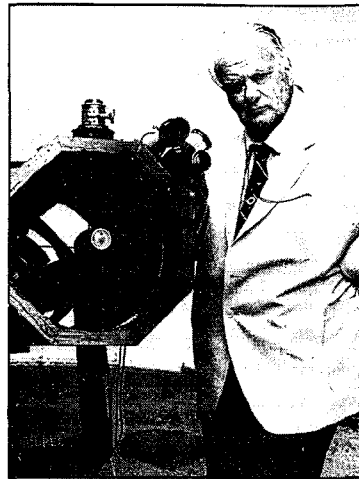

**WATCH**

BY DR PATRICK MOORE CBE

**Despite its problems the HST is giving us a better view of the universe, though we could soon be examining Mars with the naked eye.**

**A NEW LOOK AT MARS**

Mars reaches opposition this month, and cannot be overlooked; it shines brilliantly down, and surpasses any other star or planet apart from Venus and Jupiter. Telescopes

show its red surface, its dark patches, and its whitish poles. Mars is a fascinating place - and beyond the Moon, it must surely be our next port of call.

The main trouble about Mars is the lack of a breathable atmosphere. The atmosphere has a ground pressure of below 10 millibars everywhere, and is made up chiefly of carbon dioxide, with little free oxygen. Moreover, the temperature on the surface is very low. But apart from this, Mars is not so very unwelcoming and there is a great deal of H<sub>2</sub>O, locked up in the form of ice, not only at the poles but also, we believe, below the ground in lower latitudes.

What, then, are the chances of colonising Mars? If the first journeys there are made within thirty years - and this seems a reasonable estimate - advance bases will be set up, though we must first send 'sample and return' probes to tell us more about the planet's make-up. The surface gravity is one-third that of ours, and the day and night conditions are much the same inasmuch as Mars has a rotation period about half an hour longer than ours; the axial tilt is also about the same, so that the seasons will be of the same general type as those of Earth apart from being much longer. (Mars has a 'year' of 687 Earth days or 668 Martian days or 'sols'.)

There is no chance of turning Mars into a second Earth; even if we could provide it with a terrestrial-type atmosphere the weak gravity would be unable to hold it down. There is, however, every prospect that by the end of the 21st century there will be flourishing colonies there. Life will always have to be under artificial conditions, and it is also questionable whether a baby born and brought up under Martian conditions would ever be able to adapt to the stronger gravity of Earth; all the same, it does look as though Mars is the one planet beyond the Earth-Moon system where Man may be able to establish himself in the foreseeable future.

PE

**THE NOVEMBER SKY**

**W**ith the darker nights, the stars are back in their full glory. Of the planets, Mercury and Venus are to all intents and purposes out of view, and Saturn - still very low in the sky - sets early; but to make up for this we have Jupiter and Mars, both of which are striking all through the month. Mars comes to opposition on November 27, while Jupiter, in Cancer (the Crab) is on view all through the latter part of the night. Jupiter has been particularly interesting in recent months, because of the strange disturbances taking place there; one of the main belts (the South Equatorial), which vanished in 1989 with disconcerting suddenness, has started to reappear together with the famous Great Red Spot, which we now know to be a vast whirling storm coloured probably by phosphorus.

The Moon is at Last Quarter on November 9, new on the 17th, First Quarter on the 25th. Full Moon, on November 2, coincides with perigee - that is to say, the time when the Moon is at its closest to the Earth - though the difference in apparent sizes is not really noticeable with the naked eye. (Incidentally, it is a fallacy to suppose that moonlight is comparable with even weak sunlight. You would need 400,000 Full Moons to equal the light of the Sun.) There are no solar

or lunar eclipses this month.

The brilliant winter groups are now coming back into view. Orion rises at a reasonable hour, preceded by Aldebaran in Taurus (the Bull), with the Pleiades; there is also Capella in Auriga (the Charioteer), one of the two brilliant stars which can pass overhead as seen from Britain - Vega, in Lyra, is the other, but during November evenings Vega is descending in the north-west, together with the other members of the so-called Summer Triangle, Altair in Aquila (the Eagle) and Deneb in Cygnus (the Swan).

Ursa Major, the Great Bear, is at its lowest in the north, though it never sets; the W of Cassiopeia is near the zenith or overhead point, with the Square of Pegasus high in the south. Also in the south is Cetus (the Whale). Mira or Omicron Ceti, the famous variable star, was at maximum in October, but should remain a naked-eye object through November even though it will fade steadily.

Look also for the misty patch which marks the Great Spiral in Andromeda, not far from Pegasus. It does not seem very impressive but it is in fact a vast galaxy, containing more than our quota of 100,000 million stars, and so remote that its light takes well over two million years to reach us.

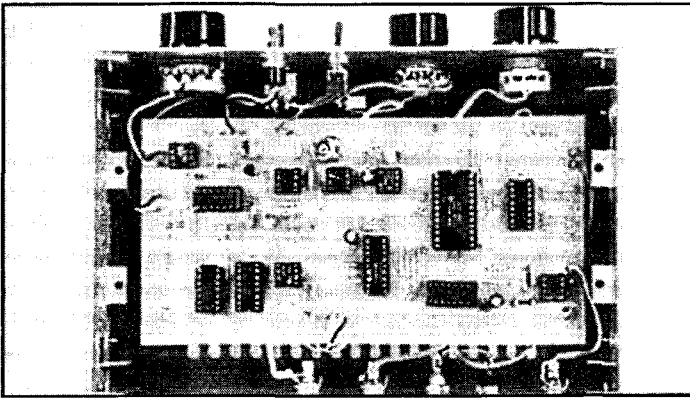

## NICE AND EASY DOES IT

**B**uilding the projects published in PE is a lot easier than some of you perhaps might think. Especially when you use one of our professionally made printed circuit boards.

It's almost like painting by numbers. All the pcbs are fully drilled, and basically all you need to do is slot in the components and carefully solder them to the pcb track pads. Their places are shown in the drawings published with the project.

## IDENTITIES

Component identities are usually clearly marked on them. Even if they are colour coded, like some resistors and capacitors, their values are easily worked out from component colour code charts. From time to time we publish these charts, but if you don't already have one, send a 9in x 4in stamped and self-addressed envelope to the Editorial office asking for one.

## TOOLS

For many projects you only need a few simple tools - Soldering iron between 15W and 25W, with a bevelled tip. Damp sponge for keeping the tip clean. Good multicore solder of 18swg or 22swg grade. Fine nose pliers for wire shaping. Adjustable spanner or heavy pliers for tightening nuts. Miniature screwdriver for adjusting preset controls. Small wire cutters for trimming component leads. Drill and selection of bits for drilling holes in boxes. Strong magnifying glass for checking joins in close up. It's also preferable to have a multimeter for setting and checking voltages. There are some very good low cost ones available through many of our advertisers, but get one that is rated at a minimum of 20,000 ohms per volt. Many projects do not require you to have a meter, but if you are serious about electronics, you really should have one.

## ASSEMBLING THE PCB

Authors will sometimes offer their own advice on the order of assembly, but as a general guide, it is usually easier to assemble parts in order of size. Start though with the integrated circuit sockets. Please use them where possible, they make life much easier than if you solder the ics themselves - with sockets you can just lift out an ic if you want.

Then insert and solder in order of resistors, diodes, presets, small capacitors, other capacitors, and finally transistors. Clip off the excess component wires before soldering, then make sure the solder covers the pads and the wires. Now use a magnifying glass, ideally one that you can hold to your eye, and take a good look at the joints, checking that they are satisfactorily soldered, and that no solder has spread between the pcb tracks and other joints. Be really thorough with visual checking since errors like this are the most likely reason for a circuit not working first time.

## SOLDERING

Bring the tip of the iron into contact with the component lead and the pcb solder pad, then bring the end of the solder into contact with all three, feeding it in as it melts. Once sufficient solder has melted to fully surround the pad and the lead, remove the solder, and then the iron. Now allow the join to cool before touching it, otherwise the solder may set unsatisfactorily. If it does move, just reheat the join once more.

## WIRING

Connecting the pcb to the various panel controls is the final assembly stage. Do this just as methodically, following the published wiring diagram. You can connect the wires to the pcb in one of three ways. The best is to insert terminal pins into the connecting holes on the pcb, and then solder wires direct to them. Or, pass the end of the wire through the pcb hole, soldering it on the other side. Alternatively, the wire can be carefully soldered direct to the pcb tracking. In all cases first strip the plastic covering off the wire, twist the strands together, and apply solder to them to keep them secure.

## TESTING

Now you are ready to test and use the project as described by the author. Components can occasionally fail, but these days it is extremely uncommon, and if you have followed the instructions, been careful with your joins, and bought the parts from a good supplier, you will have the enormous satisfaction of having built an interesting and working unit. It really can be easy if you do it with care.

## CHOOSE ONE NOW!

The PE PCB Service list shows all the pcbs available through PE. Look down the list and see which title takes your fancy - there must be at least one that will interest you! You will probably already have the relevant issue of PE, but even if you don't we can still help you.

## BACK ISSUES

We can usually supply copies of back issues of PE up to three years old. These are £1.75 each including postage (£2.25 for overseas readers). If we no longer have the issue needed, we will be pleased to send a photocopy of the article for the project that you want to build. These are £1.00 each per issue, including postage (£1.50 to overseas readers).

## OBTAINING PARTS

Some projects are available from advertising suppliers as complete kits. Otherwise, all the components listed in the text will be available from suppliers who specialise in individual components.

Occasionally a specific part may only be available from a particular supplier, if so the source will be given in the parts list. Otherwise there should be no difficulty in buying the parts. We have many good suppliers advertising in PE so have a look through their adverts - that's why they're here! Even though a part may not be listed in the adverts, a phone call or two should find a supplier who will be pleased to help. Like us, they too are in the business of encouraging you to enjoy electronics!



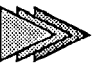

**W**e began to look at the concept for addition last month. Let's follow with an investigation.

**Investigation 4 - Adder circuit**

Figs. 13 and 14 show how to demonstrate the adder on a breadboard. The three input resistors R1-R3 and the feedback resistor R4 all have the same value. We obtain two input voltage levels from the resistor chain R5-R7. The voltage at the R5/R6 junction is approximately 0.18V and that at the R6/R7 junction is approximately 0.11V. Actual values and the results of adding them depend on the actual values of the resistors used.

There are three flying leads from each input resistor. Try plugging two or all three of these into the 0.18V or 0.11V sockets to find the sum of the following sets of voltages.

- 0.11 + 0.18 =
- 0.18 + 0.18 + 0.18 =
- 0.11 + 0.11 + 0.18 =
- 0.11 + 0.11 + 0 = (use the 0V rail)

How would you modify this circuit to find the value of  $1.5 \times (0.11 + 0.18)$ ? Unless you need the breadboard for something else, keep this circuit made up, as it needs only a little modification to prepare the board for the next investigation.

**Part 12: Owen Bishop continues the opamp theme, discussing addition, subtraction and integration.**

**MORE ADDITION**

In the investigation we were adding steady (dc) voltages, but the opamp can add varying (ac) voltages just as easily. An application of this is when the opamp is used to add audio signals - as an audio mixer. The signals from a microphone, a disc player, an electric guitar and possibly from other instruments as well, are fed to the (-) input through separate input resistors. The output signal contains all the component signals.

The adder can deal with subtraction too, simply by inputting negative voltages. Base your investigation on Fig. 14, but set up a second potential divider to provide negative voltages. Fig. 13 has three input resistors, but we can have more if we need them. Thus the circuit can add (or subtract) a large number of values simultaneously.

Fig. 15 shows another way of inputting to the opamp adder. The voltages are all equal

( $V_{in}$ ) but the resistors differ. The currents flowing to the opamp are *weighted*. Running down the diagram, each current is exactly half that of the previous input. Let us see how this works. Suppose that  $V_{in} = 0.4V$  and the feedback resistor has the value R. We connect various combinations of inputs to  $V_{in}$ , and leave others unconnected, to obtain a series of values of  $V_{out}$ . In the table below, 'O' represents 'unconnected' (or connected to 0V) and '1' represents 'connected' (to +0.4V).

Connections			Currents	$V_{out}$
A	B	C		
0	0	0	0	0
0	0	1	1/4	0.1
0	1	0	1/2	0.2
0	1	1	1/2+1/4	0.3
1	0	0	1	0.4
1	0	1	1+1/4	0.5
1	1	0	1+1/2	0.6
1	1	1	1+1/2+1/4	0.7

The combinations of inputs on the left represent the numbers 0 to 7, in binary. The value of  $V_{out}$  obtained in each case is the equivalent decimal number, scaled so that  $0.1V = 1$  on the scale. Thus a binary weighting of the input resistors gives an adder circuit that converts binary numbers into decimal numbers. With more weighted inputs, the adder could cope with more binary digits

**BASIC ELECTRONICS**

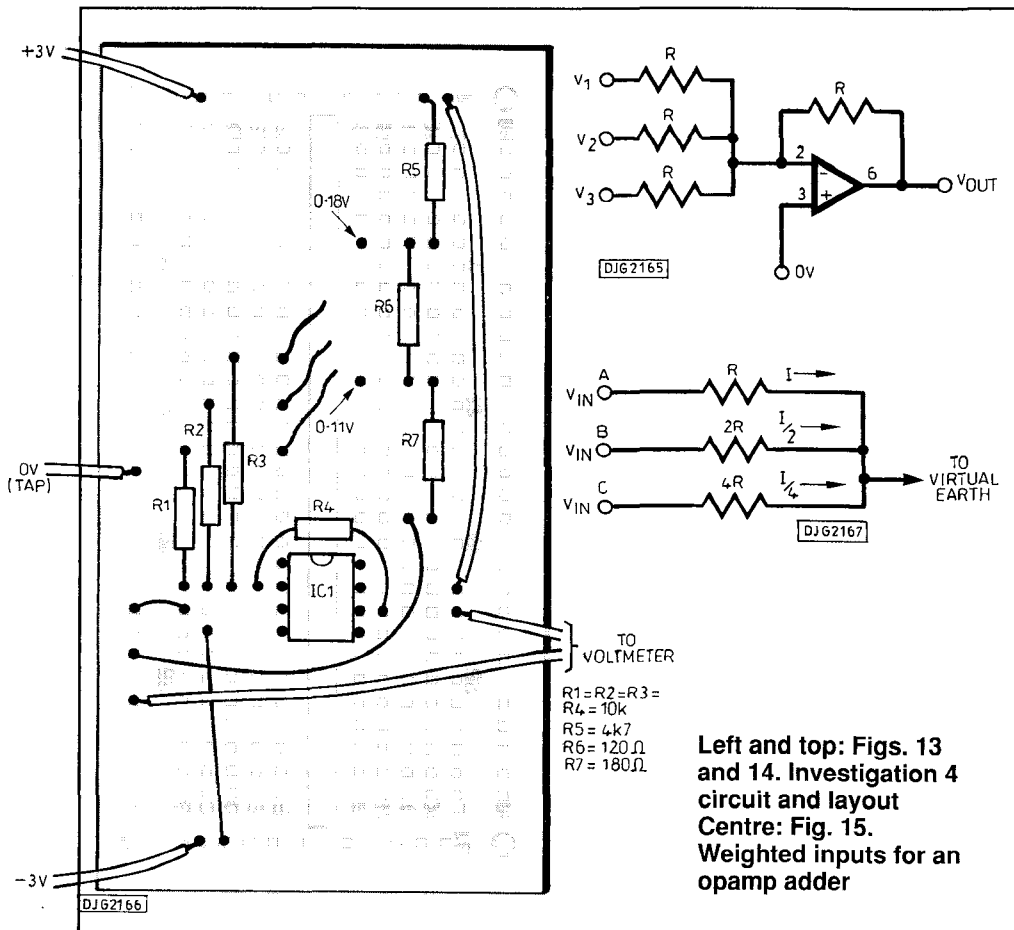

Left and top: Figs. 13 and 14. Investigation 4 circuit and layout  
Centre: Fig. 15. Weighted inputs for an opamp adder

and the values of  $V_{out}$ , although still actually stepped, would appear to range smoothly over the scale. This is one way of making a *digital to analogue converter*. If the output of the opamp is used to vary the speed of an electric motor, for example, we can control the speed of the motor by means of a binary input, such as from a computer.

**DIFFERENTIAL AMPLIFIER**

Fig.16 shows the opamp being used to measure the difference between two input signals,  $V_1$  and  $V_2$ . Since the resistors are all equal in value, the voltage at (+) is  $V_2/2$ . There is negative feedback to (-) so this must also be at  $V_2/2$ . The voltage across the (-) input resistor is  $V_1 - V_2/2$  and so the current through it is

$$-\frac{(V_1 - V_2/2)}{R}$$

This current flows on through the feedback resistor, so the voltage drop across that resistor must be:

$$-\frac{(V_1 - V_2/2)}{R} \times R = -(V_1 - V_2/2)$$

With the (-) end of the resistor at  $V_2/2$ , output voltage is

$$V_2/2 - (V_1 - V_2/2) = V_2 - V_1$$

The output depends upon the *difference* between the inputs. Another way of looking at the action of this circuit is to say it is a *subtractor*. You could try breadboarding this circuit to confirm that it works as stated.

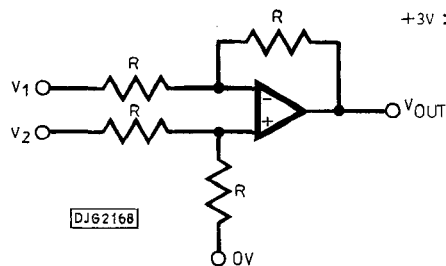

DJ62168

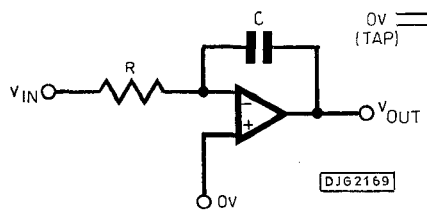

DJ62169

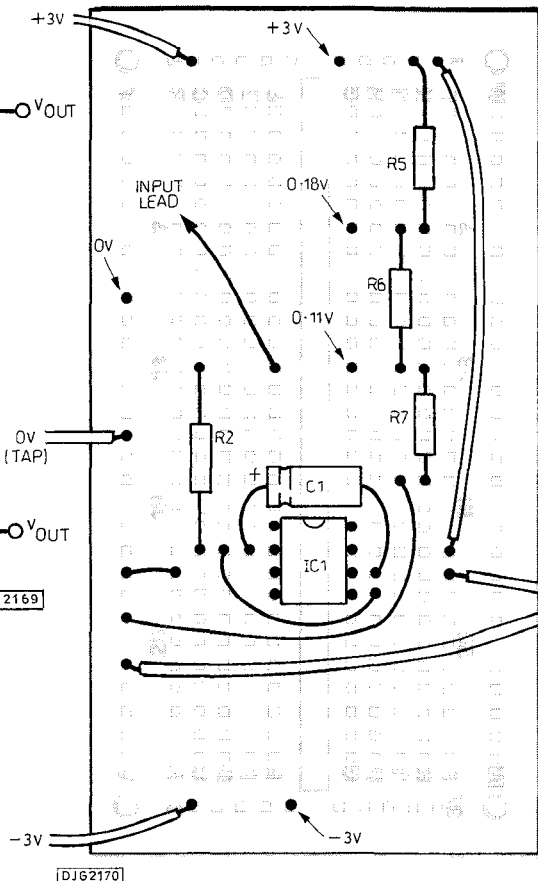

DJ62170

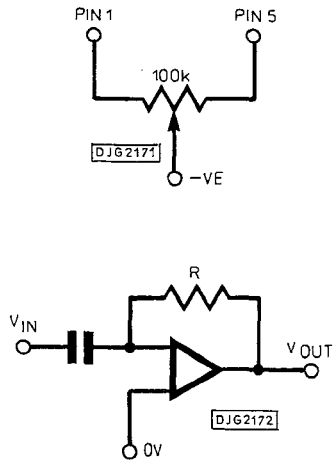

Fig. 19 (Top).  
Compensating for input voltage offset.  
Fig. 20 (Above).  
Differentiator.

Fig. 16 (Top). Differentiation amplifier.  
Fig. 17 (Above). Investigation 5. An integrator.  
Fig. 18 (Centre). Layout for investigation 5.

## CAPACITORS AND OPAMPS

What happens if we replace the feedback resistor of an inverting amplifier by a capacitor, as in Fig. 17? Obviously, it is going to have an effect on the way the opamp responds. Let us try it and see.

### Investigation 5 - the effect of a capacitor

The breadboard layout is almost the same as for Investigation 4, except that there is only one input resistor, and that the feedback resistor is replaced by a 10μ capacitor. A flying lead is used to short-circuit pins 2 and 6, to discharge the capacitor when required. For this investigation it is preferable to use a testmeter with a moving-coil meter, as we need to be able to visualise the *rate of change* of voltage, rather than its value. Alternatively, use a digital meter with an analogue 'bar' display. Connect the meter with its negative terminal to pin 6 and its positive terminal to 0V.

1. Connect the battery. What is the output voltage?
2. Plug the input lead into the 0.11V socket. What happens to the output voltage?
3. Plug the input lead into a 0V socket. What happens?
4. Discharge C1 by using the other flying lead, so that the output voltage returns to 0V.
5. Repeat step 2, using the 0.18V socket. What difference do you notice in the response of the opamp? If necessary, discharge C1 and repeat steps 2, then 4 and 5.
6. Repeat step 2, using a +3V socket. What happens?

7. Now plug the input lead into a -3V socket? What happens?
8. Discharge C1, repeat step 2 using the 0.11V socket but insert the lead and remove it several times. What effect does this have?
9. Replace the input resistor with a 100k resistor, and repeat some of the steps above. What difference do you notice?
10. Replace the 10k input resistor; then replace C1 with a 100μ capacitor and repeat some of the steps above. What difference does this new capacitor make?

## INTEGRATION

The investigation shows that output increases (in the negative direction) for as long as there is a positive input voltage. The greater the voltage, the greater the rate of increase. The circuit is acting as a storage device, summing the input voltage over time. In mathematics we describe this action as *integration*. The equation for the output of this circuit is:

$$V_{out} = \frac{-1}{RC} \int V_{in}.dt$$

The way this equation is derived is beyond the scope of this series but those who have done calculus at school will recognise that the expression for  $V_{out}$  is an integral in time. The constants R and C show that  $V_{out}$  at any instant also depends on the values of the input resistor and the capacitor. If the resistor is 10k and the capacitor is 100μ, as in step 10 of the investigation,  $RC = 10^3 \times 100 \times 10^{-6} = 1$  so that  $V_{out} = \int V_{in}.dt$ . The output voltage increases at the rate of Vin volts (0.11V) per

second. Actually, it is not likely that you will be able to demonstrate this, for two reasons. One reason is that electrolytic capacitors have a relatively high leakage current. This affects the rate at which the charge accumulates. This difficulty can be overcome by using a higher value resistor with a lower value polyester capacitor. A resistor of 10M, with a capacitor of 100n, also makes  $RC = 1$ .

If you try this, you will probably find that  $V_{out}$  either rises or falls slowly, even when  $V_{in}$  is connected to 0V. This is due to a source of error inherent in the opamp. It is known as *input voltage offset*, and is due to slight asymmetries in the construction of the chip. The consequence of this is that the opamp *behaves* as if there is a voltage difference between its inputs, when there is not. The input offset voltage varies from chip to chip. Typically this offset is only 1mV-2mV but may be up to 5mV in extreme cases. The offset is small enough to be ignored in many applications but, in the case of the integrator, it is something that increases in importance the longer the circuit is running. With input connected to 0V, the offset voltage becomes integrated with respect to time. Given long enough, the output gradually goes positive or negative (depending on the polarity of the offset voltage) and eventually finishes up fully positive or negative. The next investigation shows how to compensate for voltage offset.

### Investigation 6 - input offset compensation

The circuit is the same as in Fig. 18, with the addition of a variable resistor. The input resistor is 10M and C1 is 100n (polyester). Connect the resistor as in Fig. 19.

Plug the input lead into a 0V socket. You may need to reverse the meter connections to get a positive reading on the scale. Watch the meter needle - it is probably moving slowly up or down the scale. If it moves below 0V,



return it to the scale by plugging the input lead into +3V or -3V for an instant. Then return it to 0V.

Slowly adjust the variable resistor. It is possible to make the needle move one way or the other by suitable adjustments. Adjust it until the needle does not move - or at least makes no appreciable movement in a period of about one minute. you have now compensated for the input offset voltage.

Connect the meter as before, with its negative terminal to the opamp output and its positive terminal to 0V. If necessary, touch the input lead to +3V or -3V to bring it to the lower part of the scale. Now plug it into 0.11V. Measure how much the voltage rises during a period of 10s. What is the voltage change per second?

**RAMP GENERATOR**

The integrating opamp circuit is an obvious candidate foanologue computing since it is able to perform the mathematical operation of integration. It can perform all sorts of calculations relating to velocities and accelerations, find the areas under curves, find the volumes of complex solids, and any other computations which involve integration.

As illustrated in Investigation 6, the integrator has another useful action as a *ramp generator*. We met such a circuit in an earlier part when we used a unijunction transistor for that purpose. A ramp generator produces a voltage output that increases or decreases at a fixed rate. Such voltage ramps have many applications in circuits that involve timing - in the sweep generator of an oscilloscope, for example. Opamps are widely used to produce ramps because the rate of change of voltage can be very precisely set.

**CONVERSE CIRCUIT**

Now we will try swapping round the resistor and capacitor of Fig.17. As we might guess, the new circuit (Fig.20) performs the reverse operation. The reverse of integration is *differentiation*. When we integrate using an opamp, we convert a voltage into a rate of change of voltage. A differentiator converts a rate of change of voltage into a voltage. The

output of the circuit of Fig.20 is given by the equation:

$$V_{out} = -RC \frac{dv}{dt}$$

In this equation, dv/dt is the rate of change of input voltage. What this means is that, if input voltage changes slowly, Vout is small. Note that the actual level of the voltage does not matter (provided that it is within the supply rail limits). It is the *rate of change* that is important. In the extreme instance, if Vin has a fixed value and does not change at all, Vout is zero. But if Vin changes rapidly, Vout is large. The differentiator is very good at detecting changes in its input voltage but it suffers from a high disadvantage. It is very susceptible to 'noise' such as electrical spikes in the circuit. These spikes may not cause a large change in input voltage but, with a short spike lasting only a few microseconds, the rate at which the voltage changes can be very high. The output shows large erratic spikes unless steps are taken to eliminate noise from the input circuit.

This month we have looked at some of the many applications of the versatile operational amplifier. There are still some other ways it can be used, particularly in the audio field, which we shall discuss next month.

**MODULE OF THE MONTH**

**Module 15 - Non-inverting amplifier**

This module (Fig. 21) is based on Fig.3 but the feedback resistor is variable, so that the gain can be varied over the range 1 to 1000 or more. The input voltage can be fed either directly to the input resistor or indirectly by way of a coupling capacitor. This gives the option of using it for dc amplification or for amplifying ac signals that

have a dc component. The opamp is the CA3140, as used in this month's investigations. This opamp operates on a power supply of +2V to +18V. Many other opamps have the same pin-out so can be substituted for the CA3140. These include CA3130, LM308, 741 and TL071C. The design of this module can be used as the basis for other opamp modules.

**Parts required:** VR1 1M miniature horizontal preset resistor (a 'volume control' variable resistor can be substituted for this if preferred); C1 100n polyester; IC1 CA3140 opamp SKT1, SKT3 2-way pcb socket (2 off); SKT2 2-way pcb socket; stripboard 63mm x 25mm.

**DISCUSSION**

**Investigation 4:**

Outputs are 0.29V, 0.54V, 0.40V, 0.22V, but you will get different results if the voltages on the potential divider are not exactly 0.11V and 0.18V (check them).

To multiply the sum by 1.5, use a 15k feedback resistor.

**Investigation 5:**

- 1) Vout = 0V. 2) Vout slowly swings negative.
- 3) No change in Vout. 4) Vout swings negative, but more quickly than at step 2. 5) Vout wings negative more quickly still. 6) Vout swings quickly positive. 7) Vout swings negative when the lead is in the 0.11V socket; stops swinging when it is in the 0V socket; continues when the lead is replaced in the 0.11V socket. 8) As before but much more slowly. 9) As before but much more slowly.

**Investigation 6:** If the input offset is correctly adjusted, Vout falls as the rate of 0.11V per second.

PE

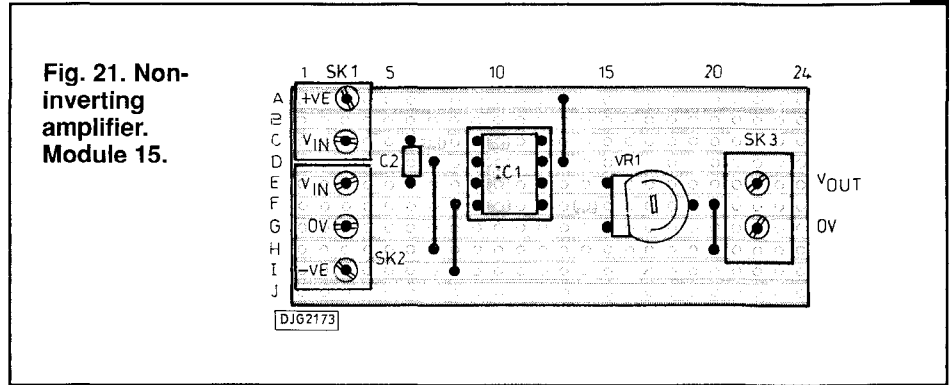

**Fig. 21. Non-inverting amplifier. Module 15.**

**Newsagent Order Form**

Dear Newsagent, I like reading Practical Electronics magazine. Please deliver/save one copy each month until further notice.

My name is .....

Address .....

**Don't miss a single issue of PE! Make a firm order with your Newsagent!**



Newsagent

# PE PCB SERVICE

## IT IS EASY TO BUILD PRACTICAL ELECTRONICS PROJECTS!

Simplify your project assembly - use a ready-made printed circuit board. All are fully drilled and roller tinned. Just slot in the components as shown in the project texts, and solder them. PCBs are the professional route to project perfection.

### MAIL ORDERING

Select the boards you want, and send your order to:

PE PCB SERVICE, PRACTICAL ELECTRONICS, 193 UXBRIDGE ROAD, LONDON W12 9RA.

Prices include VAT and postage and packing. Add £2 per board for overseas airmail. Cheques should be made payable to Intra Press (Payments by Access and Visa also accepted). Quote the project name and PCB Code Number, and print your name and address in Block Capitals. Do not send any other correspondence with your order.

### TELEPHONE ORDERS

Use your Access or Visa card and phone your order to **081-743-8888** clearly stating your name and address, card number and order details. All orders receive priority attention. Many PCBs are held in stock, so they are dispatched within a few days, but please still allow 28 days for delivery in case a PCB is temporarily out of stock.

**We can only supply the PCBs listed here! Please always check the latest issue of PE before ordering.**

We can also supply the photocopies of the text at £1.50 for each project part inclusive of postage and packing (overseas £2.00).

Please note that we do not supply components - they can be ordered from our advertisers!

<b>FEB 88</b>			
DC MOTOR SERVO	165	£7.53	
<b>MAR 88</b>			
APPLIANCE TIMER	166A/B	£9.38	
LOGIC ANALYSER - Double-sided	168	£20.65	
<b>APR 88</b>			
LIGHT METAL EFFECTS	169	£7.10	
<b>JUNE 88</b>			
AMSTRAD ROM EXPANSION	173	£12.60	
MAINS MODEM	174	£4.90	
<b>AUG 88</b>			
SPEAKING CLOCK	176	£16.75	
<b>SEPT 88</b>			
BBC MULTIPLEXER	177	£4.50	
<b>OCT 88</b>			
METAL DETECTOR	178	£6.50	
<b>DEC 88</b>			
PANNING MIXER	181	£7.80	
<b>MAR 89</b>			
CAMERA SHUTTER TIMER	187	£9.95	
<b>APR 89</b>			
PC MULTIPOINT	188A/B	£20.55	
<b>MAY 89</b>			
KIRLIAN CAMERA	189A/C	£10.50	
<b>JUNE 89</b>			
DELUXE METRONOME	198	£10.95	
<b>JULY 89</b>			
PROJECTOR SYNCHRONISER	190A	£9.50	
<b>SEP 89</b>			
FREQUENCY COUNTER-GENERATOR	194A/B	£12.50	
<b>OCT 89</b>			
HOME SECURITY CONTROLLER	196A/C	£19.50	

### DEC 89

VIDEO AGC STABILISER	199	£6.50
ECHO STATION	200A/B	£11.50
MINI METRONOME	201	£5.90

### JAN 90

BARGRAPH TACHOMETER	202	£5.90
EEPROM PROGRAMMER (KEYBOARD VER)	203	£14.50

### FEB 90

EEPROM PROGRAMMER (SWITCH VERSION)	204	£4.90
MODEM	205	£11.50
MOCK STEREO	206	£4.90

### MAR 90

RADIO CLOCK (TUNER AND PULSE)	207	£6.50
-------------------------------	-----	-------

### APR 90

RADIO CLOCK (DISPLAY DECODER)	208	£13.50
PC/INTERFACE	209	£5.90

### MAY 90

EPROM POLY-PROG (MAIN PCB)	210	£8.50
----------------------------	-----	-------

### JUNE 90

EPROM POLY-PROG (TOP PCB)	211	£7.50
MESSAGE MAKER	212	£9.50
BAUD RATE CONVERTER	213	£4.90
INTERMITTENT WIPER	214	£3.90
CIRCUIT BREAKER	215	£4.90

### JULY 90

MORSE DECODER	216	£9.50
---------------	-----	-------

### AUG 90

SCOPE EXPANDER	217	£9.50
VOLTAGE PROBE	218	£5.80
AF OCTAVE MEASURER:		
FILTER DRIVE	219	£6.60
ANALOGUE FILTER	220	£7.35

### SEP 90

AF OCTAVE MEASURER		
AMPLIFIER	221	£7.35
SWITCHED FILTER	222	£7.35
SWITCHED FILTER DRIVE	223	£7.35
TELE-SCOPE - MAIN PCB	224	£11.50

### OCT 90

TELE-SCOPE - SIGNAL PCB	225	£4.90
TV INTERFACE	226	£4.90
CHIPTESTER	227	£11.50

### NOV 90

BIKE COMPUTER - MAIN PCB	228	£9.50
- POWER SAVER	229	£4.90

### DEC 90

8748 PROGRAMMING ADAPTOR	230A/B	£6.50
--------------------------	--------	-------

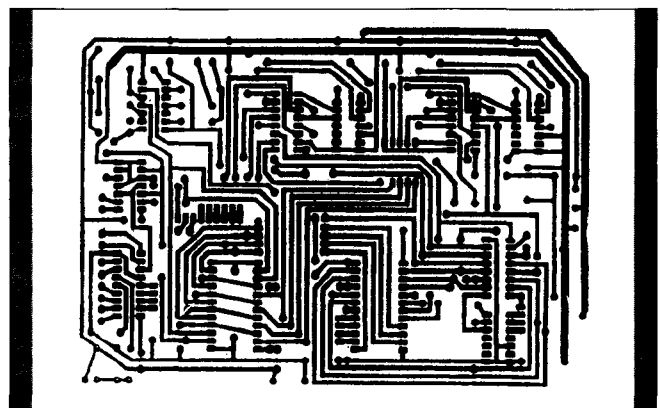

**PE PCBs are the professional route  
to project perfection!**



**S**amuel Finley Breese Morse was born on April 27th 1791 in Charlestown Massachusetts (his bicentenary will be celebrated next year). His father, Jedidiah Morse, who was an eminent geographer and a strict clergyman, sent young Morse to start his education at Phillips Academy in Andover (USA). He proved to be a slow and rather poor scholar, but in spite of this he was moved to Yale College a few years later. Here his two main interests started to grow. The first was associated with the new science of electricity and the second was painting.

## AN IDEA DAWNS

Morse graduated from Yale in 1810 and became a clerk for a book publisher in Boston. However, he found the job uninteresting and he longed to become a painter. So a year later with help from his parents he set out for England to study the traditional style of painting followed there.

Four years later he returned to America and to his dismay he found that the style of art he had studied was not appreciated. Accordingly, he became an itinerant portrait painter. Although Morse did not earn much he enjoyed his work and after a few years he was

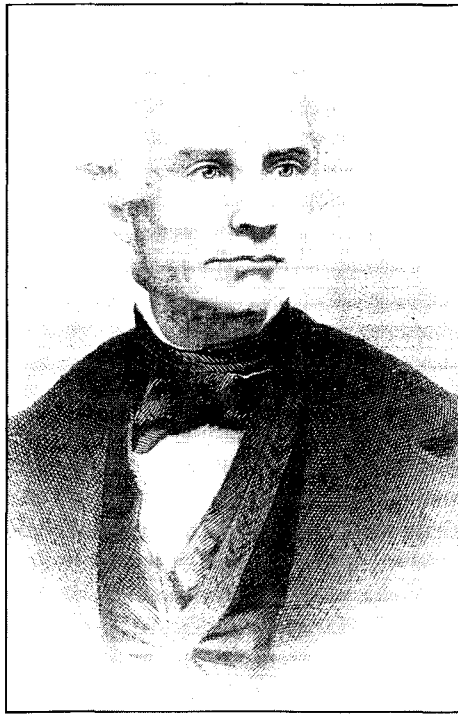

Photograph by courtesy of the Institution of Electrical Engineers.

the famous first message which read "What hath God wrought?"

With this system operating interest grew very fast. Many of the railroad companies saw the possibilities and they started to have systems installed. After only four years more than 5,000 miles of line had been installed to take the new telegraph system. In addition to this, orders soon started to come in from Europe as they heard about the system and how it performed. With all of these orders Morse became very wealthy.

Along with success, though, came trouble. His former partners filed law suits against him as they felt they had contributed to the system. These legal battles took many years to settle and cost a great deal of money, but eventually Morse won and was able to hold onto all his ideas.

## THE NEW CODE

Although the original code which Morse had derived served its purpose well it had several limitations. Some letters had pauses in them, others had dashes which were longer than others, and there was no provision for accents required by some European languages. These problems meant that the

# SAMUEL MORSE

producing some very fine work. In fact many of his portraits are considered to be amongst the best ever produced by an American artist.

## FOREIGN TRAVEL

The reputation of Morse began to grow, as did his income. So he decided to travel to Europe to study more about the styles used there. At this time the electromagnet had just been discovered and a number of elementary forms of telegraph system had also been proposed. Morse, who had retained his interest in electricity, heard about the electromagnet and he started thinking about how this new invention could be used. It was during his trip home an idea for a practicable telegraph system started to develop.

As Morse was very busy with his painting as well as lecturing, he did not devote much time to his idea for a telegraph. It was not for about three years that he was able to develop a prototype. Once he had done so his enthusiasm for the idea grew and in 1837 he gave over all his time to it, putting his painting and lecturing to one side.

Unfortunately he did not have all the resources to build the complete system himself and so enlisted the help of a number of friends to get the system off the ground. One named Alfred Vail was gifted with mechanical ideas and many people believe that he actually invented the Morse key. Progress was swift at first and within a year they had developed a system of dots and dashes to represent the letters and numbers. In

## Technological advancement does not necessarily originate from the elite ranks of scientists - Ian Poole reveals that Morse was an artist!

fact this original code has many similarities to the one used today and it was used for several years before the need arose for it to be changed.

The partners realised that they had to interest the large organisations and government institutions if their idea was to succeed. They gave demonstrations to the American Congress and several other organisations in America but without success. Undeterred by this they even came to England where they hoped for a different response but again without success.

Morse was not easily stopped. Having failed to secure any interest with the help of his partners he set out on his own and this time he was successful. He managed to gain the support of Congress and received a grant of \$30,000 to set up an experimental line between Baltimore and Washington, a distance of about 40 miles. Despite a number of major setbacks it took less than a year to complete and on the 28th May 1844 he sent

code was not always easy to use. As a result of this a new code was devised and introduced in 1851. It bore many similarities to the old one but it was much easier to send having no spaces in the letters themselves and standard lengths for all the dots and dashes. In fact this code is called the International Morse Code and it is the one which is still used today.

## LAST YEARS

In his later life Morse was able to enjoy his success and wealth. He bought two houses, one of which was a mansion on an estate overlooking the Hudson River, and it was here that he used to spend most of his time with his family. The other was in New York City, which he used in the Winter.

Morse was generous with his money. He supported many organisations from the religious to the educational. He also supported many itinerant artists because he remembered his time on the road during his younger years.

Morse died in April 1872 at the age of 80. He said he wanted to be remembered chiefly for his invention of the telegraph which he thought was his greatest achievement. However, with new methods of sending data being used more and more these days and the increase in popularity of his paintings it is likely that in years to come he will be remembered chiefly as the foremost American Artist.

(PE published a semi-intelligent morse decoder in July 90. Ed.)

# PRACTICAL ELECTRONICS CLASSIFIED

Reach thousands of serious electronic and computer enthusiasts. Advertise in PE Classified pages: Rates 20p (plus 3p VAT) per word or £8.50 per single column cm (plus VAT). All classified advertisements must be pre-paid. Send your copy with the remittance (payable to Intra Press or payment by Visa or Access accepted) to: **Practical Electronics, Intra House, 193 Uxbridge Road, London W12 9RA. Tel: 081-743-8888. Fax: 081-743-3062**  
**LET PE WORK FOR YOU!**

## EDUCATION

### FULL-TIME TRAINING COURSES

#### 2 YEAR

**BTEC NATIONAL DIPLOMA**  
 Electronics and Communications Engineering  
 (TV, Computers, Programming, IT)

#### 1 YEAR

**BTEC NATIONAL CERTIFICATE**  
 1. Electronic Equipment Servicing  
 (TV, Video, CCTV)  
 2. Computing Technology  
 (Microprocessors, DataComms, Interfacing)  
 3. Information Technology  
 (Telecomms, Satellite TV, Networks)  
 4. Software Engineering  
 (Assembler, BASIC, Pascal, CAD/CAM)

★ Those eligible can apply for E.T. grant support ★

★ An equal opportunities programme ★

**COURSES COMMENCE**  
 Monday 7th January 1991

### LONDON ELECTRONICS COLLEGE

Dept: AA, 20 Penywern Road,  
 London SW5 9SU. Tel: 071-373 8721

### Start training now for the following courses.

- Telecomms Tech C&G 271
- Radio Amateur Licence C&G
- Microprocessor
- Introduction to Television

Send for our brochure - without obligation or telephone us on 06267 79398 (Ref: PE12/90)  
 Name.....

Radio & Telecommunications  
 Correspondence School,  
 12 Moor View Drive, Teignmouth,  
 Devon TQ14 9UN

## RETAILERS

### EDINBURGH

### OMNI ELECTRONICS

stock a wide range of electronic components at  
**174 Dalkeith Road**  
**Edinburgh EH16 5DX**  
**Tel: 031 667 2611**  
 Open Mon-Fri 9am-6pm  
 Sat. 9am-5am

**NEW CATALOGUE OUT SOON**  
 Price is just £1.50  
 Contact Omni Electronics now for details

### Practical Electronics Classified Works!

Dear Mr. Bonner,

Just a line to say that I was delighted with the response from my advert in the June Practical Electronics; the number and quality of replies exceeded my best expectations.

Yours sincerely,

M. H. C. Lewis  
 Newcastle-upon-Tyne

**Phone David Bonner on 081-743-8888 for details!**

## LONDON WEST

### TECHNOMATIC LTD

*Please see our display advertisement in this issue for more details!*

## LONDON WEST

### Large Selection of Kits & Other Goodies

from  
 TK Electronics,  
 13 Boston Road,  
 LONDON W7 3SJ  
 Tel: 081-567-8910

## MANCHESTER

### THE ELECTRONICS SHOP

We stock a large range of electronic components, test equipment, telephone accessories, computer accessories, microphones, speakers, discolorighting, mixers, meters, stylus, so call in and have a look around.

29 Hanging Ditch, Manchester M4 3ES  
 Telephone: 061-834 1185  
 Fax: 061-833-2969

## SOUTHSEA

### ELECTRONIC COMPONENTS

EVERYTHING FOR YOUR NEXT PROJECT  
 THE BIGGEST DISPLAY IN THE SOUTH IS AT

### FRASER ELECTRONICS

42 ELM GROVE ★ SOUTHSEA ★ HANTS  
 Telephone: 0705-815584

Barclaycard

Access

COMPONENTS

CAMBRIDGE COMPUTER SCIENCE LTD

10MByte Winchester, used, 3 months Wty, £42.00 each  
 5.25" Disk Drives, 80 Track DSDD £34.00 each  
 5.25" drive cases, room for drive, PSU and fan £10.00 each  
 5.25" Disk Drives, 80 Tk DSDD Used No Wty £15.00 each  
 (The £15.00 drives are sold on a strictly "as is" basis)  
 5.25" Disks, DSDD, 48tpi boxes of 10 £3.00 box  
 40W PSU 5V 3.75 A, 12V 1.5A-12V 0.4A cased with on/off switch £10.00 each  
 Bare switch mode PSU 5V 2.5A, 12V 2A -12V 0.1A £7.00 each  
 Gould PSU 0-30V @5A Limited quantity only at £45.00 each  
 Single Data lead (BBC Micro to Disk Drive) £2.00 each  
 Dual Data lead (BBC Micro to 2 Disk Drives) £4.00 each  
 Power lead (BBC Micro to Disk Drive) £2.00 each  
 Dual power lead (BBC Micro to 2 Disk Drives) £4.00 each  
 68000 CPUs (The first orders get 10MHz chips) £3.50 each  
 8086 CPU chips £2.00 each  
 Z80A CPU, CTC, P10 £120 each; DMA £2.00  
 74LS TTL, pick and mix, buy 10 or more for £4.50 all 4  
 Types available: '00 '02 '04 '08 '11 '13 '15 '20 '21 '26 '27 '30 '32  
 '33 '37 '38 '42 '74 '83 '86 '96 '107 '109 '122 '132 '136 '139 '145  
 '151 '153 '157 '158 '162 '163 '164 '165 '174 '191 '193 '253 '257  
 '298 '353 '365 '390 '399 '670  
 2764 EPROMS (Ex-equipment) £1.00 each  
 27128 EPROMS (Ex equipment) £120 each or £5.00/5  
 27128 EPROMS £2.50 each  
 27C256-25 EPROMS £3.50 each  
 256K Byte DRAM Modules, removed from equipment £6.00 each  
 6116 2K Byte SRAM £1.10 each  
 6264 8K Byte SRAM -15 £3.00 each -12 £3.80 each  
 62256-10 32K Byte SRAM £5.00 each  
 65256 32K Byte rams £4.00 each  
 8K Byte NV ram chips £3.00 each £10.00 four  
 20 pin dl low profile IC sockets £0.50 (ten) - £ 4.00 (100)  
 40 pin dl low profile IC sockets £0.60 (ten) - £ 5.00 (100)  
 DEC LS11/23 CPU cards used but working £50.00 each  
 CPU cards (Newbrain) Z80 CPU, 3 EPROMS & 60+ mostly 74LS ICs £2.00 each  
 LCD graphics module 240 by 64 pixel with driver chips £13.00 each  
 Circuit tester, finds faults in TTL & CMOS logic circuits, inc leads £8.00 each  
 Keyboard, 100 keys on board LCD & micro if £8.00 each  
 Metal project boxes drilled & painted but unused 28x32.5x5cm £5.00 each  
 Toroidal mains transformer 12V 4A & 0.4A, 12-0-12 0.1A & 2A, 9-0-9 0.2A £4.00 each - £8.00 for 2 - £8.00 for 3  
 Video Tapes, E180 VHS £2.50 each  
 Smoke detectors, small size £7.00 each  
 Smoke detectors, large with escape light and pause feature £13.00 each  
 Prices include postage. Add 50p to orders below £5.00.  
 All items new unless stated. Add 15% VAT to all prices.  
 Send an SAE for our latest list or for more info.  
**Dept PE, 374 Milton Road, Cambridge, CB4**  
**1SU Tel: 0223 424602 or 0831 430496 or**  
**0831 430552**  
 (Mail order only, no facilities for callers)

CATALOGUE £1.00 + 25P&P

Resistor Pack 85 different E12 values + zero ohm link total content  
 1000 resistors ..... £8.95  
 LEDs 3mm or 5mm red/green ..... 6p each. Yellow 1p each,  
 Cable ties 1p each £5.95/1,000 £49.50 per 10,000  
 Stepping motor 4 phase 12V 7.5" step 50 ohms ..... £8.95  
 SAA1027 stepping motor driver chip ..... £3.95  
 FM Transmitter kit good quality sound ..... £8.60  
 High quality photo resist copper clad epoxy glass boards  
 Dimensions single sided double sided  
 3x4 inches £ 0.95 £1.07  
 4x8 inches £ 2.40 £2.68  
 6x12 inches £ 5.37 -  
 12x12 inches £10.66 -  
**Special Offers**  
 Computer Grade Capacitors with screw terminals 38000µf 20V.... £2.50  
 8700µf 10V £1.95, 68000µf 15V £2.95, 10000µf 16V..... £1.50  
 7 segment Common anode led display 12mm ..... £0.45  
 LM2931AT5.0 Low drop out 5V regulator T0220 package ..... £0.85  
 BS250 P channel MOSFET £0.45, BC559 transistor ..... £3.95 per 100  
 74LS05 hex inverter £10.00 per 100, used 8748 Microcontroller ..... £3.50  
 Stereo LW/MW/FM Tuner pre-amp assembly complete with volume/tone  
 controls and tuning scale Brand new in maker's carton. £6.95, faulty £3.50  
 Circuit etc. for above £0.50.  
 Hour counter (used) 7 digit mains 240V AC 50Hz ..... £1.45  
 LCD display 16 digit 7x5 dots dot matrix ..... £2.50  
 Qwerty keyboard 58 key good quality switches new ..... £5.00  
 Qwerty keyboard with serial output, no data ..... £5.00

Wide range of CMOS TTL 74HC 74F Linear transistors kits  
 capacitors, resistors tools etc always in stock.  
 Please add 95p towards P&P - VAT included

JPG Electronics 276 - 278 Chatsworth Road  
 Chesterfield S40 2BH  
 Access/Visa orders (0246) 211202. Callers welcome

COMPONENTS

Carbon Film Resistors ¼W E24 series 0-51R to 10MΩ - 1p  
 100 off per value - 75p 1000 off in even hundreds per value - £7  
 Metal Film ¼W 10R0 to 1MΩ 5% E12 series - 2p 1% E24 series - 3p  
 ¼Watt metal/carbon film E24 series 1R0 to 10MΩ - 11p  
 1 Watt metal/carbon film E12 series 4R7 to 10MΩ - 5p  
 BC107/8/9 - 12p BC547/8/9 - 8p BC182L 184L - 10p  
 BFY50/S1/S2 - 20p 2N3055 - 40p TIP31A, 32A - 25p TIP41, 42, - 40p  
**Tantalum bead subminiature electrolytics (Mids/Volts)**  
 0-1/35, 0-22/35, 0-47/35, 3-3/16, 4-7/16 - 14p 4-7/35 - 15p  
 2-2/35, 4-7/25, 10-5 - 15p 4-7/35, 6-8/16 - 16p 10-16, 22/6 - 20p  
 22/16 - 20p 33/10 - 30p 47/10 - 35p 100/6 - 40p  
**Aluminium Electrolytics (Mids/Volts)**  
 1/50, 2-2/50, 4-7/25, 4-7/50, 10/16, 10/25, 10/50 - 5p 22/16, 22/25 - 6p  
 22/50, 47/16, 47/25, 47/50 - 6p 100/16, 100/25 - 7p 100/50 - 12p  
 100/100 - 14p 220/16 - 8p 220/25, 220/50 - 10p 470/16, 470/25 - 11p  
 1000/25 - 18p 1000/35, 220/25 - 22p 4700/25 - 70p  
**Miniature Polyester Capacitors 250V Wtg. Vertical Mounting**  
 .01, .015, .022, .033, .047, .068 - 4p 0-1 - 5p 0-15, .22 - 6p 0-47 - 8p  
**Mylar Capacitors 100V Wtg. Vertical Mounting E12 Series**  
 1000p to 8200p - 3p .01 to .068 - 4p 0-1 - 5p 0-15, 0-22 - 6p  
**Subminiature Ceramic Plate 100V Wtg. E12 Series Vertical Mounting**  
 2% 1P8 to 47P - 3p 56P to 330P - 4p 10% 390P to 4700P - 4p  
 Ceramic plate/disc E6 Series 50V 22P to .047 - 2p  
**Polyethylene Capacitors 63V Wtg. E12 Series Axial Mounting**  
 10P to 820P - 3p 1000P to 10,000 - 4p 12,000P - 5p  
 1N4148 - 2p 1N4002 - 4p 1N5404 - 14p W01 bridge - 25p  
 0A31 - 8p AA143 - 8p W005 - 20p 1N4006 - 6p  
 Zener diodes E24 series 3V3 to 33V 400mW - 8p 1 watt - 12p  
 L.E.D.'s Red, Green & Yellow 3mm & 5mm - 10p 8mm - 26p  
 20mm fuse 0-1A to 5A quick blow - 5p Anti Surge - 8p  
 High Speed drills 0-8mm, 1-0mm, 1-3mm, 1-5mm, 2mm - 30p  
 Expo Reliant drilling machines 12Vd.c. with improved 3-jaw chuck £7.00  
 Nicada AA - 8p HP11 - £2 PP3 - £4.20 Universal Chargers - £8.50  
 Glass reed switches single pole make contacts - 8p Magnets - 12p

VAT Inclusive. Return postage 30p (free over £5). Lists free

**THE C.R. SUPPLY CO.,**  
 127 Chesterfield Road,  
 Sheffield S8 0RN. Tel. 557771.

LYS Electronics Components

We have the largest range inc. surface  
 mount devices  
 The best stock and lowest prices in the South.  
 Goods sent return of post - Mail order only  
 Tel: 0705 386550  
 10 Westbrook Rd.,  
 Portchester, Hants PO16 9NS

N.R. BARDWELL LTD

200-Signal diodes 1N4148 ..... £1.00  
 100-Rectifier diodes 1N4001 ..... £1.00  
 100-Zener diodes 6V8 400mW ..... £1.00  
 30-Assorted Dil sockets up to 40 pin ..... £1.00  
 30-Assorted Sockets/Cons. Dil, Edge, I.D.C., Header etc ..... £1.00  
 30-Transistors BC478 ..... £1.00  
 20-Minature SP/CO Slide switches ..... £1.00  
 20-Magnetic ear pips + lead and Plug ..... £1.00  
 75-Electrolytics 4.7uf 63V ..... £1.00  
 1-10 Watt stereo amplifier - 4 controls and data ..... £2.95  
 Prices include VAT, postage 60p. All items new.

Many other lines in stock.

Shop open Mon/Sat 9.30-5.30. Lists S.A.E

288 ABBEYDALE ROAD, SHEFFIELD S7 1FL  
 TEL: (0742) 552886 FAX: (0742) 500689

C.E.S. N.W.  
 FOR ELECTRONICS COMPONENTS

TEST EQUIPMENT REPAIRS IBM PC  
 ACCESSORIES  
 AT DISCOUNT PRICES

LET US SOURCE THAT DIFFICULT TO FIND  
 COMPONENT FOR YOUR KIT OR PROJECT.  
 SEND FOR DETAILS OF ALL OUR SERVICES.

APPT. 2, NO.8 MERION GARDENS,  
 COLWYN BAY, CLWYD, NORTH WALES  
 LL29 7PR

TEL: 0492 533083 FAX: 0492 534716

COMPONENTS

Winter Bargains From SARM Digital

LEDs 3 and 5mm Red, Yellow and Green Pkt of 5 40p  
 Diodes 1N4148 Pkt of 10 20p 1N914 Pkt of 10 30p  
 Zener Diodes 8ZX55C 2.7V to 30.0V 5p each  
 BZX85C 4.7V to 75.0V 7p each  
 Veroboard 2939 £0.96, 2958 £1.05, 3939 £1.00  
 Right angle D-Plugs 9-way £0.59, 15-way £0.80, 25-way  
 £0.98, 37-way £1.37. D-Sockets 9-way £0.73, 15-way  
 £0.89, 25-way £1.06, 37-way £1.90

Metal Film Resistors 0.5W 1% All values 2p each  
 Presets 0.15W Horiz or Vert All values 10p each

Add 15% VAT to all prices. Post/Packaging £1.00

1991 CATALOGUE OUT NOW CONTAINS 000'S OF  
 COMPONENTS INCLUDING SMD £1.80 (NO VAT)

Cheques or PO's made payable to: SARM DIGITAL,  
 13 PEARLE STREET, MACCLESFIELD, CHESHIRE,  
 SK10 2AL  
 MAIL ORDER ONLY, PROP N. FARRAR

COMPONENT PACKS - COMPUTER PARTS

Processor Chips, CMOS devices, logic chips,  
 transistors, caps, switches, (all packs £1)  
 memory expansion boards (AT com)/display  
 adaptors (AT comp) • SAE for lists  
 LANGHAM SOFTWARE  
 Shaftesbury Centre  
 Percy Street  
 Swindon SN2 2AZ  
 TEL (0793) 514055 (day)  
 (0793) 491048 (night)  
 FAX (0793) 512477

TEST EQUIPMENT

**Cooke International**

DO YOU WANT USED SCOPES, SIGNAL  
 GENERATORS, POWER SUPPLIES,  
 POWER METERS, DVM's, OSCILLATORS,  
 ATTENUATORS, TEST EQUIPMENT.

Contact: Cooke International, Unit 4,  
 Fordingbridge Site, Main Road, Barnham,  
 Bognor Regis, West Sussex PO22 0EB  
 Tel: 0243 545111 - Fax: 0243 542457  
 Wide range of items available. Send for lists.

ENCLOSURES

**RACK CHASSIS**

**FOR THE CONSTRUCTOR**  
 UNITS ARE CONSTRUCTED OF  
 ALL ALUMINUM PARTS  
 FRONT & REAR PANELS ARE  
 CLEAR BRUSHED ANODIZED  
 THE BALANCE OF PARTS ARE  
 BLACK BRUSHED ANODIZED  
 UNITS SHIPPED FLAT  
 UNASSEMBLED  
 SEND FOR FREE CATALOG OF  
 SHEET METAL BOXES, RACK CHASSIS,  
 RACK PANELS, SHEET METAL  
 PUNCHES, PRESS-ON LETTERING,  
 HAND PUNCH TOOL AND PUNCH KITS,  
 AND OUR LINE OF OVER 300  
 PROFESSIONAL  
 AND SEMI-PROFESSIONAL  
 AUDIO PRODUCTS.  
 ACCESS, VISA ACCEPTED.  
 SHIPPED AIR PARCEL POST  
 AT NO CHARGE.

MODEL	SIZE (H,W,D) E	PRICE
RU-1.75'		
1RU5	1.75 x 19 x 5	38.00
1RU7	1.75 x 19 x 7	40.50
1RU10	1.75 x 19 x 10	43.00
2RU5	3.50 x 19 x 5	40.50
2RU7	3.50 x 19 x 7	43.00
2RU10	3.50 x 19 x 10	46.00
3RU5	5.25 x 19 x 5	51.00
3RU7	5.25 x 19 x 7	54.00
3RU10	5.25 x 19 x 10	57.00

**SESCOM, INC.**  
 2100 WARD DR.  
 HENDERSON, NV. 89015 U.S.A.  
 (702) 565-3400 FAX (702) 565-4828

# CLASSIFIEDS

## SURVEILLANCE

### SIMPSON'S MANUFACTURING

**Manufacturers of chips  
and security products**

**Rocket Trading  
Centre  
Broadgreen  
Liverpool L14 3NZ  
051-220-9328**

**SURVEILLANCE DEVICES**, lasers, Tesla coils, scramblers, ultrasonic and many more, over 150 designs. Send SAE to: Placentre, Old Wharf, Dynock Road, Ledbury HR8 2HS for free list.  
**NEW VHF MICROTRANSMITTER KIT**, tuneable 80-135 MHz, 500 metre range, sensitive electret microphone, high quality PCB. **SPECIAL OFFER** complete kit **ONLY £5.95, assembled and ready to use £9.95** post free. Access orders telephone 021 411 1821. Cheques/ P.O.'s to: **Quantek Electronics Ltd**, (Dept P.E.), 45a Station Road, Northfield, Birmingham, B31 3TE  
**VHF MICROTRANSMITTERS**, high sensitivity, long range, useful as baby monitors etc. Tunable to 115MHz Guaranteed ready to use, fully encased £8.50 Cheques/POs Mrs. M Hicks, 24 Brewster Road, Boston Lincs. PE21 ODY TEL: 0205 362003

## PCBs

### ● RB DESIGN ●

Professional PCBs designed + made both single sided and double sided through hole plating at budget prices  
Tel: 0705-325928

## MISCELLANEOUS

**DATAMAN S3 EPROM PROGRAMMER.** Many professional features. Will program hundreds of PROM types. In-circuit RAM evaluation up to 64 kbytes. Mint condition. Full documentation. Offers around £450. (0737) 764782

**VOICE/SOUND ACTIVATED SWITCHES** Easy to follow diagrams and uses, only £1.00. Components and PCBs available from Herrington, London W7 1NL

**CIRCUIT DIAGRAM +INSTRUCTIONS** for a 25 Watt FM Broadcast Transmitter Cheques/POs £3.50 to AM Enterprises 44 Altyre Way Beckenham, Kent BR3 3HA

**WANTED ATARI 65XE COMPUTER.** Telephone 0846 693668

"INVENTION DEVELOPMENT & INNOVATION LTD" can help commercialise your idea - telephone Cambridge (0223) 892789

### **KITS ARE POPULAR!**

**Advertise them in Practical  
Electronics!**

**Phone David Bonner on  
081-743-8888  
for advertising details!**

## SURPLUS

### TURN YOUR SURPLUS

ICS transistors etc into cash, immediate settlement. WE welcome the opportunity to quote for complete factory clearance.

Contact:

**COLES-HARDING & CO.,**  
103 South Brink, Wisbech, Cambs.  
**ESTABLISHED 15 YEARS**  
Tel: 0945 584188 - Fax: 0945 588844

### SURPLUS/REDUNDANT ELECTRONICS COMPONENTS WANTED

ICs - Tuners - Transistors - Valves - Diodes etc - any quantity considered - immediate payment.

**ADM ELECTRONICS SUPPLIES**  
Tel 0827 873311 Fax: 0827 874835

## KITS

### VELLEMAN KITS

Over 100 Project kits in stock. Send 50p for 1990 catalogue plus price list.

Electronic Retailers wanted throughout the country with a view to stocking our product.

**High Q Electronics**  
PO Box 14810  
London NW7 4RF  
TEL:0707-263562

## CLASSIFIED COUPON

									£3.22
									£4.83
									£6.44
									£8.05
									£9.66
									£11.27

Rates are 20p per word plus 3p VAT (lineage, for semi-display advertisements contact our Ad. Dept.). All classified advertisements must be pre-paid. Please send your copy with the remittance (payable to Intra Press or payments by Visa or Access accepted) to: Practical Electronics Classified Dept., Intra House, 193 Uxbridge Road, London W12 9RA. Tel: 081-743-8888, Fax: 081-743-3062



**W**hen a British Telecom technician came to repair our home telephone I was greatly impressed by the speed and efficiency with which he tracked down the fault and cured it (an intermittent short-circuit with arching in the twin line). At the same time he decided to replace our old carbon microphone with one of the latest transmitter insets containing an integrated-circuit amplifier. I asked him what kind of microphone it had.

"Oh, this doesn't need a microphone - it's all electronic" he replied triumphantly.

I was about to explain that there must be some way of converting the voice sound-waves into an electrical signal for the electronics to work on, but stopped and just nodded. It would have been patronising and rude, especially as he was such a nice friendly chap. (Later I discovered that the new microphone is an electret type).

Apparently there was something of a gap between this person's training and his education. In dealing with the fault he was

## INDUSTRY



## NOTEBOOK

industry, for example, although total employment has actually declined by about 14% over the past decade, the jobs that remain are demanding higher and higher skills. During this period the proportion of unskilled workers has been falling but the employment of scientists and engineers has practically doubled.

This column has already discussed how information technology is changing the pattern of all industrial work. It's cutting across the distinction between managers doing largely mental work and factory operatives doing largely manual work on objects. Information technology is gradually making the work on objects more mental than manual.

### SOCIAL ATTITUDES

There's also a blurring of the traditional boundary between professional engineers and technicians/craftsmen. In electronics firms you quite often find academically qualified

# HIGH TECH HEWERS

superb. Yet at the same time he seemed to have the notion that, because the carbon microphone could be dispensed with, no microphone was necessary: it was all somehow done by the magic of electronics.

### FUNDAMENTALS

But perhaps it is indeed possible to run an organisation with well trained people who don't necessarily understand the fundamentals of what they are working at. This is not to say they aren't able to understand. They might well be intelligent and capable human beings. But because their vocational training only requires them to think and act within certain defined limits, and this is what they are paid for, they have no interest in looking beyond these limits.

The traditional separation between training and education produces not only blind spots in a person's understanding but also great gaps in his/her abilities. This problem is particularly relevant now in Britain. There's a severe shortage of skilled people in industry, especially in electronics, and we have a lamentable record on training compared with our industrial competitors (eg, France has three times as many qualified electronic/electrical technicians).

Professionals like lawyers, doctors and accountants have to be well trained before they are safe to be let loose on the public. But they couldn't achieve the required level of training without an adequate education to start with. Equally, nobody can become properly educated until they have first been trained to acquire the basic skills of literacy and numeracy. So at certain levels the interdependence of education and training is obvious and considered perfectly natural.

When it comes to manufacturing industry

By Tom Ivall

### Inherited attitudes towards manual and mental skills are in danger of inhibiting technological advancement.

this relationship seems to break down. People who work in manufacturing industry make things that the world needs. They may be researchers, designers, managers, systems analysts, patent lawyers and the like, using mainly their brains, but they are still helping to make things. So in class-ridden Britain they tend to be seen by those at the top of the social hierarchy as something like modern descendants of the hewers of wood and drawers of water - just doing slightly more complicated things than the Biblical drudges.

### TRAINING AND EDUCATION

And the conventional wisdom imposed from above by this attitude is that industrial workers need to be trained but not educated to any great extent. It derives from the old, mistaken assumption that people who are 'clever with their hands' don't need to use their brains.

The nature of modern, high-tech industry makes this ancient dichotomy completely irrelevant and absurd. The level of skills needed by many workers has already blurred the old distinction between education and training in this field. In the UK electronics

engineers doing the work of technicians and vice-versa, according to their personal abilities and opportunities.

I think the reason for the UK's poor performance in industrial training is historically to do with the social attitudes mentioned above. The present Government's free-market philosophy is probably not helping by leaving so much to employers. What may be expedient for individual companies is not necessarily good for the country as an economic whole. We need a national infrastructure of skill resources. Economic success depends on a highly skilled workforce adding maximum value to materials. And this degree of skill is a product of both training and education.

To remedy the situation we could, of course, just try to catch up with our industrial competitors. Witness the Government's latest hasty efforts in crisis management: the Technical and Enterprise Councils and what they call New Youth Training (successor to YOP and YTS). But maybe our failure to keep up with the leaders in the race gives us an opportunity to look around and take a wider view.

To begin with, manufacturing industry could undergo changes as a result of world environmental problems and human reactions against perpetual economic growth and the rat-race of life in competing economies. There are also new ideas brewing in UK education. Critics are arguing that our system of producing a minority of A-level high-flyers and a majority with low-level vocational qualifications is wasteful. They say we should have a unified system of learning resulting in a single qualification. Too many young people are abandoning education at sixteen. Instead of early selection with low participation in full education, we need late selection with high participation.

PE



# PRACTICAL ELECTRONICS BOOK SERVICE

*Here is your Editor's choice of books he thinks will be of interest to electronics and computer enthusiasts*

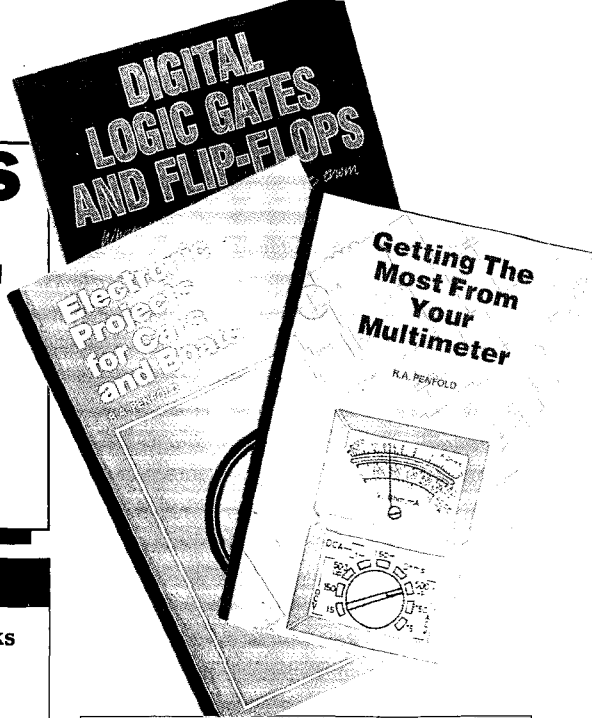

## BEGINNERS AND EARLY STARTERS

### Mini-Matrix Board Projects.

R.A.Penfold. 112 pages. £2.50. Order Code BP99

Shows a selection of 20 useful and interesting circuits that can be built on a mini-matrix board of 24 holes by 10 copper strips in size - an ideal book for early experimenters.

### From Atoms to Amperes.

F.A.Wilson. 160 pages. £3.50. Order Code BP254.

For the absolute beginner, clearly explaining the fundamentals behind the whole subject of electricity and electronics.

### Electronic Projects for Beginners.

F.G.Rayer. 128 pages. £1.95. Order Code BP48

Specially for the newcomer to electronics who is looking for a book containing a wide range of easily made projects. Some circuits need no soldering and many others show actual component and wiring layouts.

### Electronics Build and Learn

R.A.Penfold. 128 Pages. £5.95. Order Code PC 101

Combining theory and practice, the book describes a circuit demonstrator unit that is used in subsequent chapters to introduce common electronic components and circuit concepts, complete with practical experiments.

### Practical Electronic Building Blocks

R.A.Penfold. There are two books -

Book 1 : 128 pages. £1.95.

Order Code BP117

Book 2 : 112 pages. £1.95.

Order Code BP118

Book 1 is about oscillators and gives circuits for a wide range, including sine, triangle, square, sawtooth and pulse waveforms and numerous others from voltage controlled to customised ic types.

Book 2 looks at amplifiers, ranging from low level discrete and opamp types to ic power amps. A selection of mixers, filters and regulators is included.

### 30 Solderless Breadboard Projects

R.A.Penfold. Two books each of 160 pages. Book 1 : £2.95. Order Code BP107. Book 2 : £2.25. Order Code BP113.

Each project is designed for building on a Verobloc breadboard and is accompanied by a description, circuit and layout diagrams and relevant constructional notes. Many of the components are common to several projects. Book 1 covers linear devices, and Book 2 covers cmos logic chips.

### Beginners Guide to Building

Electronic Projects R.A.Penfold. 112 pages. £1.95. Order Code BP 227

Shows the complete beginner how to tackle the practical side of electronics and includes simple constructional projects.

## AUDIO AND MUSIC

### Introducing Digital Audio

I.Sinclair. 112 pages. £5.95.

Order Code PC102

A non-mathematical introduction to the new digital technology, discussing the principles and methods involved in devices such as cd, dat and sampling.

### Electronic Music Projects

R.A.Penfold. 112 pages. £2.50. Order Code BP74

24 practical constructional projects covering fuzz, wah, sustain, reverb, phasing, tremolo etc. The text is split into four sections covering guitar, general, sound generation and accessory projects.

### More Advanced Electronic Music Projects

R.A.Penfold. 96 pages. £2.95. Order Code BP174

Complementing BP74 by covering more advanced and complex projects including flanging, chorus, ring modulation, plus a selection of drum, cymbal and gong circuits.

### Computer Music Projects

R.A.Penfold. 112 pages. £2.95. Order Code BP173

Shows how home computers can produce electronic music and covers sequencing, analogue and Midi interfacing, digital delay lines and sound generators.

### Practical Midi Handbook

R.A.Penfold. 160 pages. £5.95. Order Code PC103

A practical how-to-do-it book for musicians and enthusiasts who want to exploit the capabilities of Midi. Covers keyboards, drums, sequencers, effects, mixers, guitars, and computer music software.

### Midi Projects

R.A.Penfold. 112 pages. £2.95. Order Code BP182

Practical details of interfacing many popular home computers with Midi systems, and also covering Midi: interfacing to analogue and percussion synths.

### Electronic Synthesiser Construction.

R.A.Penfold. 112 pages. £2.95. Order Code BP185.

Even relative beginners should find the monophonic synthesiser described here within their capabilities if the book is thoroughly read. Individual aspects of the synth are dealt with separately and pcb designs are shown for the main modules.

## SATELLITE TV

**Satellite TV Installation Guide - 2nd edition John Breeds. £11.95. Order Code STV1**

Full of vital information for any competent diyer who wishes to install a satellite tv antenna and obtain optimum reception quality.

### An Introduction to Satellite Television

F.A.Wilson. 112 pages. £5.95. Order Code BP195

Informative answers to many of the questions about this communications revolution. The information is presented on two levels, one aimed at the complete beginner, the other at professional engineers and serious amateur enthusiasts.

## TEST AND MEASUREMENT

### Getting the Most from Your Multimeter

R.A.Penfold. 112 pages. £2.95. Order Code BP239

There's more to what you can do with a meter than meets the casual eye. The book covers the basics of what you can do with analogue and digital meters and discusses component and circuit testing.

### Test Equipment Construction

R.A. Penfold £2.95. Order Code BP248

Describes in detail how to construct some simple and inexpensive, but extremely useful, pieces of test equipment.

### Oscilloscopes 2nd Edition

I.Hickman. £12.95. Order Code NT3

Subtitled 'How to Use Them, How They Work' the book is illustrated with diagrams and photographs and is essential reading for any one who wants to know about scopes, from first principles to practical applications.

### How to Get Your Electronic Projects Working.

R.A.Penfold. 96 pages. £2.50. Order Code BP110.

Essential reading for anyone who wants first-time success in project assembly. Covers tracing mechanical faults as well as testing for failures of active and passive components of most types.



## DIGITAL AND COMPUTING

**A Concise Introduction to MS-DOS.**  
N. Kantaris. 64 pages. £2.95.  
Order Code BP232

A ready-reference guide for those who need a quick insight into the essential command functions of this operating system, but who don't have the time to learn it fully.

**An Introduction to Computer Peripherals**

R.A. and J.W. Penfold. 80 pages.  
£2.50. Order Code BP170

Covers such items as monitors, printers, disc drives, cassettes, modems, etc. explaining what they are and how to use them with your computer and with each other.

**NEW! Digital Logic Gates and Flip-Flops.** Ian R. Sinclair. 192 pages. £8.95. Order Code PC 105

Intelligently looks at the basic building blocks of all digital circuits and is intended for enthusiasts, students and technicians who seek to establish a firm grasp of fundamental principles.

**Introduction to 6800/6802 Microprocessor Systems**

R.J. Simpson and T.J. Terrell. 238 pages. £10.95. Order Code NT9

The book covers systems hardware, programming concepts and practical experimental work that will assist in understanding the 6800/6802 microprocessor, with additional information on the 6802D5E evaluation system.

**An Introduction to 68000 Assembly Language.**

R.A. and J.W. Penfold. 112 pages.  
£2.95. Order Code BP184

Covers the fundamentals of writing programs that will vastly increase the speed of 68000 based machines such as the Commodore Amiga, Atari ST range, Apple Macintosh, etc.

**Getting the Most from Your Printer**  
J.W. Penfold. 96 pages. £2.95.  
Order Code BP181

How to use the features found on most dot-matrix printers from programs and popular wordprocessors, showing examples of what must be typed to achieve a given effect.

**Micro Interfacing Circuits**

R.A. Penfold. Two books, each of 112 pages.

Book 1 : £2.25. Order Code BP130.

Book 2 : £2.75. Order Code BP131

Both books include practical circuits and useful background information though pcb layouts are not included. Book 1 mainly covers computer input-output techniques. Book 2 deals primarily with practical application circuits.

**An Introduction to 6502 Machine Code.**

R.A. and R.W. Penfold. 112 pages.  
£2.95. Order Code BP147

Covers the main principles of machine code programming on 6502-based machines such as the Vic-20, Oric-1/Atmos, Electron, BBC and Commodore 64. It assumes no previous knowledge of microprocessors or machine code and gives illustrative programming examples.

**A Z-80 Workshop Manual.**

E.A. Parr. 192 pages. £3.95.  
Order Code BP112

A book for those who already know Basic but wish to explore machine code and assembly language programming on Z80 based computers.

**Practical Digital Electronics Handbook**

M. Tooley. 208 pages. £6.95.  
Order Code PC 104

Nine constructional projects introduce digital circuits, logic gates, timers, microprocessors, memory and interface circuits - an essential book for anyone interested in digital devices.

## DATA AND INFORMATION BOOKS

**NEW! Radio and Electronics Engineer's Pocket Book - 18th Edition.** Keith Brindley. 325 pages. £9.95. Order Code NT 11

An invaluable compendium of facts, figures and formulae and is indispensable to the designer, student, service engineer and all others interested in radio and electronics.

**NEW! Microprocessor Pocket Book.** Steve Money. 252 pages. £9.95. Order Code NT 12

Provides a wide selection of information which will be of general use to anyone involved in developing, designing or servicing, or who just wants to learn more about microprocessor systems.

**NEW! Computer Engineer's Pocket Book - 2nd Edition.** Michael Tooley. 224 pages. £9.95. Order Code NT 13

An invaluable compendium of facts, figures, circuits and data indispensable to designers, students, service engineers and all others interested in computer and microcomputer systems.

**Op Amps**

B. Dance. £7.95.

Order Code NT2

Subtitled 'Their Principles and Applications' this interesting book is written in a simple non-mathematical style and provides a source of practical circuits that use both commonplace and more sophisticated opamps.

**Electronic Hobbyists Handbook**

R.A. Penfold. 96 pages. £4.95. Order Code BP233

Provides a source of useful information that the amateur enthusiast is likely to need for day-to-day pursuance of hobby electronics.

**Newnes Electronics Pocket Book**

I.E. Parr. £9.95.

Order Code NT10

Presents all aspects of modern electronics in a readable and largely non-mathematical style, and is a good source of valuable information for enthusiasts and professional engineers alike.

**Key Techniques for Circuit Design**

G.C. Loveday. £6.95.

Order Code BM 101

Tackles the problems of designing circuits from scratch, introducing the concept of target specifications, the design sequence, device selection, rules of thumb, and useful equivalent circuits.

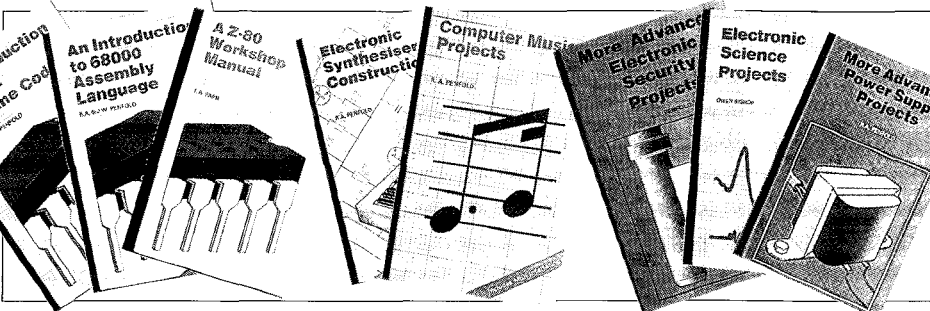

## GENERAL CONSTRUCTIONAL

**Electronic Science Projects.**

Owen Bishop. 144 pages. £2.95. Order Code BP104

A bumper bundle of experimental projects ranging in complexity and including a colour temperature meter, electronic clock, a solid state (led display) scope, an infra-red laser, a fascinating circuit for measuring the earth's electrical field strength, and many more.

**Electronic Security Devices**

R.A. Penfold. 112 pages. £2.50. BP56

Full of ideas for keeping your valuables safe. The circuits include designs for light, infra-red, ultrasonic, gas, smoke, flood, door and baby sensors.

**More Advanced Electronic Security Projects.** R.A. Penfold. 112 pages.

£2.95. Order Code BP190

Follows on from where BP56 leaves off and describes a number of more up-to-date and sophisticated projects, such as pyro-sensors, infra-red and doppler-shift detection, fibre-optic loops, and many others.

**Electronic Projects for Cars and Boats.**

R.A. Penfold. 96 pages. £1.95.

Order Code BP94

15 fairly simple projects that can be used with a car and/or boat. Stripboard constructional details are included, as are explanations of the circuit theory.

**Power Supply Projects**

R.A. Penfold. 96 pages. £2.50.

Order Code BP76

A selection of power supply designs, including simple unregulated, fixed voltage regulated and variable voltage, stabilised, ni-cad charger, voltage step-up, and inverter.

**More Advanced Power Supply Projects**

R.A. Penfold. 96 pages. £2.95.

Order Code BP192

Covers more advanced topics than BP76 and includes precision supplies, switch mode and computer controlled supplies, plus a selection of miscellaneous circuits.

**Popular Electronic Circuits.**

R.A. Penfold. 160 pages. £2.95. Order Code BP80

Containing a wide range of circuit designs for experienced constructors who are capable of producing working projects direct from a circuit diagram without specific constructional details.

## HOW TO ORDER

State your order code and your name and address clearly. Enclose a cheque, PO or international money order (add 50p postage per book - £1.00 for overseas surface mail), and send to:

**PE Book Service  
Intra House  
193 Uxbridge Road  
London W12 9RA**

Books are normally delivered within 10 days but please allow 28 days for delivery.

**184 PAGES  
PACKED WITH  
COMPONENTS,  
KITS, TEST  
EQUIPMENT  
AND BOOKS...**

**BATTERIES**

Ni-cad, Dry Cell, Ni-cad Chargers, Eliminators, Holders, Connections

**BOOKS**

General, Textbook and Basics, Radio and TV, Data/Reference, Projects/DIY, Measurement/Servicing, Linear Electronics, Audio, Digital Electronics, Computers

**CABLE AND WIRE**

Equipment Wire, Mains Cable, RF Cable, Audio Cables, Ribbon Cable, Enamelled Copper Wire, Accessories

**CAPACITORS**

Electrolytic, Ceramic, Foil, Variable, Trimmers

**COMPONENT PACKS**

**COMPUTERS**

Amstrad 464/6128 Peripherals, Software, Computer Leads, Cable Adapters/Testers, Data Switches, PC Cards, Microcomputing Kits/Modules, Accessories

**CONNECTORS**

Audio, Servo, DC, RF, RF Adapters, IEC Mains, 13A Mains, Low Current, Terminal Blocks, PCB Ribbon, IDC Edge, 0.1" Pitch Edge, IC Sockets, Waterproof Sockets

**COUNTERS AND TIMERS**

LCD Modules Stopwatch

**CRYSTALS**

Crystals, Ceramic Resonators

**FILTERS**

Ceramic, Pilot Tone/and Birdie, LC Video Block, Helical, Crystal, Ceramic, RF Interference

**HARDWARE**

Equipment Cases, Aluminium Boxes, Plastic Boxes, Mounting Accessories, Knobs, Breadboards, Fuses, Fuseholders, Heatsinks, DC Fans

**INDUCTORS**

Toko Coils, Fixed Inductors, Axial RF Chokes, Surface Mount Inductors, Moulded VHF Coils, Ferrite Materials, Dust Iron Toroids

**KITS AND MODULES**

FM Tuner Sets, FM IF Amplifiers, Digital Frequency Meters, TV and Video Systems, Aerial Amplifiers, AM Systems, HF Amplifiers, Signal Processors, 6m Systems, VHF Systems, Satellite Systems, UHF Systems, Audio Amplifiers, Audio Accessories, Cassette Systems, Home and Hobby, Radio Control Systems, RF Test Equipment,

**"YOU NEVER  
KNEW THERE  
WAS SO  
MUCH IN IT"**



**THE NEW WINTER  
90/91 CATALOGUE  
OUT NOW**

**FREE!**

**25W SOLDERING IRON  
WORTH £5.98**

**WHEN YOU SUBSCRIBE  
TO THIS AND THE NEXT TWO  
ISSUES - FOR ONLY £5.00.**

**SIMPLY FILL IN THE  
COUPON AND KEEP  
UP TO DATE!**

Signal Generators and Detectors, Time and Frequency Standards, Logic Probes, Digital Meters, Power Supplies, LCD Modules

**METERS**

Moving Coil

**PCBs & EQUIPMENT**

Prototyping Systems, Artwork Materials

**RELAYS**

Coaxial, PCB

**RESISTORS**

Carbon Film, Presets, Rotary Pots, Slide Pots, Multiturn Pots, Precision Pots

**RIGS AND RECEIVERS**

2m Systems, High Power HF ATUs, Accessories, Scanning Receivers

**SEMICONDUCTORS**

4000 Series CMOS Devices, 74HC Series, 74LS Series TTL, Linear ICs,

Prescalers ICs, Microprocessors

Memories, Transistors, Diodes Regulators and Power Control ICs, Schottky Diode Balanced Mixers, LEDs, Mounted LEDs, Infra Red LEDs, 7 Segment LED Displays, Neon and Signal Lamps

**SPEAKERS/SOUNDERS**

Piezo Buzzers, Headphones, Loudspeakers, Microphones

**SWITCHES**

Key, DIL, Push Button, Contact, Code, Rotary

**TEST EQUIPMENT**

Oscilloscopes, Frequency Meters, Signal Generators, AF and RF Generators, Analogue Multimeters, Digital Multimeters, Multimeter Accessories, RF Power Measurement, Digital Thermometers, Logic Probe and Pulsers, DC Power Supplies, LCR Meters, Oscilloscope Probes, Test Leads, Calculators

**TOOLS**

Soldering Irons, Soldering accessories, Drills and accessories, Screwdrivers, General Tools, Static Protection, Service Aids

**TRANSFORMERS**

PCB Mounting, Chassis Mounting

- AVAILABLE FROM LARGER NEWSAGENTS OR DIRECT FROM CIRKIT
- £10 WORTH OF DISCOUNT VOUCHERS
- LOW COST MULTIMETERS
- MANY NEW PRODUCTS

**Cirkkit**

**Cirkkit Distribution Ltd**  
Park Lane, Broomsbourne, Herts EN10 7NQ  
(0992) 444111



**Please supply:**

- Winter '90/91 Catalogue @ £1.60
- Winter '90/91 Catalogue and subscription to the next two Issues @ £5.00

I enclose Cheque/Postal Order for \_\_\_\_\_

Please debit my Access/Visa card for \_\_\_\_\_

NAME: \_\_\_\_\_

ADDRESS: \_\_\_\_\_

POST CODE \_\_\_\_\_

ACCESS OR VISA

EXPIRY DATE: \_\_\_\_\_

SIGNATURE: \_\_\_\_\_ DATE: \_\_\_\_\_



# Interak 1 BUILD YOUR OWN COMPUTER

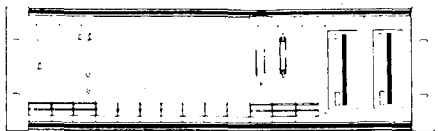

INTERAK can be commenced with the minimum of outlay. Bare boards from £10.95, beg borrow or steal the components, or buy from us - all parts available separately. No special or custom chips (ie PALs, ULAs, ASICs etc) used - no secrets.

Go as fast or as slowly as your funds and enthusiasm permit.

Made for those who must know what goes inside. Full circuit diagrams and descriptions are provided. And honestly, can you really use a computer effectively if you don't know what's inside and nobody will tell you?

Solid engineering construction - something to be proud of. 19" 3U rack mounting, plug-in circuit boards and modular construction keeps obsolescence at bay.

Flourishing Independent Users Group and newsletter. Hundreds of programs on disk at little or no cost from the Users Group.

Program in machine code (Assembler), Basic, C, Forth, etc Database, Word Processing, Scientific applications.

Cassette tape operation or disk (up to 4 drives, 1 Megabyte 3.5" available from us, but you can add 3" 5.25" 8" if you want). Disk operating system CPM Plus.

64K RAM, Z80 based at present with potential for expansion to a 16 Megabytes address space and Zilog's latest Z80280 in the future.

Needs no specialised knowledge to construct, and we will happily get you out of a jam if you get into one.

Availability of personal and individual after sales service, impossible to obtain from large companies who are only after your money.

Security of supply - from Greenbank Electronics, established in 1970.

**Greenbank**

For more details write or phone us:

**Greenbank Electronics, Dept E12P, 460 New Chester Road, Rock Ferry, Birkenhead, Merseyside, L42 2AE. Tel: 051-645 3391**

## INDEX TO ADVERTISERS

ADM Electronics.....56	Keytronics.....11
A & G Electronics.....15	Labcenter.....39
Antex.....15	Langham Software.....55
Astronomy Now.....47	Limrose.....28
J&N Bull Electrical.....22	Lond Electronics College...54
Cache Systems.....31	Lys Electronics.....55
Cambridge Computer Sci. .55	Maplin Electronics.....0BC
C.E.S. NW.....55	Marapet.....45
Circuit Distribution.....60	National College of Tech...45
Coles Harding.....56	NR Bardwell.....55
Cooke International.....55	Number One Systems.....16
Cricklewood Electronics...46	Omni Electronics.....54
C.R. Supply.....55	Radio & Telecom School...54
Electronics Shop.....54	RB Designs.....56
Electroparts.....25	Sarm Digital.....55
Fraser Electronics.....54	Sescom Inc. ....5
Gem-Tech.....25	Simpsons Manu. ....56
Greenbank Electronics.....62	Suma Designs.....25
Henry's Audio.....31	Tandy.....IFC
High Q Electronics.....56	Technomatic Ltd.....40
International Corr. Sch.....45	TK Electronics.....62
JPG Electronics.....55	Websters.....56

**PLEASE MENTION  
PRACTICAL ELECTRONICS  
WHEN REPLYING TO ADVERTS**

## PROGRAMMABLE ELECTRONIC LOCK KIT

**NEW**

Keys could be a thing of the past with this new high security lock. Secure doors to sheds, garages, even your home or prevent the unauthorised use of computers, burglar alarms or cars. One 4-digit sequence will open the lock while incorrect entries will sound an alarm. The number of incorrect entries allowed before the alarm is triggered is selected by you. Further entries will be ignored for a time also set by you. Only the correct sequence will open the lock and switch off the alarm. The sequence may easily be changed by entering a special number and code on the supplied keyboard. Kit includes: keyboard, alarm buzzer, high quality PCB and all electronic components. Supply: 5-15V d.c. Will drive our Latch Mechanism (701 150 @ £16.50) or relay directly.

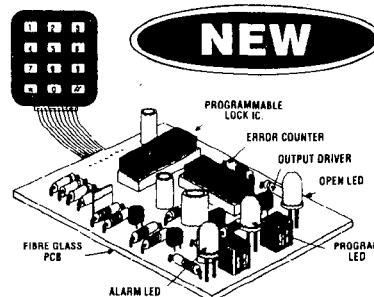

**XK131 ..... £19.95**

## DISCO LIGHTING KITS

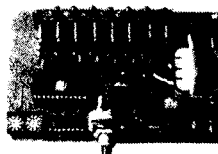

DL8000K 8-way sequencer kit with built-in opto-isolated sound to light input. Only requires a box and control knob to complete. .... **£39.95**

DL1000K 4-way chaser features bi-directional sequence and dimming 1kW per channel. .... **£23.95**

XK139 Uni-directional version of the above. Zero switching to reduce interference. .... **£12.95**

DLA/1 (for DL & DLZ1000K) Optional opto input allowing audio 'beat' light response. .... **95p**

DL3000K 3-channel sound to light kit, zero voltage switching, automatic level control and built-in mic. 1kW per channel. .... **£19.55**

## POWER STROBE KIT

Produces an intense light pulse at a variable frequency of 1 to 15Hz. Includes high quality PCB, components, connectors. 5Ws strobe tube and assembly instructions. Supply: 240V ac. Size: 80 x 50 x 45. XK124 STROBOSCOPE KIT. .... **£17.25**

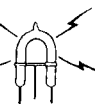

## REMOTE CONTROL DIMMER KIT

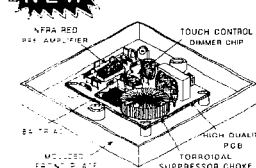

Imagine controlling the brightness of your lights or switching them on or off from the comfort of your armchair! This kit contains all the components from front panel to the last screw to enable you to do just that and fit the shallowest wall boxes. Max power 300W (not fluorescent). XK132..... **£19.95**

## IR TRANSMITTER KIT

Designed for use with the XK132 and comes complete with a pre-drilled box. A PP3 9 volt battery is required. MK8..... **£4.95**



XK136 TOUCH DIMMER KIT..... **£12.95**

## VERSATILE REMOTE CONTROL SYSTEM

These kits can switch up to 16 pieces of equipment on and off or control 16 functions depending on the keyboard selected for the MK18 transmitter. MK12 receiver has 16 logic outputs and operates from 12 to 24V ac or 240V ac via the transformer supplied. The MK18 requires a 9V battery and keyboard. Great for controlling lights, TVs, garage doors etc. MK12 IR Receiver..... **£19.65**  
MK18 Transmitter..... **£8.95**  
MK3 4-Way Keyboard..... **£2.75**  
MK10 16-Way Keyboard..... **£7.95**  
601 133 Box for transmitter..... **£2.95**

## VOICE RECORD/PLAYBACK KIT

This simple to construct and even simpler to operate kit will record and playback short messages or tunes. It has many uses - seatbelt or lights reminder in the car, welcome messages to visitors at home or at work, warning messages in factories and public places, in fact anywhere where a spoken message is announced and which needs to be changed from time to time. Also suitable for toys - why not convert your daughter's £8 doll to an £80 talking doll!!

Size..... 76 x 60 x 15mm  
Message time..... 1 - 5 secs normal speed, 2 - 10 secs slow speed  
**XK129 ..... £25.95**

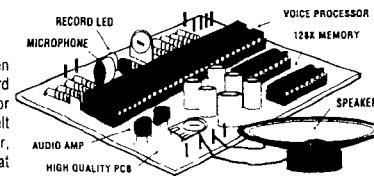

## TR ELECTRONICS

13 BOSTON RD. LONDON W7 3SJ

TEL: 01-567 8910.

FAX: 01-566 1916



ORDERING INFORMATION:

All prices include VAT. Free P & P on orders over £60 (UK only), otherwise add £1.15. Overseas P & P: Europe £3.50, Elsewhere £10. Send cheque/PO/Visa/Access No. with order. Giro No. 529314002

LOCAL AUTHORITY AND EXPORT ORDERS WELCOME  
GOODS BY RETURN SUBJECT TO AVAILABILITY



**POWER AMPLIFIER MODULES-TURNABLES-DIMMERS-LOUDSPEAKERS-19 INCH STEREO RACK AMPLIFIERS**

**OMP POWER AMPLIFIER MODULES**

Supplied ready built and tested.

**OMP POWER AMPLIFIER MODULES** Now enjoy a world-wide reputation for quality, reliability and performance at a realistic price. Four models available to suit the needs of the professional and hobby market i.e. Industry, Leisure, Instrumental and Hi-Fi etc. When comparing prices, NOTE all models include Toroidal power supply, Integral heat sink, Glass fibre P.C.B. and Drive circuits to power compatible Vu meter. Open and short circuit proof.

**THOUSANDS OF MODULES PURCHASED BY PROFESSIONAL USERS**

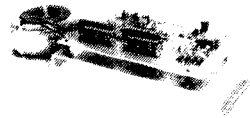

**OMP100 Mk 11 Bi-Polar** Output power 110 watts R.M.S. into 4 ohms. Frequency Response 15Hz - 30KHz - 3dB, T.H.D. 0.01%, S.N.R. - 118dB, Sens. for Max. output 500mV at 10K, Size 355 x 115x65mm. **PRICE £33.99 + £3.00 P&P.**

**NEW SERIES II MOS-FET MODULES**

**OMP/MF 100 Mos-Fet** Output power 110 watts R.M.S. into 4 ohms. Frequency Response 1Hz - 100KHz - 3dB, Damping Factor, >300, Slew Rate 45V uS, T.H.D. Typical 0.002%, Input Sensitivity 500mV, S.N.R. - 125dB, Size 300 x 123 x 60mm. **PRICE £39.99 + £3.00 P&P.**



**OMP/MF200 Mos-Fet** Output power 200 watts R.M.S. into 4 ohms. Frequency Response 1Hz - 100KHz - 3dB, Damping Factor >300, Slew Rate 50V uS, T.H.D. Typical 0.001%, Input Sensitivity 500mV, S.N.R. - 130dB, Size 300 x 155 x 100mm. **PRICE £62.99 + £3.50 P&P.**



**OMP/MF300 Mos-Fet** Output power 300 watts R.M.S. into 4 ohms. Frequency Response 1Hz - 100KHz - 3dB, Damping Factor >300, Slew Rate 60V uS, T.H.D. Typical 0.0008%, Input Sensitivity 500mV, S.N.R. - 130dB, Size 330 x 175 x 100mm. **PRICE £79.99 + £4.50 P&P.**

NOTE—MOS-FET MODULES ARE AVAILABLE IN TWO VERSIONS STANDARD INPUT SENS 500mV BAND WIDTH 100KHz P.E.C./PROFESSIONAL EQUIPMENT COMPATIBLE: INPUT SENS 775mV BAND WIDTH 50KHz ORDER STANDARD OR P.E.C.

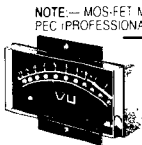

**Vu METER** Compatible with our four amplifiers detailed above. A very accurate visual display employing 11 LED diodes (7 green, 4 red) plus an additional on off indicator. Sophisticated logic control circuits for very fast rise and decay times. Tough moulded plastic case, with tinted acrylic front. Size 84 x 27 x 45mm. **PRICE £8.50 + 50p P&P.**

**LOUDSPEAKERS**



**LARGE SELECTION OF SPECIALIST LOUDSPEAKERS AVAILABLE, INCLUDING CABINET FITTINGS, SPEAKER GRILLES, CROSS-OVERS AND HIGH POWER, HIGH FREQUENCY BULLETS AND HORNS, LARGE S.A.E. (30p STAMPED) FOR COMPLETE LIST.**

**McKENZIE—INSTRUMENTS, P.A., DISCO, ETC.**

- ALL MCKENZIE UNITS 8 OHMS IMPEDANCE**
- 8" 100 WATT C8100GPM GEN. PURPOSE LEAD GUITAR, EXCELLENT MID, DISCO. RES. FREQ. 80Hz FREQ. RESP. TO 14KHz SENS. 99dB. **PRICE £28.59 + £2.00 P&P.**
  - 10" 100 WATT C10100GP GUITAR, VOICE, ORGAN, KEYBOARD, DISCO, EXCELLENT MID. RES. FREQ. 70Hz FREQ. RESP. TO 6KHz SENS. 100dB. **PRICE £34.70 + £2.50 P&P.**
  - 10" 200 WATT C10200GP GUITAR, KEYBOARD, DISCO, EXCELLENT HIGH POWER MID. RES. FREQ. 45Hz FREQ. RESP. TO 7KHz SENS. 103dB. **PRICE £47.48 + £2.50 P&P.**
  - 12" 100 WATT C12100GP HIGH POWER GEN. PURPOSE, LEAD GUITAR, DISCO. RES. FREQ. 45Hz FREQ. RESP. TO 7KHz SENS. 98dB. **PRICE £36.66 + £3.50 P&P.**
  - 12" 100 WATT C12100TC TWIN CONE HIGH POWER WIDE RESPONSE, P.A., VOICE, DISCO. RES. FREQ. 45Hz FREQ. RESP. TO 14KHz SENS. 100dB. **PRICE £37.63 + £3.50 P&P.**
  - 12" 200 WATT C12200B HIGH POWER BASS, KEYBOARDS, DISCO, P.A. RES. FREQ. 40Hz FREQ. RESP. TO 7KHz SENS. 100dB. **PRICE £64.17 + £3.50 P&P.**
  - 12" 300 WATT C12300GP HIGH POWER BASS LEAD GUITAR, KEYBOARDS, DISCO, ETC. RES. FREQ. 45Hz FREQ. RESP. TO 5KHz SENS. 100dB. **PRICE £85.79 + £3.50 P&P.**
  - 15" 100 WATT C15100BS BASS GUITAR, LOW FREQUENCY, P.A., DISCO. RES. FREQ. 40Hz FREQ. RESP. TO 5KHz SENS. 98dB. **PRICE £53.70 + £4.00 P&P.**
  - 15" 200 WATT C15200BS VERY HIGH POWER BASS. RES. FREQ. 40Hz FREQ. RESP. TO 4KHz SENS. 99dB. **PRICE £73.26 + £4.00 P&P.**
  - 15" 250 WATT C15250BS VERY HIGH POWER BASS. RES. FREQ. 40Hz FREQ. RESP. TO 4KHz SENS. 99dB. **PRICE £80.53 + £4.50 P&P.**
  - 15" 400 WATT C15400BS VERY HIGH POWER, LOW FREQUENCY BASS. RES. FREQ. 40Hz FREQ. RESP. TO 4KHz SENS. 102dB. **PRICE £94.12 + £4.50 P&P.**
  - 18" 400 WATT C18404BS EXTREMELY HIGH POWER, LOW FREQUENCY BASS. RES. FREQ. 27Hz FREQ. RESP. TO 3KHz SENS. 99dB. **PRICE £167.85 + £5.00 P&P.**

**EARBENDERS—HI-FI, STUDIO, IN-CAR, ETC.**

- ALL EARBENDER UNITS 8 OHMS EXCEPT EB8-50 AND EB10-50 DUAL 4 AND 8 OHM. BASS, SINGLE CONE, HIGH COMPLIANCE, ROLLED FOAM SURROUND**
- 8" 50 WATT EB8-50 DUAL IMPEDANCE, TAPPED 4 & 8 OHM BASS, HI-FI, IN-CAR. RES. FREQ. 40Hz FREQ. RESP. TO 7KHz SENS. 97dB. **PRICE £8.90 + £2.00 P&P.**
  - 10" 50 WATT EB10-50 DUAL IMPEDANCE, TAPPED 4 & 8 OHM BASS, HI-FI, IN-CAR. RES. FREQ. 40Hz FREQ. RESP. TO 5KHz SENS. 99dB. **PRICE £12.00 + £2.50 P&P.**
  - 10" 100 WATT EB10-100 BASS, HI-FI, STUDIO. RES. FREQ. 35Hz FREQ. RESP. TO 3KHz SENS. 96dB. **PRICE £27.50 + £3.50 P&P.**
  - 12" 60 WATT EB12-60 BASS, HI-FI, STUDIO. RES. FREQ. 28Hz FREQ. RESP. TO 3KHz SENS. 92dB. **PRICE £21.00 + £3.00 P&P.**
  - 12" 100 WATT EB12-100 BASS, STUDIO, HI-FI, EXCELLENT DISCO. RES. FREQ. 26Hz FREQ. RESP. TO 3KHz SENS. 93dB. **PRICE £32.00 + £3.50 P&P.**
  - FULL RANGE TWIN CONE, HIGH COMPLIANCE, ROLLED SURROUND**
  - 5 1/2" 60 WATT EB5-60TC (TWIN CONE) HI-FI, MULTI-ARRAY DISCO ETC. RES. FREQ. 63Hz FREQ. RESP. TO 20KHz SENS. 92dB. **PRICE £9.99 + £1.50 P&P.**
  - 6 1/2" 60 WATT EB6-60TC (TWIN CONE) HI-FI, MULTI-ARRAY DISCO ETC. RES. FREQ. 38Hz FREQ. RESP. TO 20KHz SENS. 94dB. **PRICE £10.99 + £1.50 P&P.**
  - 8" 60 WATT EB8-60TC (TWIN CONE) HI-FI, MULTI-ARRAY DISCO ETC. RES. FREQ. 40Hz FREQ. RESP. TO 18KHz SENS. 89dB. **PRICE £12.99 + £1.50 P&P.**
  - 10" 60 WATT EB10-60TC (TWIN CONE) HI-FI, MULTI-ARRAY DISCO ETC. RES. FREQ. 35Hz FREQ. RESP. TO 12KHz SENS. 86dB. **PRICE £16.49 + £2.00 P&P.**

**TRANSMITTER HOBBY KITS**

**PROVEN TRANSMITTER DESIGNS INCLUDING GLASS FIBRE PRINTED CIRCUIT BOARD AND HIGH QUALITY COMPONENTS COMPLETE WITH CIRCUIT AND INSTRUCTIONS**

- 3W FM TRANSMITTER** 80-108MHz, VARICAP CONTROLLED PROFESSIONAL PERFORMANCE RANGE UP TO 3 MILES. SIZE 38 x 123mm SUPPLY 12V u.s. AMP. **PRICE £14.49 + £1.00 P&P**
- FM MICRO TRANSMITTER** BUG! 100-108MHz VARICAP TUNED COMPLETE WITH VERY SENS FET MIC RANGE 100-300m. SIZE 56 x 46mm SUPPLY 9V BATT. **PRICE £8.62 + £1.00 P&P**



3 watt FM Transmitter

\* PRICES INCLUDE V.A.T. \* PROMPT DELIVERIES \* FRIENDLY SERVICE \* LARGE S.A.E., 30p STAMPED FOR CURRENT LIST.

**OMP VARISPEED TURNTABLE CHASSIS**



★ MANUAL ARM ★ STEEL CHASSIS ★ ELECTRONIC SPEED CONTROL 33 & 45 ★ VARI PITCH CONTROL ★ HIGH TORQUE SERVO DRIVEN DC MOTOR ★ TRANSIT SCREWS ★ 12 DIE CAST PLATTER ★ NEON STROBE ★ CALIBRATED BAL WEIGHT ★ REMOVABLE HEAD SHELL ★ CARTRIDGE FIXINGS ★ CUE LEVER ★ POWER 220 240V 50 60Hz ★ 390-305mm ★ SUPPLIED WITH MOUNTING CUT-OUT TEMPLATE

**PRICE £59.99 + £3.50 P&P.**

**OPTIONAL MAGNETIC CARTRIDGES**

**STANTON AL500**  
PRICE £16.99 + 50p P&P

**GOLDRING G850**  
PRICE £6.99 + 50p P&P

**OMP MOS-FET POWER AMPLIFIERS, HIGH POWER, TWO CHANNEL 19 INCH RACK**

**THOUSANDS PURCHASED BY PROFESSIONAL USERS**

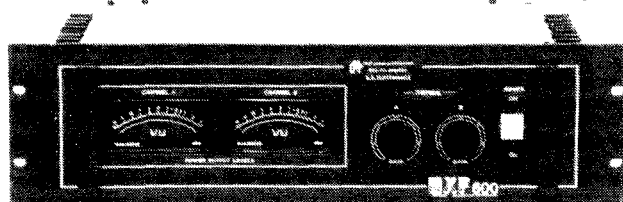

**NEW MXF SERIES OF POWER AMPLIFIERS**  
**THREE MODELS:— MXF200 (100w + 100w)**  
**MXF400 (200w + 200w) MXF600 (300w + 300w)**  
All power ratings R.M.S. into 4 ohms.

**FEATURES:** ★ Independent power supplies with two Toroidal Transformers ★ Twin L.E.D. Vu meters ★ Rotary indexed level controls ★ Illuminated on off switch ★ XLR connectors ★ Standard 775mV inputs ★ Open and short circuit proof ★ Latest Mos-Fets for stress free power delivery into virtually any load ★ High slew rate ★ Very low distortion ★ Aluminium cases ★ MXF600 Fan Cooled with D.C. Loudspeaker and Thermal Protection.

**USED THE WORLD OVER IN CLUBS, PUBS, CINEMAS, DISCOS ETC.**

- SIZES:—** MXF 200 W19" x H3 1/2" (2U) x D11"  
MXF 400 W19" x H5 1/4" (3U) x D12"  
MXF 600 W19" x H5 1/4" (3U) x D13"

**PRICES: MXF200 £171.35**  
**MXF400 £228.85**  
**MXF600 £322.00**

**SECURICOR DELIVERY £12.00 EACH**

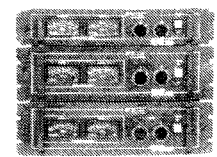

**OMP SLIDE DIMMER 1K WATT & 2.5K WATT**

CONTROLS LOADS UP TO 1KW & 2.5KW SUITABLE FOR RESISTIVE AND INDUCTIVE LOADS. BLACK ANODISED CASE READY TO FLUSH MOUNTED THROUGH PANEL. CABINET CUT-OUTS ADVANCED FEATURES INCLUDE:

- ★ Full 1.65mm Si IDf Thawf
- ★ NFO
- ★ Monitor Indicator
- ★ Flash Over Ride Button
- ★ High & Low Level Presets
- ★ Fully Suppressed TO 85, 800

**PRICES:— 1K WATT £15.99**  
**2.5K WATT £24.99 + 60p P&P**

**OMP LINNET LOUDSPEAKERS**

THE VERY BEST IN QUALITY AND VALUE

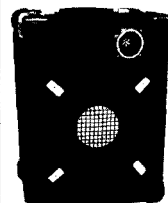

MADE ESPECIALLY TO SUIT TODAY'S NEED FOR COMPACTNESS WITH HIGH OUTPUT SOUND LEVELS. FINISHED IN HARDWEARING BLACK VINYL WITH PROTECTIVE CORNERS GRILLE AND CARRYING HANDLE INCORPORATES 12" DRIVER PLUS HIGH FREQ. HORN FOR FULL FREQ. RANGE. 45Hz-20KHz BOTH MODELS 8 OHM. SIZE H18" x W15" x D12"

CHOICE OF TWO MODELS

**POWER RATINGS QUOTED IN WATTS RMS FOR EACH CABINET**

**OMP 12-100 (100W 100dB) PRICE £159.99 PER PAIR**  
**OMP 12-200 (200W 102dB) PRICE £209.99 PER PAIR**

**SECURICOR DEL.— £12.00 PER PAIR**

**PIEZO ELECTRIC TWEETERS—MOTOROLA**

Join the Piezo revolution. The low dynamic mass (no voice coil) of a Piezo tweeter produces an improved transient response with a lower distortion level than ordinary dynamic tweeters. As a crossover is not required these units can be added to existing speaker systems of up to 100 watts (more if 2 put in series). **FREE EXPLANATORY LEAFLETS SUPPLIED WITH EACH TWEETER.**

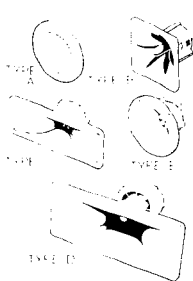

**TYPE 'A' (KSN2036A)** 3" round with protective wire mesh, ideal for bookshelf and medium sized Hi-Fi speakers. **Price £4.90 each + 50p P&P.**  
**TYPE 'B' (KSN1005a)** 3" super horn. For general purpose speakers, disco and P.A. systems etc. **Price £5.00 each + 50p P&P.**  
**TYPE 'C' (KSN6016A)** 2" x 5" wide dispersion horn. For quality Hi-Fi systems and quality discos etc. **Price £6.99 each + 50p P&P.**  
**TYPE 'D' (KSN1025A)** 2" x 6" wide dispersion horn. Upper frequency response retained extending down to mid range (2KHz). Suitable for high quality Hi-Fi systems and quality discos. **Price £9.99 each + 50p P&P.**  
**TYPE 'E' (KSN1038A)** 3" horn tweeter with attractive silver finish trim. Suitable for Hi-Fi monitor systems etc. **Price £5.99 each + 50p P&P.**  
**LEVEL CONTROL** Combines on a recessed mounting plate, level control and cabinet input jack socket. 85 x 85mm. **Price £3.99 + 50p P&P.**

**STEREO DISCO MIXER**

**STEREO DISCO MIXER** with 2 x 5 band L & R graphic equalisers and twin 10 segment L.E.D. Vu Meters. **Many outstanding features** 5 inputs with individual faders providing a useful combination of the following—  
3 Turntables (Mag), 3 Mics, 4 Line including CD plus Mic with talk over switch Headphone Monitor, Pan Pot L & R, Master Output controls. Output 775mV. Size 360 x 280 x 90mm. Supply 220-240V.  
**Price £134.99 — £4.00 P&P**

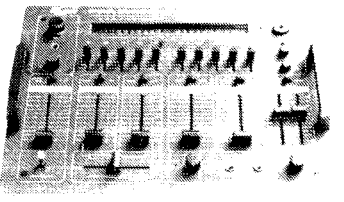

**B. K. ELECTRONICS** Dept PE  
UNIT 5, COMET WAY, SOUTHEND-ON-SEA, ESSEX. SS2 6TR  
TEL: 0702-527572 FAX: 0702-420243

1991 BUYER'S GUIDE TO ELECTRONIC COMPONENTS

# Maplin

FEATURING:  
AN ELECTRONICS  
CAST OF  
THOUSANDS!

POWER-PACKED  
WITH OVER  
600 PAGES!!

STARRING  
HUNDREDS OF  
NEW PRODUCTS  
AT SUPER  
LOW PRICES!

**SHOWING NOW!**  
at your local  
WHSMITH

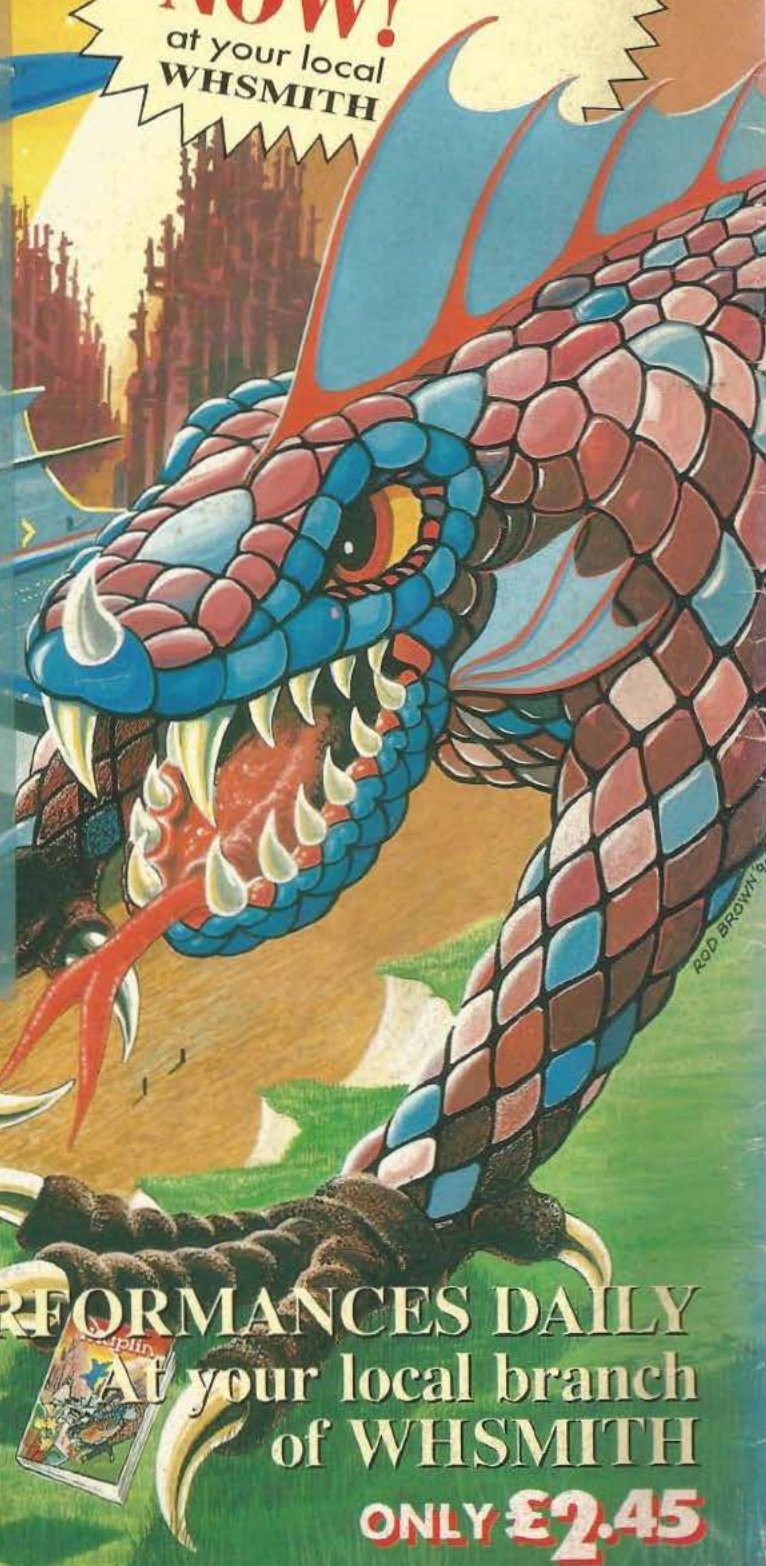

ROD BROWN '91

PERFORMANCES DAILY  
At your local branch  
of WHSMITH

**ONLY £2.45**

**Order you copy of the New MAPLIN Catalogue on sale NOW**  
Pick up a copy from any WHSMITH for just £2.45 + 50p p&p. If you live outside the UK, send £4.85  
copy for just £2.45 + 50p p&p. 20 International Reply Coupons. I enclose £2.95.

Name \_\_\_\_\_  
Address \_\_\_\_\_  
Post Code \_\_\_\_\_  
Send to Maplin Electronics,  
P.O. Box 3, Royleigh,  
Essex SS6 8LR.  
PE91