

PRACTICAL

OCTOBER 1989 • £1.25

ELECTRONICS

SCIENCE & TECHNOLOGY

TELESCOPE CONTROL INTERFACE

**Build a Versatile Port for
Earth-Bound Ground-Ops**

PLUS:

**NEXT MONTH'S
SILVER JUBILEE**

**The Celebrations Begin!
See Pages 9 and 61**

ECHO STATION

**Don't Delay Building Our
New Multifunction Audio
Enhancer**

ELECTRONIC SNAPSHOTS

**Will the New Mag-
Cams make you
smile for posterity**

Home Security Controller

**Put a HEX on Intruders
With Your Own Crime
Watcher**

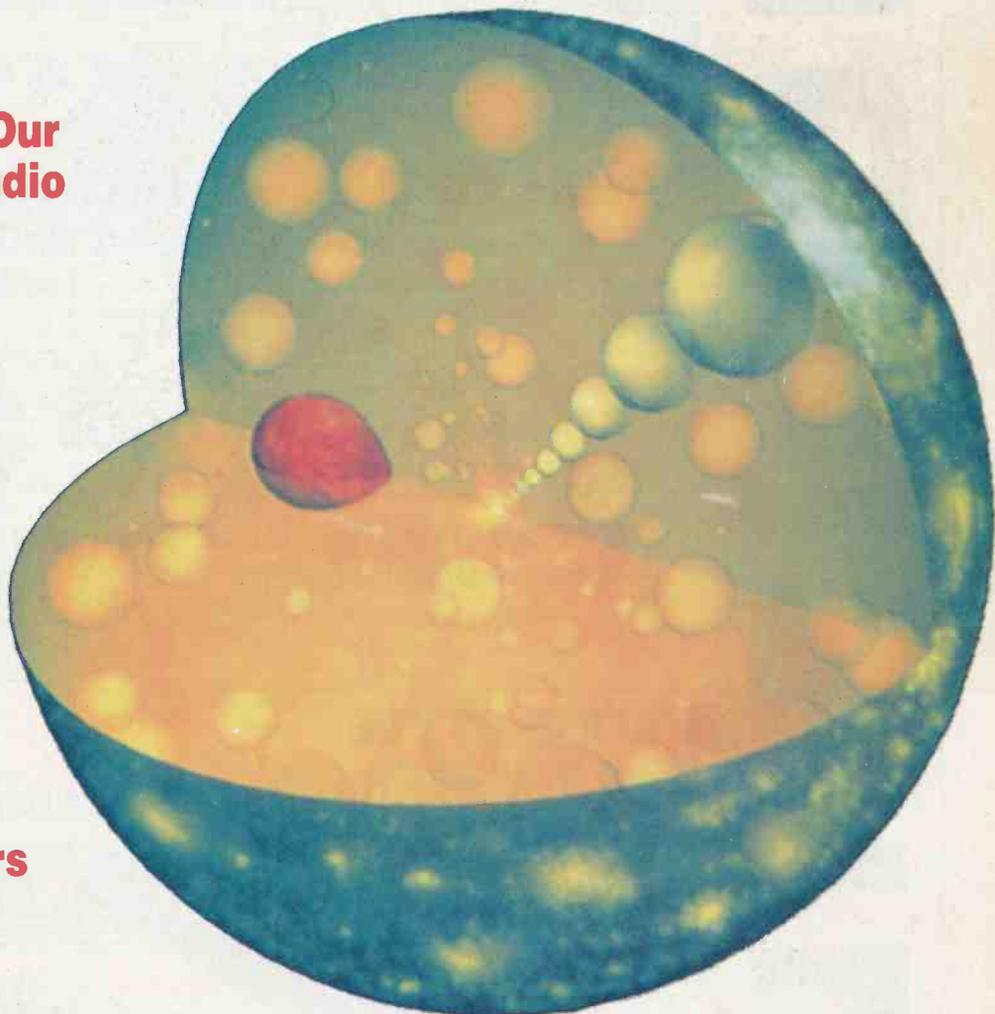

**ALSO –
ANOTHER
EASI-BUILD
PROJECT!**

TRANSPUTER TRAINING

**Reviewing a System That
Parallels the Future**

MICRONITA[®]

MULTIMETERS FROM TANDY[®]



BENCHTOP DIGITAL LCD MULTIMETER £79⁹⁵

- Measures AC/DC Volts, Current And Resistance
- Manual Or Autoranging Facility

22-195

43-RANGE ANALOGUE MULTIMETER £29⁹⁵

- 50,000 Ohms Per Volt DC Sensitivity
- Range Doubler Facility

22-214

PROBE-STYLE MULTIMETER £29⁹⁵

22-165

- Fully Automatic Range And Polarity

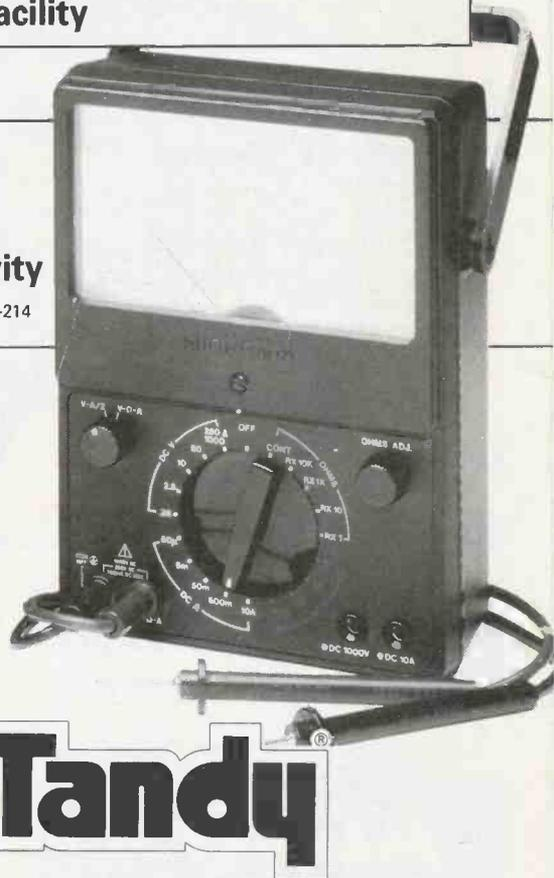
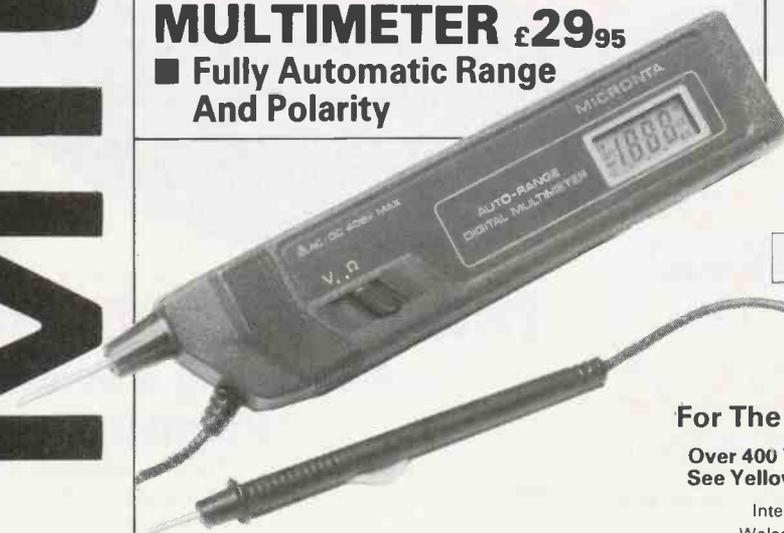

Tandy[®]

For The Best In High Quality Electronics

Over 400 Tandy Stores And Dealerships Nationwide.
See Yellow Pages For Address Of Store Nearest You.

InterTAN U.K. Ltd., Tandy Centre, Leamore Lane,
Walsall, West Midlands. WS2 7PS Tel: 0922 710000

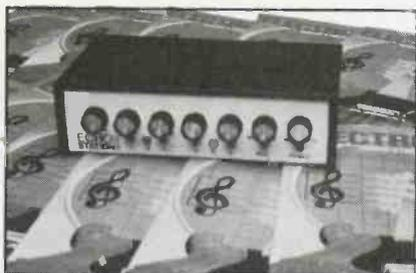

NEXT MONTH

25 YEARS OF PE!

Yes, next month
PE celebrates it's
Silver Anniversary!
We've an extra-special
bumper issue for you
- SEE PAGES 9 AND 61

★ OUR NOVEMBER 1989
ISSUE IS FAR
TOO GOOD TO MISS!

★ ON SALE FROM
FRIDAY OCTOBER 6TH

★ YOU CAN'T BEAT
OUR VALUE

★ OR OUR
CELEBRATORY
OFFERINGS!

PRACTICAL ELECTRONICS

VOL 25 NO 10

OCTOBER 1989

CONTENTS

CONSTRUCTIONAL PROJECTS

- TELESCOPE CONTROL INTERFACE** by David Clarke12
Whether you want to control a telescope or any other equipment, this versatile parallel-serial interface could provide the answer.
- MONO-STEREO ECHO STATION** by John Becker27
Herewith, by popular demand, a new multi-option audio delay-line unit for echo, reverb, multitracking, chorus and other favourite functions.
- EASI-BUILD CIRCUIT** by John Becker32
Let your voice become a third hand with this simple sound-operated remote switching circuit.
- HOME SECURITY CONTROLLER - PART TWO** by Kevin Browne .49
Constructive data on the microprocessor controlled alarm system that can assist you in setting up your own crime-watch scheme.

SPECIAL FEATURES

- ELECTRONIC SNAPSHOTS** by Barry Fox17
Film is dead for home movie making; will it also die for happy holiday still-snapping, killed-off by magnetic disks?
- TRANSPUTER TRAINER REVIEW** by Robert Penfold23
Flight Electronics' training system enables those with programming and electronic skills to come to grips with transputer technology.
- ASK PE - NUMBER TWO** by Andrew Armstrong34
A reader asks about stability when taking signal feedback from a loudspeaker, and is given an answer that also includes line regulation.
- DIGITAL ELECTRONICS** by Owen Bishop36
Digital electronics can provide solutions in many applications, and we can provide the solutions to last month's exam - how well did you do?
- HF RADIO - PART THREE** by Mike Sanders41
How modulation piggy-backs audio signals onto radio frequencies, plus a look at amplifiers, distortion, heatsinks and filters.

REGULAR FEATURES

- EDITORIAL** by John Becker - Party preparations9
- LEADING EDGE** by Barry Fox - Digital stereo tv8
- SPACEWATCH** by Dr Patrick Moore - Brown dwarfs and jet-sets46
- INDUSTRY NOTEBOOK** by Tom Ivall - End of a love affair57
- READERS' LETTERS** - and a few answers31

PRODUCT FEATURES

- MARKETPLACE** - what's new, where and when4
- BAZAAR** - Readers' FREE advertising service53
- ARMCHAIR BOOKSHOP** - haven for practical bookworms58
- PCB SERVICE** - professional PCBs for PE Projects45
- ADVERTISERS' INDEX** - locating favourite stockists62

PE TAKES TECHNO-ANNIVERSARIES FURTHER - BE PART OF THEM!

MULTI-GOOD PRINTOUT



We've had news of a new handheld digital multimeter, the Hioki 3234, which measures ac and dc voltage, current and resistance, and can produce a permanent copy of the results from an integral printer. With a large clear 3 1/2 digit lcd with a 3199 count, it also has a 6 digit clock which enables the start time, date and measured interval to be added to the printout. This new unit can be used as a dedicated recording printer for other measurements such as temperature, rotational speed and power, and in fact with any analogue output measuring instrument.

Fully autoranging, the 3234 measures dc voltage to 500V in five ranges with a basic accuracy of 0.35%. AC voltage is to 500V in four ranges, resistance to 30M ohms in six ranges with a 300 ohm full scale range. Low power ohms are to 30M ohms in five ranges, whilst ac and dc current are to 300mA. Powered by rechargeable batteries, this useful multimeter is supplied with an adaptor which can be used as an ac power supply or as a battery charger.

Thermal serial dot printing is employed at a speed of 1.2 seconds/line on recording paper 38mm wide and 3 metres long, giving some 750 lines of print. Print rates can be automatically set at 10 and 30 secs, 1, 3, 5, 10, 30 and 60 mins. The 3234, which weighs just 400 gms, is supplied ready for use with test leads, alligator clips, spare fuse, one roll of recording paper, instructions and an ac adaptor. Useful optional accessories include a protective carrying case and recording paper in five roll packs. For further information, contact: Universal Instrument Services Ltd, Unit 62, GEC Site, Cambridge Road, Whetstone, Leicester LE8 3LH. Tel: 0533 750123.



COUNT ON MAPLIN

The all new electronic counter module from Maplin features a five digit, large format lcd display and an exceptionally low price. The module counts up to 99,999 from switch or relay at up to five counts per second. The display increases by one every time a positive-going edge is applied to pin 3.

The system features an anti-bounce circuit and reset input. Also available is a tone output which can drive a directly connected piezo sounder which beeps on every count and on reset. Square wave outputs at 512Hz and 32768Hz are also provided.

Spec: Working voltage: 1.5Vdc
Current: 2µA standby (8µA average when counting)

Count range: 00000 to 99999 (resets to 00000 after count 99999)

Max input frequency: 7Hz

Input voltage range: 1V to 1.5V

Min duration pulse: 100µs

Overall size: 68 x 35 x 24mm

The Maplin counter module type FS13P cost only £6.95, plus vat and is available by direct mail or from the Maplin nation-wide chain of shops.

For further information, please contact: Doug Simmons, Maplin Electronics, PO Box 3, Rayleigh, Essex SS6 8LR. Tel: 0702 554161.

CATALOGUE

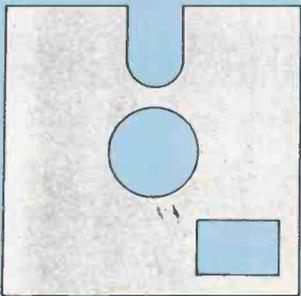

DATABASE

Continuing our browse through advertisers' literature

Cooke International describe themselves as the original source for all types of test and measurement equipment and laboratory instruments. Their loose-leaf brochure shows a good variety of such equipment from a range of well known manufacturers. Most of the equipment is either surplus stock or secondhand, though some new items are also mentioned. In particular, they have introduced a range of new oscilloscopes from Topward. Cooke International Services, Unit 4, Fordingbridge Site, Main Road, Barnham, Bognor Regis, West Sussex, PO22 0EB. Tel: 0243 545111.

A somewhat specialised guide has been sent by Lambda Photometrics. Its part one of a guide to piezo positioning technology, and it describes itself as a user's handbook with basic principles, examples and products. If piezo products and designs are your fields, you should find much valuable information in this 66 page guide. Lambda Photometrics Ltd, Lambda House, Batford Mill, Harpenden, Herts, AL5 5BZ. Tel: 05827 64334.

It's good to see Magenta's catalogue again. Supplying electronics for education, robotics, music, computing and fun is Magenta's role in life, according to the caption on the cat cover. Magenta offer a good variety of components and equipment. The section on robotics is of special interest to those looking for mechanical bits and pieces for robot construction. Magenta Electronics Ltd, 135 Hunter Street, Burton on Trent, Staffs, DE14 2ST. Tel: 0283 65435.

Another company with a large catalogue is Marco Trading. In over 200 pages they describe thousands of products from right across the range of what any constructor may be looking for. Aerials head the list, and video equipment ends it, and in between are components and equipment as varied as diodes, grills, keyswitches, microphones, oscilloscopes, panel meters, resistors, telephones, and watch batteries. Marco also have a variety of special offers and valuable discounts. They also offer a full video and audio service/repair facility at competitive prices. Ah! there's a another good point as well - they say that many items in the catalogue are made in the UK. It's good to know where the The Flag is flying! Marco Trading, Head Office, The Maltings, High Street, Wem, Shrewsbury, SY4 5EN. Tel: 0939 32763. (Ask for details of their other shops as well.)



YEDA PRIZE PRAISE

Her Royal Highness The Duchess of York, presented the 1989 Young Electronic Designer Awards at the Queen Elizabeth II Conference Centre on 29 June and showed a keen interest in contestants' projects which varied from a doorbell for the deaf to a motor vehicle computer system and from a stringless musical instrument for handicapped people to a device for measuring the distance travelled by a horse in walk or trot.

There were 22 young designers in the final representing 14 different educational institutions across the country. Their ages ranged from 13 to 23.

First prize in the Senior category of this year's awards went to Cheltenham College Roger Lucas, aged 18, who designed an electronic pill reminder for patients on complicated courses of treatment. He wins sponsorship of £900 a year from Texas Instruments Ltd, while he is at university, a reserved place in the company's graduate intake during his graduation year, a guaranteed vacation job with TI this summer and £450 cash.

Addressing the finalists after the awards presentation, the Duchess spoke of her pleasure at seeing the concern of young people for helping the physically handicapped and aged reflected in so many of the entrants' projects.

For further information, contact: The YEDA Trust, 24 London Road, Horsham, West Sussex RH12 1AY. Tel: 0403 211048.

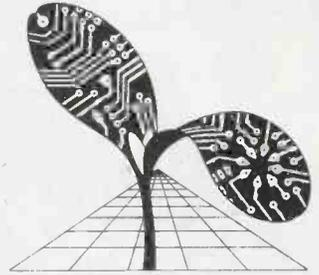

SMART SCOPE

Now available from the IR group, both for ex-stock sales and on IR's wide range of rental or leasing options, is the Philips PM3070 Smart Series oscilloscope.

The PM3070 is a 100MHz delayed timebase instrument featuring fully automatic cursor-controlled measurement facilities and an illuminated liquid-crystal display to give instant readout of status and settings.

A 16KV cathode-ray tube



provides optimum brightness and trace quality, while an 'auto-set' intelligent beam-finding facility automatically selects the channel, amplitude, timebase and triggering for the error-free display of any input signal.

Amplitude or timing measurements may be made automatically on any channel, and timing measurements can be made between channels. Relative amplitude measurements can be made from any reference, and the instrument maintains full calibration for accurate overshoot and modulation depth measurements.

Other facilities include cursor timing measurements on delayed sweep, and a 'zoom' function which automatically sets up delayed sweep parameters using the cursors to isolate signal detail.

For further information, contact: IR Group, Dorcan House, Meadfield Road, Langley, Slough, SL3 8AL. Tel: 0753 44878.

Component Solutions Ltd.

Unit 62, Enterprise Centre, Bedford Road, Stoke-On-Trent, Staffordshire.

0782 287038

"answering your component problems"

MICROPROCESSORS

Z80A CPU	1.10	Z80	
80C85	2.50	P10/S10/CTC	.80
6502	3.20	81C55	2.20
8031	2.00	82C12	2.20
80C31	3.50	82C51	2.25
68000P8	5.88	82C55	2.20

MEMORY

2708Q	2.70	27C256	4.00
2716	3.20		
2732	1.80	6116	2.00
2764	2.00		
27064	2.60	62256	14.00
27C128	2.75		
27128 plus	1.10	PAL12L1C	2.50

GOOD STOCKS ON ALL
ADVERTISED LINES,
SHIPMENTS BY
RETURN
ALL NEW PRODUCTS

BARGAINS OF THE MONTH

D8749H	3.75	27128-25	1.65
6264SRAMS	2.75	27C512	4.00

ALL TRANSACTIONS
CWO P&P 75p
+ VAT 15%
FULL PRICE LIST
£1.00 PER COPY

COMMODITY PRODUCTS TO CLEAR

74LS -	01 / 125 / 132 / 373 / 273 / 153 / 191 / 193	.12
	243 / 158 / 175 / 374	
78L08 - .10,	7812 - .10, 79L05 - .08,, 7905/7805 - .14,	6N136'138 / 139 - .25,
	8 & 12 MHz Crystals HE18U - .20,	MC 34018P - .60
4008 / 4012 / 4040 / 4066 / 4512 / 4556		.08



MAPLIN SELF-SERVICE

Doug Simmons, of Maplin tells me that their latest store, at 146/148 Burnt Oak Broadway, Edgware in North London, is very much up and running. He says the spacious, fully self-service store is creating an impressive landmark in the area. It is also creating sales results with trading at the end of the first week, well above expectations. Unusually for London the new store boasts excellent parking facilities. Buses, London underground and motorways are also in close proximity.

Opening the store, Patrick Horton, marketing director of the Middlesex Polytechnic, welcomed the new local arrival. It was, he said, an exciting time for Maplin.

In reply, Maplin's joint managing director, Roger Allen, pointed out that this was their ninth store – a far cry from the days when the mail order operations were run from his bedroom. (*Your Editor recalls that this was probably in about 1972. Is that right, Roger?*)

Maplin Electronics stores are already located in: Birmingham; Bristol; Leeds; London – Burnt Oak and Hammersmith; Manchester; Nottingham; Southampton and Southend on Sea. With further stores planned, Reading, Brighton and Newcastle are next in line, Doug comments that the Maplin logo and service looks like becoming a familiar high street fixture.

I'm pleased to hear it, Doug. Good luck!

For further information, contact: Lawrence Saunders, Manager, Maplin Burnt Oak Broadway Store. Tel: 01-951 0969.

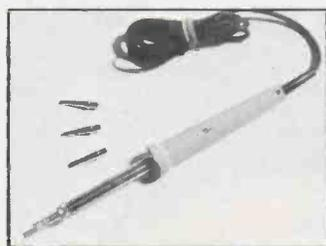

NEW BRASS IRONS

We know that a lot of PE readers are also interested in model making. Over the past few years, there has been phenomenal growth in the popularity of etched brass kits among model railway enthusiasts. Brass, however, can create problems when solder joints require the use of a miniature precision iron – simply because brass acts as a highly efficient heat sink and thus counteracts the heating efficiency of the iron.

This problem has now been solved by Greenwood Electronics with the introduction of its Oryx TC82-100 iron. Although extremely compact, the 240 volt unit features a remarkable output of up to 100 watts.

To allow for use in different applications, the tip temperature can be preset to any point between 260°C and 420°C via a simple manual adjustment. The value is indicated on a dial and close control of temperature is maintained throughout soldering operations.

The iron has a 12mm diam, 110mm long shaft and the complete unit is just 240mm long with a weight of only 190gms. It is supplied with a burn-proof lead and an iron-plated, screwdriver-shaped, 7mm wide long-life tip. Other available tips employ the same profile and include 4.8mm wide and miniature 3.2mm types.

The TC81-100 retails at £31.63, including vat, and spare tips cost £1.67.

For further details, contact: Alan Cooke-Sanderson, Greenwood Electronics, Portman Road, Reading, Berks RG3 1NE. Tel: 0734 595843.

ADVERTISERS!

If you'd like your new product mentioned here, send us the info about it, plus a nice photo!

EVENTS DIARY

If you are organising any event to do with electronics, big or small, drop us a line – we shall be glad to include it here.

Please note: Some events listed here may be trade or restricted category only. Also, we cannot guarantee information accuracy, so check details with the organisers before setting out.

Sep. 4-6. Eurobus 89 – UK Conference. Novotel Hotel, London. 01-940 4625.

Sep. 12-14. Optical Systems. Ramada Inn, London.

Sep. 12-15. EPOS 89. The World's largest exhibition of retail information systems. Alexandra Palace, London. RMDP. 0273 722687.

Sep. 26-28. British Laboratory Week 89. Incorporating Computer Aided Sciences. Olympia, London.

Oct. 16-20. Systems, Computers and Communications. 11th International Trade Fair and Congress. Munich Trade Fair Centre. 01-948 5166.

Oct. 24-26. Sensors and Systems – International Transducer Exhibition and Conference. Wembley Conference Centre. 0822 614671.

Nov. 7-11. Productronica. 8th International Trade Fair for Electronics Production. Munich Trade Fair Centre. 01-948 5166.

GREEN GROW BATTERIES OH!

Although several battery manufacturers have developed mercury-free zinc chloride batteries, few have addressed the far more critical alkaline types where mercury waste is over 105 tonnes (1988 – Western Europe) – compared to 3 tonnes for zinc carbon/chloride.

Alkaline batteries account for almost 50% of the UK primary battery market which is estimated at £260 million and Ralston Energy Systems has developed the first ultra-low mercury content alkaline battery.

The battery contains less than 0.02% of mercury – meeting EEC requirements for 1992 – and, in addition offers a staggering 50% increase in performance in certain high-drain applications. Mercury-free UCAR zinc chloride cells are also available.

For further details, Contact: Howard Batley, STC Electronic Services, Edinburgh Way, Harlow, Essex CM20 2DF. Tel: 0279 626777.

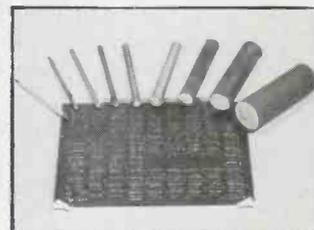

STICK AND BRUSH-UP

Series 4 have introduced a new range of low cost cleaning brushes for electronics use.

The cleaning brushes are high density glass fibre abrasive sticks for many cleaning applications, including pcbs, electrical contacts, commutators moulds, rust removal and print/mark removal.

They are available in stick form, which can be cut back to expose the bristles. The more bristle exposed, the less abrasive. A 2mm clutch pencil and 4mm propelling pencil with fibre inserts are also available for micro work.

Contact: Series 4 Limited, PO Box 112, Southampton, Hants SO9 7NN. Tel: 0703 474581.

ANSWERING BACK ON DAT

We have given much publicity to the technical and ethical problems relating to digital audio tape (dat). The ethical considerations have hitherto been expressed largely by those with an opposing outlook. It is thus with interest that we have now heard from the Home Taping Rights Campaign (HTRC).

The campaign says that it has responded with caution to reports of an agreement between the international recording and electronic industries concerning dat recorders.

Marianne Yarwood, HTRC Coordinator said "If this agreement means that the benefits of digital recording technology are now to be made widely available to consumers, it is to be welcomed.

"The agreement would appear to provide consumers with the ability to take first generation digital copies of pre-recorded music and two generations if an analogue source is used. This acceptance of the right to home tape is most encouraging."

Whilst the recognition of the basic interests of consumers expressed in the agreement is welcome, the HTRC, whose supporting organisations include groups representing consumers, teachers, students, manufacturers and blind people, will be looking for independent confirmation that the new system does not create the artificial degradation of quality which has been shown by devices proposed in the past.

"We will be seeking to ensure that the new dat format will meet the requirements of all our supporters and particularly of regular tape users such as teachers and blind people. Whilst we welcome any discussions between the recording and electronic industries which lead to greater public access to new recording technology, HTRC would reject totally any outcome which led to the imposition of levies either on equipment or on tapes," said Miss Yarwood.

HTRC has long opposed levies as an unacceptable, unjustified and unworkable interference in consumers rights to tape at home. The principle of levies was overwhelmingly rejected by the British Parliament only last year.

The HTRC was formed in 1986 by organisations seeking to defend home taping and to oppose any attempt to penalise it. The Campaign is supported by the following UK member organisations: Consumers' Association, Consumers in the European Community Group, National Consumer Council, National Union of Students, National Union of Teachers, Recording Equipment Group, Royal National Institute for the Blind, Tape Manufacturers Group.

For further information, please contact: Marianne Yarwood, Home Taping Rights Campaign Office, Number One, Dean's Yard, Westminster, London SW1P 3NR. Tel: 01-799 9811.

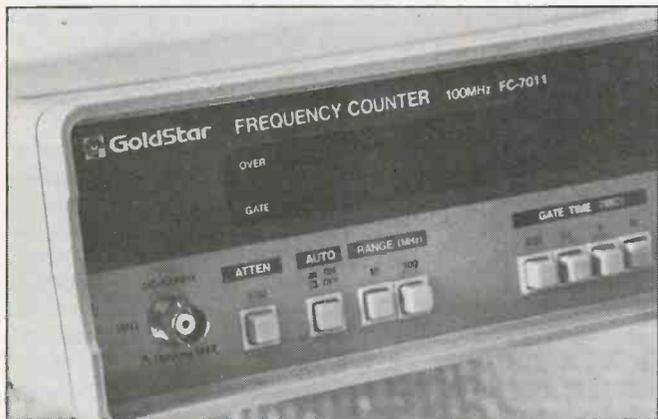

STAR COUNTING

Alpha Electronics have available the first of a series of frequency counters from Gold Star. Model FC 7011 is a state of the art 8-digit single channel counter which measures directly from 1Hz to

100MHz. Small, compact and lightweight, this first unit comes with a choice of reference oscillators and case material.

An 8-digit led display is enhanced by switchable manual or automatic ranging and the ability to hold indefinitely the last measured value. direct measurements from 1Hz to 100MHz have resolutions of 0.1, 1.0, 10 and 100 seconds and a basic

CHIP COUNT

This month's highlight choice are two high precision chopper-stabilised opamps from Texas Instruments.

TLC2652 AND TLC2654

The TLC2652/A and TLC2654/A are high precision chopper-stabilised opamps designed using Texas Instruments' Advanced LinCMOS process. Chopper stabilised techniques enable extremely high dc precision by continually sampling the input signals and nulling any offsets. Because the sampling is continuous, offset errors due to variations in temperature, time, common-mode voltage and power supplies are practically removed.

The TLC2652/A is optimised for low input offset voltage. The maximum Vio is only 1 microvolt and the offset drift due to time and temperature is guaranteed at 0.03 microvolts per degree Celsius and 0.02 microvolts per month.

Chopper stabilised opamps are used predominantly in applications needing high dc precision, but many applications also require good ac performance. Although suitable for the majority of applications, some critical designs may see problems due to intermodulation of the chopping and input signals. These effects are normally reduced by on-chip circuitry, but precise applications needing a wide bandwidth will not be able to use standard chopper opamps. The actual usable bandwidth is limited to half the chopping frequency. Until now, design constraints have resulted in a trade-off between input offset voltage and chopping frequency - the latter normally being limited to a few hundred Hertz (450Hz for the TLC2652). By using patented design techniques, Texas Instruments have developed the TLC2654/A to remove these problems. These devices use a chopping frequency of 10kHz but still have a maximum Vio as low as 10 microvolts. The usable bandwidth of nearly 5kHz now makes applications in the audio range possible.

A further benefit of chopper opamps is an ultra low 1/f noise. Because the input is continually sampled, offset errors due to the noise voltage can also be reduced and the noise voltage at frequencies from dc to greater than 10Hz is almost constant. The higher chopping frequency of the TLC2654 and TLC2654/A has also meant that the noise voltage is even further reduced, significantly improving this device, say Texas Instruments, over similar parts on the market.

The TLC2652 and TLC2654 have a common mode input range which includes ground, enabling the devices to be used with both single and dual supplies. The TLC2652 can operate with supplies down to $\pm 1.9V$.

Applications requiring the high dc precision offered by these devices may include thermocouples, strain gauges and other transducer amplifiers.

For more information on the TLC2652 and TLC2654 contact Texas Instruments Ltd, Manton Lane, Bedford, MK41 7PA. Tel : 0234 223000.

input sensitivity of 10 millivolts. Model 7011 has an input impedance greater than 1M ohm that can accept up to 150V rms.

FC 7011 has a 10MHz crystal reference oscillator with better than 5 ppm stability and an ageing rate of less than 5ppm/year. Models 7012 and 7013 are both fitted with temperature compensated crystal oscillators with better than 1 ppm temperature stability and ageing rate per year.

For further information contact: Alpha Electronics Ltd, Unit 5, Linstock Trading Estate, Wigan Road, Atherton, Manchester M29 0QA. Tel: 0942 873434.

POINTS ARISING

Boating Revolution (July 89).

The VHF radio telephone photo on page 53 was wrongly attributed to Seafarer. It should, of course, have been quoted as a Navico product. Navico point out that they are the only company designing and manufacturing marine VHF transceivers in the UK. They may be contacted at Star Lane, Margate, Kent, CT9 4NP.

By the time you read this, ITV and Channel 4 should be officially broadcasting stereo sound with television, in the London and Yorkshire areas.

Unofficially, the BBC has been broadcasting in London for several years, and ITV and Channel 4 have been using the same system in London and Yorkshire for many months. But when ITV and Channel 4 start a regular service (it was scheduled for September) it will be a milestone.

The system used is Nicam 728 - and it will be the first everyday, scheduled use of digital sound for terrestrial entertainment broadcasting direct into the home, anywhere in the world.

To re-cap briefly, Japan has for several years been using a multiplex broadcast stereo system, similar to the system used for vhf radio. The US adopted a similar system, but with dbx noise reduction on the stereo sub-carrier. West Germany uses two separate fm sound carriers - each like the single one used for mono. All are all-analogue.

The Nicam stereo signal is in digital code and it rides on an extra carrier above the ordinary and fm analogue mono sound carriers.

LEADING

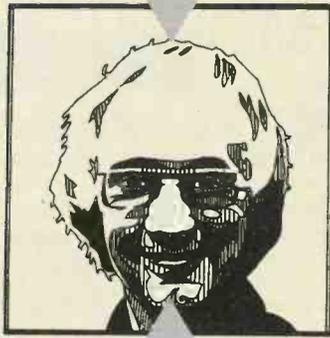

EDGE

are picking up sound that has nothing to do with the pictures - or sometimes just silence.

The official IBA line is that all will be resolved when regular transmissions begin because the fm mono and Nicam soundtracks will always be the same, even if the Nicam track is simply a digital mono version of the fm mono track.

But this begs the question of how the IBA will cope with bilingual broadcasts, with multi language soundtracks, eg for a dubbed film.

London had a foretaste of the muddles that lie ahead in mid July. Without any announcement, Thames TV broadcast "The Marriage of Figaro" in Nicam stereo, over two nights (July 10/11).

Afterwards Thames engineers left their audio feeds patched to transmit silence on the Nicam track. This meant that anyone with a Nicam receiver set in auto mode got no sound for the following programme ("I Spy"). Then at the beginning of "Sportsworld Extra" they got a test tone.

I talked with the IBA the next day who said they would talk to Thames, who said it was all down to "finger trouble". Fair enough.

DIGITAL STEREO TV

The 728 refers to the total number of digital bits per second that are transmitted, 728 kilobits. Each channel is sampled at 32 kHz, giving an audio bandwidth of 15 kHz. Each sample is then coded into 14 bit words and these compressed into 10 bit words. The sound quality is not as good as cd, but only acute ears will hear the difference.

Conventional mono fm sound is still transmitted on the standard sound carrier at 6MHz above the picture. The digital code is carried at 6.552 MHz.

The two Nicam sound channels are completely separate, both from each other and from the mono analogue sound. This means that two or even three quite different language soundtracks can be broadcast at the same time, to give listeners a multilingual choice. The digital signal is so robust, that clear stereo is heard even when the pictures have been spoiled by noise and interference.

The BBC started giving demonstrations of the system in 1984. A technical specification was agreed with IBA and in September 1986 the Department of Trade and Industry gave Nicam its formal blessing of Nicam as a broadcast standard for the UK.

Led to believe that the BBC would start broadcasting a regular Nicam service in Spring 1988, Toshiba, Texas Instruments and Mullard/Philips all developed Nicam chips. Just as JVC started selling a Nicam vcr, in October 1987, Michael Checkland, the new Director General of the BBC, unveiled his cost-cutting strategy for the 1990s. Nicam was shelved.

Test transmissions have continued from Crystal Palace but the BBC will not start a service until the 1990s. By then ITV and

BY BARRY FOX
Winner of the
UK Technology Press Award

The change over to digital stereo tv sound is leaving many mute with exasperation over yet another case of double standards.

Channel 4 will be serving at least three quarters of the population.

All the major electronics companies now sell Nicam tv sets and vcrs. The IBA, ITV and Channel 4 have spent the last nine months learning how to use Nicam, and making some very public mistakes.

The root problem is how Nicam receivers respond to tv programmes which have different soundtracks on the fm mono and Nicam stereo carriers. If the receiver is normal in automatic mode, it will latch onto the Nicam stereo signal, in preference to the fm mono signal. For normal programming, the two soundtracks will be the same. But to test separation, engineers like to transmit tones or silence or music from cd or dat cassettes on the Nicam carrier, with normal programme sound transmitted only on the fm mono carrier. So viewers with Nicam receivers in auto mode end up hearing the wrong soundtrack.

There have been a lot of puzzled people in London and Yorkshire recently, wondering why their lovely new stereo tv sets and vcrs

Mistakes happen. But then, believe it or not, Thames made exactly the same mistake that night, when transmitting the second half of "Figaro". After the programme, a feature film ("Behind the Mask") went out with the Nicam feed line left connected to Thames' video tape recorder suite. Over the air listeners heard the telltale sound of tape rewinding at high speed. I tried telephoning Thames and asked to speak to the duty officer to warn what was going on. The duty officer had gone home at midnight and no-one would put me through to vtr.

"Our duty officers always go home at midnight", said Thames later. Yes, even when the station stays on air all night and even when the company is making history with its first major Nicam transmissions. During London Weekend's Gala Night, soon after, the programme was in stereo but the adverts had no sound.

There is even a muddle over the encoders being used to route digital sound signals round the country between transmitters.

The BBC and Channel 4 already distribute the mono sound for their tv programmes round the country, between transmitters, as digital code slotted into the gaps created in the video waveform by the picture synchronisation pulses. The system is called sound-in-sync sis. To squeeze stereo into the syncs, the gaps are slightly widened and four-level, instead of two-level, digital coding used.

ITV has been using BT analogue landlines with a bandwidth of only 8-10kHz, not sis.

Both the BBC and the IBA, are now busily converting whole networks to stereo SIS overnight. ITV listeners, regardless of whether they are receiving Nicam stereo, should hear a big difference as they are cut free from the noisy low pass landlines.

PE

What an exhilarating atmosphere there is around the office! The anniversary's nearly here - *The anniversary*, the Silvered 25th one! Twenty five years old, that's how old PE will be on Friday 6th of October 1989. What a birthday to celebrate! And so we shall ...

To join in with the festivities, we have some notable guests for the November issue, and there are an extra sixteen pages as well!

One of the special features is an interview with Sir Clive Sinclair. He shares his views on technology past and present, and on his own involvement with it. In a recent poll among a number of PE readers, Sir Clive was overwhelmingly voted as the personality to whom a PE award should be made for outstanding contributions to technology over the last 25 years. More on that in moment!

Veteran readers, you'll be delighted to know that Fred Bennett, PE's founding editor, will be telling his reminiscences of how PE started. They make fascinating reading. Did you know it took over two years to plan PE? You'll be interested in the photos of Fred as well, one fresh from the camera, and the other found in the archives!

Those who were reading PE before 1986 will remember PE's second editor, Mike Kenward. Even before he took over from Fred,

PRACTICAL ELECTRONICS



CONSUMER SCORING

he'd been with PE for many years. He's a tale or two tell about how he came to be involved. We've found an archive picture of him too!

We've some mini-memoirs from Richard Barron as well. He assisted Mike during IPC days at Poole and then edited PE during 1986 after it was bought by Angelo.

As a reader since Issue Number One, I'll be taking a nostalgic trip back in time. Paging through over 300 issues, I found it fascinating to relive some of the past. How things have moved on! Then, changing hats from reader to Editor, I'll lead you on from Richard's time to how PE looks at the world now.

Other regular columnists too will have their personal views of technology included. Tom Ivall assesses the significance of some major happenings over the last 25 years. A look at what the next 25 years may have in store is taken by Barry Fox. From across the pond, Wayne Green inimitably regards State-side technology with hindsight, and crystal gazes to the future.

There's an amazing story, too, from another of our contributors, Tony Smith, about a reader who runs a multi-million pound business started because of a PE project!

Nor should you miss the fabulous competition with all its valuable prizes!

As a separate celebration, we're holding a real live party at the Kew Bridge Steam Museum, on the evening of 27th September. We'd like some of you to join us! The first five readers who *write in* (please don't phone) by Tuesday September 5th telling us you'd like to come will receive a pair of invitations. Sorry, we can't offer transport or overnight accommodation. The lucky pairs will be present when Sir Clive receives his award, and have the opportunity to mingle with PE personalities and advertisers, plus our colleagues from the publishing world.

Celebrations, here we come!

THE EDITOR

Editor:

John Becker

Sub-Editor:

Helen Armstrong

Technical Illustrator:

Derek Gooding

Advertisement Executives:

David Bonner, Richard Caplis

Business Manager:

Mary-Ann Hubers

Production Manager:

David Hewett

Publisher:

Angelo Zgorelec

Editorial and Advertising Address:

Practical Electronics,
Intra House, 193 Uxbridge Road,
London W12 9RA
Tel: 01-743 8888
Telecom Gold: 87: SQQ567
Fax: 01-743 3062

Advertisements

All correspondence relating to advertise-



ments, including classified ads, should be addressed to: **The advertisement department, Practical Electronics, at the above address and telephone number.**

Readers' Enquiries

All editorial correspondence should be addressed to the editor and any letters requiring a reply should be accompanied by a stamped addressed envelope, or equivalent payment.

We regret that lengthy technical enquiries cannot be answered over the phone.

Subscription Address:

Practical Electronics, Subscription Dept.,
P.O. Box 500, Leicester LE99 0AA.

Annual Subscription Rates:

U.K. £15.00 Overseas £18.00

Cover Illustration

A representation of the V1500 Cygni Binary System immediately after outburst. By courtesy of University of Arizona.

© Intra Press 1989. Copyright in all drawings, photographs and articles published in PRACTICAL ELECTRONICS is fully protected, and reproduction or imitations in whole or in part are expressly forbidden. All reasonable precautions are taken by PRACTICAL ELECTRONICS to ensure that the advice and data given to readers is reliable. We cannot, however, guarantee it, and we cannot accept legal responsibility for it. Prices quoted are those current as we go to press. All material is accepted for publication on the express understanding that the contributor has the authority to permit us to do so. **ISSN 0032-6372**

Published on 1st Friday of each month by Intrapress, 193 Uxbridge Road, London W12 9RA. Typesetting, artwork and film by Gilfillan Ltd. Mitcham, Surrey and printed in England by Andover Press Ltd. Andover, Hants. Distributed by Seymour 01-679 1899. PRACTICAL ELECTRONICS is sold subject to the following conditions, namely that it shall not, without the written consent of the Publishers first having been given, be lent, resold, hired out or otherwise disposed of by way of Trade at more than the recommended selling price shown on the cover, and that it shall not be lent, resold, hired out or otherwise disposed of in a mutilated condition or in any unauthorised cover by way of Trade or affixed to or as part of any publication or advertising, literary or pictorial matter whatsoever.

MAGENTA ELECTRONICS Ltd

PROJECT KITS

Magenta supply Full Kits: Including PCB's (or Stripboard), Hardware, Components, and Cases (unless stated). Please state Kit Reference Number, Kit Title and Price, when ordering. REPRINTS: If you do not have the issue of P.E. which includes the project, you will need to order the instruction reprint as an extra: 80p each. Reprints are also available separately - Send £1 in stamps. Magazine dates refer to Everyday Electronics.

REF NO.	KIT-TITLE	PRICE	REF NO.	KIT-TITLE	PRICE
812	ULTRASONIC PET SCARER May 89	£13.80	581	VIDEO GUARD Feb 87	£8.39
811	MIDI PEDAL Mar 89	£39.98	584	SPECTRUM SPEECH SYNTH. (no case) Feb 87	£20.92
810	MIDI MERGE Mar 89	£11.59	578	SPECTRUM I/O PORT less case Feb 87	£9.44
809	CALL ALERT Mar 89	£13.51	569	CAR ALARM Dec 86	£12.47
807	MINI PSU Feb 89	£22.71	563	200MHz DIG. FREQUENCY METER Nov 86	£62.98
806	CONTINUITY TESTER Feb 89	£10.28	561	LIGHT RIDER LAPEL BADGE Oct 86	£10.20
505	4 CHANNEL LIGHT DIMMER Feb 89	£37.99	560	LIGHT RIDER DISCO VERSION	£19.82
803	REACTION TIMER Dec. 88	£29.98	559	LIGHT RIDER 16 LED VERSION	£13.64
802	PHASOR (Light Controller) Dec 88	£25.61	556	INFRA-RED BEAM ALARM Sept 86	£28.35
801	DOWNBEAT METRONOME Dec 88	£17.57	544	TILT ALARM July 86	£7.82
800	SPECTRUM EPROM PROGRAMMER Dec 88	£26.97	542	PERSONAL RADIO June 86	£11.53
796	SEASHELL SYNTHESIZER Nov 88	£24.99	528	PA AMPLIFIER May 86	£26.95
795	I.R. OBJECT COUNTER Nov 88	£29.63	523	STEREO REVERB Apr 86	£26.44
790	EPROM ERASER Oct 88	£24.95	513	BBC MIDI INTERFACE Mar 86	£27.94
786	UNIVERSAL NICAD CHARGER July 88	£6.99	512	MAINS TESTER & FUSE FINDER Mar 86	£8.82
780	CABLE & PIPE LOCATOR April 88	£15.35	497	MUSICAL DOOR BELL Jan 86	£18.72
775	ENVELOPE SHAPER Mar 88	£14.99	493	DIGITAL CAPACITANCE METER Dec 85	£41.55
769	VARIABLE 25V-2A BENCH POWER SUPPLY Feb 88	£49.73	481	SOLDERING IRON CONTROLLER Oct 85	£5.47
	CAR LAMP CHECKING SYST. Feb 88	£7.10	464	STEPPER MOTOR INTERFACE FOR THE BBC	
763	AUDIO SIGNAL GENERATOR Dec 87	£13.64		COMPUTER less case Aug 85	£11.68
739	ACCENTED BEAT METRONOME Nov 87	£20.95		1035 STEPPER MOTOR EXTRA	£14.50
740	ACOUSTIC PROBE Nov 87 (less bolt & probe)	£16.26		OPTIONAL POWER SUPPLY PARTS	£5.14
744	VIDEO CONTROLLER Oct 87	£29.14	461	CONTINUITY TESTER July 85	£6.20
745	TRANSTEST Oct 87	£9.70	455	ELECTRONIC DOORBELL June 85	£7.56
734	AUTOMATIC PORCH LIGHT Oct 87	£17.17	453	GRAPHIC EQUALISER June 85	£26.94
736	STATIC MONITOR Oct 87	£8.66	444	INSULATION TESTER Apr 85	£19.58
723	ELECTRONIC MULTIMETER Sept 87	£46.96	430	SPECTRUM AMPLIFIER Jan 85	£6.91
728	PERSONAL STEREO AMP Sept 87	£14.31	392	BBC MICRO AUDIO STORAGE SCOPE	
730	BURST-FIRE MAINS CONTROLLER Sept 87	£13.57		INTERFACE Nov 84	£36.25
724	SUPER SOUND ADAPTOR Aug 87	£38.39	387	MAINS CABLE DETECTOR Oct 84	£5.53
718	3 BAND 1.6-30MHz RADIO Aug 87	£26.53	386	DRILL SPEED CONTROLLER Oct 84	£8.58
719	BUCCANER I.B. METAL DETECTOR July 87	£18.26	362	VARI-CAP AM RADIO May 84	£13.15
	inc. case, less handle and hardware July 87	£26.45	337	BIOLOGICAL AMPLIFIER Jan 84	£24.14
720	DIGITAL COUNTER/FREQ METER (10MHz)		263	BUZZ OFF Mar 83	£5.68
	inc. case July 87	£67.07	242	2-WAY INTERCOM no case July 82	£5.69
722	FERROSTAT July 87	£12.14	240	EGG TIMER June 82	£6.86
711	VISUAL GUITAR TUNER Jun 87	£22.99	205	SUSTAIN UNIT Oct 81	£17.63
715	MINI DISCO LIGHT Jun 87	£12.59	108	IN SITU TRANSISTOR TESTER Jun 78	£9.42
707	EQUALIZER (IONISER) May 87	£15.53	106	WEIRD SOUND EFFECTS GEN Mar 78	£7.82
700	ACTIVE I/R BURGLAR ALARM Mar 87	£35.85	101	ELECTRONIC DICE Mar 77	£6.26

TOP KITS

MOSFET VARIABLE BENCH 25V 2.5A POWER SUPPLY

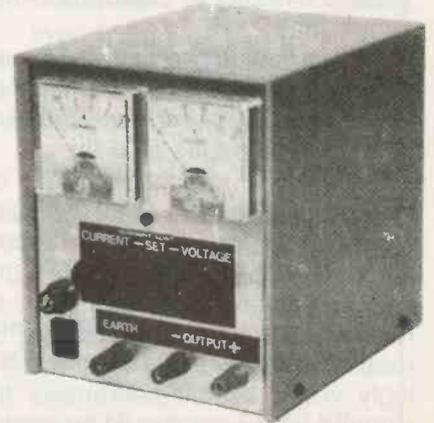

A superb design giving 0-25V and 0-2.5A. Twin panel meters indicate Voltage and Current. Voltage is variable from zero to 25V. Current-Limit control allows Constant Current charging of NICAD batteries, and protects circuits from overload. A Toroidal transformer MOSFET power output device, and Quad op-amp IC design give excellent performance.

OUR KIT REF. 769 £49.73

COMPONENTS, KITS, BOOKS, TOOLS, MOTORS, GEARS, PULLEYS, OPTICAL FIBRES, ROBOTICS, AND MUCH MUCH MORE - IN OUR CATALOGUE £1.00

EE TREASURE HUNTER

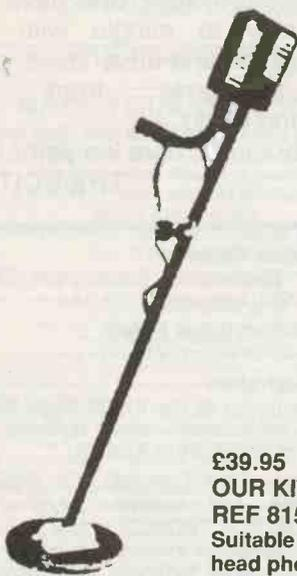

£39.95
OUR KIT
REF 815
Suitable
head phone
£1.99

P.I. METAL DETECTOR

A sensitive pulse induction Metal Detector. Picks up coins and rings etc. up to 20cms deep. Low "ground effect". Can be used with search-head underwater. Easy to use and build, kit includes search-head, handle, case, P.C.B. and all parts as shown.

DIGITAL FREQUENCY 200 MHz METER KIT REF 563

£62.98

An 8 digit meter reading from A.F. up to 200 MHz in two ranges. Large 0.5" Red LED display. Ideal for AF and RF measurements. Amateur and C.B. frequencies.

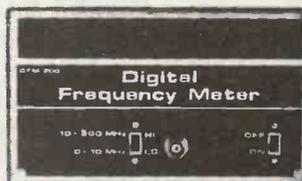

VISUAL GUITAR TUNER



Crystal controlled, with a super rotating LED display. Indicates high, low, and exact degree of mistuning. Use with pick-up or mic. Also has audible output.

KIT REF E711 £21.99

3 BAND SHORTWAVE RADIO



OUR KIT
REF 718 £26.53

Covers 1.6-30 MHz in 3 bands using modern miniature coils. Audio output is via a built-in loudspeaker. Advanced design gives excellent stability, sensitivity and selectivity. Simple to build.

MOTOR-GEARBOX ASSEMBLIES

Miniature gearboxes complete with quality electric motor. Variable ratios by fitting 1 to 6 gears. 1.5-4.5v, 3-2200 rpm. Long 3mm shaft. Ideal for robots and buggies.

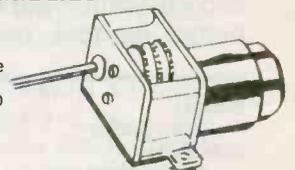

SMALL (MGS) £3.49 LARGE (MGL) £3.98

ADVENTURES WITH ELECTRONICS

BOOK £4.75 PACK £20.98
An easy to follow book suitable for all ages. No soldering, uses an S DEC breadboard. Lots of clear diagrams and instructions to build 16 projects. Component pack includes S DEC and all components for the projects.

LEGO Technic Sets
TEACHERS WE ARE STOCKISTS OF THE WHOLE RANGE. CONTACT US FOR BROCHURES. VERY COMPETITIVE PRICES AND QUICK DELIVERIES

STEPPING MOTORS 12 VOLT

48 STEPS | 200 STEPS
1035 | MD200
£14.50 | £16.80

OPTICAL FIBRES TRIAL PACK OF 10 METRES. Nine assorted types & data.

£1.99

Fax: 0283 46932
Phone: 0283 65435



FROM MAGENTA

A SELECTION OF OUR BEST PROJECT KITS

As usual these kits come complete with printed circuit boards, cases, all components, nuts, screws, wire etc. All have been tested by our engineers (many of them are our own designs) to ensure that you get excellent results.

INSULATION TESTER

An electronic High Voltage tester for mains appliances and wiring. An inverter circuit produces 500 volts from a PP3 battery and applies it to the circuit under test. Reads insulation up to 100 Megohms. Completely safe in use.

OUR KIT REF 444 £19.58



MAGENTA ELECTRONICS LTD
 PE15 HUNTER STREET,
 BURTON-ON-TRENT,
 STAFFS. DE14 2ST.
 0283 65435, Mon-Fri 9-5 Sat 9-2
 Access/Barclaycard (Visa) by
 phone or post.
 24 hr Answerphone for credit
 card orders.
 Our prices include VAT

ADD £1 P&P TO ALL ORDERS.
PRICES INCLUDE VAT.
SAE ALL ENQUIRIES.
OFFICIAL ORDERS WELCOME
OVERSEAS: Payment must be
sterling.
IRISH REPUBLIC and BFPO. UK
PRICES.
FAX: 0283 46932

DIGITAL CAPACITANCE METER

Simple and accurate (1%) measurements of capacitors from a few pF up to 1,000 uF. Clear 5 digit LED display indicates exact value. Three ranges -- pF, nF, and uF. Just connect the capacitor, press the button and read the value.

£41.55
OUR KIT
REF 493



MAGENTA

LOWCOST

68000

CROSS-ASSEMBLER
FOR BBC. ALSO
AVAILABLE
£60.00
(DISK)

68020
PLUG-IN UPGRADE
NOW AVAILABLE
PLEASE ASK FOR DETAILS

USED
BY SCHOOLS
COLLEGES &
UNIVERSITIES
U.K & WORLDWIDE

MICROPROCESSOR
TRAINER
AND SINGLE
BOARD
COMPUTER

***PERFECT FOR ROBOTICS**
APPLICATIONS REQUIRING
POWER AND SPEED*

KIT PRICE
£110 INC VAT

OTHER OPTIONS, DATA PACKS,
AND LITERATURE AVAILABLE
- SEND FOR DETAILS.

- Full 8MHz 68000 Processor with 16 bit data bus.
- Top-class monitor program included on two Eproms.
- Communicates via RS232 interface to terminal, BBC computer, P.C. computer etc.
- Use as a Trainer, or as a stand-alone computer system.
- Fast, powerful processing - Ideal for real time control systems.

- Dual U.A.R.T. allows simultaneous connection of printer and terminal.
- Add-on options include: G64 Bus, 68230 P.I.T. 8k and 32K Ram upgrades, and line by line assembler.
- Available from stock now - with support literature and full technical back up.

STANDARD SYSTEM IN KIT FORM (Ref 600)	£110.00	68230 P.I.T. ADD ON OPTION (Ref 603)	£ 11.97
STANDARD SYSTEM BUILT & TESTED	£190.00	G64 BUS ADD-ON (Ref 604)	£ 5.49
LINE BY LINE ASSEMBLER PROGRAM (IN EPROM)	£ 27.00	8K x 16 RAM UPGRADE (Ref 605)	£ 19.25
POWER SUPPLY (Ref 609)	£ 13.99	32K 16 RAM UPGRADE Ref 606	Phone

Astronomers piece together the mysteries of the Universe from simple measurements. In most cases, these involve monitoring the position, the brightness and the spectrum of the various celestial objects over the whole range of the electromagnetic spectrum, from γ -rays, through X-rays, the ultraviolet, the optical (visual), the infrared to the radio region.

Ground-based optical observations are very rarely made by eye. A plethora of detectors is now employed at the focus of the telescope, the devices providing an objective approach to the measurements. Permanent records are also produced for accumulation in data banks. Most detectors employ the photoelectric effect in some form whereby the starlight is converted into electrical signals which are then measured. A regular stellar photometer is likely to use a photomultiplier as the detector. Rather than measuring the current flow that each star engenders, the light is so feeble that the electrons liberated by the energy of the incoming photons can be counted as they are released by the detector's sensitive surface. Thus the brightnesses of the stars and their variations are monitored by counting the arrival of individual photons!

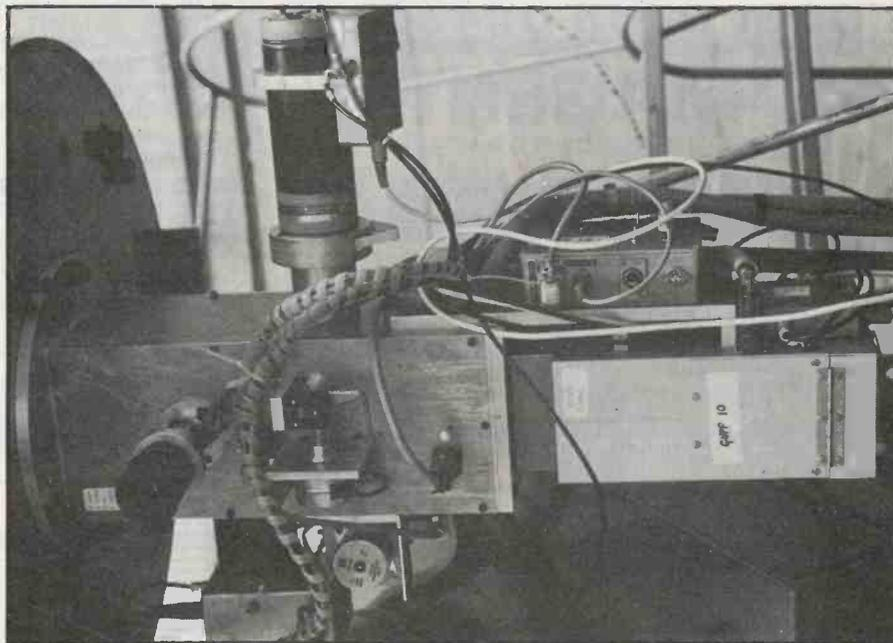

Photo 1. A photometer box attached to the base-plate of a telescope. An eyepiece allows the selected star for measurement to be checked visually. The starlight is split into two beams which are measured by photomultipliers, one housed in a cooling box. Two stepper motors are used to control the colour passband of the light that is being measured. The inside of the box is temperature stabilised to $\pm 0.1^\circ\text{C}$.

TELESCOPE CONTROL INTERFACE

Accumulated photon counts recorded over set integration times correspond directly to digitised stellar brightness values, their form ideally suited for direct processing by computer.

A standard photometer also allows the colours of stars to be measured by recording the brightnesses as "seen" through optical filters. The observational routine requires the filters to be set in the light beam in turn, an operation easily undertaken by stepper motors.

At many larger observatories the control of all the instrumentation, from the dome opening and rotation, telescope pointing and tracking, the control of the analysing equipment attached to the telescope down to the logging of the photon counts is now invariably under direct computer control. Software packages are available to run all the various observational routines. It is also common practice to incorporate some level of real time analysis whereby the raw data in the form of direct photon counts are presented immediately to the operator. The observer rarely ever sees stars through the telescope; the night time vigil is spent before a keyboard and a visual display unit.

Many of the smaller microcomputers that are on the market are limited in the form of input/output ports they support. This immediately poses problems for

BY DAVID CLARKE

Control and data signals move in and out of the RS232 port with this versatile parallel serial interface.

Although the photometer referred to within this article may be too expensive for the electronically minded amateur astronomer, the computer control circuit described can be put to many other uses, both for astronomy and for other applications.

communicating with the outside world, either in controlling peripheral machinery or taking in data from external sensing devices.

While undertaking the design of a stellar photometer for attachment to a telescope it was decided to explore an interface for use with micros with a serial output port. The

developed system operates in both directions with the computer providing the control of the telescope equipment and the intaking of data, using quiet time between the various operations to perform calculations and to display real time results. Any computer with a standard RS232C interface can be used with the fabricated circuit.

The original requirements for the astronomical photometer were that it should be able to control external counters used to record the photon counts generated by a photomultiplier detector when the telescope is directed to a star. As it turns out, accumulated photon counts recorded over set integration times correspond directly to stellar brightness values, the digitised nature of the measurements being ideally suited for direct processing by computer. Also, the interface should be able to move optical devices (eg, colour filters) in the light beam prior to its detection.

Thus the interface had to be capable of opening the counters to accept photon pulses, closing them when the integration time had elapsed, latching the counts in temporary stores so that the stellar measurement could still proceed during the data transfer to the computer, clearing the photon counters, advancing the position of stepper motors, etc. Even if the micro-

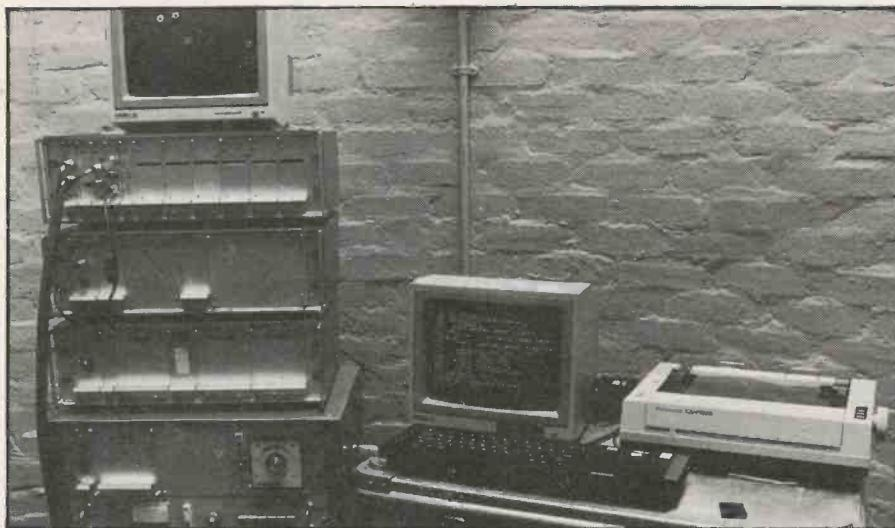

Photo 2. An array of electronic equipment allows the brightnesses of stars to be measured with an accuracy of $\pm 0.1\%$. The QL microcomputer is used to control the photometer and record the data. In order, the vertical rack comprises

- (i) a monitor for displaying the starfield as seen by a tv camera attached to a tracking telescope**
- (ii) the designed interface system for the QL to control the photon counters (6) and stepper motors attached to the photometer box**
- (iii) power supplies to support the electronics**
- (v) a system for temperature stabilisation of the photometer box**
- (vi) high voltage supplies and cooler control for the photo-multiplier detectors.**

computer provides a parallel port, the number of lines available would be insufficient to control all the desired operations.

In this article an interface system is described that works with a serial port, using single character messages sent by the computer. In essence it is a simple serial to parallel converter. Its operation is centred on a standard uart (universal asynchronous receive and transmit - 6402) chip. Although the original application was specific to the support of a photometer, the concept of the interface is completely general and it can be adapted to a wide variety of purposes.

Photo 3. The QL system for solar experiments, the middle box holding the interface board, three photon counters and circuitry for controlling stepper motors.



Experience with the system has revealed several important design problems. These are high-lighted in the various sections below with working solutions.

BASIC SYSTEM

The interface allows communication to be performed using Basic language with simple programs that can be readily written for the particular electronic control that is desired. In the design described here, 18 communication lines are set up, although this number could be increased to 255 with

higher levels of sophistication in the logic circuitry. Some of these lines are used to control the operations of the observations. Others are used to manipulate a data address bus whereby a photon counter is chosen for interrogation and a particular digit is despatched from the counter to the computer. In the stellar photometer that has been made, six photon counters may be operated simultaneously each able to record to 9999999 with a leading eighth digit permanently set to identify the counter. Although the circuit design could immediately be extended to support 16 counters each with 16 digits, this level of data logging is beyond the usual requirements.

The system does not pretend to be the most elegant in terms of concept and deployment of the more modern, powerful chips but its construction is readily understood and it has proved to be most reliable in the field having been transported many times in the back of a car. Except for one chip, a simple power supply of five volts is required, most of the circuitry comprising ttl devices. The chip for receiving data from the outside machine requires a supply with ± 15 volts but in cases for which only direct control is required, without the computer reading in the data, this latter chip may be excluded.

The interface has been designed to operate with any standard serial port but in the experiments described here, a Sinclair QL microcomputer has been used. Examples of the programs are written for that machine; simple modifications may be required for the programs to be run on other computers.

UART SUPPORT

The uart is a device that accepts characters in serial form on a line and converts them to a parallel format. It is also able to accept characters in parallel form and transmit them as a serial signal.

Several options and facilities of the uart need to be considered for the design of the interface. Switches may be fitted to pins 36, 37 and 38 so that these inputs can be connected as high (H) or low (L) according to the configuration of the character format of the computer (ie 5, 6, 7 or 8 bit characters; 1 or 2 stop bits). These could be hard wired for use with a given chosen computer. To keep things as simple as possible, many of the functions available from the uart may be ignored. The states of the 40 pins of the chip for use with the QL are readily assessed from the layout Fig. 1. Modifications might be incorporated in the wiring of the uart according to the degree of sophistication required, eg whether checks on overflow or parity might be useful.

In order to operate the uart, the chip needs some simple support circuitry. In the first place it requires a frequency reference so that the characters can be received/accepted at the right speed. The

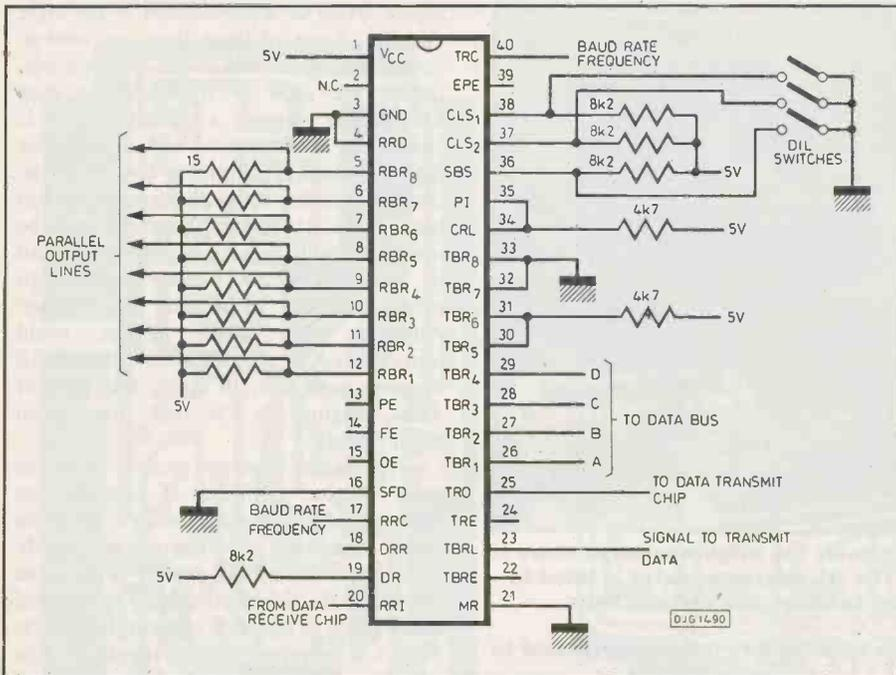
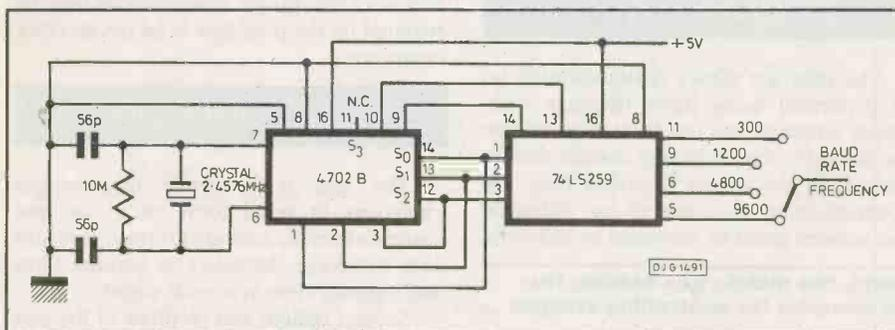

Fig. 1 The 6402 UART is shown with the basic connections wired to transmit numerical data and receive characters transmitted by the microcomputer serial port. The baud rate frequency (see Fig. 2) is connected to pins 17 and 40. Receive characters and data for transmission from the requisite chips (see Fig. 3) enter and leave at pins 20 and 23 respectively. The 8 parallel outputs each require pull-up resistors (15K); they are also connected to the decoding chips as shown in Fig. 5. All pins depicted with short legs need not be connected.

Fig. 2 The switchable baud rate frequency circuit provides the selection of the commonly used rates of 300, 1200, 4800 or 9600. For a given fixed rate, the S0, S1, and S3 inputs can be preset (H or L according to the code for the required baud rate) and the addressable latch dispensed with.



above. Normally, for the photometer, the highest value of 9600 is used.

Various levels of sophistication may be needed to run the receive and driver chips depending on the kind of control envisaged or on the nature of the computer serial port. In addition to the Transmit (Tx), Receive (Rx) and ground lines from the port, the operation of the handshake lines may need to be considered. These are the Data Terminal Ready (DTR) and Clear To Send (CTS) signals. All the communications lines need either receive or driver chips to handle them. In Fig. 3 the necessary chips are depicted as 1489 (receiver) for the lines carrying signals generated by the computer and as 1488 (driver) for the lines with signal from the outside circuitry to the computer. (There are some modern chips that incorporate both receive and driver parts in a single unit.) The connections are shown in relation to the Serial Port 2 of the QL and its output via a conventional 25-way D-type connector. Before any character can be sent from the computer to the uart, the computer must "know" that the outside instrumentation is ready to receive it. In the designed system, this has been permanently set in a state of readiness by grounding the inputs on one of the drivers (pins 4 and 5) and connecting its output to the DTR of the computer. Depending on the degree of control required, this handshake line might be operated by logic circuitry rather than having it permanently set. A second circuit in the driver chip is used to transmit data characters to the computer but the description of this procedure will be given later.

The receiver chip has been wired to accept the characters from the computer and to transfer them to the uart. Also the CTS line from the computer is received on this same chip and the signal is used in timing the instruction to the uart to transmit characters from its buffer. The circuitry for this will also be described later under the section "Transmissions Control".

Fig. 3 Connections for the receive (1489) and transmit (1488) chips via the 25-way D-type connector and the special plug to the QL Serial 2 port.

speed, or baud rate, has to match that of the computer. Secondly the received and despatched characters require special chips that allow their signals to be transmitted along reasonable lengths of cable and at the right time, eg, the computer must be ready to receive a character when the uart despatches it.

Fig. 2 displays the basic frequency generating circuit. In the configuration shown, baud rates of 300, 1200, 2400 and 9600 have been made available, but other rates are possible using the same chips with different wiring configurations. If a regular and fixed baud rate is to be used, the circuit may be simplified and streamlined. The chosen frequency is applied to both the receive and transmit sections of the uart (pins 17 and 40). By default, the QL's serial ports operate at 9600 baud but they can be programmed to other values including those

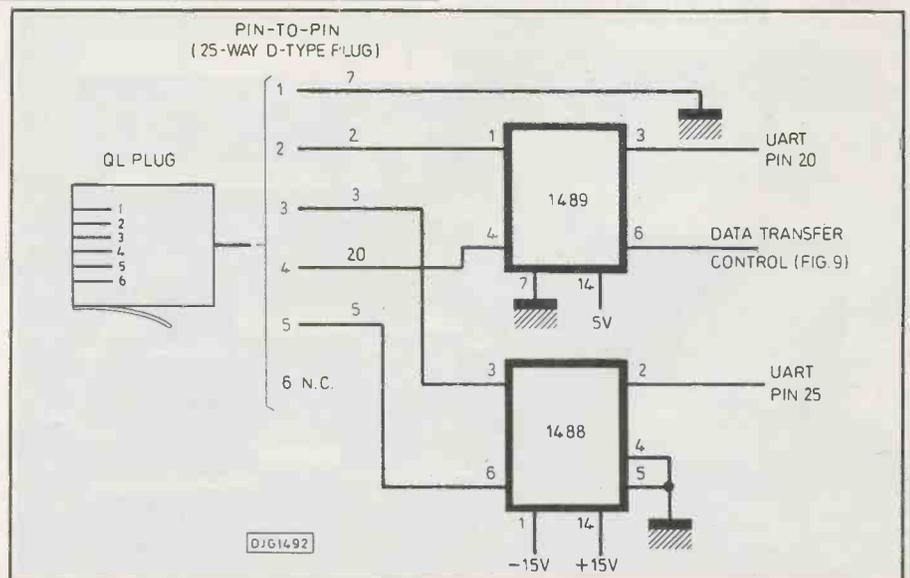

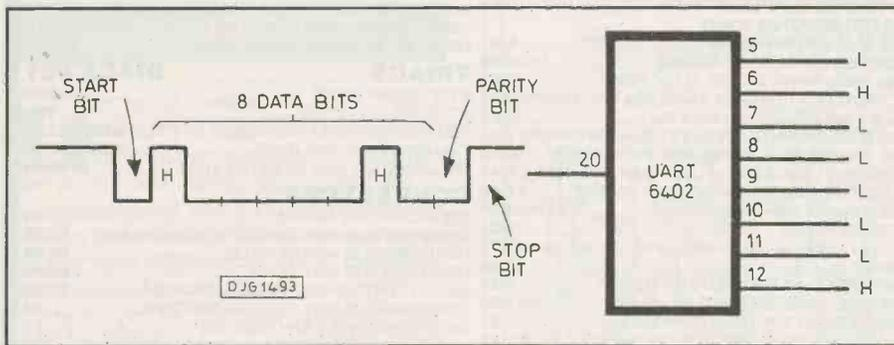

Fig. 4 Following the start bit, the transmission comprises 8 data bits which may be high or low. For the character "A", the first and seventh bits are high and this pattern emerges at the parallel outputs of the UART. The parity bit (nlnth) is ignored in this design.

THE UART DECODED

When a character is transmitted on a serial line, it is coded by using a train of bits, usually seven or eight. Each bit may be in a high (H) or low (L) state; the character is recognised by its unique bit pattern. For example, using an eight bit code (as for the QL), the character "A" would be represented by

L H L L L L L H
(128) (64) (32) (16) (8) (4) (2) (1)

with the right hand bit being transmitted and read first. Each code is equivalent to a binary number and by examining the states of the columns, as depicted above, it can be seen that "A" is equivalent to the binary representation of 1 + 64 or 65. Thus "A" may be sent out to

the serial port of the micro either by transmitting it as "A" or as CHR\$(65).

When the uart is being used to receive characters from the serial output of a micro, the string of bits is converted to a parallel form with the state of the bits (H or L) being displayed from the eight output buffers. A schematic for this, related again to the character "A" is displayed in Fig. 4. The transmission of each of the characters represented by the binary values of 0 to 255 allows all possible bit combinations to be produced at the output lines of the uart.

In the arrangement of the designed interface, not all of the full character set is utilised. The eight bits have been organised so that the first four act as binary coded decimal (BCD) lines which are decoded to decimal by a 7442 chip. Similarly, the last

Fig. 5 The 8 outputs from the UART are decoded as two groups by BCD to decimal chips (7442) to provide 18 switchable lines. Although available, output zero from these decoders has not been used. Each output from the UART requires a pull-up resistor and may have an led state indicator. Similar leds may be attached to the 18 decoded lines. For simplicity, these components are shown only on one of the UART outputs and one of the decoded lines.

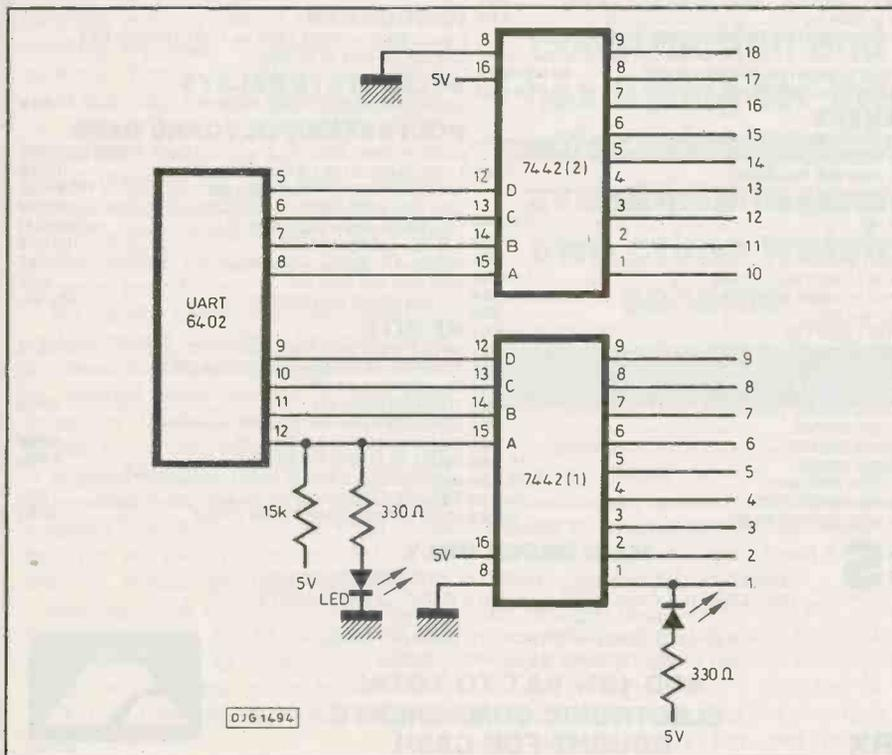

four bits are also used as BCD and then decoded. The diagram of the circuit with all the support chips is shown in Fig. 5. It will be seen that characters 0 to 9 sent from the micro operate the nine lines of 7442(1), while characters 0, 16, 32, 48, 64, 80, 96, 112, 128, 144 operate the 9 lines of 7442(2) labelled 10 to 18. The appropriate decoded line goes low according to the character that is received from the computer.

It may also be noted that the only characters to be transmitted to the computer are numerical data corresponding to the numbers 0 to 9, ie CHR\$(48) to CHR\$(57). As a consequence the higher binary bits of the input buffers may be permanently fixed with pins 33 and 32 set low and pins 31 and 30 both set high. The remaining four lower order buffers are connected to the data address bus and, according to their states, CHR\$(48) to CHR\$(63) may be transmitted.

CHARACTER RECEPTION

With the circuit completed as far as is shown in Fig. 5, it is possible to receive characters from the serial port of the micro and check that they are interpreted correctly. The eight output lines are shown with leds connected to them allowing their state to be displayed, but this arrangement is optional. Similar status leds may also be connected to the 18 decoded lines. The program below allows each binary output of the uart to be checked and also the operation of the 18 decoded lines.

```

100 REMark ** Program 1 **
110 REMark ** Exercise for Interface **
120 REMark ** Set Serial 2 Port **
130 BAUD 9600
140 OPEN #5, ser 2
150 REMark ** Check on Binary Count
160 FOR n= 1 TO 255
170 PRINT #5, CHR$(n) : PAUSE 20
180 END FOR n
190 REMark ** Check on Decoded Lines
200 FOR n= 1 TO 9
210 PRINT #5, CHR$(n) : PAUSE 20
220 END FOR n
230 FOR n=16 TO 144 STEP 16
240 PRINT #5, CHR$(n) : PAUSE 20
250 END FOR n
    
```

It will be noted that on receiving a preferred character the appropriate decoded output will go low. On receipt of a second but different character that same output will go high and the new appropriate line will go low. The second character may be zero, putting all the outputs at high. By dividing the outputs into two groups of four, it will also be appreciated that it is possible to control two lines simultaneously on receipt of a single character. For example, the transmission of CHR\$(65) will activate both decoded lines 1 and 10.

TO BE CONTINUED NEXT MONTH

Dr. David Clarke is a lecturer at the Department of Physics and Astronomy of Glasgow University

2/11 35-25

ELMASET INSTRUMENT CASE

300 x 133 x 217mm deep £10 ea (£2.20)

REGULATORS

LM317T PLASTIC TO220 variable £1
LM317 METAL £2.20
7812 METAL 12V 1A £1
7805/12/15/24V plastic 35p 100+20p 1000+15p
7905/12/15/24 plastic 35p 100+20p 1000+15p
CA3085 T099 variable reg 2/£1
LM338 5A VARIABLE £5

COMPUTER ICs

HD68000-8 £5ea
IM6402 UART £3
8086 processor equipment £2
USED 41256-15 £3.00
USED 41256-12 £3.40
9 x 41256-15 SIMM MODULE NEW £25
8 x 4164-15 SIP MODULE NEW £8
41256-10 SURFACE MOUNT EX NEW BOARDS £3
HD146818 CLOCK IC £2
2864 EEPROM £3
27128A 250NS EPROM NEW £3.20
FLOPPY DISC CONTROLLER CHIPS 1771 £10 ea
FLOPPY DISC CONTROLLER CHIPS 1772 £16 ea
68008 PROCESSOR EX-EQPT £5
ALL USED EPROMS ERASED AND BLANK CHECKED CAN BE PROGRAMMED IF DESIRED.
2764-30 USED £2
2716-45 USED £2 100/£1
2732-45 USED £2 100/£1
2764-30 USED £2 100/£1.60
27128-25/30 USED £2.50
27C256-30 USED £3 NEW £3
1702 EPROM EX EQPT £5
2114 EX EQPT 60p 4116 EX EQPT 70p
6264-15 8k static ram £4
4416 RAM £3.50
USED 4416-15 RAM £2
USED 41464-15 £7
ZN427E-8 £3.50
ZN428E-8 £3.50

CRYSTAL OSCILLATOR

1.8342 MHz £1 each

CRYSTALS

2.77 MHz/4.000 MHz/4.9152MHz 20MHz 49.504 MHz

TRANSISTORS

BC107, BCY70 PREFORMED LEADS £1 £4/1000 £30/1000 full spec
BC557, BC548B 30/£1 £3.50/100

SIL RESISTOR NETWORKS

8 PIN 10k 22k 5/£1
8 PIN 22k 5/£1
10 PIN 68R 180R 22k 5/£1

POWER TRANSISTORS

OC35 (Marked CV7084) £1
POWER FET IRF9531 8A 60V 2/£1
2SC1520 sim BF259 3/£1 100/£22
TIP141/2 £1 ea TIP112/125/42B 2/£1
TIP35B TIP35C £1.50
SE9301 100V 10A DARL. SIM TIP121 2/£1
2N3055 EX EQPT TESTED 4/£1
PLASTIC 3055 OR 2955 equiv 50p 100/£35
2N3773 NPN 25A 160V £1.80 10/£16

QUARTZ HALOGEN LAMPS

A1/216 24V 150 WATTS £2.25
H1 12V 50W (CAR SPOT) £1.50

ZIF SOCKETS

TEXT00L single in line 32 way. Can be ganged (coupling supplied) for use with any dual in line devices. 14 WAY AMP ZIF SOCKET 2/£1

LARGE ELECTROLYTIC CAPACITORS COMPUTER GRADE

3300uF 350V SIC SAFCO FELSIC 037 £6(£1.50)
2200uF 160V SIC SAFCO FELSIC CO38 £4(£1.20)

TURNS COUNTING DIALS FOR MULTI TURN POTENTIOMETERS

all for 0.25" shaft
10 turn dial 21 mm dia. fits 3mm spindle £2
10 turn digital dial (3 digits) for 3mm or 6mm shaft £3.50
10 turn clock face dial for 6mm spindle £4

MISCELLANEOUS

ASSORTED SWITCHES, ROCKER, SLIDE, PUSH £2.50
SLOPING FRONT PLASTIC CASE 225 x 215 x 76mm 76 mm WITH ALI FRONT PANEL 200 x 130mm £4.00(£1)
HUMIDITY SWITCH ADJUSTABLE £2
WIRE ENDED FUSES 0.25A 30/£1
NEW ULTRASONIC TRANSDUCERS 40kHz £2/pair

12 CORE CABLE 7/0.2mm OVERALL SCREEN. £1/3 metres

POWERFUL SMALL CYLINDRICAL MAGNETS 3/£1
OP AMP LM101CLN £2.90
BNC 50 OHM SCREENED CHASSIS SOCKET 3/£1
BNC TO CROC CLIPS LEAD 1 metre £1
MOULDED INDUCTOR 470uH size of a 1 watt film resistor 5/£1
TO-220 HEAT SINK sim RS 403-162 10/£2.50
SMALL MICROWAVE DIODES AEI DC1028A 2/£1
D.I.L. SWITCHES 10 WAY £1 8 WAY 80p 4/5/6 WAY 50p
180 volt 1 watt ZENERS also 12v & 75v 20/£1
PLASTIC EQUIPMENT CASE 9x6 x 1.25 in. WITH FRONT AND REAR PANELS CONTAINING PCB WITH EPROM 2764-30 AND ICS 7417 LS30 LS32 LS74 LS367 LM311 7805 REG, 9 WAY D PLUG, PUSH BUTTON SWITCH, DIN SOCKET £1.90
VN10LM 60v 1/2A 50hm TO-92 mosfet 4/£1 100/£20
MIN GLASS NEONS 10/£1
RELAY 5v 2 pole changeover looks like RS 355-741 marked STC 47WB05T £1 ea
MINIATURE CO-AX FREE PLUG RS 456-071 2/£1
MINIATURE CO-AX FREE SKT. RS 456-273 2/£1.50
DIL REED RELAY 2 POLE n/o CONTACTS £1
PCB WITH 2N2646 UNIJUNCTION with 12v 4 POLE RELAY £1
400m 0.5w thick film resistors (yes four hundred megohms) 4/£1
MINIATURE CO-AX FREE PLUG RS 456-071 2/£1
MINIATURE CO-AX FREE SKT. RS 456-273 2/£1.50
STRAIN GAUGES 40 ohm Foil type polyester backed balco grid alloy £1.50 ea 10+ £1
ELECTRET MICROPHONE INSERT £0.90
Linear Hall effect IC Micro Switch no 613 SS4 sim RS 304-267 £2.50 100+ £1.50
HALL EFFECT IC UGS3040 + MAGNET £1
OSCILLOSCOPE PROBE SWITCHED X1 X10 £10
CHEAP PHONO PLUGS 100/£2 1000/£18
1 pole 12 way rotary switch 4/£1
AUDIO ICS LM380 LM386 £1 ea
555 TIMER 5/£1 741 OP AMP 5/£1
ZN414 AM RADIO CHIP 80p
COAX PLUGS nice ones 4/£1
COAX BACK TO BACK JOINERS 3/£1
4 x 4 MEMBRANE KEYBOARD £1.25
15.000uF 40V £2.50 (£1.25)
INDUCTOR 20uH 1.5A 5/£1
NEW BT PLUG + LEAD £1.50
1.25" PANEL FUSEHOLDERS 3/£1
CHROMED STEEL HINGES 14.5 x 1" OPEN £1 each
12v 1.2w small wire ended lamps fit AUDI VW TR7 SAAB VOLVO 10/£1
12V MES LAMPS 10/£1
STEREO CASSETTE HEAD £2
MONO CASS. HEAD £1 ERASE HEAD 50p
THERMAL CUT OUTS 50 77 85 120°C P1 ea
THERMAL FUSE 121°C 240V 15A 5/£1
TRANSISTOR MOUNTING PADS TO-5/TO-18 £3/1000
TO-3 TRANSISTOR COVERS 10/£1
STICK ON CABINET FEET 30/£1
PCB PINS FIT 0.1" VERO 200/£1
TO-220 micas + bushes 10/50p 100/£2
TO-3 micas + bushes 15/£1
PTFE min screened cable 10m/£1
Large heat shrink sleeving pack £2
CERAMIC FILTERS 6M/9M/10.7M 50p 100/£20
MAINS LEAD WITH MOULDED 13A PLUG AND IEC SOCKET £1.50
IEC chassis plug rfi filter 10A £3
Potentiometers short spindles values 2k5 10k 25k 1m 5/£1
2M5 lin 4/£1
500k lin 500k log 4/£1
40kHz ULTRASONIC TRANSDUCERS EX-EQPT NO DATA £1/pr
PLESSEY INVERTER TRANSFORMER 50 CYCLES
11.5-0-11.5V to 240V 200VA £6 (£3)

ZENERS

5.6V 1W3 SEMIKRON 50K AVAILABLE @ £25/1000
SUPPRESSOR OF 606 120V BI DIRECTIONAL ZENER IN 3 AMP W/E PACKAGE 5/£1

DIODES AND RECTIFIERS

1N4148 100/£1.50
1N4004/SD4 1A 300V 100/£3
1N5401 3A 100V 10/£1
BA158 1A 400V fast recovery 100/£3
BA159 1A 1000V fast recovery 100/£4
120V 35A STUD 65p
BY127 1200V 1.2A 10/£1
BY254 800V 3A 8/£1
BY255 1300V 3A 6/£1
6A 100V SIMILAR MR751 4/£1
1A 800V BRIDGE RECTIFIER 4/£1
4A 100V BRIDGE 3/£1
6A 100V BRIDGE 2/£1
8A 200V BRIDGE 2/£1.35
10A 200V BRIDGE £1.50
25A 200V BRIDGE £2 10/£18
25A 400V BRIDGE £2.50 10/£22

SCRS

PULSE TRANSFORMERS 1:1+1 £1.25
2P4M EQUIV C106D 3/£1
MCR72-6 10A 600V SCR 3/£1
35A 600V STUD SCR £2
TICV106D 800mA 400V SCR 3/£1 100/£15
MEU21 PROG. UNIJUNCTION 3/£1

TRIACS

BT137-600 8A TO-220 2/£1
BT138-600 12A TO-220 20/£1
NEC TRIAC AC08F 8A 600V TO220 5/£2 100/£30
TXAL225 8A 400V 5mA GATE 2/£1 100/£35
TRAL2230D 30A 400V ISOLATED STUD £4 each

DIACS 4/£1

CONNECTORS

D25 IDC SOCKET FUJITSU £2
34 way card edge IDC CONNECTOR (disk drive type) £1.25
CENTRONICS 36 WAY IDC PLUG £2.50
CENTRONICS 36 WAY IDC SKT £4.00
BBC TO CENTRONICS PRINTER LEAD 1.5M £3.50
CENTRONICS 36 WAY PLUG SOLDER TYPE £4
USED CENTRONICS 36W PLUG+SKT £3

USED D CONNECTORS price per pair
D9 60p, D15 £1.50, D25 £2, D37 £2, D50 £3.50 covers 50p ea.

WIRE WOUND RESISTORS

W21 or sim 2.5W 10 of one value £1
R10 OR15 OR22 2R7 4R7 5R0 5R6 8R2 10R 12R 15R 18R 20R 22R 27R 33R 47R 56R 62R 91R 120R 180R 390R 430R 470R 680R 820R 910R 1K15 1K2 1K5 1K8 2K4 2K7 3K3 3K0 5K0 R05 (50 milli-ohm) 1% 3w 4 FOR £1
W22 or sim 6W 7 OF ONE VALUE £1
R47 R62 1R0 1R5 1R8 3R3 6R8 9R1 12R 20R 24R 27R 33R 51R 56R 62R 68R 100R 120R 180R 220R 390R 560R 620R 910R 1K0 1K2 1K5 1K8 2K2 2K7 3K3 3K9 4K7 8K2 10k 15k 16k 20k
W23 or sim 9W 6 of one value £1
R22 R47 1R0 1R1 15R 56R 62R 100R 120R 180R 220R 300R 390R 680R 1K0 1K1 5K1 10K
W24 or sim 12W 4 OF ONE VALUE £1
R50 2R0 9R1 18R 22R 27R 56R 68R 75R 82R 100R 150R 180R 200R 220R 270R 400R 620R 1K0 6K8 8K2 10K 15K

PHOTO DEVICES

SLOTTED OPTO-SWITCH OPCOA OPB815 £1.30
2N5777 50p
TIL81 PHOTO TRANSISTOR £1
TIL38 INFRA RED LED 5/£1
4N25, OP12252 OPTO ISOLATOR 50p
PHOTO DIODE 50p 6/£2
MEL12 (PHOTO DARLINGTON BASE n/c) 50p
RPY58A LDR 50p ORP12 LDR 70p
LEDs RED 3 or 5mm 12/£1 100/£6
LEDs GREEN OR YELLOW 10/£1 100/£6.50
LEDs ASSORTED RD/GN/YW + INFRA/RED 200/£5
FLASHING RED OR GREEN LED 5mm 50p 100/£35

STC NTC BEAD THERMISTORS

G22 220R, G13 1K, G23 2K, G24 20K, G54 50K, G25 200K, G16 1M, RES @ 20°C DIRECTLY HEATED TYPE £1 ea
FS22BW NTC BEAD INSIDE END OF 1" GLASS PROBE £1 ea
RES @ 20°C 200R £1 ea
A13 DIRECTLY HEATED BEAD THERMISTOR 1k res. Ideal for audio Wien £2 ea

CERMET MULTI TURN PRESETS 9/4"

10R 20R 100R 200R 250R 500R 2K 2K2 2K5 5K 10K 47K 50K 100K 200K 500K 2M2 50p each

IC SOCKETS

6 pin 15/£1 8 pin 12/£1 14/16 pin 10/£1 18/20 pin 7/£1, 22/24/28 pin 4/£1 40 pin 30p

SOLID STATE RELAYS

40A 250V AC SOLID STATE RELAYS £18

POLYESTER/POLYCARB CAPS

100n 63v 5mm 20/£1 100/£3 1000/£25
n/3n/35n/6n/2/10n 1% 63v 10mm 100/£6
10n/15n/22n/33n/47n/68n 10mm rad 100/£3.50
100n 250v radial 10mm 100/£3
100n 600v sprague axial 10/£1 100/£6 (£1)
2u2 160v rad 22mm 100/£10
10n/33n/47n 250v ac x rated 15mm 10/£1
470n 250v ac x rated rad 4/£1
1U 600V MIXED DIELECTRIC 50p ea.

RF BITS

MINIATURE CO-AX 50Ω URM95 100m/£12
12 volt CO-AXIAL relays sim. RS 349-686 £6
Ex-equipment, with BNC tails 4/50p
TRIMMER CAPS ALL 4/50p
SMALL 5pF 2 pin mounting 5mm centres 4/50p
SMALL MULLARD 2 to 22pF 4/50p
SMALL MULLARD 5 to 50pF 4/50p
£1.50 larger type grey 2 to 25pF black 15 to 90pF 60p
TRANSISTORS 2N4427 10/£18
FEED THRU CERAMIC CAPS 1000pF 10/£1

KEYTRONICS

TEL. 0279-505543

FAX. 0279-757656

P O BOX 634

BISHOPS STORTFORD

HERTFORDSHIRE CM23 2RX

MAIL ORDER ONLY

MIN CASH ORDER £3.00 OFFICIAL ORDERS WELCOME
UNIVERSITIES COLLEGES SCHOOLS GOVT DEPARTMENTS
MIN. ACCOUNT ORDER £10.00

P&P AS SHOWN IN BRACKETS (HEAVY ITEMS)
65p OTHERWISE (LIGHT ITEMS)

ADD 15% VAT TO TOTAL
ELECTRONIC COMPONENTS
BOUGHT FOR CASH





On Japan, there has for many years been no firm dividing line between different areas of consumer electronics. Electronic shops are multi-storey department stores, which stock a bewildering range of audio, video, tv and photographic equipment, domestic lighting, budget audio, rice cookers, air conditioners, refrigerators and so on.

Now these shops have another range of products on display – electronic still picture cameras, which capture images on magnetic disk instead of film.

It is too early to say yet whether the technology will become a strong market force. So far sales seem to have been slow. This is partly because the price of electronic snapshot cameras is still high compared to snapshot film cameras. The Japanese electronic companies are now likely to try and solve this problem by reducing the price of basic models to make electronic technology more competitive with film. There will also be completely new, second generation models which use solid state memory instead of magnetic disks, and thus need no moving parts.

The pic-a-disk carousel is spinning, and it looks likely to throw up a winner – for the Japanese in the end.

Although Kodak has dabbled in home video, the company has so far simply bought in ready-made product from the Far East. The lead which Japan is now building in low cost electronic imaging technology may well prove too strong for Kodak to contest.

Some advantages of electronic still imaging are obvious. Like video movies, the medium is re-usable and needs no processing. Less obviously, the electronic

measures 60 x 54 x 3.6mm and weighs around eight grammes. The disk case has a dust protection shutter and safety catch to prevent inadvertent double recording or erasure. The image disk closely resembles the micro floppy disk now used by many personal computers. This is not surprising, because the micro floppy was developed by Sony as spin-off from the company's work on magnetic still picture photography.

HIGH BAND STANDARDS

Two years later, in April 1986, the disk family had grown to 42 companies, and they agreed on a standard for recording short snatches of digitally coded sound as well as analogue visual data. Sony and Canon used disc cameras to cover the 1984 Los Angeles Olympic Games but the system was still judged too expensive for domestic use, and picture quality inadequate for professionals. So in July 1988 the 42 participating companies agreed a second "high band" standard.

ELECTRONIC SNAPSHOTS

The other, and perhaps more significant, problem faced by the makers of electronic still cameras is that the captured images are intended to be displayed on a tv screen – whereas most people like to carry paper prints in their pocket or wallet. With this in mind much of the research into the new medium is now – paradoxically – aimed at producing low cost, high quality hard copy prints of selected electronic images.

HOME VIDEO

Over the last five years video has killed film as a home movie medium. Anyone who wants to take moving pictures of their holiday, or baby on the lawn, now uses a combined video camera and recorder, or camcorder, no larger than an 8mm cine camera. It records colour tv pictures with synchronised sound. Although many camcorders cost £1000 or more, most movie makers feel the initial outlay is worthwhile. An hour's worth of tape costs what movie film costs for a minute. It needs no processing and is re-usable. Only the most dedicated buffs now use cine film. Cameras and film are increasingly hard to buy.

A similar switch to electronic still picture imaging will change the balance of commercial power in favour of companies, notably Fuji of Japan, which have equal expertise in electronics and photography. This could spell trouble for Kodak, which for many years has been the world leader in wet photography and so far announced no intention to commercialise electronic imaging for the domestic market.

BY BARRY FOX Winner of the UK Technology Award

image can be sent down a telephone line, like electronic mail.

US companies, Polaroid and 3M, have already announced their intention to capitalise on long experience in film photography to provide the public with a cheap way of transferring video images to paper.

MAVICA

Sony was the first company to demonstrate the point and shoot magnetic still picture photography. In August 1981 Sony unveiled Mavica. It looked like a conventional 35mm single lens reflex camera, but recorded 50 colour still pictures on a small magnetic disk spinning inside the camera body. Although the disk resembles a computer floppy, of the type routinely used for storing digital data, an electronic still camera records an analogue tv waveform not a stream of digital pulses.

Once Sony had shown Mavica, most of the other major electronics companies in Japan developed their own systems. In February 1983 twenty electronics, camera and magnetic tape manufacturers formed a committee to promote worldwide standardisation of a magnetic disk format. By May 1984 there were 32 companies participating, and the first standard was set. They agreed on a disk, coated with metal powder, 47mm in diameter, and enclosed in a rigid plastic case which

This gives higher quality images by recording the video signal at higher frequencies.

The cameras now on sale in Japan have a solid state image sensor, usually 1.7cm across, made up from a mosaic of around half a million individual image elements, each capable of resolving a separate picture point or "pixel". The chip sensitivity to light is equivalent to domestic film rated at 200 or 400 ASA/ISO, but additional amplification circuits can raise chip sensitivity to 1600 ASA/ISO.

The chip puts out three video signals, one representing black and white detail, and two containing colour difference information. The three signals are separately recorded onto the disk as an fm signal. When mixed together again on replay, the three signals give detail and red, green and blue colour information.

The disk rotates at 3600 rpm, which is 60rps to conform with the 60 pictures per second tv system used in the US and Japan. For European tv, where 50 pictures a second are displayed, the disk speed will be reduced to 3000rpm.

FIELD AND FRAME

The magnetic disk recording standard gives users the choice between "field" and "frame" recording. All television pictures are made up from horizontal scanning lines; 525 lines in Japan and the US and 625 lines in Europe. A television set does not display all these lines on screen at the

same time. Instead it displays a half scan of even lines, then a half scan of odd lines, then a half scan of even lines and so on. On screen the half scans interlace so rapidly that the human eye never realises that only half the lines are being displayed at any one time.

When a magnetic disk camera is set to record fields, it registers only half scans. These are then displayed on a tv screen twice over, to create the illusion of interlace, albeit with only half the vertical resolution.

When the camera is set to record full frames, it captures full interlaced pictures, which give better resolution on screen. The penalty is that there is only room on the disk for 25 full frame pictures, whereas there is room for 50 half frame or field recordings.

SONY MAG-CAM

Sony's magnetic disk camera, now on sale in Japan, looks like a film disc camera. It has a fixed focus lens and the iris diaphragm and shutter speed set themselves automatically to suit the room lighting conditions. When there is not enough light, the camera automatically use flash. Because there is no film to move, the disk can record up to nine pictures per second, for instance to analyse a golf swing. Fuji, Canon and Konica all offer similar toys.

Although the feature is not yet implemented on the first generation cameras now on sale, each video picture track can be accompanied by a recording of 5, 10 or 20 seconds of digital sound, depending on the required quality. The camera also registers the image and track number, the date and time of shooting, and technical data, such as the exposure time and aperture.

In frame recording mode a magnetic disk camera has a horizontal resolution of around 400 lines, which means that it can resolve 400 separate vertical lines, like vertical posts, without merging one into the other. In practice, domestic disk cameras will resolve less lines, usually around 300, because their image sensors are not good enough to match disk potential. This is still better than most domestic video recorders, but nowhere near the resolution of still picture film.

COMPARISONS

Video-versus-film comparisons are dangerous. There is no agreed method for equating video resolution with the picture information captured on film. The film image is analogue with random distribution of the silver crystals. Even though the first still picture cameras record an analogue fm signal, the image sensor samples like a digital coder and the scanning line structure of the tv picture samples the displayed image.

Both Kodak and Polaroid work to the same guideline; one frame of 35mm colour slide film records around 100 million individual bits of picture information, with clusters of six bits registering each picture point or pixel. By this reckoning, and one byte of digital code needed for each pixel of an electronic image, one frame of film is equivalent to well over 10 megabytes of computer storage; which in turn is equivalent to 10 or more computer floppy disks storing 10 million text characters. 3M puts film image quality even higher, at around 20 megabytes per frame. A Polaroid print resolves around 10 million pixels.

By comparison even the highest quality tv pictures in commercial use, the European 625-line PAL and SECAM formats, compose the image from a maximum of 0.7 million discrete picture points or pixels; Fuji is selling a camera with an 800,000 pixel image sensor, giving horizontal resolution of 500 lines. Kodak claims to have made a 1.4 million pixel sensor.

Even so the resolution gap between electronics and film is still very wide. Kodak puts it at a factor of at least fifteen for conventional colour film.

Also the contrast ratio of film, that is to say the brightness ratio between the lightest and darkest subjects recorded, is around 500:1. This is far in excess of any tv system which would usually have a ratio as low as 50:1.

MATCHING STABILITY

In a real world situation, however, snapshot photographers are content with prints of appalling quality and tv viewers sit happily and watch maladjusted sets.

The one issue on which everyone agrees, is that the public will want the option of paper prints from electronic recordings. The potential market is vast. Kodak estimates that 39 billion colour photos are printed every year; one picture every seven weeks for every person on the planet. Japanese "photo-maniacs" shoot 500 pictures in a weekend.

In Japan Fuji has for several years sold a hybrid electronic/film system, called Fujix. The photographer takes still snapshots with an ordinary camera and sends the colour film off to the lab for processing in the usual way. The lab develops the film and transfers the images onto magnetic disk.

The photographer can then display the pictures through a tv set, using a budget disk player, and ask for conventional prints of the best shots from the original film. The disk thus becomes a cheap pre-print preview tool.

Fuji has not yet marketed the system outside Japan. Says Managing Director Shozo Takekoshi: "You need the cooperation of the photo finishers and laboratories. That is possible in Japan

where we are number one, but in Europe and the West Kodak has control".

Fuji admits that the Fujix pre-print preview system has not sold as well in Japan as expected.

"But the situation will change," says Takekoshi. "Previously people expected the high quality images you can only get from silver halide still photographs. But now perceptions are changing. Young people have grown up with video and tv and their standards are lower. They don't compare with silver halide quality any more."

3M disagrees. "People don't relate tv quality to hard copy quality," says Douglas Dybvig, who heads 3M's research labs at Harlow. "As people see better prints, they expect better prints."

3M RESEARCH

3M still smarts from the mistake of saying "no" to Chester Carlson and his xerography invention, the first technology to bridge the gap between electronic and paper imaging. 3M also regrets the decision to stop making audio tape, when Japanese competitors cut prices. Since then 3M has invested heavily in the development of Scotch brand video tape and has for five years been brand leader in the UK. 3M has also invested heavily in conventional film technology, since buying Italian photographic company Ferrania in 1964.

"We do not see anything coming close to photographic cameras and colour films within the next five to seven years," says Dybvig. "But we are working hard to make it happen."

POLAROID

The traditional method of transferring a video image to film without loss of quality is to display the picture on a high resolution tv screen, photograph it with a conventional 35mm camera and process the film in conventional fashion. This is slow and messy, and any mistakes do not show until after processing.

It is quicker and easier to photograph the displayed image with a Polaroid instant picture camera.

Edwin Land invented instant picture photography, soon after the war, to keep his young daughter happy. "Why?" she asked her father on holiday "do I have to wait a week before I see the photographs you are taking?" Back at his laboratory in Cambridge, Massachussets, Land immediately began work on film which would develop itself. His seminal invention was the concept of a lead pod full of chemical developer, and packed with the photographic film. Easily broken, by squeezing through a pair of rollers, the lead pod gives each exposed photograph a fresh supply of chemicals so active and



unstable that they could not possibly be stored in bulk and dispensed shot by shot.

The first instant picture cameras went on sale in America in November 1948. The disadvantage of the system was that the two halves of the film, negative and positive, had to be peeled apart after a minute or so development time. In 1972 Land introduced the SX-70 system, which no longer required that two layers be peeled apart after development. Since then Polaroid has changed the chemistry many times, speeding development to a few seconds, but the principle remains the same.

RESOLUTION

Polaroid has shown how easy it is to build a "black box" which takes a video input and outputs a Polaroid print. The box contains a Polaroid camera permanently focussed on a tv screen. To improve resolution the image is exposed in three stages one for red picture content, one for blue and one for green. This takes longer. Polaroid photography is more expensive than conventional photography, and especially for large prints, more expensive.

As a first step into electronic imaging, Polaroid is working with British company Hadland Photonics, of Bovingdon, on a high resolution system which records still images onto Super VHS video tape. The picture is captured with a 600,000 pixel image sensor, and broken down into 26 horizontal strips. Each strip is then recorded on tape as if it were a full picture. To reconstitute the picture, the tape is replayed and the 26 partial pictures blended together into a single high definition image. This way one two-hour video tape can store up to 14,000 high resolution still picture images.

JETS AND THERMALS

The Japanese electronics firms are all using either ink jet or dye thermal transfer printers to produce hard copy images. Both were developed for the computer industry.

An ink jet printer paints a colour image on paper by the digital control of different ink sprays. The system is slow, and neither resolution nor colour rendition can match film.

In a thermal dye transfer printer, a dot matrix printing head heats a sandwich of plain and coloured dye papers, so that the dye sublimates from one sheet to the other to create a colour image. Calibration of the head elements is vital, as the print must be made by repeating the sublimation process three times, with cyan, magenta and yellow sheets, and ideally with a fourth transfer using a black dye sheet to sharpen resolution. The technique is slow and colour rendition poor.

DRY CHEMISTRY

3M's ace is the new technology of dry silver halide chemistry. This grew out of an office copy system, called Thermofax, which 3M developed to rival the xerographic paper copy system which the Xerox Corporation bought from Chester Carlson after 3M turned the idea down.

"Twenty-five years ago we tried to make the material sensitive to light instead of heat," says David Morgan, technical director of 3M's photo colour systems laboratory in the US. "Making it light sensitive took us a week. We have spent the last twenty-five years perfecting a product which copies in colour."

A sheet of paper (or transparent film) is coated with an emulsion which contains a small quantity of light sensitive silver halide and a much larger quantity of a non-light sensitive organic silver compound, such as silver behenate. There are three separate layers, individually sensitive to red, green and blue light.

When the emulsion is exposed to light, the light sensitive silver halide registers a latent image. To develop this image, the paper is heated to 135°C, for six seconds. This triggers a chemical reaction which releases silver from the reservoir of non-light sensitive chemicals to produce cyan, magenta and yellow dye images.

MATCHING STABILITY

Although many thousands of dyes obligingly behave in this way, only a few colours match and balance to give a natural colour image. 3M has now found a cyan dye, which almost exactly matches the dyes used by Kodak in conventional colour print paper. Magenta dyes proved more difficult, and yellow the most difficult of all. The first dry halide papers are now available. They give a colour image which is slightly blemished by a yellow green tinge to areas which should be pure white, but 3M is confident it can match Kodak's colours.

The emulsion is ten times less sensitive than conventional emulsions, but this is of no consequence because the image is formed by exposing the emulsion to an electronic image either by freezing the image on a tv screen, or by scanning the paper surface with a light beam which is modulated by the video signal.

The main snag is that the image is not stable over a long period of time, because some chemicals remain active in the finished print. So 3M has now developed a second generation technology, which superficially resembles the early Polaroid system.

The print paper is made from two layers, one a slightly porous plastics material. After heat development, any remaining active chemicals migrate to the plastics. This is then stripped off and

thrown away to leave a stable colour image.

Simplified printers should eventually sell for a few hundred pounds, with the paper costing around £1 for a 20cms x 25cms sheet. Photographic shops and processing laboratories, which currently spend around £40,000 on a "minilab" for automated film processing could offer customers an additional service for transferring video images onto paper.

"For a hundred years people tried to make light sensitive silver halide work dry, and failed," says Morgan. "We started with dry silver material and tried to make it light sensitive."

LASER WRITING

In the much longer term, 3M hopes to adapt a technology currently used to write video images direct onto conventional photographic emulsion, using laser diodes. A rotating mirror scans the emulsion with three infra red laser beams, each of slightly different wavelength (789 nanometres, 830nm and 890nm). The photographic emulsion contains three separate layers, each capable of producing a yellow, magenta or cyan dye in response to illumination at one of the three infra red frequencies.

To create a colour image, the video signal is converted into digital code, and the red, green and blue content separated. The red content is then used to control the intensity of one laser beam, the blue content controls the second laser, and the green content the third. In this way the three laser beams produce a full colour image, even though they themselves are all in the infra-red range and bear no visible relationship to the colours.

3M's next step is to modify the dry silver halide paper, so that its three dye layers respond to infra-red laser light, instead of visible red, green and blue.

Polaroid is working on parallel lines and developing a printer, which will use laser diodes to expose instant picture film.

KODAK'S OUTLOOK

Kodak's position remains a mystery. Although it sells professional electronic disk recorders, and a dye printer made by Hitachi, the company has never announced any intention to commercialise a domestic electronic camera. Instead, in February 1982 Kodak launched a film camera system which uses a disc of film instead of the normal roll.

Each disc has 15 exposure frames, approximately 8 x 10mm in size. Because the frame area is so small, picture quality is poor when an attempt is made to make an enlarged print.

Patents on the system show that it was originally designed for use with a video reader so that colour positive pictures from



a series of discs can be displayed on a tv set. But this option was never offered.

Film disc cameras initially sold fairly well because six years ago 35mm cameras were still bulky and awkward to use. Now there are light and cheap 35mm cameras which are fully automatic. Budget 110 cameras are even cheaper and easier to use. Film disc picture quality never fulfilled early promises, manufacturers have stopped making disc cameras and the fixed batteries in many of the units sold are now worn out. Some retailers no longer bother to stock disc film.

Kodak points to the fact that most of the snapshot cameras used in the US today cost less than \$150, whereas there is no sign of an electronic camera and playback system selling for less than \$450.

On the face of things Kodak can afford to be confident. In the US, photographers took 13 billion pictures last year, most on the Kodacolor films and papers Kodak has been selling since 1942. But there is a fine line between confidence and complacency.

FUJI DIGITISED

Even before the first magnetic disk cameras had gone on sale, they had been made potentially obsolete by a new technology developed by Fuji.

The new Fuji system is much lighter and smaller, because it uses computer memory chips instead of a motor and disk drive. Also, instead of recording the video

signal as an fm analogue waveform, the new Fuji camera converts the signal into digital code and stores it in a 16 megabit random access memory card.

One card can store five full tv picture "frames" or ten "fields", each made up from half the normal number of tv scanning lines.

Fuji developed the memory card with Toshiba, as spin-off from the company's work for Robert Maxwell on a solid state sound recording system for language tuition. Fuji says it is now working on data compression technology, which will allow a single card to store up to forty full frame images.

Because the camera contains no mechanical drive it weighs only 0.5Kg. And because the stored signal is digital it can be fed to a personal computer for image processing, or sent down a telephone line like an electronic mail signal.

ELECTRONIC IMPACT

Wilbur Prezzano, General Manager of Photographic Products at Eastman Kodak in the US, is still sceptical about the immediate impact of electronic imaging.

The company has in the past made the valid point that if electronic imaging had been invented first, and someone now discovered the remarkable ability of silver salts to record optical images, it would be heralded as a dramatic breakthrough.

Prezzano cites the mistake made by

book publishers, who thought they could sell copies on microfilm. The idea flopped because people want to see books on their shelves and touch the paper pages.

"Paper is one of the most perfect devices ever invented," says Prezzano. "Silver halide has a long and healthy life ahead of it. And so does electronic imaging. By the year 2000, both systems will co-exist."

But the year 2000 is still over a decade away and it took the Japanese electronics industry less than that to create and dominate a home video industry in which Kodak's only role now is to sell tape made by Far Eastern competitors, TDK of Japan and Goldstar of Korea. **PE**

THAT'S STILL LIFE

So, photo technology zooms ever onwards. However, your Editor has a digital pre-tech light meter from his childhood days that may deserve museum status, but which still works. It's a rectangular tube containing a numbered translucent grey-scale; you point the tube at the subject and note which one of the five numbers you can just see through. The number represents the light value factor from which exposure settings are then calculated using a rotary disc on top of the tube. It served me well enough until my one-shilling a week pocket money had been saved up to buy a selenium cell meter. And that digitally inspired interest eventually took me into professional film making for fifteen years. What is hi-tech one day, may become lo-tech the next, but the crucial test for any tech is: does it do the job that's needed?

CRICKLEWOOD

OUT NOW!

ELECTRONICS

1989 100 PAGE COMPONENT CATALOGUE PRICE £1

SEND OFF FOR YOUR COPY TODAY...

- WE STOCK AN UNRIVALLED RANGE
- ALL OUR COMPONENTS ARE FIRST CLASS BRANDED ITEMS
- WE OFFER A SAME DAY SERVICE ON ALL STOCK ITEMS
- NO MINIMUM ORDER—IF YOU NEED ONE COMPONENT WE CAN SUPPLY ONE COMPONENT
- WE HAVE ADOPTED A NEW LOWER PRICING POLICY + QUANTITY DISCOUNTS
- FREE VOUCHERS WITH YOUR CATALOGUE—ORDER ONE NOW!...

JUST FILL IN THE COUPON OPPOSITE AND POST IT WITH YOUR £1 PAYMENT TO THE ADDRESS BELOW. YOU WILL RECEIVE NOT ONLY OUR SUPERB 100 PAGE CATALOGUE, BUT ALSO FREE VOUCHERS WHICH YOU CAN USE ON YOUR NEXT COMPONENTS ORDER.

CRICKLEWOOD ELECTRONICS LTD 40 CRICKLEWOOD BROADWAY LONDON NW2 3ET TEL: 01-450 0695/452 0161 FAX: 01-208 1441 TELEX: 914977

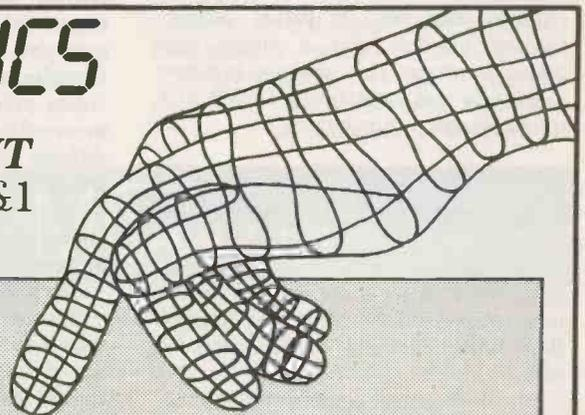

FREE VOUCHERS!

SEND OFF FOR YOUR CATALOGUE AND VOUCHERS TODAY.

I WOULD LIKE TO RECEIVE..... COPY(COPIES) OF THE 1989 CRICKLEWOOD ELECTRONICS COMPONENT CATALOGUE. I ENCLOSE £..... PLEASE ENCLOSE MY FREE VOUCHERS.

Tape your £1 coin here, or send a cheque or postal order for £1.00 for every catalogue you require.

NAME.....

ADDRESS.....





POWER AMPLIFIER MODULES-TURNABLES-DIMMERS-LOUDSPEAKERS-19 INCH STEREO RACK AMPLIFIERS

OMP POWER AMPLIFIER MODULES

Supplied ready built and tested.

Now enjoy a world-wide reputation for quality, reliability and performance at a realistic price. Four models available to suit the needs of the professional and hobby market, i.e., Industry, Leisure, Instrumental and Hi-Fi etc. When comparing prices, NOTE all models include Toroidal power supply, integral heat sink, Glass fibre P.C.B., and Drive circuits to power compatible VU meter. Open and short circuit proof.

THOUSANDS OF MODULES PURCHASED BY PROFESSIONAL USERS



OMP100 Mk 11 Bi-Polar Output power 110 watts R.M.S. into 4 ohms, Frequency Response 15Hz - 100KHz -30dB, Damping Factor, >300, Slew Rate 45V/uS, T.H.D. Typical 0.002%, Input Sensitivity 500mV, S.N.R. -130dB. Size 300 x 123 x 65mm. PRICE £33.99 + £3.00 P&P.

NEW SERIES II MOS-FET MODULES



OMP/MF 100 Mos-Fet Output power 110 watts R.M.S. into 4 ohms, Frequency Response 1Hz - 100KHz -30dB, Damping Factor, >300, Slew Rate 45V/uS, T.H.D. Typical 0.001%, Input Sensitivity 500mV, S.N.R. -130dB. Size 300 x 123 x 100mm. PRICE £39.99 + £3.00 P&P.



OMP/MF200 Mos-Fet Output power 200 watts R.M.S. into 4 ohms, Frequency Response 1Hz - 100KHz -30dB, Damping Factor >300, Slew Rate 50V/uS, T.H.D. Typical 0.001%, Input Sensitivity 500mV, S.N.R. -130dB. Size 300 x 155 x 100mm. PRICE £62.99 + £3.50 P&P.



OMP/MF300 Mos-Fet Output power 300 watts R.M.S. into 4 ohms, Frequency Response 1Hz - 100KHz -30dB, Damping Factor >300, Slew Rate 60V/uS, T.H.D. Typical 0.0008%, Input Sensitivity 500mV, S.N.R. -130dB. Size 330 x 175 x 100mm. PRICE £79.99 + £4.50 P&P.

NOTE— MOS-FET MODULES ARE AVAILABLE IN TWO VERSIONS, STANDARD— INPUT SENS. 500mV BANO WIDTH 100KHz. PEC (PROFESSIONAL EQUIPMENT COMPATIBLE)— INPUT SENS. 775mV, BANO WIDTH 50KHz. ORDER STANDARD OR PEC



Vu METER Compatible with our four amplifiers detailed above. A very accurate visual display employing 11 L.E.D. diodes (7 green, 4 red) plus an additional on/off indicator. Sophisticated logic control circuits for very fast rise and decay times. Tough moulded plastic case, with tinted acrylic front. Size 84 x 27 x 45mm. PRICE £8.50 + 50p P&P.

LOUDSPEAKERS



LARGE SELECTION OF SPECIALIST LOUDSPEAKERS AVAILABLE, INCLUDING CABINET FITTINGS, SPEAKER GRILLES, CROSS-OVERS AND HIGH POWER, HIGH FREQUENCY BULLETS AND HORNS, LARGE S.A.E. (30p STAMPED) FOR COMPLETE LIST.

McKENZIE:— INSTRUMENTS, P.A., DISCO, ETC.

All MCKENZIE UNITS 8 OHMS IMPEDENCE

- 8" 100 WATT C8100GPM GEN. PURPOSE. LEAD GUITAR, EXCELLENT MID. DISCO. RES. FREQ. 80Hz. FREQ. RESP. TO 14KHz. SENS. 99dB. PRICE £28.59 + £2.00 P&P.
- 10" 100 WATT C10100GP GUITAR, VOICE, ORGAN, KEYBOARD, DISCO, EXCELLENT MID. RES. FREQ. 70Hz. FREQ. RESP. TO 6KHz. SENS. 100dB. PRICE £34.70 + £2.50 P&P.
- 10" 200 WATT C10200GP GUITAR, KEYBOARD, DISCO, EXCELLENT HIGH POWER MID. RES. FREQ. 45Hz. FREQ. RESP. TO 7KHz. SENS. 103dB. PRICE £47.48 + £2.50 P&P.
- 12" 100 WATT C12100GP HIGH POWER GEN. PURPOSE. LEAD GUITAR, DISCO. RES. FREQ. 45Hz. FREQ. RESP. TO 7KHz. SENS. 98dB. PRICE £36.66 + £3.50 P&P.
- 12" 100 WATT C12100TC TWIN GONE HIGH POWER WIDE RESPONSE. P.A., VOICE, DISCO. RES. FREQ. 45Hz. FREQ. RESP. TO 14KHz. SENS. 100dB. PRICE £37.63 + £3.50 P&P.
- 12" 200 WATT C12200B HIGH POWER BASS, KEYBOARDS, DISCO, P.A. RES. FREQ. 40Hz. FREQ. RESP. TO 7KHz. SENS. 100dB. PRICE £64.17 + £3.50 P&P.
- 12" 300 WATT C12300GP HIGH POWER BASS LEAD GUITAR, KEYBOARDS, DISCO, ETC. RES. FREQ. 45Hz. FREQ. RESP. TO 5KHz. SENS. 100dB. PRICE £85.79 + £3.50 P&P.
- 15" 100 WATT C15100BS BASS GUITAR, LOW FREQUENCY, P.A., DISCO. RES. FREQ. 40Hz. FREQ. RESP. TO 5KHz. SENS. 98dB. PRICE £53.70 + £4.00 P&P.
- 15" 200 WATT C15200BS VERY HIGH POWER BASS. RES. FREQ. 40Hz. FREQ. RESP. TO 4KHz. SENS. 99dB. PRICE £73.26 + £4.00 P&P.
- 15" 250 WATT C15250BS VERY HIGH POWER BASS. RES. FREQ. 40Hz. FREQ. RESP. TO 4KHz. SENS. 99dB. PRICE £80.53 + £4.50 P&P.
- 15" 400 WATT C15400BS VERY HIGH POWER, LOW FREQUENCY BASS. RES. FREQ. 40Hz. FREQ. RESP. TO 4KHz. SENS. 102dB. PRICE £94.12 + £4.50 P&P.
- 18" 400 WATT C18400BS EXTREMELY HIGH POWER, LOW FREQUENCY BASS. RES. FREQ. 27Hz. FREQ. RESP. TO 3KHz. SENS. 99dB. PRICE £167.85 + £5.00 P&P.

EARBENDERS:— HI-FI, STUDIO, IN-CAR, ETC.

- ALL EARBENDER UNITS 8 OHMS EXCEPT EB8-50 AND EB10-50 DUAL 4 AND 8 OHM. BASS, SINGLE CONE, HIGH COMPLIANCE, ROLLED FOAM SURROUND**
- 8" 50 WATT EB8-50 DUAL IMPEDENCE, TAPPED 4/8 OHM BASS, HI-FI, IN-CAR. RES. FREQ. 40Hz. FREQ. RESP. TO 7KHz. SENS. 97dB. PRICE £8.90 + £2.00 P&P.
- 10" 50 WATT EB10-50 DUAL IMPEDENCE, TAPPED 4/8 OHM BASS, HI-FI, IN-CAR. RES. FREQ. 40Hz. FREQ. RESP. TO 5KHz. SENS. 99dB. PRICE £12.00 + £2.50 P&P.
- 10" 100 WATT EB10-100 BASS, HI-FI, STUDIO. RES. FREQ. 35Hz. FREQ. RESP. TO 3KHz. SENS. 96dB. PRICE £27.50 + £3.50 P&P.
- 12" 60 WATT EB12-60 BASS, HI-FI, STUDIO. RES. FREQ. 28Hz. FREQ. RESP. TO 3KHz. SENS. 92dB. PRICE £21.00 + £3.00 P&P.
- 12" 100 WATT EB12-100 BASS, STUDIO, HI-FI, EXCELLENT DISCO. RES. FREQ. 26Hz. FREQ. RESP. TO 3KHz. SENS. 93dB. PRICE £32.00 + £3.50 P&P.
- FULL RANGE TWIN CONE, HIGH COMPLIANCE, ROLLED SURROUND**
- 5 1/2" 60 WATT EB5-60TC (TWIN CONE) HI-FI, MULTI-ARRAY DISCO ETC. RES. FREQ. 63Hz. FREQ. RESP. TO 20KHz. SENS. 92dB. PRICE £9.99 + £1.50 P&P.
- 6 1/2" 60 WATT EB6-60TC (TWIN CONE) HI-FI, MULTI-ARRAY DISCO ETC. RES. FREQ. 38Hz. FREQ. RESP. TO 20KHz. SENS. 94dB. PRICE £10.99 + £1.50 P&P.
- 8" 60 WATT EB8-60TC (TWIN CONE) HI-FI, MULTI-ARRAY DISCO ETC. RES. FREQ. 40Hz. FREQ. RESP. TO 18KHz. SENS. 89dB. PRICE £12.99 + £1.50 P&P.
- 10" 60 WATT EB10-60TC (TWIN CONE) HI-FI, MULTI-ARRAY DISCO ETC. RES. FREQ. 35Hz. FREQ. RESP. TO 12KHz. SENS. 86dB. PRICE £16.49 + £2.00 P&P.

TRANSMITTER HOBBY KITS

PROVEN TRANSMITTER DESIGNS INCLUDING GLASS FIBRE PRINTED CIRCUIT BOARD AND HIGH QUALITY COMPONENTS COMPLETE WITH CIRCUIT AND INSTRUCTIONS

3W FM TRANSMITTER 80-108MHz. VARICAP CONTROLLED PROFESSIONAL PERFORMANCE, RANGE UP TO 3 MILES, SIZE 38 x 123mm, SUPPLY 12V @ 0.5AMP. PRICE £14.49 + £1.00 P&P

FM MICRO TRANSMITTER (BUG) 100-108MHz. VARICAP TUNED COMPLETE WITH VERY SENS FET MIC. RANGE 100-300m. SIZE 56 x 46mm. SUPPLY 9V BATT. PRICE £8.62 + £1.00 P&P



3 watt FM Transmitter

POSTAL CHARGES PER ORDER £1.00 MINIMUM. OFFICIAL ORDERS WELCOME FROM SCHOOLS, COLLEGES, GOVT. BODIES, ETC. PRICES INCLUSIVE OF V.A.T. SALES COUNTER. VISA ACCESS ACCEPTED BY POST, PHONE OR FAX.



* PRICES INCLUDE V.A.T. * PROMPT DELIVERIES * FRIENDLY SERVICE * LARGE S.A.E., 30p STAMPED FOR CURRENT LIST.

OMP VARISPEED TURNTABLE CHASSIS.



★ MANUAL ARM ★ STEEL CHASSIS ★ ELECTRONIC SPEED CONTROL 33 & 45 ★ VARI PITCH CONTROL ★ HIGH TORQUE SERVO DRIVEN DC MOTOR ★ TRANSIT SCREWS ★ 12" DIE CAST PLATTER ★ NEON STROBE ★ CALIBRATED BAL WEIGHT ★ REMOVABLE HEAD SHELL ★ 1/2" CARTRIDGE FIXINGS ★ CUE LEVER ★ POWER 220-240V 50/60Hz ★ 390x305mm ★ SUPPLIED WITH MOUNTING CUT-OUT TEMPLATE. PRICE £59.99 + £3.50 P&P.

OPTIONAL MAGNETIC CARTRIDGES

STANTON AL500
PRICE £16.99 + 50p P&P

GOLDRING G850
PRICE £6.99 + 50p P&P

OMP MOS-FET POWER AMPLIFIERS, HIGH POWER, TWO CHANNEL 19 INCH RACK

THOUSANDS PURCHASED BY PROFESSIONAL USERS

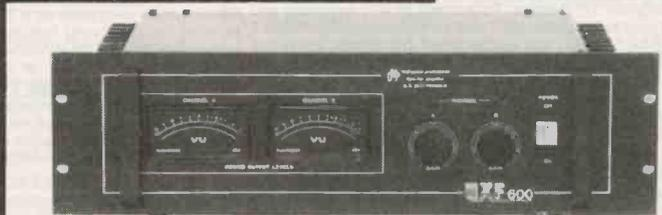

NEW MXF SERIES OF POWER AMPLIFIERS
THREE MODELS:— MXF200 (100w + 100w)
MXF400 (200w + 200w) MXF600 (300w + 300w)

All power ratings R.M.S. into 4 ohms.

FEATURES: ★ Independent power supplies with two Toroidal Transformers ★ Twin L.E.D. Vu meters ★ Rotary indexed level controls ★ Illuminated on/off switch ★ XLR connectors ★ Standard 775mV inputs ★ Open and short circuit proof ★ Latest Mos-Fets for stress free power delivery into virtually any load ★ High slew rate ★ Very low distortion ★ Aluminium cases ★ MXF600 Fan Cooled with D.C. Loudspeaker and Thermal Protection.

USED THE WORLD OVER IN CLUBS, PUBS, CINEMAS, DISCOS ETC.

SIZES:— MXF 200 W19"xH3 1/2" (2U)x D11"
MXF 400 W19"xH5 1/4" (3U)x D12"
MXF 600 W19"xH5 1/4" (3U)x D13"

MXF200 £171.35
MXF400 £228.85
MXF600 £322.00

SECURICOR DELIVERY £12.00 EACH

OMP LINNET LOUDSPEAKERS

THE VERY BEST IN QUALITY AND VALUE



MADE ESPECIALLY TO SUIT TODAY'S NEED FOR COMPACTNESS WITH HIGH OUTPUT SOUND LEVELS. FINISHED IN HARDWEARING BLACK VINYLIDE WITH PROTECTIVE CORNERS, GRILLE AND CARRYING HANDLE, INCORPORATES 12" DRIVER PLUS HIGH FREQ. HORN FOR FULL FREQ. RANGE: 45Hz-20KHz BOTH MODELS 8 OHM, SIZE H18" x W15" x D12".

CHOICE OF TWO MODELS

POWER RATINGS QUOTED IN WATTS RMS FOR EACH CABINET

OMP 12-100 (100W 100dB) PRICE £159.99 PER PAIR
OMP 12-200 (200W 102dB) PRICE £209.99 PER PAIR

SECURICOR DEL.— £12.00 PER PAIR

OMP SLIDE DIMMER 1K WATT & 2.5K WATT

CONTROLS LOADS UP TO 1KW & 2.5KW. SUITABLE FOR RESISTIVE AND INDUCTIVE LOADS BLACK ANODISED CASE, READY FLUSH MOUNTED THROUGH PANEL/CABINET CUT-OUTS, ADVANCED FEATURES INCLUDE:—

- ★ FULL 65mm SLIDE TRAVEL
- ★ NEON MONITOR INDICATOR
- ★ FLASH OVERRIDE BUTTON
- ★ HIGH & LOW LEVEL PRESETS
- ★ FULLY SUPPRESSED TO BS 800

SIZES:— 1KW H128xW40xD55mm
2.5KW H128xW76xD79mm

PRICES:— 1K WATT £15.99
2.5K WATT £24.99 + 60p P&P

PIEZO ELECTRIC TWEETERS-MOTOROLA

PIEZO ELECTRIC TWEETERS — MOTOROLA

Join the Piezo revolution. The low dynamic mass (no voice coil) of a Piezo tweeter produces an improved transient response with a lower distortion level than ordinary dynamic tweeters. As a crossover is not required these units can be added to existing speaker systems of up to 100 watts (more if 2 put in series). FREE EXPLANATORY LEAFLETS SUPPLIED WITH EACH TWEETER.

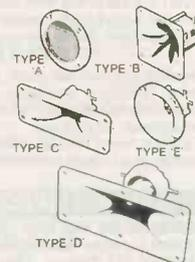

TYPE 'A' (KSN2036A) 3" round with protective wire mesh, ideal for bookshelf and medium sized Hi-fi speakers. Price £4.90 each + 50p P&P.

TYPE 'B' (KSN1005A) 3 1/2" super horn. For general purpose speakers, disco and P.A. systems etc. Price £5.00 each + 50p P&P.

TYPE 'C' (KSN6016A) 2"x5" wide dispersion horn. For quality Hi-fi systems and quality discos etc. Price £6.99 each + 50p P&P.

TYPE 'D' (KSN1025A) 2"x6" wide dispersion horn. Upper frequency response retained extending down to mid range (2KHz). Suitable for high quality Hi-fi systems and quality discos. Price £9.99 each + 50p P&P.

TYPE 'E' (KSN1038A) 3 3/4" horn tweeter with attractive silver finish trim. Suitable for Hi-fi monitor systems etc. Price £5.99 each + 50p P&P.

LEVEL CONTROL Combines on a recessed mounting plate, level control and cabinet input jack socket. 85x85mm. Price £3.99 + 50p P&P.

STEREO DISCO MIXER

STEREO DISCO MIXER with 2 x 5 band L & R graphic equalisers and twin 10 segment L.E.D. Vu Meters. Many outstanding features 5 inputs with individual faders providing a useful combination of the following:— 3 Turntables (Mag), 3 Mics, 4 Line including CD plus Mic with talk over switch Headphone Monitor, Pan Pot L & R, Master Output controls, Output 775mV. Size 360x280x90mm. Supply 220-240V. Price £134.99 — £4.00 P&P



B. K. ELECTRONICS Dept PE
UNIT 5, COMET WAY, SOUTHEND-ON-SEA, ESSEX. SS2 6TR
TEL: 0702-527572 FAX: 0702-420243

THE ORIGINAL SURPLUS WONDERLAND!

THIS MONTH'S SPECIAL!

Very high resolution, fully cased 14" green or amber screen monitor with non-glare screen and swivel/tilt base. The very latest technology at the very lowest price! Fully compatible and plug compatible with all IBM PCs and clones fitted with a high res Hercules or equivalent card! Enables superb graphics and resolution, all at a give away price. Has many extra features including aux +5 & 12v DC outputs to power at least 2 disk drives, if your PC power supply is getting hot! Supplied BRAND NEW and boxed. State whether amber or green screen required.

Amber£79 Green£69 (E)

COMPUTER SYSTEMS

TATUNG PC2000. Big brother of the famous Elstein. The TPC2000 Professional 3 piece system comprises: Quality high resolution Green 12" monitor. Sculptured 92 key keyboard and plinth unit containing Z80A CPU and all control circuits. PLUS 2 Integral TEAC 5.25 80 track double sided disk drives. Generous other features include dual 8" IBM format disk drive support. Serial and parallel outputs, full expansion port, 64K ram and ready to run software. Supplied complete with CP/M, Wordstar and Basic. Brand new and covered by our famous 90 day guarantee and backup. Normal price of this unit is over £1400!

Our price only£299 (E)

PC-AT 286 CLONE Lowest ever priced 8 mhz PC-AT clone complete with a 20mhz hard drive, a 5.25" 360k floppy, 640k of RAM plus Hercules card compatibility. The keyboard is NCR with 85 keys in an attractive beige, grey and cream finish to match the computer. The monitor is very high resolution 14" non-glare, with your choice of amber or green screen. A very nice package at a super price!

Our price only£799 (E)

SPECIAL PURCHASE V22 1200 baud modems

We got a tremendous buy on further stocks of this popular **Master Systems 2/12** microprocessor controlled V22 full duplex 1200 baud modem - we can now bring them to you at **half last advertised price!** Fully BT approved unit, provides standard V22 high speed data comm, which at 120 cps, can save your phone bill and connect time by a staggering 75%! Ultra slim 45 mm high. Full featured with LED status Indicators and remote error diagnostics. Sync or Async use; speech or data switching; built in 240v mains supply and 2 wire connection to BT. Units are in used but good condition. Fully tested prior despatch, with data and a full 90 day guarantee. What more can you ask for - and at this price!

ONLY £69 (D)

Write to us today and get your name on our mailing list for our FREE eight weekly bargain flyer *The Display News* with thousands of unadvertised special offers.

MONITORS

COLOUR MONITORS

Decca 16" 90 series budget range colour monitors. Features include PIL tube, an attractive teak style case and guaranteed 80 column resolution, features which are only normally seen on colour monitors costing 3 times our price! It is absolutely ready to connect to a host of computer or video outputs. Manufacturers fully tested surplus, sold in little or hardly used condition with 90 day full RTB guarantee. Decca 80 RGB TTL and sync input for BBC and similar type interface etc. Decca 80 COMPO 75 ohm composite video input with integral audio amp & speaker. Ideal for use with video recorder or our Telebox ST, or any other audio visual use.

Any type only £99.00 (E)

HI-DEFINITION COLOUR MONITORS

Brand new Centronic 14" monitor for IBM PC and compatibles at a lower than ever price! Completely CGA equivalent. Hi-res Mitsubushi 0.42 dot pitch giving 669 x 507 pixels. Big 28 Mhz bandwidth. A super monitor in attractive style moulded case. Full 90 day guarantee.

Only £149 (E)

20", 22" and 26" AV SPECIALS

Superbly made UK manufacture. PIL all solid state colour monitors, complete with composite video & sound inputs. Attractive teak style case. Perfect for Schools, Shops, Disco, Clubs. In EXCELLENT little used condition with full 90 day guarantee.

20"....£155 22"....£170 26"....£185 (F)

MONOCHROME MONITORS

Wang green screen 12" chassis monitor with composite video input. Adjustable for tilt. Requires 12 vdc. Brand new and boxed in perfect condition.

Only £39 each or 2 for £75 (E)

Motorola M1000-100 5" black & white compact chassis measuring only 11.6H x 12W x 2.2D. Ideal for CCTV or computer applications. Accepts standard composite or individual H & V syncs. Needs 12vdc at only 0.8a. Some units may have minor screen blemishes. Fully tested with 30 day guarantee and full data.

£29.00(C)

Fully cased as above in attractive moulded desk standing swivel. Dim 12 x 14.5 x 26cm. £39.00(C)

JVC 751 ultra compact chassis monitor for 12vdc 0.7a. Dim 11 x 14 x 18cm. Simple DIY data included to convert to composite video input. Full data. BRAND NEW £65.00(B)

20" Black & white monitors by Aztek, Cotron & National. All solid state, fully cased monitors ideal for all types of AV or CCTV applications. Standard composite video inputs with integral audio amp and speaker. Sold in good used condition - fully tested with 90 day guarantee. £85.00(F)

FLOPPY DISK DRIVES BARGAINS GALORE!

NEW 5 1/4 inch from £29.95!

Massive purchases of standard 5 1/4" drives enables us to present prime product at industry beating low prices! All units (unless stated) are removed from often brand new equipment and are fully tested, aligned and shipped to you with a 90 day guarantee and operate from +5 & +12vdc, are of standard size and accept the standard 34 way connector.

SHUGART SA405. BRAND NEW £29.95(B)

TANDON TM100-2A IBM compatible DS £39.95(B)

TANDON TM101-4 80 Track DS £49.95(B)

CANON, TEC etc. DS half height. State 40 or 80T £75.00(B)

TEAC FD-55-F. 40-80 DS half height. BRAND NEW £99.00(B)

3 1/2 INCH BRAND NEW AT £19.95!!

Never before seen price for a 3 1/2" drive. Standard size believed to be by Canon. Brand new and packaged - mint condition! 40 track SS, run from +5 & +12vdc with standard power connector.....Only..... £19.95 or 2 for £34.50(B)

CHOOSE YOUR 8 INCH!

Shugart 800/801 SS refurbished & tested £125.00(E)

Shugart 851 double sided refurbished & tested £195.00(E)

Mitsubishi M2894-63 double sided switchable hard or soft sectors - BRAND NEW £250.00(E)

SPECIAL OFFERS!!

Dual 8" drives with 2 megabyte capacity housed in a smart case with built in power supply! Only £499.00 (F)

Ideal as exterior drives!

End of line purchase scoop! Brand new NEC D2246 8" 85 megabyte of hard disk storage! Full CPU control and industry standard SMD interface. Ultra hi speed transfer and access time leaves the good old ST506 interface standing. In mint condition and comes complete with manual. Only.....£399(E)

MAINS SUPPRESSORS & FILTERS

The "Flitan" from Cotran is a British made high current mains spike suppressor and RF filter in one, capable of handling up to 10 amps! The attractive case has an integral 13 amp socket for your equipment plug and a flying lead terminates in a quality plug (to BS 1363A standard) to go to the mains socket. There is an internal fuse plus one in the plug. Two LED indicators, one for power on and the other lights if the internal fuse fails. Dims: 6" x 3" x 2". Brand new. Normal distributor's price is £65.00!

Our price only£15.95 each or 2 for £29.95 (B)

Belling-Lee type L2127 mains RF filters rated at 250 volts 3 amps maximum. Comes complete with a built in mains cable (English coding), and a three pin miniature non-reversible socket and a mating plug, to go to the equipment. Ideal for those who are bugged by RF interference. Very compact. Dims 3-1/8" x 2.5" x 1.5".....£3.95 each or 3 for £10 (A)

COOLING FANS

Please specify 110 or 240 volts for AC fans.

3 Inch AC. 1 1/2" thick £ 8.50(B)

3 1/2 Inch AC ETRI silmline. Only 1" thick. £ 9.95(B)

4 Inch AC 110/240v 1 1/2" thick. £10.95(B)

4 Inch AC 1 1/2" thick £ 9.95(B)

10 Inch Round. 3 1/2" thick. Rotron 110v £10.95(B)

62 mm DC 1" thick. No.812 for 6/12v.814 24v. £15.95(A)

92 mm DC 12v. 19 mm thick. £10.95(A)

4 Inch DC 12v. 17 1/2" thick £12.50(B)

4 Inch DC 24v 8w. 1" thick. £14.50(B)

RECHARGEABLE BATTERIES

LEAD ACID

Maintenance free sealed long life. Type A300.

12 volts 12 volts 3 amp/hours £13.95(A)

6 volts 6 volt 3 amp/hours £ 9.95(A)

6-0-6 volts Centre tapped 1.8 amp hours £ 5.95(A)

12 volts 12 volts 24 amp hours. A200. RFE. £29.00(B)

SPECIAL OFFER!

100 amp/hours at 6 volt! Brand new Chloride Powersafe 3VB11. Leakproof with additional snap-on security lid. Perfect for uninterruptible power supplies, portable power source, caravans etc. Normally costs £80! £39 (E)

NICKEL CADMIUM

Quality 12v 4ah cell pack. Originally made for the Technicolor video company. Contains 10 GE top quality D nicad cells in a smart robust case with a DC output connector. Ideal for portable equipment. Brandnew. £19.95(B)

Ex-equipment NICAD cells by GE. Removed from equipment and in good, used condition: D size 4ah 4 for £5(B)

F size 7ah 6 for £8(B)

SPECIAL INTEREST

Racal-Redac real time colour drafting PCB layout system. Includes furniture and huge monitor. Complete ready to go! £395.00

DEC VAX11/750 Inc. 2 Meg Ram DZ and full documentation, in brand new condition! £3900

Large Calcomp plotter £ 650

Tektronix RM529 Waveform Monitor £ 300

1.5kw 115v 60hz power source. £ 950

Wayne Kerr RA200 audio real time freq.res. analyser. £3000

VG Electronics 1033 Teletext Bridge £3750

Tektronics R140 NTSC TV test signal standard. £ 875

Veratek V80 Printer plotter £1500

DEC LS11/02 CPU board £ 150

SPECIAL EXPERIMENTERS PSU's

These 2 PSU's are built to BT's rigorous specs and give fully protected DC outputs ideal for the electronic hobbyist & experimenter. Type EPSU1 input is 240v AC; outputs are 5v @ 2a, ±12v @ 1a, 24v @ 1a, 5v fully floating 50ma. EPSU2 input is 30-70vdc outputs are 5v @ 6a, 12v @ 1a, -12v @ 0.5a & 5 others. Circuit diagram on request for EPSU1. No data with EPSU2 - hence the price! Both at parts alone price!

EPSU1.....£16.95 (C) EPSU2.....£9.95 (C)

BARGAIN PARTS & BOARDS PACKS

Its stock taking time once more so we have made up a lot of our famous bargain parcels again! These parcels represent the best value for money available and the greatest bargains of the century - a real thrill to open them up when you find that you have bought equipment and components (mostly brand new) for well under a third of our normal low price!!

Mix of general electronic parts & equipment:

5kios weight for.... £8.95(B) 20 kios weight for£22.50(D)

Boards Parcels for parts recovery:

Parcels contain almost any type of boards including ICs, memory, logic, passives and vast assortments of parts!

10 board parcel.....£7.50(B) 20 board parcel.....£13.95(C)

POWER SUPPLIES

All PSU's 220-240vac input and are BRAND NEW unless stated. Many types ranging from 3v to 10kv always in stock.

Byte BD301 5vdc @ 1.6a. 12vdc @ 1.5a. Perfect for disk drives; with Molex sockets. Very attractively cased. Illum. sw. £19.50(B)

Greendale 19AB0E 60 watts switch mode. +5v @ 6a, ±12v @ 1a, ±15v @ 1a. RFE and fully tested. 11 x 20 x 5.5cms. £24.95(C)

Conver AC130. 130 watt hi-grade VDE spec. Switch mode. +5v @ 15a, -5v @ 1a, ±12v @ 6a, 27 x 12.5 x 6.5cms £49.95(C)

Bosert 13090. Switch mode. Ideal for drives & system. +5v @ 6a, +12v @ 2.5a, -12v @ 0.5a, -5v @ 0.5a. £29.95(B)

Famell G6/40A. Switch mode. 5v @ 40a. Encased £95.00(C)

IBM KEYBOARD DEAL

A replacement or backup keyboard, switchable for IBM PC, PC-XT or PC-AT. LED's for Caps, Scroll & Num Locks. Standard 85 keyboard layout. Made by NCR for the English & US markets. Absolutely standard. Brand new & boxed with manual and key template for user slogans on the function keys. Attractive beige, grey and cream finish, with the usual retractable legs underneath. A generous length of curly cord, terminating in the standard 5 pin DIN plug. A beautiful clean piece of manufacturers surplus. What a deal!

BRAND NEW AND BOXED ONLY..... £49 (B)

THE AMAZING TELEBOX!

Converts your colour monitor into a QUALITY COLOUR TV!!



TV SOUND & VIDEO TUNER!

Brand new high quality, fully cased, 7 channel UHF PAL TV tuner system. Unit simply connects to your TV aerial socket and colour video monitor turning same into a fabulous colour TV. Don't worry if your monitor does not have sound, the TELEBOX even has an integral audio amp for driving a speaker plus an auxiliary output for headphones or Hi Fi system etc. Many other features: LED Status Indicator, Smart moulded case, Mains powered, Built to BS safety specs. Many other uses for TV sound or video etc. Supplied BRAND NEW with full 1 year guarantee.

Telebox ST for composite video input monitors.....£29.95(B)

Telebox STL as ST but with integral speaker.....£34.95(B)

Telebox RGB for analogue RGB monitors.....£59.95(B)

NOT suitable for IBM or Clone type colour monitors.

BRAND NEW PRINTERS

Epson MX-90 F/T One of the most popular printers around! Bi-directional printing with full logic seeking. 9 x 9 dot matrix for enlarged, bold, condensed etc. Standard parallel interface. Brand label removed from front. Handles tractor, fanfold and individual paper. OK with IBM PC and most others. A tremendous buy!

£129.00 (E)

Hazeltine Eprint small desktop, 100 cps with RS232 and standard parallel. Full pin addressable and 6 user selectable fonts. Up to 9.5" paper. Sheet & tractor feed. £149.00(E)

Centronics 150 series. Always known for their reliability in continuous use - real workhorses in any environment. Fast 150 cps with 4 fonts and choice of interfaces.

150-SN up to 9.5" paper.....£155.00(E)

150-SW up to 14.5" paper.....£199.00(E)

Specify whether serial or parallel required.
CALL FOR THE MANY OTHERS IN STOCK INCLUDING DAISY WHEELS.

Visit our Shop - Technical help always on hand plus many un-advertised specials. You can buy a colour television for as little as £29! Come and join the gang at 215 Whitehorse Lane!

DISPLAY

MAIL ORDER/OFFICES
Open Mon-Fri 9.30-5.30
32 Biggin Way,
Upper Norwood,
London SE19 3XF.

LONDON SHOP
100's of bargains for
callers!
Open Mon-Sat 9-5.30
215 Whitehorse Lane,
South Norwood,

DISTEL © The Original
Free dial-up database!
1000's of items+Info On Line
300bd 01-879-1888, 1200/75
01-879-8183, 1200/1200
01-879-8769

ALL ENQUIRIES
01-679-4414
Fax- 01-679-1927
Telex 894502



-Electronics-

All prices for UK Mainland. UK customers ADD 15% VAT to total order amount. Minimum order £10. PO orders from Government, Universities, Schools & Local Authorities welcome - minimum account order £25. Carriage charges (A)=£1.50, (B)=£3.50, (C)=£6.50, (D)=£8.50, (E)=£12.50 (F)=£15. (G)=Call. All goods supplied subject to our standard Conditions of Sale and unless otherwise stated guaranteed for 90 days. All guarantees given on a return to base basis. We reserve the right to change prices & specifications without prior notice. Orders accepted subject to stock. Quotations willingly given for higher quantities than those stated.

It would be difficult to take an interest in the world of computing for any length of time without stumbling across a few references to transputers. On the other hand, relatively few people have any more experience of them than reading articles on the subject. Although transputers have, as yet, failed to gain widespread acceptance and use, they are becoming more common. They are certainly available in a number of commercial products such as add-on processor boards and intelligent graphics displays for the IBM PCs and compatibles. For someone wishing to master transputer technology, gaining the all-important hands-on experience at programming and interfacing to these devices is by no means easy. It is made somewhat easier by the introduction of a transputer training system by Flight Electronics, and it is this interesting system that forms the basis of this review.

This is not the place to go into great detail about transputers, which is the purpose of the Flight Electronics



The Flight Electronics training system is based on the Inmos IMS-T414 transputer. The system consists of no less than five manuals plus manufacturer's data sheets and IMS C012 link adaptor.

TRANSPUTER TRAINER REVIEW

transputer training system, and its several hundred pages of documentation.

THE SYSTEM

For the uninitiated it should perhaps be explained that a transputer is a powerful processor which utilizes risc (reduced instruction set computer) technology. This is a processor which, as its name implies, has a limited (but well chosen) set of instructions. The reduced instruction set enables the architecture to be streamlined so that few clock cycles are required per instruction. In fact most risc processors operate largely on the basis of one or two clock cycles per instruction. Even though it may sometimes be necessary to use a few instructions where an ordinary microprocessor would require only one or two, this approach permits faster processing to be achieved. Bear in mind that some microprocessors take over twenty clock cycles to perform many of their instructions. The yardstick by which processors are normally judged these days is their mips rating. MIPS stands for "million instructions per second", which is self explanatory. A single IMS T414 transputer provides 10 mips' performance, which is very impressive. For comparison purposes, the highly rated Acorn Archimedes computers are based on a risc chip which provides approximately 4 mips operation, and this is several times faster than something like an 8MHz 68000

BY ROBERT PENFOLD

A solid investment in the future with Flight Electronics and their Inmos transputer training system.

processor. RISC processors are normally of the 32 bit variety, which also aids high performance in many applications.

Perhaps the transputer's main claim to fame is that it is possible to use several of them in a network to perform parallel processing. In other words, tasks are split up into several jobs which are undertaken simultaneously by several transputers, each job being tackled by its own device. With several processors working on a task simultaneously it can obviously be completed several times quicker than by using a single device. With half a dozen transputers you could obtain 60 mips operation. This is largely irrelevant in the current context, since the Flight Electronics training system is based on a single Inmos IMS-T414 transputer.

However, it is possible to use up to thirteen of these transputer boards together to act as a network.

The training system consists of no less than five manuals plus the manufacturer's data sheets for the IMS T414 transputer and IMS C012 link adaptor. The latter is responsible for the link to the host computer, plus any linking to other transputer boards. None of the ring-bound manuals are particularly long, and they seem to have been produced on something less than the ultimate dtp system, but all the documentation you should need is there. The four main manuals are a general user guide, a hardware installation guide and manual, an introduction to the Occam programming language, and the main user manual. The fifth manual is Inmos' Occam manual. The hardware manual includes circuit diagrams for the main and interface boards, together with brief circuit descriptions. The large number of manuals and data sheets can be a bit confusing at first, and there is a certain amount of overlap in their coverage. The inclusion of the data sheets is a nice touch - often training systems make numerous references to data sheets which you have to obtain by your own means, if you can.

The hardware consists of the transputer board, a power supply, and an interface card. This training system is not a stand-alone unit, and it must be used in conjunction with an IBM PC or compatible. As yet, no other computers can act as the host for the system. The host

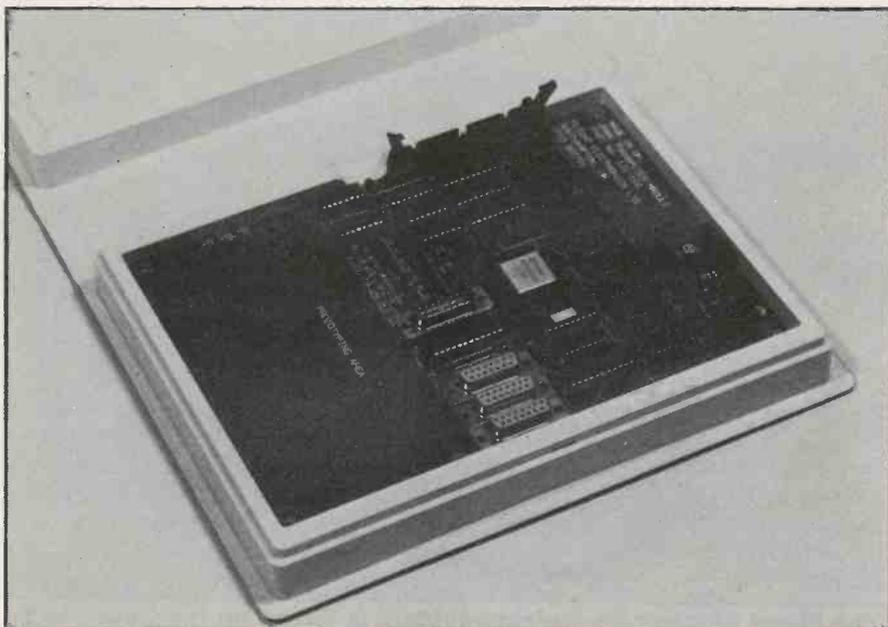

Thirteen of these transputer boards may be linked to act as a network.

computer does not need to be anything too exotic, and the system worked fine with both an Amstrad PC1512 (upgraded to 640K ram) and a 12MHz AT clone. Some PCs are unsuitable though, since at least 640K of ram is needed, together with 1M of disk space. A twin 360K machine is therefore unsuitable, and a computer fitted with a hard disk is clearly an asset. The interface card is a standard half length type which can be fitted without difficulty. It refused to work at first, but we had omitted to configure its jumper terminals correctly. Connection from the interface card to the transputer board is via the 15 way D lead supplied. Although the system includes a small mains power supply unit, in most cases power can be drawn from the host computer, and the power supply will be unnecessary. Last but by no means least, there are four 5.25 inch (40 track DS/DD format) disks which contain the software including the Occam compiler.

THE OCCAM LANGUAGE

Occam is the language of the transputer. It is specially designed to allow programs to be configured to run on more than one transputer at a time, in true parallel processing. However, Occam programs can also be run on a single transputer, by a system of time slicing.

The language supplied with the TTS is Occam 1. This is a fairly limited language, and in terms of high level/low level it is somewhat lower than, for example, C. It has only integer arithmetic, and there are no in-built facilities for reading a string from the keyboard or writing one to the screen, for instance, only for character-by-character reads by means of channels.

However, 'library' routines to perform these functions are included in the supplied software.

Channels are important in Occam. As well as being used for communication with the outside world, channels are also used for communication between transputers in a network. When only a single transputer is being used, these channels are logical channels within the language, but when a network of transputers is available, these same channels can be configured (explicitly by the programmer) to become physical channels between the components. Thus it is that only a single transputer is necessary on the TDS board to allow parallel programming to be explored.

THE EDITOR/COMPILER

It is not surprising that an unusual language like Occam needs a fairly unusual editor. It is described as a 'folding' editor. The explanation of this name is that, when a suitable section of code has been written, it can be referred to in future by name, and hidden from view, like folding up a piece of paper. The contents of a fold are similar to the procedures, modules and subroutines of other languages. In part, this folding is necessary because of the way Occam is written. The indenting used in some other languages to indicate program structure is compulsory in Occam, as it is used by the compiler. As you go deeper into the program, you can tend to get rather a long way from the left margin. Within a fold, you start afresh flushed left, making the screen display much more readable. One problem, however, is that it is very difficult to get a coherent printed listing

from the editor.

The editor is not friendliest or most helpful of programs. For example, it displays a message to press 'Enter Fold' to continue, referring to one of the function keys, whereas a message to 'Press F7 to Enter Fold' would be clearer and also save having to reach for the manual and look up the keyboard chart. On the plus side, the program is undoubtedly robust. Unlike other languages which have separate editor and compiler programs, in the TDS the two are integrated. Facilities are also provided to download the code to the transputer board and execute it.

Compiling includes syntax and error checking, and, probably as a result of this, compiling is not a fast process. However, providing the code within a fold meets certain rules, it can be separately compiled (and is then termed a 'separately compiled fold'). The advantage of this is that recompiling of this section is not necessary if the program is modified, which saves some time.

The transputer board does not have to be connected to the host computer for either editing or compiling, so where there are several students, it is not necessary to have one of these, or an interface board, for each student. It is necessary to have the boards to actually download and run the programs, of course. Unfortunately, the ability to run the programs under DOS on the host computer is no longer implemented.

SOFTWARE

The software included is supplied in MS-DOS backup format, and has to be installed on the hard disk (or high capacity floppy disk) using the RESTORE command. As this could give problems with differing versions of DOS, the system files are included on the master disk, and provided you boot up from this, file transference should present no problems. As well as the editor, compiler and utilities, all the example programs from the manuals are provided on the disks. The bias of the examples is towards real-time and control applications, rather than data processing, but all aspects of the language are covered.

There is also an on-line tutorial which takes you through all the stops of writing, compiling, downloading and running a simple program. However, as (nearly) always with such tutorials, having been led through by the hand, and told at each step exactly what keys to press, I found myself at the end wondering if I had in fact actually learned anything. The problem with such tutorials is that you tend to proceed through them, idly pressing keys and wondering how the test match is progressing. When you are left to do something yourself (in this case completing a line within a fold) you find

yourself foundering because you have not been paying attention. I am just not convinced that this is a valid teaching method. This is only a small criticism of the Transputer Training System, of course, as it is only a small part of what is supplied. All in all, there is everything here that is necessary for a thorough grounding in programming the Transputer. It is just up to the student to pay attention!

THE HARDWARE

It has to be stressed that this is primarily a training system, and it is not designed to turn the PC into a lightning fast computer capable of running transputer applications software. It is very much in the same vein as the training systems for processors such as the 6800 and 68000 which have been available for many years. Like many of these systems, it has some development potential, but it is primarily aimed at teaching you about the processor. Traffic light simulation rather than flight simulation is the type of thing you are likely to produce on a system of this type.

The processor board is a double-sided type of good quality, and contains about a dozen ttl logic chips, the transputer, a couple of support chips, and 256K of 41464 dram chips (organised as 32 bits by 64K of course). All the chips are fitted in sockets. There are fourteen leds on the board, five of which give status information, and eight of which are memory mapped and driven via latches. These eight leds provide a means of trying out simple control programs, and make an interesting alternative to obtaining output via the screen of the host computer. The board has a 15 way D plug which takes the lead from the interface card in the host computer, and there are three 15 way D sockets which can be coupled to further transputer boards. The nine sockets on these additional boards can be connected to further transputer boards, permitting up to thirteen boards to be networked. As we

had only a single board available for review purposes, we were unable to try out any multi-board systems. The interface sockets on the boards carry an interface which is essentially the same as that on the interface card – a high speed synchronous serial type.

There is a decent size "PROTOTYPING AREA" on the board which can be used to wire-wrap your own hardware. A 40 way IDC plug provides 8 bit input and output ports which permit communications with your prototype circuits. There is no general expansion bus incidentally, and these ports would appear to be the only method of interfacing to your own hardware. Controlling a few leds is fine initially, but in order to really do some worthwhile experiments with the system, and to really learn about transputers, I think that you would soon need to make use of the ports and some simple add-on circuits.

Someone who already has some programming and electronics skills should soon be able to get to grips with transputers with the aid of this training system.

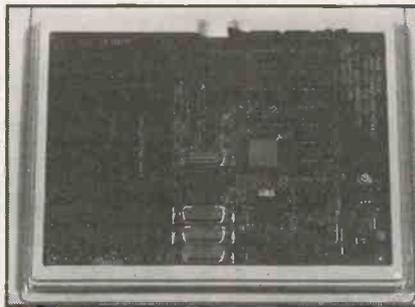

Further information on the transputer training system can be obtained from:

Flight Electronics Ltd., Ascupart Street, Southampton, SO1 1LU. Tel: 0703 227721

CONCLUSIONS

This system certainly ranks as one of the more interesting things I have reviewed over the years. It is reasonably straightforward to get everything up and running, there is plenty of documentation of adequate quality, and given a moderate amount of effort it enables you to learn a fair bit about transputers. It is not aimed at complete beginners to electronics and computing, which is sensible, as transputers are probably not a good starting point. Someone who already has some programming and electronics skills should soon be able to get to grips with transputers with the aid of this training system.

The only serious drawback is the price of around the thousand pounds mark. The system does not seem to provide you with very much for this sort of outlay, but you need to bear in mind that transputers are relatively expensive at present. Anything that gives hands-on experience with transputers is likely to be pretty expensive for the foreseeable future. Also, training systems and development systems do not sell in the same sort of numbers as home and business microcomputers. This inevitably makes them less good value for money. I have no doubt that most PE readers could have great fun using this system, but at this price I do not know how many will have the funds to buy one.

While the high price takes the system beyond the reach of all but the richest of electronics hobbyists, it will no doubt still appeal to companies and educational establishments. The system is unusable without an IBM PC or compatible, but presumably most companies and educational establishments will have a suitable computer available. As a transputer training system this Flight Electronics system succeeds quite well, and is certainly worthy of recommendation to organisations that can justify this sort of monetary outlay.

PE

Newsagent Order Form

Dear Newsagent, I like reading Practical Electronics magazine. Please deliver/save one copy each month until further notice.

My name is

Address

.....

Do not miss a single issue of PE! Make a firm order with your Newsagent!



Newsagent

MAKING ELECTRONICS C.A.D. AFFORDABLE

EASY-PC

PCB CAD, FOR THE PC/XT/AT

TINY-PC

- Are you still using tapes and a light box?
- Have you been putting off buying PCB CAD software?
- Have you access to an IBM PC/XT/AT or clone inc Amstrad 1640 & 1512
- Would you like to be able to produce PCB layouts up to 17" square?
- With up to 8 track layers and 2 silk screen layers?
- Plus drill template and solder resist?
- With up to eight different track widths anywhere in the range .002 to .531"
- With up to 16 different pad sizes from the same range?
- With pad shapes including round, oval, square, with or without hole and edge connector fingers?
- With up to 1500 IC's per board, from up to 100 different outlines?
- With auto repeat on tracks or other features – ideal for memory planes?
- That can be used for surface mount components?
- With the ability to locate components and pads on grid or to .002" resolution?
- With an optional auto via facility for multilayer boards?
- With the ability to create and save your own symbols?
- That can be used with either cursor keys or mouse?
- That is as good at circuit diagrams as it is a PCB's?
- That outputs to Dot Matrix Printer, Pen-Plotter or photo-plotter (via bureaux)?
- Where you can learn how to use it in around an hour?
- That only costs from £49 inc. VAT.

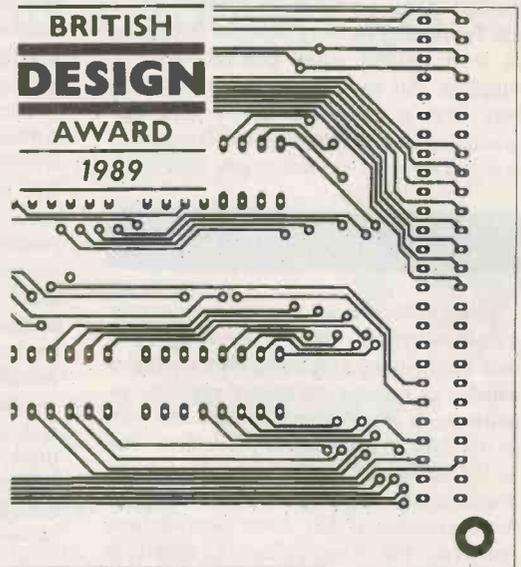

Excellent quality from dot matrix printer

SMITH CHART PROGRAM –

Z-MATCH

For IBM, PC/XT/AT and clones inc. Amstrad 1512 and 1640 and BBC B, B+ and Master.

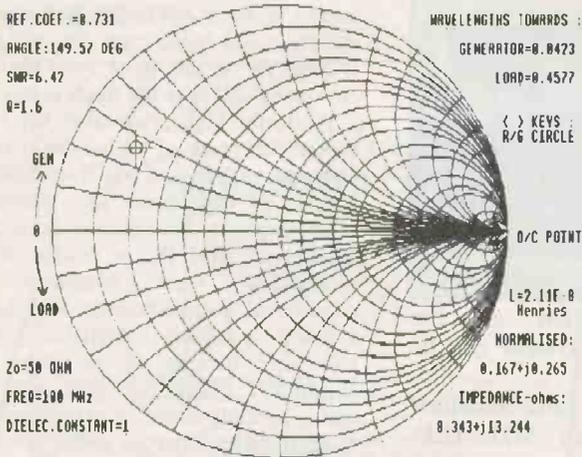

Z-MATCH – Takes the drudgery out of R.F. matching problems. Includes many more features than the standard Smith Chart. Provides solutions to problems such as TRANSMISSION LINE MATCHING for AERIALS and RF AMPLIFIERS with TRANSMISSION LINE TRANSFORMER and STUB MATCHING methods using COAXIAL LINES MICROSTRIP, STRIPLINE and WAVEGUIDES. The program takes account of TRANSMISSION LINE LOSS, DIELECTRIC CONSTANT, VELOCITY FACTOR and FREQUENCY. Z-MATCH is supplied with a COMPREHENSIVE USER MANUAL which contains a range of WORKED EXAMPLES

£130 for PC/XT/AT etc
£65.00 for BBC B, B+ and Master

CIRCUIT ANALYSIS BY COMPUTER – ANALYSER II

For IBM, PC/XT/AT and clones inc. Amstrad 1512, 1640, R.M. NIMBUS, and BBC B, B+, and Master.

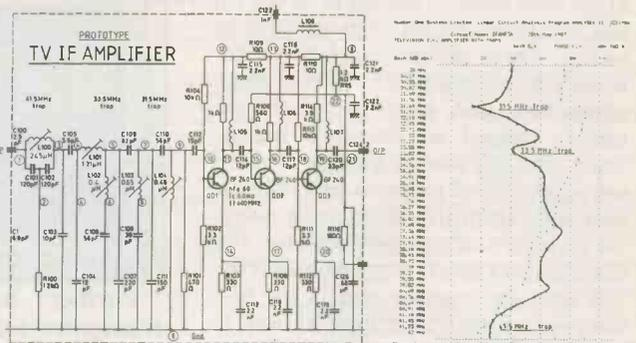

"ANALYSER II" – Analyses complex circuits for GAIN, PHASE, INPUT IMPEDANCE, OUTPUT IMPEDANCE and GROUP DELAY over a very wide frequency range. Ideal for the analysis of ACTIVE and PASSIVE FILTER CIRCUITS, AUDIO AMPLIFIERS, LOUDSPEAKER CROSS-OVER NETWORKS, WIDE-BAND AMPLIFIERS, TUNED R.F. AMPLIFIERS, AERIAL MATCHING NETWORKS, TV I.F. and CHROMA FILTER CIRCUITS, LINEAR INTEGRATED CIRCUITS etc. STABILITY CRITERIA and OSCILLATOR CIRCUITS can be evaluated by "breaking the loop". Can save days breadboarding and thousands of pounds worth of equipment.

£195 for PC/XT/AT etc.
£130 for BBC B, B+ and Master

All prices Ex-VAT
WRITE OR PHONE FOR FULL DETAILS:- REF PE

Number One Systems Ltd



Harding Way, St Ives, Huntingdon Cambs, PE17 4WR
Tel: St Ives (0480) 61778 (4 lines)
We provide full after-sales support with free telephone 'hotline help' service.
Software updates are free within 6 months of purchase date.



The lament has been loud and clear: "Why, dear Editor, why did Mullard/Philips kick the bucket brigade delay line chips TDA1022 and TDA1097 from their repertoire? Can't you produce an echo-delay unit that uses alternative chips?"

Even before my Editorial comment in PE August 88 bemoaning the loss of these delay chips, readers were asking why they had become scarce and what could replace them. My reply was to the effect that more than one manufacturer had deleted bbd chips from the production lines, but at least Panasonic had retained their series of MN3004, MN3008 and MN3011. Since my reply, the cries for PE's help have fairly reverberated my ear drums. So, by popular request, herewith a new echo unit!

REPEATING OPTIONS

Being a great believer in giving value for money, I've made you an offer you'll find hard to refuse. The design to be described here is far more than just an echo

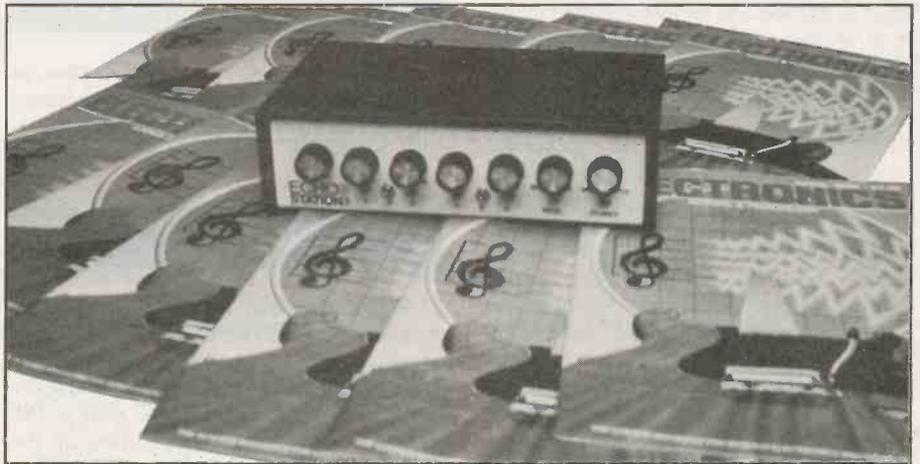

Jan 85, as well as Robert Penfold's discussion in his Signal Processing article of July 87, (and who haven't been eavesdropping elsewhere!) here's a quick mini tutorial on bbd principles and the delayed nature of life with the bucket brigade. Those who've graduated through previous lectures can fast-wind down to "DELAY CIRCUITS".

and low logic levels that are clocked through, but discrete voltage levels. The logic switches are replaced by capacitors, and at each clock pulse each capacitor takes on the charge level of an adjacent capacitor. The name 'bucket brigade' has been coined for such devices since the principle is supposedly analogous to the pre-tech fire-fighting method in which buckets of water

MONO-STEREO ECHO STATION

unit. With a bit of judicious sleight of hand I've added a few more lines and symbols to the circuit diagram so that the unit can produce nearly the full range of echo-related effects possible with delay chips. More than that, it can be used for both mono and stereo input signals.

The line up of controlled options consists of echo, reverberation, double tracking, phasing, flanging, chorus, vibrato and a delayed signal independent from the original signal. I'm additionally (is there no end to my good-heartedness?) offering you a choice of which delay chip you can use, depending on the status of your cash-flow criteria.

CHIP CHOICE

The choice of delay chips open to you is either the MN3004 or the MN3011. The former offers 512 internal delay stages in a single block, whereas the latter has 3328 stages split into six combinatory blocks. Not unexpectedly, the MN3011 is the more expensive. But I reckon you'll find it hard to resist the enticement of the extra stages. Even if you do resist, though, you'll undoubtedly find a lot of satisfaction from using the shorter delay chip. I'll tell you about the actual echo and reverb times later.

For those of you who missed my Echo-Reverb and Chorus units of PE Aug 84 and

BY JOHN BECKER

**By popular request,
here's a new multi-
function echo unit using
Panasonic
delay chips.**

SHIFTING BUCKETS

You've probably heard of shift registers. These are normally associated with digital electronics and consist of a number of electronic switches coupled in series and connected to a clocking oscillator. At each clock pulse each switch becomes set to the same on or off state as the one before it, except for the first switch which takes on the logic state of the input line. The output is taken from the final switch. If the shift register has 16 switches, then it takes sixteen clock pulses to pass a single input bit to the output. The longer the series of switches, or the slower the clocking rate, so the delay between input and output becomes greater.

A bucket brigade device works in a somewhat similar fashion to the shift register, except that it is not clean-cut high

were passed along a chain of people, from the pond to the pyrotechnics! Personally, I don't think it's a totally representative analogy - with bbd devices the charge on each capacitor is effectively tipped into the following capacitor. Bucket-brigade firemen don't normally go tipping their buckets of water into each other's buckets! However, the term is now part of the language, so I'll have to live with it ...

In reality, with a bbd, capacitor A does not transfer its contents to capacitor B while B is still transferring to C. To continue the analogy, you can't add your bucket of water to the next man's until he has passed on his, or at any rate, not without loss of load! Instead, a buffer bucket/capacitor is used but, contrary to what you might expect after the previous statement, the buffer starts off full.

Imagine five buckets, 1, 2, 3, 4, 5. Buckets 1, 3 and 5 are partially empty, 2 and 4 are full. On the first clock pulse 2 fills 1, 4 fills 3. The charge remaining in 2 is equal to the charge originally in 1, and similarly with 4 and 3. On the second pulse, 3 fills 2, and 5 fills 4. On the next pulse, the cycle starts over again. Although the buckets are emptying from right to left (5 through to 1), the residual charge quantity is moving from left to right (1 to 5).

For this operation, two antiphase clock signals are needed, one controlling odd numbered capacitors, the other controlling even numbered capacitors.

The original charge was sampled at the input to the bbd and represented the voltage level of the audio signal at that moment. The next sample will also represent the audio signal level at the next moment, and will quite likely be a different level. Consequently, the chain of successive sample levels will move along through the bbd to its output, at which point the overall waveform will be equivalent to the original sampled waveform, albeit delayed by the number and rate of the clock pulses required to pass it through. Although the basic wave shape will be the same, there will be a minor, but significant, change since the shape is made up of a series of discrete steps, corresponding to the sample points. These must be smoothed out by a filter to restore the signal as near as possible to its original shape.

Having delayed the output signal with regard to the original, we can do a variety of things with it, such as use it on its own, feed it back to the start of the delay loop, or mix it with the original. We can also constantly vary the delay time by modulating the clocking rate. Depending on which combination of options we choose, so we can produce a range of different effects. Let's examine the major ones.

STRAIGHT DELAY

One useful function for simply delaying a signal is that the technique can be used to help eliminate feedback howl between a microphone and loudspeaker. If the delay is of such a length that there is a phase difference between the original signal and that arriving back at the mic from the speaker, the returning signal will not reinforce the original, successively increasing its amplitude until feedback saturation is reached. The best delay to shift the phase will vary with the acoustics of the room and the distance between the speaker and the mic, and should be found by trial and error.

DOUBLE TRACKING

This makes one sound become two. You simply mix the delayed signal with the original, and listen to the combined output. The delay time required is usually quite a short one, and the levels of the two signals should be roughly equal.

REVERBERATION

For reverb the delayed signal is fed back into the delay chain, but at a level slightly lower than that which comes from the delay output. Too much feedback level will cause the system to go into perpetual howl. The art is to allow the signal to decay slightly each time round the delay loop. It is usual, though not vital, to mix the reverb signal with the original at the final output and listen to the composite. Short delay times are best for reverb.

ECHO

This is produced in the same fashion as reverb, except that much longer delay times are used so that even short individual words can be heard repeating at diminishing levels.

PHASING

Due to the delay time, the phase of the delayed signal will normally be shifted with regard to the original. The amount of phase shift will depend on the signal frequency and the length of delay. If the shift is 180 degrees, mixing equal quantities of the original and delayed signals will result in mutual cancellation. If the shift is 360 degrees, adding equal quantities of each will double the amplitude. If we constantly vary the delay period, the phase shift for a particular frequency will likewise vary in response. The combined signal amplitude will thus similarly vary in amplitude. With signals consisting of multiple frequencies, as with music for example, each frequency will be subjected to a different phase shift. Consequently, different regions of the signal will be given varying amounts of cancellation or enhancement, producing the phasing effect with which we have become familiar. The best effects are produced with signals that have a harsher quality to them; those that are close to sinusoidal in shape will not produce such dramatic effects.

(The most pronounced phasing effects are often produced by also introducing variable filtering characteristics, though this technique is not offered here. See my *Filter-Shift Phaser* of PE Oct 84 if you're interested in the technique.)

To repeatedly vary the delay time, and thus the phase shift, a low frequency oscillator is used to vary the rate of the master clocking oscillator. The modulation rate is usually set for a period of several seconds.

FLANGING

Flanging is produced in the same way as that used for phasing, except that we also feed back some of the signal through the delay line. In other words, we add reverb to it. For the most interesting sounds, the reverb feedback is set just below the level at which howl occurs. As with phasing, the modulation rate should be very slow.

CHORUS

This is another variation on the phasing technique, but for this the modulation rate is much faster, usually at about 6Hz, though faster rates can be used. With this modulation rate, the effect sounds as though the voice or instrument quantity has been multiplied many times over. It's an ideal technique to use for making a small

group of instruments sound like an orchestra! It's necessary to mix the modulated signal with the original.

VIBRATO

For this effect, the delayed signal is used on its own without being mixed with the original. The delay rate is modulated at about 6Hz. The constant speeding up and slowing down of the signal as it passes through the delay line results in an apparent shift of the signal frequency. The modulation depth is usually set so that the frequency shift is about one third of a tone for the middle octave. Since each note will be subjected to an apparently slightly different frequency shift, the result is less precise than would be produced by a professional musician on a manually tuned instrument.

DELAY CIRCUITS

On previous delay-type circuits I have used a variety of analogue and digital techniques for producing the clocking oscillator. This time, though, I am making use of Panasonic's MN3101 purpose-designed delay line clock chip, the pin-outs and block functions for which are shown in Fig.1.

As you will see in Fig.1b, the frequency generator is based on the conventional twin-inverting gate technique. C1 is the frequency range controlling capacitor, and R2 sets the particular frequency within that range. By varying the value of R2, so we can vary the clock rate. We could replace R2 by a potentiometer to provide panel control of the delay rate, or we can substitute a field effect transistor and control the resistive drop across it by means

Fig.1. MN3101 block functions and internal oscillator circuit.

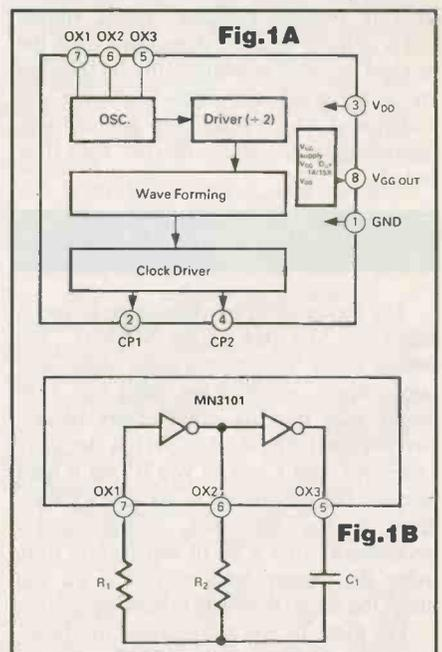

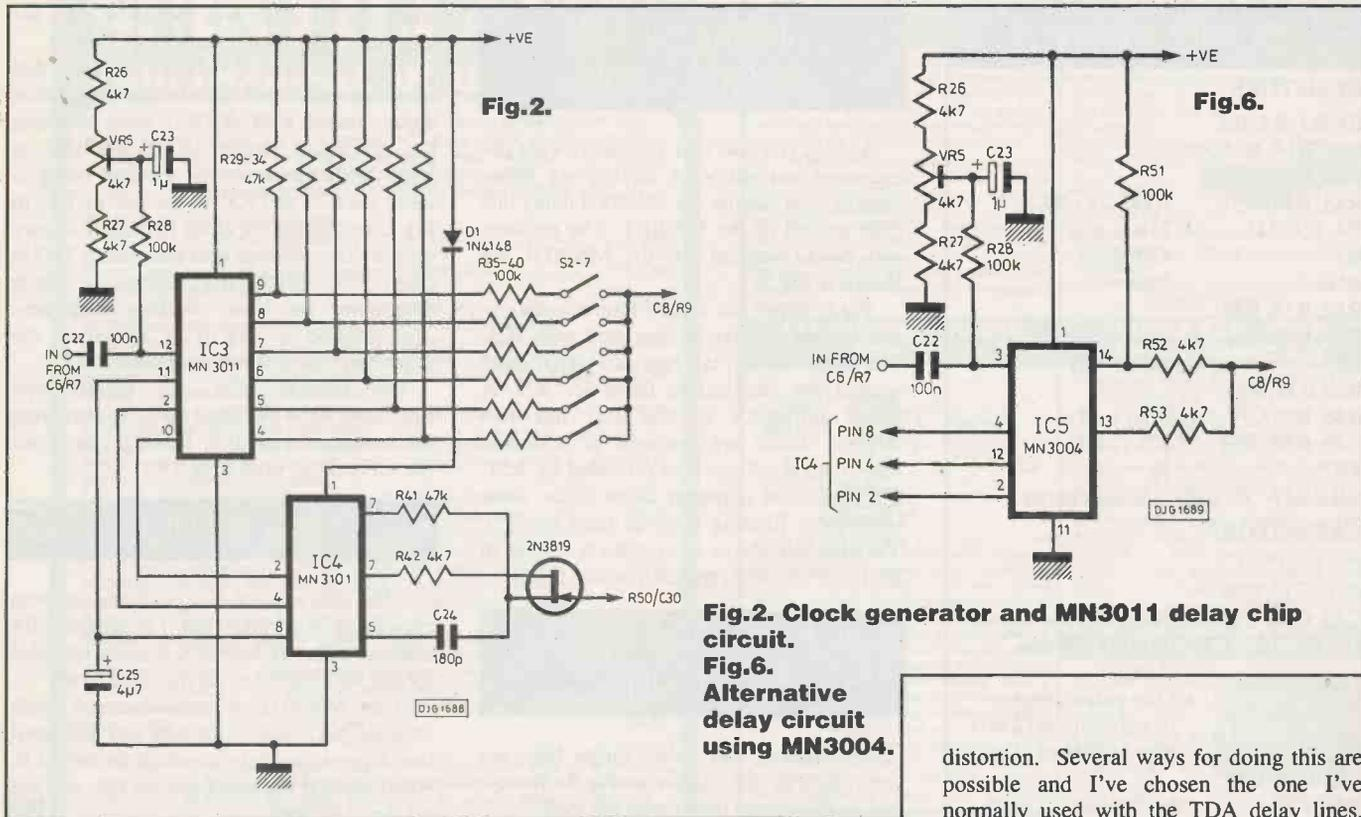

of the bias applied to its gate. In Fig 2, the MN3101 clock chip is represented by IC4, and you will see that I am using the fet technique, TR2, to control the clock rate. More on that in a moment.

Pins 2 and 4 of IC4 are the antiphase clock outputs which are fed to the delay line chip itself, IC3. It doesn't matter which clock line goes to which clock input.

With the now-obsolete TDA1022 and TDA1097 devices, a series of resistors were used to set the required tail bias. The bias for the MN3011 chip, though, is supplied directly by IC4, from its pin 8.

MULTIPLE DELAY CHIP

Audio signals are brought into IC3 at pin 12 via C22. A second bias level is required at this point, and requires adjustment to minimise waveform

Fig. 2. Clock generator and MN3011 delay chip circuit.
Fig. 6. Alternative delay circuit using MN3004.

distortion. Several ways for doing this are possible and I've chosen the one I've normally used with the TDA delay lines. This comprises the circuit around VR5, adjustment of the pot presetting the bias voltage.

The pin-outs and internal block diagram for the MN3011 are shown in Figs.3 and 4. Each of the six delay outputs require a pull-up resistor, represented in Fig.2 as R29 to R34. They are then taken via R35-R40 and S2-S7 to a mixer/filter stage that will be described later. The switches can be used in any order or combination. You can thus individually select a chosen output delay, or combine several output delays together. The latter option allows not only for normal double-tracking, as referred to above, but multiple-tracking of up to seven differently delayed tracks. This has further significant implications to the types of sound produced with all other main effects options of reverb, flanging, chorus, and so on.

The chip typically introduces no insertion loss of signal amplitude, though individual samples could show a change of around ± 4 dB.

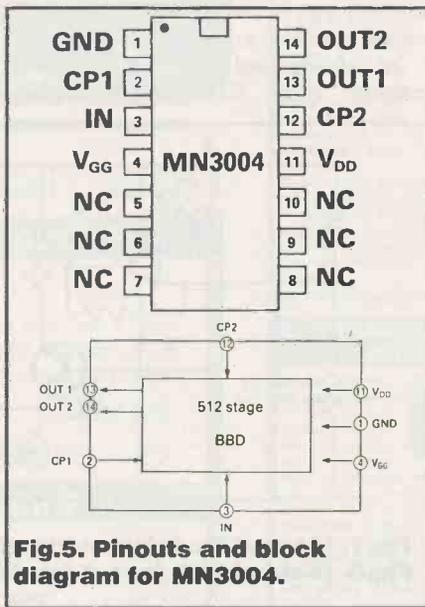
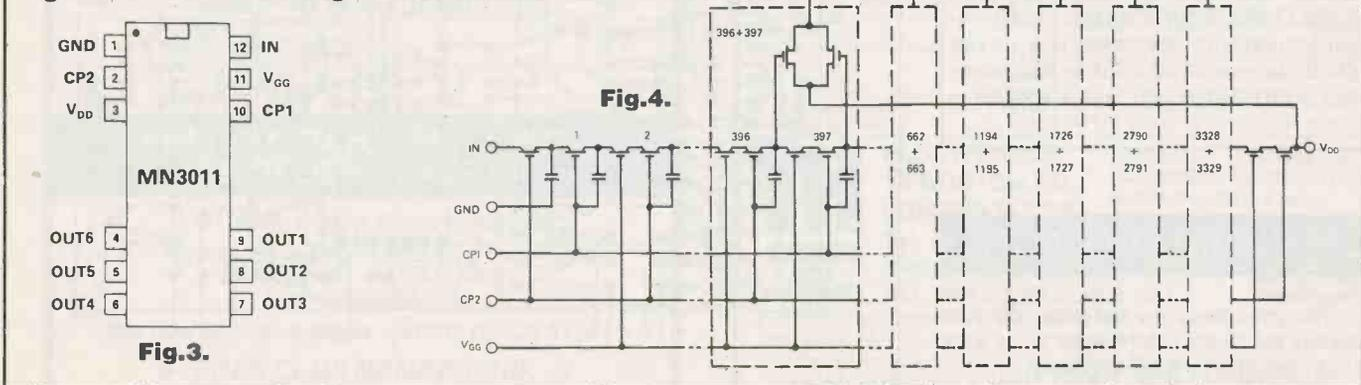

Fig. 3. Pinouts for MN3011.

Fig. 4. Internal block diagram for MN3011.





COMPONENTS

RESISTORS

- R1-R3, R5, R6, R11, R14, R16-R25, R28, R35-R40, R43, R44, R51 100k (27 off)
- R4, R9, R15 75k (3 off)
- R7 470 ohms
- R10 200k
- R12, R13, R26, R27, R42, R52, R53 4k7 (7 off)
- R29-R34, R41, R46, R48 47k (9 off)
- R45, R49, R50 10k (2 off)
- R47 1k

All 0.25W 5% carbon film or better.

CAPACITORS

- C1, C2, C5, C6, C10, C17, C20, C22, C26, C30 100n polyester (10 off)
- C3, C9, C12, C24 180p polystyrene (4 off)
- C4 330p polystyrene
- C7, C8 1n polystyrene (2 off)
- C11, C21, C31 22µ 16V elect (3 off)
- C13-C16, C18, C19, C23 1µ 16V elect (7 off)
- C25, C27 4µ 7 16V elect (2 off)
- C28, C29 470µ 25V elect (2 off)

POTENTIOMETERS

- VR1, VR6 1M lin mono rotary (2 off)
- VR2 25k lin mono rotary
- VR3, VR4, VR8 100k log mono rotary (3 off)
- VR5 5k skeleton preset
- VR7 100k skeleton preset
- VR9 10k log mono rotary
- VR10 10k skeleton preset

SEMICONDUCTORS

- D1 1N4148
- TR1 BC549
- TR2 2N3819
- IC1 LM324
- IC2, IC6 741
- IC3 MN3011 (see text)
- IC4 MN3101
- IC5 MN3004 (see text)

SWITCHES

- S1-S8 min spdt toggle (8 off)

MISCELLANEOUS

Printed circuit board pair, pcb clips (8 off), knobs (7 off), 8-pin ic sockets (5 off), 14-pin ic sockets (2 off), stereo jack sockets (2 off), box size 9 x 5 x 2.5 inches, rubber feet (4 off), battery clip, wire and solder to suit.

SINGLE DELAY BLOCK CHIP

Should you feel that you don't want the enhanced versatility of having six delay outputs, you can use the MN3004 delay line chip instead of the MN3011. The pin-outs and block diagram for the MN3004 are shown in Fig.5.

Fig.6 shows the circuit implementation, and is very similar to that used with IC3. The clock signals, tail bias and signal input section are identical to those for IC3. A minor difference is that IC5 has two outputs. These are summed at R52 and R53, with a pull-up bias provided by R51. The combined output is taken to the same subsequent filtering stage as used for IC3. The chip introduces an amplitude change in the range of ±4dB, typically about 1.5dB.

MODULATION CIRCUIT

Modulation and delay range bias are controlled by the circuit in Fig.7. There's less to this circuit than meets the eye!

IC6 is configured as a squarewave oscillator with its rate set by VR6. We don't use the squarewave, though, instead we are a bit sneaky and use the waveform generated across C27. This is roughly

triangular in shape and so can be used for smoothly varying the main clock rate.

The waveform is buffered by TR1, and taken via VR7 and C28 to the modulation depth control VR8. VR7 is there to preset the maximum output swing available at VR8. With S8 closed the varying swing is taken via C29 and R50 to the gate of TR2 in Fig.2, so causing the clock frequency to vary up and down. The dc bias controlling TR2 is taken from VR9, the setting of which determines the basic clocking frequency. The purpose of VR10 is to preset the minimum bias that can be applied to TR2.

For normal echo and reverb type functions, S8 is switched open, so removing the modulation control, leaving you to set the static delay time with VR9.

DELAY PCB

The delay board has positions for both choices of delay chip, but it is intended for use with *either* IC3 or IC5. It is not intended for use with them both at the same time.

The MN3011 is manufactured with unusual pin connections and you will need two 6-pin ic sockets in which to mount it. Alternatively, use two 8-pin sockets and cut off the extra legs. **PL**

Next month we conclude with the interface circuit and setting up.

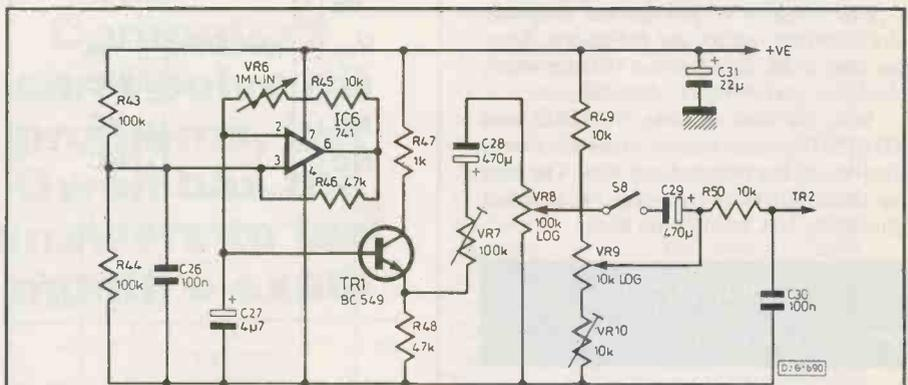
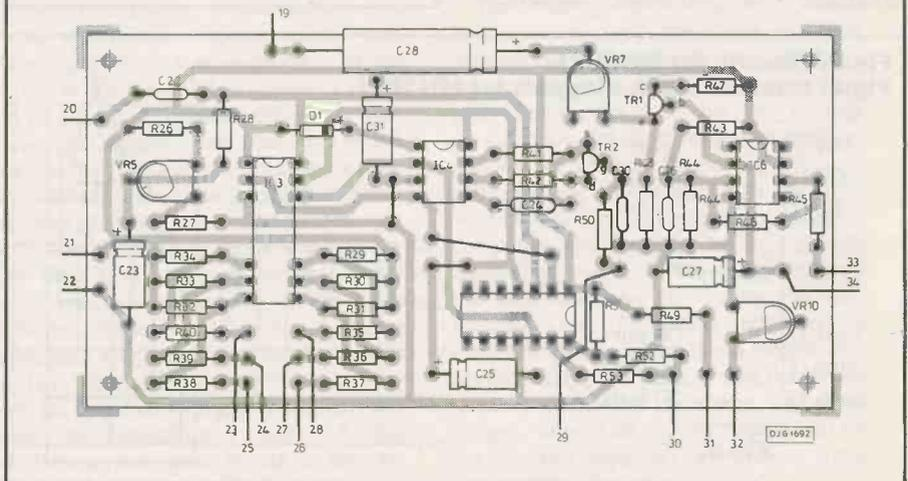

Fig. 7. (Above) Modulation circuit.

Fig. 8. (Below) PCB layout for delay and modulation circuits.



ACKNOWLEDGEMENT

The pin connection and block diagram circuits for all three MN series chips were kindly supplied by RS Components.

BECAUSE
I LIKE IT

Dear Ed,

I have been an avid reader of PE for as long as I can remember. I still recall sitting in bed one night, with an early edition of PE (was it Dec 68?) and learning all the circuit symbols (as they were then!). Over the years I have seen other magazines come and go, each purporting to supply electronic enthusiasts with what they need to know about electronics, but I have avidly stuck with PE - because I like it!

I used to subscribe to Practical Wireless, because it was a general electronics magazine, but when it specialised in amateur radio I found it did not give me what I was seeking. This was a pity as I have some early "Camm's Comics" in my collection, older than I am!

Originally I used to take PE, PW, PT (later Television) and EE (when it first came out), mostly for the constructional articles. As my tastes developed, and I learned more about electronics (at school, and later at Polytechnic) I culled this down to PE and PW, buying mostly for the adverts! Unfortunately the days of Doram and Home Radio are long passed, and "The Smiths" seem to have left Edgware Road, along with a few other suppliers.

Consequently fewer firms are advertising components, and most bits are now only obtainable via catalogues (possibly because people are trying to reduce their advertising costs). Fortunately PE has expanded the General Interest articles, so although I really only buy PE for the adverts, I also find it a very good read, and often find that I have much to learn from the constructional projects.

I fully applaud your Easi-build series and look forward to many articles in the series. It will be interesting to see how this series develops, and to what cost ceiling it extends.

As praise is no useful criticism I would just like to say, in closing, that the only part of your magazine that I would slightly criticise is the "clever" play on words accompanying the article titles (and I bet it takes you ages to think them up!).

Please rest assured that I for one will continue to subscribe to PE, especially as it seems to be evolving just as my tastes are!

John Rendall BSc (Hons)
Wyken, Coventry.

**If you have any comments,
criticisms or suggestions,
write and let us know.
We are interested in what
you think and say.**

One of the interesting facts to come from our recent survey is just how many people have been long term devotees of PE. Many of these will remember with affection the reference to "Camm's Comics" - a reference to Frederick (?) Camm who, I believe, started the ball rolling by introducing wireless-orientated magazines for home constructors. (Some day I must track down the full story behind the reference.) His initiative resulted in the eventual arrival of PE, EE, PW and PT, all of which at one time were sister magazines, though we each go our independent ways now.

Yes, over the years many once-familiar trading names have gone. Some because people simply retired, others because they found the recent recession too destructive, and some because their interests have taken them into different fields. But a lot of new names have come onto the scene and a very healthy marketplace exists with an excellent selection of good suppliers around. It will pay any reader to spend a few stamps and obtain catalogues from our advertisers and so have an enormous variety of components and other products readily accessible. The stack of catalogues I have from our advertisers measures about two feet high - too much to fit into PE each month!

Many readers are pleased with our introduction of the Easi-build project series. In designing them I shall continue to have regard for their simplicity, low cost, and ready availability of components.

In claiming responsibility for the frequent word plays, I must also honour my assistant editor, Helen, whose sense of word and phrase relationships is equally prolific to my own! Electronics is a serious subject, but it doesn't mean that we have to be totally serious in everything. Playing around with a few puns and conundrums is just another way to keep investigative minds alert to different ways of looking at things.

Ed

ENCRYPTION
SOFTWARE

Dear Sir,

I have read with interest the article in PE July 89 entitled *Encryption* and found it highly interesting, and a good introduction to the subject.

Having been involved with cryptology for some years, I thought you and the author of the article may be interested in a collection of encryption programs that I have developed for use with the IBM PC.

The programs are grouped together under the name 'Iris' and provide access to some sophisticated cryptographic techniques. I have released this software into 'Shareware' recently, and feel that your readers may be interested in using such software.

Iris is available from the leading Shareware suppliers, such as the Public Domain Software Library (PDSL), and directly from myself.

If any of your readers would like to obtain the latest copy, then they can write to me enclosing £5.00 plus £1.00 p&p, at Digital Crypto, PO Box 1, Penarth, South Glamorgan, CF6 2WB.

Peter S. Moreton, Penarth.

*Many thanks for the offer,
and for the disk you sent me.
Fascinating!*

Ed

ENCRYPTION
HARDWARE

Dear Ed,

The *Encryption* articles in PE July and August greatly interested me. I was additionally intrigued by the illustrative cover of the July issue.

You showed an artist's

impression of four related circular objects. Obviously they were all representing aspects of cryptology. The one at the top appears to be a silicon disc comprising many chips, and must represent the solid state microprocessing aspect of cryptology. The next disc is then a reel of computer tape, as used for a similar purpose. Thirdly, the disc with pointers, is the Wheatstone encryption disc as mentioned in the text on page 21. But, try as I might I cannot decide what the bottom disc shows, though it's obviously some ancient coded disc of some sort. Please enlighten me!

Jim Stevens, Salisbury, Wilts.

*Quite right on the first three.
The last one is the famous
Phaestos Disc.*

Phaestos is the site of an ancient Minoan palace in south central Crete dating back to around 1900 BC and excavated at the turn of this century. The Minoans, you may recall are particularly remembered for their labyrinths, their worship of bulls, and for the myth of the Minotaur, a creature half bull and half man.

The best known finds from the excavation are a superb series of Kamares ware vases, and for the intriguing Phaestos Disc. This is a unique clay disc of about six inches in diameter with stamped inscriptions in a spiral on each face. Although scholars believe the symbols hint at Anatolian origin, no one has yet succeeded in deciphering them.

When thinking up the illustration for the July cover, I was firstly tempted to use the Rosetta stone image, since this enabled archeologists to start deciphering Ancient Egyptian hieroglyphics. The Phaestos disc, though, seemed more appropriate since it is circular, in keeping with the other images, and because it remains an encryption mystery - despite all our modern computerised ciphering and deciphering techniques.

Your mystery is solved, but not that of the Phaestos disc. Perhaps it's just a route map to the centre of a labyrinth, or simply means "Beware the Bull!"

Ed

Originally, the general title to this series of simple projects was to be the *Quick-Chip Series*. The name was changed, though, to *Easi-Build* since the former title implied that each project would be designed around just a single integrated circuit. Upon consideration, I found that concept to be too limiting. Nevertheless, the philosophy behind the series is that, where possible, only one or two chips should be used. With the project I have for you this month, I stick to the original concept, and use just one ic, the LM324.

REMOTE CONTROL

The intention of this month's design is to show you one way in which simple remote control of a device can be accomplished without any interlinking wiring. In this instance we simply use sound as the linking medium, using it to activate a relay, which in turn can be used to turn another device on or off.

**You only need
two hands
to build this handy
unit that turns
your voice into a
third hand!**

microphone. Other mics can be used so long as their signal strength is sufficient to trigger the envelope stage. However, with the amount of gain available across the two stages of IC1a and IC1b, I've had the unit working with all my mics, ranging from cheap crystal ones to expensive magnetic types, and at a distance of several feet.

of R11, R12 and C10, restrict the lower frequency end. If the unit is to be used in a very quiet atmosphere free from low frequency noise, the latter three components may be omitted. In the middle of the bandpass range, the gain is round about 100, as set by R4 and R5.

ENVELOPE DETECTION

In the absence of an input signal, the voltage on C6 will hold the comparator IC1c in a high output state, ensuring that C7 is charged. This in turn keeps the output of comparator IC1d low, so keeping the relay driver, TR1, turned off.

When a sufficiently strong input signal starts, the positive-going output from IC1b is passed through D2, causing IC1c to change to a low output state. C6 filters out the voice frequencies, leaving the basic speech envelope, with a decay rate set by R6 and R7.

VOICE OPERATED SWITCH

BY JOHN BECKER

GAIN AND FILTERING

Such a technique has far more applications than I would care list here, or indeed than I could even possibly think of. Applications could range from vocally activating a light switch should your hands be laden with goods, to automatically switching a radio transceiver between send and receive. But I am sure that you will have your own ideas on how to use it.

CIRCUIT SECTIONS

The circuit in Fig.1 consists of five main sections, signal input gain stage, simple bandpass filter, envelope extender, delay control, and relay driver stage.

Basically, the circuit is intended for use with a cheap high-output crystal

IC1a is the input stage at which you can control the gain from a panel mounted pot, VR1. With VR1 at minimum resistance, the gain is set at about times two, increasing to around times 100 at maximum resistance. C2 is there to cut out some of the higher frequencies to give a little bit of noise immunity.

Following IC1a, a further filter restricts the signal frequencies to those normally associated with speech. The value of C5 determines the top cut, and the combination

When IC1c goes low, C7 is almost instantaneously discharged via D3 and R8. The result is that IC1d changes its output state from low to high. The current now passing through R10 turns on TR1, which consequently turns on the relay coil. Within the voltage and current limitations of the relay contacts, you can switch on or off any electrically operated device.

When the input speech signal ceases, C6 will discharge, principally via R6, and when the voltage level falls below the reference level, IC1c will revert to its high output state. C7 will then charge up at a rate set by VR2. When that level passes the reference point, IC1d also reverts to its original state, TR1 is turned off, and so is the relay coil. The action of C8 gives a little bit of additional smoothing to the response time.

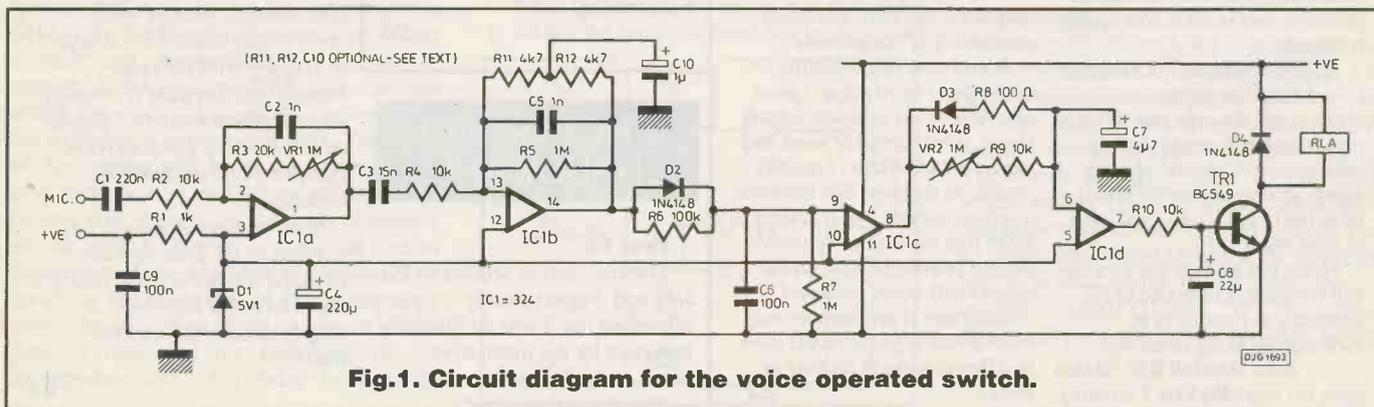

Fig.1. Circuit diagram for the voice operated switch.



REFERENCE AND TIMING

Zener diode D1 sets the reference level at about 5V. This method of setting the reference was found to be preferable to the more customary twin resistor potential divider, providing a greater degree of stability to the trigger points.

Although VR2 allows for a fairly wide range of delays to be set for the relay hold-on, you can modify this by changing the value of C7. It is most likely that you might wish to extend the hold-on time, in which case C7 may be increased, probably up to about 470µF.

DISCRETIONARY USE

You must obviously use discretion and common sense in determining where and how this unit is used. It will not, of course, on its own recognise the difference between noise and speech unless suitable precautions are taken. The unit can, as mentioned above, be operated at a distance of several feet, but in reality you should have the mic as close to you as is reasonable. This will enable the gain control to be kept down, inhibiting the detection of background noise. It is also recommended that the unit is only used in locations where the background noise is minimal.

The unit's switch-on response time is fast, typically around seven milliseconds, but for speech to trigger it this fast, it is preferable for your command word to start with a hard letter, such as D, G (as in "good"), K or T.

COMPONENTS

RESISTORS

R1	1k
R2, R4, R9, R10	10k (4 off)
R3	20k
R5, R7	1M (2 off)
R6	100k
R8	100 ohms
R11, R12	4k7 (2 off)
All 0.25W 5% carbon film	

CAPACITORS

C1	220n polyester
C2, C5	1n polystyrene (2 off)
C3	15n polyester
C4	220µF 16V elect
C6, C9	100n polyester (2 off)
C7	4.7µF 16V elect
C8	22µF 16V elect
C10	1µF 16V elect

SEMICONDUCTORS

D1	5V1 zener
D2-D4	1N4148 (3 off)
TR1	BC549
IC1	LM324

POTENTIOMETERS

VR1, VR2	1M lin mono rotary
----------	--------------------

MISCELLANEOUS

14-pin dil socket, 16-pin dil socket, spst toggle switch, dpco dil relay (see text), knobs (2 off), printed circuit board, box and connecting sockets to suit.

RELAY AND CONNECTIONS

I used a double pole changeover pcb mounting dil relay on my unit, having a rating of 125Vac at 1 amp on its switch contacts. You can equally well use other types of relay mounted off-board. The relay coil should be of the 12V variety. For mains switching, the relay I used is not suitable and you must choose one capable of handling at least 250Vac across its switch contacts.

Even though cb radio is largely out of favour now, I know there are many of you who still have active rigs. This unit is ideal for automatically switching the rig to transmit when you start speaking. When you stop speaking, it will then switch back to receive after the pause set by VR2. A typical example of cb socket wiring is shown, but note that some rigs may have different connections - consult your handbook on this one.

POWER SUPPLY

The unit will run off any dc power line between about 9V and 15V. Consequently, a 9V battery is a suitable source of power, or even the 13.5Vdc supply associated with many rigs.

PE

There'll be another interesting Easi-Build project for you in PE Dec 89.

Fig.2. Printed circuit board layout
Fig.3. Basic panel wiring.
Fig.4. Relay connections schematic
Fig.5. Alternative wiring for use with CBC4 type sockets.

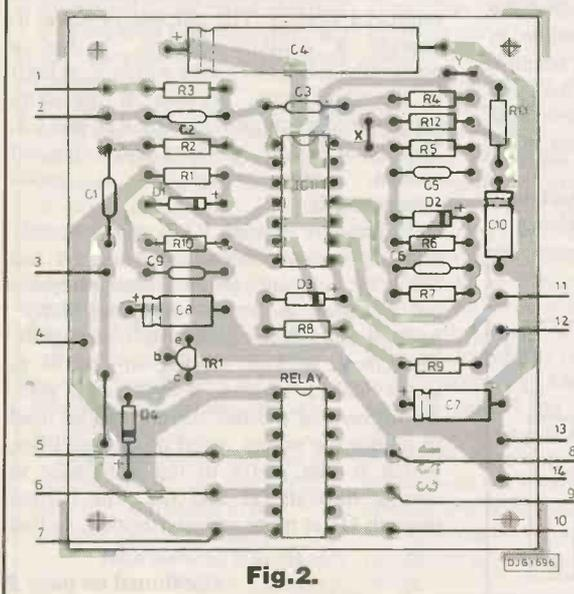

Fig.3.

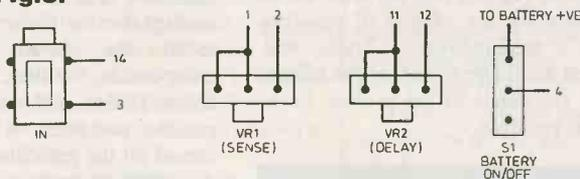

Fig.4.

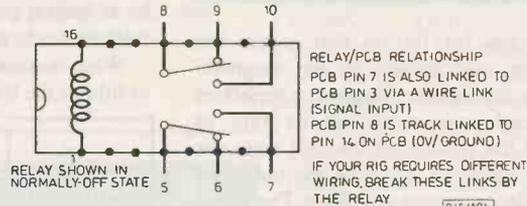
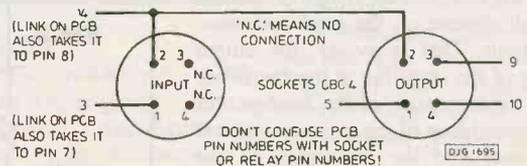

Fig.5.



This month we have an enquiry about the mosfet power amplifier featured in Part 7 (June 88) of my series on semiconductors. A reader says "I have purchased amplifier pcbs and, referring to Fig 1, would like to take the negative feedback directly from the loudspeaker terminal connected to L1. Would this work, or would it upset the stability of the circuit? I would also like to use solid state regulation before the output stage. I envisage two conventional adjustable 3-pin regulators respectively supplying Q1, Q2, and the Q3 network. What voltages are there at Q1 and Q2, and between R8 and R9?"

I will address the question of the negative feedback first. The one certain way to find out if it will work is to try it, because this will depend on the actual installation. If the feedback is taken from the end of a high resistance cable connected to a low impedance loudspeaker with a reactive crossover unit, the circuit could become unstable and the sound unpleasant. On the other hand, a short low resistance loudspeaker cable should cause few problems, though the sound could still end up worse if the crossover unit generates significant phase shift at higher frequencies. Of course, the negative end of C4 should be connected to the junction of Q5 and Q6 rather than to the feedback point.

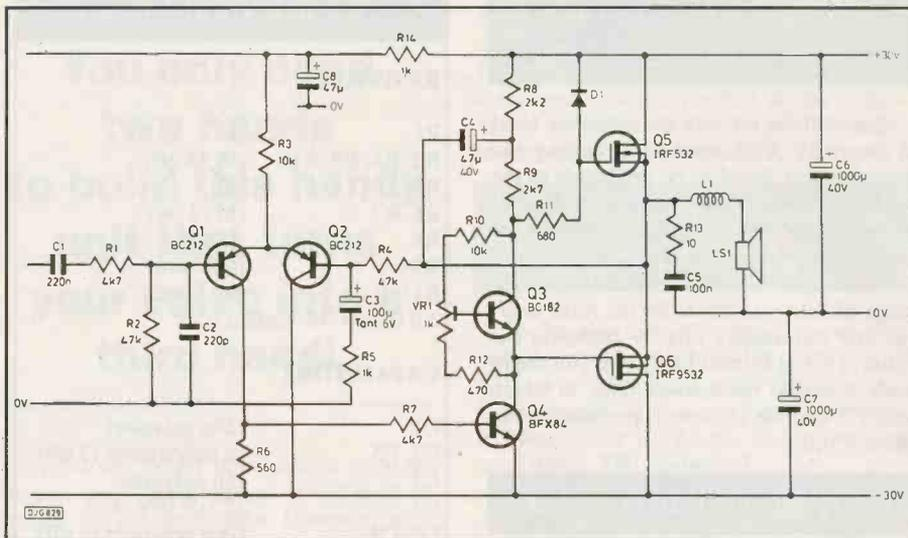

Fig.1. Circuit for a mosfet power amplifier, as shown in Fig.65. of PE June 1988

dominate the situation in most cases, because the coil must be light and hence must use thin wire.

There is a way to do this, and it can definitely improve the sound of smaller loudspeakers, though I have not tried it on anything large. Many years ago I constructed a system with the amplifiers mounted on the loudspeaker cabinets, and with a separate amplifier for treble and

"to its own thing", and make the bass sound cleaner. Too much feedback introduced a muddy sound once again, and I concluded that a little less feedback than the perceived optimum at the time of adjustment would ensure long term good performance. This technique is not magic, and cannot compensate for limp speaker cabinets and the like, but it does produce a marked improvement.

ASK PE

On the other hand, why do it anyway? If the resistive losses in the cable are tiny compared to the losses in the loudspeaker coil, which should be the case with a properly chosen cable, then the question arises as to whether any audible improvement is possible by altering the feedback point. All this can do, after all, is to compensate for the effects of resistive cable or terminations. The real improvement would be to cancel the effects of the total resistance in the system, or as much of it as possible.

DAMPING FACTOR

The reason for this is that, when the loudspeaker coil moves in the magnetic field of the loudspeaker magnet, it generates a back emf proportional to its rate of motion. If the motion of the coil does not match the electrical signal on the output of the amplifier, a current will flow. The effect of this current will be to try to correct the motion of the coil, and the magnitude of the current will depend on the total resistance on the circuit. That is to say, the output impedance of the amplifier at the frequency involved, the resistance of the loudspeaker cable, the resistance of the crossover unit if there is one, and the resistance of the loudspeaker coil. This latter is likely to

NUMBER TWO - IN WHICH ANDREW ARMSTRONG ANSWERS A QUESTION ON SPEAKER FEEDBACK

bass. This eliminated cable resistance and crossover resistance at a stroke. Current feedback was then taken from the bass loudspeaker as shown in Fig. 2. I do not recall the details of the stability components, but the circuit worked at up to about 150Hz without overall phase shifts causing problems. It was not possible to cancel all the resistance, of course, because the effective resistance including dynamic losses depends on frequency, and there must be at least a small positive resistance at all frequencies to avoid oscillation.

What this did do, however, was seriously to inhibit the bass loudspeaker's tendency to

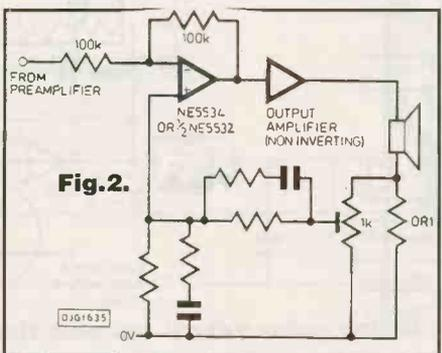

REGULATION

The idea of adding voltage regulation to earlier stages is presumably to minimise the effects of voltage variations imposed on the power supply by the varying load of the output stage. Regulating the voltage as such is not the best approach, but if R3 were changed for a constant current source the performance of the long tailed pair could be improved slightly. The purpose of R3 is to provide a constant current. It has a nominally constant voltage across it, at least in the short term, because of the extra supply decoupling provided by R14 and C8. This is not perfect, however, and a constant current source would be a useful improvement.

The current through R3 is approximately 3mA, split almost equally between Q1 and Q2. If the constant current source were used on its own it would dissipate 90mW, perhaps enough to cause it to drift slightly. The circuit of Fig. 3 using an LM334 in series with a resistor, should work well. Adjustment of the tail current can be used to reduce the output offset of the amplifier, which is due partly to the imbalance in current through Q1 and Q2. The current through Q1 is more or less constant, so that

Continued on page 39

SURVEILLANCE PROFESSIONAL QUALITY KITS

A range of high quality kits as supplied to leading UK security companies, all in-house designed and produced, not to be confused with cheap imports. All kits come fully documented with concise assembly and setting-up details, fibreglass PCB and all components. All transmitters are fully tuneable and can be monitored on a normal VHF radio or tuned higher for greater security. Build up service available if required.

MTX Micro Miniature audio transmitter. 17mm x 17mm. 9V operation. 1000m range	£12.95
VT500 Hi-power audio transmitter. 250mW output. 20mm x 40mm. 9-12V operation. 2-3000m range	£15.95
VOX75 Voice activated transmitter. Variable sensitivity. 30mm x 40mm. 9V operation. 1000m range	£18.95
CTX900 Sub-carrier scrambled audio transmitter. Cannot be monitored without decoder fitted to radio. 30mm x 40mm. 9V operation. 1000m range	£21.95
DSX900 Sub-carrier decoder unit for monitoring CTX900. Connects to radio earphone socket. Provides output for headphones. 35mm x 50mm. 9-12V operation	£21.95
HVX400 Mains powered audio transmitter. Connects directly to 240V AC supply. 30mm x 35mm. 500m range	£18.95
XT89 Crystal controlled audio transmitter. High performance. 100mW output. Supplied with xtal for 108MHz. Others available to 116MHz. 85mm x 28mm. 9V operation. 2-3000m range	£36.95
TKX900 Tracker/Beeper transmitter. Transmits continuous stream of audio pulses. Variable tone and rate. Powerful 200mW output. 63mm x 25mm. 9V operation. 2-3000m range	£21.95
ATR2 Micro size telephone recording interface. Connects between telephone line (anywhere) and cassette recorder. Tape switches automatically with use of phone. All conversations recorded. Powered from line. 10mm x 35mm	£12.95
TLX700 Micro Miniature telephone transmitter. Connects to line (anywhere) switches on and off with phone use. All conversations transmitted. 20mm x 20mm. Powered from line. 1000m range	£12.95
XML900 RF bug detector. Variable sensitivity. Triggers LED and beeper when in presence of RF field. Detects MTX 15-20 feet. 55mm x 55mm. 9V operation	£26.95
XL7000 Professional bug detector/locator. Variable sensitivity. Twin mode ten segment LED readout of signal strength with variable rate beeper. Second mode AUDIO CONFIRM distinguishes between localised bug transmission and normal legitimate signal such as pagers, cellular etc. 70mm x 100mm. 9V operation	£54.95

UK customers please send cheques, PO's or registered cash. Please add £1.50 per order for P&P. Goods despatched ASAP allowing for cheque clearance. Overseas customers send sterling bank draft or Eurocheque and add £5.00 per order for shipment. Credit card orders accepted on 0827 714476. Full catalogue available on receipt of 28p stamp. Trade enquiries welcome.



THE WORKSHOPS
95 MAIN ROAD, BAXTERLEY
Nr Atherstone. WARCS CV9 2LE



0827 714476

NATIONAL COMPONENT CLUB

SPECIAL OFFERS * SPECIAL OFFERS

SCANNER KIT(T)

A complete, six channel LED chaser kit for less than a fiver! The kit comes complete with all components, including PCB and instructions simple enough for even a complete novice. Works from 6-15vdc.

Only £4

MAINS POWER SUPPLY FOR ABOVE £1

* SPECIAL OFFER PACKS *

100	ASSORTED CAPACITORS	£1
30	ASSORTED TRANSISTORS	£1
25	ELECTROLYTIC CAPACITORS	£1
12	LED's (5mm red or green)	£1
5	555 TIMER IC's	£1
5	741 OP-AMPS	£1

FREE MYSTERY PACK WITH ALL ORDERS OVER £6

Please add £1 P&P, but do not add VAT.
P.O. or cheque to: NATIONAL COMPONENT CLUB, DEPT PE,
BAILEY HILL, CASTLE CARY,
SOMERSET BA7 7AD

We now accept Access - phone (0963) 51171

*** FREE CLUB MEMBERSHIP ***

Just phone above number or write for details

THREE SIMPLE CONSTRUCTION KITS

SOLID STATE RELAY BARGAIN

Especially aimed for the beginner. Have fun with your project even after you have built it and also learn a little from building it. These kits include high quality solder resist printed circuit boards, all electronic components (including speaker where used) and full construction instructions with circuit description.

SK1 DOOR CHIME - plays a tune when activated by a pushbutton **£3.90**
SK2 WHISTLE SWITCH - switches a relay on and off in response to whistle command **£3.90**
SK3 SOUND GENERATOR - produces FOUR different sounds, including police/ambulance/fire-engine siren and machine gun **£3.90**

SPECIAL OFFERS FOR SCHOOL AND TRAINING CENTRES - Contact Sales Office for discounts and samples.

*ZERO VOLTAGE SWITCHING- No radio interference problems.
 *2.5KV INPUT TO OUTPUT ISOLATION- No risk of damage to your computer or driver circuits.
 *4 KV TERMINALS TO HEAT-SINK ISOLATION- Simply bolt onto a heatsink.
 *3V to 32V INPUT VOLTAGE- easily interfaced to TTL or CMOS LOGIC.
 *24V to 240V rms LOAD VOLTAGE- allowing mains loads to be switched.
 *BUILT IN SNUBBER NETWORK- Enabling switching of inductive loads.
 *10A MAXIMUM CURRENT- 4A with no heatsink fitted at 40°C.

CD240/10 £2.25

ELECTRONIC GUARD DOG KIT

SUPER SENSITIVE FM MICROBUG KIT

One of the best deterrents to a burglar is a guard dog and this new kit provides the barking without the bite! The kit when assembled can be connected to a doorbell, pressure mat or any other intruder detector and will produce a random series of threatening barks making the would-be intruder think you have a guard dog and try his luck elsewhere. The kit is supplied complete with high quality PCB, mains transformer, all components and instructions. The kit even includes a horn speaker which is essential to produce the loud sound required. The "dog" can be adjusted to produce barks ranging from a Terrier to an Alsatian and contains circuitry to produce a random series of barks giving a more realistic effect. Don't delay, fit one before you go on holiday and let our dog help you guard your home.

Xk 125 Complete kit of parts £26.00

Highly sensitive FM transmitter measuring only 45 x 25 x 15mm, including the built-in microphone. Frequency 88-100MHz enabling reception on a standard domestic FM radio. Range approximately 300m depending on terrain. Powered by 9V PP3 (7mA). Its small size and highly sensitive electret microphone makes it ideal for surveillance, baby alarm, etc.

INTRODUCTORY PRICE £5.50

POWER STROBE KIT

MICROPROCESSOR TIMER KIT

Designed to produce a high intensity light pulse at a variable frequency of 1 to 15Hz, this kit also includes circuitry to trigger the light from an external voltage source (eg. a loudspeaker) via an opto isolator.

Instructions are also supplied on modifying the unit for manual triggering, as a slave flash in photographic applications or as a warning beacon in security applications. The kit includes a high quality pcb, components, connectors, SWs strobe tube and full assembly instructions. Supply: 240V ac. Size: 75x50x45.

XK 124 Stroboscopic Kit £15.00

Designed to control 4 outputs independently switching on and off at present times over a 7-day cycle. LED display of time and day, easily programmed via 20 way keyboard. Ideal for central heating control including different switching time for weekends. Battery back-up circuit. Includes box 18 time settings.

CT6000K £49.50
XK114 Relay kit for CT6000 includes PCB connectors and one relay. Will accept up to 4 relays 3A/240V c/o contacts £4.75
701 115 Additional relays £1.80

DISCO LIGHTING KITS

The DL1000K This value-for-money 4-way chaser features by-directional sequence and dimming. 1kW per channel **£21.00**
DL1 1000K - A lower cost uni-directional version of the above. Zero switching to reduce interference **£11.80**
DLA/1 Optional opto input allowing audio 'beat/light response **80p**
DL 3000K - 3-channel sound to light kit features zero voltage switching, automatic level control and built-in microphone. 1kW per channel **£17.00**

The DL8000K is an 8-way sequencer kit with built in opto-isolated sound to light input which comes complete with a pre-programmed EPROM containing EIGHTY - YES 80 different sequences including standard flashing and chase routines. The KIT includes full instructions and all components (even the PCB connectors) and requires only a box and a control knob to complete. Other features include manual sequence speed adjustment, zero voltage switching, LED mimic lamps and sound to light LED and a 300W output per channel. And the best thing about it is the price: **ONLY £34.60**

VERSATILE REMOTE CONTROL KIT

GIANT SOLAR CELLS

This kit includes all components (+ transformer) to make a sensitive IR receiver with 16 logic outputs (0-15V) which with suitable interface circuitry (relays, triacs, etc - details supplied) can be used to switch up to 16 items of equipment on or off remotely. The outputs may be latched (to the last received code) or momentary (on during transmission) by specifying the decoder IC and a 15V stabilised supply is available to power external circuits.

Supply: 240V AC or 15-24V DC at 10mA. Size (excluding transformer) 9 x 4 x 2 cms. The companion transmitter is the MK18 which operates from a 9V PP3 battery and gives a range of up to 60ft. Two keyboards are available MK9 (4-way) and MK10 (16-way), depending on the number of outputs to be used.

MK12 IR Receiver (incl. transformer) £17.00
MK 18 Transmitter £7.80
MK 9 4-Way Keyboard £2.40
MK 10 16-Way Keyboard £7.00
601 133 Box for Transmitter £2.60

NOW IN STOCK these giant size solar panels 12 x 12in will deliver 12 volts 200mA in bright sunlight and 11.5 volts 60mA on a typical British summer day (dull and over-cast). HUNDREDS OF USES in the car or caravan, e.g. Charging NiCads, powering low voltage circuits where mains or battery supplies are inconvenient or coupled to a lead acid battery and a simple inverter you could build yourself a self contained mains supply for low power appliances. Stock No. 303 145. **£14.50 (plus £2.00 for p&p on total order).**

ELECTRONICS
13 BOSTON RD.
LONDON W7 3SJ
Tel: 01 567 8910

SEND 9" x 6" SAE & 50p FOR CATALOGUE OR CALL AT SHOP Mon-Fri 9-5 pm Saturday 10-4 pm

ORDERING INFORMATION:
ALL PRICES EXCLUDE VAT

FREE P&P on orders over £50 (UK only), otherwise add £1 + VAT. Overseas P&P: Europe £3.50. Elsewhere £10. Send cheque/PO/ Barclaycard/Access No. with order. Giro No. 529314002.
LOCAL AUTHORITY AND EXPORT ORDERS WELCOME
GOODS BY RETURN SUBJECT TO AVAILABILITY

THE OTHER FACE

Just before we take a deep breath and look at the problems that computers bring, let us have an appreciative look at their benefits. The applications quoted above and other applications which we have not had space to include, may be summarised like this:

* **services** – banking, cash points, police records, medical records, medical diagnosis, intensive care units, library cataloguing, specialised databases (eg data on past legal cases for use by solicitors and barristers).

* **government** – tv licence records, DHSS records, DLV (vehicle licence) records, immigration records.

* **commerce** – point-of-sale (ie supermarket checkouts), buying from home (eg through Prestel, Telecom Gold etc), stock-keeping and re-ordering, word processing, payrolls, accounts, fax, airline reservations.

Unauthorised persons (or previous employees of the organisation) may be able to access the data, even to tamper with it. The data holder may agree to transfer the data to the computer of another organisation without the knowledge or permission of the individual.

It is to prevent abuses such as this that the Data Protection Act was brought into operation. The Data Protection Act is intended to ensure that people have access to their own personal data stored on computers by firms and individuals, and the right to complain if it is found to be incorrect. However, despite the Act, there still remains the feeling that somewhere there is someone who can obtain private and personal information (perhaps incorrect) about an individual and use that information to the individual's disadvantage. Some people feel that we are only a short step from the Big Brother type of society.

* **computer fraud** – there have been several instances of computer systems

* **information control** – control of information is a major key of power – military or commercial. The rich and already powerful nations have the computer technology to amass and analyse information on a scale never dreamed of hitherto. They can select what information is released and what is suppressed; they can distort and misrepresent the truth. This brings the danger that the poorer nations and other minorities will become even more dominated by the larger nations and the majorities. This point was discussed in some detail by Tom Ivald in PE July 1988. It is an aspect of the use of computers that is only now becoming apparent and to which we must become increasingly vigilant.

* **employment** – there must be many who have lost their jobs because a computer has taken it over. Employment opportunities in clerical work and many industrial assembly jobs have been reduced. This has caused distress and disillusion to many of those involved. But

DIGITAL ELECTRONICS

Part 12 – Conclusions

* **industry** – robots, computer-aided design, graphics, control of industrial processes, research and development.

* **computer assisted learning** – educational programs at school, in further education and in industrial training; flight simulators.

* **aid for the infirm and elderly** – a largely neglected field?

* **communications** – electronic mail, digital telecommunications.

* **home computers** – games, home accounts, word-processors, educational programs, communications (Prestel, Telecom Gold, bulletin boards).

* **domestic appliances** – washing machines, video recorders, watches and clocks, tv sets, teletext, Prestel terminal, video games.

* **administrative aids** – electronic diaries and 'organisers', decision-making systems.

* **aerospace** – air navigation, aeroplane control systems, satellite information processing, spacecraft navigation and control.

Most of these applications of computers can be said to be of benefit, either to the individual or to society as a whole. But there are aspects of computer use that do not necessarily bring good to all:

* **privacy is threatened** – details of an individual are held in many data banks – employers, banks, credit card companies (including department stores), DHSS, tv licences, book clubs – maybe the local tennis club. This is reasonable as long as the data is correct and remains confidential. But this is not easy to ensure.

BY OWEN BISHOP

Computers can't solve all problems, but Owen has the answers to last month's exam

being broken into, either with the aim of altering data or for financial gain. In many ways this is no different from ordinary robbery but, with computers, the results can be more serious. A bank robber or a person who falsifies documents may well leave clues which lead to bringing of the culprit to justice. With a databank, data can be altered or deleted without any clue being left. Computer data files don't reveal fingerprints! Moreover, alterations in data are absolute and undetectable. A bit that has been changed from a '1' to an '0' is now an '0' and no evidence remains that it has ever been a '1'. Massive stores of data invite massive catastrophe if they are corrupted. There are many ways of making stored data secure and it is obvious that, in the past, companies and individuals have been lax about providing data security. But most are becoming aware of the precautions that must be taken and the situation should improve in the future.

most surveys show that, taking society as a whole, computers have created as many jobs as they have destroyed. There is a continual reduction in many traditional occupations but increases in new occupations. The rapid expansion of the service industries made possible by computers is one of the more obvious changes in employment patterns. The real problem arises not with the changes themselves, since re-training and other measures can make the transition fairly painless, but with the speed at which the computer has brought these changes about. Government, employers and trade unions have frequently been taken by surprise. Experience of the impact of the computer is growing and one hopes that the future will be less harassing for the individual employee.

The headings above cover the main problem areas. As experience in using computers grows, ways are being found of overcoming them. In spite of this there still remains the fact that the average person does not find computers easy to understand. They are frightened by them; computers seem to be unfriendly and alien. This feeling is not necessarily restricted to computers. We remember having a bedside tea-making machine that evoked exactly the same emotions. It was just not 'user friendly' and frequently provoked a traumatic start to which could have been a beautiful day. The point is that the device – be it computer, tea-maker, or video-player – should be easy to operate and (in the case of computers) help you out when you operate it wrongly.

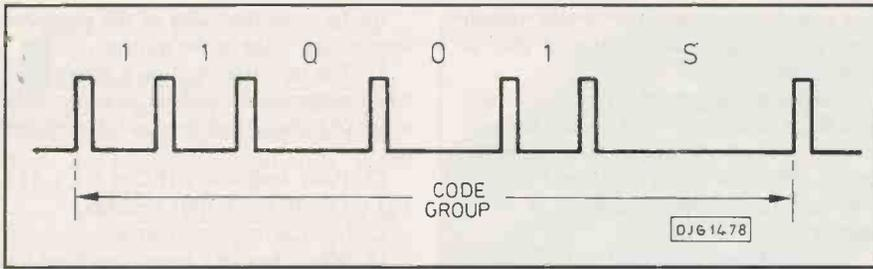

Fig.6. Pulse coded modulation. In the system above, a code group consists of six short pulses. The code transmitted depends on the intervals between the pulses. The 1, 0 and S (synchronising) pulses are in the ratio of 2:3:6.

PULSES IN CONTROL

Although the world (and this article) is becoming dominated by computers, we must not forget that digital electronics has many other applications. One of these is remote control, as in the device that is used to control the tv set or video recorder. The tv controller usually operates by transmitting an infra-red signal to the set. When you press one of the buttons on the controller, the infra-red leds at the front end of the controller flash a series of pulses towards the tv set. The controller contains a special digital ic that produces a different series of pulses according to which button is pressed. In other words, the pulses are a *code* (Fig. 6). The infra-red detector on the tv set picks up the signal, amplifies it and feeds the pulses to a decoder ic. This is another digital ic. It registers the code that has been received and as a result one or more of its outputs changes from low to high, or from high to low. This might result in changing the tv channel being viewed, altering the teletext mode, or muting the sound. The decoder ic may also have analogue outputs which produce varying output voltages. For example, as long as the associated code is being received, the output voltage increases or decreases step by step. This output could be used to control something that needs to be varied gradually, such as picture brightness or sound volume.

The possibility of interference in transmission is reduced by the logic of the decoder ic. For example, it could be annoying if a spark from the coal fire or a chance reflection of the infra-red from an object in the room caused a '0' to be substituted for a '1'. In one particular system the decoder registers two successive pulse groups and compares them. If they are both exactly alike, it accepts the command. If not, it waits until it *does* receive two consecutive groups that are identical.

The ics used for this type of control (known as *pulse code modulation*) are good examples of specialised applications of digital electronics. Internally, these ics are built up of just the same simple logical units – gates, flip-flops, counters etc – that we have already looked at in this series. Other examples of specialised digital ics

include those used in telephone modems, digital measuring equipment (such as digital test-meters), clocks, watches, timers, counters, lamp flashers, stepper motor drivers, speech synthesisers, and many more.

PULSES IN CONTROL

An audio signal is normally an analogue signal. It is an analogue of sound, the variations in air pressure caused by the source of sound, and detected by a microphone. The signal usually takes the form of a varying *voltage*. To digitise the signal, it is fed to an analogue-to-digital converter (see Part 6A, PE March 1989) and the output of the converter is sampled at regular intervals. Fig. 7 shows the results of sampling, assuming an 8-bit a-to-d converter is used. Most audio

digitisers would use 12 or more bits, but the principle is the same.

The audio signal is now represented as a series of 8-bit bytes which can be recorded, or maybe transmitted over a telephone line using suitable equipment. On playback, or at the receiving end of the telephone line, the digital signal is sent to a digital-to-analogue converter. The output from this converter is a varying voltage that is *approximately* like the original audio signal. If the approximation is near enough, this varying voltage can be fed to an amplifier and loudspeaker. The sound coming from the speaker is an approximation to the original sound.

Speaking of 'approximations' might give the idea that digitisation is a rough kind of process which gives poor quality reproduction. The opposite is usually the case since digital circuits are designed so that the approximation is extremely close. Even the most critical listener can not tell the difference between the original sound and the digitised sound. (*PE does not always agree with its esteemed authors! Ed*). To ensure faithful reproduction, the digitising circuit must be designed to:

* **sample frequently** – too slow a sampling rate will 'miss' rapid changes in the analogue voltage. The frequency of sampling (ie reading the output of the a-to-d converter) must be at least double the highest audio frequency that it is required to cover. For example, to cover a range up to 10kHz, the signal must be sampled at least 2000 times per second.

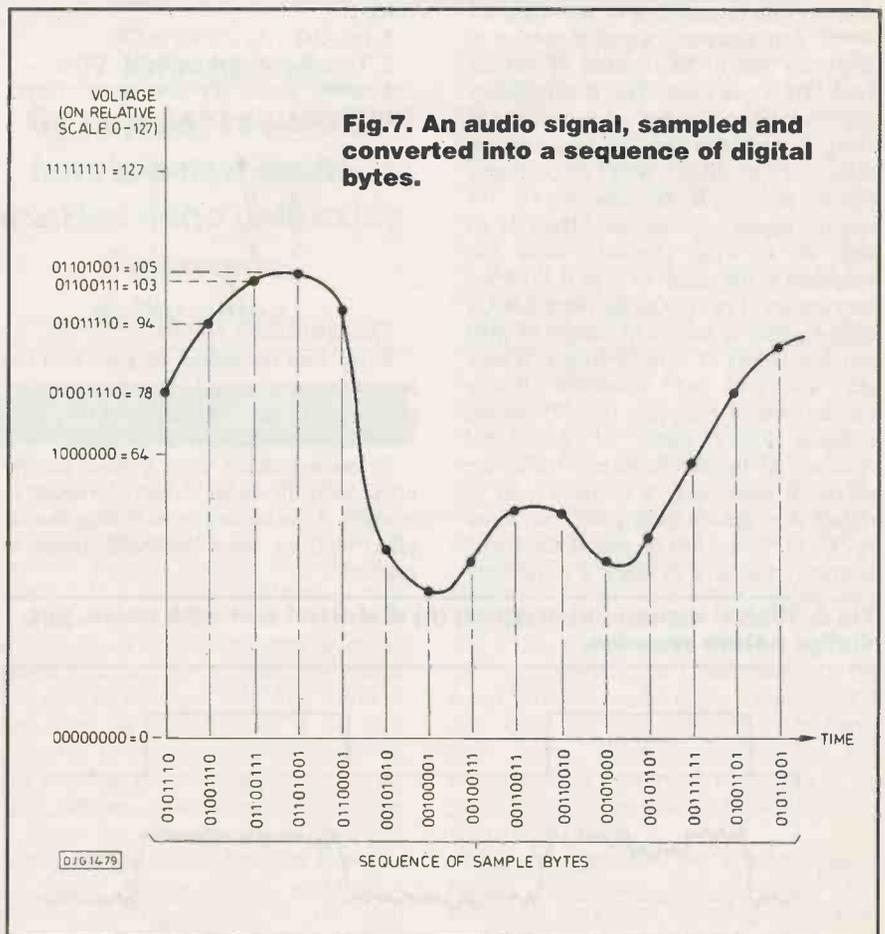

Fig.7. An audio signal, sampled and converted into a sequence of digital bytes.

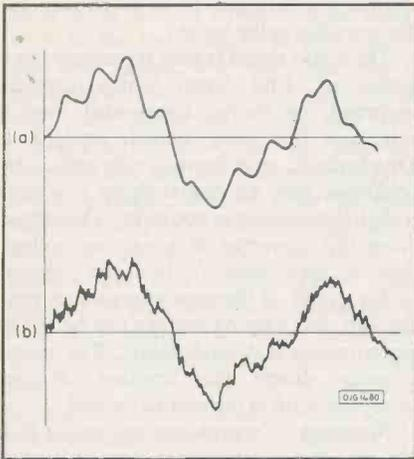
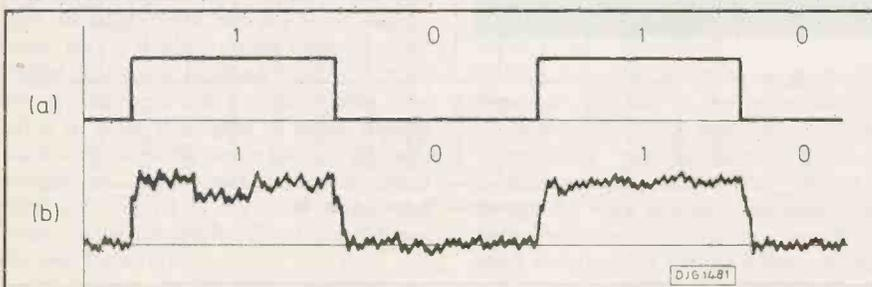

Fig.8. Audio signals (a) original; (b) distorted and noisy.

* **sample precisely** – an 8-bit a-to-d converter gives only 256 possible outputs (00000000 to 11111111), so only 256 different voltage levels can appear in the final digitised signal. In other words the 'steps' in the output signal are coarse. To make the digitised signal smoother and more like the original signal, we need finer 'steps'. A 12-bit converter gives 4096 'steps', which gives a much better approximation to the original.

Readers may be wondering why we go to the trouble of digitising an analogue signal only to convert it back to an analogue signal again. One of the reasons is to do with transmitting or recording the signal. Any electronic signal is subject to distortion and to interference of various kinds, known as noise. This is particularly important when a signal is transmitted (eg along a telephone line, or broadcast by radio) or recorded. With an analogue signal, any such degradation of the original signal is permanent. There is no way of knowing precisely what has happened to the signal so as to remove the interference (Fig. 8). On the other hand, a digital signal is known to consist of high and low pulses of definite length. It may get distorted and corrupted during transmission or recording (Fig. 9) but the essential binary nature of the signal remains. At the receiving end (or in the player) it needs only a simple circuit to restore the signal to its original crisp form. No '0's or '1's are lost or gained, the signal is *exactly* the same as when it came from

Fig.9. Digital signals (a) original; (b) distorted and with noise, yet digital nature remains.



the a-to-d converter. This is one reason why reproduction from a digital disc is less affected by wear.

This immunity from interference and distortion is a reason that digital audio is being increasingly used for telephony, compact disc audio and digital audio tapes. The same applies to digitisation of video signals.

Another feature of digital audio is that it lends itself to precise processing. Processing includes amplification, filtering and innumerable other 'tricks'. Amplifiers and filters may operate on the analogue signal but they may introduce distortions due to the nature of their circuits. Amplification and filtering may be achieved much more exactly by performing mathematical operations on the bytes of the digital signal. Obviously, if this has to be done in real time (eg during actual transmission) it has to be done fast. Back to computers again! (*Readers may also care to read Vivian Capel's article on cd technology in PE July-Sept 88. Ed*)

ANSWERS TO QUESTIONS

(The questions were posed last month)

- 100, 1111, 1101110, 11111110.
- 2, 6, 13, 170.
- By the value '1', or by a 'high' voltage.
- (a) AND, (b) exclusive-OR.
- Transistor-transistor logic- 5V dc.
- '4000' series, 3V-18V dc; or 74HC, 74HCT, 74AC, 2V-6V dc.

7.	Input		Output
	A	B	Z
	0	0	1
	0	1	1
	1	0	1
	1	1	0

This operation is NAND.

8. (a) Join the output of gate 1 to the unused input of gate 2. Join the output of gate 2 to the unused input of gate 1. (b) Make input B briefly low, then high.

9. An increasing input voltage has no effect until the upper threshold voltage is reached. A decreasing input voltage has no effect until the lower threshold voltage is reached.

10. Increase the value of the capacitor; increase the value of the resistor.

11. The monostable gives a single pulse when triggered; the astable gives a regular series of pulses for as long as it is switched on.

12. Pulse length = $1.1RC = 1.1 \times 33 \times 103 \times 47 \times 10^{-6} = 1.7061$ seconds

13. Input, processing, output.

14. When the clock input rises from low to high, data present at the D input appears at the Q output. The inverse of the data appears at the Q output.

15. Binary counters, frequency dividers, storage registers, shift registers.

16. &D, &58, &F1.

17. 100, 1100, 1010110.

18. In the synchronous counter, all stages are clocked at exactly the same time; they all change state at once.

19. The fanout of a gate is the maximum number of inputs of a given logic series that can be driven by that gate.

20. Light dependent resistor. Resistance decreases. In the dark the ldr has high resistance. Potential at A is low. The transistor is off. Potential at B is high. Gate output is low. As light increases, resistance of ldr decreases and potential at A rises. Transistor is switched on. Potential at B falls to low. Gate output becomes high.

21. LDR, photodiode, phototransistor.

22. Thermistor, negative temperature coefficient (ntc).

23. Use a power transistor or a relay.

24. The output may be logic low, or logic high, or 'high impedance'. In the high impedance state the output is in effect disconnected from the circuit.

25. Short for 'parallel-in, serial-out'; describes a shift register with parallel loading and serial output.

26. 11010100; doubles the value.

27. A register records the data that was being fed to it at a given instant (eg when the clock input rises). At other times it ignores the data (its output remains unchanged). The output of a latch changes as the data changes (it is transparent) as long as the clock input is high. When the clock goes low the data present at the output is held until the clock input goes high again.

28. When WE is low, data on the bus is stored in the chip; when WE is high data stored in the chip is put on to the data bus.

29. Data can be read from both types. Data can be written into ram by a computer circuit. Data is written into rom only during manufacture of the rom, or by a special rom programming device.

30. Erasable programmable read only memory. It can be programmed electrically. Its contents are erased by exposing the chip to ultra-violet radiation.

31. The arithmetic and logical unit (alu).

32. For holding the data that is currently being worked on.

33. It has a single input, which accepts a continuously changing voltage. It has (typically) eight logical outputs. As the

input voltage changes, the binary value at the outputs changes correspondingly. In other words, it converts an analogue voltage input to the corresponding binary digital output.

34. Digital-to-analogue converter (dac).
35. Voltage-to-frequency converter, voltage-to-time converter (507C).
36. A device (usually electronic) that processes data automatically.
37. Central processing unit.
38. Data bus, address bus, control bus.
39. Op-code.
40. Load and store, increment or decrement accumulator, compare a value with the value in the accumulator, jump to another part of the program.
41. An assembler program.
42. The abbreviated instructions used in writing programs in assembler language. Anything that helps you to remember something.
43. Artificial intelligence (AI).
44. Washing machine, video recorder, dishwasher, Prestel terminal, video games machine, home computer.
45. Parallel processing.
- 46./47. Refer to the article.
48. 10kHz.
49. Precision is improved.
50. Reduction or elimination of distortion and interference; precision of processing the sound.

And here we end this series on digital electronics. Owen Bishop will soon be starting a new series - this time on basic electronics. Don't miss it! **PE**

ASK PE NO2 CONTINUED FROM PAGE 34

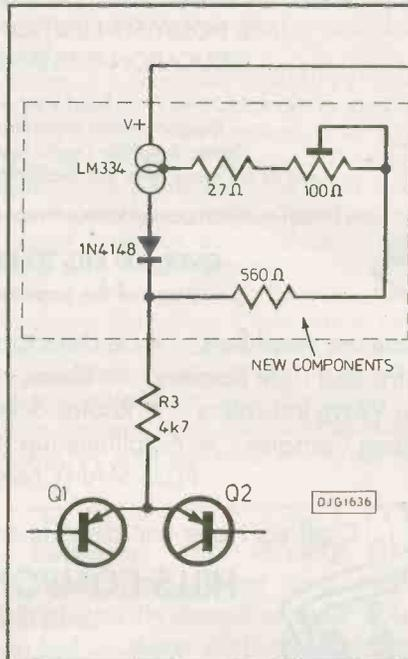

voltage on the junction of R8 and R9 is designed to exceed the power supply voltage for part of the output cycle. The voltage on this point, far from being

Fig.3.

constant, must follow the output signal. This maintains the current through R9 substantially constant over the whole output swing, and thus removes the possibility of premature clipping, slew rate limiting, or gain reduction at the extremes of positive signal excursions.

Increasing the value of C4 could improve low frequency performance marginally, but the phase shift on the signal at the junction of R8 and R9 is about 5° at 20Hz. The current variation in R9 caused by this is unlikely to affect the output signal detectably, because the effect of current variation is anyway a second order effect, which is reduced by a large factor by the action of negative feedback. We are looking here at an effect which would probably contribute under 0.1% distortion open loop, but which negative feedback divides by several hundred. Halving this contribution to the overall distortion is unlikely to matter. **PE**

variation of the tail current will vary the current in Q2 and hence vary the balance. The very best performance would come from using matched transistors and then balancing the dc level.

Voltage regulation cannot be used around R8, R9, and C4 because the



★ LEARN BY BUILDING ★ ENJOY BY USING ★

PROJECT KITS

★ BE CREATIVE ★ RAISE YOUR SKILLS ★ GET KITTED! ★

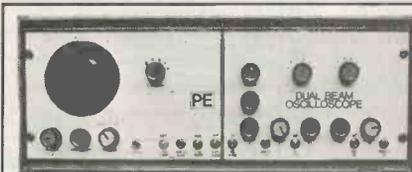

DUAL BEAM OSCILLOSCOPE

2Y-amps, 6 ranges, variable level, DC to over 1MHz. 4 modes - Y1, Y2, Y1 & Y2, Y1 & Y2 to X. Time base variable from 0.05Hz to 20KHz. Variable sync level, polarity and source. Separate bright-line, brilliance and focus controls. Independent trace deflection controls. Details in catalogue.

BURGLAR ALARM CONTROLLERS

MULTIZONE CONTROL SET280

£23.90

Two entry-zones, anti-tamper loop, personal attack, entry-exit timing, timed duration, automatic resetting, latching LED monitors.

SINGLE ZONE CONTROL SET279

£10.50

With timed duration control and latching LED monitor. Both units can be used with any standard detection devices, such as contact or magnetic switches, pressure pads, tremblers, ultrasonics, infrared etc., and will activate standard bells, strobes or sirens.

COMPUTER KITS

The software listings published with the computer kit projects are for use with C64, PET and BBC computers.

CHIP TESTER SET258F £41.50

Computer controlled logic and chip analyser.

EPROM PROGRAMMER SET277 £26.20

Computer controlled unit for 4K Eproms.

MICRO-CHAT SET276 £69.50

Computer controlled speech synthesiser.

MICRO-SCOPE SET247 £49.50

Turns a computer into an oscilloscope.

MICRO-TUNER SET257 £57.40

Computer controlled, tuning aid and freq counter.

MORSE DECODER SET269 £26.70

Computer controlled morse code-decoder.

**MORE KITS IN CATALOGUE
SEND MEDIUM S.A.E. FOR CATALOGUE AND
WITH ALL ENQUIRIES
(OVERSEAS SEND £1.00 TO COVER POSTAGE)**

VARIOUS

VOICE SCRAMBLER SET287 £49.50

32 switchable channels to keep your communications confidential.

STORMS! £35.50 each unit

Raw nature under panel control! Wind & Rain SET250W.

Thunder & Lightning SET250T.

DISCO-LIGHTS SET245F £69.50

3 chan sound to light, chasers, auto level.

EVENT COUNTER SET278 £36.60

4-digit display counting for any logic source.

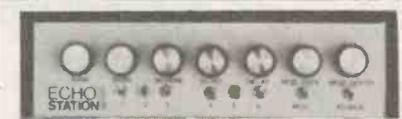

PE ECHO STATION DETAILS IN CATALOGUE



PE FREQUENCY COUNTER AND GENERATOR DETAILS IN CATALOGUE

ENVIRONMENT

ELECTRONIC BAROMETER

SET285 £41.20

Computer controlled unit for monitoring atmospheric pressure.

GEIGER COUNTER SET264 £65.50

A nuclear radiation detector for environmental and geological monitoring. With built in speaker, meter and digital output. This project was demonstrated on BBC TV.

ORDERING

Add 15% VAT. Add P&P - Sets over £50 add £3.00. Others add £2.00. Overseas P&P in catalogue. Text photocopies - Oscilloscope £3.00, Geiger £3.00, Weather £2.00, others £1.00, plus 50p post or large SAE. Insurance 50p per £50. MAIL ORDER, CWO, CHQ, PO, ACCESS VISA. Telephone orders: Mon-Fri, 9am - 6pm. 0689 37821. (Usually answering machine).

MORE KITS IN CATALOGUE

PHONOSONICS, DEPT PE99, 8 FINUCANE DRIVE, ORPINGTON, KENT, BR5 4ED.

MAIL ORDER



Established since 1973 Hills Components can offer the trade a selection of nearly 4,000 product lines covering the following ranges

- Aerials & Accessories
- Batteries & Accessories
- Cables & Accessories
- Computer Accessories
- Connectors (all types)
- Electronic kits/Modules
- Filters/Fuses
- Hardware/Fixings
- Headphones/Intercoms
- Connecting leads (all types)
- Microphones
- Multimeters
- Passive Components
- P.C. Boards
- Relays
- Speakers
- Switches
- Service Aids
- Soldering Equipment
- Telephones & Accessories
- Transformers

TRADE ENQUIRIES ONLY
Please phone or write quoting your company name & address for a copy of our 1990 catalogue

TRADE ONLY

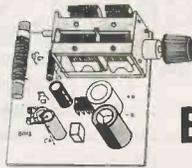

ELECTRONIC KITS & MODULES

FOR HOBBYISTS ELECTRONICS ENTHUSIASTS
EDUCATIONAL ESTABLISHMENTS ETC.

Build your own:

- Geiger-Mueller Indicator, Metal Detector,
- Stereo Amplifier Digital Combination Lock, or
- any of the many other kits available for numerous applications

Each kit comes in component form with easy to follow instructions for assembly

OVER 100 KITS TO CHOOSE FROM

Some of the popular kits include

- * Antenna Amplifiers
 - * Lie Detectors
 - * Alarm Systems & Monitors
 - * Infra-Red Light Barriers
 - * Sirens - Kojak-Warship-FBI-Ships-Space
 - * Micro-Wave Indicators
 - * Radios & Receivers
 - * Electronic Barking Dog
 - * Lighting Consoles
 - * Amplifiers (up to 200w)
 - * Car Aerial Amplifiers
- PLUS MANY MANY MORE

Call us now for details of your local Stockist

HILLS COMPONENTS LTD

Units 5 & 6
Melinite Industrial Estate
Brixton Road, Watford
Herts WD2 5SL
0923 52000

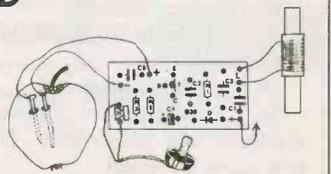
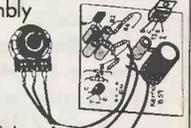
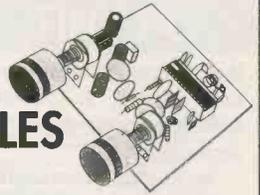
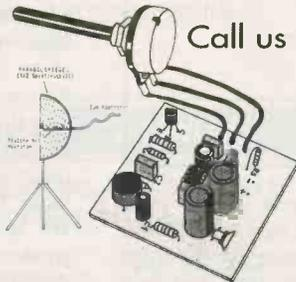
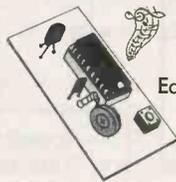

Interak 1 SINGLE BOARD COMPUTER

"SBC-1"

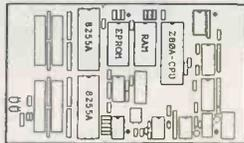

A computer doesn't have to look like you'd expect a computer to look. It doesn't have to have a keyboard and a screen and floppy disks and so on.

The SBC-1 has the bare minimum of chips a Z80 computer can have and still be a computer: A 4 MHz Z80-CPU chip, an EPROM chip (up to 32K), a static RAM chip (up to 32K) and a pair of 8255A I/O (input output) chips giving 48 individual lines to wobble up and down. There are one or two additional "glue" chips included, but these are simple "74LS" or "HC" parts.

A star feature is that no special or custom chips (ie PALs, ULAs, ASICs etc) are used — and thus there are no secrets. The Z80A is the fastest and best established of all the 8-bit microprocessors — possibly the cheapest too!

Although no serial interface is included, it is easy for a Z80A to wobble one bit up or down at the appropriate rate — the cost is a few pence worth of code in the program: why buy hardware when software will do?

Applications already identified include: Magnetic Card reader, mini printer interface, printer buffer, push button keypad, LCD alphanumeric panel interface, 40-zone security interface for auto sending of security alarms, code converter (eg IBM PC keyboard codes to regular ASCII), real time clock (with plug in module), automatic horticultural irrigation controller.

By disabling the on-board Z80A-CPU this card will plug into our Interak 1 CP/M Plus disk-based development system, so if you don't fancy hand-assembling Z80 machine code you don't have to!

The idea is (if you are a manufacturer) you buy just one development system and then turn out the cheap SBC-1 systems by the hundred. If you are really lazy we can write the program for you and assemble the SBC-1 cards so you can get on with manufacturing your product, leaving all your control problems to us.

Greenbank

For more details write or phone us:
Greenbank Electronics, Dept (E10P), 460 New Chester Road,
Rock Ferry, Birkenhead, Merseyside. L42 2AE. Tel: 051-645 3391

OSCILLOSCOPES

TEKTRONIX 2213 Dual Trace 60MHz Delay Sweep	£400
TEKTRONIX 465 Dual Trace 100MHz Delay Sweep	£500
TEKTRONIX 454 Dual Trace 150MHz Delay Sweep	£400
TELEQUIPMENT D83 Dual Trace 50MHz Delay Sweep	£300
GOULD/ADVANCE OS3000A Dual Trace MHz Delay Sweep	£300
TRIO CS 1556A Dual Trace 20MHz	£250
PHILIPS PM3233 Dual Trace 10MHz	£200
TELEQUIPMENT D755 Dual Trace 50MHz Delay Sweep	£275
KIKUSUI 5530A Dual Trace 35MHz	£250
HP 1220A Dual Trace 15MHz	£200
GOULD/ADVANCE OS1100 Dual Trace 30MHz	£210
GOULD/ADVANCE OS255 Dual Trace 15MHz	£210
COSSOR CDU150 Dual Trace 35MHz Delay Sweep Solid State Portable	£150
8 x 10cm Display	£150
Optional front cover containing 2 probes etc.	£10
SE LABS SM 111 Dual Trace 18MHz Solid State Portable AC or external DC operation 8 x 10cm Display	£150
SCOPEX 4D108 Dual Trace 10MHz	£150

MARCONI TF2006 AM/FM 10MHz-1GHz Sig Gen	£500
MARCONI TF2008 AM/FM 10MHz-510MHz Sig Gen	£375
MARCONI TF2015 AM/FM 10-520MHz Sig Gen with Synchroniser TF2171	£550
MARCONI TF2016 without Synchroniser	£425
MARCONI TF2016 AM/FM 10MHz-120M with Synchroniser TF2173	£400
MARCONI TF2016 without Synchroniser n	£300
Dymar 1525 AM/FM 0.1-184MHz Sig Gen	£200
H.P. 694 SWEET OSCILLATOR 7-12.4GHz	£500
H.P. 620 Signal Generator 7.11GHz	£400
H.P. 614 Signal Generator 600-2100MHz	£450
FERROGRAPH RIS2 Recorder Test Set	£275
WOELKE Woa & Filter Meter ME108	£100
LEADER LMW 186A Two channel Millivoltmeter 5Hz-500kHz 100uV-300V	£100
LEVEL TG200M 1Hz-1MHz Sine/Square	£125
MARCONI Automatic Distortion Meter TF2237A 400Hz or 1KHz. Measures down to 0.01%	£150
MARCONI TF2700 UNIVERSAL LCR Bridge. Battery Operated From £150	£150
PHILIPS PM456 FM Stereo Generator	£95

PHILIPS COLOUR BAR GENERATOR PM5519. UHF/VHF/Video Over 20 Test Patterns	£400
SADELTA MC321 COLOUR BAR GENERATOR RF Bands 1/3/4 & Video, 8 Functions. Sound Carrier. Unused (P&P £7)	£125
SADELTA COLOUR BAR GENERATOR PAL MC101. 8 Patterns Pocket Size. Rechargeable Batteries. Complete with Battery Charger Adaptor. Unused (P&P £4)	£75
DECCA/MORTING Colour Bar Generator type 82514	£125
Laigear Colour Bar Generator KG1 8 test Patterns (P&P £4)	£125
LARGEAR FIELD STRENGTH METERS ONLY £40 ea.	£40
LARGEAR CROSSHATCH GENERATORS Type CM6038-D3 Cross hatch/Grey Scale/Blank Paster. Mains or BATTERY. Unused (P&P £7)	£18
Used	£12 (P&P £3)
TRIO RF SIGNAL GENERATOR Type SG402 100kHz-30MHz. Unused (P&P £7)	ONLY £75
ADVANCE SGG28 AM 150kHz-220MHz	£45 (P&P £7)

TELEPHONES - YES! REAL DIAL TYPE TELEPHONES - that don't slide around the desk. Type no. 745 supplied with standard BT plug (Used) ONLY £5 ea. (P&P £3). Quantity discount

Used equipment - with 30 days guarantee. Manuals supplied if possible This is a VERY SMALL SAMPLE OF STOCK. SAE or Telephone for Lists. Please check availability before ordering. CARRIAGE all units £16. VAT to be added to Total of Goods & Carriage.

SPECIAL OFFER

HEWLETT PACKARD OSCILLOSCOPE
TYPE 1740 A - Dual Trace 100MHz Delay Sweep. Trigger View
£575

HAMEG MODULAR SYSTEM ONLY £400

HM8001 Main Frame with HM8032 Sine Wave Generator 20Hz-20MHz
HM8030 2 Function Generator 0.1-1MHz Sine/Square/Triangle; and HM8011 2 Digital Multimeter 4 1/2 digit.
FARNELL SWITCHED MODE PSU 5V 40A & +-12C 5A £30 ea. (P&P £4)
Other Switched Mode PSUs available. Please enquire
DISK DRIVES 5 1/4" DS/DD 80 track from £50
Some keyboards available. Please enquire.

MULTIMETERS (P&P All AVOs £10)

AVO 8 Complete with Batteries & Leads From £50
AVO 8 MkV Complete with Batteries & Leads £90
AVO TEST SET No 1 (Military version of AVO 8) Complete with batteries & leads £65
TEST LEADS suitable for AVOMETERS. Red & Black with 2 Croc-Clips & 2 probes £5 (P&P £3)
Black "Ever-Ready" case for AVOs. Unused £15 (P&P £4)
Batteries 15 volt. £3 ea. 10 off £25 (P&P extra)

AVO TRANSISTOR ANALYSIS Mk2 CT445 Surface style complete with batteries and operating instructions ONLY £25 EACH (P&P £7)
MARCONI AF POWER TF993A 20Hz-35kHz 20mW-10W with manual ONLY £35 (P&P £7)
MARCONI RF POWER METER TF1152A1 DC 500MHz 0.5 to 25W 50 Ohm with manual ONLY £45 (P&P £7)

NEW EQUIPMENT

HAMEG OSCILLOSCOPE 604 Dual Trace 60MHz Delay Sweep. Component Tester + two probes	£375
HAMEG OSCILLOSCOPE 203.6 Dual Trace 20MHz. Component Tester with two probes	£314
All Other Models Available	
BLACK STAR COUNTER TIMERS (P&P £5)	
APOLLO 10-100kHz Radio/Panel Time interval etc.	£222
APOLLO 100-100MHz (As above with more functions)	£295
BLACK STAR FREQUENCY COUNTERS (P&P £4)	£99
Meteor 600-600 MHz	£129
Meteor 1000-1GHz	£178
BLACK STAR JUPITOR 500 FUNCTION GENERATOR. Sine/Square/Triangle. 0.1Hz-500kHz (P&P £4)	£110
ORION COLOUR BAR GENERATOR Pal TV/Video	£209
HUNG CHANG DMM 7030 3 1/2 digit. Hand held 28 ranges including 10 Amp AC/DC 0.1%. Complete with batteries & leads (P&P £4)	£35.50
As above DMM 6010 0.25%	£33.50
Carrying cases for above	£3 each
OSCILLOSCOPES PROBES. Switched x1, x10 (P&P £3)	£11

STEWART OF READING

110 WYKEHAM ROAD, READING, BERKS RG6 1PL
Telephone: 0734 68041 Fax: 0734 351696
Callers welcome 9 am-5.30 pm Mon-Fri. (until 8 pm Thurs.)

At the end of last month's article we looked at mixers, referring to Figs 19 and 20. These figures are shown here and illustrate the transistor versions of single-ended and balanced mixers.

MODULATION

The basic principles will be dealt with here and the techniques special to a particular kind of modulation will be covered again under the relevant kind of receiver or transmitter. Similarly some of the foregoing sections will be expanded wherever relevant.

Many of the techniques applied to receivers are also applied to transmitters. For instance phase locked loops are relevant to both for holding the local oscillator within the required limits. Mixers are used to translate a carrier from the if to the rf range in transmitters and in the reverse direction for receivers.

Modulation is a process of piggy backing the audio signal to be transmitted, onto a radio frequency. The reverse process called demodulation is used at the receiver. Modulation is necessary because the energy of an audio wave is rapidly dissipated in the atmosphere whereas a

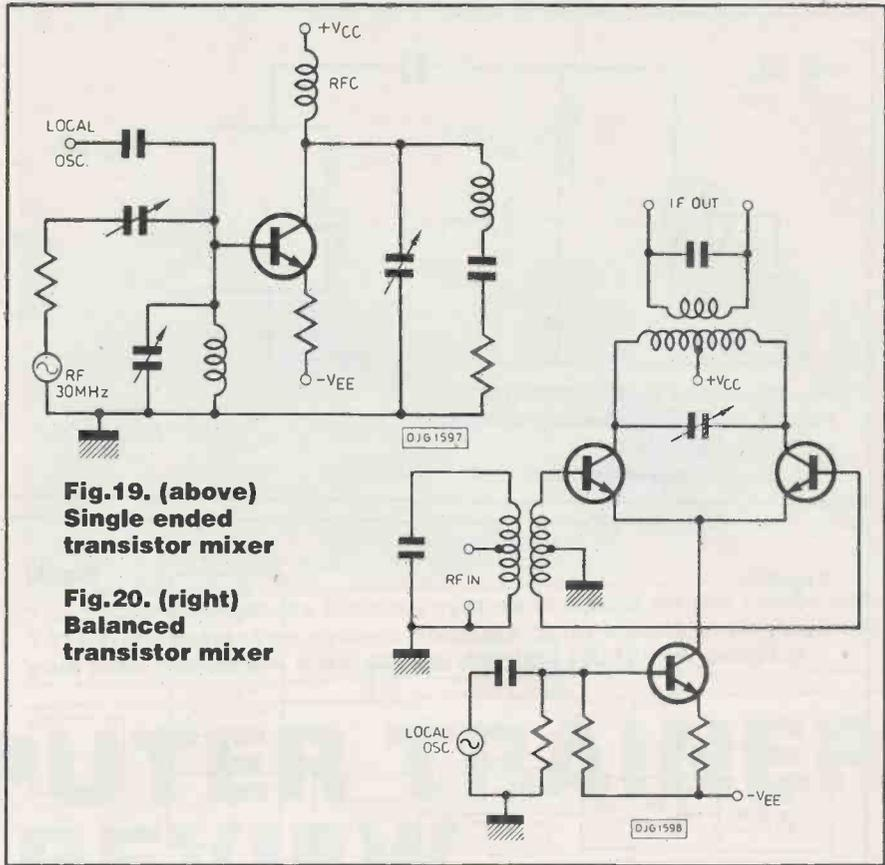

Fig.19. (above) Single ended transistor mixer

Fig.20. (right) Balanced transistor mixer

HF RADIO

PART THREE
BY MIKE SANDERS

Piggy backing audio and radio signals helps minimise the incidence of pierced eardrums!

radio wave travels much further. Apart from this the incidence of headaches and pierced eardrums would rise significantly if every transmitter sent out high energy audio waves.

There are many kinds of modulation and they will be touched on briefly. One of the oldest type is on-off keying as in telegraphy, called continuous wave (cw), Fig. 21. Although there are breaks in the transmission of rf energy as in the Morse code, the amplitude of the signal when transmitted does not change and for this reason it is called a continuous wave.

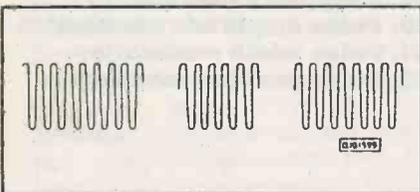
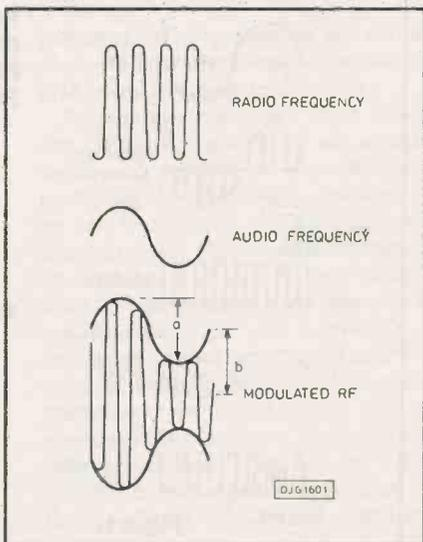

Fig.21. Continuous wave (CW)

Another type of modulation which followed Morse transmission was amplitude modulation (am), Fig. 22. The modulation index is the ratio a/b in Fig. 22 and should not exceed 1 or 100%, or distortion will be incurred.

A simple method of amplitude modulating an rf carrier is to incorporate

Fig.22. (right) Amplitude modulation



the modulating signal in series with the collector voltage of a class C rf amplifier, Fig. 23. The opposite process, demodulation or detection, can be carried out by the simple circuit of Fig. 24. The diode merely removes the bottom part of the waveform since the audio is contained in both top and bottom half and only one half is required. The voltage V_2 contains a dc component which is blocked by the capacitor C_2 giving only the ac variations at V_3 .

Amplitude modulating an rf wave with an audio wave produces sum and difference frequencies, called double sidebands (dsb) Fig. 25. The rf carrier transmits no information and if suppressed, the output is called a double sideband suppressed carrier (dsb/sc).

There is no need to transmit both sidebands since the information is duplicated and if one sideband is also suppressed the result is a single sideband suppressed carrier (ssb/sc). Therefore, a ssb/sc not only occupies half the bandwidth of a dsb/sc but requires only half the power for transmission.

A single sideband can be generated by two methods: the filter method or the phasing method. In the filter method one of the sidebands is filtered out and the rejection of the unwanted sideband must be at least 40 dB.

The filter scheme is shown in Fig. 26,

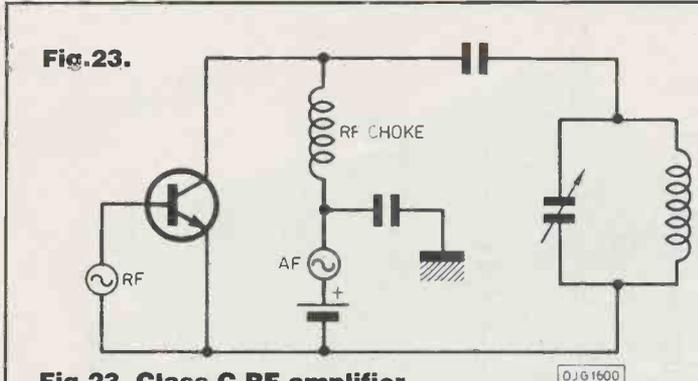

Fig.23.

Fig.23. Class C RF amplifier
Fig.24. Simple detector circuit and waveforms
Fig.25. Double sideband

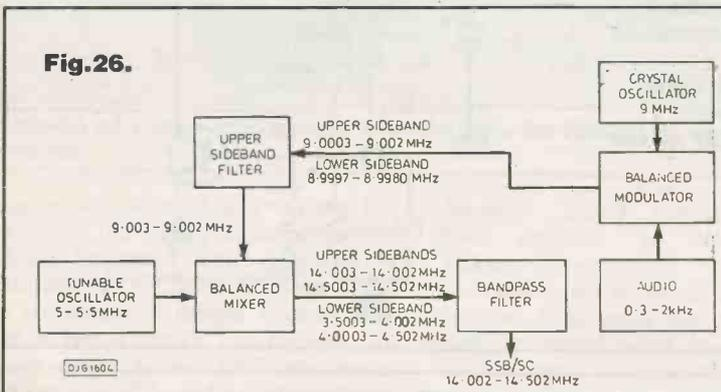
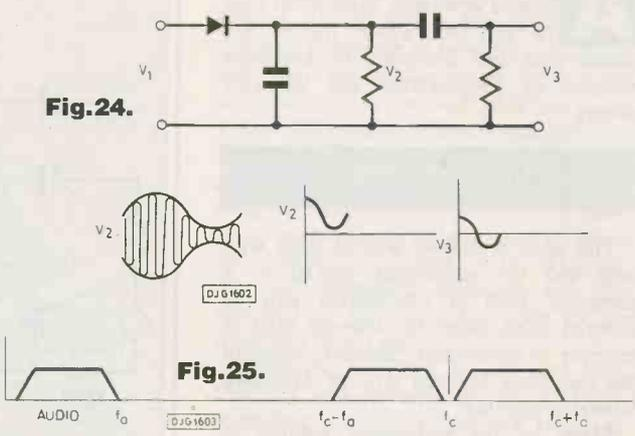

Fig.26.

Fig.26. SSB by filter method
Fig.27. Phase method of SSB generation

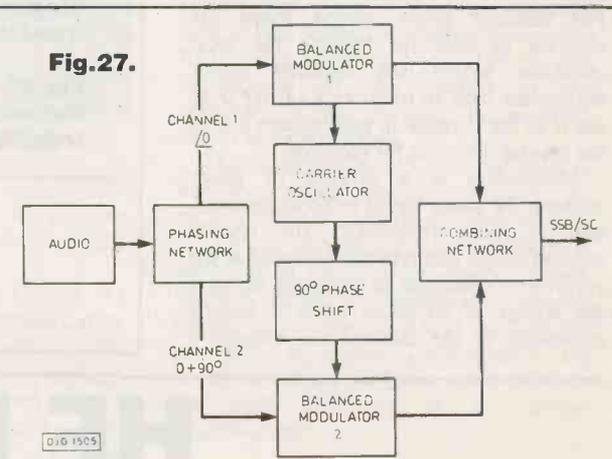

Fig.27.

where a balanced modulator and 9MHz crystal oscillator provide two sidebands. A crystal filter rejects the lower sideband and passes the upper sideband on to a balanced mixer with a 5MHz to 5.5MHz oscillator input. The upper sideband is now in the 14MHz to 14.5MHz range which is much higher than the lower sideband range of 3.5MHz to 4.5MHz. Therefore, a fixed tuned bandpass filter is sufficient to pass the upper sideband.

The combined output then cancels for one sideband and adds for the other if the balanced modulators are identical and the phase networks are accurate. Therefore, sharp filters are not required.

In practice a circuit cannot produce a phase shift of 90 degrees in one channel over the required frequency range. To overcome this, two all-pass networks are designed, Fig. 28, to give a phase shift of

Fig.28. Phase characteristics

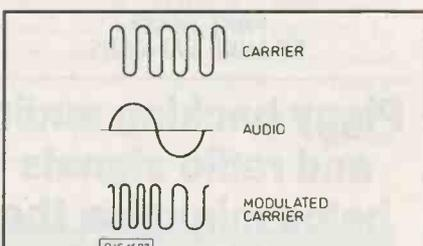
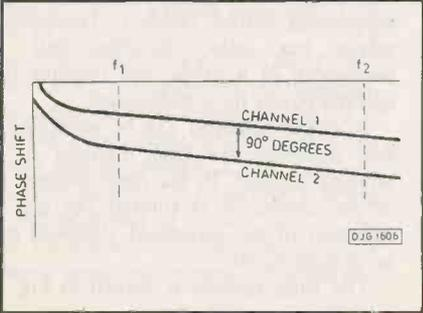

Fig.29.

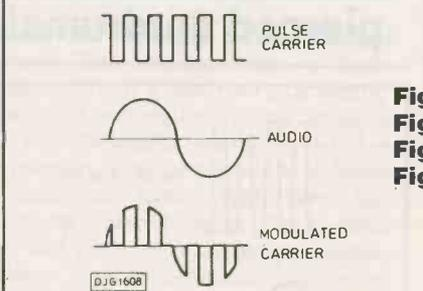

Fig.30.

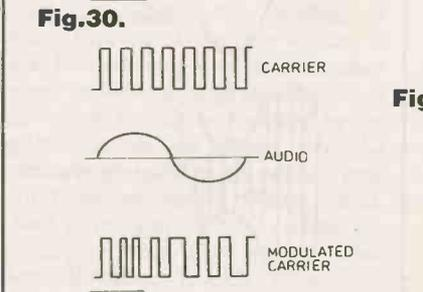

Fig.31.

90 degrees in the required frequency range.

Frequency modulation (fm) does not alter the amplitude of the carrier like amplitude modulation but alters the frequency of the carrier, Fig. 29. Therefore, fm is immune to amplitude induced noise, as are digitally modulated signals.

Using pulses, an audio signal can be encoded using pulse amplitude modulation (pam), pulse width modulation (pwm), pulse position modulation (ppm) or pulse

Fig.29. Frequency modulation
Fig.30. Pulse amplitude modulation
Fig.31. Pulse width modulation
Fig.32. Pulse position modulation

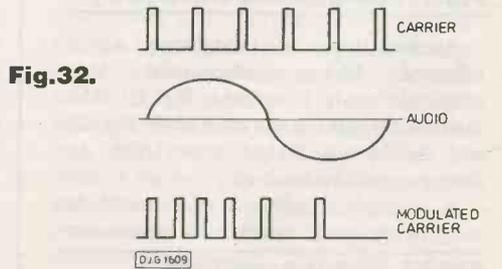
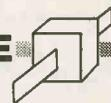

Fig.32.



combinations of low/high frequency and low/high energy.

LINEAR AMPLIFIERS

Amplifiers are designated classes A, B, C, D, E, F, G, H, S. These differ from each other by method of operation or circuit configuration. Class A amplifiers are similar to small signal amplifiers (hf amplifiers) and can be modelled by two port or linear equivalent circuits.

Class A and B linear amplifiers will be dealt with here. They have a reasonable gain and help amplify the input current or voltage. This is important in ssb operation which requires a faithful reproduction of the envelope and phase.

Bipolar transistors as well as vertical mosfets (vmos) are used. The latter are particularly popular because of resistance to secondary breakdown and ease of biasing. The ratings on data sheets occasionally relate to actual applications. For instance a transistor for class B rated for a 28V dc supply has a maximum rating of 56V.

Fig. 35 shows a class A amplifier and Fig. 36 a class B. The class B push-pull is the more common version although a single ended class B narrow band linear amplifier similar to class C can be used. The class B push pull is more efficient than class A for linear power amplification and therefore used for medium and high powers.

The class B application for rf is the same as for audio with two transistors driven in alternate half cycles. The higher efficiency of class B is due to zero collector current when the voltage is at its peak.

In practice, amplifiers have saturation voltages and resistance and loads are reactive instead of being purely resistive. At high frequencies, closer to the design limit of the transistor, the efficiency is reduced because the collector current is distorted by charge storage effects. These problems are insignificant at frequencies below $f_T/10$, where f_T is the cut off frequency of the transistor, and start to gain importance above $f_T/2$.

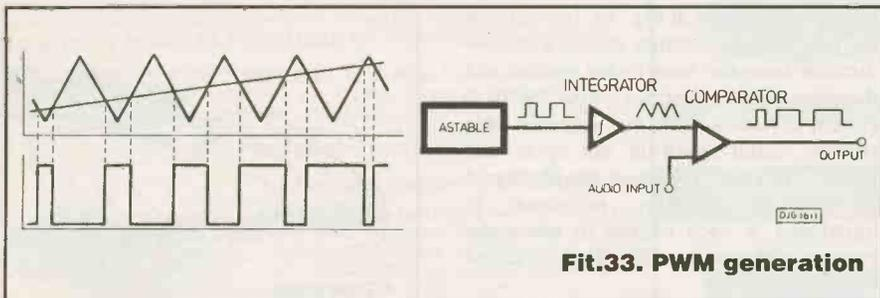

Fig.33. PWM generation

code modulation (pcm). In pulse amplitude modulation, the waveform is sampled at regular intervals and a pulse produced of a height that corresponds to the height of the waveform at that instant, Fig. 30. Although digital techniques are applied, the result remains analogue since the resultant output is continuously varying in height.

In pulse width modulation, the width of the pulse varies to encode the height of the pulse, Fig. 31, and in pulse position modulation the time window in which the pulse appears varies, Fig. 32. Each of these methods would have their own peculiar problems in the design of modulators and demodulators. Fig. 33 shows one method of generating pwm using a comparator and a sawtooth waveform.

The most popular pulse method is pulse code modulation where samples must be taken at twice the highest frequency to be transmitted. The samples are also spaced out non-linearly, Fig. 34, so that more samples are taken of lower amplitudes and

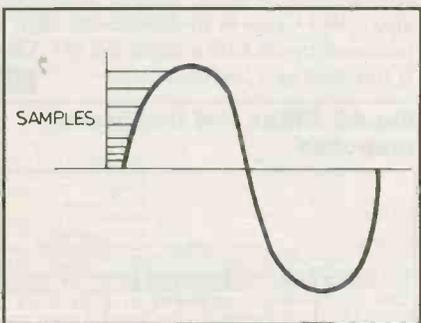

Fig.34. PCM non-linear sampling

encoding is better in the presence of noise. For a 4kHz speech circuit the sampling rate is 8kHz and eight bits are used to encode each sample giving a transmission rate of $8 \times 8 = 64K$ bits. Therefore the bandwidth is much greater than for an amplitude modulated wave but the noise immunity is a distinct advantage.

A further development of pcm is delta modulation where only the change in amplitude of the previous sample is transmitted hence cutting down on the required bandwidth. Shannon's law shows the relationship between the transmission rate, bandwidth and signal to noise ratio:

$$C = B \log_2 \left(\frac{1 + V_s}{V_n} \right) \text{ bits/sec}$$

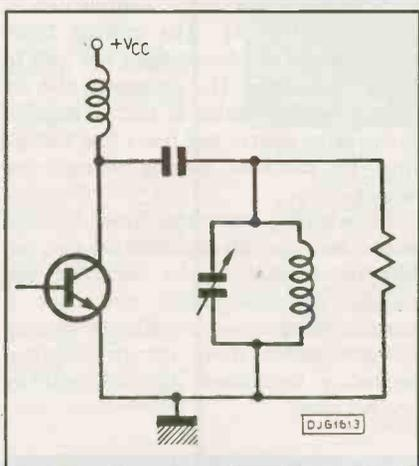

Fig.35. Class A amplifier

- Where C = transmission rate in bits/sec
- B = bandwidth in Hz
- V_s = signal volts
- V_n = noise volts

This means that if the bandwidth is increased in order to increase the transmission rate, the signal to noise ratio degrades.

AMPLIFIERS

In addition to mixers, modulators/demodulators and detectors, amplifiers play an important part in radio circuits. Transmitters require high power amplifiers operating at the carrier frequency in order to broadcast the signal. Receivers require audio amplifiers to boost the signal after it has been detected and good quality receivers even have an rf amplifier to give the weak signal a lift before it is processed. So there is a variety of amplifier design to include the

Fig.36. Class B push-pull

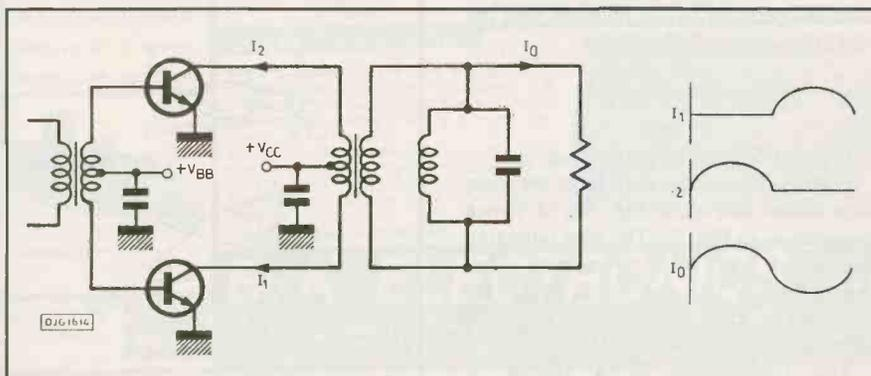

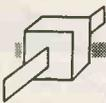

CROSS OVER DISTORTION

Active devices like valves and transistors do not switch sharply from active to cut off and vice versa.

Since the switching is gradual and non-linear, an offset voltage is involved, Fig. 37, and the result is called crossover distortion. This problem is more pronounced when the signal is small compared to the maximum output of the amplifier.

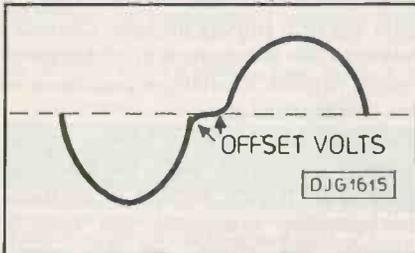

Fig.37. Crossover distortion

The effect is reduced by biasing the base or gate of the transistor so that there is a quiescent current in the collector or drain respectively. The value of the quiescent current is decided experimentally since too little bias means there is no output for signals below the bias threshold. Too much bias means that even small signals will receive excessive amplification. The minimum intermodulation distortion ratio occurs when the quiescent current is 1% to 10% of the peak collector (or drain).

The term class AB has been applied to transistors conducting over slightly more than half the rf cycle but class B is quite widely used with the understanding that it is drawing quiescent current.

HEAT SINKS

The maximum permissible junction temperature of a transistor is about 200°C and the reliability decreases so heatsinks are necessary. A heatsink for dissipating the heat is usually made of aluminium with fins to give a large surface area.

For class A operation with a resistive load the maximum power dissipation is twice the maximum output power. For class B operation with a resistive load the maximum power dissipation is:

$$2 \frac{V^2}{\pi^2 R} cc$$

or about 40% of the peak output.

rf power transistors may be in the form of a screw stud as in Fig. 38, or flange mounted as in Fig. 39. The stud mounting is found on old transistors and overtightening the stud could break the mounting. The flange in Fig. 39 overcomes this problem.

The construction of a bipolar rf

transistor is shown in Fig. 40. Interleaving the base with the emitter means a smaller distance from the base to the emitter and therefore lower resistance. Also the base current divides evenly, but so many little emitters could result in hot spots and thermal runaway. To reduce the likelihood of thermal runaway, resistance is introduced in each emitter to cause the current to divide equally. This is called ballasting.

A power fet of vmos construction is shown in Fig. 41. The current flows vertically and the device has a low gate to drain capacitance. The advantage of a fet over a bipolar device is that it requires lower drive current and has a low storage time for electrons passing through the device.

In switching operations, vmos fets can pass current in both directions, ie, they are bilateral whereas bipolar transistors are usually unilateral. FETs also have a negative temperature co-efficient so they do not suffer from current hogging, secondary breakdown, thermal runaway and hot spots.

FILTERS

Power amplifiers produce harmonic currents and before connecting the transmitter to the aerial these harmonics must be filtered out. Odd harmonics at 15dB to 20dB below signal level are the result of current distortion, and even harmonics at 20dB to 40dB below signal level are the result of gain variation.

It is necessary to attenuate these to at least 60dB below the carrier signal and the tank circuit has largely given way to a bank of filters, as in Fig. 42. The filter design is usually based on Butterworth which is maximally flat or Chebychev

Fig.38. Stud mounted transistors
Fig.39. Flange mounted transistors

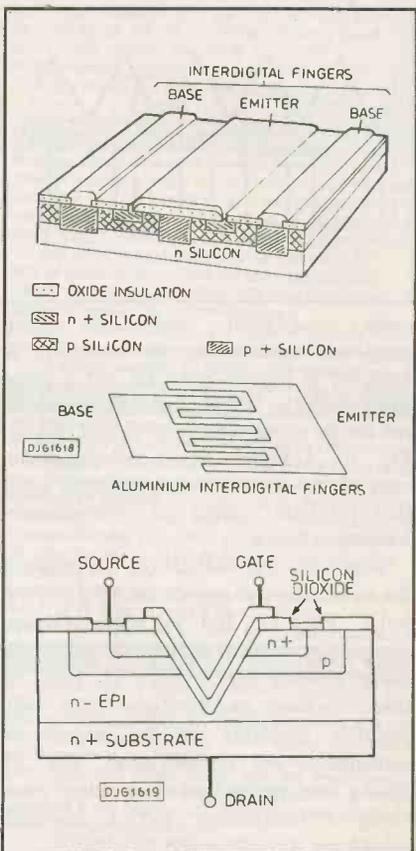
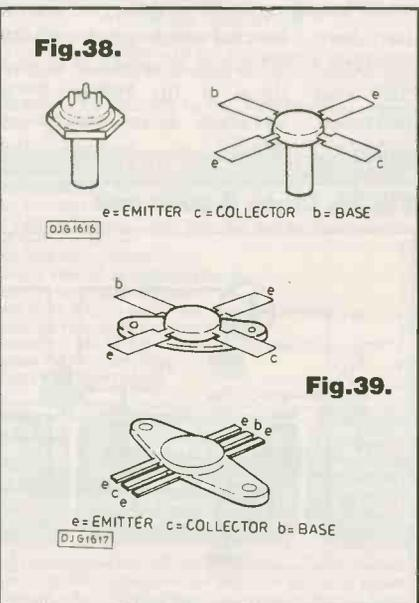
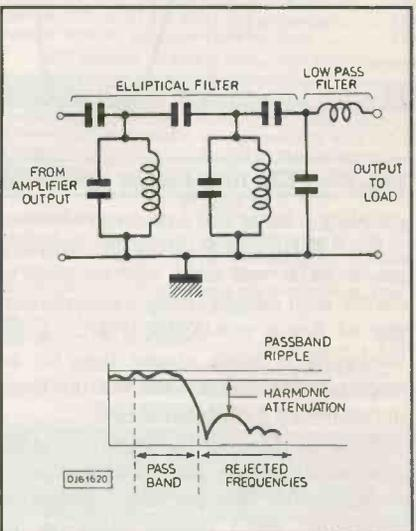

Fig.40; Bipolar RF transistor
Fig.41. Vmosfet RF transistor

which has equal ripple in the passband. The requirement is for a wide passband and large harmonic attenuation so an elliptic filter is used. Elliptic filters are also called Cauer or m-derived and have a passband ripple with a rapid roll off. This is followed by a low pass filter. **PI**

Fig.42. Filter and frequency response



In part four we'll be looking at tuned and high efficiency amplifiers. Tune in next month!

READY-MADE P.C. BOARDS

Simplify your project assembly – use a ready-made printed circuit board. All are fully drilled and roller tinned. Just slot in the components as shown in the project texts, and solder them. PCBs are the professional route to project perfection.

MAIL ORDERING

Select the boards you want, and send your order to
PE PCB SERVICE, PRACTICAL ELECTRONICS,
193 UXBRIDGE ROAD, LONDON W12 9RA.

Prices include VAT and postage and packing. Add £2 per board for overseas airmail. Cheques should be crossed and made payable to Intra Press.

Quote the project name and PCB Code Number, and print your name and address in Block Capitals. Do not send any other correspondence with your order.

TELEPHONE ORDERS (OPEN 24 HOURS)

Use your Access card and phone your order to

0268 289923

clearly stating your name and address, card number, and order details.

All orders receive priority attention, but allow 28 days for delivery in case a PCB is temporarily out of stock.

WE CAN ONLY SUPPLY THE PCBs LISTED HERE

**CHECK LATEST ISSUE FOR
PRICES BEFORE ORDERING**

PHOTOCOPIES OF THE TEXTS MAY BE BOUGHT FROM THE EDITORIAL OFFICE AT £1.00 EACH PART (£1.50 OVERSEAS), P&P INCLUSIVE. COMPONENTS ARE AVAILABLE FROM ADVERTISERS.

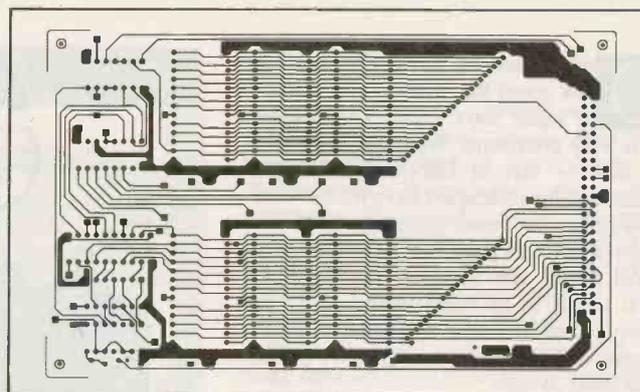

DEC 86	VIDEO ENHANCER – manually adjustable video improvement.	126	£8.76
JAN 87	VIDEO FADER – simple inexpensive video mixer	127	£4.50
	VOICE SCRAMBLER – confidential trans.	128	£8.06
MAR 87	4 CHANNEL ENHANCER	135	£4.60
	LIGHT PEN – uses fibre optics for accuracy	136	£4.10
	ULTRASONIC TAPE MEASURE	138	£9.50
APR 87	VIGILANTE CAR ALARM – keeps cars alert	139	£5.90
	INDUCTIVE LOOP TRANSCEIVER – remote control for models:	143/144	£7.80
MAY 87	BRIGHT FUZZ – Foot operated overdrive	145	£3.90
JUN 87	AUDIO SIGNAL GENERATOR	146	£10.20
JUL 87	WORD GENERATOR – 16-bit binary words	147	£13.42
	SCOPE STORE oscilloscope add-on data storage	148	£11.94
SEP 87	SPEECH PROCESSOR – clarifies speech	150	£5.86
	GCSE TIMER UNIT – versatile variable delay	151	£5.18
	FUNGEN – triple waveform signal generator	152/153	£9.69
	LIGHT CONTROLLER – delayed switching	154	£4.64
OCT 87	TEACHER LOCKER – digital lock control	155	£7.50
	POWER SUPPLY – stabilised ±15V	156	£7.50
	GUITAR TO SYNTH – music interface	157A/B	£9.95
NOV 87	DUAL POWER SUPPLY – GCSE	158	£6.20
	MIDI EXPANDER – Music Interface	159	£5.04

DEC 87	RS 232C TO MIDI	160	£6.43
	TEACHER RADIO – GCSE	161	£5.58
JAN 88	LÉGO BUGGY DRIVER	163	£6.42
FEB 88	TEACHER TALKBACK – GCSE	164	£6.36
	DC MOTOR SERVO	165	£7.53
MAR 88	APPLIANCE TIMER	166A/B	£9.38
	TEACHER LIGHTSHOW – GCSE	167A/B	£9.09
	LOGIC ANALYSER – Double-sided	168	£20.65
APR 88	LIGHT METAL EFFECTS	169	£7.10
	TEACHER COUNTER	170	£4.95
		171	£4.92
MAY 88	RF SPEECH PROCESSOR	172	£6.26
JUN 88	AMSTRAD ROM EXPANSION	173	£10.80
	MAINS MODEM	174	£4.27
JULY 88	VOCALS ELIMINATOR	175	£4.31
AUGUST 88	SPEAKING CLOCK	176	£16.75
SEPT 88	BBC MULTIPLEXER	177	£4.50
OCT 88	METAL DETECTOR	178	£6.50
DEC 88	PLD PROGRAMMER	179	£9.90
		180	£4.90
	PANNING MIXER	181	£7.80
JAN 89	RUDOLPH'S NOSE	182	£6.25
	ANGEL'S HALO	183A/B	£9.40
	CANDLE FLICKER	184	£6.25
MAR 89	CAMERA SHUTTER TIMER	187	£9.95
APR 89	PC MULTIPOINT	188A/B	£20.55
MAY 89	KIRLIAN CAMERA	189A/C	£10.50
JULY 89	PROJECTOR SYNCHRONISER	190-E	£9.50
AUG 89	EASI-BUILD – VODALEK	191	£4.90
	HAND CLAPPER	192	£6.50
SEP 89	EASI-BUILD – COMPRESSOR	193	£4.90
	FREQUENCY COUNTER-GENERATOR	194A/B	£12.50
OCT 89	EASI-BUILD VOICE-OP-SWITCH	195	£4.90
	HOME SECURITY CONTROLLER	196A/C	£19.50

Once again we have been hearing talk about the discovery of planets of other stars – and once again, this is very premature. What has happened this time is that at Harvard, Dr David Latham and his colleagues have traced what seems to be a low-mass companion of a star known as HD114762. The star itself is a normal dwarf, less massive than our Sun, and it seems to be being perturbed by an unseen companion with about eleven times the mass of Jupiter, the most massive planet in the Solar System.

Whether a body of this mass can be classed as a true star is doubtful. Certainly it cannot trigger off nuclear reactions inside it, and radiate in the same way that the Sun does. It could be what is termed a "brown dwarf", which is intermediate in time between a star and a planet – a sort of cosmical missing link. The distance from the parent star seems to be about the same as that between the Sun and its own closest planet, Mercury.

Brown dwarfs are very much in the news, but we have to admit that so far we have no positive proof of them. Perhaps the Hubble Space Telescope, now due for launching next spring, will tell us.

At La Silla in Chile, the Danish astronomer B. Relpurth has made a very interesting observation of a young star in the giant interstellar cloud of which the Orion Nebular is a part. The star, Haro-Herbig 111 (or HH 111 for short) seems to be sending out relatively narrow, high-speed jets in opposite directions; these supersonic jets penetrate far into the surrounding cloud before they are halted by collision with the particles, but they probably last for only a few hundreds of thousands of years, so that they are rare. HH 111 yields the largest and most perfect narrow Stellar jet systems ever seen. The emitting star is about 25 times as luminous as the Sun, and is about 1500 light-years

SPACE

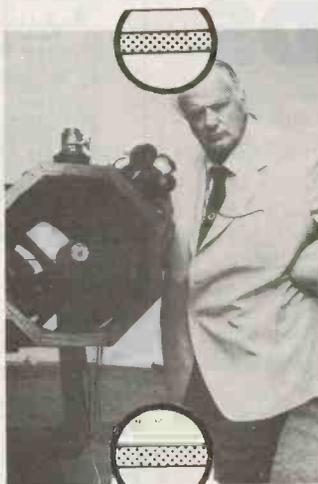

WATCH

BY DR PATRICK MOORE CBE

There's still no proof of planets orbiting other stars, nor of brown dwarfs, but there's good proof of stellar and committee jet-sets!

away; it is still collecting material from its surroundings, and we may in fact be witnessing a true stellar birth. Monitoring it will tell us what is going on near the young star and its associated disc of 'collected' material.

Much nearer home, the mystery of

Comet Brorsen-Metcalf continues. At the time when I write these words (July 3) it has simply not appeared, though its orbit was well known and it had been expected to reach naked-eye visibility later this autumn. Whether there has been some error in the calculated orbit (unlikely), whether it has been destroyed or has been dissipated (also unlikely) or whether we have simply missed it, remains to be seen!

THE PARLIAMENTARY SPACE COMMITTEE

So far as Space is concerned, parliamentarians have not always made the best possible decisions. (This extends back even to aeronautics; in the early 1930s the newly-designed jet engine was rejected as being no rival to the air screw-engine combination.) However, a Parliamentary Space Committee has now been set up, and has had its first meeting. The Chairman is Michael Marshall, MP for Arundel; Vice-Chairman, John McWilliam, MP; other members Spencer Batiste MP, Dr Michael Clark MP, Ernie Ross MP, and Gerald Birmingham. Non-parliamentary representatives are John Holt (British Aerospace), Dr Bruce Smith (Smith Associates), Barry Hargrave (Logica), Dennis Cummings (Marconi), Nigel Press, and Dr Adrian Lloyd-Lawrence (SD Scicon).

The committee has been formed from the All Party Space Committee together with various industrial concerns, the main aim being to promote Britain's role in space and broaden the interests of the British space community. Their first communique contained several points, all of which have been blatantly obvious for some time – such as the statement that "the lack of integration of military and civil earth observation activities is extremely wasteful of

THE SKY THIS MONTH

Various planets are on view this month. Venus is visible in the evening, though it sets not so very long after the Sun, telescopically it is still seen to be gibbous (that is to say, between half and full), and no details can be expected to be visible telescopically. Jupiter rises before midnight, and is a brilliant object in Gemini (the Twins) – far brighter than any star. The other giant planet, Saturn, is in Sagittarius (the Archer) and is low down as seen from Britain, though it is on view for much of the period of darkness. Of the other planets, Mercury and Mars are virtually invisible this month; the telescopic planets Uranus and Neptune are in Sagittarius, not far from Saturn, while Pluto remains near the border between Virgo and Libra.

The moon is at first quarter (half) on September 8, full on the 15th, last quarter on the 22nd, and new on the 29th. There are no eclipses this month, and neither are there any meteor showers of note. We had expected a fairly bright comet (Brorsen-Metcalf), but, as so often happens with comets, it has failed us miserably.

Among the stars, we still have the Summer Triangle of Vega, Altair and Deneb, but the evening sky is dominated by the Square

of Pegasus, high in the south. It is easy to identify, though, as I have often said, maps tend to make it seem smaller and brighter than it really is; all its stars are between magnitudes of 2 and 3. One of them, Scheat (the upper right-hand member of the Square) is variable; it may be compared with the star to the lower right of the square, Markab (magnitude 2.5). Like many of its type, Scheat is orange-red, while the other three stars in the Square are white. Look at them with binoculars, and you will see what I mean.

During September, look for Fomalhaut in the Southern Fish, directly below the Square of Pegasus and not far from the southern horizon. This is one of the stars found by IRAS, the Infra-red Astronomical Satellite, to be associated with cool material which just could indicate a system of planets – though to claim this is a certainty would be most unwise!

In the east, the lovely star-cluster of the Pleiades or Seven Sisters is coming into view, marking the approach of winter; later we can also see Aldebaran, the bright orange star in the Bull, which is the "advance guard" of Orion's retinue.

technology, investment and resources." (Surprise, surprise!)

Whether the Committee will in fact be able to inject some new ideas (and, equally importantly, more money) into the space industry remains to be seen; we can only hope for the best. The official Press release ends with the statement that further information can be obtained either from Michael Marshall MP, House of Commons (telephone 01-219 4698 and 3462) or Dennis Cummings, Marconi Space Systems (0705 674409).

However the Committee evolves, it will find difficulty in beating one section of the Soviet Civil Service, which really surpassed itself earlier this year. In the USSR, young men are still liable for military service, and in March 1989 a call-up summons was sent by the Army draft centre to one young Soviet citizen, Sergei Krikalev. He was instructed to report to the draft centre to begin his military training. Unfortunately, at that precise moment he was unable to comply. He was, and had been for several months, on board the orbiting Russian space-station Mir!



This photograph shows the newly discovered large jet in the HH 111 complex and has been kindly made available by the European Southern Observatory.

The straight jet emerges from the surrounding interstellar cloud in the lower part of the picture. The outline of the cloud is vaguely visible by the brighter background near the right edge of the picture.

Also seen is a diffuse reflection nebula around the lower part of the jet. This nebula is illuminated by the light from the newborn star, hidden deep within the cloud. Because of the heavy obscuration, the star itself is not visible on this photo.

The jet produces a "bow-shock" nebula; this is the bright, mushroom shaped nebular in the upper part of the picture. The round points are background stars in the Milky Way.

The picture was produced as a composite of four 1 hour ccd exposures, obtained with the Danish 1.5m telescope at La Silla through a narrow optical filter. The light seen here from the jet is emitted by singly ionised sulphur atoms.

PE

TUTORKIT MICROELECTRONICS TUTORS

Logic Tutors
OP Amp Tutors
I.C. Patchboards
GCSE Units
Computer Interfaces

Prices from

**£27.50
PLUS VAT**

Including instruction manual and patch leads

*used by hundreds of schools in U.K. and overseas.

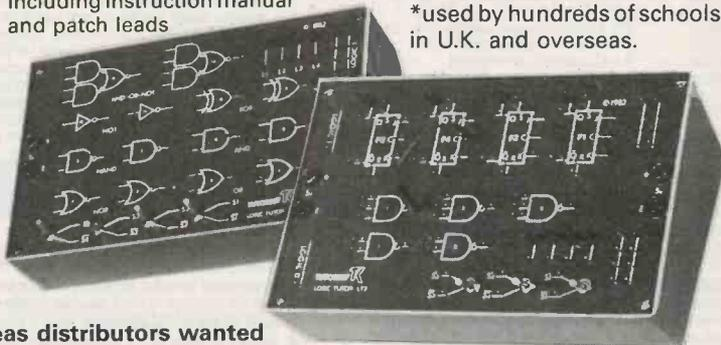

TUTORKIT PRODUCTS
(Div of Limrose Electronics Ltd)
Llay Industrial Estate
Wrexham, Clwyd, U.K.
LL12 0TU. Tel 097 883 2285

Overseas distributors wanted

19" RACK MOUNTING EQUIPMENT CASES

This new range of 19" rack equipment cases have been designed with economy and versatility as their objective. These cases are supplied as a flat pack kit with assembly instructions. The equipment cases feature a black powder coat 1/2" (3mm) aluminum front panel with the rest of the case constructed from 7mm or 9mm Stelvetite PVC coated steel. All kits include front panel handles and rubber feet.

They are available in the following popular sizes with all the units having a standard front panel width of 19", and an enclosure width of 17 1/2" (438mm) by a depth of 10" (254mm)

ORDER	CODE	HEIGHT	PRICE
U1	1 3/4"	(44mm)	19.55*
U2	3 1/2"	(88mm)	23.00
U3	5 1/4"	(133mm)	21.85*
U4	7"	(178mm)	24.50

*Special offer prices for PE readers.

All prices Exclude V.A.T.
Please include £2.50 + VAT. Per Item
For Post & Packing.

Flat pack size = 500 x 260 x 32
Maximum weight = 1.5Kgs.

Blanking Panels, Racking Consoles
and Rack Cabinets also available.

Please send S.A.E. for further details
* TRADE ENQUIRIES WELCOME *

Tel 0275 823983 for Access/Visa card sales for
immediate despatch or send cheque with order to:

**RACKZ PRODUCTS PO, BOX NO. 1402, MANGOTSFIELD, BRISTOL,
ENGLAND. BS17 3RY**

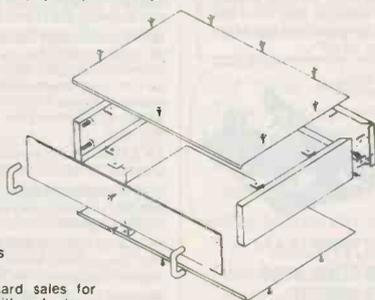

BINDERS for Sale!

Back copies of Practical Electronics are a valuable source of High-Tech information!

Keep them safe in a sturdy, red, gold-embossed binder, which costs only £5-95!

Send your cheque, P.O. or payment by Visa or
Access to: Intra Press (PE Binders), Intra House,
193 Uxbridge Road, London W12 9RA





No. 3 LIST BAKERS DOZEN PACKS

All packs are £1 each, if you order 12 then you are entitled to another free. Please state which one you want. Note the figure on the extreme left of the pack ref number and the next figure is the quantity of items in the pack, finally a short description.

- BD 152 1 Gas or liquid shut off valve, clockwork dial, setting can be on four up to 12 hours.
- BD 153 1 Same as BD 152 but thermostatically operated.
- BD 154 1 12v operated drip proof relay, ideal for outdoor or in-car operation.
- BD 158 41 12 way 5amp screw down polythene bodied connector strips. Used to be called choc blocks when made of Bakelite
- BD 159 2 12 way 25amp connector blocks.
- BD 160 1pf Plug together 12 way connector blocks, ideal for quick joins in leads.
- BD 168 2 Component mounting tag strips each with 50 stand up tags.
- BD 169 42 Short wave air spaced trimmers 3-30pf. Screw driver operated.
- BD 170 4 Assorted neon type numicator tubes made by HIVAC.
- BD 175 1 2watt mains motor driving gearbox, final speed 200rpm.
- BD 177 5 12v Lilliput bulbs.
- BD 178 3 Panel mounting slim line indicator lights with amber lens. These take Lilliput bulbs.
- BD 179 3 Oblong mains neon indicator lights, approx 1in x 1/2in.
- BD 181 100 PVC grommets for insulation through 3/8th hole.
- BD 182 1 25pf air spaced tuning capacitor, small hole fixing with 1/4in spindle.
- BD 189 1 20amp double pole switch on flush plate which fits standard 3x3 electrical box, illuminated when on.
- BD 190 1 20amp dp switch but surface mounting, oblong shape.
- BD 191 6 Lamp holder adaptors which take two pin plug, also supplied.
- BD 200 1 10 digit switch pad, telephone type.
- BD 205 1 Very small 12v operated relay with one pair change-over contacts.
- BD 212 1 Mains transformer 230v primary and two 8v 1/2amp secondaries.
- BD 213 2 5 core curly leads, tinsel wire for phones, etc.
- BD 214 2 Sub-min toggle switches double pole double throw.
- BD 215 4 Mini dpdt slide switches with chrome dolly instead of the usual plastic toggle.
- BD 217 100 Standard wire ending push-ons for standard 1/4in tags.
- BD 218 100 Ditto, but right angled.
- BD 219 100 Soldercon tags. With these you can make your own sockets for ICs etc.
- BD 223 4 1200 watt fire spirals, bright nickel chrome wire.
- BD 224 1 Battery operated motor made for 9v cassette players but speed controllable by lowering voltage.
- BD 227 4 50k quad pots. Standard 1/4in spindle single hole fixing.
- BD 228 1 Ice stat thermostat. Ideal for controlling water pipe antifreeze coils
- BD 229 1 Instrument buzzer, variable low, medium or soft.
- BD 233 2 Eagle educational kits. One makes chemical balance with weights and the other has electricals for experiments.
- BD 234 4 500uf + 500uf 50v electrolytics.
- BD 236 1 Mains transformer with 9v 750mA secondary.
- BD 237 1 Computer grade electrolytic 3150uf at 40v.
- BD 243 2 8 x 4 16ohm loud speakers permanent magnet, 5 watts.
- BD 246 4 Standard size 1/2meg pot with 1/4in spindle and dp switch.
- BD 247 1 The medium wave permeability tuner, couple this to a ZN414 and you have a radio.
- BD 248 1 A noise suppressor/mis filter.
- BD 249 1 13A socket on plate with spur, fits normal electrical box.
- BD 253 1 Oven thermometer - bimetal type, reads 200-500°F.

There are over 1,000 items in our Bakers Dozen List. If you want a complete copy please request this when ordering.

CAMERAS. Three cameras, all by famous makers, Kodak, etc. One disc, one 35mm and one instamatic. All in first class condition, believed to be in perfect working order, but sold as untested. You can have the three for £10 including VAT, which must be a bargain - if only for the lenses, flash gear, etc. Our ref 10P58.

EQUIPMENT WALL MOUNT It is a multi-adjustable bracket that could be used for mounting flood light, loud speaker, TV camera, even a fan and on almost any sort of wall or ceiling even between wall and ceiling. The main fixing brackets rotate such that an inward or an outward corner can be accommodated. Front panel also tilts upward or downwards to a reasonable angle and can be easily removed separately for wiring. A very useful bracket. Regular price would be around £6 each. Our price only £3. Our ref 3P72. Or 2 for £5. Our ref 5P1152.

MICROPHONE LEADS 6m twin screened wire terminating one end with a standard 1/4in mono jack plug and the other with the usual screwed on microphone connector. With coiled spring for lead protection. Price £1. Our ref BD714.

EXTRA SPECIAL CROC CLIPS Medium size, just right for most hook-ups. Normally sell for around 10p to 15p each. These are insulated and have a length of wire connected to them but this is very easy to snip off if you do not need it. 20 for £1. Our ref BD117A.

DON'T MISS THAT IMPORTANT CALL Fit an extension lead and take your phone in the other room with you. 5m long, one end has the standard flat BT socket and the other the standard flat BT plug so you don't have to interfere with the house phone wiring, you simply plug it in. Price £3. Our ref 3PP70.

COPPER CLAD PANEL for making PCB. Size approx 12in long x 8 1/2in wide. Double-sided on fibreglass middle which is quite thick (about 1/4in) so this would support quite heavy components and could even form a chassis to hold a mains transformer, etc. Price £1 each. Our ref BD683.

POWERFUL IONISER

Generates approx 10 times more IONS than the ET1 and similar circuits. Will refresh your home, office, workshop, etc. Makes you feel better and work harder - a complete mains operated kit, cases included. £12.50 plus £2 postage. Our ref 12PS1.

LINEAR RECORD PLAYER Made by BSR, their ref VL315. Hailed as the most sophisticated of record players, is completely electronically controlled. Due to cancelled export order we are now able to offer these brand new, complete with cartridge and diamond stylus at only £15 plus £2 post. This is a 12v DC operated unit. Our ref 15P25. Two or more post free.

VIDEO TAPES These are three hour tapes of superior quality, made under licence from the famous JVC Company. Offered at only £3 each. Our ref 3P63. Or 5 for £11. Our ref 11P3. Or for the really big one 10 for £20. Our ref 20P20.

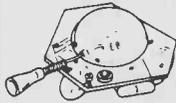

ELECTRONIC SPACESHIP Sound and impact controlled, responds to claps and shouts and reverses when it hits anything. Kit with really detailed instructions. Ideal present for budding young electrician. A youngster should be able to assemble but you may have to help with the soldering of the components on the pcb. Complete kit £8. Our ref BP30.

THERE IS GOING TO BE A BURIAL! For several years now we have been offering mains operated clocks at only £1 each. These are cooker clocks which in addition to telling you the time would also switch things on and off at pre-set times. However, despite this silly price these have been very slow sellers and as we have still almost 10,000 of them in a store which we have to clear we are making one even sillier final offer before burying them. You can have 16 brand new clocks still in original packing for only £5. Our ref 5P151. Add £3 post if not collecting.

BUSH RADIO MIDI SPEAKERS Stereo pair, BASS reflex system, using a full range 4in driver of 40hms impedance. Mounted in very nicely made black finish walnut finish cabinets. Cabinet size approx 8 1/2in wide, 14in high and 3 1/2in deep. Fitted with a good length of speaker flex and terminating with a normal audio plug. Price £5 the pair plus £1 post. Our ref 5P141.

3 1/2 FLOPPY DRIVES We still have two models in stock: Single sided, 80 track, by Chinon. This is in the manufacturers metal case with leads and IDC connectors. Price £40, reference 40P1. Also a double sided, 80 track, by NEC. This is uncased. Price £39.50, reference 60P2. Both are brand new. Insured delivery £3 on each or both.



ATARI 65XE COMPUTER

At 64k this is most powerful and suitable for home and business. Brand new, complete with PSU, TV lead, owner's manual and six games. Can be yours for only £45 plus £3 insured delivery.

65XE COMPENDIUM Contains: 65XE Computer, its data recorder XC12 and its joystick, with ten games for £62.50 plus £4 insured delivery.

AGAIN AVAILABLE: ASTEC PSU Mains operated switch mode, so very compact. Outputs: +12v 2.5A, +5v 6A, +5v 5A, +12v 5A. Size: 7 1/4" long x 4 3/4" wide x 2 3/4" high. Cased ready for use. Brand new. Normal price £30+, our price only £10 plus £1 postage. Our ref 10P34.

VERY POWERFUL 12 VOLT MOTORS. 1/2 Horsepower. Made to drive the Sinclair C5 electric car but adaptable to power a go-kart, a mower, a rail car, model railway, etc. Brand new. Price £15 plus £2 postage. Our ref 15P8.

PHILIPS LASER

This is helium-neon and has a power rating of 2mW. Completely safe as long as you do not look directly into the beam when eye damage could result. Brand new, full spec. £30 plus £3 insured delivery. Mains operated power supply for this tube gives 8kv striking and 1.25kv at 5mA running. Complete kit with case £15. Ditto for 12v battery, also £15. Our ref 15P22.

ORGAN MASTER Is a three octave musical keyboard. It is beautifully made, has full size (piano size) keys, has gold plated contacts and is complete with ribbon cable and edge connector. Can be used with many computers. We can supply information sheet. Brand new, only £15 plus £3 postage. Our ref 15P15.

FULL RANGE OF COMPONENTS At very keen prices are available from our associate company SGS COMPONENTS. You may already have their catalogue, if not request one and will send it FOC with your goods.

A REAL AIR MOVER Circular axial fan. It moves 205 cu.ft per minute which is about twice as much as our standard 4 1/2in square fans. Low noise, mains operated, 6 1/2in diameter. Ex computers. Regular price over £30 but yours for £10 if you order quickly. Our ref 10P71A.

HIGH RESOLUTION MONITOR. In black and white, uses Philips tube M24/305W. Made up in a lacquered frame and has open sides. Made for use with OPD computer but suitable for most others. 5 and new. £16 plus £5 post. Our ref 16P1.

12 VOLT BRUSHLESS FAN. Japanese made. The popular square shape 1 1/2 x 4 1/2 x 1 1/2in. The electronically run fuse not only consume very little current but also they do not cause interference as the brush type motors do. Ideal for cooling computers, etc. or for a caravan. £8 each. Our ref 8P28.

FDD BARGAIN

3 1/2in made by Chinon of Japan. Single sided, 80 track, Shugart compatible interface, interchangeable with most other 3 1/2in end 5 1/4in drives. Completely cased with 4 pin power lead and 34 pin computer lead £40. Plus £3 ins. del. Our ref 40P1.

MINI MONO AMP on p.c.b. size 4" x 2" (app.) Fitted volume control and a hole for a tone control should you require it. The amplifier has three transistors and we estimate the output to be 3W ms. More technical data will be included with the amp. Brand new, perfect condition, offered at the very low price of £1.15 each, or 13 for £12.00.



J & N BULL ELECTRICAL

Dept PE, 250 PORTLAND ROAD, HOVE BRIGHTON, SUSSEX BN3 5QT

MAIL ORDER TERMS: Cash, PO or cheque with order. Orders under £20 add £1.50 service charge. Monthly account orders accepted from schools and public companies. Access and Barclay orders accepted minimum £5. Phone (0273) 734648 or 203500.

NEW THIS MONTH

POPULAR ITEM AGAIN AVAILABLE Twin 0005 tuning capacitor with normal 1/4in spindle now listed by many firms at over £10 each. We have them brand new and in perfect condition at £2 each. Our ref 2P40.

SUB-MIN PUSH SWITCHES Not much bigger than a plastic transistor but double pole. PCB mounting. Three for £1. Our ref BD688.

CARTRIDGES for the Double Microdrive. Price 4 for £5. Our ref 5P146.

NICAD CHARGER UNIT Metal pronged, plastic case contains mains transformer and rectifiers with output lead and plug - mad to charge two cells but no doubt adaptable or wonderful spares value. Only 50p each, two for £1. Our ref BD385.

EDGEWISE PANEL METER If you are short of panel space then this may be the answer. It has a FSD of 100uA and a nice full vision scale. It fits through a hole approx 1 1/4in x 1/2in. Another feature is that it has an indicator lamp behind the scale which you could light up, it would then serve as an on/off indicator. Price £1. Our ref BD700.

AA CELLS Probably the most popular of the rechargeable NICAD types. 4 for £4. Our ref 4P44.

COMPUTER SPECIAL The Perex 16meg Byte tape streamer. These are brand new and really an exceptional bargain. A few only so hurry. Only £15. Our ref 15P29.

20 WATT 40 OHM SPEAKER With built-in tweeter. Really well made unit which has the power and the quality for hi-fi reproduction. 6 1/2in diameter. Price £5. Our ref 5P155. It is heavy so please add £1 to cover postage if not collecting.

MINI RADIO MODULE Only about 2in square with ferrite aerial and solid, dia tuner with its own knob. It is a superhet and it operates from PP3 battery and would drive a crystal headphone direct but be better with our mini mono amp. Price £1. Our ref BD716.

BULGIN MAINS PLUG AND SOCKET The old faithful 3 pin with screw terminals. The socket mounts through a 1 1/2in hole and the mains is brought in by the insulated plug. Used to be quite expensive but you can have 2 pairs for £1 or 4 of either plug or socket for £1. You could make yourself a neat and compact bench panel with these. Our ref BD715, BD715S or BD715P.

MICROPHONE If you want a low cost microphone then just arrange we have a very small hand-held dynamic mic without/on switch in the handle, its lead terminates with one 3.5 plug and the other a 2.5 plug for remote control. Price only £1. Our ref BD711.

EXTENSION CABLE WITH A DIFFERENCE It is flat on one side making it easy to fix and to look tidy. It is 4 core so suitable for telephone, bell, burglar alarms, etc. 50 yard coil for £5. Our ref 5P153.

BATTERY OPERATED TRAVEL MECHANISM On a plastic panel measuring approx 9in x 3 1/2in. Is driven by a reversible 12v battery motor, fitted with pulley and belt which rotates a threaded rod and causes a platform to travel backwards and forwards through a distance of approx 5in. Price £5. Our ref 5P140.

MAINS OPERATED WATER VALVE with hose connection for inlet and outlet suitable for low pressure. Auto plant watering, etc. Only £1 each. Our ref BD370.

20 VOLT 4 AMP MAINS TRANSFORMER Upright mounting with fixing feet. Price £3. Our ref 3P59.

160HM PM SPEAKERS Approx 7in x 4in. 5 watts. Offered at a very low price so you can use two in parallel to give you 10 watts at 8 ohms. £1 for the two. Our ref BD684.

EHT TRANSFORMER 4kv 2mA Ex-unused equipment. £5. Our ref 5P139.

4 CORE TINSEL COPPER LEAD As fitted to telephones, terminating with flat BT plug. 2 for £1. Our ref BD639.

EHT TRANSFORMER 8kv 3mA. £10. Our ref 10P56.

VERY USEFUL MAGNETS Flat, about 1in long, 1/2in wide and 1/4in thick. Very powerful. 6 for £1. Our ref BD274(a).

ACORN COMPUTER DATA RECORDER REF ALF03 Made for the Electron or BBC computers but suitable for most others. Complete with mains adaptor, leads and handbook. £10.00. £2 special packing. Ref 10P44.

SOLAR POWERED NI-CAD CHARGER 4 Ni-Cad batteries AA (HP7) charged in eight hours or two in only 4 hours. It is a complete, powered ready to use unit. Price £6. Our ref 6P3.

METAL PROJECT BOX Ideal size for battery charger, power supply etc.; sprayed grey, size 8in x 4 1/4in high, ends are louvred for ventilation other sides are flat and undrilled. Price £3. Order Ref. 3P75.

13A PLUGS Good British make complete with fuse, parcel of 5 for £2. Order ref. 2P186.

13A ADAPTERS Takes 2 13A plus, packet of 3 for £2. Order ref. 2P187.

28V-0-20V Mains transformers 2 1/2 amp (100 watt) loading, tapped primary. 200-245 upright mountings £4. Order ref. 4P24.

CAPACITOR BARGAIN - axial ended, 4700uF at 25V. Jap made, normally 50p each, you get 4 for £1. Our ref. 613.

SINGLE SCREENED FLEX 7.02 copper conductors, pvs insulated then with cooper screen; finally outer insulation. In fact quite normal screened flex. 10m for £1. Our ref BD686.

3-CORE FLEX BARGAIN No. 1 - Core size 1.25mm so suitable for long extension leads carrying up to 13amps, or short leads up to 10amps. 15m for £2. Ref. 2P190.

3-CORE FLEX BARGAIN No. 2 - Core size 1.25mm so suitable for long extension leads carrying up to 13amps, or short leads up to 25A. 10m for £2. Ref. 2P190.

ALPHA-NUMERIC KEYBOARD - This keyboard has 73 keys giving trouble free life and no contact bounce. The keys are arranged in two number pad, board size is approx. 13" x 4" - brand new but offered at only a fraction of its cost, namely £3 plus £1 post. Ref. 3P27.

1/8TH HORSEPOWER 12 VOLT MOTOR Made by Smiths, the body length of this is approximately 3in, the diameter 3in and the spindle 3/8th of an inch diameter. It has a centre flange for fixing or can be fixed from the end by means of 2 nuts. A very powerful little motor which revs at 3,000 rpm. We have a large quantity of them so if you have any projects in mind then you could rely on supplies for at least two years. Price £5. Our ref 6P1, discount for quantities of 10 or more.

3 VOLT MOTOR Very low current so should be very suitable for working with solar cells. £1 each. Our ref BD681.

STEREO HEADPHONE AMPLIFIER Very sensitive. A magnetic cartridge or tape head will drive it. Has volume control and socket for stereo headphones. 3v battery operated. £1 each. Our ref BD680.

FET CAPACITOR MICROPHONE EAGLE C100 Output equivalent to a high class dynamic microphone while retaining the characteristics of a capacitor microphone. Price £1. Our ref BD646.

SUM-MIN TOGGLE SWITCH Body size 8mm x 4mm x 7mm SBDT with chrome dolly fixing nuts. 4 for £1. Our ref BD649.

SUB-MIN PUSH SWITCH DPDT. Single hole fixing by hexagonal nut. 3 for £1. Our ref BD650.



CONSTRUCTION

The usual method of circuit board assembly is suggested, starting with the smaller components, resistors and diodes, and leaving the ics until last. It is recommended that good quality sockets be purchased for the ics as some cheaper sockets have reliability problems caused by oxidation of the contacts.

The relays are the 'ultra miniature' type (6V operation) and may be soldered direct to the pcb.

A heatsink is required for IC5 and can be made from a piece of aluminium cut to fit vertically along the side of the box.

The terminal blocks for the alarm circuits are fitted to a piece of plastic sheet which is supported above the upper part of the main pcb with spacers. The terminal blocks are then wired to the pcb as shown in Fig.12.

A miniature micro switch can be mounted inside the case with two small screws. The alarm wiring to connection 9 can be diverted through the switch, so when the lid of the alarm controller is removed the micro switch will break the circuit and set off the alarm.

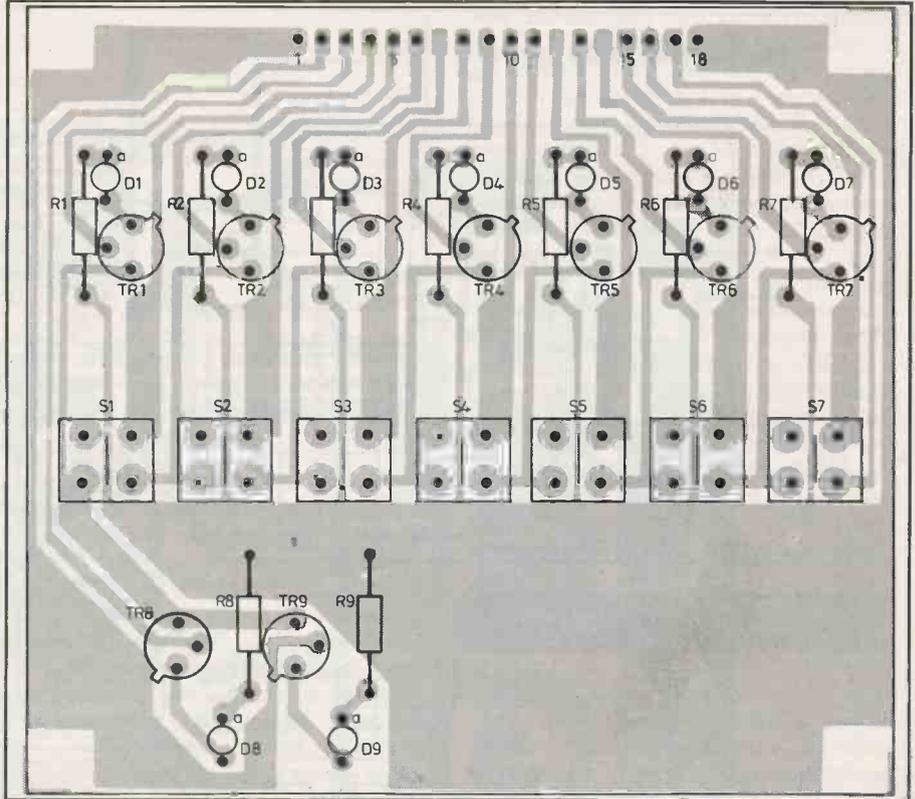

HOME SECURITY CONTROLLER

The display pcb may be a slightly awkward section to assemble. First fit all the resistors, and then fit the transistors as close to the pcb as possible. Next fit the switches, ensuring correct orientation and checking alignment and clearance between each one. Then fit the led clips to the front panel and insert the leds the correct way up, but without using the securing collars. Thread the leds onto the pcb and mount the pcb in place on the front panel, ensuring that the switches protrude evenly through it. Finally, solder the leds in place. The wiring of the display panel to the plug PL1 is shown in Table 1.

The standby battery and siren control is a straightforward assembly. However, since this board is designed to be mounted within an external siren housing it will need protection from damp by a coating of lacquer or varnish on both sides. A heatsink is required for TR2. This transistor should be mounted in the centre of the heatsink and insulated from it. It should be wired to the pcb. The pcb itself can be mounted on the heatsink spaced by 10cm spacers. The connecting block can also be mounted on the heatsink (see Fig.12 last month) and wired to the pcb as shown. The standby battery is connected to the pcb with two spade type terminals on the end of flexible leads.

**PART TWO
BY KEVIN BROWNE**

Details of the construction and hex listing for the project designed to assist you in your own crime watch scheme.

TESTING

A thorough check of all wiring and soldering should be undertaken before connecting any power to the circuit. Links should be inserted to form the closed loop circuits. Option switches S1 and S2 should be set as required, as in Table 2.

Without IC3 inserted or any battery connected, connect the psu to the circuit. A check should then be made of all the power supply voltages. Using a wire link in the socket of IC3 connect each of pins 12 to 19, 35 and 36 to 0V turn and check the

appropriate led or relay operates. See Table 3. Check also that pin 1 is 0V and pin 40 is +5V. Check that operation of each of the keys in turn take the appropriate pin 27-34 to the 0V line.

Connect battery B2, remove the mains power, and check that 5V is maintained at pin 40 of IC3. Finally disconnect all power.

Now insert IC3, reconnect the power and run a check on all facilities of the alarm unit.

The standby battery control board can now be connected and tested. First connect a 120 ohm 1W resistor in place of the standby battery. Connect the control board to the Alarm Control Unit and adjust VR1 until a voltage of between 13.5V and 13.8V is measured across the 120 ohm resistor. Increase the current drawn from the charge supply ensuring that the current limit operates at around 800mA. Replace the dummy load with the standby battery and check that it is charging satisfactorily.

Next, check that the alarm relay will operate when an alarm condition is sent from the main control unit, and that the charge supply to the battery is removed. Then disconnect the mains from the control unit and check that the standby battery takes up the load. Finally, check that disconnecting the alarm input lead will operate the alarm relay for approximately five minutes before resetting.

Fig.14. Main PCB layout

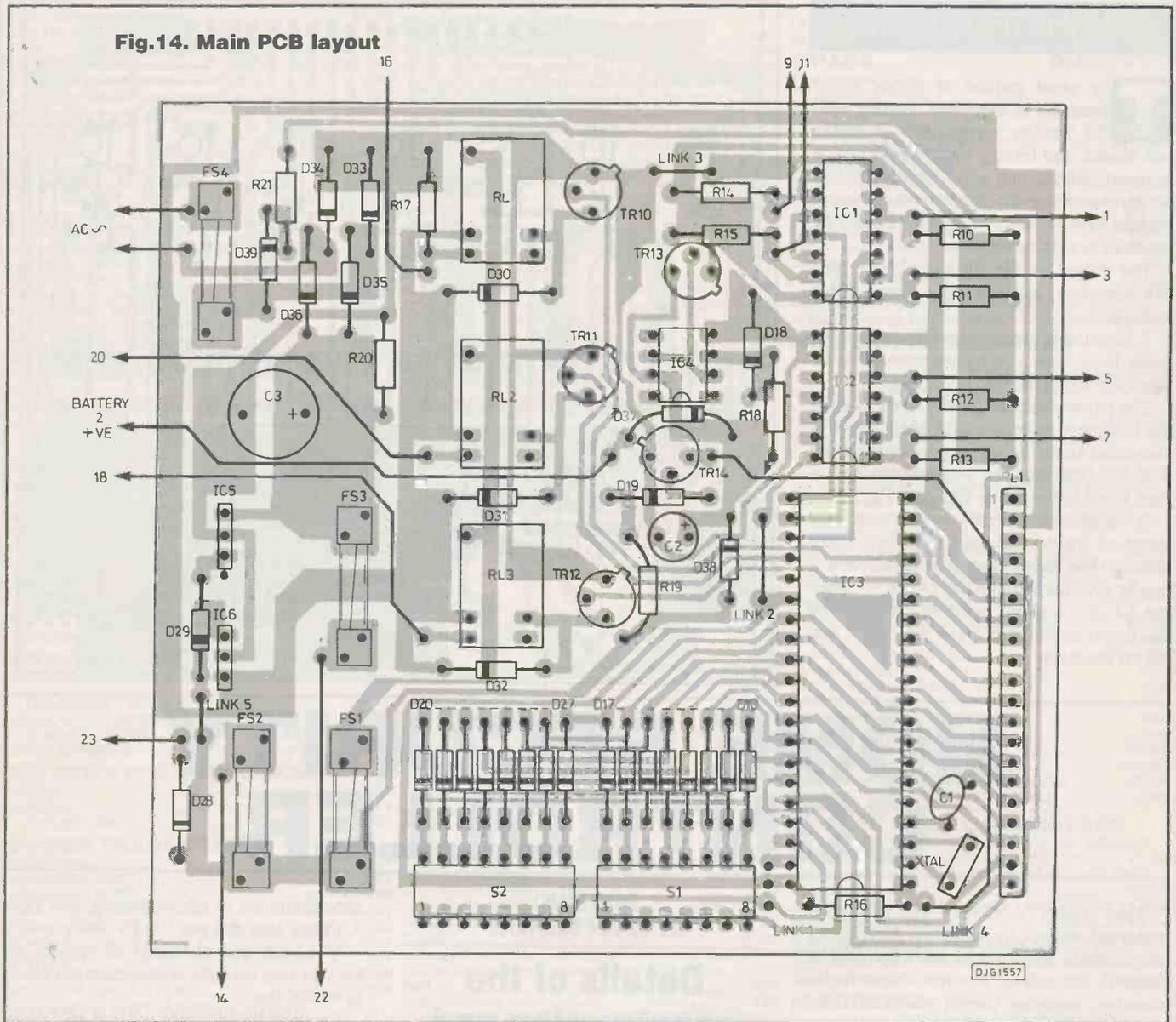

DJG1557

Fig.15. Standby battery control pcb layout

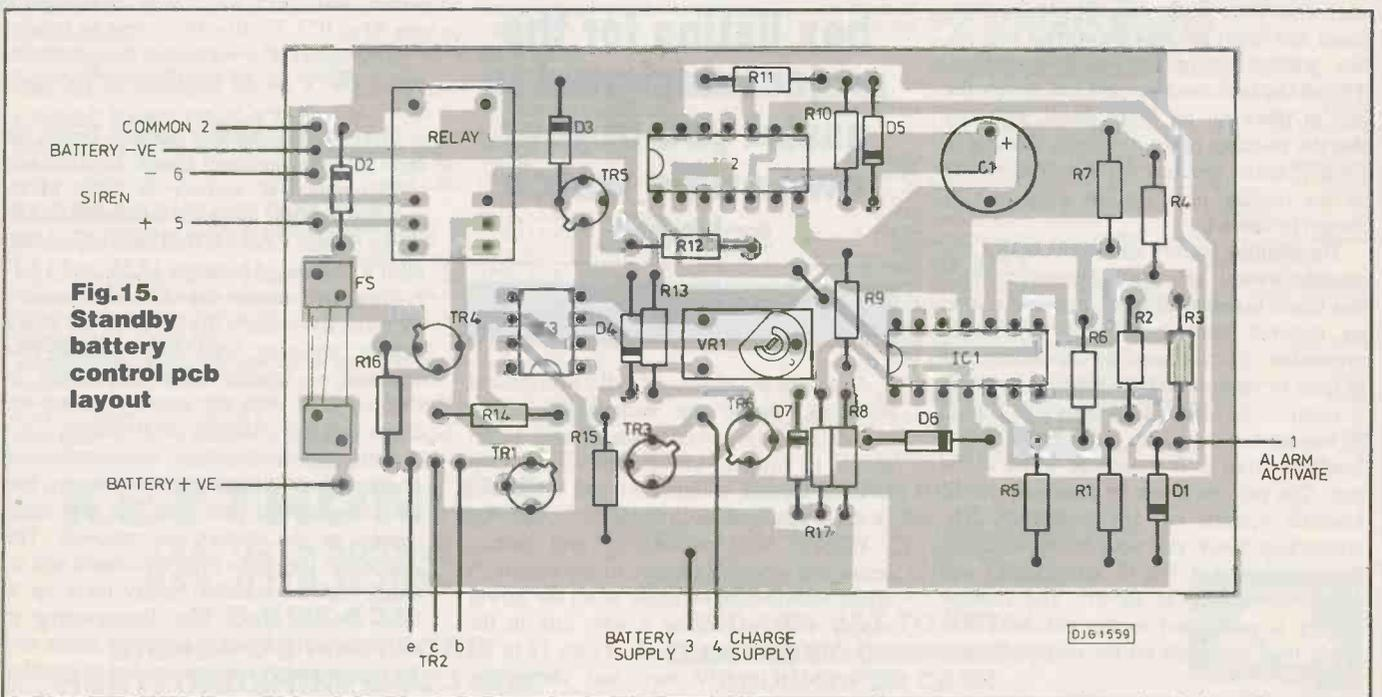

DJG1559

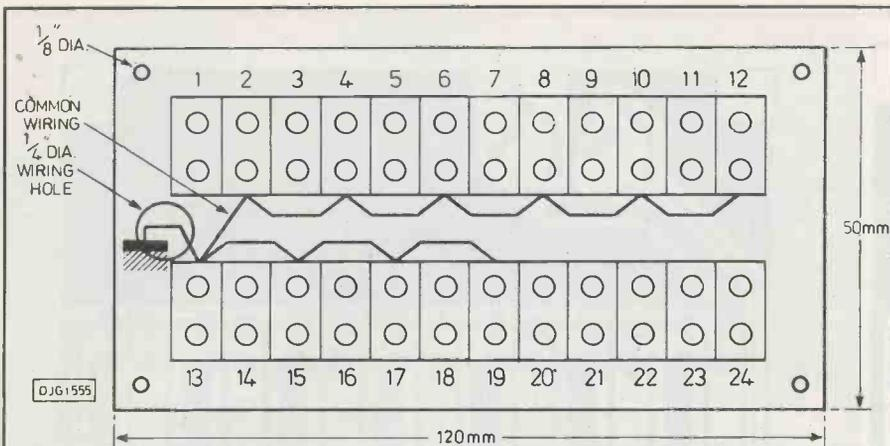

- | | |
|---------------------------|---------------------------------|
| 1 ZONE 1 closed loop. | 13 - external feed. |
| 2 ZONE 1 closed loop. | 14 + external feed. |
| 3 ZONE 1 open loop | 15 - main siren/common. |
| 4 ZONE 1 open loop. | 16 + main siren/alarm activate. |
| 5 ZONE 2 closed loop. | 17 - entry.exit buzzer. |
| 6 ZONE 2 closed loop. | 18 + entry /exit buzzer. |
| 7 ZONE 2 open loop. | 19 - strobe light. |
| 8 ZONE 2 open loop. | 20 + strobe light. |
| 9 FIRE ZONE closed loop. | 21 spare. |
| 10 FIRE ZONE closed loop. | 22 + charge supply. |
| 11 FIRE ZONE open loop. | 23 + batt supply. |
| 12 FIRE ZONE open loop. | 24 spare. |

Notes. Connection 9 can be wired through a microswitch to provide anti-tamper protection for the Alarm Controller Case. Connections 15 and 16 alternative use will depend upon a standby battery control option being fitted or not.

Fig.16. (above) Alarm controller connections.
Fig.17. (below) PCB track for main board.

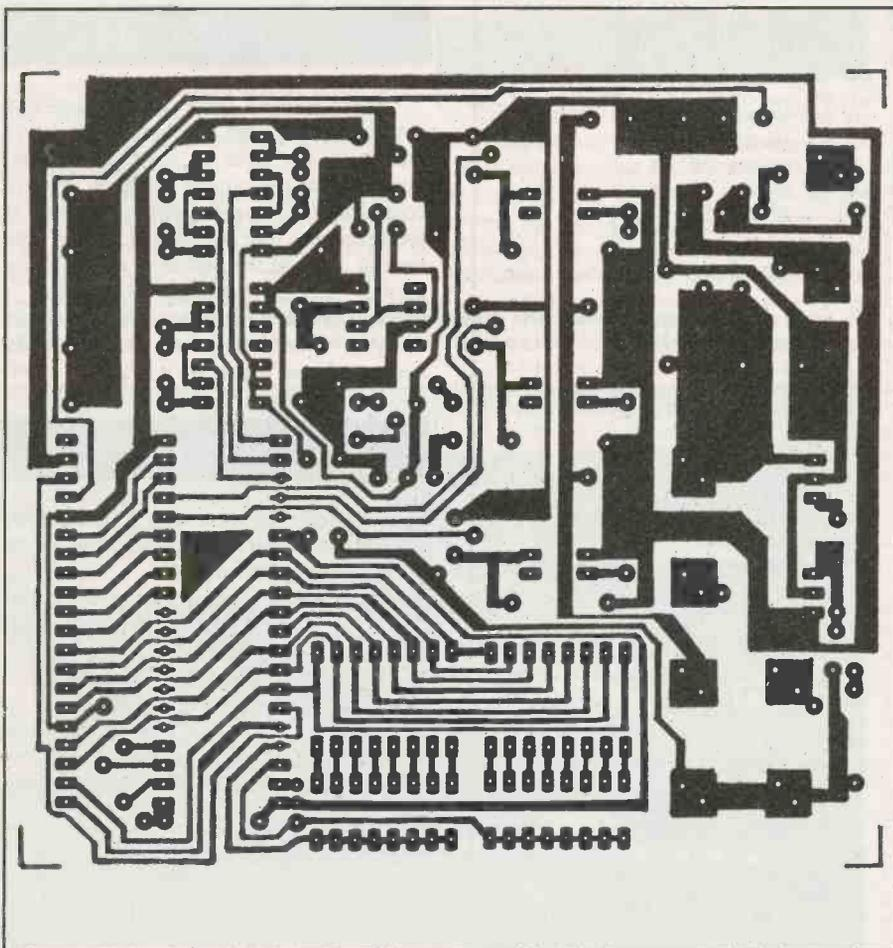

Table 1 Plug P1 to Display PCB Wiring.

PLUG PIN	DISPLAY PCB	Use
1	-	not used
2	18	+5 volts
3	11	Battery low led
4	13	Power led
5	17	Ground
6	1	Zone 2 off led
7	2	Zone 1 off led
8	15	System on led
9	7	Zone 2 alarm led
10	5	Zone 1 alarm led
11	9	Fire zone alarm led
12	10	Key switch '1'
13	12	Key switch '2'
14	14	Key switch '3'
15	16	Key switch '4'
16	-	Ground
17	4	Key switch 'Test'
18	6	Key switch 'Zone 1'
19	8	Key switch 'Zone 2'
20	3	Fault led

Table 2 OPTION SWITCH SETTINGS

SWITCH BLOCK 1 (UPPER)			SWITCH BLOCK 2 (LOWER)		
8 Grey	Main alarm time	b	1st key of code	a	
7 Purple	Main alarm time	a	1st key of code	b	
6 Blue	Entry delay	c	2nd key of code	a	
5 Green	Entry delay	b	2nd key of code	b	
4 Yellow	Entry delay	a	3rd key of code	a	
3 Orange	Exit delay	c	3rd key of code	b	
2 Red	Exit delay	b	4th key of code	a	
1 Brown	Exit delay	a	4th key of code	b	

MAIN ALARM TIME

'b'	'a'	
on	on	5 minuits
on	off	10 minuits
off	on	15 minuits
off	off	20 minuits

SECURITY CODE

'b'	'a'	
on	on	one
on	off	two
off	on	three
off	off	four

ENTRY AND EXIT DELAYS

'c'	'b'	'a'	
on	on	on	nil
on	on	off	10 seconds
on	off	on	20 seconds
on	off	off	30 seconds
off	on	on	40 seconds
off	on	off	50 seconds
off	off	on	60 seconds
off	off	off	70 seconds

Table 3 8748 PORT ALLOCATION

'BUS'			
0 (12)	Fire zone alarm indication output	LED 4	
1 (13)	Zone 1 alarm indication output	LED 2	
2 (14)	Zone 2 alarm indication output	LED 3	
3 (15)	System on indication output	LED 7	
4 (16)	Entry/Exit sounder output	RL 3	
5 (17)	Main siren output	RL 2	
6 (18)	Zone 1 off indication output	LED 8	
7 (19)	Zone 2 off indication output	LED 9	

'Port 1'			
0 (27)	Key 1	Exit data 0	4th code 1
1 (28)	Key 2	1	0
2 (29)	Key 3	2	3rd code 1
3 (30)	Key 4	Entry data 0	0
4 (31)	-	1	2nd code 1
5 (32)	Test/clear	2	0
6 (33)	Zone 1 on/off	Alarm time 0	1st code 1
7 (34)	Zone 2 on/off	1	0

'Port 2'			
0 (21)	Fire zone alarm input		
1 (22)	Zone 1 alarm input		
2 (23)	Zone 2 alarm input		
3 (24)	Strobe indicator output	RL 2	
4 (35)	Battery low indicator output	LED 5	
5 (36)	Fault indicator output	LED 1	
6 (37)	Interrogate dil switch 1		
7 (38)	Interrogate dil switch 2		
T0 (1)	Mains power present input		
T1 (40)	Aux (B2) battery in use input		

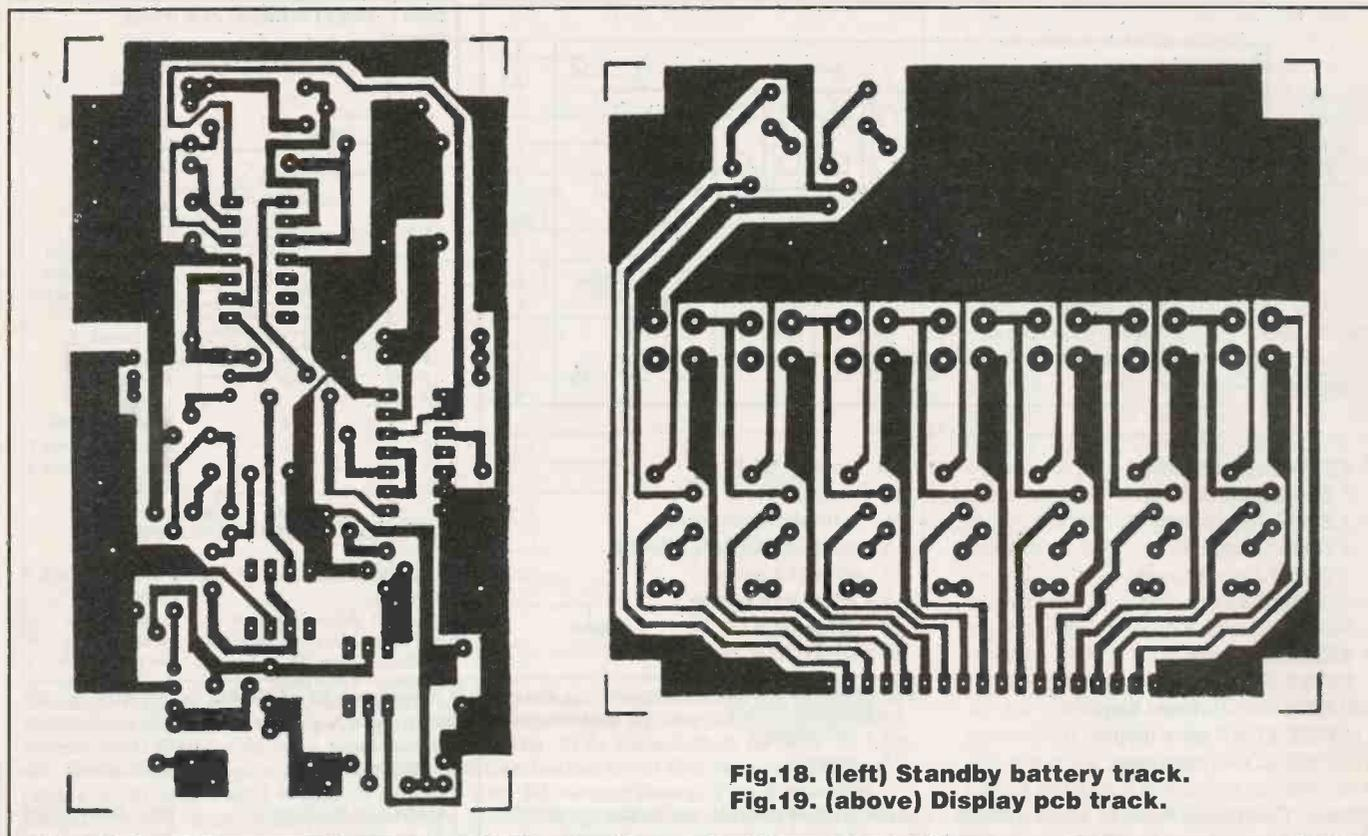

Fig.18. (left) Standby battery track.
Fig.19. (above) Display pcb track.

0000	-	04	42	00	00	00	00	d5	af	fa	c6	0d	ca	fb	c6	11	-	(33)	
0010	-	cb	fc	c6	17	cc	ff	93	bc	32	cd	fe	96	21	c5	54	c6	-	(51)
0020	-	d5	b8	28	54	95	c5	fa	d5	f2	15	b8	2a	54	95	96	3e	-	(d8)
0030	-	b0	04	b8	2c	54	95	96	15	23	10	14	be	04	15	36	32	-	(b2)
0040	-	04	15	b8	02	b9	3e	27	a0	18	e9	46	54	b5	23	ff	14	-	(17)
0050	-	c5	14	aa	54	a7	ba	07	bd	07	54	d0	25	55	14	79	c6	-	(f4)
0060	-	65	14	cb	a5	b5	54	2f	96	4e	23	20	14	c5	27	5d	c6	-	(8b)
0070	-	73	54	09	54	58	34	f1	04	5d	09	37	53	ef	a9	96	85	-	(48)
0080	-	af	d5	aa	a5	93	df	c6	91	f9	af	d5	ba	03	be	0a	27	-	(c5)
0090	-	93	d5	4a	c6	97	27	93	4e	c6	95	c5	27	76	9f	f9	93	-	(ff)
00a0	-	a8	96	a5	27	93	27	69	a8	a6	93	b8	23	40	02	a0	83	-	(8e)
00b0	-	b8	23	37	50	02	a0	83	d5	ad	27	4d	96	b9	93	b8	24	-	(3b)
00c0	-	37	50	3a	a0	83	b8	24	40	3a	a0	83	a9	fa	72	ef	b8	-	(19)
00d0	-	23	f0	37	92	ef	b2	ef	23	0f	59	c6	df	14	ff	83	23	-	(55)
00e0	-	c0	59	c6	e7	34	3f	83	23	20	59	c6	ee	34	51	93	23	-	(47)
00f0	-	0f	59	c6	f7	34	a8	83	23	20	59	c6	fe	54	cc	93	54	-	(eb)
0100	-	2f	c6	08	23	20	14	be	83	bd	07	23	10	14	b0	b8	20	-	(28)
0110	-	f0	53	07	b9	0a	14	a0	b8	28	a0	14	79	96	1a	14	79	-	(0b)
0120	-	53	0f	96	29	b8	28	f0	96	1e	23	10	14	aa	54	2f	c6	-	(df)
0130	-	36	23	20	14	be	83	23	08	4a	aa	23	08	14	b0	83	b8	-	(17)
0140	-	23	a9	d0	a0	02	53	c0	e7	e7	a9	23	f9	5a	49	aa	-	-	(18)
0150	-	83	b8	24	f0	72	5b	23	08	14	c5	83	54	b5	54	d0	23	-	(f3)
0160	-	07	14	b0	23	0a	14	b7	23	07	14	aa	54	2f	c6	74	23	-	(8b)
0170	-	20	14	be	83	23	10	14	b0	23	05	14	b7	23	10	14	aa	-	(50)
0180	-	23	08	14	be	23	05	14	b7	23	08	14	c5	54	2f	c6	95	-	(d2)
0190	-	23	20	14	be	83	23	20	14	b0	23	03	14	b7	23	20	14	-	(e7)
01a0	-	aa	36	90	23	20	14	c5	83	b9	ff	19	67	e6	aa	fc	e7	-	(ba)
01b0	-	e7	49	ac	1b	23	04	db	c6	ba	83	b8	21	f0	dc	18	96	-	(4f)
01c0	-	c4	34	d3	83	10	bc	00	bb	00	23	03	d0	96	d2	23	01	-	(57)
01d0	-	54	09	83	23	08	14	c5	54	2f	53	01	37	53	07	ad	85	-	(7e)
01e0	-	23	38	14	aa	54	c6	27	b8	29	a0	c8	a0	23	f7	5a	aa	-	(61)
01f0	-	83	23	07	dd	c6	fd	d5	23	07	5d	c5	c6	fe	83	54	2f	-	(38)
0200	-	a9	fd	37	59	37	53	07	ad	83	b6	2e	b8	20	a9	07	c6	-	(29)
0210	-	28	fa	37	72	2e	f9	5a	c6	2e	52	28	23	38	50	77	77	-	(53)
0220	-	77	b9	0a	14	a0	b8	28	a0	23	10	14	b0	85	95	83	0a	-	(0c)
0230	-	53	07	a9	96	3e	d5	ab	c5	23	07	14	aa	27	93	de	c6	-	(62)
0240	-	48	f9	ae	d5	bb	03	27	93	d5	4b	c6	4e	27	93	c5	23	-	(12)
0250	-	07	14	aa	f9	14	b0	f9	93	b6	5b	83	b8	29	f0	96	88	-	(91)
0260	-	c8	f0	96	88	b8	23	f0	92	89	23	10	14	aa	23	20	14	-	(04)
0270	-	b0	23	08	14	be	b8	20	23	c0	50	e7	e7	17	a9	23	2c	-	(95)
0280	-	14	a0	b8	28	a0	f9	18	a0	93	23	20	14	aa	85	54	2f	-	(81)
0290	-	37	53	07	ad	83	f0	c6	9c	07	a0	17	83	18	f0	c6	a6	-	(c8)
02a0	-	07	a0	17	c8	b0	ff	83	b8	2d	b0	ff	c8	b0	ff	c8	b8	-	(43)
02b0	-	04	c8	b0	00	83	b8	20	23	bf	3a	09	a0	18	23	7f	3a	-	(90)
02c0	-	09	a0	23	ff	3a	83	f8	b8	22	b0	00	a8	27	ab	ac	83	-	(b3)
02d0	-	b9	80	46	db	23	bf	3a	56	db	b9	00	23	ff	3a	23	7f	-	(5e)
02e0	-	5a	49	aa	83	00	00	00	00	00	00	00	00	00	00	00	00	-	(d0)

The full hex dump for the home alarm microcontroller is shown on the left.

INSTALLATION

This is where I leave you to your own devices. It is worth mentioning, however, that it is advisable to spend some time planning the positioning of alarm sensors, control unit, etc, paying careful attention to protection of your house and at the same time to some of the problems of wiring the various sensors together. Remember, a successful alarm system gives a potential thief no chance to attack or disable the system without triggering it first.

REFERENCE

Two useful reference books are available for anyone interested in more detail on the 8748 microcontroller.

1. *Practical Electronics Microfile* October 1983 A brief guide to the 8748 microcontroller.
2. *Embedded Controller Handbook*. A detailed handbook covering all aspects of MCS-48, MCS-51 and MCS-96 microcontrollers and peripheral devices. (Available from Intel 0793 696000 price £17.00.)

Free Reader Adverts

Searching for that elusive component? Surplus equipment to sell? Read the rules and fill in the form below to have your free ad published in PE BAZAAR.

80C85 Computer Telephone Boards with UART, PIAs, RTC etc. Ideal stand alone controller, only £12 inclusive. Tel: Steve on 01-701 4331.

V23 Viewdata terminals keyboard acoustic coupler uncased, working, £35, others £20 or job lot £150. Mr. M. Stenson, 6 Chestnut Walk, Omersley, Dr. Droitwich Worcs WR9 0EB. Tel: (0905) 620207.

Can someone make me up a switch giving either mains power or tv aerial? Please phone Geoff on (0737) 766963.

Wanted: Hameg scope with component tester, preferably working, up to £100 paid. Electronics student. Mr. S.M. Harvey, 124 Cadge Road, Norwich, Norfolk NR5 8DD. **Commodore CBM 4032.** Wanted circuit diagrams and/or service data or manual. L. Harris. Tel: 01-533 2052.

Maplin 27MHz transmitter and receiver. Built and working complete with X'Tal set, £12. Tel: 01-792 8463.

"Electronic Acupuncture Outfit" Has anyone circuit or information? Please phone expenses repaid. Mr. D.E. Barrett, 31 Belmont Road, St. Andrews, Bristol BS6 5AW. Tel: (0272) 241383.

Components and test gear to clear. i.c.s., caps, tools, testers, etc. Please send s.a.e. for list. D. Collins, 11 Stafford Close, London NW6 5TW.

Clear plastic component bags, new top quality 5" x 7", ideal. Screws, nuts and bolts £2.50 for 50, £5 for 100 by post. Mr. D. Martin, 6 Downland Gardens, Epsom, Surrey KT18 5SJ.

AVO Multiminor £20. Fluke digital multimeter £50. Tel: 01-554 2913 6-8 p.m.

Audio wattmeter AWIU by Heath £15 o.n.o. Dawe stroboscope model 1214, £25. D.K.R. Russell, 9 South Beach Road, Ardrossan, Ayrshire KA22 8AX. Tel: (0294) 64144.

Digital Poly-whatsit can anyone help me to get mine to work as I cannot. Cherry Tree Cottage, Arundel Road, Boxgrove, West Sussex PO18 0DU. Tel: (0243) 784535.

Wanted: Any data on older Commodore 128s (i.e.) (PC 500) any damaged 128s or cheap C64 music keyboard. M. McKay-Dirden, 58 Queens Gardens, Wednesbury, W. Midlands WS10 7PF. Tel: (021) 502 3511.

Fuzz Box: Lovely sound £9.50. Bags of 555 ics, 741 ics diodes, transistors 8 + 14 pin sockets £5.25 by post. Mr. D. Martin, 6 Downland Garden, Epsom, Surrey KT18 5SU.

300 Assorted valves, old types, new types still in boxes, one off, £65. Mr. T. Mooney, 12 Ackroyd Avenue, Abbey Hey Gorton, Manchester M18 8TL. Tel: (061) 370 3191.

Hundred assorted transformers (small £1 each) variacs (one 4KW), oscilloscope £10, other items, see full list. S. Wozmak, The Jays, Bell Lane, Bedmond Watford Kings Langley (09277) 65486.

Wanted: PE Band box and PE master rhythm units, working or otherwise. Mr. J.C. Rixon, 10 Hartwell Road, Hanslope Milton Keynes MK19 7BZ. Tel: (0908) 511195.

For Sale: PCBs, excellent condition, bulk stock, good range of components and integrated circuits. Michael Mattinson, Mattinsons Yard, Station Road, Wigton, Cumbria CA7 9BA. Write only.

Urgently Wanted: Chips by Curtis Electromusic Specialists, especially CEM3310, CEM3320, CEM3330, CEM3340 or any information. Contact: Mr. N. Gallagher, 23 Stratheden Park, Cupar, Fife KY15 5RP/Tel: (0334) 56507.

Wanted: Book, Programming Programmable Calculator by Harold Engelsohn, condition and price to F. Hill, 19 Leith Road, Sale, Cheshire M33 2LR. Tel: (061) 973 3559.

Shack clearance send sae for full list of radios, components, motors, PSUs, scopes plus loads more. Mr. N. Jenkey, 23 Silverton Road, Liverpool L17 6AT.

Desperately wanted: Valve amp theory books/circuits. Also O/T for single EL84 valve amp will pay! Richard Vernon, 319 Archway Road, Highgate London N6.

For sale: 4 channel 4 program lighting controller. 5 available £30 each. More information on request. The Ultimate Roadshow, 8 Woodland Avenue, Congleton, Cheshire CW12 1LN.

Philips colour monitor CM8055. New £150 Philips amplifier. 60 watts £30 ono. Tel: 01-997 5396.

Hameg oscilloscope 203.6 dual trace 20MHz component tester + probes only five months old as new. £225. Tel: (0272) 429758.

Wanted: circuit and service data for Hitachi Opus 1 CD system. Tel: (0235) 23626

A500, modulator, mouse, 2 joysticks, 3 programmer manuals, 52 games, worth £2000, sell £500. Phone: Simon (061) 440 9861.

Newnes radio and tv servicing. 26 volumes 1956 to 1980 plus card index. Offers: Phil (0252) 875390.

Tandy model 1 level 2. Four disc drives, manuals etc. £100 or offers. Tel: 091 4695111.

Small AVO£20. Clamp meter £15. Fluke digital meter £50. Tel: 01-554 2913 6-9pm.

Telequipment type D43 twin beam oscilloscope with amplifiers A and C working order. Buyer collects £50. P. Thompson, Lyndhurst, Pearcroft Road, Stonehouse, Glos GL10 2JY. Tel: (0453) 823188 (evenings).

Free: printed circuit boards, assorted designs and sizes. Just boards 10 kilos in a box. Send £5.50 p&p. Mr. D. Payne, 6 Avenue Melidon, Canon, Honiton, Devon EX14 8TT.

Wanted: Maplin combo amp PCB and TCA350Z bucket brigade device to finish project. Tel: (0926) 497056.

PE BAZAAR

Name & Address			

Please publish the following small ad. FREE in the next available issue. I am not a dealer in electronics or associated equipment. I have read the rules.
Signature.....Date.....

RULES Maximum of 16 words plus address and/or phone no. Private advertisers only (trade or business ads. can be placed in our classified columns). Items related to electronics only. No computer software. PE cannot accept responsibility for the accuracy of ads. or for any transaction arising between readers as a result of a free ad. We reserve the right to refuse advertisements. Each ad. must be posted within one month of cover date. (One month later for overseas readers).
Send this form (or a photocopy of it) to:
PE Bazaar, Practical Electronics, 193 Uxbridge Road, London W12 9RA.

PRACTICAL ELECTRONICS CLASSIFIED

Reach thousands of serious electronic and computer enthusiasts. Advertise in PE Classified pages: Rates 20p per word or £8.50 per single column cm (plus VAT). All classified advertisements must be pre-paid. Send your copy with the remittance (payable to Intra Press or payment by Visa or Access accepted) to: Practical Electronics, Intra House, 193 Uxbridge Road, London W12 9RA. Tel: 01-743 8888. Fax: 01-743-3062
LET PE WORK FOR YOU!

EDUCATION

FULL-TIME TRAINING COURSES

2 YEAR

BTEC NATIONAL DIPLOMA
 Electronics and Communications Engineering
 (TV, Computers, Programming, IT)

1 YEAR

BTEC NATIONAL CERTIFICATE
 1. Electronic Equipment Servicing (TV, Video, CCTV)
 2. Computing Technology (Microprocessors, DataComms, Interfacing)
 3. Information Technology (Telecomms, Satellite TV, Networks)
 4. Software Engineering (Assembler, BASIC, Pascal, CAD/CAM)

★ Those eligible can apply for E.T. grant support ★

★ An equal opportunities programme ★

COURSES COMMENCE
 Monday 18th Sept. 1989

LONDON ELECTRONICS COLLEGE

Dep: AA, 20 Penywern Road,
 London SW5 9SU. Tel: 01-373 8721

Start training now for the following courses.

- Telecomms Tech C&G 271
- Radio Amateur Licence C&G
- Microprocessor
- Introduction to Television

Send for our brochure - without obligation or telephone us on 06267 79398 (Ref: PE10/89)
 Name.....

Radio & Telecommunications
 Correspondence School,
 12 Moor View Drive, Teignmouth,
 Devon TQ14 9UN

RETAILERS

BATH

L.F. HANNEY

77 Lower Bristol Road, Bath,
 Avon.
 Tel: 0225-24811

Your electronics component specialist for
 AVON, WILTS. & SOMERSET
 Open every day, except on Thursday

EDINBURGH

OMNI ELECTRONICS

stock a wide range of
 electronic components at
174 Dalkeith Road
Edinburgh EH16 5DX
Tel: 031 667 2611

Open Mon-Fri 9am-6pm
 Sat. 9am-5am

Send 2x19 stamps for CURRENT CATALOGUE!

LONDON EAST

A & G ELECTRONICS LTD

If you are buying Electronics Components elsewhere you are almost certainly paying too much!. Write to us for a free 1989 catalogue and start saving money. Please send two 19p stamps towards postage.

100 Park Avenue, London, E6 2SR. Tel: 01-552 2386

LONDON S.WEST

MULTILODE LTD

For electronics components, leads, aerosols, aerials, I.C.'s, diodes, video heads, tools, telephone accessories, books, magazines etc., etc., etc.,
 Multilode Ltd. 7 Arlington Parade, Brixton Hill,
 SW2 1RH Tel: 01-326 1793
 Open Mon to Sat 9am to 6pm

MANCHESTER

DEANSGATE ELECTRONICS

We stock a large range of electronic components, test equipment, telephone accessories, computer accessories, microphones, speakers, disc lighting, mixers, meters, stylus, so call in and have a look around.

263 Deansgate, Manchester
 Telephone: 061-834 1185

SOUTHSEA

ELECTRONIC COMPONENTS

EVERYTHING FOR YOUR NEXT PROJECT
 THE BIGGEST DISPLAY IN THE SOUTH IS AT

FRASER ELECTRONICS

42 ELM GROVE ★ SOUTHSEA ★ HANTS
 Telephone: 0705-815584

Barclaycard

Access

STAFFORDSHIRE

MAGENTA ELECTRONICS LTD

For top low-price kits see our ad. on pages 10 and 11. We supply full kits including PCBs, hardware, components and cases.

STOKE-ON-TRENT

ANDOR ELECTRONICS

11 Victoria House,
 Paxton Street,
 Hanley,

Stoke-on-Trent, ST1 3SD
 Tel: 0782 283642

SURREY

PLS

16 Central Road
 Worcester Park
 Surrey KT4 8HZ
 Tel: 01-330 6540

Programmable device specialists.
 (PAL's PROM's, PLD's etc). Many other components in stock

Resistors 1/4 W 5% carbon (E12) 1p metal film 1%3p
 Resistor Pack 85 different E12 values + zero ohm link total content
 1000 resistors£8.95
 LEDs red/green 3/5mm6p each. Yellow 11p
 Cable ties 75mm1p each £5.95/1,000 £49.50 per 10,000
 Stepping motor 4 phase 12v 7.5 step 50 ohms£8.95
 SAA1027 stepping motor driver chip£3.95
 FM transmitter Kit good quality sound£7.94
 High quality photo resist copper clad epoxy glass boards
 Dimensions single sided double sided
 3x4 inches £0.95 £1.07
 4x8 inches £2.40 £2.68
 6x12 inches £5.37
 12x12 inches £10.66

Special Offers
 Computer Grade Capacitors with screw terminals 38000uf 20v £2.50
 8700uf 10v £1.95, 6800uf 15v £2.95, 10000uf 16v £1.50
 7 segment Common anode led display 12mm£0.45
 LM2931A T5.0 Low drop out 5V regulator T0220 package£0.85
 BS250 P channel MOSFET £0.45, BC559 transistor£3.95 per 100
 74LS05 hex inverter £10.00 per 100, used 8748 Microcontroller £3.50
 Stereo LW/MW/FM Tuner pre-amp assembly complete with
 volume/tone controls and tuning scale Brand new in makers carton
 £5.95, faulty £2.50

Circuit diagram description and setting up procedure for tuner
 assembly described above £0.50. 5 digit 6v electromagnetic counter
 £1.95
 Hour counter (used) 7 digit mains 240V AC 50Hz£0.95
 LCD display 16 digit 7x5 dots dot matrix£2.50
 Query keyboard 58 key good quality switches£5.00
 wide range of CMOS TTL 74HC 74F Linear transistors kits
 capacitors, resistors tools etc always in stock
 JPG Electronics 276 Chatsworth Road Chesterfield S40 2BH
 Access orders (0246) 211202. Callers welcome

Carbon Film Resistors 1/4W E24 series 0-51R to 10M0 - 1p
 100 off per value - 75p 1000 off in even hundreds per value - £7
 Metal Film 1/4W 10R0 to 1M0 5% E12 series - 2p 1% E24 series - 3p
 1/2Watt metal/carbon film E24 series 1R0 to 10M0 - 11/2p
 1 Watt metal/carbon film E12 series 4R7 to 10M0 - 5p
 BC107/8/9 - 12p BC547/8/9 - 8p BC182L 184L - 10p
 BFV50/51/52 - 20p 2N3055 - 50p TIP31A, 32A - 25p TIP41, 42, - 40p

Tantalum head subminiature electrolytics (Mids/Volts)
 0-1/35, 0-22/35, 0-47/35, 3-3/16, 4-7/16 - 14p 4-7/35 - 15p
 2-2/35, 4-7/25, 10/5 - 15p 4-7/35, 6/8/16 - 16p 10/16, 22/6 - 20p
 22/16 - 30p 33/10 - 30p 47/10 - 35p 100/6 - 40p

Aluminium Electrolytics (Mids/Volts)
 1/50, 2-2/50, 4-7/25, 4-7/50, 10/16, 10/25, 10/50 - 5p 22/16, 22/25 - 6p
 22/50, 47/16, 47/25, 47/50 - 6p 100/16, 100/25 - 7p 100/50 - 12p
 100/100 - 14p 220/16 - 8p 220/25, 220/50 - 10p 470/16, 470/25 - 11p
 1000/25 - 18p 1000/35, 220/25 - 22p 4700/25 - 70p

Miniature Polyester Capacitors 250V Wkg. Vertical Mounting
 .01, .015, .022, .033, .047, .068 - 4p 0.1 - 5p 0.15, .22 - 6p 0.47 - 8p

Mylar Capacitors 100V Wkg. Vertical Mounting E12 Series
 1000p to 8200p - 3p .01 to .068 - 4p 0.1 - 5p 0.15, 0.22 - 6p

Subminiature Ceramic Plate 100V Wkg. E12 Series Vertical Mounting
 2% 1P8 to 47P - 3p 56P to 330P - 4p 10% 390P to 4700P - 4p
 Ceramic plate/disc E6 Series 50V 22P to .047 - 2p

Polystyrene Capacitors 63V Wkg. E12 Series Axial Mounting
 10P to 820P - 3p 1000P to 10,000 - 4p 12,000P - 5p
 1N4148 - 2p 1N4002 - 4p 1N5404 - 14p W01 bridge - 25p
 0A91 - 6p AA143 - 8p W005 - 20p 1N4006 - 6p
 Zener diodes E24 series 3V3 to 33V 400mW - 8p 1 watt - 12p
 L.E.D's Red, Green & Yellow 3mm & 5mm - 10p 8mm - 35p
 20mm fuse 0-1A to 5A quick blow - 5p Anti Surge - 8p
 High Speed drills 0-8mm, 1-0mm, 1-3mm, 1-5mm, 2mm - 30p
 Expo Reliant drilling machines 12V d.c. with improved 3-jaw chuck 6.50
 Nicads AA - 80p HP11 - £2 PP3 - £4.20 Universal Chargers - £6.50
 Glass reed switches single pole make contacts - 8p Magnets - 12p

VAT inclusive. Return postage 25p (free over £5). Lists free.

THE C.R. SUPPLY CO.,
 127 Chesterfield Road,
 Sheffield S8 0RN. Tel. 557771.

*** Series X Mixer Kits**
 * up to 1,000 inputs
 * 60+100 mm faders, pots, panels and audio switches
 * 6 auxiliaries
 * versions for recording PA, radio, disco
 * circuit diagrams
*** From £9.92**



Send 19p for catalogue to: K. Tek, P.O. Box 172a, Surbiton, Surrey KT6 6EN. Tel: 01-399-3990

TURN YOUR SURPLUS
 ICS transistors etc into cash, immediate settlement. WE welcome the opportunity to quote for complete factory clearance.
 Contact:
COLES-HARDING & CO.,
 103 South Brink, Wisbech, Cambs.
 ESTABLISHED 15 YEARS
 Tel: 0945 584188 - Fax: 0945 588844

**IS YOUR
 CLASSIFIED AD
 A TIGHT SQUEEZE?**

**STRETCH
 OUT**

**in the display pages
 of PE! Phone RICHARD
 CAPLIS on
 01-743-8888 for details!**

CAMBRIDGE COMPUTER SCIENCE LTD

10MByte Winchester, used, 3 months Wty, £42.00 each
 5.25 inch Disk Drives, 80 Track DSDD £34.00 each
 3" Disk Drives, 40Tk, SSDD £28.00 each
 5.25" Disk Drives, 80Tk, DSDD Used, No Wty £15.00 each
 5.25" Disks, DSDD, 48tpi boxes of 10 £3.00/box
 Dual Disk Drive Power Supply £20.00 each
 Lead to connect one drive to psu £2.00 each
 50W PSU 5V 6A, 12V 2.5A, -5V 0.5A, -12V 0.5A £16.00 each
 Gould PSU 0-30V @5A Limited quantity only £45.00 each
 Single Data lead (BBC Micro to Disk Drives) £2.00 each
 Dual Data lead (BBC Micro to 2 Disk Drives) £4.00 each
 Power lead (BBC Micro to Disk Drive) £1.00 each
 Dual leads (BBC Micro to 2 Disk Drives) £2.00 each
 68000 CPUs (The first orders get 10MHz chips) £3.50 each
 74LS TTL, 100 brand new ICs £10.00 pack
 8K Byte NV ram chips £3.00 each £10.00 hour
 20 pin dil low profile IC sockets £0.50 (ten) - £ 4.00 (100)
 40 pin dil low profile IC sockets £0.60 (ten) - £ 5.00 (100)
 Keyboard, 100 keys on board LCD & micro if £8.00 each
 Toroidal mains transformer 12V 4A & 0.4A, 12-0-12 @0.1A & 2A, 9-0-9 @0.2A £4.00 each - £6.00 for 2 - £8.00 for 3

All items new unless stated. Add 15% VAT to all prices. Prices include postage. Add 50p to orders below £5.00. Send an SAE for our latest list or for more info.

**Dept PE, 374 Milton Road, Cambridge, CB4 1SU
 Tel: 0223 424602**

>>>RESISTOR PACKS<<<

**1/4W 5% CARBON FILM
 E12 RANGE 10R to 10M
 10 of any 1 value 6p
 10 OF EACH VALUE
 Total 730 resistors
 £3.95**

Add 35p P&P & 15% VAT

**RMOS P.O. BOX 3
 USK GWENT NP5 2YF.**

**SURPLUS/REDUNDANT ELECTRONICS
 COMPONENTS WANTED**

ICs - Tuners - Transistors - Valves - Diodes etc - any quantity considered - immediate payment.
ADM ELECTRONICS SUPPLIES
 Tel 0827 873311 Fax: 0827 874835

ROBOTICS

Use your home computer to operate servo based Robots of your own design. Suitable for ZX Spectrum, Tatung, Einstein and Amstrad CPC.
 Send SAE for details to:
**PRF Software Dept. PE, 26 Olton Road,
 Mickleover, Derby DE3 5PL.**

Are you an electronics hobbyist?

If so, you will benefit from joining British Amateur Electronics Club!
**BAEC, C. Bogod, 26 Forrest Rd.,
 Penarth, South Glamorgan**

PROGRAM NOW

The Professional Software Developers Journal

Available from all good newsagents price £1.50
 From The publishers of PE.

74HC series ICs

74HC00 19p	74HC02 19p	74HC03 19p
74HC04 19p	74HC08 19p	74HC10 19p
74HC11 26p	74HC14 39p	74HC20 19p
74HC27 31p	74HC30 35p	74HC74 38p
74HC86 29p	74HC107 36p	74HC138 41p
74HC161 48p	74HC175 52p	74HC393 69p

74LS series ICs

74LS00 20p	74LS02 20p	74LS05 20p
74LS30 20p	74LS32 20p	74LS51 20p
74LS90 30p	74LS93 30p	74LS107 23p
74LS112 23p	74LS138 35p	74LS139 35p
74LS151 38p	74LS164 38p	74LS193 55p
74LS245 58p	74LS374 52p	74LS375 64p

74F series ICs

74F00 32p	74F02 32p	74F64 32p
74F174 77p	74F251 64p	74F353 64p
74F373 91p	74F398 96p	74F399 96p

ECL series ICs

10101 1.15	10102 1.15	10103 1.15
10104 1.15	10124 3.68	10125 3.68

A wide range of components and TTL, CMOS and ECL ICs are available. We also supply PC, XT and AT spares at **LOW PRICES**. Write or phone for our **FREE** catalogue.

Resistors at bulk prices Your Mix
 Carbon film, 0.25W, 5% 1p each or 45p for 50
 Metal film, 0.25W, 1% 3p each or £1.35 for 50

IC sockets, solder type (pin:price)
 14:10p, 16:11p, 20:14p, 24(0.6 or 0.3):16p.

IC sockets with 0.1uF decoupler 14:60p, 16:65p.

Prototyping boards (Vero)
 IBM XT £45.00, IBM AT £52.00

ACCESS welcome by post or phone. Callers by appointment please. **VAT INCLUDED**. Please add 50p for post and packing. Catalogue free. No minimum order charge.

BLACKMORE ELECTRONICS LTD.
 FREEPOST, Blandford Forum
 Dorset DT11 7BR

0258 451347 (24hr answerphone)

FALCONER STUDIOS

We have two busy 24-track studios in London and have two positions to fill:
MAINTENANCE CO-ORDINATOR
 &
HIRE COMPANY CO-ORDINATOR
 For further information call Nick on 01-267 7777

CLASSIFIEDS

SERVICES



Do not gamble with your advertising!
Use Practical Electronics with confidence!
Phone our Advertisement Dept. on
01-743-8888 for details

We will make drilled PCBs to your specifications - one-offs to small production runs. Cost 6p/cm² single sided 12p/cm² double sided. An initial charge may be made for artwork transfer to acetate. Send your artwork to us or for further details contact Paul Oakes, PCB Production, Intec (Inverclyde) Ltd, 5 East Blackhall Street, GREENOCK, PA15 1HD.

For Electronic Design and
PCB Manufacture
call

PROTO DESIGN

Unit 8, Ilford Trading Estate
Paycocke Road Basildon
Essex SS14 4DR
Tel: 0268 289923

MAKE YOUR OWN PCB's

Just about everything from polishing blocks to plated through hole equipment.
Very keen prices - discount on quantity.
S.A.E. for complete price list or telephone:
Ward Electronics,
27 North Street, Redruth, Cornwall TR15 1HJ
Tel: 0209 211050

TECHNICAL INFO SERVICES (PE)

76 Church St., Larkhall, Lanarkshire ML9 1HE
Phone 0698 884585 Mon-Fri, 9-5

any other time 0698 883334 FOR FAST QUOTES

WORLD'S LARGEST COLLECTION SERVICE MANUALS Most unobtainable elsewhere. Prices range from only £4.50 - large s.a.e. any quotation, no obligation to buy.

WORLD'S SOLE Suppliers of TV & Video Repair manuals, etc. from TV TECHNIC, Thorn etc. Every published service sheet in stock, supplied full size, not bits & pieces. CTV's or any combination £3.50 plus Lsae, any other single item £2.50 plus Lsae. Complete Circuit Sets for most Videorecorders only #7 set (no serv. shts made).

LSAE for QUOTATIONS plus GIANT CATALOGUE NEWSLETTERS BARGAINS FREE S/Sht as available.

Comprehensive TV Repair Manual £9.50. Complete Radio Service and Repair Course £9.50. Complete Repair & Service Manuals Mono TV £12.50; CTV £17.00; Video £19.50. Complete Repair Data with circuit. Mono TV £9.50; CTV £12.50; Video £10.50.

£3.00 plus LSAE BRINGS THE ONLY COMPREHENSIVE SERVICE SHEETS & MANUALS, CATALOGUES plus FREE CHASSIS GUIDE and £4.00 OF VOUCHERS

WORKSHOP SERVICE MANUALS

Video Recorders - £12.50

Most Colour TV, Audio, Test, Vintage, Amateur etc. £6.00
Please state Make/Model/Type with order.

FREE Catalogue Unique Repair and Data Guides with all orders or LSAE for your copy.

MAURITON ELECTRONICS LTD (PE),
8 Cherry Tree Road, Chinoor, Oxfordshire OX9 4QY
Tel: (0844) 51694

SURVEILLANCE

NEW VHF MICROTRANSMITTER KIT, tuneable 80-115 MHz, 500 metre range, sensitive electret microphone, high quality PCB. SPECIAL OFFER complete kit ONLY £5, assembled and ready to use £8.95 post free. Access orders telephone 021 411 1821. Cheques/ P.O.'s to: Quantek Electronics Ltd, (Dept P.E.), 45a Station Road, Northfield, Birmingham, B31 3TE

Surveillance devices, lasers, Tesla coils, scramblers, ultrasonic and many more, over 150 designs. Send SAE to: Placentre, Old Wharf, Dynock Road, Ledbury HR8 2HS

KITS MICROTRANSMITTER, VHF/FM, received on standard radio, 25x15mm, free microphone included - £4.50. Telephone transmitter, amazingly uses no batteries - £5.49. Bleeper transmitter vhf - £8.59 inc p&p. SAE list. Remittance to: A.C.E. (PE), 99 Greenheath, Hednesford, Staffs. - Access orders 05438 71902 - same day dispatch

SURVEILLANCE & COUNTER SURVEILLANCE EQUIPMENT

WE MANUFACTURE AND SUPPLY TOP QUALITY SURVEILLANCE AND SECURITY EQUIPMENT



including VHF Transmitters
Automatic Telephone
Recorders, Recording
Briefcases Bug
Detectors
Telephone
Counter-Tap Units
We also offer a complete
range of accessories
including microcassette recorders, microphones,
receivers, cassettes and batteries

CCTV AND SECURITY SYSTEMS SPECIALISTS

Write or phone for a detailed catalogue to:

ESKAN ELECTRONICS LTD.
DEPT. PE, 172 CALEDONIAN ROAD, LONDON. N1

01-278 1768

BOOKS

"Satellite
Television -
Installation
Guide"
by John
Breeds.



Price- £11.95
Available from Practical

73 AMATEUR RADIO

World's leading ham radio magazine.

Annual subscription \$39.00 (US Funds) from: 73 Amateur Radio, P.O. Box 58866, Boulder, CO 80322-8866, U.S.A.

MISCELLANEOUS

Laboratory stock clearance equipment, ECG transducers, Geigers, anemometers, spare motors etc. SAE list. Laboratories, Maplehurst, RH13 6LL Tel: 0403 891 236
Solar Eclipse 22nd July 1990 - Finland. For your travel and accomodation needs phone Margaret at Salford Travel Agency on 061-8329131. ABTA members. We are Finland specialists.

VOICE/SOUND activated switches easy to follow diagrams and uses only £1.00. Components and P.C.Bs available: Herrington, 63 Home Farm Road, Hanwell, London W7 1NL.

RM Nimbus Experimental Analogue port. Two analogue and two digital channels, using mouse socket. Circuit, layout and listing £5.00; PCB £3.50. Logical Answers, 24 Elmwood, Mersea, Colchester, Essex CO5 8RD.

Azimuth Test Cassettes, £5.85. Ian Harrison, 7 Mill Hill, Repton, Derby. Tel: 0283 702875.

FOR SALE. PART TIME MONEY SPINNER. This business would ideally suit someone with reasonable knowledge of microprocessor/digital electronics specifically 6800 series, who wants to turn electronic skills into cash, on a part time basis. A mail order specialist computer repairs business with net annual profits of £10,00 per annum. The sale includes full test equipment, all circuit diagrams, customer mailshot/database listing, miscellaneous spares and stock equipment. Everything to start you off - at a price of £4500 (no liabilities attached). For details ring 0636 84220.

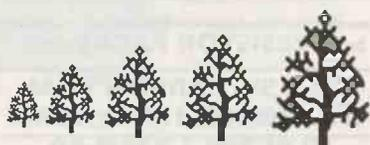

From little acorns
mighty oaks will grow!

Small businesses - use PE
Classified section for your
products or services and
watch your business develop!

Phone Richard Caplis on
01-743-8888 for details!

Thorn EMI recently announced that it is getting out of electronics altogether. As reported in this column, the group has already disposed of its consumer electronics manufacturing business (Ferguson) and vlsi semiconductor company (Inmos). Now Thorn EMI Electronics is up for sale. This means largely computers, military electronics equipment, special tubes and the American subsidiary Systron Donner.

It's all part of the general restructuring and consolidation of the electronics industry now going on, which I've mentioned previously. This firm, like many others, has realised it must gird up its loins to face intensifying competition in an international market – and in particular the coming of the European single market in 1992.

Colin Southgate, the man who has been revitalising the group since his appointment as managing director in 1985, has decided

INDUSTRY



NOTEBOOK

being the project engineer responsible for one of the UK's first solid-state machines, the Emidec 1100.

Hounsfield's idea for computer-assisted tomography came out of work he was doing on pattern recognition by computer. The resulting EMI scanner, first used at the Atkinson Morley Hospital, Wimbledon, was a technological sensation in the medical world. As a result Godfrey Hounsfield (who did not have a university degree) was awarded the Nobel Prize for Physiology and Medicine and was later knighted by the Queen.

What happened? Again the EMI management of the time (before Thorn had come on the scene) got commercial cold feet. After manufacturing a few scanners and selling them successfully to hospitals at home and abroad they abandoned the whole business and sold out to General Electric in the USA.

END OF A LOVE AFFAIR

BY TOM IVALL

Thorn EMI is packing its bags and selling off the kids – the muse Electronic must find another swain in the UK.

that the company is too weak in electronics to stand up against the big guys in the world. This doesn't mean weak technologically but in the commercial sense of sales, market shares, economies of scale and other such factors which I discussed last month.

So electronics manufacturing is being sold off (along with food mixers and gas meters) to leave the company free to concentrate on what it considers to be its main strengths: lighting, music products and domestic equipment rental.

To me this final break seems like Thorn EMI coming to the end of a long love affair with electronics. The affair has had its great moments but has never settled into a really stable relationship. Over the years the changing management seems not to have fully recognised the importance of electronics technology on the world scene nor the brilliance of some of its own people in this field. Consequently, through lack of interest or imagination, it has lost tremendous opportunities for technical and commercial development in this industry.

The first 'great moment' in the love affair was in the early 1930s. Isaac Shoenberg, leading a brilliant research team at EMI, became convinced that mechanically-scanned television was doomed and that the future lay with all-electronic television. His work, and in particular that of his colleague McGee, led to the development in 1933 of the first UK television camera tube, the Emitron.

Out of this came the Marconi-EMI television system, with EMI providing mainly the electronic picture generation and Marconi the transmitting equipment. The system was adopted for Britain's first tv broadcasting service in 1936.

An extremely prolific member of the Shoenberg team was A.D. Blumlein. He was first with many important inventions in circuits and systems.

After the 1939–45 war EMI started to

manufacture tv transmitting equipment on a regular basis. But after producing what was undoubtedly the best studio tv camera in the world the firm inexplicably lost faith in this winner as a commercial venture and abandoned the camera field to the Americans, Germans and Japanese.

In the intervening years Thorn EMI – mainly through the EMI side – has had a go at practically everything else you can think of in the electronics sphere. Offhand I can remember automation equipment, digital computers, measuring instruments, transducers, radar, magnetic recording, audio equipment, electronic tubes and medical instruments – not forgetting the recent dalliance with integrated circuits.

Another 'great moment' and lost opportunity was the computer-assisted tomograph – or cat scanner as it's often called! This machine, for automatically constructing three-dimensional X-ray images of the human brain, was developed almost single-handedly, on a string-and-sealing-wax basis, by an EMI engineer called Godfrey Hounsfield. He had joined the firm to work on radar and later specialised in computers,

I sometimes wonder if the unsatisfactory outcome of Thorn EMI's love affair with electronics was really due to an early identity crisis. Thorn, founded in 1928, was always straightforwardly electrical, but perhaps Electric and Musical Industries Ltd couldn't make up its mind whether it was really an electrical company or a gramophone company.

It all started with that revered name The Gramophone Company, formed in 1892. Others involved were an American office boy called David Sarnoff, who had arrived in the USA as an immigrant in 1900, and a British radio set manufacturer, the Marconiphone Company.

Sarnoff was an office boy with the American Marconi Company. He eventually became its boss, after it was transformed into the Radio Corporation of America (RCA) in 1919. The Marconiphone Company was launched in 1923 to make domestic radio sets now that broadcasting had just started in the UK. But by 1929 Marconi's were having financial problems as a result of the economic depression and decided to dispose of this set manufacturing business. As RCA already owned The Gramophone Company, Sarnoff thought it would be a good idea to buy Marconiphone and another record company, Columbia Graphophone, and merge all three to form an organisation that would have a strong position in home entertainment by encompassing both recording and radio reception.

This he did by a series of deals and the resulting new company was named Electric and Musical Industries Ltd. A lot of properties were brought together, like the Marconi and RCA domestic receiver patents. Another outcome, which confused everyone for decades, was that EMI found itself using the trade-name 'Marconiphone'. People thought there must be a financial link between EMI and Marconi, while in fact there was no such connection.

PE

PRACTICAL ELECTRONICS BOOK SERVICE

Here is your Editor's choice of books he thinks will be of interest to electronics and computer enthusiasts

BEGINNERS AND EARLY STARTERS

NEW Mini-Matrix Board Projects.

R.A.Penfold. 112 pages. £2.50.

Order Code BP99

Shows a selection of 20 useful and interesting circuits that can be built on a mini-matrix board of 24 holes by 10 copper strips in size - an ideal book for early experimenters.

NEW From Atoms to Amperes.

F.A.Wilson. 160 pages. £2.95.

Order Code BP254.

For the absolute beginner, clearly explaining the fundamentals behind the whole subject of electricity and electronics.

NEW Electronic Projects for Beginners.

F.G.Rayer. 128 pages. £1.95.

Order Code BP48

Specially for the newcomer to electronics who is looking for a book containing a wide range of easily made projects. Some circuits need no soldering and many others show actual component and wiring layouts.

Electronics Build and Learn

R.A.Penfold. 128 Pages. £5.95.

Order Code PC 101

Combining theory and practice, the book describes a circuit demonstrator unit that is used in subsequent chapters to introduce common electronic components and circuit concepts, complete with practical experiments.

Practical Electronic Building Blocks

R.A.Penfold. There are two books -

Book 1 : 128 pages. £1.95.

Order Code BP117

Book 2 : 112 pages. £1.95.

Order Code BP118

Book 1 is about oscillators and gives circuits for a wide range, including sine, triangle, square, sawtooth and pulse waveforms and numerous others from voltage controlled to customised ic types.

Book 2 looks at amplifiers, ranging from low level discrete and opamp types to ic power amps. A selection of mixers, filters and regulators is included.

30 Solderless Breadboard Projects

R.A.Penfold. Two books each of 160

pages. Book 1 : £2.25. Order Code

BP107. Book 2 : £2.25. Order Code

BP113.

Each project is designed for building on a Verobloc breadboard and is accompanied by a description, circuit and layout diagrams and relevant constructional notes. Many of the components are common to several projects. Book 1 covers linear devices, and Book 2 covers cmos logic chips.

Beginners Guide to Building

Electronic Projects R.A.Penfold. 112

pages. £1.95. Order Code BP 227

Shows the complete beginner how to tackle the practical side of electronics and includes simple constructional projects.

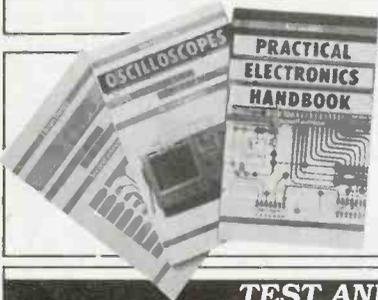

TEST AND MEASUREMENT

Getting the Most from Your Multimeter

R.A.Penfold. 112 pages. £2.95.

Order Code BP239

There's more to what you can do with a meter than meets the casual eye. The book covers the basics of what you can do with analogue and digital meters and discusses component and circuit testing.

NEW Test Equipment Construction

R.A. Penfold £2.95.

Order Code BP248

Describes in detail how to construct some simple and inexpensive, but extremely useful, pieces of test equipment.

Oscilloscopes

I.Hickman. £6.95.

Order Code NT3

Subtitled 'How to Use Them, How They Work' the book is illustrated with diagrams and photographs and is essential reading for any one who wants to know about scopes, from first principles to practical applications.

How to Get Your Electronic Projects Working.

R.A.Penfold. 96 pages. £2.50.

Order Code BP110.

Essential reading for anyone who wants first-time success in project assembly. Covers tracing mechanical faults as well as testing for failures of active and passive components of most types.

SATELLITE TV

NEW Satellite TV Installation Guide - 2nd edition John Breeds. £11.95. Order Code STV1

Full of vital information for any competent diyer who wishes to install a satellite tv antenna and obtain optimum reception quality.

An Introduction to Satellite Television

F.A.Wilson. 112 pages. £5.95.

Order Code BP195

Informative answers to many of the questions about this communications revolution. The information is presented on two levels, one aimed at the complete beginner, the other at professional engineers and serious amateur enthusiasts.

AUDIO AND MUSIC

Introducing Digital Audio

I.Sinclair. 112 pages. £5.95.

Order Code PC102

A non-mathematical introduction to the new digital technology, discussing the principles and methods involved in devices such as cd, dat and sampling.

Electronic Music Projects

R.A.Penfold. 112 pages. £2.50.

Order Code BP74

24 practical constructional projects covering fuzz, wah, sustain, reverb, phasing, tremolo etc. The text is split into four sections covering guitar, general, sound generation and accessory projects.

More Advanced Electronic Music Projects

R.A.Penfold. 96 pages. £2.95.

Order Code BP174

Complementing BP74 by covering more advanced and complex projects including flanging, chorus, ring modulation, plus a selection of drum, cymbal and gong circuits.

NEW Computer Music Projects

R.A.Penfold. 112 pages. £2.95.

Order Code BP173

Shows how home computers can produce electronic music and covers sequencing, analogue and Midi interfacing, digital delay lines and sound generators.

Practical Midi Handbook

R.A.Penfold. 160 pages. £5.95.

Order Code PC103

A practical how-to-do-it book for musicians and enthusiasts who want to exploit the capabilities of Midi. Covers keyboards, drums, sequencers, effects, mixers, guitars, and computer music software.

Midi Projects

R.A.Penfold. 112 pages. £2.95.

Order Code BP182

Practical details of interfacing many popular home computers with Midi systems, and also covering Midi interfacing to analogue and percussion synths.

NEW Electronic Synthesiser

Construction.

R.A.Penfold. 112 pages. £2.95.

Order Code BP185.

Even relative beginners should find the monophonic synthesiser described here within their capabilities if the book is thoroughly read. Individual aspects of the synth are dealt with separately and pcb designs are shown for the main modules.

DIGITAL AND COMPUTING

NEW A Concise Introduction to MS-DOS.

N. Kantaris. 64 pages. £2.95.
Order Code BP232

A ready-reference guide for those who need a quick insight into the essential command functions of this operating system, but who don't have the time to learn it fully.

An Introduction to Computer Peripherals

R.A. and J.W. Penfold. 80 pages.
£2.50. Order Code BP170

Covers such items as monitors, printers, disc drives, cassettes, modems, etc, explaining what they are and how to use them with your computer and with each other.

Microprocessing Systems and Circuits

F.A. Wilson. 256 pages. £2.95.
Order Code BP77

A comprehensive guide to the elements of microprocessing systems, covering the fundamental principles behind this important subject.

Introduction to 6800/6802 Microprocessor Systems

R.J. Simpson and T.J. Terrell. 238 pages. £10.95. Order Code NT9

The book covers systems hardware, programming concepts and practical experimental work that will assist in understanding the 6800/6802 microprocessor, with additional information on the 6802D5E evaluation system.

NEW An Introduction to 68000 Assembly Language.

R.A. and J.W. Penfold. 112 pages.
£2.95. Order Code BP184

Covers the fundamentals of writing programs that will vastly increase the speed of 68000 based machines such as the Commodore Amiga, Atari ST range, Apple Mackintosh, etc.

Getting the Most from Your Printer

J.W. Penfold. 96 pages. £2.95.

Order Code BP181

How to use the features found on most dot-matrix printers from programs and popular wordprocessors, showing examples of what must be typed to achieve a given effect.

Micro Interfacing Circuits

R.A. Penfold. Two books, each of 112 pages.

Book 1 : £2.25. Order Code BP130.

Book 2 : £2.25. Order Code BP131

Both books include practical circuits and useful background information though pcb layouts are not included. Book 1 mainly covers computer input-output techniques. Book 2 deals primarily with practical application circuits.

NEW An Introduction to 6502 Machine Code.

R.A. and R.W. Penfold. 112 pages.
£2.50. Order Code BP147

Covers the main principles of machine code programming on 6502-based machines such as the Vic-20, Oracle/Atmos, Electron, BBC and Commodore 64. It assumes no previous knowledge of microprocessors or machine code and gives illustrative programming examples.

NEW A Z-80 Workshop Manual.

E.A. Parr. 192 pages. £3.50.
Order Code BP112

A book for those who already know Basic but wish to explore machine code and assembly language programming on Z80 based computers.

Practical Digital Electronics Handbook

M. Tooley. 208 pages. £6.95.
Order Code PC 104

Nine constructional projects introduce digital circuits, logic gates, timers, microprocessors, memory and interface circuits - an essential book for anyone interested in digital devices.

DATA AND INFORMATION BOOKS

Digital IC Equivalents and Pin Connections

A. Michaels. 320 pages. £5.95.
Order Code BP140

Linear IC Equivalents and Pin Connections

A. Michaels. 256 pages. £5.95.
Order Code BP141

Between them these two books show equivalents and pin connections of a popular user-orientated selection of European, American and Japanese ICs. They also include details of functions, manufacturer and country of origin. The Digital ICs book also quotes details of packaging and families.

Opamps

B. Dance. £6.50.
Order Code NT2

Subtitled 'Their Principles and Applications' this interesting book is written in a simple non-mathematical style and provides a source of practical circuits that use both commonplace and more sophisticated opamps.

Electronic Hobbyists Handbook

R.A. Penfold. 96 pages. £4.95. Order Code BP233

Provides a source of useful information that the amateur enthusiast is likely to need for day-to-day pursuance of hobby electronics.

Practical Electronics Handbook

I. Sinclair. £7.95.
Order Code NT1

A useful and carefully selected collection of standard circuits, rules-of-thumb and design data for enthusiasts, students and engineers involved in radio, computing and general electronics.

Newnes Electronics Pocket Book

I.E. Parr. £6.95.
Order Code NT10

Presents all aspects of modern electronics in a readable and largely non-mathematical style, and is a good source of valuable information for enthusiasts and professional engineers alike.

NEW Key Techniques for Circuit Design

G.C. Loveday. £6.95.
Order Code BM 101

Tackles the problems of designing circuits from scratch, introducing the concept of target specifications, the design sequence, device selection, rules of thumb, and useful equivalent circuits.



GENERAL CONSTRUCTIONAL

NEW Electronic Science Projects.

Owen Bishop. 144 pages. £2.95.
Order Code BP104

A bumper bundle of experimental projects ranging in complexity and including a colour temperature meter, electronic clock, a solid state (led display) scope, an infra-red laser, a fascinating circuit for measuring the earth's electrical field strength, and many more.

Electronic Security Devices

R.A. Penfold. 112 pages. £2.50. BP56

Full of ideas for keeping your valuables safe. The circuits include designs for light, infra-red, ultrasonic, gas, smoke, flood, door and baby sensors.

NEW More Advanced Electronic Security Projects.

R.A. Penfold. 112 pages. £2.95. Order Code BP190

Follows on from where BP56 leaves off and describes a number of more up-to-date and sophisticated projects, such as pyro-sensors, infra-red and doppler-shift detection, fibre-optic loops, and many others.

NEW Electronic Projects for Cars and Boats.

R.A. Penfold. 96 pages. £1.95.
Order Code BP94

15 fairly simple projects that can be used with a car and/or boat. Stripboard constructional details are included, as are explanations of the circuit theory.

Power Supply Projects

R.A. Penfold. 96 pages. £2.50.
Order Code BP76

A selection of power supply designs, including simple unswitched, fixed voltage regulated and variable voltage stabilised, ni-cad charger, voltage step-up, and inverter.

More Advanced Power Supply Projects

R.A. Penfold. 96 pages. £2.95.
Order Code BP192

Covers more advanced topics than BP76 and includes precision supplies, switch mode and computer controlled supplies, plus a selection of miscellaneous circuits.

NEW Popular Electronic Circuits.

R.A. Penfold. 160 pages. £2.95.
Order Code BP80

Containing a wide range of circuit designs for experienced constructors who are capable of producing working projects direct from a circuit diagram without specific constructional details.

HOW TO ORDER

State your order code and your name and address clearly. Enclose a cheque, PO or international money order (add 50p postage per book - £1.00 for overseas surface mail), and send to:

**PE Book Service
Intra House
193 Uxbridge Road
London W12 9RA**

Books are normally delivered within 10 days but please allow 28 days for delivery.

**"NETWORKING SEEMS LIKE
THE PERFECT SOLUTION,
BUT WHERE DO WE START?"**

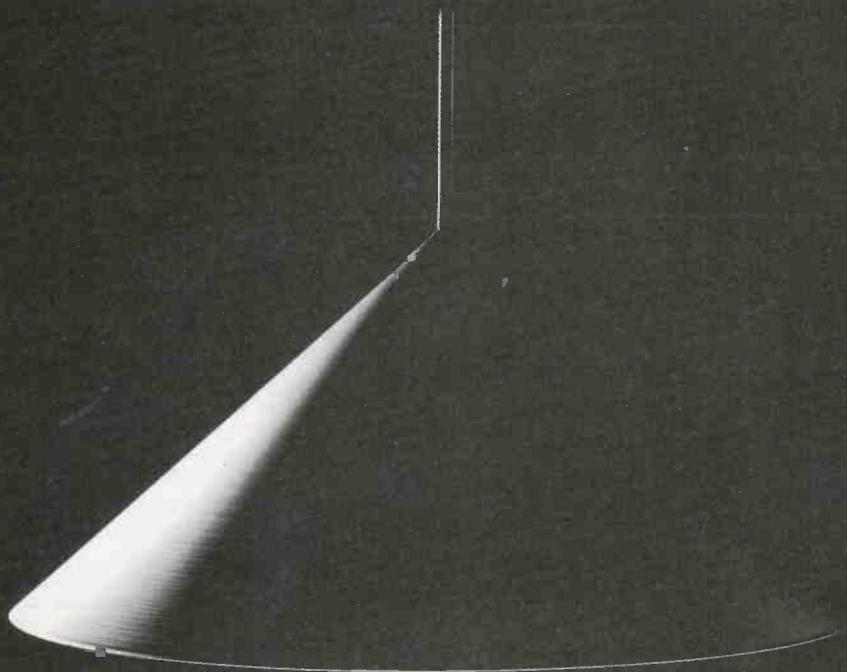

At the Personal Computer Show, that's where. With over 500 of the world's leading companies, no other event offers more opportunities to see computers working together. Three separate halls full of bright ideas for the professional user, general user and enthusiast. It's the ideal environment to check out the latest hardware and software for networking. Switch on, and apply for tickets now. Just complete the coupon or phone 0203 464004.

Show open first 3 days exclusively for business and trade.

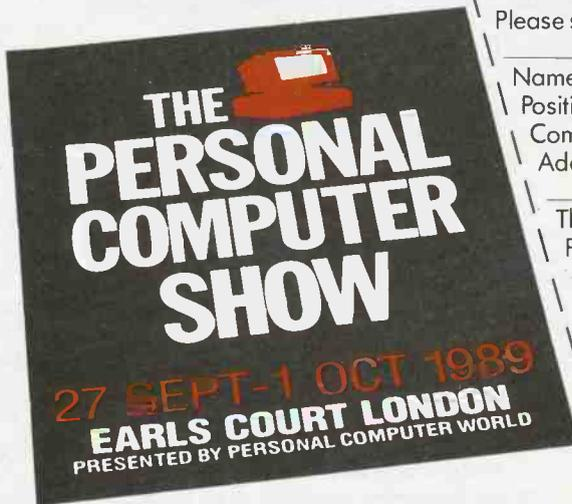

Please send me

_____ tickets(s)

Name _____

Position _____

Company _____

Address _____

PRN

These tickets are available to Business Professional and Trade visitors only. Anyone under 18 years old will not be admitted to the Business Hall. Admission without a ticket will cost £3.50 on the day. Personal Computer Show Ticket Office, Data House, Curriers Close, Tile Hill, Coventry CV4 8AW.

SWITCHED ON FOR BUSINESS

The Personal Computer Show is presented by Personal Computer World Magazine a V.N.U. publication.

Organisers: Montbuild Ltd., 11 Manchester Square, London W1M 5AB.

Personal Computer Show Ticket Office, Data House, Curriers Close, Tile Hill, Coventry CV4 8AW.

**NEXT
MONTH:**

**25 YEARS
OF PE!**

**NOVEMBER
1964 - 1989**

**THE STORY OF
TECHNOLOGY
IN THE
MAKING!**



**WHERE
IT ALL
BEGAN!**

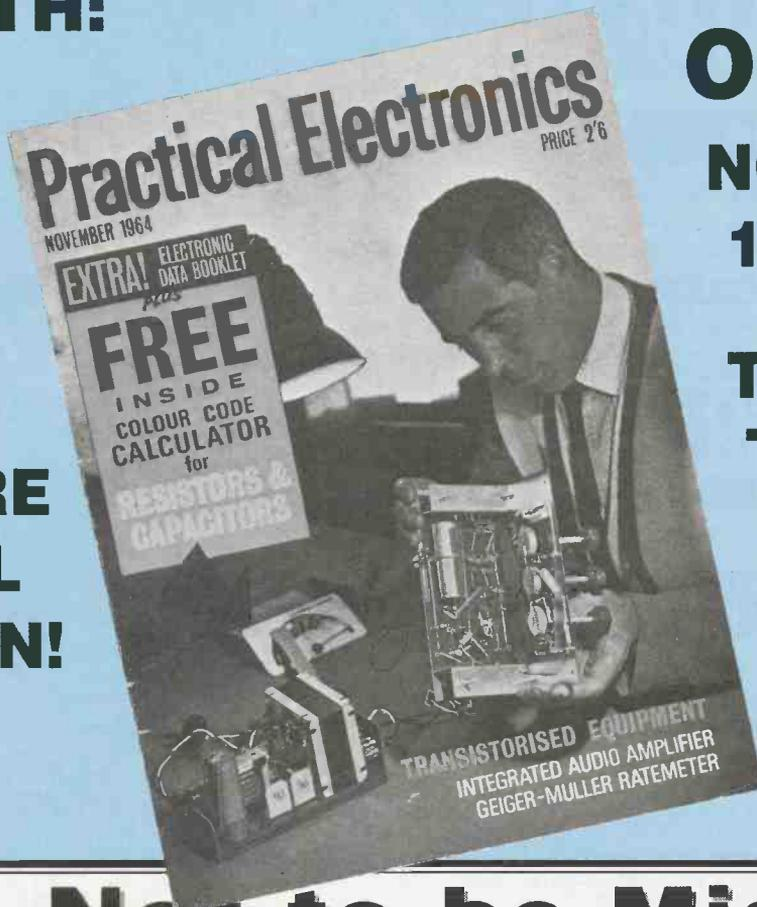

Not to be Missed!

Practical Electronics
25th Anniversary Issue

In this issue:

- 80 page bumper issue (16 more pages than usual)
- Results of the PE 25th Anniversary Technology Award Poll
- An exclusive interview with the Poll winner (Sir Clive Sinclair)
- A retrospective look at the last 25 years of Practical Electronics
- A historical look at the developments in electronics and technology
 - The future of electronics and technology by Barry Fox
 - The story of a person whose multi-million pound business started from a project published in PE
- An exciting competition with a computer as the main prize plus 25-year subs to PE and other valuable prizes
- And of course, all of our regular features

The November issue - on sale from October 6th -Price still only £1-25

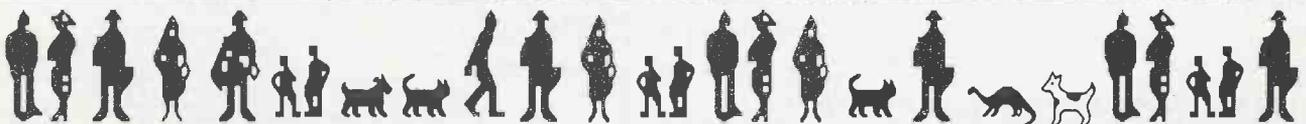

Widen your horizons!

Astronomy Now

Britain's leading
astronomical magazine

Feature articles by leading professional
and amateur astronomers and a host of
regular features of interest to the
newcomer and experienced
enthusiast alike.

Edited by well known astronomer
and regular contributor to
Practical Electronics
Dr. Patrick Moore CBE

Place a regular order with your newsagent or for £15-00
(overseas £18-00) take out an annual subscription from Intra
Press, Intra House, 193 Uxbridge Road, London W12 9RA

TRANSFORMERS

12/24V or 12-0-12V	2 x 12V Secs	2 x 25V Tapped Secs to give
24V	12V £ P&P	5,7,8,10,13,17, 20,25,33,40, 50V
0.15	0.05 3.44 1.87	or 20-0-20V or 25-0-25V
0.25	0.5 3.64 1.87	50V 25V £ P&P
0.5	1 4.36 1.87	0.5 1 5.91 2.09
1	2 6.08 2.09	1 A 2 7.91 2.20
2 A	4 7.01 2.20	2 M 4 12.81 2.75
3 M	6 12.08 2.36	3 P 6 14.82 2.75
4 P	8 12.87 2.42	4 S 8 20.30 3.24
6 S	12 15.62 2.64	6 12 25.81 3.24
8	16 18.59 3.08	8 16 36.52 3.57
10	20 25.02 3.52	10 20 43.34 4.07
15	30 31.10 3.63	12 24 51.87 4.29
20	40 44.40 4.12	
30	60 63.75 4.89	
41	83 73.41 6.32	

MAINS ISOLATORS

110V Centre Tapped	20VA	60	100	200	250	500	1000	1500	2000	3000	6000VA
£ 8.33											
p 2.69											
& 2.91											
p 3.52											
4.23											
5.33											
6.54											
6.54											
O.A											
O.A											

AUTOS

105,115,220,230,240V	For step-up or down	80VA	150	250	350	500	1000	1500	2000	3000	4000	5000	7500	10kVA	50/25V or 25-0-25V
£6.91															
p 2.09															
& 2.31															
p 2.75															
3.08															
3.68															
4.18															
5.11															
6.32															
O/A															
O/A															
O/A															
O/A															

CASED AUTOS 240-115V

240V Cable Input, 3-pin 115V USA Socket Outlet	20VA	80	150	250	500	1000	2000	3000
£9.85								
p 2.14								
& 2.58								
p 3.57								
5.00								
6.13								
O/A								

110V to 240V Cased Autos
Now available

Send SAE for lists.
Please add 15% to all items
after P&P

PO BOX 70
ILFORD
ESSEX
IG5 0AP

EX STOCK

60/30V or 30-0-30V	2 x 30V Tapped Secs	Volts available: 16, 18, 36, 40, 60V or 24-0-24V or 30-0-30V
60V	30V £ P&P	
0.5	1 6.72 2.09	
1 A	2 10.25 2.20	
2 M	4 13.17 2.53	
3 P	6 19.05 2.64	
4 S	8 21.72 2.75	
5	10 27.46 3.19	
6	12 31.32 3.42	
8	16 44.04 4.14	
10	20 51.28 4.40	
12	24 59.09 4.89	

96/48V or 36-0-36V 2 x 36-48V
Secs to give 60,72,84, 96V or
36-0-36V, 48-0-48V

96V 36/48V	0.5	1	2	3	4	5	6	8
£	7.16	12.80	21.05	25.49	32.54	46.21	57.87	63.12
P&P	1.76	2.31	2.91	3.02	3.32	4.18	4.48	5.28

INVERTERS

12/24V DC to 240V AC
Sine-wave or Square Wave

TOOL TRANSFORMERS

240-110VCT Cable input
16A BS socket output
2.2KVA £90+£5.33 p&p
CONSTANT VOLTAGE
Transformers for Spike-free
Stable Mains

Also Valve Mains Output &
Matching Transformers

TRANSFORMER WOUND TO SPEC

Batch Winding 3VA to 15KVA
Toroidals 30VA to 4KVA
3VA to 1KVA

TOROIDALS

Batches Wound to Order

AVO's & MEGGERS

Full range

BARRIE ELECTRONICS LTD
TELEPHONE: 01-551 8454

INDEX TO ADVERTISERS

A & G Electronics	54	London Electronics College	54
A.D.M. Electronics Supplies	55	Magenta Electronics	10, 11
Andor Electronics	54	Maplin Electronics	OBC
Astronomy Now	62	Mauritron Electronics	56
B.A.E.C	55	Multilode Ltd.	54
Barrie Electronics	62	National Component Club	35
B.K. Electronics	21	Number One Systems	26
Blackmore Electronics	55	Omni	54
Bull J.	48	Paul Oakes	56
Cambridge Computer Science Ltd	55	Personal Computer Show	60
Classified Ads	54-56	Phonosonics	39
Coles Harding	55	PLS	54
Component Solutions	5	PRF Software	55
Cricklewood Electronics	20	Program Now	55
C.R. Supply Co.	55	Proto Design	56
Deansgate	54	Rackz Products	47
Display Electronics	22	Radio and Telecommunications Correspondence School	54
Eskan Electronics	56	RMOS	55
Falconer Studios	55	Service Trading Co	62
Fraser Electronics	54	Specialist Semiconductors	IBC
Greenbank Electronics	40	Stewart of Reading	40
Hanney, L.F.	54	Suma Designs	35
Hills Components	40	Tandy	IFC
J.P.G. Electronics	55	Technical Info Services	56
Keytronics	16	T.K. Electronics	35
K-Tek	55	Ward Electronics	56
Limrose Electronics	47		

PLEASE MENTION PRACTICAL ELECTRONICS
WHEN REPLYING TO ADVERTS

VARIABLE VOLTAGE TRANSFORMERS

INPUT 220/240V AC 50/60 OUTPUT 0-260V
200W 0.1 amp max £24.00 p&p £3.00 (£31.05 inc VAT)
0.5KVA 2.5amp max £26.50 £3.75 (£34.79 inc VAT)
1KVA 5amp max £34.00 £4.25 (£43.99 inc VAT)
2KVA 10amp max £49.00 £5.50 (£62.68 inc VAT)
3KVA 15amp max £65.00 £6.25 (£81.94 inc VAT)
5KVA 25amp max £115.00
Carriage on request

VOLTAGE CHANGING TRANSFORMER

1250 Watt auto. Tapped 0-90V, 100, 110, 115,
120, twice to obtain voltages between 90
and 240V. Fitted in heavy duty louvered
metal case. Fused input. Price incl VAT &
p&p £39.50.

COMPREHENSIVE RANGE OF TRANSFORMERS-LT-
ISOLATION & AUTO (110-240V Auto transfer either
cased with American socket and mains lead or open
frame type. Available for immediate delivery.

ULTRA VIOLET BLACK LIGHT FLUORESCENT TUBES

4ft 40 watt £10.44 (£12.00 inc VAT) Caller only
2ft 20 watt £7.44 + £1.25 p&p (£9.99 inc VAT)
13in 10 watt £5.80 + 75p p&p (£7.53 inc VAT)
12in 8 watt £4.80 + 75p p&p (£6.38 inc VAT)
9in 6 watt £3.60 + 50p p&p (£5.12 inc VAT)
6in 4 watt £3.60 + 50p p&p (£5.12 inc VAT)

230V AC BALLAST KIT for either 6in, 9in or
12in tubes £5.50 + 55p p&p (£6.96 inc VAT)
For 13in tubes £6.00 + 75p p&p (£7.75 inc VAT)

400 WATT UV LAMP

Only £28.00 + £2.50 p&p (£35.08 inc VAT)

175 WATT SELF BALLASTED BLACK LIGHT
MERCURY BULBS Available with BC or ES
fitting. Price incl VAT & p&p £18.65.

12 VOLT BILGE PUMPS

Buy direct from the importers

500 GPH 15ft head 3 amp
£16.00 inc.

1750 GPH 15ft head 9 amp
£19.25 + £2.00 p&p (£25.00 inc VAT)

EPROM ERASURE KIT

Build your own EPROM ERASURE for a fraction of
the price of a made-up unit kit of parts. Less case
includes 12in 8 watt 2537 Angat Tube Ballast unit
pair of bi-pin leads neon Indicator on/off switch
safety microswitch and circuit £14.00 + £2.00 p&p
 (£18.40 inc VAT)

SUPER HY-LIGHT STROBE KIT

Designed for Disco, Theatrical users etc.
Approx 16 joules. Adjustable speed £48.00 + £2.00 p&p
 (£57.50 inc VAT)

Case and reflector £22.00 + £2.00 p&p (£27.60 inc VAT)
SAE for further details including Hy-Light and
industrial Strobe Kits.

Ample
Parking Space

Showroom open
Monday/Friday

SERVICE TRADING CO

57 BRIDGMAN ROAD, CHISWICK, LONDON W4 5BB

01-995 1560

ACCOUNT CUSTOMERS MIN. ORDER £10

WIDE RANGE OF XENON FLASH TUBES

Write/Phone your enquiries

SOLID STATE RELAY

Single make will switch up to 250 V AC 10 amp.
operating voltage 3-32 V DC silent contactless opto-
isolated. Fraction of maker's price £3.00 + 50 p p&p.
Total inc VAT £4.03.

SPECIAL OFFER AC CAPACITORS

1.5 MFD 440V £2.00 5 MFD 440V £4.00
2 MFD 440V £2.50 5.4 MFD 280V £2.00
4.1 MFD 440V £3.50 12 MFD 440V £3.00

p+p 50p per unit plus VAT to be added to total.

TORIN CENTRIFUGAL BLOWER

230V ac 2,800 RPM 0.9amp 130mm diameter impeller
outlet 63 x 37mm overall size 195 x 160 x 150mm (long).
Price £17.50 + £2.50 p&p (£23 inc VAT)

SHADED POLE GEAR MOTORS

In the following sizes:
9 RPM 12 RPM 80 RPM 160 RPM 110V AC or 240V AC
with capacitors (supplied). Price incl VAT & p&p £12.65

GEARED MOTORS

71 RPM 20lb inch torque reversible 115V AC input
including capacitor and transformer for 240V AC
operation. Price incl VAT & p&p £23.00.

12 V DC COOLER EXTRACTOR FAN

New brushless motor 92mm sq. Price incl VAT & p&p
£11.50.

SOLID STATE EHT UNIT

Input 230/240V AC. Output approx 15kV. Producing
10mm spark. Built-in 10 sec timer. Easily modified
for 20 sec, 30 sec to continuous. Designed for boiler
ignition. Dozens of uses in the field of physics and
electronics, eg supplying neon or argon tubes etc.
Price less case £8.50 + £1.00 p&p (£10.93 inc VAT) NMS

COOLING FANS-BRAND NEW!

200/400V AC American Boxer 'Peewee' 7-bladed high
efficiency cooling unit 90mm sq x 40mm deep 40cm
approx. Price incl VAT & p&p £10.35.

EX-EQUIPMENT FANS 120mm sq x 38mm deep in
either 115V or 230V AC Tested and guaranteed. Price
incl VAT & p&p £7.75.

Large selection of various speed geared motors from
stock. Phone or write for details.

From stock at prices that defy competition

C/F Blowers Program Timers
Microswitches Synch Motors
write/phone your enquiries

NMS = NEW MANUF SURPLUS
R&T = RECONDITIONED AND TESTED

POWER CONDITIONER

FEATURED IN ETI
JANUARY 1988

The ultimate mains purifier. Intended mainly for lowering the noise floor and improving the analytical qualities of top-flight audio equipment.

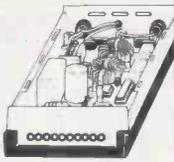

The massive filter section contains thirteen capacitors and two current balanced inductors, together with a bank of six VDRs, to remove every last trace of impulsive and RF interference. A ten LED logarithmic display gives a second by second indication of the amount of interference removed.

Our approved parts set consists of case, PCB, all components (including high permeability toroid cores, ICs, transistors, class X and Y suppression capacitors, VDRs, etc.) and full instructions.

PARTS SET £29.80 + VAT

A low cost (but high performance) mains conditioner is also available
MAINS CONDITIONER PARTS SET £5.40 + VAT
RUGGED PLASTIC CASE £1.80 + VAT

THE DREAM MACHINE

FEATURED IN ETI
DECEMBER 1987



Adjust the controls to suit your mood and let the gentle, relaxing sound drift over you. At first you might hear soft rain sea surf, or the wind through distant trees. Almost hypnotic, the sound draws you irresistibly into a peaceful, refreshing sleep.

For many, the thought of waking refreshed and alert from perhaps the first truly restful sleep in years is exciting enough in itself. For more adventurous souls there are strange and mysterious dream experiences waiting. Take lucid dreams, for instance. Imagine being in control of your dreams and able to change them at will to act out your wishes and fantasies. With the Dream Machine it's easy!

The approved parts set consists of PCB, all components, controls, loudspeaker, knobs, lamp, fuseholders, fuse, mains power supply, prestige case and full instructions.

PARTS SET £19.80 + VAT

Ben Sweetland's best seller GROW RICH WHILE YOU SLEEP is now in stock. £2.95 (NO VAT)

TV BOOSTER

Good TV pictures from poor aerials is what this project is all about. Keith Brindley's Aerial Booster gives a massive 20dB gain to ensure good viewing for campers and caravaners from indoor aerials, or wherever a properly positioned high-gain antenna is not practical.

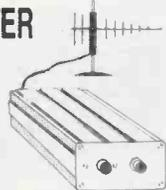

Based on the OM335 hybrid amplifier, the booster has specifications to rival the best wideband operation from 10MHz to 1.4 GHz, mid-band gain of up to 20dB and a wide supply range of 9V to 26V (it will run on car batteries for caravaners, dry batteries for campers, or a mains battery eliminator in the home). No special UHF construction skills are needed — the project could be made by a careful beginner.

There are two parts sets for the project. AA1 contains the printed circuit board, OM335 hybrid amplifier, components and instructions. AA2 is the optional case set rugged screened box, front and rear panels, waterproofing gaskets, feet, sockets and hardware.

AA1 PARTS SET £12.80 + VAT

AA2 PARTS SET £4.80 + VAT

AA3 OPTIONAL MAINS POWER SUPPLY PARTS SET £6.80 + VAT.

POWERFUL AIR IONISER

FEATURED IN ETI
JULY 1986

Ions have been described as "vitamins of the air" by the health magazines, and have been credited with everything from curing hay fever and asthma to improving concentration and putting an end to insomnia. Although some of the claims may be exaggerated, there is no doubt that ionised air is much cleaner and purer, and seems much more invigorating than "dead" air.

The DIRECT ION ioniser caused a great deal of excitement when it appeared as a constructional project in ETI. At last, an ioniser that was comparable with (better than?) commercial products was reliable, good to build... and fun! Apart from the serious applications, some of the suggested experiments were outrageous!

We can supply a matched set of parts, fully approved by the designer, to build this unique project. The set includes a roller turned printed circuit board, 55 components, case, mains lead and even the parts for the tester. According to one customer, the set costs "about a third of the price of the individual components. What more can we say?"



Instructions are included

PARTS SET WITH BLACK CASE £12.60 + VAT

PARTS SET WITH WHITE CASE £12.80 + VAT



KNIGHT RAIDER

FEATURED IN ETI JULY 1987

The ultimate in lighting effects for your Lamborghini, Maserati, BMW (or any other car, for that matter). Picture this: eight powerful lights in line along the front and eight along the rear. You flick a switch on the dashboard control box and a point of light moves lazily from left to right leaving a comet's tail behind it. Flip the switch again and the point of light becomes a bar, bouncing backwards and forwards along the row. Press again and try one of the other six patterns. An LED display on the control box lets you see what the main lights are doing.

The Knight Raider can be fitted to any car (it makes an excellent fog light) or with low powered bulbs it can turn any child's pedal car or bicycle into a spectacular TV-age toy!

The parts set consists of box, PCB and components for control, PCB and components for sequence board, and full instructions.

Lamps not included.
PARTS SET £24.80 + VAT

RAINY DAY PROJECTS



All can be built in an afternoon!

JUMPIN' JACK FLASH (ETI March 1988) £6.90 + VAT

Spectacular rock, stage and disco lighting effect!

CREDIT CARD CASINO (ETI March 1987) £5.90 + VAT

The wicked pocket gambling machine

MAINS CONTROLLER (ETI January 1987) £6.20 + VAT

Isolated logic to mains interface

MATCHBOX AMPLIFIERS (ETI April 1985) £6.50 + VAT

Listen: 50W of Hi-Fi power from an amp small enough to fit in a matchbox!

Matchbox Amplifier (20W) £8.90 + VAT

Matchbox Bridge Amplifier (50W) £3.90 + VAT

L165V Power Amplifier IC, with data and circuits

TACHO/DWELL METER (ETI January 1987) £16.40 + VAT

Turn your Metro into a Porsche!

HI-FI POWER METER (ETI May 1987) £3.90 + VAT

Measures Hi-Fi output power up to 100W

— includes PCB, components, meters

Mono power meter £7.20 + VAT

Stereo power meter

THE MISTRAL AIR IONISER



The best ioniser design yet — this one has variable ion drive, built-in ion counter and enough power to drive five multi-point emitters. For the technically minded, it has nine main drive stages, five secondary drives, and a four section booster to give an output capability of almost fifteen billion (1.47 x 10¹¹) ions every minute, or 2.45 x 10¹¹ ions per second. With extra emitters this can be increased still further!

PARTS SET £28.40 + VAT

The parts set includes case, printed circuit boards, 126 top grade components, all controls, lamps, hardware, a multi-point phosphor-bronze emitter and full instructions.

Some parts are available separately — please send SAE for lists, or SAE + £1 for lists, circuit and construction details and further information (free with parts set).

READY-BUILT MISTRAL

The Mistral Ioniser (and most of our other projects) can now be supplied built, tested and ready to go. For details, please contact Peter Leah at P.L. Electronics, 8 Woburn Road, Eastville, Bristol BS5 6TT. Tel: 0272 522703. Evenings Only

INTERNAL EMITTER £2.80 + VAT

Can be used in place of the P-B external emitter, or both can be used together for the highest ion output. Parts set includes PCB, ion emitters, components and instructions.

IPA BOARD CLEANER

Essential for removing grease and flux residues from the Mistral PCB to achieve peak performance. Applicator brush supplied.

£0.98 + VAT

ION FAN

An almost silent piezo-electric fan, mains operated, to pump ions away from the emitter and into the room. Increases the effectiveness of any ioniser by five times!

£9.80 + VAT

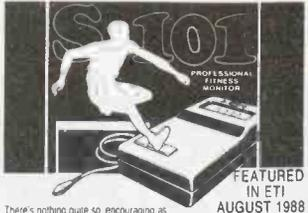

BRAINWAVE MONITOR

There's nothing quite so encouraging as having a quantifiable result to show for your training efforts. If you are not particularly fit, your resting heart rate will be around 80 beats per minute. As your jogging, aerobics or sport strengthens your heart, the rate will drop dramatically — possibly to 50bpm or less. With the S101, you can watch your progress day by day.

Breathing is important too. How efficiently do you take up oxygen? How quickly do you recover from 'oxygen debt' after strenuous activity? The S101 will let you know.

The approved parts set consists of: case, 3 printed circuit boards, all components (including 17 ICs, quartz crystal, 75 transistors, resistors, diodes and capacitors), LCD, switches, plugs, sockets, electrodes, and full instructions for construction and use.

PARTS SET £33.80 + VAT

Some parts are available separately. Please send SAE for lists, or SAE + £2 for lists, circuit, construction details and training plan (free with parts set).



ION DISPERSION METER

FEATURED IN ETI
FEBRUARY 1989

The Orion is a hand-held meter which sorts out ions in the air. It can tell the good ones from the ducts if you're thinking of buying a commercial ioniser, check the efficiency and output of one you've made yourself, help you set up fans and position the ioniser for best effect, do an ion-survey of your house or office — in short, it will let you do anything you want to know about ions in the air.

In direct mode the bar-graph readout will detect the presence of negative or positive ions and measure neg-ion strengths from 5 x 10⁷ to 10¹⁰ ions per second, which covers the levels you can expect when an air ioniser is in use. For the smaller concentrations of natural air ions, integrator mode will increase the sensitivity as far as you like.

Our approved parts set comprises: case, ion collector, printed circuit board, all components (including six ICs, schottky diode, ceramic, VDR, zener, 37 resistors and capacitors, LEDs, plug, socket, earth lead, etc.) and full instructions.

PARTS SET £18.40 + VAT

Some parts are available separately — please send SAE for lists, or SAE + £1 for lists, circuit, construction details and further information (free with parts set).



BIO-FEEDBACK

FEATURED IN ETI
DECEMBER 1986

Bio-feedback comes of age with this highly responsive, self-balancing skin response monitor! The powerful circuit has found application in clinical situations as well as on the bio-feedback scene. It will open your eyes to what GSR techniques are really all about. The complete parts set includes case, PCB, all components, leads, electrodes, conductive gel, and full instructions.

PARTS SET £16.80 + VAT

BIO-FEEDBACK BOOK £4.50 (NO VAT).

Please note: the book, by Stern and Ray, is an authorised guide to the potential of bio-feedback techniques. It is not a hobby book, and will only be of interest to intelligent adults.



BURGLAR BUSTER

Be safe from intruders with our Burglar Buster alarm system! It has all the features you'd expect from a high-tech alarm: entry and exit delay, anti-lamp loop, delay warning and control-box protection.

The parts set includes all four PCBs and all components to go on them. Other parts (case, switches, etc.) are available separately, if you haven't got anything suitable in your spares box. Set contains 4 PCBs, ICs, transistors, relays, capacitors, resistors, diodes, regulator, piezo sander and full instructions.

BB1 PARTS SET £12.80 + VAT

LEDs

Green rectangular LEDs for bar-graph displays
50 for £3.50 500 for £25
100 for £6 1000 for £45

DIGITAL AND AUDIO EQUIPMENT LEDs
Assorted 3mm LED's: red, green, yellow and orange
25 of each (100 LEDs) for £6.80

U.K. orders: please add 80p post and packing and 15% VAT to total.
Euro and overseas:
NO VAT. Carriage and insurance £4.50.
Please allow up to 14 days for delivery.

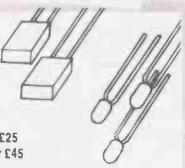

BRAINWAVE MONITOR

The most astonishing project ever to have appeared in an electronics magazine. Similar in principle to a medical EEG machine, this project allows you to hear the characteristic rhythms of your own mind! The alpha, beta and theta forms can be selected for study and the three articles give masses of information on their interpretation and powers.

In conjunction with Dr. Lewis's Alpha Plan, the monitor can be used to overcome shyness, to help you feel confident in stressful situations, and to train your self to excel at things you're 'not good at'.

Our approved parts set contains case, two PCBs, screening can for bio-amplifier, all components (including three PMI precision amplifiers), leads, brass electrodes and full instructions.

PARTS SET £39.80 + VAT ALPHA PLAN BOOK £2.50

SILVER SOLUTION (for pairing electrodes) £3.60 + VAT

Parts set available separately. We also have a range of accessories, professional electrodes, books, etc. Please send SAE for lists, or SAE + £2 for lists, construction details and further information (free with parts set).



FEATURED IN ETI
AUGUST 1987

Specialist
SEMICONDUCTORS
LIMITED

Tel: (0600) 3715
SALES DEPT., ROOM 108, FOUNDERS HOUSE, REDBROOK, MONMOUTH, GWENT.

AMAZING LOW PRICE

SOLDERING IRONS

FLAME MASTER HOT GAS SOLDERING TOOL

Superb Pocket Size Portable Gas
Soldering Iron

ONLY
£12.95
FS110



★ Interchangeable Tips ★

- ★ Powered by Butane Gas
- ★ Simple to Refill
- ★ Temperature up to 400°C (750°F)
- ★ Up to 2 Hours Continuous Use

FLAME MASTER 5 IN 1 HOT GAS TOOL KIT

Complete with tough moulded to measure case and including:
MULTI-PURPOSE TOOL

- ★ 4 Interchangeable Soldering Iron Tips
- ★ Soldering Iron
- ★ Hot Cutting Knife
- ★ Wide Area Flame Torch
- ★ High Temperature Flame Torch
- ★ Hot Air Blower

GREAT FOR

- ★ Electrical and Electric Work
- ★ Cutting Plastics and Fibres
- ★ Sealing, Bonding and Shrinking
- ★ Removing Paint and Putty

ONLY
£19.95
FMK10



The Flame Master hot gas tool kit has many uses. It can be a soldering iron, a pencil flame torch, a hot air blower or a wide (flat) flame torch. You can fit the soldering head with a selection of soldering tips and the hot knife, or you can fit the flame head, onto which you can attach the hot blower or the wide flame unit. The choice is yours!

Post Your Order Now ...

Order Coupon		Send this coupon to P.O. Box 3, Rayleigh, Essex SS6 8LR	
Quantity	Description	Code	Price
Name		Add Carriage If order below £5 please add 50p	50p
Address		Total	
	Post Code		

I authorise you to debit my Credit Card account for the cost of goods despatched.

Credit Card No.

Access Amex Visa Delete as required.

If ordering by Credit Card please sign

Expiry date of Credit Card PE

Maplin ELECTRONICS

CREDIT CARD HOTLINE

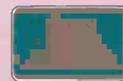
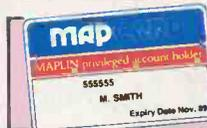

0702 554161

PHONE BEFORE 5PM FOR SAME DAY DESPATCH

ALL PRICES INCLUDE VAT.

All items subject to availability, both items will be on sale in our shops in Birmingham, Bristol, Leeds, Hammersmith, Edgware, Manchester, Nottingham, Southampton and Southend-on-Sea.