

PRACTICAL ELECTRONICS

SEPTEMBER 1967

PRICE 2/6

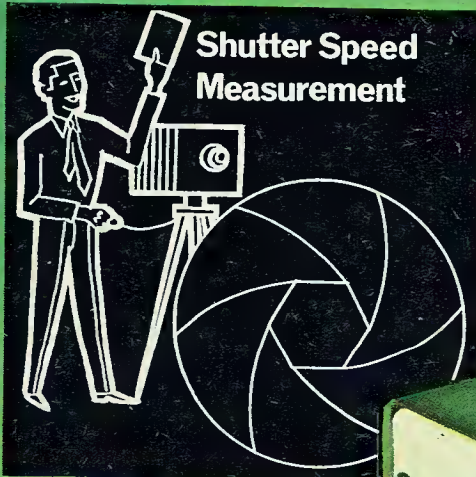

ELECTRONIC STOPCLOCK

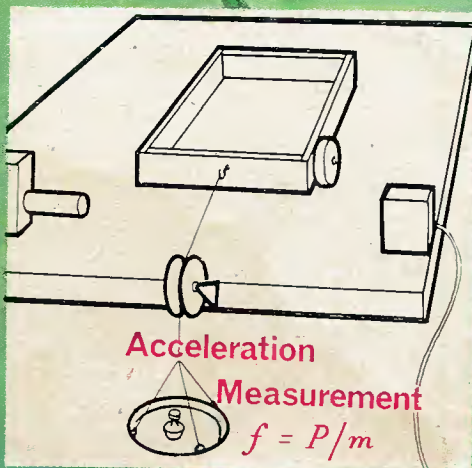
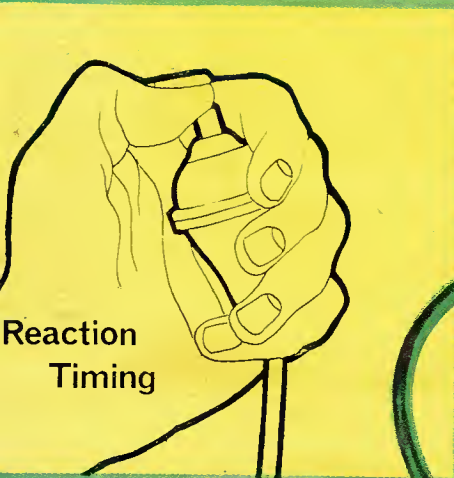

MEASURES INTERVAL
ELAPSED BETWEEN
TWO EVENTS

Four Ranges Covering
0.012 - 12 seconds

Lasky's Radio

SPECIAL INTEREST ITEMS!

EXCLUSIVE LASKY'S BARGAIN—SOLID STATE MULTIPLEX STEREO AM/FM TUNER/AMPLIFIER CHASSIS

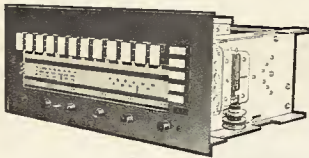

Model T10E—made for U.K. use by famous North American manufacturer and originally installed in De Luxe Hi-Fi consoles costing several hundred pounds. The chassis is of outstanding appearance and quality and offers many unique features plus an extremely comprehensive specification.

Features: Separate transistorised AM and FM tuners • 3 AM wavebands—LW, MW and Continental T.B. band • full FM cover with 5 push button preselected stations (sep. tuning controls for AM and FM ranges) • built in multiplex decoder with unique FMX feature which provides automatic switching from mono to stereo when stereo signal is received and vice versa • unique split amplifier facility for simultaneous play of radio plus any other source • channel reverse • switched inputs for tape and auxiliaries (sep. sockets for tape in and out) • switched extension speaker outlet • remote safety trip • socket for stereo headphones.

Tech. spec.: Output 100 watts RMS per channel; output imp. 8 Ω p.c.; sensitivity 50mV for 8W output at 1K Ω ; input amp. 100K Ω p.c.; 12 unique tumblers type function controls, 8 push button wavechange and station selection controls, vol., bass, treble and balance controls, push button contour (loudness) control; illuminated tuning scale; AM ranges: MW 520-1640 Kc/s, LW 140-290 Kc/s, Continental TR 170-345 Kc/s; FM range 88-108 Mc/s with switched AFC. Operates on 200/250V A.C., 50 or 60 c/s. Size 17 $\frac{1}{2}$ x 8 x 12in.

LASKY'S PRICE 59 Gns. Post & Packing 20/-

A range of high quality Hi-Fi Console Cabinets by the same famous manufacturer is also available at almost 1/2 list price and may be seen at our Hi-Fi Audio Centres.

UHF T.V. TUNERS

Well known British makers' surplus stocks. Now available for the first time to the Home Constructor. Add 2/6 Post and Packing on each.

VALVE UHF MODEL

In metal case size 4 x 6 x 1 $\frac{1}{2}$ in. Fully tunable—complete with PCC86 and PCC88 valves. **LASKY'S PRICE 29/6.** Without valves 7/6

TELEVISION IF AMPLIFIERS

38 Mc/s. Contains a large number of components, IF transformers, resistors, capacitors, etc., and the following valves: 2xPCF80, 1xEB91, EF80, EF183 and EF84. Overall size 11 $\frac{1}{2}$ x 3 $\frac{1}{2}$ x 4" deep. Ideal for servicemen and experimenters. This IF amp. when used with the Valve model UHF Tuner (above) provides a suitable conversion for B.B.C.2. Circuit supplied.

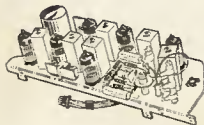

LASKY'S PRICE 29/6 Post 2/6

SPECIAL PACKAGE OFFER

Free standing table cabinet, size 17 $\frac{1}{2}$ x 9 x 5 $\frac{1}{2}$ in., finished in medium Mahogany. Scale marked 21 to 68 (UHF band). Designed to accept the above IF Amplifier with space for a Valve UHF Tuner Cabinet only 27/6. Post 3/6.



Special Package Offer IF Amplifier, UHF Tuner with valves and Table Cabinet.

PACKAGE PRICE 59/6 Post 6/-

EXPORT TTC B4002 FM WIRELESS MIC.

Highly sensitive—suitable for either static or mobile use. Signal can be picked up by any FM radio or tuner which receives frequencies between 96-104 Mc/s. over several hundred yards. Size only 3 x 2 $\frac{1}{2}$ x 1in. (in leather case). Operates on one PP3 type battery. Complete with neck cord, clip-on dynamic extension mike (1 x 2 x 3/8in.) and battery.



LASKY'S EXPORT PRICE 10 Gns. Post Free. Anywhere in the World.

TTC 18/500. More powerful version of above—size 7 $\frac{1}{2}$ x 1 $\frac{1}{2}$ x 4in. Operates on one PP3 type battery. **LASKY'S PRICE 12 Gns.** Post Free. Anywhere in the World.

These cannot be operated in the U.K. owing to G.P.O. regulations.

WATER TEMPERATURE THERMOSTATS

British made—orig. for use in high quality washing machine. range adjustable between 114°F and 230°F. Rating 200/250 V.A.C., 20 amps (also D.C. up to 125 V.A.). Size 2 $\frac{1}{2}$ x 1 $\frac{1}{2}$ x 1 $\frac{1}{2}$ with 18in. capillary tube and 6in. bulb. Single hole fixing—3/16in spindle.

LASKY'S PRICE 15/- Post 2/-

Branches

207 EDGWARE ROAD, LONDON, W.2 Tel.: 01-723 3271

33 TOTTENHAM CT. RD., LONDON, W.1 Tel.: 01-636 2605

Open all day Saturday, early closing 1 p.m. Thursday

152/3 FLEET STREET, LONDON, E.C.4 Tel.: FLEet St. 2833

Open all day Thursday, early closing 1 p.m. Saturday

ALL MAIL ORDERS AND CORRESPONDENCE TO: 3-15 CAVELL ST., TOWER HAMLETS, LONDON, E.1 Tel.: 01-790 4821

CONSTRUCTORS BARGAINS

THE SKYROVER

De Luxe

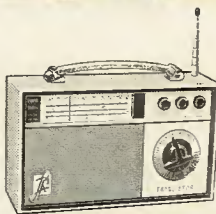

7 transistor plus 2 diode superhet, 6 waveband portable receiver covering the full Medium Waveband and Short Waveband 31-84Mc and also 4 separate switched handspread ranges, 13M, 16M., 19M. and 25M., with Band Spread Tuning for accurate Station Selection. The coil pack and tuning heart is factory assembled, and tested. Uses 4 U2 batteries. 5 in. Ceramic Magnet P.M. Speaker. Telesopic and Ferrite Rod Aerial. Tone Circuit, wood cabinet, size 11 $\frac{1}{2}$ x 6 $\frac{1}{2}$ x 3 in. covered with washable material, plastic trim and handle. Car aerial socket fitted.

Can be built for **£8.19.6** Post H.P. Terms: 60/- deposit and 11 monthly payments of 12/9. Total H.P.P. **£10.0.3.** Data 2/6 extra: refunded if you purchase parcel. All parts avail. sep. Four U2 batt. 3/4 A simple additional circuit provides cover of the 1100/1950M Long Waveband. All components with construction data. Only 10/- extra Post Free.

PEAK SOUND SA-88 TRANZISTORISED STEREO AMP AND PRE-AMP KIT

A high quality 17 watt, 14 transistor High Fidelity Integrated Amplifier which anyone can easily build using the revolutionary Peak Sound "Cir-Kit" wiring system. Size assembled only 10 x 2 $\frac{1}{2}$ x 3 in. Complete kit with detailed construction data. **LASKY'S PRICE £12.19.6** Post FREE. POWER SUPPLY KIT for the SA-88 **£3.10.0** Post FREE.

LASKY'S MINIATURE TRANZISTOR AMPLIFIER MODULES

Incorporating the very latest circuitry to provide high sensitivity and good quality in conjunction with extreme small size and compactness. High quality Newmarket transistors used throughout. All designed to operate on 9v. miniature battery. Add 1/- on each for post & packing

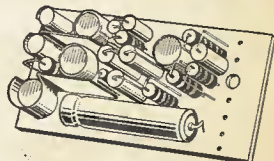

TYPE LRPC 1. 3 transistor. Input sens. 50 mV., output 150 mW, output imp. 40 Ω , size 2 $\frac{1}{2}$ x 1 $\frac{1}{2}$ in. **PRICE 27/6**

TYPE LRPC 4. 5 transistor. Input sens. 150 mV., output 330 mV, output imp. 15 Ω , size 2 $\frac{1}{2}$ x 1 $\frac{1}{2}$ in. **PRICE 18/6**

TYPE LRPC 5. 6 transistor. Input sens. 8mV., output 3W, output imp. 3 Ω , size 5 $\frac{1}{2}$ x 1 $\frac{1}{2}$ in. **PRICE 59/6**

TYPE LRPC 9. High to low impedance matching pre-amp.—input imp. 1 megohm, output imp. 2 k/ohms. Size 1 $\frac{1}{2}$ x 1 $\frac{1}{2}$ x 2in. **PRICE 10/6**

TYPE LRPC 10. Magnetic tape replay pre-amp. designed so that a 450 mH head can be matched into any of the audio amplifier modules listed above. Size 2 $\frac{1}{2}$ x 1 $\frac{1}{2}$ x 2in. **PRICE 10/6**

TYPES LRPC 9 and 10 are ideal for use with LRPC 1, 4 and 5 and are available at the reduced price of 7/6 each if bought with the LRPC 4.

FULLY ENCAPSULATED MODULES

Special function modules—all one size 1 $\frac{1}{2}$ x 1 x 1 $\frac{1}{2}$ in. Complete with detailed function and installation instructions. Send S.A.E. for data.

TYPE PA-1. Public address amp. for use with carbon, crystal or Dynamic microphones. 3 Ω output imp. **PRICE 30/6**

TYPE GR-1. Gramophone amplifier—provides sufficient power to fill average room. 3 Ω output imp. **PRICE 30/6**

TYPE CO-1. Morse code practice oscillator—for use with morse key and 3 Ω speaker. **PRICE 20/6**

TYPE MT-1. Metronome module—provides audible and visual beat from 30 to 240 beats per minute (for use with 3 Ω speaker or ind. lamp) **PRICE 22/6**

SINCLAIR SUPER MINIATURE KITS

We stock the complete range. Write for details of package deals.

THE MICRO-6 miniature radio only 1 $\frac{1}{2}$ x 1 $\frac{1}{2}$ x 1 $\frac{1}{2}$ in. **£2 19 6**

THE MICRO-FM. (tuner/receiver) **£5 19 6**

THE MICROMATIC mini-radio Kit **£2.19.6.** Fully built **£3 19 6**

STEREO 25 pre-amp control unit fully built **£9 19 6**

THE Z-12 12 watt amplifier and pre-amplifier. Fully built and tested **£4 9 6**

PZ-3 power pack for Z-12 **£3 19 6**

TRANSISTORS

ALL BRAND NEW AND GUARANTEED

GET S1, GET S5, GET-86 2/6; 873A, 874P 3/6; OC45, OC71, OC81D 4/6; OC 44, OC 70, OC 76, OC 81 5/6; pair (10/8); AF 117, OC 200 6/6; OC 42, OC 43, OC 73, OC 82D 7/6; OC 201, OC 204 15/-; OC 205, OC 206 19/6; OC28 24/6; OC 75 8/-.

TRANSFILTERS

BY BRUSH CRYSTAL CO. Available from stock.

TO-01B 465 kc/s. \pm 2 kc/s. TO-02D 470 kc/s. \pm 1 kc/s. TF-01B 465 kc/s. \pm 2 kc/s. TF-01D 470 kc/s. \pm 2 kc/s. **9/6 EACH**

Post 6d

High Fidelity Audio Centres

42 TOTTENHAM CT. RD., LONDON, W.1 Tel.: 01-580 2573

Open all day Thursday, early closing 1 p.m. Saturday

118 EDGWARE ROAD, LONDON, W.2 Tel.: 01-723 9789

Open all day Saturday, early closing 1 p.m. Thursday

NEW LOUDSPEAKER

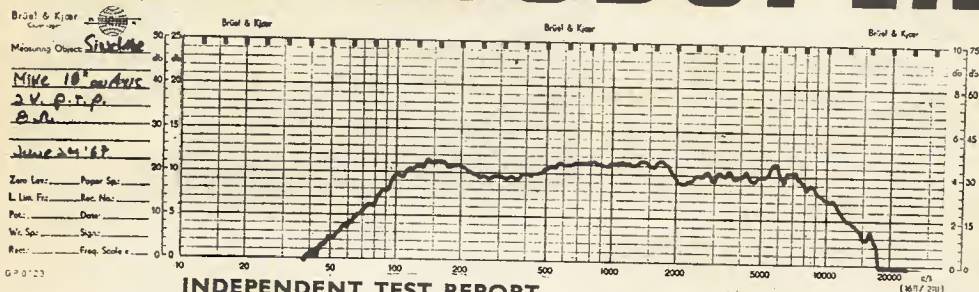

Unretouched reproduction of performance curve taken from a Sinclair Q.14 from stock. This is better than curves from speakers cost-up to £25.

INDEPENDENT TEST REPORT

The above curve was taken by an independent testing laboratory and shows clearly why the Q.14 achieves such remarkable standards of reproduction. Superb response is maintained between 60 and 15,000c/s, completely covering listening requirements and assuring the user of getting the best from the equipment to which the speaker is coupled.

WHY THE SINCLAIR Q.14 IS FAR AHEAD IN EVERY WAY

CONSTRUCTION

The sound, or pressure chamber and mounting baffle are of special high-density ultra-low resonant materials made possible by modern bonding and processing techniques. The sound chamber is of seamless construction and the loudspeaker mounted to ensure complete freedom from spurious "coloration".

LOADING

The Sinclair Q.14 has an input impedance of 15 ohms and will comfortably accept loadings in excess of 28 watts music power. This rating is far greater than that required for average listening requirements. However, using the Q.14 in module formation (a unique Sinclair facility) enables a very powerful system to be built up efficiently and economically. This makes an ideal quality P.A. system.

FREQUENCY RESPONSE

As the independently made curve shows, a remarkably smooth response is maintained between 60 and 15,000c/s. This extends comfortably beyond either end of the sound spectrum to provide true hi-fi standards.

REPRODUCING UNIT

A specially designed driver unit is used. It has an exceptionally high

AN ALL-BRITISH SINCLAIR GUARANTEED PRODUCT

Hear one in your own home—your money refunded in full if not satisfied.

sinclair

compliance in the cone suspension, a massive 11,000 gauss ceramic magnet and an aluminium speech coil. The cone is treated to ensure brilliant transient response.

CONTOURED PRESSURE CHAMBER

The shape and proportions of the sealed sound or pressure chamber have been determined mathematically thereby ensuring maximum energy to sound conversion ratio with forward sound "presence" and freedom from any directional effect. This is why the Sinclair Q.14 is ideal for stereo. Connections at the rear are marked for correct phasing when using two or more Q.14's.

SIZE

9 $\frac{3}{4}$ in \times 9 $\frac{3}{4}$ in \times 4 $\frac{3}{4}$ in deep. A separate base for free standing position is provided as well as a template for wall or flush mounting. A neat solid aluminium bar inset is used to embellish the front of the speaker.

SEND FOR YOUR'S TODAY

£6.19.6

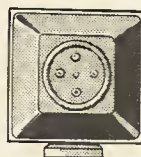

USING A SINCLAIR Q.14 SYSTEM

The size and form of the Sinclair Q.14 permit it to be used in a far wider variety of applications than with conventionally designed loudspeakers. This makes it possible to match the speaker to its environment much more easily and to achieve performance standards far better than anything in its size or price group. Here are some typical ways of using the Q.14. The enthusiast for hi-fi will find many more.

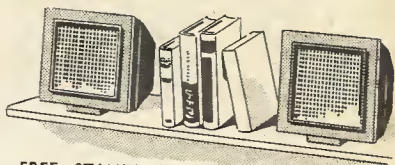

FREE STANDING BOOK SHELF ASSEMBLY
Ideal for stereo. A base is supplied with the Q14, which screws on for convenience.

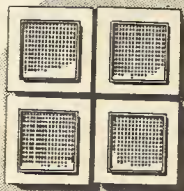

CORNER SPEAKER AT ANY HEIGHT
The Q.14 will fit comfortably into a wall corner, taking up a minimum of space. The wall surfaces then contribute to the sound radiation.

MULTI UNIT ASSEMBLY
Any number of Q.14's can be flush mounted on to a flat surface, such as a false wall or room divider. They can also be arranged for P.A. work.



Order form and more
Sinclair products on next pages

DE LUXE PLAYERS

4-Speed Mono Players 2-tone Cabinets 17x15x8 1/2 in. High Quality Loudspeakers and High Quality Amplifiers ready built. Quicker output. Volume and Bass controls. Special instructions enable assembly in 30 minutes, only 5 wires to join. 12 months' guarantee.



TO BUILD YOURSELF

Post 2/6 per item.
PORTABLE CABINET As illustrated. To fit standard player or autochanger. **69/6**
RCS AMPLIFIER 3 WATT. Ready made and tested with UCL88 triode pentode valve. **59/6**
SINGLE PLAY MONO
 BSR GU7 £41.9/6
 Garrard SRP12 £41.9/6
 Garrard SP25 £10.19.8
 Philips AG1016 £11.9.8
 Garrard A70 £21.19.8
 Garrard LABO £24.19.8
 Garrard A40 £29.19.8

SUPERIOR AMPLIFIER. Ready made and tested. Guaranteed better sound! Fully isolated AC Mains Transformer 4 watt output. ECL86 triode pentode valve. Volume and tone controls with knobs. Quality Loudspeaker. **89/6**
AUTOCHARGE MONO
 BSR Superslim £5.19.8
 Garrard 1000 £5.19.8
 Garrard 2000 £6.19.8
 Garrard 3000 £8.9.8
 Garrard AT60 Mk II discrot turntable £12.19.8

All with mono cartridge (Stereo 12/6 extra)
GARRARD TEAKWOOD BASE WB1 Ready cut for mounting 1000, 2000, 3000, SP25, AT60. **72/6**
A.18 TRANSCRIPTION TONE ARM with tracking template and two plug-in shells. Original price £13.19.8. **OUR PRICE 5 gns.**
Decca Demar Stereo Diamond Cartridge £4.14.8 extra.

Q MAX CHASSIS CUTTER

Complete: a die, a punch, an Allen screw and key
 1in. 14/8 zin. 15/9 1 1/4in. 18/- 1 1/2in. 20/6 2 1/4in. 37/9
 1in. 14/8 zin. 18/9 1 1/4in. 18/8 1 1/2in. 22/6 2 1/4in. 44/3
 1in. 15/6 1 1/4in. 18/- 1 1/2in. 20/6 2 1/4in. 34/3
BARGAIN XTAL PICK-UP ARM Complete with ACOS LP-78 Turnover Head and Styli 20/- Stereo 30/-
SPEAKER FRET Tegan various colours, 52in. wide, from 10/-; 1/4; 26in. wide from 5/-.
SAMPLES S.A.E.
EXPANDED METAL GOLD OR SILVER 12 x 12 in. 6/-
NEW GARRARD GRAM MOTORS 2,500 r.p.m. 100-130v. 15/- pair for 200/250v. A.C. (in series), or 10/- ea. Post 2/6.

FULL WAVE BRIDGE SELENIUM RECTIFIERS:
 6-12 v. outputs, 1 1/2 amp. 8/9; 2 a. 11/3; 4 a. 17/8.
CHARGER TRANSFORMERS. P & P 2/6. Input 200/250 v. for charging at 6 or 12 v., 1 1/2 amps. 17/8; 2 amps. 21/-; 4 amps. 25/-.
Circuit free. Ammeter 0 to 5 amp. 10/8.
MOVING COIL MULTIMETER TK 25. 47/6
 0-1,000v. A.C./D.C. ohms 0 to 100k, etc.
MOVING COIL MULTIMETER EP10K. 79/6
 0-1,000v. A.C./D.C. ohms 0 to 3 meg. etc.
MOVING COIL MULTIMETER EP20K
 0-2,500v. D.C. 20,000 ohms per volt. 0-1,000v. A.C. Ohms 0 to 6 meg. 50 Microamps full scale. **99/6**

NEW MULLARD TRANSISTORS
 OC71 6/-; OC72 7/6; OC81D 6/-; OC81 6/-; AF115 8/-; AF114 8/8; OC44 8/-; OC45 8/-; OC171 9/-; OC170 8/6; AF117 7/-; OC23 12/6; AD140 15/-; OC35 15/- Holders 1/3.

ARDENTE TRANSISTOR TRANSFORMERS
 D8035, 7.3 CT: 1 Push Pull to 3 ohms for OC72, OC81 11/-
 D8034, 1.75 1 CT. Push Pull Driver for OC72, OC81 11/-
 D8058, 11.5 1 Output to 3 ohms for OC72, OC81 11/-
TRANSISTOR MAINS ELIMINATORS, FAMOUS "POWER MITE", 9 VOLT. SAME SIZE AS PP3 BATTERY. 45/-
FULLY SMOOTHED, 150mA. FULL WAVE CIRCUIT.

WEYRAD P50 - Transistor Coils
 RA2W 6 in. Ferrite Aerial Spare Cores..... 6d.
 with car aerial coil..... 12/6
 Driver Trans. LEDTA..... 9/6
 Osc. P50/IAC..... 5/4 Printed Circuit, PCAI..... 8/6
 I.P. P50/2CC 470 k/ohms..... 5/7 J.B. Tuning Gang..... 10/8
 3rd L.F. P50/37C..... 6/- Weyrad Booklet..... 2/-

Volume Controls 80 Ohm Coax 6d. yd.
 Semi-air spaced Cable
 100 yd. drum 50/- post free.
FRINGE LOSS 1/6 yd.
 Ideal 825 lines

COAXIAL PLUG 1/-. PANEL SOCKETS 1/-. LINE SOCKETS 2/-. OUTLET BOXES, SURFACE OR FLUSH 4/6.
BALANCED TWIN FEEDERS 1/- yd. 80 or 300 ohms.
TELESCOPIC CHROME AERIALS. 6in. extends to 23in. 6/6 each. CAR AERIAL PLUGS 1/6. Sockets 1/3.

SPECIAL PURCHASE!

B.S.R. GU7
 9 volt Battery
 Operated Record
 Player Decks



4 speeds, automatic stop. Plays any size record. Complete with mono LP/78 xial and sapphire stylus. **69/6 P.P.**
 (With stereo cartridge 12/6 extra). ONLY **6/6**

RETURN OF POST DESPATCH Post and Packing 1/6 unless otherwise stated. **C.O.D. 5/- extra. Full List 1/-. CALLERS WELCOME**

RADIO COMPONENT SPECIALISTS

Written guarantee with every purchase. (Export: Send remittance and extra postage, no C.O.D.) Buses 133, 68 pass door. S.R. Stn. Selhurst. Tel. 01-684-1665

STELLA RECORD PLAYER AMPLIFIER

4 watt. 2 stage. 3 to 7 ohm. Neg. feedback. UCL82. UY85. 200-250v. A.C. tapped input. Chassis size 8 x 2 1/2 x 4 in. high. Gold Walnut knobs. Volume and Tone controls on separate Polished Wood Panel 6 x 2 in. Brand new with makers' guarantee. **24 GAIN PRICE P. & P. 2/6. 78/6**

NEW TUBULAR ELECTROLYTICS:
 2/350 v. ... 2/3. 100/25 v. ... 2/ 8/600 v. 9/6
 4/350 v. ... 2/3. 250/25 v. ... 2/6 18/000 v. ... 12/6
 8/450 v. ... 2/3. 500/15 v. ... 3/- 18-18/6500 v. ... 7/6
 16/450 v. ... 3/- 8-8/450 v. 3/6 32-32/4500 v. 6/-
 32/450 v. ... 3/9 8-16/450 v. 3/9 50-50/350 v. 7/6
 25/25 v. ... 1/9 18-18/450 v. 4/3 60-100/350 v. 11/-
 50/50 v. ... 2/- 32-32/350 v. 4/6 100-200/275 v. 12/6

PAPER TUBULARS
 350v.-0.91µ, 0.52µ; 1 mid. 3/-; 2 mid. 150v. 3/-.
 500v.-0.001 to 0.05 µ; 0.1 1/-; 0.25 1/6; 0.5 3/-
 1,000v.-0.01, 0.0022, 0.0047, 0.01, 0.02, 1/6; 0.047, 0.1 2/6.
E.H.T. CONDENSERS. 0.001mfd., 7kV., 6/6; 20kV., 10/6.

SILVER MICA. Close tolerance (plus or minus 1/2 p.p.), 5 to 47 p.p. 1/- ditto 1/5; 50 to 800 p.p. 1/-; 1,000 to 5,000 p.p. 2/-; 10,000 to 15,000 p.p. 2/6; 20,000 to 30,000 p.p. 3/6; 30,000 to 40,000 p.p. 4/6; 40,000 to 50,000 p.p. 5/6; 50,000 to 60,000 p.p. 6/6; 60,000 to 70,000 p.p. 7/6; 70,000 to 80,000 p.p. 8/6; 80,000 to 90,000 p.p. 9/6; 90,000 to 100,000 p.p. 10/6; 100,000 to 150,000 p.p. 12/6; 150,000 to 200,000 p.p. 14/6; 200,000 to 300,000 p.p. 16/6; 300,000 to 400,000 p.p. 18/6; 400,000 to 500,000 p.p. 20/6; 500,000 to 600,000 p.p. 22/6; 600,000 to 700,000 p.p. 24/6; 700,000 to 800,000 p.p. 26/6; 800,000 to 900,000 p.p. 28/6; 900,000 to 1,000,000 p.p. 30/6; 1,000,000 to 1,500,000 p.p. 32/6; 1,500,000 to 2,000,000 p.p. 34/6; 2,000,000 to 3,000,000 p.p. 36/6; 3,000,000 to 4,000,000 p.p. 38/6; 4,000,000 to 5,000,000 p.p. 40/6; 5,000,000 to 6,000,000 p.p. 42/6; 6,000,000 to 7,000,000 p.p. 44/6; 7,000,000 to 8,000,000 p.p. 46/6; 8,000,000 to 9,000,000 p.p. 48/6; 9,000,000 to 10,000,000 p.p. 50/6; 10,000,000 to 15,000,000 p.p. 52/6; 15,000,000 to 20,000,000 p.p. 54/6; 20,000,000 to 30,000,000 p.p. 56/6; 30,000,000 to 40,000,000 p.p. 58/6; 40,000,000 to 50,000,000 p.p. 60/6; 50,000,000 to 60,000,000 p.p. 62/6; 60,000,000 to 70,000,000 p.p. 64/6; 70,000,000 to 80,000,000 p.p. 66/6; 80,000,000 to 90,000,000 p.p. 68/6; 90,000,000 to 1,000,000,000 p.p. 70/6; 1,000,000,000 to 1,500,000,000 p.p. 72/6; 1,500,000,000 to 2,000,000,000 p.p. 74/6; 2,000,000,000 to 3,000,000,000 p.p. 76/6; 3,000,000,000 to 4,000,000,000 p.p. 78/6; 4,000,000,000 to 5,000,000,000 p.p. 80/6; 5,000,000,000 to 6,000,000,000 p.p. 82/6; 6,000,000,000 to 7,000,000,000 p.p. 84/6; 7,000,000,000 to 8,000,000,000 p.p. 86/6; 8,000,000,000 to 9,000,000,000 p.p. 88/6; 9,000,000,000 to 10,000,000,000 p.p. 90/6; 10,000,000,000 to 15,000,000,000 p.p. 92/6; 15,000,000,000 to 20,000,000,000 p.p. 94/6; 20,000,000,000 to 30,000,000,000 p.p. 96/6; 30,000,000,000 to 40,000,000,000 p.p. 98/6; 40,000,000,000 to 50,000,000,000 p.p. 100/6; 50,000,000,000 to 60,000,000,000 p.p. 102/6; 60,000,000,000 to 70,000,000,000 p.p. 104/6; 70,000,000,000 to 80,000,000,000 p.p. 106/6; 80,000,000,000 to 90,000,000,000 p.p. 108/6; 90,000,000,000 to 1,000,000,000,000 p.p. 110/6; 1,000,000,000,000 to 1,500,000,000,000 p.p. 112/6; 1,500,000,000,000 to 2,000,000,000,000 p.p. 114/6; 2,000,000,000,000 to 3,000,000,000,000 p.p. 116/6; 3,000,000,000,000 to 4,000,000,000,000 p.p. 118/6; 4,000,000,000,000 to 5,000,000,000,000 p.p. 120/6; 5,000,000,000,000 to 6,000,000,000,000 p.p. 122/6; 6,000,000,000,000 to 7,000,000,000,000 p.p. 124/6; 7,000,000,000,000 to 8,000,000,000,000 p.p. 126/6; 8,000,000,000,000 to 9,000,000,000,000 p.p. 128/6; 9,000,000,000,000 to 10,000,000,000,000 p.p. 130/6; 10,000,000,000,000 to 15,000,000,000,000 p.p. 132/6; 15,000,000,000,000 to 20,000,000,000,000 p.p. 134/6; 20,000,000,000,000 to 30,000,000,000,000 p.p. 136/6; 30,000,000,000,000 to 40,000,000,000,000 p.p. 138/6; 40,000,000,000,000 to 50,000,000,000,000 p.p. 140/6; 50,000,000,000,000 to 60,000,000,000,000 p.p. 142/6; 60,000,000,000,000 to 70,000,000,000,000 p.p. 144/6; 70,000,000,000,000 to 80,000,000,000,000 p.p. 146/6; 80,000,000,000,000 to 90,000,000,000,000 p.p. 148/6; 90,000,000,000,000 to 1,000,000,000,000,000 p.p. 150/6; 1,000,000,000,000,000 to 1,500,000,000,000,000 p.p. 152/6; 1,500,000,000,000,000 to 2,000,000,000,000,000 p.p. 154/6; 2,000,000,000,000,000 to 3,000,000,000,000,000 p.p. 156/6; 3,000,000,000,000,000 to 4,000,000,000,000,000 p.p. 158/6; 4,000,000,000,000,000 to 5,000,000,000,000,000 p.p. 160/6; 5,000,000,000,000,000 to 6,000,000,000,000,000 p.p. 162/6; 6,000,000,000,000,000 to 7,000,000,000,000,000 p.p. 164/6; 7,000,000,000,000,000 to 8,000,000,000,000,000 p.p. 166/6; 8,000,000,000,000,000 to 9,000,000,000,000,000 p.p. 168/6; 9,000,000,000,000,000 to 10,000,000,000,000,000 p.p. 170/6; 10,000,000,000,000,000 to 15,000,000,000,000,000 p.p. 172/6; 15,000,000,000,000,000 to 20,000,000,000,000,000 p.p. 174/6; 20,000,000,000,000,000 to 30,000,000,000,000,000 p.p. 176/6; 30,000,000,000,000,000 to 40,000,000,000,000,000 p.p. 178/6; 40,000,000,000,000,000 to 50,000,000,000,000,000 p.p. 180/6; 50,000,000,000,000,000 to 60,000,000,000,000,000 p.p. 182/6; 60,000,000,000,000,000 to 70,000,000,000,000,000 p.p. 184/6; 70,000,000,000,000,000 to 80,000,000,000,000,000 p.p. 186/6; 80,000,000,000,000,000 to 90,000,000,000,000,000 p.p. 188/6; 90,000,000,000,000,000 to 1,000,000,000,000,000,000 p.p. 190/6; 1,000,000,000,000,000,000 to 1,500,000,000,000,000,000 p.p. 192/6; 1,500,000,000,000,000,000 to 2,000,000,000,000,000,000 p.p. 194/6; 2,000,000,000,000,000,000 to 3,000,000,000,000,000,000 p.p. 196/6; 3,000,000,000,000,000,000 to 4,000,000,000,000,000,000 p.p. 198/6; 4,000,000,000,000,000,000 to 5,000,000,000,000,000,000 p.p. 200/6; 5,000,000,000,000,000,000 to 6,000,000,000,000,000,000 p.p. 202/6; 6,000,000,000,000,000,000 to 7,000,000,000,000,000,000 p.p. 204/6; 7,000,000,000,000,000,000 to 8,000,000,000,000,000,000 p.p. 206/6; 8,000,000,000,000,000,000 to 9,000,000,000,000,000,000 p.p. 208/6; 9,000,000,000,000,000,000 to 10,000,000,000,000,000,000 p.p. 210/6; 10,000,000,000,000,000,000 to 15,000,000,000,000,000,000 p.p. 212/6; 15,000,000,000,000,000,000 to 20,000,000,000,000,000,000 p.p. 214/6; 20,000,000,000,000,000,000 to 30,000,000,000,000,000,000 p.p. 216/6; 30,000,000,000,000,000,000 to 40,000,000,000,000,000,000 p.p. 218/6; 40,000,000,000,000,000,000 to 50,000,000,000,000,000,000 p.p. 220/6; 50,000,000,000,000,000,000 to 60,000,000,000,000,000,000 p.p. 222/6; 60,000,000,000,000,000,000 to 70,000,000,000,000,000,000 p.p. 224/6; 70,000,000,000,000,000,000 to 80,000,000,000,000,000,000 p.p. 226/6; 80,000,000,000,000,000,000 to 90,000,000,000,000,000,000 p.p. 228/6; 90,000,000,000,000,000,000 to 1,000,000,000,000,000,000,000 p.p. 230/6; 1,000,000,000,000,000,000,000 to 1,500,000,000,000,000,000,000 p.p. 232/6; 1,500,000,000,000,000,000,000 to 2,000,000,000,000,000,000,000 p.p. 234/6; 2,000,000,000,000,000,000,000 to 3,000,000,000,000,000,000,000 p.p. 236/6; 3,000,000,000,000,000,000,000 to 4,000,000,000,000,000,000,000 p.p. 238/6; 4,000,000,000,000,000,000,000 to 5,000,000,000,000,000,000,000 p.p. 240/6; 5,000,000,000,000,000,000,000 to 6,000,000,000,000,000,000,000 p.p. 242/6; 6,000,000,000,000,000,000,000 to 7,000,000,000,000,000,000,000 p.p. 244/6; 7,000,000,000,000,000,000,000 to 8,000,000,000,000,000,000,000 p.p. 246/6; 8,000,000,000,000,000,000,000 to 9,000,000,000,000,000,000,000 p.p. 248/6; 9,000,000,000,000,000,000,000 to 10,000,000,000,000,000,000,000 p.p. 250/6; 10,000,000,000,000,000,000,000 to 15,000,000,000,000,000,000,000 p.p. 252/6; 15,000,000,000,000,000,000,000 to 20,000,000,000,000,000,000,000 p.p. 254/6; 20,000,000,000,000,000,000,000 to 30,000,000,000,000,000,000,000 p.p. 256/6; 30,000,000,000,000,000,000,000 to 40,000,000,000,000,000,000,000 p.p. 258/6; 40,000,000,000,000,000,000,000 to 50,000,000,000,000,000,000,000 p.p. 260/6; 50,000,000,000,000,000,000,000 to 60,000,000,000,000,000,000,000 p.p. 262/6; 60,000,000,000,000,000,000,000 to 70,000,000,000,000,000,000,000 p.p. 264/6; 70,000,000,000,000,000,000,000 to 80,000,000,000,000,000,000,000 p.p. 266/6; 80,000,000,000,000,000,000,000 to 90,000,000,000,000,000,000,000 p.p. 268/6; 90,000,000,000,000,000,000,000 to 1,000,000,000,000,000,000,000,000 p.p. 270/6; 1,000,000,000,000,000,000,000,000 to 1,500,000,000,000,000,000,000,000 p.p. 272/6; 1,500,000,000,000,000,000,000,000 to 2,000,000,000,000,000,000,000,000 p.p. 274/6; 2,000,000,000,000,000,000,000,000 to 3,000,000,000,000,000,000,000,000 p.p. 276/6; 3,000,000,000,000,000,000,000,000 to 4,000,000,000,000,000,000,000,000 p.p. 278/6; 4,000,000,000,000,000,000,000,000 to 5,000,000,000,000,000,000,000,000 p.p. 280/6; 5,000,000,000,000,000,000,000,000 to 6,000,000,000,000,000,000,000,000 p.p. 282/6; 6,000,000,000,000,000,000,000,000 to 7,000,000,000,000,000,000,000,000 p.p. 284/6; 7,000,000,000,000,000,000,000,000 to 8,000,000,000,000,000,000,000,000 p.p. 286/6; 8,000,000,000,000,000,000,000,000 to 9,000,000,000,000,000,000,000,000 p.p. 288/6; 9,000,000,000,000,000,000,000,000 to 10,000,000,000,000,000,000,000,000 p.p. 290/6; 10,000,000,000,000,000,000,000,000 to 15,000,000,000,000,000,000,000,000 p.p. 292/6; 15,000,000,000,000,000,000,000,000 to 20,000,000,000,000,000,000,000,000 p.p. 294/6; 20,000,000,000,000,000,000,000,000 to 30,000,000,000,000,000,000,000,000 p.p. 296/6; 30,000,000,000,000,000,000,000,000 to 40,000,000,000,000,000,000,000,000 p.p. 298/6; 40,000,000,000,000,000,000,000,000 to 50,000,000,000,000,000,000,000,000 p.p. 300/6; 50,000,000,000,000,000,000,000,000 to 60,000,000,000,000,000,000,000,000 p.p. 302/6; 60,000,000,000,000,000,000,000,000 to 70,000,000,000,000,000,000,000,000 p.p. 304/6; 70,000,000,000,000,000,000,000,000 to 80,000,000,000,000,000,000,000,000 p.p. 306/6; 80,000,000,000,000,000,000,000,000 to 90,000,000,000,000,000,000,000,000 p.p. 308/6; 90,000,000,000,000,000,000,000,000 to 1,000,000,000,000,000,000,000,000,000 p.p. 310/6; 1,000,000,000,000,000,000,000,000,000 to 1,500,000,000,000

TAPE AMPLIFIERS — TAPE DECKS — CONTROL UNITS

20 + 20W
STEREO
AMP.
AA-22U



GARRARD
PLAYER
AT-60



TRUVOX
DECK

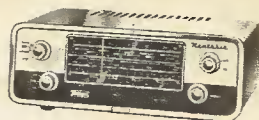

AM/FM
TUNER

20 + 20W TRANSISTOR STEREO AMPLIFIER. Model AA-22U. Outstanding performance and appearance. Kit £39.10.0 (less cabinet). Attractive walnut veneered cabinet £25.0 extra. Assembled incl. cabinet, £59.15.0

GARRARD AUTO/RECORD PLAYER. Model AT-60, less cartridge £14.12.10. With Decca Deram pick-up £19.7.4 incl. P.T.

Many other Garrard models available, ask for Lists.

HI-FI MONO AMPLIFIER. Model MA-5. A general purpose 5W Amplifier, with inputs for Gram., Radio. Modern functional appearance. Kit £11.9.6 Assembled £15.15.0

TAPE PRE-AMPLIFIERS. TA-1M (MONO): Kit £19.18.0. Assembled £28.18.0. TA-1S (STEREO): Kit £25.10.0. Assembled £35.18.0. Will work satisfactorily with almost any tape deck.

TRUVOX D-106 and 108 TAPE DECKS. High quality stereo/mono tape decks. D106, $\frac{1}{2}$ track, £39.15.0 D108, $\frac{1}{2}$ track, £39.15.0

TRANSISTOR INTERCOM. Models XI-1U and XIR-1U. A time-saving device for office, shop or for the home. Master unit XI-1U will operate up to 5 remote stations. Master, XI-1U Kit £11.9.6 Assembled £17.9.6. Rempte, XIR-1U Kit £4.9.6 Assembled £5.18.0. Send for full specification leaflet.

MONO CONTROL UNIT. Model UMC-1. Designed to work with the MA-12 or similar amplifier requiring 0.25V or less for full output. 5 inputs. Baxandall type controls. Kit £9.2.6 Assembled £14.2.6

STEREO CONTROL UNIT. Model USC-1. Push-button selection, accurately matched ganged controls to ± 1 dB. Rumble and variable low pass filters. Printed circuit boards. Kit £19.19.0 Assembled £27.5.0

Build Your Own Electronics



SPEAKER SYSTEMS



SSU-1

HI-FI SPEAKER SYSTEM. Model SSU-1. Ducted-port bass reflex cabinet "in the white". Two speakers. Vertical horizontal models with legs, Kit £12.12.0, without legs, Kit £11.17.6 incl. P.T.

The **BERKELEY SLIM-LINE SPEAKER SYSTEM**, fully finished walnut veneered cabinet for faster construction. Special 12" bass unit and 4" mid/high frequency unit. Range 30-17,000 c/s. Size 26" x 17" only 7 $\frac{1}{4}$ " deep. Modern attractive styling. Excellent value. Kit £19.10.0 Assembled £24.0.0

COTSWOLD SPEAKER SYSTEMS. Outstanding performance for price.

MFS: Size 36" x 16 $\frac{1}{2}$ " x 14" deep. Kit £25.12.0 Assembled £33.17.0 (in the white)

STANDARD: Size 26" x 23" x 14 $\frac{1}{2}$ " deep. Kit £25.12.0 Assembled £33.17.0 (in the white)

STANDARD Model now available in beautiful walnut finish. Completely factory assembled and finished at £33.4.0

NEW MODEL!

AVON HI-FI PERFORMANCE 'MINI' SPEAKER KIT. A compact, bookshelf size, 7 $\frac{1}{2}$ " wide x 19 $\frac{1}{2}$ " high x 8 $\frac{1}{2}$ " deep, speaker with beautiful walnut veneered fully-finished cabinet, wide frequency response, special 6" bass, 3" HF units and crossover network. Cabinet Kit £8.18.0. Speaker Kit £4.18.0. Total Price £13.16.0 incl. P.T.



Berkeley



FREE!
36 page Catalogue.
SEND FOR YOUR
COPY
NOW!



Over 150 models shown,
many in Full Colour

To **DAYSTROM LTD., Dept. P.E.9, Gloucester**

Without obligation please send me

FREE BRITISH HEATHKIT CATALOGUE.....

FULL DETAILS OF MODEL(S).....

(Please write in **BLOCK CAPITALS**)

NAME

ADDRESS

(Tick here)

Please send **FREE** catalogue to my friend.

NAME

ADDRESS

P.E.9

NEW MODELS!

Portable Stereo Record Player, SRP-1

Automatic playing of 16, 33, 45 and 78 rpm records. All transistor—cool instant operation. Dual LP/78 stylus. Plays mono or stereo records. Suitcase portability. Detachable speaker enclosure for best stereo effect. Two 8" x 5" special loudspeakers. For 220-250V A.C. mains operation.

Compact, economical stereo and mono record playing for the whole family — plays anything from the Beatles to Bartok. All solid state circuitry gives room filling volume.

Kit £27.15.0 incl. P.T. Assembled price on request.

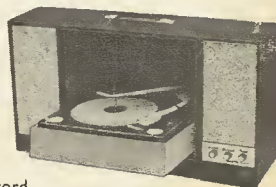

Transistorised AM-FM Stereo Tuner

In the same attractive styling as our well-known AA-22U Stereo Amplifier. Features 18 transistor, 7 diode circuit. AM-LW/MW, FM Stereo and Mono tuning. Stereo indicator light. AFC, AGC. Pre-assembled and aligned FM unit. Separate AM and FM circuit boards. Self-powered. Handsome, finished walnut veneered cabinet. (Optional extra).

Comprising: Model AFM-2T RF Tuning Unit. Kit £7.17.6 including P.T. AFM-2A IF Amp. and power supply kit £24.9.6. Cabinet £25.0 extra.

TOTAL PRICE KIT £32.7.0 incl. P.T.

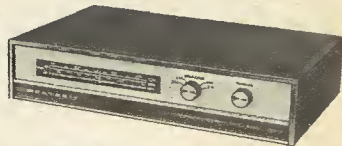

LOW-COST TRANSISTOR STEREO AMPLIFIER KIT TS-23.

A really low priced unit yet incorporates all essential features for good reproduction from gramophone, radio and other sources, 3 watts for channel output (15 ohms). Kit £17.15.0. Beautiful walnut veneered cabinet £2.0.0 extra.



NEW MODEL 500. 30,000 o.p.v. With overload protection, mirror scale. 0/5/1/1,000 volts, D.C. and A.C. 0/25/10/25/100/250 500/1,000v. D.C. 0/50μA/5/60/50mA. 12 amp. D.C. 0/60K/6 Meg./60. Meg Ω. £8/17/6 Post Paid.

PROFESSIONAL 20,000 o.p.v. LAB. TYPE MULTITESTER

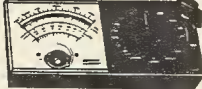

With automatic overload protection, mirror scale. Ranges: 1/10/50/250/500/1,000 volts, D.C. and A.C. 0-500 μA, 10 mA, 250 mA. Current: 0/20 K, 200 K, 2 megohm. Decibels - 20 to + 22db. £5/10/-. P. & P. 2/6.

TE-900 20,000 Ω/VOLT **GIANT MULTIMETER** 6in. full view meter. 2 colour scale. 0/25/10/250/1,000/5,000 v. A.C. 0/25/12.5/10/50/250/1,000/5,000 v. D.C. 0/50μA/110/100/500 mA/10 amp. D.C. 02K/200K/20 Megohm. £12/18/6. P. & P. 5/.



MODEL ZQM TRANSISTOR CHECKER

It has the fullest capacity for checking on A, B and Tco. Equally adaptable for checking diodes, etc. Spec. A: 0-7-0-3987, B: 5-200, Tco: 0-50 microamps, 0-5 mA. Resistance 200 Ω - 1 Meg. Supplied complete with instructions, battery and leads. £5/18/6. P. & P. 2/6.



★TRANSISTORISED FM TUNER★

6 TRANSISTOR HIGH QUALITY TUNER, SIZE ONLY 6in. × 4in. × 2½in. 3 I.F. stages. Double tuned discriminator. Ample output to feed most amplifiers. Operates on 9 volt battery. Coverage 88-108 Mc/s. Ready built ready for use. Fantastic value for money. £6/17/6. P. & P. 2/6.

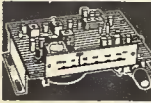

NOMBREX TRANSISTORISED EQUIPMENT

ALL Post Paid With Battery



Model 22 P.S.U. 0-15v. D.C. £14. Model 30 Audio Generator 10 c/s-100 Kc/s £19/10/0. Model 31 R.F. Generator 150 Kc/s-350 Mc/s £12/10/0. Model 27 Signal Generator 150 Kc/s-350 Mc/s. £10/10/0. Model 63 Audio Generator 10 c/s-100 Kc/s £16/15/0. Model 62 C.R. Bridge £9. Model 66 Inductance Bridge £18. Model 61 P.S.U. 0-5-15v. D.C. £8/10/0.

SILICON RECTIFIERS

200 v. P.I.V. 200mA.	2/8
200 v. P.I.V. 5 amp.	5/8
400 v. P.I.V. 3 amp.	7/8
1,000 v. P.I.V. 5 amp.	7/8
400 v. P.I.V. 6 amp.	6/6
400 v. P.I.V. 8 amp.	7/6
1,000 v. P.I.V. 650 mA	6/6
800 v. P.I.V. 500mA.	5/8
800 v. P.I.V. 5 amp.	7/8
400 v. P.I.V. 500mA.	6/8
70 v. P.I.V. 1 amp.	3/6
150 v. P.I.V. 165mA.	1/-
150 v. P.I.V. 25 amp.	19/6
400 v. P.I.V. 100 amp.	49/6
400 v. P.I.V. 3 amp. (S.C.R.)	10/-
100 v. P.I.V. 5 amp. (S.C.R.)	15/6
200 v. P.I.V. 5 amp. (S.C.R.)	15/6
400 v. P.I.V. 5 amp. (S.C.R.)	17/6

Discounts for quantities. Post extra.

TYPE 13A DOUBLE BEAM OSCILLOSCOPE BARGAIN!



A high quality instrument, offered at a fraction of original cost. Timebase 2 c/s-750 kc/s. Separate Y1 and Y2 amplifiers up to 6.5 Mc/s. Built-in calibrators at 100 kc/s. and 1 Mc. Operation for 115/250 v. A.C. Available in excellent condition, fully tested and checked. £22/10/-. Carr. 30/-.

TE-20RF SIGNAL GENERATOR



Accurate wide range signal generator covering 120 kc/s-250 Mc/s on 6 bands. Directly calibrated. Variable R.F. attenuator. Operation 200/240 v. A.C. Brand new with instructions £12/10/-. P. & P. 7/6. S.A.E. for details.

LAFAYETTE TE-46 RESISTANCE CAPACITY ANALYSER



2 P.F. - 2,000 MFD. 2 ohms-200 megohms. Also checks impedance, turns ratio, insulation, 200/250 v. A.C. Brand New £15. Carr. 7/6.

TE22 SINE SQUARE WAVE AUDIO GENERATORS

Sine: 20 cps to 0-3987 on 4 bands. Square: 20 cps to 30 kc/s. Output impedance 5,000 ohms, 200/250 v. A.C. Supplied brand new and guaranteed with instruction manual and leads, £15. Carr. 7/6.

ARF-100 COMBINED AF-RF SIGNAL GENERATOR



AF. SINE WAVE 20 - 200,000 cps. Square wave 20-30,000 cps. O.P.F. HIGH IMP. 21 v. P.P. 600 Ω 3-8 v. P.P. T.F. 100 Kc/s-300 Mc/s. Variable R.F. attenuation. Int/Ext. Modulation. Incorporates dual purpose meter to monitor AF output and % mod. on R.F. 220/240 v. A.C. £27/10/-. Carr. 7/6.

TE-65 VALVE VOLTMETER



High quality instrument with 28 ranges. D.C. volts 1.5-1,500 v. A.C. volts 1.5-1,500 v. Resistance up to 1,000 megohms. 220/249 v. A.C. operation. Complete with probe and instructions, £15. P.P. 6/-. Additional Probes available: R.F. 35/-; H.V. 42/6.

F.M. WIRELESS MICROPHONE



94-104 Mc/s. Transistorised. Operates from 9 v. battery. Complete with additional secret clip microphone. List £12/10/0. ONLY £8/15/0. P. & P. 2/6. These cannot be operated in U.K.

COSSOR 1035 MK III DOUBLE BEAM OSCILLOSCOPES

Latest model using miniature valves. Perfect condition. £45. Carr. 30/-.

Catalogue of Electronic Components and Equipment

Send today 5/- P&P 1/-

G.W. SMITH (LONDON)

CATALOGUE

- ★ ELECTRONIC COMPONENTS
- ★ TEST EQUIPMENT
- ★ COMMUNICATION EQUIPMENT
- ★ HI-FI EQUIPMENT

We are proud to introduce our first comprehensive catalogue of Electronic Components and equipment. Over 150 pages, fully illustrated, listing thousands of items many at bargain prices. Free discount coupons with every catalogue. Everyone in electronics should have a copy.

CLEAR PLASTIC PANEL METERS

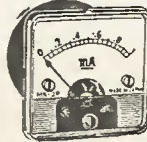

First grade quality. Moving Coil panel meters, available ex-stock. S.A.E. for illustrated leaflet. Discounts for quantity. Available as follows: Type MR. 38P. 1/21/32in. square fronts.

100-0-100μA	27/6	200mA	22/6	100V D.C.	22/6
500-0-500μA	22/6	300mA	22/6	150V D.C.	22/6
1-0-1mA	22/6	500mA	22/6	300V D.C.	22/6
1mA	22/6	750mA	22/6	500V D.C.	22/6
2mA	22/6	1A D.C.	22/6	750V D.C.	22/6
5mA	22/6	2A D.C.	22/6	15V A.C.	22/6
10mA	22/6	5A D.C.	22/6	50V A.C.	22/6
20mA	22/6	3V D.C.	22/6	150V A.C.	22/6
50mA	22/6	10V D.C.	22/6	300V A.C.	22/6
100mA	22/6	20V D.C.	22/6	500V A.C.	22/6
500mA	25/-	150mA	22/6	50V D.C.	22/6
50-0-50μA	25/6			"S" Meter/1mA 29/6	

POST EXTRA. Larger sizes available—send for lists.

R209 MK. II COMMUNICATION RECEIVER

11 valve high grade communication receiver suitable for tropical use. 1-20 Mc/s on 4 bands. AM/CW/FM operation. Incorporates precision vernier driver, BFO. Aerial trimmer, internal speaker and 12 v. D.C. internal power supply. Supplied in excellent condition, fully tested and checked. £15. Carr. 20/-.

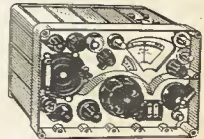

ADMIRALTY B.40 RECEIVERS

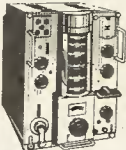

Just released by the Ministry. High quality 10 valve receiver manufactured by Murphy. Coverage in 5 bands 650 Kc/s-30 Mc/s. 1/F 500 Kc/s. Incorporates 2 R.F. and 3 I.F. stages, crystal bandpass filter, noise limiter, crystal controlled B.F.O. calibrator, I.F. output, etc. Built-in speaker, output for phones. Operation 150/230 volt. A.C. Size 19½in. × 13½in. × 16in. Wt. 14 lbs. Offered in good working condition, £22/10/0. Carr. 30/- with circuit diagrams. Also available B41 L.F. version of above. 15 Kc/s-700 Kc/s. £17/10/0. Carr. 30/-.

LAFAYETTE KT-340 COMMUNICATION RECEIVER SEMI-KIT

Build this wonderful receiver and save Pounds! Supplied semi-completed, main components ready mounted, R.F. Section already wired and aligned. Full and precise instructions supplied. Specification: 8 valves + rectifier, 4 bands, covering 550 Kc/s-30 Mc/s. Incorporates 1 R.F. and 2 I.F. stages, "Q" multiplier, B.F.O., A.N.L. "S" meter, bandspread, aerial trimmer, etc. Operation 115/230v. A.C. Price 25 GNS. Carr. 10/-.

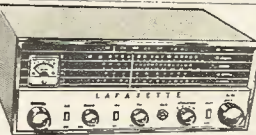

NEW LAFAYETTE MODEL HA-700 AM/CW/SSB AMATEUR COMMUNICATION RECEIVER

8 valves, 5 bands incorporating 2 MECHANICAL FILTERS for exceptional selectivity and sensitivity. Frequency coverage on 5 bands 150-400 kc/s, 550-1,500 kc/s, 1.6-4.0 Mc/s, 48-14.5 Mc/s, 10-30 Mc/s. Circuit incorporates R.F. stage, aerial trimmer, noise limiter, B.F.O., product detector, electrical bandspread, S meter, slide rule dial. Output for phones, low to 2KΩ or speaker 4 or 8 ohms. Operation 220/240 volt A.C. Size 7½in. × 13in. × 10in. Supplied brand new and guaranteed with handbook 36 GNS. carr. 10/- S.A.E. for leaflet.

HAM-I. 4 BAND COMMUNICATION RECEIVER

4 wavebands covering 535 Kc/s-30 Mc/s 5-valve superhet circuit, incorporates S meter, B.F.O., BANDSPREAD TUNING, BUILT-IN 4in. SPEAKER, FERRITE AERIAL AND EXTERNAL TELESCOPIC AERIAL. Operation 220/240v. A.C. Supplied brand new with handbook. £16/10/0. Carr. 10/-.

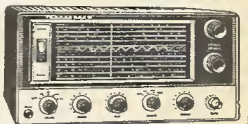

CALLERS WELCOME!

Open 9 a.m. to 6 p.m. every day Monday to Saturday. Trade supplied.

G.W. SMITH & CO (RADIO) LIMITED

Phone: GERRARD 8204/9155
Cables: SMITHEX LESQUARE
3-34 LISLE STREET, LONDON, W.C.2

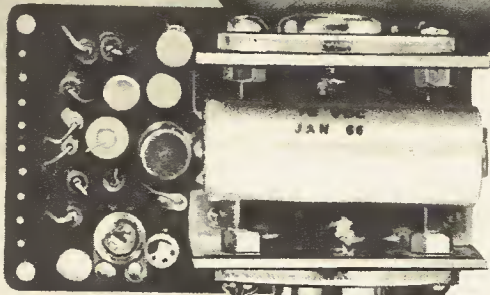

SINCLAIR Z.12

COMBINED 12 WATT HI-FI AMP & PRE-AMP

- ULTRALINEAR CLASS B OUTPUT
- 12 WATTS RMS CONTINUOUS SINE WAVE OUTPUT (24 W. Peak)
- 15 WATTS MUSIC POWER OUTPUT (30 W. Peak)
- INPUT—2mV into 2Kohms
- OUTPUT suitable for 15, 7.5 and 3 ohm speakers. Two 3 ohm speakers may be used in parallel

SINCLAIR PZ.3 Transistorised mains power supply unit with ample output for two Z.12's and Stereo 25 together.

79/6

Eight special H.F. transistors are used in the Z.12 to achieve results to compare favourably in every way with the costliest equipment you can buy. But the Z.12 is smaller, is more versatile and certainly saves you money. It is preferred not only for mono and stereo hi-fi, but it also enjoys enormous popularity fitted in electric guitars, used for P.A. and intercoms and many other instances where power and dependability are imperative. This superb amplifier with integrated pre-amp is supplied ready-built, tested and guaranteed together with the Z.12 manual which details matching, volume and tone control and selector switching circuits using one Z.12 in mono or two in stereo.

- 3in. × 1½in. × 1¼in.
 - 15-50,000 c/s ±1dB
 - IDEAL FOR USE WITH BATTERIES
- BUILT, TESTED AND GUARANTEED **89/6**

A NEW SINCLAIR LOUDSPEAKER
See previous pages

SINCLAIR STEREO 25 PRE-AMP AND CONTROL UNIT



For use with two Z.12's or any good hi-fi stereo system. The front panel is elegantly styled in solid brushed and polished aluminium with well styled solid aluminium knobs. Frequency response 25c/s to 30kc/s ±1dB connected to two Z.12's. Sensitivity Mic. 2mV into 50kΩ: P.U.—3mV into 50kΩ: Radio —20mV into 4.7Ω. Equalisation correct to within ±1dB on RIAA curve from 50 to 20,000c/s. Size 6½in × 2½in × 2½in plus knobs.

BUILT, TESTED AND GUARANTEED

£9.19.6

If you prefer not to cut this page, please quote PE.9 when writing your order

To: **SINCLAIR RADIONICS LTD., 22 NEWMARKET ROAD, CAMBRIDGE**

Please send items detailed below:

NAME.....
ADDRESS.....
.....
.....
.....

For which I enclose cash/cheque/money order

PE.9

MAINS MOTOR



made by Garrard for their best changers. Laboratory balanced, size 2 1/2in. x 2 1/2in. Suitable for 115 V or 230/240 V working by re-arranging lead connections. 15/- each. P. & P. 4/6.

ACOS TYPISTS STETHOSCOPE
Made for use with Tape Recorder but equally suitable for radio or amplifier, or for a deaf person. 15/- each.

SIMMERSTAT

TYX-FL and TYX-F. Both popular types fitted to many cookers. Suitable for 230/240V up to 15 amps. Handy device to have around the workshop. 12/6 each.

SATCHWELL OVEN THERMOSTAT

Type TO. With capillary tube and sensor. 20A A.C. type and as fitted to many cookers. Adjustable by control knob (not supplied) 12/6 each.

MESSAGE TAPES

150ft Scotch Tape on 5in spools. Normally 4/6 each. We offer 4 tapes for 10/-.

TAPE CASSETTE

Holds 2-3in spools. Supplied with one empty spool only. Fits the "Arrow" and several other tape recorders. 7/- each or 3 for £1.0.0.

FANE 20 WATT HI-FI SPEAKER

This is a 12in model with 2in voice coil. Really fantastic performance which will do justice to the best amplifier. Heavy cast frame, normally these retail at £7 or £8 each. We can offer a limited quantity at £3.9.6. 15 ohm coil only. Carriage and insurance 7/6. Similar model, especially designed for guitar amplifiers, same price. Please specify when ordering.

WHITE CIRCULAR FLEX

Ideal for lighting drops, twin made by BICC. Usually 8d per yd. 100yd coil for 30/-, plus 6/- postage.

EDGEWISE CONTROL

Morganite, as fitted many transistor radios. 2K or 5K with switch. 2/6 each or 24/- per dozen.

SCR's (THYRISTORS)

Pin	6/8	100V	300V	400V
1 amp	6/8	2/6	8/6	9/6
3 amp	7/6	3/6	8/6	10/6
2 amp	30/-	35/-	47/6	60/-

SILICON RECTIFIERS

Tested and guaranteed		1A		10A	
750mA	100V	1/8	200V	100V	3/-
	200V	1/6	200V	200V	4/-
	400V	3/6	400V	400V	6/-
3A	100V	3/6			
	200V	5/-	10A	100V	9/6
	400V	7/6		200V	12/6
	600V	9/6		400V	14/6

Sub-miniature glass encased—only approx. 1in long, wire ended.
400mA 60V 1/8 100V 2/6 200V 4/6

SEMI-CONDUCTOR BARGAINS

Type	No.	Price	Type	No.	Price	Type	No.	Price
2N1727	15/-		MAT120	7/9		OC72	5/-	
2N1728	10/-		MAT121	8/8		OC75	6/-	
2N1742	25/-		OA5	5/-		OC76	5/-	
2N1747	25/-		OA10	6/-		OC77	7/-	
2N1748	10/-		OA47	3/-		OC78	5/-	
AC107	9/-		OA70	2/-		OC78D	5/-	
AC127	9/-		OA79	2/6		OC81	5/-	
ACY17	8/6		OA81	2/6		OC81D	5/-	
ACY18	5/6		OA85	2/6		OC82	5/-	
ACY19	6/6		OA90	2/6		OC83	5/-	
ACY20	5/6		OA91	2/6		OC84	6/-	
ACY21	6/-		OA200	3/3		OC139	3/6	
ACY22	4/6		OA202	4/3		OC140	12/6	
AF114	7/-		OC20	12/6		OC170	5/-	
AF115	6/8		OC22	10/6		OC171	6/-	
AF116	7/-		OC23	17/6		OC200	9/-	
AF117	5/-		OC24	15/-		OC201	12/6	
AF118	10/-		OC26	7/6		OC202	13/6	
AF139	12/6		OC28	15/-		OC203	12/6	
AF186	17/6		OC29	17/6		OC271	15/-	
AF212	15/-		OC35	12/6		ORP12	8/8	
AS221	15/-		OC36	15/-		ORP60	10/6	
BC107	14/6		OC43	6/8		SB078	6/8	
BY100	4/6		OC44	4/-		SB305	8/8	
BY213	7/6		OC45	3/6		SB251	10/-	
MAT100	7/9		OC70	4/-		ST140	4/-	
MAT101	8/8		OC71	3/6		ST141	6/-	

MINIATURE WAFER SWITCHES

4 pole, 2 way—3 pole, 3 way—4 pole, 3 way—2 pole, 4 way—3 pole, 4 way—2 pole, 6 way—1 pole, 12 way. All at 3/6 each 36/- dozen, your assortment.

12V INVERTER

Fully transistorised for operating a 20W fluorescent tube. Size 6in long by 1 1/2in. £3.10.0. Post and insurance 3/-.

5 TRANSISTOR AMPLIFIER

Mounted on a printed board, size approx. 6in x 2 1/2in with volume control, input microphone socket and push-pull output using pair of OC81. An excellent amplifier rated at 1W for gram or tape recorder. Price £2.10.0.

Where postage is not definitely stated as an extra then orders over £3 are post free. Below £3 add 2/9. Semi-conductors add 1/- post. Over £1 post free.

CONTROL DRILL SPEEDS

DRILL CONTROLLER

Electronically changes speed from approximately 10 revs. to max. Full power at all speeds by fingertip control. Kit includes all parts, case, everything and full instructions. 19/6 or ready made 32/6 plus 2/6 post and insurance

THE VECTRONOME CAPSTAN DRIVEN TAPE RECORDER

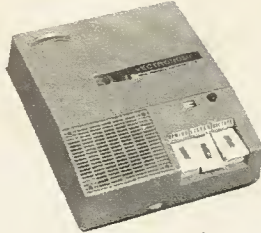

This is a truly portable self-contained instrument with built-in microphone and loudspeaker using a 5 transistor amplifier with PP output and suitable for operation from mains or by chargeable batteries. Tape capacity is 25 minutes on easily changed spools. A tape position indicator gives quick reference to any part of dictation. Recording level is automatically preset during dictation and can be adjusted to suit operator. Interlock prevents unintentional erasures. Tape speed controlled by fly wheel driven capstan. Very portable in neat case with carrying handle, overall size of which is approximately 6 1/2 x 7 1/2 x 2 1/2in. Price with tape, nickel cadmium rechargeable batteries and mains battery charger £9.19.6. (rather less than 3 original price). Postage and insurance 7/6. Unused and in perfect working order.



GARRARD AUTO RECORD PLAYER Model 2000

This is one of the latest products of the World's most experienced maker of fine record reproducers. Its superior features include—automatic playing of up to 8 mixed size records—stopping and starting without rejecting—manual playing—pick-up pivots to give low stylus pressure—large diameter turntable for max. stability—adjustments include pick-up height—pick-up drooping position and stylus pressure. Size is 13 1/2 x 1 1/2in. clearance 4 1/2in. above 2 1/2in. below—fitted with latest hi-compliance cartridge for stereo—and mono L.P. and 78. Supplied complete with mounting template and service sheet. Offered this month at the Special Snip price of £6.9.6 plus 7/6 carriage and insurance.

THIS MONTH'S SNIP

BECKASTAT

An Instant Thermostat. Simply push it into your wall socket and plug your fire or other appliance into it. Knob setting. Will save its cost in a season. Normally £8. We offer at 18/6 plus 2/- post. When ordering state whether for 13A or 15A socket.

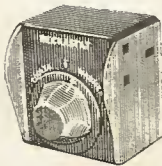

F.M. TUNER

Of exceptional quality, giving really fantastic results with virtually no noise. Suitable for mains or battery operation. 6 transistors—three IF stages—double tuned discriminator. Complete, new, and built up all ready to work on chassis. Size 6in x 4in x 2 1/2in with tuning scale and slow motion drive. A £12.12.0 tuner for only £6.19.6 plus 3/6 post and insurance.

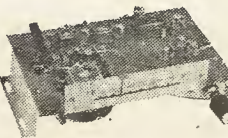

HURSEAL AUTOMATIC TIME SWITCH

12 hour, 15A, to control heating, lighting, radio, immersion heaters, etc. Regular price £4.4.0. Limited quantity 39/6 p. & p. 3/-.

HEAT AND LIGHT UNIT

Bring luxury to your bathroom—have comforting heat where you now only have light—all the parts to build a full size (16in. diameter) model are now available—you will build it in an hour—12in. 750W circular silica-glass encased element—opal bowl for up to 100W lamp—non-rust spun reflector—white enamelled base heat shield, pull switch, and insurance.



BATTERY OPERATED TAPE DECK

With Capstan control. This unit is extremely well made and measures approx. 6in x 5in x 2in deep. Has three piano key type controls for Record, Playback and Rewind. Motor is a special heavy duty type intended for operation off 4 1/2 volts. Supplied complete with 2 spools ready to install. Record. Replay head is the sensitive M4 type intended for use with transistor amplifier. Price £4.15.0. Post and insurance 4/6.



EX-WD BARGAIN Easily rebuildable to short wave radio

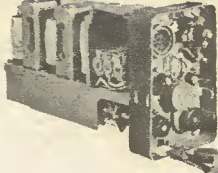

This is the 46 Receiver/Transmitter. It has a range of approx. 6 miles. Operates from dry batteries. Complete with six valves and in metal case. Size approx. 12in x 6in x 3 1/2in. Complete but less crystal, not tested nor guaranteed. 19/8 plus 7/6 post and insurance. Should not be operated as a transmitter in the U.K.

See in the Dark INFRA-RED BINOCULARS

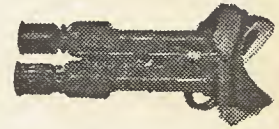

These infra-red binoculars when fed from a high voltage source will enable objects to be seen in the dark, providing the object are in the rays of an infra-red beam. Each eye tube contains a complete optical lens system as well as the infra-red cell. These optical systems can be used as lenses for T.V. cameras—light cells, etc. (details supplied). The binoculars form part of the Army night driving (Tabby) equipment. They are unused and believed to be in good working order but sold without a guarantee. Price £3.17.8, plus 10/- curr. and ins. Handbook 2/6.

RECORD DECK

Heavy gauge pressed metal plinth, size 13in x 11in. Fitted with Motor, Decca pick-up, on-off switch and 10in turntable. Motor normally mains working but 73 r.p.m. only. Could no doubt be altered to 33 or 45 r.p.m. Limited quantity only. 29/6 each, plus post and insurance 6/6.

9 VOLT PRECISION MOTOR

Intended for driving battery operated tape recorders and record players. Laminated, 6 Pole armature with Brush Gear and rapid start switch. Normally 25/- . Our Price 7/8, plus post and insurance 1/6.



MAINS TRANSISTOR POWER PACK

Designed to operate transistor sets and amplifiers. Adjustable output 6V, 9V, 12V for up to 500mA (class B working). Takes the place of any of the following batteries: PP1, PP3, PP4, PP6, PP7, PP9 and others. Kit comprises: mains transformer rectifier, smoothing and load resistor, 5,000 and 500 mfd. condensers. Zener diode and instructions. Real snip at only 14/6, plus 3/6 postage.

SENSITIVE HAND MICROPHONE

Dynamic type. Low impedance, moving iron, fitted in unusually neat plastic head with anti-microphonic coupling to handle. Extra small size, very sensitive. 15/- each.



POLYESTER FILLED FLUORESCENT CHOKE

Extra silent operation, suitable for 230/240V 40W tubes. Price only 13/6 or push with two bi-pin push on ends, two spring tube clips, starter and starter holder 17/6 complete. Postage for kit or choke only is 4/6. 80W as above, price 17/6 for the choke or 21/- for the kit. Post 4/6.

STUPENDOUS OFFER—£11 for £2 The Princess Superhet

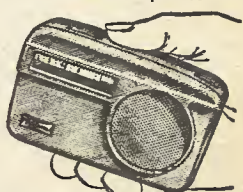

Only recently sold for £10.9.6. Note these features: ● Long & Medium Wave ● Long dial ● Push pull output ● A.V.C. and feed back ● Ferrite aerial ● Six transistors ● Cabinet size 4 1/2in x 3in x 1 1/2in with carrying strap. You get everything you need and instructions. 39/8 plus 3/6 p. & p. Battery 1/9 extra. Data separately 2/6.

ELECTRONICS (CROYDON) LIMITED

(Dept. P.E.) 102/3 TAMWORTH RD., CROYDON, SURREY (Opp. W. Croydon Stn.)
also at 266 LONDON ROAD, CROYDON, SURREY

MICROELECTRONICS AND THE AMATEUR

MICROELECTRONICS has been described as the most significant development in the field of electronics since the invention of the transistor.

Last month we discussed the probable effects upon the industry as integrated circuits become widely adopted in place of traditional discrete components. We now propose to consider microelectronics from the amateur point of view.

In contrast to industry where the future trend will lead toward large scale conversion to integrated circuits, it is safe to predict that amateur constructors will continue to rely mainly on traditional components.

It is certain that lower prices and general availability will in due course make the integrated circuit an attractive proposition for some amateur purposes. Suitable applications will be found for the IC to *augment* discrete components, but certainly not to replace them. However, it must be admitted that the majority of "one-off" projects hardly justify the use of IC's, nor have these devices the flexibility required for experimental work in circuit design.

Nevertheless, from a novelty aspect alone these devices will naturally appeal to many. Building some relatively simple project like, for example, a compact audio amplifier, will provide a practical introduction to the new world of microcircuits. Such a project will, in fact, be presented to our readers next month.

But we think the most important and exciting contribution of the IC will be in making feasible the kind of projects which previously have seemed too ambitious for the private individual. The seeming complexity of many exotic electronic equipments is largely accounted for by the multiplicity of a number of quite ordinary "standard" circuits; the real complexity lies in the system of interconnections. Thus we can surely expect that the amateur designer, like his counterpart in industry, will find himself becoming more "systems" orientated.

With these new building blocks the drudgery of repetitive wiring work will disappear. Thus one of the disincentives to building complex equipment such as organs and calculating machines will be removed. With more extensive circuitry employed, the advantage of miniaturisation becomes immediately apparent. Spatial demands will be less—a not insignificant factor when limited accommodation has to be shared with other members of the family.

It would seem that the amateur will, in short, be able to enjoy the best of both worlds. The range of his potential activities, already of some magnitude, will be expanded further as the new devices become available. The limit will be set by his ambition—and his pocket.

THIS MONTH

CONSTRUCTIONAL PROJECTS

ELECTRONIC STOPCLOCK	645
SCREENWIPER DELAY UNIT	661
CHEMOSTAT	668
TRANSISTOR TEST SET	682

SPECIAL SERIES

COMPUTER EVOLUTION—4	654
MICROELECTRONICS—2	673

GENERAL FEATURES

ELECTRONIC TELEPHONE EXCHANGES	640
INGENUITY UNLIMITED	681

NEWS AND COMMENT

EDITORIAL	639
MARKET PLACE	660
N.P.L. OPEN DAY	663
AUDIO TRENDS	664
ELECTRONORAMA	666
DETACHED PARTICLES	693

Our October issue will be published on
Friday, September 15

time division multiplex (t.d.m.) group, the speech highways are time divided and as many as 100 conversations can be time shared on one highway. Each conversation is sampled at, say, 100 microseconds (μ s) intervals for 1μ s and the speech amplitude at that instant is passed forward. This is known as "amplitude modulation".

However, the amplitude may be coded in binary form and passed forward as binary digits and this is known as pulse code modulation (p.c.m.). The principal disadvantage with this system is the cost of the modulators and demodulators which are required for every subscriber.

In the space division group, a discrete path is provided for each conversation and this path makes use of reed relay crosspoints, "ferreed" crosspoints (a ferreed is a magnetically latched reed relay), or semiconductor crosspoints. The control of such an exchange is simpler than that of a time division exchange but the speech switching network requires more equipment than that of the t.d.m. exchange.

CENTRALISED CONTROL

The system, now being built for up to 2,000 lines is register controlled providing a separate physical path for each established speech path connection; switching actions are separated from the controlling actions. Moreover, all calls through the switching network for all lines are directed by one centralised electronic control, comprising a combination of magnetic cores, semiconductors and reed relays. This central control processes calls on a one-at-a-time basis but, because of fast electronic switching speeds, it can handle calls occurring *almost* simultaneously.

When calling through the new electronic system (see Fig. 2), the subscriber's telephone is connected to a line circuit which responds when the subscriber picks up his telephone. A pulse is produced and this is converted by the "calling number generator" into a pulse pattern representing the calling subscriber's directory number, for example 2114.

The register selector chooses a free register, and the calling subscriber's number is passed into it. The register then demands access to Call Control, this access being regulated by the register finder which prevents more than one register gaining access at any one time.

CALL CONTROL

Call Control instructs the register to pass the calling subscriber's number to the decoder. The output of the decoder is a potential on a unique lead representing the calling subscriber. This lead is threaded through the class of service field and then to its line circuit to operate the marker relay, which marks the *A* switch of the switching network to which the subscriber is connected.

At the same time the Call Control instructs the electronic speech path selectors to select a free "own exchange" supervisory relay set and a path through the *C*, *B*, and *A* switches to the calling subscriber. The chosen relay set is connected to the register via the register switch and the completion of the path is detected over a common lead from the line circuit to Call Control.

Call Control is then released from the register, which returns dial tone over the established path. This process from lifting the handset to dial tone being heard takes approximately 50 milliseconds.

The calling subscriber now dials the digits of the subscriber he wishes to call, for example 2132. The pulses generated by the dial are received in the register, counted, and stored. When he has completed dialling,

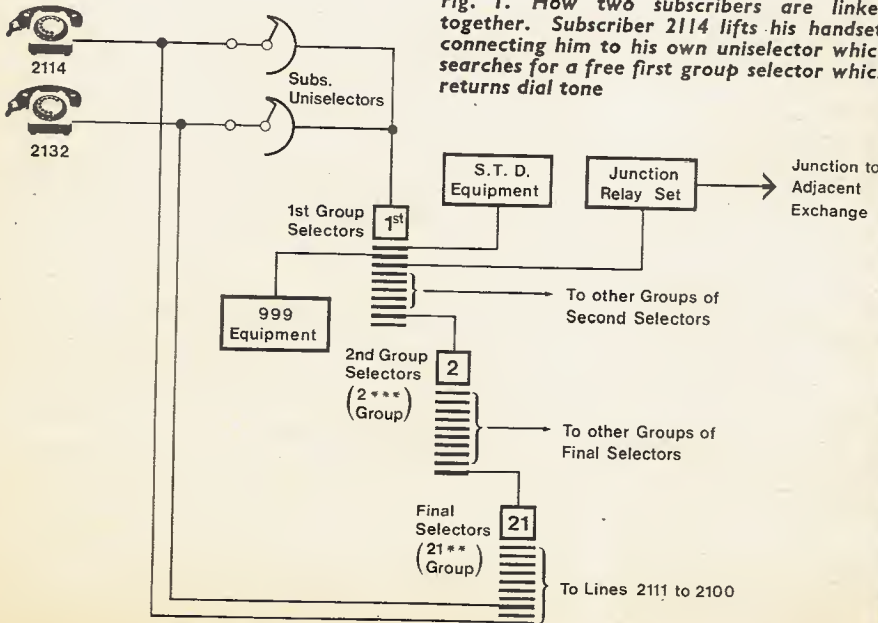
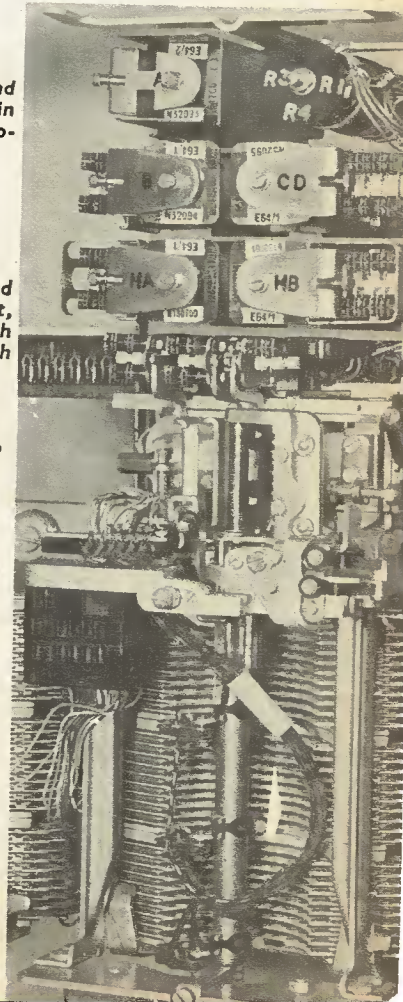

Fig. 1. How two subscribers are linked together. Subscriber 2114 lifts his handset, connecting him to his own uniselector which searches for a free first group selector which returns dial tone

A two-motion selector and relay set used in conventional electro-mechanical exchanges



representing a digit of the subscriber's number.

The wire from the subscriber's line circuit carrying the calling pulse (and threaded through the cores according to the subscriber's directory number) induces a pulse in the secondary winding of each core so threaded. The resulting pulse pattern is amplified, shaped and written into a queueing store awaiting the connection of a free register; this queueing store utilises small square-loop ferrite cores.

A signal from the store control causes the register selector to choose a free register, which is then connected to the queueing store. The information is read out of the store, amplified, lengthened, and used to switch reed relay stores in the register. The store is then released.

The queueing store can handle two calling numbers provided they occur more than 1ms apart; choosing a register, connecting it to, and releasing it from the store takes approximately 10ms. (These speeds are quite fast enough for exchanges in the small to medium range.) To cover spurious induced pulses the amplifiers of the store are arranged to ignore the first 5μs of any calling pulse.

PATH SELECTION

The selection of a path through the switching network is performed by a combination of the *B* switch selector, *C* switch selector, and supervisory selector. The choice of a register is arranged by the primary and secondary register selectors; the secondary selector chooses one of a group of registers, the primary selector chooses a register in that group; similarly with the register finders.

Each selector consists of five or six input gates in a logic circuit allowing only one gate to be operated at a time. Each gate receives its input signal from a switch, or register, indicating that the switch or register is free. The input gates are also controlled by a "start" signal.

Each gate has an output circuit which is connected to the same switch or register as the input lead. An output signal is generated only by the gate which has operated as a result of the selection process, and "marks" the chosen switch or register.

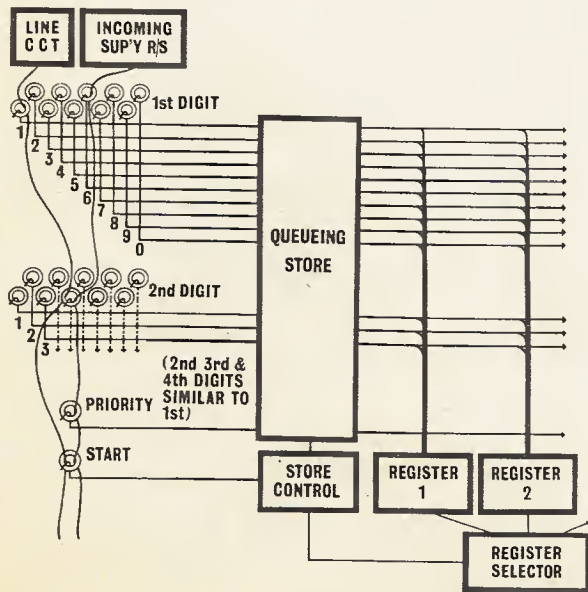
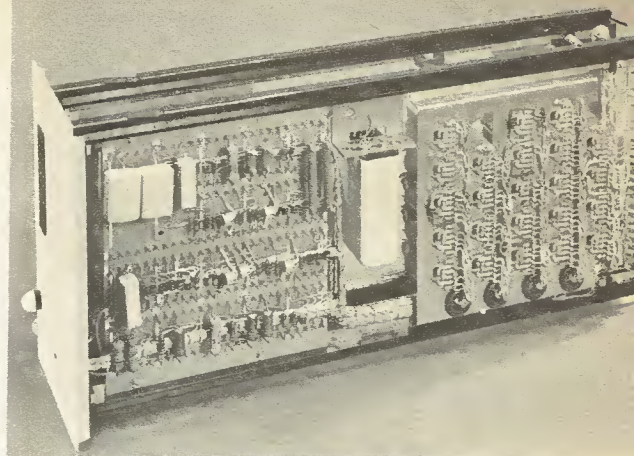

Fig. 3. Block diagram of the calling number generator



The supervisory relay set in the electronic exchange

The secondary register finder is brought into use when more than one register is demanding access to Call Control at the same time. The registers are divided into groups of five, and the secondary register finder chooses a group of registers with a demand signal. The start signal comes from the primary register finder.

All those gates with a demand signal and a start signal begin to operate but the lowest numbered gate immediately inhibits the higher-numbered gates, resulting in its own full operation and the cutting-off of all the others.

POWER SUPPLIES

The exchange operates from a conventional nominal 50V (negative) exchange battery, i.e. a battery whose voltage can vary between 46 and 52. A 50V positive supply also is needed for some of the circuits and if no suitable supply already exists it can be derived from the exchange battery by transistor inverters.

To avoid the distribution and security problems of providing further voltage rails, 60V transistors have been employed and the majority of the circuits use CV8760 transistors. An avalanche diode CV8805 is used for marking reed relay crosspoint switches and all other applications in the circuits.

RELIABILITY AND SERVICE SECURITY

Production of equipment possessing absolute reliability is not practicable. Therefore, the exchange has been designed to be fault tolerant, allowing calls to be processed continuously and accurately despite the occurrence of occasional faults.

In the setting up and control of each call, use is made of equipment common to the whole exchange; such equipment is duplicated. Each set of common equipment is brought into service alternately every eight minutes under normal working conditions. On detection of a fault, the affected set is locked out and the other maintains service continuously; in the meantime, a signal is given to the maintenance control centre requesting the attendance, when convenient, of a maintenance engineer.

When any call fails to mature, owing to a transient fault, call control makes a second attempt in setting-up the call. The original path chosen, together with the numbers of the calling and called subscribers, is recorded on paper tape and this, together with alarm lamps, will enable the maintenance engineer to identify

A CONSTRUCTIONAL
PROJECT USING
PRE-PACKAGED
CIRCUIT MODULES



ELECTRONIC stopclock

By M. L. Birch

THE instrument to be described in the following article, for want of a better name, has been termed an "Electronic Stopclock". Basically, it measures the interval of time elapsed between two events or stimuli which are fed to the instrument as electrical analogues. Where it differs from a conventional stopclock is in the range of times it can measure.

The instrument to be described has four pre-determined ranges each having maximum periods of 12, 1.2, 0.12, and 0.012 seconds respectively.

Although the instrument is capable of resolving each of these ranges into 60 individual units of time (i.e. it is theoretically possible to measure a period of 0.2ms on the fastest range), there are other factors such as component tolerance and accuracy of meter reading which limit the usefulness to a resolving power of approximately 5 per cent of the selected range, and a tolerance of 10 per cent of the recorded value.

The instrument, therefore, does not make great claims for accuracy in its present form (even though this can quite easily be achieved by using more expensive components). However, it is an invaluable tool for the laboratory, school, photographic department or dark-room. Alternatively, it can be used with special input circuits to act as a velocity meter or a reaction time meter.

There is nothing revolutionary about the design of this instrument and there are indeed several instruments on the market which will do the job in the same way. However, the disadvantage with the latter is that the cost tends to be in the region of hundreds of pounds. If the following design is adhered to in detail and, assuming every component including the cabinet has to be bought, the total cost should not exceed £18

LOGIC BLOCKS

The major part of this equipment is therefore designed around standard ready made "logic blocks". Developments are now such that it is more economic, on component cost alone, for the amateur to use these new facilities. It also means that a great deal of the tedium of wiring multiple circuits is removed and the designer can spend more time and thought on the system rather than on the circuitry.

It is not intended to go into great details on defining the logic symbols or terms used in describing this unit, as these have already been extremely well covered in other articles. However, it is necessary to define the fact that wherever a reference is made to a "logical 1" (as opposed to a 0) this is a negative voltage of a magnitude between -4 and -8 volts. A "logical 0" is a voltage between -0.5 and +1.0 volts.

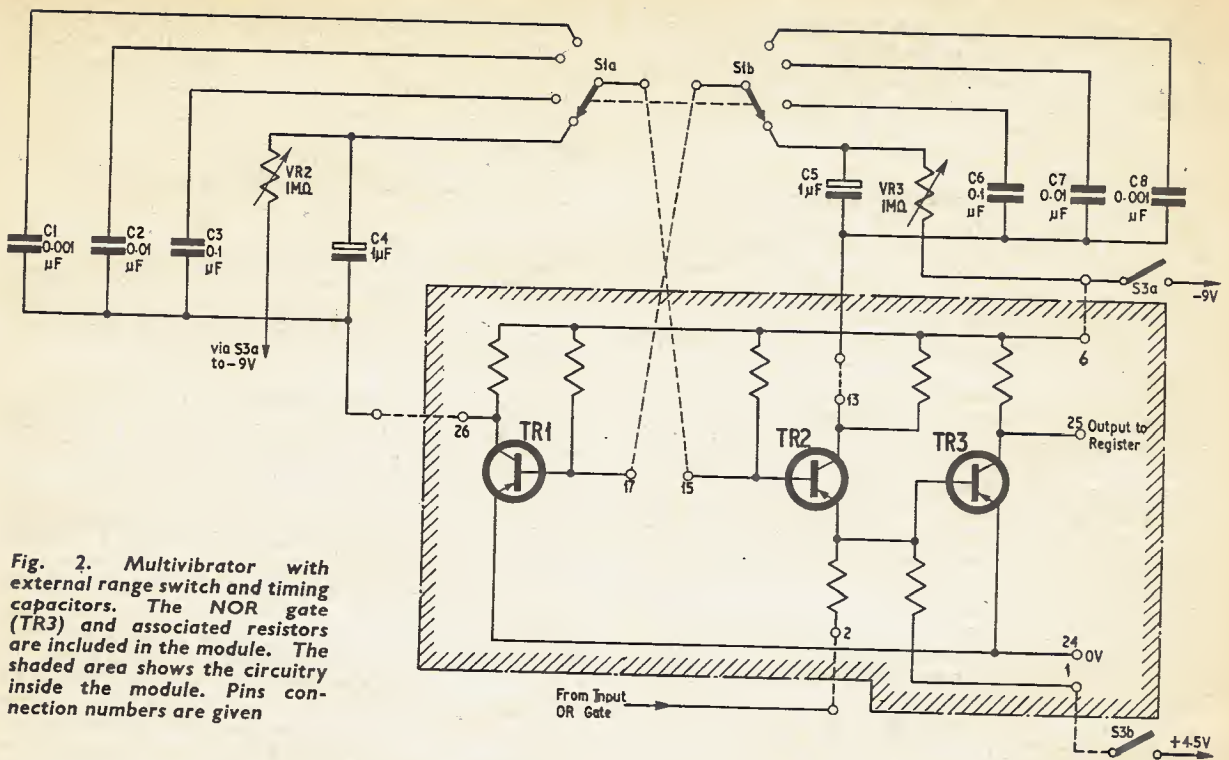

Fig. 2. Multivibrator with external range switch and timing capacitors. The NOR gate (TR3) and associated resistors are included in the module. The shaded area shows the circuitry inside the module. Pins connection numbers are given

greater than one pulse less, and will only be significant at low counts.

The count of 24 or 25 will be displayed as an analogue output on the meter, which is directly calibrated in seconds and of course the reading would be 0.5 second. This figure is permanently held on the meter until the reset button is depressed, when the reading will once more return to zero.

If we allow the input to hold condition 0 for 1.5 seconds, we should count 75 pulses, but as soon as 60 is reached, the inhibit circuit comes into operation, and applies a level 1 on to the multivibrator NOR gate, thus preventing entry of any further pulses.

The meter will indicate that this has happened by reading full scale, which means that the pulse repetition frequency of the multivibrator must be reduced by means of the range switch, and the measurement repeated.

Various types of input transducers and circuits will be described later in this article, but of course, there are many possible ways of creating the correct input conditions and these will depend on the application to which the timer is to be put.

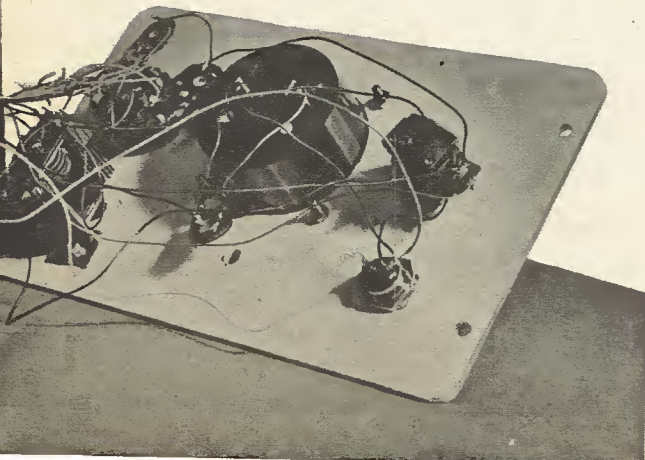

In Figs. 2, 4, and 5 the areas within the shaded boxes are the parts of the circuits contained within the modules.

If the home constructor so desired he could undertake the job of wiring up his own circuitry to cover that within the logic modules. Component values have not been included in this article, but the circuits used are fairly standard and equivalent circuits with component values can be found in several textbooks.

MULTIVIBRATOR AND CONTROL "NOR" GATE

Fig. 2 shows the basic module and the associated cross-coupling capacitors wired externally to the module. If one ignores TR3 the module is a simple multivibrator circuit with the cross-coupling left out. The circuitry is such that if a theoretically perfect capacitor is used to cross-couple, the dwell time for that side will be 1ms for every 0.01 μ F.

It must be realised though that to get continuous pulses, both sides must be cross-coupled to each other, and the same criterion for dwell time will apply. In this application it is most convenient to use a mark/space ratio between pulses of 1 : 1 and therefore it is necessary to use two identical capacitors for each range of frequency.

The actual time between identical points on output levels will therefore be 2ms per 0.01 μ F of coupling. In this design values of 1 μ F, 0.1 μ F, 0.01 μ F, and 0.001 μ F have been used; these give periods between pulses of 200, 20, 2, and 0.2ms respectively. For all the ranges except the slowest, using the 1 μ F electrolytic capacitor, these figures can be taken as accurate, and are controlled purely by the tolerance of the capacitors.

Due to the high leakage of electrolytic capacitors, the period on the slowest range will be found to be approximately 20 per cent longer than calculated, but this can be compensated for by including a preset 1 megohm

INCREASE YOUR KNOWLEDGE



RADIO TELEVISION ELECTRONIC ENGINEERING

MEMBER OF THE ASSOCIATION
OF BRITISH CORRESPONDENCE COLLEGES

CHOOSE THE RIGHT COURSE FROM
RADIO AND TELEVISION ENGINEERING,
INDUSTRIAL TELEVISION, RADIO AND
TELEVISION SERVICING, ELECTRONICS,
COMPUTERS AND PROGRAMMING,
ELECTRONIC TECHNICIANS, SERVO-MECH-
ANISMS, TELEMTRY, CLOSED CIRCUIT TV,
INSTRUMENTATION, AND PRINCIPLES OF
AUTOMATION.

ALSO EXAMINATION COURSES FOR:

- Inst. of Electronic and Radio Engineers
- C. & G. Telecommunication Techns'. Cert.
- C. & G. Supplementary Studies
- R.T.E.B. Radio/TV Servicing Cert.
- P.M.G. Certificates
- Radio Amateurs' Exam.

LEARN AS YOU BUILD

Practical Radio Courses: Gain a sound knowledge of Radio as you build YOUR OWN 5-valve superhet Receiver and Transistor, Portable Signal Generator and High Quality Multitester. At the end of the course you have valuable practical equipment and a fund of personal knowledge and skill. ICS Practical Radio Courses open a new world to the keen amateur.

THERE IS AN ICS COURSE FOR YOU

Whether you need a basic grounding, tuition to complete your technical qualifications, or further specialized knowledge, ICS can help you with a course individually adapted to your requirements.

There is a place for you among the fully-trained men. They are the highly paid men—the men of the future. If you want to get to the top, or to succeed in your own business, put your technical training in our experienced hands.

ICS Courses are written in clear, simple and direct language, fully illustrated and specially edited to facilitate individual home study. You will learn in the comfort of your own home—at your own speed. The unique ICS teaching method embodies the teacher in the text; it combines expert practical experience with clearly explained theoretical training. Let ICS help you to develop your ambitions and ensure a successful future. Invest in your own capabilities.

FILL IN AND POST THIS COUPON TODAY

You will receive the FREE ICS Prospectus listing the examinations and ICS technical courses in radio, television and electronics. PLUS details of over 150 specialised subjects.

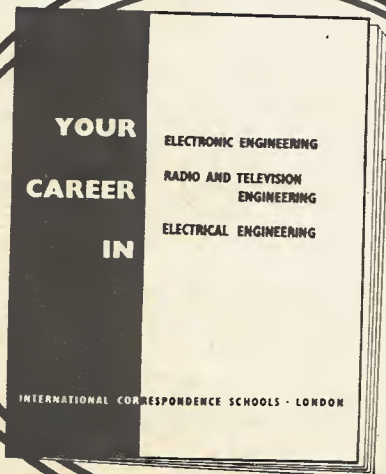

PLEASE SEND FREE BOOK ON.....

NAME

ADDRESS

.....

OCCUPATION..... AGE.....

INTERNATIONAL CORRESPONDENCE SCHOOLS
Dept. 150, INTERTEXT HOUSE, PARKGATE ROAD, London, SW11
9/87

+4.5V supply, so these have also to be linked externally. Pins 3 and 8 are what are called "direct entry points", or "set" and "reset" respectively.

If a logic level 1 is applied to, say, pin 8 this will cause the output point 15 to go to level 0 and this will override any signals which may still be entering the bistable by way of the capacitive inputs. Assuming that no signals are arriving on the capacitive clock entry point, the bistable will stay in the condition of output point 15 at state 0 after the "reset" pulse is removed.

Whatever state the output at pin 15 is at, the output at pin 17 will be the opposite; we therefore define in this article, pin 15 as the "output" and pin 17 as the "complementary output".

When the final equipment is in operation and the "reset" button is pressed, all the binary divider outputs go to level 0, therefore, pins 8 on all the six stages are linked together so that the reset pulse is applied simultaneously to all the units. In order to achieve binary division down the chain, it is only necessary to couple the output (pin 15) of the first binary to the linked capacitive inputs (pins 25 and 26) of the following stage and this is repeated down the line.

At this stage it is worth showing part of the truth table for a divider network of this type, so that the state of the output points on each stage can be clearly defined for any number of entry pulses. This is extremely important here as it has a direct bearing on the function of the digital-to-analogue converter.

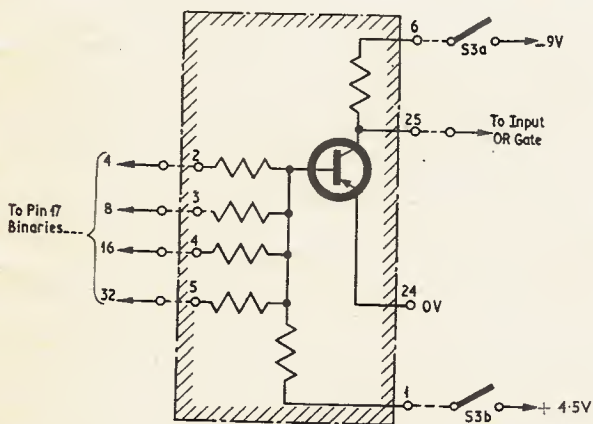

Fig. 5. Inhibit NOR gate

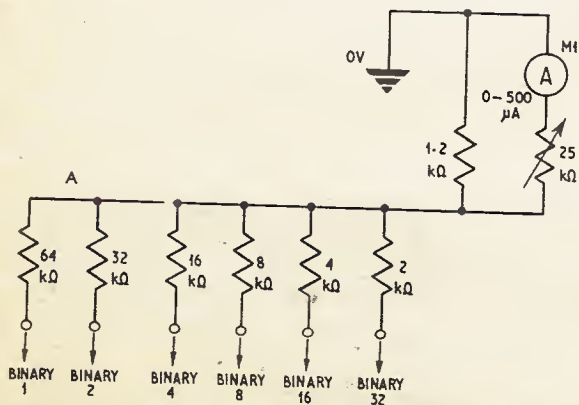

Fig. 6. Digital-to-analogue resistor network

Table 1: TRUTH TABLE FOR DIVIDER NETWORK

Mode	Pulse	State of Outputs					
		Binary number					
		1	2	4	8	16	32
RESET	0	0	0	0	0	0	0
COUNTING	1	1	0	0	0	0	0
	2	0	1	0	0	0	0
	3	1	1	0	0	0	0
	4	0	0	1	0	0	0
	5	1	0	1	0	0	0
		and so on up to					
	57	1	0	0	1	1	1
	58	0	1	0	1	1	1
	59	1	1	0	1	1	1
STOP	60	0	0	1	1	1	1

At the count of 60 pulses the outputs of binaries 4, 8, 16, and 32 are all at level 1. This means that their complementary outputs are at level 0. This satisfies the condition which will operate the inhibitor NOR gate, and prevents any further pulses entering the register. It is for this reason that the complementary outputs of the last four stages are fed to the inhibit gate.

INHIBIT "NOR" GATE

The inhibit NOR gate is shown in Fig. 5. The four inputs are coupled to the complementary outputs of the last four binary dividers, and the output is coupled back to the simple diode OR gate of Fig. 3. The power requirements, as with all these modules, are again -9V and +4.5V.

DIGITAL-TO-ANALOGUE CONVERTER

The digital-to-analogue converter has a direct bearing on the accuracy and linearity of the instrument and although the circuit (as shown in Fig. 6) looks simple, it is perhaps too simple to be true.

Digital-to-analogue resistor networks are probably one of the biggest headaches the system designer has to contend with. In this application the problem is not too great as we are only dealing with a 6-bit register, however, with larger storage chains up to 10 bits the problems of designing these networks to operate with available components can be extremely difficult and can involve considerable component cost.

What are the hidden problems? The first is fairly obvious, and that is the fact that the resistor values called for are not standard and cannot therefore be obtained "off the shelf". It will also be noted that the values alter as a binary ratio, starting at 2 kilohms and ending at 64 kilohms. For a 10-bit register, the top value would be 1.024 megohms.

While the actual values of these resistors are not critical, the ratio between them is extremely important and this must stay constant to within a fraction per cent for perfect linearity of scale. They must also match each other under different temperature conditions, i.e. all have exactly the same temperature coefficient. In our case, where the equipment will probably only ever be subjected to room temperature, the latter problem is not critical, and as we are only working to 6 bits, the actual tolerance on ratio, while still important, is not too difficult to achieve.

PRACTICAL ELECTRONICS

* *next month*



FREE
6-INCH
33 $\frac{1}{3}$ RPM **RECORD**
'ELECTRONIC SOUNDS
AND EFFECTS'

Specially made to provide sound accompaniment to a big feature on

ELECTRONIC MUSIC TECHNIQUES

This special article defines electronic music, describes how it is composed and produced, and includes details of electronic tone sources, storage devices and techniques employed by professionals, plus circuits and hints for the amateur. With the help of the record, it shows how you can find a fascinating new creative field of personal expression in this exciting musical form.

Also **OUR FIRST INTEGRATED CIRCUIT PROJECT**

A compact **GRAMOPHONE UNIT** incorporating a readily available integrated linear amplifier.

OCTOBER ISSUE
ON SALE SEPT. 15th

Big Demand! Order your copy now!

is passed through the centre of a core, the direction of magnetisation can be changed by means of the current. The wire carrying the current is known as a "drive" or "co-ordinate" wire.

In a medium-size core store, however, there may be $\frac{1}{2}$ million cores, and this would need a large number of drive wires. The M.I.T. arrangement gets round this by setting the cores out in a matrix (see Fig. 4.1). This enables one drive wire to be used for several cores. When it is desired to switch a particular core, drive currents of approximately half that required to switch it are passed down each of the appropriate drive wires.

This does little more than disturb most of the cores on a wire, but where they cross at a core, they add up to sufficient drive to switch the core. By using this "coincidence" principle, the number of drive wires is considerably reduced. In the example drawn in Fig. 4.1, only eight wires are needed to switch sixteen cores.

It is possible to achieve a further saving in drive wires by breaking the "bits" up into words. If the sixteen bits were to be composed of eight words, each of two bits, the number of wires required could be dropped to six, by arranging the bits in "planes" (see Fig. 4.2). Now eight computer words are stored with one bit in each plane.

This is not the end of the story however. As the store stands, if a drive current is sent down the drive wires appropriate to a particular word, then all the bits in that word will switch.

To enable a word of any combination of bits to be written, a third wire is needed. This wire is known as the "inhibit" wire; each plane has its own inhibit wire, and this wire threads each core in the plane in the opposite sense to one of the drive wires. When a "0" is to be written into a core, an inhibit current is passed down the inhibit wire for that plane, and this prevents the drive currents from reinforcing each other, and hence stops the core from switching.

There is one further refinement to be added before the store is complete. It is all very well being able to write information into the store, but how is it to be read out again? This is where the fourth wire of the four wire system comes in.

A wire known as the readout wire is also threaded through each core in a plane. When a word is to be read out, the drive currents are reversed; hence, any core that was switched to a "1" originally, will now switch back to a "0". Those which were a "0" will not do anything. When a core switches back, the magnetic disturbance registers on the readout wire, and a "1" is recorded.

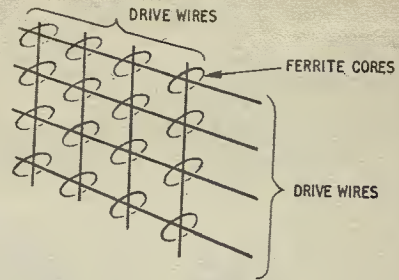

Fig. 4.1. Magnetic core store matrix

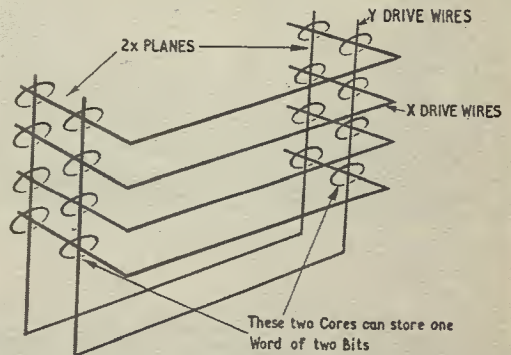

Fig. 4.2. Arranging "bits" in planes

One disadvantage of this system is that when a word is read out of the store, the store is left empty. If it is required to save the word read out, then arrangements must be made for it to be written back again after it has been used.

Although this is a very popular type of store, it is not the only type. In general, a core store can be used, either as a "direct" store, to which the computer can gain access directly; or else as a "buffer" store for a slower type of storage such as magnetic tape.

A temporary store for use during an operation is known as a register. This usually consists of a string of bistables, which can store one word at a time.

Other forms of storage in common use are magnetic tape, magnetic discs and drums, punched cards, and punched tape.

Magnetic storage core matrix plane containing 4096 cores, manufactured by Mullard. Very fast switching times ($0.17\mu s$) are obtainable from the smaller matrix under the magnifying glass

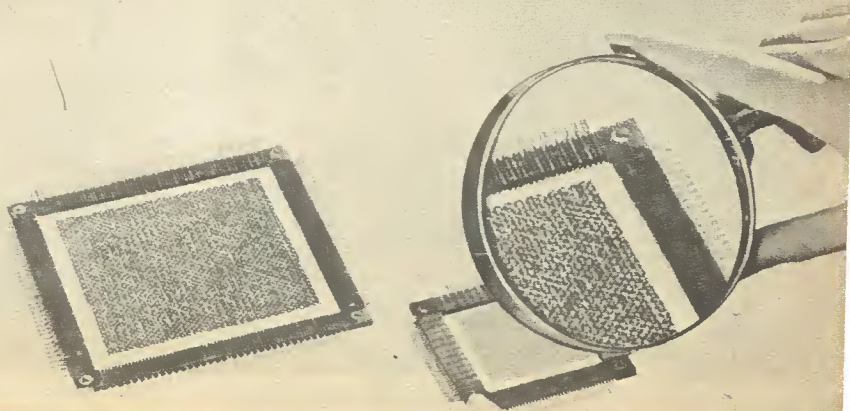

LOOK!

PRACTICAL!

VISUAL!

EXCITING!



a new 4-way method of mastering
ELECTRONICS
by doing — and — seeing . . .

1 ▶ **OWN and HANDLE a**

complete range of present-day **ELECTRONIC PARTS** and **COMPONENTS**

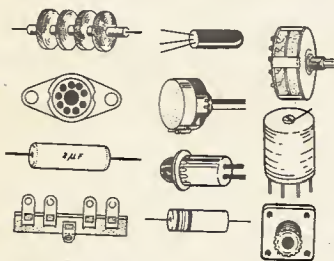

2 ▶ **BUILD and USE**

a modern and professional **CATHODE RAY OSCILLOSCOPE**

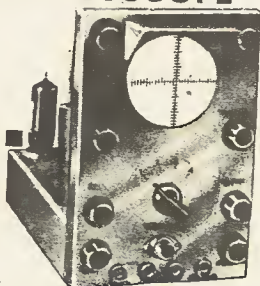

3 ▶ **READ and DRAW and UNDERSTAND CIRCUIT DIAGRAMS**

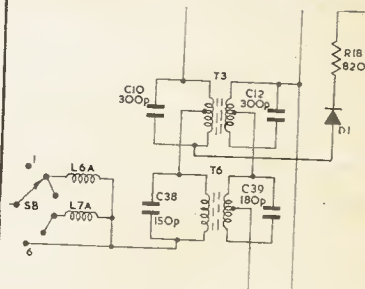

4 ▶ **CARRY OUT OVER 40 EXPERIMENTS ON BASIC ELECTRONIC CIRCUITS AND SEE HOW THEY WORK . . . INCLUDING . . .**

- | | | |
|--------------------------|--------------------------|------------------------|
| ● VALVE EXPERIMENTS | ● PHOTO ELECTRIC CIRCUIT | ● A.C. EXPERIMENTS |
| ● TRANSISTOR EXPERIMENTS | ● COMPUTER CIRCUIT | ● D.C. EXPERIMENTS |
| ● AMPLIFIERS | ● BASIC RADIO RECEIVER | ● SIMPLE COUNTER |
| ● OSCILLATORS | ● ELECTRONIC SWITCH | ● TIME DELAY CIRCUIT |
| ● SIGNAL TRACER | ● SIMPLE TRANSMITTER | ● SERVICING PROCEDURES |

This new style course will enable anyone to really understand electronics by a modern, practical and visual method—no maths, and a minimum of theory—no previous knowledge required. It will also enable anyone to understand how to test, service and maintain all types of Electronic equipment, Radio and TV receivers, etc.

FREE POST NOW
for
BROCHURE

or write if you prefer not to cut page

To: **BRITISH NATIONAL RADIO SCHOOL, READING, BERKS.** Please send your free Brochure, without obligation, to: we do not employ representatives

NAME

ADDRESS

BLOCK CAPS

PLEASE PEQ

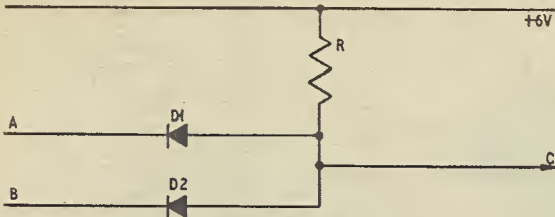

Fig. 4.6. Electronic AND gate

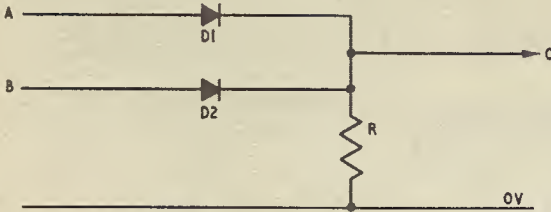

Fig. 4.7. Electronic OR gate

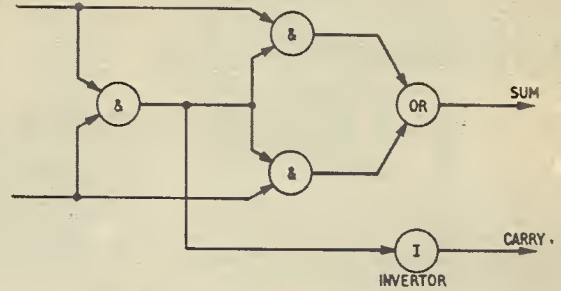

Fig. 4.8. Half-adder configuration

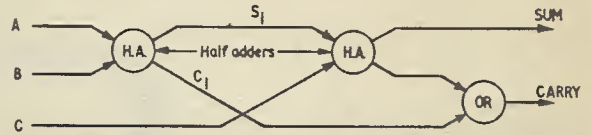

Fig. 4.9. Two half-adders make an adder

C can only be "1" when both A and B are "1".

The use of the "&" and "+" signs for the AND and OR functions is deliberate, since Boolean equations can be manipulated in just the same way as the equivalent algebraic ones. For instance,

$$A(B + C) = A.B + A.C$$

in both Boolean and ordinary algebra.

ELECTRONIC ARITHMETIC

Electronically, none of these Boolean functions is difficult to imitate. A transistor makes a very good inverter for a start, and it is partly for this reason that Boolean algebra is used at all.

An AND gate is shown in Fig. 4.6.

A "1" is defined as, say, +6V and a "0" as 0V. Then when both A and B sit at "0", current can flow through D1 and D2 to 0V. If either A or B rises to 6V, current can still flow through one of the two diodes to 0V. However, once both A and B have risen to 6V, there is no further path to earth for the current, and the output will rise to 6V.

The OR gate functions in almost an identical fashion and its circuit is given in Fig. 4.7.

Using these three logical functions and their negative counter parts, it is possible to perform arithmetic operations on binary numbers. Suppose, for instance, that two numbers A and B are to be added together. The truth table for this operation is given in Table 4.2.

When both A and B are 1, their sum is 2, which in binary is written as 10. This means that any logical circuit capable of adding the two numbers must also deal with the sum and the "carry" bits of the answer. A typical circuit that performs this function for just

two binary numbers is known as a "half-adder". One such is shown in Fig. 4.8.

The reader may like to verify for himself, by means of a truth table, that this circuit really does work.

When two half-adders are connected as in Fig. 4.9, the result is known as a full-adder, and can add three binary numbers together.

This is just one of the many functions that logical elements can perform on binary numbers. It can probably be seen that the story does not end there, and that any arithmetic function, and quite a few non-arithmetic ones, can be performed by means of Boolean logic.

The next article will delve into the manner in which numbers are represented in different types of computer, and into the way negative numbers are taken care of.

The line printer opened for maintenance on the I.C.T. 1901 digital computer

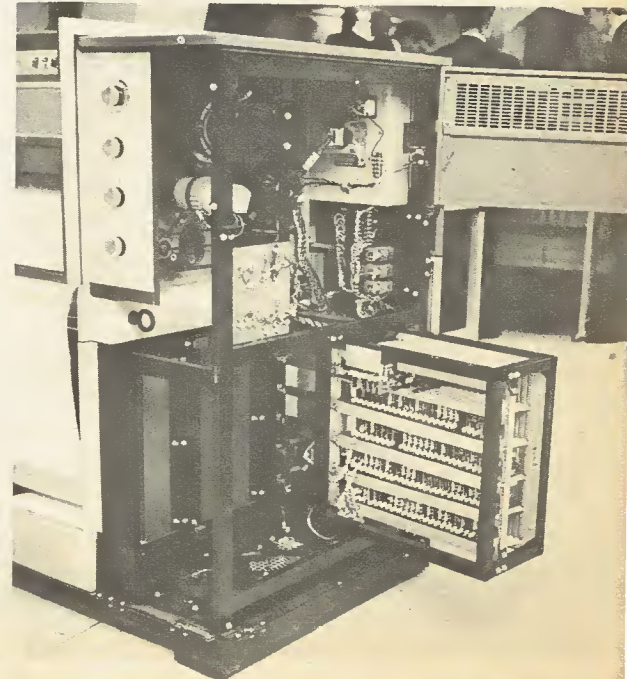

Table 4.2. TRUTH TABLE OF A PLUS B

A	B	C = (A plus B)
0	0	0
0	1	1
1	0	1
1	1	10

calibration preset potentiometer (VR2) which is also intended for matching arbitrary samples of AC126 transistors within their manufacturing tolerance range. Calibration checks should be made at monthly or quarterly routine overhauls of the equipment.

STARTING CONDITIONS

At the start of each session of photographic work, it is necessary to have some means of determining when the system has reached the selected nominal temperature and is ready for operation. In principle, the nominal temperature has been reached as soon as the circuit switches for the first time. However, this may take up to half an hour or even more, so that it is inconvenient to watch the panel lamps.

Fortunately this is quite unnecessary. The manual temperature selection control may also be used as search control to take readings of the actual temperature. If it is *slowly* turned to the point at which the circuit switches, then the scale reading at that point is the actual temperature of the liquid and feeler at the time. If the nominal control state has already been reached, displacement of the manual control through at most 0.2 degrees C in the appropriate direction causes the circuit to switch.

The switching time constant is about 0.5 seconds, so that response delays up to 2.5 seconds may result. These are essential to avoid spurious responses to mains voltage or water flow transients and to suppress hunting at critical hysteresis cancellation setting. Therefore move the manual control VR1 *slowly* and in *small steps* when using it to take a temperature reading.

The nominal control state is not significantly disturbed by a temperature read-off search adjustment of the manual control, provided the latter is returned to the nominal setting within 30 seconds. This allows adequate time to take a temperature reading. If continuous temperature indication is nevertheless desired, an ordinary mercury thermometer or some form of simple electronic thermometer should be suspended in the controlled liquid in addition to the Chemostat feeler.

THERMAL TIME CONSTANTS

In most cases, performance would be very disappointing if a haphazard plumbing system were to be used without due consideration. The accuracy of the electronic circuit in the Chemostat is beyond reproach,

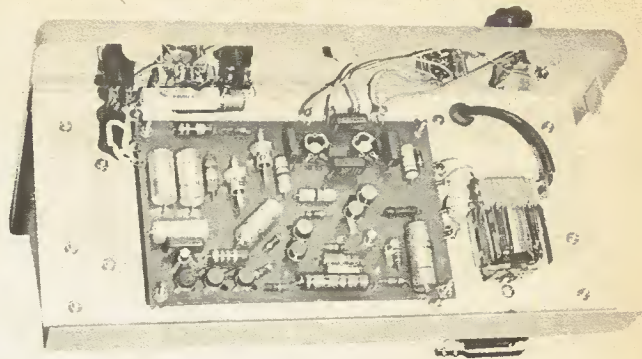

since it proved possible to reduce its hysteresis to less than a fifth of the photographic bath temperature tolerance without undue circuit complication. The performance accuracy of the complete system is therefore determined entirely by the suitability of the plumbing system. The ultimate aim is to match the heating or cooling time constants of the plumbing system to the time constant of the temperature feeler in such a manner that corrections are not made so rapidly that overshoots beyond the tolerance range result, and not so slowly that random temperature drifts can again exceed the tolerance range.

Temperature adjustments always take place according to an exponential law which is of the same form as the discharge of a capacitor through a resistor. The so-called thermal time constant is the time taken for the temperature *difference* of a body with respect to its surroundings to drop to a fraction $1/e$ of its initial value. In the same way, the electrical time constant of a resistor-capacitance combination is the time taken by the capacitor to discharge through the resistor to a fraction $1/e$ of its initial voltage.

When this exponential law is expressed mathematically and differentiated to find the corresponding *rates of change*, we find that the rate of discharge of a capacitor (volts per second), or the rate of temperature change of a body (degrees per second), is always equal to the *existing voltage or temperature difference, divided by the time constant*. This simple rate law is of fundamental importance in the design of any thermostatic control system.

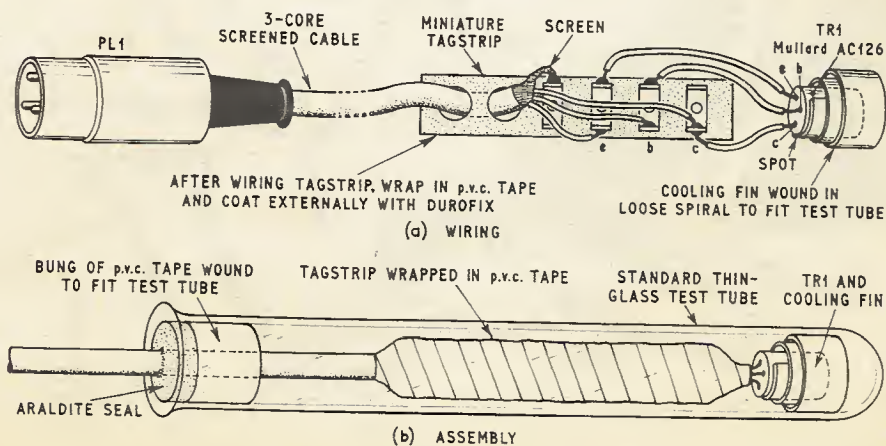

Fig. 6. Temperature feeler constructional details

MATCHING THE RATES

We will be using some form of heating or cooling device to apply continual corrections to the temperature of the photographic bath, according to the errors sensed by the feeler. The rate (degrees per second) of the temperature correction is given by the temperature difference impressed with respect to the photographic bath, divided by the thermal time constant of the bath with respect to the heater/cooler. The thermal time constant of the bath depends upon the manner in which heat is conveyed to or from the bath and thus differs profoundly for different physical arrangements.

The temperature feeler attempts to follow the heating or cooling of the photographic bath, but will thereby lag behind due to its own thermal time constant. The temperature lag will rise to a value enabling the feeler temperature to rise at the same rate as the bath temperature is increasing. Thus if the lag, which is the ultimate temperature error of the entire control system, is not to exceed the bath temperature tolerance, the rate of bath heating or cooling must not exceed the bath temperature tolerance divided by the feeler time constant. On the other hand, the rate of bath temperature correction should not be slower than this value, because disturbances are then not corrected as rapidly as inherently possible with a given system.

MEASUREMENTS

The feeler time constant is easily measured by keeping the bath temperature constant manually and plotting a graph of the rise or fall of feeler temperature against time. The feeler temperature is thereby measured with the help of the manual temperature control VR1, searching for the switch-point at successive intervals of time. Section (a) of Fig. 9 shows such a plot. The curve "in water" is the relevant one here. The thermal time constant is read-off from the graph as the time taken for the curve to drop to a fraction $1/e$ of its initial height. The temperature tolerance of the photographic bath is ± 0.5 degrees C and the thermal time constant of the Chemostat feeler was measured to be 100 seconds in water for the prototype. Thus the heating/cooling system should apply temperature corrections to the photographic bath at an optimum rate of $1/200$ degree C/sec. A faster rate of temperature correction would lead to overshoot, whilst a slower rate would take longer than necessary to correct random disturbances.

AMBIENT VARIATION

Using variation of ambient air temperature as correction method, the relevant time constant of the bath is readily measured by filling the developer tray with water raised to a certain temperature above room temperature and then plotting the cooling curve in the absence of draughts (section (b) of Fig. 9). The same tray as will be used in the final system should be used, and the amount of water (or preferably actual developer) in it should correspond to the average amount which will be used in the tray during normal processing. The thermal time constant came out at about 2,000 seconds for prototype measurements with a light yellow plastic tray 7in x 9in containing 750cc of developer solution.

According to the rate law, we require an impressed temperature difference of 10 degrees C to obtain the required heating/cooling rate of $1/200$ degrees C/sec with this thermal time constant of 2,000 seconds.

DESIGN PARAMETER

This is the nominal design parameter for the Chemostat plumbing system. As long as the feeler temperature is below the selected threshold, the photographic bath should be subjected to ambient air which is 10 degrees C hotter than the nominal bath temperature. When the feeler is above the threshold, the ambient air should be switched to 10 degrees C colder than the nominal bath temperature.

TWO-WAY CORRECTIONS

We have assumed that two-way corrections will be applied, i.e. heating if the temperature is too low and cooling if it is too high. This practice is indeed quite essential, because room temperatures normally tend to be above 20 degrees C, so that the Chemostat would lose positive control if only a heater were to be employed. Two-way corrections with positive heating and positive cooling make the system inherently insensitive to room temperature variations over a wide range and thus provide the only reliable method of working for all seasons of the year.

COOLING

Cooling is problematic when a good water main is not available. In such cases, electrical refrigeration equipment is essential. Commercial units are available for cooling running water. Experiments may also be carried out with adapted domestic refrigerators, with tepid tapwater running through folded tubing on the freezer plate. Such problems require individual attention in consultation with appropriate contractors.

We will assume that a cold water main connection is available, and that after an initial stabilising period, the steady temperature of the water issuing from it lies between 5 degrees C and 20 degrees C. This condition is normally satisfied for British and other temperate climates. Refrigeration equipment will then not be required.

HEATING

A normal immersion heater dipping into the photographic bath would give far too short a time constant, resulting in greater overshoot errors than original random drift errors. Such a system would impair, not improve, the bath temperature stability. Suitable low-wattage immersion heaters with mechanical stirrers may be used in principle, but it is then difficult to apply a matched cooling cycle. Indirect heating methods are

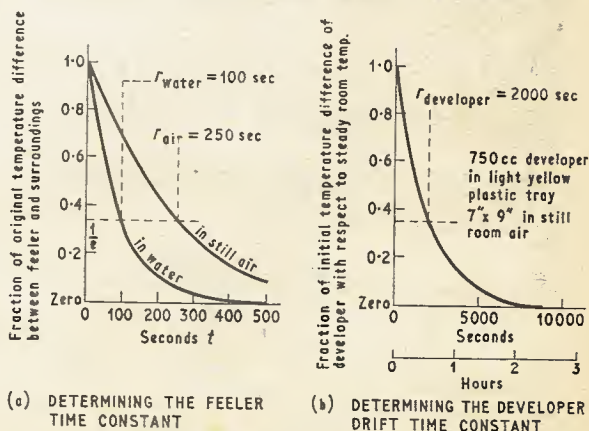

Fig. 9. These curves indicate how the optimum heating/cooling correction gradient for a given feeler and bath may be determined



microelectronics

PART TWO

By M. J. HUGHES M.A.

THE first part of this article last month delved into the intricacies of thin film circuits. A glossary of terms was included which is completed this month. Now let us continue with a close look at silicon planar semiconductor integrated circuits.

SILICON PLANAR DEVICES

The concept of making integrated circuits from semiconductor materials stems back to the basic method of manufacturing conventional silicon planar transistors. It is worth describing the simple transistor before complicating the issue by introducing other types of components.

A planar transistor comprises three electrodes, the base, emitter, and collector. In the case of an *npn* device the emitter and collectors are of *n*-type silicon, while the base is *p*-type. The difference between *n* and *p*-type materials is the method by which current flows; in the former case by electron mobility, and in the latter case by hole mobility.

To obtain these two types of majority carriers, accurately controlled amounts of dopants have to be introduced to the silicon.

In the case of *pnp* germanium alloy diffused transistors, this is effected by alloying a small amount of doping material (e.g. indium) into each side of a sliver of *n*-type germanium. Under the action of heat the indium atoms diffuse into the germanium from both sides and form fronts, more commonly called junctions, between the indium pellets and the original germanium.

The two pellets of indium form the emitter and collector contacts respectively; the narrow band of original *n* type germanium left between them forms the base area. The gain of the transistor is roughly proportional to the width of this base region; the breakdown voltage is proportional to the quality and concentration of the doping material in the vicinity of the junction.

The same principle applies in making a planar transistor, except that, as the name implies, all diffusions are carried out in a single plane and from only one surface of the device.

DIFFUSION

To make an *npn* planar transistor, it is necessary to start with *n*-type silicon which will ultimately form the collector (see Fig. 4a). By forming a thin layer of silicon dioxide on the surface of this silicon—usually by heating to a high temperature in an atmosphere of steam—it is possible to passivate the surface, or protect it from chemical attack or contamination (Fig. 4b). If a small window is cut into this passivating layer by a photolithographic process using a powerful etch

such as hydrofluoric acid, a *p*-type impurity such as boron can be diffused into this selected area (Figs. 4c and 4d).

The boron usually originates from boron tribromide, a gas, which is passed over the surface of the hot silicon. The length of time, and the temperature at which this operation is carried out controls the depth of penetration, and also the concentration of boron on the surface. The remaining passivating oxide prevents diffusion elsewhere on the surface. The boron diffuses sideways through the silicon as well as downwards; therefore the all important junction between the new *p*-type region and the original *n*-type material is under the surface of the oxide, thus being protected from outside influences.

The actual depth of penetration of this *p* material, or base region, is usually not more than 2 or 3 microns (a micron is a millionth of a metre). By regrowing a new layer of thermal oxide on top of the *p*-type material the window can be closed (Fig. 4e).

If now a smaller window is etched in this oxide exactly over the same centre as the first, it is possible to diffuse in an *n*-type impurity—for example phosphorus (again from a gas such as phosphorus oxychloride) (Figs. 4f and 4g). The protective covering of silicon dioxide again prevents diffusion taking place except over the window area.

Careful control of this second diffusion allows the *n*-type layer to penetrate the base region by an amount which must be less than the original base diffusion which in this case would be approximately 1 micron.

GLOSSARY

(CONTINUED)

manufacture involving epitaxial isolation can be used to overcome this. We will deal with the subject of epitaxial deposition in detail a little later.

Although this has been an extremely rudimentary description of how a silicon planar transistor is made, a large number of production details have been omitted for the sake of clarity. The important feature of this method of manufacture is the fact that as all processes are carried out on one surface of the silicon, there is no reason why a large piece of silicon should not be used to fabricate several transistors simultaneously.

The only requirement for this would be to have photographic negatives carrying multiples of the base, emitter, and contact patterns, each negative being

Large scale integration—The process of fabricating complex circuits by interconnecting adjacent circuits on a wafer of silicon to form larger working circuits on a single substrate.

Logic family—A term used to define certain types of circuitry which are often ideal designs for making integrated circuits. Some typical family names follow:

CML—Current Mode Logic.

CTL—Complementary Transistor Logic.

DCTL—Direct Coupled Transistor Logic.

DTL—Diode Transistor Logic.

ECCSL—Emitter Coupled Current Steered Logic.

ECTL—Emitter Coupled Transistor Logic.

HLTTL—High Level Transistor Transistor Logic.

RCTL—Resistor Coupled Transistor Logic.

RTL—Resistor Transistor Logic.

TTL—Transistor Transistor Logic.

Mask—A very high quality photographic negative which carries a step and repeated pattern for use in photolithographic processes. The pattern could very well be of bases, emitters, or metallisation.

Stencil Mask—A thin piece of metal foil etched with windows which is used to define areas for metallisation in the thin film vacuum process.

Metallisation—The deposition of metal—usually aluminium—over the surface of a silicon wafer to form contacts and interconnections. Deposition is usually carried out by vacuum deposition.

Micromodules—Assembly of miniature components.

Micron—A millionth of a metre, or 0.001mm.

Monolithic—A monolithic integrated circuit is one in which all the components are fabricated from a single piece of material.

Mosaics—Registered trade mark for metal oxide silicon (transistor) array integrated circuits.

MOST—Metal oxide silicon transistor, a type of field effect transistor.

MTBF—Mean time between failures. This is a term used to define the reliability of a device, and is particularly used when referring to the reliability of integrated circuits.

Multichip circuits—As opposed to monolithic circuits, these are made by using several different chips of silicon each containing independent circuit elements. The chips may be mounted on a conventional header, and interconnected by wire bonding, or they may be of the flip chip type, and can be mounted on to circuit board, or thin film circuits.

Ohmic contact—Any contact whether mechanical, soldered, or welded which does not have rectifying properties, and where the current through the contact is directly proportional to the potential difference across it. Simply a contact which obeys Ohm's Law.

Parasitic—A parasitic is an undesirable stray capacitance, inductive coupling, resistance leakage, or similar effect such as undesirable transistor action. The first and last are the most serious in monolithic integrated circuits.

Passivation—The protection of a surface from chemical attack. Surface passivation is often used to describe the use of oxide layers which prevent diffusion in the planar process.

Photolithographic etching—A term used to describe the process by which materials can be etched preferentially in some areas and not in others by the use of photo-sensitive chemical resists.

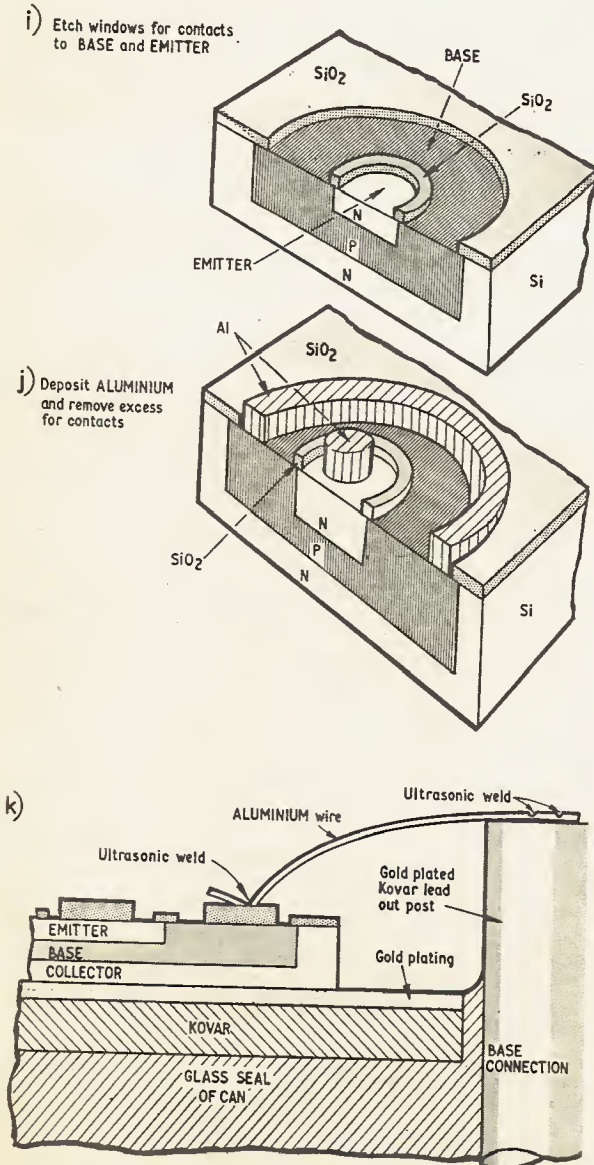
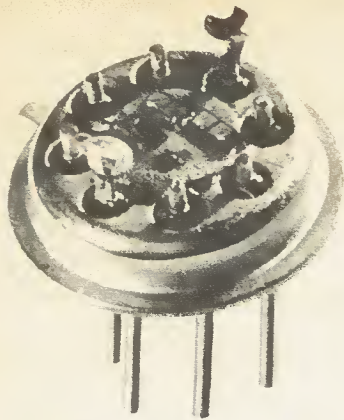
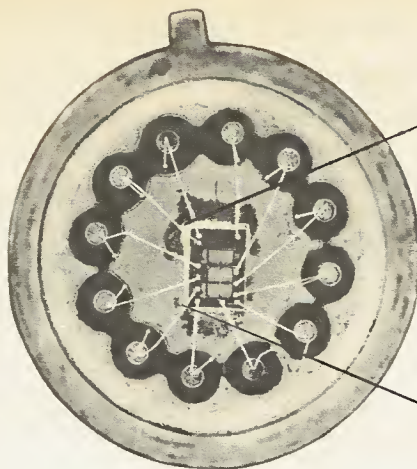

Fig. 4. Stage-by-stage process of making a silicon planar transistor from an n-type wafer to final connections



A Marconi SCIC oscillator. The cover and gold electrodes on the circular crystal have been left out



A metal oxide silicon transistor circuit

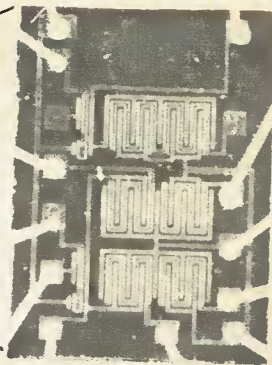

An enlarged view of the MOST disc

material loses its semiconducting properties, and becomes "ohmic". By careful process control it is possible to produce regions of accurately controlled resistivity, and these areas form the basis of resistors in integrated circuits. If a controlled resistivity region is diffused to a known depth (T) and the region is in the shape of a rectangle with dimensions $W \times L$, the resistance along the length (L) is simply $(\rho \times L)/(W \times T)$ where ρ is the average resistivity of the region.

Increasing the length, decreasing the width, or decreasing the junction depth (providing the average

resistivity stays the same) will all increase the value of resistance. A feature of a resistor produced this way is that its boundary comprises a pn junction (provided, of course, that the dopants are suitably selected). Under correct bias conditions this serves to isolate the resistor from the rest of the dice or wafer (Fig. 8).

As the dimensions of a resistor control its ohmic value, there are obviously some practical limits to possible values which can conveniently be used in miniature circuits. Usual resistance values which can be accommodated range from 10 ohms to 10,000 ohms.

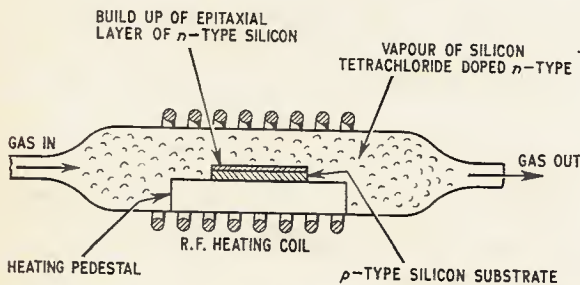

Fig. 5. Epitaxial deposition system. The glass envelope is heated by the coil, shown in section here for clarity

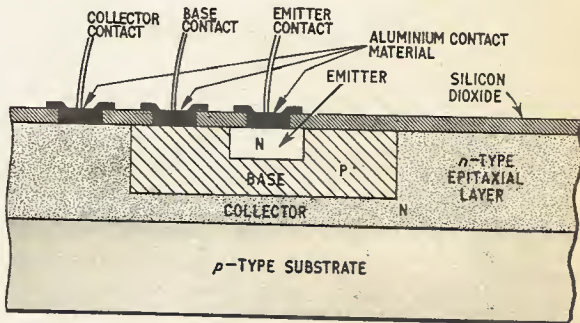

Fig. 7. Detail of a single epitaxially isolated planar transistor

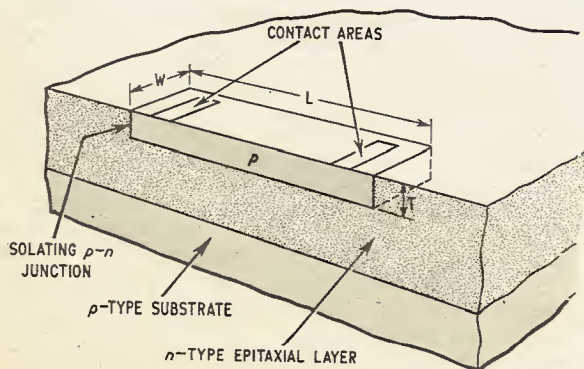

Fig. 6. Cross-section showing the basic structure of epitaxially related planar transistors

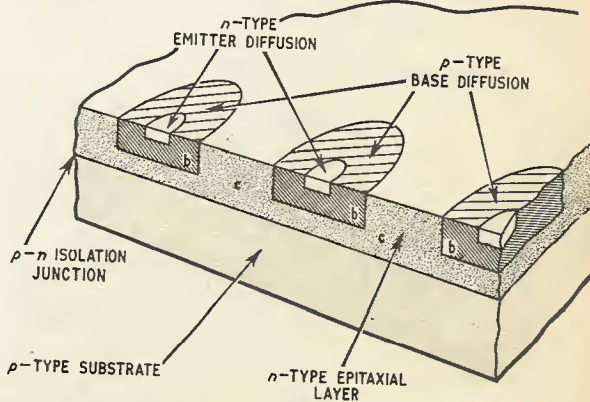
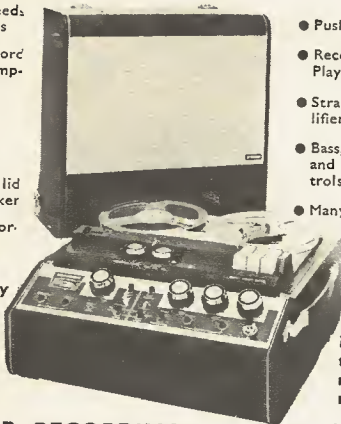

Fig. 8. Cross-section through a p-type resistor diffused into n-type material

the WyndSOR Vanguard . . . the most versatile recorder at its price* offering so many outstanding features . . .

- 4 track-3 speeds, —7 in. spools
- Separate Record and replay amplifiers
- Double play
- Sound-on-Sound
- Detachable lid fitted 8" speaker
- Tape Monitoring facility



- Push button controls
- Recording meter and Playback indicator
- Straight through amplifier facility
- Bass, treble, volume and record gain controls
- Many other features

Before you buy an ordinary tape recorder write for full details of the Vanguard and other models.

* All British and full value for money at only 59 gns. inc. 1800 ft. LP tape and Tape manual. (less mike).

WYNDSOR RECORDING CO. LTD. (Dept. PE8)
WyndSOR Works, Bellevue Road, Friern Barnet, London, N.11. ENT. 2226

COMPUTERS FOR THE AMATEUR CONSTRUCTOR

R. H. Warring

This immensely readable book sets out to provide the amateur computer constructor with a background knowledge of computers, their working principles and their capabilities. The bulk of the book, however, is devoted to practical descriptions of computer circuits and circuit elements well within the capabilities of anyone to build. Details instructions are given for two designs—an adder/subtractor and a decimal counter. Both are easy to build, yet they are quite advanced computer designs.

20s net

If you would like more information about this book write to Dept. DL at the address below:



Museum Press Ltd.
39 Parker St London W.C.2

You can depend on Shure quality MICROPHONES For amateur radio communications

Shure Model 444 Controlled Magnetic Microphone

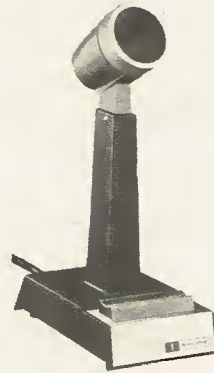

Specially designed for radio communications, giving optimum performance from single sideband transmitters as well as AM and FM units. Response cuts off sharply below 300 c/s and above 3,000 c/s, with a rising characteristic to 3,000 c/s. This results in optimum speech intelligibility and audio punch to cut through noise interference. High impedance. Dependable under all operating conditions. Complete with switch for instantaneous press-to-talk or VOX operation; finger-tip control bar; long-life switch; adjustable microphone height; sturdy, high-impact base and case; 7 ft. two-conductor shielded cable.

Shure Model 201 Diaphragm Type Ceramic Microphone

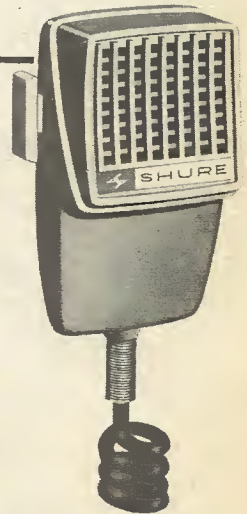

- * Provides clear, crisp, natural voice reproduction of high intelligibility
- * High impedance * Ideal voice response and omni-directional polar pickup characteristics
- * No humidity or temperature problems
- * Light, strong and compact
- * Heavy duty push-to-talk (non-locking) switch
- * Frequency response: 200 to 4,000 c/s
- * 3-conductor retractable cable.

SHURE

Setting the
world's standard
in sound

SHURE ELECTRONICS LTD.
84 Blackfriars Road, London, S.E.1. Tel. WATerloo 6361



IN THIS feature we hope, from time to time, to be able to publish suggestions submitted by some of our readers on the possible improvement of projects previously described in PRACTICAL ELECTRONICS; short contributions on other subjects may be included. The aim is not to find fault or undermine the abilities or knowledge of our contributors. It may well be that the original article is *par excellence* but it could be improved or adapted to suit individual requirements. The views expressed by readers are not necessarily those of the Editor.

NO-THUMP TREMOLO

THOUGHT you might be interested in a "no-thump" electronic tremolo.

The flashing lights in the circuit cause the cadmium sulphide cell to alter its resistance.

The cell is wired in place of the grid leak resistor in the preamplifier.

When illuminated the cell short-circuits the signal to earth and when no light is present the amplifier acts normally.

Thus a flashing bulb produces a tremolo effect.

One of the bulbs may be used as a flashing pilot to indicate that the tremolo is on.

H. Hughes,
Sheffield 9.

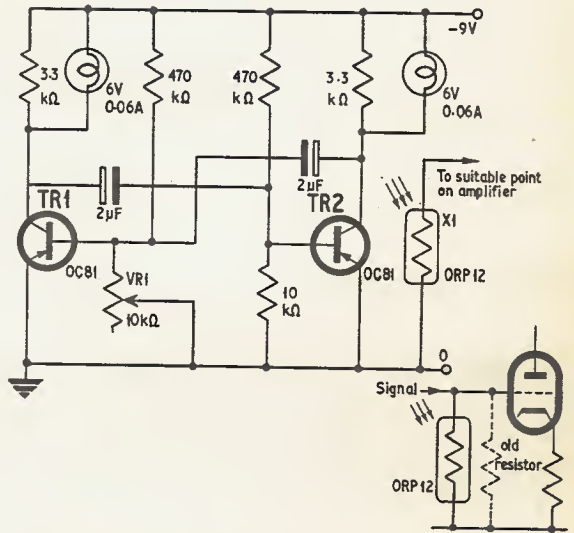

ANTI-SURGE FOR PROJECTOR LAMPS

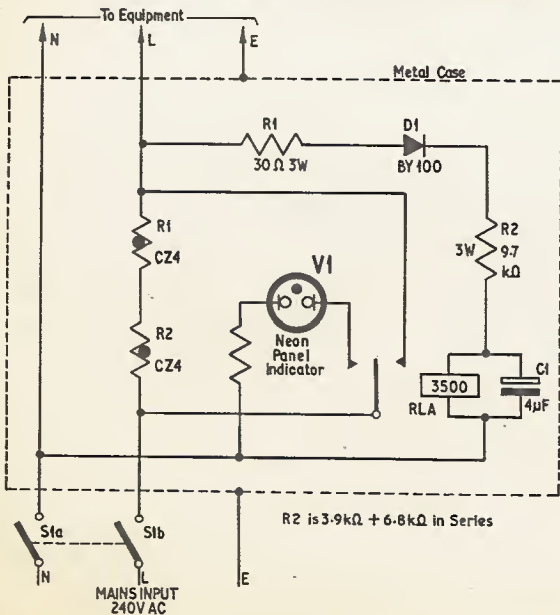

THE attached circuit was devised for automatic current surge limiting designed for slide or movie projectors up to 500 watts.

The unit was constructed inside a 6in × 4in × 2½in aluminium box type chassis.

All the components being mounted on an 18-way group board (except the relay), the thermistors are mounted vertically from the group board and away from other components. The relay is a surplus American P.O. type with its contacts adjusted to close at 6mA at 20 volts.

Heat-proof sleeving should be used on all wires near the thermistors.

It is essential that the equipment being used from the limiter should be switched on before operating the switch on the limiter.

P. G. Holland,
Castleford,
Yorkshire.



Take one for 8/3

***stereo or mono**

a genuine **12" LP***
or 3 $\frac{3}{4}$ ips tape
(9/11)



60 Glorious melodies performed by Jacqueline Delman, John Larsen, Linden Singers and the Sinfonia of London under Hollingsworth.



In person... **202** One of Nat's greatest discs! You'll Never Grow Old; Because You're Mine; Walkin'; Because of Rain; plus 8 other tops.



31 John Hollingsworth conducts the Sinfonia of London in a thrilling performance of this famous ballet music.



443 Chart-topping folk group sing Morning Town Ride; Eriskay Love Lilt; Blowin' in the Wind; Kumbaya; Chilly Winds; plus 7.



37 Sinfonia/Faris play Bach Air on G String; Boccherini's Minuet; Tchaikovsky's Serenade for Strings; Handel's Berenice; Minuet.

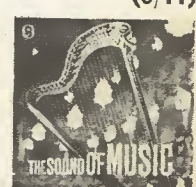

89 Star cast singing all the greats: Climb Ev'ry Mountain; Do-Re-Mi; Lonely Goat-Herd; Favourite Things; Maria; Edelweiss; etc.



239 Virtuoso performance by Youri Boukoff of Beethoven's finest concerto. L'Orchestre des Concerts Colonne with Pierre Dervaux.



20 Star cast sings all the famous songs inc: Hello Young Lovers; Getting to Know You; Shall We Dance?; March of The Siamese Children; etc.



285 Ideal party record! Swinging arrangements of Z Cars; Maigret; Coronation St.; Kildare; Perry Mason; Route 66; many more.



151 As Long As He Needs Me; Consider Yourself; Glorious Food; I'll Do Anything; all the hits with Joyce Blair, Ian Carmichael, full cast.

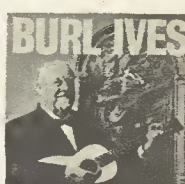

302 Vintage collection of 14 ballads by the Big Daddy of folk-singers! Inc. Early One Morning; Irish Rover; Henry Martin; Wanderin'.



449 Unforgettable songs from the Continent! Romantica; Volare; La Mer; Never on Sunday; Al Di La; Quando, Quando; Mi Lord; etc.

HERE'S WHY: We want you to *prove for yourself* that what we say about World Record Club recordings is absolutely true – that for sheer quality they are unsurpassed by *any* other records selling at any price. *Anywhere!*

So choose any one of these magnificent WRC recordings, and actually test it yourself on your own home equipment for 7 days. And read through the fascinating literature we shall send you about WRC, and seriously consider joining Britain's finest record club. You'll find WRC's annual programme of 128 special club releases very tempting! The cream of the World's great Classical, Folk, Jazz, Popular and other music as well – and all offered exclusively to members at special privilege prices.

Available in stereo & mono LPs and 3 $\frac{3}{4}$ ips mono tapes

Don't miss this astonishing offer – post the coupon TODAY!

SEND NOW! CLAIM YOUR CHOICE HERE!

TO WORLD RECORD CLUB, P.O. BOX 16, HAYES, MIDDLESEX

Please send me, without further obligation, the recording I have indicated below, together with FREE illustrated brochure about WRC. I understand that even if I take no further interest in the Club, I may still keep my recording and pay you only 8/3 (tape – 9/11) plus 1/9 p & p. Or, if I wish, return my recording within 7 days in perfect condition and owe you nothing.

IMPORTANT! THIS IS YOUR ADDRESS LABEL – PLEASE PRINT CLEARLY

MY CHOICE IS NO.

MR
MRS
MISS

STREET

TOWN
436

For office use only

COUNTY

Enter choice number only in box.



Tick for mono 12" LP

Tick for stereo 12" LP

Tick for 3 $\frac{3}{4}$ ips mono tape

This offer applies to G.B. and N. Ireland only.

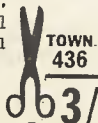

PARAMETERS AND SYMBOLS

Fig. 1 shows the symbols for transistors and diodes together with some typical physical outlines. The positive and negative signs show the normal biasing conditions. The small signal current gain for a transistor in the common emitter mode is defined as

$$h_{fe} = \frac{\text{the small change in collector current}}{\text{small signal change in base current which caused it}}$$

(ignoring the leakage current), and can be written mathematically as $\delta I_C / \delta I_B$.

This fraction varies with the absolute value of the collector current (I_C), and so when stating the h_{fe} of a transistor, the collector current at which it was measured must also be stated. The circuit described below allows h_{fe} to be measured for collector currents between 1 and 7mA.

Fig. 2 shows the I_C/I_B curve and Fig. 3 the variation of h_{fe} with I_C for the OC201 transistor. The slope of the I_C/I_B curve (called the transfer characteristic) varies with I_C . Now h_{FE} is defined as I_C/I_B , whereas

$$h_{fe} = \frac{\delta I_C}{\delta I_B}$$

If any transistor is connected so that its collector is correctly biased with respect to its emitter, but the base is left open circuit, it will be found that a very small residual collector current continues to flow, even though the base current must be zero. This current is known as the collector leakage current (I_{CEO}) and is temperature dependent. In general germanium transistors have a larger I_{CEO} than silicon, and the variation of this current may well effect the thermal stability of a circuit. For this reason it is useful to have a rough guide to the magnitude of this leakage, since a transistor which shows a good h_{fe} value but has a very high value of I_{CEO} should not be used.

A typical diode characteristic is given in Fig. 4. Note the change of current scale between forward and reverse bias conditions. The diode has a low forward resistance but high back resistance. This can be checked with the test set. For a diode which has broken down the resistance will be low in both directions.

NULL INDICATION

The circuit diagram is given in Fig. 5 and comprises three basic sections. Section A is a simple astable multivibrator. Each transistor is alternately switched hard on or hard off by the charge/discharge actions of the capacitors, and this results in the generation of a square wave. The frequency of oscillation is

$$\text{approximately } \frac{1}{0.7(C_1R_2 + C_2R_1)}$$

Section B includes the connection of the transistor under test. Switches S1a and S1b are two switches ganged together. S1a and b provides the polarity

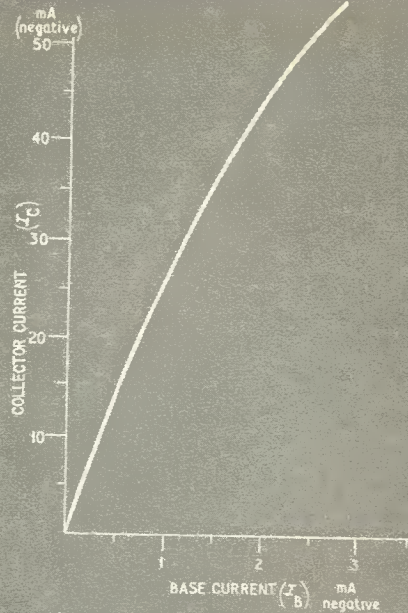

Fig. 2. A typical graph of I_C/I_B

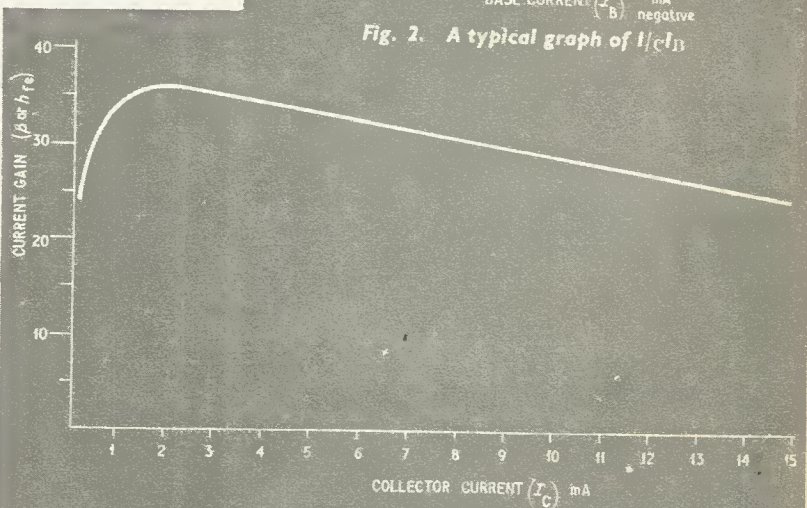

Fig. 3. Variation of h_{fe} with I_C for an OC201

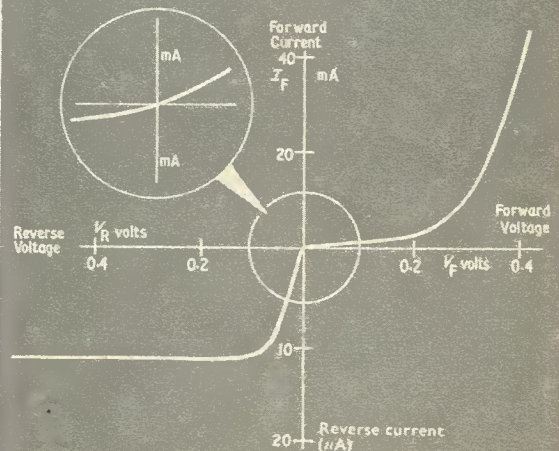

Fig. 4. Typical diode characteristic

What the experts said about the **Electroniques Hobbies Manual**

PRACTICAL ELECTRONICS

added to the above list and we strongly recommend readers to obtain a copy for reference. It is part of a

PRACTICAL WIRELESS

Electroniques. Even those obscure items are listed, like variable capacitance diodes, screw mounting feed-through capacitors, tubular trimmers

R.S.G.B. BULLETIN

There's plenty of v.h.f.-info in its 610 pages full of practical constructor-appeal, and quite obviously the cover price of 10s. 6d. is only a notional one; the Manual must cost more than that to produce. If you didn't get one at the RSGB

DO IT YOURSELF

An important feature of this unique service is the credit available to constructors.

SHORTWAVE MAGAZINE

Catalogue/Manual, a magnificent compendium of some 600 pages, full of illustrated detail covering an enormous range of parts and equipment. Even if

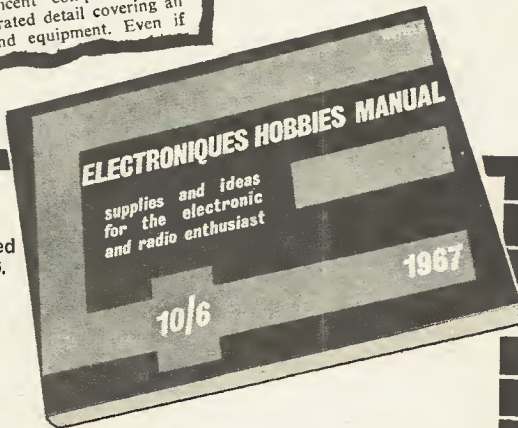

Please send me a copy of the Electroniques Hobbies Manual. Enclosed is a cheque/P.O. for 10/6.

NAME _____

ADDRESS _____

PE8

67/12MG

Whatever your particular interest in electronics, you'll find the **Electroniques Hobbies Manual** a first-class investment. Over 600 pages packed full of tips, kits and details of over 11,350 different parts from 85 leading manufacturers.

It saves you time. No searching around for the parts you need. Every type of equipment—from stock components to sophisticated professional items—is here. All available by mail order on fast despatch.

It aids your projects. Complete designs, and details of kits available for beginners and experts, are all contained in the Manual. Inside, too, there's a wealth of technical data, practical tips and formulae to help you build with confidence.

It costs just 10/6 post free. And it puts the whole electronics industry at your service, including the specialised knowledge of Electroniques. Behind this brilliant new venture are the vast resources of STC and ITT, so you're assured of a first-class service! Be sure of your Electroniques Hobbies Manual. Clip the coupon and send today—while stocks last!

Electroniques (Prop. STC Ltd.)
Edinburgh Way, Harlow, Essex.
Telephone: Harlow 26777.

GET YOUR COPY NOW!

Plus free 40-page Book Supplement, listing over 140 titles—all obtainable from Electroniques—many for the first time in the U.K.

High-grade components for amateur communications



electroniques

COMPONENTS...

Resistors

R1	10k Ω	R8	1k Ω 1% highstab.
R2	100k Ω	R9	47k Ω
R3	100k Ω	R10	47k Ω
R4	10k Ω	R11	82k Ω
R5	100k Ω	R12	4.7k Ω
R6	10k Ω	R13	1k Ω
R7	10k Ω		

All 10% $\frac{1}{4}$ watt except where stated

Potentiometers

VR1	50k Ω linear carbon
VR2	1M Ω linear carbon

Capacitors

C1	0.02 μ F polyester 150V
C2	0.02 μ F polyester 150V
C3	4 μ F elect. 12V
C4	0.1 μ F polyester 150V
C5	0.1 μ F polyester 150V
C6	100 μ F elect. 12V

Transistors

TR1, 2, 3	OC71 (3 off)
TR4	OC72 (1 off)

Switches

S1	Four-pole changeover (2 two-pole switches with toggles mechanically linked or rotary wafer switch)
S2	Single-pole on/off toggle
S3	Single-pole on/off toggle

Battery

BY1 9V type PP9 or equivalent

Meter

M1 0 to 10mA moving coil, $2\frac{1}{2}$ in diameter

Loudspeaker

LS1 3 ohm, $2\frac{1}{2}$ in diameter

Transformer

T1 11.5 : 1 (Ardente D3058)

Miscellaneous

Wood for case $10\frac{1}{2}$ in \times $8\frac{1}{2}$ in \times 3in
Crocodile clips (3 off)
Knobs and dial plate for VR1

MAKING THE BOX

A simple wooden box may be constructed as in the photograph. It may be made with $\frac{1}{4}$ in plywood or similar. Alternatively a metal box may be used provided no wiring connections are made to it. Strips of aluminium or other suitable material are required for making battery and transformer retaining clips.

The component mounting and wiring is carried out by using stand-off insulated terminal strips. Fig. 6 shows the front panel layout. Connection to the transistor under test is by suitable flying leads terminated with crocodile clips.

DIAL CALIBRATION

It is theoretically possible to calibrate VR1 by calculation corresponding to a given h_{te} , but the arithmetic is rather protracted. Consequently it is much more convenient to calibrate practically from the scale given in Fig. 7. Trace the diagram and transfer it to white paper glued to the box front.

Turn the knob to its clockwise extremity (i.e. where the wiper is at the end nearest R5 corresponding to the * marked on the circuit diagram). Line up the $h_{te} = 10$ mark with the pointer. This gives the position of fixing the scale.

MAKING TESTS

The following procedure should be carried out when making measurements. It must be noted that at no time should the connections to the transistor be touched during test, otherwise an incorrect reading may be obtained.

Make the required connections to the transistor using Fig. 1 as a guide if necessary. Switch on the set, and select the β (h_{te}) position of S2. Select *pnp* or *npn* as appropriate. If you do not know which type of transistor is being tested, choose the *pnp* position first, and if no positive result is obtained, then switch to *npn* and try again.

Adjust the collector current by VR2 to a value between 1mA and 7mA and then vary VR1 until a minimum of audio output is obtained. This should quite easily

be found by carefully adjusting the control about the "null" position. Read off the h_{te} from the dial setting obtained.

I_{CEO} . The collector-to-emitter leakage current is normally very small, so it will not be possible to obtain a good reading on the meter used. However, if the transistor is faulty, a high leakage current (greater than, say, 0.1mA for small signal transistors, or 1mA for power transistors) will be directly detectable.

Select *pnp* or *npn* as before, and then I_{CEO} position on the function switch. The meter will then give a direct indication of the collector leakage current in common emitter mode, with a collector voltage of approximately 9V and with the base open circuit.

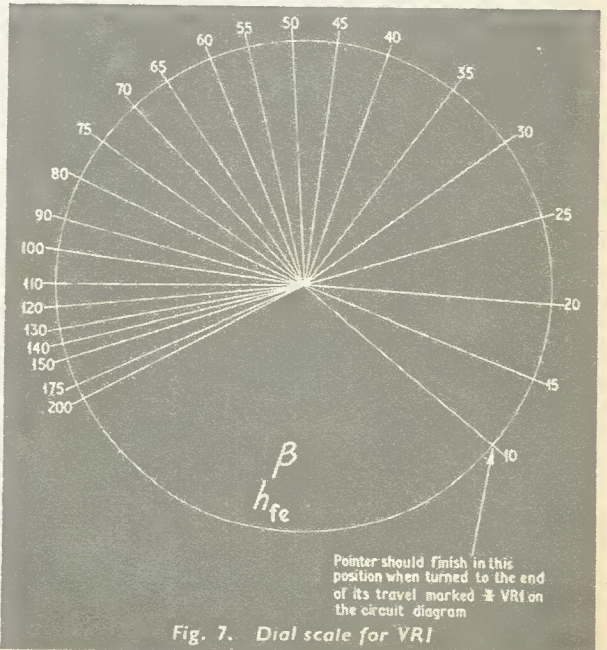

Fig. 7. Dial scale for VR1

BUILD YOURSELF A QUALITY TRANSISTOR RADIO—FULL AFTER SALES SERVICE!

THE MAGNIFICENT ROAMER 7 MK.IV

SEVEN WAVEBAND PORTABLE AND CAR RADIO WITH A SUPER SPECIFICATION.

- 7 FULLY TUNABLE WAVEBANDS—MW1, MW2, LW, SW1, SW2, SW3 and Trawler Band.
- Extra Medium waveband provides easier tuning of "pop" stations.
- Built in ferrite rod aerial for Medium and Long Waves.
- 5 Section 22 in. chrome plated telescopic aerial for Short Waves—can be angled and rotated for peak S.W. listening.
- Socket for Car Aerial.
- Powerful push-pull output.
- 7 transistors and two diodes including Philco Micro-Alloy R.F. Transistors.
- Famous make 6×4 in. P.M. speaker.
- Air spaced ganged tuning condenser.
- Separate on/off switch, volume control, wave change switches and tuning control.
- Attractive leather look case with hand and shoulder straps. Size 9×7×4 in. approx.
- First grade components.
- Easy to follow instructions and diagrams make the Roamer 7 a pleasure to build with guaranteed results.

Total building costs
£5.19.6.

P. & P. 5/6 Parts price list and easy build plans 3/- (FREE with kit).



TRANSONA FIVE

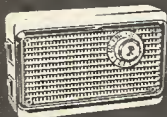

MEDIUM WAVE, LONG WAVE AND TRAWLER BAND PORTABLE

Attractive case with red speaker grille. Size 6½ × 4½ × 1½ in. Fully tunable. 7 stages—5 transistors and 2 diodes—ferrite rod aerial, tuning condenser, volume control, fine tone super dynamic speaker, all first grade components. Easy build plans and parts price list 1/6 (FREE with kit). Medium Wave, Short Wave and Trawler Band version can be supplied if preferred.

Total building costs
42/6 P. & P. 3/6

POCKET FIVE

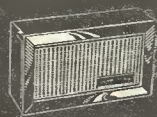

TWO WAVEBAND PORTABLE WITH 3in. SPEAKER

Attractive black and gold case. Size 5½ × 1½ × 3½ in. Fully tunable over both Medium and Long Waves with extended M.W. band for easier tuning of "pop" stations. All first grade components, 7 stages—5 transistors and 2 diodes—super-sensitive ferrite rod aerial, fine tone 3in. moving coil speaker, etc. Easy build plans and parts price list. 1/6 (FREE with kit). POCKET FIVE Medium and Long Wave version with miniature speaker ONLY 2/6. P. & P. 3/6.

Total building costs
42/6 P. & P. 3/6

MELODY SIX

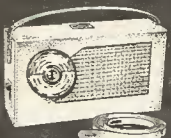

TWO WAVEBAND PORTABLE WITH 3in. SPEAKER

Handsome leather-look case, size 6½ × 3½ × 1½ in. with gilt trim and hand and shoulder straps. Fully tunable over both Medium and Long Waves. Incorporates pre-tagged circuit board, 8 stages—6 transistors and 2 diodes—ferrite rod aerial, push-pull output, wave change slide switch, tuning condenser, volume control, 3in. moving coil speaker, etc. Easy build plans and parts price list 2/- (FREE with kit).

Total building costs
59/6 P. & P. 3/6

MELODY MAKER 6

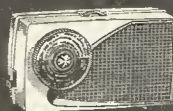

THREE WAVEBAND PORTABLE WITH 3in. SPEAKER

Smart pocket size case, 6½ × 3½ × 1½ in. with gilt fittings. Fully tunable over both Medium and Long Waves with extra M.W. band for easier tuning of "pop" stations. 8 stages—6 transistors and 2 diodes—top grade 3in. speaker, 2 R.F. stages for extra boost, high "Q" ferrite rod aerial. Easy build plans and parts price list 2/- (FREE with kit).

Total building costs
69/6 P. & P. 3/6

ROAMER SIX



SIX WAVEBAND PORTABLE WITH 3in. SPEAKER

Attractive case with gilt fittings, size 7½ × 5½ × 1½ in. World wide reception. Tunable on Medium and Long Waves, two Short Waves, Trawler Band plus an extra M.W. band for easier tuning of "pop" stations. Sensitive ferrite rod aerial and telescopic aerial for Short Waves. All top grade components, 8 stages—6 transistors and 2 diodes including Philco Micro-Alloy R.F. Transistors, etc. (carrying strap 1/6 extra). Easy build plans and parts price list 2/- (FREE with kit).

Total building costs
79/6 P. & P. 3/6

SUPER SEVEN



THREE WAVEBAND PORTABLE WITH 3in. SPEAKER

Attractive case size 7½ × 5½ × 1½ in. with gilt fittings and carrying strap. The ideal radio for home, car or outdoors. Covers Medium and Long Waves and Trawler Band. Special circuit incorporating 2 R.F. stages, push-pull output, ferrite rod aerial, 7 transistors and 2 diodes, 3in. speaker (will drive larger speaker) and all first grade components. Price list 2/- (FREE with kit).

Total building costs
79/6 P. & P. 3/6

RADIO EXCHANGE Ltd

61a HIGH STREET, BEDFORD

Telephone: Bedford 52367

Callers side entrance Barratt's Shoe Shop. Open 9-5 p.m. Saturday 9-12.30 p.m.

detached particles

JOHN VALENCE

COLOUR WITHOUT VALVES

The decision of the British Radio Corporation to develop an all-transistor colour receiver was obviously a shrewd, carefully deliberated business move. It must have been based on hard realistic thinking, as befits the launching of any large scale production.

It appears that some 18 months ago a small team of engineers were assigned to this project. In facing the many new problems of an all-transistor circuit, these designers knew they had a chance of gaining "a first" for British industry. Perhaps it is not altogether too fanciful to imagine that they were spurred towards this goal by the knowledge that in their Enfield laboratory they were working but three or four miles from Alexandra Palace, scene of that unique event in television history.

Be that as it may, the success of their efforts has certainly added another important chapter to the television story. And it has given this country a boost, I think, in a field which once we pioneered but in recent years have played but minor roles—that is colour wise.

Let us then applaud the B.R.C. The victory they have achieved is in no way diminished by the news that Motorola of U.S.A. were breathing hard down their necks in this race. The American firm (unfortunately for them) could not find the way to dispense with *one* remaining valve in the e.h.t. circuit!

LOW RANGE RADAR

One of the complexities of life is the fact that by solving one problem you then immediately create another one, or more. Road users are all too well aware that construction of a multiway flyover usually means merely the transfer of the bottleneck elsewhere. As Barbara Castle no doubt soulfully intones to herself "you can't win".

However, the particular transport problem I have in mind at the moment concerns her colleague the Minister of Aviation.

The success of the auto landing systems for aircraft seems assured. It is likely to be only a short time before this automated operation becomes quite standard at the larger airports, so permitting safe landings in conditions of zero visibility. But now the supplementary problem arises. How do the airport service vehicles find and reach aircraft under such conditions?

This matter has concerned the authorities for some time, and a study group has been set up at Birmingham University to investigate possible radar type systems for land vehicles. Various methods, including ultrasonics, infra-red and "normal" radar are being considered for this particular application. Similar research is being undertaken in industry, sometimes in collaboration with this university group, and sometimes as a purely private venture.

Having read accounts of these activities during the past 12 months or so, I was pleased to have just recently the opportunity of seeing some tangible evidence of progress in this potentially important branch of applied electronics. This was at the Mullard Research Laboratories, Redhill, Surrey, where an experimental short range radar equipment was demonstrated. The function of this equipment is explained by the name AVOID (Airfield Vehicle Obstacle

Indication Device). For obvious reasons the equipment is simple and compact; it operates in the X band, and uses frequency modulated c.w., and the range is 100 yards maximum, 3 yards minimum. An interesting feature is the electronic scanner, a 4ft length of horn-loaded waveguide, and thus there are no moving parts.

As the designers explained, the radar is still very much in experimental form. One of the important problems to be resolved is the method of display for the driver.

Quite unofficially of course, I offer my own opinion that with full use of microelectronic techniques this equipment might well provide the answer to the fog menace on public roads. Not tomorrow, I realise. But electronic technology moves on at such a pace that it seems a safe enough bet that some indicating device on the lines of AVOID will become available for the ordinary motorist before many years are past. And certainly before the M.O.T. have removed for good all those bottlenecks on our roads.

SELF SERVICE DEPT

It is generally known of course that the good business enjoyed by supermarkets is explained by the open display and immediate accessibility to the shopper of a large variety of goods.

Such a system has its weakness and more and more supermarkets are having to devise ways and means for defeating the would be filcher. One idea that I believe has already been tried out involves the fitting of a magnetic tag to each article of merchandise on display. At the exit, the articles are de-magnetised by the cashier as she registers the amount. Should the shopper walk past this point without declaring some item, its presence will be betrayed by a sensitive pick-up device and a warning flashed to the cashier.

If you want to ensure there are no embarrassing moments in store (sorry!) for you, check over your pockets beforehand. The chances are that pocket screwdriver you carry will need degaussing!



"I could be out there like a shot—if only I could find my coach"

ELECTRONIX LIMITED
ANALOGUE AND DIGITAL COMPUTER KITS

Jobs galore for Computer Trained men at higher than ever salaries! Now is the time to learn FIRST HAND what makes the giant computers tick!

Analogue Computer 1 and Digi-Comp 1, designed to meet the needs of people with little or no knowledge of computers—helps you to do that. No scientific background needed—if you can read you can build and master the first fundamentals of computer technology in next to no time.



Desk Top ACI is battery operated and has a fully transistorised Audio Sine wave generator. It computes heights of objects, solves mathematical problems, teaches fundamental theory of Analogue computers, measures unknown resistors, capacitors and inductors with AN ELECTRONIC MEASUREMENT BRIDGE. It can handle many different problems in arithmetic, geometry, trigonometry, algebra, mechanics, electricity, electronics, heat, light and sound. The further you advance in your knowledge, the more applications you will find for the computer. Supplied complete with all parts, hardware and accessories, including batteries, large pictorial wiring diagrams and clearly written manual. Ingenious patented design requires no soldering. Beautifully engineered and fully guaranteed for one year. **Minimum Retail Price £10.14.6. Special Introductory Offer only £8.14.0. + 5/6 p. & p.**

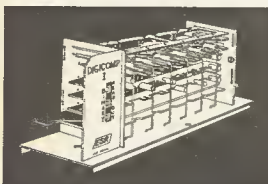

Digi-Comp 1. This remarkable teaching aid is the first of its kind. It is a binary computer kit that anyone can assemble and programme and learn first hand about the operations hidden in the circuits of a giant computer. They can see while they carry out a total of 15 experiments how a computer adds, subtracts, shifts, complements, multiplies and divides. An excellent science and maths project for classroom demonstration and discussion or home-study. Digi-Comp 1 is a highly successful and revolutionary concept in teaching the ABC of computers. *Supplied complete with 32-page instruction manual and large pictorial diagrams for assembly (about 1-2 hours).* For those who want to know more about Boolean Algebra, Programming, computer logical design, use of truth tables and flow charts and the detailed mathematical derivations of the programmes in the Digi-Comp 1 Instruction Manual, an "Advanced Text Book" has been prepared. **Digi-Comp 1. ONLY 54/- + 4/6 p. & p. Advanced Text Book 12/6 incl. p. & p. Electronics and computers are fast progressing. Don't delay, act now! This could be the best investment for your future.**

ELECTRONIX LIMITED (P.6)
One The Hamlet, Champion Hill, London, S.E.5

240 VOLT ELECTRIC POWER FROM YOUR 12 VOLT or 6 VOLT CAR BATTERY

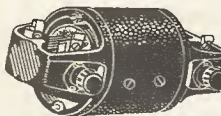

Run your mains a.c./d.c. equipment direct from your car battery with this compact low battery consumption dynamo. Size only 5in. x 3in.

Sturdy construction. Converts a 12 volt input to a 240 volt output. Huge purchase enables us to offer them at only 39/6 each, post and packing 5/-. 6 volt input model only 35/-. post and packing 5/-. Thousands already sold.

S. & R. SUPPLIES
(Dept. P.E.2), 14 Clifton Grove, Leeds 9

SITUATIONS VACANT

LONDON BOROUGH OF HOUNSLOW
ISLEWORTH POLYTECHNIC
LABORATORY TECHNICIAN

An experienced engineer is required as Technician-in-charge of the well equipped electrical and electronics laboratories and workshops in the Department of Science and Engineering.

Duties will include preparations for laboratory and workshop periods, maintenance of equipment, stocks and records.

A 38-hour, five-day week is worked and this will include some evening duty during term time.

Salary: Grade T.3, £895—£1,095

Application forms, returnable within 14 days, may be obtained from the Registrar, Isleworth Polytechnic, London Road, Isleworth, Middlesex.

RADIO TECHNICIANS

A number of suitably qualified candidates are required for permanent and pensionable employment (mostly in Cheltenham, but from time to time there are some vacancies in other parts of the U.K. including London). There are also opportunities for service abroad.

Applicants must be 19 or over and be familiar with the use of Test Gear, and have had practical Radio/Electronic workshop experience. Preference will be given to candidates who can offer "O" Level GCE passes in English Language, Maths and/or Physics, or hold the City and Guilds Telecommunications Technician Intermediate Certificate or equivalent technical qualifications.

Pay according to age, e.g. at 19—£812, at 25—£1,046 (highest age pay on entry) rising on 1/1/68 to—at 19—£828, at 25—£1,076.

Prospects of promotion to grades in salary range £1,159—£1,941. There are a few posts carrying higher salaries.

Annual Leave allowance of 3 weeks 3 days, rising to 4 weeks 2 days. Normal Civil Service sick leave regulations apply.

Application forms available from:

Recruitment Officer (RT)
Government Communications Headquarters
Oakley
Priors Road
CHELTENHAM, Glos.

TECHNICAL TRAINING by
ICS **IN RADIO, TELEVISION AND**
ELECTRONIC ENGINEERING

First-class opportunities in Radio and Electronics await the ICS trained man. Let ICS train YOU for a well-paid post in this expanding field.

ICS courses offer the keen, ambitious man the opportunity to acquire, quickly and easily, the specialized training so essential to success. Diploma courses in Radio/TV Engineering and Servicing, Electronics, Computers, etc. Expert coaching for:

- * INSTITUTION OF ELECTRONIC AND RADIO ENGINEERS.
- * C. & G. TELECOMMUNICATION TECHNICIANS' CERTS.
- * C. & G. SUPPLEMENTARY STUDIES.
- * R.T.E.B. RADIO AND TV SERVICING CERTIFICATE.
- * RADIO AMATEURS' EXAMINATION.
- * P.M.G. CERTIFICATES IN RADIOTELEGRAPHY.

Examination Students Coached until Successful.

NEW SELF-BUILD RADIO AND ELECTRONIC COURSES

Build your own 5-valve receiver, transistor portable, signal generator, multi-meter and valve volt meter—all under expert guidance.

POST THIS COUPON TODAY and find out how ICS can help YOU in your career. Full details of ICS courses in Radio, Television and Electronics will be sent to you by return mail.

MEMBER OF THE ASSOCIATION OF BRITISH CORRESPONDENCE COLLEGES.

INTERNATIONAL
CORRESPONDENCE
SCHOOLS

A WHOLE WORLD
OF KNOWLEDGE
AWAITS YOU!

International Correspondence Schools
(Dept. 152), Intertext House, Parkgate Road,
London, S.W.11.

NAME
Block Capitals Please

ADDRESS

9.67

(continued)

MICROMINIATURE MICROPHONES

Sensitive dynamic type. Will pick-up rustle of newspaper from 30 feet. Size 9 mm. X 9 mm. X 3.5 mm. Impedance 1 K Ω .

ONLY 28/6
Post free—C.W.O.

SHOWN FULL SIZE
MICRO DATA SYSTEMS
30 BAKER ST., LONDON, W.1

REAL HI-FI

IN A MINIATURE ENCLOSURE

The Revolutionary 'AUDIMAX I' Loudspeaker with Pneumatically suspended diaphragm.

Size: 8 $\frac{1}{2}$ in X 4 $\frac{1}{2}$ in X 10 $\frac{1}{2}$ in deep.
Finish: Oiled teak.
Power: 8 W, 12 W Pk.
Impedance: 4-5 Ω .
Frequency Response: 50 c/s—6dB, 100 c/s—4dB, 500 c/s, 0dB, 1 Kc + 1dB, 2K/c/s + 2dB, 5K/c/s + 2dB, 10K/c/s + 2dB, 15K/c/s—4dB (intermediate variations <1dB), at 20 Kc/s—8dB (intermediate variations <3dB)

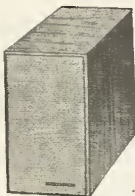

£12 each or £23 a pair
postage free

Silicon Rectifiers: 0.5A at 70°C (no heat sink required). 400 P.I.V. 2/9, 800 P.I.V. 3/-, 1,250 P.I.V. 3/6, 1,500 P.I.V. 3/9, 1.2A at 50°C (no heat sink required). 400 P.I.V. 5/6, 800 P.I.V. 6/9, 1,250 P.I.V. 7/6, 1,500 P.I.V. 8/4, 2.5A at 50°C (no heat sink required). 400 P.I.V. 6/-, 800 P.I.V. 7/6, 1,250 P.I.V. 8/3, 1,500 P.I.V. 11/3.
Potentiometers: Long life, low noise, 1W at 70°C. Body $\frac{1}{2}$ in dia., Spindle $\frac{1}{16}$ in X $\frac{1}{16}$ in 1/9 each. Linear: 1k, 2.5k, 5k, 10k, 25k, 50k, 100k, 250k, 500k, 1M, 2.5M, 5M, 10M. Logarithmic: 5k, 10k, 25k, 50k, 100k, 250k, 500k, 1M, 2.5M, 5M, 2.5M, 5M, 10M.
Jack Plugs (screened): Heavily chromed $\frac{1}{16}$ in 2/9 each.
Jack Sockets: With black or white bezel and chrome nut. 2/9 each, available with: Break Break, Make/Break, Break/Make, Make/Make contacts.
Transistor Mounting Pads: TOS and TO18 1d. each.

DUXFORD ELECTRONICS
DUXFORD, CAMBS.

C.W.O. P. & P. 1/- (cheques 7 days clearance)
Minimum order value 5/-.

TIME SWITCHES. Reconditioned 14-day clock, once on once off every 24 hours. Fully guaranteed. 5A Horstmann 29/6—15A Venner 37/6. Postage 2/6. A. R. BATCHELOR (Dept. P.E.), 4 Park Road, Bromley, Kent.

BRAND NEW NORBIT UNITS

25/- Post Free
CONSISTING OF
9" X 3" CHASSIS
CON STRIPS, RESISTANCES
2-OC29^s 2-OC35^s

M.A.C. LTD.
TROY ROAD, MORLEY, Nr. LEEDS
Phone: Morley 2334

150 NEW ASSORTED Capacitors, Resistors, Silvered Mica, Ceramic, etc. Carbon, Hystab, Vitreous, 1-20 watt, 12/6. Post Free. WHIT-SAM ELECTRICAL, 18 Woodrow Close, Perivale, Middlesex.

TRANSISTOR PANELS

New boxed, size 9" X 6" X 1 $\frac{1}{2}$ " with "Valvo" transistors type OC45 or similar, with full length leads, also an equal number of OA85 diodes; H/S resistors, etc. Built on perforated board in a metal frame.

Panel of 20 transistors, diodes, etc. 20/-
30—25/- 60—40/-
40—30/- 70—45/- Postage 2/- per panel.
50—35/- 80—50/-

Computer boards, two types average 30 planar epitaxial transistors, ZT.708 or equiv, 300 megs. 30 diodes, Hystab resistors. 19/6. P. & P. 1/-.

ZENER DIODES
2.4v, 2.7v, 3v, 3.6v, 4.3v, 4.75v, 5.25v, 5.75v, 6.2v, 6.8v, 7.5v, 9.1v, 13v, 15v, 16v, 18v, 20v, 27v, 30v, 33v, mostly 1W at 3/6 each.

Pkts. of 50 transistors all new, unmarked and untested 10/- pkt. 50/- for 6 pkts.

Polystyrene Capacitors, 350v. 680, 820, 1,800, 2,200, 2,700, 5,600, 6,800, 0.018, 0.022, 0.033, 0.25v, 1,000, 1,200, 1,500, 1,800, 3,300, 3,900, 4,700, 8,200, 0.012, 0.015, 2/- dozen any selection. Heat Sinks 10W finned, 5/-. Miniature Relays, 1" X 1" X 1", 950 ohm, 2 pole change over 10/-. Electrolytics, 5,000 MFD, 50v. 6/6, 1,000 MFD, 60v. 3/-, 1,000 MFD, 30v. 4/-. 3,000 MFD, 10v. 2/- Gold Bonded Diodes, 75v. P.I.V. 75mA. cards of 25, 10/-. Wire Wound Post 5, 10, 25, 50, 100, 250, 500, 1k, 2k, 2.5k, 5k, 10k, 20k, 25k, 50k, 100k, not presets, 2/- each. OC23 6/-; NKT452 6/-; NKT453 6/-; NKT216 5/-; OA81 2/-. Minimum order 5/-, post 1/-.

NEW CROSS RADIO
6 OLDHAM ROAD, MANCHESTER 4

REPANGO Transistor Coils and Transformer. for the Constructor. Send stamp for lists **RADIO EXPERIMENTAL PRODUCTS LTD.,** 33 Much Park Street, Coventry.

JOHN'S RADIO (Dept. B)
OLD CO-OP, WHITEHALL ROAD
DRIGHLINGTON, BRADFORD

FAMOUS ARMY SHORT-WAVE TRANSRECEIVER
MK. III

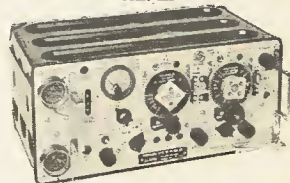

This set is made up of 3 separate units: (1) a two valve amplifier using a 6V6 output valve; (2) (some only, not built in the very latest models) a V.H.F. transistor covering 220-241 Mc/s using 4 valves; (3) the main short wave transmitter/receiver covering, in two switched bands, just below 2-4 Mc/s, and 4.5-8 Mc/s (approx. 160-37.5 metres) using 9 valves. For R.T., C.W. and M.C.W. The receiver is super-heterodyne having 1 R.F. stage, frequency changer, two L.F. (465 kc/s) signal detector, A.V.C. and output stage. A B.F.O. included for C.W. or single side-band reception. T.X. output valve 807, other valves octal bases. Many extras, e.g. netting switch, quick flick dial settings, squelch, etc. Power requirements L.T. 12 volts, H.F. receiver 275 volts d.c., H.F. transmitter 500 volts d.c., size approx. 17 $\frac{1}{2}$ X 7 $\frac{1}{2}$ X 11ins. Every set supplied in new or as new condition in carton with book including circuits, only £4.10.0, or Grade 2 slightly used 50/- carriage both 15/-.

A FULL KIT of brand new attachments for this set including all connectors, control box, headphones and mike, aerial tuning unit, co-axial lead, etc. at only 45/- carriage 5/-. WE MAKE A MAINS 200/250 VOLT POWER UNIT in louvered metal case to plug direct into set power socket to run (1) receiver, 70/- post 5/-. (2) TX and RX, £8.10.0 post 7/6. (3) 12 VOLT D.C. P.U. for receiver, 50/- carriage 5/-. A charge of 10/- to unpack and test the receiver of these sets is made only if requested.

V.H.F. TRANSRECEIVER ME. 1/1



This is a modern self-contained tunable V.H.F. low powered frequency modulated transceiver for R.T. communication up to 8-10 miles. Made for the Ministry of Supply at an extremely high cost by well known British makers, using 15 midget B.G. 7 valves, receiver incorporating R.F. amplifier. Double superhet and A.F.C. Slow-motion tuning with the dial calibrated in 41 channels each 200 kc/s apart. The frequency covered is 99-48 Mc/s. Also has built-in Crystal calibrator which gives pipe to coincide with marks on the tuning dial. Power required L.T. 4.5 volts, H.T. 150 volts, tapped at 90 volts for receiver. Every set supplied complete with valves and crystals. New or as new in carton, complete with adjustable whip aerial and circuit. Price £4.10.0, carriage 10/-. Headset or hand telephone 30/-. Internal power unit stabilised for 200/250 A.C. input, £8.10.0 extra.

TOP VALUE SEMICONDUCTORS

Silicon Transistors
Low noise high gain AF, NPN: BC109 4/6, 2N3707 5/-; PNP: 2N4058 8/6.
General purpose AF: 2N2926 from 2/6; high gain: BC108 3/11, 6645/R 3/-.
AF driver, NPN: BC107 (40V 0.3W) 4/3, 2N3704 (30V 0.3W) 4/-, BFY50 (80V 0.8W) 7/6, BFX85 (80V 0.8W) 10/9.
AF driver, NPN: 2N3702 (25V 0.3W) 4/-, 40319 (40V 1W) 13/3, 40362 (70V) 14/9.
High power O/P, NPN: 40465 (40V 70W at 70°C case) 16/3, 2N3055 (100V 65W at 100°C case) £1 only.
High voltage: 120V 0.2W, C407 6/9. UHF 1,200 Mhz 2N3563 11/3.
Ultra high gain NPN: 2N3390 β 400-800 6/6.

Germanium Transistors
Low noise AF, PNP: NKT265 3/6, 2G308 6/9.
High gain 2G309 7/9.
General purpose AF, PNP: NKT264/274 high gain

(15V) 3/6, NKT214 (32V) 3/9.
G.P. switching, PNP: ACY17 (60V 1A) 8/3, NKT217 (60V 125mA) 7/-, ACY22 (20V 1A) 3/6.
High power PNP: NKT405 (β 100-200) 50V 13/9, 2N2148 (β over 60) 40V 11/9.
High voltage PNP: 200V 3A 10W 2N3730 12/6, 320V 10A 5W 2N3731 16/3.
AF driver and O/P PNP: NKT261 3/6, 2N1305 4/-, NPN: 2N1304 4/-.
Germanium diodes: 0A47, 0A70, 0A81, 0A90, 0A95 2/- each. Silicon OA202 3/-.

Special types
Triac (SCR for AC) sensitive—only 20mA to trigger, 400V 5A max. 4/6. Sub-miniature transistor, BC122, low noise AF/RF amplifier/switching NPN, 5/9.

NEW CARBON FILM LOW NOISE RESISTORS
12 values per decade covering the range from 4.7 Ω to 10M Ω .

2W 10% 1/9 doz. mixed, 13/6 100 mixed, 12/- 100 of one value, 1W 5% 2/- doz. mixed, 16/- 100 mixed, 14/6 100 of one value. All mixtures are to your specified value. Large quantities stocked. Quality Carbon Skeleton Pre-sets, 100 Ω , 250 Ω , 500 Ω , etc. to 10M Ω . All values available in vertical or horizontal mounting 1/- each.
Volume controls: 100 Ω , 250 Ω , 500 Ω , etc. to 10M Ω linear 2/6 each. 5k Ω , 10k Ω , 25k Ω , etc. to 5M Ω log. 2/6 each. 5k Ω , 10k Ω , 25k Ω , etc. to 2M Ω log., DP switch 5/3 each.

PEAK SOUND PRODUCTS

CIR-KIT pack No. 3 12/6, strip: 15ft X $\frac{1}{16}$ in 7/6, sheet 6in X 12in 7/6. Transistorised Stereo Amplifier SAs-8. Amplifier Kit £10/10-. Power supply kit £3.

For full semiconductor data and equivalents, see our catalogue, price 6d. All stock is brand new, not surplus.

TOP QUALITY—FAST SERVICE—10% DISCOUNT OVER £3
ELECTROVALVE 6 Mansfield Place, Ascot, Berkshire

YOUR BASE FOR SEMICONDUCTOR BARGAINS!!

2N3819 FET 16/:

2N3528 SCR 18/:

2N1599 SCR 9/6

OCP71equiv. 9/6

BC107 5/8

SPECIAL OFFER!
400piv 3 Amp
S.C.R.

9/:

2N2646UJT 12/6

A25	12/6	CR74	22/6	OC77	10/3	2N1302	5/-
AC126	6/-	GET105	7/-	OC81	3/-	2N1303	5/-
AC128	4/-	GM290	18/-	OC81D	3/-	2N1304	6/-
AC176	6/-	OA5	3/-	OC81Z	9/-	2N1305	6/-
AD161	7/6	OA10	3/-	OC82	4/6	2N1306	8/-
AD162	7/6	OA70	1/6	OC82D	4/6	2N1307	8/-
ADT140	12/6	OA79	1/6	OC83	4/-	2N1308	10/6
AF114	6/-	OA81	1/6	OC84	6/-	2N1309	10/6
AF115	6/-	OA90	3/-	OC139	12/-	2N2147	17/-
AF116	6/-	OA91	1/6	OC140	9/6	2N2160	14/9
AF117	5/-	OA200	4/-	OC170	4/-	2N2925	7/-
AF118	9/-	OA202	4/-	OC171	6/-	2N2926	3/9
AF139	15/-	OC20	22/6	OC205	10/6	2N3053	11/6
B3M	17/6	OC28	15/-	OCP71	19/6	2N3055	25/6
BC108	5/-	OC29	15/-	ORP12	9/6	2N3702	5/6
BC109	6/-	OC35	12/-	ORP60	6/-	2N3826	8/-
BCY31	16/-	OC36	20/-	2G374	5/-	2N4416	47/6
BCZ11	10/-	OC41	3/6	2G381	5/-	2N4417	54/6
BFY50	12/-	OC42	4/-	2N385A	15/-	R53	23/-
BFY51	9/6	OC44	3/-	2N696	9/6	1S44	4/-
BFY52	12/-	OC45	3/-	2N697	9/6	1S423	14/9
BSY27	9/-	OC71	3/6	2N706	4/-	ST2	13/-
BSY53	21/-	OC72	4/6	2N706A	6/6	ST140	3/-
BSY95A	5/-	OC73	3/-	2N914	8/6	ST141	5/-
BUY11	15/-	OC75	5/9	2N1132	19/6	V405A	13/-
BY100	5/-	OC76	4/-				

Mullard output set 2 x OC81 + OC81D 7/-
Mullard RF set 2 x OX45 + OC44 8/6

BARGAIN PARCELS 10/:

- 60 Transistors unmarked untested
- 25 Transistors npn silicon unmarked untested
- 25 Transistors pnp silicon unmarked untested
- 4 Silicon planar 2N706 fully tested
- 3 Silicon epitaxial planar 2N2926 yellow
- 4 Silicon epitaxial planar BC113
- 5 Germanium 2G374 (OC75) Texas
- 2 Silicon power 2S012 full tested
- 36 square inches of 0-15in matrix Veroboard
- 10 Zeners 1.2 V 250 mW fully tested
- 4 Silicon rectifiers 100piv 3 A tested
- 8 Studs 100-400 V 3 A unmarked untested
- 2 V30/30P power transistors plus heat sink!
- 2 NKT404 power transistors new and marked

MORE BARGAINS!

- 4 BY100 Sil. rectifiers 800piv 550 mA 13/-
 - 4 OA210 Sil. rectifiers 400piv 550 mA 12/-
 - 12 Silicon diodes equivalent to OA200 6/-
 - 12 Silicon diodes equivalent to OA202 9/-
 - 25 New marked diodes germanium and silicon 20/-
 - 3 STC superhet kit IF1, IF2 and mixer 6/-
- 16 Page FREE Catalogue

POSTAGE & PACKING PLEASE ADD 9d.

TRANSISTORISED TRANSMITTERS 35/:

Have you sent for details of our "X" Line which contains these tiny transmitters, ready built and tested? Also, amplifiers, sirens, light flashers, metronome intercom, etc., "X" Line is not encapsulated, you can get inside! Send S.A.E. for details now.

Containing: Mullard, Newmarket, STC, Fairchild, Motorola, Sinclair, Texas, JEDEC types. Silicon rectifiers, zeners, thermistors, TV transistors, thyristors, capacitors, amplifiers, our famous "X" Line modules, meters, books, field effect transistors, planars, photocells, tunnel diodes, varicaps, unijunctions, integrated circuits, veroboard, heat sinks, neon, resistors, preset potentiometers, etc., etc. Please send S.A.E.

QUOTATIONS BY RETURN FOR QUANTITY

24hour postal service

L.S.T. COMPONENTS 23 NEW RD. BRENTWOOD. ESSEX. (tel: 7904)

R & R RADIO

51 Burnley Road, Rawtenstall
Rossendale, Lancs
Tel.: Rossendale 3152

Salvage Valves	Good Emission	Guaranteed
EF80 1/6	30P4 7/-	30FL1 5/-
ECC82 3/-	EB91 1/-	PL82 4/6
ECL80 3/6	EF85 5/-	PL36 5/-
30F5 3/-	30PL1 5/-	PCC84 4/-
PCF80 4/-	EY86 4/-	PY81 3/6
PL81 5/-	U301 6/-	PY33 6/-

Speakers, Ex T.V. 5 inch rnd. 3/6. 6 x 4 3/6. Min. post 2/6.
BY100 and equiv. rects. with 10 watt res. 3/6.
Fireball tuners, less cover can 9/-.
Ekco line O/P Trans, U26 type 35/-, post paid.
Push Button tuners, using 30L15 and 30C15 valves, rectangular buttons 27/6, post paid.
Postage on valves 6d, over three, post paid.
S.A.E. with all enquiries.
Closed July 21st to August 5th.

COMPONENTS

POSTAL SERVICE

* RECHARGEABLE

BATTERIES

(Sealed DEAC Ni-Cad)

PP3 Equiv.: 9v. 37/- (p. & p. 2/-)

U2 Equiv.: 1.25v. 32/6 (p. & p. 2/-)

U7 Equiv.: 1.25v. 12/- (p. & p. 1/6)

U11 Equiv.: 1.25v. 26/- (p. & p. 1/6)

* TRANSISTORS - Matched Output Kit:

OC81D and 2-OC81 9/6

R.F. Kit: OC44 and 2-OC45 9/6

OC44, 45, 70, 71, 72, 81 and 81D Equivalent, each 3/-

* ASSORTED CAPACITORS - New Paper, Polyester, Ceramic, Electrolytic, 100 off ... 10/6

* ASSORTED RESISTORS - Hi-Stab. 300 off (5%, 10, 2, 1/2 watt, worth £3) 15/-

(P. & P. 1/6 per order) C.W.O.

ELMBRIDGE INSTRUMENTS LTD.

Island Farm Avenue, West Molesey, Surrey



WANTED

HIGHEST prices paid for certain G.E.C. and other relays in any condition. Also wanted notched relay contacts. S.A.E. details ELEY ELECTRONICS, 112 Groby Road, Glenfield, Leicester.

HIGH SPEED MAGNETIC COUNTERS (4 x 1 x 1 in.). 4 digit. 12/24/48V. (state which) 6/8 each, P. & P. 1/-.

RE-SET H.S. MAGNETIC COUNTERS (3 x 1 x 1 in.). 3 digit. 12/24/48V. (state which) 32/8 each. P. & P. 2/6.

COPPER LAMINATE BOARD (8 1/2 x 5 1/2 x 1/8 in.). 2/6 each. 5 for 10/-.

PRINTED CIRCUIT CONNECTORS. 13 way 'in-line'. Gold Plated Pins. 4/6 Pair. P. & P. 6d.

BULK COMPONENT OFFERS

100 Capacitors (latest types) 50P to .5uF.

250 Carbon Resistors 1/2 & 1W. (Transistor types).

250 Carbon Resistors 1/2 & 1W.

100 High-Stab Resistors 1/2 & 1W.

100 Ceramic Capacitors 2-1000 pF.

25 Vitreous W/W Resistors (5%).

15 Precision Resistors (1%).

25 Close Tolerance Caps. (2%).

ANY ITEM 10/- . ANY 5 ITEMS £2.

SILICON CONTROLLED RECTIFIERS. CRS 1/30 (360 P.I.V. 1 amp) 7/8 each. CRS 3/40 (460 P.I.V. 3 amp) 10/- each.

THYRISTOR LAMP DIMMER/SPEED CONTROL KIT. 200 watt kit, 27/6, P.P. 2/6; 500 watt kit, 37/8, P.P. 2/6.

ELECTROLYTICS 100uF. 60V. 2/8; 200uF. 250V. 3/8; 100 & 400uF. 275V. 6/8; 500uF. 100V. 4/-; 1000uF. 50V. 5/-; 3000uF. 100V. 7/8; 5000uF. 50V. 7/8. P. & P. 2/6 in. £1.

PATRICK & KINNIE

81 Park Lane
Romford, Essex
ROMford 44473

ADROIT ELECTRONICS

Lord Alexander House
Waterhouse Street
Hemel Hempstead, Herts

TRANSISTORS		TRANSISTORS		DIODES, ETC.		SMALL SILICON BRIDGES				
OC28	4/6	2N696	4/6	OA5	1/3	PIV	1A	1.5A	6A	10A
OC35	10/-	2N697	5/-	OA81	1/3	50	17/6	27/6	47/-	60/-
OC36	8/6	2N706	4/3	OA200	2/6	100	—	40/-	49/-	65/6
OC41	2/3	2N711	9/6	OA202	3/6	200	19/-	42/-	57/-	80/-
OC44	2/3	2N2646	12/6	OA210	6/6	300	—	45/-	60/-	85/-
OC45	2/3	2N2926	2/6	BZY13	7/6	400	25/-	52/6	69/-	95/-
OC70	2/3	2N3053	10/-			600	35/-	55/-	—	—
OC71	2/3	2N3055	19/-							
OC72	2/3	2N3702	4/-							
OC81	2/-	2N3704	5/-							
OC139	2/6	2N3705	5/-							
OC140	4/6	2N3706	4/6							
OC170	2/3	2N3708	5/-							
OC171	2/6									

INTEGRATED CIRCUITS, RTL

Dual Buffer	35/-
Dual J-K	55/-
2 I/P Gate	35/-

Send 9d. stamps for complete lists Transistors, Rectifiers, Integrated Circuits, Etc.

Cash with order please. Postage 9d. Airmail extra

7-STATION INTERCOM 18 Gns.

1 Master and 6 Subs in strong metal cabinets. Fully transistorised 3 $\frac{1}{2}$ speakers. Call/talk/listen. Ideal for the Office, Hotel, Hospital and Factory. Complete with 50 yds. Cable and batteries. P. & P. 12/6.

4-STATION INTERCOM

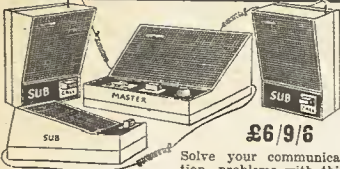

£6/9/6

Solve your communication problems with this 4-Station Transistor Intercom system (1 master and 3 Subs), in de-luxe plastic cabinets for desk or wall mounting. Call/talk/listen from Master to Subs and Subs to Master. Ideally suitable for Business, Surgery, Schools, Hospital, Office and Home. On/off switch. Volume control. Complete with 3 connecting wires each 66ft. and battery. P. & P. 6/6.

INTERCOM/BABY ALARM



Originally 6 gns.
OUR PRICE ONLY 57/6

Same as 4-Station Intercom for two-way instant communication. Ideal as Baby Alarm and Door Phone. Complete with 66 ft. wire. Battery 2/6. P. & P. 3/6.

Transistor TELEPHONE AMPLIFIER



55/- Why not boost business efficiency with this incredible De-luxe Telephone Amplifier. Take down long telephone messages or converse without holding the handset. A useful office aid. On/off switch. Volume control. Battery 2/6 each. P. & P. 2/6.

WEST LONDON DIRECT SUPPLIES (PE) 9
169 KENSINGTON HIGH STREET, LONDON W.8.

VARIABLE VOLTAGE TRANSFORMERS



PORTABLE TYPE
£8. 10. 0.



SHROUDED TYPE
1 amp, £4. 10. 0. 2.5 amps, £5. 17. 0. 4 amps, £8. 7. 6. 5 amps, £9. 0. 0. 8 amps, £13. 10. 0. 10 amps, £17. 0. 0. 12 amps, £19. 10. 0. 15 amps, £22. 0. 0. 20 amps, £32. 10. 0. 37.5 amps, £65. 0. 0. 50 amps, £85. 0. 0.



50 AMPS

INPUT 230/240v. A.C. 50/60-
OUTPUT VARIABLE 0-260v.
BRAND NEW Carriage Paid.
Buy direct from the importer.
Keenest prices in the country.
All Types (and Spares) from
 $\frac{1}{2}$ to 50 amp. from stock.
OPEN TYPE (Panel Mounting)
 $\frac{1}{2}$ amp, £3. 3. 0. 1 amp, £4. 10. 0.
2 $\frac{1}{2}$ amps, £5. 12. 6.
SHROUDED TYPE
1 amp, £4. 10. 0. 2.5 amps, £5. 17. 0. 4 amps, £8. 7. 6. 5 amps, £9. 0. 0. 8 amps, £13. 10. 0. 10 amps, £17. 0. 0. 12 amps, £19. 10. 0. 15 amps, £22. 0. 0. 20 amps, £32. 10. 0. 37.5 amps, £65. 0. 0. 50 amps, £85. 0. 0.
1.5 amp. portable fitted metal case, voltmeter, lamp switch, etc. £8.10.0. P. & C. 10/-.
Similar to above 2.5 amp. £9.17.6. P. & C. 10/-.

LIGHT SENSITIVE SWITCH

Kit of parts, including ORP12 Cadmium Sulphide Photo-cell, Relay, Transistor and Circuit, etc., 6-12 volt D.C. op. price 25/- plus 2/6 P. & P. ORP 12 including circuit, 10/6 each, plus 1/- P. & P.

A.C. MAINS MODEL Incorporates Mains Transformer, Rectifier and special relay with 3, 5 amp mains c/o contacts. Price inc. circuit 47/6 plus 2/6 P. & P.

LIGHT SOURCE AND PHOTO CELL MOUNTING

Precision engineered light source with focusible lens assembly and ventilated lamp housing, to take MBC bulb. Separate photo cell mounting assembly for ORP 12 or similar cell. Both units are single hole fixing. Price per pair £2.10.0. P. & P. 3/6.

MINIATURE UNISELECTOR SWITCH

3 banks of 11 positions plus homing bank. 40 ohm coil. 24-36 v. D.C. operation. Carefully removed from equipment and tested. 22/6, plus 2/6 P. & P.

UNISELECTOR SWITCHES

75 ohm coil 24 v. D.C.
6 Bank 25 position, 5 non-bridging 1 Bridging Wiper
6 Bank arranged to give 3 bank, 50 positions. Carefully removed from equipment. All at 35/- each. P. & P. 2/6.

BRAND NEW 4 Bank 25 Way Uniselector, 3 Bank + Homing 25 ohm coil. 12-24v. D.C. operation £4.17.6 plus 2/6 P. & P.

SCOOP!!

DIGITAL VOLTMETERS

at a fraction of makers price !!!
FOUR DIGIT DISPLAY WITH AUTOMATIC DECIMAL POINT
Manufactured by Daws Instruments Ltd. Type 652A D.C. Voltmeter, new in makers packing. Volts D.C. 2 millivolt to 1,000v. 0.2% accuracy in four f.s.d. ranges of 1v, 10v, 100v, and 1,000v.
A.C. Mains operation, 110 v and 200-250 v 50-60c/s.
This fully transistorised portable unit weighing only 9 lb. is offered complete with handbook, for only £39.10.0. incl. Postage (U.K. only). Descriptive leaflets on request.

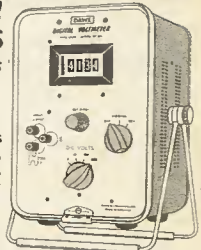

100 WATT POWER RHEOSTATS (NEW)

AVAILABLE IN THE FOLLOWING VALUES
1 ohm, 10 a.; 5 ohm, 4.7 a.; 10 ohm, 3 a.; 25 ohm, 2 a.; 50 ohm, 1.4 a.; 100 ohm, 1 a.; 250 ohm, .7 a.; 500 ohm, .45 a.; 1,000 ohm, 280 mA.; 1,500 ohm, 230 mA.; 2,500 ohm, .2 a. Diameter 3 $\frac{1}{2}$ in. Shaft length $\frac{1}{2}$ in., dia. $\frac{1}{8}$ in. All at 27/6 each. P. & P. 1/6.

50 WATT POWER RHEOSTATS

1 ohm, 7a.; 5 ohm, 3a.; 10 ohm, 2.25a.; 25 ohm, 1.4a.; 50 ohm, 1a.; 100 ohm, .7a.; 250 ohm, .45a.; 500 ohm, .3a.; 1,000 ohm, .22a.; 2,500 ohm, .14a.;

25 WATT POWER RHEOSTATS

10 ohm, 1.5a.; 25 ohm, 1a.; 50 ohm, .75a.; 100 ohm, .5a.; 250 ohm, .3a.; 500 ohm, .2a.; 1,000 ohm, .15a.; 1,500 ohm, .12a.; 2,500 ohm, .1a.; all at 14/6. P. & P. 1/6.

SANWA Multi Range Meters

We now stock just one make of multi range meters SANWA, the ultimate in test meters. Four types from stock. Price from £3.2.0.
Full range of spares and repair service available. Descriptive leaflet on request.

NICKEL CADMIUM BATTERY

Sintered Cadmium Type 1-2 v. 7AH. Size: height 3 $\frac{1}{2}$ in., width 2 $\frac{1}{2}$ x 7 $\frac{1}{2}$ in. Weight: approx. 13 oz. Ex-R.A.F. Tested, 12/6. P. & P. 2/6.

INSULATED TERMINALS

Available in black, red, white, yellow, blue and green. New 15/- per doz. P. & P. 2/-.

36 VOLT 30 AMP AC or DC VARIABLE LT SUPPLY UNIT

Input 220/240 volts A.C. output continuously variable 0-36v. Fully isolated. Fitted in robust metal case with Voltmeter, Ammeter, Panel Indicator and Chrome Handles. Input and output fully fused. Ideally suited for Lab. or Industrial use. £55 + 40/- CP.

COMPACT HEAVY DUTY 6v. D.C. RELAY 2 change-over, 3 ohm coil, 7/6 each. P. & P. 1/6. 3 for 20/- Post paid.

CONSTANT VOLTAGE TRANSFORMER

Input 185-250 v. A.C. Output 230 v. A.C. Capacity 250 watt. Attractive metal case. Fitted red signal lamp. Rubber feet. Weight 17 lbs. Price £11.10.0. P. & P. 15/-.

DIGITAL VOLTMETERS

at a fraction of makers price !!!
FOUR DIGIT DISPLAY WITH AUTOMATIC DECIMAL POINT
Manufactured by Daws Instruments Ltd. Type 652A D.C. Voltmeter, new in makers packing. Volts D.C. 2 millivolt to 1,000v. 0.2% accuracy in four f.s.d. ranges of 1v, 10v, 100v, and 1,000v.
A.C. Mains operation, 110 v and 200-250 v 50-60c/s.
This fully transistorised portable unit weighing only 9 lb. is offered complete with handbook, for only £39.10.0. incl. Postage (U.K. only). Descriptive leaflets on request.

THYRISTOR 400 piv. 3 amp. 9/6 post paid.

THYRISTOR 400 piv. 8 amp. 28/6 post paid.

230 VOLT A.C. GEARED MOTORS

5 r.p.m. 1-7 lb. inch £2.9.6. P. & P. 2/6. 13 r.p.m. 1-45 lb. inch £2.17.6. P. & P. 2/6. 80 r.p.m. .26 lb. inch £2.2.0. P. & P. 2/6.

DOUBLE WOUND VARIABLE LT TRANSFORMERS

Fully isolated low tension secondary winding. Input 230 v. A.C. Output continuously variable 0-36v. A.C.
0-36 Volt at 5 Amp. £8.10.0. P. & P. 8/6.
0-36 Volt at 20 Amp. £19.10.0. P. & C. 15/-.
These fully shrouded Transformers designed to our specifications are ideally suited for Educational and Industrial Laboratory use.

SUPER POWER MAGNET

Fantastic ex-W.D. magnets, weighing only 4 lb. will lift well over 100 lb. Swivelled handle and keeper. Size 4 in. x 3 $\frac{1}{2}$ in. x $\frac{1}{2}$ in. Packed in two's. Price 30/- per pair plus 7/6 C. & P.

MOVING COIL HEADPHONE AND MIKE

Soft rubber ear-pieces with M/C Mike fitted 5-way plug as on No. 19 set. New in makers packing, 16/6 plus 3/6 C. & P.



WELCOME LIGHT

With a SELCON Automatic Photo Electric Control Switch. Safety-security-convenience. Lights automatically on at sundown - off at dawn. Selcon gives SOLAR-control for garage and porch lights, in nurseries, shop windows, etc. 200/250v. A.C. Comparable controls cost double.
ONLY 49/6 p. & p. 2/6
Send C.W.O., or details from:

PHOTAIN CONTROLS LTD. (K)
Randalls Road, Leatherhead, Surrey

Resistors

$\frac{1}{4}$ W, 10%, High Stab, low noise 3/- per doz. 18/6 per 100

Capacitors

Min. Electrolytic. Pack of 12 9/- Polyester and Foil. Pack of 12 6/-

Transistors (See Lists for large selection)

Matched Output Kit OC81D + 2 x OC81 7/6 per set

Type 1020 PNP Germ. AF. 50mW 8/- per doz.

Type 1021 PNP Germ. AF. 200mW 12/6 per doz.

OC44, OC45, OC70, OC71, OC81, OC81D, 2/3 each

BC108 Silicon NPN Epitaxial Planar 5/6 each

OC26 7/6 each, OC25 8/6, OC36, 10/-

For complete list of Laboratory Components send s.a.e. to:

LABORATORY EQUIPMENT (ELEC)
38 CRAWFORD STREET, LONDON, W.1

SERVICE TRADING CO

All Mail Orders—Also Callers—Ample Parking Space
57 BRIDGMAN ROAD, LONDON, W.4 Phone 995 1560
SHOWROOM NOW OPEN CLOSED SATURDAY
Personal callers only
9 LITTLE NEWPORT ST.
LONDON, W.C.2. Tel. GER 0576

VALUABLE NEW HANDBOOK FREE TO AMBITIOUS ENGINEERS

Have you had your copy of "Engineering Opportunities"?

The new edition of "ENGINEERING OPPORTUNITIES" is now available—without charge—to all who are anxious for a worthwhile post in Engineering. Frank, informative and completely up to date, the new "ENGINEERING OPPORTUNITIES" should be in the hands of every person engaged in any branch of the Engineering industry, irrespective of age, experience or training.

On 'SATISFACTION OR REFUND OF FEE' terms

This remarkable book gives details of examinations and courses in every branch of Engineering, Building, etc., outlines the openings available and describes our Special Appointments Department.

WHICH OF THESE IS YOUR PET SUBJECT?

ELECTRONIC ENG.

Advanced Electronic Eng.—
Gen. Electronic Eng.—Practical
Electronics—Radar Tech.—
Frequency Modulation—
Transistors.

ELECTRICAL ENG.

Advanced Electrical Eng.—
General Electrical Eng.—
Installations—Draughtsman-
ship—Illuminating Eng.—
Refrigeration—Elem. Elec.
Science—Elec. Supply—
Mining Elec. Eng.

CIVIL ENG.

Advanced Civil Eng.—
General Civil Eng.—Muni-
cipal Eng.—Structural Eng.—
Sanitary Eng.—Road Eng.—
Hydraulics—Mining—
Water Supply—Petrol Tech.

RADIO ENG.

Advanced Radio—General
Radio—Radio & TV Servicing
—TV Engineering—Tele-
communications—Sound
Recording—Automation—
Practical Radio—Radio
Amateurs' Examination.

MECHANICAL ENG.

Advanced Mechanical Eng.—
Gen. Mech. Eng.—Mainte-
nance Eng.—Diesel Eng.—
Press Tool Design—Sheet
Metal Work—Welding—
Eng. Pattern Making—
Inspection—Draughtsman-
ship—Metallurgy—Production
Eng.

AUTOMOBILE ENG.

Advanced Automobile Eng.—
General Auto. Eng.—Auto.
Maintenance—Repair—
Auto. Diesel Maintenance—
Auto. Electrical Equipment—
Garage Management.

WE HAVE A WIDE RANGE OF COURSES IN OTHER SUBJECTS INCLUDING CHEMICAL ENG., AERO ENG., MANAGEMENT, INSTRUMENT TECHNOLOGY, WORKS STUDY, MATHEMATICS, ETC.

Which qualification would increase your earning power?
A.M.I.E.R.E., A.M.I.Mech.E., A.M.S.E., A.M.I.C.E., B.Sc.,
A.M.I.P.E., A.M.I.M.I., A.R.I.B.A., A.I.O.B., A.M.I.Chem.E., A.R.I.C.S.,
M.R.S.H., A.M.I.E.D., A.M.I.Mun.E., C.ENG., CITY & GUILDS, GEN.
CERT. OF EDUCATION, ETC.

BRITISH INSTITUTE OF ENGINEERING TECHNOLOGY
316A ALDERMASTON COURT, ALDERMASTON, BERKSHIRE

THIS BOOK TELLS YOU

- ★ HOW to get a better paid, more interesting job.
- ★ HOW to qualify for rapid promotion.
- ★ HOW to put some letters after your name and become a key man . . . quickly and easily.
- ★ HOW to benefit from our free Advisory and Appointments Depts.
- ★ HOW you can take advantage of the chances you are now missing.
- ★ HOW, irrespective of your age, education or experience, YOU can succeed in any branch of Engineering.

132 PAGES OF EXPERT
CAREER - GUIDANCE

PRACTICAL EQUIPMENT

Basic Practical and Theoretic Courses for beginners in Radio, T.V., Electronics, Etc., A.M.I.E.R.E. City & Guilds Radio Amateurs' Exam. R.T.E.B. Certificate P.M.G. Certificate Practical Radio Radio & Television Servicing Practical Electronics Electronics Engineering Automation

INCLUDING TOOLS

The specialist Electronics Division of B.I.E.T. NOW offers you a real laboratory training at home with practical equipment. Ask for details.

B.I.E.T.

You are bound to benefit from reading "ENGINEERING OPPORTUNITIES"—send for your copy now—FREE and without obligation.

POST NOW!

TO B.I.E.T., 316A ALDERMASTON COURT, ALDERMASTON, BERKSHIRE.

Please send me a FREE copy of "ENGINEERING OPPORTUNITIES." I am interested in (state subject, exam., or career).

NAME

ADDRESS

WRITE IF YOU PREFER NOT TO CUT THIS PAGE



3d. stamp if posted in an unsealed envelope.

THE B.I.E.T. IS THE LEADING INSTITUTE OF ITS KIND IN THE WORLD

Published about the 15th of the month by GEORGE NEWNES LIMITED, Tower House, Southampton Street, London, W.C.2. Printed in England by THE CHAPEL RIVER PRESS, Andover, Hants. Sole Agents for Australia and New Zealand: GORDON & GOTCH (A/sia) Ltd.: South Africa and Rhodesia: CENTRAL NEWS AGENCY LTD.: East Africa: STATIONERY & OFFICE SUPPLIES LTD. Subscription rate including postage for one year: To any part of the World £1 16. 0.

NEW SOLID STATE HIGH FIDELITY EQUIPMENT

IMPROVED PERFORMANCE — NEW STYLING — NEW MODELS — MONO & STEREO

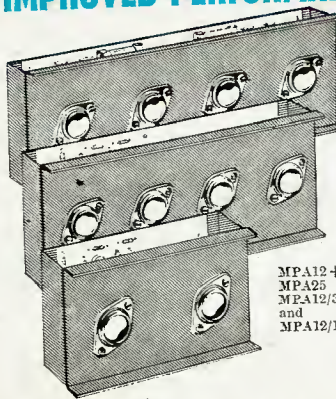

MPA12+12
MPA25
MPA12/3
and
MPA12/15.



MP3

SP6-2



MP3. Mono preamplifier. All silicon low noise zener stabilised circuit. Full range of controls—fully equalised inputs for xta pu, dyn/xtal/mic, radio tuners, tape head and preamp. replay. Supplied built and tested on metal chassis complete with grey/silver front panel, alu. knobs and handbook. Output 250 mV. Supply 12 to 60 volts 3 mA. Overall size 9 1/2 x 11 x 1 1/2 in. **MP3 Price £6.19.6, P.P. 3/-**

SP6-2. Mono/stereo preamplifier. Uses 8 silicon/germanium devices. Zener stabilised. Completely new low noise design. Full range of controls and filters. Inputs for magnetic/xtal/ceramic cartridges, radio tuners, tape preamp, microphones, tape head, etc. Record output and matching knobs. Complete with input sockets and hand-book. Output 250 mV per channel. Supply 12 to 60 volts 4 mA. Overall size 12 x 3 1/2 x 3 1/2 in. **SP6-2 Price £14.19.6, P.P. 5/-**

SP4. Mono/stereo preamplifier as previously advertised. Complete with front panel and knobs. Size 9 x 3 1/2 x 1 1/2 in. **SP4 Price £10.19.6, P.P. 3/6**

MPA12/3 and MPA12/15. 12 watt power amplifiers for use with above preamplifiers. Improved response and performance with even lower distortion levels. MPA12/3 for 3 to 5 ohm speakers, 24/28 volt supply. MPA12/15 for 10 to 16 ohm speakers, 40/45 volt supply, uses 8 silicon and germanium devices. Inputs 100 mV for 12 watts, response ± 1 dB, 30 c/s to 20 kc/s. THD 0.2% at 12 watts. High gain stable push-pull output designs. Built on to metal chassis as illustrated. Overall size 5 x 2 x 3 1/2 in. Complete with handbook. **MPA12/3 Price £4.10.0, P.P. 2/6**

MPA12+12. Twin amplifier for mono/stereo use with above preamplifiers. Consists of two matched MPA12/15 amplifiers (see above) on single chassis. Output for 10 to 16 ohm speakers. 40/45 volts supply. Overall size 10 x 2 x 3 1/2 in. **MPA12+12 Price £9.19.6, P.P. 4/-**

MPA25. 25/30 watt power amplifier for use with above preamplifiers. New design and layout with improved response and overall performance. Output for 7 1/2 to 16 ohm speaker systems. Input 180 mV for full output. Push-pull circuit. Uses 10 silicon and germanium devices. Supply 50/60 volts. Overall size 8 x 2 x 3 1/2 in. **MPA25 Price £7.10.0, P.P. 3/6**

XP2 and XS4. New preamplifier modules for use where controls of above preamplifiers may not be necessary. XP2 Mono, XS4 Stereo. Input 47 k 4 mV. Equalisation RIAA for mag./dyn. cartridges, also tape head for 1 1/2 in./sec. to 7 1/2 in./sec. and also 60 ohm dynamic mic. Sufficient output to drive power amplifiers direct, also headphones. 9 volt operated. **XP2 Price 45/-, P.P. 1/6. XS4 Price 70/-, P.P. 1/6**

CHOICE OF PREAMPLIFIERS MAINS UNITS POWER AMPLIFIERS 12 WATTS MONO TO 60 WATTS STEREO

MAINS UNITS
110/240 volt 50/60 c/s input. AC/DC fused. Fully smoothed and isolated. MU series has additional choke/capacitor filtering and panel voltage selectors. All types on metal chassis. **PS24/40.** Output 24 and 45 volts 1 amp. For use with 1 or 2 MPA12/3, MPA12/15, or 1 MPA12+12. **Price 70/-, P.P. 3/-**
MU24/40. Choke smoothed. Output 24 and 45 volts 1 amp. For use with 1 or 2 MPA12/3 and MPA12/15 or 1 MPA12+12. **Price 87/6, P.P. 3/6**
MU60. Choke smoothed. Output 50 volts 1 amp. For use with 1 or 2 MPA25. **Price 95/-, P.P. 4/-**

RECOMMENDED SYSTEMS	
MP3+MPA12/15+PS40	£14.12.6, P.P. 6/6
MP3+MPA12/3+PS24	£13.17.6, P.P. 6/6
MP3+MPA25+MU60	£18.5.0, P.P. 8/-
SP6-2+MPA12+12 or 2MPA12/15+MU40	£28.5.0, P.P. 10/-
SP6-2+2 MPA12/3+MU24	£28.15.0, P.P. 10/-
SP6-2+MPA25+MU60	£33.5.0, P.P. 10/6
SP4+2 MPA12/15+PS40	£24.0.0, P.P. 9/-
SP4+2 MPA12/3+PS24	£22.15.0, P.P. 9/-
MP3+2 MPA12/15+MU40	£20.17.6, P.P. 8/-
MP3+2 MPA12/3+MU24	£19.7.6, P.P. 8/-

16-PAGE BROCHURE FREE ON REQUEST

THE FINEST VALUE IN HIGH FIDELITY—FULLY GUARANTEED CHOOSE A SYSTEM TO SUIT YOUR NEEDS AND SAVE POUNDS

NEW SCOOP CAR RADIO OFFER

BRITISH MADE. £7.19.6, P.P. 4/6

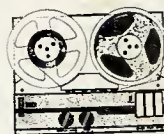
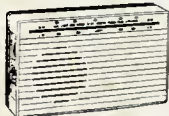

WE CAN SUPPLY FROM STOCK MOST OF THE PARTS SPECIFIED ON CIRCUITS IN THIS MAGAZINE. SEND LIST FOR QUOTATION OR BETTER STILL—BUY THE NEW 1967 CATALOGUE. EVERYTHING YOU NEED IS LISTED AND AVAILABLE FROM STOCK.

See page 704 for further range of stock items

REGENT-6 MW/LW POCKET RADIO TO BUILD
6-Transistor superhet. Geared tuning. Push-pull speaker output. Moulded cabinet 5 x 3 x 1 1/2 ins. Phone socket. **TOTAL COST TO BUILD £6.19.6, P.P. 2/-**

Full tuning on both bands
GLOBEMASTER TO BUILD
3-waveband superhet Portable Radio as previously advertised. **£7.19.6, P.P. 3/6**

TOURMASTER TRANSISTOR CAR RADIO British Made
7-Transistor MW/LW Car Radio. 12 volt operated. 3 watt output. Push-button wave-change. RF stage. Supplied built, boxed, ready to use with Speaker and Baffle. Car fixing kit and manufacturers' current guarantee. Special Bargain Offer. Buy Now! **LIST PRICE 15 GNS. £7.19.6, P.P. 4/6**
£11.19.6, P.P. 4/6

VHF FM TUNER TO BUILD
87/105 Mc/s Transistor Superhet. Geared tuning. Terrific quality and sensitivity. For valve or transistor amplifiers. 4 x 3 1/2 x 2 1/2 in. Complete with dial plate. 5 Mullard Transistors, Plus 4 Diodes. (Cabinet Assembly 20/- extra). Leaflet on request. **TOTAL COST TO BUILD £6.19.6, P.P. 2/6**

FM STEREO DECODER
7 Mullard Transistors. Printed Circuit Design with Stereo Indicator. For use with any valve or transistor FM. Uses pot cores to Mullard design and ger. and silicon transistors. Leaflet on request. As used by B.B.C. and G.P.O. **£5.19.6, P.P. 2/-**
Complete Kit Price

BUILD A QUALITY 2 OR 4 TRACK TAPE RECORDER
3-speed version using 360 decks
● TWO-TRACK. Deck £10.10.0. Martin Amplifier. £14.19.6. Cabinet and speaker 7 gns. Complete kits with FREE 7in. 1200ft. tape, spare spool. **27 gns. P.P. 15/-**
● FOUR-TRACK. Deck £13.10.0. Martin Amplifier. £15.19.6. Cabinet and speaker 7 gns. Complete kits with FREE 7in. 1200ft. tape, spare spool. **30 gns. P.P. 15/-**
Today's Value £50.

BUILD THESE PW/E DESIGNS
EXPLORER (less chassis) 79/6
or with drilled chassis 99/6
MILITARY BAND SUPERHET £10.10.0
PHOTO FLASH SLAVE UNIT 42/6
SOLID STATE IGNITION £8.19.6
(Post and Packing 2/6 extra any type)

MAYFAIR PORTABLE ELECTRONIC ORGAN



NOW AVAILABLE AS:
● COMPLETE KIT OF PARTS ● BUILT AND TESTED ● PRE-BUILT ASSEMBLIES. REVERBERATION UNITS AND RECOMMENDED SPEAKERS AND AMPLIFIERS IN STOCK.
Designed by L. W. ROCHE

STRAIGHT FORWARD TO BUILD AND TUNE—EASY TO PLAY—FULLY GUARANTEED. ALL PARTS AVAILABLE SEPARATELY—ASTOUNDING VALUE AND PERFORMANCE. Start to build for as little as £5.

- Plug-in printed circuits ● 170 transistors and devices ● 10 selected tone colours ● Fully sprung keyboard ● Vibrato ● 6 Octaves of generators ● Simple locked-in tuning ● 110/250 volt mains unit ● Cabinet size 30 1/2" x 15 1/2" x 9" ● Weight 35 lb. Cabinet with detachable legs, music stand and foot swell pedal ● Fully detailed building manual with photos, drawings and full circuits.

COMPLETE RANGE OF ORGAN PARTS IN STOCK. H.P. FACILITIES AVAILABLE. TRADE/EXPORT SUPPLIED. FULLY DETAILED LEAFLET AND PRICE LIST ON REQUEST. CALL FOR DEMONSTRATION AND PLAY THE MAYFAIR.

★ **TOTAL COST OF COMPLETE KIT 99gns.** (Carriage, etc. U.K. 30/-)
★ **ASK FOR FREE DESCRIPTIVE BROCHURE.** ALL PARTS ARE AVAILABLE SEPARATELY. PRICE LISTS ON REQUEST. ★ BELGRAVIA CONCERT ORGAN—FULL SIZE—DETAILS ON REQUEST.

LISTS AVAILABLE (incorporated in full catalogue)
● Transistors/Rectifiers/SCR's/Valves/Crystals/Zeners, etc. 24 pages, 1/-
● 4-page hi-fi stock list with discounts. All popular makes. Free on request.
● Car radio and tape recorders. Free.
● Organs and components lists. Free.

HENRY'S RADIO LTD.
303 EDGWARE RD., LONDON, W.2
Telephone 01-723-1008
Open Mon. to Sat. 9-6. Thurs. 1 p.m.
Open all day Saturday
All items fully guaranteed

1967 CATALOGUE
Have you a copy? Fully detailed and illustrated. Over 200 pages of components, equipment, etc. Over 5,000 stock items. FULLY DETAILED AND ILLUSTRATED. PRICE 8/6, post paid. 5 Free discount vouchers, value 10/- with every catalogue.
200 PAGES—PLUS!



WE CAN SUPPLY FROM STOCK MOST OF THE PARTS SPECIFIED ON CIRCUITS IN THIS MAGAZINE. SEND LIST FOR QUOTATION.

OR BETTER STILL—BUY THE NEW 1987 CATALOGUE. EVERYTHING YOU NEED IS LISTED AND AVAILABLE FROM STOCK.



SCR'S (THYRISTORS)

● 1 AMP SERIES WIRE LEADS

50 PIV	7/6	100 PIV	7/6
200 PIV	12/6	300 PIV	15/-
400 PIV (280V Rms)	1 Amp		17/6
100 PIV, 3 Amp Stud Type			9/6
400 PIV, 3 Amp (280V Rms) Stud			20/-
400 PIV, 5/7 Amp (280V Rms)			25/-

SEMICONDUCTOR CATALOGUE

Contains details and prices of hundreds of Transistors, Diodes, Rectifiers, etc. of all types—1/-.

TUNNEL DIODES

1mA 22/6; 5mA 15/-; 15mA 12/6. Brand new with fraction of normal price. Free Specs. supplied.



HENRY'S RADIO LTD.
303 EDGWARE RD., LONDON, W.2
PADdington 1008/9 (STD: 01-723 1008)
Open Mon. to Sat. 9-6. Thurs. 1 p.m.
Open all day Saturday

SEE BACK COVER FOR MORE ITEMS OF INTEREST

GARRARD DECKS—BRAND NEW, FULLY GUARANTEED

1000 mono	£5 19 6	†SP25 stereo	£10 19 6	401 less cart./arm	£27 10 0
AT5 mono	£6 9 6	†SP25 Deram	£13 19 6	Deccadeck Mk. II	£17 17 0
2000 mono	£6 9 6	*AT60 less cart.	£10 19 6	A70 less cart.	£17 17 0
2000 stereo	£6 19 6	*AT60 mono	£11 10 0	(P. and P. 5/- any type)	
3000 1m stereo	£7 19 6	*AT60 stereo	£11 19 6	†SP25 Pressed Turntable,	
†SP25 less cart.	£9 19 6	*AT60 Deram	£14 19 6	Cast Version 40/- extra	
†SP25 mono	£10 10 0	LAB80 Mk. II	£25 0 0	*AT60 Mk. II 30/- extra	

All other makes of decks and cartridge in stock

RADIO CONTROL RECEIVER
"TINY TONES" 27 mcs band receiver. Printed circuit construction. Sensitive 4-transistor design. Size only 2" x 2" x 1". Complete with circuit and instructions. **TOTAL COST 55/- P.P. TO BUILD** 1/6
(Circuit, etc. 1/3 separately).

DEAC RECHARGEABLE BATTERY
● 9.6 volt 225 mA/H 80/-, P.P. 1/6
DEAC CHARGER
To charge 3.6 volt and 9.6 volt packs. Fully mains isolated in moulded case. **45/- P.P.** 2/-

MULTI-METERS/SCOPE
PT34 1kV 39/6 EP30k 30kV £6.10.0
TPI10 2kV 75/- 500 30kV £8.17.6
ITI-2 20kV 79/6
● CT52 Scopes £22.10.0, p.p. 10/-
Complete range of test equipment in stock

TRANSISTOR TESTER
Model ZQM-2
Tests NPN and PNP for Gain/Leakage, etc. Large size Meter. Complete with full instructions, Leads and Battery. Fully Guaranteed. Price £7.70, post paid. Large range of panel meters in stock—see catalogue.

GARRARD BATTERY 2-SPEED TAPE DECK
Brand New with R/P head, erase/osc. head, tape cassette. Specifications and osc. circuits. 2 speed 2-track 9 volt operated. List Price 13 gns.

PRICE £8.19.6 P. & P. 3/6

TAPE PARCEL FOR THE EXPERIMENTER. 5-transistor unit on PC board, tape head, erase, mic., spkr., plus cct. diag. Price 39/6, p.p. 2/6.

MW/LW QUALITY TRANSISTOR RADIO TUNER
Fully tunable superhet with excellent sensitivity and selectivity. Output up to 1/2 volt peak. Complete with front panel, etc. 9 volt operated. For use with any amplifier or tape recorder.
TOTAL COST £3.19.6 P.P. TO BUILD 2/6

VHF FM TUNER
Supplied as 2 Preamplified Panels, plus metal work Superhet design. 88-108 Mc/s, 9 volt operated. 6 Mullard Transistors. Total cost to assemble £12.17.6, p.p. 2/6

STABILISED POWER SUPPLY
Two outputs. 3.6 volt and 9.6 volt up to 250mA each. Transistorised and Zener stabilised. 110 to 250 volt mains input. In case with leads. PRICE 67/6, p.p. 2/6.

5 WATT AMPLIFIER
6-Transistor Push-pull, 3 ohms. 6mV into 1k. 12/18V supply, 2 1/2 x 2 x 1 1/2 in.
BUILT AND TESTED 69/6 P.P. 2/-
(optional mains units 54/-)
1 1/2 watt version 59/6.
Matching Preamplifier, 6 inputs, treble/bass selector/volume controls. 6-10mV o/put. 9-18V supply. 79/6, p.p. 2/-.
For use with any Transistor Amplifier LEAFLET ON REQUEST.

FMT41 FM TUNER. 6-transistor, 3 diode design. Com- £6.19.6 P.P. 2/-
pletely built and tested.
AMT31. Med. Wave Tuner. Built ready to use. 79/6, p.p. 2/-.

27 Mc/s BAND RADIO CONTROL
Sub-miniature crystals... 17/6 each
Matched pairs for superhet... 35/- pair
(State 455 kc/s or 470 kc/s I.F.)
Complete range of Receiver and Transmitter Kits in stock—leaflets on request.



new VARI-STAT
thermostatic soldering iron

High Production Model D PRICE 55/-
Miniature Iron 50 watt
Voltage 12-250 volt
Weight 1 3/4oz.
"Screw on" Bit sizes 3/32in., 1/8in., 3/16in., 1/4in.
Our range also includes:
Standard Instrument Model 50W
Standard Instrument Model 70W
High Production Instrument Model 125W
Industrial Model 500W

All these irons give excellent bit and element life since the thermostat completely eliminates overheating and controls reserve heating capacity which makes possible continuous soldering without chilling of the bit. The constant temperature makes these irons ideal for printed circuit work.

CARDROSS ENGINEERING CO. LTD.,

Woodyard Road, Dumbarton.

Phone: Dumbarton 2655

NEW HI-GAIN EXPORT VHF/FM AERIALS FOR MONO/STEREO



- Full band width spacing
- High forward gain
- High front to back ratio
- Fibreglass moulding
- Universal clamp for up to 2 1/2" masts
- The perfect answer to Mono/Stereo FM reception
- HGFM/3 3 element 60/-
- HGFM/4 4 element 75/- (Illustrated)

ALSO HIGH PERFORMANCE UHF 625 COLOUR AERIALS

Type C 500 3 element	25/-
Type C 570 7 element	32/6
Type C 510 10 element	40/-
Type C 514 14 element	47/6

- Full range of masts and fittings on request
- State channels required when ordering
- C.W.O. or C.O.D. p. & p. 4/6d.

"C" AERIALS LTD.

14-15 QUARRY STREET, GUILDFORD, SURREY
TEL.: GUILDFORD 67704

BATTERY ELIMINATORS

The ideal way of running your TRANSISTOR RADIO, RECORD PLAYER, TAPE RECORDER, AMPLIFIER, etc. Types available: 9v; 7 1/2v; 6v; 4 1/2v (single output) 39/6 each. P. & P. 2/9.
9v + 9v; 6v + 6v; or 4 1/2v + 4 1/2v (two separate outputs) 42/6 each. P. & P. 2/9. Please state output required. All the above units are completely isolated from mains by double wound transformer ensuring 100% safety.

R.C.S. PRODUCTS (RADIO) LTD.
(Dept. P.E.), 11 Oliver Road, London, E.17

AMAZING CIGARETTE RADIO

Total Building Price 25/-



No soldering

Yes, a perfectly ordinary packet of cigarettes! But watch your friends' astonishment on hearing its range of stations loud and clear. Holds 10 cigarettes! —yet conceals sensitive, fully transistorised circuit (including tiny battery). A young boy can assemble it in 2 hours. No soldering. Only 18 connections to make. ALL PARTS including semi-conductors, ABC Plans, etc. ONLY 25/- plus 2/6 P. & P. Parts available separately.



Frustrated Import Shipment Offered BELOW HALF PRICE to Clear. 500 Only Five Transistor

PERSONAL TRANSCIEVER SETS
Our Price

£6.18.11

You've heard about them—you've read about them. NOW YOUR CHANCE TO OWN THEM. Highly sensitive two-way transistor transceiver sets have individual volume control and talk-listen switch. Telescopic aerial pulls in the voice from the other set over tremendous distances—no wires—a genuine transceiver as used by official bodies and forces. 500 sets only at £6.18.11, including accessories, batteries, etc. Plus 4/7 P. & P. These cannot be used in U.K.

MAKE 5 DIFFERENT RADIOS
Total Building Price 39/6



Amazing Radio Construction Set! Become a radio expert for 39/6. A complete Home Radio Course. No experience needed. Parts including instructions for each design. Step-by-Step plan, all Transistors, loudspeaker, personal phone, knobs, screws, etc. all you need. Box size 14" x 10" x 2" (parts available separately). Originally £6. NOW 39/6 plus 4/6 P. & P.

CONCORD ELECTRONICS LTD., P.E. '35
77 New Bond St., W.1. (Mail orders only)

WENTWORTH RADIO

BAR 3087

104 SALISBURY ROAD, HIGH BARNET, HERTS.

Suppliers of High Quality Semiconductors

NKT0003	12/-	NKT2044	110/11	NKT226	9/-	NKT272	3/6	NKT451	12/10	OC44	2/6	2G303	5/3	2N177	10/9	2N1809	11/3	2N3705	6/6	2S322A	8/2
NKT12	5/3	NKT211	6/-	NKT227	8/6	NKT273	3/6	NKT452	12/6	OC45	2/6	2G304	7/-	2N178	12/3	2N1420	30/-	2N3707	7/10	2S323	16/-
NKT123	9/-	NKT212	4/7	NKT228	4/4	NKT274	3/6	NKT453	13/9	OC70	5/-	2G306	8/3	2N178A	14/10	2N1507	14/8	2N3708	9/-	2S501	15/7
NKT124	8/6	NKT213	4/9	NKT237	8/3	NKT275	3/6	NKT605	6/-	OC71	2/6	2G308	6/9	2N179	25/6	2N1613	18/9	2N3709	5/1	2S502	24/-
NKT126	5/4	NKT216	8/6	NKT239	6/7	NKT301	18/6	NKT612	4/11	OC74	5/-	2G309	7/9	2N179A	22/6	2N1711	28/6	2N3710	5/6	2S503	27/-
NKT127	8/11	NKT218	4/4	NKT241	5/7	NKT302	12/9	NKT674	5/2	OC75	5/-	2G371	3/6	2N720	37/6	2N3011	12/-	2N3711	6/3	2S512	9/6
NKT128	6/-	NKT219	4/10	NKT242	4/7	NKT303	11/9	NKT676	4/4	OC81	2/6	2N218	6/-	2N720A	45/-	2N3563	6/6	2N3712	20/-	2S701	12/-
NKT129	5/2	NKT221	4/11	NKT244	4/7	NKT351	10/9	NKT677	4/4	OC170	3/-	2N219	6/-	2N721	47/-	2N3564	7/7	2S102	17/-	2S702	15/8
NKT141	6/-	NKT222	4/3	NKT245	4/6	NKT381	10/-	NKT713	6/6	OC171	6/-	2N219	6/-	2N722	50/-	2N3565	6/6	2S103	19/6	2S703	17/9
NKT142	5/2	NKT223	4/4	NKT251	3/6	NKT362	10/-	NKT773	5/7	OC172	4/5	2N219	6/-	2N726	18/6	2N3566	6/6	2S104	24/3	2S731	10/9
NKT143	5/-	NKT22331	30/-	NKT252	3/6	NKT401	17/7	NKT774	5/7	OC192	36/1	2N697	12/3	2N753	14/8	2N3594	7/8	2S302	9/9	2S3010	6/10
NKT162	4/11	NKT224	3/9	NKT263	3/6	NKT402	18/6	OC20	37/6	2G104	12/9	2N698	22/6	2N1305	6/6	2N3702	6/10	2S302A	7/10	2S3020	7/10
NKT163	4/11	NKT2241	30/-	NKT264	3/6	NKT403	16/6	OC35	10/-	2G106	15/7	2N706	8/3	2N1306	8/8	2N3703	7/10	2S303	15/7	2S3021	7/4
NKT164	4/11	NKT22421	30/-	NKT265	3/6	NKT404	13/3	OC36	10/-	2G301	4/6	2N706A	9/9	2N1307	8/8	2N3704	7/10	2S321	10/9		
NKT2024	110/11	NKT225	3/9	NKT271	3/6	NKT405	14/3	OC42	6/-	2G302	5/4	2N708	11/9	2N1308	11/3	2N3705	7/1	2S322	10/6		

SIX PAGE LIST NOW AVAILABLE. S.A.E. TERMS, CASH WITH ORDER. P.P. ADD 9d. SEMICONDUCTORS AND MAIL ORDER ONLY, WE REGRET, NO CALLERS.

For men who like doing a job properly

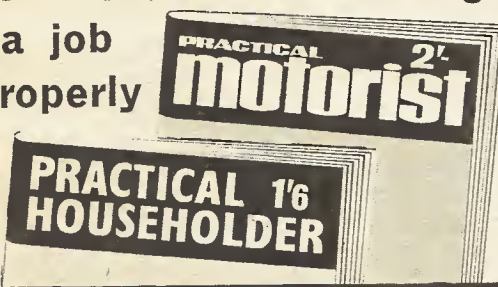

Expert advice, instruction and up-to-the-minute ideas

The most accurate pocket size CALCULATOR in the world

The 66 inch OTIS KING scales give you extra accuracy. Write today for free booklet, or send 75/- for this invaluable spiral slide rule on approval with money back guarantee if not satisfied.

CARBIC LTD. (Dept. PE12)
54 Dundonald Road, London, S.W.19

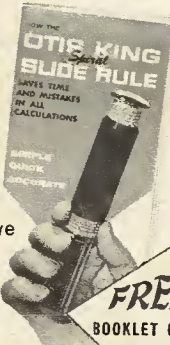

FREE BOOKLET ON REQUEST

YUKAN SO PROFESSIONAL THE YUKAN SELF-SPRAY AEROSOL WAY - Get these AIR DRYING GREY HAMMER or BLACK WRINKLE (CRACKLE) Finishes

Yukan Aerosol spraykit contains 16 ozs. fine quality durable easy instant spray. No stove baking required. Hammers available in grey, blue, gold, bronze. Modern Eggshell Black Wrinkle (Crackle) all at 14/11 at our counter or 15/11, carriage paid, per push-button self-spray can. Also Durable, heat and water resistant Black Matt finish (12 ozs. self-spray cans only) 13/11 carriage paid.

Other Yukan Air Drying Aerosols include: Zinc Chromate Primer, Clear Lacquer, Anti-Tarnish Gold and Metallic Finishes.



SPECIAL OFFER: 1 can plus optional transferable snap-on trigger handle (value 5/-) for 18/11, carriage paid. Choice of 13 self-spray plain colours and primer (Motor car quality) also available.

Please enclose cheque or P.O. for total amount to: **YUKAN, Dept. PE/9 307a Edgware Rd., London W.2.** Open all day Saturday. Closed Thursday afternoons.

TECHNICAL TRADING Co.

All items previously advertised available, also see items advertised in Practical Wireless. Huge Hi-Fi and Components stocks at all branches.

Standard Play		Double Play		Triple Play	
3"	150ft. 2/3	3"	300ft. 4/-	3"	900ft. 13/-
4"	300ft. 4/8	4"	600ft. 6/-	4"	1800ft. 25/-
5"	600ft. 7/6	5"	1200ft. 15/-	5"	2400ft. 34/-
5 1/2"	900ft. 10/6	5 1/2"	1800ft. 19/6	5 1/2"	3600ft. 44/-
7"	1200ft. 13/6	7"	2400ft. 27/-		
Long Play		Quadruple Play			
3"	225ft. 2/9	3"	600ft. 8/-		
4"	450ft. 5/6				
5"	900ft. 10/6				
5 1/2"	1200ft. 13/-				
7"	1800ft. 18/6				
	Post 1/-				

10 TOTTENHAM COURT RD., LONDON, W.1 Tel.: MUS 2639
350/352 FRATTON RD., PORTSMOUTH. Tel.: 22034
72 EAST STREET, SOUTHAMPTON. Tel.: 25851
132 MONTAGUE STREET, WORTHING. Tel.: 2585
ALL MAIL ORDER AND RETAIL SHOP
PARK CRESCENT PLACE, BRIGHTON

CURRENTLY FITTED TO OVER 100 MODELS BY MAJOR MANUFACTURERS
BRING YOUR RECORD PLAYER UP TO DATE WITH

Sonotone **TCL**

HIGH FIDELITY STEREOHONIC CERAMIC CARTRIDGES

Sonotone 9TA SERIES. Superior quality cartridges offering extremely high compliance for a cartridge with dual styli. Tracking weights as low as 1-3 gm. allow reproduction from heavy modulated records without distortion on most changers. Standard 1/2" fixing centres. Prices: Sapphire £2.18.10. Tax paid. Diamond £3.16.7. Tax paid. Other types available. Other types available. Send for leaflet.



metrosound metrosound manufacturing co. ltd.
bridge works, wallace road,
london, n.1. tel. 01-226 8641/2/3

RECEIVERS AND COMPONENTS

(continued)

TAPES AND TRANSISTOR BARGAINS

Std. play	LP.	D.P.	E.R.
7 1,200' 7/9	1,800' 12/-	2,400' 20/3	2/3
5 900' 6/9	1,200' 8/9	1,800' 15/3	2/-
5 600' 5/6	900' 7/3	1,200' 11/3	2/-
3 150' 2/3	225' 3/9	300' 4/9	9

Post and packing, 2/9 per order

Money refunded in full if not satisfied

OC22	8/-	OC83	4/-	AF117	4/-
OC23	8/-	OC82D	3/-	AF18	4/-
OC24	8/-	OC84	4/6	AFZ12	8/-
OC25	8/-	OC170	4/-	BCY33	6/6
OC26	8/-	OC171	4/-	BCY34	6/6
OC28	8/-	OAB1	2/-	BCY38	6/6
OC30	8/-	OA202	2/-	BFY50	5/6
OC35	10/-	AC107	8/-	BFY52	5/6
OC44	3/-	AC126	4/-	BY100	4/6
OC45	3/-	AC127	4/-	BYZ12	8/-
OC46	3/-	AC128	4/-	BYZ13	6/6
OC70	3/-	ACY17	4/-	GET103	4/-
OC71	3/-	ACY18	4/-	GET113	4/-
OC72	3/-	ACY19	4/-	GET116	10/-
OC75	3/-	ACY20	5/6	GET119	4/6
OC76	3/-	ACY21	5/6	GET119	4/6
OC77	4/-	ACY22	4/-	GET887	4/6
OC78	3/-	AD140	8/-	GET889	4/6
OC78D	3/-	AD149	8/-	GET890	4/6
OC81	3/-	AF114	4/-	GET896	4/6
OC81D	3/-	AF115	4/-	GET897	4/6
OC82	3/-	AF116	4/-	GET898	4/6

All fully tested and guaranteed. Discount for quantity orders on request.

Post and packing, 1/- per order

A. MARSHALL & SON (LONDON) LTD. (Dept. P.E.14)
28 Cricklewood Broadway, London, N.W.2
Tel: 01-452 0161

ME4001 4/6	2N3819 18/6	UJT T1543 13/-
ME4002 4/9	2N3820 23/-	1N4004 4/3
ME4003 5/3	2N3055 19/6	Diode ST2 8/6
ME6003 4/9	2N2926 4/-	2N3391A 8/6
ME3011 4/9	TRIAC BTR403. 400V. 3A.	32/6
ME0404 4/9	TRIAC BTR406. 400V. 6A.	35/-

MILLITRONICS

1 ULLSWATER ROAD, LEVERSTOCK GREEN
HEMEL HEMPSTEAD, HERTFORDSHIRE
C.W.O.: Post Free. S.A.E. List. Mail Order Only.

D.C. TO A.C. CONVERTER KIT

Input voltage 12 volts D.C. Output voltage 250 volts A.C. 50~40 watt. Ideal for running fluorescent lights in caravans, tape recorders, fans, etc. Complete kit with simple circuit, £5.10.6 + 5/- p.p.

TEXAS TRANSISTORS

GMO290 V.H.F. cut of freq. 700 Mc/s. 19/6 each p. paid. 2S301 Audio, 2/6 each. 2G339A = AC127, 2/6 each. 2G302 = GF872, 7/6 each. 2G301 = GET873, 6/6 each. 2G381, 5/6.

Diodes HS1010 gen. purpose, 1/- each 4d. p.p. any quantity. HG1005 Silicon = OA200, 1/3 each - 4d. p.p. any quantity. OAB1, 1/6 + 4d. p.p. OA79, 1/6 + 4d. p.p. OA91, 1/6 + p.p.

CADMIUM SULPHIDE CELLS
Light sensitive, 7/9 each p. paid. Mazda 6L12 ECC85 valves, 4/6 + 4d. pp. any quantity. OC44, OC45, OC72, OC81, OC81D, 2/6 - 6d. p.p. any quantity. OC170, AF117, AF116, 3/6 p. paid. ASY28, 7/6. AFY19, 7/6. OC172, 3/-. MAT121, 8/6. MAT120, 7/9. OC71, 2/6 + 4d. p.p. AC126, 7/6. AF115, 4/-. AF118, 3/-. MAT101, 8/6. OC26, 6/6. ACY22, 3/6. OC83, 3/-. AF149, 3/-. MAT100, 7/9. ACY18, 3/6.

Acos record player cartridge suitable for B.S.R. Garrard, Collaro, etc., 12/6 with needles.

MINI TRANSISTOR CONDENSERS
1MFD 12V 1/- 0.25MFD 1/3
10MFD 12V 1/3 0.5MFD 1/3
30MFD 12V 1/3 0.01-0.02 7d. each
50MFD 12V 1/3 0.04-0.05 8d. each
100MFD 12V 1/4 0-1 9d.

Plus 4d. p.p. any quantity.
Labgear V.H.F. transistorised TV booster for poor reception areas, 75/- each all channels available.

B.B.C.2 V.H.F. aerials by Labgear, 18 element high gain outdoor type, £2.16.0 + 4/- p.p. 14 element outdoor type, £2.4.0 + 4/- p.p. 18 element high gain loft type, £2.19.0 + 4/- p.p. 14 element loft type, £2.7.0 + 4/- p.p. Double 18 element high gain, difficult areas, £10.17.0 - 6/- p.p.

BTY-79-400R thyristors grade (I) 200 P.I.V. 4.7 amp, 37/- p. paid.

ACOS EAR PIECES
High quality type 10 ohm, 150 ohm, 300 ohm, 1,000 ohm, 8/6 each + 4d. p.p. 1 OC82D + 2 OC82, 6/6 set p. paid. 1 OC44 + 2 OC45 + 1 OA81 + 1 OC81D + 2 OC81, 12/6 + 4d. p.p. 2in. 3 ohm loudspeakers, 7/6 + 6d. p.p.

J. ROBINSON (RADIO TV)
DEPT. 1
4 HIGHCLIFF ROAD, BLACKLEY
MANCHESTER 9. Tel. 061-740 1175
(MAIL ORDER ONLY)

RECEIVERS AND COMPONENTS

(continued)

PHOTOELECTRIC KIT

Build 12 EXCITING PHOTOELECTRIC DEVICES on a Printed Circuit Chassis

CONTENTS: 2 P.C. Chassis Boards, Chemicals Etching Manual, Infra-Red Sensitive Photocell, Latching Relay, 2 Transistors, Resis. Cond. Pot. Terminal Block, Elegant Case. Screws, etc. In fact, everything you need to build a simple but efficient Photo-Switch/Burglar Alarm/Counter, etc. (Project No. 1 shown below) which can be modified for modulated light operation (Projects Nos. 2 & 3).

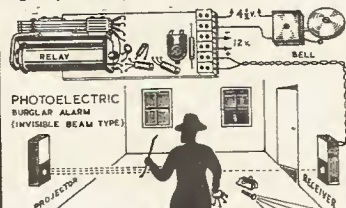

Also Essential Data, Circuits and Plans for building 12 PHOTOELECTRIC PROJECTS. (1) Simple Photo-Switch. (2) Modulated Light Alarm. (3) Long Range Stray-Light Alarm. (4) Relay-less Alarm. (5) Warbling-Tone Alarm. (6) Closed-Loop Photoelectric Alarm. (7) Projector Lamp Stabiliser. (8) Electronic Projector Modulator. (9) Mains Power Supply Unit. (10) Automatic Car Parking Lamp Controller. (11) Super Sensitive Relay-Less Modulated Light Alarm. (12) Car Automatic Headlamp Dipper. Basic Kit: 39/6. Post and Packing 2/6 (U.K.)

OPTICAL KIT

Everything needed (Except plywood) for building 1 Folded-Beam Projector and 1 Photocell Receiver to suit PHOTOELECTRIC PROJECTS. CONTENTS: 2 lenses, 2 mirrors, Infra-Red Filter, 2 45 deg. Blocks. Projector Lamp Holder and Bracket. Plans, etc. Optical Kit: 19/6. Postage and Packing 1/6.

EXPERIMENTER'S PRINTED CIRCUIT CHASSIS KIT

BUILD 40 TRANSISTORISED PROJECTS

on a printed circuit chassis with parts and transistors from your spares box. Latest very efficient designs for Radios, Amplifiers, Scientific Devices, etc., etc., to suit everyone's needs and laminate boards, etchant resist, solvent, degreaser, 16-page etching manual "Printed Circuits for Amateurs", 2 miniature Radio Diodes. Also Essential Design Data, Circuits and Printed Circuit, Chassis Plans for building.

40 SUGGESTED PROJECTS

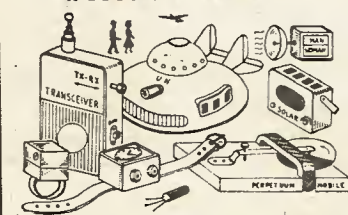

Many recently developed circuits published for the first time including **THE SMALLEST 3 RADIOS IN THE WORLD**: Ring Radio (.70 x .70 x .55in.), Wristwatch Radio (1.15 x .80in.), Postage Stamp Radio (1.6 x .95in.). Recently invented Triple Reflex with self-adjusting regeneration. 4 Pocket Transistor Double Reflex. Pocket Transceiver (licence required). Solar Loudspeaker Radio, Bacteria Powered Radio. Control of Models by Induction (not radio). Light-Seeking Robot. Guided Missile. Electronic Man/Woman Discriminator. Perpetual Motion Machine. 4 Pocket Transistor Radios. 4 Amplifiers. 2 Intercoms. Burglar Alarm. 4 Unusual Crystal Sets, etc., etc. All designs suit PC boards enclosed. Price of Kit: 8/6. Post and Packing 1/6 (U.K.)

Send a S.A.E. for full details, a brief description and Photographs of all 52 Radio, Electronic and Photoelectric Projects. Assembled.

"YORK ELECTRICS"
333 YORK ROAD, LONDON, S.W.11

RECEIVERS AND COMPONENTS

(continued)

SPEAKERS. 8in and 7in, 3 ohm 10/-. Ex brand new equipment. Many other sizes in stock. P. & P. 2/6 all. **BARRY HEATH**, 175 Newbury Gdns., Stoneleigh, Surrey.

COMPONENT BARGAINS

Silicon Bridge Rectifiers 1A 400 P.I.V. encapsulated in cylinder 1cm by 1cm.15/6
Unijunction transistor 2N2646.12/-
2N2925 high-gain NPN silicon planar hfe 235 min. 470 max.7/6
2N2713 NPN with low saturation voltage and good current gain up to 200mA hfe 60. ...8/6
2N1893 for switching at medium power 3W hfe 60.20/6
Midget Plessey pots 1M lin.2/6
SCRs 400 PIV, 1A9/-, 3A11/6
Cir-kit No. 3.14/-

Postage and packing 6d.

Send 1/- for illustrated catalogue

NESLO ELECTRONICS
(Dept. P.5), 53 GROSVENOR PLACE
NEWCASTLE UPON TYNE 2

SILICON PRODUCTS

2N3053, 10/6. 2N3055, 22/-.. All 2N2926, 3/9.
2N696, 6/6. 2N697, 5/-.. 2N706, 3/9.
Miniature N-Type, 25V, 200mW, FET, 10/6.
2N1302-9, all types, 4/6.

S.A.E. for full lists

C.W.O. Add postage

PREMMIT LTD., Components Div.
31 Queen Anne's Gate
London, S.W.1

SPECIAL OFFER

1 Watt S.T.C. 300 MC/S N.P.N. Silicon Planer. Transistors. With data. Limited Stocks. £1 for 6.

3/- each. OC44, OC45, OC70, OC71, OC81, OC81D, OC200, Get 16, Get 20.

4/- each. AF114, AF115, AF116, AF117, OC170, OC171.

5/- each. OC139, OC140, Get 7, Get 8, Get 9, XC141, BY100, OA211.

ZENER DIODES

3.9v. to 26 volt, 1/4w. 3/6 each, 1.5w. 5/-, 7w. 6/- each.

Send 6d. for full lists: inc. S.C.R. Zeners.

BSY 27, 7/6 each. OC20, 10/- each.

Cursons
78 Broad Street
Canterbury
Kent

ENGINEERS

plus

IBM computers can give you a future plus

To become a successful IBM Data Processing Customer Engineer, you need more than engineering qualifications. You need to be able to talk confidently and well to any level of customer management, and to have a pleasing personality in your work. As a D.P.C.E., you work in direct contact with your customers, on some of the world's most advanced data processing equipment.

You must have a sound electronic and electro-mechanical background, such as ONC/HNC Electronic or Electrical, or Radar/Radio/Instrument Fitters course in the armed services.

You will get thorough training on data processing equipment throughout your career. Starting salaries depend on experience and aptitude, but will not be less than £1,100 a year. Salary increases are on merit—within 3 years you could be earning £1,750. Drive and initiative are always well rewarded at IBM; promotions are made on merit and from within the company.

If you would like this chance to become part of a rapidly expanding and exciting computer industry, can maintain a high standard of work in one of the foremost companies in the world, and are between 21 and 31, write to IBM.

Send details of training, experience and age to Miss S. A. Jones, IBM United Kingdom Limited, 389 Chiswick High Road, London, W4, or simply telephone 01-995 1441, quoting ref. DP/PE/893.

IBM

SURPLUS HANDBOOKS

19 set Circuit and Notes 4/6 P.P. 6d
 1155 set Circuit and Notes 4/6 P.P. 6d
 H.R.O. Technical Instructions ... 3/6 P.P. 6d
 38 set Technical Instructions... 3/6 P.P. 6d
 46 set Working Instructions .. 3/6 P.P. 6d
 88 set Technical Instructions... 5/- P.P. 6d
 B.C. 221 Circuit and Notes 3/6 P.P. 6d
 Wavemeter Class D Tech. Instr. 3/6 P.P. 6d
 18 set Circuit and Notes 3/6 P.P. 6d
 B.C.1000 (31 set) Circuit & Notes 3/6 P.P. 6d
 C.R.100/B.28 Circuit and Notes 8/6 P.P. 9d
 R.107 Circuit and Notes..... 5/- P.P. 6d
 A.R.88D. Instruction Manual .. 15/- P.P. 1/6
 62 set Circuit and Notes 4/6 P.P. 6d
 52 set Sender & Receiver Circuits 6/- post free
 Circuit Diagrams 3/- each post free.
 R.1116/A. R.1224/A, R.1355, R.F. 24, 25, & 26.
 A.1134, T.1154, CR.300, BC.342. BC.312.
 BC.348.J.E.M.P. BC.624. 22 set.
 Resistor colour code indicator, 1/6 P.P. 6d.
 S.A.E. with all enquiries please.

Postage rates apply to U.K. only.

Mail order only to:

Instructional Handbook Supplies
 Dept. P.E., Talbot House, 28 Talbot Gardens
 Leeds 8

TAPE RECORDERS, TAPES, ETC.

20% CASH DISCOUNT on most famous makes of Tape Recorders, Hi-Fi equipment, Cameras, etc. Join England's largest Mail Order Club now and enjoy the advantages of bulk buying. Send 5/- for membership card, catalogues, price lists and ask for quotation on any item. C.B.A. (Dept. A18), 370 St. Albans Road, Watford, Herts.

RECEIVERS AND COMPONENTS

ZN1305 Transistors, short leads, 1/6 plus postage. S.A.E. List. B. GREEN, 24 Goodhart Way, Wickham, Kent.

RESISTORS

1 watt carbon film 5%
 All preferred values in stock
 from 10 ohms to 10 megohms 2d. each.
 Send S.A.E. for free sample.

CAPACITORS

Mullard Miniature Metallised Polyester
 P.C. Mounting all 250 v. D.C. working,
 .01mf, .022mf, .047mf, .1mf, .22mf,
 all 6d. each.

Please include 1/- for postage and packing
 on all orders under £1.

Dept. P.E.4

BRENSAL ELECTRONICS LTD.
 CHARLES STREET, BRISTOL 1

HOME CONSTRUCTORS. Veroboard, Transistors, Loudspeakers, Ferrite, Components, etc. Send stamp for lists. **CROWBOROUGH ELECTRONICS**, 3 Rotherhill Road, Crowborough, Sussex.

SILICON TRANSISTORS, ETC.

Medium Power, 250mW-600mW

2N696, 6/6. 2N697, 5/- 2N706, 4/3.
 2N3702/6/8/9/10, 4/6. 2N3703, 5/-
 2N3704/5/7, 5/6.

High Power, 5W-115W

	Vcb.	Ic.	Pd.	Each
2N3053	40	0.5A	5W	11/-
2N3055	100	1.5A	115W	21/6
2N3738	250	3A	20W	37/6

Single Phase Silicon Bridges

Full range from 1 Amp to 16 Amp, 25 PIV to 600 PIV, S.A.E. for list.

C.W.O. Add postage

RECTRA COMPONENTS LTD.
 25 Victoria Street
 London, S.W.1

For a Lovelier, More Productive Garden . . .

YOU NEED AMATEUR GARDENING every week. Hundreds of thousands of keen gardeners rely on this famous weekly for its down-to-earth guidance on the cultivation of every kind of Flower, Fruit and Vegetable. Its contributors are all specialist gardeners with years of working experience behind them. Week by week, season by season, they bring you the benefit of that experience, analysing the snags, introducing you to the best varieties and the latest gardening methods, showing you how to get the best possible results from everything you grow.



Amateur Gardening

Every Thursday 8d.

Get a copy today — and order regularly

ONLY 7" 6" LONG!

NEWS FLASH!

R.S.G.B. CONTEST WON
by Peter J. Baxter
BRS 26,444 using a
"JOYSTICK" aerial

ONLY 7" 6" LONG!

WE HAVE SOLVED your aerial problem for WORLD-WIDE RECEPTION — NO MATTER WHERE YOU LIVE !!!

World Expert Radio Amateur WIBB (USA) claims the "JOYSTICK" aerial—easier to read stations than with his massive 520' VEE aerial 70' high. ZL4GA, probably NEW ZEALAND'S best known Radio Amateur, scrapped his outstanding 300' 45' high world-spanning aerial and has WORKED ALL CONTINENTS on the "JOYSTICK" V.F.A. IN UNDER 12 HOURS !!!

"CQ", the Radio Amateurs' journal claims "JOYSTICK" V.F.A. better for reception than the world famous DIPOLE (4 different receivers were used to confirm this decision).

YOU can be the PROUD OWNER of the WORLD'S MOST VERSATILE AND COMPACT "JOYSTICK" V.F.A. system for as little as:—

£5. 18. 6 including postage

Money Back if not Delighted!

Free Brochure by return of mail from:—

PARTRIDGE ELECTRONICS LTD.

(Dept. P.E.1)

CAISTER HOUSE, PROSPECT ROAD
BROADSTAIRS, KENT

Or enquire your local dealer

TRANSISTOR SQUARE WAVE GENERATOR
Useful for signal tracing or Morse practice. Variable amplitude. Parts to build 11/- with circuit.

EAGLE MULTIMETERS
TK20A 35/- p.p. 2/-; EP10K 67/6 p.p. 3/-; EP20K 75/- p.p. 3/-; EP30K 105/- p.p. 4/6; EP10KN 85/- p.p. 4/6; EP20KN 98/- p.p. 4/6; EP30KN 130/- p.p. 4/6, details on request.

FOOTBALL POOL COMPUTER CIRCUIT and three other analogue circuits, 4/6.

DIGITAL COMPUTER CIRCUIT
A simple digital Adder/Subtractor using switches and lamps only. A fascinating demonstration of Binary arithmetic. Full circuit, wiring diagram and notes on the Binary system, 3/6.

NOUGHTS AND CROSSES MACHINE CIRCUIT. Uses standard miniature switches and lamps only. This machine cannot be beaten. Full circuit, wiring diagram and instructions, 3/6.

PLANET INSTRUMENT CO.
25 (E) DOMINION AVENUE, LEEDS 7



Masterbox

kits afford the quickest, easiest method of assembling control boxes, indicator panels, small switchboards, etc., using a screwdriver only and in a matter of minutes. The modular principle of construction of Masterbox is unique—units can be bolted together in any combination to build larger assemblies—can be altered, extended and adapted indefinitely to meet altered requirements.

Masterboxes are ideal for all kinds of experimental work, combining convenience with smartness, strength and adaptability. Write to Cockrobin for details of Masterbox—or send 9d. for full lists.

COCKROBIN CONTROLS
36 Villiers Avenue, Surbiton, Surrey

TRANSISTOR SPECIFICATION & SUBSTITUTION HANDBOOK

New 1967 Ed. By Tec-Press 22/6

Transistor Electronic Organs for the Amateur, by Douglas. 19/-.

Silicon Controlled Rectifiers, by Lytel. 22/-.

Introduction to Lasers and Masers, by Lytel, new ed. 19/-.

PAL Colour T.V. The PAL System and Mullard Circuits described. 13/6.

Modern Dictionary of Electronics, by Graf. 54/6.

Radio Handbook, new 17th ed., by Orr, Editors and Engineers. 88/6.

Circuits for Audio and Tape Recording, by Judd. 8/3.

Elements of Transistor Pulse Circuits, by Towers. 36/-.

Transistor Technology, by Middleton. 31/6.

Tape Recorder Servicing Manual, by Hellyer. 67/6.

All prices include U.K. postage

Where possible 24-hour service guaranteed

UNIVERSAL BOOK CO.

12 LITTLE NEWPORT ST., LONDON, W.C.2
(Leicester Square Tube Station)

If you're a skilled technician and you don't feel you're moving fast enough.. Join the Army.

In 6 weeks time you could be a Sergeant earning £987 a year clear. (£1,123 if you're married). And that's only the start.

After that, you'd be off on a special 18-month course at an Army Technical College. And then, after successfully completing your course, you get promotion to Staff Sergeant, more pay, and, if you're in the field of electronics, every chance of gaining a Higher National Certificate.

Right now the Army needs full apprenticed men, between 23-30 (you can apply when you're 22) who already have the appropriate Ordinary National Certificate or City and Guilds technicians qualifications, to train as supervisors in Radar, Radio, Control Equipment, Aircraft or Automobile Engineering.

You would be trained as an Artificer in the Royal Electrical and Mechanical Engineers, specialising in any one of these fields. And the equipment you'd be using—transmitters, closed circuit TV, gunfire control equipment, multi-fuel engines, helicopters—is the most advanced of its kind anywhere.

And don't forget that in the Army, along with good pay and a secure job, there's plenty of opportunity for action, travel, sport and excitement, too.

POST THE COUPON FOR ALL THE FACTS

TO: ARMY CAREERS MP6(A), LANSDOWNE HOUSE,
BERKELEY SQUARE, LONDON W.1
Please send me full details of how to become an Artificer

NAME

ADDRESS

TOWN

COUNTY

DATE OF BIRTH

(You must be resident in the UK)

M70794201

When you are ready for better equipment move up to **LUSTRAPHONE** quality

LUSTRAPHONE

microphones : audio equipment
accessories : components : fitments

send for illustrated information

LUSTRAPHONE LTD.

St. George's Works, Regents Park Road,
London, N.W.1 Telephone 01-722 8844

GOODMANS HIGH FIDELITY MANUAL

A Guide to full listening enjoyment

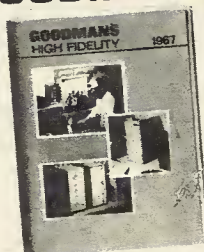

The Manual is much more than a catalogue of Goodmans High Fidelity Loudspeakers—it contains informative articles, including advice on stereo, special beginners page, and full cabinet drawings. You'll find it interesting as well as informative.

The Perfect Combination MAXAMP 30

TRANSISTORISED STEREOGRAPHIC HIGH FIDELITY AMPLIFIER 15 + 15 watts · Silicon solid state · Integrated pre-amplifier · Negligible distortion · £49.10.0.

STEREOMAX

MATCHING AM/FM STEREOGRAPHIC FM TUNER
Transistorised · Outstanding specification · Stereo de-coder (optional) £60.0.0. + £11.18.3. P.T. inc. Surcharge.

Both MAXAMP 30 and STEREO MAX have polished wood cases (10½" x 5½" x 7½" deep) in Teak or Walnut to order.

Full specifications of the Maxamp 30 and Stereomax are given in the High Fidelity Manual—send the coupon for your FREE copy—or pay an early visit to your Goodmans dealer.

FREE

Please send 'Hi-Fi Manual' together with name and address of my nearest Goodmans dealer.

Name

Address

PE 9

GOODMANS INDUSTRIES

AXIOM WORKS · WEMBLEY · MIDDLESEX. Tel: 01-902 1200
A Division of Radio Rentaset Products Ltd.

Diodes. Set switch positions to "pnp" and " I_{CEO} ". Short circuit the emitter lead to the collector lead on the test set, and note the meter reading, say I_1 . Disconnect them and connect the anode of the diode to the emitter lead and the cathode to the collector lead. The meter should at once read another current, say I_2 . The diode forward voltage and resistance at this current can then be found as follows:

$$\text{Forward voltage} = V_F$$

$$\text{Diode resistance} = R_d$$

$$R_d = 9000 \left(\frac{1}{I_2} - \frac{1}{I_1} \right) \text{ ohms}$$

$$V_F = R_d I_2 \text{ millivolts}$$

where I_1 and I_2 are in milliamps. It should be noted that this gives the "d.c." and not the small signal value.

Now change the switch S1 to npn. The current indicated by the meter should at once fall to a very low value; it may not be possible to detect any current at all. This shows that the reverse current I_R is very small when the diode is reverse biased with a voltage V_R of approximately 9V. If several milliamps of current flow is detected, the diode has broken down and is no longer useable.

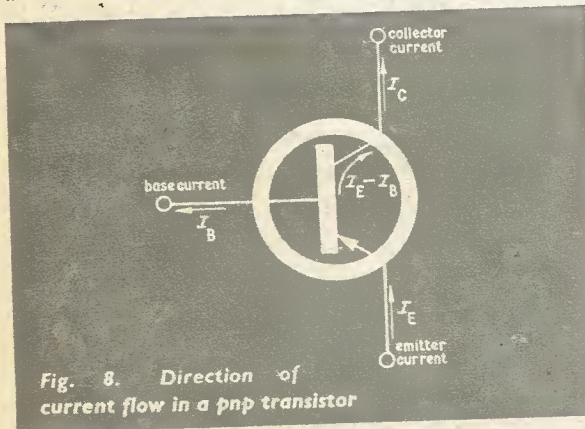

Fig. 8. Direction of current flow in a pnp transistor

Calculation of α . Fig. 8 gives an indication of the direction of the current flow in a pnp transistor, ignoring the leakage. It can be seen that $I_E = -(I_B + I_C)$ since, by convention, the current flowing into a transistor is positive, and that flowing out is negative.

Now α is defined as the current gain in common base, $= I_C/I_E$ assuming small current changes.

$$\text{Therefore } \alpha = \frac{-I_C}{-(I_B + I_C)} = \frac{1}{1 + \frac{I_B}{I_C}}$$

But $\frac{I_C}{I_B} = h_{te}$

therefore $\alpha = \frac{1}{1 + \frac{1}{h_{te}}} = \frac{h_{te}}{1 + h_{te}}$

Hence α may be found from the measured value of h_{te} .

The value usually lies in the range 0.9 to 0.996, showing that the current gain of a transistor operating in common base is always less than unity. ★

FLOW CONTACT

Fig. 11 sketches a simple flow contact for the blocking loop. This may be connected at the final water output, to monitor that water is actually flowing through the entire system. The screw cleat (3) on the flow contact cylinder should be adjusted to drain the cylinder at a rate slightly slower than the working flow rate through the system, i.e. considerably more water should be coming out of (3) than out of (2). Serious reductions of the water flow rate will then trip the blocking loop almost immediately, drawing the attention of the operator to the need for readjustment.

Under normal conditions, it should not be necessary to readjust the flow system during a working session. All adjustments are carried out during the initial preparatory half hour.

It is of advantage to maintain the ambient room temperature on the high side of the nominal bath temperature. This ensures stable air stratification above the jacket tray most of the time, and thus minimises convective interchange between the developer liquid surface and the general room air. Avoid draughts.

SMALL FILM TANKS

When small tanks are used for film processing, these may be stood in a layer of water in the jacket tray, with the Chemostat feeler dipping into this water layer. Mixing takes place by convection on the heating cycle, but the water layer tends to assume stable stratification on the cooling cycle, so that it is advisable to fit a motor-driven stirrer in this arrangement.

ROOM AIR CONTROL

A structurally simpler method of working would be to use the Chemostat to sense the ambient room temperature and to switch forced convective heaters accordingly. The relevant time constant for the Chemostat feeler is then 250 seconds (upper curve in section (a) of Table 1), so that the rate of change of room temperature should ideally be 1/500 degrees C/sec, i.e. just under 10 minutes for a change of 1 degree C. According to room size, this is a reasonable figure for small domestic turbo-heaters in the range 500W to 2kW. It is possible to fit series/parallel switching to a multi-element heater, to obtain a greater selection of wattages.

Faster rates of room heating are generally tolerable, because of the considerably greater thermal time constant of the developer baths. Indeed, this would give fastest correction of random disturbances of the developer temperature, but it necessitates two-way control with positive heating and positive cooling, since bath temperature fluctuations remain attenuated with respect to room air temperature fluctuations only on cyclic temperature variations.

The optimum cyclic amplitude would be given by the ratio of feeler and bath time constants multiplied by the bath temperature tolerance, which comes out to a temperature swing of 8 degrees C peak-to-peak for the room air. Such pronounced cyclic temperature variations of the room air are physiologically disconcerting, so that a proper plumbing system according to Fig. 10 is definitely preferable in the long run. ★

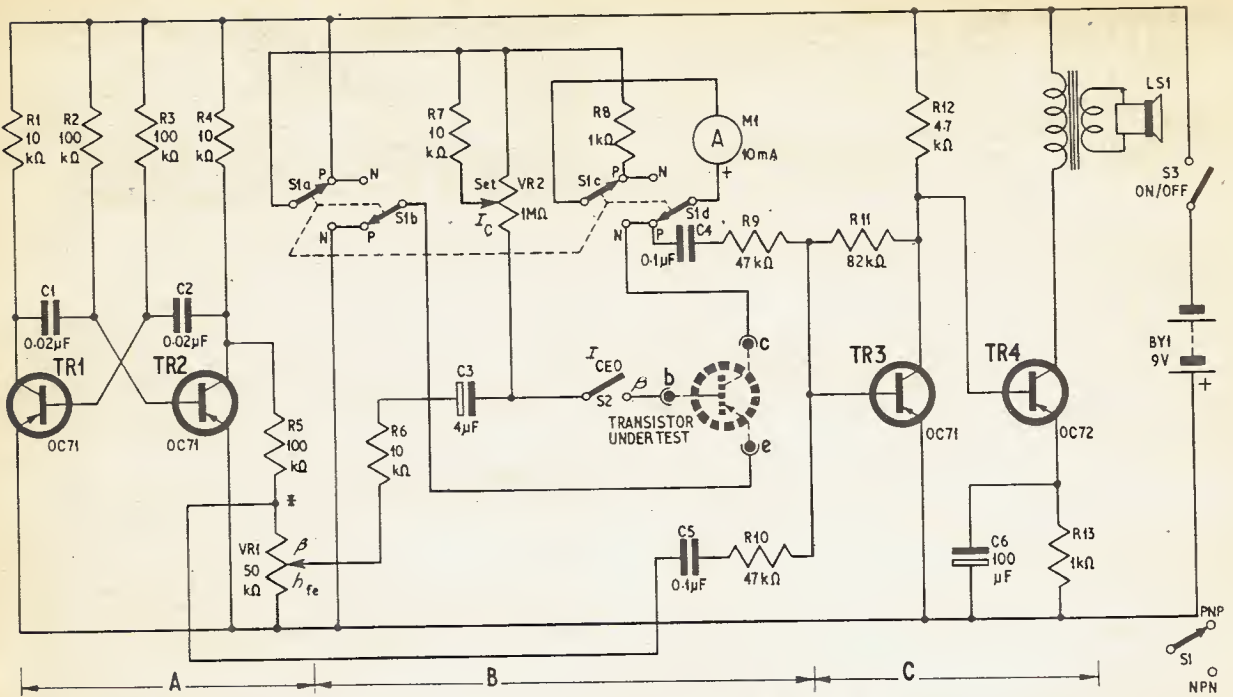

Fig. 5. Complete circuit diagram of the test set. The three sections A, B, and C are the different functional circuits as described in the text

reversal required for testing *pn*p and *np*n transistors, whilst S1c and d reverses the meter connection to cope with the changed direction of current flow. S2 removes the base current bias from the transistor when I_{CEO} is being checked. When closed, S2 provides the nominal d.c. bias condition necessary to fix the working point on the output characteristic of the transistor under test. Variable resistor VR2 varies the base current and hence the collector current of the transistor (as $I_C = h_{FE} I_B$).

A proportion of the oscillator voltage is selected by VR1 and applied through a series resistor to the base of the transistor under test. Current amplification occurs and a larger signal appears at the collector. The gain between the wiper of VR1 and the collector of the transistor under test is directly proportional to the transistor current gain, assuming that R6 effectively swamps any changes of input resistance to the transistor. Since

$$\delta I_B = \frac{\delta V}{R_6}$$

$$\text{and } \delta I_C = h_{fe} \times \delta I_B \\ = h_{fe} \frac{\delta V}{R_6}$$

where V = voltage at wiper of VR1 therefore, small change of collector voltage

$$= \delta V_C = h_{fe} \frac{\delta V}{R_6} \times R_L$$

R_L is the load resistance equal to R_8 , therefore the voltage gain

$$A_V = \frac{\delta V_C}{\delta V} = h_{fe} \frac{R_L}{R_6}$$

Hence if R_L and R_6 are fixed, A_V depends only on h_{fe} . This amplified voltage is added to a signal

obtained directly from the oscillator. Since an inversion occurs between base and collector of the transistor to be tested, the two signals are added in antiphase, so that when they are of equal amplitude the resultant is zero. This state can be obtained by adjusting VR1 according to the h_{fe} of the transistor under test, since the proportion of oscillator voltage required will depend on the voltage gain and hence h_{fe} of the transistor. The summed signal is then applied to a simple audio amplifying stage for driving a loudspeaker. Hence, by adjusting VR1 until the audio output is a minimum, a direct reading of h_{fe} can be obtained by calibration of the potentiometer.

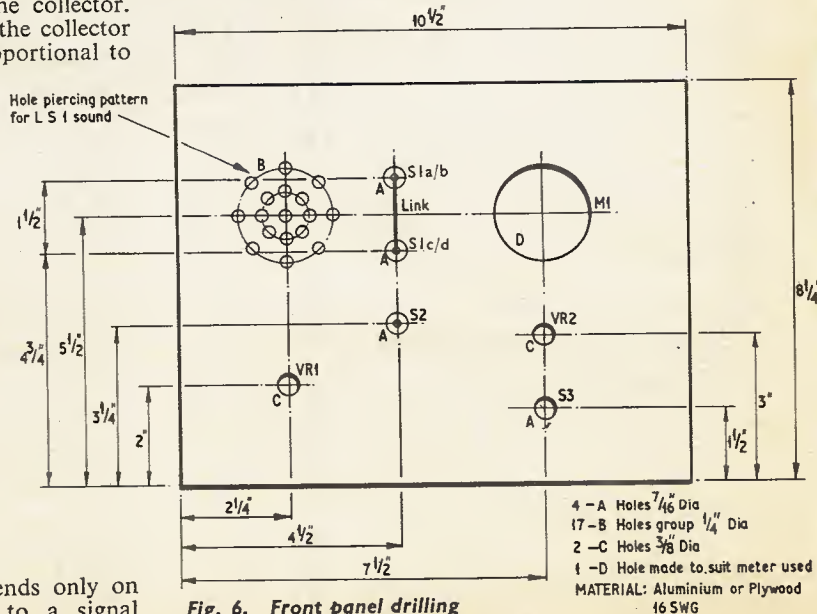

Fig. 6. Front panel drilling

- 4 - A Holes $\frac{7}{16}$ " Dia
 - 17 - B Holes group $\frac{1}{4}$ " Dia
 - 2 - C Holes $\frac{3}{8}$ " Dia
 - 1 - D Hole made to suit meter used
- MATERIAL: Aluminium or Plywood
16 SWG

FOLLOW THE LEADERS

KING SIZE QUALITY-TESTED PAKS

NOW EVEN MORE FOR YOUR MONEY

2	Drift Trans. 2N1225 Germ. PNP 100 Mc/s..	10/-
6	Matched Trans. OC44/45/81/81D	10/-
16	Red Spot AF Trans. PNP	10/-
10	White Spot RF Trans. PNP	10/-
5	Silicon Rects. 3 A 100-400 PIV	10/-
2	10 A Silicon Rects. 100 PIV	10/-
2	Bi-directional Trans. NPN Switching	10/-
1	12 A SCR 100 PIV	10/-
3	Sil. Trans. 25303 PNP	10/-
12	Assorted Computer Diodes	10/-
4	NPN Med. Speed Switching Trans.	10/-
4	Zener Diodes 250 mW 3-12 V	10/-
5	2G417 Trans. Eqvt. AF117	10/-
3	200 Mc/s Sil. Trans. NPN BS726/27	10/-
2	Bi-directional Trans. ASY66 PNP	10/-
3	Zener Diodes 400 mW 33 V 5% Tol.	10/-
4	High Current Trans. OC42 Eqvt.	10/-
2	Power Transistors I OC26 I OC35	10/-
5	Silicon Rects. 400 PIV 250 mA	10/-
4	OC75 Transistors Mullard Type	10/-
1	NPN Silicon Trans. 70 Mc/s	10/-
1	Power Trans. OC20 100 V	10/-
4	OA202 Sil. Diodes Sub-min	10/-
2	Low Noise Trans. NPN 2N929/30	10/-
1	Sil. Trans. NPN VCB 100 ZT86	10/-
8	OAB1 Diodes (CV448)	10/-
4	OC72 Transistors Mullard Type	10/-
4	OC77 Transistors Mullard Type	10/-
5	Metal Alloy Transistors Mat Type	10/-
4	Sil. Rects. 400 PIV 500 mA	10/-
5	GET884 Trans. Eqvt. OC44	10/-
5	GET883 Trans. Eqvt. OC45	10/-
2	GET20 Germ. PNP Trans. with Heat-sink	10/-
3	VHF Sil. Epoxy Trans. NPN 100 Mc/s	10/-
2	2N708 Sil. Trans. 300 Mc/s NPN	10/-
5	GT41/45 Germ. Trans. PNP Eqvt. OC71	10/-
3	GT31 LF Low Noise Germ. Trans. PNP	10/-
6	IN914 Sil. Diodes 75 PIV 75 mA	10/-
8	OA95 Germ. Diodes Sub-min IN69	10/-
3	NPN Germ. Trans. NKT773 Eqvt. AC130	10/-
2	OC22 Power Trans. Germ.	10/-
2	OC25 Power Trans. Germ.	10/-
2	OC73 Mullard Trans.	10/-
4	AC128 Trans. PNP High Gain	10/-
2	AC127/128 Comp. pair PNP/NPN	10/-
10	Assorted Gold Bonded Diodes.	10/-

FREE One 10/- Pack of your own choice free with orders valued £4 or over

6	TK22C Germ. Switching Trans.	10/-
3	2N1307 PNP Switching Trans.	10/-
20	Germ. Diodes General Purpose	10/-
7	CG62H Germ. Diodes Eqvt. OA71	10/-
3	AF116 Mullard Type Trans.	10/-
12	Assorted Germ. Diodes Marked	10/-
1	30 Amp Power Rectifier 100 PIV	10/-
4	AC126 Germ. PNP Trans.	10/-
5	10 A Germ. Rect. 200 PIV	10/-
1	ORP61 Photo-conductive cell	10/-
4	Silicon Rects. 100 PIV 750 mA	10/-
3	AF117 Trans. Mullard Type	10/-
7	OC81 Type Trans.	10/-
3	OC171 Trans. Mullard Type	10/-
3	2N216 Sil. Epoxy Trans.	10/-
7	OC71 Type Trans.	10/-
2	GET9 Power Trans. 60 Vcb. 8 A	10/-
25	Trans. Heatsinks fit TO18, SO12, etc.	10/-
1	TK400A Power Germ. Trans. ADY22	10/-
2	25701 Sil. Trans. Texas	10/-
2	BFY16 Sil. Trans. STC	10/-
2	Zeners 22A150F. 15 V 1 watt.	10/-
3	BCY43 Sil. Trans. 100 m/cs.	10/-
3	12 Volt Zeners 400 mW	10/-
2	GET571 Germ. Trans. OC28	15/-
2	10 A 600 PIV Sil. Rects. 15425R	15/-
3	BC108 Sil. NPN High Gain Trans.	15/-
2	Zener Diodes 25 W 18 and 22 V	15/-
1	2N910 NPN Sil. Trans. VCB100 80Mc/s	15/-
2	1000 PIV Sil. Rect. 1-5 A RS310 AF	15/-
3	High Volt. AF Trans. PNP ACY17	15/-
3	BSY95A Sil. Trans. NPN 200 Mc/s	15/-
3	OC200 Sil. Trans. Mullard	15/-
2	Sil. Power Rects. BYZ13	15/-
6	Sil. Power Trans. NPN100 Mc/s TK201A	15/-
6	Zener Diodes 3-15 V Sub-min	15/-
1	2N1132 PNP Epitaxial Planar Sil. Trans.	15/-
2	2N697 Epitaxial Planar Trans. Sil.	15/-
4	Germ. Power Trans. Eqvt. OC16 Mullard	15/-
1	Unijunction Trans. 2N2646 Eqvt. D5E29	15/-
2	Sil. Trans. 200 Mc/s 60Vcb ZT83/84	15/-
1	Sil. Planar Trans. NPN 100 Mc/s BS225	15/-
1	Sil. Trans. IS104 150 Mc/s HFE 200 NPN	15/-
2	SCRs 50 PIV 1 A TO-5 can	15/-
1	Tunnel Diode IN3720 (TDS) G.E.	15/-
1	Unijunction Trans. 2N2160 TO-5 can G.E.	15/-
2	Germ. Power Trans. OC28/29	15/-
1	10 A Sil. Stud Rect. 800 PIV	15/-
1	Tunnel Diode AEY111 1050 Mc/s STC	15/-
2	2N2712 Sil. Epoxy Planar HFE25 max	15/-
1	2N1257 PNP Sil. Planar TO-5 can	15/-
1	Sil. Power Trans. NPN 25721 85 W	20/-
6	BY100 Type Sil. Rects.	20/-
25	Sil. and Germ. Trans. Mixed all Marked New	30/-

MANY NEW PAK ITEMS

ANOTHER CROWNING SUCCESS—

Mullard DEVICES

AT FRACTIONAL PRICES

NEW SILICON RECTIFIERS TESTED

PIV	750 mA	3 AMP	10 AMP	30 AMP
50	2/-	3/-	4/6	9/6
100	2/3	3/6	6/-	15/-
200	2/6	4/6	6/6	20/-
300	3/-	4/9	8/-	22/-
400	3/6	6/-	9/-	25/-
500	4/-	6/6	9/6	30/-
600	4/3	7/-	10/-	37/-
800	4/9	8/-	15/-	40/-
1000	6/-	10/-	17/6	50/-

750mA TOP-HAT TYPE 3, 10 and 30 A STUD TYPE

SCR's (THYRISTORS) LOWEST PRICE YET

PIV	LARGEST RANGE EVER			
	1 AMP (TO-5 can)	7 AMP (STUD)	16 AMP (STUD)	30 AMP (STUD)
25	—	7/6	—	30/-
50	7/6	8/6	10/6	35/-
100	8/6	10/-	15/-	45/-
200	12/6	15/-	20/-	55/-
300	15/-	20/-	25/-	—
400	17/6	25/-	35/-	80/-
500	—	40/-	45/-	95/-
600	—	40/-	50/-	—

TRANSISTOR MANUAL BY G.E.

CIRCUITS, APPLICATIONS, CHARACTERISTICS, THEORY. 30/- EACH P.P. 26

647 PAGES S.C.R. MANUAL BY G.E.

★ VALUE PACKS FOR '67 ★ NEW UNTESTED

120 GERM. SUB-MIN. DIODES 10/-

50 MIXED TRANSISTORS 10/-

16 SILICON 750 mA TOP-HAT RECTIFIERS 10/-

20 ALL TYPES MIXED VOLTS ZENERS 10/-

25 SIL. NPN 200 Mc/s TRANSISTORS 10/-

10 STUD. SILICON RECT. 10/-

75 GERM DIODES GOLD-BONDED 10/-

30 PNP NPN MIXED SILICON TRANSISTORS 10/-

60 SILICON 200 mA DIODES 10/-

40 ZENERS RECTIFIERS MIXED TOP HAT 10/-

20 1 AMP. GERM. UP TO 300 PIV RECTIFIERS 10/-

40 LIKE OC81 AC128 TRANSISTORS 10/-

10 50-400 PIV 1 AMP SCR's 20/-

Our vast stocks change daily with hundreds of Semiconductor bargains becoming available. Just send 2/6 to cover 3 months mailing of our latest stock lists, eqvt. charts, circuits, etc. Minimum Order 10/- CASH WITH ORDER PLEASE. Add 1/- postage and packing per Order. GUARANTEED by return postal service. Overseas add extra for Airmail.

BI-PAK SEMICONDUCTORS 8 RADNOR HOUSE, 93-97 REGENT ST., LONDON W.1.



BI-PAK Semiconductors

AF117	3/6
AF139	10/-
AFZ12	10/-
BC107	6/-
BC108	5/-
BFY50	10/-
BFY51	7/6
BFY52	10/-
OA5	1/9
OA9	1/10
OA10	1/9
OA47	2/-
OA70	1/3
OA79	1/6
OA81	1/3
OA91	1/6
OA182	1/6
OA200	3/-
OA202	3/6
OC44	1/9
OC45	2/3
OC71	3/-
OC76	3/-
OC81D	2/3
OC82D	2/3
OC170	2/6
OC200	4/-
OC201	7/6
ORP12	8/6

ALL BRAND NEW AND GUARANTEED

"INTEGRATED CIRCUITS"

8 LEAD — EPOXY CASE RT/L MICROLOGIC

1/2 L 900 "Buffer" 19/6

1/2 L 914 "Gate" 19/6

1/2 L 923 "J.K." 35/- (FLIP-FLOP)

COMPLETE DATA AND CIRCUITS SEND 1/6. OR FREE WITH ALL IC ORDERS

BI-PAK



KING OF THE PAKS

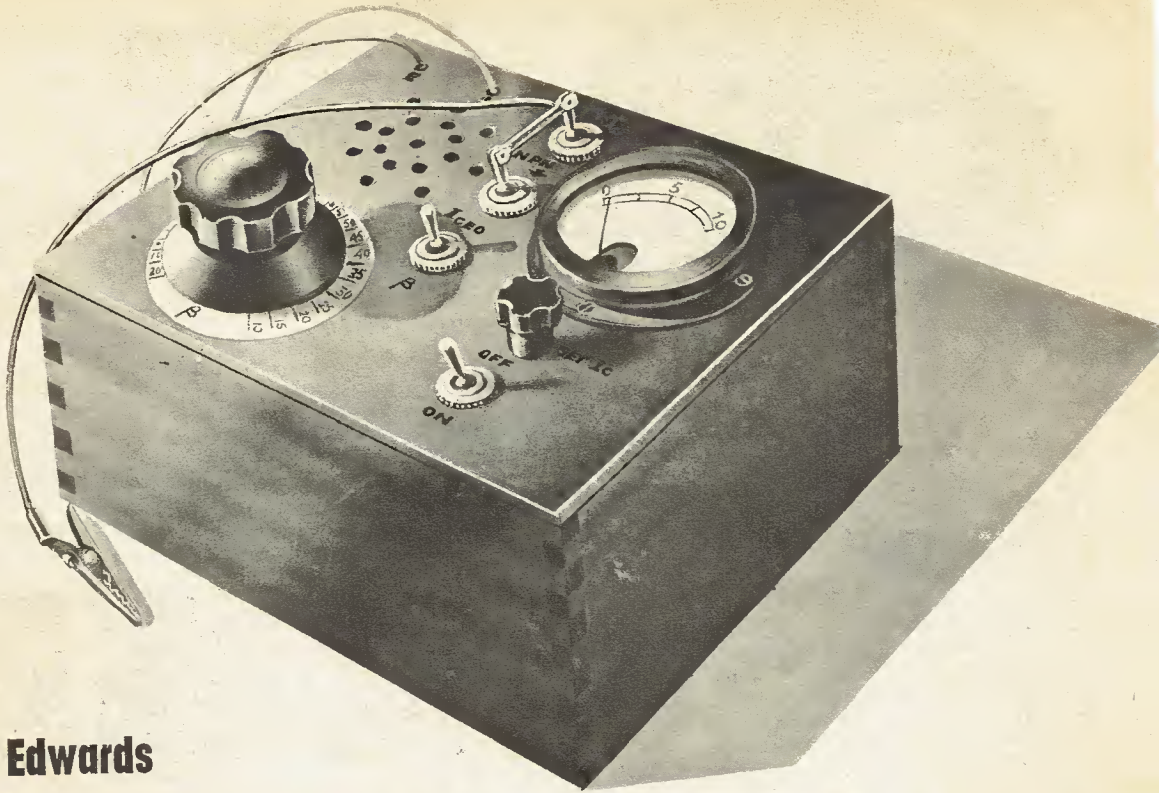

By P. Edwards

TRANSISTOR TEST SET

MANY types of transistors and diodes can be quickly checked by using this particular test set which caters mainly for those with similar or closely related parameters. In some instances elegance of design has been traded for low cost outlay, and so the constructor is free to introduce his own improvements where applicable.

The layout suggested is not obligatory, but the form shown was found to offer ease of operation. The following facilities are provided:

- (a) Measurement of h_{te} (also called β or α') for *pn*p or *np*n transistors with collector currents adjustable from 1 to 7mA;
- (b) A check on I_{CEO} (or I'_{CO});
- (c) Measurement of diode forward voltage (V_F) at a given forward current (I_F);
- (d) A check on I_R diode reverse leakage current;
- (e) Calculation of α from the measured value of h_{te} .

The test set was designed in an attempt to eliminate some of the disadvantages experienced by the author when using commercially manufactured units. The most important of these were:

- (a) The need for several knob adjustments and/or no direct reading of h_{te} ;
- (b) Adjustment of the h_{te} control affected the preset collector current;

- (c) No indication that the unit was switched on;
- (d) D.C. systems where the actual parameter measured was h_{FE} , the large signal current gain rather than h_{te} (β).

The set described here largely overcomes these difficulties and gives a direct dial reading of h_{te} indicated by the null effect of an audio output.

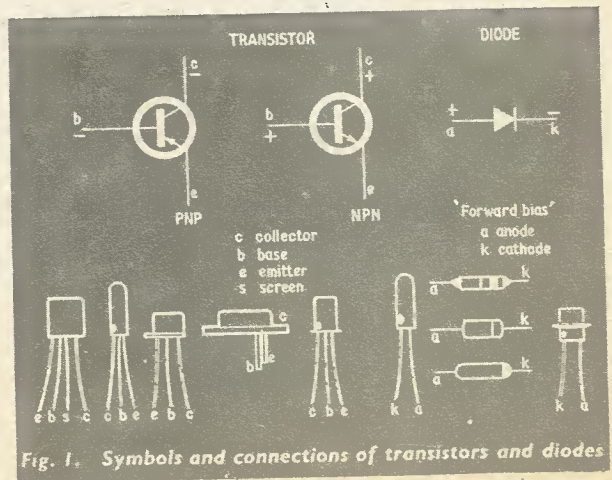

Fig. 1. Symbols and connections of transistors and diodes

NOW ADDED TO

The COMMON CORE Series



THE 'NUMBERS GAME'

Play it with TRAINER-TESTER Response Sheet No. E3 and the eleven
ADJUNCTIVE PROGRAMMING SUPPLEMENTS TO

basic electricity and basic electronics

Full details and prices will be sent on application to

THE TECHNICAL PRESS LTD.

112 WESTBOURNE GROVE, LONDON, W.2

Incidentally BASIC TELEVISION part 1 is now ready (see below)

YOURS FREE FOR 7 DAYS

The New 'Picture - Book' way of learning

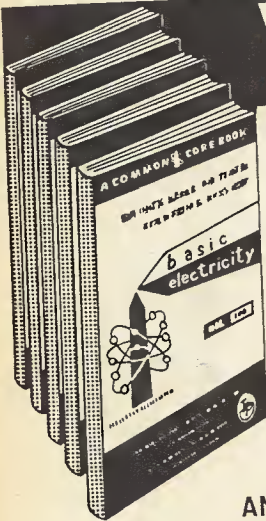

BASIC

ELECTRICITY (5 Vols)
ELECTRONICS (6 Vols)
ELECTRONIC CIRCUITS (2 Vols)
INDUSTRIAL ELECTRICITY (2 Vols)
SYNCHROS & SERVOMECHANISMS (2 Vols)

You'll find it easy to learn with this outstandingly successful new pictorial method—the essential facts are explained in the simplest language, one at a time; and each is illustrated by an accurate cartoon-type drawing.

The books are based on the latest research into simplified learning techniques. This has proved that the Pictorial Approach to learning is the quickest and soundest way of gaining mastery over these subjects.

**SPECIAL
ANNOUNCEMENT**

—NOW READY—

BASIC TELEVISION Pt. 1.

Price 22/- inc. postage.

Complete in two parts, publication date of Pt. 2 to be announced later. Available on 7 days free trial, see coupon.

**TO SELRAY BOOK CO.
60 HAYES HILL, HAYES, BROMLEY, KENT**

Please send me Without Obligation to Purchase, one of the above sets on 7 Days Free Trial. I will either return set, carriage paid, in good condition within 7 days or send the following amounts. Basic Electricity 70/- Cash price or Down Payment of 15/- followed by 4 fortnightly payments of 15/- each. Basic Electronics 82/- Cash Price or Down Payment of 15/- followed by 5 fortnightly payments of 15/- each. This offer applies to U.K. only. Overseas customers cash with order.

Tick set required (only ONE set allowed on free trial)

BASIC ELECTRICITY 70/-
BASIC ELECTRONIC CIRCUITS 40/-
BASIC INDUSTRIAL ELECTRICITY 40/-
BASIC SYNCHROS & SERVOMECHANISMS 38/-
BASIC TELEVISION PART 1 22/-

BASIC ELECTRONICS 82/-

All prices include postage

PE 8

Signature..... (If under 21, signature of parent or guardian)

NAME..... **BLOCK LETTERS BELOW**

FULL POSTAL ADDRESS.....

POST NOW FOR THIS OFFER!

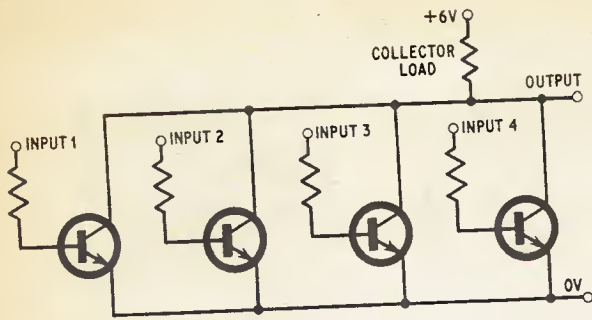

Fig. 9. A simple DCTL gate

INTEGRATION

Armed with the processes of making epitaxially isolated planar transistors and resistors, we can now consider a simple form of integrated circuit. Fig. 9 shows the schematic diagram of a very simple logic gate. This is a DCTL (direct coupled transistor logic) NOR gate. It comprises four inputs through resistors to the bases of four transistors, with common collectors coupled to a single collector load resistor. The output point is taken from the common collectors.

The circuit can be quite easily split into two discrete sections, one containing the transistors, and the other containing the resistors. As far as the transistor section is concerned we already have this part of the circuit as good as made from the wafer containing individual epitaxially isolated transistors, described earlier. Although the collectors of the transistors on this wafer are isolated from the bulk of the substrate through the epitaxial layer, all the collectors are commoned as they are actually formed from the epitaxial layer itself (Fig. 10a).

The transistor section can therefore be made merely by breaking the original wafer into groups of four transistors. A slight modification is needed; all the emitters also have to be commoned, but this can be done later on by interconnecting them with fine wire, using a process called "stitch bonding" (this operation is an extension of normal ultrasonic or thermo-compression bonding).

The resistor section can be formed by diffusing groups of five strips of *p*-type dopant into an *n*-type epitaxial layer on a completely separate wafer. The *pn* junction surrounding each of these resistors will isolate it from its neighbour (Fig. 10b). This wafer can then be broken into dice each dice containing a complete group of five discrete resistors. We can now take one dice of

Probe testing a Plessey integrated circuit

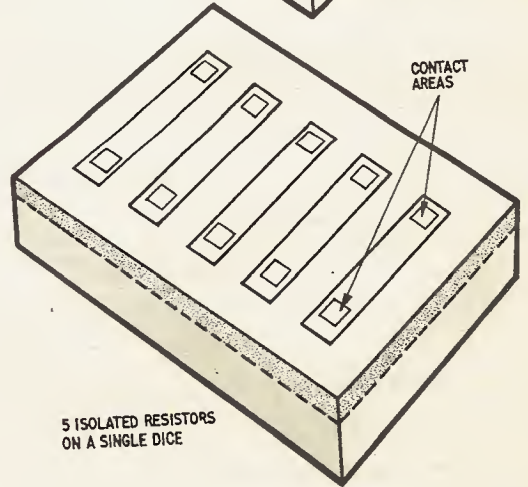
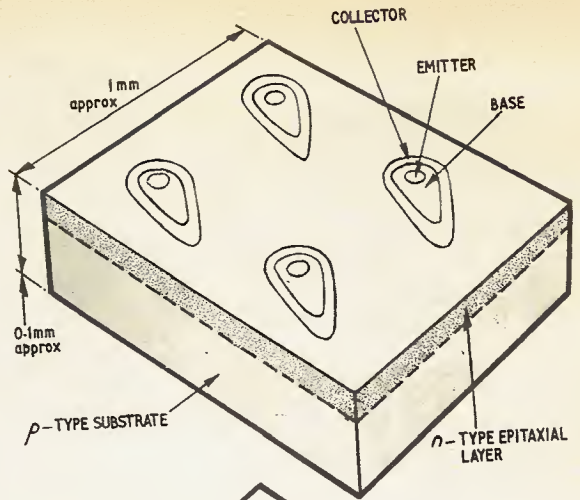
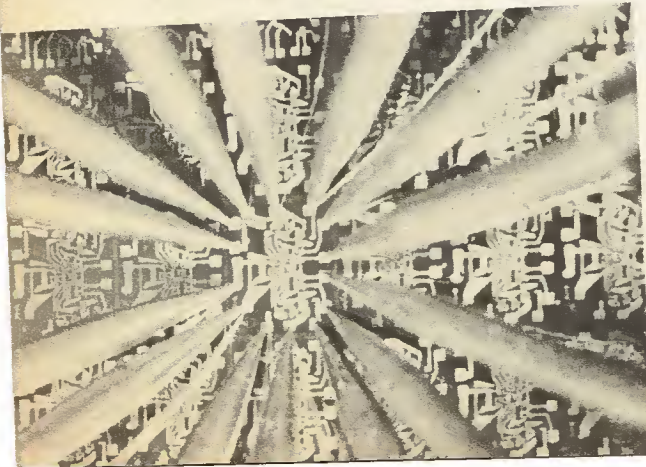

Fig. 10a. Four common collector transistors on a single dice

Fig. 10b. Five isolated resistors on a single dice

resistors, one dice of transistors, and mount them onto a header. All the individual components (apart from the collectors) are isolated from each other, even though the header may be of metal.

As a final operation before encapsulation, all that is necessary to complete the circuit is the interconnection of one end of each of the four base resistors to their respective bases, the collector load resistor to any one of the transistor collectors, the lead out connections to the other end of each resistor, and one from the commoned collectors.

Because this circuit is made from more than one chip of silicon, it is called a "multichip integrated circuit". The process is rather intricate and requires two completely separate types of wafer as starting points, thus causing complications in process control. Perhaps a worse problem with this sort of circuit is the large number of manual operations required to carry out the stitch bond interconnections. Although these circuits are still being made in quite large quantities, they are falling out of favour due to the rapid developments in "monolithic" circuits.

Next month: Monolithic circuits

Photo resist—Light sensitive material usually applied in thin films deposited uniformly on a wafer or substrate. They are used to establish the patterns for controlled etching and diffusion.

Planar process—The planar process of forming integrated circuits and semiconductor components is based upon the use of a single surface for referencing each successive operation. The planar process depends upon the repeated use of silicon dioxide from one surface to control the location of diffusions.

Probing—A term used to describe testing techniques for checking the working quality of integrated circuits before the wire bonding operation. Several very fine tipped probes are accurately positioned over the metallised contact areas of the circuit to effect contact to the circuit.

Propagation delay—The finite period of time measured from the instant when the input signal is applied until the output has reached its final value.

Raw chips—Unmounted chips containing circuits or components.

Resistivity

Bulk resistivity—A constant value for a given material which is used to calculate the resistance of the material when engineered into various geometrics. It is measured in ohm centimetres.

Sheet resistivity—Effectively the resistivity of a material in a single plane of constant thickness. It is a term often used to determine the doping concentration in extremely shallow diffused layers—the higher the doping level the lower the sheet resistivity. As the thickness of the film or diffused layer is constant, sheet resistivity is only a function of surface area and is measured in ohms per square centimetre.

Resolution—The ability to separate between adjacent lines. It is a limitation often associated with photographic emulsion, lenses, and etching processes.

Saturation voltage—The voltage drop across a transistor—measured from emitter to collector—when a transistor is in a fully conductive state. It is proportional to the internal or collector resistance of the device and usually should be kept as low as possible.

SCIC—An abbreviation commonly used for semiconductor integrated circuit.

SIC—Silicon integrated circuit—a circuit formed entirely on a silicon chip.

Slice—Thin disc cut from a crystal and used in the fabrication of a multiplicity of circuits. Finally separated into chips.

Substrate—A piece of material used to support components.

Active substrates—All silicon wafers containing diffused components, upon which thin films are deposited.

Passive substrates—Glass, ceramic, or other insulating substrates upon which thin film components can be deposited.

Thermal SiO₂—Protective layer of silica, grown by the thermal oxidation of silicon.

Thick film circuit—Silk screened circuit; cermet circuit; circuit made by depositing paint on an insulating substrate and burning off the organic matter to leave a purely mineral component.

Thin film circuit—A circuit in which all passive components are made by the process of depositing thin films of various materials on insulating substrates.

Transistor base diffusion—Diffusion giving the base region of a transistor, e.g. boron into *n*-type silicon.

capable of accurate superimposition over the image produced by the others. As the actual size of a small signal type of planar transistor is very small (rarely exceeding 500 microns (0.5mm) diameter) it is possible to make as many as 1,500 individual transistors on a piece of silicon no more than 1½ in in diameter. This piece of silicon which is usually about 200 microns (0.2mm) thick is called a wafer. When all the diffusions and metallisation operations have been carried out it is cut into squares—or dice—each dice comprising an individual transistor.

ISOLATION

The bulk of the dice containing the planar transistor forms the collector region of the device. If the device was bonded into a metal can, the can would inevitably be directly coupled to the collector of the transistor. This may be perfectly acceptable for some simple types of transistors, but it is obviously desirable to produce a structure in which the collector may be isolated from the can.

Isolation is achieved in practice by using a process called "epitaxial isolation", which builds up a layer of silicon of opposite conduction type on to a conventional substrate of silicon. The "epitaxial growth" is carried out by heating the substrate in an atmosphere of hydrogen which contains the vapour of a chemical called silicon tetrachloride (Fig. 5). Without going into the complexities of the chemical reaction, the result is that the silicon tetrachloride decomposes at the surface of the silicon substrate and deposits silicon on the substrate at the rate of about 1 micron per minute.

An important feature of this process is that by introducing extremely small quantities of dopant vapour into the main hydrogen stream it is possible to control the type of conductivity as well as the value of conductivity of the deposited layer. The layer is usually grown to a thickness of 10 to 20 microns, but varies somewhat according to the application.

As one can control, at will, the conductivity type of the deposited layer, one could make a transistor similar to the one already described by first depositing a 20 micron thick layer of *n*-type silicon on to a *p*-type substrate.

If the rest of the diffusions are carried out in the same manner as before we can build up the same type of transistor except that there is now a *pn* junction between the collector and the bulk of the material. This junction has identical properties to a reverse biased diode, and therefore forms a very high resistance to current flow into the rest of the substrate, therefore giving effective isolation.

Obviously one cannot now make contact with the collector of the transistor from the rear of the dice through this high resistance; therefore it is necessary to etch a third window into the passivating oxide layer on the front surface to expose an area of the collector region. After breaking, this dice can be mounted into a metal can with the collector effectively isolated from the can itself.

This process of epitaxial isolation is the key to making complex integrated circuits, and will be referred to several times in this article. Important features of the diffused structure are the levels of doping and the depth of the junctions.

SILICON RESISTORS

Silicon that is 100 per cent pure is an extremely poor conductor of electricity at normal temperatures, but as impurities are added the conductivity increases until the

Again an oxide layer is grown over the window to passivate the surface completely (Fig. 4h).

MAKING CONNECTIONS

The transistor is now complete apart from making connections to the respective electrodes. This is carried out by opening up an annulus shaped hole in the oxide over the base region, and a small circular hole over the emitter (Fig. 4i). Aluminium is evaporated over the whole of the surface of the device by the same method as described for thin film circuits. Excess aluminium is removed by photolithographic methods leaving a contact annulus over the base and a spot over the emitter (Fig. 4j).

Contact to the collector is made in this case by welding the large area surface of the original starting material to a gold plated platform which will form part of the final transistor can. Wired connections to the base and emitter are made by ultrasonically welding very fine aluminium wires (perhaps 10 microns in diameter) to the evaporated aluminium and then to the more substantial lead out wires of the can (Fig. 4k).

The transistor produced by this method is called a double diffused transistor, and there are many types similar to this being made. A drawback with this type of transistor is that the collector connection is not insulated from the can, and this can present certain problems in use. A more sophisticated method of

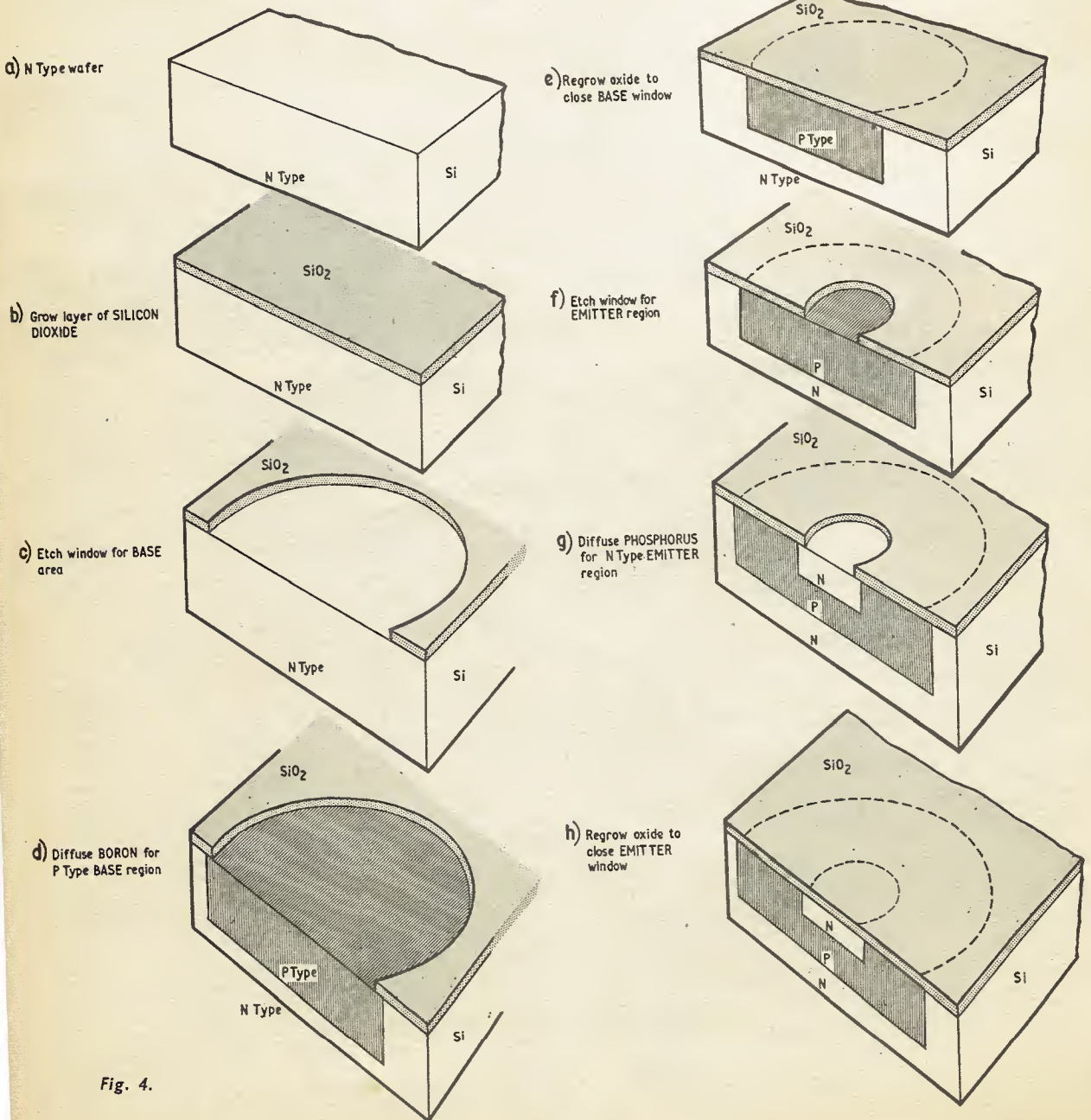

Fig. 4.

therefore preferable, since they may be integrated with the cooling cycle, and have inherently longer time constants.

PLUMBING SYSTEM

Fig. 10 sketches a complete system which is strongly recommended and relatively easy to install in a dark-room. A deep double-walled jacket tray (I) contains the photographic baths. The latter stand on wooden blocks, so that they are affected only by the temperature of the air in the tray, which in turn is determined by the temperature of the water flowing between the walls of the jacket tray.

With reference to Fig. 10, the following details require comment. The optimum input water temperature is 10 degrees C, and when the 2kW immersion heater is switched on, the optimum output water temperature is

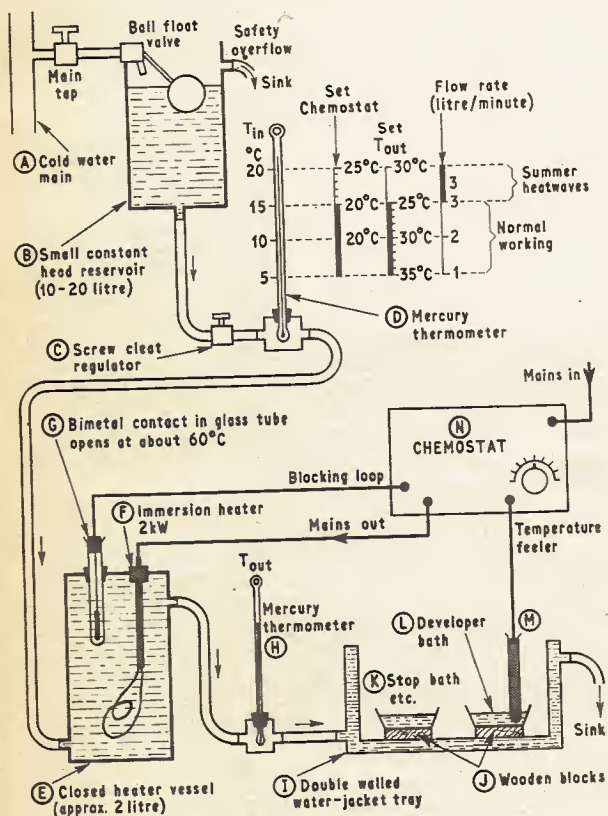

Fig. 10. A plumbing system for colour photographic processing

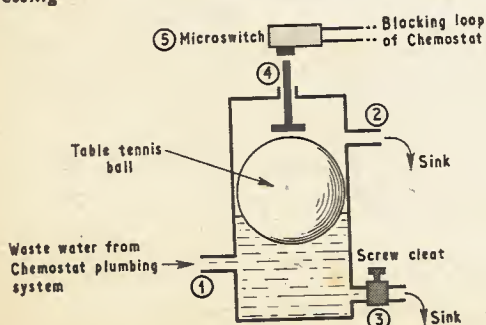

Fig. 11. Flow contact for blocking loop

30 degrees C. About 40 kcal are required to heat the (approximate) 2 litre contents of the heating vessel through the difference of 20 degrees C. An electrical rating of 2kW produces roughly 30 kcal/minute, so that the correction inversion time constant is approximately equal to the Chemostat feeler time constant. The simple arrangement of a transistor in an ordinary test tube as feeler, with its rather long time constant compared to a conventional mercury thermometer, is thus fully satisfactory.

It would be pointless to devise special mountings with shorter time constants, because inconveniently large electrical heating ratings would then be necessary to exploit them fully and the resulting short-period control cycles would be much more sensitive to inevitable departures from optimum conditions. (However, make sure to use a thin-walled test tube of the ordinary kind, not a thick-walled special type, and fit the feeler transistor with a small cooling fin bent to wedge against the glass in the bottom region of the tube, see Fig. 6.) The resulting thermal time constant should not differ too greatly from 100 seconds in water. The volume of water contained between the walls of the jacket tray (I) should be approximately equal to the volume of the heating vessel (E).

ADJUSTMENTS

For input water temperatures above 15 degrees C, the nominal photographic bath temperature must be increased above 20 degrees C accordingly, as shown in Fig. 10. It is convenient to fix an instruction scale behind the water input thermometer (D). This indicates the nominal setting of the Chemostat and the nominal output water temperature at (H) on the heating cycle, corresponding to each input water temperature reading of (D).

By the time the Chemostat has reached the steady control state, (D) and (H) will also have reached steady readings which remain tolerably set for several hours, i.e. throughout a normal working session. It normally suffices to switch on about 30 to 60 minutes before intending to commence processing. The screw-clip (C) should be adjusted until the thermometer (H) reads the appropriate temperature on the heating cycle. Corresponding approximate water flow rates are also marked against (D) merely to permit rapid coarse adjustment at the start (collect output water for 1 minute in a measuring cylinder). Fine adjustments to (C) should be made only with reference to thermometer (H).

Thick-walled pressure-type rubber tubing should be used for all interconnections. This is largely unaffected by positioning and movements. A simple screw-clip gives accurate and steady control of the flow rate when used on thick-walled rubber tubing. The flow rate should be adjusted coarsely to 3 litres/minute or a little more with the cleat fully open, by choosing an appropriate mounting height of the cistern (B) on the wall.

The ball-valve cistern (B) is quite essential because water-main pressures tend to fluctuate, and normal taps working straight from a high-pressure main into a low-pressure discharge circuit do not give steady flow rates even with constant main pressure. Such arrangements would be extremely unreliable.

The cistern (B) is readily made by adapting a w.c. cistern. Any watertight insert may be used for mounting the thermometers (D) and (H). The insert must be as small as possible. It is also possible to make a small hole in the rubber tube, push-in the thermometer bulb and seal with some watertight adhesive.

continued on page 690

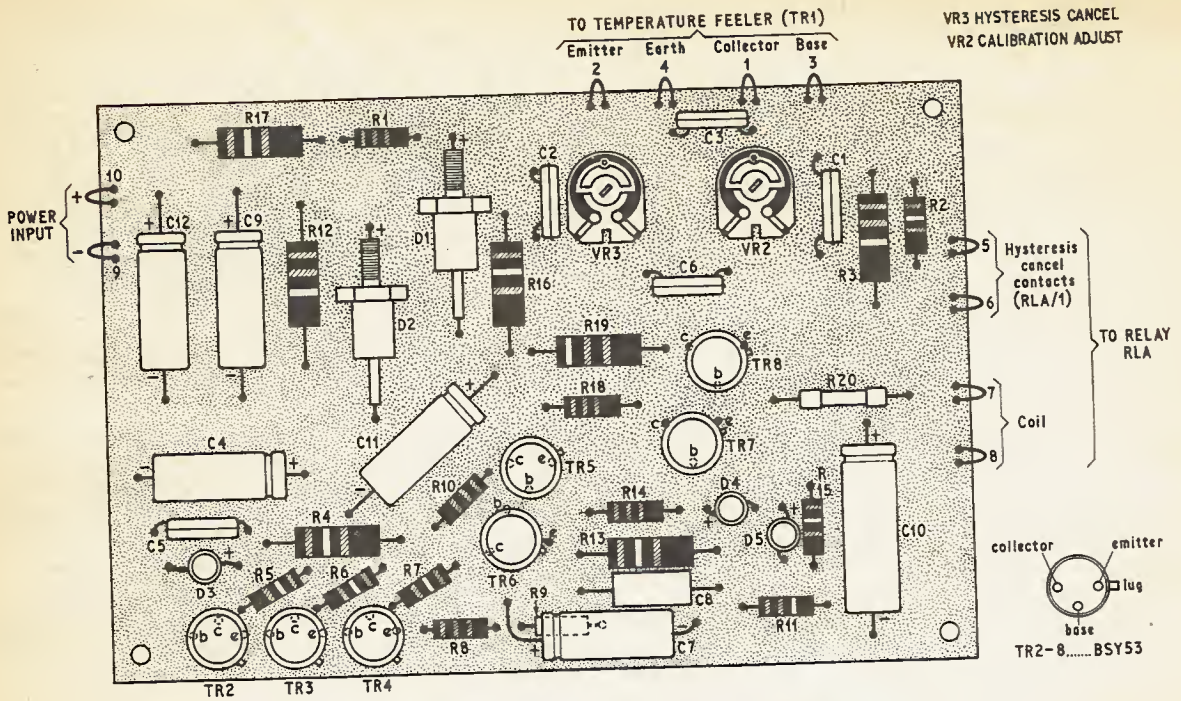

Fig. 7. Printed Circuit Board, component layout

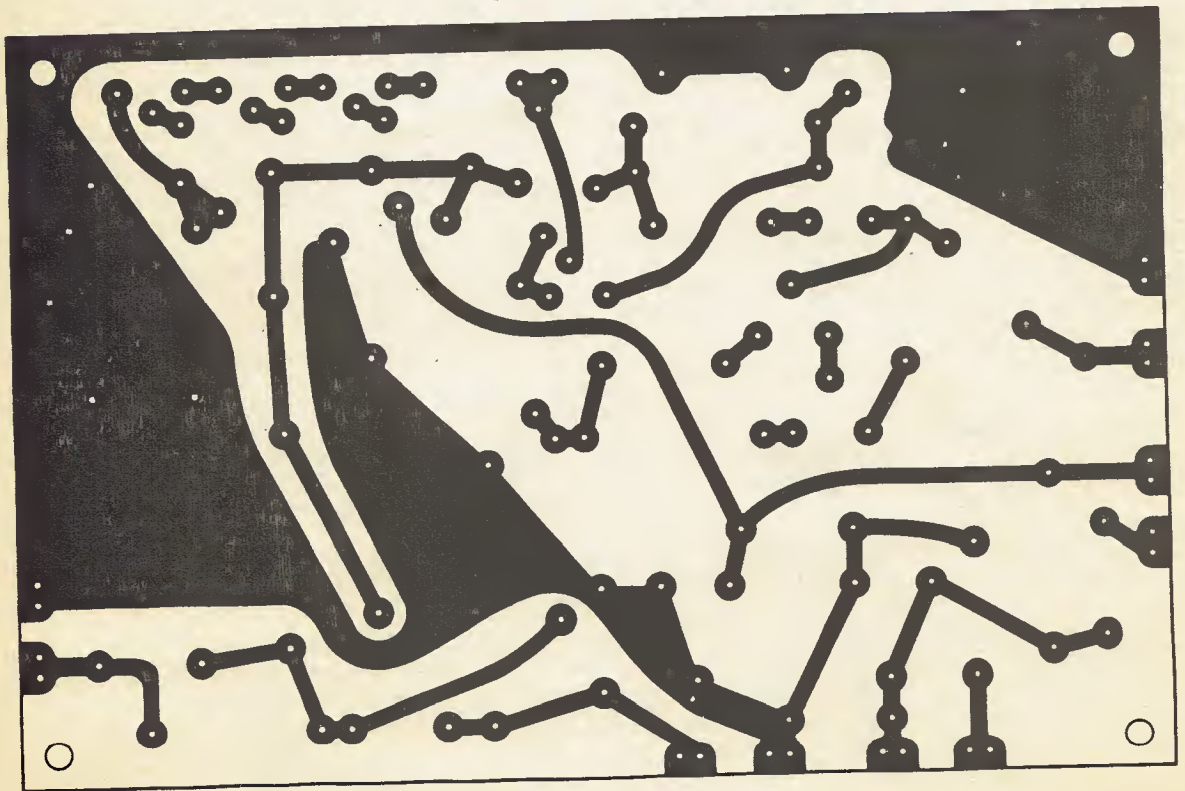

Fig. 8. Printed Circuit Board (actual size)

MARKET PLACE

Items mentioned in this feature are usually available from electronic equipment and component retailers advertising in this magazine. However, where a full address is given, enquiries and orders should then be made direct to the firm concerned.

EQUIPMENT

As a result of experiments into the problems of designing battery chargers, specifically for the purpose of charging batteries used in ultrasonic aids for the blind, Stoneleigh Electronics Ltd., Factory No. 8, Bridge Close, Romford, Essex, have produced a sub-miniature charger which has a mains isolated input circuit.

Called the "Stoneleigh" the constant current charger has a transistor stabilised circuit and will charge, without any switching, either one or two Deac Nickel Cadmium batteries (type 7/150DK) at a constant current of $15\text{mA} \pm \frac{1}{2}\text{mA}$. The charger weighs only 5 ounces and measures $4\text{in} \times 1\frac{1}{2}\text{in} \times 2\frac{1}{2}\text{in}$, including battery holder.

The charger can be modified to suit other batteries and with the increasing use of alkaline batteries in all domestic equipment it should save on the cost of battery replacement in such items as radios, tape recorders, and other portable appliances that are in constant use.

One excellent point about the Photain Burgalarm Kit is that it can also double as a fire alarm, and is claimed to provide a foolproof installation which can be fitted by the average handyman or any electrician.

Obtainable from Photain Controls Ltd., Randalls Road, Leatherhead, Surrey, the kit cost £60 complete plus 15s for each fireswitch and comprises: control unit, three sets of encapsulated magnaswitches and magnets, two 6in gong 12V d.c. bells, Chubb Castle mortice dead lock, 100yd twin cable for loop circuit wiring and two 12V d.c. batteries.

The control unit is housed in a pressed steel case with hinged lid and contains the electronic circuit, operational relays, batteries, automatic a.c./d.c./a.c. changeover circuit, tamper-proof screw contact and key on/off switch.

The magnaswitches and magnets are fixed to the door or window in such a position that when the door is closed the magnet is in close proximity with the magnaswitch which is screwed or stuck to the door frame.

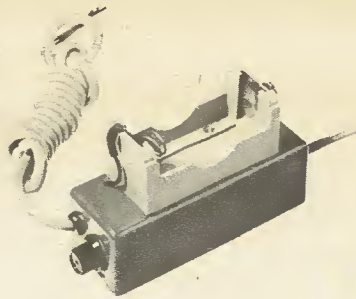

Stoneleigh charger



Nombrex signal generator type 31

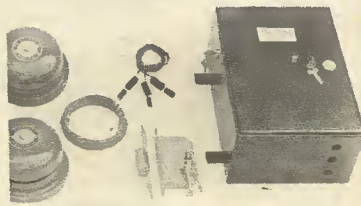

Burgalarm kit from Photain Controls

Hilka or QQQ soldering iron



Suspect spring

The switches are wired in a double-pole loop system, a negative voltage being applied to one leg of the loop and a positive voltage to the other leg. This ensures that if any wire is cut or if they are shorted together in an attempt to override any switch then the alarm will sound.

The Chubb mortice dead lock is fitted with a switch which is operated by the bolt, and is wired in the loop circuit.

The alarm is powered by the mains supply with automatic changeover to the battery supply in the event of mains failure or interference, and reverts back automatically once the mains supply has been restored.

The fireswitches, if required, can be wired in the loop circuit and operate when the ambient temperature reaches 160 degrees Fahrenheit or 71 degrees Centigrade.

If correctly installed and maintained the "Burgalarm" will comply with insurance company specifications.

Test gear is another field where personal taste and pocket play important parts in stocking out the workshop. The Nombrex Ltd., Exmouth, Devon, signal generator, type 31, is certainly reasonably priced at £12 10s 0d. The main features of this transistor signal generator are: frequency range from 150kHz to 350MHz in eight overlapping ranges with an accuracy better than 2 per cent. The signal unmodulated or modulated is approximately 3 per cent sine wave at 400Hz. A continuously variable r.f. signal attenuator. Directly calibrated frequency scales, discrimination within 1 per cent of the selected frequency. The average output is 100mV according to the frequency selected and the output impedance is 400 ohms maximum.

WARNING

The Home Office warns readers that soldering irons from Japan and sold in this country under the trade names of Hilka and QQQ can be potentially dangerous. These names are printed in red on a small metal plate on the side of the handle which includes the iron rating 40W 220-240V and may also give the serial number 1513.

The trouble is that a protective spring surrounding the cord where it enters the iron can be pushed further into the handle than the manufacturers intended, and can make contact with a live terminal resulting in electrocution.

Trade associations representing importers, wholesalers and retailers have undertaken to warn their members of the defect and to advise them against selling any of the irons without first replacing the coil spring with a non-conductive flex protector.

It is recommended that members of the public should not use these irons unless they have been examined by a competent person and if necessary modified to make them safe.

BRAND NEW T.V. U.H.F. TUNER AND SOUND AND VISION I.F. PANEL

By world famous maker. Suitable for use in conversion of T.V sets to B.B.C.2 (625 line reception). OFFERED (less valves) AT THE BARGAIN PRICE OF ONLY 27/6. Post Paid. (The components are worth far more than our price for the complete unit and due to the very high value we regret that no correspondence can be entered into regarding this item.)

HIGH GAIN 4 TRANSISTOR PRINTED CIRCUIT AMPLIFIER KIT Type TAI

- Peak output in excess of 1 1/2 watts.
- All standard British components.
- Built on printed circuit panel, size 6 x 3in.
- Generous size Driver and Output Transformers.
- Output transformer tapped for 3 ohm and 15 ohm speakers.
- Transistors (GET 114 or S1 Mullard OC81D and matched pair of OC81 o/p).
- 9 volt operation.
- Everything supplied, wire, battery clips, solder, etc.
- Comprehensive easy to follow instructions and circuit diagram 2/6 (Free with Kit). All parts sold separately: SPECIAL PRICE 45/- P. & P. 3/-. Also ready, built and tested, 52/6. P. & P. 3/-. A pair of TAIs are ideal for stereo.

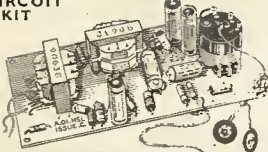

STEREO AMPLIFIER

Incorporating 2 ECL86s and 1 E280, heavy duty double wound mains transformer. Output 4 watts per channel into 3 ohm speakers. Full tone and volume controls. Absolutely complete.

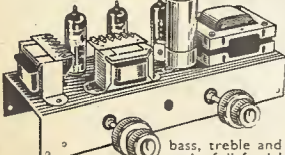

ONLY £4.19.6 P. & P. 8/-
Super Deluxe version with ECL86 valves, sep. bass, treble and balance controls, full feedback. 4 watts per channel into 3 ohm speakers. 8 gns. P. & P. 8/-.

SPECIAL PURCHASE! TURRET TUNERS
By famous maker. Brand new and unused. Complete with PCC84 and PCF80 valves 34-38 Mc/s I.F. Biscuits for Channel 1 to 5 and 8 and 9. Circuit diagram supplied. ONLY 25/- each. P. & P. 3/9.

GÖRLER F.M. TUNER HEAD
88-100 Mc/s 10.7 Mc/s I.F., 15/-, plus 2/- P. & P. (ECC85 valve, 8/6 extra).

ACOS CRYSTAL MIKES. High imp. For desk or hand use. High sensitivity, 18/6. P. & P. 1/6.
ACOS HIGH IMPEDANCE CRYSTAL STICK MIKES. Listed at 42/-. Our price, 21/-. P. & P. 1/6.

SPECIAL PURCHASE!
B.S.R. GUY 9 volt Battery Operated Record Player Units.

4-speeds, Automatic stop. Plays any size record. Complete with mono t/h head and sapphire styli.
ONLY 69/6. P. & P. 5/6.
(With stereo cartridge 12/6 extra).



QUALITY RECORD PLAYER AMPLIFIER Mk II
A top-quality record player amplifier employing heavy duty double wound mains transformer, ECC83, EL84, E280 valves. Separate Bass, Treble and Volume controls. Complete with output transformer matched for 3 ohm speaker. Size 7in. w. x 3in. d. x 6in. h. Ready built and tested. PRICE 69/6. P. & P. 6/-.
ALSO AVAILABLE mounted on board with output transformer and speaker ready to fit into cabinet below. PRICE 89/6. P. & P. 7/6.

DE LUXE QUALITY PORTABLE R/P CABINET
Uncut motor board size 14 1/2in. x 12in. clearance 2in. below, 5in. above. Will take above amplifier and any B.S.R. or GARRARD Autochanger or Single Player Unit (except AT60 and SP25). Size 18in. x 15in. x 8in. PRICE £39/6. P. & P. 9/6.

4-SPEED PLAYER UNIT BARGAINS
Mains Models. All brand new in maker's original packing.

SINGLE PLAYERS
B.S.R. TU/12 £39/6 Carr. 5/6.
GARRARD SP25 De Luxe £10/19/6 Carr. 5/6.
B.S.R. GU7 with unit mounted pickup arm. £4/18/8 Carr. 5/6.

AUTO CHANGERS Carr. 6/6 on each.
Latest B.S.R. UA25 Super slim £6 2 6
GARRARD 1000 with Hi-Fi arm £6 19 6
GARRARD 2000 £7 10 0
GARRARD 3000 £8 15 0
LATEST GARRARD AT60 Mk. II £12 0 0
All the above units are complete with t/o mono head and sapphire styli or can be supplied with compatible stereo head for 12/6 extra.

BRAND NEW CARTRIDGE BARGAIN!
ACOS GP69-1 MONO CARTRIDGE. For E.P. and L.P. Complete with stylus. ONLY 12/6. P. & P. 1/-.
BRAND NEW. 12" 15w. H/D Speakers. 3 or 15 ohm. Current production by well-known British maker. Offered below list price at 89/6. P. & P. 5/-.
Guitar models: 25w. £5.5.0; 35w. £6.8.0.

BRAND NEW 3 OHM LOUSPEAKERS:
5 in., 12/6; 6 1/2 in., 15/-; 8 in., 22/6; 10 in., 27/6; 7 in. x 4 in., 16/-; 10 in. x 6 in., 27/6.
E.M.I. 8 in. x 5 in. with high flux magnet 21/-.
E.M.I. 13 1/2 x 8 in. with high flux ceramic magnet. 42/- (15 ohm) 45/-. P. & P. 4/- 5 2 1/2, 6 1/2 & 8 2/6, 10" & 12 3/8 per speaker.
E.M.I. PLASTIC CONED TWEETER.
2 1/2" 3 ohm. Limited number: 12/6 each, P. & P. 1/6.

VYNAIR AND REXINE SPEAKER AND CABINET FABRICS app. 54 in. wide. Usually 35/- yd., our price 13/6 per yd. length min. 1yd.) P. & P. 2/6. S.A.E. for samples.

7-10 watt OUTPUT TRANSFORMERS to match pair of ECL 86's in push-pull to 3 ohm output. ONLY 11/-. P. & P. 2/6.

MAINS TRANSFORMER for transistor power supplies. Tapped pri. 200-250v. Sec. 40-0-40 at 1 amp. (with electrostatic screen) and 6.3v. at 5 amp for dial lamps etc. Drop thro mounting. Stack size 1 1/2" x 3 1/2" x 3 1/2". P. & P. 4/6.

MATCHED PAIR OF 21 WATT TRANSISTOR DRIVER AND OUTPUT TRANSFORMERS. Stack size 1 1/2" x 1 1/2" x 1 1/2". Output trans. tapped for 3 ohm and 15 ohm output. 10/- pair plus 2/- P. & P.

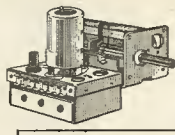
SPECIAL OFFER! FM/AM TUNER HEAD
Beautifully designed and precision engineered by Dormer and Wadsworth Ltd. Supplied ready fitted with twin .0005 tuning condenser for AM connection. Prealigned FM section covers 86-102 Mc/s I.F. output 10.7 Mc/s. Complete with ECC85 (6L12) valve and full circuit diagram of tuner head. Another special bulk purchase enables us to offer these at 27/6 each. P. & P. 3/-. Order quickly!
Limited number also available with precision geared 3:1 reduction drive. 30/- P. & P. 3/-.

3-VALVE AUDIO AMPLIFIER MODEL HA34

Designed for Hi-Fi reproduction of records. A.C. Mains operation. Ready built on plated heavy gauge metal chassis, size 7 1/2in. w. x 4in. d. x 4 1/2in. h. Incorporates ECC83, EL84, E280 valves. Heavy duty mains transformer and output transformer matched for 3 ohm speaker, separate Bass, Treble and volume controls. Negative feedback line. Output 4 1/2 watts. Front panel can be detached and leads extended for remote mounting of controls.
The HA34 has been specially designed for us and our quantity order enables us to offer them complete with knobs, valves, etc., wired and tested for only **£4.5.0** P. & P. 6/-.



HSL 'FOUR' AMPLIFIER KIT A.C. Mains 200 250v., 4 watt, using ECC83, EL84, E280 valves

★ Heavy duty double-wound mains transformer with electrostatic screen.
★ Separate Bass, Treble and volume controls, giving fully variable boost and cut with minimum insertion loss.
★ Heavy negative feedback loop over 2 stages ensures high output at excellent quality with very low distortion factor.
★ Suitable for use with guitar, microphone or record player.
★ Provision for remote mounting of controls or direct on chassis.
★ Chassis size only 7 1/2 in. wide x 4 in. deep. Overall height 4 1/2 in. ★ All components and valves are brand new. ★ Very clear and concise instructions enable even the inexperienced amateur to construct with 100% success. ★ Supplied complete with valves, output transformer (3 ohms only), screened lead, wire, nuts, bolts, solder, etc. (No extras to buy.) PRICE 79/6. P. & P. 6/-.
Comprehensive circuit diagram, practical layout and parts lists 2/6 (free with kit).
This kit although similar in appearance to HA34 employs entirely different and advanced circuitry.

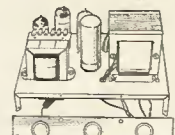

10/14 WATT HI-FI AMPLIFIER KIT

A stylishly finished monaural amplifier with an output of 14 watts from 2 EL84s in push-pull. Super reproduction of both music and speech, with negligible hum. Separate inputs for mike and gram allow records and announcements to follow each other. Fully shrouded section wound output transformer to match 3-15Ω speaker and 2 independent volume controls, and separate bass and treble controls are provided giving good lift and cut. Valve line-up 2 EL84s, ECC83, EF86, and E280 rectifier. Simple instruction booklet 2/6. (Free with parts.) All parts sold separately. ONLY £79/6. P. & P. 8/6. Also available ready built and tested complete with std. input sockets, £95/-. P. & P. 8/6. Carrying Case for above 28/6. P. & P. 7/6.
MATCHED PAIR AM/FM I.F.'s. Comprising 1st I.F. and 2nd I.F. discriminator. (465 Kc/s 10.7 Mc/s). Size 1" x 1 1/2" x 2 1/2" H. Will match FM/AM Tuner head on left. 11/- pair. P. & P. 2/-.

HARVERSON SURPLUS CO. LTD.

170 HIGH ST., MERTON, S.W.19 01-540 3985
Open all day Saturday Early closing Wed., 1 p.m.
A few minutes from South Wimbledon Tube Station. (Please write clearly)
OVERSEAS P. & P. CHARGED EXTRA. S.A.E. with all enquiries



BAKER MAJOR "MODULE"

A new Loudspeaker system featuring the famous 12 inch Baker Major Full range speaker on 19" x 12 1/2" baffle board with 2 1/2" tweeter and crossover. Output 20 watts. Response 30-17,000 c.p.s. Impedance 15 ohms. Ideal mono or stereo conversions of existing cabinets, furniture, etc.

£12.10.0 Post Free
Also available in kit form with instructions £10.19.6
Cabinet Plans and Catalogue Free

(Dept. P.E. 21) **Baker Reproducers Ltd**
Bensham Manor Road Passage, Thornton Heath, Surrey. 01-684-1665

Mini-Drill the new concept in DRILLS



This BATTERY OPERATED precision miniature drills is only 5" long. It incorporates a motor of exceptional power & speed. Drills plastic, aluminium, woods etc. Comes complete with a set of specially designed MINI-TOOLS. Indispensable to all enthusiasts.

ACT NOW - rush 41/- cheque or P.O. to:
E.P. Mail Order Co.
33 Southey St. Nottingham
only **39/6** plus 16p.p.

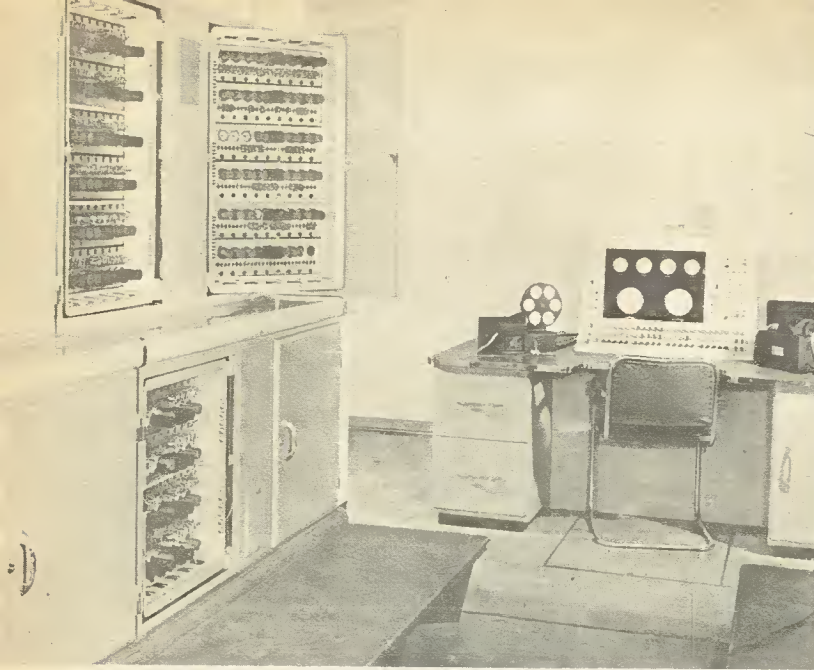

An early electronic digital computer—Ferranti Mk. I—using large valves

The use of the term “memory” for the computer store has been deliberately avoided until now. This is because it could be mistaken as being analogous to human memory. The store is the memory of the computer only in the sense that it can store numbers previously written there by the programmer.

BOOLEAN ALGEBRA

Turning now to the other two sections of the computer, it is necessary to digress for a while into the realms of Boolean algebra. This is a most amusing algebra that produces such results as $1 + 1 = 1$.

Beneath a light-hearted exterior though, lurks a highly sophisticated and powerful tool for performing mathematical functions on binary numbers. It also has its applications in the control and routing of signals in the computer, so this is a convenient place to study it.

There are three main functions in Boolean algebra, the simplest being “inversion”. This changes a “1” into a “0”, and *vice versa*. In algebraic terms, if a binary number A is inverted, it becomes \bar{A} (pronounced “not A ” or “ A bar”).

Currently use I.B.M. System 360 digital computer

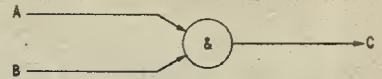

Fig. 4.3. Basic AND gate symbol

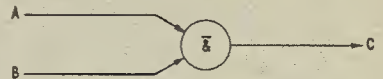

Fig. 4.4. Basic NAND gate symbol

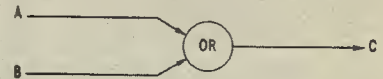

Fig. 4.5. Basic OR gate symbol

The second function is the AND operation. This can be represented in diagrammatic form (as in Fig. 4.3) or else in algebraic form by $C = A \cdot B$ where the dot is used to mean AND.

All that this AND unit does is to give an output C of “1” only when both A AND B are “1”. An extension of this unit consists of an AND followed by an inverter. In this configuration (known as a NAND element), the output C is only a “0” when both the inputs A and B are “1”. At all other times the output is a “1”.

A NAND unit is shown diagrammatically in Fig. 4.4; its algebraic form is $C = \overline{A \cdot B}$.

The third logical function is the OR operation (Fig. 4.5).

This is written algebraically as $C = A + B$, where the $+$ sign represents the word OR. In this case C will be a “1” if either A OR B becomes a “1”. This unit also has its counterpart in “negative” logic in the NOR element, in which the output is the inverse of that of an OR unit.

These logical elements or “gates”, as they are called, are very important in binary arithmetic, and control units of a digital computer. A useful way to keep track of the “1”s and “0”s in a Boolean expression is to use a “truth table”, which sets out in tabular form all the possible combinations of “1”s and “0”s that will satisfy the expression. For example, the truth table of the AND element of Fig. 4.3 is as shown in Table 4.1.

Table 4.1. TRUTH TABLE OF FIG. 4.3

A	B	C
0	0	0
0	1	0
1	0	0
1	1	1

COMPUTER EVOLUTION

S.A. HODSON B.90

BASIC
DIGITAL
CIRCUITS

PART FOUR

THE digital computer is the so-called "electronic brain" of today which is revolutionising our way of life. By applying its fantastic speed and accuracy to routine problems, it can take from our shoulders the burden of such things as accounting, book-keeping, payrolls, statistical analyses, ordering, and so on. The list is almost endless.

It may be remembered that in the first article of this series, it was explained that a digital machine could only work in terms of exact numbers. This is not such a great disadvantage as it may seem, especially in such fields as finance. The progress of the digital computer was left (in Part 1) at the stage where Babbage had to abandon development of his computer through lack of sufficient technical advance in his day. He did not, however, abandon it until he had formulated the basic layout of his machine. This layout is in use in modern computing machines.

Babbage's computer was to consist of three main units: the "mill", the "store", and the "control". Since it was envisaged that all the operations could be performed faster than a man could enter numbers, all data used had to be put into the store beforehand. Then the "mill", or "arithmetic unit", as it would be called today, would operate on the numbers in the store under the supervision of the control unit. The one difference between Babbage's machine and a modern one, is that his had to work with decimal numbers, whilst most modern computers work with binary numbers.

TWO STATES

With the advent of electronics, it is a common experience that electrical or electronic conditions come in pairs or duals; on/off, short-circuit/open-circuit, conducting/non-conducting, forward-biased/reverse-biased, and so on. Seldom, if ever, does an electronic device have more than two states.

Suppose now that the number 153 were to be represented using such two-state devices. Thirty would be needed (10 each for the hundreds, tens, and units). If, instead of units, tens, hundreds, and so on, the numbering system had columns of units, twos, fours, eights, etc. then the highest number in any column would be "1". Hence each column has only two states: "1", and "0", and can thus be represented completely by one electronic device. This numbering system is called "binary notation". Returning to the number 153, in binary this becomes 10011001. Therefore only eight devices are needed to represent it. These devices may be valves or transistors.

A number such as 10011001 is referred to as a computer "word", and is said to have eight "bits". The word "bit" is an abbreviation of "binary digit"; each "1" or "0" is a "bit".

Turning now to the three parts of the computer, the whole machine revolves about its store. There are many types of store; one that is quite widely used, and will serve as an example, is called a "four-wire, coincident current, core store", developed by the Massachusetts Institute of Technology (M.I.T.).

MAGNETIC CORE STORE

A magnetic core is a ring of magnetic material that can be magnetised in either a clockwise or an anti-clockwise sense. One core can store one "bit" of information, the "1" or "0" being signified by the sense of magnetisation of the core.

It is well known that a wire carrying a current generates a magnetic field around itself. If the wire

COMPONENTS . . .

Resistors

R1 64k Ω	R4 8k Ω
R2 32k Ω	R5 4k Ω
R3 16k Ω	*R6 2k Ω
	R7 1.2k Ω

(See text for details)

Potentiometers

VR1 25k Ω skeleton preset
VR2 1M Ω skeleton preset
VR3 1M Ω skeleton preset
*VR4 5k Ω skeleton preset

*VR4 can be used in place of R6 (see text)

Capacitors

C1 0.001 μ F	} polyester 400V
C2 0.01 μ F	
C3 0.1 μ F	
C4 1.0 μ F	} elect. 15V
C5 1.0 μ F	
C6 0.1 μ F	} polyester 400V
C7 0.01 μ F	
C8 0.001 μ F	

Logic Modules

Register/bistable type 43A (6 off)

Multivibrator type 43D (1 off)

NOR gate type 40A (1 off)

All available from Electronics (Prop STC) Ltd., Edinburgh Way, Harlow, Essex.

Diodes

D1, D2 OA81 (2 off)

Meter

M1 500 μ A moving coil type MR52P (Electroniques)

Switches

S1 Two-pole, 4-way rotary wafer switch

S2 Single pole, on/off, push button, normal open

S3 Double-pole, on/off, toggle switch

Plug and socket

PL1 and SK1 3-way panel mounting

Miscellaneous

Datum box type DD585 (Electroniques)

Veroboard, 61 \times 44 holes, 0.1in matrix with copper strips (2 off) (Electroniques type VC695-44)

Batteries 4.5V flat pack (3 off)

The total resistance between the output point on binary 1 and earth is made up from 64 kilohms plus the total effective parallel resistance of 32k Ω , 16k Ω , 8k Ω , 4k Ω , 2k Ω , and 1.2k Ω .

Total resistance = 64,000 + 554 = 64,554 ohms.

(The parallel resistance of the meter can be neglected.)

The total current flow is therefore

$$\frac{6 \times 10^3}{64,554} = 0.093\text{mA}$$

The potential difference between point A and earth is therefore 0.093 \times 0.554 = 0.051 volts.

If this same calculation is carried out for each combination of logical condition of register, it will be found that for every pulse input the potential at point A will rise by (to the first approximation) 0.05V increments.

To obtain the binary values of resistance necessary for this network, it is best to use conventional $\frac{1}{2}$ watt solid carbon resistors, to the nearest preferred value below the value required. If the surface of the resistor is gently filed, so as to remove some conductive material, the value of the resistor will increase. This process can be done while monitoring the actual value on a good quality meter, or resistance bridge.

An alternative method is to use preferred values for the larger values, matching them to the binary ratios as accurately as is possible. (Remember that there is a tolerance associated with every resistor, and if you are lucky you may hit on a precise binary value.) It will almost certainly be necessary to adjust the lower values, particularly the 2 kilohms. To overcome this problem, the author used a preset potentiometer for the 2 kilohm resistor, and selected values for the rest of the chain.

The worst that can happen if there is a mismatch in the binary ratios is that the increments between voltages associated with the incoming pulses may vary, and in the worst case might even cause a drop back of meter reading, as the register steps from, say, binary 1111 (decimal 15) to binary 10000 (decimal 16).

Although this network obviously controls the display accuracy of the instrument, it should be remembered that there is a certain amount of error associated with reading a meter, and as the full scale of the meter will display, in this case a total of 60 pulses, it will hardly be possible to detect any movement of the needle for a single pulse difference. (Normal accuracy of reading a moving coil meter is 2 per cent.)

Next month constructional details will be given followed by suggestions of input circuits to make this stopclock suitable for:

- Camera shutter speed measurement;
- Human reaction timing;
- Velocity and acceleration measurement.

The binary ratios are chosen so that for every single pulse into the register the current through the resistor chain will increase by one unit, two pulses would give an increase in current of two units and so on in linear steps. This can best be shown, by a simple calculation.

RESISTOR NETWORK

Let us assume that the register is in the "reset" condition. This means that all the outputs will be at level 0, which is, to all intents and purposes, zero volts. As the other end of the resistor network is also held at earth potential no current will flow. On the entry of one pulse into the register, binary 1 will change its output to level 1, which is -6V. We will now have current flowing through the 64 kilohm resistor which can be simply calculated by Ohm's Law.

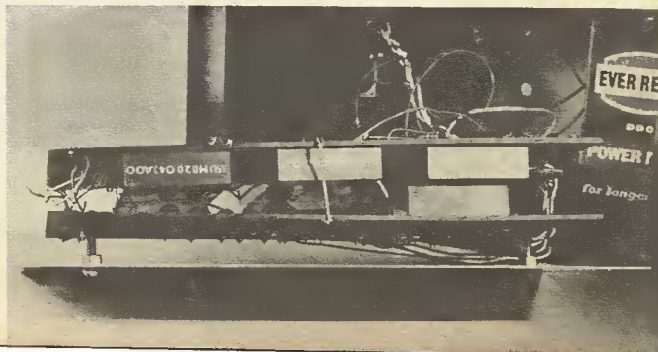



POCKET MULTI-METER

Size $3\frac{1}{2} \times 2\frac{1}{2} \times 1\frac{1}{2}$ in. Meter size $2\frac{1}{2} \times 1\frac{1}{2}$ in. Sensitivity 1000 O.P.V. on both A.C. and D.C. volts. 0-15, 0-150, 0-1000. D.C. current 0-150mA. Resistance 0-100k Ω . Complete with test prods, battery and full instructions, 42/6. P. & P. 3/6. **FREE GIFT** for limited period only. 30 watt Electric Soldering Iron value 15/- to every purchaser of the Pocket Multi-Meter

8-VALVE STEREO RADIOGRAM CHASSIS

3-4 WATTS PER CHANNEL

By Famous Manufacturer

Superb new 8-valve chassis covering long, medium and short waves on AM, also VHF transmissions on FM. AM circuit's high sensitivity permits internal aerial for most stations. Well-known Gorler tuning heart in separate FM input. Tone and volume controls. Extra large illuminated dial. External AM and FM aerial inputs. Gram. pick-up socket. Standard 3 ohm speaker. 200/250 volts A.C. **£14. 14. 0**
Size $17 \times 7 \times 5\frac{1}{2}$ in. deep. P. & P. £1

ANTI-THIEF CAR BURGLAR ALARM

The Melguard Safermatic consists of an electrical device housed in small metal box $4" \times 2" \times 1\frac{1}{2}"$, which has been designed and developed to provide protection required by the average motorist at an economic cost. Using this system, an alarm and the immobilised condition is set automatically as soon as you park the car. Should you leave the key in the ignition, no one but you can drive the car away. Upon entering the vehicle the method of starting the car is by switching on the ignition, depressing two hidden switches and simultaneously operating the starter. Location of the switches is known only to you. Should the alarm be set off it can be stopped by following the normal starting procedure. For 12V operation. List price 79/6 our price 29/6 plus 2/6 P. & P. Full easy-to-follow instructions supplied.

TRANSISTORISED $\frac{1}{2}$ WATT AMPLIFIER

comprising Mullard 2AC 128, 20C 75 and 2 AA129 separate bass and treble volume controls. Complete with Power Supply AC mains 240 v. Size $7\frac{1}{2} \times 3\frac{1}{2} \times 2"$. Price 50/- plus 2/6 P. & P.

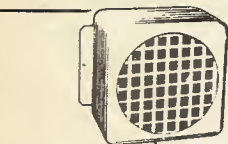
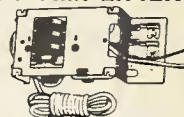

EXTRACTOR FAN

AC Mains 230/250v complete with pull switch. Size $6" \times 6" \times 4"$. Price 27/6 plus 5/- P. & P.



3 to 4 WATT AMPLIFIER

3-4 watt Amplifier built and tested. Chassis size $7 \times 3\frac{1}{2} \times 1$ in. Separate bass, treble and volume control. Double wound mains transformer, metal rectifier and output transformer for 3 ohms speaker. Valves ECC81 and 6V6. **£25.0** plus 5/6 P. & P. The above in Kit Form, **£1.14.6** plus 5/6 P. & P.

40W FLUORESCENT LIGHT KIT

Incorporating GEC Choke size $8\frac{1}{2} \times 1\frac{1}{2} \times 1\frac{1}{2}"$, 2 bi-pin holders, starter and starter holder. 11/6. P. & P. 5/6. Similar to above: 80 W. Fluorescent Light Kit incorporating GEC Choke size $11\frac{1}{2} \times 1\frac{1}{2} \times 1\frac{1}{2}"$, 2 bi-pin holders, starter and starter holder 17/6. P. & P. 6/6. Twin 40 W Choke instant start for 2×2 ft. tubes. 17/6. P. & P. 5/6.

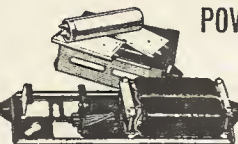
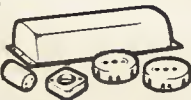

POWER SUPPLY KIT

A.C. MAINS 200-250 V Incorporating "C" core type mains transformer, full wave metal rectification and smoothing condenser. Smooth output 250 v, 250 mA and 6.3v. 4 amp. for Heaters. 25/- P. & P. 9/6.



FIRST QUALITY P.V.C. TAPE

5 $\frac{1}{2}$ " Std. 850ft. ... 9/-	5" L.P. 850ft. ... 10/6
7" Std. 1200ft. ... 11/6	3" T.P. 600ft. ... 10/6
3" L.P. 240ft. ... 4/-	5" T.P. 1800ft. ... 25/6
5 $\frac{1}{2}$ " L.P. 1200ft. ... 11/6	5 $\frac{1}{2}$ " T.P. 2400ft. ... 32/6
7" L.P. 1800ft. ... 18/6	7" T.P. 3600ft. ... 42/6
5 $\frac{1}{2}$ " D.P. 1800ft. ... 18/6	4" T.P. 900ft. ... 15/-

P. & P. on each 1/6, 4 or more post free

Special offer ELEGANT SEVEN mk IIa

SPECIAL OFFER. Power supply kit to purchasers of 'Elegant Seven' parts, incorporating mains transformer, rectifier and smoothing condenser, A.C. mains 200/250 volts. Output 9v, 100 mA. 9/6 extra.

Buy yourself an easy to build 7 transistor radio and save at least £10.0.0. Now you can build this superb 7 transistor superhet radio for under £4.10.0. No one else can offer such a fantastic radio with so many de luxe star features.

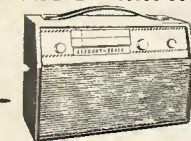

ONLY £4.4.0
Plus 7/6 Post & Packing

- ★ De luxe grey wooden cabinet size $12\frac{1}{2} \times 8\frac{1}{2} \times 3\frac{1}{2}"$.
- ★ Horizontal easy to read tuning scale printed grey with black letters, size $11\frac{1}{2} \times 2"$.
- ★ High 'Q' ferrite rod aerial.
- ★ I.F. neutralisation on each separate stage.
- ★ D.C. coupled push pull output stage with separate A.C. negative feedback.
- ★ Room filling output 350mW.
- ★ Ready etched and drilled printed circuit board back printed for foolproof construction.
- ★ Fully comprehensive instructions and point to point wiring diagrams.
- ★ Car aerial socket.
- ★ Fully tunable over medium and long wave, 168-535 metres and 1250-2000 metres.
- ★ All components, ferrite rod and tuning assembly mount on printed board.
- ★ 5" P.M. Speaker.
- ★ Parts list and circuit diagram 2/6, free with parts.

600mW SOLID STATE 4-TRANSISTOR AMPLIFIER

Features NPN and PNP Complementary Symmetrical Output Stage. The elimination of transformers ensures maximum efficiency and frequency response. Automatic heat compensation. Combined AC/DC feed back. Class B output stage, i.e. output power is proportional to total current consumption, this ensures long battery life. Under no signal condition (IQ) current drain is approx. 12mA at 9 volts (4mA in the output pair). Printed circuit construction, size: $2\frac{1}{2} \times \frac{3}{4} \times \frac{1}{2}"$. Speaker output impedance 12 ohms. Output power 600mW at 5% distortion, 400mW at 2.5% distortion, 750mW at 10% distortion. Supply 9 volts. Total current consumption at a reasonable listening level approx. 35-40mA at full power (speech and music), average 65mA. Sensitivity for 50mW output is 10mV. Frequency response -3db points 90 c/s and 12 Kc/s. Price 15/- plus 1/- P. & P.

NEW Transistorised SIGNAL GENERATOR

Size $5\frac{1}{2} \times 3\frac{1}{2} \times 1\frac{1}{2}"$. For IF and RF alignment and AF output, 700 c/s frequency coverage 460 Kc/s to 2 Mc/s in switched frequencies. Ideal for alignment to our Elegant Seven and Musette. Built and tested. 39/6. P. & P. 3/6.



8-WATT 4-VALVE PUSH-PULL AMPLIFIER & Metal RECTIFIER

Size $9" \times 6" \times 11"$. A.C. Mains, 200-250 v. 4 valves. For use with Std. or L.P. records, musical instruments. All makes of pick-ups and mikes. Output 8 watts at 5 per cent of total distortion. Separate bass and treble lift control. Two inputs, with controls for gram. and mike. Output transformer tapped for 3 and 15 ohm speech coils. Built and tested. **£4.4.0.** P. & P. 11/- 8" \times 5" Speaker to suit. Price 14/6 plus 1/6 P. & P. Crystal Mike to suit 12/6 plus 1/6 P. & P.

BSR Tape deck

AC 200/250 v., tape speed $3\frac{1}{2}$ twin track.

Special price £5.19.6
Post and packing 7/6



GEC KETTLE ELEMENT

3,000W WITH AUTOMATIC EJECTION 200/240 v. size of hole required $1\frac{1}{8}"$. List Price 32/- Our PRICE 15/- P. & P. 1/6.

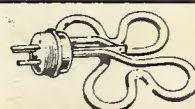

RADIO AND T.V. COMPONENTS (ACTON) LTD.

21D HIGH STREET, ACTON, LONDON, W.3

Shop hours 9 a.m. to 6 p.m. Early closing Wednesday. Goods not despatched outside U.K. All enquiries stamped addressed envelope. Terms C.W.O.

Also at 323 EDGWARE ROAD, LONDON, W.2
Early closing Thursday
PERSONAL SHOPPERS ONLY
All orders by post must be sent to our Acton Address

potentiometer on each side of the unit. In practice, these can be used to calibrate the slowest scale when the equipment is completed. The ranges are selected by means of a ganged, double-pole, four-way switch.

On close inspection TR3, which is contained within the module, forms the active element of a double input NOR gate, one input being taken straight from the emitter of TR2, the second via a resistor from pin 2. This NOR gate is used to control the outflow of pulses from the multivibrator.

A logic level 1 on pin 2 will cause TR3 to go into conduction, or "bottom", and the output level at pin 25 will stay at level 0 irrespective of the state of the multivibrator. It should be noted that the gating operation merely controls the outflow of pulses and does not stop the multivibrator running.

Although only four ranges have been chosen for this instrument, there is no reason why this should not be extended in the "slower" direction with higher value capacitors. Rather than have ranges as multiples of 10 it might be better to have overlapping scales, which could lead to higher accuracies on the final instrument.

There is, however, a limit to the fastest speed of operation and this is set by the parameters of the modules. The manufacturer specifies a maximum pulse repetition frequency of 10,000 p.p.s. which means the shortest period would be 0.1ms, which would be obtained using cross-coupling capacitors of 500pF each.

The power requirements for this stage are -9V at 15mA, and +4.5V at 300mA. The preset potentiometers across the 1μF capacitors are taken straight to the -9V line.

INPUT "OR" GATE

The circuit shown in Fig. 3 comprises two germanium diodes. If both input points are in condition 0 the output will stay at 0; however, if either, or both the

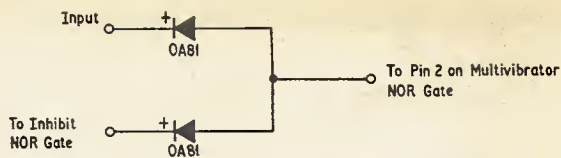

Fig. 3. Input OR gate

inputs go to level 1 the output will rise to level 1 and therefore block the output from the multivibrator. Although it is possible to buy this circuit ready made as a module, it was felt hardly worth while due to the simplicity of this particular stage.

BINARY STAGES AND REGISTER

The six stage binary register comprises six identical modules, the circuit of one being shown in Fig. 4.

The module used is a type 43A bistable/register element. Generally speaking, this module can be used as a "set", "reset" bistable, a shift register stage, or a binary divider, depending on which input points are used, and also on the interconnections between pins.

In this application, we wish to use the latter facility and, in order to achieve a complementary changeover on the entry of pulses from a single line, it is necessary to provide the internal pulse steering circuits which will route the incoming pulse to the correct side of the bistable. Without going into great detail, this is done by coupling the output of one side back to the capacitive input of the same side, this is then repeated for the complementary side of the bistable. Thus we have to link pin 7 to pin 2 on one side, and pin 4 to pin 9 on the other side externally.

As we have only single-line entry, it is also necessary to couple the two capacitive input points together (pins 25 and 26). Pins 1 and 10 both have to go to a

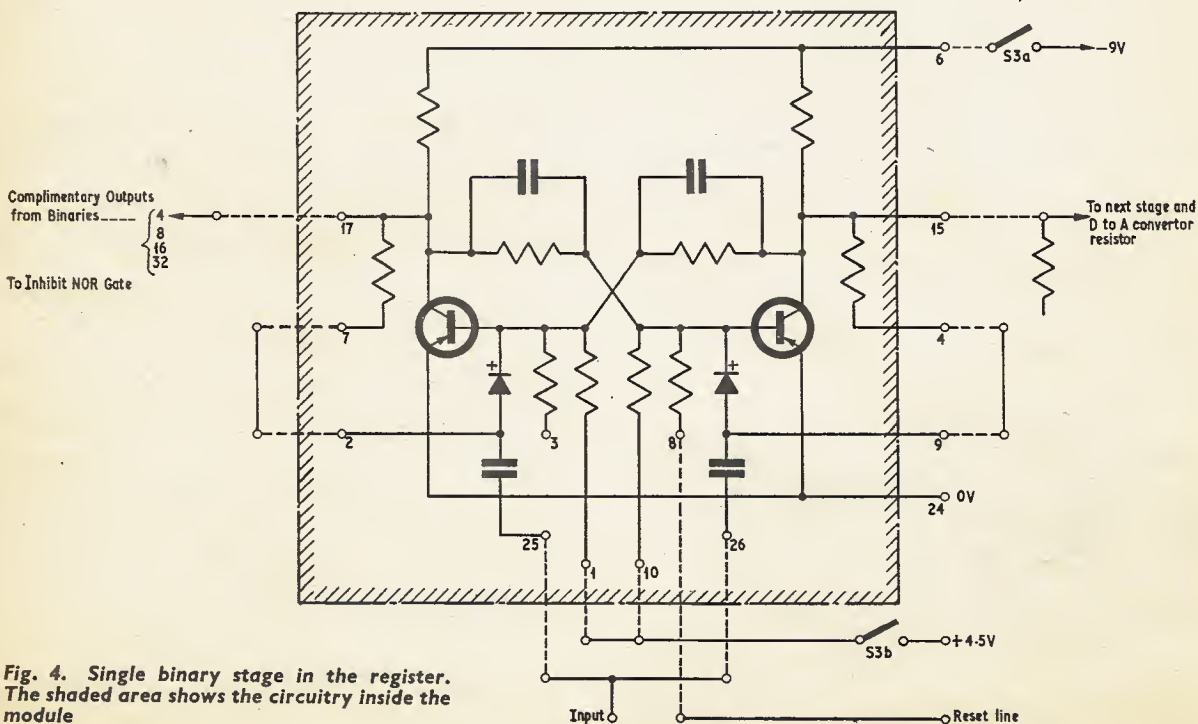

Fig. 4. Single binary stage in the register. The shaded area shows the circuitry inside the module

This is termed "negative logic" and all descriptions of operation will be based on these criteria. Germanium transistors are used throughout, and this in part accounts for the fact that negative logic is used in this system.

BASIC SYSTEM

Fig. 1 shows a block schematic diagram of the timer unit. Basically, it consists of a built-in "clock", the multivibrator, which can be switched to run at various pre-determined frequencies. The output from this clock is a series of square pulses having constant mark/space ratio. These pulses are fed through a NOR gate into a binary divider unit, sometimes called a ripple counter.

Each stage of the register is a clocked flip-flop with outputs coupled back to the inputs, thus on entry of each clock pulse, the stage will divide by a factor of 2. Each stage is cascaded to the next and, with six stages as in this unit, the final stage will divide by 32.

Assuming that the register starts in a "reset" state, i.e. all the binary outputs are at level 0, the register will accept a total of 63 clock pulses before it completes the full circle and returns to the condition when all outputs are at 0.

The NOR gate between the multivibrator and the register is present to allow the external stimulus to control the flow of pulses from the clock into the register. Assuming the input stimulus continued for more than 63 clock pulses, the register would return to the reset state, and continue counting on a second lap.

It would, therefore, be very difficult to tell what figure had been counted at the end of a period such as this. To prevent this "overflow" and recycling occurring, an "inhibit circuit" is incorporated which prevents any further pulses from the clock entering the register when the register is full, or, in this case, nearly full.

This "inhibit" circuit is simply a further 4 - input NOR gate coupled to the complementary outputs of the last four stages of the register. When the register has counted to 60, the complementary outputs of the last four stages will be in condition 0, then the output from the inhibit NOR gate changes from level 0 to level 1.

This signal is fed back through the input OR gate to the multivibrator NOR gate, which blocks the flow of any further pulses. Apart from preventing overflow, this simple arrangement allows us to work with a total register count of 60 which is a much simpler figure (arithmetically speaking) than 63.

It will be seen from Fig. 1 that the output of each binary stage of the register has associated with it a resistor which is commoned at one end, and taken via a 25 kilohm potentiometer to a meter. This simple resistor network is, in effect, a digital to analogue converter. This circuit converts the total count held in the register into an output current, which is displayed on the meter; the higher the count, the higher the reading on the meter.

OPERATING FUNCTION

Whenever a level 1 appears at the input point, clock pulses are prevented from entering the register, irrespective of whether or not the inhibit circuit has been brought into operation.

Let us assume that at the time of switching the instrument on, the input level is at level 1. When switched on, the register will take up a random condition depending on internal tolerances of the individual binaries, the output meter will therefore give a reading.

Before any measurement can be carried out, the register must be reset so that all the binary outputs are at level 0. This is done by applying a level 1 signal to all the direct "reset" entry points of the binaries simultaneously. In this instrument, this is accomplished merely by pressing the reset button. The output meter should now read zero.

Assuming that the multivibrator is generating pulses at the rate of 50 pulses per second, and we allow the input logic level to drop to state 0 and remain in this condition for 0.5 second before returning to level 1, we should theoretically allow 25 pulses to pass into the register.

There is, however, a chance that the multivibrator was already halfway through a cycle as the NOR gate was opened, therefore we may only count 24 pulses—this is one source of error in the equipment, but it can never be

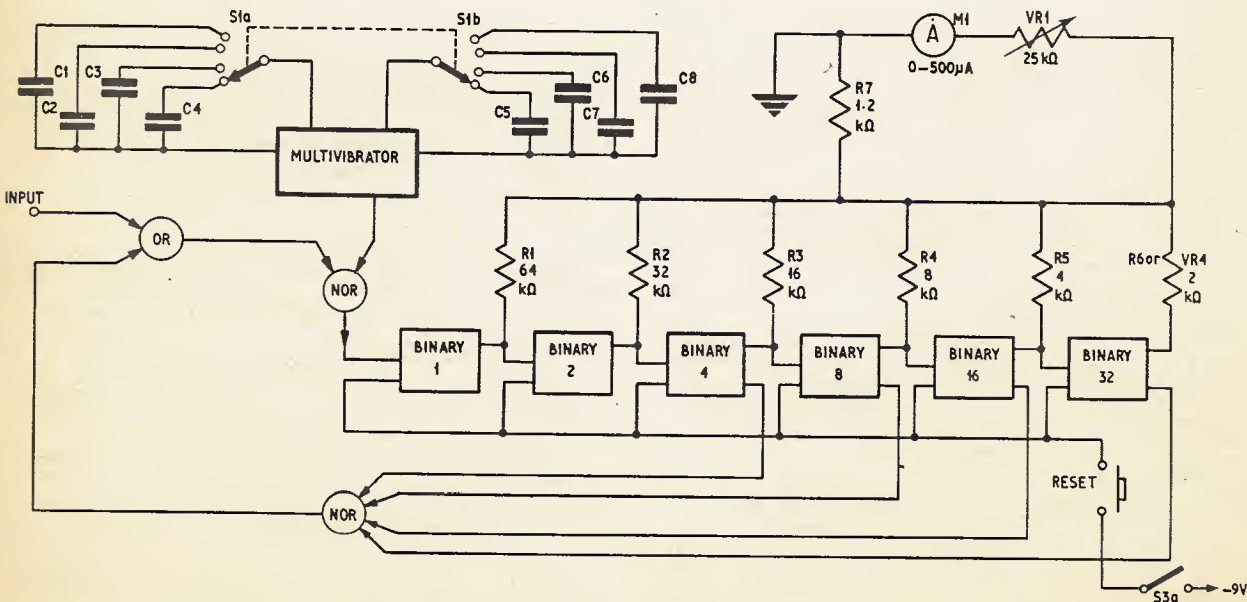
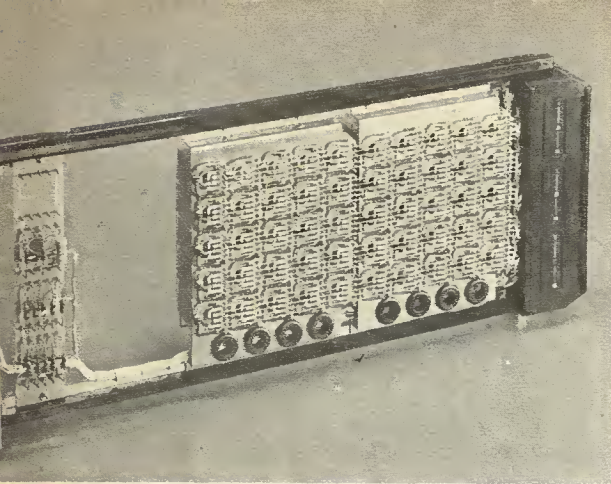

Fig. 1. Block diagram of the main timer unit



View of a typical switching unit incorporating fifty reed relay sets

quickly the faulty section. Test points on the front of the units then enable strategic parts of a circuit to be checked before the replacement of the faulty unit.

To eliminate any possibility of a fault remaining undetected for long periods, as could occur during a low calling rate period, test calls are passed through the system every eight minutes.

IN SERVICE

The modular design and use of registers and high speed electronic circuits combine to give an inherent flexibility to improve certain features and to introduce new services as the demand arises.

Among the improved features is the simplified method of barring outgoing and incoming calls, which is readily imposed by the appropriate threading of a lead through the class-of-service field.

An improvement in the private branch exchange (PBX) facility dispenses with the customary practice of reserving groups of numbers for possible PBX extensions; any directory number can be used for a PBX group of lines.

As the dial pulse counter can accept pulses at a greater rate than 10 pulses per second, a higher speed dial is now practicable. Even more useful in these days of subscriber trunk dialling (STD) when up to 10 digits are required on national calls and up to 15 digits on international calls, is the introduction of push-button telephones in place of dial telephones. In local calls within the exchange, the called subscriber will be rung by the time the last button is released.

On calls to exchanges of the electro-mechanical type, push-button signals have to be converted into 10 p.p.s. signalling until such time as multi-frequency signalling is introduced between exchanges.

Another new service is the ability for a subscriber to transfer incoming calls made to his directory number, to any of a specified group of subscriber stations, by dialling an appropriate code. This subscriber is also allowed an ex-directory number so that close associates having this private information are able to communicate with the subscriber, such as an off-duty doctor, while normal incoming calls are on transfer. A variant of this facility allows transfer of incoming calls to a recorded announcement to indicate that the subscriber does not wish to receive calls.

The Pentex system also makes it possible for a subscriber to dial the extension of a private automatic branch exchange without being routed through a switchboard operator.

A further facility is abbreviated dialling whereby a subscriber is allocated a list of short dialling codes representing directory numbers he frequently calls.

Other facilities which are being developed include 3-way conference calls, call-waiting, and an alternative transfer facility enabling calls to be transferred to any number rather than to an allocated group.

CONCLUSION

The exchange at Ambergate is currently serving 700 subscribers and by the end of 1967 a further six exchanges should be serving the public; thereafter new exchanges of this type will be put into service at a rate of more than one a week. This new system, embracing the use of the latest electronic techniques and components, and by virtue of the centralised control system, has exceptional flexibility in adapting to and providing new services and facilities.

With the progressive introduction of faster signalling in the national trunk network and the introduction of push-button telephones, the system will enable subscribers to enjoy "instant" switching and improved transmission performance. ★

The calling number generator and jumper frame of the Pentex electronic system

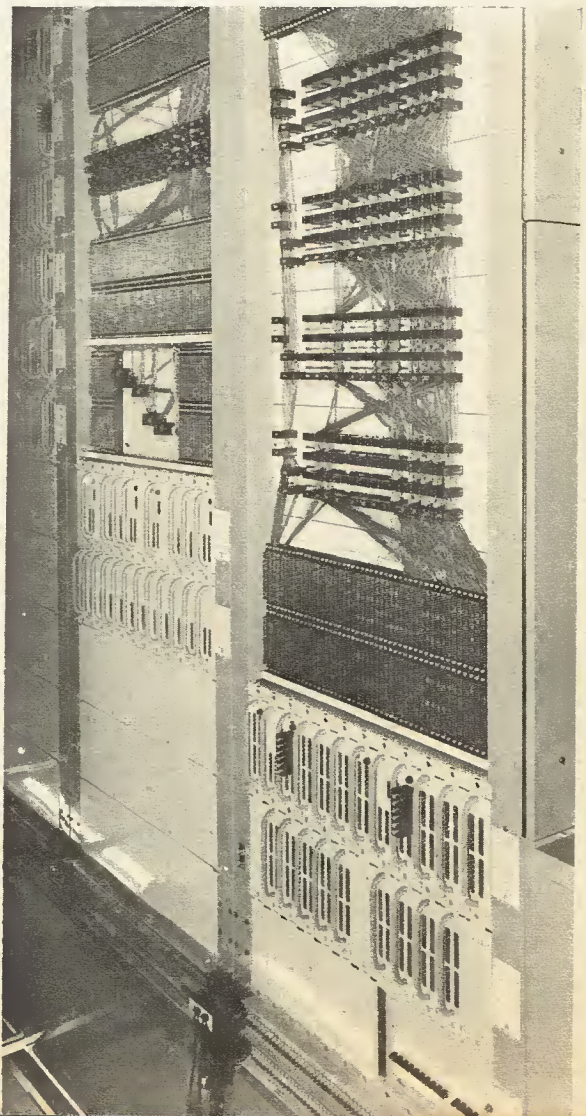
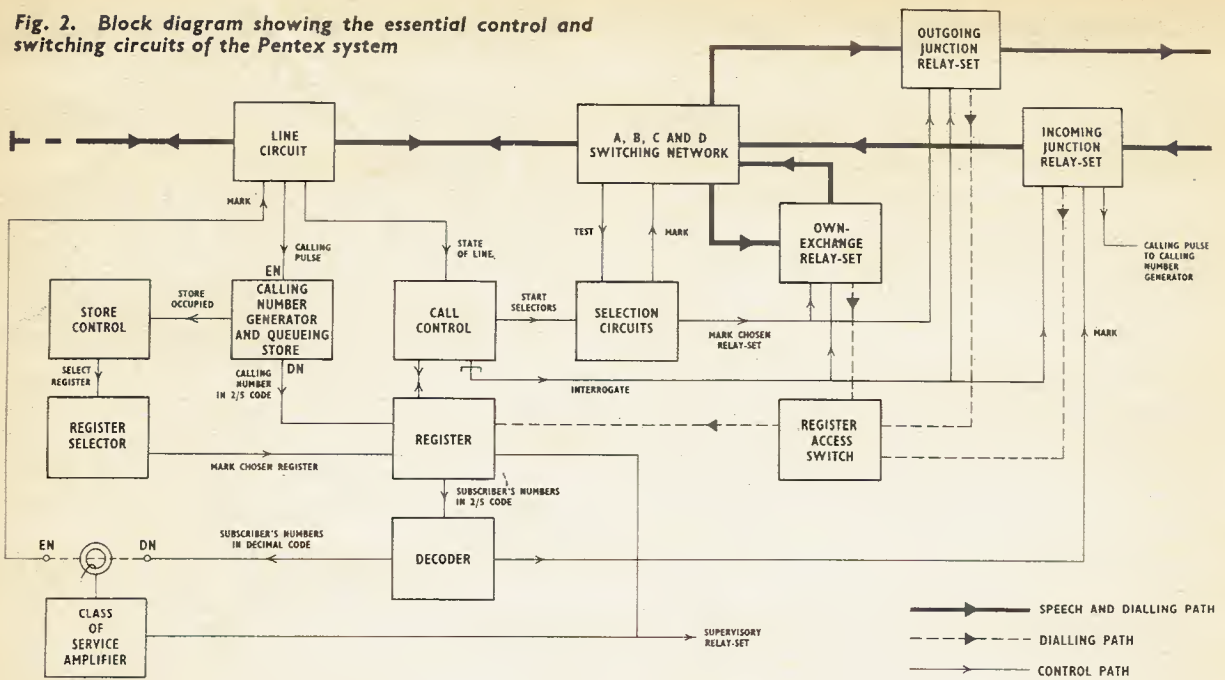

Fig. 2. Block diagram showing the essential control and switching circuits of the Pentex system



the register again requests access to the Call Control which instructs it to pass the called subscriber's number to the decoder, resulting in the marker relay of the called subscriber (2132) being operated.

Call Control checks over the test lead that the called subscriber is free, and then instructs the speech path selectors to choose a path from the originating exchange relay set, which is already connected to the calling subscriber, via the *D*, *C*, *B*, and *A* switches to the called subscriber's line circuit.

The establishment of this path is confirmed over the test lead by Call Control which then releases the register and itself from the call. This sequence also takes approximately 50 milliseconds. The "own exchange" relay set sends ringing tone to the calling subscriber and ringing current to ring the called subscriber's bell, and supervises the call throughout its duration.

LITTLE SIMILARITY

From these very brief descriptions of the two systems, it can be seen that there is little similarity. The step-by-step final selector and the "own exchange" relay set perform similar functions in that each supervises a call, giving ringing tone and ringing current, providing meter pulses, monitoring the end of the call and arranging release. Each must be provided according to the number of calls established in the exchange; a final selector can give access to 100 directory numbers and must be provided according to the probability of how many of these 100 subscribers will be making simultaneous calls. In Pentex, the "own exchange" relay set is available to all subscribers and must be provided according to the probability of the number of simultaneous "own exchange" calls.

In the step-by-step system the setting up of the path is geared in time to the pulses produced by the dial. The frequency (nominally 10 pulses per second) and duration of these pulses are critical. In the electronic system, it is not critical and the dial pulse counter has

been designed to receive pulses at speeds up to 20 per second.

Having compared the two systems let us now take a closer look at the equipment used in Pentex.

REED RELAYS

The whole of the speech switching network is made up of reed relays. Four reed contact units are mounted inside a screened coil which provides the required electromagnetic force to operate the reed contact units. The reeds, which are gold-plated over their contact areas, are sealed in a glass tube containing a gas mixture ensuring a long life free from contamination. The overall dimensions of the relay are 2in × 1in × 1in, which compares favourably with the conventional 3000 type of up to 4in × 2½in × 1in.

The reed relay is quite fast in operation, taking approximately 1ms to operate and 0.5ms to release. It is, therefore, suitable for many applications in the common control of the exchange. It is used exclusively for storing digits in a 2 out of 5 code, the four contacts per relay providing an easy means of decoding into decimal. Circuits which have to operate faster, such as the selectors and the calling number generator, use semiconductors.

CALLING NUMBER GENERATOR

In some types of electronic exchanges, the identity of a calling subscriber is discovered by scanning all lines in sequence. The Pentex system is too small to allow the cost of such scanning equipment, so the calling subscriber is identified in the following manner.

When the subscriber lifts his handset the line relay is operated. A contact on this relay discharges a charged capacitor producing a pulse of current approximately 1A in magnitude and 20μs in duration. This pulse is fed along a wire to the calling number generator (Fig. 3), which consists of an array of metal tape transformer cores arranged in rows of ten, each row



ELECTRONIC TELEPHONE EXCHANGES

By
G.A. MATTHEWS B.Sc.

PLESSEY

TELECOMMUNICATIONS

GROUP

THE END of 1966 marked the beginning of a new era in the field of telecommunications. A major step in Britain's aim to "go all electronic" with its telephone switching system was achieved with Europe's first production electronic exchange entering public service at Ambergate in Derbyshire.

Known as the Post Office TXE2, it was developed by Plessey in conjunction with the Post Office under the auspices of the Joint Electronic Research Committee. A similar system is marketed by Plessey under the name PENTEX. TXE2 is intended primarily for rural and small urban areas where subscriber demand lies in the appropriate range of 200 to 2,000 lines. It is the first full-scale electronic exchange to be integrated into the national network and the forerunner of many similar exchanges now in full production.

The new exchange at Ambergate operates on the space division principle with a sectionalised and duplicated common control.

CONVENTIONAL EXCHANGE

In order to appreciate the differences between electronic exchange systems and conventional electro-mechanical exchanges, let us first briefly look at the basic working methods employed in the conventional exchange.

The existing step-by-step electro-mechanical exchange is a sectionalised control system where individual switching stages are associated with and controlled by the pulses made by dialling particular digits of a telephone number.

Briefly, this system uses uniselectors and two-motion selectors for its switching stages. A uniselector is an electromagnetic rotary switch with wipers scanning 25 groups of outlet contacts; in the two-motion selector the wipers are stepped vertically by the dial pulses, past banks or levels of contacts to the selected bank or level; at this level the wipers make a rotary horizontal scan over ten groups of contacts in the bank.

ELECTROMECHANICAL ROUTING

The subscriber's telephone is connected to a subscriber's uniselector (Fig. 1) which, when the subscriber lifts his handset, searches for a free first group selector, which returns dial tone. If a subscriber (number 2114) dials 2132, the pulses representing the digit 2 lift the wipers of the first group two-motion selector to "level 2" bank of contacts, over which they hunt horizontally for a free second group selector connected to that level.

This group selector will respond in a similar way to the second digit 1, extending the subscriber to a free final selector connected to level 1. The third digit 3 will lift the wipers of the final selector to level 3, and the final digit 2 will step the wipers to the second outlet on that level. This outlet will be connected to telephone 2132 and the final selector will send ringing tone to the calling subscriber and ringing current to ring the called subscriber.

When the called subscriber answers, the ringing tone and current are removed and one pulse is recorded on the calling subscriber's meter for charging purposes. When the call is completed, the final selector detects this condition and releases all the switches held in the connection.

TWO ELECTRONIC GROUPS

Electronic telephone exchanges can be classified into two groups: time division and space division. In the

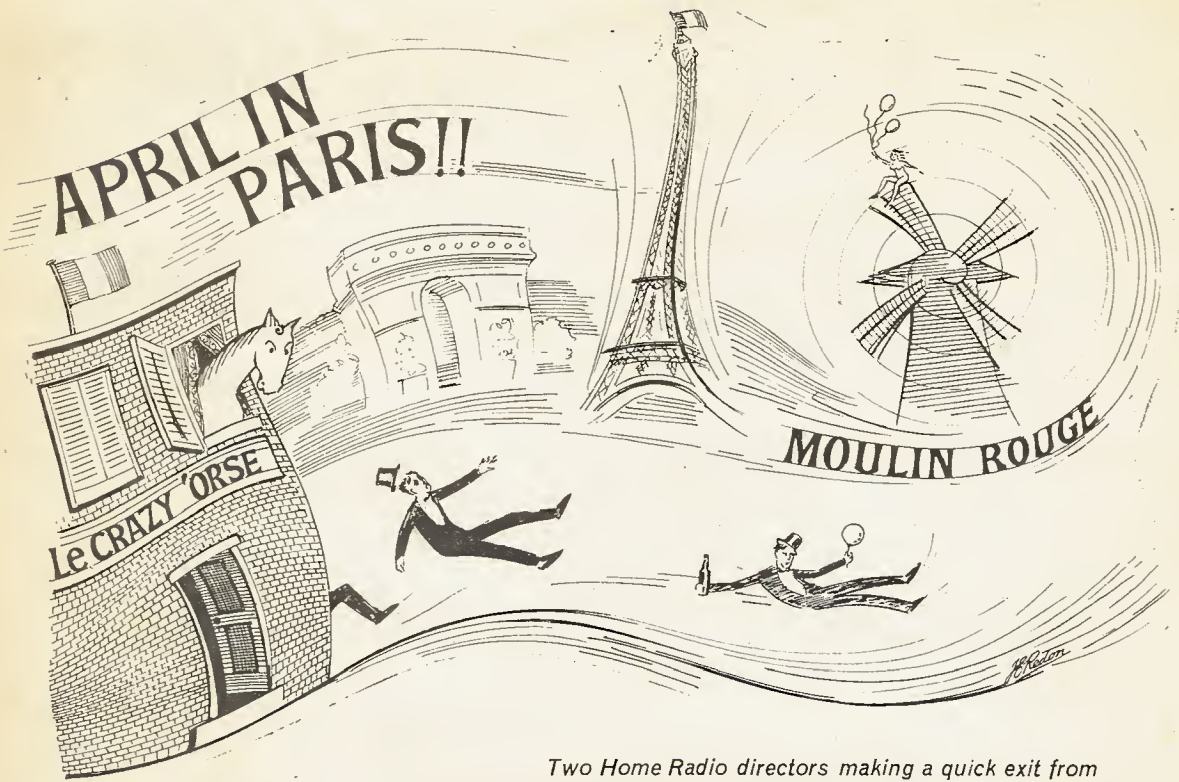

Two Home Radio directors making a quick exit from the Crazy Horse Saloon, following an unsuccessful attempt to find some new components. (What we did see was certainly not new—neither was it very adequately insulated!)

You can take the above cartoon just as seriously or as unseriously as you choose. The fact is that two of us from Home Radio **did** go to Paris last April to visit the Electronic Components Exhibition. It is one of the finest exhibitions of its kind in the world—we have been regular visitors for several years. Moreover, **wherever** there is an important exhibition of this kind you will find us there, for we are keen to keep up with the very latest developments in electronics, and to list the cream of the components in our catalogue. Only in this way can we ensure that our catalogue is really comprehensive and up to the minute, and that it will maintain its reputation as one of the finest component catalogues available.

If **you** wish to keep up to the minute, electronically, you certainly need not spend a fortune and weeks of your time touring

round the world's exhibitions. You simply have to spend nine shillings (our catalogue costs 7/6 plus 1/6 p. & p.) and a minute or two of your time sending the cheque or P.O. with the attached coupon. Your catalogue will be sent by return post. We guarantee you will be delighted with its contents—especially with the page containing 5 vouchers, each worth a shilling when used as directed!

Please write your Name and Address in block capitals

Name

Address

Home Radio Ltd., Dept. PE, 187 London Road, Mitcham, CR4 2YQ



DISTRIBUTED EXCLUSIVELY BY
SEMICONDUCTORS
 BI-PRE-PAK LTD., DEPT. A.
 222-224 WEST ROAD, WESTCLIFF-ON-SEA, ESSEX
 PHONE: SOUTHEND (0502) 46344

FANTASTIC! BARGAINS OF THE YEAR!

No.	DESCRIPTION	PRICE
A1.	6—Silicon rectifiers BY100 type	20/-
A2.	10—Relays mixed types and voltages	20/-
A3.	20—Mixed marked and tested trans.	20/-
A9.	1—2N 174 real power trans. 80V 150W	20/-
A16.	2—Power Comp. Pair. AD161/2	20/-
A17.	3—Sil. stud recs. 6 amp. 400 PIV. BYZ12	20/-
A18.	2—Sil. stud recs. 10 amp. 300 PIV.	20/-
A20.	1—AUY10 VHF power trans. 60 Mc/s 70V	20/-
B1.	50—Unmarked untested, trans., new	10/-
B2.	4—Solar cells, inc. Book of Instructions	10/-
B3.	4—OA5 gold bonded, diodes Mullard	10/-
B5.	7—Matched set. OC44, 45/81D/81 + diode	10/-
B6.	15—Real spot AF trans. or white spot RF	10/-
B8.	2—Power trans. OC28/36 type	10/-
B9.	1—Light sensitive cell, ORP12 type	9/-
B10.	10—50V trans. germ. PNP latest type	10/-
B44.	1—Tunnel diode, AEY11, 1050 Mc/s	10/-
B21.	2—Sil. recs. 10 amp., 50-100 PIV	10/-
B52.	30—Trans. new tested, but unmarked	10/-
B42.	5—Switching trans. TK292 STC	10/-
B45.	1—Power trans. ADY22/TK400A VCB60 IC 8 amps. PNP	10/-
B47.	10—Sil. stud recs. 3 amp. unmarked, untested	10/-
B49.	2—Power trans. GET 9 VCB64 IC 8 amp. germ. PNP	10/-
B50.	2—Light sensitive cells ORP60 type	10/-
C2.	1—Uni junction, 2N2160 or 2N2646	15/-
C4.	2—RF power trans., OC22 and BUY11	15/-
C31.	4—Sil. recs. 800 PIV 2 amp. top hat	15/-
C32.	2—Power trans. TK400A/NKT404 VCB64 IC 8 amp.	15/-

GENUINE TRANSISTORS NOT REMARKS			
OC45	1F transistor	1/9	OA9 Equal to OA5 2/-
OC44	Osc. transistor	1/11	OC36 Power transistor (better than OC35) 7/6

NEW FACTORY TESTED PRE-PAKS. ALL PERFECT BUT UNMARKED			
50	Germ. Min.	DIODES	10/-
10	Silicon 750 mA Top Hat	RECTIFIERS	10/-
5	3 amp. Silicon	STUD RECS.	10/-
30	All types	TRANSISTORS	10/-
40	Silicon Sub. Min.	DIODES	10/-
10	NPN Silicon	TRANSISTORS	10/-

TRANSISTORS	PRICE	BFY50	15/-	OC170	2/6	2N1309	7/6
AC107	6/-	BSY25	10/-	OC171	4/-	2S303	2/6
AC126	2/8	BSY26	5/-	OC200	5/-	POWER TRANSISTORS	
AC127	2/8	BSY27	5/-	OC201	3/8	OC20	10/-
AC128	3/-	BSY28	5/-	2G301	2/8	OC23	10/-
AC129	5/-	BSY29	5/-	2G303	2/8	OC25	8/-
AF114	4/-	BSY95A	5/-	2N697	5/-	OC26	5/-
AF115	3/-	OC41	2/6	2N706	5/-	OC28	5/-
AF116	3/-	OC71	2/6	2N711	10/-	OC35	5/-
AF117	4/-	OC72	2/6	2N1302	4/-	DIODES	
AF118	3/8	OC73	5/-	2N1303	4/-	AAV42	2/-
AF119	3/8	OC81	2/6	2N1304	5/-	OA10	2/-
AF178	10/-	OC81D	2/6	2N1305	5/-	OA70	1/9
ASY76	2/-	OC83	4/-	2N1306	6/-	OA79	1/9
BCZ11	7/8	OC139	2/6	2N1307	6/-	OA81	1/9
		OC140	5/-	2N1308	8/-	OA182	2/-
						1N914	1/8

'FREE' ★ ★ SEND FOR OUR **FREE** LISTS AND CATALOGUE OF ALL OUR PRODUCTS. CHECK YOUR OWN EQUIVALENTS WITH OUR FREE SUBSTITUTION CHART.

LARGE RANGE—LOW COST SILICON CONTROLLED RECTIFIERS. SEND FOR FULL RANGE AND CIRCUIT DIAGRAMS. **FREE OF CHARGE.**

GREAT NEWS ★ ★ We now give a written guarantee with all our semiconductors.

FIRST EVER LOGIC KITS. Learn for yourself how computers work, even make one for yourself. Full instructions for a number and crosses machine, binary counters, timers, etc. L.1. 5 gns. L.2. 10 gns. No need to purchase both kits, you can start with L.2. which incorporates L.1. **DETAILS FREE.**

MAKE A REV. COUNTER FOR YOUR CAR. THE 'TACHO BLOCK'. This encapsulated block will turn any 0-1mA meter into a perfectly linear and accurate rev. counter for any car. State 4 or 6 cylinder. **20/- each**

NO CONNECTION WITH ANY OTHER FIRM. MINIMUM ORDER 10/- CASH WITH ORDER PLEASE. Add 1/- post and packing per order. **OVER-SEAS ADD EXTRA FOR AIRMAIL.**

RADIOGRAM CABINETS ONLY £5.19.6

An attractive discreetly designed space saving cabinet in natural grained polyestered sapele. Press-drop flap for autochanger and record storage compartment. 10" x 5" speaker position. Complete with legs. DIM. 29½" H x 14½" D x 29" W. Carr. Ins. 25/-.

OTHER MODELS—SEND FOR LIST

17 in. TWO-YEAR GUARANTEE EX-RENTAL TELEVISIONS £11.10.0

3 star Guarantee ★ Tube ★ Valves ★ Components
Channels for all areas Insured Carriage 30/-

FREE ILLUSTRATED LIST

Slim line models
17" — 19" — 21" — 23"

A wide range of sizes, models and prices.

Demonstrations daily



TRANSISTOR CASES
7/6, 9½" x 6½" x 4½"
P. & P. 3/6.

TRANSISTOR CASES
19/6. Cloth covered, many colours. Size 9½" x 6½" x 3½"
P. & P. 3/6. Similar cases in plastic 7/6.



TAPE RECORDER CABINETS 49/6
Dia. 16" x 12½" x 7½". Red and Grey. Cut out for BSR deck.
P. & P. 7/6.

SINGLE PLAYER CABINETS 19/6. P. & P. 7/6.

T.V. TURRET TUNERS 2/6. New Less Valves. Slim Models 5/-. Press Button Models 19/6. P. & P. 4/6.

DUKE & CO. (LONDON) LTD.
621/3 Romford Road, Manor Park, E.12
Phone: 01-478 6001-2-3. Stamp for Free List.

TWO COMPUTERS

Two kinds of computers—analogue and digital. Two different animals. Analogue are a bit like guinea pigs; you can experiment with them without having to test the real thing. Analogue circuits simulate the conditions of complex mechanical or electrical systems. Digitals are like dogs trained to cross a busy road—they need to be programmed. You have to analyse the situation and produce a step-by-step description of the task to be performed; the digital device will then faithfully follow your instructions.

MAC-I is the Mini-Analog Computer. Its electrical circuitry simulates the conditions of a wide variety of calculations and problems. Multiplication, division, logs, trig, powers and square roots can be ascertained at the touch of a button—and rotation of the calibrated dials. The Experimental Instruction Manual lays down a simple step-by-step procedure for each of these operations; with just a little practice 9 year-olds are able to get accurate results in a few seconds. The Manual also relates the computer to the wider problems of electronics, physics and mechanics.

Now available in a wooden instrument case, MAC-I costs £4.18.6 (inclusive). It is expertly built using the latest cable-form techniques, and supplied with 4½ volt battery. A complete kit can be purchased at 4 gns. There is a 10 day return guarantee. Write for details.



DIGI-COMP is an operating digital computer. It represents the nerve-centre of a giant electronic brain; and because it is mechanical, you can actually see how computers make 'decisions'. The highly descriptive Instruction Manual (written with 10 year-olds in mind) offers many different experiments; they are organised around the basic operations — of binary arithmetic, logical problems, and the theory of games such as 'Guess the number' and 'Nim'. The 50 page Advanced Booklet lucidly analyses the programmes, and is intended for those seriously interested in the logic of computer design.

DIGI-COMP costs only 59/11d (£3.10.6 to include the Advanced Booklet). This computer is now available to schools and the public on a free trial basis. Please write for the trial-offer leaflet.

I-COR SYSTEMS (File P.E.8), 18 Stamford Hill, London, N.16

The smallest
set in the
World...



ACTUAL
SIZE

SINCLAIR MICROMATIC

To the fantastically small size of the Sinclair Micromatic must be added its brilliant performance. This British-made set assures you at all times of choice of BBC and many other stations in the medium waveband. After dusk, even more stations come in all round the dial with amazing power and excellent quality. Vernier type tuning takes full advantage of the set's selectivity. This remarkable set provides good listening no matter where you are—indoors, in car, bus, train—everywhere. The Sinclair Micromatic brings a refreshingly new approach to personal listening and for its size, appearance, price and performance, there is nothing to equal it anywhere in the world.

SINCLAIR MICRO FM

7 TRANSISTOR COMBINED FM TUNER AND RECEIVER

Less than 3in. x 1½in. x ½in. F.M. Superhet using pulse counting discriminator for superb audio quality. Low I.F. makes alignment unnecessary. Tunes 88-108Mc/s. The telescopic aerial suffices for good reception in all but poorest areas. Signal to noise ratio—30dB at 30 microvolts. Takes standard 9V battery. One outlet serves for feeding to amplifier or recorder, the other allows set to be used as a pocket portable. Brushed and polished aluminium front, spun aluminium dial. A fascinating set to build which gives excellent reception by any standards. Complete kit inc. aerial, case, earpiece and instructions.

£5.19.6

NEEDS NO ALIGNING FASCINATING TO BUILD
FULL SERVICE FACILITIES AVAILABLE

Technical description

The Sinclair Micromatic is housed in a neat plastic case, size 1½in. x 1½in. x ½in. with attractive aluminium front panel and spun aluminium calibrated tuning dial. Special Sinclair transistors are used in a six-stage circuit of exceptional power and sensitivity—two R.F. amplification; double diode detector; and a high gain three stage audio amplifier which feeds to a specially matched high quality lightweight earpiece. A.G.C. counteracts fading from distant stations. Bandsread brings in "pop" stations extra easily. The set is powered by two Mallory ZM.312 Cells obtainable anywhere for 1/7 each.

Built, tested and guaranteed with earpiece and batts. **79/6**

It (Micro FM) works very well and gives a quality very close to my hi-fi records.
W.J.A., Notal, S.A.

Without doubt the Z-12 is the best value of the present day.
A.W., Lanark

I am absolutely lost for words, it (Micromatic) is one of the most amazing inventions I have ever known.
L.L., Norwich

I am very impressed with the quality of reproduction (Stereo 25).
S.M.W., London, N.W.10

Complete kit in new "see-for-yourself" pack with earpiece instructions and solder

59/6

sinclair

SINCLAIR RADIONICS LTD., 22 Newmarket Rd., CAMBRIDGE

Telephone OCA3-52996

BARGAIN OPPORTUNITIES FROM



VEROBOARD—All standard sizes including 2 1/2in x 6in 3/8; 2 1/2in x 8 1/2in 3/4; 3 1/2in x 6in 5/8; 3 1/2in x 8 1/2in 3/4; 2 1/2in x 17in 12/8. All accessories and tools in stock.

OUR NEW LISTS

feature more lines than ever at money saving prices. For latest issue please send

6d.

Please include S.A.E. with all enquiries.

GARRARD UNITS & PLINTHS

LM 3000 Record Player with 9T.A. Stereo Cartridge. Brand new as from factory... 8 gns

AT.60 Mk II De-luxe Auto-changer, die-cast turntable. Less cartridge... £10.19.5

SP.25 De-luxe single record player, die-cast turntable. Less cartridge... 9 1/2 gns

Packing and carriage on any one of above 7/6 extra.

Garrard Plinth. Ideal mounting for the Garrard Units offered here. Will readily suit any hi-fi set-up. In fine Teak. Complete with useful soft plastic dust cover. Packing and carriage 5/-... 75/-

Garrard clear-view rigid perspex cover (carriage 3/6)... 57/6

Garrard Mono Cartridges from 15/-; Stereo from 25/-.

TRS MULLARD AMPLIFIERS

STEREO 10-10

Valve amplifier to exact Mullard spec. With pre-amp, tapped o/p transformer 3 and 15Ω all controls, H.T. and L.T. outlet, mono, stereo and speaker phase switching. Complete with escutcheon, knobs, plugs, etc. Ready built (p. & p. 12/6) **£20.00**

Kit form due shortly (p. & p. 12/6) **£17.10.0**

5-10 MONO

5 valve, 10W high amp kit complete. (p. & p. 7/6) **£9.19.6**
with passive control network and panel **£11.19.6**
2 valve pre-amp kit **£8.12.8**

3-3 MONO

3 valve 3W amplifier with controls, absolutely complete kit including panel, knobs, etc. (p. & p. 7/6) **£7.10.0**

ONLY FROM T.R.S. FREE LIBRARY WALLET WITH EVERY REEL

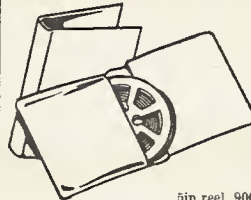

With each reel of this tape by an internationally famous manufacturer we give you a beautifully made wallet strongly made in simulated leather with space for a reel of tape each side. This is professional quality full frequency tape with metallised leader/stop foils. These library wallets solve once and for all the problems of storing tapes efficiently and tidily.

7in reel 1800ft with wallet **22/6**

5in reel, 900ft with wallet **12/6**
p. & p. 1/6 per reel

5 1/2in reel, 1200ft or 7in reel 1200ft with wallet **17/6**

7 VALVE AM/FM RG CHASSIS

A superbly powerful high performance instrument for the keenest enthusiasts. Provides tuning on long, medium and F.M. wavebands. Excellent sensitivity. Permeability tuning on F.M. Large clear dial, A.V.C., good neg. feedback. Magic eye. 3W output. A.C. 200/250V. Circuit diagrams available. Aligned, tested and ready for use (Carr. and ins. 7/6). S.A.E. brings full details. **£13.19.6**

TYGAN FRET or Vynair speaker fabric, 12in x 12in 2/-; 12in x 18in 3/-; 12in x 24in 4/-, max. width 48in.
BONDACoust Speaker Cabinet Acoustic Wadding, approx. 1in thick 18in wide, any length cut 2/8 ft 6/- yd.
All latest Sinclair kits and products in stock as advertised.

TRS RADIO COMPONENT SPECIALISTS

Established 1946

70 BRIGSTOCK ROAD, THORNTON HEATH, SURREY

Tel.: 01-684 2188. Hours 9 a.m.—6 p.m. 1 p.m. Wednesdays
A few doors from Thornton Heath Station (S.R. Victoria section)

PEOPLE PREFER MARTIN

FOR RELIABILITY, FOR QUALITY, FOR ADD-ON-ABILITY, FOR ECONOMY



F.M. TUNER



STEREO CONTROL ASSEMBLY

You can do so much with MARTIN kits. The system of using pre-fabricated transistorised units which can be interlinked in a variety of ways enables you to assemble the combination of your choice and then extend it unit by unit until you possess a full stereo gramophone and radio assembly. When new units are produced, they can be added to existing equipment very easily with the advantage that you can continue to use equipment you already have,

so that your installation is always up to date. Most important of all is the power and quality which MARTIN Audiokits give you. Their sturdy construction assures compactness without sacrifice to quality or efficiency. They offer excellent value, are very easily installed and will give years of unflinching service. That is why people prefer MARTIN — it's simple to instal, good to listen to, and looks completely professional.

AMPLIFIER SYSTEMS • TUNERS • RECORDERS

MARTIN AUDIOKITS are available for Mono, and can be doubled up for stereo, or as complete stereo units. 3 ohm and 15 ohm systems are available. There is a special pre-amp for low output pick-ups and escutcheon panels to suit the arrangement you choose. The tuner is styled to match.

- 5-stage input selector **£2.7.6**
- Pre-amp/tone controls **£3.2.6**
- 10 watt amp. (3 ohms) **£5.12.6**
- 10 watt amp. (15 ohms) **£6.12.6**
- Mains power supply **£2.15.0**
- F.M. Tuner **£12.17.6**

MARTIN ELECTRONICS

154 High Street, Brentford, Middlesex
Please send Recordkit/F.M. Tuner/Audiokit Hi-Fi Leaflets. (Strike out items not wanted)

Name

Address

From Radio and Hi-Fi Stockists

Trade enquiries invited

MARTIN ELECTRONICS LTD. 154/5 HIGH STREET, BRENTFORD MIDDLESEX. ISLeworth 1161/2

PE57

HI-FI AMPLIFIERS — TUNERS — RECORD PLAYERS



**FM
TUNERS
FM-4U**



TFM-IS

HI-FI FM TUNER. Model FM-4U. Available in two units. R.F. tuning unit (£2.15.0 incl. P.T.) with I.F. output of 10.7 Mc/s and I.F. Amp. unit and valves (£13.13.0). Total Price Kit **£16.8.0**

HI-FI AM/FM TUNER. Model AFM-1. Available in two units which, for your convenience, are sold separately. Tuning heart (AFM-T1—£4.13.6 incl. P.T.) and I.F. amplifier (AFM-A1—£22.11.6). Printed circuit board, 8 valves. Covers L.W., M.W., S.W., and F.M. Built-in power supply. Total Price Kit **£27.5.0**

STEREO DECODER SD-1. Available as extra for above models. Self-powered. Kit **£8.10.0**. Assembled **£12.5.0**

Hear the BBC stereo FM programmes on the **TRANSISTOR STEREO FM TUNER.** Elegantly designed to match the stereo Amplifier, AA-22U. Available in two units, sold separately, can be built for a Total Price:

Kit (STEREO) **£24.18.0** incl. P.T.

Kit (MONO) **£20.19.0** incl. P.T.

**10W
POWER
AMP.
MA-12**



**9 + 9W
STEREO
AMP.
S-99**



HI-FI MONO AMPLIFIER. Model MA-12. 10W output, wide freq. range, low distortion. Use with control unit.

Kit **£12.18.0** Assembled **£16.18.0**

HI-FI CABINETS. Full details available. MALVERN: Kit **£18.1.0**. GLOUCESTER: Kit **£18.10.0**.

DE LUXE STEREO AMPLIFIER. Model S-33H. De luxe version of the S-33 with two-tone grey perspex panel, and high sensitivity necessary to accept the Decca Gram pick-up. Kit **£15.17.6** Assembled **£21.7.6**

HI-FI STEREO AMPLIFIER. Model S-99. 9+9W output. Ganged controls. Stereo/Mono gram, radio and tape inputs. Push-button selection. Printed circuit construction. Kit **£28.9.6** Assembled **£38.9.6**

TRANSISTOR MIXER. Model TM-1. A must for the tape enthusiast. Four channels. Battery operated. Similar styling to Model AA-22U Amplifier. Kit **£11.16.6** Assembled **£16.17.6**



Enjoy Yourself While You Save

RADIOS

Complete your motoring pleasure with this outstanding car radio, Model CR-1



Will give you superb LW and MW entertainment wherever you drive. Tastefully styled to harmonise with any car colour scheme. 8 latest semi-conductors (6 transistors, 2 diodes) for 12V positive or negative

earth systems. Powerful output (4 watts) will drive two loudspeakers. Pre-assembled and aligned tuning unit. Available for your convenience in two units. Can be obtained for a Total Price: Kit (excl. L.S.) **£12.17.0** incl. P.T. 6" x 4" 3 Ω loudspeaker **£1.4.5**.



Oxford

"OXFORD" LUXURY PORTABLE Model UXR-2. Specially designed for use as a domestic or personal portable receiver. Many features, including solid leather case. Kit **£14.18.0** incl. P.T.



UXR-1

TRANSISTOR PORTABLE. Model UXR-1. Pre-aligned I.F. transformers, printed circuit. Covers L.W. and M.W. Has 7" x 4" loudspeaker. Real hide case. Kit **£12.11.0** incl. P.T.



GC-1U

JUNIOR EXPERIMENTAL WORKSHOP. Model EW-1. More than a toy! Will make over 20 exciting electronic devices, incl.: Radios, Burglar Alarms, etc. 72 page Manual. The ideal present! Kit **£7.13.6** incl. P.T.

"MOHICAN" GENERAL COV. RECEIVER for Amateur or Short Wave listening. Send for leaflet. Kit **£37.17.6** Assembled **£45.17.6**

Prices quoted are Mail Order, retail prices slightly higher

WELCOME TO OUR LONDON HEATHKIT CENTRE

233 Tottenham Court Road, W.1

We open MONDAY-FRIDAY 9 a.m.-5.30 p.m.

SATURDAY ... 9 a.m.-1.0 p.m.

Telephone No.: 01-636 7349

RETAIL AND MAIL ORDER PURCHASE CAN BE MADE

TEST INSTRUMENTS

Our wide range includes:

3" LOW-PRICED SERVICE OSCILLOSCOPE. Model OS-2. Compact size 5" x 7 $\frac{1}{2}$ " x 12" deep. Wt. only 9 $\frac{1}{2}$ lb. "Y" bandwidth 2 c/s-3 Mc/s \pm 3dB. Sensitivity 100mV/cm T/B 20 c/s-200 kc/s in four ranges, fitted mu-metal CRT Shield. Modern functional styling. Kit **£23.18.0** Assembled **£31.18.0**

5" GEN.-PURPOSE OSCILLOSCOPE. Model 10-12U. An outstanding model with professional specification and styling. "Y" bandwidth 3 c/s-4.5 Mc/s \pm 3dB. T/B 10 c/s-500 kc/s. Kit **£35.17.6** Assembled **£45.15.0**

DE LUXE LARGE-SCALE VALVE VOLT-METER. Model IM-13U. Circuit and specification based on the well-known model V-7A but with many worth-while refinements. 6" Ernest Turner meter. Unique gimbal bracket allows operation of instrument in many positions. Modern styling. Kit **£18.18.0** Assembled **£26.18.0**

AUDIO SIGNAL GENERATOR. Model AG-9U. 10 c/s to 100 kc/s, switch selected. Distortion less than 0.1%, 10V sine wave output metered in volts and dB's. Kit **£23.15.0** Assembled **£31.15.0**

VALVE VOLTMETER. Model V-7A. 7 voltage ranges d.c. volts to 1,500. A.C. to 1,500 r.m.s. and 4,000 peak to peak. Resistance 0.1 Ω to 1,000M Ω with internal battery. D.C. input resistance 11M Ω . dB measurement, has centre-zero scale. Complete with test prods, leads and standardising battery. Kit **£13.18.6** Assembled **£19.18.6**.

MULTIMETER. Model MM-1U. Ranges 0-1.5V to 1,500V a.c. and d.c.; 150 μ A to 15A d.c.; 0.2 Ω to 20M Ω 4 $\frac{1}{2}$ " 50 μ A meter. Kit **£12.18.0** Assembled **£18.11.6**

R.F. SIGNAL GENERATOR. Model RF-1U. Up to 100 Mc/s fundamental and 200 Mc/s on harmonics. Up to 100mV output. Kit **£13.18.0** Assembled **£20.8.0**

SINE/SQUARE GENERATOR. Model IG-82U. Freq. range 20 c/s-1 Mc/s in 5 bands less than 0.5% sine wave dist. less than 0.15 μ sec. sq. wave rise time. Kit **£25.15.0** Assembled **£37.15.0**

TRANSISTOR POWER SUPPLY. Model IP-20U. Up to 50V, 1.5A output. Ideal for Laboratory use. Compact size. Kit **£35.8.0** Assembled **£47.8.0**

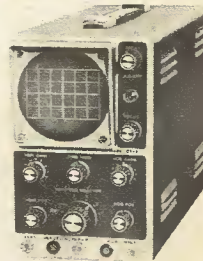

OS-2



VVM, IM-13U



V-7A



RF-1U



IG-82U

Prices and specifications subject to change without notice

RADIONIC

**INDISPENSABLE ALIKE TO:
STUDENT
TEACHER
AMATEUR EXPERIMENTER**

This simple, rugged and versatile construction system is used for electronic instruction in many hundreds of educational establishments throughout Britain—Universities, Technical Colleges, Schools, the Armed Forces—are already using Radionic for electronic instruction. Enthusiastic experimenters range from 9 to 82 years of age.

Selected by the Council of Industrial Design for all British Design Centres. Featured in Sound and Television broadcasts.

The system is beautifully engineered from top quality British components. No soldering. No mains. No prior knowledge needed. Simply arrange components on perforated transparent panel, position brass connecting strip underneath, fix with 6BA nuts and circuit works with full efficiency. You can then dismantle and build another circuit. Your results are guaranteed by our Technical Department and News Letter Service. All parts available separately for conversion or expansion of sets.

UNIQUE! Our "No soldering" printed circuit board for superhet portable. Simply insert components and tighten nuts.

- No. 1 Set £5.18.6. 14 Circuits (Earphone)
- No. 2 Set £6.19.6. 20 Circuits (Earphone)
- No. 3 Set £10.19.6. 22 Circuits (7 x 4in. Loud-speaker output)
- No. 4 Set £14.19.6. 26 Circuits (include 6 Transistor and reflex superhets)

PLUS: P.T. Surcharge of 1/8d; 1/11d; 3/1d; 4/2d, respectively.)

Full details from:

**RADIONIC PRODUCTS LIMITED
STEPHENSON WAY, THREE BRIDGES
CRAWLEY, SUSSEX**

Tel.: CRAWLEY 27028

Trade Enquiries Invited

RADIO & ELECTRONIC CONSTRUCTION SYSTEM

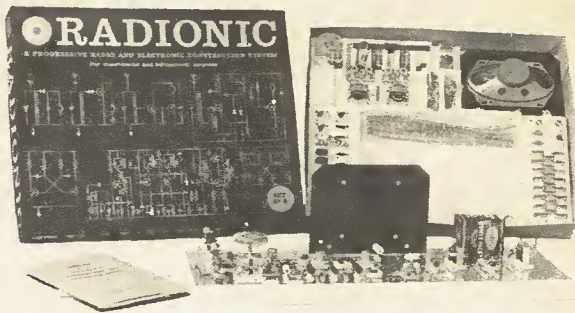

A No. 4 SET and 6-TRANSISTOR SUPERHET

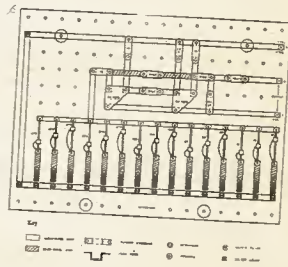
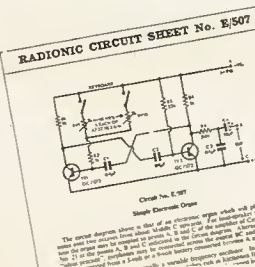

Our 'E' Series of basic electronic circuits are available separately at 9d each. See Electronic Organ (E/507) above.

ERSIN



5 CORE SOLDER

**for quick
easy faultless
soldering**

Containing 5 cores of non-corrosive flux, instantly cleaning heavily oxidised surfaces. No extra flux required. Ersin Multicore Savbit Alloy reduces wear of copper soldering iron bits.



**SIZE 5
HANDY SOLDER
DISPENSER**
Contains 12 ft. coil of 18 s.w.g. Ersin Multicore Savbit Alloy. 2/6 each



SIZE 15
21 ft coil of 60/40 Alloy, 22 s.w.g. in a dispenser. Ideal for small components, transistors, diodes, etc. 3/- each



SIZE 12
Ideal for home constructors. Contains 102 ft. of 18 s.w.g. Ersin Multicore Savbit Alloy on a plastic reel. 15/- each



**BIB MODEL 8
WIRE STRIPPER
AND CUTTER**
Strips insulation without nicking the wire, cuts wire and splits plastic twin flex. Plastic cushioned handles. 8/6 each

From Electrical or Hardware shops. If unobtainable write to:
Multicore Solders Ltd., Hemel Hempstead, Herts.



**PARKERS SHEET
METAL FOLDING
MACHINES
HEAVY VICE
MODELS**



With Bevelled Former Bars

- No. 1. Capacity 18 gauge mild steel x 36in. wide ... Carr. free
 - No. 2. Capacity 18 gauge mild steel x 24in. wide ... £12.10.0
 - No. 3. Capacity 16 gauge mild steel x 18in. wide ... £7.5.0
- Also new bench models. Capacities 48in. x 18 gauge £40. 36in. x 18 gauge £25. 24in. x 16 gauge £24. Carriage free.

End folding attachments for radio chassis. Tray and Box making for 36in. model, 5/6 per ft. Other models 3/6. The two smaller models will form flanges. As supplied to Government Departments, Universities, Hospitals.

One year's guarantee. Money refunded if not satisfied. Send for details.

A. B. PARKER, Folding Machine Works, Upper George St., Heckmondwike, Yorks. Heckmondwike 3997

**The safest, quick and handy connector
for electrical appliances**

**MAINS
Keynector**

Only 5 x 3 x 1 1/2 ins. the MAINS KEYNECTOR is made of non-combustible urea-formaldehyde. Designed in modern style and attractive two-tone colour. The unit eliminates the need of terminating the mains input lead of any electrical instrument or appliance with a plug. Also enables more than one appliance to be connected in parallel and used simultaneously.

Colours: Duo-Green Rating: 13 amp.
Duo-Grey
Duo-Fawn

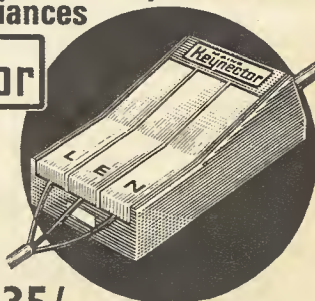

35/-
inc. p. & p.

British and Foreign
Patents applied for

CYBERNAUT CONTROLS LTD. (Ref. P.E.5), 28-30 Rivington St., London, E.C.2

FROM SINCLAIR - A

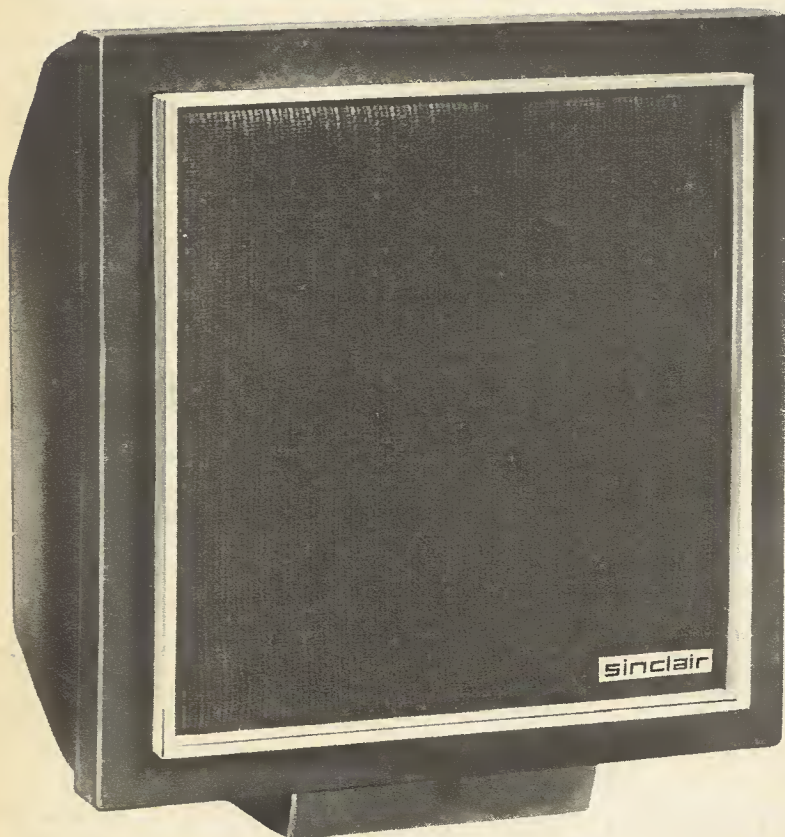

SINCLAIR Q.14

- ACOUSTICALLY CONTOURED SOUND CHAMBER
- WIDE ANGLE OF SOUND DISPERSION
- NEW DESIGN PRINCIPLES AND NEW MATERIALS FOR BRILLIANT TRANSIENT RESPONSE
- MAXIMUM LOADING IN EXCESS OF 14 WATTS AT 1 kc/s R.M.S.
- 15 OHMS INPUT IMPEDANCE
- ALL-BRITISH DESIGN AND MANUFACTURE

The Sinclair Q.14 is an entirely new sound reproducer designed and developed in Sinclair Radionics' Cambridge laboratories. The application of fundamentally proven acoustic principles and the use of new materials has resulted in exceptionally good standards of performance. The uniquely formed pressure chamber of the Sinclair Q.14 allows the instrument to be positioned in a variety of ways to take full advantage of the surroundings in which it will be used. Its shape and size will be found more adaptable in use than conventionally styled cabinets. At the same time, it presents a functionally elegant appearance used singly, paired for stereo or in multiple unit assemblies. In performance, the Sinclair Q.14 compares to advantage with loudspeakers costing over four times its price.

IDEAL FOR THE SINCLAIR Z.12
AND OTHER GOOD AMPLIFIER SYSTEMS

sinclair

SINCLAIR RADIONICS LIMITED
22 NEWMARKET ROAD, CAMBRIDGE

OCA3-52996

ADCOLA

PRODUCTS LIMITED
(Regd. Trade Mark)

SOLDERING EQUIPMENT

for the

DISCRIMINATING
ENTHUSIAST

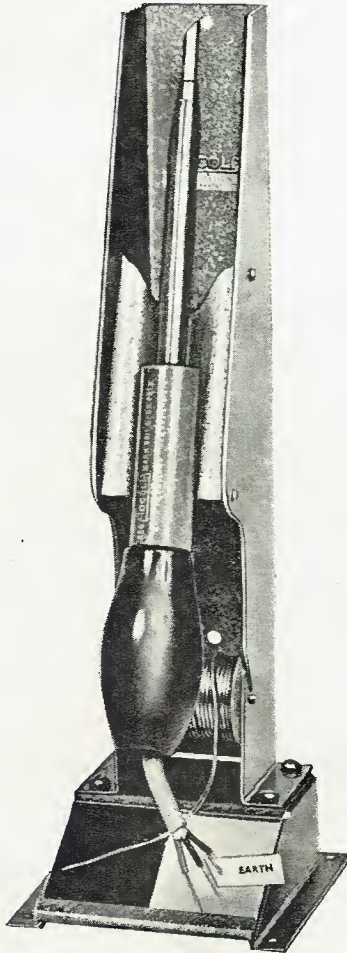

ILLUSTRATED:
L64 $\frac{3}{16}$ " BIT INSTRUMENT IN
L700 PROTECTIVE SHIELD

APPLY DIRECT TO:

SALES & SERVICE DEPT.
ADCOLA PRODUCTS LTD.
ADCOLA HOUSE
GAUDEN ROAD
LONDON, S.W.4
TELEPHONE 01-622 0291

ELECTROLYTIC CONDENSERS

0.25uf. .3V.	4uf. .4V.	16uf. .150V.	100uf. .3V.
1uf. .10V.	4uf. .12V.	20uf. .3V.	100uf. .6V.
1uf. .15V.	4uf. .25V.	20uf. .6V.	100uf. .10V.
1uf. .40V.	4uf. .100V.	20uf. .9V.	100uf. .12V.
1uf. .50V.	5uf. .6V.	20uf. .15V.	100uf. .15V.
1uf. .350V.	5uf. .25V.	25uf. .6V.	150uf. .12V.
1.25uf. .16V.	5uf. .50V.	25uf. .12V.	150uf. .25V.
2uf. .3V.	5uf. .70V.	25uf. .25V.	200uf. .3V.
2uf. .9V.	6uf. .12V.	25uf. .30V.	200uf. .4V.
2uf. .10V.	6uf. .15V.	30uf. .6V.	200uf. .16V.
2uf. .15V.	6.4uf. .40V.	30uf. .10V.	250uf. .2.5V.
2uf. .70V.	8uf. .3V.	30uf. .15V.	250uf. .9V.
2uf. .150V.	8uf. .6V.	32uf. .1.5V.	250uf. .15V.
2.5uf. .16V.	8uf. .50V.	32uf. .25V.	32uf. .2.5V.
2.5uf. .25V.	10uf. .6V.	40uf. .3V.	50uf. .4V.
3uf. .3V.	10uf. .10V.	40uf. .6.4V.	64uf. .2.5V.
3uf. .12V.	10uf. .12V.	50uf. .6V.	75uf. .18V.
3uf. .25V.	10uf. .25V.	50uf. .9V.	100uf. .6V.
3.2uf. .6V.	12.5uf. .4V.	64uf. .2.5V.	
3.2uf. .6.4V.	12.5uf. .40V.	64uf. .9V.	
3.2uf. .40V.	16uf. .16V.	64uf. .10V.	
3.2uf. .64V.	16uf. .30V.	64uf. .40V.	

All at 1/- each, 9/- per dozen. Mixed packet (our selection) 20 for 10/-, 200/100uf., 275V.; 200/200uf., 275V.; 125/300/50uf., 275V.; 5/- each or 3 for 10/-.

PAPER CONDENSERS

0.001uf. .500V.	0.005uf. .750V.	0.1uf. .350V.	0.5uf. .150V.
0.001uf. .1000V.	0.02uf. .600A.C.	0.1uf. .750V.	0.5uf. .350V.
0.002uf. .500V.	0.02uf. .350V.	0.25uf. .500V.	0.5uf. .500V.

All at 15/- per 100, or mixed packet (our selection) 50 for 10/-.

VERY SPECIAL VALUE! SILVER MICA, POLYSTYRENE, CERAMIC CONDENSERS

Very well assorted. Mixed types and values. 10/- per 100.

RESISTORS

Very small $\frac{1}{2}$ watt, 5% long leads, ideal for transistor work, 10/- for 50. $\frac{1}{2}$ watt assorted values including printed circuit types, 10/- for 100, 55/- per 1,000.

$\frac{1}{2}$ watt to 3 watt mixed values and types, 10/- for 100, 55/- per 1,000.

TO CLEAR: 10 Meg. 1/6th watt resistors, £1 per 1,000.

WIRE-WOUND 3 watt, 5 watt—6d each.

7 watt, 10 watt—9d. each.

Most values, 1 Ω to 47K Ω .

TRANSISTORS

AFZ12, Screened V.H.F. oscillator transistors, 5/- each.

OC44, 45, 81D—2/6d each.

OC71 equivalent, 1/- each, £3 per 100.

Switching Transistors ASY22 (npn) or I.B.M. (pnp), 6 for 10/-.

Car radio type Output Transistors type NKT405, 10/- each.

UNMARKED, UNTESTED TRANSISTORS—50 for 10/-.

LIGHT-SENSITIVE TRANSISTORS SIMILAR TO OCP71—2/- each.

TELEVISION VALVES. BRAND NEW AND BOXED

PCF80, 7/6; PL81, 7/6; PCL82, 7/6; PCL85, 7/6; PCL84, 7/6; PCC84, 6/6; PY81, 6/-; ECC82, 6/6; PL36, 9/-; EY86, 6/-; PCL83, 9/-; PY33, 9/-; ECL80, 6/6; PCC89, 9/-.

Silicon diodes. Make excellent detectors. Also suitable for keying electronic organs. 1/- each or 20 for 10/-.

BY100 TYPE TELEVISION H.T. RECTIFIERS, SPECIAL PRICE 5/- each, 30/- dozen.

ORP12 light sensitive resistors, 9/- each.

TRANSISTOR BATTERY ELIMINATORS—same size as PP9, 30/-; PP6, 20/-.

BATTERY CHARGERS, with meter and fuse, 4 amp, 6/12V., 55/- each.

SOLOMON MODEL 615 Slim Pencil-bit Soldering Irons, 25/- each.

WELLER DUAL-HEAT SOLDERING GUN, 57/6.

NUTS, SCREWS and WASHERS, very useful assorted packs, 6/- each.

TRANSCEIVERS (not for use in U.K.), £7/10/- pair.

SIGNAL INJECTOR, parts and circuit to make, 10/- only.

SIGNAL TRACER, parts and circuit to make, 10/- only.

MOTOR CAR REV. COUNTER (less 1mA meter), parts and circuit to make, 10/- only.

TRANSISTORS, COMPONENTS AND CIRCUIT to convert 1mA meter to 0 to 10 Meg. ohm meter, 10/-.

TRANSISTORISED RUMBLE AND SCRATCH FILTER (for improving reproduction of old records), all components and circuit, 30/-.

SINCLAIR. All products in stock including latest version of MICRO-6—World's smallest radio—and only 59/6!

NEEDLES FOR RECORD PLAYERS. HALF PRICE!

All types below at 3/6 each!

TC8LP; GC2LP; GC8LP; BF6LP; GP6LP; GP37; GP59; TC8 Stereo LP;

Studio O LP.

CARTRIDGES

SONOTONE MONO, 10/-; ACOS, 15/-; ACOS STEREO SAPPHIRE 12/6;

DIAMOND, 17/6. All complete with needles!

LAPEL MICROPHONES, Magnetic or Crystal, 10/- each.

TAPE RECORDER MICROPHONES, Fantastic value at 12/- each.

ACOS MIC. 45, 30/-; Many others, both crystal and dynamic in stock.

THIN CONNECTING WIRE. 10yd., 1/-; 100yd., 7/6; 500yd., 25/-;

Post 4/6. 1,000yd., 40/-; Post 6/-.

LOUDSPEAKERS. 12in. Richard Allen, 37/6d. 12in. Bakers Guitar,

£5/3/-; 3in., 4in., and 5in x 3in., all at 10/- each; 8in. x 2 1/2in.,

13/6; 2in. 80 ohm, 7/6.

EARPIECES. Magnetic or Crystal, 5/- each.

VEROBOARD

2 1/2in. x 5in., 3/11; 2 1/2in. x 3 1/2in., 3/3; 3 1/2in. x 5in., 5/6; 3 1/2in. x 3 1/2in., 3/11.

Terminal Pins, 50 for 3/-; Spot Face Cutter, 7/3; Pin Insert Tool, 9/6.

Special Offer—Cutter and 5 boards, 2 1/2in. x 1in., 9/9.

ORDERS BY POST—TO G. F. MILWARD, 17 PEEL CLOSE,

DRAYTON BASSETT, STAFFS.

PLEASE INCLUDE APPROPRIATE POSTAGE COSTS

No Enquiries without stamped addressed envelope

For customers in the Birmingham area, goods may be obtained from:

Rock Exchanges, 231 Alum Rock Road, Birmingham 8