

Practical Electronics

NOVEMBER 1965

PRICE 2/6



BUILD THE P.E.
DOORPHONE

FREE INSIDE

2 FULL
SIZE
BLUEPRINTS
AND
DATA CHARTS

Tubes

HIGHEST QUALITY
COMPARE OUR PRICES

Cart. A Dis. 12 6

	GUARANTEED		NEW TYPES
	6 Months	12 Months	
MOST MULLARD.	12in.	£2. 0.0	£3. 0.0
MAZDA, COSSOR,	14in.	£2.10.0	£3.10.0
EMITRON, EMI-	15-17in.	£3. 5.0	£4. 5.0
SCOPE, BRIMAR,	19in.	£3. 5.0	£4. 5.0
FERRANTYPES	21in.	£3.15.0	£5.15.0
PROCESSED IN OUR OWN FACTORY	23in.	£3.15.0	£5.15.0

SATISFACTION GUARANTEED

Autochangers, etc.

LATEST GARRARD

All Factory Fresh. All with cartridge.
SRP10 Mono (Single) Player, £11.9.0.
SP25 Semi-Transcription (Single), £11.9.0.
AUTOSLIM Standard Auto, £5.19.0. AT5 Auto (Limited Number), £8.19.0. AT6 Slimline similar to AT6, £7.15.0. Model 1.000 Compact low priced record changer, automatically playing up to 10 records, £8.19.0. Model 2.000 Automatic record changer with large turntable, playing up to 8 records, £7.19.0. Model 3.000 Designed for use with high-compliance cartridges, low-mass arm, exceptionally low record wear, £10.10.0. AT60 Automatic or manual operation, has precision arm, bias compensator and heavy turntable, £11.19.0. A70 For the critical user offers automatic playing, with pusher-platters, and many other features, £19.19.0. LAB80 An outstanding automatic transcription turntable for professional reproduction, £25. 30.1. Transcription Heavy Table, £22. 40.1. Transcription turntable with heavy 12in. turntable, machine-cut strobe, neon lamp and speed control, £29.19.0. Model 50 Automatic record changer with large turntable, weight-counterbalanced arm and phono pickup head, £9.10.0. B.S.R.

GU7 Single Desk Complete, £4.5.0.
UA14 or U25 Auto Changer, £5.15.0.

PRICES SLASHED

LZ27 TAPE RECORDERS. Famous make, latest Silver Grey finish, 4 inputs, 2-speed 3" x 7 1/2in. Complete with microphone, footage counter, volume level indicator, tone control, scene speed. This machine takes 2in. speeds and is a full size Recorder, not a toy! Price normally £17.10.0 £30.9.0. 2-p.p.p. **£17.10.0**

WALKIE TALKIES TYPE RT33. The very latest Silver Black finish. They give a fantastic performance with reliability, long telescopic aerial, crystal controlled. Note a licence is required to transmit. They compare with much dearer models. 2-p.p.p. **£8.19.0**

MEMO CALL. Pocket sized battery operated tape recorder, complete with tape, earphone, built-in speaker. Normally £12.10.0. A must for those who want to record telephone conversations, ideas, letters, etc., whilst travelling or home. 2-p.p.p. **£8.10.0**

TELEPHONE AMPLIFIER. "Desk Companion". A larger model complete with pen and holder, etc. Fully portable and transistorised. A must for the desk leaving both hands free to deal with papers, etc., etc. 2-p.p.p. **£3.10.0**

25 WATT GUINAR SPEAKERS. Very heavy cone 12in. cast chassis. There is nothing to touch it for power handling and quality at the price **£4.19.0** Plus 2-p.p.p.

BINATONE 10-TRANSISTOR. All wave set, complete with telescopic aerial, earphone, leather case, medium size, superb performance. Not to be confused with cheap sets, **£10.19.0** amazing value.

MULTI-METERS, TK.20.A. 8 Ranges AC/DC Current, Resistance 0-100K. 49 6 moving coil. EP.10.K. 10,000 OHM. High quality. 15 Ranges AC/DC Current, Resistance, Accuracy $\pm 3\%$. **£3.19.6**
EP.20.K. 20,000 OPV, more sensitive version of EP.10.K. **£4.19.6**

EP.30.K. 30,000 OPV, 15 Ranges, including Resistance to 1M. **£6.19.6**
EP.40.K. Professional Quality, 22 Ranges AC/DC Voltage, Current, Resistance. Details Call prices **£9.19.6**

TEST EQUIPMENT. FT-1 Transistorised Signal Injector, complete with Transistor Oscillator with Indicator Lamp, Detachable Test Probe and instructions. **35/-**

IDEAL FOR ANY RECORDER. PRICES SLASHED. GUARANTEED APPROX. 1 PRICE. WORLD FAMOUS MAKE BY ENORMOUS PURCHASE.

★ TAPE ★

We offer you fully tensoned polyester, taylor and P.V.C. tapes of identical quality hi-fi, wide range recording characteristics as top grade tapes. Quality control manufacture. Not substandard in any way. Try one for yourself. They are truly worth a few more pence than acetate, sub-standard, jointed or cheap imports. Try one and prove it for yourself!

	Standard Play	Double Play
4-31	190ft. 2 3/4	300ft. 4
4-32	200ft. 4 1/4	400ft. 8
4-33	300ft. 7 1/4	1200ft. 15
4-34	500ft. 10 3/4	1800ft. 19 1/2
4-35	1200ft. 13 3/4	2400ft. 27
	Long Play	Triple Play
4-36	225ft. 2 3/4	300ft. 13
4-37	450ft. 5 3/4	1800ft. 25
4-38	900ft. 10 3/4	2400ft. 34
4-39	1200ft. 13 3/4	3600ft. 44
4-40	1800ft. 18 3/4	5400ft. 58

Postage 1/- or Post Free less 5% on three reels. Quantity and Trade enquiries invited.

AM FM RADIOS

Latest wonderful styles, guaranteed top make, 10-transistor with full long and medium waves. Size 9 1/2" x 6 1/2" x 12 1/2". Magnificent reproduction. A pleasure to look at. "An ambassador in its class". 12 months' guarantee against faulty manufacture. Genuine retail price £25.7.6. Carpenters' **17 Gns.**

QUALITY PORTABLE TAPE RECORDER

Fabulous quality and reproduction of music. 6 transistor, 1 1/2in. and 3 1/2in. speeds. Output 500mW into high quality speaker. Ingenious single control knob. Fast forward and rewind. Battery level and record level meter. Fast load. Precision cassette drive with dynamic earphone monitor recording. Radio recording leads. Outside speaker facilities. The most outstanding portable in the country. Size 8 1/2" x 4 1/2" x 6 1/2". Genuine normal price of 35 gns. Unrepeatable. 12 months' guarantee. All spares available. With tape, tape reel, mikes, etc. **19 Gns.**

VALUE IN VALVES

GUARANTEED 3 MONTHS BY RETURN OF POST

Satisfaction or Money Back Guarantee on goods if returned unused within 14 days on ALL VALVES ARE NEW 1.0.0. LESS OTHERWISE INFORMED. FREE TRANSIT INSURANCE. POSTAGE 1/- over 6d. 2-11 1/2. Free over 1.

OZ4 4	6K8GT 6	20L1 16	DL92 5	EZ80 5	9 U22 4	9 8
1A7GT 83	6K7 5	20P1 9	DL94 6	EZ81 6	U22 12	14 2
1C6GT 7	6K7G 2	20P2 12	DL96 7	FC4 8	U25 10	6
1D5 7	6K7GT 4	20P3 17	EA50 13	FWA 5007 7	U28 8	6
1D8 9	6K9G 5	20P5 15	EAB080 6	GT1C 12	U31 7	7
1A5GT 8	6K8GT 11	25AGT 2	EAC9Y 4	GZ32 12	U31 14	17
1L 3	6K25 8	25B6GT 7	EAF42 8	GZ34 11	U35 12	6
1LD5 4	6L1 9	25Y5G 8	EB34 13	HK90 9	U37 26	26
1LN5 4	6L8G 7	25Z4G 7	ED41 5	HL1ADD 8	U50 4	9
1N5GT 8	6L18 7	25Z5 8	EB91 3	HN309 10	U52 4	9
1R5 5	6L19 11	25Z6G 8	EB333 4	HVR2 8	U78 5	6
1U5 5	6LD20 7	27SU 17	E634 4	KT92 6	U78 4	6
1S4 7	6N7 6	30C1 9	EC81 7	K33C 4	U107 12	6
1S5 4	6P1 9	30C15 11	EBF80 7	KT38 14	U191 11	6
1T4 3	6P25 8	30P5 7	EBF83 9	KT44 6	U281 9	6
2D21 5	6P23 9	30FL1 9	EBF89 7	KT55 17	U282 12	6
3A4 4	6Q6G 8	30L1 6	ELB21 10	KT61 11	U301 12	6
3A5 8	6Q7G 9	30L15 9	E634 7	N78 17	UBF85 6	6
3B4 4	6R7G 9	30P4 9	EC91 4	KT68 13	U328 9	6
3Q4 7	6SA7 5	30P12 7	EC92 8	KT78 3	U339 11	6
3C4 5	6SC7 4	40P19 13	EC631 7	KT88 19	U403 10	6
3V4 6	6SC7 4	40P11 9	EC632 4	KTW61 5	U404 6	6
3R4GT 9	6SH7 3	30PL13 8	EC633 4	KTW62 6	U801 17	6
4A5 8	6SH7 3	30L15 9	EC634 7	KTW63 5	U801 17	6
5U4G 6	6SK7 3	35L8GT 7	EC635 5	KTW66 11	UBF89 7	6
5V4G 7	6SL7GT 5	35W4 6	EC636 9	L67 3	UB41 7	6
5Y3G 4	6SN7GT 4	35Z4GT 5	EC637 5	LN152 6	UB41 7	6
5Y3GT 5	6GQ7 5	35Z5GT 7	EC638 6	MU14 7	UB41 7	6
5Y4G 9	6SS7 3	4 4 1 6	EC639 6	N37 10	UBF89 7	6
5Z4 9	6U4GT 9	42 6	EC640 7	N78 17	UBF85 6	6
5Z4G 7	6V8G 4	50B5 7	EC641 8	N108 17	UB41 7	6
5Z4GT 9	6V8GT 6	50C5 8	EC642 8	N152 8	UC92 7	9
6 30L2 9	6X4 4	50L6GT 7	EC643 8	P41 7	UC684 9	9
6A6 3	6X5G 5	53KU 9	EC644 8	P61 2	UC685 7	6
6A7 7	6X5GT 6	61BT 17	EC645 11	PAB300 8	UCF80 10	6
6B7 9	6Y6T 10	61ST 7	EC646 11	PC93 11	UC684 9	6
6B8GT 12	7B7 7	62BT 13	EC647 8	PC94 6	UC684 9	6
6AC7 3	7C5 7	7 5 6	EC648 7	PC84 6	UC684 9	6
6AG5 2	7C8 7	7 8 5	EC649 8	PC85 7	UL32 9	12
6AG7 6	7H7 7	7 3 8	EC650 8	PC88 11	UC133 9	12
6AK5 5	7Y4 6	8 3 6	EC651 8	PC89 9	UF41 8	6
6Z4 9	7Z4 6	8 5 8	EC652 8	PC189 12	UC132 12	6
6AM6 3	8D3 3	185BTA 19	EC653 10	PC89 9	UF80 3	6
6AQ5 6	10C1 11	807 7	EC654 10	PCF2 7	UF85 7	6
6AT8 5	10C2 14	813 4	EC655 10	PCF84 12	UF89 3	6
6AU8 7	10F1 4	862 14	EC656 10	PCF86 11	UL41 8	6
6AV6 5	10F3 10	882A 12	EC657 8	PC182 7	UL44 14	14
6B7 9	10F8 10	85BT 10	EC658 7	PC183 9	UL48 13	6
6B8G 3	10LD11 14	855 2	EC659 11	PC184 7	UL84 6	6
6BA6 5	10P13 8	856 2	EC660 11	PC185 10	UM80 3	6
6BE6 5	10P14 9	8625 5	EC661 8	PC186 10	UR1C 7	6
6HG6 15	10P18 7	6080 7	EC662 10	PC50-BR 1	PE25 3	6
6BH6 6	12A6 2	6057 9	EC663 8	PC50-A 2	PCN45 8	6
6B9 8	12A8 11	6067 7	EC664 8	PC50-B 2	PCN46 6	6
6BQA 6	12AT6 6	6783 7	EC665 10	PC50-C 4	PCN 4	6
6BR7 8	12AT7 5	6901 3	EC666 6	PCF86 11	PCN 4	6
6BR5 9	12AUX 9	9002 4	EC667 6	PCF86 11	PCN 4	6
6BW8 7	12AU7 6	9003 5	EC668 6	PCF86 11	PCN 4	6
6BW7 5	12AV6 6	9AT4 2	EC669 6	PCF86 11	PCN 4	6
6C4 2	12AX7 6	9401 7	EC670 6	PCF86 11	PCN 4	6
6C5 5	12BA6 7	A241 7	EC671 6	PCF86 11	PCN 4	6
6C6 6	12BE6 6	B36 6	EC672 6	PCF86 11	PCN 4	6
6C9 11	12BH7 8	C1C 8	EC673 6	PCF86 11	PCN 4	6
6CD6G 18	12C8 5	CB31 13	EC674 6	PCF86 11	PCN 4	6
6CH6 6	12E1 17	CH35 13	EC675 6	PCF86 11	PCN 4	6
6D2 3	12H6 1	CV1 7	EC676 6	PCF86 11	PCN 4	6
6D3 9	12J5GT 3	D77 3	EC677 6	PCF86 11	PCN 4	6
6D3 3	12J7GT 8	DA30 11	EC678 6	PCF86 11	PCN 4	6
6E1 4	12K7GT 4	DA32 8	EC679 6	PCF86 11	PCN 4	6
6E8 7	12K8 9	DAF91 4	EC680 6	PCF86 11	PCN 4	6
6F6G 4	12K8GT 11	DAF95 7	EC681 6	PCF86 11	PCN 4	6
6F13 4	12Q7GT 4	DF33 8	EC682 6	PCF86 11	PCN 4	6
6F14 9	12SA7 7	DF91 3	EC683 6	PCF86 11	PCN 4	6
6F15 8	12SG7 4	DF98 7	EC684 6	PCF86 11	PCN 4	6
6F19 6	12SH7 3	DF97 7	EC685 6	PCF86 11	PCN 4	6
6F32 4	12SJ7 5	DH63 5	EC686 6	PCF86 11	PCN 4	6
6F33 4	12SK7 6	DH78 6	EC687 6	PCF86 11	PCN 4	6
6H8 4	12SK7 4	DK32 9	EC688 6	PCF86 11	PCN 4	6
6J5 4	12SN7GT 6	DK91 5	EC689 6	PCF86 11	PCN 4	6
6J5G 3	12SQ7 8	DK92 7	EC690 6	PCF86 11	PCN 4	6
6J5GT 4	13D3 6	DK98 7	EC691 6	PCF86 11	PCN 4	6
6J6 3	19AQ5 7	DL33 7	EC692 6	PCF86 11	PCN 4	6
6J7 8	19BG6 14	DL35 7	EC693 6	PCF86 11	PCN 4	6
6J7G 4	20D1 8	DL75 6	EC694 6	PCF86 11	PCN 4	6
6J7GT 7	20F2 9	DL82 9	EC695 6	PCF86 11	PCN 4	6

CONNECTING WIRE

P.V.C. Bright Colours. Five 25ft. coils only. **4/-**

MAINS TRANSFORMERS

Excellent Quality Guaranteed Upright mounting 250V-250V, 60mA, 63V, 3A (50mA 12.6" Ditto semi-shrouded. **9 6**

SPECIAL C.R.T. OFFER

Due to long Bulk Special Purchase we are offering CRM41 and MW 3624 Tubes at the unrepeatable price of 39/- P.P. 12.6". The above are guaranteed for 6 months.

★ BULK BARGAINS ★

12 Tubs. Popular values, 5K, 10 2 Meg. Unseal, mixed preset, long sp. switch, etc. **4/6**

CONDENSERS. 25 mixed electrolytics. Many popular values. List available. Our price. **10/-**

100 RESISTORS 6/6

Excellent Sizes 1/2 watt.

100 CONDENSERS 9/6

Miniature Ceramic and Silver Mica Condensers. 3pF to 5000 pF. LIST VALUE OVER 10.

25 TAG STRIPS 4/-

2, 4, 6, 8-way, etc. Unseal.

Post: 2 lbs. 2/-, 4 lbs., 2 1/2, 7 lbs. 3 1/2, 10 lbs., 4/-, etc. (N.O.D. extra). ALL VALVES LESS 5% AND POST FREE IN DOZENS.

TECHNICAL TRADING CO.

Retail Only. Hi-Fi Demonstrations, 72 East Street, Southampton. Tel. 25851
350-352 Fratton Road, Portsmouth. Tel. 22034
1174 North Road, Brighton. TEL. RETAIL SHOP
11 12 NORTH ROAD, BRIGHTON Tel. 67999

WHARFEDALE SOUND

stereo/mono

CONCRETE COLUMN SPEAKER

WHARFEDALE SOUND



ONE TO BUILD YOURSELF FROM THE WHARFEDALE RANGE

Build a loudspeaker system in a concrete pipe and obtain good results. Impossible? If it were, Wharfedale would not recommend it. The fact is that experimental results of this type of enclosure were so successful that Wharfedale have produced an inexpensive kit especially for the Do-it-Yourself enthusiast. The kits come in two sizes—for 8" or 10" speakers and cost £5.0.0 and £6.5.0. In addition you will need a spun concrete pipe which costs about 12/6 from good builders' merchants. The concrete column can be decorated with a variety of finishes—paint, wallpaper, fabric etc. The top is fitted with a loose weave acoustic material.

*** Principle of construction of system in concrete column**

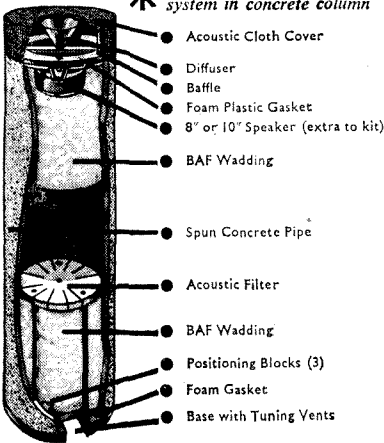

RECOMMENDED UNITS FOR THE WHARFEDALE CONCRETE COLUMN ARE

SUPER 8/RS/DD

A highly efficient full range speaker with the latest type of ceramic ring magnet. Roll surround gives smooth low frequency response down to 40 c/s. Power handling capacity 6 watts. Impedance 15 ohms. **£7.0.0.** (Tax Paid)

SUPER 10/RS/DD

A 10" speaker with double diaphragm, roll surround and powerful magnet. This unit gives frequency response down to 30 c/s. Power handling capacity 10 watts. Impedance 15 ohms. **£11.13.3.** (Tax Paid)

WHARFEDALE WIRELESS WORKS LTD. IDLE BRADFORD YORKS.

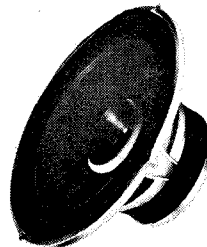

POST THIS COUPON TODAY*

for fully illustrated simple to follow construction folder

NAME..... Dept. E

ADDRESS.....

TOWN..... COUNTY.....

Sinclair's greatest triumph

The world's very
pocket-size

F.M. TUNER

SINCLAIR

7 TRANSISTORS • 2 DIODES

100% BRITISH
DESIGN

Sinclair's latest design, the SINCLAIR MICRO FM is a high quality FM tuner designed to be used with hi-fi amplifier or tape recorder. It can also be used independently as a self-contained pocket F.M. receiver for personal listening anywhere. This exciting Sinclair triumph, barely half the size of a packet of 20 cigarettes, is a fully fledged 7 transistor, 2 diode superhet circuit incorporating many unique and original design features to achieve fantastically good standards of performance. Pulse counting detection ensures better linearity than conventional detection methods, and therefore better audio quality. Powerful A.F.C. which locks on to the station tuned in, together with unusually good sensitivity make tuning easy and the set's own telescopic aerial suffices almost everywhere. Separate output stages are provided for feeding to an amplifier or tape-recorder and to the earpiece included with the Micro FM. It is this arrangement which allows the unit to be used both as a tuner and as a self-contained receiver. *In styling, this is the most elegant, most professional looking design in miniaturised equipment ever made available to constructors, and is one you will be very proud to possess.* YET WITH ALL THESE WONDERFUL FEATURES, THE SINCLAIR MICRO F.M. COSTS POUNDS LESS AND MEANS THAT ANYONE CAN AFFORD AND ENJOY THE ADVANTAGES OF F.M. RADIO TO-DAY.

FULL SERVICE FACILITIES ALWAYS
AVAILABLE TO ALL SINCLAIR CUSTOMERS

Order form on pages following

- TELESCOPIC AERIAL
- TUNES FROM 88-108 Mc/s
- ONE OUTPUT FOR HI-FI AND TAPE
- ONE OUTPUT FOR PERSONAL LISTENING
- SPUN ALUMINIUM DIAL
- POLISHED AND BRUSHED ALUMINIUM ESCUTCHEON
- BLACK CASE
- SELF-CONTAINED BATTERY
- A.F.C. FOR EASY TUNING
- UNIQUE CIRCUITRY

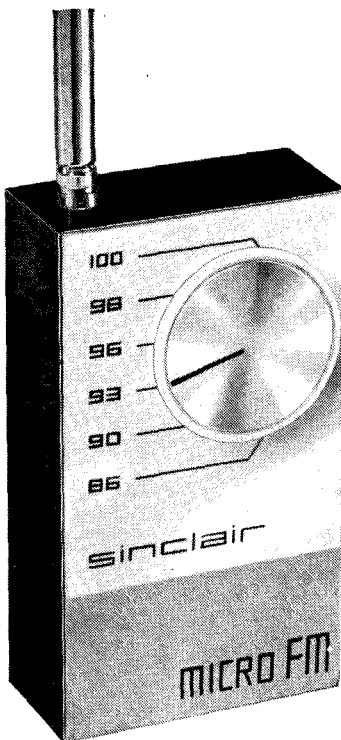

★ **MEASURES ONLY**
 $2\frac{15}{16}$ " X $1\frac{11}{16}$ " X $\frac{3}{4}$ "
 PLUS DETACHABLE AERIAL



All you want is a small soldering iron (preferably with $\frac{1}{16}$ " bit), tweezers and something to cut wire, such as nail clippers. The instructions take you step by step through every stage, and are very easy to follow.

ANYONE
CAN
BUILD IT
898

SINCLAIR

SINCLAIR RADIONICS LTD., COMBERTON, CAMBRIDGE

Telephone: COMBERTON 682

triumph yet!

y first

/RECEIVER

IR MICRO FM

DES • NO ALIGNMENT PROBLEMS • A.F.C.

TECHNICAL DESCRIPTION

THE SINCLAIR MICRO FM is a seven transistor, two diode F.M. superhet designed to be used both as a tuner for feeding to an amplifier or tape recorder and as a self-contained pocket portable receiver. The telescopic aerial, which screws into the top of the case, is coupled to an R.F. amplifier followed by a self oscillating mixer. Use of a low I.F. dispenses with the need for bulky I.F. transformers and removes the need for alignment. A three stage I.F. amplifier amplifies and limits the signal to produce a square wave of constant voltage which is fed into the pulse counting discriminator. This converts the square wave formation into uniform pulses, the average output from which is directly proportional to the signal frequency, so that the original modulation is reproduced exactly. After equalisation for pre-emphasis, the signal is fed to the audio output socket for use with an amplifier or recorder and also to the receiver's own audio amplifying stage which enables the Micro FM to be used as an independent self-contained receiver. The inclusion of A.F.C. makes tuning simple as each station tuned in is automatically "locked" as the dial is turned. THE SINCLAIR MICRO FM is completely

self-contained within a neat black plastic case faced by an elegantly designed front panel of brushed and polished solid aluminium with spun aluminium tuning dial to match. The tuning scale is marked in Mc/s.

- **SUPPLY VOLTAGE**—9V from self-contained standard battery.
- **CONSUMPTION**—5mA
- **SENSITIVITY**—Typically 3 microvolts
- **AUDIO OUTPUT**—300mV approx. from 25K ohms
- **HIGH LEVEL AUDIO OUTPUT**—9V peak to peak
- **TUNING RANGE**—87.5 to 108 Mc/s
- **SIGNAL TO NOISE RATIO**—30dB at 30 microvolts
- **AUDIO FREQUENCY RESPONSE**—10 to 20,000 c/s \pm 1dB

THE COMPLETE KIT OF PARTS for building the SINCLAIR MICRO FM including extending aerial, 7 transistors, case, tuning dial, aluminium front panel, lightweight earpiece, plugs and sockets and instructions costs only

£5.19.6

BUILDING AND USING THE SINCLAIR MICRO FM

This remarkable FM design, the most ambitious yet in the Sinclair programme, is simple to build with the precisely detailed instructions supplied, even if you have had no previous experience in building miniaturised transistor equipment. By eliminating the need for aligning the set when built, Sinclair have overcome the main obstacle to building your own FM set. When finished, you will find that the Sinclair Micro FM performs as well as any other good FM tuner and except in occasional poor reception areas, in which no set will function efficiently, this newest Sinclair design can be depended on to give satisfaction anywhere.



Use it as —

AN F.M. TUNER FOR YOUR TAPE RECORDER

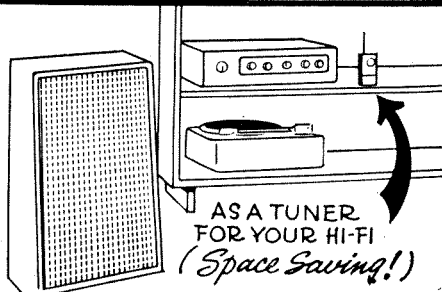
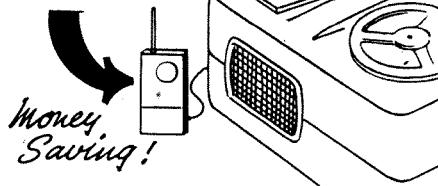

AS A SELF-CONTAINED POCKET F.M. RECEIVER.



sinclair

ORDER FORM AND MORE EXCITING SINCLAIR DESIGNS ON PAGES FOLLOWING 899

MORE UNIQUE DESIGNS FROM

SINCLAIR X-20

20 WATT P.W.M. AMPLIFIER
WITH INTEGRATED PRE-AMPLIFIER

*The most amazing advance in
audio amplifiers in years*

Gives you
20 watts R.M.S. OUTPUT

By the use of Pulse Width Modulation in circuitry developed exclusively by Sinclair Radionics, the unique X-20 achieves standards never before reached by any audio amplifier in the world. From the input of the integrated pre-amp through to the power output stage, this amazing amplifier gives quality and power far ahead of anything in its class to make it the most original and interesting design in years. You use your X-20 like any conventional quality amplifier, for mono or paired for stereo, but it occupies far less space, costs less, behaves perfectly and brings a refreshingly new approach to audio that is setting the standard for the whole industry.

ONLY THE SINCLAIR X-20 HAS THESE UNIQUE FEATURES

- ★ No. of transistors—12
- ★ Silicon epitaxial planar output transistors providing 95% energy conversion
- ★ Response—20 to 20,000 c/s ± 1dB
- ★ Total harmonic distortion at 10 watts R.M.S.—0.1%
- ★ Input sensitivity—1 mV into 5-K ohms
- ★ Signal-to-noise ratio—better than 70dB
- ★ 20 WATTS R.M.S. MUSIC POWER OR 15 WATTS R.M.S. CONTINUOUS INTO 7.5 OHMS
- ★ 15 WATTS R.M.S. MUSIC POWER OR 12 WATTS R.M.S. CONTINUOUS INTO 15 OHMS
- ★ Ideal for guitar or other forms of P.A.
- ★ Widely tolerant of the load at the output
- ★ Power required—36 V dc at 700 mA

QUALITY AND POWER FOR SUCH VERY SMALL OUTLAY

Complete kit of parts including transistors and X-20 Manual in sealed carton **£7.19.6**

Built and tested with X-20 Manual in sealed carton **£9-19-6** X-20 Power Pack sufficient to drive two X-20's **£4-19-6**

THE X-20 MANUAL gives full details of tone and volume control systems for adding to your X-20. Includes circuits for STEREO, INPUT SWITCHING, STEREO BALANCE, etc. **FREE WITH EVERY X-20.** Available separately—2/- post free.

FULL SERVICE FACILITIES AVAILABLE TO ALL SINCLAIR CUSTOMERS

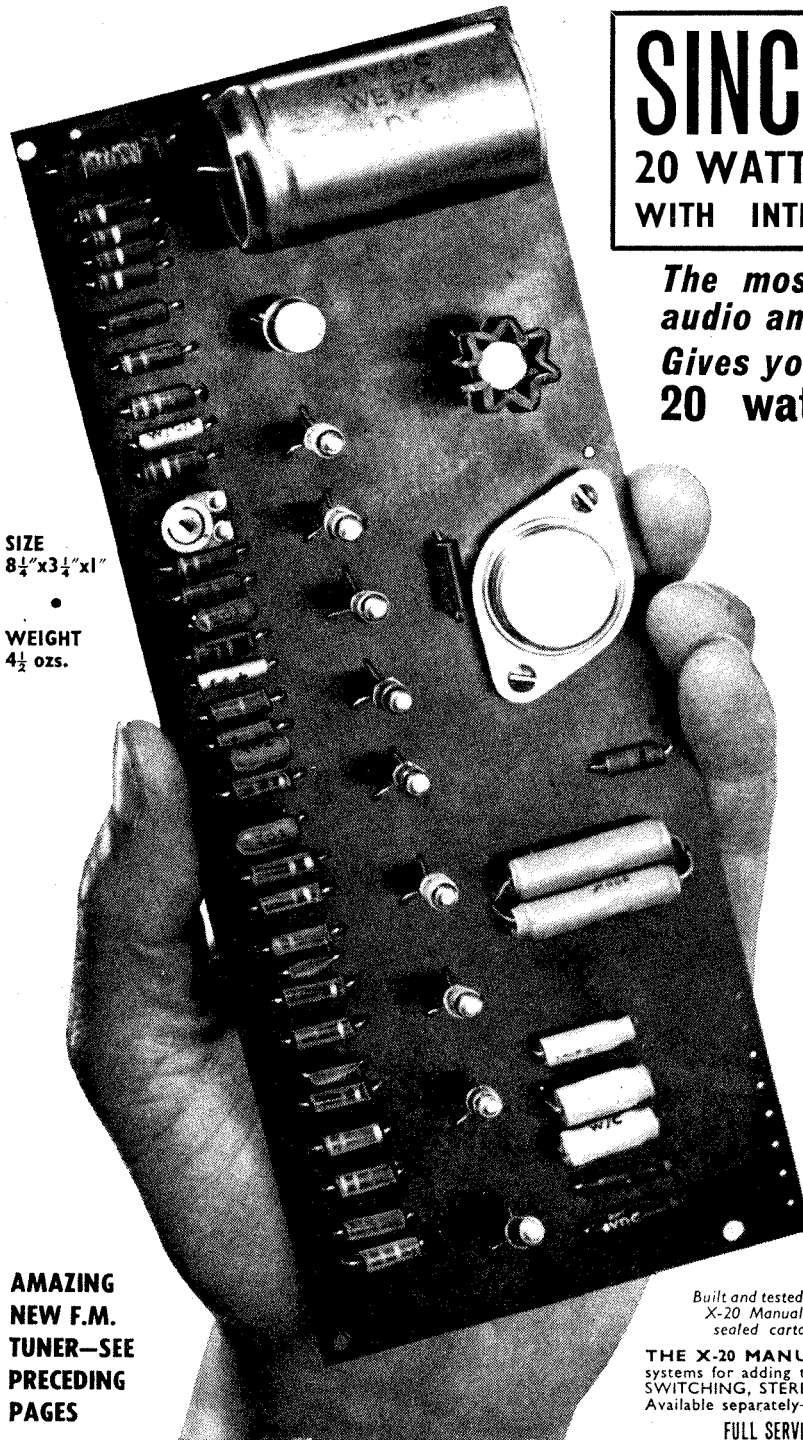

SIZE
8½" x 3¼" x 1"

WEIGHT
4½ ozs.

**AMAZING
NEW F.M.
TUNER—SEE
PRECEDING
PAGES**

sinclair

SINCLAIR RADIONICS LTD.
COMBERTON, CAMBRIDGE Telephone: COMBERTON 682

SINCLAIR

SINCLAIR MICRO-6

Everybody's building it!

- **SIZE**— $1\frac{1}{5} \times 1\frac{3}{10} \times \frac{1}{2}$ ● **PLAYS ANYWHERE**
- **WEIGHT**—Under 1 oz. ● **BANDSPREAD FOR**
- **FANTASTIC RANGE AND POWER** ● **EASY LUXEMBOURG RECEPTION**

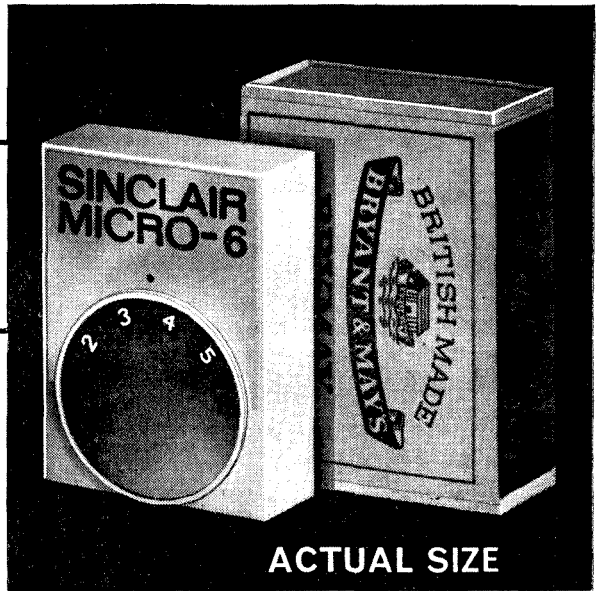

ACTUAL SIZE

THE SMALLEST SET IN THE WORLD!

No transistor set has ever yet compared with the Micro-6 for size, power, performance and design. Thousands upon thousands have been built by enthusiasts from electronic engineers to beginners in transistor construction and are now in use throughout the world. Everything except the lightweight earpiece is contained within the smart minute white gold and black case. With batteries and self-contained aerial, the Micro-6 weighs under one ounce! Unique features which make such wonderful performance possible include bandspread over the higher frequency end of the medium waveband for easy reception of Luxembourg, powerful A.G.C. to counteract fading of distant stations, and vernier type tuning. Quality of reproduction is outstandingly good, so that you derive real pleasure from using this fantastic set. Order your Micro-6 now and prove for yourself why it cannot be too highly recommended as an intriguing design to build and a most practical radio to use. You can build it in an evening and when you have built your first, be certain others are going to want one too, when they see and hear your Micro-6.

- **OPERATES IN BAD AREA**
"I am highly satisfied with this kit which receives most stations on the medium wave with remarkable volume apart from the fact that this is a bad signal area." *M. A., Sheffield G.*
- **AGREEABLY SURPRISED**
"My pleasure at the way it works is only exceeded by the pleasure it gave me in building it and my own surprise at being able to complete such miniature work satisfactorily. I am no longer the youngster that assembled radios before the B.B.C. was born." *W. J. R., Warwick.*
- **AMAZING VOLUME**
"Performance easily surpassed expectations. Luxembourg and AFN were loud and clear and many continental stations could be heard at adequate strength including Moscow." *R. S., Northumberland.*
- **TRANSISTOR FIEND DELIGHTED**
"Having been a transistor fiend for the last eight years, I must say it is the finest little set I have ever constructed. Please send one more of these marvellous little instruments." *R. K., Preston, Lancs.*

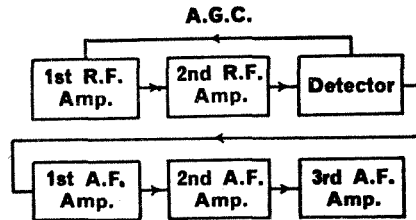

Amazing 6-stage circuit

In the Micro-6, a six stage circuit using 3 special Micro-alloy transistors (Sinclair M.A.T.s) provides two stages of R.F. amplification, double diode detector and high gain 3-stage A.F. amplifier plus A.G.C. and bandspread over the higher frequency end of the tuning to bring in Luxembourg like a local station. Inserting the plug of the earpiece switches the Micro-6 ON; withdrawing switches it OFF. Tuning is by vernier-type dial over the medium wave band. Two self-contained pill-size batteries give about 70 hours working life.

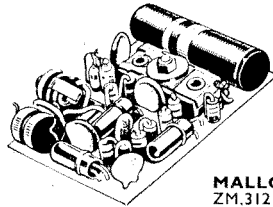

All parts including M.A.T.s, case, dial, lightweight earpiece and beautifully detailed instructions come to

59/6

MALLORY MERCURY CELL Type ZM.312 (2 required) each 1/11.
Pack of 6 10/6

FULL SERVICE FACILITIES AVAILABLE TO ALL SINCLAIR CUSTOMERS

GUARANTEE ORDER FORM

NAME..... Please send me

ADDRESS.....

.....

..... For which I enclose Cash/Cheque/Money Order value

£.....s.....d.

Guarantee

Should you not be completely satisfied with your purchase when you receive it from us, your money will be refunded in full and at once without question. It is important to quote Pr.E11 should you prefer to write your order instead of cutting out this coupon.



Semi-conductor module—fully transistorised and completely wired and tested circuits that only require a 9-volt battery and connection to input and output to provide a compact ready-made unit. Encapsulated types are shockproof and almost indestructible. Supplied with instructions.

METRONOME—New design giving both audible and visual indication over the range 30 to 240 beats per minute. Requires only 3-ohm speaker, 250 k/ohm pot, and torch bulb to complete. 22/6. P. & P. 1/-.

CODE PRACTICE OSCILLATOR—Advanced design giving powerful, authentic tone and visual indication if required. Uses standard 3-ohm speaker. 20/-, P. & P. 1/-.

PUBLIC ADDRESS AMPLIFIER—Ideal as a basis for loud hailers. Uses 3-ohm speaker and suitable for use with carbon crystal or dynamic microphones. 35/-, P. & P. 1/-.

FIRE ALARM—module contains temperature sensor and operates in conjunction with 8-ohm loudspeaker and 2-megohm potentiometer. Increase of room temperature above pre-set level immediately triggers screaming siren alarm. 50/-, P. & P. 1/-.

PROOPS MULTI-TESTER

Specially designed for Proops! This 39/6 Post and Packing 2/- truly low-priced, all-purpose tester combines the most useful voltage, current, and resistance measuring ranges for home and motor car wiring and servicing, amateur radio and T.V. fixing, and electronics hobby construction checking. Extremely robust construction employs rugged, large scale meter movement, hard-wearing switch contacts, and impact resisting tough plastic case. Ranges: 0-10-50-250-500-1000 volts AC or DC. 0-1-500 DC 0-100,000 ohms and -20 to +36 decibels. Size overall: 5 × 3½ × 1½ in. deep. Supplied complete with red and black insulated connector leads, battery and full instructions.

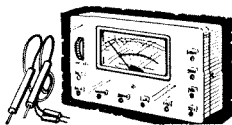

Construct Electronics with NEW VEROBOARD Quickly, Cheaply, Professionally

VEROBOARDS supplied by Proops Brothers Limited have been specially designed to meet the needs of the amateur constructor: hole matrices have been pitched to provide the greatest utility in a wide variety of circuit layouts; purchase price has been kept low by the deliberate selection of one standard board width (22 way) which may be used with almost any circuit but permits large quantity purchase with attendant saving; specially prepared design sheets are provided with each purchase to simplify circuit layout; accessories have been kept to an essential minimum to further reduce cost.

VEROBOARD SHEETS. 12/6 each. Post Free.
Board size overall: 17 in. long × 3½ in. wide 0.0312 in. thick. Each is clad with 22 × 0.0015 in. thick copper conductors which are fully pierced in line at 0.156 in. intervals across width and 0.2 in. along length. Boards are treated with flux preservative to give protection and ensure satisfactory soldering. A design sheet is supplied with each board.

SPOT FACE CUTTER. 8/6. Post Free.
Specially designed hand cutting tool with hole locating spigot. Light turning and pressure removes copper conducting strip locally to make a neat break.

TERMINAL PINS. 50 for 3/6. Post Free.
Made specially for Veroboards of pre-tinned brass with a flat head to give maximum contact, and self-cutting serrations near the head to ensure a tight fit when pushed into the hole.

INTRODUCTORY VEROBOARD KIT. 24/-, Post Free.
Includes one sheet of Veroboard, Design Sheet, Spot Face Cutter, 50 Terminal Pins, and instruction on design method and layout procedure.

PROOPS
BROTHERS LIMITED

52 TOTTENHAM COURT ROAD, LONDON W1
PHONE: LANGHAM 0141. HOURS: 9am-6pm
THURS: 9am-1pm. OPEN ALL DAY ON SATURDAY

PHOTO MULTIPLIER POWER TRANSISTOR—complete photo-electric system in one unit of power transistor amplifier. Photo-electric cell and electronic relay. Make your own photo-control system—door opener, burglar alarm, automatic door chimes, counters, etc. Complete with instruction literature of unusual applications. 25/-, P. & P. 1/-.

WIRELESS TELEPHONE AMPLIFIER MODULE—complete, electronic, solid state circuitry ready to amplify and transmit both sides of a telephone conversation into any A.M. broadcast band radio without interconnecting cables. Operates from 9 volts "transistor" battery and requires only telephone pick-up coil to operate. 30/-, P. & P. 1/-.

MICROPHONE TRANSMITTER MODULE—contains complete solid state circuitry ready for use as a means of transmitting speech from any high impedance microphone into an ordinary A.M. radio without connecting wires. Requires only 9 volts battery and crystal microphone. 30/-, P. & P. 1/-.

GRAMOPHONE AMPLIFIER—Can be used with magnetic, crystal or ceramic pickups—full matching information supplied. High quality output fills average living room. 30/-, P. & P. 1/-.

SIREN MODULE—Needs only 3-ohm speaker and switch or warning push-button to complete. Provides powerful upward screaming note to form ideal basis for alarms, etc. 22/6. P. & P. 1/-.

ROTARY SWITCHES FOR THE HOME CONSTRUCTOR

Writers of constructional articles for Practical Electronics are reminded that readers often have difficulty in obtaining rotary switches of special type and contact arrangement. Consult us before deciding upon the switches you incorporate in your designs and be assured that a switch to any desired specification will then be immediately available to your readers.

Design charts and details (for writers and readers) from

SPECIALIST SWITCHES LTD.

23 RADNOR MEWS · LONDON W2

PADdington 8866-7

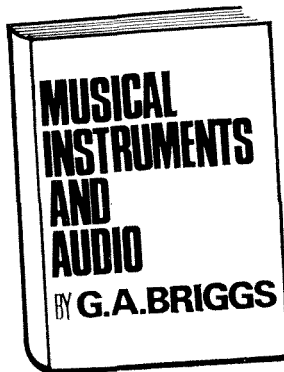

A NEW BOOK

By
G. A. BRIGGS

(Publishing date
October 22nd 1965)

240 pages 212 illustrations
Fine art paper cloth bound
32/6 (34/- post free)

In this book, the sixteenth to be produced by the Briggs-Wharfedale set-up, attention has been turned to musical instruments as the basis of audio.

The performance and frequency range of more than 60 instruments is examined, with a large number of photographs and diagrams. In fact, the book is intended to appeal to both the concert-goer and the audiophile. The usual touches of humour enliven some of the pages, with 16 cartoons to relieve the monotony of reading.

Chapters include:
GENERAL PRINCIPLES · VARIOUS SOUNDS — CAUSE AND EFFECT · CHARACTERISTICS OF INSTRUMENTS · FORMANTS · DISTORTION IN SOUNDS · DISTORTION IN REPRODUCTION · ORGANS · ELECTRONIC ORGANS · PIANOS · TUNING · MUSIC IN SCHOOLS



WHARFEDALE WIRELESS WORKS LTD.
IDLE BRADFORD YORKSHIRE
Tel. 612552/3 Grams: 'Wharfedel' Bradford

The foremost name
in microphones and sound
accessories

LUSTRAPHONE

The many Public Authority and Service users of Lustraphone equipment appreciate the quality and reliability resulting from our extensive experience as specialists in the design and manufacture of microphones and associated equipment.

Microphones for all purposes incorporating the newest techniques • portable P/A systems for indoor and outdoor use • noise cancelling intercom systems • audio equipment accessories and components.

LUSTRAPHONE LIMITED

St. George's Works
Regents Park Road • London, N.W.1
PRImrose 8844



HI-FI SPEAKER SPECIALISTS

ORDERS DESPATCHED BY RETURN
Carriage, Packing and Insurance (U.K.) FREE

	£	s.	d.		£	s.	d.
CELESTION				ROGERS			
Studio 12" CX1512	11	10	0	Cadet MkIII Speaker System	22	10	0
Studio 12" CX2012	16	10	0	Wafer Speaker System	16	19	6
Ditton 10 System	18	18	0	T.S.L. Tweeter LPH65	1	13	1
DECCA				TANNOY			
301 Speaker System	15	15	0	Lancaster Enclosure 12"	50	0	0
FANEK Model II/2/10	6	6	0	Monitor 12" Dual Concent.	30	15	0
GOODMANS				Monitor 15" Dual Concent.	37	10	0
ARU172 or 180	3	11	3	III L.Z.C. 12" Dual Concentric	22	10	0
Axiomet 8	5	10	1	III L.Z. Speaker System	32	10	0
Axiom 61, 12"	15	0	0	W.B.			
Axiom 80	21	8	1	Stentorian 8" HF812	3	16	6
Axiom 201	11	8	9	Stentorian 8" HF816	6	6	0
Axiom 301	15	18	9	Stentorian 10" HF1012	4	12	0
Axiom 10	6	12	3	Stentorian 10" HF1016	7	7	0
Trebax 5K/20XL	7	13	9	Stentorian Clumber 912C	14	13	7
Triaxiom 1220C	19	9	1	Tweeter T10	4	12	9
Magnum-K System	36	15	0	Tweeter T359	1	12	3
Maxim Mini System	17	10	6	WHARFEDALE			
JORDAN-WATTS				PST/4	3	14	5
Module	10	10	0	8" Bronze RS/DD	4	2	1
Mini 12	16	12	6	8" Bronze RS (RSDD)	3	7	7
K.E.F.				10" Bronze RS (RSDD)	5	5	10
Celeste Speaker System	26	10	0	Super 3	6	2	11
K1 Baffle Speaker System	28	0	0	Super 8RS/DD	7	0	5
T15 Tweeter	6	0	0	Super 10 RS/DD	11	14	3
B139	11	10	0	Golden 10RS/DD	8	16	2
B1B14	19	0	0	W12RS/PST	11	5	0
KELLY Ribbon HF MkII	11	10	0	RS12DD	12	0	0
LEAK "Sandwich" Speaker	39	18	0	W15/RS	18	15	0
LOWTHER				Super 12 RS/DD	17	10	0
PM6	18	18	0	Dalesman System	25	10	0
Acousta Enclosure	21	0	0	W2 Dovedale	31	10	0
PYE				W3 Speaker System	39	10	0
Brahms Speaker System	17	17	0	W4 Speaker System	49	10	0
QUAD				QS/800 Crossover unit	2	17	6
Electrostatic Speaker	52	0	0	HS/400/3 Crossover unit	6	5	0

C. C. GOODWIN (Sales) LTD. (Dept. LS.11)
7 The Broadway, Wood Green, London, N.22
Tel.: BOWes Park 0077/8
HOURS OF BUSINESS: Mon. to Sat. 9-6 p.m. Thurs. 9-1 p.m.



THINKING TAPE? THINK Brenell

If you're thinking in terms of tape recording, then the Brenell deck and complete recorders should be uppermost in your mind. The reliability, the versatility and the quality of manufacture are seldom equalled in other tape recorders (even in those costing much more).



**How many can equal or better
this specification?**

4 record/playback speeds $1\frac{7}{8}$, $3\frac{3}{8}$, $7\frac{1}{2}$ and 15 ips • 3 motors (capstan motor-hysteresis synchronous) • low 'wow and flutter' content (0.05% at 15 ips, 0.1% at $7\frac{1}{2}$ ips, 0.15% at $3\frac{3}{8}$ ips and 0.25% at $1\frac{7}{8}$ ips) • double-gapped ferrite erase head to minimise erase noise • narrow-gapped record/playback head to give extended frequency response • pause control • superimpose control • $8\frac{1}{2}$ " dia. reels (to take $10\frac{1}{2}$ " dia. N.A.B. reels at extra cost) • fast rewind • digital rev. counter.

Mark 5 Series 3 Deck

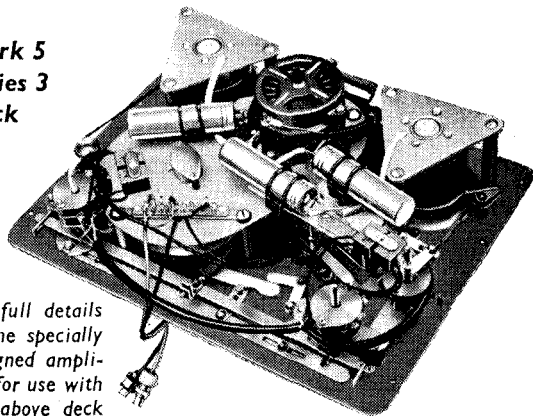

For full details of the specially designed amplifier for use with the above deck and the range of mono and stereo recorders, write or telephone the sole manufacturers:



BRENNELL ENGINEERING CO. LTD.
231-5 LIVERPOOL ROAD, LONDON, N.1
Telephone: NORth 8271 (5 lines)

HIGH QUALITY

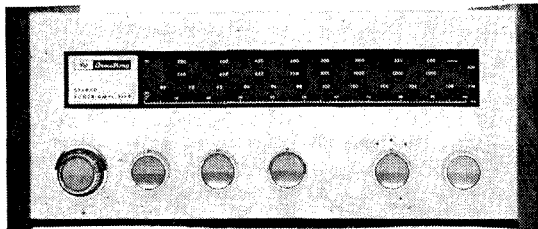

LOWER COST

Combine an Armstrong Tuner and Amplifier and you have a compact item with all the advantages of the separate units, plus easier installation, and equivalent performance at a lower price.

Stereo model 127, above, is derived from the more expensive 227, and has an identical AM-FM tuner section, but with an amplifier section designed for those whose power requirements are more modest. It has a more modest price too, as does the mono version model 127M.

Each Armstrong Tuner-Amplifier is ideal as the basis of a high fidelity system for radio and record reproduction tape recording and playback, and each unit may be built into your own cabinet or used in our optional case, of teak and vinyl hide, as shown.

For full details and technical specifications plus list of over 300 stockists, post coupon or write mentioning I IPE 65

model 127 STEREO TUNER AMPLIFIER ... £37.10.0
 model 127M MONO TUNER AMPLIFIER ... £26.10.0
 optional case for each model £3.10.0



ARMSTRONG AUDIO LTD - WARLTERS ROAD - N.7
 Telephone: NORth 3213

Name

Address

11-PE-65



FIRST QUALITY PVC TAPE

5 1/2" Std. 850 ft. 9/- 5" L.P. 850 ft. 10/6
 7" Std. 1200 ft. 11/6 3" T.P. 600 ft. 8/-
 3" L.P. 240 ft. 4/- 5" T.P. 1800 ft. 20/6
 5 1/2" L.P. 1200 ft. 11/6 5 1/4" T.P. 2400 ft. 27/6
 7" L.P. 1800 ft. 18/6 7" T.P. 3600 ft. 37/6

P. & P. on each 1/6, 4 or more post free.

Complete with McLaren Variable Thermostat 90° to 180°F. 20 amp. A.C. and GEC double pole 20 amp. mains switch. 18", 30" and 36". State length required. £2.0.0 plus 5/- P. & P.

3 kW IMMERSION HEATER

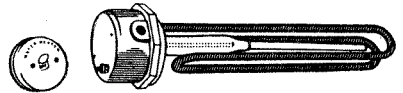

"PREMIER" KETTLE ELEMENT

1000 w., 8/6 + 3/- P. & P. Retaining nut and flange 2/6, switch plug to suit 2/6.

A.C. MAINS MOTOR



Can be used for a variety of purposes, silent running, satisfactory in every way. 230/250 v. A.C. 9/6. P. & P. 3/-.

3 to 4 WATT AMPLIFIER KIT

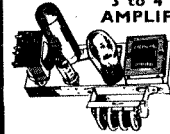

comprising chassis 8 3/4" x 2 1/2" x 1 1/4".

Double wound mains

transformer, output transformer, volume and tone controls, resistors, condensers, etc. 6V6, ECC81 and metal rectifier. Circuit 1/6 free with kit. 29/6 plus 4/6 P. & P.

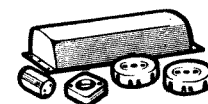

40w. FLUORESCENT LIGHT KIT

incorporating GEC Choke size 8 1/2" x 1 3/4" x 1 3/8", 2 bi-pin holders, starter and starter holder, 11/6. P. & P. 4/6.

Similar to above: 80w. Fluorescent Light Kit incorporating GEC choke size 11 3/4" x 1 3/4" x 1 3/8", 2 bi-pin holders, starter and starter holder, 17/6. P. & P. 5/6.

8-watt 5-valve PUSH-PULL

AMPLIFIER & METAL RECTIFIER

Size: 9 x 6 x 1 1/4" A.C. Mains 200-250v. 5 valves.

For use with Std. or L.P. records, musical instruments, all makes of pick-ups and mikes.

Output 8 watts at 5 per cent total distortion.

Separate bass and treble lift controls. Two

inputs, with controls, for gram, and mike. Output Transformer

tapped for 3 and 15 ohms speech coils. Built and tested. £3.19.6.

P. & P. 8/-.

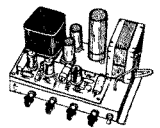

SPECIAL OFFER!

ELEGANT SEVEN Mk. II

Combined Portable and Car Radio

The Radio with the "Star" Features

★ 7-transistor superhet. Output 350 mW.

★ Grey wooden cabinet, fitted handle with silver-coloured fittings, size 12 1/2 in. x 8 1/2 in. x 3 1/2 in.

★ Horizontal tuning scale, size 11 1/2 in. x 2 1/2 in. in silver with black lettering.

★ All stations clearly marked.

★ Ferrite-rod internal aerial.

★ Operated from PP9 battery.

★ I.F. neutralisation on each stage 460 kc/s.

★ D.C. coupled output stage with separate A.C. negative feedback.

★ All components, ferrite rod and tuning assembly mounted on printed board.

★ Fully comprehensive instructions and point-to-point wiring diagram.

★ Printed circuit board, back-printed with all component values.

★ Fully tunable over medium and long waveband.

★ Car aerial socket.

★ Full after-sales service.

4 in. SPEAKER. Parts list and circuit diagram 2/6. FREE with parts.

Shop Hours 9 a.m. — 6 p.m. Early Closing Wednesday

RADIO & T.V. COMPONENTS (ACTON) LTD.

21D, HIGH STREET, ACTON, LONDON, W.3

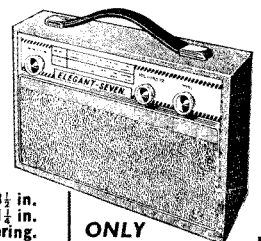

ONLY

£4.4.0

Plus 6/6 Post & Packing

SPECIAL OFFER—

POWER SUPPLY KIT

to purchasers of Elegant

Seven parts, incorporating

mains transformer, etc.

A.C. mains 200-250v. Output 9v. 100mA.

7/6.

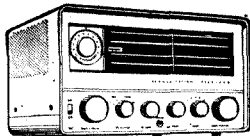

LAFAYETTE HA-63 COMMUNICATION RECEIVER
7 valves plus Rectifier. 4 Bands. 550 kc/s—31 Mc/s. "S" Meter—BFO—ANL—Bandspread Tuning. 200/250V. A.C. Brand New 24 Gns. Carr. Paid.

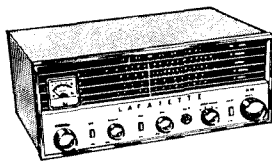

NEW MODEL! LAFAYETTE HA-230 AMATEUR COMMUNICATIONS RECEIVER

Supersedes model HE-30. 8 valves + rectifier. Continuous coverage on 4 bands. 550 Kc/s—30 Mc/s. Incorporates 1 RF & 2 IF stages. Multiplier, B.F.O., ANL, "S" meter. Electrical bandspread, Aerial trimmer etc. Supplied brand new and guaranteed. 33 gns. S.A.E. for full details. Also available in semi Kit Form. 25 gns.

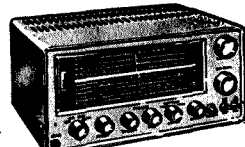

NEW MODEL! LAFAYETTE HA-55 AIR-CRAFT RECEIVER

168-136 Mc/s. High selectivity and sensitivity. Incorporates 2 RF stages including 6CW4 Nuvistor, 8 tubes for 11 tube performance, solid state power supply, adjustable squelch control, slide rule dial, built in 4in. speaker and front panel phone jack. 220/240V. A.C. Supplied brand new and guaranteed. 19 gns. Carr. 10/-.

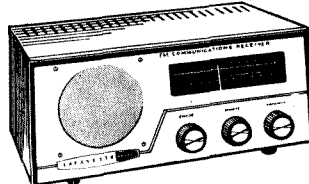

TE22 SINE SQUARE WAVE AUDIO GENERATORS

Sine: 20 cps to 200 kc/s. on 4 bands. Square: 20 cps to 20 kc/s. Output impedance 5,000 ohms. 200/240V. A.C. operation. Supplied Brand New and Guaranteed with instruction manual and leads. £15. Carr. 7/6.

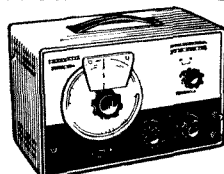

LAFAYETTE NUVISTOR GRID DIP METER

Compact true one hand operation. Frequency range 1.7-180 Mc/s. 230V. AC operation. Supplied complete with all coils and instructions. £12.10.0. Carr. 5/-.



LEADER LSG-10 R.F. SIGNAL GENERATOR

120 kc/s—260 Mc/s on 6 ranges. Variable R.F. and A.P. outputs. Large clear scale. Size 7 1/2" x 10 1/2" x 4 1/2". 220/250V. A.C. Operation. Brand New £12. Carr. 7/6.



2-WAY RADIOS

Superb quality. Complete with all accessories and fully guaranteed.

- 3 Transistor £9.17.6 pp
 - 4 Transistor 11 gns. pr.
 - 6 Transistor £25 pr.
 - 10 Transistor 28 gns. pr.
- Post extra. (S.A.E. for full details).

VOLTAGE STABILIZER TRANSFORMERS

Input 80-120V. and 150-240V. Constant output 110v. or 240v., 250 watts. Brand New Guaranteed. £10.10.0. Carr. 7/6.



VARIABLE VOLTAGE TRANSFORMERS

Brand New Guaranteed—Fully Shrouded. Input 230v. 50/60 c/s. Output 0-260 Volts.

- 1 Amp. £4.10.0
- 2.5 Amp. £5.17.6
- 5 Amp. £9.0.0
- 8 Amp. £13.10.0
- 10 Amp. £17.0.0
- 12 Amp. £19.10.0
- 20 Amp. £32.10.0

2.5 Amp. Portable—Metal Case with Meter-Fuses, etc. £9/17/6.

MODEL PV-58 VALVE VOLTMETER

11 Meg. input. 7 D.C. volt ranges. 1.5-1,500 v. 1,500 v. 7 A.C. volt ranges 1.5-1,500 v. 4,000 Peak to Peak. Resistance 3 ohm to 1,000 megohm. Decibels —10db to +65db. Supplied brand new with instructions, leads and probe. £12/10/- P. & P. 3/6.



TS-76 20,000 O.P.V. PUSH BUTTON MULTI-TESTER

Simple operation, D.C. volts up to 1,000 v. A.C. volts up to 1,000 v. Resistance up to 10 megohm. Current up to 250 mA. Decibels —20 to +36 db. £55.0. P. & P. 2/-.

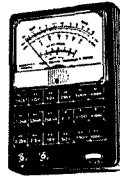

MODEL "TE-12

20,000 O.P.V. 0/0.5/ 6/30/120/600/3,000/3,000/6,000 v. D.C. 0/6/30/120/600/1,200V. A.C. 0/600uA 6/60/600 MA. 0/6K/600K/6 Meg. 60 Meg. £2. P.F. £2 MF. £15/10/6. P. & P. 2/6.

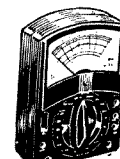

MODEL 500. 30,000

O.P.V. 0/0.5/1/2.5/10/25/100/250/500/1,000V. D.C. 0/2.5/10/25/100/250/500/1,000V. A.C. 0/50uA/5/50/500mA. 12 amp. D.C. 0/60K/6 Meg./60. Meg. £2. £8/17/6 Post Paid.

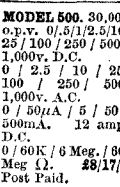

TE-51 NEW 20,000Ω/VOLT MULTIMETER

0/6/60/120/1,200V. A.C. 0/3/30/60/300/600/3,000V. D.C. 0/60uA/12/300 MA. D.C. 0/60K/6 Meg. £2 85/- P. & P. 2/6.



STAR SR.40 COMMUNICATION RECEIVER

4 Bands. 550 kc/s—30 Mc/s. "S" Meter—BFO—ANL—Bandspread Tuning—Built-in speaker 200/250V. A.C. Brand New. 18 1/2 Gns. Carr. 10/-.

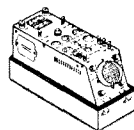

OS/8B/U OSCILLOSCOPES

High quality Portable American Oscilloscope. 3" c.r.t. T/B 3 c/s-50 kc/s X Amp; 0-500 kc/s Y Amp; 0-2 Mc/s. Power requirements 105-125V. A.C. Supplied in brand new condition, fully tested. £25. Carr. 10/-. Suitable 230/115V. Transformer 15/6.

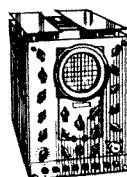

ERSKINE TYPE I3 DOUBLE BEAM OSCILLOSCOPE

Time base 2 c/s-750 kc/s. Calibrators at 100 kc/s and 1 Mc/s. Separate Y1 and Y2 amplifiers up to 5.5 Mc/s. Operation 110/230 volt A.C. Supplied in perfect working order. £27/10/-. Carriage 20/-.

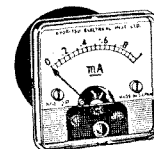

CLEAR PLASTIC PANEL METERS

First grade quality. Moving Coil panel meters, available ex-stock. S.A.E. for illustrated leaflet. Discounts for quantity. Available as follows: Type MR. 3SP. 1 21/32in. square fronts.

5mA.....	22.6	1A D.C.....	22.6	500V D.C. ...	22.6
10mA.....	22.6	2A D.C.....	22.6	500V D.C. ...	22.6
20mA.....	22.6	5A D.C.....	22.6	750V D.C. ...	22.6
50mA.....	22.6	5V D.C.....	22.6	15V A.C. ...	22.6
100mA.....	22.6	10V D.C.....	22.6	50V A.C. ...	22.6
150mA.....	22.6	20V D.C.....	22.6	150V A.C. ...	22.6
200mA.....	22.6	50V D.C.....	22.6	300V A.C. ...	22.6
300mA.....	22.6	100V D.C.....	22.6	500V A.C. ...	22.6
500mA.....	22.6	150V D.C.....	22.6	"S" Meter 1A 22.6	
100-0-100uA	27.6	750mA.....	22.6		
500-0-500uA	22.6				
1-0-1mA.....	22.6				
1mA.....	22.6				
2mA.....	22.6				

POST EXTRA Larger sizes available—send for lists. ILLUMINATED "S" METER. 1 1/2 in. square front. Cal. in 8 units. 6V. lamp. 29.6. P. & P. 1/-. Ditto 2 1/2 in. square 39.6. P. & P. 1/-.

TRANSORISED TWO-WAY TELEPHONE INTERCOM.

Operative over amazingly long distances. Separate call and press to talk buttons. 2-wire connection. 1600's of applications. Beautifully finished in ebony. Supplied complete with batteries and wall brackets. 7 gns. pair. P. & P. 5/-.

MAGNAVOX 363 TAPE DECKS

New 3-speed tape deck, supersedes old Collaro studio deck. 2-track £10.10.0. 4-track £13.10.0. Carr. Paid.

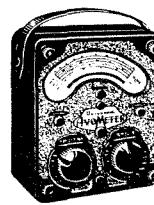

AVO METERS

Supplied reconditioned, guaranteed perfect.

Model D £8.19.6

Post and Ins. 5/-

MINE DETECTOR No. 4A

Will detect all types of metals. Fully portable. Complete with instructions. 39.6. Carr. 10/-. Battery 8/6 extra.

BEST BUY!

Send 1/- P.O. for full Catalogue and Lists. Open 9 a.m. to 6 p.m. every day Monday to Saturday. Trade supplied.

G.W. SMITH & CO (RADIO) LIMITED
Phone: GERRARD 8204/9155
Cables: SMITHEX LESQUARE
3-34 LISLE STREET, LONDON, W.C.2

STOP PRESS NEWS! A FABULOUS OFFER FROM GRAMDECK!

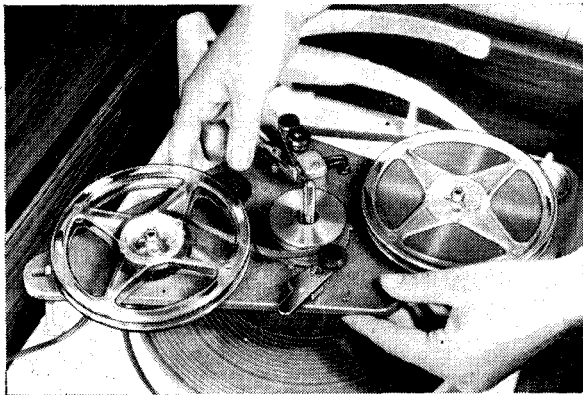

1 The famous Gramdeck, complete with accessories and the Gramdeck Transistorised Preamplifier/Control Unit, delivered to your home.

FOR ONLY £6. 10. 0

2 The famous high-quality moving-coil Lustraphone microphone. (value £3. 8s.)

FREE WITH EVERY ORDER

- ★ Uses standard tapes.
 - ★ Plays at 7½" per sec. or 3 other speeds.
 - ★ Records direct from radio or microphone.
 - ★ Erase and fast rewind.
- The Gramdeck will turn any record player, radiogram or hi-fi system into a first-class tape recorder. And it's as easy as putting on a record. Brilliantly designed, beautifully engineered, the Gramdeck's performance will astonish you, giving you a quality of reproduction determined only by your existing equipment.

Gramdeck is a 'must' for the man who likes to experiment—for anyone who wants full recording and playback facilities at a fraction of the normal cost. And it's now offered to you at a sensationally low price—together with a FREE high-quality moving-coil microphone (List price £3.8s.). Limited numbers available—cash orders only. Send only £6.10s.0d. and the outfit, together with your free Lustraphone microphone, will be sent direct to your home. Money gladly refunded if you are not delighted.

Rush your order now to:

GRAMDECK

ANDREW MERRYFIELD LTD.

(Dept. PL/801), 29 Wrights Lane, London, W.8

Today's Greatest Repair Aid

READY NOW!

PACKED WITH TIME-SAVING MONEY-MAKING INFORMATION

3,700 PAGES OF DATA
Ace, Aerodyne, Ajax, Alba, Arnosy, Baird, Beethoven, Berec, B.R.C., B.S.R., Bush, Capitol, Champion, Channel, Collaro, Cossor, Dansette, Decca, Defiant, Doric, Dynatron, E.A.R., Ekco, Elizabethan, Elpico, E.M.I., Emerson, Emisonic, Eumig, Ever Ready, Ferguson, Ferranti, Fidelity, Ford Motor Co., Garrard, G.B.C., G.E.C., Gramdeck, Grundig, H.M.V., Hitachi, Invicta, K.B., Magnavox, Marconiphone, Masteradio, McMichael, Motorola, Murphy, National, Nematic, Pageant, Pam, Perdio, Peto Scott, Philco, Philips, Pilot, Playcraft, Playmate, Portadyne, Portogram, Pye, Radiomobile, Recording Devices, Redifusion, Regentone, Retra, Revelation, R.G.D., Roberts' Radio, Sharp, Sinclair, Sobell, Sonolor, Sony, Sound, Spencer-West, Standard, Stella, Stereosound, Stuzzi, Teletron, Thorn, Trans Arena, U.K.W., Ultra, Vidor, Volmar, Walter, Waltham - Standard, Zenith.

Take a look at the big list of over 90 makes on left. ALL THESE are covered in the latest edition of **NEWNES RADIO & TV SERVICING**. In six volumes it gives you the **CIRCUITS, DIAGRAMS** and **REPAIR INSTRUCTIONS** you need for nearly 2,500 popular models produced from 1959 to 1965. This complete library is a guaranteed time-saver and profit-maker in every repair shop. Use it on **FREE TRIAL**—post coupon today.

TV • Radio • Radiograms • Tape Recorders • Record Reproducers

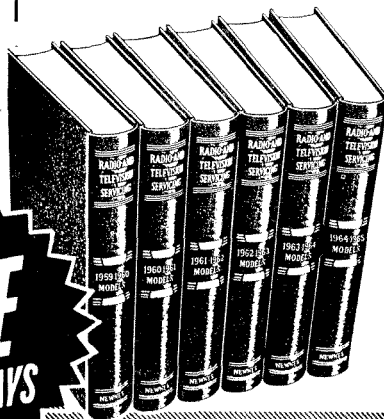

USE IT FREE FOR 7 DAYS

Circuits • Diagrams • Repair Data

FOR NEARLY

2,500 POPULAR MODELS

Plus all these developments.—Solid State Stereograms, Silicon Diodes and Transistors, Semiconductor Code, Miniature Receivers, Transistor Servicing Tips, Bias Compensating Diodes, Transistor A.G.C. Circuits, Replacing Potentiometers, Developments in E.H.T. systems, Mast-head Amplifiers, Transistor U.H.F. Tuner, Colour TV, etc.

GIVEN AWAY

TO EVERY PURCHASER

TV Engineers Pocket Book

Invaluable for on-the-spot repairs. 272 pages of data on installing, fault-tracing and repairing, etc. Over 200 illustrations. Value 12/6 but yours Free with the set.



To: George Newnes Ltd., 15-17 Long Acre, London, W.C.2

Please send Newnes Radio & TV Servicing and TV Engineers Pocket Book without obligation to buy. If you accept this application I will post 16/- deposit 8 days after receipt of books, then 20/- monthly for 16 months, paying £16 16s. in all—or under the books. Cash in 8 days £16 16s.

If under 21 your father must fill up coupon

Full Name (BLOCK LETTERS) (Mr., Mrs., Miss)

Address

Occupation

Signature

42 / 1509

Tick ✓ where applicable

The address on left is—

My Property

Rented unfurnished

Parents' Home

Furnished Accom.

Temporary Address

Why

NOT BUILD ONE OF OUR PORTABLE TRANSISTOR RADIOS

BACKED BY OUR SUPER AFTER SALES SERVICE

All components used in our receivers may be purchased separately if desired. Parts price lists and easy build plans available separately at fixed prices stated.

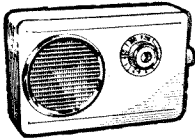

"Transona Five"
Size 6½ x 4½ x 1½ in. approx.

Covers M. and L. Waves and Trawler Bands a feature usually found in only the most expensive radios. On test Home, Light, 208, and many Continental stations were received loud and clear. Designed round supersensitive Ferrite Rod Aerial and new type fine tone super dynamic 2½ in. speaker, attractive plastic cases with red grille.

Total cost of all parts for either type now only **42/6** P. & P. 3/6 (State type required)
Parts Price List and easy build plans 2/-

TRANSONA 5 or POCKET 5

● 7 stages—5 transistors and 2 diodes

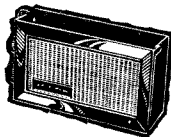

"Pocket Five"
Size 5½ x 1½ x 3½ in.

TRANSONA SIX

● 8 stages—6 transistors and 2 diodes

This is a top performance receiver covering full Medium and Long Waves and Trawler Band. Push pull output. High-grade speaker makes listening a pleasure. Ferrite rod aerial. Many stations listed in one evening including Luxembourg loud and clear. Attractive case in grey with red grille. Size 6½ x 4½ x 1½ in. (Uses PP4 battery available anywhere.) Carrying Strap 1/- extra.

Total cost of all parts now only **59/6** P. & P. 3/6 Parts Price List and easy build plans 1/6

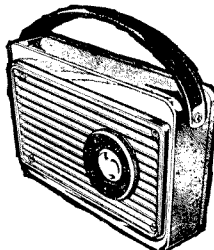

SUPER SEVEN

● 9 stages—7 transistors and 2 diodes

Covers Medium and Long Waves and Trawler Band. The ideal radio for home, car, or can be fitted with carrying strap for outdoor use. Completely portable—has built-in Ferrite rod aerial for wonderful reception. Special circuit incorporating 2 R.F. Stages, push-pull output, 3in. speaker (will drive large speaker). Size 7½ x 5½ x 1½ in. (Uses 9v battery available anywhere.)

Total cost of all parts now only **£3.19.6** P. & P. 3/6 Parts Price List and easy build plans 2/-

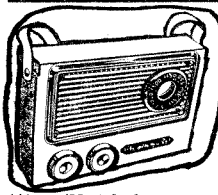

NEW! ROAMER 7 Mk IV

7 WAVEBAND PORTABLE OR CAR RADIO

FULLY TUNABLE ON ALL WAVEBANDS
★ Now with PHILCO MICRO-ALLOY R.F. TRANSISTORS

Amazing performance and specification

● 9 stages—7 transistors and 2 diodes

Covers Medium and Long Waves, Trawler Band and two Short Waves to approx. 15 metres. Push-pull output for room filling volume from rich toned heavy duty "Celestion" speaker. Air spaced ganged tuning condenser. Ferrite rod aerial for M & L Waves and telescopic aerial for S Waves. Real leather-look case with gilt trim and shoulder and hand straps. Size 9 x 7 x 4 in. approx. The perfect portable and the ideal car radio. (Uses PP7 batteries available anywhere.)

Extra band for easier tuning of Pirate Stations, etc.
Total cost of parts now only **£5.19.6** P. & P. 5/6
Parts Price List and easy build plans 3/-

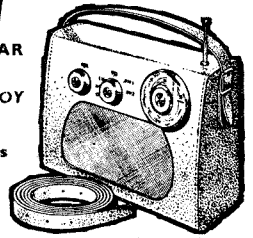

MELODY SIX

"... amazed at volume and performance, has really come up to my expectations".
S.G., Stockton-on-Tees.

● 8 stages—6 transistors and 2 diodes

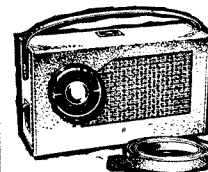

Parts Price List and easy build plans 2/- Total cost of all parts now only **£3.9.6** P. & P. 3/6

NEW!! ROAMER SIX

NOW WITH PHILCO MICRO-ALLOY R.F. TRANSISTORS

● 6 WAVEBAND!!

● 8 stages—6 transistors and 2 diodes

Listen to stations half a world away with this 6 waveband portable. Tunable on Medium and Long Waves, Trawler band and three Short Waves. Push pull output. Sensitive Ferrite rod aerial and telescopic aerial for short waves. Top grade transistors, 3-inch speaker, handsome case with gilt fittings. Size 7½ x 5½ x 1½ in. (Carrying Strap 1/6 extra.)

★ Extra band for easier tuning of LUX., etc.
Parts Price List and easy build plans 2/- Total cost of all parts now only **£3.19.6** P. & P. 3/6

SPECIAL RADIO EXCHANGE BARGAINS

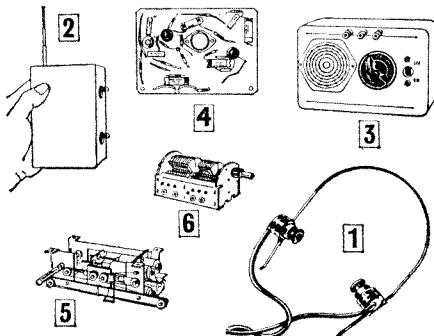

- HEADPHONES.** Sonotone H.S.30 High Fidelity Headphones. Made by famous American manufacturers. APPROX. 150 ohms impedance for direct matching into most transistor circuits. BRAND NEW in original sealed cartons. 15/- P. & P. 1/6. Matching Transformers for higher impedance 2/6 extra.
- THE SIG-GEN.** A versatile Signal Injector. Something no constructor should be without. This ingenious device generates an audible signal through the Audio and R.F. ranges. With variable output. Telescopic Probe. Pocket size slim-line case measures 4½ x 3½ x ½ in. Complete set of parts with full instructions. 19/6. P. & P. 1/6.
- QUICK CHECK TRANSISTOR TESTER.** Checks gain of R.F. and Audio Transistors. Also checks for noise level and duds. All parts ready to be assembled in attractive grey case with red grille, complete with Dial, Knobs, and 2" Speaker. Simple assembly instructions free with set of parts. 39/6. P. & P. 3/6.
- 1200mW TRANSISTOR AUDIO AMPLIFIER.** Designed to give high quality at low cost. This superb Amplifier uses 4 Transistors including a special power type operating from a 12 volt battery. Variable input impedance. Matches directly into 25 ohms—35 ohms Loudspeaker. Special gain control circuit can also reduce noise to a minimum. All parts including Transistors, Printed Circuit Board, etc. 42/6. P. & P. 2/6. Easy build plans free with sets of parts. 6" x 4" 35 ohm speaker. 12/6. P. & P. 1/6.
- CYLDON PERMEABILITY TUNERS.** By famous manufacturer. Full M.W. coverage. Fitted coupling coil, oscillator coil, ferrite slugs and slow motion tuning with cursor, etc. GIVE AWAY PRICE 10/- P. & P. 1/6. Switched type 2/6 extra.
- TUNING CONDENSERS.** Air spaced fine quality German manufacture with slow motion drive. 0.0005. With oscillator section. BRAND NEW!! Only 6/6. P. & P. 1/6.

RADIO EXCHANGE Ltd.

61a, HIGH STREET, BEDFORD. Phone: 2367

Callers side entrance
Barratts Shoe Shop
Open 9—5 p.m.
Sats. 9—12.30 p.m.

A FEW SNIPPETS

from the HOME RADIO CATALOGUE

To give you some idea of the vast range of electrical and electronic components to be found in the latest edition of our Catalogue we have taken a random selection of pages, showing a small part of each page.

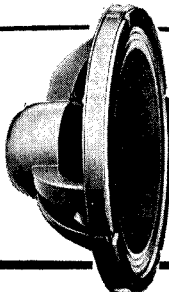

Page 147
GOODMANS AXIOM 10
Price **£6.5.11**
(87 Speakers listed)

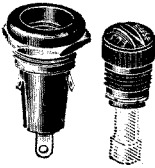

Page 84
BULGIN F297 FUSE HOLDER
Price **2/6**
(13 Fuseholders listed)
(56 Fuses listed)

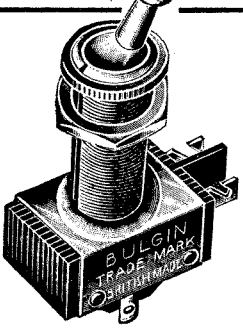

Page 156
BULGIN DOUBLE POLE ON/OFF SWITCH S 483
Price **8/3**
(128 Switches listed)

Now this is only 6 out of 5,800 items, 900 of which are illustrated. Surely you cannot wait to see the rest! The catalogue costs 7/6, plus 1/6 postage and packing, and contains five coupons, each worth 1/- when used as directed. Fill in the Coupon and post today with a cheque or P.O. for 9/-.



Page 78
EDDYSTONE 940 RECEIVER Price **£133.0.0**
(4 Eddystone Receivers listed)
(76 Eddystone Components listed)

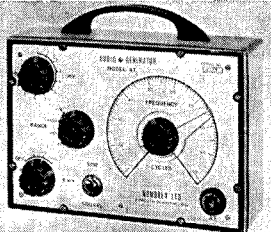

Page 171
NOMBREX AUDIO GENERATOR
Price **£16.15.0**
(28 items of Test Gear listed)

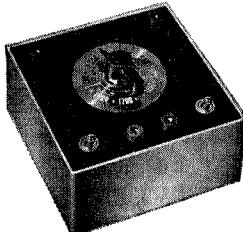

Page 86
A BEGINNER'S TRANSISTOR CRYSTAL SET KIT
Price **£1.17.6**
(100 Kits listed)

Please write your name and address in block capitals

NAME.....

ADDRESS.....

.....

.....

HOME RADIO LTD., DEPT. PE, 187 LONDON ROAD, MITCHAM

TECHNOLOGY AND EDUCATION

TECHNOLOGY has now become a fashion word. The creation of a ministry devoted to the promotion of technical advancement in industry has focused much attention on this subject. The need for such Governmental sponsorship is generally accepted; at least, no one is likely to deny the importance of keeping in the van of technical progress.

But much remains to be done to dispel old prejudices in education. Arts and pure science have long been upheld as the highest intellectual attainment, while the practical application of such arts has been stigmatised as a somewhat lower form of human activity.

* * *

Happily, there are signs that a reorientation of ideas is taking place among leading figures in the educational world. And, interestingly enough, these new thoughts are germinating not only in technical circles, but in what one might consider to be conservative areas of influence.

In this year's presidential address to the Education Section of the British Association, Mr. J. C. Dancy, Master of Marlborough College, developed the theme that some experience of creative technology is an essential part of a liberal education.

There were (Mr. Dancy said) both theoretical and practical reasons for regarding technology in secondary schools so highly. The gist of his argument was as follows.

Technology involves a threefold creative activity: of intellect, of hand, and of eye. It thus embraces the skills of the scientist, the craftsman, and the artist. Creative technology is necessary to counterbalance the undue emphasis at present given to analytical faculties as in pure science.

* * *

Dealing with the practical argument, Mr. Dancy first made reference to the fact that creative work does bring its own reward, by satisfying a deep instinct in all of us; then he referred to a sociological aspect that will have increasing importance in the future. It is generally accepted that a reduction in working hours will be the outcome of extensive use of advanced technical processes in industry and commerce. The increased leisure time will tax the resources of everyone. Here then is one of the main tasks of modern education—to prepare us to cope with the leisure of tomorrow.

In the concluding portion of his presidential address, the speaker recognised that the do-it-yourself habit has become part of our way of life and that it will play an increasingly important part in the future. We quote: "So the skills developed in creative activities at school have no lesser scope than a lifetime of fruitful use—in leisure time for some, but for others in their vocation".

THIS MONTH

CONSTRUCTIONAL PROJECTS

DOORPHONE	915
AUDIO OSCILLATOR AND VALVE VOLTMETER	918
WATER LEVEL ALARM	936
GENERAL PURPOSE SCALER	942

SPECIAL SERIES

CLASSIC COMMUNICATIONS RECEIVERS—BC348	926
NEON NOVELTIES—3	928
BUILDING BLOCKS—8	931
BEGINNERS START HERE—13	940

GENERAL FEATURES

ELECTRONICS AT BEVERCOTES	910
INGENUITY UNLIMITED	960

NEWS AND COMMENT

EDITORIAL	909
ELECTRONORAMA	938
DETACHED PARTICLES	952
AUDIO TRENDS	955
NEW PRODUCTS	959

Our December issue will be published on Thursday, November 11



ELECTRONICS AT BEVERCOTES

An account of the world's most advanced coal mine. In this "mine of the 21st Century" all the complex coalface machinery is controlled by one white-coated collier sitting at the control panel away from the coalface. Semiconductors make possible the large-scale use of electronics underground.

COALFACE mechanisation is now so widespread that it accounts for more than 80 per cent of the total output from British mines. But just as mechanisation has rendered the pick and shovel obsolete, so will new developments exploiting the opportunities provided by electronics soon make conventional mechanisation out of date—for a revolution is taking place underground, and modern technology is being applied to revitalise one of the oldest industries.

The world's first remotely operated mine at Bevercotes, Notts, will shortly be producing coal for electricity power stations. In addition to being a production unit, Bevercotes is a field laboratory. Here work will continue into the further use of electronics and new developments will be tried out under actual mining conditions. These further developments will be the final steps towards the *fully* automated mine which experts confidently predict will within 10 years

account for at least 50 per cent of the National Coal Board's output. New ideas proved at Bevercotes colliery will be extended to other pits wherever possible.

The reason for the National Coal Board's intensive research and field testing of new devices and systems is essentially economic: the need to produce coal at a competitive price in answer to the challenge from other power station fuels, particularly oil—and to achieve this despite a continuing decreasing manpower force in the industry. This apart, there is the very important human factor. The introduction of remotely controlled coal cutting machinery has already reduced the hazards faced by underground workers. As progress continues, a new type of miner will take over the comparatively few tasks remaining to be performed by humans, and he will be a highly skilled technician tending to some of the most sophisticated equipment found in any industry.

SIGNIFICANCE OF SEMICONDUCTORS

A couple of decades ago, before the advent of solid state devices, the large scale use of electronics equipment in a coal mine was entirely out of the question. The nature of vacuum valves, their need for high voltage supplies, the heat they generate, and their physical frailty, make them quite unacceptable for use in the potentially dangerous environment below ground.

In contrast, semiconductors with their meagre appetite for electric current and their general robust nature have made it possible to design and build electronic units that are intrinsically safe against fire or explosion, and that are in all other respects entirely suitable to withstand the conditions peculiar to a coal mine.

Bevercotes is a mine of great interest for the electronics enthusiast. Before briefly describing the principal electronic systems incorporated in this "mine of the future", it will be useful to have a quick look at the general organisation of the mine and to note the progress of the coal from coalface to the special railway train which takes it away to the electricity generating station.

THE MINE IN ACTION

Coal will be obtained from five longwall faces, each approximately 270 yards long. The remotely operated longwall face has been in use in mechanised mines for some eight years; known as ROLF, it is a complex piece of machinery, including mechanical, hydraulic, electrical, and electronic equipment. It is based on an armoured conveyor with a number of self advancing hydraulically powered props, which support the roof. Cutting picks are mounted on a drum and this revolves as it is pulled along above the conveyor, the coal cut from the virgin face being deflected onto the conveyor by a plough attached to the machine. The armoured conveyor delivers the coal to a stage loader in a roadway running at right angles to the longwall face.

Both the power loader and the hydraulic supports are remotely operated from a control console mounted on the remote end of a rail mounted structure known as the pantechicon which extends back down the roadway. The console is shown in our heading photograph.

From the stage loader, the coal is transported by a belt conveyor system and finally fed into a 1,000 ton capacity [underground bunker. Coal is discharged from the bunker via a skip feed conveyor. The skip is wound some 3,000 feet to the surface, and the coal discharged onto a conveyor feeding the coal preparation plant.

This plant has a capacity of 600 tons per hour and is designed to produce a product having an ash content of 15 per cent and a moisture content of 12 per cent suitable for use in electricity generating stations.

The blended product is delivered to the unloading bunkers which are built over a railway track. When a train is correctly positioned under the bunkers, coal is fed into four weighing hoppers which are weighed automatically before being discharged into four separate rail wagons. The net weight of coal discharged in the wagons is automatically recorded on an advice note. The train is repositioned by the engine driver and the procedure repeated until the whole train has been loaded.

SECTOR CONTROL

Bevercotes is equipped with an extensive remote control scheme, operated from several manned control points. Each controller is responsible for a specific area of operation known as "control sector" and is under the overall direction of the central controller located on the surface.

The sector control positions are as follows:

1. Remotely operated longwall faces.
2. Underground transport (coal, men, material and dirt).
3. Shaft No. 1.
4. Shaft No. 2.
5. Coal preparation plant.
6. Surface and underground ancillaries.

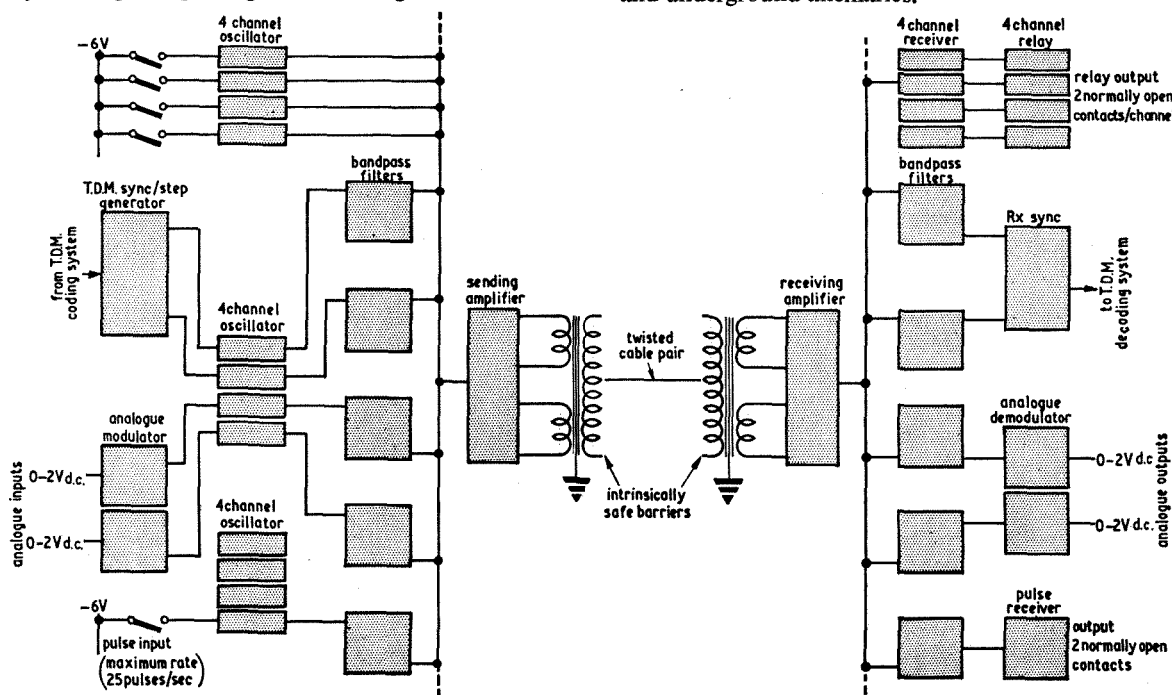
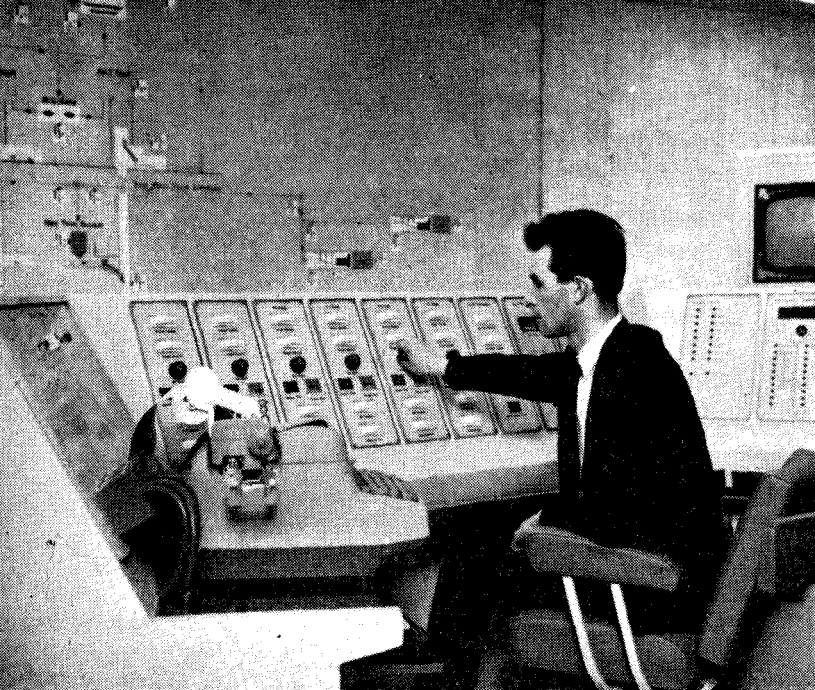

Fig. 1. A typical arrangement of the AEI Electronics voice frequency data transmission system as used at Bevercotes colliery



(Left) Central control room at pithead. The mimic diagram of the complete mine system can be seen on the wall in the background. In the foreground is an electric typewriter, and at the extreme right, the closed circuit television console.

(Far right) Remotely operated Gullick powered supports, with the face conveyors naked. On the right of the picture is the haulage chain, with the coal cutting machine in the background

(Below) Here, partly withdrawn from its place in the mimic diagram control console is one of the numerous electronic boards

Each of the sectors has facilities for remote control of the equipment within the sector from its own console, and can transmit information to and receive information and instructions from central control and other related sectors.

CONTROL AND COMMUNICATIONS SYSTEM

Information regarding the operating state of all plants within all sectors, plant faults, and any hazardous condition, is transmitted to control centres and other sectors by visual eight-light indicators. These indicators are incorporated in a mimic display unit at surface central control and underground transport control centres.

The control and communication system is based on the use of voice frequencies and time division multiplexing techniques which have the desired effect of reducing cores in control cables. The system is operated using standard 3/029 multi-core telephone cables, allowing two pairs of conductors to receive and transmit all signals for each underground transfer point. Twenty-four v.f.'s may be used for each pair of conductors. The frequencies of the 24 channels range from 420c/s to 3,180c/s with 120c/s spacing, and the signal is transmitted at a level of 100V peak to peak.

INTRINSICALLY SAFE

Fire damp (methane with traces of other gases) has always been a serious hazard in coal mines. All electrical apparatus used in mines must either be housed in a flame proof enclosure, or must be intrinsically safe—this means that the voltage and current of the power source must be of such a low value that should sparking occur, the amount of energy dissipated in this way is very limited and presents no danger of ignition of explosive atmospheres.

The voice frequency multiplex system for telemetry and control functions at Bevercotes was developed by AEI Electronics. Using solid state techniques, this complex control system is fed by supply units with an intrinsically safe output of +16, 0, -6V.

All tuned circuits employ ferrite pot cores and polystyrene capacitors, giving a temperature coefficient of about 100 ppm/°C. The circuits are built on printed boards using gold plated edge connectors. The active components are solid state devices and reed relays.

A typical arrangement of part of the system is shown in Fig. 1. Continuously running LC oscillators are grouped in blocks of four on one printed board, the oscillator outputs being switched by the control element. The outputs are summed by a two-stage transistor amplifier which drives the line transformer.

At the receiving end, a buffer amplifier drives band-pass filters. Each filter covers four adjacent channels and is followed by four single tuned active channel filters. Each filter output is amplified and rectified to drive a two-pole reed relay.

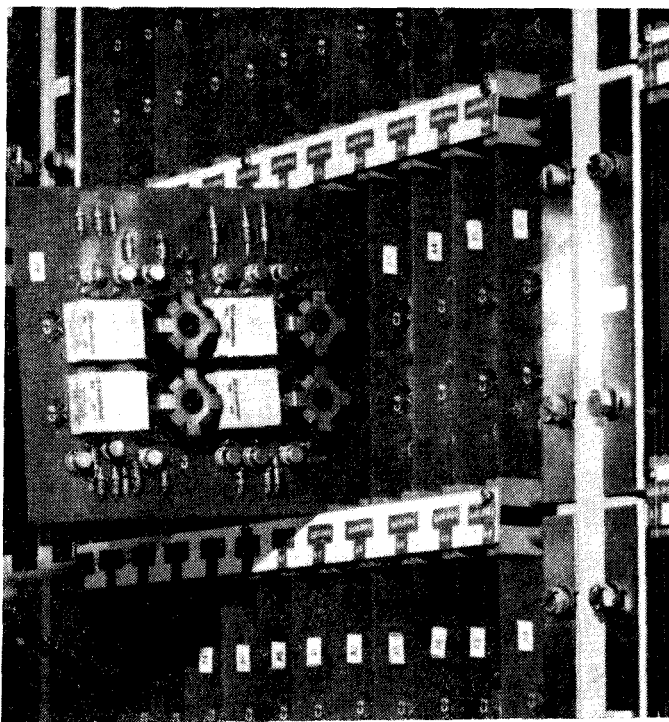

Analogue signals are standardised to 0–2V d.c. and are converted in the analogue modulator to a square wave with a repetition frequency in the range 5–25c/s. This is then used to modulate the carrier frequency. A bandpass filter between the oscillator and the summing amplifier removes all but the primary sidebands.

At the receiving end, a bandpass filter similar to that at the transmitting end follows the buffer amplifier and picks out the modulated carrier. In the demodulator the carrier frequency is removed and the modulation frequency reconverted to a direct voltage in the range 0–2V corresponding to that at the transmitting end.

Pulses at rates up to 30 per second can be transmitted by modulating the carrier. Bandpass filters are used as with the analogue system and at the receiving end the filter is followed by a monostable circuit driving a relay which can be used to drive electromechanical counters and similar devices.

TIME DIVISION MULTIPLEX SYSTEM

In order to accommodate a larger number of channels where low transmission rates are acceptable, a 64-channel time division system is used. Two voice frequency channels are required, one for the multiplexed information and the other for stepping and synch.

At the transmitting end a solid state switch steps round the 64 inputs sequentially at the rate of 25 per second. The information thus derived from the inputs is transmitted as amplitude modulation on one of the v.f. channels. The second channel carries the stepping pulses which drive a second switch at the receiving end in synchronism with that at the transmitter. A number of bistable circuits are set up to correspond to the inputs and these drive changeover relays which form the output circuits.

REMOTELY OPERATED LONGWALL FACE

The ROLF scheme involves remote control and instrumentation of the roof supports, the coal-cutting machine, the face conveyor and various other services. The controls and instruments are all contained in a small cabin on the pantechicon, where the ROLF operator sits. From there he controls all the machinery and interprets the instrumentation display. In the initial phase at Bevercotes no control or instrumentation functions are brought beyond this cabin, although spare channels are available to bring an instrumentation display to the surface if required.

The coal-cutting machine is fitted with transducers to measure main and tail haulage, and a methanometer to sample the air near the cutter drum. The signals from these devices are processed by amplifiers on the machine and transmitted via an auxiliary cable to the cabin. In addition, a methanometer with an electronic transmitter is used to monitor the return air from the face, and power transducers incorporating AEI Hall-effect plates are fitted to contactors to monitor power consumption and to control the machine haulage rate.

CHOCK CONTROL

The roof supports on the first face at Bevercotes have been supplied by Gullick Ltd. They are fitted with a system of remote control and monitoring, made by AEI Electronics to NCB specification. This system consists of a set of control panels in the ROLF cabin which are connected via three heavy duty cables to the switching boxes fitted to the roof supports. On command, each roof support extends a horizontal ram to push the armoured conveyor forward to the coal-face, then retracts from the roof, and using the con-

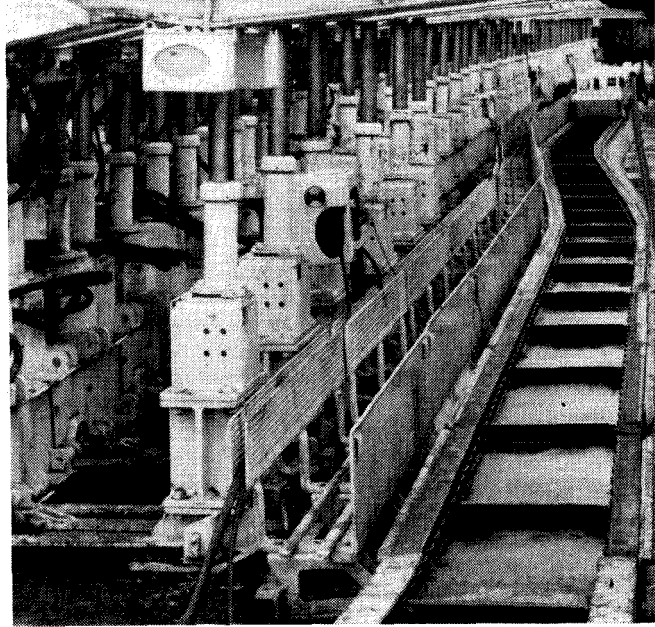

veyor as an anchor pulls itself forward and resets to the roof.

The chock control system controls this action remotely by operating electrohydraulic valves on the support. Two processes are needed, namely selection of a support and control of the sequence of pushing the conveyor and advancing the supports for the whole face. The supports are divided into sections of 20, a unique address being achieved by selecting any section and any chock number between 1 and 20. Selection is by the same process in each case, signals on two out of five wires in the chock cable and the section cable causing coincidence circuits to operate and close the correct switching box relay. Direct current of either polarity may then be supplied via the third cable to operate either the push or advance valves.

The important function of deciding which support should be operated, and the overall sequence, is carried out automatically by the snake control panel. This panel has a series of ring counters which are wired to suit the individual requirements of each coalface, and which keep in step with the whole operating sequence.

BELT WEIGHER

A conveyor belt weigher suitable for use underground has been designed. It is basically a high accuracy integrating device for producing a figure of total tons weighed. Differential transformers supplied with a stabilised primary current are used to measure the deflections of a pair of cantilevers which support an idler roller set, over which the belt passes. The signals from these transformers are added, converted to d.c. and applied to a "ramp" type analogue-to-digital converter. This converter assesses the load on the idler set and converts it to an intermittent pulse train, the pulse frequency being determined by a crystal oscillator and the number of pulses being proportional to the idler deflection.

This process is repeated each time the belt moves six inches, so that the total number of pulses produced in a period is proportional to the material carried. A binary counter divides the pulse rate down to a level suitable to drive a counter calibrated in tons.

CONVEYOR CONTROL

The whole coal transport system in the mine is controlled by one man situated in the underground transport sector control room.

A klaxon gives warning when the conveyor motors are about to be started. A microphone picks up the sound from the klaxon and feeds this signal to the control unit; the conveyor system will not start unless the klaxon has been sounded for a pre-set period.

Temperature protection, oil level and flow protection, and bad belt fault detectors are fitted to each conveyor. These two-state protection devices transmit a faulty/healthy state indication to the central control.

Belt transfer points are also monitored by television cameras in a closed loop circuit with a display at the underground transport control and in central control on the surface.

METHANE DRAINAGE

The present methods of longwall face mining break up the overlying strata, causing entrapped methane (fire damp) to be liberated so that it eventually travels through to the ventilated roadways. Drilling bore holes up into this strata enables exhausters to extract this methane and dispose of it on the surface so that the main ventilation stream is not overloaded.

Transducers developed by the NCB are used to measure the methane purity and flow rate and these may operate valves at monitor and control stations in the event of abnormal conditions. It is necessary to send control signals from the surface to these points and also to receive signals from them, at the surface. The AEI v.f. signalling system is used for this purpose, transmitting four alarm signals from, and six control signals to, each double control station. The methane flow and purity information is processed so that it is similar to the standard v.f. signals and common transmission equipment may be used.

PERSONNEL COMMUNICATIONS

At Bevercotes every modern form of communication known in mining is being applied, each fulfilling a particular role in the integrated scheme.

Electronic modules for the control console being assembled in the AEI Electronics factory at Leicester

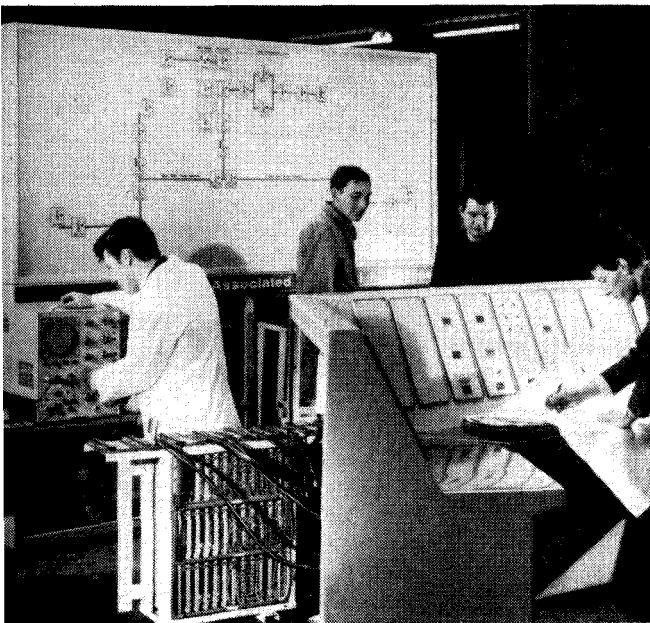

A 200-line PABX telephone exchange serves the whole colliery. Party line working, priority and emergency calling are incorporated. The central control is linked with certain outstations by a management control loud-speaking telephone system. A two-way "clear-call" industrial communications system operating through the PABX exchange is installed for paging any person on the surface.

Key persons underground carry a one-way receiver and can be paged from the surface manual exchange. Signals are transmitted on a 30 kc/s carrier and radiated from a loop erected in the mine roadway. On receipt of the appropriate tone, the receiver emits a series of loud "bleeps". The person called then contacts control via the nearest telephone.

Another inductive loop communication system provides two-way speech communication between the underground transport controller and the drivers of locomotives.

TRANSMISSION OF INFORMATION

Production data in digital form from the central control desk (and any other desired information) is fed into an electric typewriter in central control and transmitted simultaneously to a slave typewriter situated in the general manager's information room.

COAL PREPARATION PLANT CONTROL ROOM

Apart from the out-loading bunkers, all equipment in the coal preparation plant is remotely controlled from the control room within the plant.

The mimic panel indicates every drive condition; positions of all valves, together with tonnages throughout the plant, specific gravity of media, tank levels, bunker levels, and air pressures are also indicated.

MANPOWER DEPLOYMENT

An indicator unit in central control shows the state of manpower deployment of surface and underground sectors. The signals are manually initiated from the facsimile board in the manpower deployment centre.

The centre is designed round an electronic deployment system, specific reporting positions being provided for each district or sector of the mine. An information plug is provided for every underground worker. Each plug is labelled and coded with the worker's personal number and other information concerning his trade, etc. The plug contains up to 25 steel pins, the number and position of which indicate the required details.

On reporting for duty at the commencement of a shift, the worker takes his personal plug from a parking board and hands it to the deploying officer who inserts it into a frame identified with a particular sector of the mine.

The frames are eventually fitted onto the deployment boards of the electronic scanner. Associated with each pin socket on the scanner are a pair of conducting loops. One of these loops is energised from a 6kc/s signal during the scanning operation. The presence of a pin will result in the production of a flux which in turn will induce a voltage in the second loop, and this output signal is applied to the control unit. Here it is converted into a suitable form to operate a teleprinter and punched tape machine.

The records thus produced are used as the basis for a time keeping system and from the punched tape the NCB divisional computer centre will produce the weekly payroll without further direct labour. ★

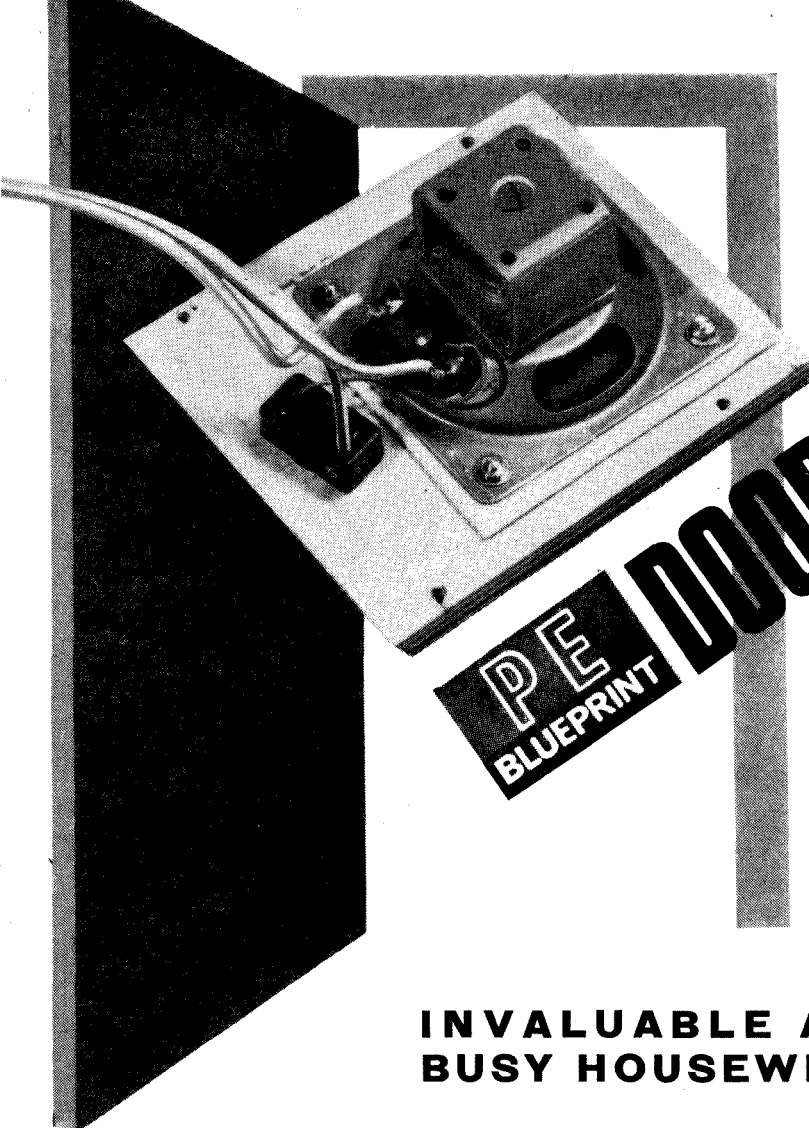

DOOR PHONE

two-way
loudspeaking
intercom
with an audible
calling signal

By R. E. F. Street

INVALUABLE ASSET FOR THE BUSY HOUSEWIFE AND INVALID

ONE of this month's blueprints shows the details for making an intercom system designed for use between the front door of a house and the kitchen. A busy housewife is thus able to convey messages to tradesmen without the need to leave a particular chore or child unattended. It has been found to be a considerable asset to an invalid or handicapped person who is left alone in the house.

No doubt readers will be able to find a host of applications for the system, since it is entirely self-contained in two units and does not rely on an external source of supply.

A "calling" system is also incorporated so that the caller at the front door can attract the attention of the occupant, so dispensing with conventional bell and knocker systems. Alternatively, the calling system may be omitted if the conventional systems are preferred. Even with the calling system, the number of interconnecting wires is kept to a minimum; there are only three wires used here.

CIRCUIT DESIGN

The circuit of the unit is shown in Fig. 1 on the blueprint. Basically, it consists of a four-transistor

amplifier having a maximum output of about 500mW. The amplifier is conventional in circuitry, apart from R5, the function of which will be explained later.

When designing the unit, the aim was to employ readily available components, and this meant that 3 Ω loudspeakers were called for. It was decided to use a single loudspeaker at each end of the two-way intercom system and use them alternately as microphones and loudspeakers. The switching necessary to accomplish this procedure is carried out by a four-pole, three-way switch, S1. The three positions of the switch, which is situated at the same end of the system as the amplifier, correspond to "off", "speak", and "listen".

When either loudspeaker is used as a microphone, it is matched into the first transistor TR1 by means of a transformer T1. The transformer suggested is a miniature type having a ratio of 50 : 1 and originally intended for use in the output stage of a valve radio receiver. It is connected to provide a step-up ratio of 1 : 50 to the base circuit of TR1. A conventional microphone transformer of ratio 35 : 1 was tried but was much larger, more expensive, and did not give such good results as the type specified.

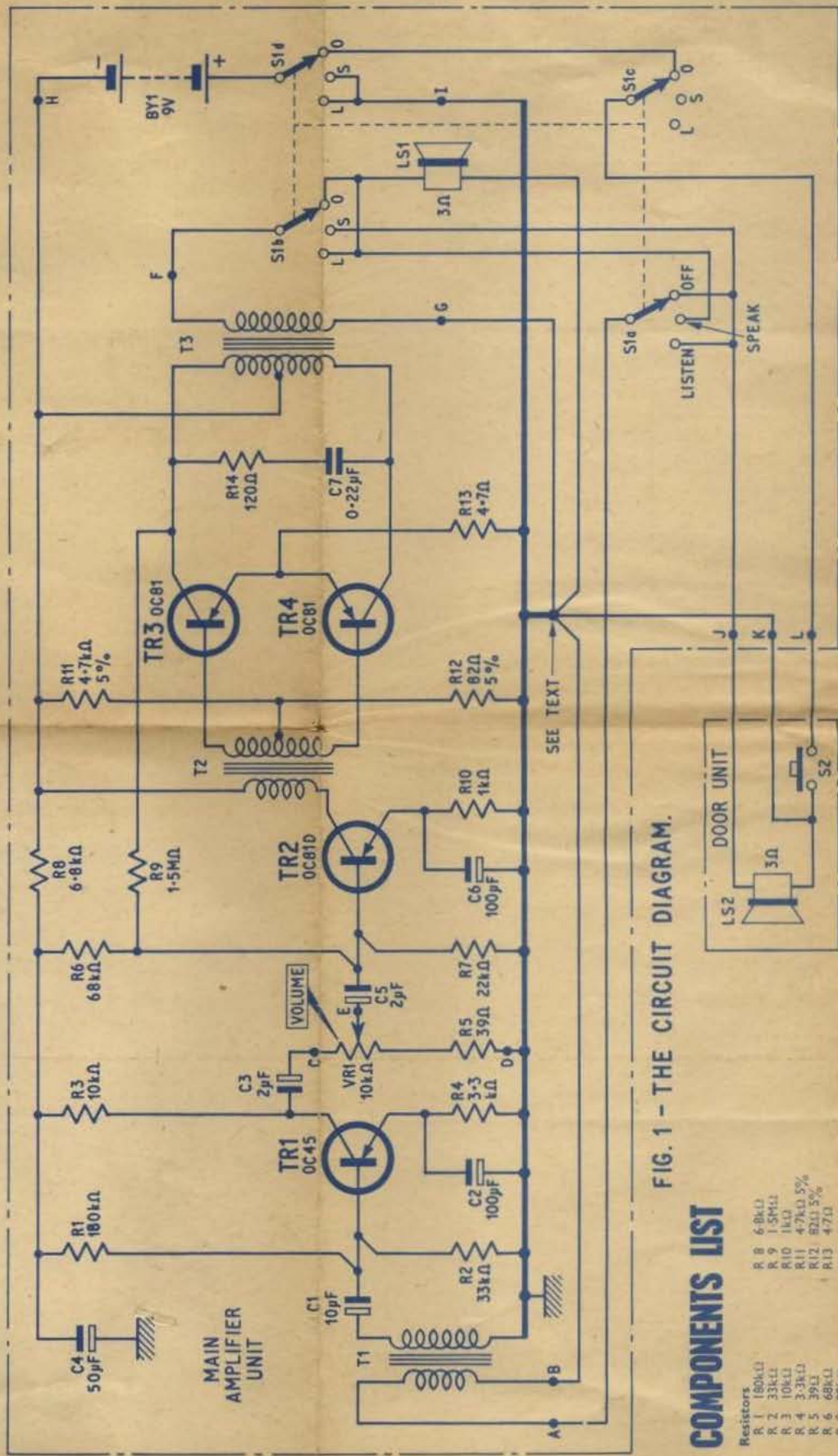

FIG. 1 - THE CIRCUIT DIAGRAM.

COMPONENTS LIST

Resistors.	
R 1	180kΩ
R 2	33kΩ
R 3	10kΩ
R 4	3.3kΩ
R 5	39Ω
R 6	68kΩ
R 7	22kΩ
R 8	6.8kΩ
R 9	1.5MΩ
R 10	1kΩ
R 11	4.7kΩ, 5%
R 12	82Ω, 5%
R 13	4.7Ω

- Capacitors**
 C4 50 μ F elect. 12V
 C1 10 μ F elect. 6V
 C3 100 μ F elect. 6V
 C2 2 μ F elect. 6V
 C5 100 μ F elect. 6V
 C7 0.22 μ F 150V or 250V
- Transformers**
 T1 "Miniature" output
 T2 T7T6
 T3 T7T7
- Transistors**
 TR1 OC45
 TR2 OC81D
 TR3, TR4 Matched pair OC81
- Switches**
 S1 4-pole, 3-way, make before break (made up from two 2-pole, 5-way m.b.b. Radiospares "Mak-Switch" wafers)
 S2 push-to-make
- Loudspeakers**
 LS1 4 $\frac{1}{2}$ in dia. round, or similar—3 Ω impedance
 LS2 2in or 2 $\frac{1}{2}$ in dia. round, or similar—3 Ω impedance
- Battery**
 BY1 9V (Vidor type VT9)
- Miscellaneous**
 $\frac{1}{4}$ in plywood for cases; expanded metal or perforated zinc or plastic for grilles; nuts; bolts; washers; screws; 18-way groupboard (Radiospares); plastic such as Formica or Waretite for panels; battery-connecting clips; wire; solder; long three-core cable between units

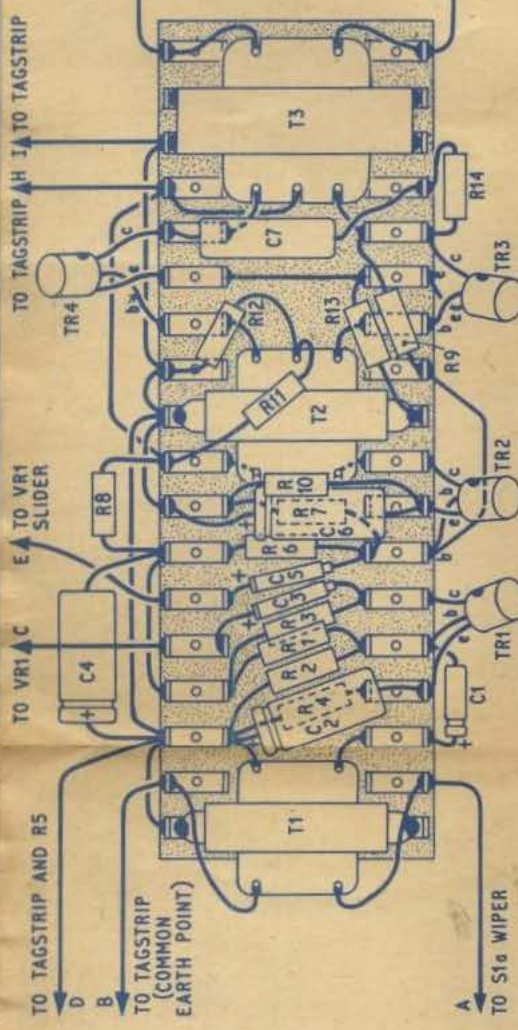

FIG. 2 - WIRING THE TAGSTRIP

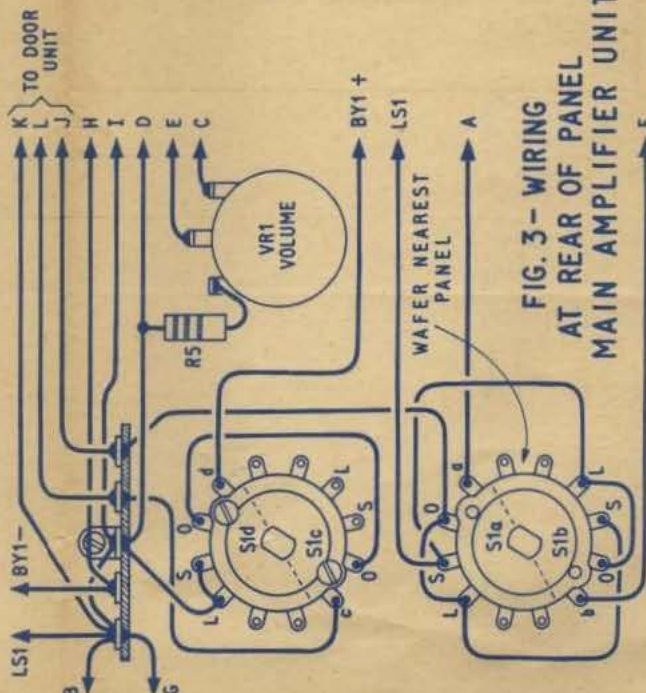

FIG. 3 - WIRING AT REAR OF PANEL MAIN AMPLIFIER UNIT

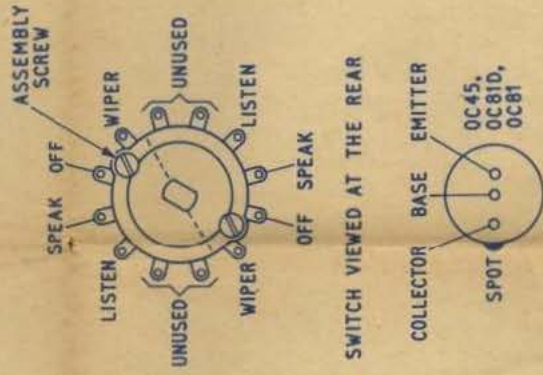

FIG. 4 - TRANSISTOR AND SWITCH DETAILS

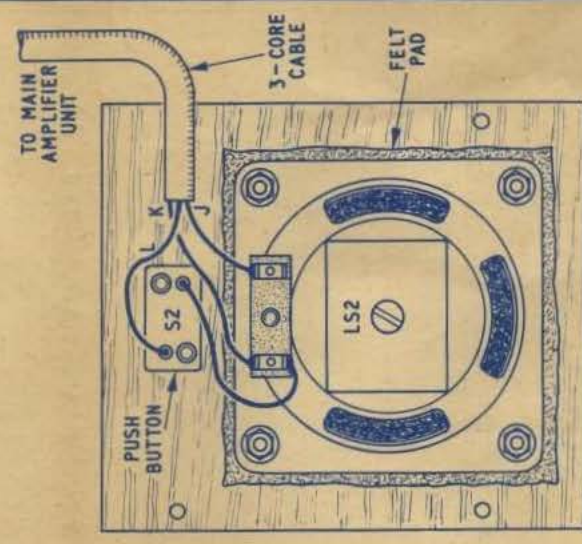

FIG. 5 - WIRING THE DOOR UNIT

SWITCHING

The input and output circuits of the amplifier, and the loudspeakers, are switched by S1a and S1b respectively. The "off" position of S1 connects the loudspeakers in the same manner as the "listen" position as will be seen from the circuit diagram.

The remaining sections of S1 (S1c and S1d) are used for switching the battery supply. The negative side of the battery is permanently connected to the negative line of the amplifier while the positive side of the battery is wired to the wiper of S1d. In the "speak" and "listen" positions of S1, the positive side of the battery is connected to the positive line of the amplifier, but in the "off" position, it is connected to the third wire of the three-core cable connecting the door unit to the amplifier unit.

The door unit is fitted with a push-button switch S2 and when this is pressed, even if the main unit is in the "off" position, power is applied to the amplifier. Switch S1c is used to render the push-button S2 inoperative when the main unit has been switched to "speak" or "listen".

COMMON IMPEDANCES

It will be seen that on the circuit diagram wire B from T1 and wire G from T3, and one side of each loudspeaker, have been joined together at a single point, which is then connected to the positive line of the amplifier. This procedure is most important; if the wiring is not carried out in the fashion indicated in Figs. 1 and 3, there is likely to be a small impedance common to both the input and output circuits of the amplifier. Since the amplifier has a very high gain, if only a few inches of wire are common to both input and output circuits, severe feedback will result and the symptoms can be most bewildering if they are not expected.

It was thought when designing the unit that it would be useful if there could be some means of "calling" the amplifier unit from the door unit. When S2 is operated, power is supplied to the amplifier when the amplifier unit is in the "off" position. Since the "off" position of S1 places the loudspeakers in the same configuration as in the "listen" position, it might

be thought that pressing S2 would enable the person using the door unit to speak and be heard from the loudspeaker in the amplifier unit. However, this is not so if the previously mentioned "common impedance" remarks are observed and "earthing" connections are adhered to.

The supply from the positive terminal of the battery passes via one of the leads of LS2, and the lead is thus common to the input circuit of the amplifier and the battery supply. The resulting "howl" of feedback is sufficient to attract the attention of anyone near the amplifier unit. Of course, the person at the amplifier unit then uses S1 in the normal way to speak to the person at the door unit.

This simple system using feedback to produce an audible signal is quite adequate. Its main disadvantage is that the note produced is not particularly harmonious, but this will not normally be disturbing since it is only heard momentarily.

CALLING SIGNAL

For the system to work satisfactorily, the volume control of the amplifier must not be at its minimum setting. R5 is inserted so that, when VR1 is at minimum volume setting an output will still be obtained if a signal is applied to the input of T1. The value of R5 can be varied in the light of experiments; if the howl produced on pressing S2 is too low or too high in volume, R5 can be increased or decreased slightly as appropriate. The value (39 ohms) was found to give adequate volume of howl under normal conditions. There may be a bell-push and bell associated with the front door already in use. If so, then obviously, the "call" system described here will be of little value, and may be omitted. The cable linking the amplifier unit to the door unit can then be of two-core type, wire L being omitted.

If required, a miniature buzzer could be fitted in the cabinet of the main unit and wired to function when S2 is operated. It would be advisable to use a separate battery for the buzzer since the specified battery would have insufficient capacity; S1c could still be used to prevent S2 from having any effect when S1 is in the "speak" or "listen" position. The buzzer would be

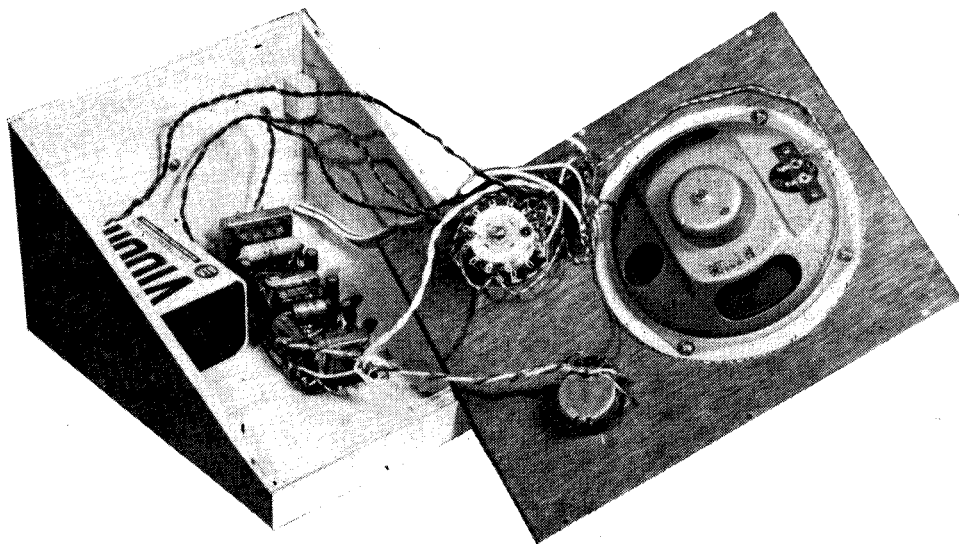

Main
amplifier
unit
and
control
panel

wired between the wiper of S1c and the wire which goes to S2, and the lead joining "O" on S1c to "O" on S1d would be disconnected. The battery for the buzzer would then be connected with the negative lead to "O" on S1c and the positive lead to the positive line of the amplifier.

AMPLIFIER CONSTRUCTION

The amplifier itself is built on an 18-way component groupboard but it should be noted that if parts larger than those shown in Fig. 2 on the blueprint are employed, it may prove difficult to accommodate them on the board. Full details of the wiring are given on the blueprint and it is recommended that the components be fitted to the groupboard first, as indicated in Fig. 2, omitting for the time being the connecting leads A to I. The mounting lugs of T1, T2 and T3 are soldered to tags on the groupboard. This is important in the case of T2 because the transformer clamp provides a link between R13 and the common positive line. The transistors should be wired in last,

taking due precautions against damage from the heat of the soldering iron by using a suitable heat shunt.

When the amplifier has been built, it can be tested, after connecting the volume control and the two loudspeakers to the appropriate points. Having established that the amplifier works satisfactorily, it can be wired up to the switch S1 as shown in Fig. 3.

Note that S1 consists of two two-pole, five-way, make-before-break wafers. The switch is a Radiospares "Maka-Switch" type and the movable "stop" should be positioned to convert the wafers into two-pole, three-way types. The diagram (Fig. 3 on the blueprint) makes clear which tags on the wafers are disregarded. It is important that the switch obtained is of the make-before-break variety; if it is not, then damage may result to the two output transistors if at any time the secondary winding of T3 is left open-circuited while there is an input signal to T1. The use of an m.b.b. switch ensures that the secondary winding of T3 is always loaded, a necessary requirement to prevent TR3 and TR4 "running away".

continued on page 937

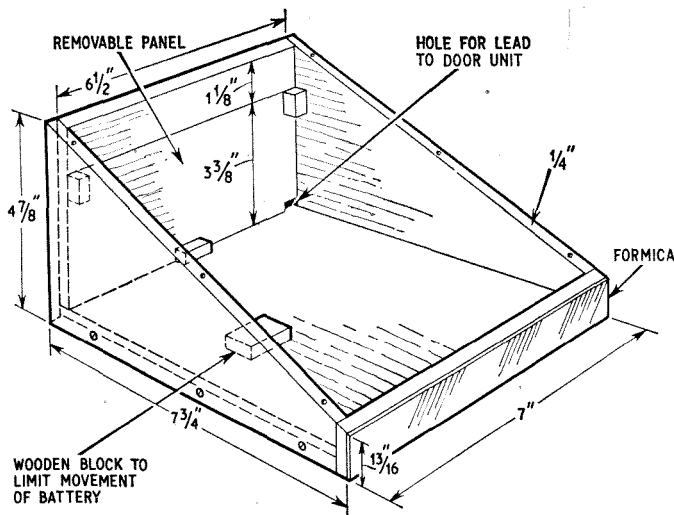

Fig. 6. Constructional details of the main amplifier unit, made from 1/4 in thick plywood and covered with a plastic laminate. The removable panel provides easy access to the battery. All parts are glued and screwed.

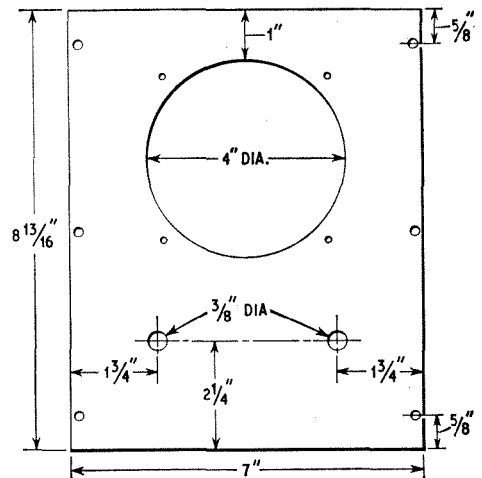

Fig. 7. The front panel of the main amplifier unit. This can be made from plastic laminate sheet. The size of the loudspeaker hole and the position of the fixing screws depends on the loudspeaker used

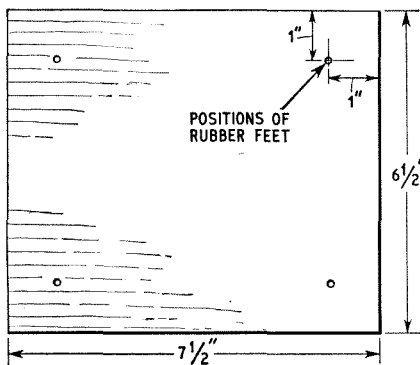
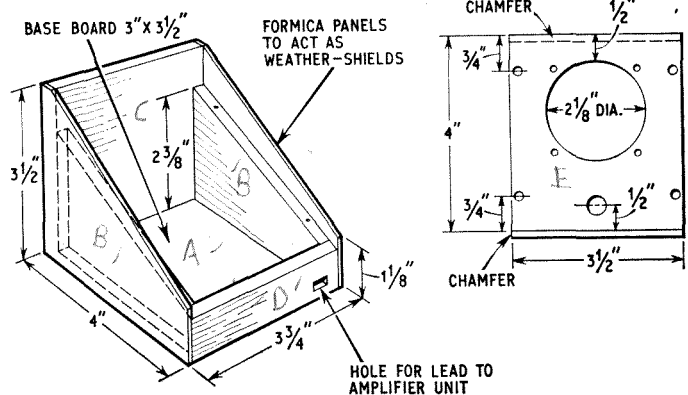

Fig. 8. Baseplate of the main amplifier unit. Four rubber or plastic feet are fitted to prevent damage to paper or paintwork on the wall



Figs. 9 and 10. Constructional details of the extension or door unit made in a similar style to the main unit. Notice that the front panel is chamfered to fit in a recessed position in the case. All parts are glued and screwed

AUDIO OSCILLATOR & VALVE VOLTMETER

PART ONE

By H. T. KITCHEN



SPECIFICATION

Oscillator

Frequency Range

1. 25c/s to 250c/s
2. 250c/s to 2,500c/s
3. 2,500c/s to 25kc/s
4. 25kc/s to 250kc/s

Output

1. 10 volts
2. 1 volt
3. 100 mV
4. 10 mV

The range and output are continuously variable.

Distortion 0.2% 100c/s to 25kc/s;

0.5% 25c/s to 100kc/s

Frequency response ± 1 dB 25c/s to 50kc/s;

± 2 dB 25kc/s to 150kc/s

Valve Voltmeter

Input Range

1. 500 volts
2. 50 volts
3. 5 volts
4. 0.5 volt
5. 0.05 volt

Frequency response on ranges 3, 4, and 5 only:

± 1 dB 25c/s to 50kc/s;

± 2 dB 10c/s to 150kc/s

MANY AMATEURS who take audio seriously, progress to the stage where they want to carry out tests on equipment they already possess, or may be building to perform a particular task. In order to make these tests, suitable equipment is necessary and it is at this stage that the short-comings of the multi-range testmeter are often revealed owing to the shunting properties of the relatively low resistance meter coil. The acquisition of a valve voltmeter can prove to be an expensive proposition, unless one is able to build such an instrument himself.

This article sets out a suitable specification which combines an audio frequency oscillator with a valve voltmeter in one cabinet, without incurring excessive expense, while at the same time being reliable and reasonably simple to construct. Care had to be exercised to avoid instability in the h.t. line by using generous smoothing and decoupling arrangements to reduce this to an immeasurably low value. All the components are conservatively rated to provide long life, to minimise heat dissipation, and to obtain good frequency stability of the a.f. oscillator.

It is not intended to give point-to-point instructions, since it is felt that the complete unit will appeal more to the advanced constructor, who will not only be able to work from the information given, but will most probably modify it to suit his own requirements and whatever components he has to hand. The less experienced constructor however, should be able to build the unit provided he is capable of working from a circuit diagram used in conjunction with a wiring layout.

Standard, easily obtained components are used throughout with one exception—the thermistor. It is the author's experience that an order placed for the thermistor may take up to six weeks to materialise although some shops do stock them. With regard to the other components, buying new, or carefully and thoroughly tested old ones, is the best guarantee of success; too much otherwise excellent equipment may be rendered virtually useless because of salvaged and untested components being used.

CASCADE

Several commonly used circuits were considered and the reason why the present circuit was chosen may prove of interest. There are two basic forms of a.c. voltmeter using valves or transistors.

The first type the "rectifier/amplifier" is commonly used for r.f. measurements and usually consists of a diode rectifier followed by a high gain d.c. amplifier. The d.c. amplifier has to be carefully designed to guard against drift, and the rectifier requires several hundred millivolts across it to provide a reasonably linear scale, this precluding all very low voltage measurements. This type, therefore, is almost automatically excluded for most audio frequency work.

The second type is the "amplifier/rectifier" and is most suited for audio frequency measurements, for with careful design, a full scale deflection can be obtained for an input as low as 1mV. Some very expensive commercial instruments are even more sensitive but are seldom necessary to most amateurs.

The "amplifier/rectifier" meter can again be divided into two basic types: cascade amplifiers and cascode amplifiers. A glance at the circuit diagram of a television turret tuner will show that the r.f. amplifier is almost always cascode connected, providing high gain and good bandwidth, this being the reason for the present choice of circuit shown in Fig. 1.

Cascade amplifiers are capable of providing very high gain, but due to "Miller" and other esoteric effects, the h.f. response is rather restricted and decreases further as more stages are added to try to increase the overall gain. Cascode amplifiers on the other hand have an enhanced h.f. performance for a given gain and with care can be made very stable.

METER CIRCUIT

Referring to Fig. 1., V1 is the cascode stage where V1a, which has R8 as its anode load, acts as the anode load of V1b. Resistors R1 to R5 form the input potential divider and should be of the best quality possible, for any change of resistance or noise generated here will affect the meter reading. C1 serves to block any d.c. voltage which might be present, such as the ripple voltage on an h.t. line which is being measured. R10 and R12 form the bias resistors for V1a and V1b, and also the potential divider for applying negative feedback. C3 is the normal cathode decoupling capacitor.

The signal from the anode of V1a is direct coupled to the grid of V2a, which functions as a cathode follower.

Since its input impedance is high V1b is only lightly damped to prevent undue loss of h.f. performance. Lack of phase reversal in V2a means that negative feedback can be applied from the anode of the output stage (V2b) to the cathode of V1b.

The amplified output from the anode of V2b is applied via C7 to four GEX34 germanium rectifiers connected in bridge form to the meter. C8 is provided to damp the needle movement.

C6 is the cathode bias capacitor connected across R16 and has the low value of $1\mu\text{F}$. At low frequencies C6 has very little effect on the gain of V2b, since its reactance is high in comparison with R16. As the frequency across C6 increases, its reactance decreases shunting R16 more and more, hence increasing the gain of V2b and compensating for voltage losses at high frequencies. The junction of D3 and D4 is returned to the junction of C3, R10, and R12, via R11.

During calibration R12 is adjusted so that the meter reading corresponds to a given input. In the prototype a value of 33 ohms was just right, but due to component tolerances it may require adjusting in subsequent models. It may be easier to substitute a wirewound potentiometer with a resistance of 50 or 100 ohms.

OSCILLATOR

Fig. 2 gives the circuit of the audio oscillator, which is based on a conventional Wein bridge with three EF80 valves, the first two forming the oscillator proper and the third being arranged as a cathode follower.

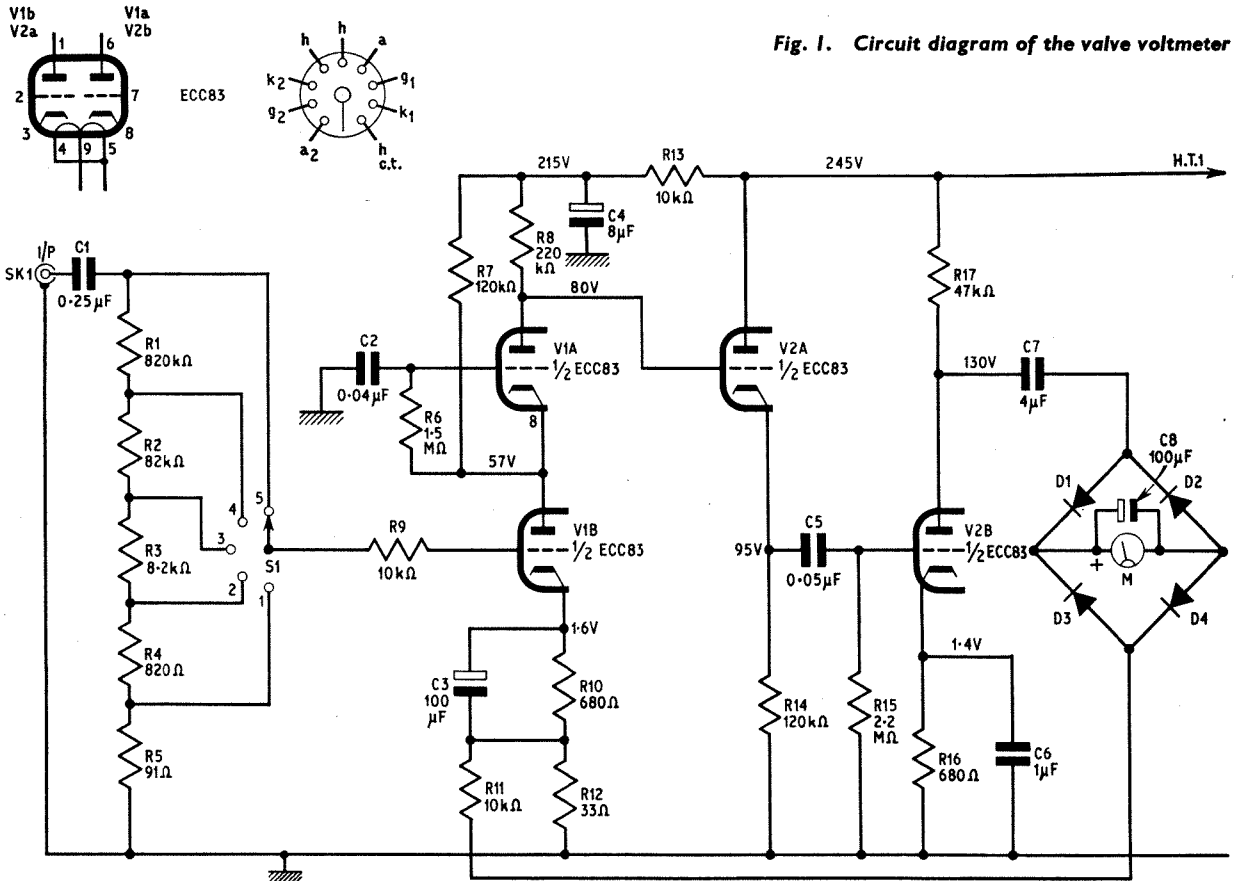

Fig. 1. Circuit diagram of the valve voltmeter

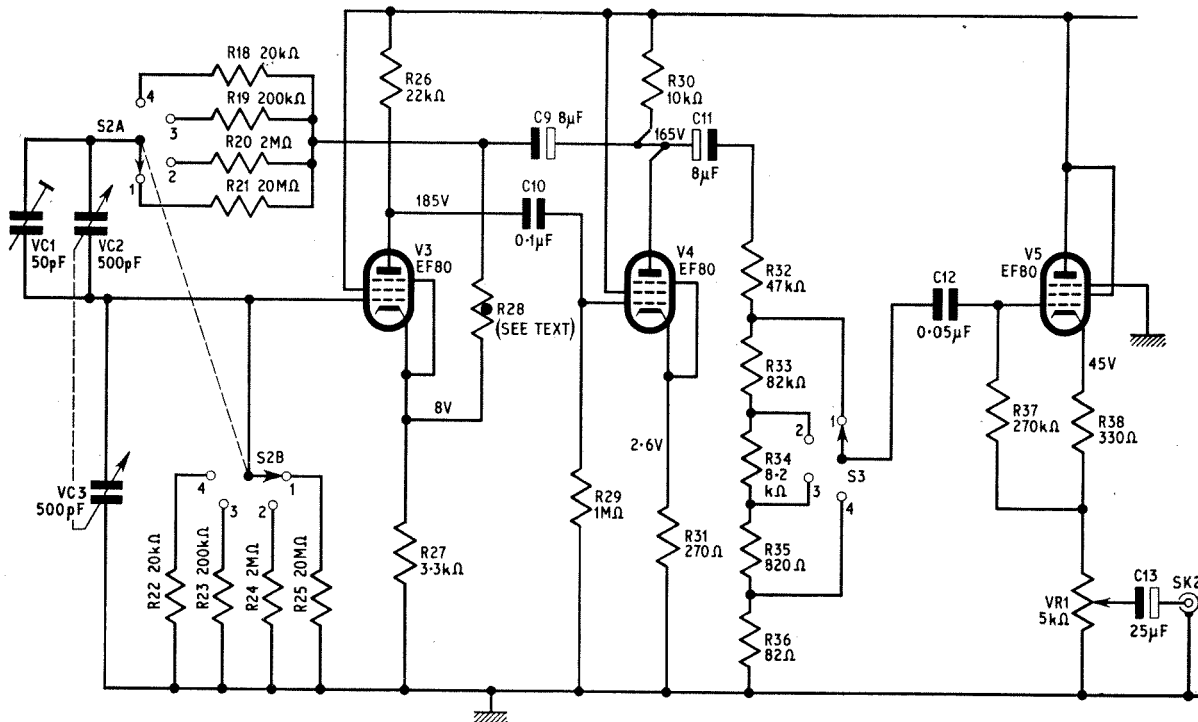
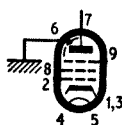
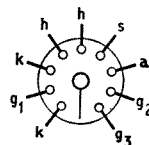

Fig. 2. Circuit diagram of the audio oscillator



V3, V4, V5
EF80



's' IS INTERNAL SHIELD
AND IS CONNECTED
TO CHASSIS

Although the output could be taken from the anode of V4 the small extra expense of a cathode follower is well worth while, since it completely isolates the oscillator section from the effect of varying loads, so preventing unwanted deviations in frequency.

The cathode follower loads, from infinity (open circuit) to zero (short circuit), have no noticeable effect on the frequency and in fact the output can be connected directly to a loudspeaker under test, although the applied voltage will be very low.

V3 and V4 are used to form the oscillator, of which the frequency determining components are VC2, VC3 and R18 to R25, the resistors being selected by S2a and S2b. The lowest frequencies are obtained with the highest value resistors (range 1) and with VC2 and VC3 at maximum capacitance. The frequency of oscillation is given by

$$f_0 = \frac{1}{2\pi\sqrt{(R_1 R_2 C_1 C_2)}}$$

where R_1 includes the valve and load resistances in parallel. The required voltage gain is

$$N = 1 + \frac{R_1}{R_2} + \frac{C_2}{C_1}$$

Since $R_1 = R_2$ and $C_1 = C_2$, f_0 is inversely proportional to R and C and the output voltage is a third of the input, or 9.5dB. If the gain of the oscillator valves, and their phase shift, can be kept at 9.5dB and zero degrees respectively, the valves will oscillate at a frequency equal

to f_0 . From the anode of V3 the signal is passed to the grid of V4, which brings about the phase reversal necessary for oscillation, and returns the signal to V3 via C9 and the frequency determining components.

To minimise unwanted phase shift in the oscillator valves, which could upset the oscillator frequency, negative feedback is introduced into the cathode of V3 by means of thermistor R28. This also stabilises the oscillator output keeping the amplitude constant within 2dB over the entire range and within 1dB up to 50kc/s.

From the anode of V4 the signal is fed via C11 to a coarse attenuator which introduces 60dB attenuation in three 20dB steps, providing outputs of 10V, 1V, 100mV and 10mV, which can be further attenuated by VR1 acting as a fine output control.

POWER SUPPLY UNIT

Fig. 3 shows the power supply circuit which is quite simple and calls for no special comment. C16, and C17 in conjunction with the l.f. choke form the main smoothing components, while R38, C14, R39 and C15 provide further smoothing and assist in decoupling the two h.t. supplies which are considerably ripple free. Cross-modulation between the oscillator and meter circuit via the h.t. has not been detected.

CHASSIS

The chassis should be constructed from a sheet of 18 s.w.g. aluminium 16½in × 11½in drilled and bent in accordance with Fig. 4. The valve holder and

Take your pick!



WORLD'S TOP SEMICONDUCTORS now available to everyone at IR SEMICONDUCTOR CENTERS

TRANSISTORS · ZENER DIODES · SILICON CONTROLLED RECTIFIERS · GERMANIUM DIODES · SOLAR CELLS SILICON RECTIFIERS · SELENIUM STACKS · BRIDGE RECTIFIERS · PHOTO CELLS · INSTRUMENT RECTIFIERS DUAL DIODES · AUTOMOTIVE RECTIFIERS · MOUNTING ACCESSORIES · PROJECT KITS · MANUALS

Over 100 items available, prepacked and prepriced, many with free instruction manual and project and experiment details. Send to your nearest IR Semiconductor Center for the full illustrated catalogue and price list—6d.

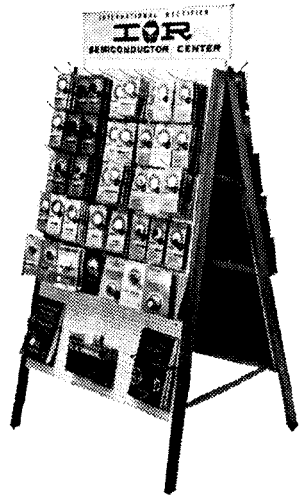

Co. Durham: Red Radio Shop, 31 Crotree Rd. Sunderland, Tel: 72087 • **Kent:** B. W. Cursons, 78 Broad St. Canterbury, Tel: 65442 • **Lancashire:** Radio Supply Co. Ltd, 60A-60B Oldham St. Manchester, Central 2778 • **London:** Henry's Radio Ltd, 303 Edgware Rd. London W2, PAD 1008 • G. W. Smith & Co. Ltd, 3 Lisle St. London WC2, GER 8204 & 9155 • Sterne-Clyne Ltd, 162 Holloway Rd. London N7, NOR 8161 • Lasky's (Harrow Road) Ltd, 42 & 33 Tottenham Court Rd. London W1, MUS 2605 • **Middlesex:** Odeon Radio Ltd, 146 College Rd. Harrow, HAR 5778 • South Supplies Electrical Ltd, 90 High St. Edgware, EDG 6751 • **Northumberland:** Aitken Bros. & Co, 48 Pudding Chare, Newcastle upon Tyne 1, Tel: 26729 • **Scotland:** Radio Supply Co. Ltd, 326 Argyle St. Glasgow, City 4158 • F. Brown & Co, 45 George IV Bridge, Edinburgh 1, Caledonian 3461 • RME Surplus Supplies, 143 Stockwell St. Glasgow C1, Bell 2634 • **Surrey:** Home Radio (Mitcham) Ltd, 187 London Rd. Mitcham, MIT 3282 • **Yorkshire:** Radio Supply Co. Ltd, 106 Newport Rd. Middlesbrough, Tel: 47096 • Radio Supply Co. Ltd, Morley St. Bradford 7, Tel: 47096 & 25349.

Fully displayed and described. Take your pick! ▶



INTERNATIONAL RECTIFIER CO. (GREAT BRITAIN) LTD., HURST GREEN, OXTED, SURREY. PHONE OXTED 3215. TELEX RECTIFIER OXTED 8819

Famous British P.V.O. Recording Tapes
 7in. L.P. 1,800ft. 19/6 7in. D.P. 2,400ft. 29/6
 5½in. L.P. 1,200ft. 14/6 5½in. D.P. 1,800ft. 24/6
 4in. L.P. 900ft. 11/6 5in. D.P. 1,200ft. 18/6

FULL WAVE BRIDGE SELENIUM RECTIFIERS:
 2, 6 or 12 v. outputs, 1½ amp., 8/9; 2 a. 11/3; 4 a. 17/6.
CHARGER TRANSFORMERS. Tapped input 200/250 v. for charging at 2, 6 or 12 v., 1½ amp.; 2 amps., 17/6; 4 amps., 22/6. Circuit included. Amp meter 5 amp. 10/6.
MOVING COIL MULTIMETER TK20A. 0-1,000 v. A.C./D.C. ohms. 0 to 100 K. 0-150 mA. Pocket size 2in. scale, 49/6.
EPIOK (10K Ω per v.) 1,000 v., 300 K., 250 mA. 79/6

NEW MULLARD TRANSISTORS
 OC71 6/-; OC78 7/8; OC81D 7/8; OC81 7/8; AF115 10/8; AF114 11/-; OC44 8/-; OC45 8/-; OC171 9/-; OC170 9/6; AF117 9/6. OC28 15/6; Transistor Holders 1/2. Sub Miniature Condensers. 0.1 mFd., 30 v. 1/3; 1.2, 4, 5, 8, 16, 25, 30, 50, 100 mFd., 15 volt 2/8. Diode OA81 3/-.

VALVE HOLDERS. EA50 6d. MOULDED Int. Oct. 6d. Mazda Oct. 6d.; B7G, B8A, B8G, B9A, 9d.; B7G with can 1/8. B9A with can 1/9. Ceramic Oct., EF50, B7G, B9A, 1/-; Valve base plugs B7G, B9A, Int. Oct., 2/3.

GRAM AMPLIFIERS

Valves: UY85 Rectifier and UCL82 Triode/Pentode 3½ wats output. Size (inc. valves) 5 × 5½ × 2in. deep. New and Tested complete 3 ohm output tone and volume **ONLY 37/6** P. & P. 2/6 on/off controls. Ready for use 200-250 v. A.C.

BARGAIN XTAL PICK-UP ARM

Complete with ACOS LP-78 Turnover Head 20/- Stereo 30/-

TRANSISTOR MAINS ELIMINATORS 29/6
 PPI-6 volt, PP9-9 volt (All same sizes as batteries)
 DOUBLES 42/6. PPI+PPI, PP9+PP9, PPI1-41+41.

WEYRAD P50 Transistor Coils

RA2W 6 in. Ferrite Aerial with car aerial coil.....12/6 Spare Cores.....12/6
 Geo. P50/LAC.....5/4 Driver Trans. T.F.P.4.....3/6
 1st and 2nd I.F. P50/2CC Printed Circuit, PCAL. Ready drilled and printed.....9/6
 470 kΩ's.....each 5/7 J.B. Tuning Gang.....10/6
 3rd I.F. P50/3CC.....6/- Booklet.....2/-

GARRARD Autoslim changers £6.10. (Stereo)
GARRARD AT5 Autochangers £8.10. 10/-
GARRARD AT6 Autochangers £10.10. (extra)

RETURN OF POST DESPATCH Post 1/6, List 1/-, C.O.D. 2/6 extra. (Export. Send remittance and extra postage, no C.O.D.) **CALLERS WELCOME**

RADIO COMPONENT SPECIALISTS

337 WHITEHORSE ROAD, WEST CROYDON Telephone THO 1665

BAKER LOUDSPEAKERS

NEW HI-FIDELITY MODELS

12in., 15 w. Stalwart 3 or 15 ohms, 45-13,000 c.p.s., 12,000 lines **5gns.**
 12in. De Luxe Foam Suspension, 14,000 lines, 15 w. 25-17,000 c.p.s. **9gns.**
 12in. Bass 25 w. 25-15,000 c.p.s. **12gns.**
 12in Super 20 w. 20-20,000 c.p.s. **16gns.**



NEW GROUP MODELS FOR BASS, LEAD and RHYTHM GUITARS

"Group 25" 12in. dia., 25 watt, 20-10,000 c.p.s. **5gns.**
 "Group 35" 12in. dia., 35 watt, 20-10,000 c.p.s. **8½gns.**
 "Group 50" 15in. dia., 50 watt, 20-10,000 c.p.s. **18gns.**

Volume Controls 80 Ohm Coax CABLE 5yd.

Long spindles. Midget Size 5 K. ohms to 2 Meg. LOG or LIN. L/S 3/-. D.P. 4/8. Stereo L/S 10/6, D.P. 14/6. Linear or Log Tracks. Semi-air spaced 6d. yd. 40 yd. 17/6. 60 yd. 25/- Low loss 5dB per 100ft. at 500 mc/s. Ideal 625 lines 1/6 yd.

COAXIAL PLUG 1/-. PANEL SOCKETS 1/-. LINE SOCKETS 2/-. OUTLET BOXES, SURFACE OR FLUSH 4/-. BALANCED TWIN FEEDERS 6d. yd., 80 or 300 ohms. TWIN SCREENED FEEDER 1/- yd., 80 ohms. TELESCOPIC CHROME AERIALS. 12in. extends to 33in. 6/6 each. CAR AERIAL PLUGS 1/6. Sockets 1/3.

THE "INSTANT" BULK TAPE ERASER AND RECORDING HEAD DEMAGNETIZER, 200/250 v. A.C. 35/-

C.R.T. BOOSTER TRANSFORMERS for heater cathode short circuit or tubes with failing emission. Full instructions supplied, mains input. **Optional 25% and 50% boost 2v. or 6.3v. or 12.6v.** State voltage required. **PRICE 15/6**

BOOKS (Please Add Postage)

"W.W.V. Radio Valve Data....."	7/6
High Fidelity Speaker Enclosures.....	5/-
Transistor Communication Sets.....	6/-
T.V. Fault Finding.....	6/-
Mullard Audio Amplifier Manual.....	8/6
Radio Valve Guide, Books 1, 2, 3, 4 or 5.....	5/-
Practical Radio Inside Out.....	4/6
Transistor Audio Amplifier Manual.....	6/-
Shortwave Transistor Receivers.....	5/-
International Radio Stations List.....	2/6
Modern Transistor Circuits, Beginners.....	7/6
Sub-Miniature Transistor Receivers.....	5/-
How to Receive Foreign T.V.....	5/-

JACK SOCKETS 8d. open-circuit 2/8, closed-circuit 4/8. Lead 6/-, Grundig type 3-pin 1/3; Grundig Lead Type 3/6.

Phono Plugs 1/-. Socket 1/-. Banana Plugs 1/-. Sockets 1/-. **JACK PLUGS STANDARD.** Screened 3/-. Grundig 3-pin 3/6. **PLUGS NON-REV PLUGS and SOCKETS.** P74 2-pin 4/3; P73 3-pin 4/6; P194 6-pin 6/6; P466 6-pin 12/6; P360 4/-. **RESISTORS.** Preferred values, 10 ohms to 10 meg. 1/2 w. w. 1 w. 20% 4d.; 1 w. 3d.; 2 w. 1/-; 1 w. 10% 6d. **HIGH STABILITY.** 1/2 w. 1% 2/- Preferred values, 10 ohms to 10 meg. Ditto 5%. 10 ohms to 22 meg., 9d. 5 watt } 0.5 to 8.2 ohm 3 w. 1/6
 10 watt } **WIRE-WOUND RESISTORS** { 1/6
 15 watt } 10 ohms to 6,800 ohms { 2/-

10K, 15K, 20K, 25K, 10W. **MAINS DROPPERS.** Midget. With sliders. 0.3 a., 1K., 0.2 a., 1.2 K., 0.15 a., 1.5 K., 0.1 a., 2 K., 6/- each. **LINE CORD** 100 ohms ft. 3-way 1/- ft. **WIRE-WOUND Pots. 3 WATT Pre-set Min. T.V. STANDARD SIZE POTS.** Type. All values 10 ohms **LONG SPINDLE VALUES** to 25 K., 3/- ea., 30 K., 4/-; 50 OHMS to 50 K., 6/6; Carbon 30 K. to 2 meg., 3/-, 100 K. 7/6. **SPEAKER-FRET.** Tysan various colours, 52in. wide from 10/-ft., 26in. wide from 5/- ft. Samples, large, S.A.E. **EXPANDED METAL.** Gold or Silver 12 × 12in. 6/-. **ARLENTE TRANSISTOR TRANSFORMERS** D3035, 7.3 CT: 1 Push Pull to 3 ohms for OC72, OC81... 11/- D3034, 1.75 : 1 CT Push Pull Driver for OC72, OC81... 11/- D3036, 11.5 : 1 Output to 8 ohms for OC72, OC81... 11/- **ARLENTE TRANSISTOR POT. 5 K. switched VC1545** 5/3 Anti-Parasitic beads (ferrite)..... doz. 3/6 **BLANK ALUMINIUM CHASSIS.** 18 s.w.g. 4 sides, riveted corners, lattice fixing holes, 2in. sides, 7 × 4in., 5/6; 9 × 7in., 6/6; 11 × 5in., 6/6; 11 × 7in., 7/6; 13 × 8in., 9/6; 14 × 11in., 12/6; 15 × 14in., 15/- **ALUMINIUM PANELS** 18 s.w.g. 12 × 12in. 5/6; 14 × 8in. 4/6; 12 × 8in. 3/6; 10 × 7in. 2/6; 8 × 6in. 2/-; 6 × 4in. 1/6.

B.T.H. TAPE MOTORS I15 v. A.C. 28 w. 12/6 pair, for 200/250 v. (in series)
COLLARO TAPE HEADS 35/- pair



D.I.Y. with GOODMAN'S HIGH FIDELITY MANUAL

A new, larger and more colourful edition—revised and completely up-to-date. It contains articles of particular interest to the D.I.Y. enthusiast—including special beginners page, advice on stereo, stage-built systems and full cabinet drawings. Whether building or improving your own audio set-up or choosing a complete speaker system, you'll find it useful and interesting as well as informative. Ask your Goodman's dealer or send coupon for your FREE copy.

Please send me a free copy of the Goodman's High Fidelity Manual

Name

Address

P.E.11

GOODMANS INDUSTRIES LIMITED
 Axiom Works, Wembley, Middlesex
 Telephone: WEMbley 1200
 A Member of the Rentasat Group

GOODMANS
 922

HOUSING HI-FI?

See how this superb cabinet will take your records, turntable, tape-recorder, amplifier and tuner—all within its 77 inches length.

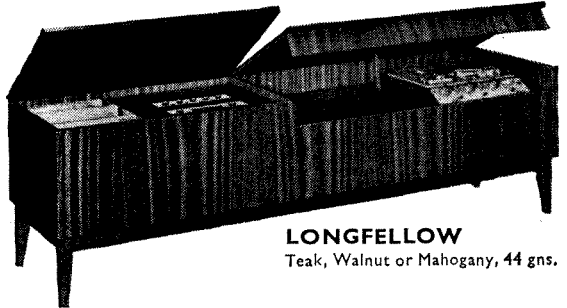

LONGFELLOW
 Teak, Walnut or Mahogany, 44 gns.

RECORD HOUSING

Write now for catalogue of full range and nearest stockist (UK only):
(Dept. PE11) Brook Rd., London, N.22
 Telephone: Bowes Park 7487

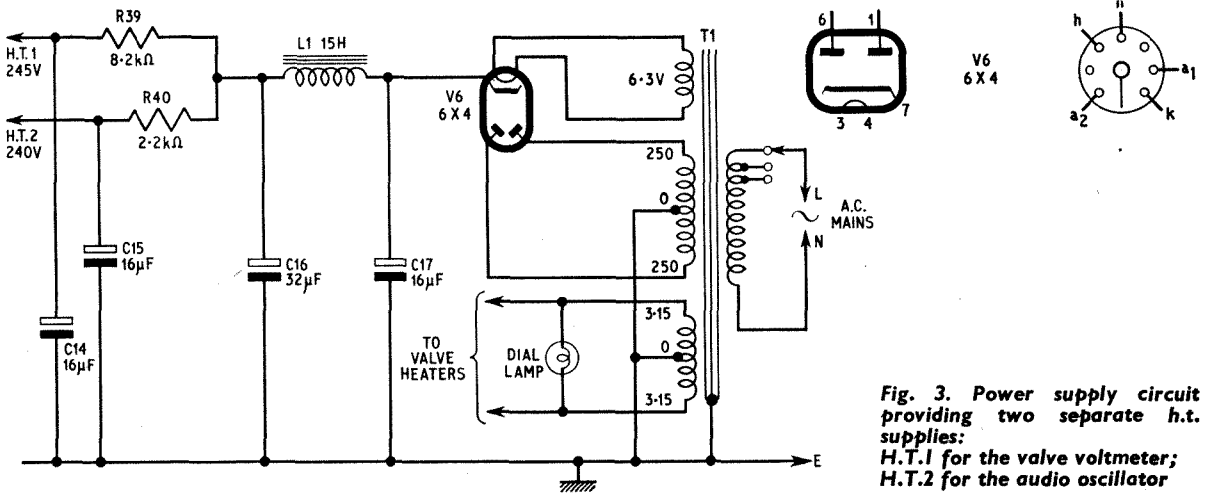

Fig. 3. Power supply circuit providing two separate h.t. supplies: H.T.1 for the valve voltmeter; H.T.2 for the audio oscillator

smoothing capacitor holes should be positioned as shown. The remaining components should then be placed in position and the positions of the fixing holes marked and drilled or filed out. Although the controls along the front of the chassis are shown staggered, they can if so desired be placed in a straight line, the size of the components actually used being taken into consideration.

When the last hole has been cut out the chassis should be cleaned and painted; hammer-finish paint is quite attractive but is by no means essential.

Dimensions for the front panel are not given since they depend on the meter actually used and upon the height of the tuning capacitor spindle from the chassis.

Jackson Brothers supply a small template with the dial so no difficulty should arise on this score. The holes for the controls and coaxial sockets are accurately marked out by aligning the finished chassis with the front panel and scribing through. The greatest care should be exercised when working on the front panel and cabinet, for nothing looks worse than scratches and gouge marks where the file or drill slipped.

Two small screens should be made from aluminium to enclose the two range switches S1 and S2, these being shaped and dimensioned as required. The screen round S2 could perhaps be dispensed with without any ill effects but the screen round S1 is essential, because any hum picked up by the range resistors will show up as

Fig. 4. Drilling details of the whole chassis giving the positions of the main components to be mounted. Small holes for nuts and bolts are not detailed since they can be marked from the components used

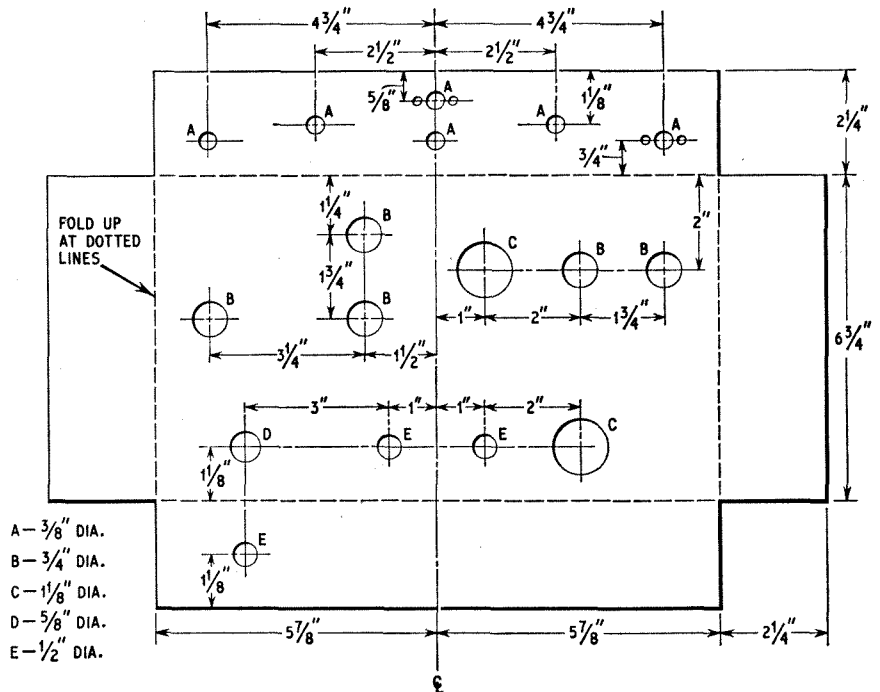

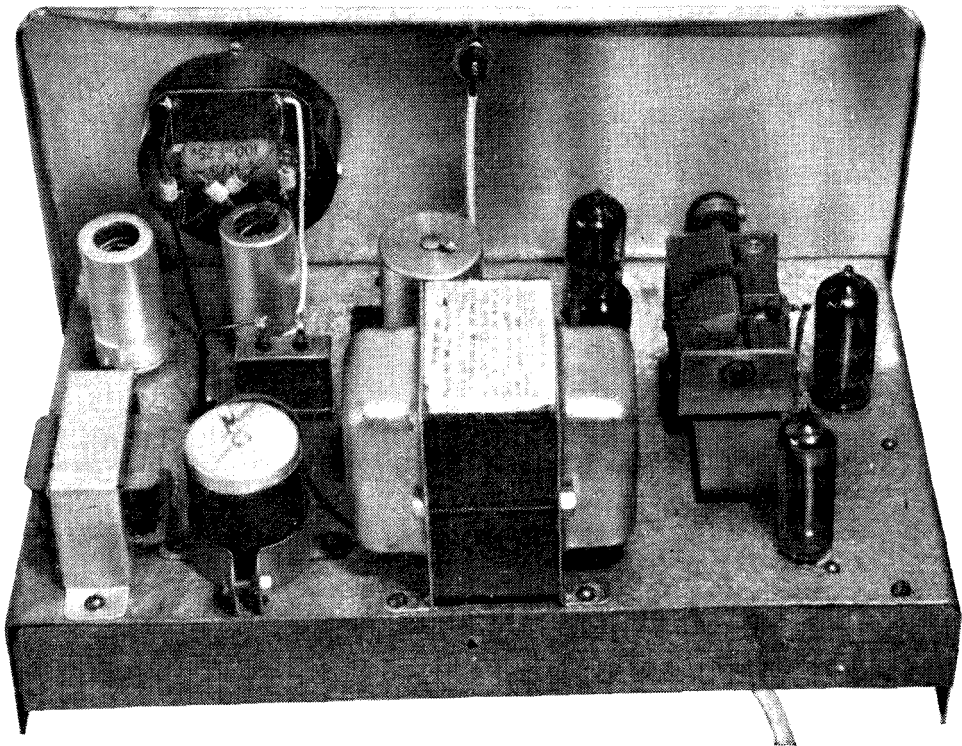
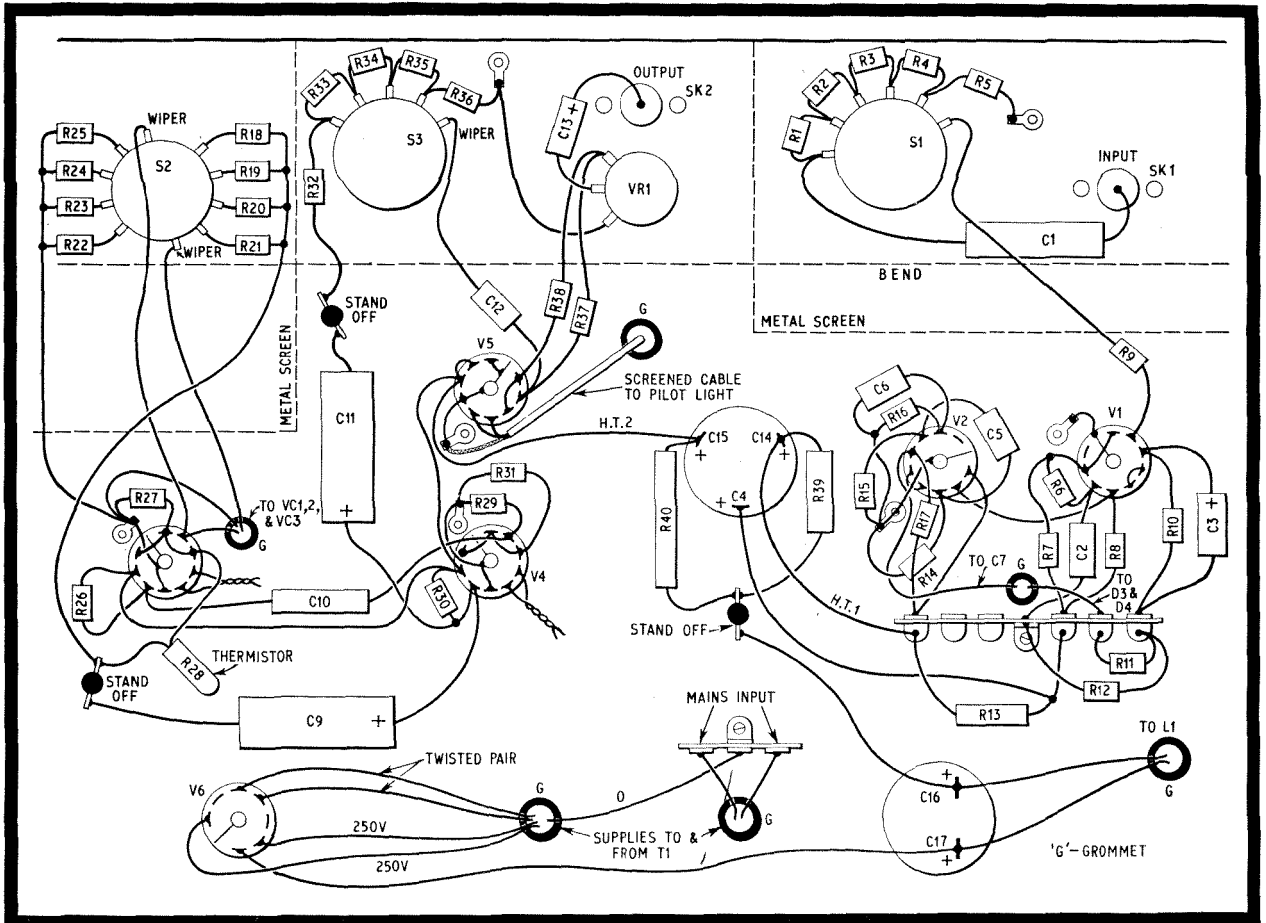

Fig. 5 (below). Layout of components on the underside of the chassis



COMPONENTS . . .

Resistors

R1	820k Ω	} 1% high stab. $\frac{1}{2}$ watt	
R2	82k Ω		
R3	8.2k Ω		
R4	820 Ω		
R5	91 Ω		
R6	1.5M Ω	} 5% $\frac{1}{2}$ watt.	
R7	120k Ω		
R8	220k Ω		
R9	10k Ω		
R10	680 Ω		
R11	10k Ω	} 10% 1 watt	
R12	33 Ω (see text)		
R13	10k Ω		
R14	120k Ω		
R15	2.2M Ω		
R16	680 Ω	} 5% $\frac{1}{2}$ watt	
R17	47k Ω		
R18	20k Ω		
R19	200k Ω		
R20	2M Ω		
R21	20M Ω	} 1% high stab. $\frac{1}{2}$ watt	
R22	20k Ω		
R23	200k Ω		
R24	2M Ω		
R25	20M Ω		
R26	22k Ω	5% $\frac{1}{2}$ watt	
R27	3.3k Ω	5% $\frac{1}{2}$ watt	
R28	200k Ω	Thermistor type A5513/100 (S.T.C.)	
R29	1M Ω	} 5% $\frac{1}{2}$ watt	
R30	10k Ω		
R31	270 Ω		
R32	47k Ω (see Calibration in part 2)		
R33	82k Ω		
R34	8.2k Ω	} 1% high stab. $\frac{1}{2}$ watt	
R35	820 Ω		
R36	820 Ω		
R37	270k Ω		5% $\frac{1}{2}$ watt
R38	330 Ω		5% $\frac{1}{2}$ watt
R39	8.2k Ω	10% 2 watt	
R40	2.2k Ω	10% 2 watt	

Miscellaneous

M1 1mA f.s.d. 100 Ω moving coil meter LPI 6-volt miniature indicator lamp (Bulgin)
 Five 9A valveholders with screens, two of which should have p.t.f.e. bases for V1 and V2
 Chassis and metal case 12in \times 7in \times 7in (H. L. Smith & Co. type Y)
 Dial type 4489 (Jackson Bros.). Two clips for mounting large capacitors (see photograph)
 Coaxial input and output sockets (with plugs) 7-way and 3-way tag strips
 Rubber grommets; knobs; 4B.A. and 6B.A. nuts, bolts, and soldering tags.

Potentiometer

VRI 5k Ω linear carbon miniature

Capacitors

C1 0.25 μ F paper 500V
 C2 0.04 μ F paper 500V
 C3 100 μ F elect. 25V
 C4 8 μ F elect. 350V (in same can as C14 and C15)
 C5 0.05 μ F paper 250V
 C6 1 μ F paper 150V
 C7 4 μ F paper 250V
 C8 100 μ F elect. 25V
 C9 8 μ F elect. 450V
 C10 0.1 μ F paper 350V
 C11 8 μ F elect. 450V
 C12 0.05 μ F paper 250V
 C13 25 μ F elect. 25V
 C14 16 μ F elect. 350V } (in same can as C4)
 C15 16 μ F elect. 350V }
 C16 32 μ F elect. 350V }
 C17 16 μ F elect. 350V }
 VC1 50pF trimmer
 VC2 500pF } twin ganged miniature
 VC3 500pF }

Valves

V1a and V1b ECC83
 V2a and V2b ECC83
 V3, V4, V5 EF80 (3 off)
 V6 6X4

Diodes

DI-4 GEX34 or OA79 (4 off)

Switches

S1 Single-pole, 5-way rotary
 S2 Two pole, 4-way rotary
 S3 Single pole, 4-way rotary

Transformer

T1 Mains transformer. Secondary windings:
 250-0-250V 60mA; 3.15-0-3.15V 2A;
 6.3V 2A (Ellison type MT161)

Inductor

L1 15H 50mA I.f. choke

a deflection on the meter. A small hole should be drilled in the screen of S1 directly in line with the wiper tag of S1 and the "grid" tag of V1a. R9 should be passed through it, and wired as near to the grid as possible.

Two small pieces of s.r.b.p. or perspex sheet are required to carry the tuning capacitor and the four germanium diodes on the meter (Fig. 6). The frame of the tuning capacitor is connected to the grid of V3. It must be insulated from the chassis by being bolted to the s.r.b.p. or perspex which is in turn bolted to the chassis. The size used in the original was 4in \times 1in, this was bolted to the chassis by means of a 4 B.A. screw at each end, the front screw serving to hold the screen round S2 under the chassis. An *insulated coupler* is essential between the tuning capacitor spindle and the dial which is earthed.

The piece of perspex or s.r.b.p. used for the meter diodes is 2in \times 1 $\frac{1}{2}$ in, four holes being drilled in it,

two 6 B.A. clearance and two 2 B.A. clearance. A 6 B.A. earth tag is screwed to each of the two smaller holes; the s.r.b.p. is attached directly to the meter terminals by means of the two larger holes, a 2 B.A. tag being placed on each terminal before the fixing nuts are tightened. The diodes are then soldered directly to these tags using heat shunts and leaving the leads as long as possible. Note the polarity of the diodes.

If the diodes are made to stand away from the panel room will be found for C7, which is soldered across the two 2 B.A. tags, again observing polarity. With the GEX34 the red end corresponds to the cathode of a thermionic diode and should therefore go to the positive terminal of the meter, as should the positive end of C7.

Next month: Calibration

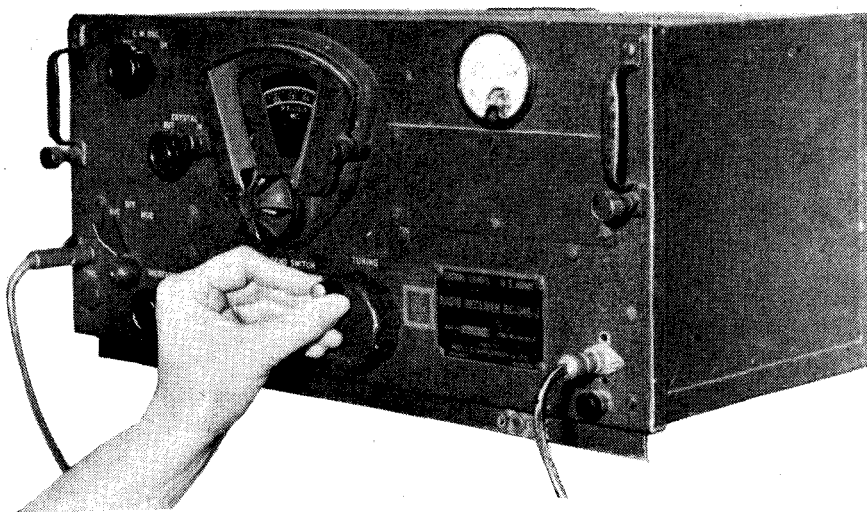

THE BC 348

Classic

Origin

THIS receiver, widely used in most American and many British aircraft from 1942 onwards, was mass-produced in the United States by numerous sub-contractors, whose identity may be ascertained from the suffix to the type-number on the front panel, e.g., BC348J comes from Wells-Gardner.

Several detail differences occur in models from different "stables". For example, some versions incorporate an aerial alignment trimmer while others do not. Basically, however, almost all versions conform with the details given below.

Basic Circuit

Two r.f. amplifiers, both	6K7
First detector	6L7
Separate local oscillator	6C5
First i.f. amplifier	6K7
Second i.f. amplifier and beat frequency oscil- lator	6L7
Third i.f. amplifier and second detector	6B8
Output valve	6K6
Voltage regulator to oscillator valve	RCA991

COMMENT: This valve line-up is a representative one, although numerous permutations occur among different models. In one version the c.w. oscillator is combined with the second detector and there are two i.f. stages. In another the luxury of three i.f. stages is achieved by putting the c.w. oscillator on to the second i.f. while the second detector and third i.f. are combined in one valve. The importance of securing the correct circuit diagram for the particular model purchased is self-evident.

The claimed sensitivity for the three-i.f. version is as good as 3 to 7 microvolts overall on all bands, this for 10 milliwatts output into a 4,000 ohm load.

Waveranges covered

Band no. 1	200-500kc/s
Band no. 2	1.5-3.5Mc/s
Band no. 3	3.5-6.0Mc/s
Band no. 4	6.0-9.5Mc/s
Band no. 5	9.5-13.5Mc/s
Band no. 6	13.5-18.0Mc/s

COMMENT: Having 200 kc/s available is extremely useful: it furnishes the standard frequency BBC Light Programme transmission against which a 100kc/s crystal calibrator may be compared. The remaining ranges embrace the 1.8, 3.5, 7 and 14Mc/s amateur bands, and it is these that most BC348 purchasers will require. To cover the 21 and 28Mc/s amateur bands—and of course all allocations higher—external converters will be needed.

Intermediate Frequency

915kc/s.

COMMENT: Users of the BC348 in the Greater London area may experience i.f. breakthrough from the 140kW transmitter at Brookmans Park on 908kc/s. Injected into the i.f. chain, this signal can at worst produce a continuous high pitched whistle on all bands.

The cure (in most cases): by-pass all supply leads to chassis through 0.01 μ F capacitors, and insert in the h.t. lead a medium wave coil used as an r.f. choke. Additionally, insert in the aerial lead a wavetrap consisting of a medium wave coil tuned to the frequency of the offending signal.

Power Requirements

In its original condition the BC348 comes with a 28 volt dynamotor that is likely to be of little or no value to the average enthusiast.

COMMENT: The space made available when the dynamotor is removed will comfortably accommodate a mains power unit of sufficient size to deliver the 200 volts at 50mA and 6.3 volts at 2.5A required by this receiver. A slightly larger mains power supply unit can be installed if a reserve is required for external converters or a crystal calibrator.

Controls

In the centre is the bandchange knob. The range in use is registered in the dial window above it. Below is the reduction-drive tuning knob actuating a four-gang capacitor: to the left, gain control and c.w. oscillator pitch control. Above them: the crystal gate switch and the c.w. oscillator on/off switch. Extreme left: manual or automatic gain control lever switch. Top right: dimmer for dial lights. Far right: aerial alignment control (when fitted).

So-called "war surplus" models are still available in great quantities, as advertisers' announcements and dealers' shop windows declare, and the communications enthusiast seeking to select one may be left in a state of some confusion as to which model he should buy.

To give him some guidance **PRACTICAL ELECTRONICS** will publish a short series of articles that will evaluate the more popular of these receivers. The aim will be to summarise the merits and demerits of each model, and suggest what basic modifications can be usefully

made to improve its operational capability.

It must be emphasised that these articles will **NOT** cover the detailed changes (if any) that may need to be made to such receivers. The supplier should be consulted before a purchase is completed and his assurance obtained either that the set is in working order or that the necessary modification details can be supplied.

These articles will in no sense meet servicing requirements: such information comes in the appropriate handbook—ask your supplier to find you one.

COMMUNICATION RECEIVERS

COMMENT: Ergonomically, the BC348 earns high marks for the intelligent placement of controls. While the right hand rotates the tuning knob, either directly or with the little handle fitted to it, the left-hand has all other needful user-controls within short reach. No cross-hands performance is called for!

Being a general coverage receiver the BC348 does not offer electrical bandspreading of the type required for use on the crowded amateur bands. Those bands occupy on the tuning scale 1 inch (1.8Mc/s), 2 inches (3.5Mc/s), ½ inch (7Mc/s) and 1½ inches (14Mc/s). However, the order of tuning knob rotation called for to cover each of these bands is:

BAND	REVOLUTIONS
1.8Mc/s	10
3.5Mc/s	16½
7.0Mc/s	4½
14.0Mc/s	8

It might be added that when the receiver is used as a 4–6Mc/s i.f. strip for a 144–146Mc/s converter this span of 2Mc/s is covered in no less than 66 revolutions.

Recommended Basic Modifications

Heaters: In the original model with 28 volt dynamotor the valve heaters are wired in a complex series-parallel arrangement to allow 6.3 volt valves to operate from 38 volt aircraft batteries. It is recommended that the existing heater wiring (generally pins 2 and 7 on I.O. valve holders) be removed and a complete re-run made to parallel all heaters for 6.3 volt operation from a mains power unit.

Aerial Input: Because most receivers will be fed from an aerial tuning unit via low impedance cable it is recommended that the existing aerial terminal be removed and replaced by a Belling-Lee coaxial socket.

Use with External Converter: The provision of a coaxial input circuit is especially essential when the BC348 is fed from a converter, to minimise i.f. breakthrough.

Separating the Gain Controls: To facilitate reception of single sideband signals it is desirable to fit separate a.f. and r.f. gain controls. In the original there are two ganged potentiometers of 20,000 ohms (front) and 350,000 ohms (rear) operated simultaneously by the front panel gain control knob. It is no difficult matter to disconnect the 20,000 ohm potentiometer—it controls the second r.f. stage—and reposition it in place of the dial light dimmer, not generally required.

Gain Equalizer: In some models a variable resistor rotates with the gang-capacitor shaft. Its purpose is to equalise the gain over the entire tuning range. It may be removed with profit.

Capacitors—a warning: Most BC348 receivers purchased today will be at least 20 years old, and some deterioration in the condition of the fixed capacitors may have occurred. This will sometimes be self-evident either through failure of a stage or stages to function, instability, or more dramatically by short-circuits on the h.t. line. To disconnect and test every one of the dozens of capacitors in this model is a tedious business but probably worth while in the long run.

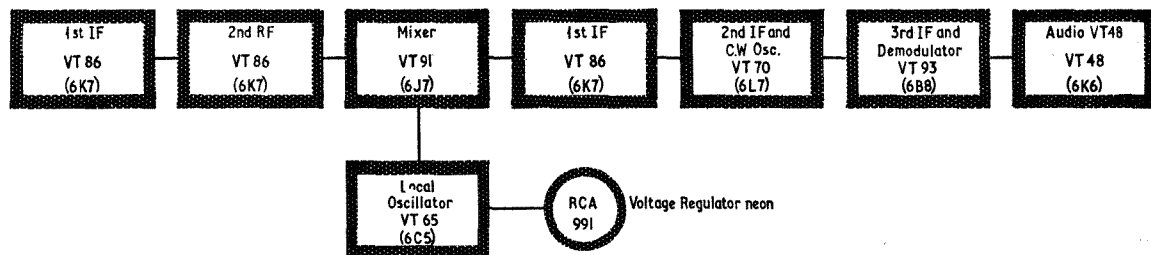
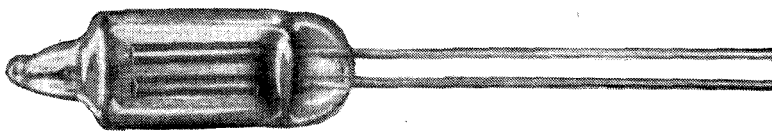

Fig. 1. Block diagram showing the basic BC348 circuit arrangement



NEON NOVELTIES



THIS is the third of a series of short articles illustrating some of the many uses of neon lamps. The neons employed are all miniature wire-ended types as shown above.

Two examples which are ideally suited to these applications are those supplied by Radiospares (striking voltage 65 volts), and the Hivac type 3L general purpose neons. The latter type requires a striking voltage of 80 volts and maintaining voltage of 60 volts.

Some neon indicators have a resistor wired in series with one of the neon wires to make them suitable for mains voltages. These would normally be unsuitable for the circuits described unless the resistor is removed or short-circuited.

THREE

ELECTRONIC DICE by R. Bebbington

GRAD.I.E.R.E.

THIS is merely an extension of the "heads or tails" principle that was described last month. Six miniature neons are used in a ring circuit with six associated capacitors and resistors. When the battery is connected the neons will flash sequentially at a rate determined, as before, by the choice of the R-C time constants of the circuit.

In order to "freeze" the flashing, all six capacitors must be short circuited simultaneously and this is the only problem that the circuit presents. Any differences in the times taken for the separate contacts of the six-pole two-way switch to close will "load" the dice in favour of certain numbers. This is accentuated if the speed of flashing is rapid, so if this trouble is encountered then the values of the R-C networks should be increased.

A chassis type of construction is best for this circuit with the six neons inside peeping through six holes patterned in true dice-fashion on the uppermost surface. Since only one neon lights at any one time they will have to be numbered one to six. A wafer switch has been used successfully in this circuit, the contacts being doctored where necessary to ensure that all switches are "made" in the same time.

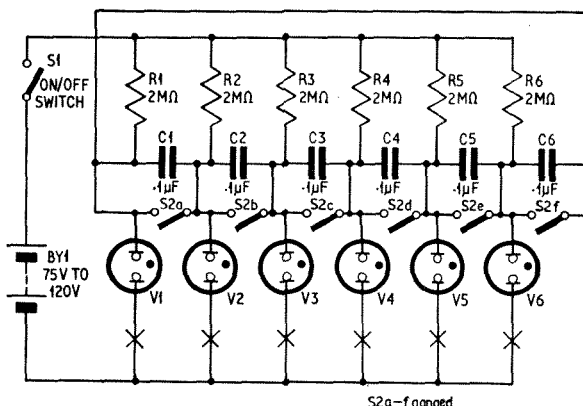

With the addition of six single contacts, this one will incorporate the panel game switch circuit, described previously. The "make" contacts should be inserted in each of the neon leads at the points marked with an "X". With the six-pole switch closed the circuit is functionally the same as the panel game switch described in the September issue.

PRACTICAL ELECTRONICS BINDERS

Volume No. 1 of Practical Electronics will contain 14 issues. Subsequent volumes will then run from January to December each year.

The Practical Electronics Easi-binder is designed to hold normally 12 issues, but it will accommodate two additional copies quite comfortably.

A new version of the Easi-binder with a special pocket for storing blueprints and data sheets is now available. The price is 14/6d inclusive of postage.

Order your binder from: Binding Department, George Newnes Ltd., Tower House, Southampton Street, London, W.C.2.

◆ READ ◆

PRACTICAL WIRELESS

November issue on sale NOW

Price 2s.

PRACTICAL TELEVISION

November issue on sale

21 October — 2s.

BUILD OVER 40 CIRCUIT/EXPERIMENTS

and master electronics the LERNAKIT way

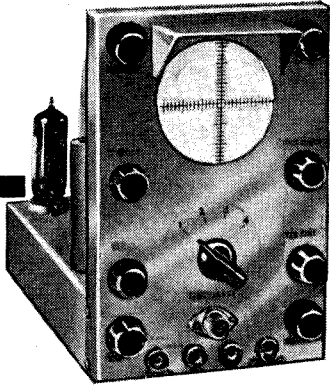

- No maths — No unnecessary theory
- NO PREVIOUS KNOWLEDGE NEEDED
- BUILD A PROFESSIONAL
CATHODE RAY OSCILLOSCOPE

Learn how to

- READ AND DRAW CIRCUIT DIAGRAMS
- RECOGNISE, HANDLE AND UNDERSTAND
every type of modern **ELECTRONIC COMPONENT**

OVER 40 EXPERIMENTS — including:-

- | | |
|--------------------------------|--------------------------|
| ● Valve Experiments | ● Square Wave Generator |
| ● Transistor Experiments | ● Morse Code Oscillator |
| ● Electro-magnetic Experiments | ● Simple Transmitter |
| ● Basic Amplifier | ● Electronic Switch |
| ● Basic Oscillator | ● Photo-electric Circuit |
| ● Basic Rectifier | ● Basic Computer Circuit |
| ● Signal Tracer | ● Basic Radio Receiver |
| ● Simple Counter | ● A.C. Experiments |
| ● Time Delay Circuits | ● D.C. Experiments |

This complete practical course will teach you all the basic principles of electronics by carrying out experiments and building operational apparatus. You will learn how to recognise and handle all types of modern components, their symbols and how to read a complete circuit or schematic diagram. The course then shows how all the basic electronic circuits are constructed and used and **HOW THEY ACTUALLY WORK BY USING THE OSCILLOSCOPE PROVIDED**. An application is given in all the main fields of electronics, i.e. Radio; control circuits; computers and automation; photoelectrics; counters, etc., together with rules and procedure for fault finding and servicing of all types of electronic equipment. For a new and exciting approach which gives a real understanding of electronics in an entirely practical way—this course has no equal anywhere to-day.

POST NOW FOR FREE COLOUR BROCHURE

To: **BRITISH NATIONAL RADIO SCHOOL, READING, BERKSHIRE**

Please send free Brochure, describing your LERNAKIT Oscilloscope Course without obligation, to:

NAME

ADDRESS

BLOCK CAPITALS PLEASE

OR WRITE IF YOU PREFER NOT TO CUT COUPON

(No representatives employed)

P.E.11.65

British National Radio School

BRAND NEW AM/FM (V.H.F.) RADIO GRAM CHASSIS AT £13.13.0 (Carriage Paid)

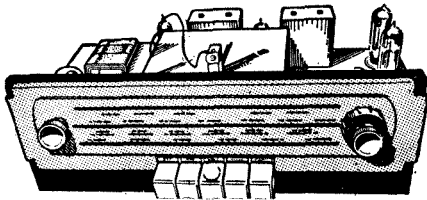

Chassis size 15 x 6 1/2 x 5 1/2 in. high. New manufacture. Dial 1 1/2 x 4 in. in 2 colours, predominantly cream. 250-250V. A.C. only. Pick-up. Ext. Speaker. Ac. E. and Dipole Sockets. Five pushbuttons—OFF, L.W., M.W., F.M., and Gram. Aligned and tested. With O.P. Transformer. Tone control. 1000-1900 M.: 200-550 M.; 88-98 Mc/s. Valves EZ80 rect.; ECH81, EF89, EABC80, EL84, ECC85, 3-ohm speaker required. 10 x 6 in. ELLIPTICAL SPEAKER 25/- to purchasers of this chassis. **TERMS: £3.10.0 down and 5 monthly payments of £2.4.0, total £14.10.0.** Room Dipole for V.H.F. 12/6. Feeder 6d. per yard. **ALTERNATIVE DESIGN.** L.W. 1000-1900 M.; S.W. (9-15 Mc/s); M.W. 190-475 M.; V.H.F. 87-100 Mc/s; Gram position. Otherwise similar to above chassis. Price **£15.15.0** (carr. paid). **TERMS: £3.10.0 down and 6 monthly payments of £2.4.0.** Total H.P. price **£16.14.0.** Circuit diagram 2/6.

2-VALVE GRAMOPHONE AMPLIFIER Price 37/6 (P. & T. 2/6)

Overall size 4" wide x 5" high x 2 1/2". Volume and tone controls. Mains lead. Screened lead input. With output transformer for 3-ohm. For series connection to Garrard and B.S.R. Autochangers and Players, having 90v. tapping. Can also be supplied on fabric covered board with mains transformer and 6" x 4" speaker at 55/- (P. & P. 5/-). 3-valve Gram. Amp. on Board 14" x 7 1/2" (x 2 1/2" overall). UY85, UCC85 and UL84 with Speaker 7" x 4". Price 80/- (P. & P. 6/-).

BATTERY ELIMINATOR

For 4 low consumption valves (96 range) 90v. 15mA and 1.4v. 125mA, 42/6. (4/- post), 200-250v. A.C. Also for 250 mA, 1.4v. and 90v. 15 mA at same price. Two units 4" x 2 1/2" x 2 1/2" high and 3" x 2 1/2" x 1 1/2" high.

SELF-POWERED V.H.F. TUNER CHASSIS. Covering 88-95 Mc/s. Mullard permeability tuner. Dims. 8 x 6 x 6 in. high. Valves ECC85, EABC80 and 2-EF89's with metal rectifier. Mains transformer. Fully wired and tested **ONLY £3.17.6** (carr. paid). Room dipole 12/6. Feeder 6d. per yard.



PUSH-PULL O.P. AMPLIFIER £5.5.0 (6/- Carr.)

Brand new 200-240 A.C. mains. Bass, treble and vol. controls, with valves EZ80, ECC83 and 2-EL84 giving full 8 w. Chassis 12 x 3 1/2 x 3 1/2 in. With o.p. trans for 2-ohm speaker. Front panel (normally screwed to chassis) may be removed and used as "flying panel". Supplied with cream/black control panel whole length of front chassis.

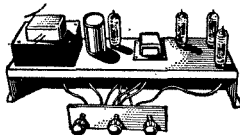

CM21 CRYSTAL MICROPHONE

With 3.5 mm. Jack plug, 12/6 (Post 1/6.)

4 TRANSISTOR BABY ALARM. Attractive walnut veneer speaker cabinet 13 1/2 x 8" front. 60ft. Ext. Lead. Ear piece as mike sensitive at 20ft. (P.P.6 battery required—will last for hundreds of hours). Volume Control and On/Off. Price **£3.19.6.** (P. & P. 5/-).

The **SUPER 6**
LONG & MEDIUM WAVE TRANSISTOR RADIO

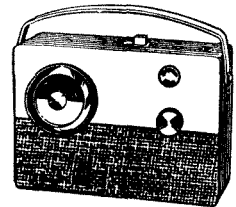

A quality radio available in parts or ready built. The sparkling performance and superb finish of the completed receiver give you value equivalent to a £12. 12. 0 commercial model.

- ★ All new parts. ★ 6 transistors and diode. ★ 350mW output.
- ★ Superhet circuit. Ferrite rod aerial. ★ Weymouth Radio printed circuit board. ★ Component positions and references printed on back of board. ★ Nicely styled wooden cabinet, 11 x 7 1/2 x 3 1/2 in.
- ★ Vinyl covered in various colours. ★ 6 x 4 in. speaker giving good bass and treble response. ★ Full instruction booklet 2/-. Free with kit.
- ★ I.F. frequency 470 kc/s. ★ Lining up service if required.
- ★ All parts supplied separately. Write for list. S.A.E. please. ★ 9v. battery required. VT9 or P.P.9. (3/9 with kit).

COMPLETE SET OF PARTS ONLY £4.17.6
PLUS 5/- POST

OR FULLY BUILT **£6.17.6 Tax & Carr. Paid**

V.H.F. Pre-amplifier with high signal-noise ratio and gain of at least 3:1 under average fringe area conditions. Metal container 3 1/2 x 3 1/2 x 1 1/2 in. high, with strap for eaves, loft or skirting fixing. 9 volt battery operated, using transistor AF114. 88 to 108 Mc/s. Order with confidence of improved reception. Only 30/- (post 2/9).

TRANSISTORS

Packet of 3 coded RF transistors (equivalent of OC44/5) 7/6 post paid. Set of 6 transistors and diode with circuit diagram. Neatly packed in foam-lined box; useful for presentation. 15/- post paid.



4 TRANSISTOR MINIATURE PUSH-PULL AUDIO AMPLIFIER HIGH IMPEDANCE

PRINTED CIRCUIT, 4 in. x 2 1/2 in. x 1 1/2 in. over transformers. Output for 3-ohm speaker. Suitable for microphone, record player and intercom. 9 volt battery required. Frequency range 100 cps. to 25 Kcps. Push-pull output class B. Instruction sheet provided. Fully wired ready for use. Three types, 200mW 35/-; 500mW 41/-; 1.2W 57/6. (P. & P. 2/6 each).

The "Viceroy" 30 watt Amplifier

Valves 2 x EL84, GZ34, EF86, ECC82, ECC83. Size 14 x 8 x 7 1/2 in. high over cover. Complete with protective cover with carrying handles. High and low gain inputs. Front controls are: Vol. (low gain), Vol. (high gain), Treble Step, Bass, Treble Slope and Mains Switch. For 3 and 15 ohm Speakers. Price **£19.19.0** carriage paid.

Tape Recorder Amplifier

Fully built. Front panel 12 1/2 x 3 in. Chassis size 10 1/2 x 5 x 4 in. Valves EF86, ECC83 and 2 EL84. Controls (1) Mic. Vol. (2) Tuner/P.U. Vol. (3) Play back or monitor, (4) Tone, 2 jack sockets for Tuner/P.U. and Mic-switch for superimpose. Separate power pack containing transf. and rectifier. For Collaro studio deck only. Price **£8.14.0** (6/- P. & P.)

GLADSTONE RADIO
66 ELMS ROAD, ALDERSHOT, Hants.

(2 mins. from Station and Buses.) Aldershot 22240
CLOSED WEDNESDAY AFTERNOON
CATALOGUE 6d.
Regret overseas orders cannot be executed

EX-RENTAL TELEVISIONS

14 in. 17 in.
£7.10.0 £11.10.0

12 months 3 Star Guarantee
★ Tube ★ Valves ★ Components
COLOURED FREE LIST
Channels for all areas

Demonstrations daily from Large Selection
Personal collection or Insured
Carriage 14in. 20/-; 17in. 30/-.

AERIALS. BBC/ITA combined Loft and room aerials—from 25/-. BBC2/UHF and colour aerials—from 29/6. **SEND FOR FREE LIST.**

VALVES £1 per 100. Assorted TV and Radio. Surplus ex- rental dismantled receivers. Post 4/6. Send for list.

CONDENSERS 10/- per 100. New Assorted Electrolytics and p.F.s. P. & P. 2/6.

RESISTORS 5/- per 100. New. Mostly High Stabs. Assorted. P & P. 2/-. Overseas 3/6.

SPEAKERS 7/8. 6in., 8in., 7 x 4in., 8 x 3in. Ex-mfd. Salvage. P. & P. 2/3. Overseas 4/-.

DUKE & CO. (LONDON) LTD. 621/3 Romford Rd., Manor Park, E.12

Liverpool Street — Manor Park — 10 mins. Stamp for Free List

Phone: ILFord 6001/2/3

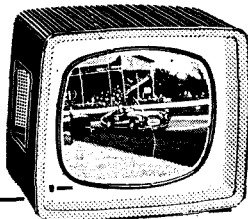

A Depth Micrometer—

This Depth Micrometer (with extra spindle for 1"—2" conversion) usual price 21/3, is given FREE as part of the SPECIAL OFFER of a 3-instrument set comprising:

- 1" Micrometer usual price 13/6
- 2" Micrometer usual price 16/6
- 1"—2" Depth Micrometer FREE (save 21/3 !)

TOTAL 30/- plus p. & p. 2/6

Each Micrometer can be bought separately for the individual prices shown (plus 1/6 p. & p.)

Ideal Micrometers for Hobbyists, Students and General Industrial use. Correct to .0009 of an inch. Put TOOLMAKER precision into your project!

SEND NOW ONLY 32/6 POST PAID TO:
DEPT. F, A.G.M. INDUSTRIES LTD.

Holloways Lane, Welham Green, Nr. HATFIELD, Herts.

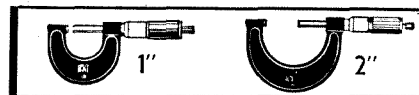

FREE!

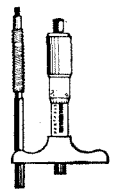

1"—2" Depth Micrometer

ELECTRONIC BUILDING BLOCKS



PART EIGHT

by R. A. DARLEY

THIS month's article will look briefly at the formation and deflection of a cathode ray tube trace, and go on to describe methods of achieving a suitable waveform for timebases.

OSCILLOSCOPE TRACE

Fig 8.1a shows the graph generally known as a sine wave drawn against two axes, one vertical and the other horizontal. The vertical, or "Y" axis, represents volts, the horizontal, or "X" axis, represents time, usually in seconds.

A cathode ray tube may be used to display a similar graph or any others based on voltage and time. An electrostatic cathode ray tube has a "gun" which fires a very narrow stream of electrons on to a phosphorescent screen; at the point where the electrons "hit" the screen the phosphor "glows", appearing as a pin-point of light. Interposed between the "gun" and the screen are four electrodes: two X plates and two Y plates. Fig. 8.1b shows the arrangement of these electrodes, when viewed from the screen end of the cathode ray tube. By applying a potential between Y1 and Y2 the electron stream, and hence the pin-point of light appearing on the screen, can be moved vertically in the "Y" axis; similarly, the beam may be moved in the "X" axis by applying a potential between X1 and X2. By applying a sine wave voltage to the "Y" axis, and a voltage that rises linearly with time to

the "X" axis, a "graph" can be traced out as shown in Fig. 8.1a.

The width of the tube face is limited, and so is the time period that can be displayed. In practice, a time "scan" sufficient to show only a few cycles is made, the "time-base" voltage rising linearly from zero to, say, 10 volts and then resetting itself to zero again and "scanning" the tube again. In this way, succeeding "cycles" of the timebase trace out similar "graphs", one over the other. If approximately 25 or more such scans are made per second, the moving spot of light appears as a continuous line and the illusion of a true graph is obtained.

TIMEBASE WAVEFORM

The "timebase" waveform that is applied to the X plates is shown in Fig. 8.1c and is generally referred to as a "sawtooth" waveform. In an ideal waveform the voltage rises steadily from zero to a maximum in a pre-determined time, and then drops *instantly* to zero again. In practice the waveform takes a small but definite time to drop to zero as shown in Fig. 8.1c. This part of the waveform is used to return the spot on the screen to the beginning of the trace as rapidly as possible; it is referred to as the "flyback" period.

Circuits that generate a sawtooth waveform are usually called "timebase" generators, "sawtooth" oscillators, "sweep" generators, or "ramp" generators.

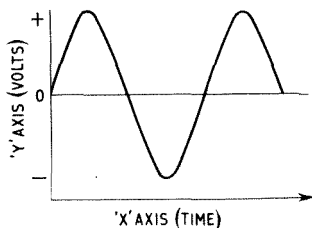

Fig. 8.1a. Sine wave shown in graph form plotted against an "X" and "Y" axis

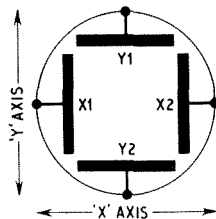

Fig. 8.1b. Position of the "X" and "Y" plates in a cathode ray tube looking at the "screen" end of the tube

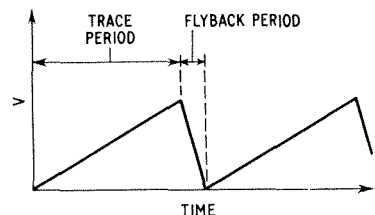

Fig. 8.1c. Sawtooth waveform showing the "trace" and "flyback" periods

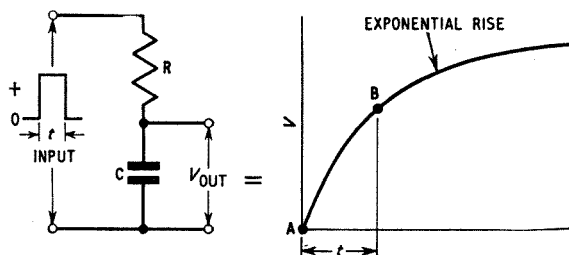

Fig. 8.2a. Simple RC circuit to convert a square wave input to an exponential output. Note that the most nearly linear part of the curve is that part nearest the origin

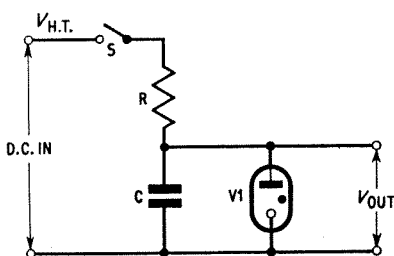

Fig. 8.2b. Modified RC circuit using a gas-filled diode to limit the output voltage

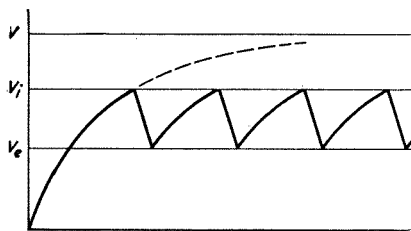

Fig. 8.2c. Output waveform from the circuit in Fig. 8.2b. V_i is the "striking" voltage and V_c the "cut-off" voltage of the gas-filled diode

BASIC SAWTOOTH OSCILLATORS

If a resistor and capacitor are connected in series, as shown in Fig. 8.2a, and a square wave is applied across the combination, the output taken from across the capacitor only will be exponential. If the duration of the input square wave is short compared to the time constant of the CR circuit, the output signal will vary from zero to maximum volts almost linearly. If the duration of the input signal is less than one tenth of the CR time constant, the deviation of the output from linearity will be less than 5 per cent. By using only a short part of the exponential rise a useful sawtooth waveform can be obtained.

One practical way in which this principle can be achieved is shown in Fig. 8.2b. The resistor and capacitor are again wired in series, but in this case a d.c. supply is connected across them. A gas-filled diode, or voltage regulator tube V_1 , is connected across the capacitor.

When a low voltage is applied across a gas-filled diode, the gas does not conduct and the diode is a virtual open circuit. As the voltage is increased, a point is reached at which the gas "ionises" and conducts heavily. The voltage at which ionisation occurs is called V_i . If the applied voltage is then reduced from V_i the gas will continue to conduct until, when a certain voltage level is reached, ionisation ceases. This second voltage is referred to as V_c .

At the instant when the d.c. is applied the output voltage across C is zero, but as time passes the voltage rises exponentially (see Fig. 8.2c) until it reaches the

"striking" voltage of V_1 . At this point, V_1 ionises and conducts, effectively short-circuiting and discharging the capacitor. As the output voltage falls to "cut-off" (V_c) conduction ceases and the short circuit across C is effectively removed. The capacitor is charged up again to repeat the cycle of events. The rise time of the waveform is dictated by the time constants of the circuit, while the decay time depends on the time constant derived from the effective resistance of V_1 in series with the resistor, and the capacitance of C.

At fairly low frequencies the decay time will be short compared to the rise time; the frequency of operation is virtually dictated by the rise time between the "striking" (V_i) and "cut-off" (V_c) voltages of V_1 .

BASIC "BOOTSTRAP" SAWTOOTH OSCILLATOR

For many applications, a sawtooth waveform that has a perfectly linear rise voltage, is essential. Such a voltage can be obtained by passing a constant current through a capacitor.

One circuit that relies on this principle is shown in Fig. 8.3a, this being the basic version of the circuit known as the "bootstrap" sawtooth oscillator. Transistor TR1 is an emitter follower, with an emitter load resistor R2. Resistor R and capacitor C are the time constant components, and R1 is an isolating resistor. Capacitor C1 provides a.c. feedback from TR1 emitter to the junction of R and R1.

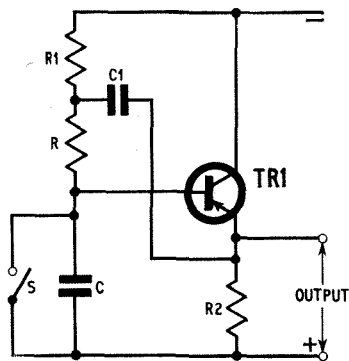

Fig. 8.3a. Basic "bootstrap" sawtooth oscillator

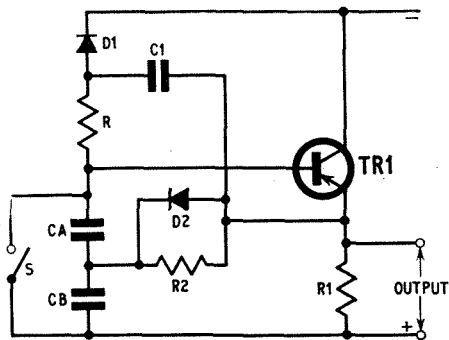

Fig. 8.3b. Improved "bootstrap" sawtooth oscillator

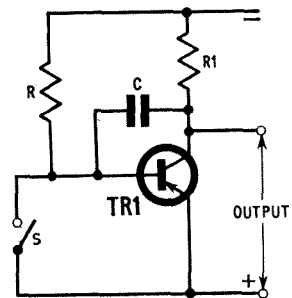

Fig. 8.4a. Basic "Miller integrator" sawtooth oscillator

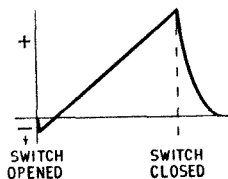

Fig. 8.4b. Output waveform of the Miller integrator

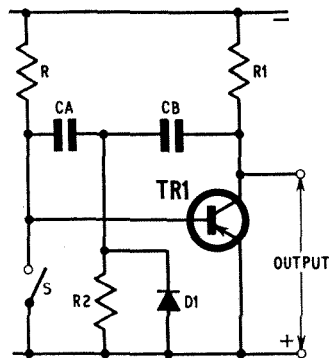

Fig. 8.4c. Improved version of the Miller integrator circuit

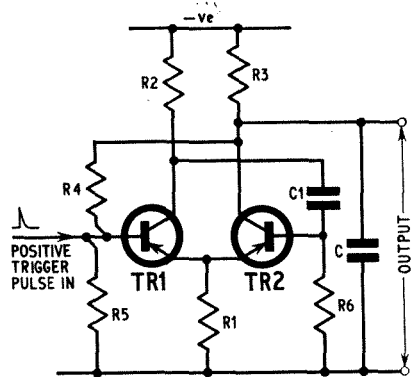

Fig. 8.5a. Sawtooth oscillator based on the monostable multivibrator triggered by an incoming pulse

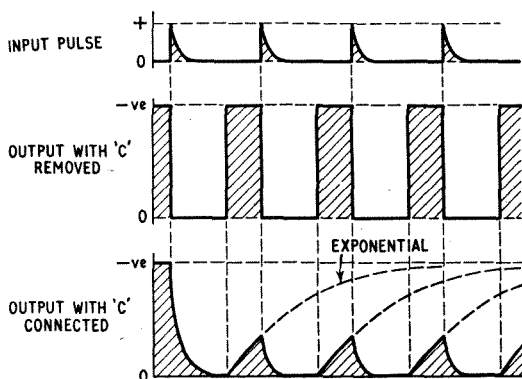

Fig. 8.5b. Input and output waveforms of the circuit shown in Fig. 8.5a.

With switch S1 closed the capacitor C is short-circuited and TR1 base is held at "earth" potential; TR1 is thus "cut off" and its emitter is at "earth" potential. If S1 is now opened, the capacitor begins to charge up in a negative direction, through R and R1. As the voltage across C becomes more negative, so does the base and emitter of TR1.

The changing voltage at TR1 emitter is transmitted via C1 back to the R-R1 junction. Thus, as the voltage at the CR junction rises, so does the voltage at the R-R1 junction, with the result that no change in voltage takes place across R. Consequently, as the voltage across R is constant and the value of R is fixed, the current through R, and therefore through C, is constant and the output voltage, taken from across the emitter resistor R2, rises linearly.

After a certain time, S1 is closed again, short circuiting C; the output voltage decays to zero in a time dictated by the time constant of R1 + R2 and C1.

For satisfactory operation of the bootstrap circuit as described it is essential that the input impedance of the transistor circuit should be high, taking only a negligible current from the CR chain; the signal fed back to the junction of R and R1 should come from a low impedance source; the feedback amplifier must have unity gain. These three requirements are met by the emitter follower circuit with little difficulty.

In practice, this simple circuit does not give perfect linearity; a considerable improvement can be obtained by making a few modifications, as shown in Fig. 8.3b.

Here, the timing capacitor is replaced by two capacitors, usually of equal value, and an additional feedback signal is fed to their junction from the emitter of TR1 via R2; this feedback resistor causes a slight non-linearity of signal at the junction, due to the time constant of this resistor and the timing capacitors. R2 is usually made a variable resistor which is adjusted on test to give good linearity. The distortion that is introduced at this point tends to cancel any distortion that occurs at the R-D1 junction due to the C1-R1 network.

Resistor R1 of Fig. 8.3a is replaced in the modified circuit by diode D1. This diode serves two purposes: (i) it prevents the sawtooth voltage rising to too high a value, i.e. if a feedback voltage of sufficient magnitude to raise the R-D1 junction above the negative rail voltage is applied, D1 will be reverse-biased and the charging current will be cut off; (ii) when the reset or flyback part of the waveform occurs the diode is forward biased and thus has a low effective resistance; the reset time constant is thus reduced from that obtainable with the resistor of Fig. 8.3a and a sharper cut-off is obtained. D1 is sometimes called the "speed-up" diode. Diode D2 also acts as a "speed-up" diode in discharging CA and CB.

BASIC MILLER INTEGRATOR TIMEBASE

Another circuit that is commonly used to give a linear timebase voltage is the Miller integrator, shown in basic form in Fig. 8.4a.

If there is capacitance between the collector and base, either in the form of inter-junction capacitance in the transistor or as provided by an external capacitor, the resulting feedback causes the effective value of that capacitance to be increased by a factor β , where β is the gain of the transistor. Thus, the time constant of the circuit becomes $R \times C \times \beta$. This apparent increase in C is known as the Miller effect, from which name this particular sawtooth generator gets its title.

By referring to the Miller circuit of Fig. 8.4a, a voltage, equal to the voltage applied to the base multiplied by the voltage gain of the transistor circuit, appears at the collector. The signal appearing at the output of the circuit is the same as would be obtained with a simple RC circuit, in which the time constant is $RC\beta$, and the applied voltage is the negative rail voltage times the voltage gain. The output of the Miller circuit cannot exceed the negative rail voltage, so in effect we have only a very short part of an exponential waveform, which can be considered as practically linear by virtue of its "shortness".

By making the value of R1 smaller than that of R, a comparatively short re-set or flyback time can be obtained.

The linearity of waveform can be improved even further by modifying the circuit as shown in Fig. 8.4c. Here, additional linearising networks have been included, their functions being similar to those already outlined for the improved bootstrap circuit of Fig. 8.3b. Diode D1 is a "speed-up diode", giving an improved flyback time.

In practical circuits, the switch is replaced by one or more transistors, and the circuit is made self-energising.

TRIGGERED SAWTOOTH GENERATORS

In the bootstrap and Miller circuits so far described, the circuits depend on the opening or closing of a switch to initiate and maintain the generation of a waveform, the period for which the switch is held open dictating the length of the sawtooth rise period. These circuits may be referred to as "driven" generators since, when the "drive" is removed, no output is available. Other sawtooth generator circuits exist, in which the length of the rise period is independent of the duration of any external switching; these generators require only a short input "pulse" to start the sawtooth generating cycle, which is then self-sustaining until one cycle is complete. Such circuits may be referred to as "triggered" sawtooth generators.

One version of a triggered sawtooth generator is shown in basic form in Fig. 8.5a, this particular circuit being based on the monostable multivibrator. (The operation of the monostable circuit will be described in detail in a later part of this series.)

Fig. 8.5b shows the output waveforms when triggered by an input pulse; a reasonable sawtooth will be obtained. Note that the waveform with this circuit is not linearised, being of a partially exponential form.

By making the value of R1 small compared to that of R3, a short flyback time can be obtained, while, by careful choice of the values of R3 and C, and the repetition frequency of the input trigger pulses, quite a good sawtooth waveform is possible. Note that the lower the peak output voltage compared to the supply rail voltage, the more nearly linear will the "rise" part of the sawtooth be.

By replacing the monostable multivibrator circuit of Fig. 8.5a by an astable one, the circuit can be made completely free running, requiring no input pulses to trigger it.

Next month: Design and operation of multi-vibrator circuits.

FREE
INSIDE NEXT
MONTH'S ISSUE

**2 FULL
SIZE**

BLUEPRINTS

TO BUILD

FIRE ALARM SYSTEM

Transistorised control unit with alarm bell and three inputs for fire detector devices located in distant rooms.

MULTI-RANGE METER

Compact, easy to build. Eleven ranges, including a.c., d.c., and ohms. Based on a 1 mA moving coil meter.

WITH FAULT-FINDING WALL CHARTS

covering

USE OF OSCILLOSCOPE

to examine waveforms of a.c. signals in power units and amplifiers.

USE OF MULTI-RANGE METER

to measure voltage, current and resistance of commonly used components including valves and transistors.

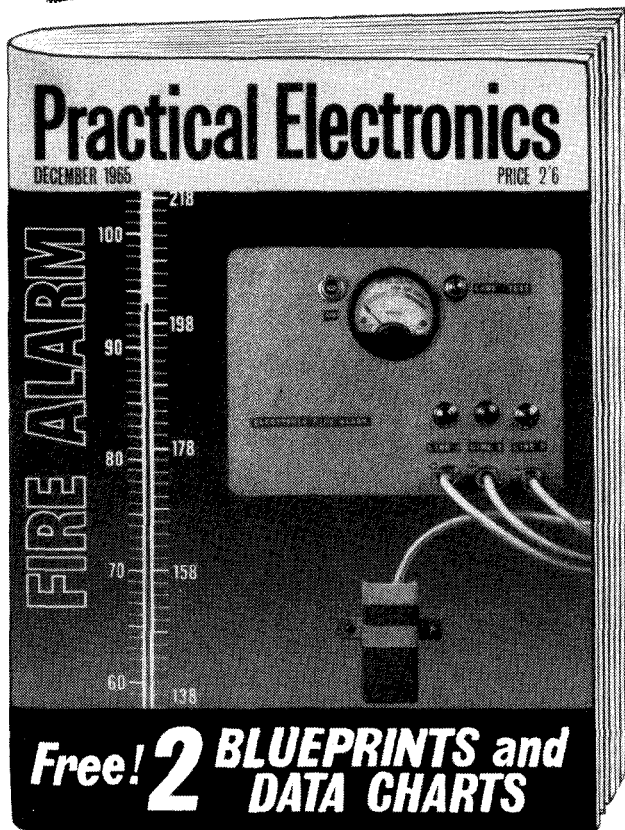

TO

(Name of Newsagent)

Please reserve/deliver the December issue of PRACTICAL ELECTRONICS (2/6) on sale Nov. 11th, and continue every month until further notice.

NAME

ADDRESS

**MAKE SURE OF
YOUR COPY!**

Complete and hand
this form to
your Newsagent

This article describes a battery-operated water level alarm device which may be built on a small piece of laminated plastics and mounted inside a small case together with two flat batteries. Output sockets are provided for connecting to an external indicating device, such as a bell, buzzer or lamp. The circuit diagram and constructional drawings appear on one of the blueprints presented with this issue.

CIRCUIT DESCRIPTION

Referring to Fig. 1 on the blueprint it will be seen that three silicon *npn* type transistors are employed in this alarm circuit. The types specified have been carefully selected for their high gain and very low leakage current characteristics. It should be noted that this circuit will not work reliably, if at all, with normal germanium transistors. The latter have generally high- and temperature dependent leakage currents. This could result in unnecessary high standing current and possibly false alarms on warm days.

The three transistors constitute a triple-cascade emitter follower which repeats (roughly) the input voltage to the input base (TR1) at the output emitter of TR3 in whose circuit the relay RLA is connected. Connections are such that when there is even a quite high resistance path across the two input connections (SK1), such as may be presented by clean water, sufficient amplified current flows in the output emitter circuit to energise the relay and ring the bell.

The 470 kilohm series resistor R1 and the 0.5 μ F shunt capacitor C1 at the input base, remove sensitivity to stray mains hum which may be picked up. This capacitor must have excellent insulation. The 5 megohm potentiometer VR1 varies the resistance level between the input electrodes.

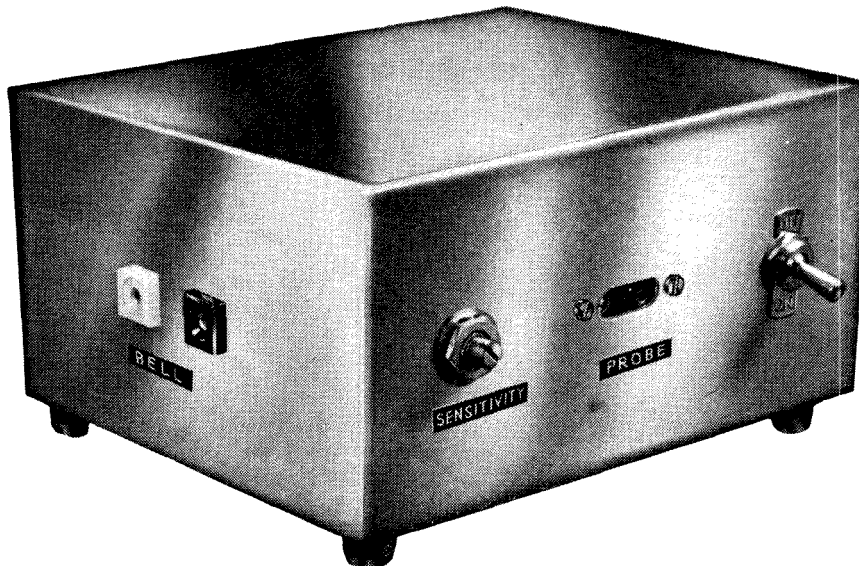

THE SENSING PROBE

The probe is a relatively simple and easily constructed device. Essentially it consists of two metal electrodes mounted on an insulator rod, as shown in Fig. 3. The lower collar is fixed and is always submerged in the water. The upper collar can be slid to the desired level at which the alarm is required to be sounded.

LOW CURRENT DRAIN

A rod or tube about $\frac{1}{4}$ in diameter, made of Paxolin or Bakelite material can be used for the probe. Perspex and certain other thermo-plastic materials are suitable for cold water applications only.

The sensitivity of the probe can be increased by enlarging the area of the metal collars.

The advantage of this circuit is the extremely long battery life it ensues, because the current drain in the non-alarm condition is much less than the self-discharge of the battery. In fact, using the specified transistors, it will normally be immeasurably small if read on the average general purpose meter. Thus the on/off switch S1 could in principle be dispensed with, in which case the electrolytic C2 across the supply should also be omitted. It is unlikely that this would lead to instability, since the circuit employs no voltage gain.

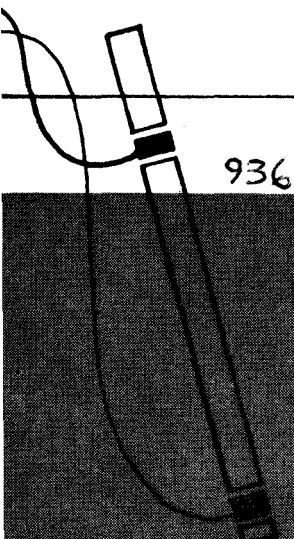

WATER LEVEL alarm

by M.L. Nicholls R.I.A.

An outstanding feature of this battery-operated alarm unit is its absolute safety. Perhaps a general warning note should be added here that constructors desiring a device to announce to them when their bath has run full should NOT contemplate using a *mains-operated unit*.

CONSTRUCTIONAL DETAILS

The electronic circuit is easily built up on a piece of laminated plastics material. Full size drawings of the top and underside of this panel appear in Fig. 2.

The method of component mounting adopted utilises proprietary terminal pins which are inserted in holes made with a No. 55 drill. These pins are tapered and form a secure anchoring point when lightly tapped home. The longer portion of the pin should protrude through the top (component side) of the panel. Not more than $\frac{1}{8}$ in of the pin should emerge through the underside of the panel, this is to ensure that no part of the circuit comes into contact with the bottom of the metal case when fitted inside.

If preferred, "home made" terminal pins may be fashioned from short lengths of 18 s.w.g. tinned copper wire. In this case, a No. 56 drill will provide a hole fractionally smaller than the diameter of wire. By gently tapping the end of the wire, it may be forced through the panel.

With all 22 terminal pins in position, proceed to wire up the underside of the panel. Use 22 s.w.g. or smaller wire for this purpose. Next place the transistors in position and bring their leads through to the underside of the panel via the appropriate holes. Solder the transistor leads to the correctly numbered terminals. The remaining components should now be installed and wired up to the upperside end of the terminals. Relay RLA is secured to the panel by means of two 8 B.A. screws supplied with this component.

THE METAL CASE

The metal case consists of a standard (universal) chassis with top panel. This can be obtained in prepared sections requiring only to be bolted together from Home Radio (Mitcham) Ltd. Alternatively, a case may be made up from sheet aluminium. Dimensions can be obtained from the full size diagrams Fig. 4 and Fig. 5. Two of the sides should be drilled to accommodate the sockets and controls.

The component panel is secured to the bottom of the case with a pair of 6B.A. bolts and nuts. A $\frac{1}{4}$ in long spacer should be placed over each bolt between the metal case and the plastics panel. The sockets, potentiometer, and on/off switch are mounted and wired up according to Fig. 4. Then the two flat batteries can be installed and connected up.

INSTALLATION NOTES

The 9V supply from the internal battery BY1 is made available at sockets SK2 and 3 immediately the relay is energised. A standard electric bell can be connected up to SK2 and 3. If a visual warning is preferred, an 8V or 12V lamp could be used.

Ordinary mains flex is suitable for connecting the probe to the alarm unit. The latter may be located some distance from the water container it is intended to monitor. ★

CABINETS

The cabinet of the amplifier unit is made of plywood and has a laminated plastic (such as "Formica" or "Wareite") front panel. The construction is shown in Fig. 6, and the drilling details of the front panel in Fig. 7. The baseboard is shown in Fig. 8. It will be found that the amplifier has to be positioned inside the cabinet at a slight angle in order to be clear of the loudspeaker, battery and switch S1. The end of the amplifier which carries the largest transformer (T3) should be at the rear of the cabinet. The amplifier may be screwed down to the baseboard of the cabinet if small soldering-tags are soldered to the end terminals of the groupboard. Four rubber or p.v.c. feet should be fitted to the underside of the baseboard.

The door unit is constructed quite simply from plywood and is shown in Figs. 9 and 10. The wiring of the door unit is given in Fig. 5 on the blueprint and is quite straightforward. It should be noted though that the connection from S2 to the loudspeaker LS2 should be made to the wire which is connected to the positive line of the amplifier, and not to the wire connected to S1a. When the unit is completed, and S1 is at the "off" position, the wire from S2 can be connected to each side of LS2 in turn. Connecting it to one side will be found to result in a more pronounced howl when S2 is operated than connecting it to the other side of LS2.

LOCATION

Since the door unit will be positioned in the open, its location should be chosen with care to avoid the direct incidence of rain. Obviously, the more sheltered the position finally chosen, the less chance there will be of damage to the unit by the weather. The door unit should be painted to keep out damp and it would also be a good idea to seal all the joints when the unit is finally assembled. The grill on the front between the loudspeaker and the panel should be of fine mesh; perforated zinc was used in the prototype. However, there is now on the market a plastic substitute for perforated zinc which would be a better type of material to use. To keep out the damp, a thin sheet of polythene can be fixed to the grille behind the panel; the sound level will be reduced somewhat, but the weather-proofing will be better.

If the door concerned has a porch, this is all to the good, and the door unit can be fitted in a sheltered position.

OTHER USES

This intercom system is capable of giving an output of quite good quality and would certainly be adequate for communication between two offices. It would also be found useful for wiring between the bedroom of a sick person or invalid and another room to prevent needless journeys upstairs. Yet another use would be as a baby alarm, in which case the switches S1 and S2 would not be required, their place being taken by a simple on/off switch for the battery.

The prototype was also found handy for use when installing a television aerial in an area of weak signal, giving communication between the aerial rigger and someone watching the receiver, so that the aerial could easily be positioned for optimum results. ★

ELECTRONORAMA

HIGHLIGHTS FROM THE CONTEMPORARY SCENE

Lunar Reporter

SCIENTISTS at San Diego (California) have designed a 10ft ball-like vehicle that could roll over the surface of the moon, report back to earth, take television pictures of the moon and execute commands via radio from earth. Called a "Roamer", it is powered by the sun. The disc-like solar antenna attracts power from the sun. A small 22in model of the "Roamer" is seen here being tested by two General Dynamics engineers.

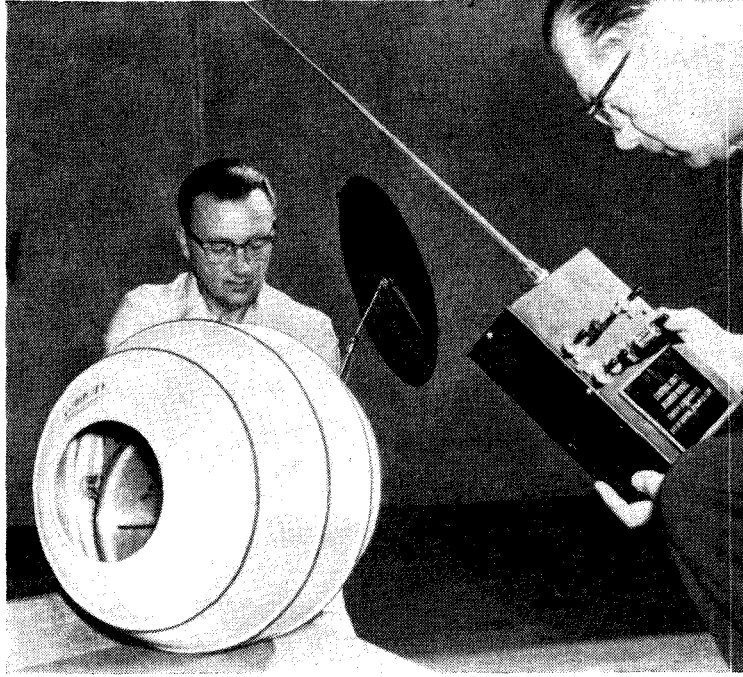

U.H.F. Radiotelephone

PYE Telecommunications have announced that they have developed a u.h.f. radiotelephone system operating on the 450 to 470 Mc/s band. It comprises two self-contained pocket cases requiring no interconnecting wires.

The transmitter and receiver are crystal controlled and use unobtrusive aerials. Power is derived from small rechargeable batteries.

High quality two-way communication is achieved over distances up to about five miles, depending on the layout and density of obstructions. PRACTICAL ELECTRONICS tried out this radio telephone in a double decker bus; no significant deterioration in quality was noticed in spite of the metallic screening of the bus body.

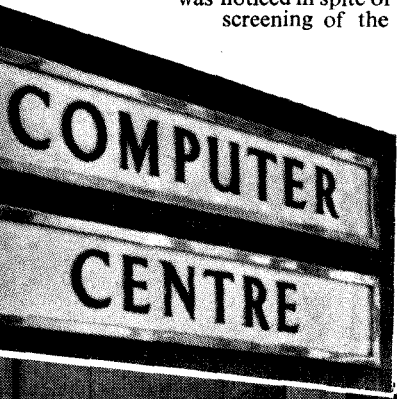

STORAGE SYSTEM



Television Field Delay

AN ELECTRONIC store that, so far as is known, is the first of its kind, is being built at the BBC Research Department, Tadworth, Surrey.

It is capable of delaying a television video signal by 20 milliseconds—the time taken to scan a complete 405 or 625 line field. The equipment will be used in experimental projects including work on standards conversion and film recording.

The broad bandwidth required and the comparatively long delay is obtained by using quartz ultrasonic delay lines. Eight 2.5 millisecond lines have been supplied by The M.E.L. Equipment Company Ltd., and are being used in cascade by the BBC to obtain the total delay of 20 milliseconds.

A BBC engineer is connecting a "booster" heater for one of the delay line ovens (photograph on the right). The boosters operate automatically when the equipment is first switched on, reducing heating-up time.

Bank's Third Computer Centre

HAVE YOU been given a new bank account number? If your account is with the Westminster Bank, you will see from our photographs at the foot of these pages that there is a reason.

On the left is the I.B.M. model 7010 computer system; on the right is one of the five "clearing" systems, now being used at the new Computer Centre off Fenchurch Street, London. These systems are only part of the huge complex of electronic data processing equipment being used by the Bank.

The 7010 system uses a central processing unit, which can store up to 80,000 characters on magnetic tape and perform arithmetic calculations. It will process a day's transactions for an average size branch in less than three minutes. The "clearing" system encodes and records the special magnetic ink numerals on the cheques. Under computer control it directs the cheques into selected pockets. Approximately 1,000 cheques can be dealt with in a minute.

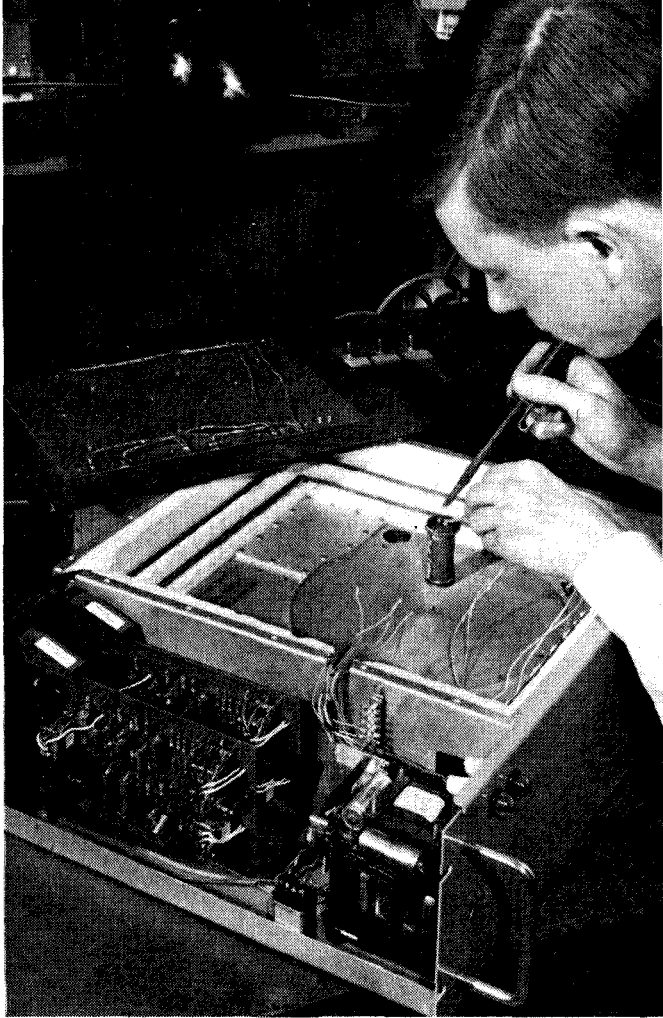

CLEARING SYSTEM



BEGINNERS start here...

13

An Instructional Series for the Newcomer to Electronics

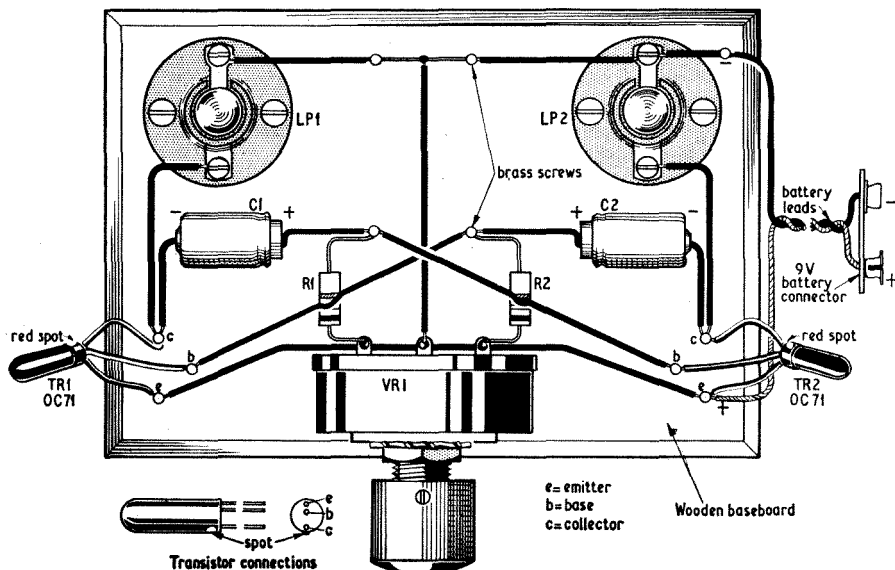

Fig. 13.1 Wiring diagram for the multivibrator

AFTER our discussion of tools and soldering, we put to the test our ability in *practical* electronics, because this month's article is devoted to a constructional project. This project is a *multivibrator*—but don't let the name worry you. Apart from providing a useful exercise in building up equipment, the completed unit will produce a.c. for you from a battery supply. The kind of a.c. obtained is in the form of square waves. This multivibrator will be a valuable aid to the understanding of a.c. theory when we commence looking at this subject next month.

So now to work!

A PROJECT TO BUILD

Two transistors, TR1 and TR2 (see the circuit diagram, Fig. 13.2) are used to switch each other off and on. It is not necessary to understand transistor action at the moment; we will come onto that later. It is sufficient to say that a signal pulse applied to one of the three transistor connections (the *base*) switches on a much larger current in another (the *collector*). This current is then used to operate some device (here simply a lamp). As the transistor is switched on, the initial pulse is applied through the capacitor C1 to the base of the second transistor TR2. The effect here is to switch off TR2. The capacitors C1, C2 gradually change their charge, and eventually the switching is reversed and the other lamp lights up. This goes on indefinitely—notice with no moving parts.

The timing of the switchover is determined by the size of the capacitors, the amount of charge on them, and the size of the resistors R1, R2 through which this charge leaks away. In fact electronic switching can go

on not only at the rate of one or two operations per second, as here, but at a few *million* if necessary, by choosing the right values of the components. This circuit is known as a *multivibrator*.

By adjusting the setting of the potentiometer VR1, the value of the resistance affecting each half of the circuit (notice its balanced or symmetrical layout) can be altered, causing unbalance between the two halves and a change in the switching time, so that one bulb will be on for a different period of time compared to the other.

In fact, as one bulb comes on for a longer time, the other does so for a correspondingly shorter time. This is called altering the *mark to space ratio* of the generated a.c. waveform.

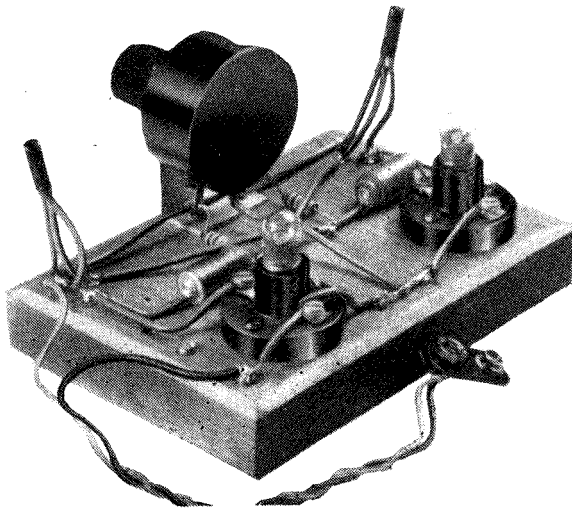

You can look upon this circuit as one which simply switches the lamps on and off, or as a generator converting the 9 volt d.c. battery supply into a form of alternating current.

CONSTRUCTION DETAILS

We have kept in mind two principles when designing this circuit, the first of a number of construction projects for beginners.

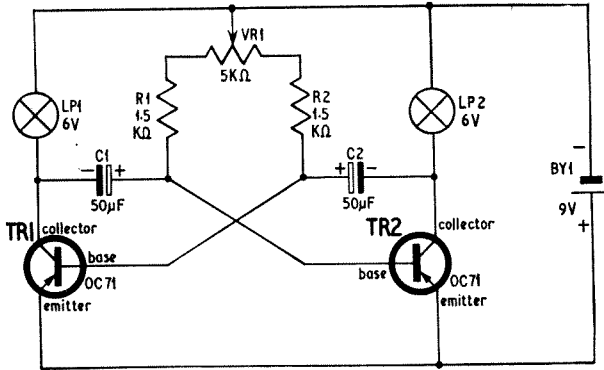

Fig 13.2. Circuit diagram

Firstly, the use of simple materials for the supporting mechanical structure, namely a wooden base and brass woodscrews as anchor points or terminals. As we mentioned in a previous article, dealing with tools, the standard methods of electronic construction involve perhaps a metal chassis, or a bonded plastics "printed circuit" base; but our methods give excellent results and ease of construction, without these complications.

Secondly, the physical layouts can be arranged to follow fairly well the schematic "plans" that are used to record details of circuits. For instance, the multivibrator always has the characteristic "criss-cross" balanced pattern of connections between the two halves. In the end, a quick glance at a circuit reveals that it contains a multivibrator, and so on. It would be poor practice to draw circuits so different that the "shape" is lost, rather like the effect of sticking stamps on envelopes upside down! (see the *Building Blocks* articles).

Thus with our method of construction, the practical layout roughly follows the theoretical pattern, and links up theory and practice for you.

Drive home the brass screws in the positions indicated, then apply the soldering iron and some cored solder to the head of each in turn and ensure that the top of each screw is well tinned.

A simple L-shaped bracket is needed to hold VR1. This bracket and the two batten-type lampholders should be screwed in position. Next connect up the two capacitors and two resistors. The negative ends of the capacitors go to the collectors of the transistors. It is advisable to fit plastics sleeving over the capacitor leads, leaving about $\frac{1}{4}$ in of wire exposed for making the soldered connections. The remaining leads should be connected up. Note that the lampholders have screw terminals.

It now remains to fit the two transistors. Carefully examine the leads on these components. It will be seen that one lead is spaced apart from the other two; this is the collector lead, and usually additional identifi-

cation is provided by a red spot painted on the body of the transistor adjacent to the collector lead. The middle lead is the base, and the remaining lead the emitter. Do not shorten these leads. Fit a piece of plastics sleeving over each, leaving about $\frac{1}{4}$ in of bare wire. If you have a selection of different coloured sleeving available, it is a good plan to adopt a standard practice, e.g. use red sleeving for the collector, blue for base, and yellow for emitter.

COMPONENTS . . .

Resistors

R1 1.5k Ω
R2 1.5k Ω } colour coding: brown, green, red
 $\frac{1}{2}$ W carbon composition type

Potentiometer

VR1 5k Ω wire wound or carbon linear track

Capacitors

C1 50 μ F electrolytic, 12V
C2 50 μ F electrolytic, 12V

Transistors

TR1 OC71 } germanium pnp type
TR2 OC71 }

Lamps

LP1 Lamp 6V 0.06A
LP2 Lamp 6V 0.06A

Battery

BY1 9 volt battery (Ever Ready PP3 or equivalent)

Miscellaneous Items

Wooden baseboard, approximately 4in \times 3in \times $\frac{1}{2}$ in.
Brass wood screws. Two batten type m.e.s. lampholders. Plastic covered tinned copper-wire (can be obtained in various colours, on small reels).

TAKE CARE HERE!

Care must be taken when soldering the transistors in position. The aim must be to complete the operation as speedily as possible and to avoid unduly heating the transistor. The heat from the iron can be shunted away from the component by placing a reasonably large metal object in contact with the bare lead, just above the point where the soldered joint is to be made. A pair of long nosed pliers or a screwdriver blade will serve as a thermal shunt. It is essential that the heat shunt remains in full contact with the bare wire throughout the soldering operation and for a few seconds after the iron has been removed.

Connect a pair of leads to the battery connector, and connect these leads to the positive and negative terminals on the board. Check carefully the polarity of these connections.

Low consumption 6V lamps are used with a current rating of 60mA, but lamps rated at 100mA (0.1A) will work equally well.

Make a final check through the wiring to see that no mistakes have arisen. If everything is in order, connect up the battery. Make sure the correct polarity is observed (+ to +; - to -). The multivibrator should start working straight away, each lamp flashing on and off alternatively.

THIS month's article describes the mechanical construction, wiring up and testing of the scaler.

METALWORK

The case, front panel, main chassis and display unit chassis (two parts) are all made of $\frac{1}{16}$ in aluminium sheet. Drilling details are given in Figs. 8, 15 and 16, but should the constructor feel that this work is outside his scope it may be left to a specialist firm who will supply the material ready shaped, quickly and at little extra cost. Some of the larger holes may be punched out at the same time if required. The panel and case may be painted or finished as desired.

MAIN CHASSIS

Assembly work starts with the main chassis which is prepared accordingly to the information given in Fig. 8. Grommets should be fitted to holes "G". The larger components should then be bolted in position as indicated in Fig. 8. Use four extra long bolts in the correct places (T2 front pair; C37 rear pair) for the later attachment of tag boards below the chassis. If components other than those specified are used, it may of course be necessary to modify the drilling arrangements.

For the input and i.s. amplifier tag board and the two power supply assemblies, the turret tag and perforated laminated plastics sheet method of construction is employed. A Radiospares standard perforated

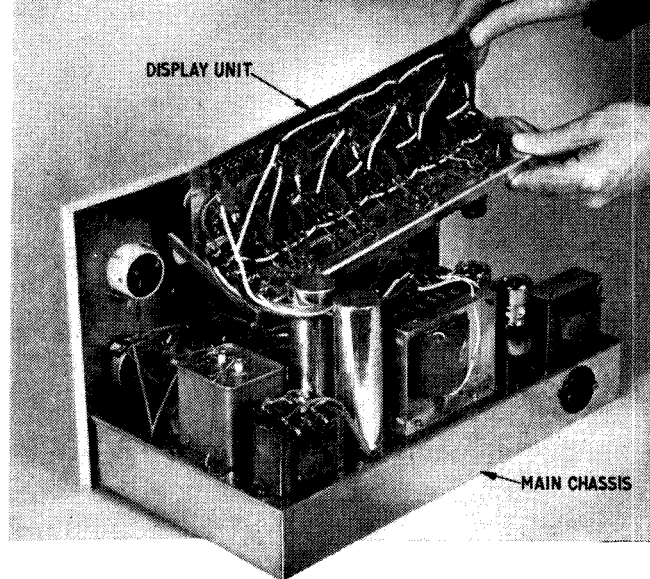

sheet measures $7\frac{7}{8}$ in by $10\frac{1}{2}$ in and one sheet can be cut with a fine saw to make the three boards. The standard turret tags are inserted through the perforations and rivetted in place with the special tool which is supplied with them.

The h.t. and e.h.t. tag boards are wired up according to Figs. 9 and 10 respectively, and then they are fixed

GENERAL PURPOSE SCALER

By R. W. SAWYER, B.Sc.

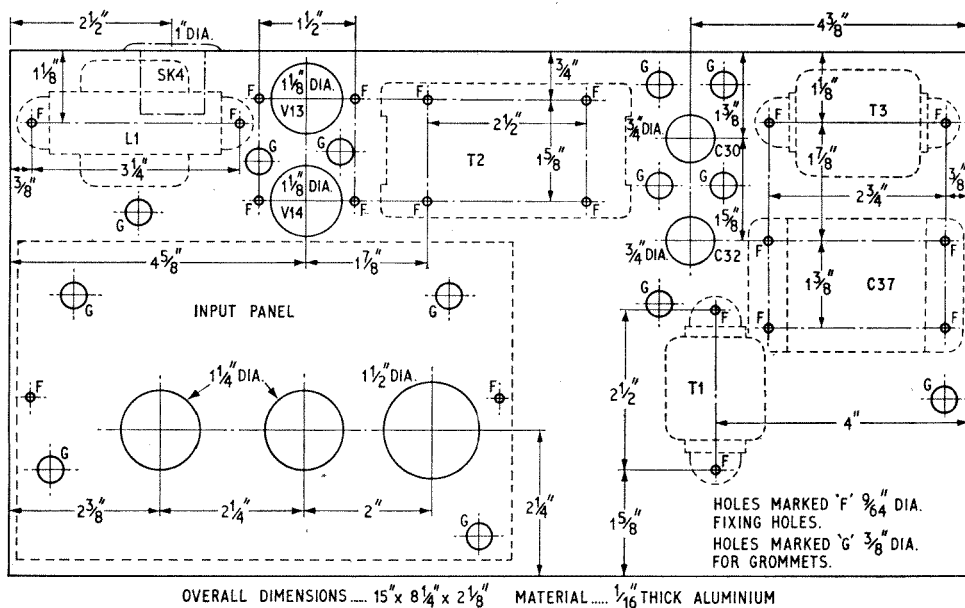

Fig. 8. Main chassis drilling details. The location of all components situated on the top of the chassis is indicated. The three large holes in the bottom left-hand quarter provide clearance for the three valves mounted on the input panel

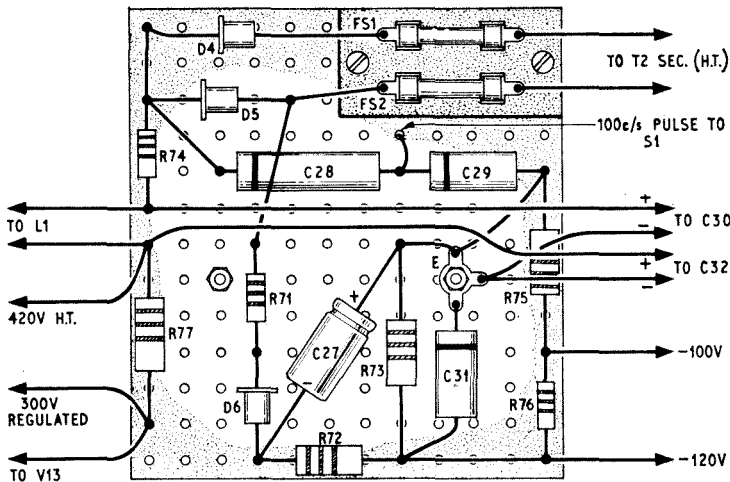

Fig. 9. Main h.t. unit tag board. This is mounted on the underside of the main chassis

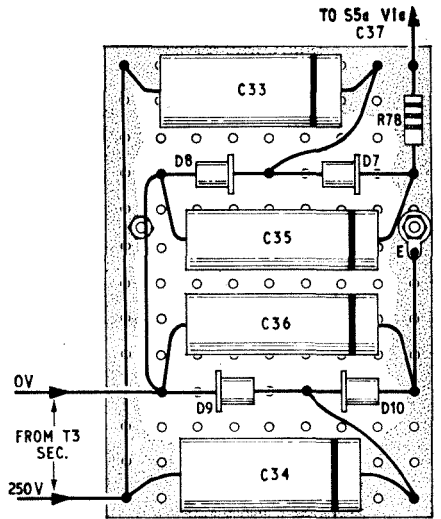

Fig. 10. E.H.T. unit tag board. This is mounted on the underside of the main chassis

on the long screws which were left projecting below the chassis. Spacing, and therefore insulation, from the chassis is ensured by the nuts already on the fixing bolts and by the grommets in the chassis. Wiring up to the other power supply components is then carried out. The screen of the mains transformer T2 should be connected to earth and the other transformer leads which are not required should be taped over.

The mains input socket SK1 should be wired up to the mains switch S4, and a pair of leads brought back and passed through a grommet-lined hole in the chassis and so up to the primary tags on T2.

Leads from the h.t. power supply are brought up through grommets in the chassis and terminated for convenience on a small tag strip mounted on the top flange of the frame of the mains transformer T2. The specified transformer has convenient holes for mounting this strip. An insulating strip of laminated plastics is placed directly below the tag strip while a metal strip with two suitable clearance holes for the mounting screws goes below the transformer frame. This ensures rigid attachment and good earthing. The mounting screws carry earth tags.

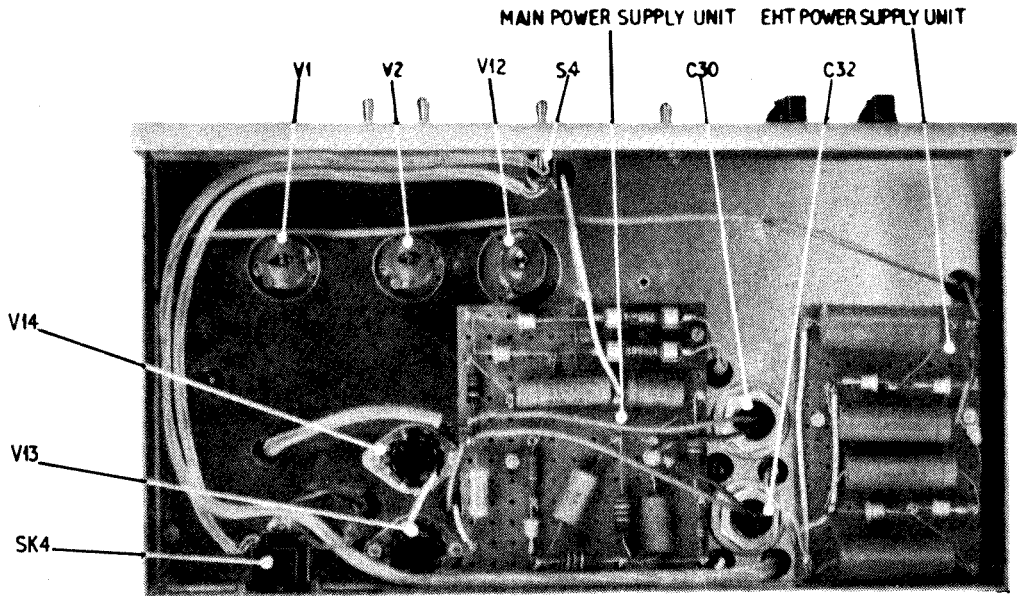

Fig. 11. Underside view of the main chassis showing the two power supply tag boards in position

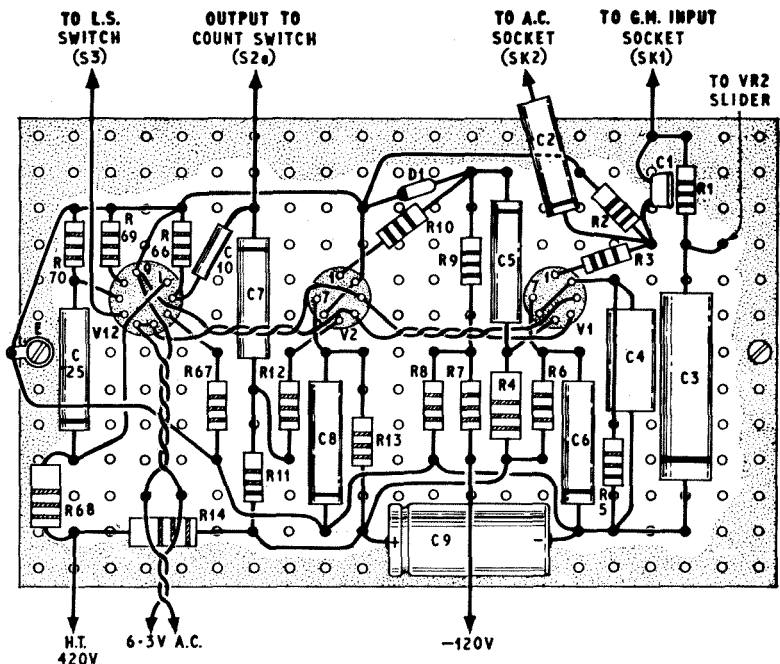

Fig. 12. Input and loudspeaker amplifier tag board showing layout of components and wiring

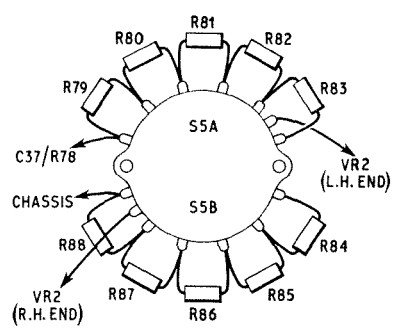

Fig. 13. Wiring details of the e.h.t. "coarse" control S5 and the associated resistors

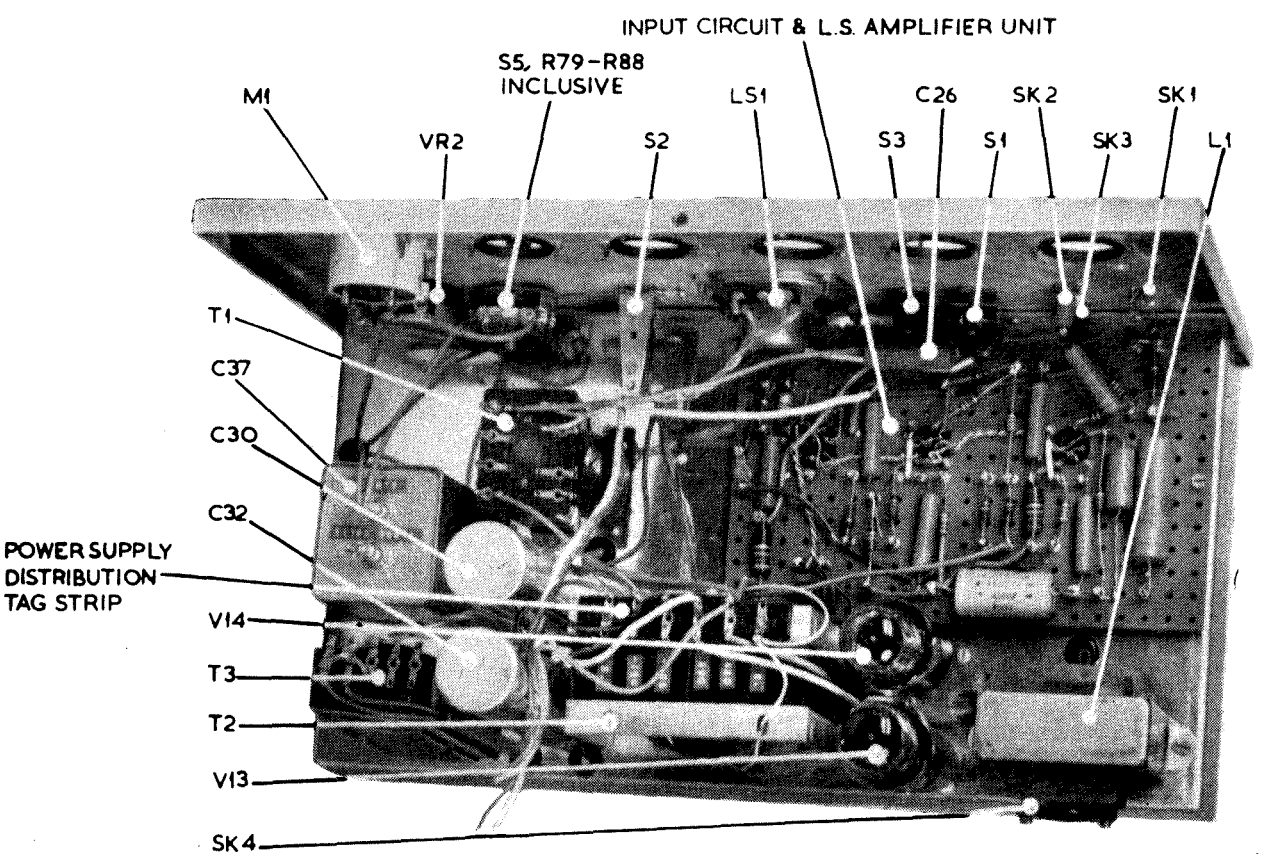

Fig. 14. Top view of the main assembly before the display unit is installed

The e.h.t. supply terminates on the $1\mu\text{F}$ high voltage capacitor C37. *Due attention must be paid to the high potential present at this terminal when the scaler is operative.*

VOLTAGE CHECKS

An inspection for correct wiring should now be carried out and then the mains voltage applied. The outputs may be checked with a suitable multimeter. All measurements are made with respect to earth.

The e.h.t. is first tested and should show just over 1,000V positive. The mains are then disconnected and the capacitor C37 discharged by shorting with an insulated screwdriver. As a further precaution the input to the e.h.t. mains transformer T3 is disconnected until required later in the construction.

With the voltage regulator valves V13, V14 in place and the mains reconnected, the voltages on the tag strip should be: main h.t. 420V positive, regulated supply 300V positive, and two negative supplies of 120V and 100V respectively. The a.c. heater supply of nearly 7V r.m.s. off load may also be checked on two unsecured wires coming from the transformer T2.

INPUT TAG BOARD

The input and l.s. amplifier tag board is constructed from one half of the perforated sheet and bears the circuitry and valves for the input, pulse-shaper and audio stages. The construction and mounting follow the technique employed for the power supply tag boards and should present no difficulty. Details are given in Fig. 12. This board is attached to the top surface of the chassis by two bolts and spaced by an extra nut on each screw between the board and chassis. The three valves protrude downwards through the holes provided in the main chassis.

The 420V h.t. and the 120V negative supplies are connected from the tag strip above on the mains transformer—the 6.3V heater supply comes directly from the main transformer T2. The 100c/s pulse line is brought up through the grommet below the front right corner of the tag board and temporarily connected through the $0.001\mu\text{F}$ capacitor C2 to the input.

The permanent connection is made from one end of the output transformer T1 primary to h.t. and a temporary connection is made between the other end and the second anode of the audio output valve V12 (pin 6). The loudspeaker is then temporarily connected to the secondary of the output transformer.

Power is supplied to the chassis and as soon as the valves have warmed up a loud staccato 100c/s note should be heard from the loudspeaker. If an oscilloscope is available a check of the output at the junction of R11 and R12 in the anode of V2 should show a train of sharp negative pulses at a frequency of 100c/s and about 160V amplitude.

DISPLAY UNIT

The display unit is the heart of the instrument, and will repay careful construction. It is built on two pieces of sheet aluminium which are joined together in the last stage of construction in an L form. Dimensions and drilling details are given in Fig. 16. Each sheet carries two sub-miniature group panels each with 18 pairs of tags, and a piece of panel containing eight pairs of tags. The panels are insulated by miniature backing plates, two on each section.

Note that the correct positioning of the fixing screws

for the Dekatron valveholders shown in the small detailed drawing in Fig. 17. This ensures correct orientation of the tubes so that "zero" appears at top centre.

All components, particularly the Dekatron valveholder tags, should be carefully cleaned before assembly. The valveholders are then fixed in position and the small components mounted on the group panels according to Fig. 17. The wiring is carried out with No. 22 or No. 24 s.w.g. tinned copper wire. It is essential for this work to use a small instrument type soldering iron and a suitable sized resin cored solder.

It will be noticed that the anode load resistors of the Dekatrons R20, R31 etc. are wired direct to the valveholder tags. This is a manufacturers' recommendation in order to reduce stray capacitance effects.

The supply lines, preferably colour coded, are brought out to a small 4-way tag strip at one end of the unit. A consistent colour scheme using red 420V; yellow regulated 300V; blue -120V; black -100V; green earth, or bias line, and white for input pulse, prevents errors in construction and assists in checking the assembly later.

TESTING THE DISPLAY UNIT

Thus constructed the display unit is complete in itself and for test purposes may be placed apart (as shown in the photograph at the head of the first part of this article). The Dekatrons and trigger tubes are placed in their sockets and the unit propped up in a convenient position. Leads about 9in long are joined to the display unit tag board and connected to the appropriate tags mounted on the main transformer T2 to give 420V, 300V, -100V, and earth supplies

The Dekatrons should now strike, a single stationary glow appearing on each in a random position. A momentary connection of the reset line to the -120 volt supply should instantly bring all the glows to the top position in the Dekatrons.

A connection from the output of V2 on the input panel, via the $0.01\mu\text{F}$ capacitor C7, to C11 at the input of the display unit should start the unit counting at 100c/s. The preset potentiometer VR1 may need adjustment; it should be set to give satisfactory steady operation of the Dekatrons, this requires a bias of approximately 35 volts.

If the apparatus fails to work at this stage the fault must be found before proceeding further. The supply voltages should be measured and all component values, connections, and soldered joints checked.

If the first Dekatron does not count, the 100c/s output from C7 on the input panel may be applied in turn to the anodes of the trigger tubes, when the later Dekatrons should operate.

Incorrect bias to the triggers of the trigger tubes will either result in failure to operate, in which case there will be one glow only in the tube, or, in continuous oscillation resulting in rapid counting by the following Dekatrons. The trigger voltage measured at the junction of the 120 kilohm resistor RC, using a 1,000 ohm per volt meter was found to be 160V to earth. This voltage can be increased or decreased by placing a megohm resistor in parallel with one of the resistors. This should not be necessary when using the high-stability, close-tolerance components specified.

Once the display unit is working it should be disconnected by unsoldering the leads to the tag strip and placed on one side to save it from mechanical damage during the further construction of the scaler.

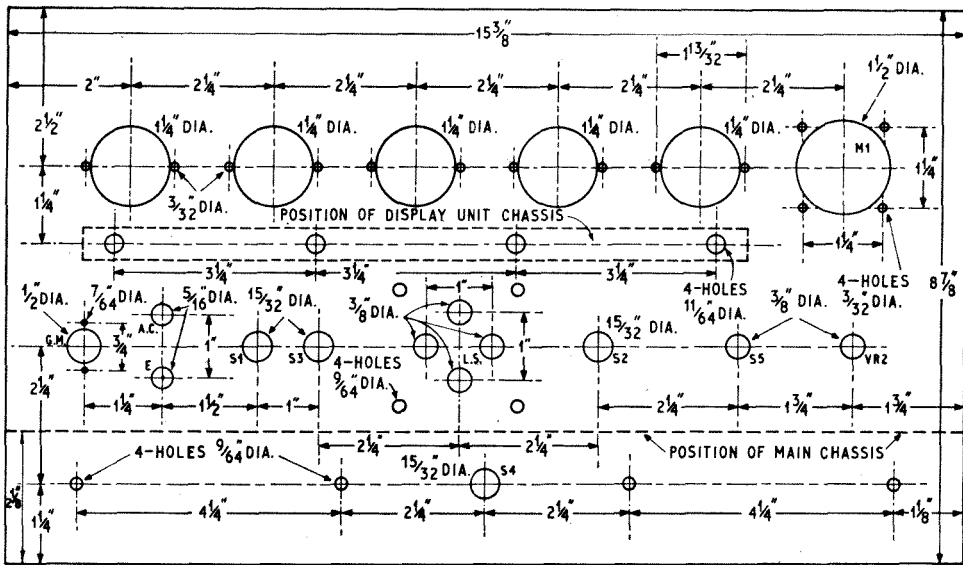

Fig. 15. Front panel drilling details

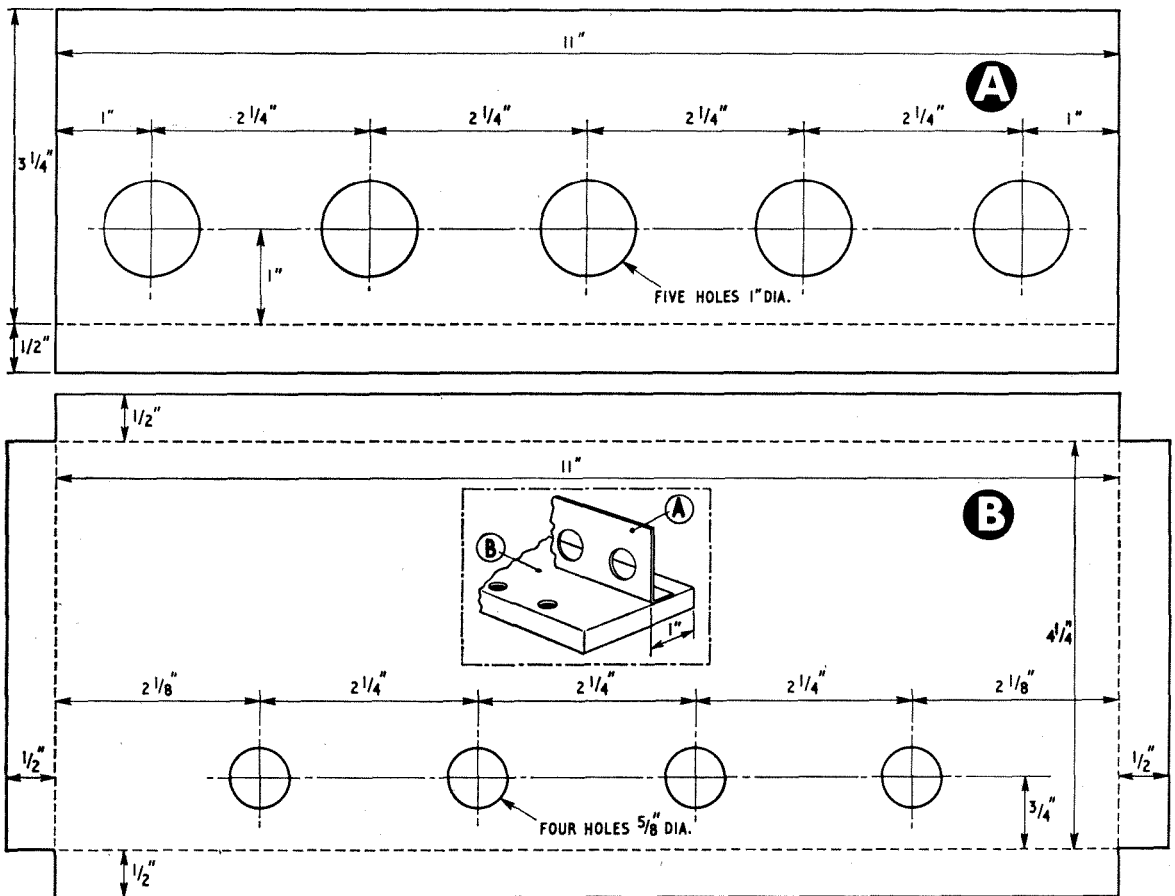

Fig. 16. Display unit chassis drilling details. The position of the Dekatron valveholder securing screws on panel "A", is indicated in Fig. 17



Home Construction made easy by Building Heathkit models

A wide range of well designed quality kit sets to choose from

Ease of assembly is guaranteed

Even for those without previous experience—by the comprehensive, yet simple step-by-step construction manuals supplied with every Heathkit model.

Save £ £'s building the models

Heathkit units cost considerably less than comparable pre-assembled equipment. You cannot buy the parts any other way as cheaply.

Guaranteed performance

Every Heathkit product—assembled in accordance with our comprehensive construction manuals is guaranteed to meet published performance specifications, or your money will be cheerfully refunded.

Convenient credit terms

By taking advantage of our credit terms—you can enjoy your model right away—and pay for it in easy monthly instalments. Deferred terms available over £10 in U.K.

AUDIO

Cabinets, Turntable units, Mono and Stereo Amplifiers, Pick-ups, Speakers, Speaker Systems, Mono and Stereo Control Units, Tape Pre-amplifiers, Tape Decks, Transistor Mixer.

RADIO

AM/FM and FM Tuners, Transistor Radios, SW and Communication Receivers.

TEST INSTRUMENTS

A wide range of Audio Test, Home Workshop, Service and Laboratory Instruments.

AMATEUR GEAR

A wide range of equipment.

MISCELLANEOUS

Hobby kits for the youngster, Tool kits, Intercoms, Electronic Organs, PA/Guitar Amplifiers, etc.

See the complete Heathkit range in the FREE catalogue



HI-FI CABINETS

RECORD PLAYERS



FM & AM/FM RADIO TUNERS



TRANSISTOR PORTABLES

TAPE DECKS



SW RECEIVERS TRANSMITTERS

CONTROL UNITS



QUALITY STEREO and MONO AMPLIFIERS

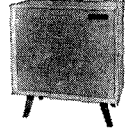

SPEAKER SYSTEMS

"MALVERN" HI-FI EQUIPMENT CABINET. Will house all your Hi-fi equipment. Left "in the white." Size: 39½ x 32 x 21½ in. Kit £18.1.0 (inc. P.T.) A wide range of other cabinets.

HI-FI TUNER. Range 88-108 Mc/s. Available in two units, sold separately. **TUNER (FMT-4U)** 10.7 Mc/s IF £2.15.0 (inc. P.T.). **IF AMPLIFIER (FMA-4U)** power supply and valves £13.13.0. Total Kit £16.8.0.

JUNIOR ELECTRONIC WORKSHOP, Model EW-1. 20 exciting experiments can be made. Special solderless connections. Kit £7.13.6 (inc. P.T.)

TRANSISTOR MIXER, TM-1. A must for the tape enthusiast. 4 inputs, 9 v. battery operation. Kit £11.16.0. Assembled £16.17.6.

"OXFORD" LUXURY TRANSISTOR PORTABLE, Model UXR-2. Beautiful solid leather case. LW and MW Coverage. Kit £14.18.0 (inc. P.T.)

GENERAL COVERAGE RECEIVER, Model RG-1. Freq. coverage 600 kc/s-1.5 Mc/s. 1.7-32 Mc/s in 6 switched bands. Many features incl. ½ lattice crystal filter. Kit £39.16.0. Assembled £53.0.0.

6W QUALITY STEREO AMPLIFIER, Model S-33H. An inexpensive stereo/mono amplifier. Ideal for use with the Decca Deram lightweight pickup. Modern attractive styling. Kit £15.17.6. Assembled £21.7.6.

50W PA/GUITAR AMPLIFIER, Model PA-1. A multi-purpose unit, suitable for vocal and instrumental groups. 4 inputs for guitars, mics, etc. 2 heavy duty speakers, vol. indicator, variable tremolo, modern cabinet. Kit £54.15.0. Assembled £74.0.0. Legs optional extra, 17/6.

TRANSISTOR GEN. COVERAGE RECEIVER, Model GC-1U. Frequency coverage 580 k/cs—30 Mc/s in 5 bands. Kit £37.17.6. Assembled £45.17.6.

TRANSISTOR INTERCOM, Master Unit. Kit £10.19.6. Assembled £16.19.6. Remote. Kit £4.7.6. Assembled £5.16.0. Will operate up to 5 remotes.

"COTSWOLD" HI-FI SPEAKER SYSTEMS. Std. model. Size: 26 x 23 x 14 in. Kit £25.12.0. MFS "Cotswold" for the smaller room. Size: 36 x 16½ x 14 in. Kit £25.12.0

SSU-1 SPEAKER SYSTEM. A practical solution to the problem of a low-price speaker system. Two speakers. (Bookcase) £11.17.6 Kit (inc. P.T.) (With legs) £12.12.0 Kit (inc. P.T.)



'SCOPES



POWER SUPPLIES

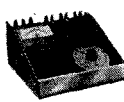

TRANSISTOR TESTER



SIGNAL GENERATORS



VALVE VOLTMETERS



TV ALIGN GENERATORS

5 in. FLAT-FACE GENERAL PURPOSE OSCILLOSCOPE, Model 10-12U. An outstanding 'scope. "Y" sensitivity, 10 mV rms per cm at 1 kc/s; Bandwidth 3 c/s to 4.5 Mc/s. T/B 10 c/s to 500 kc/s in 5 steps. Kit £35.17.6. Assembled £45.15.0.

MULTIMETER, Model MM-1U. Ranges 0-1.5 v to 1,500 v A.C. and D.C. 150 µA to 15A D.C.; 0.2 to 20 MΩ. ½ in. 50µA meter. Kit £12.18.0. Assembled £18.11.6.

REGULATED POWER SUPPLY, Model 1P-20U. Transistorised, compact unit. Current range: from 50 mA to 1.5 A f.s.d. Voltage ranges: from 5 to 50 volts f.s.d. Kit £35.8.0. Assembled £47.8.0.

TRANSISTOR TESTER, Model 1M-30U. Unmatched in quality, performance and price. Provides complete d.c. analysis of PNP, NPN transistors and diodes. Internal battery for tests up to 9 v. Kit £24.18.0. Assembled £35.10.0.

R.F. SIGNAL GENERATOR, Model RF-1U. Freq. coverage from 100 kc/s-100 Mc/s or six bands, on fundamentals and up to 200 Mc/s on calibrated harmonics. Kit £13.8.0. Assembled £19.18.0.

6 in. DE LUXE VALVE VOLTMETER, Model 1M-13U. Measures ac and dc volts 0-1.5 to 1,500 V in 7 ranges. Res. to 1,000 MΩ in 7 ranges. Modern styling, with gimbal mount. Kit £18.18.0. Assembled £26.18.0.

TV ALIGNMENT GENERATOR, Model HFV-1. 3.6 to 220 Mc/s on fundamentals. Unique electronic sweep oscillator. Built-in fixed and variable marker generators (5 Mc/s crystal). Kit £37.18.0. Assembled £47.10.0.

INTERNATIONAL MAIL ORDER SCHEME covering the American Heathkit range of 250 models. Illustrated American catalogue and full details can be obtained from us for 1/- post paid.

DECADE RESISTANCE, Model DR-1U. Range 1-99,999Ω in 1Ω steps. Kit £10.8.0. Assembled £14.8.0.

DECADE CAPACITOR, Model DC-1U range, 100µF to 0.111 µF in 100 µµF steps. Kit £7.5.0. Assembled £10.8.0.

MANY OTHER MODELS For the home, Hi-Fi enthusiast, Home workshop, Service and Test bench, Laboratory.

FULL RANGE OF MODELS IN FREE CATALOGUE SIMPLY SEND COUPON TO:—

To DAYSTROM LTD., DEPT. PM-11, GLOUCESTER, ENGLAND
Please send me FREE BRITISH CATALOGUE (Yes/No).....

Full details of model(s).....

American NAME (BLOCK CAPITALS).....

Catalogue..... ADDRESS.....

(Yes/No)..... PM-11

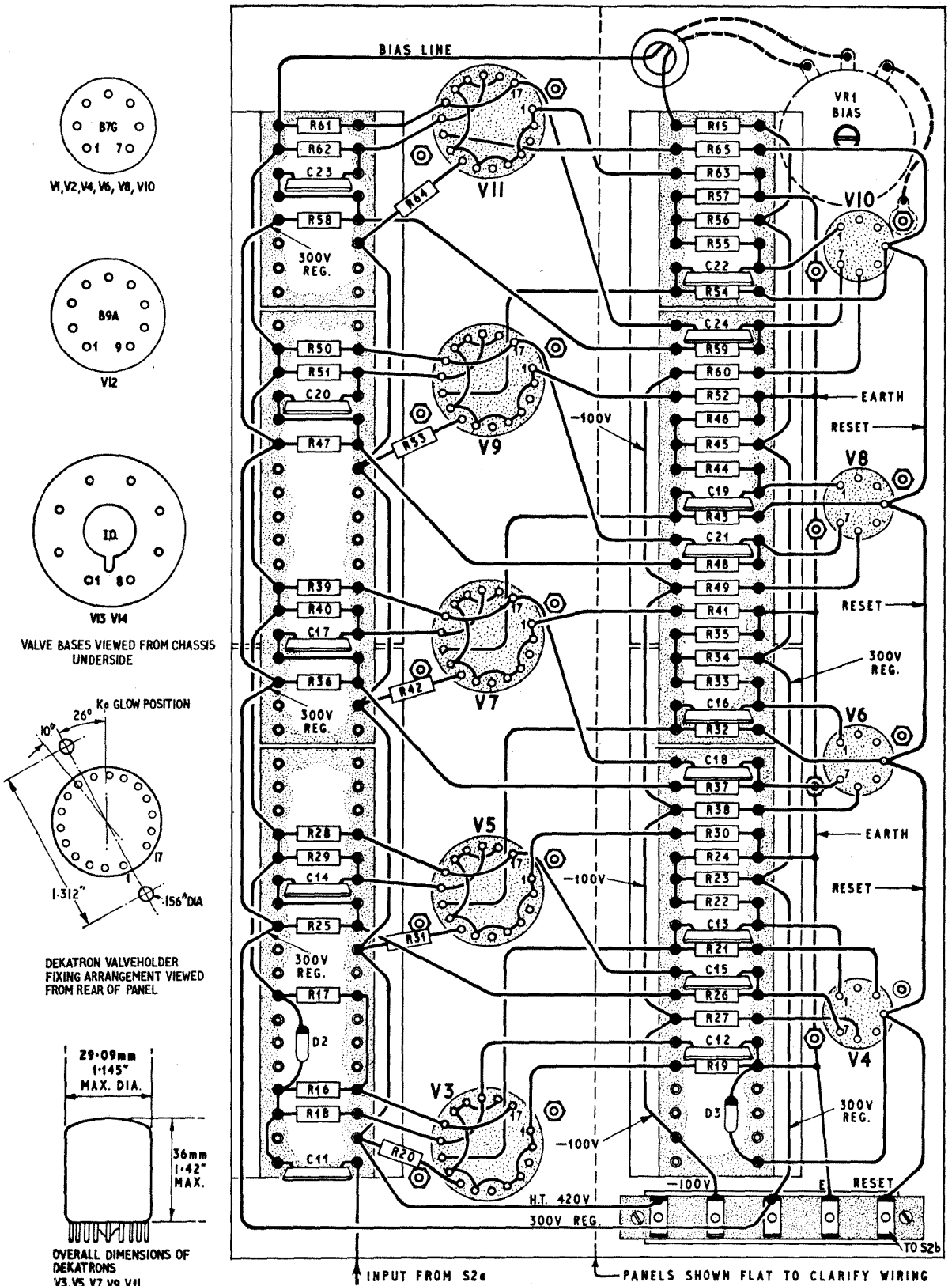

Fig. 17. Display unit chassis (opened flat) showing layout of tag boards, components, and wiring. The dotted line through centre of diagram indicates the junction of the two panels which form the L-shaped assembly

LASKY'S RADIO

For the Finest Value and Service to the HOME CONSTRUCTOR AND THE ELECTRONICS ENTHUSIAST

We consider our construction parcels to be the finest value on the home constructor market. If on receipt you feel not competent to build the set, you may return it as received within 7 days, when the sum paid will be refunded less postage.

TRANSISTOR PORTABLES

THE SKYROVER RANGE

7 transistor and 2 diode superhet portables—covering full med. plus 6 SWB Bands.

The SKYROVER Mk III.

(Illustrated). Now supplied with redesigned plastic cabinet in black, grey and chrome with edgewise controls.

Controls: Waveband Selector, Volume Control with on/off Switch, Tuning Control. In plastic cabinet, size 10 1/2 x 6 1/2 x 3 1/2 in. with metal trim and carrying handle.

Can now be built for **£8.19.6** Post 5/- extra. H.P. Terms: 27/- deposit and 11 monthly payments of 15/9. Total H.P.P. £10.0s.3d.

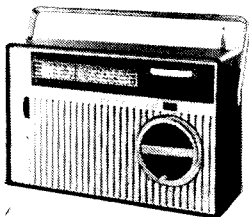

The SKYROVER De Luxe

Tone Circuit is incorporated, with separate Tone Control in addition to Volume Control. Tuning Control and Waveband Selector. In a wood cabinet, size 11 1/2 x 6 1/2 x 3 in. covered with a washable material, with plastic trim and carrying handle. Also car aerial socket fitted.

Can now be built for **£10.19.6** Post 5/- extra. H.P. Terms: 33/- deposit and 11 monthly payments of 19/7. Total H.P.P. £12.3s.10d.

Data for each receiver: 2/6 extra. Refunded if you purchase the parcel. Four U2 batteries 3/4 extra. All components available separately.

★ LONG WAVEBAND COVERAGE IS NOW AVAILABLE FOR THE SKYROVER

A simple additional circuit provides coverage of the 1100/1950M. band (including 1500 M. Light programme). This is in addition to all existing Medium and Short wavebands. All necessary components with construction data.

Only **10/-** extra Post Free. This conversion is suitable for both receivers that have already been constructed.

REALISTIC SEVEN

Fully tunable long and medium bands. Uses 7 Mullard Transistors; plus Diode OA70.

STAR features:

- 7 Transistor Superhet. ● 350 Milliwatt output 4in. high flux speaker. ● All components mounted on a single printed circuit board, size 5 1/2 in. x 3 1/2 in. in one complete assembly. ● Plastic cabinet, with carrying handle, size 7in. x 10in. x 3 1/2 in. in blue/grey. ● Easy to read dial. ● External socket for car aerial. ● I.F. frequency 470 Kc/s. ● Ferrite rod internal aerial. ● Operates from PP9 or similar battery ● Full comprehensive data supplied with each Receiver. ● All coils and P.C.s, etc. fully wound ready for immediate assembly. An outstanding Receiver.

REALISTIC SEVEN De Luxe

With the same electrical specification as standard model—PLUS A SUPERIOR WOOD CABINET IN CONTEMPORARY STYLING covered in attractive washable material, with super-chrome trim and carrying handle. Also a full vision circular dial, externally mounted to further enhance the pleasant styling. **ONLY £1 EXTRA** Both models: Battery 3/9 extra. (All components available separately.) Data and instructions separately 2/6, refunded if you purchase parcel.

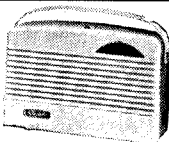

Can be built for

£5.19.6

P. & P. 4/6

SINCLAIR SUPER MINIATURES

THE MICRO-6

pocket radio. Size only 1 1/4 x 1 3/8 x 1/2 in. Complete with earphone.

Can be built for only **59/6** Mercury cell 1/11 extra. All parts sold separately.

THE SLIMLINE

2-transistor pocket radio. Size only 2 1/4 x 1 1/2 x 1/2 in. Micro alloy transistors on printed circuit. Can be built for **49/6**

THE NEW X-20 AMPLIFIER

20 watts P.W.M. amplifier and pre-amplifier built on single printed circuit size 8 1/2 x 3 1/2 in.—weight only 4 1/2 ozs. built! Input sens. 1mV for 20 watts out. Output Imp. 7.5 and 15 ohms.

KIT PRICE **£7.19.6** Post Free

AVAILABLE READY BUILT AND TESTED **£9.19.6**.

3 pots. for vol. bass and treble. 7/6 the 3 extra, mains power pack, if required **£4.19.6**.

THE X-10 AMPLIFIER

10 watt power amplifier fitted with integrated pre-amplifier. Requires only 1mV for an output of 10 watts. Only 8 x 3 x 3/4 in.

KIT PRICE **£5.19.6** Post Free

AVAILABLE READY BUILT, TESTED AND GUARANTEED, **£6.19.6**. Post Free. 3 pots for Volume, Bass and Treble, 7/6 the 3 extra. Mains power pack, if required **£4/-**.

TRANSISTORS

ALL BRAND NEW AND GUARANTEED

GET S1, GET S5, GET S6 2/8; 873A, S74P 3/6; OC45, OC71, OC1SD 4/6; OC 44, OC 70, OC 75, OC 81 5/6; (match pair) 10/6; AP 117, OC 75, OC 200 8/6; OC 42, OC 43, OC 73, OC 82D 7/6; OC 201, OC 204 15/-; OC 205, OC 206 19/6; OC 25 24/6.

TRANSISTORS By BRUSH CRYSTAL CO. Available from stock.

TO—01H 465 kc/s. ± 2 kc/s.	TO—02D 470 kc/s. ± 1 kc/s.	7/6 EACH
TO—01D 470 kc/s. ± 2 kc/s.	TF—01B 465 kc/s. ± 2 kc/s.	
TO—02B 465 kc/s. ± 1 kc/s.	TF—01D 470 kc/s. ± 2 kc/s.	Post 6d.

CONSTRUCTORS BARGAINS

The "Sixteen" Multirange METER KIT

This outstanding meter was featured by *Practical Wireless*, in the Jan. '64 issue. Lasky's are able to offer the complete kit of parts as specified by the designer.

RANGE SPECIFICATION: D.C. volts: 0-25-50-250-500 at 20,000 Ω/V. A.C. volts: 0-25-50-250-500 at 1,000 Ω/V. D.C. current: 0-50 μA, 0-2-5-50-250 mA. Resistance: 0-2,000 Ω, 0-200k Ω, 0-20 M Ω. Basic movement: 40 μA f.s.d. moving coil. With universal shunt full scale deflection current is 500 μA. Black plastic case 3 1/2 x 1 1/2 in. Controls: 12 position range switch; separate slide switch for A.C. volts—D.C. ohms; ohms zero adjustment pot. meter, meter zero. Power requirements: One 15v. and one 1.5v. batts. Complete with all parts and full construction details. H.P. Terms available.



Data and circuit available separately, 2/6; refunded if all parts bought. Pair of batteries 2/- extra.

LASKY'S PRICE **£5.19.6**.

P. & P. 5/-

FROM PRE-AMP TO 20 WATT HI-FI STEREO ASSEMBLY WITH MARTIN AUDIOKITS

Using specially developed circuits, the very latest transistors and printed circuits—these kits are all fully checked and tested before leaving the factory. Although the kits are basically designed for use together the pre-amplifier and mixer stages may be used to great advantage with existing valve or transistor equipment.

KIT 1. 5-stage Matching Input Selector Unit. LASKY'S PRICE 47/6.

KIT 2. Pre-amplifier with volume control. LASKY'S PRICE 37/6.

KIT 3. 3-Channel Mixer with plug-in adaptors for individually matching each circuit. Adaptors 8/6 each. LASKY'S PRICE 79/6.

KIT 4. Pre-amplifier with tone/volume control stages. LASKY'S PRICE 62/6.

KIT 5. 10 and 3 watt Main Amplifier. LASKY'S PRICE £5.12.6.

KIT 6. Power supply converter unit. LASKY'S PRICE 52/6.

KIT 7. 15 ohm version of Kit 5. LASKY'S PRICE £6.12.6.

KIT 8. Power supply for Kit 7. LASKY'S PRICE £2.15/-.

SPECIAL INTEREST ITEMS!

TEST METER ADAPTOR

Type P.E. 220—this is a fully transistorised device which enables any 50 microamp D.C. Multimeter to be used in place of a valve volt meter. On the 1V. range an impedance of 1 megohm is offered which increases on the 1000 V. range to 100 megohms. 7 ranges: 1 to 1000 volts. Designed for immediate connection to Avo 8 and similar size meters but quite suitable for use with any other 50 microamp meter. Size 6 x 6 x 5 in. New and boxed. List Price 7/6.

LASKY'S PRICE **39/6**

Post 2/6. Set of batteries 7/5 extra.

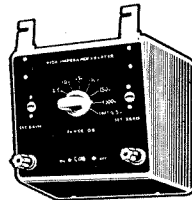

DOMESTIC PROCESS TIMERS BY SMITHS

Finest quality Smiths Clocks originally intended for use in the most expensive electric cookers. 3 types available—brand new and unused—at well below production cost.

TYPE 1. Clockwork Interval Timer. Gives loud and prolonged ringing to indicate the end of any set time from 1/2 minute to 1 hour. 3in. dia. dial. 2in. deep. LASKY'S PRICE **9/11** Post 2/-.

TYPE 2. An electric clock with combined sequence switching to give automatic switching of an electric appliance to switch on at any pre-set time up to 12 hours ahead and to switch off at any pre-set time up to 9 1/2 hours later. Switch contacts are rated at 25 amps, 200/250 V. 50 c.p.s. and are therefore suitable for cookers and heating appliances as well as tape recorders, radios, lights, etc. Easy to set. 3in. dial. Fully enclosed mechanism—overall size 5 x 3 1/2 x 2 1/2 in. LASKY'S PRICE **25/-** Post 2/6.

TYPE 3. De Luxe version of Type 2 with fully calibrated, easy to read, dial (as illustrated). Note this model does not have a back cover. LASKY'S PRICE **35/-** Post 2/6.

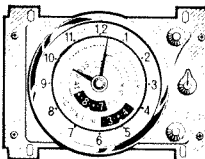

VEROBOARD — NOW IN STOCK

Vero-board is a high grade laminated board with copper strips bonded to it and pierced with a regular matrix of holes. Ideal for producing simple items.

As featured in "Practical Electronics" April '65 issue.

Boards:	Accessories:
42/1503 2 1/2 x 5 in. 3/8	Terminal pins — pkt. of 50 3/-
48/1504 2 1/2 x 3 1/2 in. 3/-	Spot face cutter tool 8/6
45/1507 3 1/2 x 5 in. 5/2	Pin inserting tool 9/9
46/1508 3 1/2 x 3 1/2 in. 3/8	Post 6d. per item extra.
44/1505 3 1/2 x 17 in. 12/6	Orders of 10/- and over post free.

207 EDGWARE ROAD, LONDON W.2 Tel: PAD 3271/2
33 TOTTENHAM CT. RD., LONDON, W.1 Tel: MUS 2605
Both open all day Saturday. Early closing Thursday.

42 TOTTENHAM CT. RD., LONDON, W.1 Tel: LAN 2573
152/3 FLEET STREET, LONDON, E.C.4 Tel: FLE 2833
Both open all day Thursday. Early closing Saturday.

Please address all Mail Orders to Dept. P.E., 207 Edgware Road, London, W.2.

LASKY'S FOR SPEEDY MAIL ORDER SERVICE

NOW ANYONE CAN AFFORD TO TRAIN TO BE AN EXPERT IN RADIO and ELECTRONICS

It's the most exciting news of the year! Just imagine. You can get 35 large, fact-packed lessons for little more than 1/- per lesson! The lessons are crystal clear, practical, easy to master and use. Early lessons make fundamentals clear even to the beginner, while other lessons will give you the practical "know-how" of an expert.

Compares favourably with some courses costing ten times as much. You save because you receive all the lessons at one time and are not required to purchase equipment you do not need.

This is a real home-study course that has been bound into one giant 8 x 11in. 216 page manual. Each page is divided into two columns. A wide column features the text, while a narrow column at the side has the instructor's comments, helpful suggestions and additional pictures to simplify the difficult parts.

Everyone can benefit from this practical course. No old fashioned (or pseudo modern) methods used here, just straight forward, easy to understand explanations to help you make more money in electronics.

The price! Only 39/6 plus postage 1/6.

Terms! Why of course! See Coupon.

OTHER COURSES AVAILABLE

RADIO COURSE (22 lessons, price 36/-)

TELEVISION COURSE (price 36/-)

**UNCONDITIONALLY GUARANTEED TO
GIVE COMPLETE SATISFACTION**

You must be convinced that this is the best value you have ever seen in Electronics, Radio or T.V. Training, otherwise you can return the course (or have your money refunded if sent with order) after you have examined it in your own home for a full seven days.

IF YOU SEND CASH WITH ORDER WE WILL INCLUDE A FREE BOOK VALUED 5/-. Tick on the coupon one book for each course ordered with full cash. These free books are authoritative, and loaded with information. Would cost at least 5/- each if bought separately—by sending cash you reduce book-keeping and other costs which savings we pass back to you.

--- FREE TRIAL OFFER ---

Pay only 5/- per week if you wish. Clip coupon right now for this special offer.

To: Sim-Tech Technical Books, Dept. ETV12, Gater's Mill, West End, Southampton, Hants.

Please send the following courses for a full seven days' trial.

- No. 1. RADIO COURSE, 37/6, incl. postage.
- No. 2. RADIO & ELECTRONICS COURSE, 41/-, incl. postage.
- No. 3. TELEVISION COURSE, 37/6, incl. postage.

(Free trial customers tick one only please).

If not delighted, I may return the course post-paid without further obligation on my part. Otherwise I will pay cash price or 5/- weekly until paid.

- Tick here if enclosing full purchase price. Please send me
- FREE TRANSISTOR CIRCUITS BOOK.
- FREE OSCILLOSCOPE BOOK.

Amount enclosed £.....

I understand that you will refund this money in full if I am not 100% satisfied. Overseas customers please send full amount (including Ireland).

NAME.....

ADDRESS.....

City..... County.....

950

VARIABLE VOLTAGE TRANSFORMERS

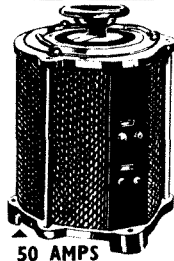

50 AMPS



1/2 AMP

INPUT 230/240v. A.C. 50/60—
OUTPUT VARIABLE 0-260v.
BRAND NEW Carriage Paid.
Buy direct from the importer,
keenest prices in the country.
All Types (and Spares) from
1/2 to 50 amp. from stock.

OPEN TYPE (Panel Mounting)
1/2 amp. £3. 3. 0. 1 amp. £4. 17. 6.
2 1/2 amps. £5. 12. 6.

SHROUDED TYPE
1 amp. £4. 10. 0. 2.5 amps.
£5. 17. 0. 4 amps. £8. 7. 6.
5 amps. £9. 0. 0. 8 amps.
£13. 10. 0. 10 amps. £17. 0. 0.
12 amps. £19. 10. 0. 15 amps.
£22. 0. 0. 20 amps. £32. 10. 0.
37.5 amps. £65. 0. 0. 50 amps.
£85. 0. 0.

PORTABLE TYPE
2.5 amps. Portable £9. 17. 6.

ULTRA VIOLET BULBS

Easy to use source of U.V. for dozens of practical and experimental uses.

12 volt 36 watt A.C./D.C. SBC 6/6. P. & P. 1/-.
12 volt 60 watt A.C./D.C. SBC 8/6. P. & P. 1/-.

Transformer to suit the above. Input 200-240 v. A.C., 12 volt 36 watts, 16/6; P. & P. 2/6. Input 200-240 v. A.C. 12 volt 60 watt, 22/6. P. & P. 3/6.

Set of 4 Colours FLUORESCENT PAINT. Red, yellow, green and cerise. In 5 oz. tins: Ideal for use with the above Ultra Violet Bulbs. 9/6, plus 1/6 P. & P.

NICKEL CADMIUM BATTERY. Sintered Cadmium Type, 1.2 v. 7AH. Size: height 3 1/2", width 2 1/2" x 1 1/2". Weight: Approx. 13 ozs. Ex-R.A.F., Tested. 12/6. P. & P. 2/6.

100 WATT POWER RHEOSTATS (NEW)

AVAILABLE IN THE
FOLLOWING 9 VALUES

10 ohm, 3 a.; 25 ohm, 2 a.; 50 ohm, 1.4 a.; 100 ohm, 1 a.; 250 ohm, .7 a.; 500 ohm, .45 a.; 1,000 ohm, 280 mA; 1,500 ohm, 230 mA; 2,500 ohm, .2 a. Diameter 3 1/2in. Shaft length 3 1/2in. dia. 1/2in. All at 27/6 each. P. & P. 1/6.

INSULATION TESTERS (NEW)

Test to I.E.E. Spec. Rugged metal construction, 500 volt, 500 megohms. Price £22. 1,000 volts, 1,000 megohms, £28.

TYPE 34R

SILICON
SOLAR
CELL

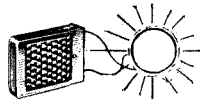

Four .5 volt units series connected in high impact polystyrene case, flying lead connections. Specially designed diffusing lens system to ensure maximum light pickup. Output up to 2v. at 10 to 16 mA in bright sunlight. Wider spectral response, and thirty times the efficiency of selenium cells. As used to power earth satellites! 37/6, and 1/- P. & P.

1st grade NEW TRANSISTORS

OC28 17/-	OC76 6/-	Get 105 10/-
OC29* 18/-	OC81* 8/-	Get 573 12/6
OC41 7/-	OC83* 6/-	2N706A 17/6
OC44 6/6	OC139 12/-	25019 30/-
OC45 5/-	OC140 19/-	AC107 14/6
OC71 5/-	OC171 9/-	AF114 11/-
OC72* 7/-	OC200 10/6	AF115 10/-
OC73 6/-	OC203 14/6	AF116 10/6
OC75 7/-	Get 104 6/-	AF117 9/6
		BCZ11 10/-

*Available in Matched Pairs.

LATEST HIGH SPEED MAGNETIC COUNTERS. 4 figure, 10 impulses per second. Type 100D, 4.1 ohm coil, 3-6 v. D.C. operation. Type 100A, 500 ohm coil, 18-24 v. D.C. operation. Type 100B, 2,300 ohm coil, 36-48 v. D.C. operation. Any type 15/- each, plus 1/6 P. & P.

230 v. A.C. RELAY. Type 1, 2 c/o, 2 amp. contacts, 9/6. Type 2, 2 x 15 amp. break, 2 x 2 amp. make, 1 x 2 amp. break, 11/6. Both types ex new equip. P. & P. 1/6 each.
12-18V. D.C. RELAY. 168 ohm coil, 3.5amp N.I. c/o contacts. New 16/6 + 1/- P. & P.

0-4 MINUTE MECHANICAL TIME SWITCH
16 Amp D.P. Switch complete with knob. Will switch off any setting between 0-4 minutes. As New fraction of makers' price. 10/- plus 2/6 p. & p.

VENNER 14 DAY CLOCKWORK TIME SWITCHES
5 amp. 230 v. contacts. 24 hr. phase, 1/2 hr. divisions allows setting for 1 make, 1 break every 24 hrs. Complete with key and mounting block. Used but guaranteed. 35/6. P. & P. 2/6.

VAN DE GRAAFF ELECTROSTATIC GENERATOR



Fitted with motor drive for 230 v. A.C. giving a potential of approx. 50,000 volts. Supplied absolutely complete, including accessories for carrying out a number of interesting experiments, and full instructions. This instrument is completely safe, and ideally suited for School demonstrations. Price £6/6, plus 4/- P. & P. Leaflet on request.

BUILD AN EFFICIENT STROBE UNIT FOR ONLY 37/6. We supply a simple circuit diagram and all electrical parts including the NSP2 Strobe tube which will enable you to easily and quickly construct a unit for infinite variety of speeds, from 1 flash in several seconds to several thousands per minute. 37/6 plus 3/- P. & P.
NSP2 TUBE brand new. I.O. base. Price 15/-. P. & P. 1/6.

UNIVERSAL DEMONSTRATION TRANSFORMER

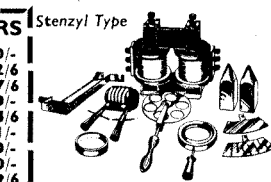

A complete composite apparatus, comprising a robustly built Transformer and electro-magnet with removable coils and pole pieces. Coil tapped for 230 v, 220 v, 110 v, 115 v; 6, 12, 36, 110 v. A.C. These coils are also used in D.C. experiments. The following accessories are included: welding coil, welding clamps and electrodes, 2 heavily plated pole pieces with conical and square ends, pendulum stand, damping and non-damping pendulum, Barlow's wheel with handle, mercury trough, fusing metal, inductive jumping ring, supplied complete with Demonstration Book giving details of a multitude of basic demonstrations complete with the theory involved. Price: £17 + 10/- Carriage (per B.R.S.)

LIGHT SENSITIVE SWITCH. Kit of parts, including ORP12 Cadmium Sulphide Photocell, Relay, Transistor and Circuit, etc., price 25/- plus 2/6 P. & P. ORP 12 including circuit, 10/6 each, plus 1/- P. & P.

A.C. MAINS MODEL
Incorporates Mains Transformer, Rectifier and special relay with 3.5 amp mains c/o contacts. Price inc. circuit 47/6 plus 2/6 p. & p.

SERVICE TRADING CO

All Mail Orders—Also callers:
47/49 HIGH STREET, KINGSTON ON THAMES
Telephone: KINGston 9450

Personal callers only
9 LITTLE NEWPORT STREET
LONDON, W.C.2 Tel: GERard 0576

FRONT PANEL

Drilling details for the front panel are given in Fig. 15. The controls and other components are indicated in their respective positions. Labels to indicate the functions of the various controls may be made with Dymotape or one of the other proprietary materials which are readily obtainable. Resistors R79 to R88 conclusive are mounted directly on the switch S5 in the manner shown in Fig. 13.

The switch S2 is the only item requiring further comment. It is neat and convenient to use one switch for count, hold and reset. The constructor could of course use two switches, one a biased type for the reset. There is one type of "surplus" switch which is very suitable, the others have too stiff an action. The specified switch is in current production and when adjusted works well.

The switch has no central stop and in going from "count" to "hold" the dolly may go too far and momentarily close the lower contacts. The lowest leaf which carries the reset voltage must therefore be bent well down so that it only just makes contact when the switch is raised to "reset". The stiffness of the movement can be adjusted with advantage by altering the curve of the springs against which the dolly acts. This is easily done with a small pair of taper nosed pliers.

Reference to the circuit diagram of the display unit (Fig. 3) will make clear the wiring of S2. The rotor of S2b is connected to the -120V supply, see Fig. 6 and Fig. 9.

The lead for the variable e.h.t. for the Geiger Muller tube is taken down from the live terminal of C37 through a grommet in the main chassis. It passes along the underside of the chassis and up through the grommet under the input tag board where it is terminated on the terminal bearing R1 and C1.

The front panel is now bolted to the front edge of the chassis and the wiring up of the components completed. Reference to the appropriate circuit diagrams will clarify any wiring not given in detail in the assembly diagrams.

The display unit leads are then reconnected to the power supply tag strip and two leads (for input and reset) connected from S2 to the display unit. The display unit is thus on flying leads and may be tested

using the 100c/s timing pulse by depressing switches S1 and S2. When satisfactory working is obtained, the apparatus is switched off and the display unit placed in position behind the front panel where it is fixed by four self-tapping screws.

Finally, the e.h.t. supply is connected by resoldering the main supply lead to the miniature mains transformer T3. Operation of the coarse and fine voltage controls should indicate on the meter a supply smoothly variable up to nearly 1,000V.

GEIGER MULLER TUBE OPERATION

Every Geiger Muller tube has its correct working voltage which must be found by experiment. At *too low* a voltage the tube will fail to ionise sufficiently when radiation enters it and so it will produce no pulses; at *too high* a voltage the tube may conduct almost continuously and will be damaged.

The e.h.t. controls should therefore be turned to minimum before the tube is connected to SK1. The scaler should be set to "count" and the loudspeaker may be on if desired. A source of radiation—a luminous watch will serve—is placed near the Geiger Muller tube. The e.h.t. voltage is then gradually increased until counting starts. A further small increase in voltage will increase the count rate but a condition is quickly reached where the count rate is virtually independent of voltage change. Now every radiation entering the tube is producing a pulse. This is the "Geiger threshold" and the voltage should be noted.

If a graph is made of count rate against voltage it can be seen that a *plateau* has been reached where an increase of approximately 200 volts makes little difference to the count rate. But beyond this comes a point after which the count increases rapidly. *This is the end of the plateau and brings danger to the tube.*

The correct working voltage is taken as 100V higher than the Geiger threshold voltage or halfway along the plateau, whichever is lower.

The third and concluding part of this article will be devoted to practical uses of the scaler. A few simple experiments will be described; these will demonstrate the capabilities of the scaler especially as a teaching aid in the physics laboratory.

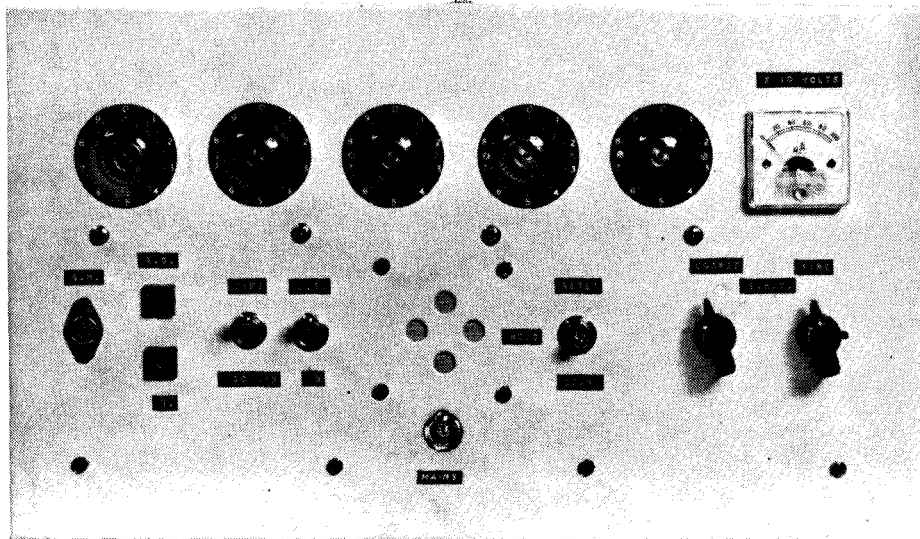

DETACHED PARTICLES

By John Valence

SILENT DETERRENT

You can't get away from it, can you? Picking up a copy of *Amateur Gardening* from a colleague's desk the other day, I thought I would find a temporary diversion among the dahlias and chrysanthemums. But the first thing to meet my eye was an account of supersonic vermin scares. It seems that one large seed firm have rid their storehouse of birds, mice and rats by criss-crossing the building with ultrasonic beams. To provide the maximum irritation to these pests, the ultrasonic signals are continuously varied in frequency and duration. According to this report, the birds in residence quickly took off; the rats soon followed, but the mice stuck it out for a few weeks. The reason they took so long getting the message was because they had buried themselves inside sacks and obviously were receiving a somewhat attenuated signal.

I don't know if it was the painful aural experience that drove these creatures away, or whether perhaps it was the heat induced within their small bodies by cell excitation. Heat effects produced by ultrasonics are used in physiotherapy for the treatment of patients. But it is known that over-excitement of the body cells results in extreme discomfort. Contra-wise, if a beam of ultrasonic waves is directed onto a particular nerve, it can produce an analgesic effect. The effective use of ultrasonics obviously demands a highly specialised knowledge of the subject. Get the frequency wrong and the beam in the wrong place, and I suppose you would have deliriously happy mice and rats lolling about the place.

PGM TO THE RESCUE

LONG suffering commuters take heart. If you are reckoning on being around in the year 2000, your daily torment on road or rail may by then be over. The solution to the ever increasing problem of getting people to work in the morning and returning them to their suburban semi's is in fact delightfully simple. They simply won't have to go. Instead of bodies, the brains and skills of these individuals will be transported to their place of employ-

ment. And it will all be done by telecommunications, involving data links and private television channels.

This is no wild dream of a science fiction writer. It is the opinion of an eminent British scientist, Alec Harley Reeves. This month the Franklin Institute of America will be honouring Mr. Reeves by presenting him with the coveted Stuart Ballantine Medal. This medal, named after a noted U.S. scientist, is awarded for "outstanding achievements in the fields of communication". Mr. Reeves receives this award for his invention of Pulse Code Modulation (PCM) way back in 1937.

Like so many inventions, PCM was before its time. For its practical application, it required a more advanced technology than then existed. The coming of semi-conductors plus the today's enormous demand for telecommunication links has focused attention once again on this invention.

Pulse code modulation is a digital system. Speech signals are scanned electronically and all significant information is transmitted in a series of pulses. One of the great advantages of PCM is that a large number of separate channels can be sent over one pair of lines. It can also be used for picture transmission, as was dramatically demonstrated a little while ago with the pictures from Mars.

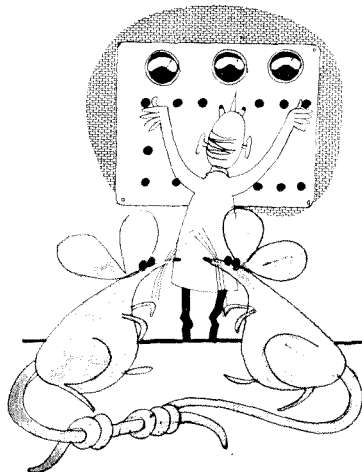

"I haven't the heart to tell him that we can't hear it either"

ON THE BEAM

Now back to Mr. Reeves's vision of the future. He feels that PCM's tremendous potential capacity for sending and receiving speech or visual data over cables or better still, over laser beams, can be most usefully harnessed to alleviate some of the problems that already beset us, and which will multiply in a terrifying way as time goes by.

Apart from keeping us off the streets, Mr. Reeves stresses the importance of central information processing centres as an answer to another problem of modern life—how to read and digest all the literature published in one's own particular field of interest. In this connection he makes the interesting observation that moving pictures will be the only way to pass the information fast enough to the caller's brain.

P.S. Full of the pioneering spirit, I have already volunteered to do my daily stint from my own home with the aid of Ye Olde G.P.O. analogue-type telephone as office link. The suggestion was politely but firmly turned down. Just another example of being ahead of one's time, of course.

THAT OTHER CHANNEL

RELATED birthday greetings to the Independent Television Authority.

I recall looking in on that first transmission from Croydon 10 years ago. With a hastily rigged up dipole suspended from the house eaves, coupled up to a converter unit perched on the top of the Band I set, the opening transmission on Band III was received surprisingly well.

In the moments before the Redifusion emblem appeared on the screen, one experienced the excitement of a first night, knowing that we were about to witness something quite new (and perhaps alien) to our way of life. How would this newcomer fit into our home, where hitherto only BBC programmes had entered? And there was much speculation about the commercials of course.

Today there is no doubt about the success of commercial TV; that is if success is measured by numbers of viewers captured and held.

LIST OF BARGAINS

Transistor ferrite rod aerial with medium and long wave coils with circuit, 7/6.

Oscillator Coil and set of 3 I.F. transistors for transistor set with circuit, 12/6. **Tuning Condenser** to suit, air-spaced, with trimmers, 9/-.

Diode but min. 10 mm. 12/6 the set, two-gang condensers to suit 8/6 (reused sub. min. circuit).

Midget 3in. P.M. Loudspeaker, 3 ohm, 12/6, 80 ohm, 13/6.

Midget 200 pF + 176 pF two-gang Tuning Condenser with trimmers for transistor set. Price 9/-.

Push-Pull Transformer, Sub-miniature, 8.6 .0005 mfd. Single Tuning Condenser. Solid dielectric 4in. spindle for transistor of Crystal set, with spindle tapped 6 BA, 2/6.

46 Sets (Receiver/Transmitter pack set). Unused sets complete except for crystals, 19/6. Post 3/-.

Battery Charger Kit, Comprises 5 amp. transformer, 5 amp. rectifier, metal case and meter to charge 6 or 12 volt batteries up to 5 amps. With variable charge rate, 39/6 each. 6/6 post and insurance.

Waterproof Heater Wire

16 yds. length, 70 watts, self regulating temperature control for repairing electric blankets, etc. 10/- post free.

Mains Transformer, 250-0-250 at 80 mA, 6.3 volts 5 a. (normal mains input), 12/6 each. Carr. 2/5.

Output Transformer, Standard pentode matching type, 9/6 each, 36/- per doz.

Slide Switch, Sub-miniature but dpdt., 2/-; 18/- doz.

T.C.C. or Duobler Tubular Condensers:

.5 mfd. 500 v.	10/8 doz.
.25 mfd. 500 v.	7/6 doz.
.25 mfd. 350 v.	6/- doz.
.01 mfd. 500 v.	5/- doz.
.0001 mfd. 1000 v.	5/- doz.
.001 1000 v.	6/- doz.
.002 1000 v.	7/6 doz.
.005 1000 v.	9/- doz.
.01 750 v.	8/6 doz.
.01 500 v.	19/- doz.

Battery Charger Rectifier, Selenium 12-15 v. 5 amp. 9/6.

Metall Chassis, Punched for Mullard 510 Amplifier complete with inner screening sections and stove enamelled. 8/6, P. & P. 2/9.

Unbreakable Mains Lead, Type of lead fitted to electric razors makes fine lead for test meters and any other devices where subject to continuous bending. Twin figure eight construction, soft cream P.V.C. covered. Normally costs 2/- per yard. Three 6ft. leads for 2/-.

Filament Transformers, 6.3 v., 1 amp, 4/6.

Neon Lamp—midget wire ended, ideal mains tester, etc. 1/9. Ex-Govt. 1/3.

Philips Trimmers, 0-30 pF 1/- each; 9/- doz.

Low Resistance Headphones, Ideal crystal sets, etc. 7/6, plus 2/6.

Cold Cathode Valve CV 413, Voltage regulator or trigger switch—unused but re-equipment 2/- each.

Tag Panels, Ideal for construction, experimental circuits, etc. 3 of each of 12 different types, 5/- Post 1/6.

Slidecock Panel Mounting Fuses, with carrier, 5 amps. 2/- each; 15 amp. 2/6 each.

Potentiometers, Sealed type by Morganite among the best ever made, standard 1 spindle, 1in. long, 6/- doz., 2 meg 3 meg, 100 K, 50 K.

MU Metal Screen for American 5 CP1, etc. 10/6 pair; for VCR97 and other 6in. tubes, 7/- complete. Ditto for 2-3in. tube, 5/- complete.

Electric Lock, 24 v. coil but rewindable to alter voltages 4/6, 48/- doz.

1 mfd. 350 v. Small tubular metal-cased condenser made by Duobler, 2/8 doz.

24 Volt Motor with blower attached, 12/6, plus 2/9.

115 Volt American magstrips (selyvins) 50/- each transmitter or receiver. Post 2/9. Pair Post Free.

Morse Practice Outfit—Comprises valve oscillator with controls in wooden box, battery operated, 12/6, Plus 2/9.

Mains from Car Battery rotary generators 12v. input 240v., output 110 mA, 40/-; 600 mA, 25/- Plus 5/- post.

H.R.O. Power Pack, Suitable for 240 or 115 volt mains give 250v. H.T. and 6.3v. l.t., new and unused, but less rectifier valve, 19/6, plus 6/6 post.

A.C./D.C. Ammeter 21in. flush mounting 0-9 amps but external shunt easily removed offered at silly price, 8/6, 25 doz.

DLR5 Headphones, 9/6 pair, Post 2/-.

Sound Powered Inserts, Make excellent microphones or speaker, 5/6 each. 23 doz.

Where postage is not definitely stated add 2/- to all orders under £3. Also add 2/6 if you would like our new 100 page list of bargains.

See in the Dark—INFRA-RED BINOCULARS

These if fed from a high voltage source will enable objects to be seen in the dark, providing the objects are in the rays of an infra-red beam. Each eye tube contains a complete optical lens system as well as the infra-red cell. These optical systems can be used as lens for T.V. cameras—light cell, etc. (details supplied). The binoculars form part of the Army night driving (Tabby) equipment. They are unused and believed to be in good working order, but sold without a guarantee. Price £21/7/6 plus 10/- carriage and insurance. Handbook 2/6.



OUR BARGAIN OF THE YEAR

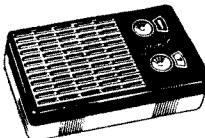

A complete kit of parts to build this 6-transistor 2 wave superhet receiver at only 39/6, plus 3/6 post and ins.

"CORONET" Mk. IV

It fully covers the medium-wave band and that part of the long-wave band to bring in B.B.C. Light. The circuit includes a highly efficient slab aerial, 21in. P.M. speaker. Overall size approximately 4 1/2 x 2 1/2 x 1 1/2in. Supplied complete with carrying case and instructions.

THIS MONTH'S SNIP

GARRARD AUTO-RECORD PLAYER MODEL A.T.5



This is undoubtedly the finest Auto changer made, in fact its large heavy, non-magnetic, die cast turntable and bias compensated constant pressure stylus together with its laboratory series motor with balanced rotor make it almost a transcription unit. Other special A.T.5 features are:—Will take 8 records which may be mixed sizes—stylus pressure adjustable—may be stopped whilst playing a record without rejecting same record—fitted with latest pick-up for playing stereo or mono records.

OFFERED AT THE AMAZING PRICE OF £6/15/0 plus 6/6 carriage and insurance.

TAPE RECORDER BARGAIN

THE "MINY" TAPE RECORDER

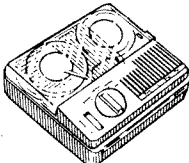

of the many tape recorders to offer at £12 or less we have at last found one we can recommend. Equally suitable for music or speech this instrument uses two motors, is completely portable and is beautifully styled and looks like a good tape recorder.

Among its many good features is a switch on the microphone to stop and start the tapes. A very useful feature for you when recording, and for your typist for note-taking, stock-taking, etc. Other points are twin track recording—40 mins with normal tapes, standard batteries.

Although originally sold at £16/10/0, we are able this month to offer for only £7/19/6, plus 5/- Post and Insurance. Brand New and complete with microphone, batteries, tape and spools, nothing else to buy.

Don't miss this AMAZING Offer.

INFRA-RED HEATERS

Make up one of these latest type heaters. Ideal for bathroom, etc. They are simple to make from our easy-to-follow instructions—uses silica enclosed elements designed for the correct infra-red wavelength (3 microns). Price for 750 watts also ext. metal casing as illustrated, 19/6 plus 2/6 post and insurance. Pull switch 3/- extra.

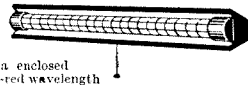

THERMOSTATS

Type "A" 15 amp. for controlling room heaters, greenhouse airing cupboard. Has spindle for pointer knob, quickly adjustable from 30-80°F, 9/6 plus 1/- post. Suitable box for wall mounting, 5/-, P. & P. 1/-.

Type "B" 15 amp. This is a 17in. long rod type made by the famous Sunvic Co. Spindle adjusts this from 50-55°F. Internal screw alters the setting so this could be adjustable over 30° to 100°F. Suitable for controlling furnace, oven kiln immersion heater or to make flame-start or fire alarm. 8/6 plus 2/6 post and insurance.

Type "C" is a small porcelain thermostat as fitted to electric blankets, etc., 1 1/2 amp. setting adjustable by screw through side, 3/6, P. & P. 6d.

Type "D" We call this the Ice-stat as it cuts in and out at around freezing point, 2/3 amps. Has many uses, one of which would be to keep the loft pipes from freezing. If a length of our blanket wire (16 yds. 10/-) is wound around the pipes, 7/6, P. & P. 1/1.

Type "E" This is a standard refrigerator thermostat. Spindle adjustments cover normal refrigerator temperature, 7/6, plus 1/- post.

WAFER SWITCHES

Poles	2 way	3 way	4 way	6 way	8 way	11 way	12 way
1	2/8	2/10	3/1	3/6	4/-	4/6	4/8
2	3/-	3/8	4/1	4/11	6/-	7/-	7/6
3	3/11	4/6	5/2	6/5	8/-	9/6	10/3
4	4/6	5/4	6/2	7/10	10/-	12/-	13/-
6	5/9	7/-	8/3	10/9	15/-	17/-	18/6
8	8/-	8/8	10/4	13/8	18/-	22/-	25/-
10	10/-	10/6	12/5	16/9	22/6	27/-	30/-
12	12/-	12/6	14/5	19/8	27/6	32/-	36/-
14	14/-	14/6	17/-	22/6	—	—	—
16	16/-	16/6	19/6	25/6	—	—	—

5 way 1 pole, 3/6; 2 pole, 4/9; 24 way 1 pole, 15/-; 2 pole, 22/6.

750 mW TRANSISTOR AMPLIFIER

4 transistors including two in push-pull-input for crystal or magnetic microphone or pick-up—feed back loops—sensitivity 5 m/v. Price 19/6. Post and ins. 2/6.



SPEAKER BARGAIN

12in. High fidelity loudspeaker. High flux permanent magnet type with either 3 or 15 ohm speech coil. Will handle up to 10 watts. Brand new, by famous maker.

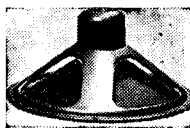

Price 29/6 plus 3/6 post and insurance.

Simmerstat Heater Regulator

Suitable to control elements, heater, soldering irons and boiling rings up to 2,500 watt. Complete adjustable, normal price 35/- each, special snip price 12/6 plus 2/- postage and insurance.

Fluorescent Light Kits

For pinnet lighting, etc. Kit consists of: Super silicite choke; 2 chrome clips to hold tube; 2 bi-pin holders for tube and starter with a starter holder. Kit A for 80 watt tube at 27/6. Kit B for 40 watt tube at 19/6. Kit C for 2 x 2ft. 20 w. lamp 25/-. Kit D for 1 x 2ft. 20 w. lamp 18/6. Post and insurance 2/9 per Kit. Absolutely silent in operation.

THIS MONTH'S NEW BARGAINS

Noughts & Crosses Machine—an opportunity to make this very amusing item—described in Practical Electronics. Kit of 19 switches only 40/- post paid.

Neons for panel Game Switch etc.—not the midget type but possibly more suitable, 12 for 10/6 post paid.

Midget wired ended type (1/3 Ex-equip.) or 1/9 new.

Faxolin Panels, Size 5 x 8 ideal for most transistor projects 6/6 doz. post paid.

Tubular Heater, New and unused by G.E.C.—60 watt per foot loading—ideal in home, office or store—curtains, papers, etc. can drop on them without catching fire—connect these for off peak rates and a warehouse may be kept damp free for the min. cost and trouble—supplied complete with fixing brackets—all lengths from 5ft. to 12ft.—only 2/9 per foot (less than half price) carriage extra at cost.

Transistor Set Cabinet—red and grey revine covered, size 10 x 8 x 3 with handles—ideal for boxing a pocket radio. You'll be amused how good these sound with a 5in. Speaker—15/- plus 3/6 post and ins.

Five Core Cable

Ideal for switching circuits, intercoms, P.A. runs, etc., each core flex copper with rubber insulation, cores covered overall in tough rubber or P.V.C. 24, 30, 40, or 50 yds. length 15/- plus 3/- post.

THREE UNUSUAL ITEMS

OZONE OUTFIT—for removing smells and generally improving any oppressive atmosphere. Kit consists of Philips ozone lamp and mains unit, only needs box. 19/6 plus 3/6 postage and insurance.

BLACK LIGHT UNIT: 40 watt intensity, comprises lamp, lamp holder and 40-watt choke. Only 29/6 plus 6/6 carr. and ins.

TIMER KIT, Special offer of all components except metal box to make mains operated interval timer for photography etc., 12/6 plus 2/6 post.

MAINS POWER PACK

MAINS POWER PACK designed to operate transistor sets and amplifiers. Adjustable taps 6 v. to 12 volts for up to 500 mA (class B working). Takes the place of any of the following batteries: P1, PP3, PP4, PP6, PP7, and others. Kit comprises: mains transformer-rectifier, smoothing and load resistor, 5,000 and 500 mfd. condensers, zener diode and instructions. Real snip at only 14/6 plus 3/- post.

ELECTRONICS (CROYDON) LIMITED

266 LONDON ROAD · WEST CROYDON · SURREY
Post orders to: Dept. PE, 43 SILVERDALE RD., EASTBOURNE, SUSSEX

TYGAN FRET (Contem. pat.), 12 x 12in. 2/-; 12x18in. 3/-; 12x24in. 4/-, etc.
EXPANDED ANODISED METAL—Attractive gilt finish 1/4 in. x 1/4 in. diamond mesh 4/6 sq. ft. Multiples of 6in. cut. Max. size 4ft. x 3ft. 47/6 plus carr.
BONDACUST Speaker Cabinet Acoustic Wadding (lin. thick approx.) 18in. wide, any length cut, 6/- yd.

Volume Controls—5K-2 Meg. ohms, 3in. Spindles, Morgan Midget Type 1 1/4in. diam. Guar. 1 year, LOG or LIN ratios less Sw. 3/-, DP. Sw. 4/6. Twin Stereo less Sw. 7/6. 100 K. to 2 Mohms with DP. Sw. 9/6.

WAVECHANGE SWITCHES. 1 p. 12-way, 2 p. 2-way, 2 p. 6-way, 3 p. 4-way, 4 p. 2-way, 4 p. 3-way, long spindle, 3/6 ea.

ENAMELLED COPPER WIRE—1lb. reels 14g-20g, 3/-; 22g-28g, 3/6; 30g-34g, 4/3; 36g-38g, 4/8; 39g-40g, 5/-, etc.
TINNED COPPER WIRE. 16-22g, 4/- 1/2 lb.
ERSIN MULTICORE SOLDER, 60/40 4d. per yard. Cartons 6d, 1/-, 2/6, etc.

New Boxed VALVES		Reduced Bargain Prices	
1T4	1/6	EF86	8/6
1R5	18/6	EL33	12/6
384	3V4	EL34	12/6
6CC81	7/-	EL34	12/6
6CC82	7/-	EY31	9/-
6CC83	7/-	EY86	9/-
ECL80	9/-	EZ81	7/-
ECL82	10/-	GZ32	9/6
ECL86	10/6	PCCS84	8/-
EP80	7/6	PCF80	8/-
		UL54	9/-
		PCL83	10/6
		PCL84	10/-
		PCL85	11/6
		PL36	10/6
		PL81	9/6
		PL83	9/-
		PY33	10/6
		PY82	7/6
		U25	10/6
		UL54	9/-

CO-AX 80 ohm CABLE
 High grade low loss Cellular Air Spaced Polythene—1in. diam. Stranded Cond.
 Now only 6d. yard
BARGAIN PRICES—SPECIAL LENGTHS
 20 yds. 9/-; Coax. Plugs 1/-; 40 yds. 17/6; 60 yds. 25/-; Sockets 1/-; Couplers 1/3.

DE-LUXE RECORD PLAYER KIT

Incorporating 4 Sp. Garrard Auto-Slim unit and Mullard latest 3 watt printed circuit amplifier (ECL86 and EZ80), vol., bass and treble controls, with 8 x 5in. 10,000 line speaker. Contemporary styled two-tone cabinet, charcoal grey and off-white with matching blue relief. Size 17 1/2 in. x 16 in. x 8 in. A stylish unit capable of quality reproduction. Circuit and const. details 2/6 (free with kit).



COMPLETE KIT
 Carr. and ins. 12/6 **£13.19.6**

Illustrated Perspex control panel escutcheon 7/6 extra. Ready wired 30/- extra. 4 contemporary mounting legs (6in. 10/6; 9in. 11/6; 12in. 12/6) per set extra.

L.P. RECORDING TAPE BARGAIN OFFER!

By leading British manufacturers—
PROFESSIONAL GRADE —DOUBLE-SIDED
 (each side coated) 5 1/2" reels only
Special Price Offer 1,450 feet 20/- post free (2 reels)

Ideal for the experimenter who wants to record both sides, and a good L.P. Tape for the enthusiast who wishes to record single side only.

SPECIAL OFFER 3" Message Tape 150', 3/9; 3" L.P. 225', 4/8; 3" D.P. 300', 6/6. P. & P. per reel 6d.

TAPE REELS Mfrs. surplus
 7", 2/3; 5", 2/-; 5", 2/-; 3", 1/3; Plastics spool containers, 5", 1/9; 5 1/2", 2/-; 7", 2/3.

TRANSISTOR COMPONENTS

Midget I.F.T.'s—485 Kc/s 1/4 in. diam. first, second or third..... 5/6
 Osc. Coil M. & L.W. 1/4 in. diam..... 5/-
 Midget Driver Trans. 9:1..... 6/-
 Midget Output Trans. Push-Pull—
 3 ohms..... 6/-
 Elect. Condensers—Midget Type 1 mid.-50 mfd. ea. 1/9, 100 mfd. 2/-, 12V.
 Condensers 150 V. working: .01 mfd., .02 mfd., .03 mfd., .04 mfd., .05 mfd., .1 mfd., 1/-; .25 mfd., 1/3; .5 mfd., 1/6, etc.
 Midget Tuning Condensers. J.B. "OO" 208 pF and 170pF, 8/6; ditto with trimmers, 9/6. J.B. 220pF and 105pF conc. slow motion 10/8. 365pF single 7/8.

Condensers—Silver Mica. All values 2pF to 1,000pF, 6d. each. Dittos Ceramics 9d. Tub. 450V T.C.C. etc. 0.01 mFd to 0.25 and 0.1/350V, 9d. 0.02-0.1/500V, 1/- 0.25 Hunt, 1/6. 0.5 T.C.C. 1/9, etc. etc. Close Tol. S/Micas—10% 5pF-500pF, 8d. 600-5,000pF, 1/-, 1% 2pF-100pF, 9d. 100pF-500pF, 11d. 575pF-5,000pF, 1/6. Resistors—Full Range 10 ohms-10 meg. ohms 20 p. and 1W, 3d., 1W, 5d., (Midget type modern rating) 1W, 6d., 2W, 9d., 50/500W, 5/6; 1W, 3W, 6d. (100 ohms-1 meg.). Other values 9d, 1% 1W, 1/6, etc., etc.

TRIMMERS, Ceramic (Compression Type)—30pF, 50pF, 70pF, 9d.; 100 pF, 150pF, 1/3; 250pF, 1/6; 600pF, 1/9.
PHILIPS. Bee Hive Types (conc. air spaced)—3.5pF, 1/-, 3-50pF, 1/-.
KNOPS—Modern Continental types. Brown or Ivory with Gold centre; 1" dia., 9d. each; 1 1/2", 1/3 each. Conc. knobs ivory with gold centre 1 1/2" dia. 2/9 pr. Matching ditto 2/6 ea. **LARGE SELECTION AVAILABLE.**
METAL RECTIFIERS, SURT. Types—RM1, 4/8; RM2, 6/8; RM3, 7/8; RM4, 1/6; RM5, 2/1; RM4B, 17/8; Mullard BY100, 8/6.

TUB-ELECTROLYTICS-CAN

25/25 v. 50/12V, 1/9; 8 + 8/450v, 4/6; 50/50v, 100/125v, 2/-; 32 + 32/275v, 4/8; 8/450v, 4/350v, 4/300v, 5/6; 16 + 16/450v, 5/8; 60/250/275v, 12/6; 32 + 32/450v, 6/6, 100 + 200/275v, 12/6.

SPECIALIST

70 Brigstock Rd., Thornton Heath, Surrey.
 THO 2188. Terms C.W.O. or C.O.D. Post and Packing up to 1/2 lb. 1/-; 1 lb. 1/9; 3 lb. 3/-; 5 lb. 3/9; 8 lb. 4/6.



SPEAKERS P.M.—3 ohms 2 1/2" E.M.I. 15/6. Goodmans 3 1/2" 15/6, 5" Rola 15/6, 6" Rola 18/6, 7" x 4" Goodmans 15/6, 8" Rola 19/6, 10" R. x A. 25/-, 9" x 6" Goodmans 22/6. E.M.I. Ceramic Magnet 37/6. Tweeter 22/6. Jack Plugs, Standard 2 1/2" Igranite Type, 2/6. Screened ditto, 3/3. Miniature scr. 1 1/2", 2/3. Sub-min. 1/3.

RADIO AND AUDIO SERVICING HANDBOOK

A practical guide to fault-tracing adjustment & repair in radio receivers, car radios, radiograms, tuner units, record reproducers, turntable units & tape recorders.
 by G. J. King

25/- Postage 1/-

TRANSISTOR ELECTRONIC ORGANS FOR THE AMATEUR, by A. Douglas & S. Astley, 18/-, Postage 1/-.

THE HANDBOOK OF ELECTRONIC TABLES, by M. Clifford, 21/-, Postage 1/-.

INTER-CREST TRANSISTOR MANUAL, 7th ed. 18/-, Postage 1/6d.

TROUBLESHOOTING WITH THE OSCILLOSCOPE by R. G. Middleton, 20/-, Postage 1/-.

PROBLEMS IN ELECTRONICS WITH SOLUTIONS, by F. A. Benson, 22/6, Postage 1/-.

THE RADIO AMATEUR'S HANDBOOK, by A.R.R.L. 1965 40/-, Postage 2/6d.

RADIO VALVE DATA 7th ed. compiled by "W.W." 7/6, Postage 1/-.

COMPLETE CATALOGUE 1/-.

THE MODERN BOOK CO.

19-21 PRAED STREET
 LONDON, W.2
 Phone: PADdington 4185
 Open 6 days 9-6 p.m.

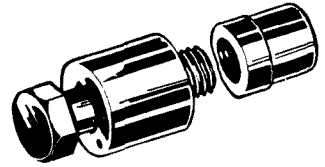

The PUNCH you need!

HOLE PUNCHES

Instant Type			
3/8" diameter	6/10 ea.
Screw-up Type			
1 1/8" diameter Toggle switch	8/6 "
1 1/8" " " " " " "	8/6 "
1 1/8" " B7G	9/- "
1 1/8" " B8A, B9A	9/6 "
1 1/8" " " " " " " "	10/2 "
1 1/8" " " " " " " "	10/8 "
1 1/8" " " " " " " "	11/8 "
1 1/8" diameter Int. Octal	13/4 "
1 1/8" " " " " " " "	16/2 "
1 1/8" " " " " " " "	18/10 "
1 1/8" " B9G	21/8 "
1 1/8" " " " " " " "	24/4 "
2 1/8" " Meter	33/2 "

Complete Set **£9.3.6.**

No extra charge for postage and packing in the U.K.
 Now supplied by:
TOMPKINS & LONGMAN LTD.
 237 GIPSY ROAD
 WEST NORWOOD, S.E.27
 Tel.: Gipsy Hill 5000

BBC2 (625 LINE) TV AERIALS

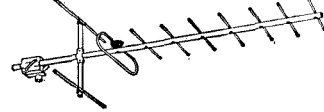

MOUNTING ARRAYS, 9 element 45/-; wide spaced high gain, 11 element 55/-; 14 element 62/6. WALL MOUNTING WITH CRANKED ARM, 9 element 60/-; wide spaced high gain, 11 element 67/6; 14 element 75/-.

CHIMNEY ARRAYS COM- PLETE, 9 element 72/-; wide spaced high gain, 11 element 80/-; 14 element 87/6. LOFT ARRAYS, 7 element 32/6; wide spaced high gain, 11 element 37/6; wide spaced high gain 62/6; 14 element 70/-.

ALL HIGH GAIN UNITS HAVE SPECIAL MULTI-ROD REFLECTOR. LOW LOSS CO-AXIAL CABLE 1/6 yd. VHF transistor pre-amps from 75/-.

BBC + ITV + F.M. AERIALS

B.B.C. (BAND 1). Tele- scope, loft 21/-. External S/D 30/-.

I.T.V. (BAND 3). 3 Element loft array 25/-, 5 element 35/-. Wall mounting, 3 element 35/-. 5 element 45/-.

COMBINED B.B.C./I.T.V. Loft 1+3, 41/3; 1+5, 48/9. Wall mounting 1+3, 56/3; 1+5, 63/9. Chimney 1+3, 63/9; 1+5, 71/3.

VHF transistor pre-amps from 75/-.

F.M. (BAND 2). Loft S/D, 12/6. "H", 30/-. 3 element, 52/6. External units available. Co-ax. cable 8d. yd. Co-ax. plugs, 1/3. Outlet boxes, 4/6. Diplexer Crossover Boxes 12/6. C.V.O. or C.O.D. P. & P. 3/6. Send 6d. stamps for illustrated lists.

K.V.A. ELECTRONICS (Dept. 2)
 3b, Godstone Road, Kenley, Surrey.
CRO 2527

Audio TRENDS...

A Commentary on Sound Reproducing Equipment by Clement Brown

A LARGE proportion of new products seen in the last two months—particularly those introduced to the trade during summer and autumn exhibitions—has been of foreign manufacture. This has emphasised yet again how, from the U.K. viewpoint, the radio and electronics market takes on an increasingly international look. The variety now offered, not least in the audio sector, is truly remarkable.

Some of the new items are of special interest to the constructor and experimenter. Many more will appeal to those who seek to obtain the best value for money by assembling audio outfits from units and who demand hardware that is well “packaged”—to use the word in the design and layout sense. Even if the amateur decides in the end to solve his own mechanical design problems, he can at least benefit from a close look at professional methods.

NEW DISC EQUIPMENT

It can be said, with every justification, that Thorens turntables are the “Rolls-Royces” of the disc equipment world, and that the Bentleys of the breed follow respectfully behind. But not every enthusiast can afford the best that Thorens make, and it is therefore especially interesting to note a new model which this firm has added to the competitive £20–£25 range.

Designed for 33 and 45 r.p.m., this transcription model—a nice-looking product—has the type number TD150. Its eight-pound, non-magnetic turntable platter is belt-driven by a synchronous motor, and an accuracy of plus or minus 0.2 per cent is claimed for the speeds. Priced at £20 13s 2d, the turntable is supplied with a separate pick-up mounting board and is ready for building into a cabinet. For a few pounds extra it can be obtained fitted on a plinth. The U.K. distributors are Metro-Sound of London.

Special attention to bearing design, and to methods of decoupling the driving motor so as to minimise rumble, must be well up the list of requirements of any design engineer interested in “transcription” standards.

Transistor f.m. tuner by Telefunken compared in size with a matchbox

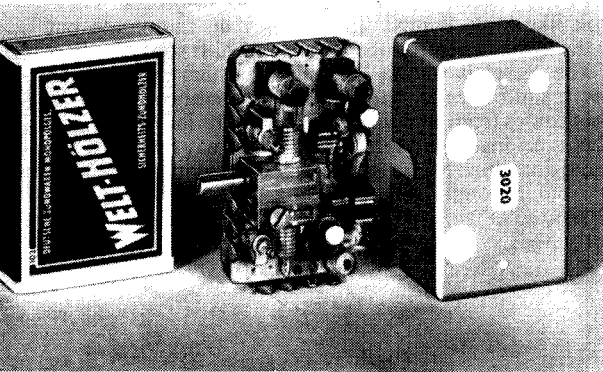

Evidently this has been so with Transcriptors Ltd., whose pick-up arms and accessories were noted in the September *Audio Trends*.

This firm has now provided details of its new turntable, which is due during November at a price of about £28. It incorporates some unusual features. For instance, there is a built-in bubble indicator for levelling; adjustable legs are fitted and the bearings are of p.t.f.e. (a plastics material noted for its “slippery” quality). Again, the drive is transmitted by an adjustable belt and pulley arrangement which gives a speed range of 10–80 r.p.m. Other practical points are a stroboscope and neon indicator.

JAPANESE DESIGN

Another new product in this field is the LSM pick-up, of Japanese design. It incorporates such technical refinements as a bias compensator (to correct side-thrust), miniature ball-bearing pivots and separate lateral and vertical balance weights. The well-finished arm, of satin chromed brass, is to be supplied at about £26 complete with a dynamic stereo cartridge. This has a hi fi specification and 1½ gm playing weight. The agents, new to audio enthusiasts, are Living Sound, 11, Essex House, George Street, Croydon, Surrey.

Constructors should look out for the wide—and recently increased—range of components and equipment imported from Japan by Adler and Sons, the London firm. There are speakers, microphones, crossover filters, and a variety of small components to interest the amateur enthusiast. All are sold by radio and hi fi specialists in the usual way, mostly under the trade name Eagle. Prices are moderate.

Uher Model 22 tape unit



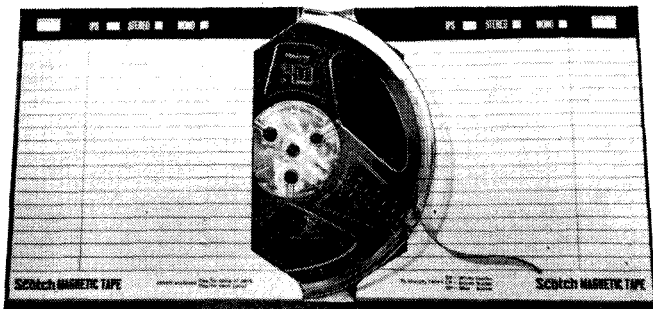

"Scotch" tape pack in book form

Elac products, from Western Germany, now include a new and improved moving-magnet stereo cartridge, the STS240D, which is to sell at a little over £15. It supersedes the familiar STS222D. Cartridges from this maker are of high quality and are particularly noted for good channel separation and consistent performance.

FOR THE TAPE ENTHUSIAST

Still on the subject of Continental designs, recent additions to tape equipment should be noted. Braun's TG60 is a very desirable piece of machinery with engineering features which will repay study by the amateur enthusiast. New Uher models include tape units which, lacking output stages and speakers, are intended to be associated permanently with hi fi equipment. They are transistorised, equipped for stereo, and are made in twin-track and four-track versions (models 22 and 24 respectively). Speeds are $7\frac{1}{2}$ and $3\frac{1}{2}$ in/sec and there are separate heads and amplifiers for recording and playback. Prices, still to be announced, will be in the medium range.

A new pack has been introduced for Scotch recording tape. It looks like a bound book with simulated leather finish and gold lettering. There are three sizes, for 5in, $5\frac{1}{2}$ in and 7in spools; each has two pockets and indexing spaces. Adhesive labels are provided. The aim is, of course, to reduce the space required for tape stage as well as to improve decor.

TUNER AMPLIFIERS

Now to the electronics of audio. Tuner-amplifiers are very much in vogue, particularly on the Continent. At least that is what one concludes after surveying the variety of models now reaching us via the U.K. agents for Telefunken, Saba, Korting and other prominent manufacturers. In this type of equipment, equal emphasis is placed on radio and amplifier sections, which are integrated in a wood or metal housing for shelf mounting. In this way hi fi becomes accepted as a normal domestic appliance, as unremarkable as television.

In the German products, technical ingenuity abounds: it is fair to say that they are most impressive on the electronic side and that U.K. experts excel when it comes to the mechanics of disc reproduction. Transistors are used liberally to secure desired performance characteristics and the radio sections, usually mono and stereo f.m. plus one or more a.m. bands, are especially imposing.

Telefunken, for example, offer outputs of up to 15 watts per channel in their Opus tuner-amplifier and

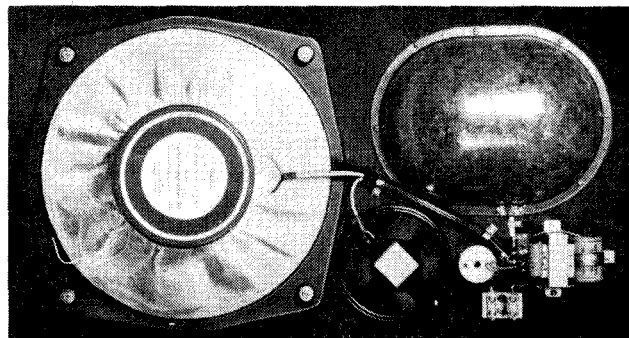

Saba Electronics System III loudspeakers on a baffle

other models, and a great deal of work has gone into miniaturising the complex transistor circuits. Elaborate electronic designs, which may involve 30 transistors and nearly as many diodes, lead to a new preoccupation with space-saving techniques.

Another compact unit of this type, supplying 15 watts per channel from class B transformerless stages, is the Korting 26-452 (79 gns). Like most of the more advanced equipment, it has switched automatic frequency control and is equipped for stereo reception. There are such refinements as a moving-coil tuning indicator, and the tuner covers f.m. plus long, medium and short waves.

The Braun Audio 2 is also a must for those wishing to survey the international scene. This very advanced product is a stereo radiogram unit, for use with separate speakers. It includes the Braun PS400 transcription turntable and pick-up and a no-compromise tuner-amplifier. Only $6\frac{1}{2}$ in high, the Audio 2 is a remarkable example of compact design.

THREE-UNIT SPEAKER SYSTEM

One high-quality item for the constructor is the System III baffle speaker introduced by Saba Electronics. This three-unit system, ready to build into an enclosure, is rated at 30 watts and covers the range 40-18,000c/s (3dB limits are quoted). Since the 12in bass unit resonates at 20c/s, there is evidently a prospect of securing still deeper bass, but this of course depends on enclosure design.

The mid-range is reproduced by a $7\frac{1}{2}$ by $4\frac{1}{4}$ in unit and the treble by a $4\frac{1}{2}$ in tweeter. As the illustration shows, a crossover filter is fitted to the baffle. Crossover frequencies are 300c/s and 7,000c/s. Saba suggest a sealed enclosure of three cubic feet, loosely filled with wadding. The System III costs £38 17s and the bass unit is available separately at 17 gns.

UNCONVENTIONAL SPEAKERS

Loudspeakers have the final word this month. LWL Distributors Ltd. not only offer conventional speakers of their own but also intend to market some distinctly unconventional American reproducers. These look like table lamps: in fact they do illuminate but at the same time produce an aura of hi fi sound! Part of the secret is in the lampshade, which conceals an electrostatic speaker handling the range above 3,000c/s. Bass comes from a moving-coil unit in the lamp pedestal. This is an ingenious solution to what may be called the audio furniture problem; it also represents a serious if unusual attempt to achieve good reproduction and, assuming it wins acceptance, prices are likely to be fairly high.



A PRACTICAL TOOL FOR A PRACTICAL MAN

The Weller Instant Heat Soldering Gun is not just for soldering, it's a universal tool. Easily interchangeable tips turn it from a soldering gun into a plastics working tool enabling you to cut and repair almost anything plastic. It reaches working heat in 3-4 seconds of pressing the trigger—yet the tip is cool within 10 seconds of release (for real safety). The pistol grip design makes work easy and accurate.

A useful booklet, 'Soldering Tips', supplied free with every gun, tells you all you need to know to get the maximum benefit from this tool.

120 watt gun is available in kit form, as shown, with supply of resin-cored solder, cleaning brush, soldering aid tool, spanner and two spare soldering bits in fully fitted polypropylene carrying case as used by service engineers in leading organisations.

Recommended price—**72/6d.**

Gun alone—**57/6d.** Heavy duty gun (275 watt)—**89/-**

★ Guaranteed for 12 months by the world's largest maker of quality soldering tools

In case of difficulty write to:—

U.K. SALES & SERVICE

Weller **ELECTRIC CORPORATION**
HORSHAM · SUSSEX · Tel. 60807

vero board

gives
constructors
the
simplest ...
most
efficient ...

WIRING BASE

for any electronic assembly work — whether experimental or quantity production. Patented Veroboard is an advance on tag board wiring techniques and printed circuits, and because of its absolute stability under all conditions it is in fact now extensively used by manufacturers all over the world instead of printed circuits.

Veroboard is obtainable in many sizes of which 4 are available through the retail trade. For the name and address of your nearest Retailer please write to:—

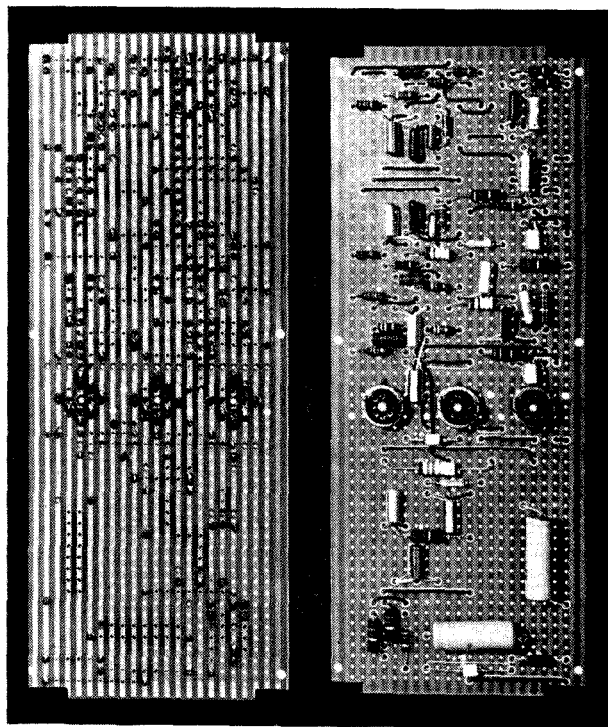

VERO ELECTRONICS LTD. (DEPT. P11)
SOUTH MILL ROAD, REGENTS PARK, SOUTHAMPTON
TEL. 71061
ENQUIRIES FROM RETAILERS AND MANUFACTURERS WELCOMED

957

MARTIN Audiokits

FOR HI-FI
AND F.M.



20 WATT INTEGRATED
STEREO

ADD-ON UNIT SYSTEM

F.M. TUNER

THE EASY WAY TO BUILD AND SAVE

Leaflet on request.

From good stockists
everywhere.

Martin Electronics Ltd
154-155 High St., Brentford,
Middlesex. IS1Leworth 1161/2

MARTIN AUDIOKITS comprise an ingeniously designed series of fully-transistorised units by means of which you can build up a hi-fi assembly starting with a simple mono amplifier system and adding to it to make a fully integrated 20-watt stereo installation, for well under £30. This can be used with low output as well as crystal pick-ups, radio, tape-heads, microphones, etc. Building is pleasantly easy. Quality is outstanding. Now units for making an FM Tuner are available for adding to Audiokit assemblies or using separately.

MARTIN ELECTRONICS LTD.
154-155 HIGH ST., BRENTFORD, MIDDX
Martin Leaflet on Audiokits
FM Tuner please.

NAME
ADDRESS
Pre. II

FOR VALVES — SEMI CONDUCTORS — METAL RECTIFIERS



NEW 1965/6 CATALOGUE
NOW AVAILABLE

56 PAGES SEND 1/- in stamps
FOR YOUR COPY

SEMI CONDUCTORS

AC154 5/6	MAT120 7/9	OA202 4/-	OC71 4/3
AC155 4/-	MAT121 8/6	OAZ203 7/6	OC72 5/6
AC156 5/6	NKT404	OAZ204 7/6	OC75 5/6
AC157 7/-	(OC35) 10/-	OAZ207 7/6	OC81 5/6
ADT140 15/-	OA5 6/-	OAZ208 5/6	OC83 4/-
ASY28 6/8	OA10 6/6	OC42 6/-	OC139 8/-
BY100 7/6	OA70 2/-	OC43 9/-	OC170 6/-
BY114 5/-	OA79 2/-	OC44 5/-	OC170 6/-
MAT100 7/9	OA81 2/-	OC45 5/-	OC200 7/6
MAT101 8/6	OA200 3/6	OC70 4/6	OCP71 25/-

VALVES

DK96 8/6	EF80 5/9	PCL83 10/-
DF96 7/3	EF86 8/-	PL81 8/6
DAF96 7/6	EY51 8/-	U25 10/-
DL96 8/-	EY86 8/6	U26 12/6
ECC81 5/-	PCC84 7/9	UCL82 9/6
ECC82 5/6	PCF80 7/9	UCL83 11/6
ECC83 6/-	PCL82 9/3	

ALPHA RADIO SUPPLY CO.

103 LEEDS TERRACE, WINTOUN STREET

LEEDS 7

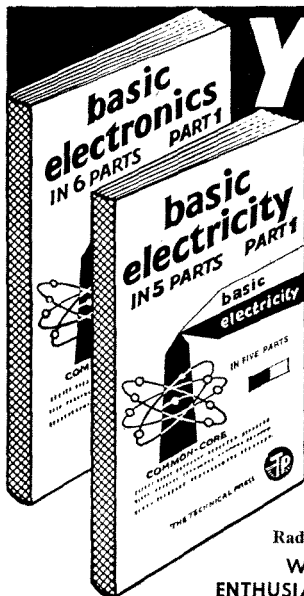

YOURS FREE FOR 7 DAYS

The New 'Picture-Book' way of learning BASIC ELECTRICITY (5 VOLS.) BASIC ELECTRONICS (6 VOLS.)

You'll find it easy to learn with this outstandingly successful new pictorial method—the essential facts are explained in the simplest language, one at a time; and each is illustrated by an accurate, cartoon-type drawing.

The books are based on the latest research into simplified learning techniques. This has proved that the Pictorial Approach to learning is the quickest and soundest way of gaining mastery over these subjects.

The series will be of exceptional value in training mechanics and technicians in Electricity, Radio and Electronics.

WHAT THIS MONTH'S ENTHUSIASTIC READERS SAY

... Your Series make a difficult subject really enjoyable. I will definitely recommend them to my friends... B.D., NEWBURY

... I would recommend this series to anyone wishing to pursue this subject either as a career or as a hobby... W.T., EPPING

... I think they should be very useful to give me a qualitative outline of the subject which can later be consolidated with a study of the mathematical aspects... J.A., BUCKSBURN

... I found in it what I sought for in that subject. I understand the basic elements which I could not understand from magazines and other books... P.H.W., NEW CROSS

A TECH-PRESS PUBLICATION

To Selray Book Co.
60 Hayes Hill, Hayes, Bromley, Kent

Please send me Without Obligation to Purchase, Basic Electricity/Basic Electronics on 7 Days' Free Trial. I will either return set, carriage paid, in good condition within 8 days or send down payment of 15/- (Basic Electricity) followed by 6 fortnightly payments of 10/-. Down payment of 15/- (Basic Electronics) followed by 6 fortnightly payments of 12/6. Alternatively, I will send 68/- (Basic Electricity—5 parts). 81/- (Basic Electronics—6 parts) post free. This offer applies to United Kingdom only.

Tick against set required (only one set allowed on free trial).
BASIC ELECTRICITY BASIC ELECTRONICS

Signature.....
(If under 21, signature of parent or guardian)

Name.....
BLOCK LETTERS BELOW

FULL POSTAL
Address..... P.E.11

POST NOW FOR THIS OFFER!!

NEW PRODUCTS

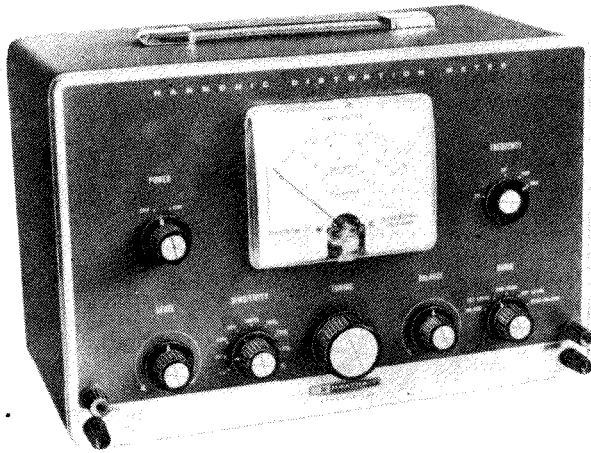

The Heathkit model IM-12U is a harmonic distortion measuring instrument of high accuracy and stability. When used with an audio generator this instrument will accurately measure harmonic distortion at any frequency between 20–20,000c/s.

The IM-12U indicates the residual signal in an amplifier under test, after the fundamental frequency is eliminated, to give an accurate reading of

Harmonic Distortion Meter

Daystrom Ltd., Gloucester, England.

hum, noise and harmonic distortion. Distortion is indicated directly on the meter in ranges of 0–1, 3, 10, 30 and 100 per cent full scale and noise level measurements, down to -60dBm , are read on a separate decibel scale. The $4\frac{1}{2}$ in meter has a $200\mu\text{A}$ movement with scales of 0–3, 0–10 volts, and -10 to $+2\text{dB}$.

The input resistance is 300 kilohm and minimum input voltage for distortion measurements is 0.3 volt. The output voltage for monitoring is 2.5 volts at full scale meter reading.

The valve voltmeter (ranges 0–1, 3, 10, 30 volts full scale) section of the IM-12U uses a twin triode amplifier with negative feedback. The output of this amplifier is available at the output terminals so that the waveforms of the voltages measured may be visually monitored with an oscilloscope.

The accuracy of the meter when used as a voltmeter is ± 5 per cent of full scale, and ± 5 per cent of full scale $+ 0.1$ per cent when distortion readings are taken.

The Heathkit IM-12U is available in kit form for £24 15s 0d or £34 assembled.

New Battery Chargers

Vane Electrical Instruments Ltd.,
Craddock Road, Reading, Berks.



A new range of battery chargers has been introduced to the market by Vane Electrical Instruments. All units in the range use silicon rectifiers at only one third of their rating for maximum safety. Cooling is effected by using modern convection techniques which eliminate the need for fan motors. Ammeters of moving coil type are used to give "at-a-glance" readings of charging current.

All operating instructions are engraved on a panel on each charger. Most models are fitted with an automatic thermal overload switch which prevents damage to the charger or the battery in the event of a reverse connection or a short circuit.

Two models are depicted in our photograph. The model 2600 "Power Boost", housed in the console trolley cabinet, costs £48 and charges at 30 amps on 6 or 12 volts and 15 amps on 24 volts.

The model 2400, 30/30 "Booster" model, has similar features to the "Power Boost", except that the polarity protector is not included but can be obtained as an optional extra. The "Booster" is housed in a portable cabinet and is priced at £36.

Both these chargers make excellent car engine starters.

INGENUITY

UNLIMITED!

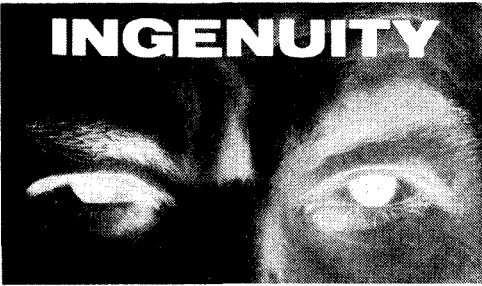

IN THIS feature we hope, from time to time, to be able to publish suggestions submitted by some of our readers on the possible improvement of projects previously described in PRACTICAL ELECTRONICS; short contributions on other subjects may be included. The aim is not to find fault or undermine the abilities or knowledge of our contributors. It may well be that the original article is *par excellence* but it could be improved or adapted to suit individual requirements. The views expressed by readers are not necessarily those of the Editor.

SIMPLE ENLARGER TIMING

One of your readers B. J. Solloway ("Readout" April), asked for a circuit to indicate exposure times for a photographic enlarger. I designed and am now using the following simple circuit with a 2in Wray enlarger.

I removed the click stops from the lens making the aperture infinitely variable. Then using a good negative I made a print which needed 15 seconds exposure; others may need more or less time. Without changing the aperture or other conditions I slid the probe containing the ORP12 cell under a "middle tone" and adjusted the potentiometer until the meter indicated half-scale deflection.

From this initial setting up any negative in the enlarger can be printed by adjusting the aperture

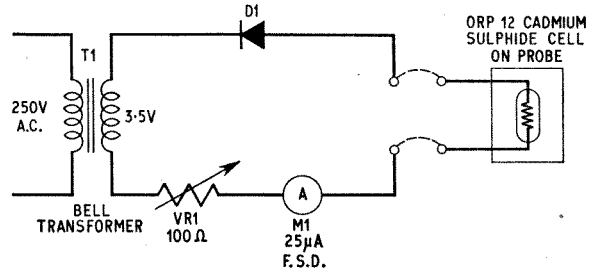

until the meter reads half scale; then expose for 15 seconds. After setting VR1 it should be locked in position.

J. Livingstone,
Luton,
Bedfordshire.

SELF DISCHARGING

AFTER THE flash gun has been used the capacitors C4 and C5 are left fully or partially charged, and remain so for some considerable time as the only leak is their own resistance and the reverse resistance of diode D5. If the power pack has been switched from full to half power, C5 is left charged and isolated (see July issue).

A permanent leak could be used, but a more efficient method is to use a standard jack with changeover contacts in place of SK2 as shown. Switch S2 is now made a changeover switch.

This circuit automatically discharges C4 and C5 when the jack plug is removed; the oscillator is switched off simultaneously. Switch S1 is no longer necessary, but is convenient when the flash gun is in frequent use, and isolates the accumulator when it is out of use.

R. A. Porter,
Chipstead,
Surrey.

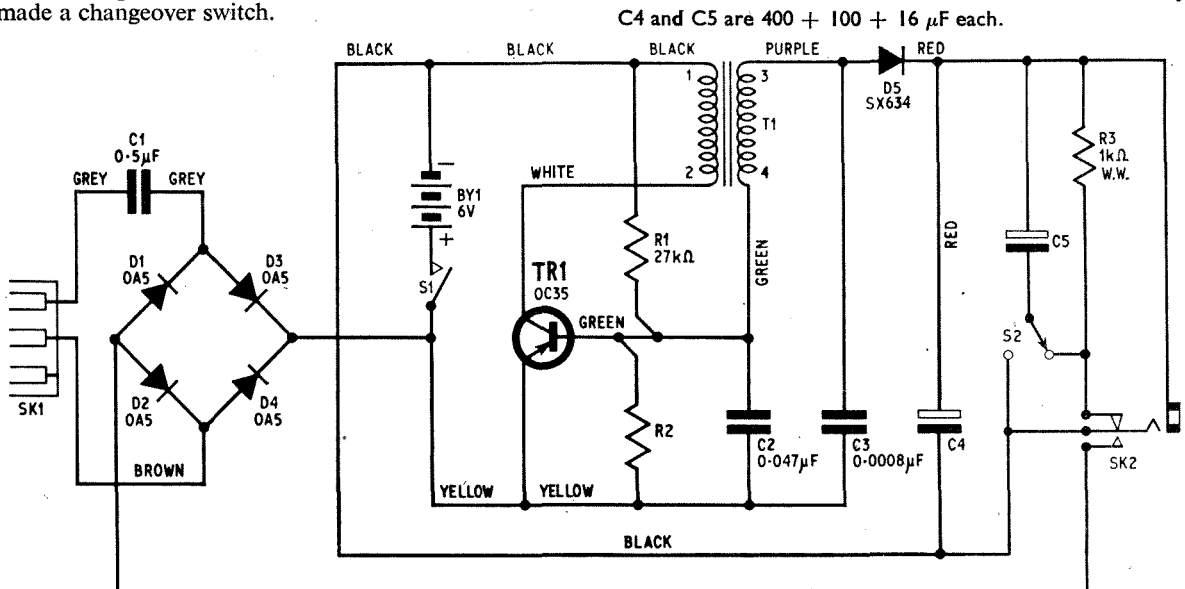

Practical Electronics Classified Advertisements

The pre-paid rate for classified advertisements is 1/- per word (minimum order 12/-), box number 1/6 extra. Semi-displayed setting £3.5.0 per single column inch. All cheques, postal orders, etc., to be made payable to PRACTICAL ELECTRONICS and crossed "Lloyds Bank Ltd." Treasury notes should always be sent *registered post*. Advertisements, together with remittance, should be sent to the Advertisement Manager, PRACTICAL ELECTRONICS, George Newnes Ltd., Tower House, Southampton Street, London, WC2, for insertion in the next available issue.

EDUCATIONAL

B.Sc.(ENG.), A.M.I.Mech.E., A.M.I.E.R.E. City & Guilds, etc., on "Satisfaction or Refund of Fee" terms. Wide range of expert Home Study Courses in Electronics, Computers, Radio, T.V., etc. 156-page Guide—FREE. Please state subject of interest. **BRITISH INSTITUTE OF ENGINEERING TECHNOLOGY**, 151a College House, Wright's Lane, London, W.8.

HOME STUDY COURSES in Practical Electronics. Free Brochure without obligation from: **BRITISH NATIONAL RADIO SCHOOL**, Reading, Berks.

STUDY RADIO, TELEVISION AND ELECTRONICS with the world's largest home study organisation. I.E.R.E., City & Guilds, R.T.E.B., etc. Also Practical Courses with equipment. All books supplied. Write for FREE Prospectus stating subject to I.C.S. (Dept. 577), Intertext House, Parkgate Road, London, S.W.11.

THE INCORPORATED PRACTITIONERS in Radio & Electronics (I.P.R.E.) Ltd., Membership Conditions booklet 1/-. Sample copy of I.P.R.E. Official Journal 2/-. post free. Secretary, Dept F, 32 Kidmore Road, Caversham, Reading, Berks.

A.M.I.Mech.E., A.M.I.E.R.E. City & Guilds, G.C.E., etc. Become a Technician or Technologist for high pay and security. Thousands of passes. For details of Exams. and Courses in all branches of Engineering, Building, Electronics, etc., write for 156-page handbook—FREE. **B.I.E.T.** (Dept. 152), London, W.8.

BOOKS AND PUBLICATIONS

VISATECHNICA. The up-to-date TECHNICAL language course French—German—English on records or tape. Three-language illustrated book covering 260 technical subjects. Send 4d. stamp for descriptive leaflet to **VISAPHONE CO. LTD.**, 17 Middleton Rd., London, N.W.11.

TAPE RECORDERS, TAPES, ETC.

TAPE TO DISC. New High-level Cutters 45 r.p.m. 21/- S.E.A. Leaflet. **DEROY**, 52 West Bank Lane, Lancaster.

SPEAK — LISTEN to the world by joining Britain's largest tape exchange — **WORLD-WIDE TAPETALK**, 35 The Gardens, Harrow. S.A.E. for particulars.

SERVICE SHEETS

SERVICE SHEETS for all makes of Radio and TV 1925-1965. Prices from 1/- with free fault-finding guide. S.A.E. inquiries. Catalogue of 6,000 models, 1/6. Valves, modern and obsolete. Radio/TV Books. S.A.E. lists, **HAMILTON RADIO**, Western Road, St. Leonards, Sussex.

TRADE SERVICE SHEETS. Radio, TV, etc. Mixed dozen @ 4/-. 100—22/6d. p.p. **TELRAY**, Maudland Bank, Preston.

STATE MODEL NO. Radio 2/-. TV 2/6. S.A.E. **DARWIN**, 19 George Street, St. Helens, Lancs.

SERVICE SHEETS

4/- each, plus postage.

We have the largest supply of Service Sheets for all makes and types of Radios, Televisions, Tape Recorders, etc. in the country. **Speedy Service.**

To obtain the Service Sheet you require, please complete the attached coupon:

From:

Name:

Address:

.....
.....
.....

To: **S.P. DISTRIBUTORS**
44 Old Bond St., London, W.1
Please supply Service Sheets for the following:

Make:

Model No.: Radio/TV

Make:

Model No.: Radio/TV

Make:

Model No.:

New 1965 List now available.

I also require list of Service Sheets at 1/6.

(please delete items not applicable)

I enclose remittance of

MAIL ORDERS ONLY Nov. PE

FOR SALE

COCKROBIN'S MASTERBOX for that special enclosure, for switchboards, indicator panels and control boxes. Sizes 2" x 3" x 3" and 2" x 6" x 6" and can be bolted together in any combination. Please write for full details, **COCKROBIN CONTROLS**, 36 Villiers Ave., Surbiton, Surrey.

DID YOU KNOW that Suffolk Tubes, still the largest independent tube rebuilders, give a free delivery service by van or passenger train to all parts of the U.K. Each tube is guaranteed 12 months and all types are always available off the shelf at keenest prices. 1-3 Upper Richmond Road, Putney, London, S.W.15. Telephone Vandyke 4304/5267.

VENNER TIME SWITCHES. Reconditioned, 14 day clock, once on once off every 24 hrs. jewelled movement, fully guaranteed. 1 amp 25/-, 5 amp 32/6d., 15 amp 39/6d. Post etc. 2/6d. Cast Aluminium Cases 7/6d. A. R. **BATCHELOR**, P.E. Dept. 4 Park Road, Bromley, Kent.

A.C. STANDARD. Mains Motors Fractional H.P. 3 1/2 in dia x 4 in long with 1/2 in spindle. Many uses. Brand new, 25/- each. P. & P. 2/6d. Small Battery Motors 1 1/2 in dia x 2 in long—4 1/2 to 9 volts. Heavy construction; only 7/6d. each. P. & P. 1/-. **WALTONS WIRELESS STORES**, 15 Church Street, Wolverhampton.

CRACKLE PAINT. Black or Grey, 1/2 pint tins 4/-, post 6d. from the component specialists. **SERVIO RADIO**, 156-8 Merton Road, Wimbledon, London, S.W.19.

TRANSISTORS UNMARKED UNTESTED. 40 for 10/-. P. & P. 1/-. 4 packets post free. Relays, thousands of types, special catalogue free. General Catalogue of Mechanical & Electrical Gear, Tools, etc., 5,000 items, free. **K. R. WHISTON** (Dept. PET), New Mills, Stockport.

TRANSISTOR TESTERS, METERS, GADGETS. Coloured home telephones. Lists 3d. stamp. **C. & C. SYSTEMS**, 30 Baker St., London, W.1.

SPECIAL OFFER

MAGNETIC RECORDING TAPES

7"	1200'	8/6	1800'	13/0	2400'	22/0
5 1/2"	900'	6/9	1200'	10/0	1800'	17/6
5"	600'	6/0	900'	8/0	1200'	13/0

Post and packing 1/- per reel. Money refunded if not satisfied.

A. Marshall & Son, Dept. 9
25 Cricklewood Broadway, N.W.2
GLADstone 0161

FOR SALE
(continued)

ELECTRIC SOLDERING IRON



FANTASTIC BARGAIN OFFER
ONLY **9/6**
Lightweight Pistol Grip handle, 40 watt, 240 - 250v. A.C. Solid copper bit, detachable handle forms cover P. & P. 1/- for iron when not in use. With 4ft. Safety 3-core flex. Indispensable for every home handyman. A boon to model makers and a necessity for every electronics enthusiast. Offered to you at this new amazing price.

C. H. SERVICE (Dept. P.E.1)
Lusted Hall Lane, Tatsfield, Kent.

WANTED

WILL ANY reader offer for sale the Nov. 1964 and Jan. 1965 issues of P.E.?—Box 18.

MISCELLANEOUS

TRANSFORMERS REWOUND. Output or Mains. Specials made to order. Reasonable prices. RATCLIFFE, 27 Station Road, Holmfirth, Yorks.

GOVERNMENT SURPLUS Electrical and Radio Equipment. Our new catalogue No. 16 now ready, 2/6 Post Free, cost refunded on purchase of goods over £2. ARTHUR SALLIS RADIO CONTROL LTD., 93 North Road, Brighton.

HAMMER FINISH PAINT. The modern finish for electronics. Can be BRUSHED or sprayed. Blue or silver. 2oz tins 3/6, post 8d., 1 pint 7/6, post 1/9, 1 pint 15/-, post 2/9. Retailers supplied, write for details. Amazing results! Return of post service. Orders over 30/- post free. FINNIGAN SPECIALITY PAINTS, (PB), Mickley Square, Stocksfield, Northumberland.

CONVERT ANY TV SET into an Oscilloscope. Diagrams and Instructions, 12/6. REDMOND, 42 Dean Close, Portlade, Sussex.

FREE! YOUR NAME EMBOSSED ON VINYL TAPE

Give your equipment that professional look with colourful embossed self-adhesive labels. Write for details and your free label to:

CAPITOL ADVERTISING SERVICE
15 Newman Street, London, W.1.

RECEIVERS AND COMPONENTS

A.1 POST FREE BARGAINS. 25k or 50k 3watt w/wound pots with S.P. switch new and boxed 5/- ea. Guaranteed reclaimed valves. S.A.E. for list. A.1 RADIO COMPONENTS, 14 The Borough, Canterbury, Kent.

L.S.T. COMPONENTS

We have moved to larger premises at—
23 NEW ROAD, BRENTWOOD, ESSEX

Some bargains from our September stock list:—
OC76 2/4d; OC71, OC81, OC82, OC42, OC45 3/-;
ACY18 7/6; AC128 5/6; PHOTOTRANSISTOR
OCPT1 9/6d. TEXAS POWER TRANSISTORS
FROM 10/-, STC THERMISTORS G15 5/-.
STILL AVAILABLE: OUR FAMOUS 25 for 10/-
TRANSISTOR PACKS and 100 DIODES FOR 12/-.
RED SPOT NPN 1/-, POST PAID OVER 5/- ORDER.
SEND 6d STAMP FOR SEPTEMBER STOCK LIST.

RECEIVERS AND COMPONENTS

(continued)

SURPLUS AIRCRAFT NAVIGATION EQUIPMENT

Originally part of an aircraft direction finding equipment and containing A.R.B. approved components.

Power Units, 12 Volt D.C. Input, 25 Watts

Outputs 2 at 350V D.C. smoothed, and 1 at 6.3V. Contains 3—OC36, 2—OC72, 9—Diodes, transformer relay, etc. In mottle grey aluminium case 5½" x 5" x 6". Could be adapted for shaver operation.

With circuit diagram — 45/- + P. & P. 6/6d.
Diagram only 2/6 + 9d. P. & P.

Power Units as above but 24V Input.

40/- + P. & P. 6/6d.

M.F. Receiver. 200-400 and 500-900 KC/s.

Contains tuning and two I.F. stages, diodes and 2—OC170, 3—OC45, 2—OC702 and 2—OC318. In mottle grey aluminium case 9" x 5½" x 3½".

With circuit diagram — 55/- + P. & P. 6/6d.
Diagram only 2/6d. + 9d. P. & P.

Indicator Unit.

Contains 2½" C.R.T. Type DG7-5 (CV.2175), 2—ECC83, 1—ECC81, E.H.T. rectifiers and numerous condensers and resistors. In mottle grey aluminium case 9" x 6" x 3½" and would form the basis of a miniature Oscilloscope.

With circuit diagram — 55/- + P. & P. 6/6d.
Diagram only 2/6 + 9d. P. & P.

The above items are brand new and complete but have not been tested and cannot be guaranteed.

A small number of incomplete units of each version are available at 15/ each + P. & P. 4/-.

Components — all first grade.

Transistors	OC36—Matched pair	25/-	} P. & P. 9d.
"	OC36—Single	10/-	
"	OC170	7/-	
"	OC45	4/-	
"	AFZ12	12/6	
Valves	12AT7(ECC81)	4/-	
"	12AX7(ECC83)	5/-	

E.H.T. Rectifiers	K3.45	7/-	} P. & P. 1/-
Vinkors	LA2409	15/-	
"	LA2103	15/-	
Crystals	10-7 mc/s	15/-	

C.R. Tubes	DG7-5	25/-	P. & P. 3/6d.
------------	-------	------	------------------

Also many other items including capacitors, resistors, relays, diodes, slow motion drives, transformers, group wiring boards. Please send S.A.E. for list.

Enquiries and orders by post only to:—

N. J. GAWLER
40 Medina Road
GOWES
Isle of Wight

RECEIVERS AND COMPONENTS

(continued)

SILICON PLANAR NPN Transistors. 200Mc/s. High gain, minimum beta 100 @ 5/-. Extra high gain, minimum beta 250 @ 7/-. Genuine brand new. Quantity discounts. PNP types from 9d. By-return service. LONGLAND'S, 6 Mansfield Place, Ascot, Berkshire.

CHASSIS ARE OLD HAT! Get with it! Radiomatics printed circuit kits. Approx. 50 sq. in. of top quality P.C. board plus all chemicals to process it and many more, complete with comprehensive instructions. All parts available separately. 8/6 plus 2/6 post and packing from RADIOMATICS, 140 Oak Street, Norwich, Norfolk.

20% OFF!!

PICK-UPS, TRANSCRIPTION-UNITS, AMPLIFIERS, SPEAKERS
ALL MAKES 20% BELOW LIST PRICES
Terms C.O.D. only—Postage extra Mail Order Only
Send S.A.E. with enquiries please
HIGH FIDELITY CENTRE
61 West Street, Dorking, Surrey Tel. 4229

TRANSISTORS—“Red Spot” and “White Spot”—28/- per 100. GJ7M Rectifiers—80 PIV. 1 amp. £3 per 50. (Minimum quantities of any types.) G3LMR, 112 Groby Road, Glenfield, Leicester.

50 TRANSISTORS all tested, marked and guaranteed. AF.R.F. Silicon and P.N.P. Unobtainable elsewhere at this low price of 35/- plus P. & P. 1/-. D & W LTD., 224 West Road, Westcliff-on-Sea, Essex.

TRANSISTORS AND COMPONENTS

OC71, OC44, OC45, OC72, OC81, OC81D—3/- each. OC82—5/- each. OC26, ORP12—7/6 each. AF115, AF116, AF117, OC170, OC171—3/6d each.
BY100 Silicon Rectifier 250V at 550 M/A—5/- each.
BYZ 13 Silicon Rectifier 200V P.I.V. 6 Amps—5/- each.
AC126—8/- each. ACY18 7/6d. each. ASY28—8/6d each. ASY29—11/- each. ASY67—11/- each.
AF186 cut of FREQ 800 Mc/s—27/6.

M.A.T. TRANSISTORS

MAT 100 7/9.
MAT 101 8/6.
MAT 120 7/9.
MAT 121 8/6.
ADT 140 15/-.

Branded Mazda ECC85 valves—4/6d. each. 10 watt Transistor driver and output transformers—22/6d. each.

Acos Record Player cartridge, suits Collaro, Garrard, B.S.R., etc.—12/6d. each.

ZENER DIODES

VOLTAGE	ZENER CURRENT	POWER DISSIPATION
(Max)	(Max)	(Max)
4.1v	50 M/A	300MW
4.5v	50 M/A	300MW
9.5v	45 M/A	300MW
6.4v	45 M/A	300MW
4.9v	250 M/A	1.5W
5.4v	250 M/A	1.5W
6.6v	225 M/A	1.5W
ALL 3/6d. EACH		
11.6v	125 M/A	1.5W
25.5v	55 M/A	1.5W
31.6v	45 M/A	1.5W
37.8v	30 M/A	1.5W
45.2v	30 M/A	1.5W

SPECIAL OFFERS

Mullard matched sets of transistors.
10C82D & 20C82—10/6d. set.
10C44 & 20C45—9/6d. set.

S.A.E. all enquiries.
All Above Post Paid
Mail Order Only:

J. ROBINSON

(Radio & T.V.)

4 Highcliffe Road, Blackley, Manchester 9

CONTINUED OVERLEAF

RECEIVERS AND COMPONENTS

(continued)

TESTED TRANSISTORS

1/- each, Red or White Spots.

2/- each, XA101, XA102, XB103, OA90, XA111, XA112, OC430, V10/IS.

3/- each, OC44, OC45, OC70, OC71, OC81, OC81D, XA151, XB104, XC101, XC101A, OC169, OC200.

4/- each, AF114, AF115, AF116, AF117, OC170, OC171, XA103, XA116, XB102, XB105, XC121, XU611.

5/- each, OC139, OC140, OC204, ORP60, XA701, XA703, GET7, GET8, GET9, XC141, BY100, OA211.

10/- each, OC19, OC22, OC25, OC26, OC28, OC35, 2SO13.

ZENER DIODES 4.7 v. to 30 v. $\frac{1}{4}$ watt, $\frac{3}{6}$, 1.5 watt, 5/-, 7 watt, 6/- each.

Plus many more, send 6d. in stamps for Full List and Equivalent Chart:

B. W. CURSONS
78 BROAD STREET
CANTERBURY, KENT

R. & R. RADIO & TV SERVICE

Dept. P.E.

44 Market Street, BACUP. Tel. 465

Salvage Valves

6F13	4/6	PCF80	4/-
6F15	5/-	PCL83	5/-
6L18	4/6	PL81	5/-
6K25	10/-	PL82	4/-
6U4GT	5/-	PL83	4/-
6BW6	5/-	PY81	3/6
6/30L2	5/-	PZ30	5/-
EB91	1/-	U801	7/6
6F1	2/6	U301	6/-
EBF80	5/-	U329	5/-
EF80	1/6	10F1	1/-
EF91	2/6	10LD11	5/-
EF85	5/-	10P13	5/6
ECC82	4/-	10P14	5/-
EY86	4/-	20L1	5/-
ECL80	4/-	20F2	5/6
20P3	5/-	20D1	2/-
20P4	7/6	20P1	6/6
30F5	5/-	20P5	6/6
30PL1	5/-	30FL1	6/6
PL38	6/-	30P12	5/-
PL36	7/6	30P4	7/6
PY33	7/6	PY32	6/-
PCC84	4/-	PY82	5/-

Postage on valves 6d.—3 or more post free.

1 Pole 8-way switch, complete with 8 resistors 2 @ 1K, 2 @ 15K, one each of 22K, 15K, 18K, 6.8K. $\frac{3}{6}$ incl. post.

Fireball Tuners as removed 14/9. Selected Tuners 18/9. Speakers ex T.V. 6 x 4 inch 3/6. 8 inch rnd 6/- . Resistors New: $\frac{1}{2}$ watt 3 $\frac{1}{2}$ d., 1 watt 5d., 2 watt 9d. all 10%.

S.A.E. with all enquiries. All goods subject to satisfaction or money refunded.

SITUATIONS VACANT

A FULL TIME TECHNICAL EXPERIENCED SALESMAN required for Retail sales. Write giving full details of age, previous experience, and salary required to: The Manager, HENRY'S RADIO LTD., 303 Edgware Road, London, W.2.

RADIO TECHNICIAN

A number of suitably qualified candidates will be required for training, leading to permanent and pensionable employment. (Normally at Cheltenham but with opportunities for service abroad or appointment to other U.K. establishments including London).

Applicants must be 19 or over and be familiar with the use of Test Gear and have had Radio/Electronic workshop experience. They must offer at least "O" level GCE passes in English Language, Maths and/or Physics, or hold the City and Guilds Telecommunications Technician Intermediate Certificate or equivalent technical qualifications.

Pay according to age, e.g. at 19 £722, at 25 £929 (highest pay on entry) rising by four increments to £1,067.

Prospects of promotion to grades in salary range £997-£1,634.

Annual Leave allowance of 3 weeks 3 days, rising to 4 weeks 2 days.

Normal Civil Service sick leave regulations apply.

Apply

Recruitment Officer (RT/54)
Government Communications Headquarters
Oakley
Priors Road
CHELTENHAM, Glos.

DIGITAL COMPUTER

A simple digital Adder/Subtractor using switches and lamps only. A fascinating demonstration of Binary arithmetic. Full circuit, wiring diagram and notes on the Binary system, 3/6d.

NOUGHTS AND CROSSES MACHINE
Uses standard miniature switches and lamps only. This machine cannot be beaten. Full circuit, wiring diagram and instructions, 3/6d.

1% High Stability Resistors
 $\frac{1}{2}$ watt 1%, 2/- each. Full range 10 ohms to 10 Meg. Many special values for meter multipliers, etc. in stock.

1% Wirewound Resistors
1% 1 watt, 1 ohm to 5K, 3/-; to 20K, 4/3. 1% add 3d. Your value wound to order. Shunts down to 0.1 ohm.

High Resistance Phones 10/-, post 1/-.
100 Resistors 1, 2 and 5% assorted 9/6d.
Signal Injector Kit 10/-, post 1/-.

PLANET INSTRUMENT CO.
25 (E), DOMINION AVE., LEEDS 7

"PRACTICAL ELECTRONICS"

CONSTRUCTIONAL DESIGNS

All specified 1st grade Components, complete Metalwork, full range of Materials, engraved Panel Plates, Ancillary Equipment and Assembled Units. Comprehensive lists available for each "P.E." Constructional Article.

Please send 6d. in stamps for each design

MALVYN ENGINEERING WORKS
Engineers to the Radio and Electronic Industries
7 CURRIE STREET, HERTFORD, HERTS

TELEPHONE: HERTFORD 2264

RADIO AND ELECTRONICS BOOKS

ON FREE TRIAL

Then only 5/- weekly for those you keep!

No. 90. PIN-POINT TRANSISTOR TROUBLES IN 12 MINUTES. By Louis E. Garner, Jr., 485 pages. Companion manual to the well-known "Pin-Point T.V. Troubles in 10 Minutes" using the famous Coyne Check Chart Trouble Shooting Method. Covers all kinds of equipment including radios, T.V.'s, audio amplifiers, pre-amplifiers and just about everything. There are hundreds of photos, illustrations, diagrams and check charts; valuable reference sections. Supplies are limited so order your copy now and avoid disappointment. Price, 49/6 including postage.

No. 12N. RADIO SERVICING. 351 pages (hard covers), with hundreds of illustrations, circuits and diagrams. By G. B. Patchett and B. Fozard. Price 28/6d. including postage. A very thorough approach to learning radio servicing, starts with simple explanations and goes on to more advanced radio theory. Doesn't miss a single point. One of the most complete radio manuals ever published. A book you will use for years to come. This is the first time this book has ever been offered on a free trial basis. Order your copy now, see coupon below.

No. 13N. TELEVISION SERVICING. 320 pages, hard covers, 296 diagrams. Price, 26/- including postage. As described above, but teaches television repair.

No. 39. RADIO & ELECTRONICS COURSE. 216 pages, quarto size, 35 complete lessons. You will find this course easy to understand. The lessons are **CRYSTAL CLEAR, PRACTICAL, EASY TO MASTER AND USE.** Early lessons make fundamentals clear even to the beginner while other lessons will give you the practical knowledge of an expert! This is a modern course, that teaches without resorting to comic strip methods... Thousands of PRACTICAL ELECTRONICS and PRACTICAL WIRELESS readers have taken this course and enjoyed every minute of it... Why not you? Price for the complete course, 41/- including postage.

No. 22. PIN-POINT COLOUR T.V. TROUBLES IN 15 MINUTES. By Robert G. Middleton. 548 pages, 382 check charts. Just about the biggest and most useful manual on Colour T.V. available anywhere. Now is the time to get the complete information on this important new subject. Price, 49/6 including postage.

No. 8. PIN-POINT T.V. TROUBLES IN 10 MINUTES. Over 340 cross indexed pages, covers 70 symptoms, 700 trouble sheets, has 50 time saving check charts, 290 diagrams. Over 30,000 copies now used in the U.K. alone!

NOW REPRINTING. Orders accepted for delivery in four weeks' time. One of the best manuals we have ever handled, well worth waiting for! Price, 41/- including postage. Send coupon today for earliest delivery.

IRONCLAD GUARANTEE

Any book not satisfactory may be returned within 10 days post-paid for full refund of the purchase price.

FREE BOOK OFFER!

Send cash with order and qualify for any free book listed on the coupon as follows: Minimum 40/- One book, 80/- or more Two books, 120/- Three books.

NOTE. These books are authoritative and loaded with useful information, cost from 4/6 to 5/- each in book stores.

FREE TRIAL OFFER!

To Sim-Tech Technical Books, Dept. E3, Gater's Mill, West End, Southampton, Hants.

Please send the following books I have circled.

9C 12N 13N 39
22 8

If not delighted I may return any book post-paid without further obligation on my part, otherwise I will pay cash price or 5/- weekly (10/- fortnightly) commencing not later than 10 days after delivery. I am over 21 years of age. (If under 21 parents should place order).

I enclose cash to the sum of £
I understand you will refund this money if I am not 100% satisfied (provided I return the book in good condition within 10 days).

Please send me the free book(s) I have ticked.

- Oscilloscope Book.
 Electronics Gadgets Book.
 Transistor Book.
 Radio Instruments Book.

Name

Address

Z & I AERO SERVICES LTD.

Head Office and Warehouse: 44A WESTBOURNE GROVE, LONDON, W.2.

Retail Shop:

85 TOTENHAM COURT, LONDON, W.1

Tel.: LAngham 8403 Open all day Saturday

Tel.: PARK 5642/213



0A2	6/-	6AK6	7/-	6BW6	9/8	6SL7GT	5/-	128K7	5/-		
0B3	6/-	6AK7	6/-	6CW7	10/-	6S4G	4/8	128Q7GT	6/-		
0C3	6/-	6AM3	2/6	6CB6	5/-	6S7GT	5/-	128R7	5/-		
0D3	5/-	6AM6	4/-	6CP6	5/-	6T8	7/-	128Y	6/-		
1H5GT	7/-	6AN4	15/-	6CP6G	6/12	6U4GT	10/-	1487	20/-		
1N5GT	8/-	6AN5	15/-	6CL6	9/-	6V6	9/-	19AQ5	5/-		
1R4	6/-	6AN8	10/-	6CV4	12/-	6V6GT	7/8	19G3	25/-		
1R5	5/-	6AQ4	5/-	6CX3	10/-	6X4	4/-	19G6	15/-		
1R4	5/-	6AQ5	6/-	6CV7	11/-	6X5C	4/8	20P2	12/-		
1R5	4/6	6AQ6A	7/6	6DK6	6/-	6Y6G	7/8	20L1	14/-		
174	3/-	6AR5	6/-	6F1	14/-	6Z6C	8/-	20P1	14/-		
175GT	6/-	6AR6	6/-	6F6	8/-	12AD6	8/-	20P3	12/-		
1U4	5/-	6AR8	17/8	6F7	5/-	12AH7GT	20P4	14/-	3523	10/-	
1U5	6/-	6AS5	5/-	6F8G	5/-	20P5	12/-	3524	10/-		
1X2A	7/-	6AS6	5/-	6F11	6/-	20P6	12/-	3524GT	8/8		
1X2B	7/-	6AS7G	20/-	6F13	6/6	20P7	12/-	3524GT	8/8		
2A3	5/-	6AT6	4/6	6F14	15/-	20P8	12/-	3524GT	8/8		
2D21	6/-	6AU4GT	9/-	6F15	11/-	20P9	12/-	3524GT	8/8		
2X2	3/-	6AU6	6/-	6F17	6/-	20P10	12/-	3524GT	8/8		
3A4	4/-	6AU8	9/-	6F23	11/8	20P11	12/-	3524GT	8/8		
3B5	7/-	6AV6	6/-	6F24	12/-	20P12	12/-	3524GT	8/8		
3Q4	6/6	6AW8A	14/-	6F25	12/-	20P13	12/-	3524GT	8/8		
3Q5GT/6G6	6/6	6AX5GT	6F26	6/6	12AW6	20/-	30A5	7/7	150B2	10/-	
3R4	5/-	12/8	6F28	10/6	12AX7	6/-	30C1	7/6	150C4	7/6	
3V4	6/-	6B7	5/-	6F32	3/-	12AX7	10/-	30C15	11/11	185BT	15/-
3Y4GY	9/-	6B8	7/8	6GG6	2/8	12BA4	9/-	30C17	13/17	807	9/-
4R4	4/-	6BR8	2/6	6J4	2/6	12BA6	6/-	30C18	11/11	813	7/-
5U4G	5/-	6BRGT	5/-	6J5	6/6	12BB6	5/-	30P5	11/11	832	20/-
5U4GB	6/6	6BA5	5/-	6J6	3/6	12BH7A	7/-	30FL1	12/6	866A	14/-
5V4G	9/-	6BE5	5/6	6J7	9/-	12BY7A10	7/-	30FL2	12/12	954	5/-
5Y3GT	5/-	6BG6	15/-	6KG6	6/-	12E1	20/-	30FL14	12/12	955	3/-
5X4G	8/-	6BH6	7/6	6KGT	5/-	12J5CT	3/-	30L1	6/6	956	2/-
5Z4	7/8	6BK4	25/-	6K8	8/-	12J7CT	7/8	30L15	12/6	958A	4/-
5Z4GT	6/6	6BK7A	9/-	6L6GA	6/-	12J9GT	5/8	30L17	14/14	959	8/-
630L2	11/-	6BL7GT	9/-	6N7GT/G7	7/8	12S47	7/-	30P12	10/10	2050	12/6
6AF4	10/-	6BN6	7/6	6P25	12/6	12SC7	4/-	30P19	14/14	5763	10/-
6AF6G	11/-	6BQ5	11/-	6Q7/6	6/-	12SR5GT	9/-	30P11	12/12	6136	9/-
6AG7	6/-	6BQ7	8/-	6R7	6/-	12SG7	4/-	30P11.3	12/12	6146	27/6
6AJ5	9/-	6B17	12/6	6S17	8/-	12SH7	4/-	30P11.4	12/6	6159	32/6
6AN5	5/6	6BR8	5/-	6S17	8/-	12S17	4/-	30P11.5	12/-	6330	4/-

BRAND		95A5	11/-	9002	5/8	EBC91	6/-	EP93	5/-	EZ81	5/6	PFL200	17/6	UBF80	7/8
		35C5	6/6	9003	9/-	EBC84	7/8	EP94	4/7	EZ82	4/7	PFL200	17/6	UBF89	7/8
		35D5	12/-	A2134	8/-	EBC85	6/6	EP95	5/6	GZ30	8/-	PL38	16/16	UBR21	11/-
		35L6GT	7/-	AC/HL/DD	8/-	EBC86	7/-	EP97	11/6	GZ32	10/-	PL81	8/-	UCCR4	10/-
		35W4	5/-			EBC88	10/-	EP98	11/6	GZ34	10/-	PL82	7/6	UCCR5	7/-
						EBC89	12/-	EP18	8/-	KT66	16/-	PL83	7/6	UCP90	10/-
						EBC90	12/-	EP184	8/-	KT88	22/-	PL84	7/6	UGH21	9/6
						AC/TH/10	4/-	EP184	8/-	KT88	22/-	PL262	14/-	UCH42	9/6
						AZ31	9/-	EP184	8/-	KT88	22/-	PL500	15/-	UCH43	8/-
						C133	9/-	EP184	8/-	KT88	22/-	PL500	15/-	UCH43	8/-
						CY31	7/-	EP184	8/-	KT88	22/-	PL500	15/-	UCH43	8/-
						DA30	10/-	EP184	8/-	KT88	22/-	PL500	15/-	UCH43	8/-
						DAP91	4/8	EP184	8/-	KT88	22/-	PL500	15/-	UCH43	8/-
						DAR96	7/8	EP184	8/-	KT88	22/-	PL500	15/-	UCH43	8/-
						DE22	42/8	EP184	8/-	KT88	22/-	PL500	15/-	UCH43	8/-
						DP96	7/8	EP184	8/-	KT88	22/-	PL500	15/-	UCH43	8/-
						DK92	9/8	EP184	8/-	KT88	22/-	PL500	15/-	UCH43	8/-
						DK96	8/8	EP184	8/-	KT88	22/-	PL500	15/-	UCH43	8/-
						DL92	5/8	EP184	8/-	KT88	22/-	PL500	15/-	UCH43	8/-
						DL93	4/8	EP184	8/-	KT88	22/-	PL500	15/-	UCH43	8/-
						DL95	6/8	EP184	8/-	KT88	22/-	PL500	15/-	UCH43	8/-
						DL96	7/8	EP184	8/-	KT88	22/-	PL500	15/-	UCH43	8/-
						DM70	5/8	EP184	8/-	KT88	22/-	PL500	15/-	UCH43	8/-
						DM160	10/-	EP184	8/-	KT88	22/-	PL500	15/-	UCH43	8/-
						E88CC	14/14	EP184	8/-	KT88	22/-	PL500	15/-	UCH43	8/-
						E180F	15/-	EP184	8/-	KT88	22/-	PL500	15/-	UCH43	8/-
						EAB380	7/8	EP184	8/-	KT88	22/-	PL500	15/-	UCH43	8/-
						EAF42	9/-	EP184	8/-	KT88	22/-	PL500	15/-	UCH43	8/-
						EAF41	5/-	EP184	8/-	KT88	22/-	PL500	15/-	UCH43	8/-
						EF80	8/8	EP184	8/-	KT88	22/-	PL500	15/-	UCH43	8/-
						EF85	6/6	EP184	8/-	KT88	22/-	PL500	15/-	UCH43	8/-
						EF86	8/8	EP184	8/-	KT88	22/-	PL500	15/-	UCH43	8/-
						EF87	9/6	EP184	8/-	KT88	22/-	PL500	15/-	UCH43	8/-
						EF88	5/8	EP184	8/-	KT88	22/-	PL500	15/-	UCH43	8/-
						EF91	4/8	EP184	8/-	KT88	22/-	PL500	15/-	UCH43	8/-
						EF92	2/8	EP184	8/-	KT88	22/-	PL500	15/-	UCH43	8/-

TRANSISTORS											
AF114	9/-	OC28	17/6	OC72	6/6	OC139	12/-	OC264	17/6	GET114	5/6
AF115	7/8	OC29	17/6	OC73	11/-	OC140	12/-	OC265	10/6	GET115	8/6
AF116	10/6	OC35	15/-	OC75	6/6	OC141	25/-	OC266	22/6	GET116	12/-
AF117	6/-	OC36	15/-	OC77	8/-	OC170	25/-	2N410	3/6	GET175	9/-
AF118	17/6	OC42	7/6	OC78	6/-	OC171	8/-	2N412	3/6	GET180	10/-
OC23	17/6	OC44	6/-	OC78D	6/-	OC200	9/6	2N697	17/6	MAT101	8/6
OC24	22/6	OC45	5/-	OC81M	7/-	OC201	20/-	2N802	20/-	MAT121	8/6
OC25	12/-	OC70	5/-	OC81DM	7/-	OC202	15/-	2N804	15/-	T1166	6/-
OC26	8/-	OC71	5/-	OC83	6/-	OC203	12/-	2N806	20/-		

As used in P.E. Oscilloscope described in March and April issues. £2.10.0. Base 4/6. P. & P. 5/-.

NUVISTOR TRIODES
2CW4, 6CW4—(2V or 6.3V heaters) for T.V. & F.M. Tuner Application. 12/-
6DS4—as above, but suitable for weak signal areas. 15/-
Bases for the above 2/6.

CATHODE RAY TUBES 3GP1				PHOTOCELLS G816			
Caesium Antimony, Side-on Window. HT 160V. Sensitivity 100μA/L. 5/-				Caesium Antimony, Side-on Window. HT 160V. Sensitivity 100μA/L. 5/-			
ZENNER DIODES							
OA2200	10/-	OA2207	10/-	VR425	6/6		
OA2201	9/8	OA2308	6/-	VR475	6/6		
OA2202	6/-	OAZ219	6/-	VR575	6/6		
OA2204	6/8	OAZ211	5/6	VR7B	6/8		
OA2205	6/-	OAZ212	7/6	VR10A	8/-		
OA2206	8/-	OAZ213	6/8	VR11A	8/-		

PLEASE SEND SAE (FOOLSCAP) FOR FULL PRICE LIST. Please add 2/6 in 3 for postage. Minimum charge 2/-. No O.O.D. Orders Accepted. Please address all correspondence to the Head Office.

SEND TODAY OR CALL

SAVE £8 NOW! ORIGINALY #H496

AMAZING PURCHASE FROM GRANADA GROUP OF COMPANIES

GENUINE TRANSWAVE 2 BAND RADIOS MODEL 720/15L

7 SONY TRANSISTORS SLASHED TO £3.19.6 POST ETC. 2/6 OR 20-DEP

Fraction of their worth! Brand new. A superb portable Transistor Tape Recorder. Record voice, music, everything! WITH VOLUME CONTROL! Ultra sensitive "built-in" speaker! More compact! More powerful! Super tone! Super performance. Try matching it for 15 gns! Records plays, meetings, etc. Permanent recordings on tape again and again. Ideal reporters, dictating, etc. Simple to operate. Fully g'teed. With microphone and standard Batteries (Cheap to run) replaceable anywhere. Standard model 79/6. P. 5/-. Or Credit Service, simply send 5/- P. & P., bal. 18 flnly. pyts. 5/6. Carrier top 20/- extra. Super tape 12/6 extra, state if required. Refund guarantee. Lists.

SENSATIONAL PURCHASE OF RECENT LARGE LIQUIDATED STOCK!

ALL TRANSISTOR TAPE RECORDER NOW ONLY **79/6** POST ETC 2/6 **NO DEPOSIT**

Headquarter & General Supplies Ltd.

SAVE £4.10 NOW! WHY PAY £5.19.6?

G'TEED ENGLISH MADE!

4 amp BATTERY CHARGER ONLY 29/6 POST ETC 2/6 NO MORE TO PAY!

Splendid 4-amp battery charger, 200/250V. So simple to use—plug in and clip to battery—leave overnight—battery well charged by morning—full power for starter, lights and horn. Why pay £5.19.6? Our price, due colossal deal, 29/6, post 4/6. With all leads and clips. Fitted with amp. meter for both 6 AND 12-volt batteries. Refund guarantee. Also Motor Cycle-Scooter model 1-amp. 28/6. carr. 3/6. Both guaranteed for years of service. SEND QUICKLY OR CALL AT OUR STORES

PORTABLE INTERCOM/ELECTRONIC BABY SITTER'

DE LUXE 6GNS MODEL

MODEL! 57/6 POST ETC 2/6

Transistor intercom system, originally listed at £6/6.0—now only 57/6, post 2/6, or 10/- dep. Credit Service Terms balance 18 flnly. pyts. of 3/3 plus post. With approx. 66ft. connecting flex, also usable for longer distances. 9-volt battery 2/6 ex. (replaceable). Every sound relayed! Hear what goes on—every sound, every movement. Two-way buzzer call and speaker system. Also usable on wall or desk in conjunction with radio, office to office, house to garage and many other uses. Only transistor model with new seal off infallible insulation! Refund if not delighted with this superb bargain. Send today or call. LISTS RADIOS.

(DEPT. PE/2) 196-200 COLDBARBOUR LANE LOUGHBOROUGH JUNCT., LONDON, S.E.1 (Wed. 1 p.m.)

4-STATION INTERCOM



£7/19/0

Solve your communication problems with this latest 4-Station Transistor Intercom system (1 Master and 3 Subs), in deluxe plastic cabinets for desk or wall mounting. Call/talk/listen from Master to Subs and Subs to Master. Operates on one 9V battery. On/off switch. Volume control. Ideally suitable to modernize Office, Factory, Workshop, Warehouse, Hospital, Shop, etc. for instant inter-departmental contacts. Complete with 3 connecting wires, each 66 ft. and other accessories. Nothing else to buy. P. & P. 5/4. 3-Station Intercom same as 4-St. Int. £5.19.0. P. & P. 4/-.

INTERCOM/BABY ALARM



Usually 6/10/-
Our Price ONLY

57'6

Modernize your Office, Shop, Warehouse, Workshop, Surgery, Nursery, and home with this latest two-way Transistor Intercom, consisting of two units, Master and Sub, in strong plastic cabinets with chromium stands. Elegantly designed to use as two-way instant communication system—Call/talk/listen—between two persons anywhere indoors or outdoors. Both units operate on one 9V battery. Complete with accessories. Ready to operate. P. & P. 2/6.

BATTERY ELIMINATOR AND CHARGER 27/6
Use your Transistor Radio or Intercom from domestic A.C. mains and charge dry battery PP3 9V to boost battery's life many times. Unbeatable value. Save your pounds on batteries. P. & P. 1/6. Complete with Plug, Lead and Snap cord.
Full price refunded if not satisfied in seven days.

WEST LONDON DIRECT SUPPLIES (PE/1)
6 Chignell Place, West Ealing, London, W.13

SERVICING ELECTRONIC ORGANS

by Pittman & Oliver 30/- P. & P. 1/3
Detailed discussions cover the operation and servicing of tone generators, pedal generators; sustain, vibrato, and tremolo oscillators, key switches, percussion, voicing, amplifier and power circuits, etc.

HAM ANTENNA CONSTRUCTION PROJECTS, by Stanley 24/- P. & P. 1/-
PRINCIPLES OF TRANSISTOR CIRCUITS, New Edition by Amos 25/- P. & P. 1/-
PRACTICAL OSCILLOSCOPE HANDBOOK, by R. Turner, 25/- P. & P. 1/-
ELEMENTS OF TRANSISTOR PULSE CIRCUITS, by Towers 35/- P. & P. 1/3
TRANSISTOR SPECIFICATIONS MANUAL, by Sams—data on all types American, Jap. etc. 24/- P. & P. 1/-
HOW TO LISTEN TO THE WORLD, New Edition by Johansen 20/- P. & P. 1/-

PICK UPS, THE KEY TO HI-FI, by Walton 10/6 P. & P. 8d.

Where possible 24-hour service guaranteed

UNIVERSAL BOOK CO.
12 LITTLE NEWPORT STREET
LONDON, W.C.2

(Leicester Square Tube Station)

AMPLIFIERS AND SPEAKERS NORTHCOURT "FIVE" AMPLIFIER

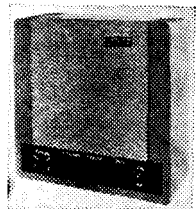

Suitable for guitars, grams and radios. The 5 watt output amplifier incorporates separate volume, treble and bass controls. Two jack socket inputs are fitted. Twin speakers give exceptionally realistic reproduction and are built into an attractive cabinet. Size: Length 11 1/2 in. Height 11 1/2 in. Depth 5 1/2 in. Finished in mottled grey with the front covered in VYNAIR. Mains Voltage 200/250, 50 K/c. Ideal for home use with any guitar. Retail £9.17.6.

production and are built into an attractive cabinet. Size: Length 11 1/2 in. Height 11 1/2 in. Depth 5 1/2 in. Finished in mottled grey with the front covered in VYNAIR. Mains Voltage 200/250, 50 K/c. Ideal for home use with any guitar. Retail £9.17.6.

P.A. EXTENSION SPEAKER

Suitable for radio and Record Players. Size: Length 10 in. Height 7 in. Depth 5 in. Fitted in durable industrial finished wood cabinet, attractively finished in mottled grey. Speaker front covered in VYNAIR. Price 29/9 Retail. As above fitted with volume control, 35/9 Retail.

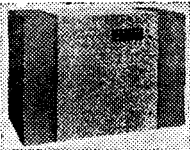

P.A. TWIN EXTENSION SPEAKER
Suitable for all radio and record players (incorporating two speakers 6x4 in.). Size: Length 12 in. Height 7 1/2 in. Depth 5 1/2 in. Fitted in durable industrial finished wood cabinet, attractively finished in mottled grey. Speaker front covered in Vynair. Price 39/6 Retail. As above fitted with volume control, 43/6 Retail.

FULLY SHROUDED UPRIGHT TRANSFORMERS

350-0-350 100mA 6.3v. 4A C.T. 0-5v. at 3 amp. 29/6 Retail.
300-0-300 100mA 6.3v. 4A C.T. 0-5v. at 3 amp. 29/6 Retail.
250-0-250 100mA 6.3v. 4A C.T. 0-5v. at 3 amp. 29/6 Retail.

All products guaranteed 12 months. Trade supplied. For name of nearest stockist and full accessory brochure, write to:

NORTHCOURT (Electrical Bfd.) LIMITED

Transformer and Coil Manufacturers
Dept. P.E. SOUTH PARK MILLS
PUDSEY, Yorks.



LOWEST EVER PRICES

5in.	Std.	600ft.	8/6
7in.	Std.	1,200ft.	12/6
5in.	L.P.	900ft.	10/0
5 1/2 in.	L.P.	1,200ft.	12/6
7in.	L.P.	1,800ft.	15/0
4in.	D.P.	600ft.	9/0
5in.	D.P.	1,200ft.	15/0
5 1/2 in.	D.P.	1,800ft.	22/6
7in.	D.P.	2,400ft.	25/0

Attractively boxed, guaranteed. Brand New. Obtainable at these low prices ONLY from: **GEE BROS. (RADIO) Ltd. (Dept. P.E.), 15 Little Newport St., W.C.2. Ger. 6794** Adjoining Leicester Square Tube Station

COMMUNICATIONS RECEIVERS



NATIONAL NC190

INTERNATIONALLY FAMOUS NATIONAL RECEIVERS

HRO-500—completely solid state professional receiver. 5 kc/s to 30 Mc/s in sixty 500 kc/s bands. £705.

NC190—10 valves, 540 kc/s to 30 Mc/s, S-meter, noise limiters, product detector, bandspread, double conversion. £97.4.2.

NC77X—beginner's receiver, 5 valves, 540 kc/s, to 30 Mc/s, built-in speaker. £32.8.9.

Write for illustrated leaflets

WE HAVE A LARGE STOCK OF NEW AND SECONDHAND RECEIVERS—MANY SECONDHAND BARAINS IN MINT CONDITION
Just write or phone for full details

BRIAN J. AYRES & CO.
Dept. DX, 21 Victoria Road
Surbiton, Surrey
Telephone: Elmbridge 2833

BATTERY ELIMINATORS

The ideal way of running your TRANSISTOR RADIO, RECORD PLAYER, TAPE RECORDER, AMPLIFIER, etc. Types available: 9v; 6v; 4 1/2 v (single output) 39/6 each. P. & P. 2/9. 9v + 9v; 6v + 6v; or 4 1/2 v + 4 1/2 v (two separate outputs) 42/6 each. P. & P. 2/9. Please state output required. All the above units are completely isolated from mains by double wound transformer ensuring 100% safety.

R.C.S. PRODUCTS (RADIO) LTD.
(Dept. P.E.), 11 Oliver Road, London, E.17

PRINTED CIRCUIT BOARDS Available for GULTON ultrasonics remote control system. Mullard 10 Watts Transistor Amplifier. Write for details to: **TATES ELECTRONIC SERVICES LTD.** 3 WATERLOO ROAD, STOCKPORT, CHESHIRE

Please mention

PRACTICAL ELECTRONICS

when replying to

Advertisements

TRANSISTOR BARGAINS!

OC 71 equivalent	1/- each
					£1 for 25
NKT 124/5 Switching type	2/- each
					10/- for 6
2G 371	2/6
OC 25	10/-
OC 35	10/-
NKT 405	10/-

Packet containing:

3 2G417	} £1 complete
2 2G371	
1 2G381	
1 2G339	
1 Diode	

(For making superhet with complementary symmetry transformerless output stage)

Diodes	1/-
Zener Diodes, ZE12, ZB4:3	5/-
BY 100 Rectifiers	7/6

Colvern 10 ohm pre-sets...	2/6
50K ohm pre-sets	1/6
1K ohm Skeleton pre-sets	1/-

Resistors, 1/6th and 1/10th watt. Your choice of value.
 Minimum 10 of any value ... 10/- per 100
 Mixed values and wattages ... 50/- per 1,000

Condensers, 2.2uuf., 500uuf., 0.0001, 0.001, 0.002, 0.005, 0.02, 0.04 uf
 7/6 per 100
 £3 per 1,000

RELAYS

700 ohm or 2,500 ohm coil. Transparent dust cover. 2 pairs of change-over contacts. PLUG-IN TYPE. Base included in price 25/- each

ELECTROLYTIC CONDENSERS TUBULAR

2uf, 4uf, 8uf, 16uf, 32uf, 64uf.	15V.	Special price	...	1/2 each
2uf ... 30Volt	...	200uf ... 30Volt	...	} All at 2/- each
25uf ... 30Volt	...	250uf ... 6Volt	...	
50uf ... 30Volt	...	250uf ... 15Volt	...	
100uf ... 30Volt	...	320uf ... 2.5Volt	...	
100uf ... 6Volt	...	400uf ... 6.4Volt	...	
100uf ... 18Volt	...	500uf ... 15Volt	...	
100uf ... 30Volt	...	500uf ... 50Volt	...	
1,000uf ... 6Volt	...			
1,000uf ... 12Volt	...			
1,000uf ... 15Volt	...			
1,000uf ... 25Volt	...			
		1,000uf 50Volt Can-type	3/-	

Special offer: Television smoothing condensers 200/100uf or 200/200uf 275Volt. Whilst stocks last. 6/6 each

FLUORESCENT FITTINGS. Bargain price!

5' Slim-line with choke and starter	39/6 (less tube)
4' Slim-line with choke and starter	32/6 (less tube)

Carriage extra on above 10/- per fitting

Special circuit and components to make transistorised:

HIGH FIDELITY LOW-NOISE PRE-AMPLIFIER	30/-
RUMBLE AND SCRATCH FILTER	30/-
REV. COUNTER FOR CAR (excluding meter)	10/-
SIGNAL INJECTOR	10/-
VERY HIGH IMPEDANCE (1 MEG. OHM/VOLT)	15/-
MULTIRANGE VOLTMETER (excluding meter)	30/-
20 MEG. OHM OHM-METER (excluding meter)	15/-
Brand-new Meters suitable for above applications	30/- each
New 4in. LOUDSPEAKERS	10/-
Midget Ear-phones with plug and lead	5/-
Magnetic Lapel Microphone with plug and lead	10/-

VERNIER DIALS

1 1/2in. 8:1 ratio	180° Calibration	14/-
2in. 8:1 ratio	180° Calibration	15/6
3in. 8:1 ratio	180° Calibration	17/-

Very useful pocket-size 1,000 o.p.v. Multimeter £3

Extra special Bargain!

ACOS PICK-UP HEADS. Complete with needles	
Monaural	14/-
Stereo	21/-
Stereo with Diamond Needles	28/9

For orders of 10/- or less please add 6d. toward postage. Regret that no orders can be accepted under 5/-. Orders over £5 deduct 5% Cash Discount.

G. F. MILWARD

17 PEEL CLOSE
 DRAYTON BASSETT

Near TAMWORTH, STAFFS.

TAMWORTH 2321

POST ONLY

EXCEL

in

ELECTRONICS

Through this ICS 3-way Training Method:

1 MASTER THE THEORETICAL SIDE
 From basic principles to advanced applications, you'll learn the theory of electronic engineering, quickly and easily through ICS. That's because each course is set out in easy-to-understand terms.

2 MASTER THE PRACTICAL SIDE
 ICS show you how to develop your practical abilities in electronic engineering—alongside your theoretical studies. It's the only sure way to success. All training manuals are packed with easy-to-follow illustrations.

3 MASTER THE MATHEMATICAL SIDE
 To many this aspect is a bitter problem. Even more so because no electronic engineer is complete without a sound working knowledge of maths. But new ICS teaching makes mathematics easier to learn.

Wide range of courses available include:
 Radio/T.V. Engineering and Servicing, Colour Television, Electronics, Electronics Maintenance, Instrumentation and Servomechanisms, Telemetry, Computers, etc.
NEW! Programmed Course on Electronic Fundamentals

EXPERT COACHING FOR:
 INSTITUTION OF ELECTRONIC AND RADIO ENGINEERS
 CITY AND GUILDS TELECOMMUNICATION TECHNICIANS
 CITY AND GUILDS SUPPLEMENTARY STUDIES
 R.T.E.B. RADIO/T.V. SERVICING CERTIFICATE
 RADIO AMATEURS' EXAMINATION
 P.M.G. CERTIFICATES IN RADIOTELEGRAPHY

And there are practical "learn as you build" radio courses as well.

Member of the Association of British Correspondence Colleges.

FOR **FREE HANDBOOK** POST THIS COUPON TODAY

I.C.S., Dept. 151, INTERTEXT HOUSE,
 PARKGATE ROAD, LONDON, S.W.11

NAME

ADDRESS

OCCUPATION.....AGE..... 11.65

INTERNATIONAL CORRESPONDENCE SCHOOLS

QUALITY RECORD PLAYER AMPLIFIER

A top-quality record player amplifier. This amplifier (which is used in a 29 gn. record player) employs heavy duty double wound mains transformer, ECC83, EL84, EZ80 valves. Separate Bass, Treble and Volume controls. Complete with output transformer matched for 3 ohm speaker. Size 7in. w. x 2 1/2 in. d. x 5 1/2 in. h. Ready built and tested. PRICE 69/6. P. & P. 4/9.

ALSO AVAILABLE mounted on board with output transformer and 6in. speaker ready to fit into cabinet below. PRICE 89/6. P. & P. 5/9.

QUALITY PORTABLE R/P CABINET
Uncut motor board. Will take above amplifier and B.S.R. or GARRARD Autochanger or Single Record Player Unit. Size 18 x 14 x 8 1/2 in. PRICE £3/9/6. Carr. 7/6.

4-SPEED PLAYER UNIT BARGAINS

All brand new in maker's original packing.
SINGLE PLAYERS
B.S.R. TU12 £3/9/6. Carr. 5/6.
GARRARD SP25 De Luxe... £12/10/6. Carr. 5/6.
B.S.R. GUT with unit mounted pickup arm. £4/18/8. Carr. 5/6.

AUTO CHANGERS

B.S.R. UA15 £6/19/6. B.S.R. UA16 £6 19 6
Latest B.S.R. UA25 Super slim £6 2 6
Latest GARRARD AT5 £8 8 0
GARRARD AT6 £10 10 0
GARRARD Auto-Slim £6.10.0. Carr. 6/6 on each.
All the above units are complete with t/o mono head and sapphire styl or can be supplied with compatible stereo head for 12/6 extra.

BRAND NEW CARTRIDGE BARGAINS!
GARRARD GC2 MONO complete. List price 24/11. Our price 12/6. P. & P. 1/-.

RONETTE STEREO 105 CARTRIDGE
Stereo/178 complete with two sapphires. Original list price 67/9. Our price 24/-. P. & P. 1/-.

MAINS TRANSFORMERS

Fully shrouded, can be mounted upright or drop through. Tapped pri. 110, 200, 220, 240v. Sec. 250v. 1/2 wave at 85mA and 6.3v. 2 amps. c/t. Stack size 3" x 2 1/2" x 1 1/2". PRICE £2/6. P. & P. 3/6. ALSO Semi shrouded drop thro' type. Pri. 200, 220, 240v. Sec. 250v. 1/2 wave at 70mA and 6.3v. at 2 amp. c/t. Stack size 3" x 2 1/2" x 1 1/2". PRICE 11/-. P. & P. 3/-.

BRAND NEW 3 OHM LOUDSPEAKERS

5in., 12/6; 6in. 15/-; 8in., 21/-; 10in., 25/-; 12in., 27/6; (12 in. 15 ohm, 30/-), 10 in. x 6 in., 26/-. E.M.I. 131 x 8 in. with high flux ceramic magnet. 42in. (15 ohm, 45/-). 4in HIGH FLUX TWEETER. 3 ohm and 15 ohm imp. Famous British make. Few only 12/-. P. & P. 4" & 5" 2/-, 6 1/2" & 8" 2/6, 10" & 12" 3/6 per speaker.

ACOS CRYSTAL MIKES. High imp. For desk or hand use. High sensitivity, 18/6. P. & P. 1/6.

YSL CRYSTAL STICK MIKE. Listed at 43/-. Our price, 18/6. P. & P. 1/6.

BRAND NEW. 12" 15w. H/D Speakers, 3 or 15 ohm. Current production by well-known British maker. Offered below list price at 89/6. P. & P. 5/-. (£28w. guitar model £5.5.0). (35w. guitar model £8.8.0).

MATCHED PAIR OF 21 WATT TRANSISTOR DRIVER AND OUTPUT TRANSFORMERS. Stack size 1 1/2 x 1 1/2 x 1/2 in. Output trans. tapped for 3 ohm and 15 ohm output. 10/- pair plus 2/- P. & P.

BRAND NEW PLESSEY 12.4 pin non-syn-c. vibrators. Type 12.1.45D. ONLY 8/6. P. & P. 1/6

4-WAY NON-TANGLE TELEPHONE CABLE
Latest spring-back coil type, extends 12 in. to 5ft. Complete with rubber bushes. 4/6 each. P. & P. 1/6.

YVNAIR AND REXINE SPEAKER AND CABINET FABRICS app. 54 in. wide. Usually 35/- yd., our price 13/6 per yd. length (mm. 1yd.) P. & P. 2/6. S.A.E. for samples.

STEREO AMPLIFIER

Incorporating 2 ECL82s and 1 EZ80, heavy duty, double wound mains transformer. Output 4 watts per channel. Full tone and volume controls. Absolutely complete.

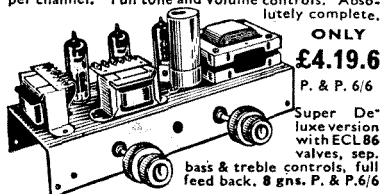

ONLY £4.19.6 P. & P. 6/6

Super Deluxe version with ECL86 valves, bass & treble controls, full feed back. 8 gns. P. & P. 6/6

HIGH GAIN 4 TRANSISTOR PRINTED CIRCUIT AMPLIFIER KIT Type TA1

- Peak output in excess of 1 1/2 watts.
- All standard British components.
- Built on printed circuit panel, size 6 x 3in.
- Generous size Driver and Output Transformers.
- Output transformer tapped for 3 ohm and 15 ohm speakers.
- Transistors (GET 114 or 51 Mullard OCB D and matched pair of OCB1 sop).
- 9 volt operation.
- Everything supplied, wire, battery clips, solder, etc.
- Comprehensive easy to follow instructions and circuit diagram 1/6 (Free with Kit). All parts sold separately.
- SPECIAL PRICE 45/-. P. & P. 3/-. Also ready built and tested, 52/6. P. & P. 3/-. A pair of TA1s are ideal for stereo.

TAPE DECKS

B.S.R. MONARDECK (Single speed) 3 1/2 in. per sec., simple control, uses 5 1/2 in. spools, £6/15/- plus 7/6 carr. and ins.

COLLARO STUDIO DECK 3 motors, 3 speeds push button control. Up to 7in. spools £10/10/- P. & P. 7/6. (Tapes extra on both.)

10/14 WATT HI-FI AMPLIFIER KIT

A stylishly finished monaural amplifier with an output of 14 watts in push-pull. Super reproduction of both music and speech, with negligible hum. Separate inputs for mike and gram allow records and announcements to follow each other. Fully shrouded section wound output transformer to match 3-15Ω speaker and 2 independent volume controls, and separate bass and treble controls are provided giving good life and cut. Valve line-up 2 EL84s, ECC83, EF86, and EZ80 rectifier. Simple instruction booklet 1/6. (Free with parts.) All parts sold separately. ONLY £6/19/6. P. & P. 8/6. Also available ready built and tested complete with std. input sockets. £8/15/-. P. & P. 8/6.

3-VALVE AUDIO AMPLIFIER MODEL HA34

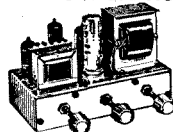

Designed for Hi-Fi reproduction of records, A.C. Mains operation. Ready built on plated heavy gauge metal chassis, size 7 1/2 in. w. x 4 in. d. x 4 1/2 in. h. Incorporates ECC83, EL84, EZ80 valves. Heavy duty, double wound mains transformer and output transformer matched for 3 ohm speaker, separate Bass, Treble and Volume controls. Negative feedback line. Output 4 1/2 watts. Front panel can be detached and leads extended for remote mounting of controls.

The HA34 has been specially designed for us and our quantity order enables us to offer them complete with knobs, valves, etc., wired and tested for only £4.5.0 P. & P. 6/-.

HSL 'FOUR' AMPLIFIER KIT.

A.C. Mains 200/250v., 4 watt using ECC83, EL84, EZ80 valves.
★ Heavy duty double-wound mains transformer with electrostatic screen.
★ Separate Bass, Treble and Volume controls giving very variable boost and cut with minimum insertion loss.
★ Heavy negative feedback loop over 2 stages ensures high output at excellent quality with very low distortion factor.
★ Suitable for use with guitar, microphone or record player ★ Provision for remote mounting of controls or direct on chassis. ★ Chassis size only 7 1/2 in. wide x 4 in. deep. Overall height 4 1/2 in.
★ All components and valves are brand new. ★ Very clear and concise instructions enable even the inexperienced amateur to construct with 100% success. ★ Supplied complete with valves, output transformer (3 ohms only), screened lead, wire, nuts, bolts, solder, etc. (No extras to buy.) PRICE 79/6. P. & P. 6/-.
★ Comprehensive circuit diagram, practical layout and parts list 2/6 (free with kit).

HARVERSON'S F.M. TUNER Mk. I

- F.M. tuning head by famous maker.
- Guaranteed non-drift.
- Permeability tuning.
- Frequency coverage 88-100Mc.
- Balanced diode output
- Two I.F. stages and discriminator.
- Attractive maroon and gold dial (7 x 3in. glass).
- Self powered, using a good quality mains transformer, volume valve rectifier.
- Valves used ECC85, two EF80s, and EZ80 (rectifier)
- Fully drilled chassis.
- Size of completed tuner 8 x 6 x 5 1/2 in. All parts sold separately. Set of parts if purchased at one time £5/19/6, plus 8/6 P.P. and ins. Circuit diagram and instructions 1/6 post free.
- Mark II Version as above but complete with magic eye, front panel and brackets, £6/12/6. P. & P. 8/6.
- Mark III Version as Mark I but with output stage (ECL82) and tone control, £7/7/6. P. & P. 8/6.
- Handsome Metal Cabinets. Choice of Black, or Green. To fit Mark I, 25/-. P. & P. 3/-. To fit Mark II, 17/6. P. & P. 3/-.

SPECIAL PURCHASE!

from LEADING HI FI MANUFACTURER
7-10 watt OUTPUT TRANSFORMERS to match pair of ECL 86's in push-pull to 3 ohm output. ONLY 11/-. P. & P. 2/6.
7-10 watt ULTRA LINEAR OUTPUT TRANSFORMERS to match pair of ECL 82's in push-pull to 3 ohm output. ONLY 15/-. P. & P. 2/6.
SPECIAL MAINS TRANSFORMERS to match either of the above. Tapped primary. Secondary 250v. 80mA. half wave and 6.3v. 2 amps. ONLY 12/6. P. & P. 3/6.

HARVERSON SURPLUS CO. LTD.

170 HIGH ST., MERTON, S.W.19. Cherrywood 3985

Open all day Saturday Early closing Wed., 1 p.m.

A few minutes from South Wimbledon Tube Station. (Please write clearly)
OVERSEAS P. & P. CHARGED EXTRA. S.A.E. with all enquiries.

YUKAN SELF-SPRAY

Get this Air Drying Grey HAMMER FINISH Now -

IT'S SUPERB... THE PUSHBUTTON WAY!

YUKAN Aerosol spraykit contains 16 ozs. fine quality durable easy instant spray. No stove baking required. Available in Grey Hammer at 14/11 at our counter or 15/11, Carr. paid, per pushbutton self-spray can. SPECIAL OFFER: I can plus optional transferable snap-on trigger handle (value 5/-) for 18/11.



Please enclose cheque or P.O. for total amount to:

YUKAN

Dept. PE/11, 307a EDGWARE ROAD, LONDON, W.2

(Closed Thursday afternoons, open all day Saturday)

Choice of 13 self-spray plain colours and primer (Motor car quality) also available

SILICON PLANAR EPITAXIAL 200 MC/S

5/- 5/- 5/- 5/-

At last! Truly general-purpose silicon transistors at germanium prices. These tiny epoxy-encapsulated NPN devices are suitable for practically every low-power application - low-noise audio, r.f. amplifiers and mixers up to the edge of the v.h.f. band, d.c. amplifiers, low-power output stages....

- ★ Selected 2N2926
- ★ Current gain (h_{fe}) 55-300 at 2 mA
- ★ Collector dissipation 200 mW
- ★ Cut-off frequency (f_T) 200 Mc/s
- ★ A.f. noise figure 2.8 dB at 10 kc/s
- ★ Collector voltage 18 V max.

Price includes U.K. postage. Cash with order. Mail order only.
AMATRONIX LTD., 396 SELSDON RD., CROYDON, SURREY

VALUABLE NEW HANDBOOK FREE TO AMBITIOUS ENGINEERS

Have you had your copy of "Engineering Opportunities"?

The new edition of "ENGINEERING OPPORTUNITIES" is now available—without charge—to all who are anxious for a worthwhile post in Engineering. Frank, informative and completely up to date, the new "ENGINEERING OPPORTUNITIES" should be in the hands of every person engaged in any branch of the Engineering industry, irrespective of age, experience or training.

On 'SATISFACTION OR REFUND OF FEE' terms

This remarkable book gives details of examinations and courses in every branch of Engineering, Building, etc., outlines the openings available and describes our Special Appointments Department.

WHICH OF THESE IS YOUR PET SUBJECT?

MECH. ENGINEERING
Gen. Mech. Eng.—Maintenance Eng.—Diesel Eng.—Press Tool Design—Sheet Metal Work—Welding—Eng. Pattern Making—Inspection—Draughtsmanship—Metallurgy—Production Eng.

RADIO ENGINEERING
General Radio—Radio & TV Servicing—TV Eng.—Telecommunications—Electronics—Sound Recording—Automation—Practical Radio—Radio Amateurs' Exam.

CIVIL ENGINEERING
General Civil Eng.—Municipal Eng.—Structural Eng.—Sanitary Eng.—Road Eng.—Hydraulics—Mining—Water Supply—Petrol Tech.

ELEC. ENGINEERING
General Electrical Eng.—Installations—Draughtsmanship—Illuminating Eng.—Refrigeration—Elem. Elec. Science—Elec. Supply—Mining Elec. Eng.

AUTO ENGINEERING
General Auto Eng.—Auto. Maintenance—Repair—Auto. Diesel Maintenance—Auto. Electrical Equipment—Garage Management.

BUILDING
General Building—Heating & Ventilation—Plumbing—Architecture—Carpentry—Painting—Decorating—Specifications & Quantities—Surveying—Architectural Draughtsmanship.

WE HAVE A WIDE RANGE OF COURSES IN OTHER SUBJECTS INCLUDING CHEMICAL ENG., AERO ENG., MANAGEMENT, INSTRUMENT TECHNOLOGY, WORKS STUDY, MATHEMATICS, ETC.

Which qualification would increase your earning power?
A.M.I.Mech.E., A.M.S.E., A.M.I.C.E., A.M.I.E.R.E., B.Sc.,
A.M.I.P.E., A.M.I.M.I., A.R.I.B.A., A.I.O.B., A.M.I.Chem.E., A.R.I.C.S.,
M.R.S.H., A.M.I.E.D., A.M.I.Mun.E., CITY & GUILDS, GEN. CERT. OF
EDUCATION, ETC.

BRITISH INSTITUTE OF ENGINEERING TECHNOLOGY
155 COLLEGE HOUSE, 29-31 WRIGHT'S LANE, W.8

THIS BOOK TELLS YOU

- ★ HOW to get a better paid, more interesting job.
- ★ HOW to qualify for rapid promotion.
- ★ HOW to put some letters after your name and become a key man . . . quickly and easily.
- ★ HOW to benefit from our free Advisory and Appointments Depts.
- ★ HOW you can take advantage of the chances you are now missing.
- ★ HOW, irrespective of your age, education or experience, YOU can succeed in any branch of Engineering.

156 PAGES OF EXPERT CAREER - GUIDANCE

PRACTICAL EQUIPMENT

Basic Practical and Theoretical Courses for beginners in Radio, T.V., Electronics, Etc., A.M.I.E.R.E. City & Guilds Radio Amateurs' Exam, R.T.E.B. Certificate, P.M.G. Certificate
Practical Radio
Radio & Television Servicing
Practical Electronics
Electronics Engineering
Automation

INCLUDING TOOLS

The specialist Electronics Division of B.I.E.T. NOW offers you a real laboratory training at home with practical equipment. Ask for details.

B.I.E.T.

You are bound to benefit from reading "ENGINEERING OPPORTUNITIES", and if you are earning less than £30 a week you should send for your copy now—FREE and without obligation.

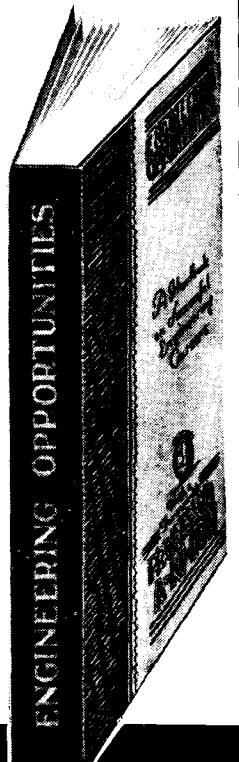

POST NOW!

TO B.I.E.T., 155 COLLEGE HOUSE,
29-31 WRIGHT'S LANE, W.8.

3d. stamp if posted in
an unsealed envelope.

Please send me a FREE copy of "ENGINEERING OPPORTUNITIES." I am interested in (state subject, exam., or career).

NAME

ADDRESS

WRITE IF YOU PREFER NOT TO CUT THIS PAGE

THE B.I.E.T. IS THE LEADING INSTITUTE OF ITS KIND IN THE WORLD

Published about the 15th of the month by GEORGE NEWNES LIMITED, Tower House, Southampton Street, London, W.C.2. Printed in England by THE CHAPEL RIVER PRESS LIMITED, Andover, Hants. Sole Agents for Australia and New Zealand: GORDON & GOTCH (A/sia) Ltd.; South Africa and Rhodesia: CENTRAL NEWS AGENCY LTD.; East Africa: STATIONERY & OFFICE SUPPLIES LTD. Subscription rate including postage for one year: To any part of the World £1 16. 0.

FULLY DETAILED AND ILLUSTRATED CATALOGUE

Now 96 big pages. The largest range available in the country. All types of components and equipment at competitive prices.

PRICE 2/6 (post paid)

PROVED AND TESTED DESIGNS

FULL AFTER SALES SERVICE AND GUARANTEE
CALL IN FOR DEMONSTRATIONS

★ DETAILED LEAFLETS FREE ON REQUEST ★

FREE! New 8 page book with details of over 80 projects, available from stock. Uses transistors, light cells, scrs, etc., etc. Ask for your FREE copy

MW/LW POCKET SUPERHET RADIO



TOTAL COST TO BUILD

85/- P.P. 2/-
(Battery 2/6 Phone 5/-)

★ All parts sold separately.

- ★ 6-Transistor design. Push-pull output.
- ★ 2 1/2 in. Cleartone speaker. Printed circuit.
- ★ Attractive moulded cabinet.
- ★ Slow motion tuning.
- ★ Full med. and long waves.
- ★ Size: 5 x 3 x 1 1/2 in.
- **AMAZING SENSITIVITY & SELECTIVITY** ●

- ★ 6-Transistor push-pull Superhet design.
- ★ Uses factory built panels.
- ★ Permeability geared tuning.
- ★ Full med./long wave tuning with push-button wave change.
- ★ Double tuned IFT's.
- ★ Chromed front panel plate.
- ★ Size: 7 x 4 x 2 in. Fits any car.
- ★ Pre-built units sold separately.

TOTAL COST TO BUILD

£8.19.6 P.P. 3/6

(7in. x 4in. speaker with car fixing kit and baffle board 20/- extra).

TWO WAVEBAND ALL TRANSISTOR CAR RADIO TO ASSEMBLE

● **HIGH PERFORMANCE SUPERHET** ●



2- AND 4-TRACK TAPE RECORDERS TO ASSEMBLE

Pre-built Equipment—6 Valves—Collaro Studio Decks—Portable Cabinets with Speakers. Complete record and playback.



★ 2-track deck 10 gns. P.P. 5/- Amplifier 11 gns. Cabinet with speaker 5 gns. OR SPECIAL PRICE **£26** P.P. 8/6 **TWO TRACK**

★ 4-track deck £13. 19.6. P.P. 5/- Amplifier 12 gns. Cabinet with speaker 5 gns. OR SPECIAL PRICE **£30** P.P. 8/6 **FOUR TRACK**

Prebuilt and tested units. Low distortion, low noise

10 Watt & 20 Watt HI-FI AMPLIFIERS

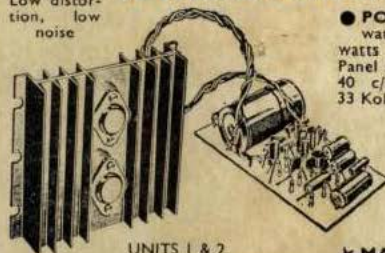

UNITS 1 & 2



UNIT 5



UNIT 3

THE FINEST QUALITY HI-FI AT UNBEATABLE PRICES

● **POWER AMPLIFIERS.** 10 watts R.M.S. music power. 20 watts peak. 6-Transistor design. Panel size 4 x 2 1/2 in. Response 40 c/s to 20 kc/s. 100mV into 33 Kohm input.

UNIT 1. For 12/15 ohm speakers. PRICE **£5.19.0** P.P. 2/6

UNIT 2. For 3 to 5 ohm speakers. PRICE **£5.10.0** P.P. 2/6

★ **MAINS UNITS.** 59/6. To power one amplifier or 69/6 to power two amplifiers (State 24 or 40 volt)

PREAMPLIFIERS. Mono and stereo versions, 8 inputs, 1 1/2 to 300mV at 1k to 500k. Response 30 c/s to 20 kc/s. Complete range of controls. Mains unit or battery operated. For pickups, tuners, tape, microphones, etc.

UNIT 3. Mono full-function pre-amplifier. Size: 9 1/2 x 2 1/2 x 2 in. PRICE **£5.10.0** P.P. (Brown/Gold front BUILT **£5.10.0** 2/- panel plate 8/6)

UNIT 4. Simplified version of Unit 3. Price 65/-. P.P. 1/6. Panel plate 6/6.

UNIT 5. Stereo preamplifier for use with two units 1 or 2. Size 9 x 3 1/2 x 1 1/2 in.

PRICE **£10.19.6** P.P. 3/6
(Front panel plate 12/6)

We stock:

TRANSISTORS
RECTIFIERS
VALVES
CRYSTALS
MICROPHONES
TEST GEAR
TAPE DECKS
SPEAKERS
MULTI-METERS
RADIO
CONTROL
AMPLIFIERS
RECORDERS
TUNERS
RECORD DECKS
TWEETERS
RECEIVERS
GENERATORS
COMPONENTS
AND
ACCESSORIES

Let us quote for parts for your circuit. Send a list for quick reply. Quality components at realistic prices

SINCLAIR DESIGNS

★ New Pocket FM Radio Kit

£5.19.6

★ Micro-6 MW/radio 59/6

★ TR750 'Add-on' power amp. 39/6

★ Micro injector 27/6

★ Micro amp. 28/6

★ X10 Amp. kit £5.19.6

BUILT £6.19.6

★ X20 kit £7.19.6 BUILT £9.19.6



5 WATT AND 1 WATT PACKAGED AMPLIFIERS

★ 6-Transistor push-pull printed circuit designs

★ Size only 2 1/2 x 2 x 1 1/2 in.

★ 5 watt 18 volt, 1 1/2 watt 12 volt

★ For 3 to 5 ohm speakers

★ 7mV into 1 Kohm. 30 c/s to 16 kc/s

PRICES **1 1/2 w. 65/-** P.P. 1/6 **5 w. 79/6** P.P. 1/6

BUILT **£4/9**



(New Version)

4-CHANNEL MICROPHONE MIXER

Transistorised, 4 inputs up to 100 Kohm. Full mixing.

PRICE **49/6**



TRANSISTOR PORTABLE TEST EQUIPMENT

All units size 6 1/2 x 4 1/2 x 2 1/2 in.

★ RF generator, 150 kc/s to 350 mc/s in 8 ranges. RF, Mod. RF, AF outputs.

PRICE **£9.10.0**



- ★ Resistance/capacitance bridge. £8.5.0.
- ★ Audio generator 10 c/s—100 kc/s. 4 ranges. £16.15.0.

VHF/FM TUNER TO ASSEMBLE

★ Two pre-built units plus metal work and front panel

Total cost **£12.17.6**

P.P. 2/6

- ★ Size: 9 1/2 x 3 1/2 x 4 in.
- ★ 88 to 108 mc/s tuning
- ★ 100mV to 100Kohm output
- ★ 6-Transistor printed cct. superhet design (All units available separately)

NEW 3-WAVEBAND PUSH-BUTTON PORTABLE SUPERHET TO BUILD

★ SHORT WAVES (17-50m)

★ MED. WAVES

★ LONG WAVES

TOTAL COST TO BUILD

£8.19.6 P.P. 3/6

6 Transistors. 1 watt push-pull output. Special circuit for car aerial. Car and tape sockets. Telescopic and ferrite aerials. Full tuning on all wavebands. Push-button coil pack. Cabinet size 11 x 7 1/2 x 3 1/2 in. Black fabric with chromed handle and fittings. THE ONLY FULLY TUNABLE MW/LW/SW RADIO AVAILABLE FOR HOME CONSTRUCTION.

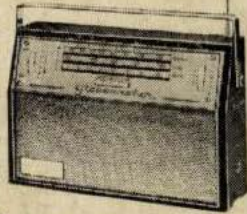

(2-waveband version as previously advertised still available at **£7.19.6** p.p. 3/6. Batteries 6/-)

VHF/FM TRANSISTOR TUNER TO BUILD

TOTAL COST

£6.19.6

P.P. 2/6 (complete with frontplate)

(Gold sprayed cabinet 20/- extra).

★ 5-Transistor 4 diodes

★ Printed circuit superhet

★ Geared tuning 87 to 105 mc/s FM

★ RF stage and double tuned IFT's

★ Output up to 1 volt peak up to 100 Kohm

★ 9 volt 9mA supply

★ Size in cabinet 4 x 3 1/2 x 2 1/2 in.

★ All parts sold separately

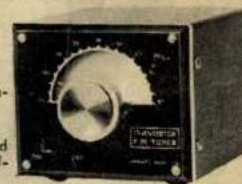

HENRY'S RADIO LTD.

303 EDGWARE RD., LONDON W2

PADDington 100B/9

Open Mon. to Sat. 9-6. Thurs. 1 p.m.

Open all day Saturday

VALVE SELECTION GUIDE on next page

Valve Symbols

r_p the 'Anode' (internal) Resistance (ohms)
 g_m the Mutual Conductance (milliamperes per volt)
 μ the Amplification Factor (a ratio)
(μ is used with triodes)

These quantities are related by:

$$\frac{\mu}{g_m} = r_p \quad \text{or} \quad \frac{\mu}{g_m} = r_p \times g_m$$

cover the symbol required in terms of the other.

Valve Bases

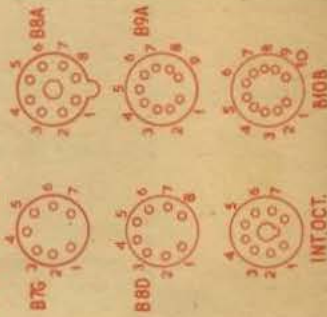

EQUIVALENT DIODE CONNECTIONS



VALVE BASE CHASSIS DRILLING

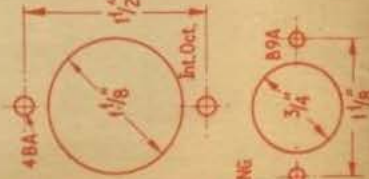

Bias and Gain Calculations

GRID BIAS: This may be obtained by a battery, but a cathode bias (automatic) is usually the method employed.



$$R_B = \frac{V_B}{I}$$

V_B is the total valve current in amps.
 I is the total valve current in amps.
 R_B is the resistance in ohms.

EXAMPLE: The EF80 requires 2 volts bias with 10 mA anode current and 2.5 mA screen grid current. Therefore $I = 10 + 2.5 = 12.5$ mA. The value of R_B required is given by: $2 \times 1000 = 680 \Omega$

The gain using a pentode as a voltage amplifier is given by: $R_L \times g_m$ where R_L is the value of the anode load resistance.

EXAMPLE: EF 80, $g_m = 6.8 \text{ mA/V}$ with an $R_L = 100 \text{ K} \Omega$; Gain = $100,000 \times 6.8 = 680$

Some Current Valve Types & Equivalents

Description	European	American	CV Code	Other Types	Base	Applications	Description	European	American	CV Code	Other Types	Base	Applications		
TUNING INDICATOR	DM 70	1M3	2980	1M1	B8D	28	HT. FULL WAVE RECTIFIER	EZ35	6X5	574	U70	1D	29		
HIGH VOLTAGE HALF WAVE RECTIFIER	DY86 DY87	1S2 1S2A			B9A B9A	30 30		EZ40 EZ41	6B74	3891	U09	U147 U150	B8A B9A	29 29	
DOUBLE TRIODE	E88 CC	6AK8	2492	6922	B9A	2		EZ80	6V4 6CA4	1535 5072	U709 U78	UU12	B9A B7G	29 29	
TRIPLE DIODE TRIODE	EABC80	6AL5	40,283	6LD2	B9A	12		EZ90	6X4	493	U76		B7G	29	
DOUBLE DIODE	E891	6AV7	3882	6D2	B7G	12		GZ30	5Z4	1863	R52	I.O.	I.O.	29	
DOUBLE DIODE TRIODE	EBC41 EBC50	6AT6	452	6LD3 DH77	B8A B7G	13 13		GZ31 GZ32	5U4G 5V4 5AR4	575 729 1377	U52 54KU		I.O. I.O.	29 29	
DOUBLE DIODE PENTODE	EBF89	6DC8	6FD12		B9A	11		GZ34			U25		wired in	30	
TRIODE	EC86 EC97	6CM4 6FY5			B9A B7G	1 1									
DOUBLE TRIODE	ECC81 ECC82 ECC83 ECC85 ECC88	6SN7 12AT7 12AU7 12AX7 6AQ8 6DJ8	1988 455 491 492 5358	13D2 B152 B329 B339 6L12	I.O. B9A B9A B9A B9A	15 2, 20, 25 15, 25, 20 15, 20 8		EHT. HALF WAVE RECTIFIER TRIODE TRIODE BEAM TETRODE	KY50	2L2		U47	B9A B9A B7G B9A B9A	30	
									PC86 PC88 PC97	4CM4 4DL4 4FY5					1 1 2
										PCC88 PCC189	7DJ8 7ES8				
								PCE82 PCF80 PCL82	9A8 16A8			LZ319 30FL12 30CI 30PL12	B9A B9A B9A B9A	3, 26 3, 4 5	

TRIODE PENTODE	ECC189 ECC804 ECC807	6J6 6ES8 6GA8 13D7	858 5331 5264	ECC91 6/30L2	B7G B9A B9A B9A	2 2 4 14
TRIODE PENTODE	ECF80 ECF82 ECF86 ECF805	6BL8 6U8 6HG8 6GV7	5215 5065	6C16	B9A B9A B9A B9A	2,26 2,26 2,8 2,11
TRIODE HEPTODE	ECH81 ECH84	6AJ8 6JX8	2128	6C12	B9A B9A	9 4
TRIODE PENTODE	ECL80 ECL82 ECL86	6AB8 6BM8 6GW8		LN152 6PL12	B9A B9A B9A	5 4,5,16 16
BEAM TETRODE	EE80			6F28		2, 23, 26
PENTODE	EF80 EF85 EF86 EF89 EF91 EF93 EF94 EF83 EF184	6BX6 6BY7 6Z67 6DA6 6AM6 6BA6 6AU6 6EH7 6EJ7	1376 1375 2901 5156 138 454 2524 5831 5810	Z152 6F26 Z729 Z77 W727 6F29 6F30	B9A B9A B9A B9A B7G B7G B7G B9A B9A	2, 4, 10 11 14 11 2, 3, 8, 10 11 10 2, 11 2, 10, 25, 26, 27
PENTODE	EL34 EL84 EL506	6CA7 6B05	1741 2975	N709	I.D. B9A B9D	17 5, 17 17
TUNING INDICATOR	EM81 EM84 EM87	6DA5 6FG6 6HU6	5055 5434		B9A B9A B9A	28 28 28
EHT HALF WAVE RECTIFIER & BOOSTER DIODES	EY51 EY81 EY83 EY84 EY86 EY87	6X2 6R3 6S2 6S2A	426 2235 2966	R12 R18	wired in B9A B9A B9A B9A	30 30 30 30 30

General Notes

- The heater volts of oxide coated cathodes should be maintained at the correct values. Underrunning especially may spoil the cathode emission.
- The heater should not be run for long periods without H.T. being applied. (Cathode poisoning is likely).
- Hum is sometimes produced by a short circuit developing between heater and cathode.
- Hum in general picked up from the A.C. heater line may be reduced by using a 'hum dinger'. It is adjusted for minimum hum.



TRIODE PENTODE	PCL84 PCL85 PFL200	15DQ8 18GV8			B9A B9A B10B	3, 4 5 3, 4
PENTODE	PL36 PL302 PL500	25E5 27GB5	30P19		I.D. I.D. B9D	6 6 6
HALF WAVE RECTIFIER & BOOSTER DIODES	PY32 PY33 PY81 PY82 PY83 PY88 PY301 PY800 PY801	17Z3 19Y3 30AE3 19GS4	U291 U153 U192 U191		I.D. I.D. B9A B9A B9A B9A I.D. B9A B9A	29 29 7 29 7 7 7 7
TRIPLE DIODE TRIODE	UABC80		U193		B9A	13
DOUBLE DIODE PENTODE	UBF89	19FL8	10LD12 10FD42 10L14 X109	WD119 8109 X109	B9A B9A B9A B9A	12 8 9
TRIODE HEPTODE	UCC85 UCH81	19D8	10C14		B9A	9
PENTODE	UL84	45B5	10P18	N119	B9A	17
HALF WAVE RECTIFIER	UY41 UY85 35Z4	31A3 38A3	U142 U381 U76	3H1SU U119 U74	B8A B9A I.D.	29 29 29
VOLTAGE REGULATOR	150C2 180C1	0A2 0B2	2500 1832 1833	STV150-30 STV108-30	B7G B7G	31 31

KEY TO APPLICATIONS

TELEVISION

- VHF Tuner
 - VHF Tuner
 - Video Amplifier and Sync. Separator and Time Base Oscillator
 - Field Output
 - Line Output
 - Efficiency Diode
- RADIO
- VHF Amplifier Oscillator and Mixer
 - H.F. Mixer
 - Straight I.F. Amplifier
 - Vari-Mu I.F. Amplifier
 - Detector
 - Double Diode A.F. Triode
- AUDIO
- Low Noise Pre-Amplifier
 - Double Triode Amplifier or Phase Splitter
 - Amplifier and Output
 - Output
 - General Purpose Triode

INSTRUMENTS

- Counters and Scalers
- Pulse Generators
- Pulse Amplifier
- Wideband Amplifier
- D.C. Amplifier
- Valve Voltmeter
- Oscilloscope
- Electrometers and P.H. Meters
- Tuning Indicator
- H.T. Rectifier
- E.H.T. Rectifier
- Voltage Stabiliser

- Any whitening of the silvery metal coating 'getter material' inside a valve indicates air and therefore a cracked envelope. The valve is useless.
- A blue glow inside a working valve shows the presence of gas. That is the valve has become soft. If the glow is only faint or on the glass envelope, it is not serious. But a strong glow filling the inside space shows a near useless valve.
- The mechanical position of valves is usually not important. This may not be so with directly heated valves such as many rectifiers where the filament may expand and sag, touching other electrodes.