

149

# Practical Electronics

MARCH 1965

PRICE 2'6

## 4 GREAT CONSTRUCTIONAL PROJECTS

**INEXPENSIVE OSCILLOSCOPE · AUTO PARKING LIGHT ·  
DIGITAL DISPLAY CLOCK · RADIO TUNER**

*Plus 8 more pages  
of your Guide to  
semi conductor  
Circuit Design*





## GOING SHOPPING

YOU cannot build without bricks. The bricks of electronics—circuit components and ancillary items of hardware—have to be purchased from somewhere. Undoubtedly some constructors will have the traditional “junk box” to dip into, but those thousands who have only in recent times taken interest in electronics as a hobby will be without any such accumulation of parts. And in any case junk boxes need replenishing and bringing up to date from time to time.

★ ★ ★

The electronics constructor is particularly fortunate in being well catered for by a large number of retailers long experienced in administering to his needs. Some of these businesses deal exclusively in new branded or proprietary components, some deal exclusively in manufacturer's or government surplus components or equipment, while there are those who handle a selection of both.

★ ★ ★

It is not our purpose here to advise for or against the use of either of the above-mentioned categories of electronic goods. This will be a matter for the individual to decide for himself in light of a number of factors. It might be useful, however, to explain that the term “surplus” does not necessarily mean that the components are of the used or second-hand variety; in some instances they may be brand new components of current type which a large manufacturer has found to be redundant to his requirements.

★ ★ ★

There are certainly other components and pieces of equipment on the market that bear unmistakable signs of having been used. These items are usually of government or service origin and are quite often good economical propositions, even if only part can be salvaged for re-use. However, those inexperienced in such matters are recommended to proceed cautiously when contemplating the purchase of such equipment, and to obtain expert advice regarding the potential utility of either the whole equipment, or its constituent parts.

The rapid changes in component design in recent years mean that many of the parts in the older surplus equipments are electrically or physically incompatible with those used in projects of modern design. On the other hand, to some of the more venturesome and intrepid spirits in our fraternity this older equipment presents a source of much enjoyment and the opportunity for them to exercise their skill at improvisation at minimum cost.

## THIS MONTH

### CONSTRUCTIONAL PROJECTS

ELECTRIC CLOCK WITH DIGITAL DISPLAY	324
INEXPENSIVE OSCILLOSCOPE	328
MAGIC BOXES	336
GUITAR AMPLIFIER	343
AUTOMATIC PARKING LIGHTS	347
TWO BAND RADIO TUNER	354

### SPECIAL SERIES

SEMICONDUCTORS—2	339
BEGINNERS START HERE—5	352

### GENERAL FEATURES

HALL EFFECT	360
DESIGN OF CERAMIC PICK-UP CARTRIDGES	366

### NEWS AND COMMENT

EDITORIAL	323
ELECTRONORAMA	350
NEW PRODUCTS	359
DETACHED PARTICLES	364
READOUT	374

Our April issue will be published on  
Thursday, March 11



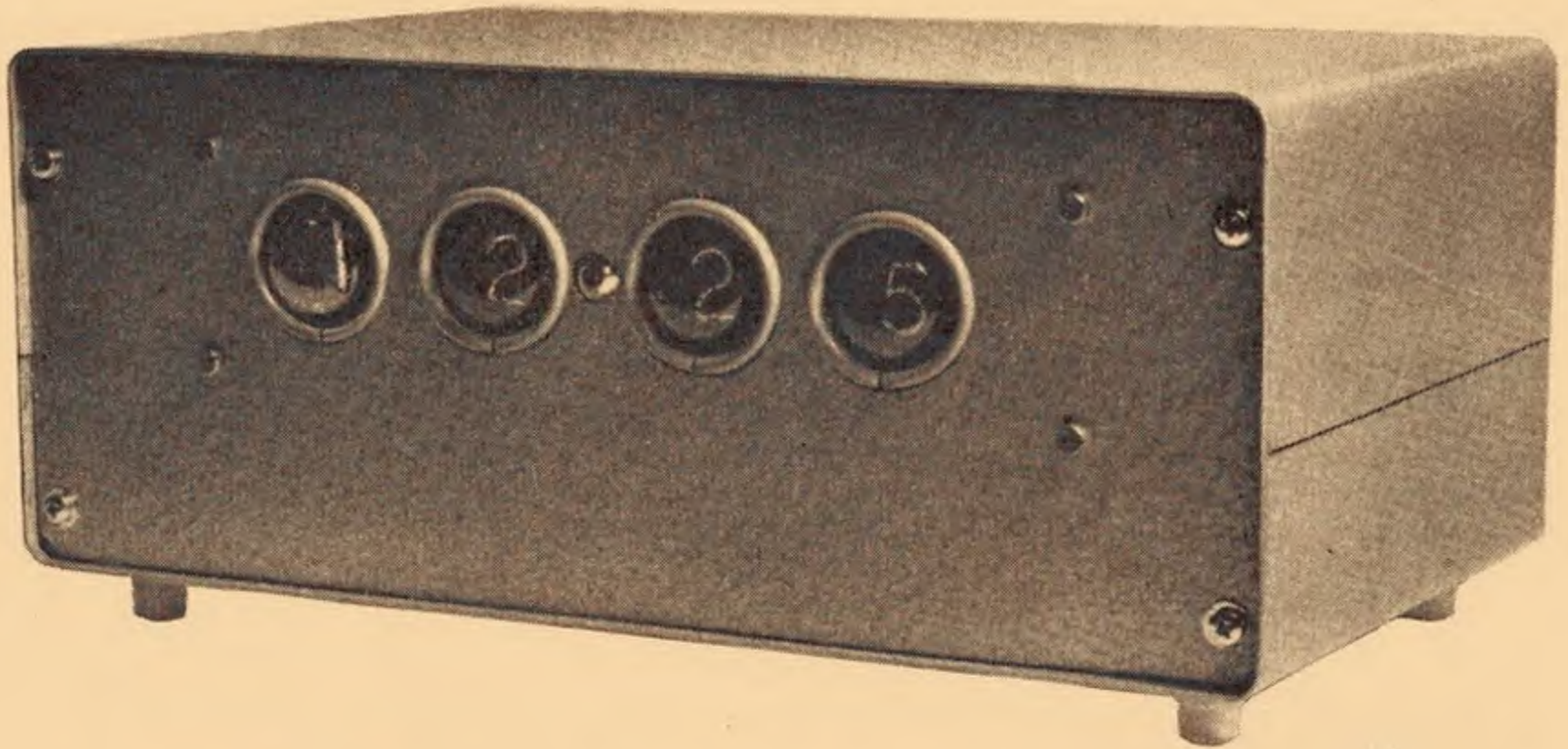

# ELECTRIC CLOCK WITH DIGITAL DISPLAY

BY J. D. LOCKE

**P**ERSONALLY, I usually give it up as a bad job! Trying to see what the time is in the middle of the night, I mean. Have you tried it lately? It takes five minutes to see, dimly, the remaining luminescence on the clock face as shapeless blodges. Deciding which hand is which and interpreting with a sleep-befuddled brain their message is beyond my power of concentration. If you switch the light on to read it properly, the results may be twofold:

- (a) Panic on the part of your wife who imagines a major catastrophe.
- (b) You can't get to sleep for hours afterwards.

As I said, I usually give it up as a bad job. What's wanted is a clock that is easy to read at all times of the day or night, hence illuminated digital presentation.

Having a preference for electronic rather than electro-optical devices, I chose digitrons for the presentation although the latter would do.

Digitrons such as Ericsson GR10J or Mullard G530M are readily available at about 32s 6d each. Having decided on the presentation, the next thing is to decide on the method of time measuring to be used. The possible schemes are:

- (a) All electronic with countdown from the mains frequency.
- (b) All electronic with countdown from an internal oscillator.
- (c) Electro-mechanical synchronised with mains frequency.
- (d) Electro-mechanical with self-contained frequency source.

Examining these possibilities, we find that:

- (a) Can be devised with binary counters driven from the mains frequency. The countdown would be done in the following stages: 50 : 1, 60 : 1 to give seconds; 60 : 1 to give minutes; 12 : 1 to give hours. Using binary division, this would require 44 valves or semiconductors not including coupling amplifiers or diodes. This scheme is likely to be too large and expensive. Tunnel diodes have been used as reliable 30 : 1 countdown devices and makes this method worth



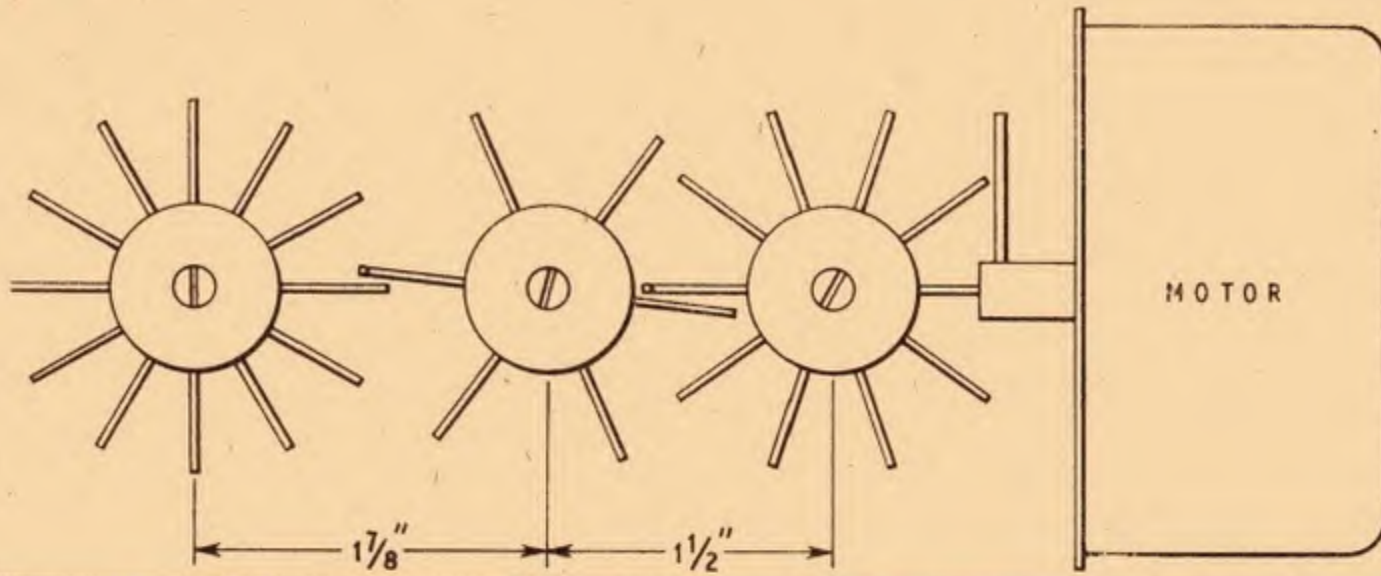

Fig. 1a. Plan view showing the gearing mechanism and the spindle spacing dimensions

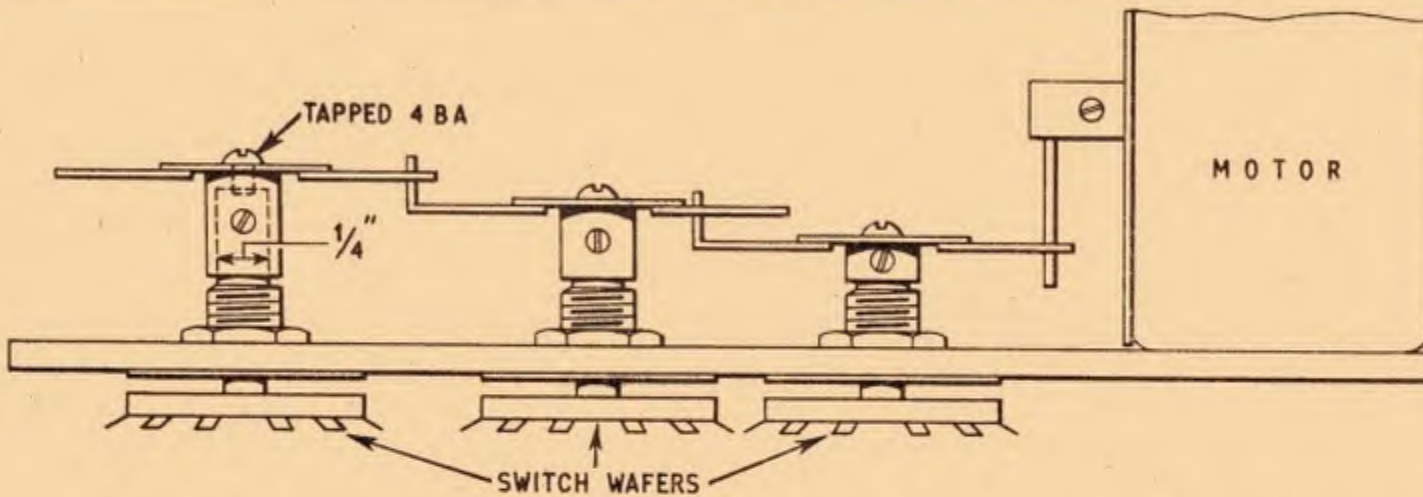

Fig. 1b. Elevation showing details of the wafer switch mountings. It will be noticed that the gearing shown on the drawing does not resemble that in the photograph below. The gearing in the photograph has been modified to form a more robust mounting for the teeth

investigating. Using decimal counters, such as dekatrons (they can be obtained to count up to 12 as well as 10 using, for example, Ericsson GC12/4B tubes), 7 dekatrons and six coupling amplifiers would be required.

- (b) This approach was discarded because of the accuracy required of the frequency source. A clock accuracy of 1 minute per month requires an oscillator accuracy and stability of two parts in  $10^6$ . In addition, to reduce the countdown circuitry, a basic frequency of 50c/s or less would be required.
- (c) This method can be achieved by using a synchronous motor suitably geared to switches for

the countdown. Almost any clock motor is suitable but one with built-in gearing to give 1 r.p.m. is the best. The gearing needs to be 10 : 1 for unit minutes, 6 : 1 for tens of minutes and 12 : 1 for hours when using a 1 r.p.m. motor assembly.

- (d) Can be obtained by using a velocity servo, using a mercury standard cell for reference and for the tacho field supply. The other requirements being a power amplifier and split field motor/tacho. The gearing equipment requirements are as in (c) if the servo gives a 1 r.p.m. output.

Of these schemes, (c) was selected as being the cheapest and simplest method of the four.

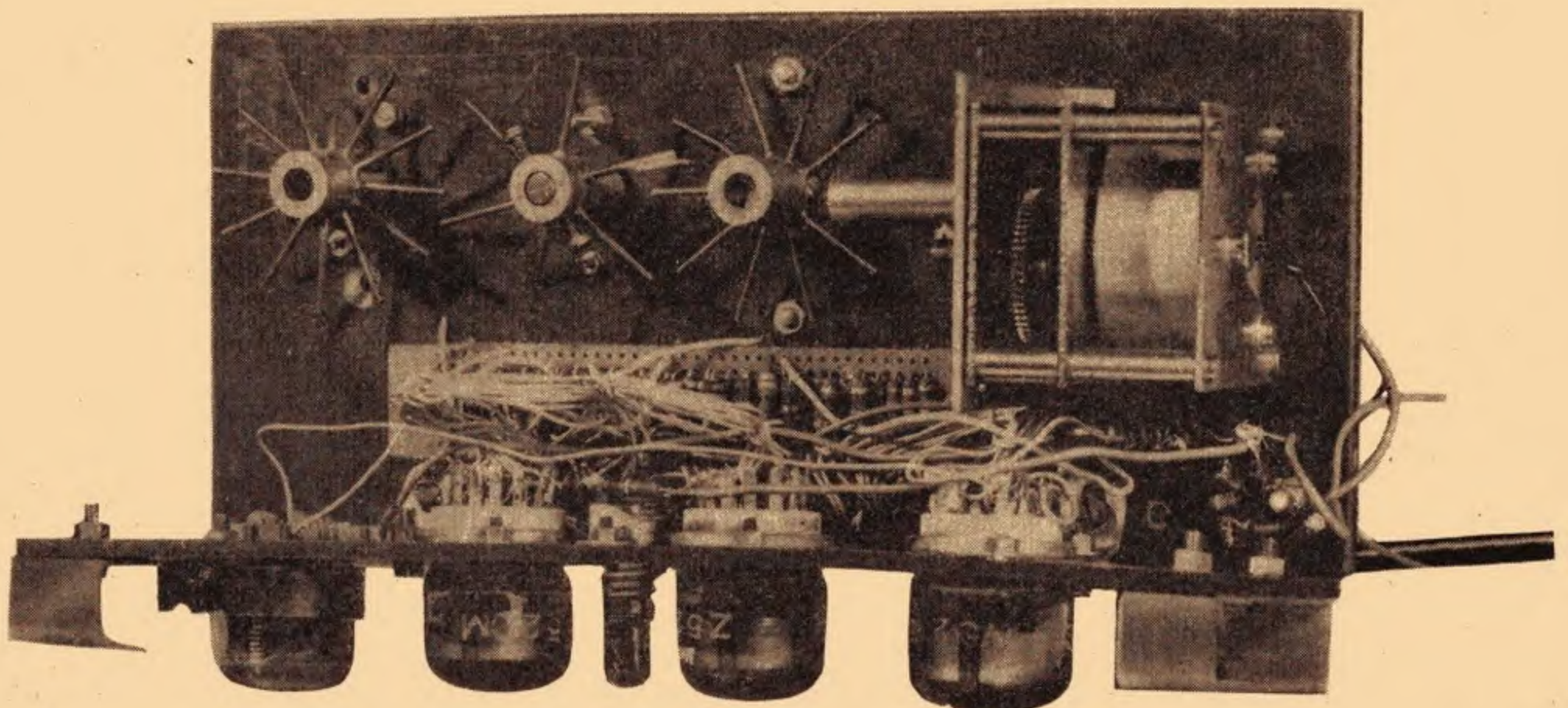



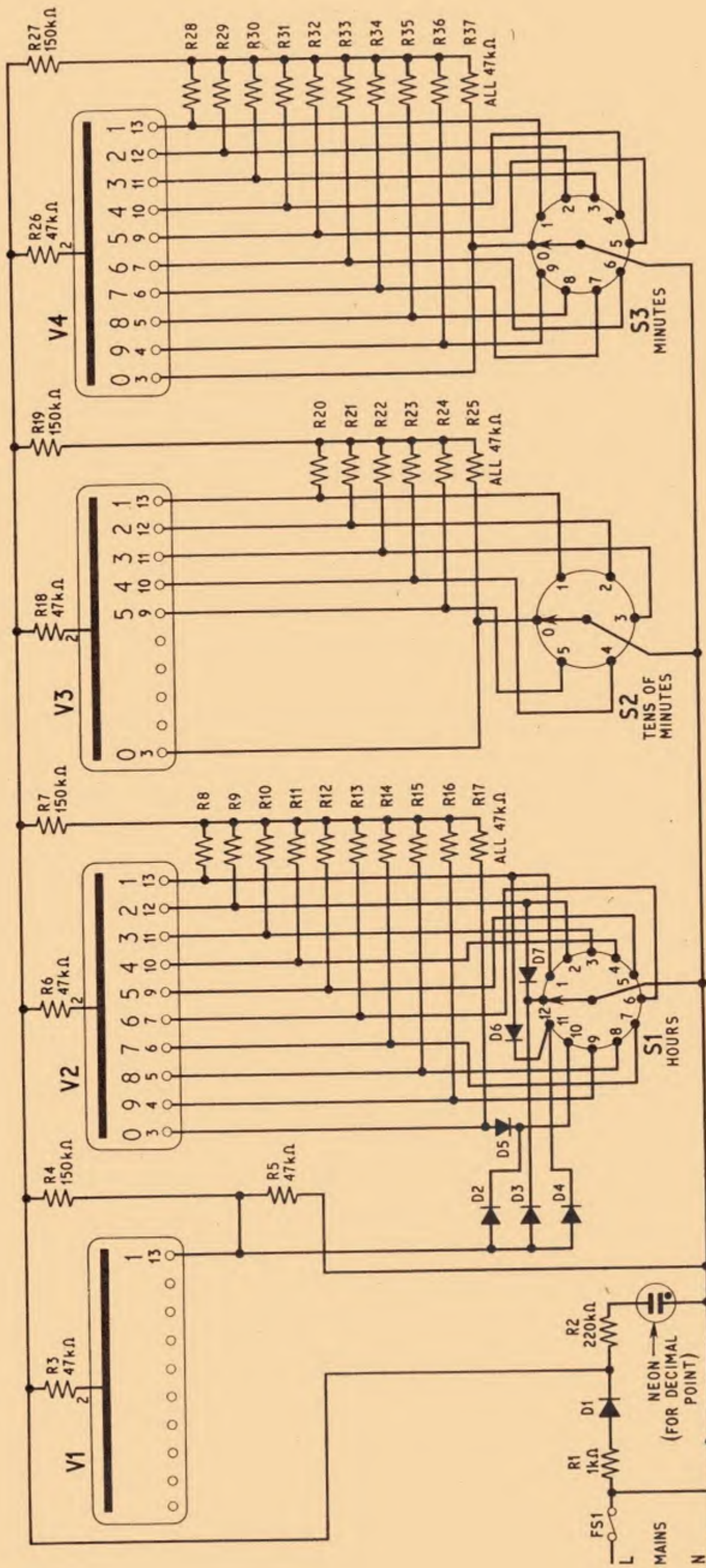

Fig. 2. Complete circuit diagram of the clock

## COMPONENTS . . .

### Resistors

- R1 1k $\Omega$
- R2 220k $\Omega$
- R3 47k $\Omega$
- R4 150k $\Omega$
- R5 47k $\Omega$
- R6 47k $\Omega$
- R7 150k $\Omega$
- R8
- R9
- R10 47k $\Omega$
- R11
- R12
- R13

- R14 47k $\Omega$
- R15
- R16
- R17
- R18 150k $\Omega$
- R19
- R20
- R21
- R22
- R23 47k $\Omega$
- R24
- R25
- R26

- R27 150k $\Omega$
- R28
- R29
- R30
- R31
- R32 47k $\Omega$
- R33
- R34
- R35
- R36
- R37

All resistors  $\frac{1}{4}$  watt 10%

### Diodes

- D1 Texas 15113
- D2
- D3
- D4 Mullard OA202
- D5
- D6
- D7

### Valves

- V1
- V2 Mullard G530M or
- V3 Ericsson GRI0J
- V4

### Switches

- S1 single-pole, 12-way rotary wafer
- S2 single-pole, 12-way rotary wafer (connected in pairs)
- S3 single-pole, 30-way rotary wafer (connected in threes) (Painton winkler switch wafer)

### Motor

- Smith Sectric movement type 55697 or
- Appliance Components Ltd. model 247

### Miscellaneous

- Cabinet to suit, tag strip, valveholders, neon



## SWITCHING

The gearing from the motor is the only item that requires further consideration. With normal gearing, the hours switch would take 1 hour to cover one segment and this would make the time of switch-over unreliable. What is required is for all the switches to change from one segment to another rapidly, i.e. within a few seconds, but still to retain the correct gear ratio. The gears drive the wipers of wafer switches to switch the supplies to the numeral that it is required to display. The gearing is shown diagrammatically in Figs. 1a and b.

This will operate all switches at the same speed giving about 5 seconds for the complete changeover from segment to segment but less than 1 second for numeral change.

The switch wafers required are 10-way 36°, six-way 60° and 12-way 30°, that is the segments must be evenly disposed. The 12-way wafer is a standard, the six-way is a 12-way wafer with the segments connected in pairs. The 10-way wafer was a problem and the only suitable wafer found was the Painton winkler switch wafer which is a 30 contact wafer and thus the contacts were wired in threes. All wafers must be made before break to avoid interruptions of the display of hours and tens of minutes.

The digitrons require +170 volts to strike and 140 volts as the minimum maintaining voltage, +60V on a cathode will extinguish that cathode. The current is 2mA. As filtering of the supply is unnecessary, a simple half-wave rectified supply is used.

Earthing any cathode will produce about +60 volts r.m.s. on all the other cathodes. The anode resistor is included to limit the total valve current if a fault should occur. The circuit used gives the greatest protection to the digitron if either a short circuit or open circuit should occur.

The full circuitry of the clock is shown in Fig. 2. Note that rather than have a separate switch wafer for the tens of hours, diodes are used so that the 10, 11 and 12 positions of the hours switch wafer will light the 1 on the tens of hours digitron as well as the required unit. The diodes are required to prevent the 1 and 2 positions on the hours switch from lighting the 1 on the last digitron.

## CONSTRUCTION

Details of the switching mechanism are shown in Figs. 1a, b. The "teeth" of the gears are made from stout piano wire soldered on to  $\frac{7}{8}$  in diameter discs. A wooden jig is strongly recommended for this soldering with the wires laid in saw cuts. Cut the wires to length after soldering. The discs are then bolted with 4 B.A. screws to the end of  $\frac{3}{8}$  in diameter spacers and secured with Araldite. The spacer is drilled out to  $\frac{1}{4}$  in for part of its length for attaching to the switch shaft. The switch wafer is mounted on the baseboard with its drive shaft in the usual way. The switch detent mechanism is however prevented from working by either removing the ball bearings or the detent spring.

The gears must be fixed to the switch shaft in the correct position by using grub screws. This is best found when the wiring is complete and with the power supply switched on. Once this is done, the clock can be set to the correct time by rotating the gears individually.

Well that's it. Incidentally, the clock gives almost enough light to read the time on my watch! ★

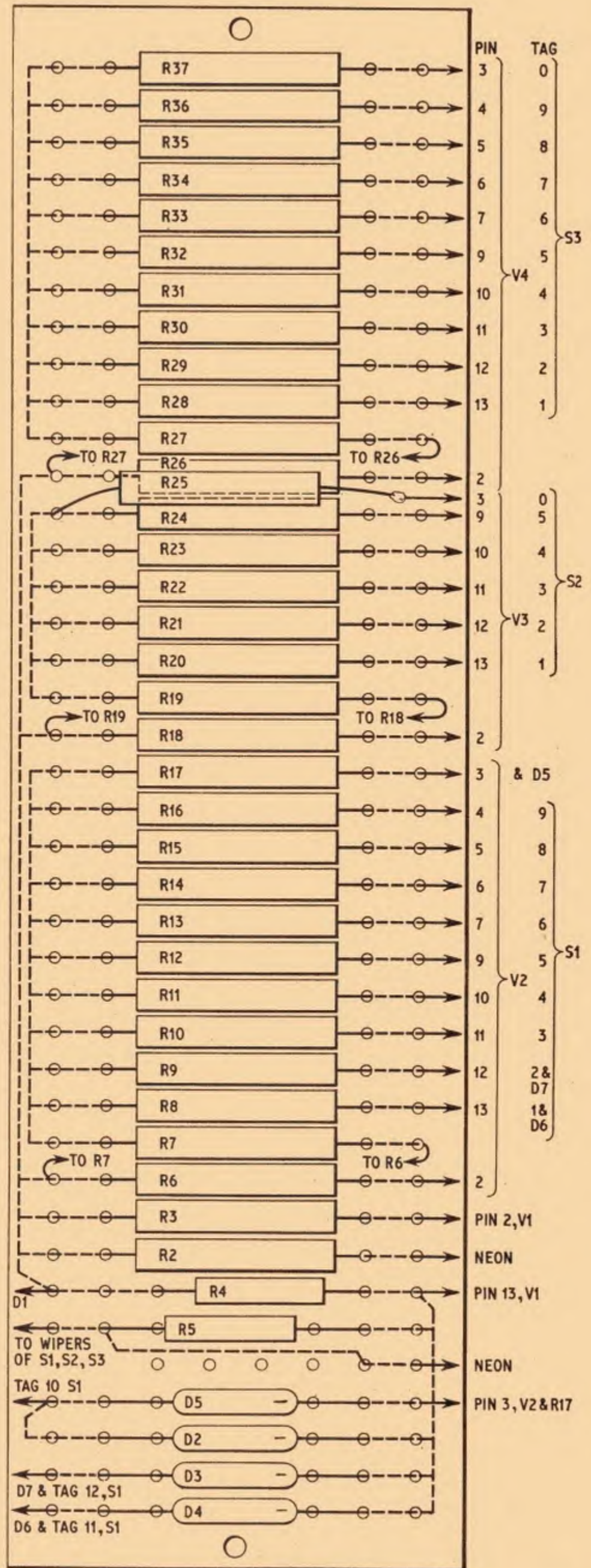
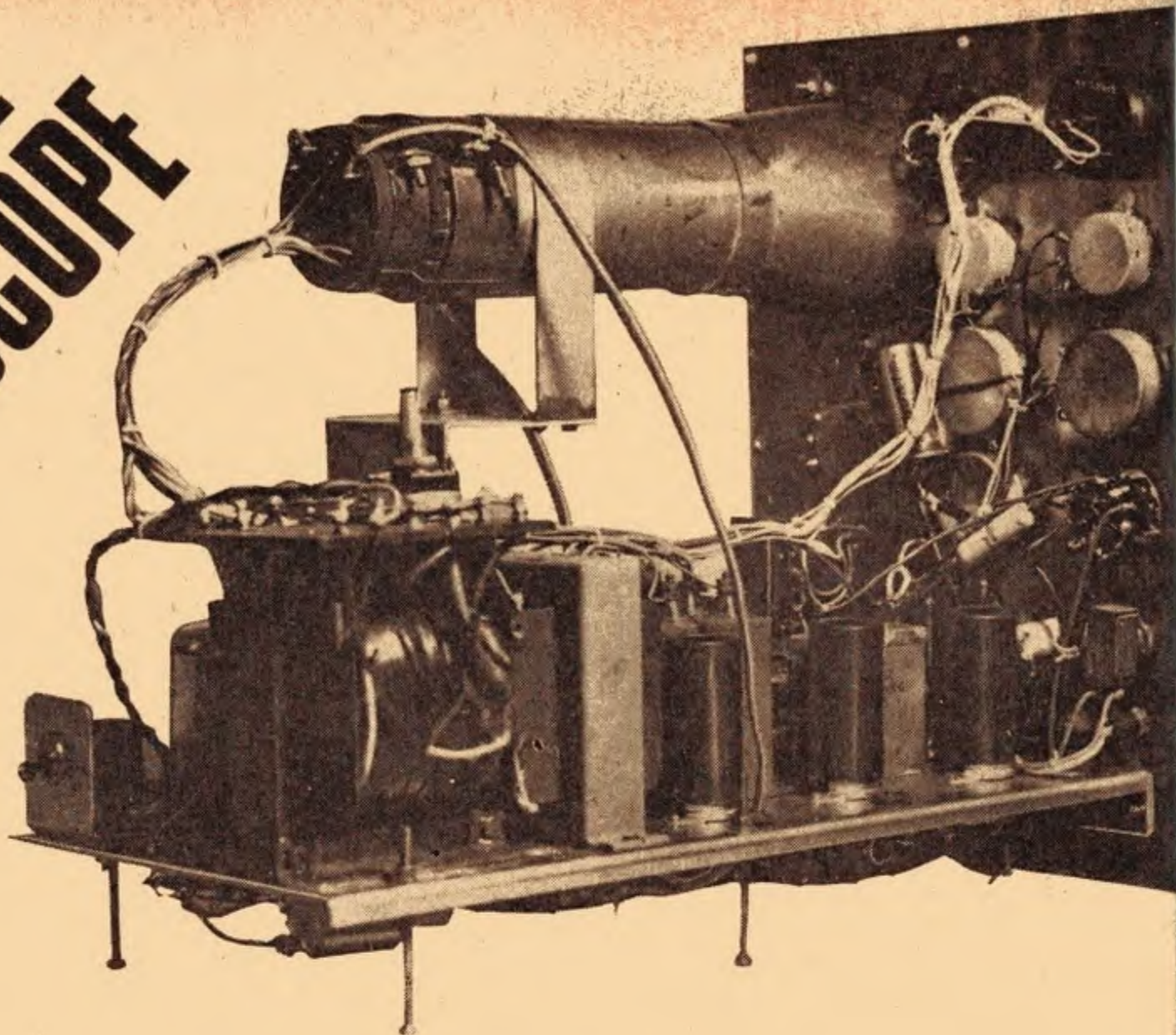

Fig. 3. Layout of components on a piece of perforated board. This diagram is not to scale



# INEXPENSIVE OSCILLOSCOPE



By  
**P. Cairns**

## PART ONE

### SPECIFICATION

#### Display tube

Electrostatically focused and deflected, 3in diameter screen, medium persistence green phosphor. Type 3BP1, 3EP1, or 3GP1.

#### Y amplifier

Input impedance  $1M\Omega$ , 30pF.  
Maximum sensitivity approximately 200mV/cm.  
Six-range attenuator with following steps:  
(1) X1 0dB; (2) X3 10dB; (3) X10 20dB;  
(4) X30 30dB; (5) X100 40dB; (6) X300 50dB.  
Response  $\pm 3$ dB from 5c/s to 175kc/s, with a useful display gain up to 1Mc/s.

#### Time base and X amplifier

Time base switch provides the following ranges:  
(1) 100ms/cm to 10ms/cm; (2) 10ms/cm to 1ms/cm;  
(3) 1ms/cm to 100 $\mu$ s/cm; (4) 100 $\mu$ s/cm to 10 $\mu$ s/cm.  
The fine control gives adequate overlap between ranges.

The fifth position gives facilities for external signal input to the X amplifier while muting time base and sync signals.

With the time base on, the X amplifier gain

gives a trace expansion of at least six times. With the switch in the external position the X amplifier has a maximum sensitivity of about 800mV/cm, and a response of 10c/s to 75kc/s  $\pm 3$ dB, and a useful display gain up to 200kc/s.

#### Sync

Synchronising is continuously variable for all types of Y input signal. Switching allows an external sync signal to be applied if required.

#### Calibration

An internal calibration unit gives a square wave output at 50c/s with a mark/space ratio of 1 : 1, an amplitude of 1 volt peak to peak, and a rise time better than 5 $\mu$ s.

#### Power consumption

The total power consumption from the mains is less than 50 watts.

#### Dimensions

The approximate overall dimensions are height 12in, width 9in, and depth 15in.

**T**HE following article describes an extremely useful and comprehensive oscilloscope which the writer has used extensively during the past few months and which has proved indispensable in practice and reliable in operation. This instrument should prove of particular interest to both the serious experimental amateur and the spare time radio or television serviceman. Those interested in audio equipment work would also find it very useful.

The oscilloscope was designed with a number of factors in mind. First, the circuit had to use all standard easy-to-get components and valves, while the cost had to be kept to a minimum. Second, the circuit had to be kept as simple as possible for ease of construction and be simple to set up, while maintaining the majority of useful features met with in much more expensive commercial instruments. Finally, it had to have reliability over a long period together with ease







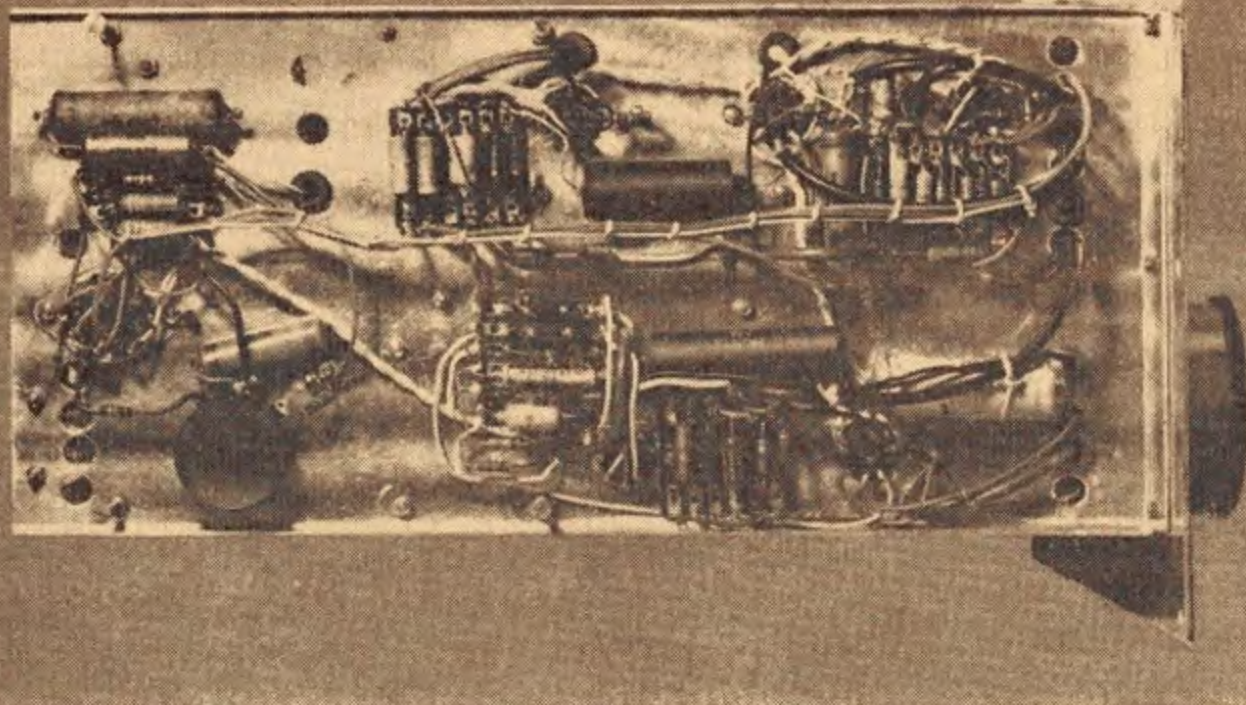

*Underside view of the completed instrument*

and simplicity of servicing which meant that the number of different types of valves employed had to be kept to a minimum.

The circuit finally evolved after a considerable amount of work is shown in Figs. 1, 2, and 3 and is considered the best compromise between the various conflicting features mentioned above.

The instrument is built around a 3in tube with green trace and relatively short persistence such as the type 3BP1, 3EP1, or 3GP1. These are American surplus tubes and can be obtained at very reasonable prices although, as with all surplus equipment, the supply position does fluctuate from time to time and place to place. Any of these three tubes may be used quite satisfactorily in this instrument, the minor differences in characteristics being automatically taken care of during the setting up and calibration of the completed oscilloscope.

Only two types of valves are used in the 10 valve circuit: these are the cheap and easily replaceable double triodes ECC81 and ECC82.

A conventional h.t. and e.h.t. arrangement is used. The only high tolerance components used are in the Y attenuator and a few resistors in the Y amplifier.

### PRINCIPAL FEATURES

The main design features include a six range Y attenuator in 10dB steps to 50dB, cathode follower input in both X and Y amplifier first stages, linear X and Y gain controls, and push-pull d.c. coupled outputs to the c.r.t. deflection plates. Both X and Y shift controls are d.c. coupled giving a positive shift action in both planes. A four range time base circuit with a fine control gives ample overlap between ranges.

Facilities are also available for external X input, the time base and sync circuits being muted in this position. The sync circuit also has switching facilities for external or internal use while the sync control locks the time base to the signal being displayed. The Y amplifier was designed to give the best compromise between gain and bandwidth in the number of stages available. The maximum sensitivity of 200mV/cm with a flat response to nearly 200kc/s and a useful display gain to over 1Mc/s should cover the majority of practical applications.

An internal transistor square wave calibration circuit is included, this being extremely useful for checking and setting up the Y amplifier. It also provides a useful time calibration check on the time base.

Finally, a pre-set astigmatism control is used to give optimum focus over the screen width.

Features which are not included and which are found in some of the more expensive commercial oscilloscopes are: stabilised h.t. and e.h.t. supplies, d.c. coupled Y amplifier with differential input, and extensive triggering facilities. While these features are obviously advantageous and increase the scope and usefulness of an instrument, it was not considered worthwhile to include them in the relatively simple and practical oscilloscope envisaged. Not only would their incorporation have increased the size and circuit complexity of the instrument, but the extra number of stages and power supplies to perform these functions would have made the oscilloscope prohibitively expensive for the amateur constructor and the advantages derived would be outweighed by the extra expense involved.

One other point which may be mentioned (though in the opinion of the writer it is a debatable one) is the inclusion of switching or plug facilities for direct external connection to the c.r.t. deflection plates. In practice the number of occasions when this feature is required are extremely rare. The stray capacitance due to the plugs or switching and the extra wiring involved all mean extra loading on the X and Y amplifier output stages with a resultant deterioration at the h.f. end of the amplifier response curves. For this reason this feature was not incorporated in the design though it could be included at negligible cost if required, but with consequent fall off in amplifier h.f. gain.

Before going on to the constructional details, a brief description of the various circuit functions will be of interest and will also help to clarify the working of the instrument and the uses to which it may be put.

### POWER SUPPLIES

Fig. 1 shows the power supply section, the cathode ray tube, and the calibration unit.

The mains transformer T1 feeds the full-wave rectifier V1, and the pulsating d.c. output is smoothed by L1 and C1. The h.t. is at a potential of 315 volts.

Three heater windings are provided on T1: y-y for the c.r.t., x-x for the valves V4-V8 inclusive and z-z for the rectifier V1. The valve heater winding x-x is centre tapped—this is essential in order to reduce hum in the amplifiers to a minimum.

The e.h.t. is derived from a half wave voltage doubling circuit comprising C5, D1, and D2. The final output after smoothing by C6, R14, and C7, is in the region of minus 750 volts with respect to earth.



As A3 is fed from the astig. control VR1 connected in a divider network across the h.t. supply, this means that approximately 1kV is applied across the c.r.t. The e.h.t. divider chain R15-VR3 provides the necessary voltage levels for the tube electrodes, VR2 being the focus control and VR3 the brilliance control.

Adequate decoupling is provided against spurious signal pick-up by means of C2, C8, and C9. Flyback suppression is applied to the tube cathode via C10 which provides d.c. isolation between the two circuits. A large positive-going pulse (about 60 volts peak) is applied via this capacitor from the time base circuit

during the flyback period, and drives the cathode positive with respect to the grid so cutting the tube off during this period.

Another divider chain across the h.t. line, R4-R6, provides a suitable low voltage supply for the transistor calibration circuit, the large capacitor C4 providing extra smoothing. A small neon tube V2 shows when the h.t. is switched on. The warming-up period is less than a minute.

The low voltage supply for the transistor calibration unit is taken via S2 to the common positive supply line for this circuit. This supply is about 11 volts.

## COMPONENTS . . .

### Resistors

R1	470k $\Omega$	R32	1M $\Omega$ 5% H.S.
R2	10k $\Omega$	R33	10k $\Omega$ 5% 3W
R3	68k $\Omega$	R34	220 $\Omega$
R4	33k $\Omega$ 1W	R35	1M $\Omega$
R5	33k $\Omega$ 1W	R36	1M $\Omega$
R6	3.9k $\Omega$	R37	10k $\Omega$
R7	3.3k $\Omega$	R38	10k $\Omega$ 5% 3W
R8	390k $\Omega$	R39	10k $\Omega$ 5% 3W
R9	220k $\Omega$	R40	1.8k $\Omega$ 5%
R10	100k $\Omega$	R41	10k $\Omega$
R11	3.3k $\Omega$	R42	1M $\Omega$
R12	10k $\Omega$	R43	120k $\Omega$
R13	1k $\Omega$	R44	1M $\Omega$
R14	33k $\Omega$ 1W	R45	33k $\Omega$ 1W
R15	330k $\Omega$ 1W	R46	1k $\Omega$
R16	180k $\Omega$ 1W	R47	1M $\Omega$
R17	2.7k $\Omega$	R48	4.7k $\Omega$
R18	1M $\Omega$ 5% H.S.	R49	220k $\Omega$
R19	5.6k $\Omega$ 5% H.S.	R50	2.2M $\Omega$
R20	6.8k $\Omega$ 5% H.S.	R51	2.2k $\Omega$
R21	1M $\Omega$ 5% H.S.	R52	47k $\Omega$ 1W
R22	10k $\Omega$ 5% H.S.	R53	33k $\Omega$ 1W
R23	1M $\Omega$ 5% H.S.	R54	4.7k $\Omega$
R24	39k $\Omega$ 5% H.S.	R55	1M $\Omega$
R25	120k $\Omega$ 5% H.S.	R56	10k $\Omega$
R26	1M $\Omega$ 5% H.S.	R57	33k $\Omega$ 1W
R27	10M $\Omega$ 5% H.S.	R58	33k $\Omega$ 1W
R28	100k $\Omega$ 5% H.S.	R59	2.7k $\Omega$
R29	680 k $\Omega$ 5% H.S.	R60	10k $\Omega$
R30	1M $\Omega$ 5% H.S.	R61	1M $\Omega$
R31	390k $\Omega$ 5% H.S.	R62	120k $\Omega$

All 10%  $\frac{1}{2}$ W unless otherwise indicated

### Potentiometers

VR1	50k $\Omega$ wire wound, linear
VR2	100k $\Omega$ carbon or wire wound, linear
VR3	50k $\Omega$ carbon or wire wound, linear
VR4	25k $\Omega$ wire wound, linear
VR5	25k $\Omega$ wire wound, linear
VR6	1M $\Omega$ carbon, linear
VR7	2M $\Omega$ carbon, linear
VR8	25k $\Omega$ wire wound, linear
VR9	25k $\Omega$ wire wound, linear

### Capacitors

C1a	32 $\mu$ F } dual elect.	C14	2 $\mu$ F paper 350V
C1b	32 $\mu$ F } 450V	C15	220pF silver mica 250V
C2	0.1 $\mu$ F paper 350V	C16	0.1 $\mu$ F paper 150V
C3	0.25 $\mu$ F paper 150V	C17	0.02 $\mu$ F paper 350V
C4	100 $\mu$ F elect. 25V	C18	15pF silver mica 350V
C5	0.5 $\mu$ F paper 750V	C19	15pF silver mica 350V
C6	0.5 $\mu$ F paper 1,000V	C20	2,000pF paper 350V
C7	0.5 $\mu$ F paper 1,000V	C21	1,000pF paper 250V
C8	0.1 $\mu$ F paper 500V	C22	0.01 $\mu$ F paper 250V
C9	0.1 $\mu$ F paper 500V	C23	0.1 $\mu$ F paper 250V
C10	0.1 $\mu$ F paper 1,000V	C24	1 $\mu$ F paper 250V
C11	0.25 $\mu$ F paper 750V	C25	0.05 $\mu$ F paper 500V
C12	16 $\mu$ F elect. 350V	C26	16 $\mu$ F elect. 350V
C13	0.025 $\mu$ F paper 150V	C27	0.5 $\mu$ F paper 350V

C28 0.1 $\mu$ F paper 150V

### Switches

S1	D.P.S.T. toggle
S2	S.P.S.T. toggle
S3	2 pole, 6 way rotary
S4	S.P.D.T. toggle
S5	2 pole 5 way rotary

### Valves

V1	6X5
V2	miniature neon lamp, 250V
V3	3BP1, 3EP1, or 3GP1
V4	ECC81
V5	ECC82
V6	ECC81
V7	ECC82
V8	ECC82

### Semiconductors

D1	OA210
D2	OA210
D3	OA81
TR1	OC200
TR2	OC200
TR3	OC200

### Inductors and Transformers

L1	Smoothing choke, 20H 50mA
T1	Mains transformer. Primary 230-250V. Secondaries: 350-0-350V 60mA; 6.3V 3A, centre tapped; 6.3V 2A; 6.3V 1A. (Radio-spares "Heavy Duty" type with extra heater winding wound on)

### Miscellaneous

Five B9A valve holders and screening cans. One I.O. valve holder. Seven OZ sockets and plugs. One coaxial socket. Grommets, tag boards and tag strips. Mu-metal shield and base for c.r.t.



## CALIBRATION UNIT

The input sine wave signal to the calibration circuit is taken from one end of the heater supply "x" through the isolating capacitor C3 and limiting resistor R7 to the base of the first transistor TR1. Here the signal is clipped by the base-emitter diode action of this transistor and the diode D3. To achieve symmetrical clipping TR1 is suitably biased by R9 which in effect controls the mark/space ratio to a certain extent. The output developed across the load resistor R10 is a symmetrical semi-square wave.

The transistors TR2 and TR3 form a cascade amplifier (sometimes called an alpha plus pair) having an extremely high gain. The output developed across R12-R13 is a symmetrical square wave having a fast rise time (5 $\mu$ sec) as this part of the amplifier is driven between its fully bottomed and fully cut-off conditions.

The reason for the tapped load is that the signal amplitude available is the full supply voltage (11 volts) which is rather high for practical applications. Only that part of the signal across R13 is actually used, this being the ratio of the divider resistors to the supply voltage, in this case one-eleventh of 11 volts. This means that a calibration signal of 1 volt peak to peak is available at the output terminal.

## Y AMPLIFIER AND ATTENUATOR

The circuit of the Y amplifier and the input attenuator is given in Fig. 2. Input is coupled via the isolating capacitor C11 to the attenuator switch S3. In position 1 the input is fed directly to the grid of the first stage, V4. In the other five positions tapped potentiometers are brought into circuit, the values of the resistors being so arranged to give increasing values of attenuation up to a maximum of about 50dB or X300 sensitivity. This means, for example, that in the sixth position the maximum sensitivity will be approximately 300  $\times$  200mV/cm, or 60 volts/cm.

The first stage of the amplifier V4a is a cathode follower which gives a high input impedance with a low output impedance so ensuring good isolation

between the input circuit and output. The cathode load is a potentiometer VR4 which constitutes a linear Y gain control, maximum sensitivity occurring when the slider is at the cathode end of the potentiometer.

Output from the slider of VR4 is coupled to the input of the second amplifier stage V4b through C12. This half of the double triode operates as a conventional amplifier with a relatively low anode load to increase the h.f. response.

It must be noted that the decoupling capacitor C13 across the bias resistor R34 is quite critical, having a noticeable effect on the amplifier response; too low a value gives rounding of the corners on a square wave signal while too high a value gives overshoot.

The output of this stage is coupled via C14 to the input of the cathode coupled push-pull output stage V5a,b. Here again relatively low values of anode load are used to maintain the overall h.f. response. A certain amount of negative feedback is also obtained through the common bias resistor R40.

The Y shift control VR5 applies a variable d.c. voltage to the valve grids. Altering this control changes the bias level on the grids in opposite directions, i.e. as one grid is made more negative the other is made correspondingly positive. Both stages can therefore be swung over their full characteristic by means of this control, the anode voltages changing in accordance with the change in grid voltage.

The grid of V5b is effectively decoupled against stray pick-up and ripple by means of C16, while the small capacitor C15 provides h.f. compensation. The outputs to the Y deflection plates of the c.r.t. are directly coupled from the anodes of V5.

The large value coupling capacitors C12 and C14 were necessary to give a good l.f. response; though the long time constants involved give a slight delay in signal response (most noticeable when the Y gain is altered with a sudden jerk) this action is unavoidable if a good l.f. response is to be maintained. This is one of the problems which would be obviated if a d.c. coupled amplifier were used.

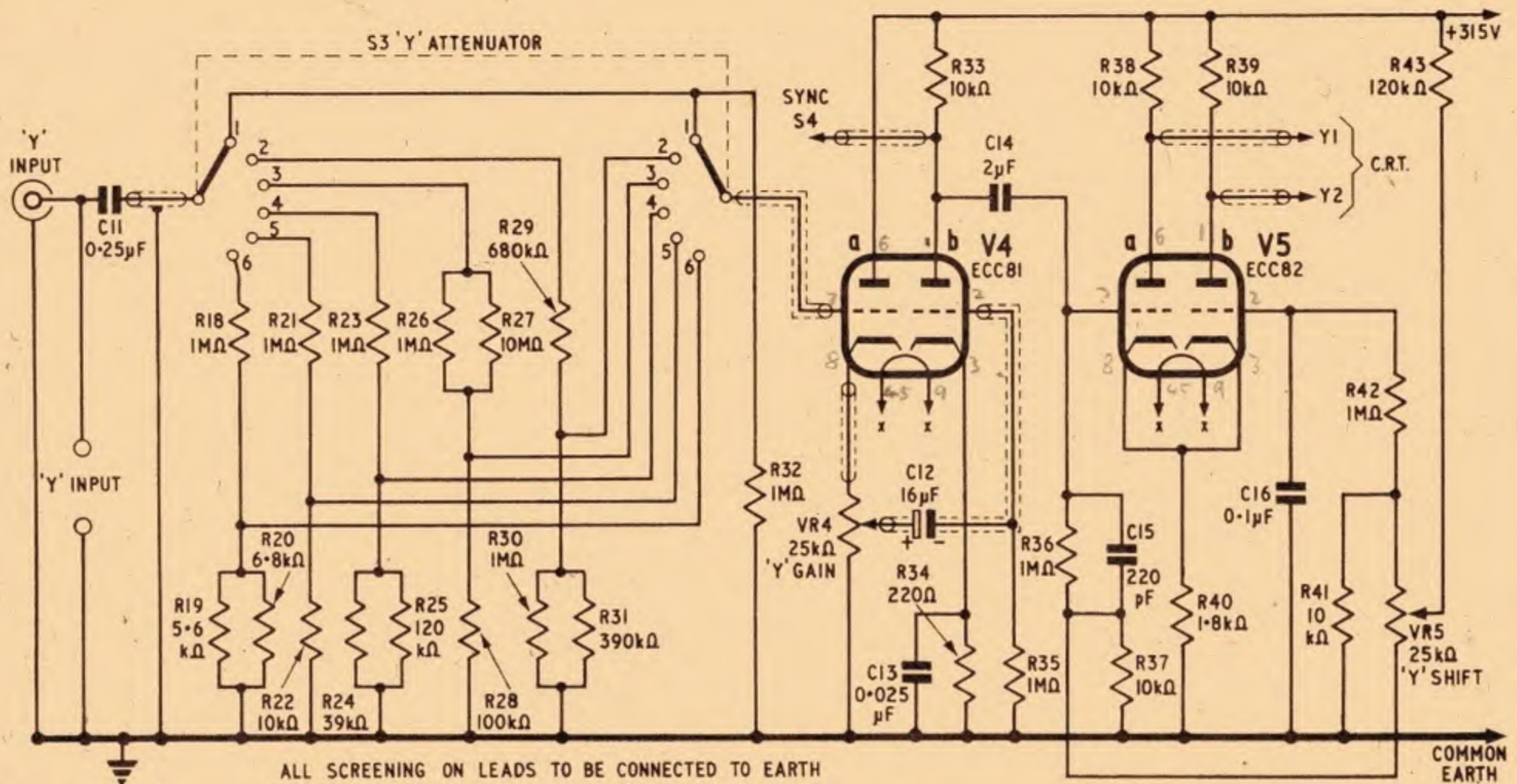

Fig. 2. The circuit of the Y amplifier and the input attenuator



\* Reverse all 4 capacitors.

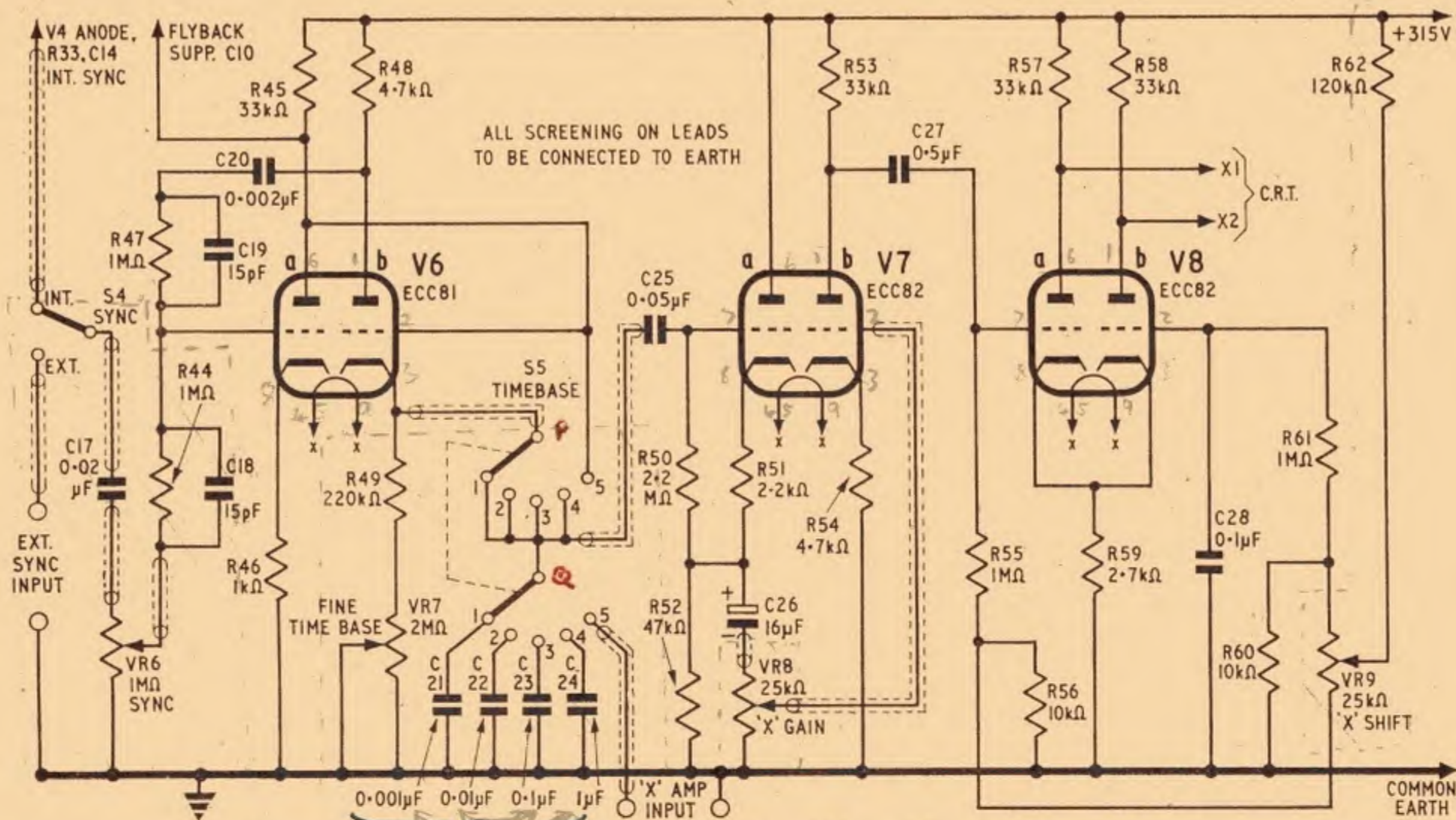

Fig. 3. Time base generator and X amplifier circuit

### TIME BASE AND X AMPLIFIER

Fig. 3 gives the circuit of the time base generator and the X amplifier.

The synchronising and time base generator functions are carried out by V6a,b which is simply a rather unorthodox form of multivibrator or flip-flop circuit. The saw-tooth waveform is dependent upon the charge and discharge of the capacitors C21-C24 through the multivibrator action. The waveform at the anode of V6a takes the form of a series of short time duration sharp positive-going pulses which correspond to the flyback period, thus the capacitor is rapidly charged during this period as V6a will be cut off and V6b will be conducting as its grid is d.c. coupled to the anode of V6a.

Having charged the capacitor the circuit reverts to its original position through the coupling C20, R47. The whole of this action is very rapid. The circuit must now wait until the charged capacitor has discharged via R49, VR7, this being the scan period whose time is principally determined by the time constant C21-C24 selected by S5 the coarse control and VR7 the fine control. When the capacitor is discharged the complete sequence is repeated, the action being repetitive. The output therefore obtained at the cathode of V6b is an extremely linear saw-tooth waveform, the linearity being improved by the bias resistor R46 which allows the slightly non-linear portion of the discharge curve to fall in the cut-off portion of the valve characteristic.

A secondary advantage of the circuit is that the sharp positive-going pulse at V6a anode can be conveniently applied to the c.r.t. cathode and so ensure effective flyback suppression. By applying an external signal to the grid of V6a the multivibrator action and thus the time base can be locked or synchronised to this signal. This synchronising signal is derived from the Y amplifier or externally, depending upon the position of S4. It is fed through the isolating capacitor C17 to the sync control VR6. This control allows

the amplitude of the incoming signal to be set until the signal and time base are effectively locked.

The saw-tooth signal obtained at the cathode of V6b is taken through the switch S5 to the cathode follower V7a. The last position on S5 allows an external signal to be fed into V7a, while at the same time V6b is short circuited, this stopping the time base generator and muting the sync signal. In this manner the time base/sync circuit is prevented from interfering with the external signal being applied to the X amplifier due to stray coupling across the switch and associated wiring.

The cathode follower V7a serves the same function as the cathode follower in the Y amplifier, the output signal being developed across the load R51, with R52 providing the necessary bias. The signal is coupled via C26 to the X gain control VR8. With S5 set to one of the time base ranges, VR8 serves as an X expansion control allowing an effective screen diameter of at least six times to be obtained. This feature allows small parts of a composite signal to be displayed on a much larger scale. With an external X signal applied VR8 serves as a straightforward gain control.

The output from this control is applied to the grid of V7b which is a conventional amplifier. A large value bias resistor R54 is used in order to maintain maximum linearity. The output of this stage is coupled via C27 to the cathode coupled push-pull output amplifier V8a,b. This is a similar circuit to that incorporated in the Y amplifier.

It will be found in practice that a slight non-linearity may occur on the very slow sweep speeds, this is partly due to the time base and partly due to the fall off in l.f. response in the X amplifier. This effect can be obviated by increasing the X gain until the small non-linear part of the trace "disappears" off the edge of the tube face.

**Next month: Details of the construction will be given**



# MAGIC BOXES?

By G. A. BOBKER

*We knew all the time!*

Apart from being an interesting gadget to amuse and mystify your friends, certain useful applications will no doubt come to mind where remote indication of the state of two circuits is needed but one is limited to just one pair of interconnecting wires.

**M**ANY readers will doubtlessly remember the "magic-boxes" which became popular as an electronic novelty a few years ago. Two boxes were connected together by a pair of wires, and then by turning a switch on one box either of two lamps in the second box could be illuminated. It was not too difficult to deduce what the boxes contained, however. The "magic" was relatively simple.

The circuit of this original device is given in Fig. 1. When the switch S1 is in the "1" position as shown, the voltage at point "A" is positive; diode D1 therefore conducts and allows current to flow through lamp LP1. When S1 is set to "2", the battery BY2 is brought into circuit, and the polarity of the supply at point "A" is now negative. Under this condition D2 conducts, so illuminating the second lamp LP2, while D1 is cut off.

## A NEW VERSION

A more intriguing puzzle is produced if a further action is added, so enabling *both* lamps to be illuminated together.

There are several methods of obtaining this third function. The method used by the author and to be described in this article seems the most practical for size and cost and—most important of all—will appear the most mystifying.

The "magic" involved in this new version is performed by a Zener diode. A diode, of course, allows current to flow through it in one direction, while if the polarity of the supply is reversed, practically no current will flow. But, should the voltage across the diode exceed a certain value, the diode "breaks down" and does allow current to flow in this "reverse" direction. Unfortunately, with a normal diode, it would be destroyed if operated in this manner.

The Zener diode operates in the manner described above except that it is designed to stabilise a reverse voltage without sustaining damage.

Fig. 1. Circuit of the earlier magic box device

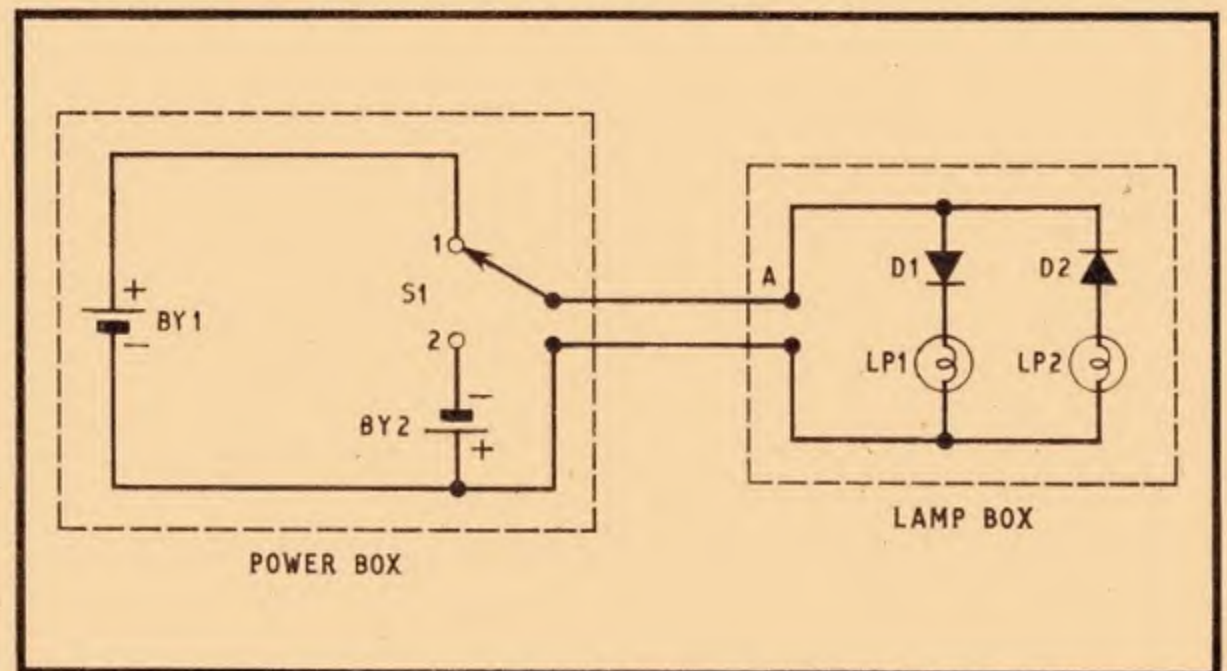



# COMPLETE CIRCUIT

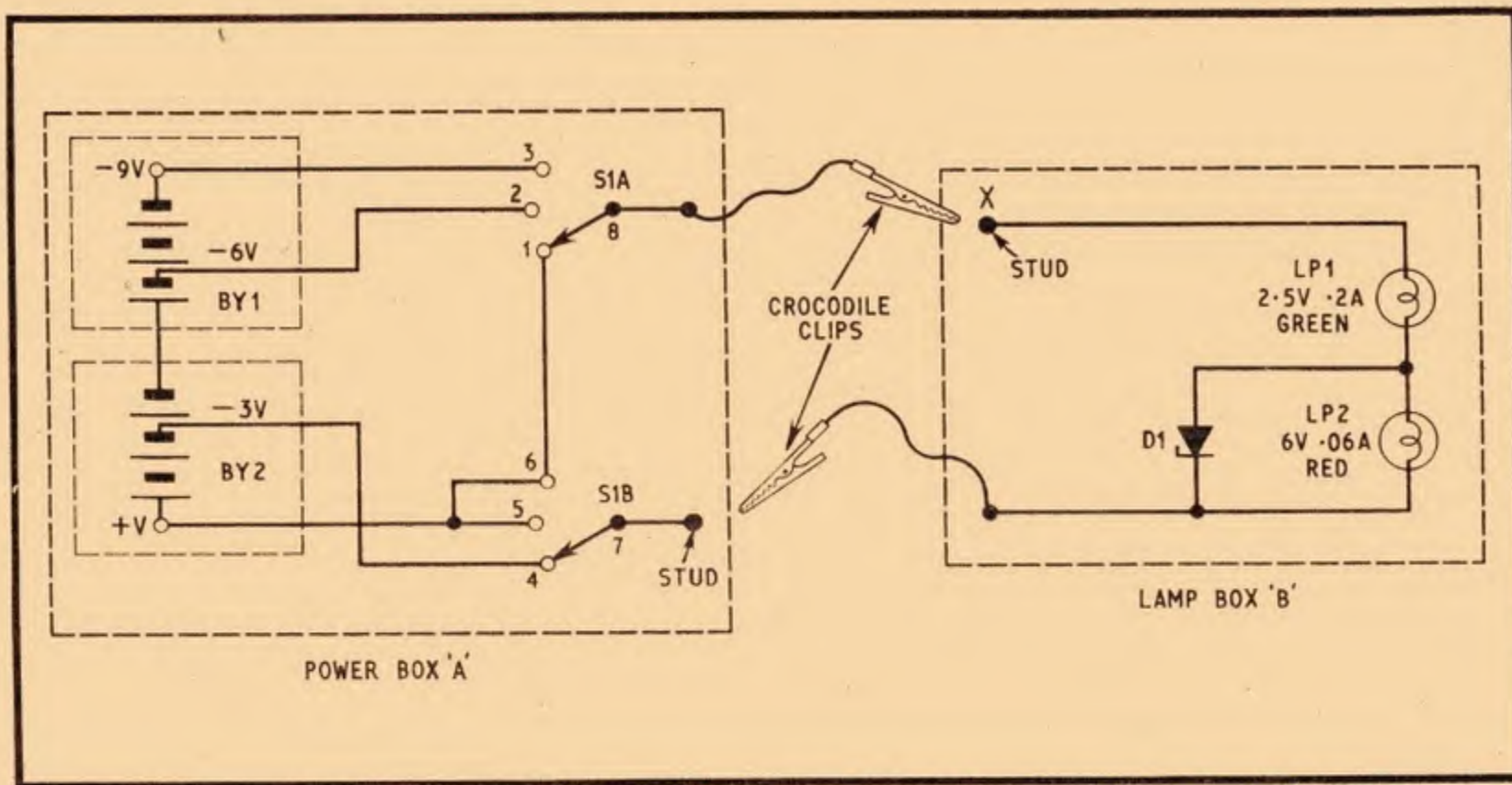

Fig. 2. Circuit of the "Magic Boxes" the construction of which is illustrated below

Fig. 3. The switch contacts are identified in the left hand drawing. The other illustration shows the wiring of the two 4.5V batteries

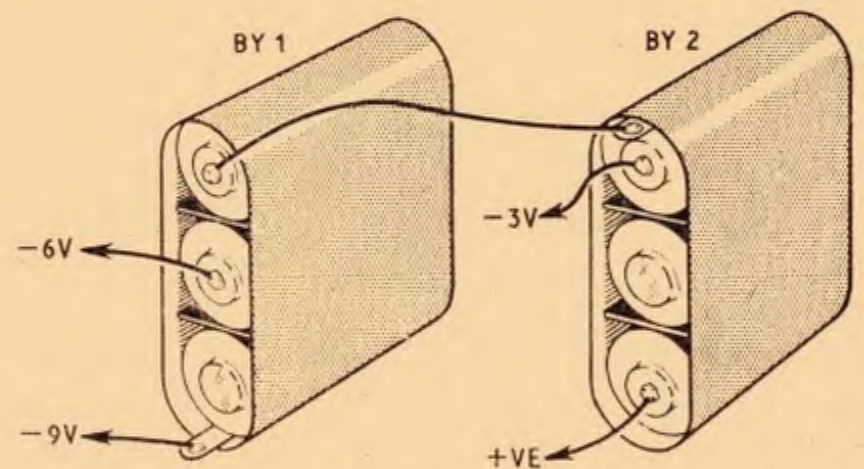
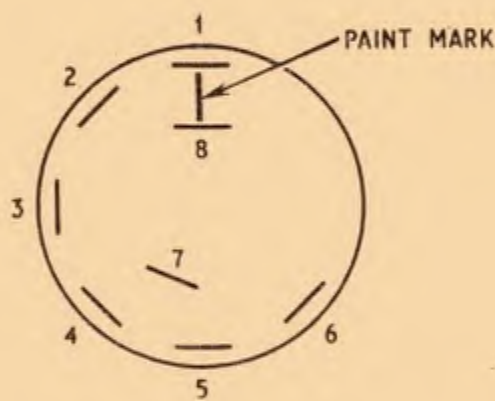
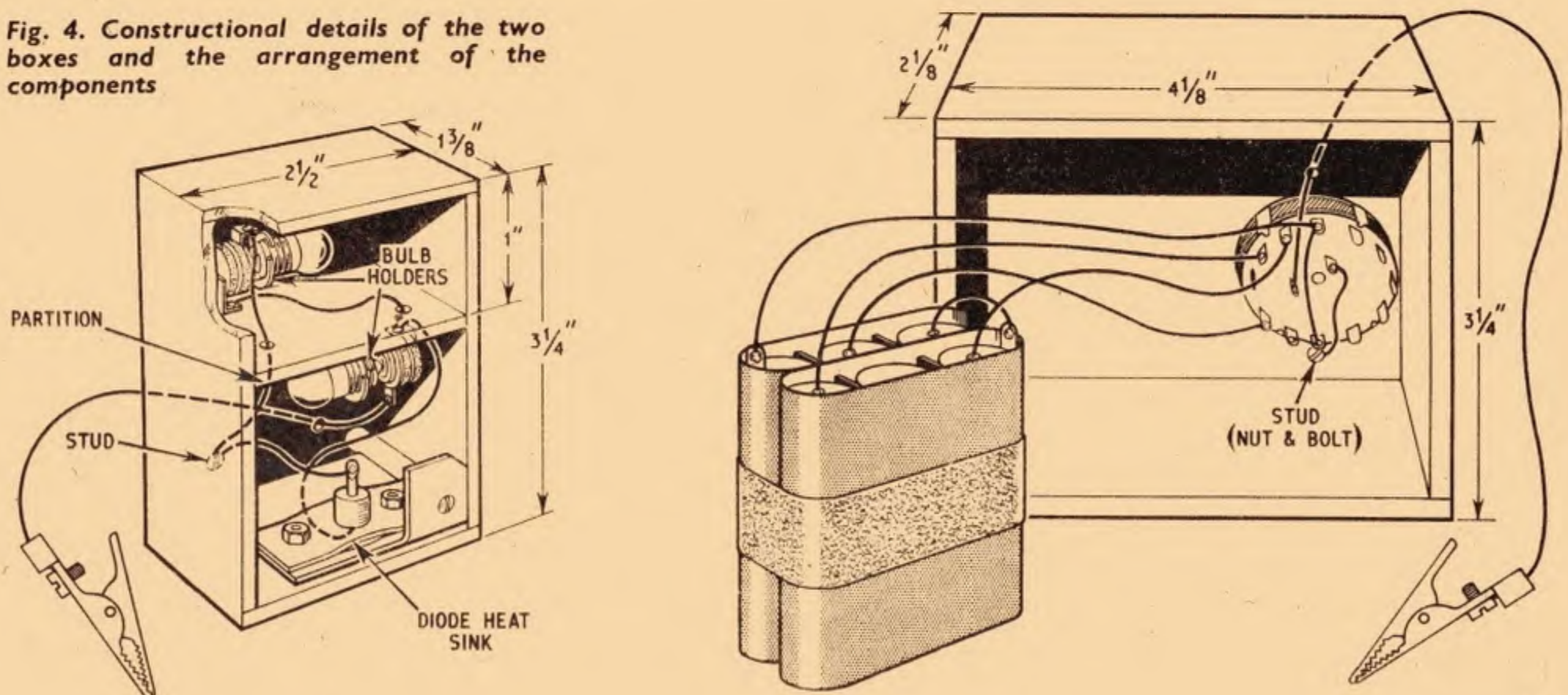

Fig. 4. Constructional details of the two boxes and the arrangement of the components





## THE CIRCUIT

The complete circuit diagram for the "Magic Boxes" appears in Fig. 2. The power box "A" is arranged to supply either +3V, -6V or -9V to point "X" in the lamp box "B". These supplies are derived from the two 4.5V batteries. The two batteries are connected in series and the appropriate voltages tapped off by the double pole switch S1. The action is as follows.

*Switch at position 1:* +3V appears at "X". Since the top of the Zener diode D1 is positive, this diode conducts so effectively shorting out lamp LP2. Therefore, the whole 3V supply is developed across LP1, and this lamp (green) becomes illuminated.

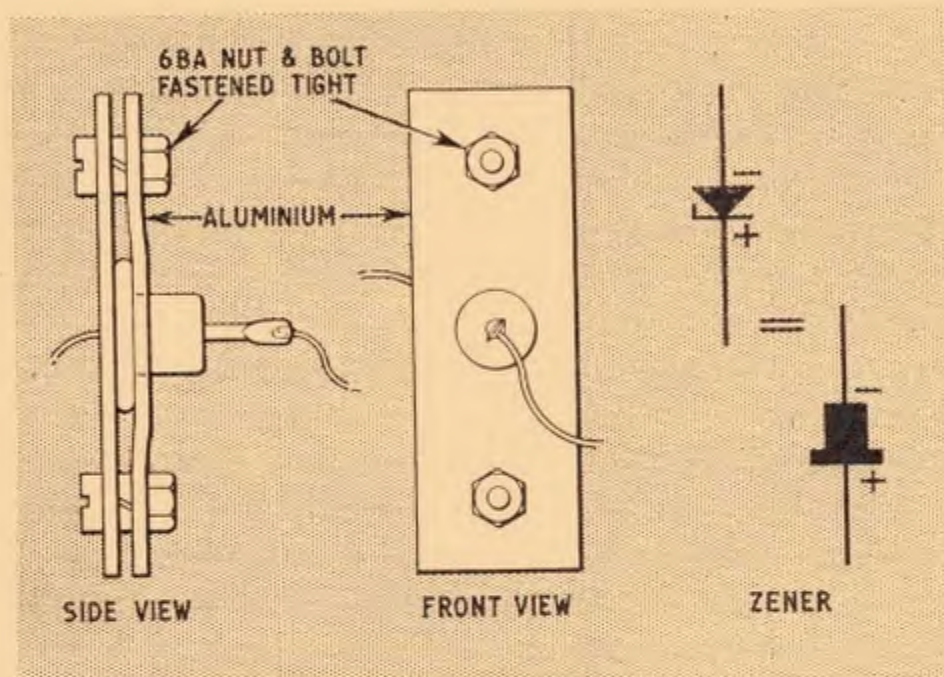

Fig. 5. The Zener diode and heat sink

*Switch at position 2:* -6V appears at "X". Due to the lamp LP2 having a much higher resistance than LP1, the majority of the 6V supply is developed across LP2. The latter becomes illuminated and since the current through it is only 0.06A, it will not be sufficient to light the other lamp LP1.

Note: The Zener diode used stabilises at about 6V. But since the voltage across LP2, and therefore also across the diode, is slightly below 6V, the current through the diode will be very small, and can be ignored.

*Switch at position 3:* -9V appears at "X". With a negative voltage applied greater than -6V, the Zener diode conducts so stabilising the voltage across it at 6V. Therefore 6V are applied across LP2, and this lamp is lit. The remaining 3V are dropped across LP1, which is also lit. The current through LP1 is made up from 0.06A through LP2, plus 0.144A drawn by D1.

The difference in brilliance, due to the use of different wattage lamps, is very effectively disguised by the use of coloured lenses; green for LP1, red for LP2.

## CONSTRUCTION

Both boxes were constructed of thin plywood, simply glued together, and covered with a self-adhesive material. This material also secures the removable backs of the boxes. See Fig. 4 for details.

The power box dimensions are just sufficient to house two flat type 4.5V batteries and the switch S1.

Before commencing wiring, turn the switch fully anticlockwise, as viewed from the front. Locate an outer contact which is touching an inner contact and mark these to facilitate wiring. Wire up the switch and batteries as shown in Fig. 3.

## COMPONENTS...

BY1, BY2	4.5V torch battery, Ever Ready 1289 (2 off)
D1	6V Zener diode type VR575 (A.E.I.)
LP1	lamp 2.5V 0.2A
LP2	lamp 6V 0.06A
S1	rotary switch, 2-pole, 3-way

### Miscellaneous

Two MES open type lampholders, one with red lens, one with green lens.

Two crocodile clips. Two 6 B.A. nuts and bolts (for the "studs").

Small piece of aluminium for heat sink.

In the case of the lamp box it is necessary to use a partition between the lampholders, as these are of the "open" type. Ensure that the Zener diode is connected the correct way round. A small heat sink must be used as the power dissipated by the diode in the third position approaches the maximum permissible. Details of the heat sink are given in Fig. 5.

## OPERATION

- Show that the two boxes are connected by two wires only.
- Demonstrate that either lamp 1 or lamp 2 can be illuminated. Ask observer how *he* thinks this is arranged.
- If person knows how it is done, then switch to the third position.

The usual comment after this demonstration is, "Do it again".

Allow anyone to inspect the power box, but don't open the lamp box. Strange as it may seem, most people think that the secret of the "magic" is within the power box.

# Guide to SEMICONDUCTOR CIRCUIT DESIGN

The second part of the pull-out booklet on semiconductor data is included as a supplement in this month's PRACTICAL ELECTRONICS. The centre pull-out pages deal with transistor characteristics.

The main parameters were briefly explained and characteristics of some of the most commonly used signal diodes and Zener diodes were given last month.

When the pages have been removed from the staples they can be folded in half and cut along the top edges.



# THE SEMICONDUCTOR . . .

## PART 2. GERMANIUM & SILICON DIODES

BY CHARLES NORMAN

IN JUNE, 1948, three scientists working for the Bell Telephone Laboratories made the first public announcement of the transistor, and to them goes the official credit for its invention. So in less than 20 years semiconductor devices have invaded the whole field of electronics. In about another 20 years the valve may have become a museum piece. Already there are more semiconductor diodes listed than there are valves of all types. Yet the triode was invented in 1906 and vacuum diodes were known long before this.

We saw last month how the junction between *p*- and *n*-type germanium acts as a unidirectional conductor. Given this, it needs little imagination to conceive detectors no larger than a grain of wheat and power rectifiers much smaller than a thimble. But this is not half of it. There are diodes that can be used to provide accurate reference voltages and others that can be used, not only as fast switches, but as amplifiers and oscillators operating up to frequencies of a million megacycles.

### SIGNAL DIODES

As a detector, the germanium diode is too well known to need a detailed description. Both its connections and its operation are similar to those of a conventional diode. It needs no heater supply, it occupies practically no space, and it is far more efficient than the old-fashioned crystal and cat's whisker. If you happen to have a pair of high resistance headphones it might be interesting to make up a modern version of the crystal set.

Use the circuit of Fig. 2.1 which should be self-explanatory. The coil L1 could be any medium wave coil or you could close-wind 90 turns of 35s.w.g.

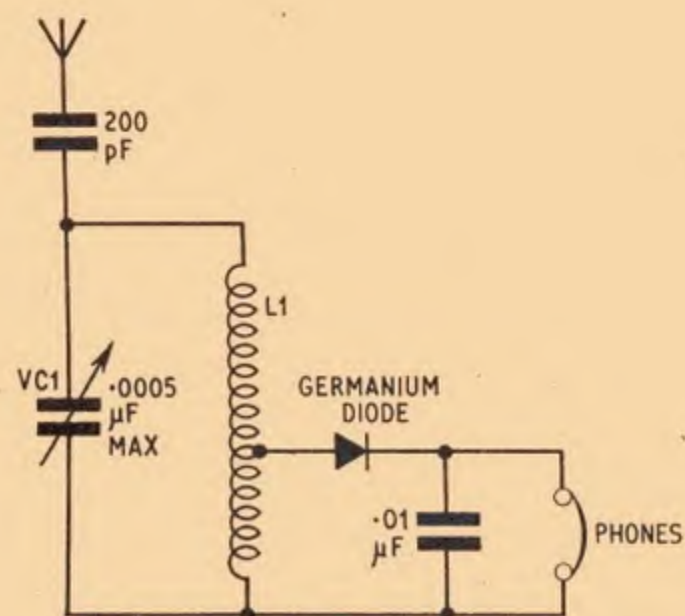

Fig. 2.1. Circuit diagram of an "updated" simple crystal set using a germanium diode in place of the old-fashioned crystal and cat's whisker

enamelled wire on a 1in former, making the tap one-third of the way along the winding. The tuning capacitor C1 could be a 500pF mica trimmer and the other two capacitors can be anything of about the values shown that happen to be available. This can hardly be called a sophisticated receiver, but it can be made in no time and will give quite good reception of the Home Service and Light Programme in most parts of the British Isles on just a few yards of aerial. After dark it will pick up one or two overseas stations.

### POWER RECTIFIERS

Semiconductor power rectifiers are usually made from silicon, which can be doped with donor and acceptor impurities in the same way as germanium. Silicon is much more difficult to melt and purify than germanium but it will handle higher powers more efficiently and is less sensitive to temperature. A single silicon diode of about the same size as a pea makes an ideal rectifier in an a.c./d.c. radio or television receiver. The most common types of diode will pass up to about half an ampere and can safely be used with reservoir capacitors of very high values.

There is nothing complicated about using a silicon diode, but one very important fact should be remembered. When a valve rectifier fails, it just ceases to conduct, but a semiconductor rectifier is more likely to be short-circuited than open-circuited. A faulty silicon diode could put raw a.c. on to your electrolytics in a universal receiver or burn out the transformer if one is used. For this reason, proper fusing is essential. This is a minor drawback though, and if you have to service any receiver in which a valve rectifier has died a silicon diode is an excellent replacement.

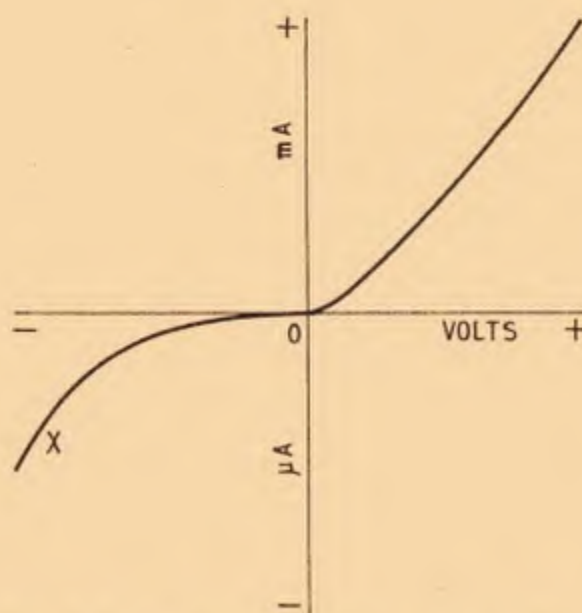

Fig. 2.2a. Characteristic curve of a normal germanium diode showing how the reverse current increases rapidly once it is beyond point X

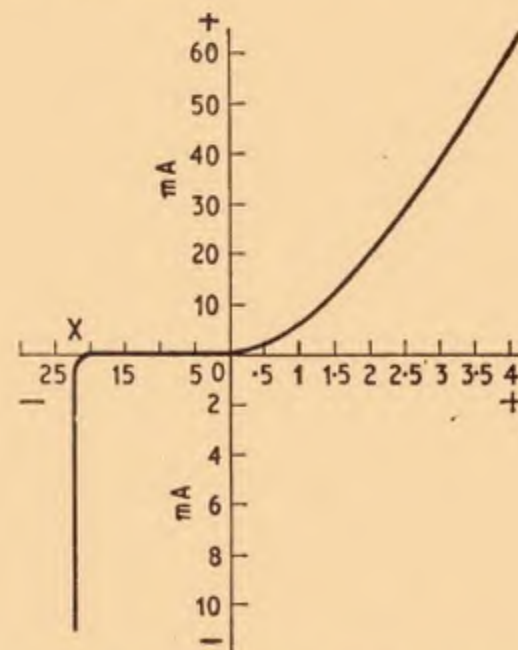

Fig. 2.2b. Characteristic curve of a silicon Zener diode designed to take full advantage of the sudden reverse current increase



With a transformer power supply a 10 ohm 2 watt composition resistor should be wired in series with each diode. Then, if a diode happens to go short-circuit, the resistor will burn out before the transformer is damaged.

### ZENER REFERENCE DIODES

In modern electronic equipment an absolutely stable power supply which will remain constant under changing load and supply conditions is often essential.

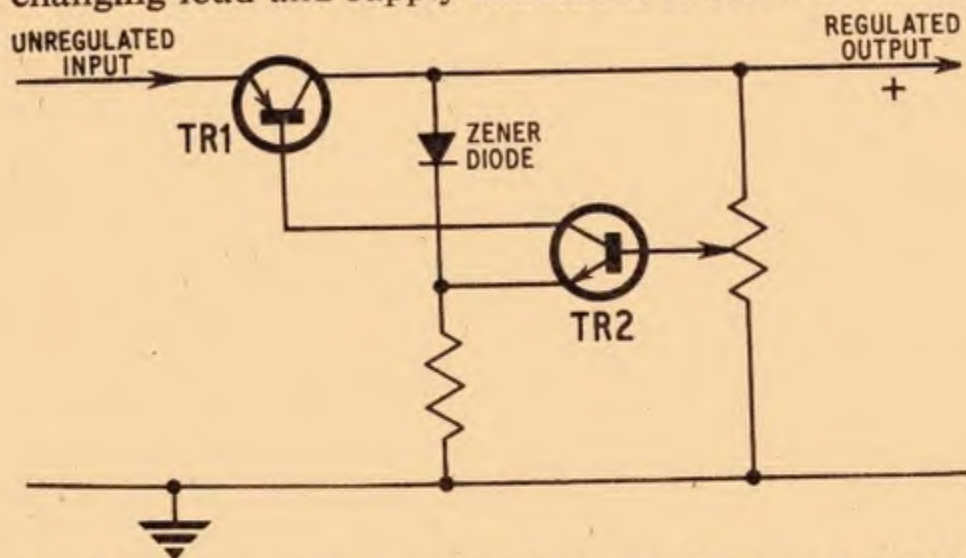

Fig. 2.3. A simplified circuit diagram of a power supply stabiliser using a Zener diode

This is where the Zener, or reference diode, comes in very useful. In essence the Zener is a specially constructed diode which works in reverse and which uses what would normally be considered as the failure part of the characteristic in the ordinary silicon diode.

Fig. 2.2a shows the characteristic curve of a normal germanium diode. The device passes a steadily increasing current in a forward direction and a very much smaller current when the applied voltage is reversed. But at point X on the graph, where the reverse voltage has increased beyond a critical value, the reverse current begins to increase sharply. The electrons are moving so fast that they knock off some of the bonding electrons from their orbits, making these available as current carriers. These in turn displace more bonding electrons and as each moving electron may displace two or more fixed electrons, the current grows like an avalanche, and the diode may very easily be destroyed.

The silicon Zener diode, whose characteristic curve is shown in Fig. 2.2b, is specially designed to take advantage of this avalanche effect. At point X on this curve, the effect is so pronounced that the reverse current curve is practically vertical, indicating that the diode behaves almost as a short-circuit. The critical reverse voltage at which this action occurs is called the Zener voltage after Clarence Zener, who discovered the effect.

If a Zener diode is connected across a low impedance source the diode will burn out as soon as the reverse voltage exceeds the Zener voltage, but if a suitable series resistance is added the increase in current will cause an increase in voltage drop across the resistance. So the voltage drop across the diode will remain at exactly the Zener voltage. These diodes can be so accurately made that in many applications they have replaced the Standard cell. They are robust and small, and can be obtained at a variety of "turnover" voltages.

Fig. 2.3 is a simplified circuit of a power supply stabiliser using a Zener diode and two transistors. For the present, let us forget about how transistors operate and just accept that they will amplify and pass current just as valves will. TR1 is a power transistor which

will pass a large current and which is placed in series with the h.t. line. Its base is connected to the collector of TR2, a low-power transistor. A Zener diode in series with a resistor is connected across the h.t. supply. The emitter of TR2 is led to the junction of these two, while its base goes to the slider of a potentiometer which is also connected across the h.t. supply. The Zener diode holds the emitter of TR2 at a constant potential whatever the variation of the supply voltage. So if the h.t. voltage goes up, TR2 base voltage goes up with respect to the emitter voltage. Its collector voltage goes down in the same way as that of a valve, making the base of TR1 go negative. This causes TR1 to conduct less heavily, which has the same effect as increasing a resistance in series with the h.t. supply. If the h.t. voltage goes down the same process takes place in reverse. So, over reasonable variations of supply and load, the output voltage remains constant at a value depending on the potentiometer setting.

### TUNNEL DIODES

And now for a look at a recent invention, the tunnel diode. We saw last month how a potential barrier is formed at a *pn* junction when the germanium is lightly doped with impurities. Now, if the metal is heavily

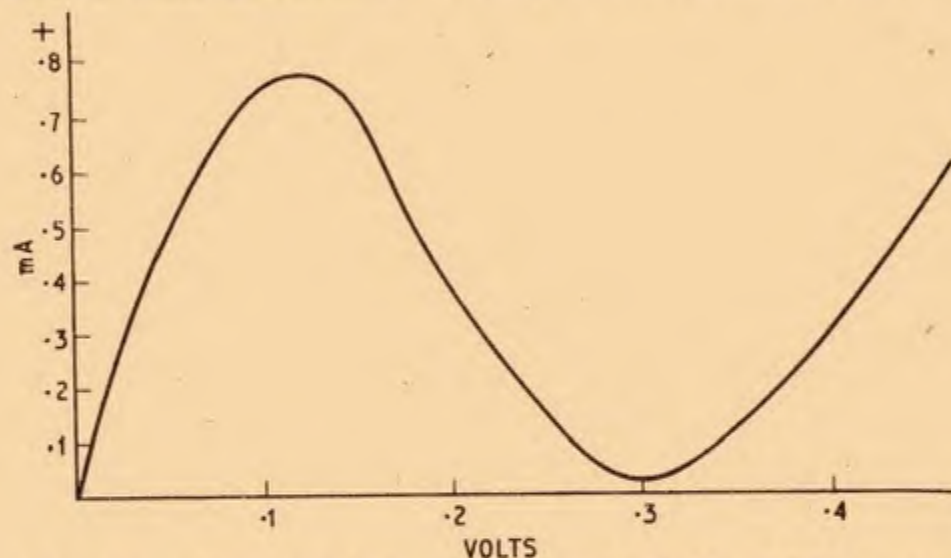

Fig. 2.4. Characteristic of a tunnel diode which is very similar to a tetrode valve

doped, the electrons, at low applied voltages, "tunnel" through this potential barrier and a current flows. As the voltage is increased, the potential barrier becomes more powerful and the device behaves more and more like a normal diode. Fig. 2.4 shows the characteristic curve of a tunnel diode; it is similar to that of a tetrode. The really important thing to notice is that as the voltage goes down from, say, 0.3 towards zero the current, in direct contradiction to Ohm's law, increases. So the tunnel diode behaves as a negative resistance. If it is connected in series with an LC circuit whose positive resistance is smaller than the negative resistance of the diode, the system will oscillate in the same way as a dynatron tetrode oscillator provided the applied voltage is within the negative resistance portion of the characteristic. If the resistance is increased to the same value as the negative resistance, the circuit will not oscillate, but the tunnel diode will act as a tuned amplifier. Because the electrons have practically no distance to travel, the tunnel diode will work at much higher frequencies than a conventional transistor or valve. The theoretical upper limit, in fact, is in the heat spectrum. The tunnel diode is finding an increasing use in all types of electronic circuitry where a very fast response is needed.

**Next Month: The principles of transistors and some simple experiments**



## PART TWO

# GUITAR AMPLIFIER

By S. Chisholm

THE information which follows describes the prototype, which employed complex tone control. As the equipment is not frequency-conscious, rigid adherence to component values and dimensions is not essential and the prospective constructor will probably find some of the material on his spares shelf already.

It must be realised, however, that there is a very high gain between input and output; when designing layout, cross-coupling between grid and anode circuits due to close proximity of wiring will cause instability. Also, because of the high gain, the main amplifier must be effectively earthed if hum is to be reduced to a minimum. The earthing arrangements must be adhered to in the sub-units and input circuit screening.

### MAIN AMPLIFIER

Fig. 5 shows the drilling details of the main amplifier using international octal valve bases. It does not show drilling details for component assembly strips, T3, L3 and L4 as these will depend on what is available. Fig. 6 shows a representative component layout when a smoothing choke is to be used instead of an energised loudspeaker. The location of the transformer (T3) is shown dotted, also the position of L4. Approximate cable entry positions are given.

As much as possible of the wiring to the grid circuit of V3 and to the compensating volume controls mounted on the relay sub-assembly should be in screened cable. The screens are earthed.

A word of caution here: in some screened cable (particularly coaxial cable) with p.v.c. or polythene

insulation, the insulation will melt at fairly low temperatures. It is best to tin the screen and centre conductor with solder before final connection. In all cases, check the insulation between the internal lead and its screen after completing the joint, making sure that no resistors are in circuit.

When wiring, do not forget the h.t. and l.t. connections for the sub-units. These can be formed into a cable, in which the heater leads should be a twisted pair. Finally, ensure all joints are sound. One poor connection can cause a great deal of annoyance and partial dismantling of the assembly. A good test for "dry" joints is to give the soldered wire a gentle tug with a pair of pliers.

### COMPONENTS

Details of components were given last month but it may be worth mentioning here that if R28 is too low in value the vibrato speed may be affected.

Relays RLA, RLB are mounted on a sub-panel which also carries the compensating volume controls. The flexible wiring from the relay contacts to the amplifier must be low loss screened cable in anode and grid circuits and may be laced into a cable form which enters the amplifier through a suitable grommet. Wiring between the relays can be single strand p.v.c. covered wire.

### PRE-AMPLIFIER

A typical layout for this sub-unit is shown in Fig. 7 and needs little explanation. Heater wiring should again be in twisted pair. Grid inputs, and anode output leads to the main amplifier, should be in screened



wiring, the screen being well earthed. Remember to leave sufficiently lengthy leads for inter-wiring between the pre-amplifier, the vibrato panel, and to the input control panel. These can be laced after the units have been fitted into the cabinet and the connections soldered.

A word of caution regarding valves. It is advisable to use new valves if possible. The reason is that some "used" but "good" valves are too noisy for those stages where high gain is required. A cathode to heater leak is one source of noise here, whereas it may not matter so much in later stages of the amplifier. The valveholders should be skirted, and have clip-on screening cans both to prevent hum pick-up and to prevent the valves becoming dislodged during transit. A small bracket, bolted to the skirt, provides a simple means of attaching the holder to the sub-unit panel.

### VIBRATO UNIT

This unit is shown in Fig. 8. The capacitors in the prototype were physically rather large and a suggested alternative layout is shown in view of this. Construction is on similar lines to the method described for the pre-amplifier.

Transformer T1 is an intervalve transformer whose secondary d.c. resistance is approximately 2,000 ohms, and primary resistance about 500 ohms. Other step-up transformers have been tried and worked quite well, but the one specified above proved most effective. Its

function is to control the vibrato "slow" frequency, thus a small amount of experimenting with readily available transformers and capacitors may be necessary. If a selection of transformers is not available, a 4:1 step-up intervalve transformer should be obtained.

The resistor R15 will determine the amplitude (depth) of vibrato; try 20 kilohms for a starting point. If "puffing" (over-modulation) of the vibrato occurs, raise the value in 5 kilohm steps until the puffing clears.

### INPUT CONTROL PANEL

The component layout of the input control panel is shown in Fig. 9. Physically small potentiometers are required in order to clear the sockets SK1, SK2 and the control socket SK3. Wiring between the panel and the sub-units is made up into a cable form, which includes screened leads from VR1 and VR2, and is secured against vibration by the insulated cleat; other leads are clamped to the interior of the cabinet.

The h.t. and l.t. supply leads coming from the main amplifier are also assembled into the cable form, but remember to twist the l.t. leads. Lamp LP1 is a 6.3V 0.05A, or 0.3A if the transformer can handle the total load quite safely, and indicates when vibrato is in use.

### GENERAL ASSEMBLY

The overall assembly of the complete amplifier was shown in Fig. 2 (last month). Note the positions of the vibrato speed control VR3, the smoothing choke

Fig. 5. Main amplifier chassis. Power supply components are not shown since their position and drilling details depend on the sizes of the items used. L3 is not shown for the same reason. A guide to the approximate positions is given in Fig. 2

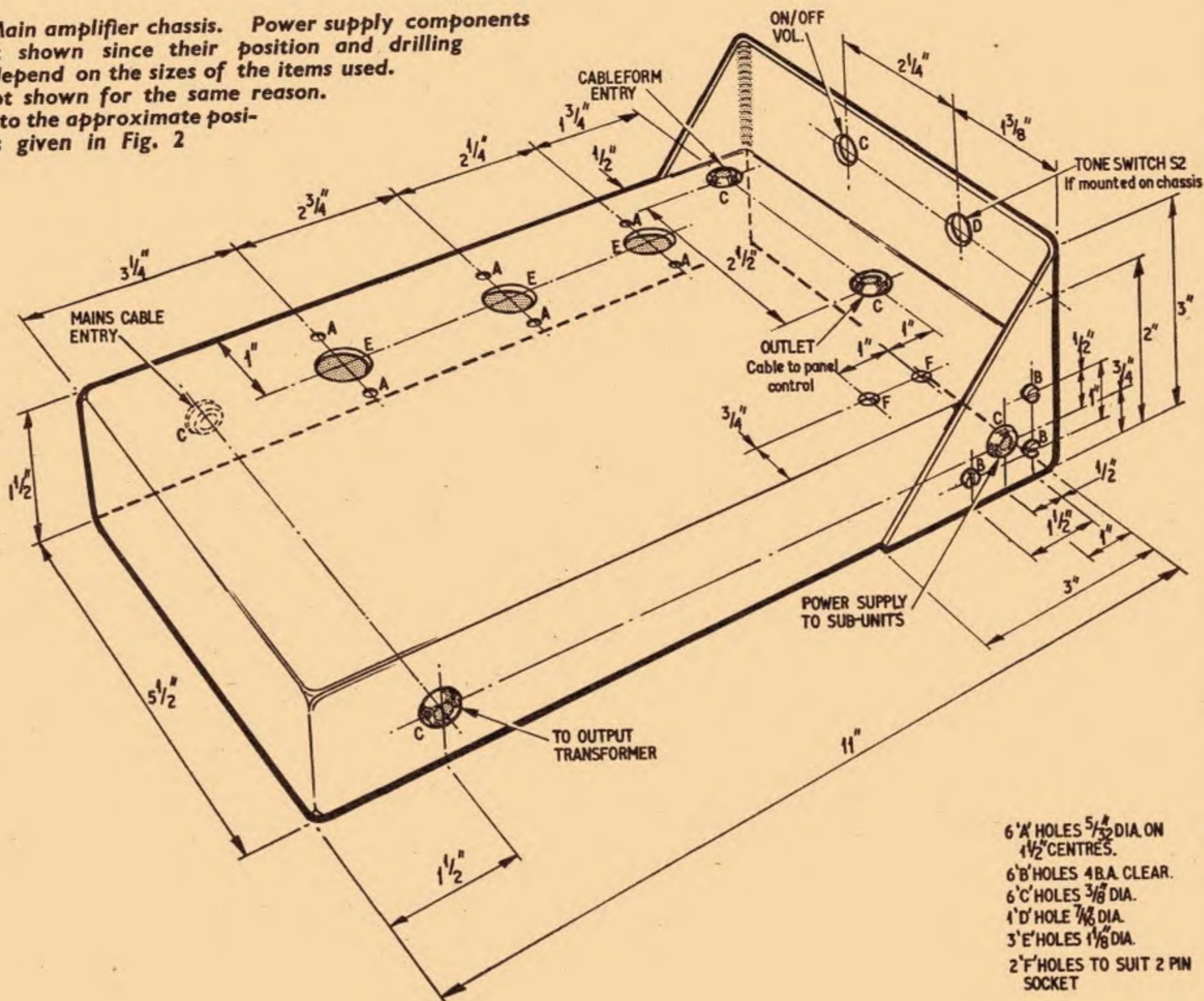



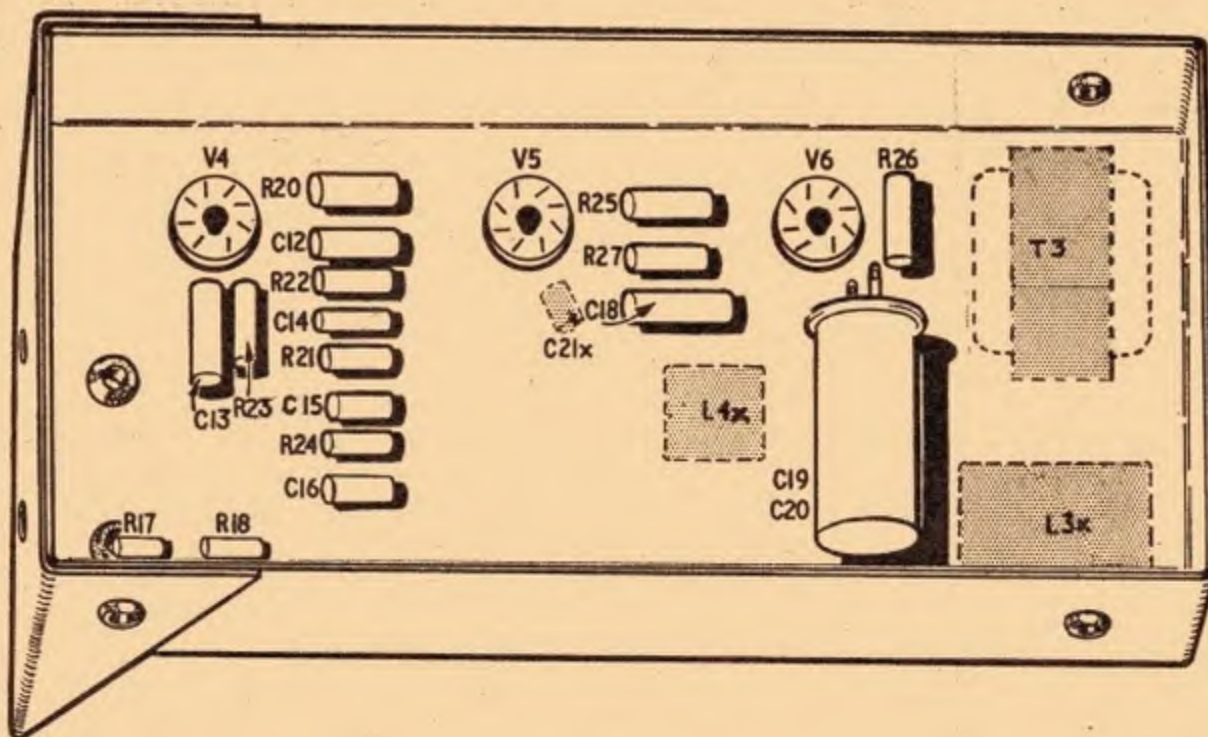

Fig. 6. Approximate layout guide to components on the underside of the main amplifier chassis. L4 and C21 are fitted only if the complex tone control circuit (described last month) is used. The approximate positions of T3 and L3 are shown; they are mounted on the top of the chassis. The cores should be arranged at right angles to each other to reduce hum

L2 and associated capacitors C8 and C11. These items (including R19) cannot be fitted into the sub-units or main amplifier without overcrowding or risk of hum due to coupling. The terminal strip secured to the loudspeaker carries the wiring to the h.t. fuse mounted on the main amplifier control panel.

The relay sub-assembly can be conveniently fitted above the top edge of the amplifier control panel. From this point, the wiring (in the cable form) to the main amplifier is quite short and, if handled carefully, the relay sub-assembly and main amplifier can be withdrawn for inspection without unsoldering.

Security of the sub-assemblies can be obtained by fitting a wood or metal pillar to the cabinet adjacent to the side of the sub-assembly concerned, and then securing the sub-assembly panel to the pillar by a screw passed through the panel. This precaution is worth taking if the amplifier is to be transported frequently.

The vibrato and tone controls shown on the guitar (January issue) are S1 and S2 respectively (see the components list last month). If desired S1 can be mounted on the control panel of the amplifier as shown in Fig. 9. S2 can be mounted on the main amplifier chassis as indicated in Fig. 5. In this case the international octal control sockets can be eliminated so that only one screened cable is left to link the guitar volume control with the amplifier.

### EXTENSION LOUDSPEAKER

If the lid of the cabinet is used to house an extension loudspeaker, it will be necessary to fit a hardboard panel over the interior of the amplifier to guard against damage when the extension speaker is in use.

### TRYING OUT THE GUITAR

Fit the guitar plug into the guitar socket, and the control plug and input plug into the amplifier sockets. Switch the amplifier on and allow time to warm up.

Set the amplifier volume control to about mid-travel. Set the tone switch to normal, and the gain controls to two-thirds of full travel. Set the vibrato switch to off. Set the guitar volume control about mid-way and the tone switch to the central position (normal tone). Set the vibrato switch (S1) to "off". The central position gives slow speed; downward gives fast speed.

Now pluck the strings and adjust the volume control to the required level. If insufficiently loud, increase the input gain control (VR1) on the amplifier or, if this is already at maximum, set the main amplifier volume

control to a higher level. Check the effect of the tone control and note the switch positions. Check the vibrato circuit at low speed and high speed and note the switch positions. Adjust the bass and treble gain to balance volume when using normal tone.

### USING THE AMPLIFIER

- (1) Ensure the amplifier is efficiently earthed by as short a lead as is practicable.
- (2) Switch on 10 minutes before requiring to use the amplifier to allow it to settle down.
- (3) If using only one input, turn the unused input volume control to minimum otherwise hum may be picked up. This effectively shorts the grid of the other half of V1 to earth.
- (4) Vibrato is most effective on sustained notes. Do not try to use it on fast moving music.
- (5) To prevent excessively noisy operation, use no more *input* gain than is necessary.
- (6) When using a microphone, which must be a high impedance type, or a low impedance type coupled through a transformer, guard against acoustic feedback, especially if two speakers are in use,

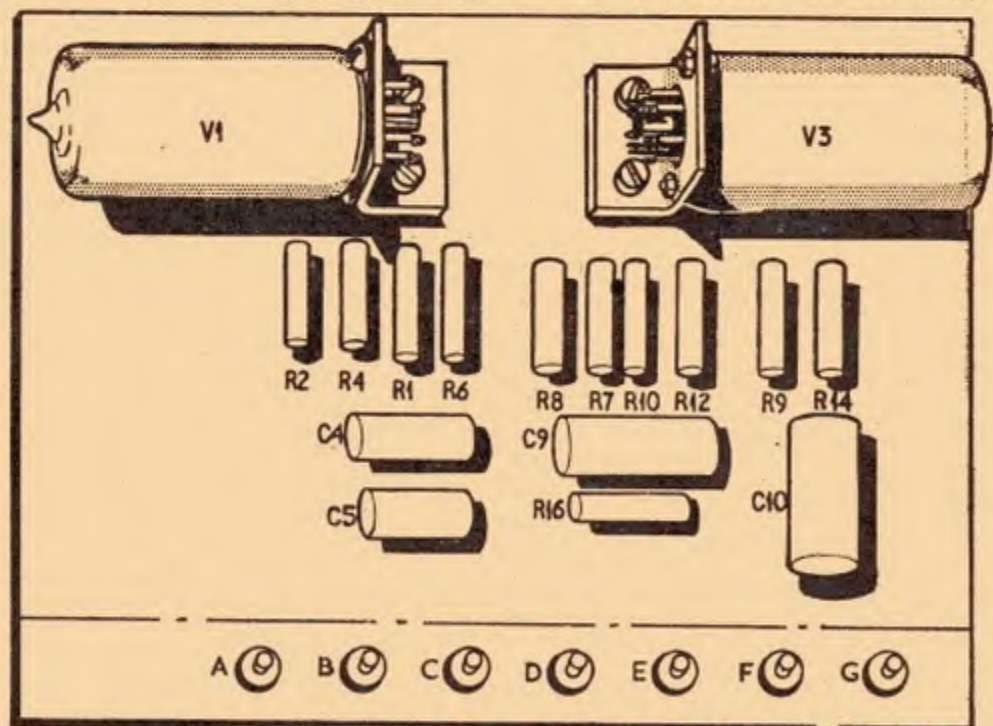

Fig. 7. Pre-amplifier unit built on Veroboard. Terminal connections are as follows (see also Figs. 6, 8, and 9): A to L1, C1; B to R15 (and L2 see text); C—coaxial to R17; D and E to heater supply; F—coaxial to VR1; G—coaxial to VR2



otherwise the loudspeaker may be damaged. For high quality, a crystal microphone should be connected through a matching circuit to suit a 50 kilohm input impedance.

### ADDITIONAL GUITAR DETAILS

The following notes may help readers who are constructing the guitar described in the January issue.

#### Head Matching Transformer

This component is mounted in the body of the guitar, so the most critical feature is its physical size determined by the space available. It should preferably have a voltage ratio 30:1; a microphone transformer should serve the purpose. Alternatively, a loudspeaker output transformer with a 3 ohm low impedance winding can be used provided the impedance of the other winding is at least 2,700 ohms.

It may be worthwhile providing one channel of the amplifier to take a high impedance input while the other channel can be low impedance. This transformer can then be mounted on the amplifier chassis and wired to one channel only, keeping the same physical connections as described earlier. This means that the "sound" lead from the guitar will be low impedance and reduce the likelihood of hum being picked up. The restriction of physical size is also overcome.

#### Guitar Volume Control

This is a miniature carbon potentiometer either 25 kilohms or 50 kilohms. Here again the physical size is important. The higher resistive value will give a coarse control, i.e. a faster reduction of volume.

#### Strings and Winders

The strings used are standard taped strings specially made for electronic guitars (they must be steel) and are readily obtainable in sets of six from music shops dealing in guitars. The winders or "machine heads" are single units secured to the instrument as described in the article. The string is passed through the hole in the winder pin which is attached to the spur wheel. There should be sufficient slack in the string to give at least two turns around the pin before the strings become taut. The turns should be low down on the pin.

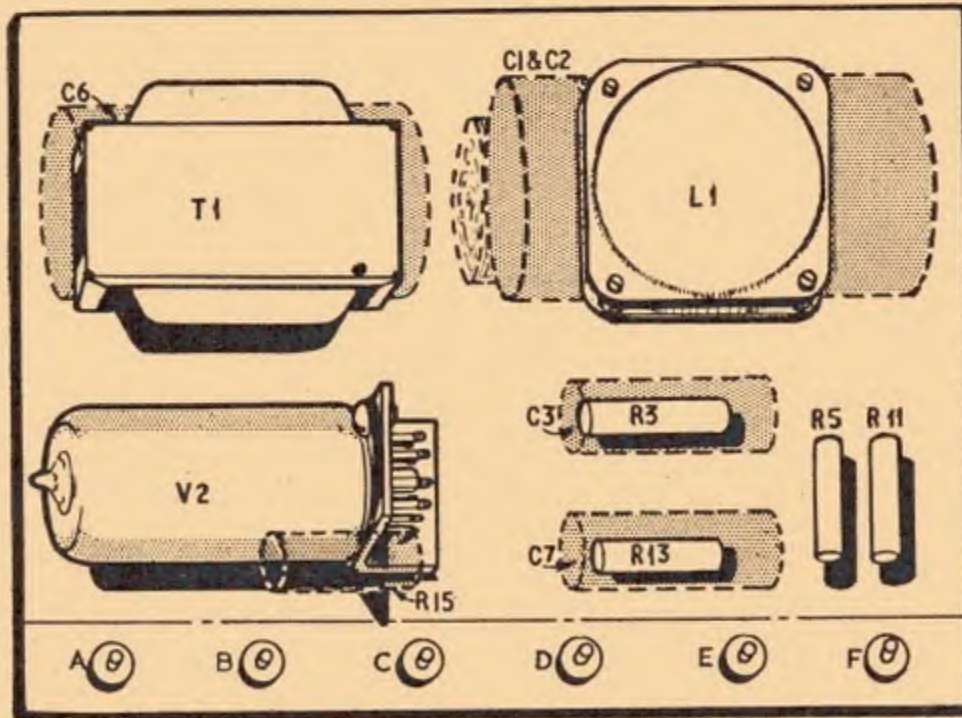

Fig. 8. Vibrato unit built on Veroboard. Terminal connections are as follows (see also Figs. 6, 7 and 9): A to R2; B to R4, R10, R12; C—coaxial to S1b (1); D and E to heater supply; F to VR3 (mounted on cabinet). Screen of coaxial cable to chassis

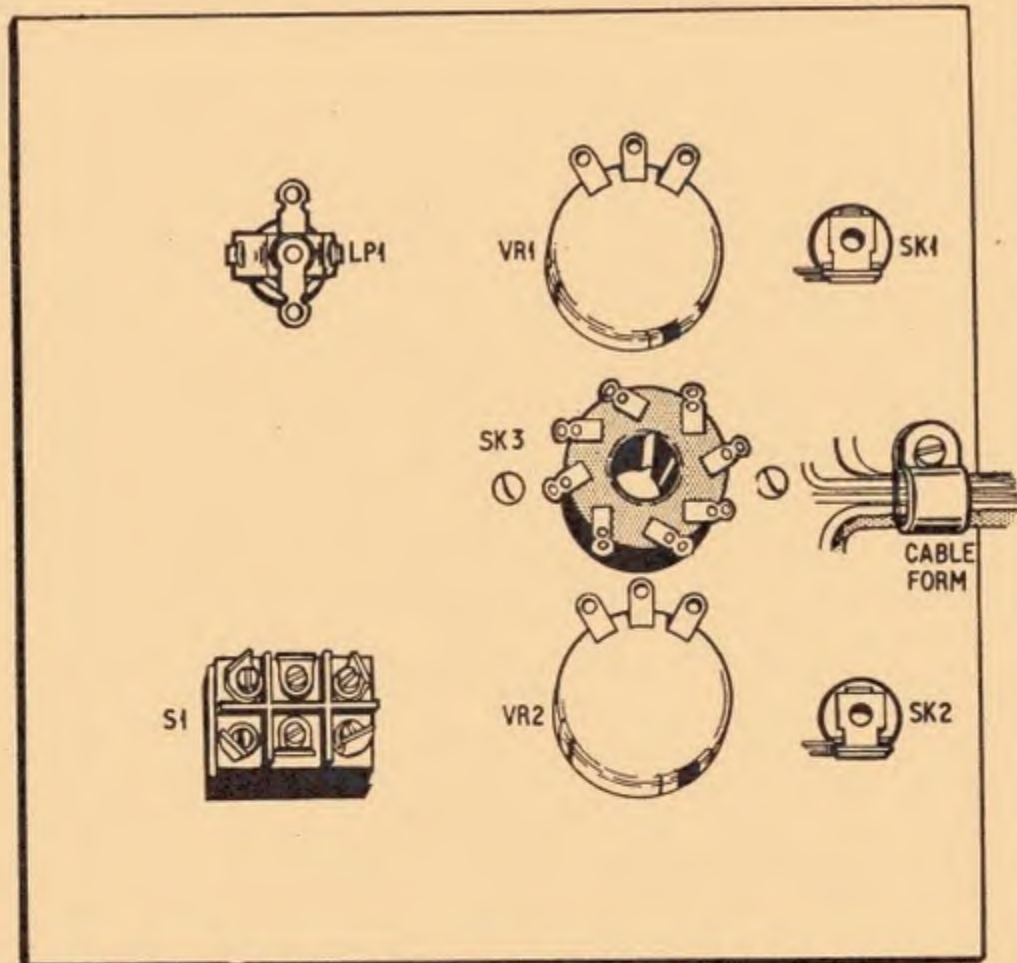

Fig. 9. Control panel layout. Socket SK3 links with the remote controls on the guitar. Sockets SK1 and SK2 are the signal input jacks

### GUITAR FAULT ANALYSIS

One or two points may be mentioned in conclusion, and may help a constructor to overcome difficulties or avoid pitfalls when using the guitar.

**Falling Out of Tune.** Check the condition of storage; a damp room will cause this. Check for curvature of stem due to soft wood; check the movement of the stem due to insecure fixing screws or to very soft shim material. Check for movement of tailplate; the body *must* be very sound hardwood otherwise it will allow the tailpiece to drag its screws.

**Inaccurate Tuning Over the Range of Frets.** This is due to (a) use of incorrect string for the position, or (b) inaccurate measurement and placing of frets. Try moving the bridge block to correct mistuning.

**Low Sensitivity Over-all.** Check that the strings are steel strings (internally, if wrapped) as used in electronic guitars. Nylon strings are useless with a pick-up.

**Low Sensitivity at One String.** This is likely to be due to a short circuit when winding the pick-up limb concerned. It will require rewinding.

**No Output.** Pick-up winding broken, or circuit to transformer broken or short-circuited. Check from transformer by removing fingerboard, connecting up the amplifier in the usual way, and with the volume control set high, touch the transformer terminals. Touching one terminal should produce a loud hum. If this is not so, check the wiring to the volume control, the connector cable and the input plug.

**Greater Sensitivity at Low Notes.** This is probably due to the string material, but may be partly or wholly overcome by increasing the height of the affected string above the pick-up. The height may be increased by alteration to the bridge slot.

**Feedback.** A sensitive guitar, played very near to its loudspeaker, will pick up notes to which the "open" strings will respond. This causes the strings to vibrate and produce a continuous, often unpleasant, note. The volume control should be decreased or the loudspeaker may be placed further away from the guitar and facing away from it. ★



**T**HE unit to be described is basically very simple, and yet extremely useful for the motorist without a garage.

If a car fitted with this device is parked in a street, the parking light will go on automatically when it begins to get dark. This saves the owner the task of having to come out and switch them on at lighting-up time to avoid a "ticket" for parking without lights. Not only does this unit switch the lights on in the evening, but it also switches the lights off in the morning when it is light.

#### CIRCUIT

The heart of the circuit (see Fig. 1) is the very sensitive OCP71 phototransistor, which combines the advantages of a low voltage photocell and a built-in transistor amplifier all in a single envelope.

The signal from the phototransistor TR1 is passed to a multistage, directly coupled transistor amplifier, in emitter follower configuration. The number of stages employed in the amplifier depends on the characteristics of the relay used, which will be discussed later. Bias is supplied to the phototransistor via VR1, which controls the operating point of the whole circuit. *Note that R2 has a negative temperature coefficient, to compensate for changes in temperature, and is, in fact, a thermistor.*

#### RELAY

The output from the amplifier is fed to the relay RLA, which must be as sensitive as possible, with the energising coil rated at 12 volts. The contacts need not have a high current rating; a single-pole changeover type rated at 12V 1A being suitable.

Before building the amplifier, the vital statistics of the relay must be assessed, as these govern the number of stages used in the amplifier.

Find the current needed to energise the relay, and also the current at which it "drops out", i.e. becomes de-energised. The smaller the difference between these two current values, the more suitable is the relay. This is because the changes in light intensity produce changes in current in the phototransistor which are in turn amplified by TR1 and TR2. If this change in output current is not enough to take the relay from the "on" position to the "off" position (or vice versa) the unit will not function correctly.

The relay used (type MH2, 700 ohms) was found to operate at about 12mA and drop out at about 4mA.

#### CONSTRUCTION

The construction of the unit is not critical, and with small components can be built in a surprisingly small space.

The whole unit can be built up on a 15-way miniature component tag strip with the switch and potentiometer mounted on the side of a plastics box 2 $\frac{3}{4}$ in  $\times$  4 $\frac{1}{2}$ in (see Fig. 2).

The phototransistor TR1 can be mounted through a hole in the stem of a rubber suction pad and soldered to a length of twin-cored screened flex, as used in record players, etc. This enables the phototransistor to be mounted in a suitable position on the car, while the amplifier and relay unit is hidden away out of sight.

The most light-sensitive side of the OCP71 is the base-emitter junction (recognised as the side of the base with the smallest "blob" on it). The collector wire is the one nearest the white line at the side of the plastics envelope.

**Night time parking in safety.**

**Let your parking light switch itself**

**on at dusk and off at dawn**

**by A. K. STEVENSON**



# AUTOMATIC PARKING LIGHT



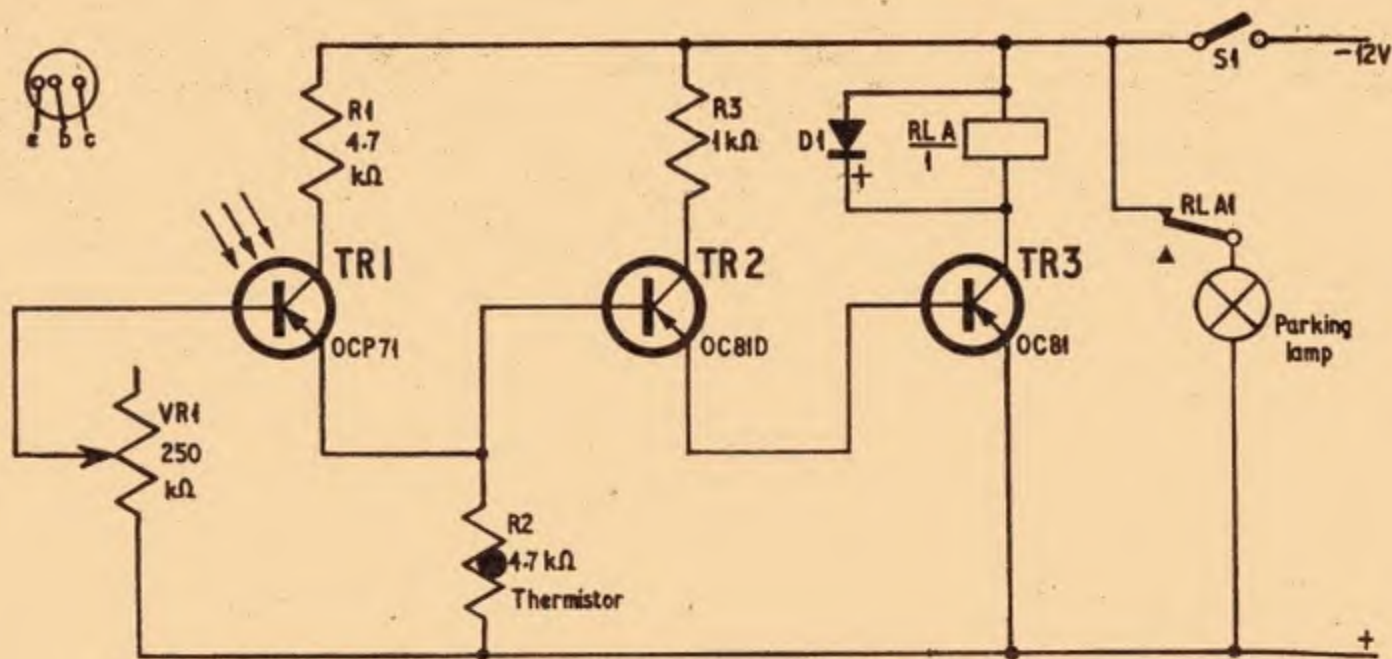

Fig. 1. Complete circuit diagram of the amplifier and relay unit. Note that R2 is a thermistor which compensates for any changes in temperature

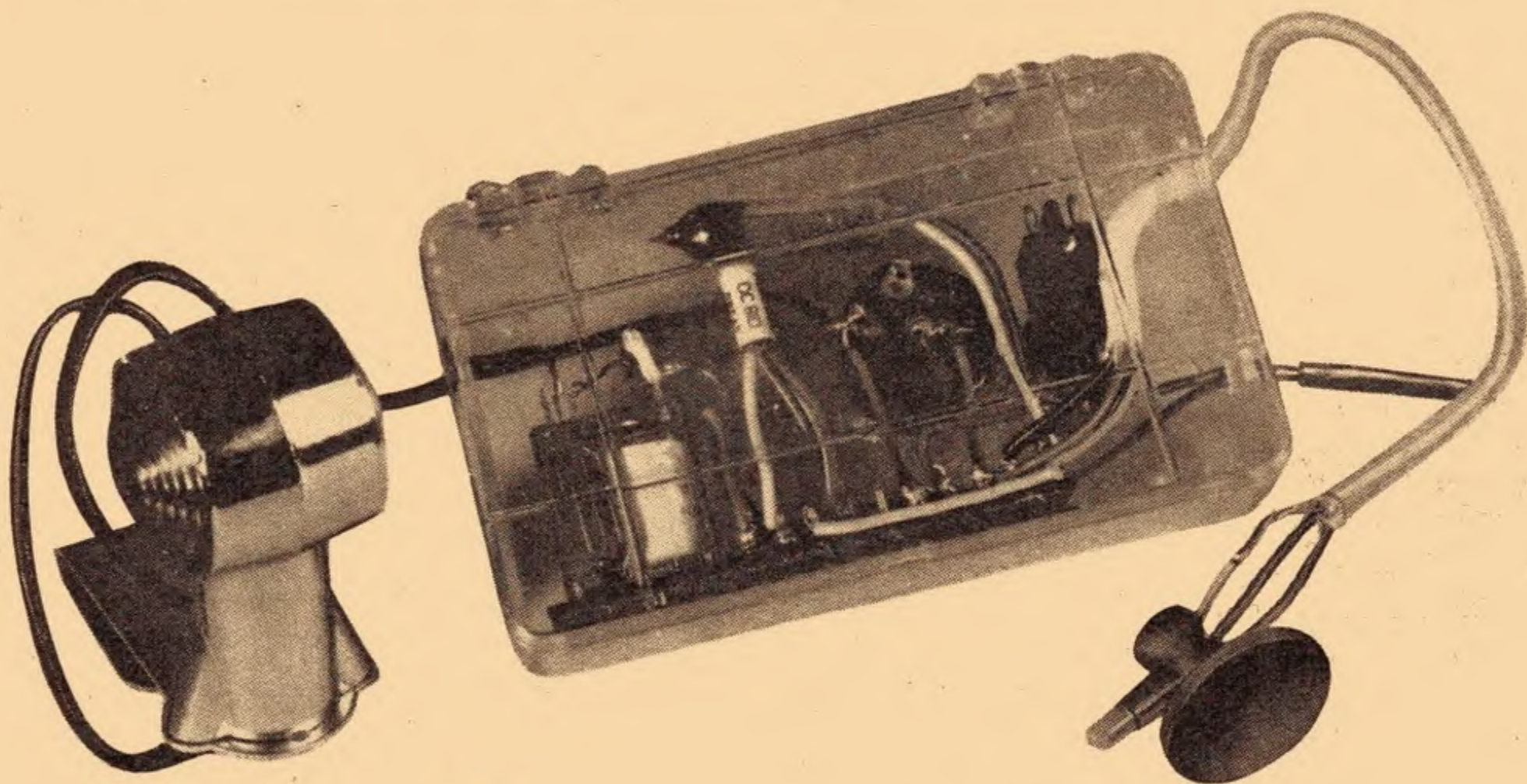

Fig. 2. This version has three leads coming from the plastics box enabling the unit to be hidden away. The three leads are: one from the relay to the parking light, one from the unit to the car battery, and finally a lead from the unit with the photocell soldered to the end and inserted through the end stub of a rubber suction pad for mounting in the car

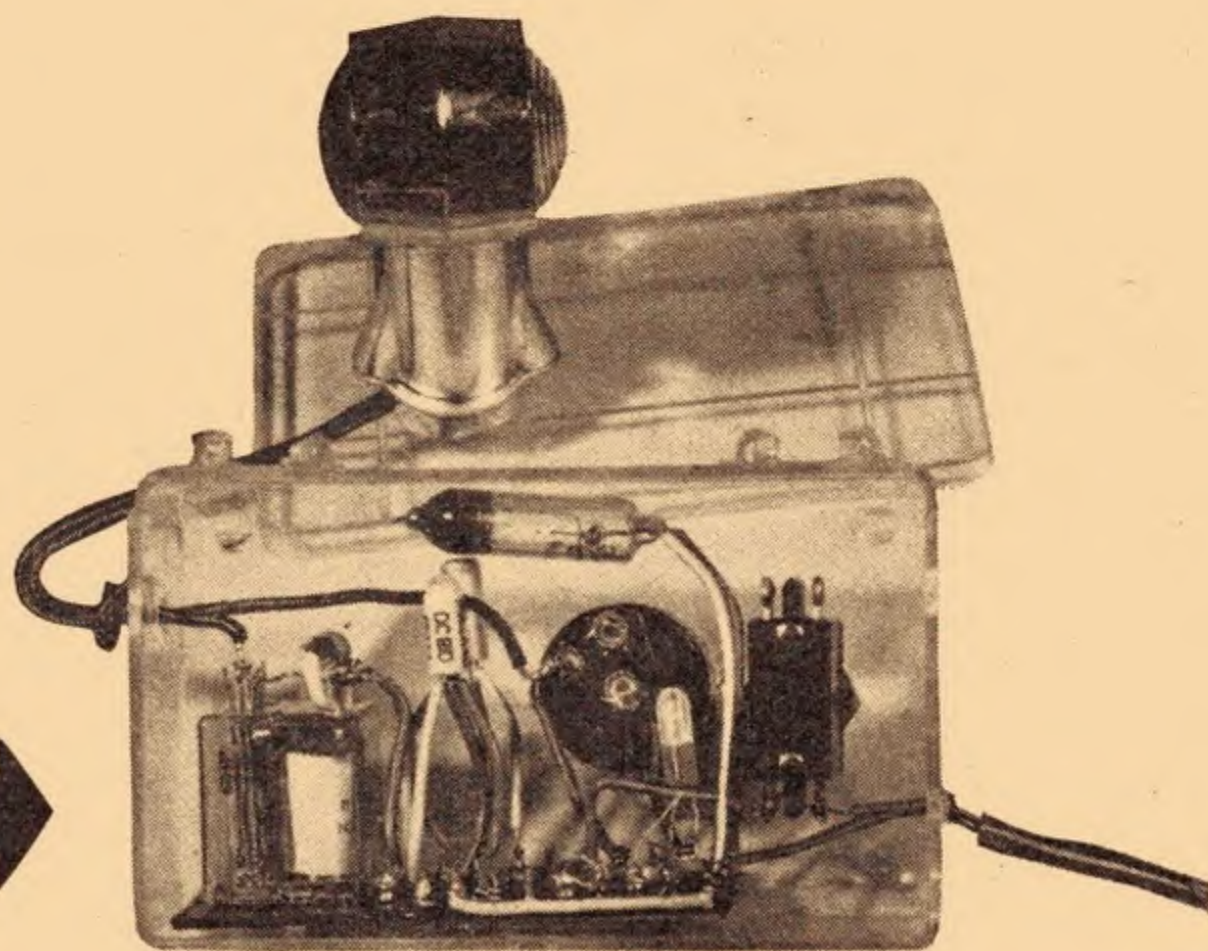

Fig. 3. In this version one lead from the car battery to the unit is the only external connection. The photocell and parking light are mounted in or on the transparent plastics box. Although the mounting is much simpler there is the added risk of theft since the complete unit is mounted on the window



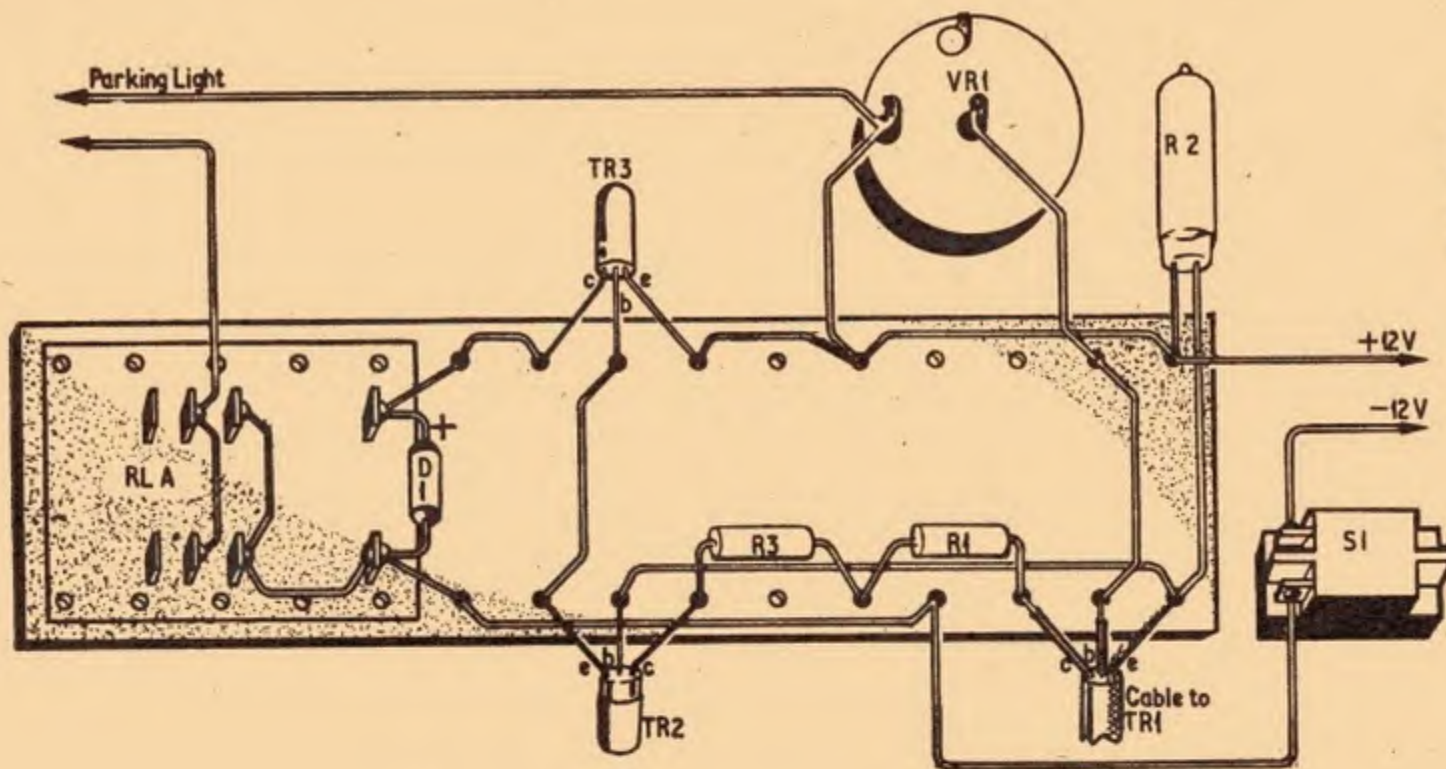

Fig. 4. Component wiring layout. Note that ten tags are removed from one end of the panel to accommodate the relay

Readers may have their own ideas about housing the unit, but to keep the wiring to the battery and lamp to a minimum the box should be close to them.

#### SETTING-UP

Set VR1 anticlockwise (lowest resistance) and connect the relay coil in series with a 0-25mA meter. The meter is used merely to check that excess current is not being drawn.

Place the phototransistor, on the end of its lead, in normal daylight (not direct sunlight). Advance VR1 slowly until the relay is just heard (or seen) to click in. This should be the correct setting for VR1.

Any decrease in the light intensity will cause the relay to drop out, and thus switch on the parking light via the relay contacts. Check that the current taken by the relay is within the range previously mentioned. The amplifier should take only a few milliamps more.

The current taken when the phototransistor is in the dark should be quite low, only a few milliamps.

If the phototransistor needs almost complete darkness to switch off the relay, either VR1 is set too high or the amplifier or relay is not sensitive enough.

**One word of warning:** it is possible that the street lighting, if powerful enough, may interfere with the correct function of the unit, so the transistor should be shielded from it. ★

## COMPONENTS . . .

#### Resistors

- R1 4.7k $\Omega$   $\frac{1}{4}$ W 10%
- R2 4.7k $\Omega$  thermistor
- R3 1k $\Omega$   $\frac{1}{4}$ W 10%
- VR1 250k $\Omega$  miniature pre-set potentiometer

#### Transistors

- TR1 OCP71 phototransistor
  - TR2 OC81D
  - TR3 OC81
- } or similar a.f. transistors

#### Relay

- RLA Sensitive energising coil, 12V, 700 $\Omega$  (Type MH2, Keyswitch Relays Ltd.)
- Single-pole changeover contacts rated at 12V 1A.

#### Lamp

- LP Parking lamp 12 volts 0.5A amp

#### Miscellaneous

- 15-way component tag strip, on-off toggle switch, wire, plastics case

## PRACTICAL WIRELESS

THIS MONTH

### THE "CADET"

A 7W hybrid amplifier, using transistors for low signal amplification and a valve output stage.

### KEYED AUDIO OSCILLATOR

A versatile unit for the experimenter.

### VOLTAGE STABILISED V.F.O.

Special feature for "hams".

March issue on sale NOW. Price 2s.

## PRACTICAL TELEVISION

THIS MONTH

### DO-IT-YOURSELF GUIDE TO TV SERVICING

Instructional article for the newcomer.

### G3NOX/T

The well known amateur television transmitting station.

### IMPROVING THE P.T. C.C.T.V. CAMERA

Further notes on this popular feature.

March issue on sale 18 February. Price 2s.



# ELECTRONORAMA

HIGHLIGHTS FROM THE CONTEMPORARY SCENE

## What A Dish!

THE 210ft radio telescope at Parkes, New South Wales, has acquired a new friend recently in the form of a 60ft diameter interferometer (seen on the left of the picture).

This interferometer is, to a certain extent, mobile since it runs on a system of circular and straight quadrant tracks. It is capable of providing an additional degree of accuracy in finding the position of radio sources in the universe, including artificial satellites.

This interferometer has been financed by the Commonwealth Scientific and Industrial Research Organisation, which also designed it.



## Precision Communications Receiver

FOUR YEARS of research and development by the National Radio Company in America has culminated in this HRO-500 communications receiver. No less than 57 semiconductors are employed in solid state plug-in circuits to cover 5kc/s to 30Mc/s. Frequency stability is maintained to a high order by a phase locked synthesiser with a crystal controlled oscillator.

The receiver can be operated on s.s.b., c.w., or a.m. Provision is made for remote control use and it can be powered by 115-230 volts a.c. or 12 volts d.c. It is said that the performance is commensurate with the price for such an advanced piece of equipment.

Distribution in the U.K. is being handled by Ad. Auriema Limited. The price—£606 2s. 9d. retail. Strictly for affluent hams!

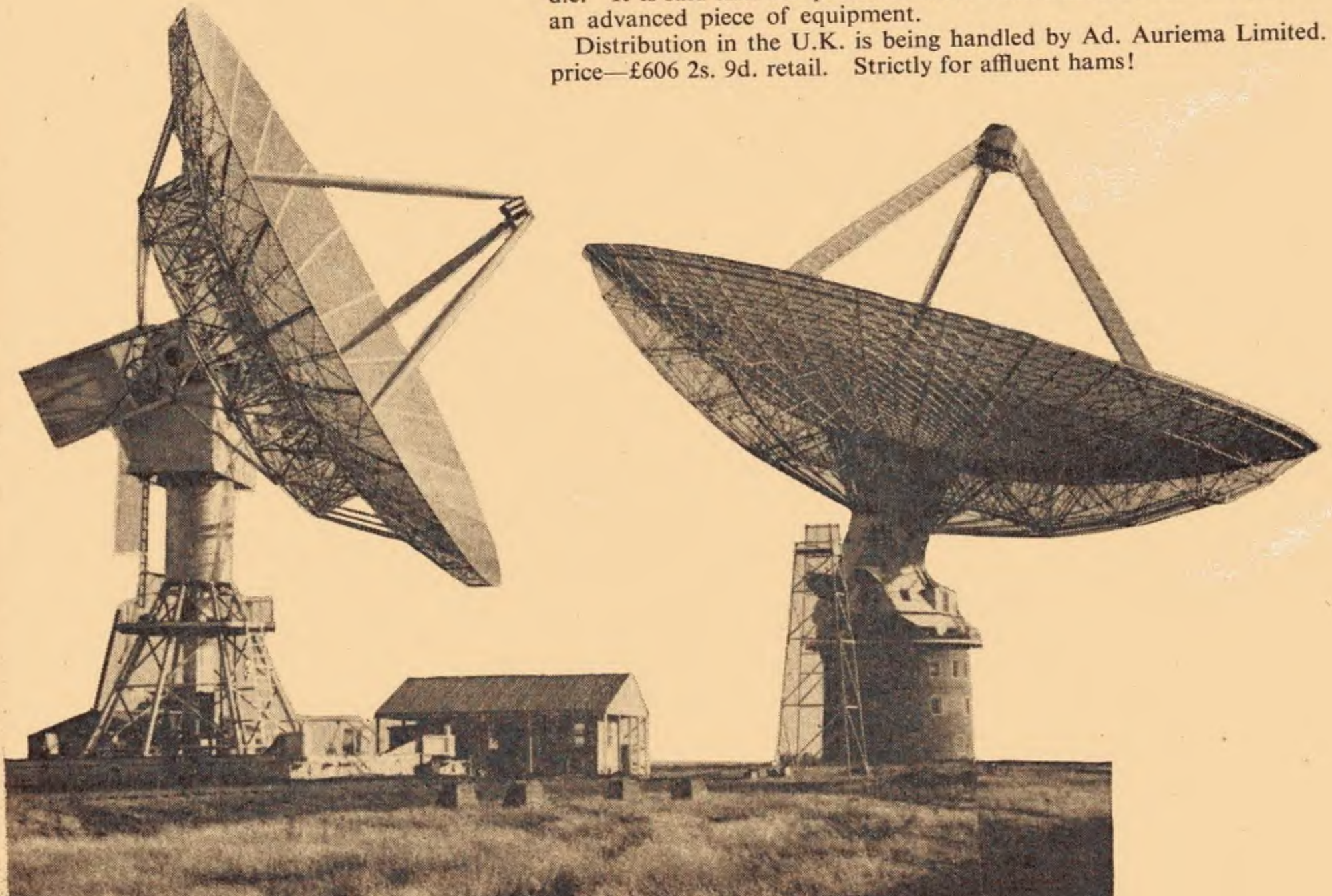



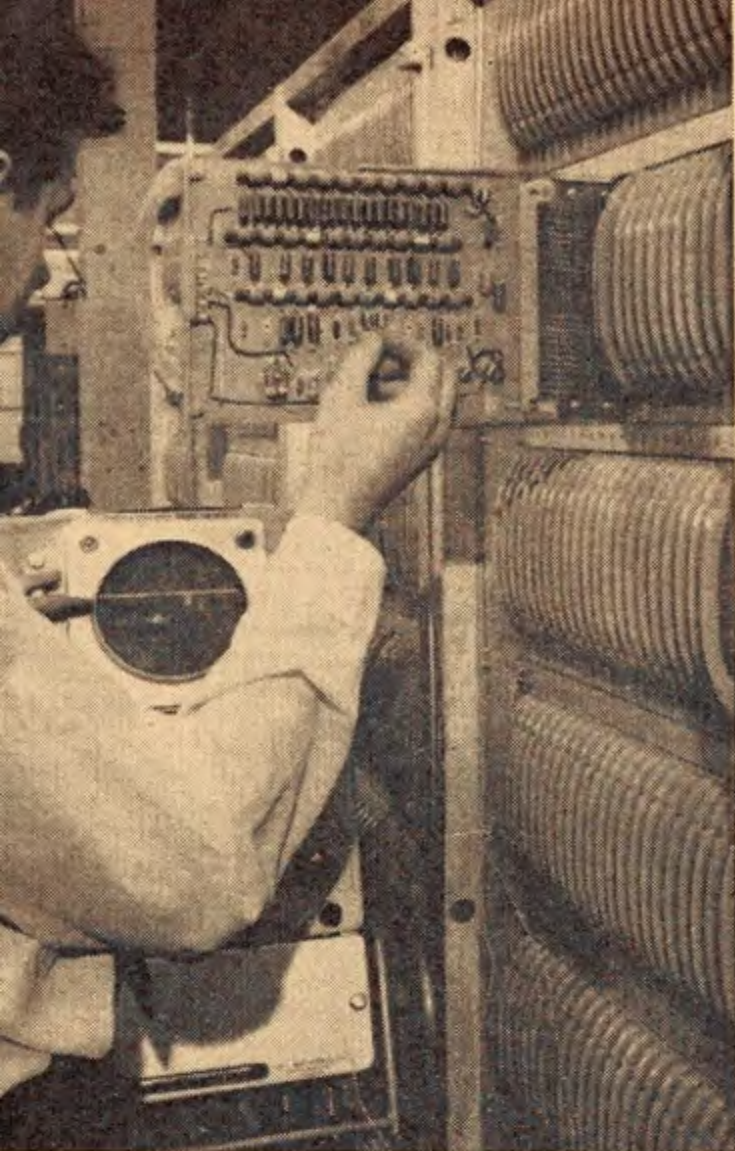

## Don't Dig That Road !

A NEW way of increasing the number of speech channels between telephone exchanges without digging up the road has been under investigation for a number of years by the Post Office. The outcome is a system of transmission by pulse code modulation which was first invented in 1937.

Now Standard Telephones and Cables have built equipment for trials over the cable route between Guildford and Haslemere in Surrey. Up to twenty-three speech channels can be accommodated on a four wire circuit with one pair carrying the "go" channels and the other the "return" channels.

Speech from each of twenty-three subscribers is sampled sequentially 8,000 times per second. Each sample is measured against a 125-level scale and a coded pulse train is produced corresponding to the level of each sample. Pulses are transmitted at 1,750,000 per second along the line.

A 24th channel is used for synchronisation. Repeaters can be installed in existing manholes to boost the signals. The pulses received at the other end are decoded and transmitted as "real" speech on twenty-three lines.

And they don't get mixed up!

## Look After the Pennies . . .

FIVE COMPUTERS, designed and built by English Electric Leo, and worth £2½ million, will help the Post Office look after its accounts, including the savings bank and premium bonds. From 1 January next year the characters on postal orders will carry a magnetic ink so that coded details can be "filed" on magnetic tape.

## Ghost Train !

THE MODERN idea of a driverless train is by no means confined to the London Underground Railway. This particular model, designed by E.M.I. Electronics and in use here at their record factory, runs on any kind of road surface which has been fitted with a special "live" wire. The Robotug, as it is called, detects the current flowing through the wire, which is buried half an inch below the surface, and steers itself according to the signal received from it. As it reaches a point where it needs to cross the road a traffic signal is automatically switched to red to halt ordinary vehicular traffic.

After crossing the road the signal reverts to green. The factory doors are opened automatically when the Robotug approaches. If the train is delayed *en route* for more than 10 seconds an alarm signal is set off.

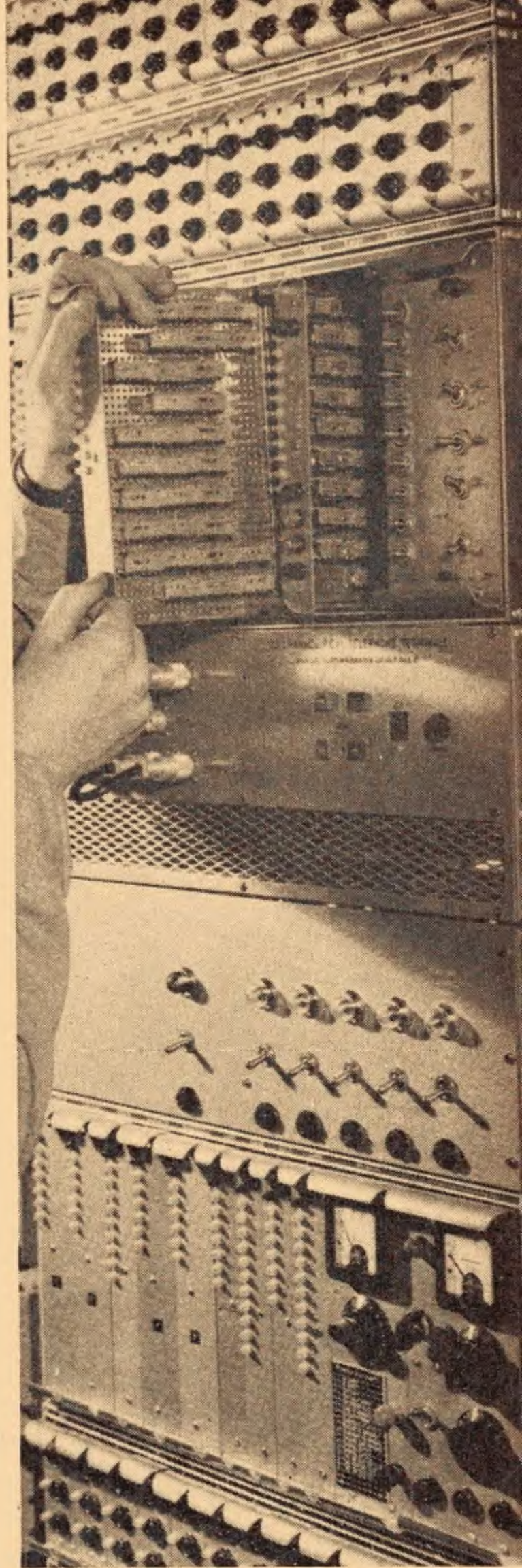



## An Instructional Series for the Newcomer to Electronics

RESUMING our discussion on the capacitor, we first note two basic but vital formulae which enable the total value of capacitance to be calculated when two or more capacitors are connected in series or in parallel.

### CAPACITORS IN PARALLEL

Last month we saw that one of the factors which determine the amount of charge stored in a capacitor is the area of the plates. Increase the dimensions of the plates and the charge stored increases—or in other words the capacitance of the component increases.

From this it will not be difficult to see that when two or more capacitors are connected in parallel, as shown in Fig. 5.1, the total capacitance is then the sum of the individual capacitances. The formula is given below.

$$C_{\text{total}} = C_1 + C_2 + C_3 \text{ etc.}$$

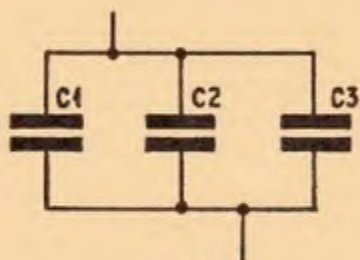

Fig. 5.1.

### CAPACITORS IN SERIES

If a number of capacitors are connected in series, as in Fig. 5.2, the resultant value of capacitance is calculated using the formula:

$$C_{\text{total}} = \frac{1}{\frac{1}{C_1} + \frac{1}{C_2} + \frac{1}{C_3}}, \text{ etc.}$$

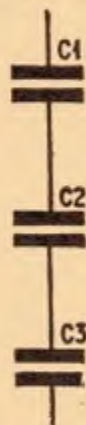

Fig. 5.2.

It will be noted that the formula for capacitors in parallel is similar to that for resistors in series, while the formula for capacitors in series is similar to that for resistors in parallel.

### PRACTICAL CAPACITORS

We will now proceed to look at practical capacitors—the actual components one meets in everyday work on electronics. One expression that crops up several times in the following brief descriptions is “Power Factor”. Do not worry about this term at present; we will explain the meaning of *power factor* later. As you will soon discover, there is a large variety of types. Each type has its own particular advantages and disadvantages. We must learn about their characteristics in order to be able to choose the most suitable capacitor for a particular purpose.

### PAPER AND FOIL

These capacitors, commonly referred to as “paper” type, are inexpensive and are widely used in medium capacity values of from about 0.0001–1μF, although higher values are obtainable. Capacity value tolerances are 10 per cent and 25 per cent. They are made in various d.c. ratings from 150V to 1,000V and even higher.

Paper capacitors are ideal for audio frequency (a.f.) purposes but have a fairly poor power factor (0.25 per cent) which makes them rather unsuitable for the higher frequencies. A certain amount of inductance is often present and this is a further limiting factor as far as the higher frequencies are concerned.

Paper and foil capacitors are made by winding strips of aluminium or tin foil with interleaving strips of specially treated paper. The strips of metallic foil form the two electrodes or plates of the capacitor and they are insulated throughout by the paper dielectric which is impregnated with paraffin wax or other material to prevent the absorption of moisture. The completed roll is hermetically sealed in a tubular case of cardboard or metal. The cardboard cases are usually coated with wax. Metal cased types are often covered with a plastic sleeve.

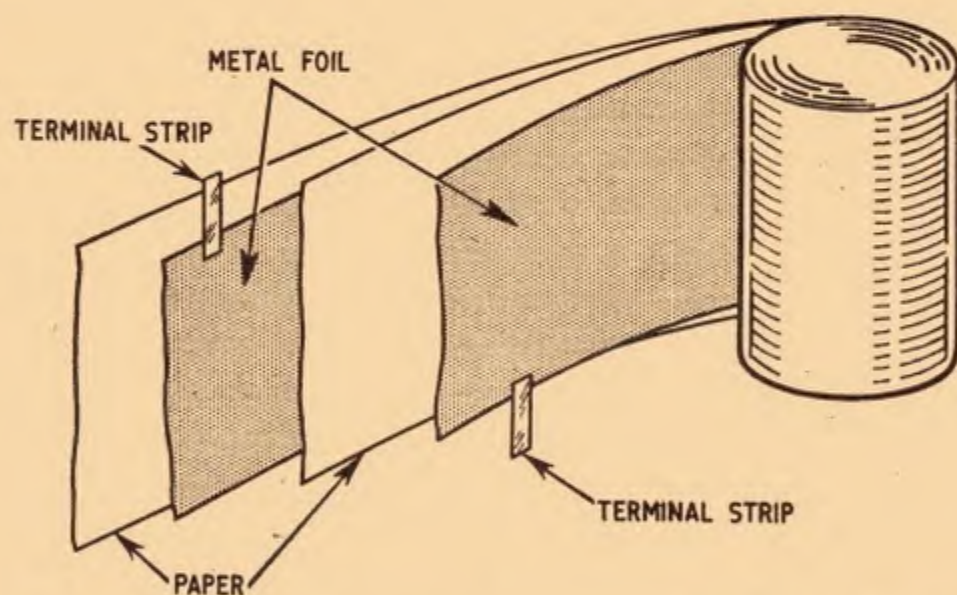

Fig. 5.3. The general form of construction of a paper and foil type capacitor

It is becoming more the practice now for these capacitors to be encapsulated in a plastic tube. This kind of housing is generally more effective, particularly at high temperatures, where there is always the possibility of wax melting. The moulded plastic container also permits a reduced overall size as compared with the conventional tubular capacitor.

With the larger values, from about 0.01 to 10μF, the roll is pressed flat and then fitted into a rectangular metal case.



## METALLISED PAPER

This is a development from the paper and foil type capacitor, where a thin deposit of metal on the paper forms the plates, instead of separate metallic foils. Due to this technique, a more compact component can be made for a given value of capacity. Another valuable feature of the metallised paper capacitor is its ability to withstand the application of excessive voltage without sustaining permanent damage.

Capacity values up to  $2\mu\text{F}$  are common, with voltage ratings such as 250, 500 and 750.

## PLASTIC AND FOIL

A recent development is the use of plastic films as a substitute for paper. Plastics such as p.t.f.e., polystyrene and polyester have characteristics which make them particularly suitable as a dielectric material. The high dielectric strength of these plastics permits a considerable reduction in physical size compared with a paper type capacitor of equivalent value. Good stability is maintained over a wide temperature range and since the material is impervious to moisture these capacitors are ideal for operation under conditions of extreme humidity.

Plastic and foil capacitors are manufactured in approximately the same range of values as the paper type.

An interesting range of low voltage working capacitors specially designed for close packing on printed wiring boards has become popular in recent years. In their components, the winding of foil and dielectric film is flattened so the component takes the shape of a small tablet. Insulation and protection is provided by a hard lacquer coating.

## METALLISED PLASTIC FILM

Metallised plastic foil (polyester) capacitors follow the same form of construction as the metallised paper types, but they are thus completely insulated electrically and from atmospheric conditions. This moulding method permits a variety of shapes, and rectangular components are common; these are of course, very useful when close packing of components is necessary.

Typical ranges of metallised plastic capacitors are  $0.01$  to  $2.2\mu\text{F}$  160V;  $0.01$  to  $0.47\mu\text{F}$  400V.

In this particular range one connecting lead is considerably longer than the other and facilitates vertical mounting.

Miniature metallised polyester capacitors ("flattened type") have the following values;  $0.01$ ,  $0.047$  and  $0.1\mu\text{F}$ . The voltage rating is 200V.

## MICA—STACKED FOIL

In this type of capacitor layers of mica and metal foil are clamped together to make a compact stack. Alternative layers of foil are connected together thus forming the two electrodes. The stack is enclosed in a moulding through which are brought out two connecting wires or terminal lugs.



Fig. 5.4. Alternate layers of mica and metal foil are stacked in this manner to form a capacitor

Mica is the best of all the solid dielectrics, but it is rather expensive and bulky, and so its use is confined to the smaller values of capacity, ranging from  $5\text{pF}$  to  $5,000\text{pF}$  ( $0.005\mu\text{F}$ ) approximately. These capacitors are very stable and have a very low power factor (0.02 per cent or lower) and are ideal for r.f. purposes. The working voltage of these capacitors is normally about 350.

## SILVERED MICA

The silvered mica or metallised mica capacitor is formed of one or more pieces of mica coated on both sides with a thin film of silver. In the case of multiple plates these are stacked and all the upper coatings are connected to one lead-out metal strip and lower coatings likewise to another wire. The assembled capacitor is either encased in a moulding or is given a protective coating of wax. Miniature types can be obtained with the conventional axial connecting strips or with side strips which make them particularly suitable for printed wiring panels.

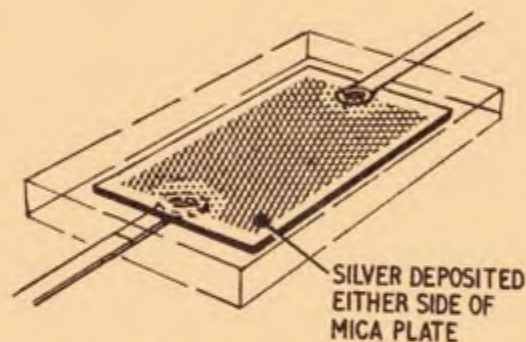

Fig. 5.5. The method employed in making silvered mica capacitors is shown here

Silvered mica capacitors have marked advantages in that they are little affected by time or temperature and they should be used whenever a precise value of capacity and a higher order of stability are essential requirements. Values range from  $1.5\text{pF}$  to  $12,000\text{pF}$  ( $0.012\mu\text{F}$ ), and tolerances of 1 per cent, 2 per cent, or 10 per cent can be obtained. Voltage rating 350, 500. Power factor less than  $20 \times 10^{-4}$  per cent.

## CERAMIC

Ceramic has a high dielectric constant and the use of this material enables a range of lower value capacitors to be made having very small dimensions. A variety of styles are used but in all the basic method of construction is to deposit a thin metallic coating on two surfaces of a ceramic plate, tube, disc or cup. Two somewhat unusual forms are a lead-through type, and a stand-off type; these provide the answer to many constructional problems that arise when designing the layout of a piece of equipment.

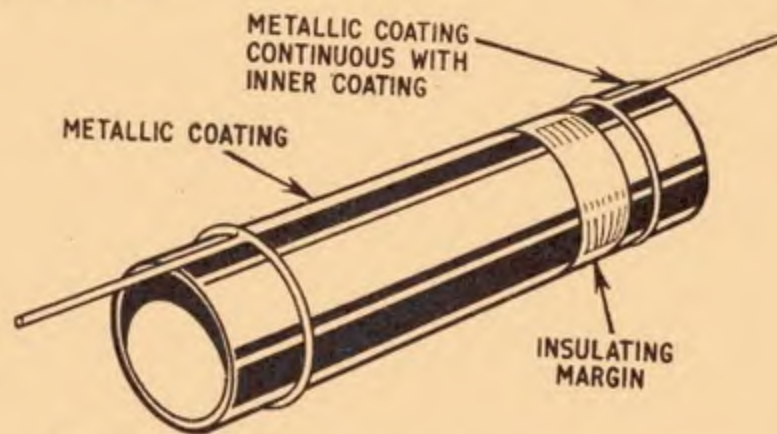

Fig. 5.6. A tubular ceramic type capacitor

There remains yet one more important type of fixed capacitor—the electrolytic. Next month we discuss this component.





# TWO BAND RADIO TUNER

By **A. SYDENHAM**

IN the electronics sphere transistors are considered to be one of the most important advancements since the war. Miniaturisation of hitherto cumbersome apparatus is made possible and efficiency is improved.

In domestic entertainment they provide an excellent means for building small inexpensive units for adding to existing equipment. The aim of this article is to present a reliable device, in simple form, that can be used to detect broadcast signals and feed radio programmes into a tape recorder. The unit can also be employed in other ways as will be explained later.

Considerable attention has been given to design and presentation and the outcome is a unique unit, fully portable, and weighing only 12 ounces. It is completely self-contained and is powered by a small battery which will last a very long time due to a low current drain of only 2mA.

Programme material over two wave bands is available and switching is so arranged that the chances of accidentally leaving the unit switched on are minimised. From the constructional angle care has also been taken to utilise only those items easily obtainable.

The minimum number of small tools needed to complete the project are required and a "kitchen table" construction is feasible if needs so dictate.

## RECORDING FROM THE RADIO

First attempts at making recordings frequently consist of little more than placing a microphone in front of an operating radio receiver. Fig. 1 depicts various ways in which recordings can be made, the simple scene just mentioned being shown in Fig. 1a. Provided room noises are kept low very good results are possible when the programme material is not musical in content. Microphone recording is without doubt a convenient method but it is best left on one side if music is to be recorded with any degree of fidelity. Quality can be impaired if the loudspeaker in the radio set, the microphone, and the room acoustics are not perfectly loss free over the audio frequency range.

A slightly better method is shown in Fig. 1b but this too has its drawbacks for it is soon realised that any imperfections present in the sounds issued by the loudspeaker are truly copied on to the tape.

To obtain distortion free signals from a radio receiver it is necessary to extract them from the part of the circuit where they are comparatively pure—for example, at "w" in Fig. 1c. Sometimes an existing receiver can be "adapted" to provide the take-off points but in many instances it is wiser to build a separate unit.

Main requirements of a unit such as the one described later are:

1. The device should be tuneable over both medium and long wavebands.
2. It should be small physically.
3. It should be self-contained.
4. It should be versatile so that it can be used with other reproducing equipment.

All the above requirements are fulfilled in this article. For even better quality reproduction a v.h.f. f.m. tuner is recommended.

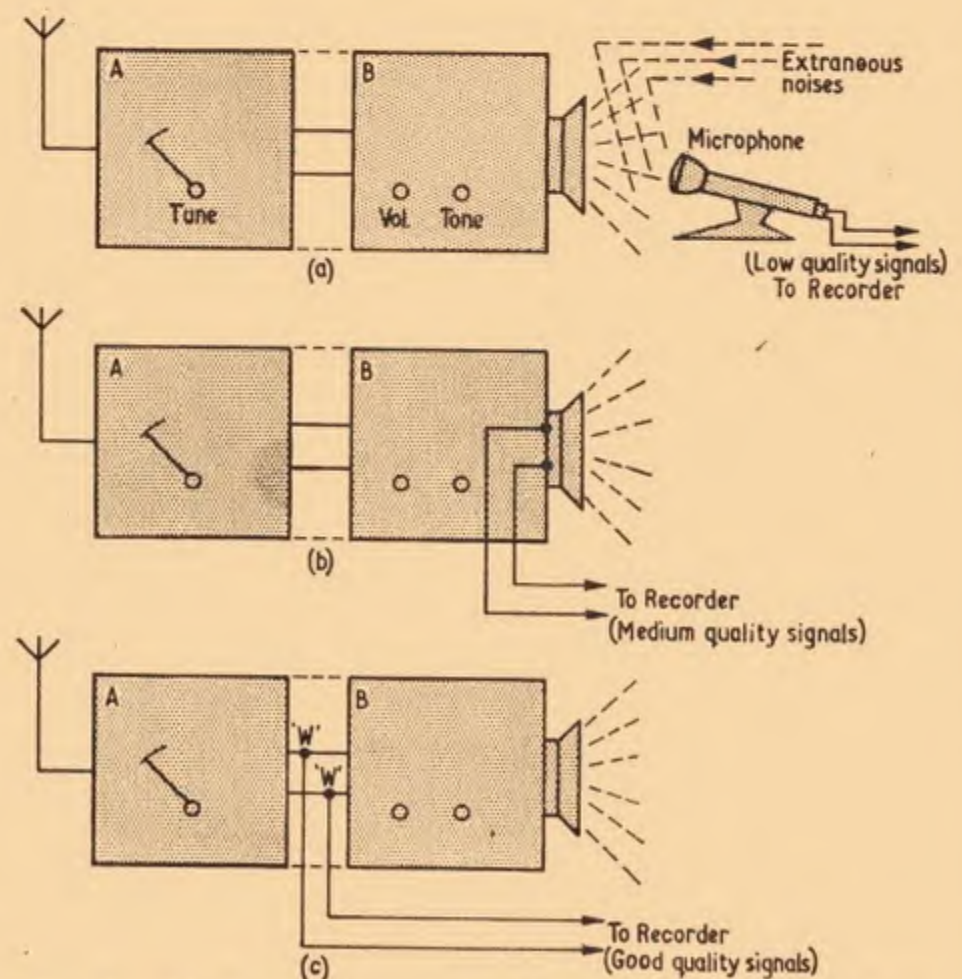

Fig. 1. Methods of recording from a domestic receiver



## CIRCUIT THEORY

The theoretical circuit is given in Fig. 2 and shows a 3-transistor grounded emitter configuration in which TR1 accepts signals selected from the aerial transformers L1 and L2. The mixer stage introduces a frequency changing action to produce a lower frequency of 470kc/s by combining the r.f. signal with a local oscillator signal. TR2 and TR3 amplify the resulting signal with the aid of tuned intermediate frequency (i.f.) transformers.

Diode D1 rectifies this signal and makes it audible. The diode also causes a voltage to be developed across resistor R7 during the rectification process and this varies in proportion with signal strength. By feeding back this voltage to the transistor TR2 an automatic gain control circuit is set up increasing the effective output of weak signals; strong signals are automatically reduced.

The board must be drilled to accommodate the four canned transformers (as shown in Fig. 3); the strips and holes have been given reference numeral and letter designations. If a  $\frac{1}{2}$ in diameter hole is cut out for each transformer exactly as shown it will be found that the metal cans will stand comfortably on the plain side of the board, allowing the pins to project below; the dust cores will also be available from either end. The transformer mounting lugs may then be passed through existing holes, for instance, the lugs of T4 will engage holes 3d and 6d and so on. These lugs are then bent over to lie along strips 3, 6, 9, and 12, but note the orientation, especially with regard to T1, before soldering.

A hole must also be cut out for the shaft of VC1 as shown and the conductor strip must be severed as indicated at points w, x, y and z. The shaded portions at the opposing corners must also be removed. The

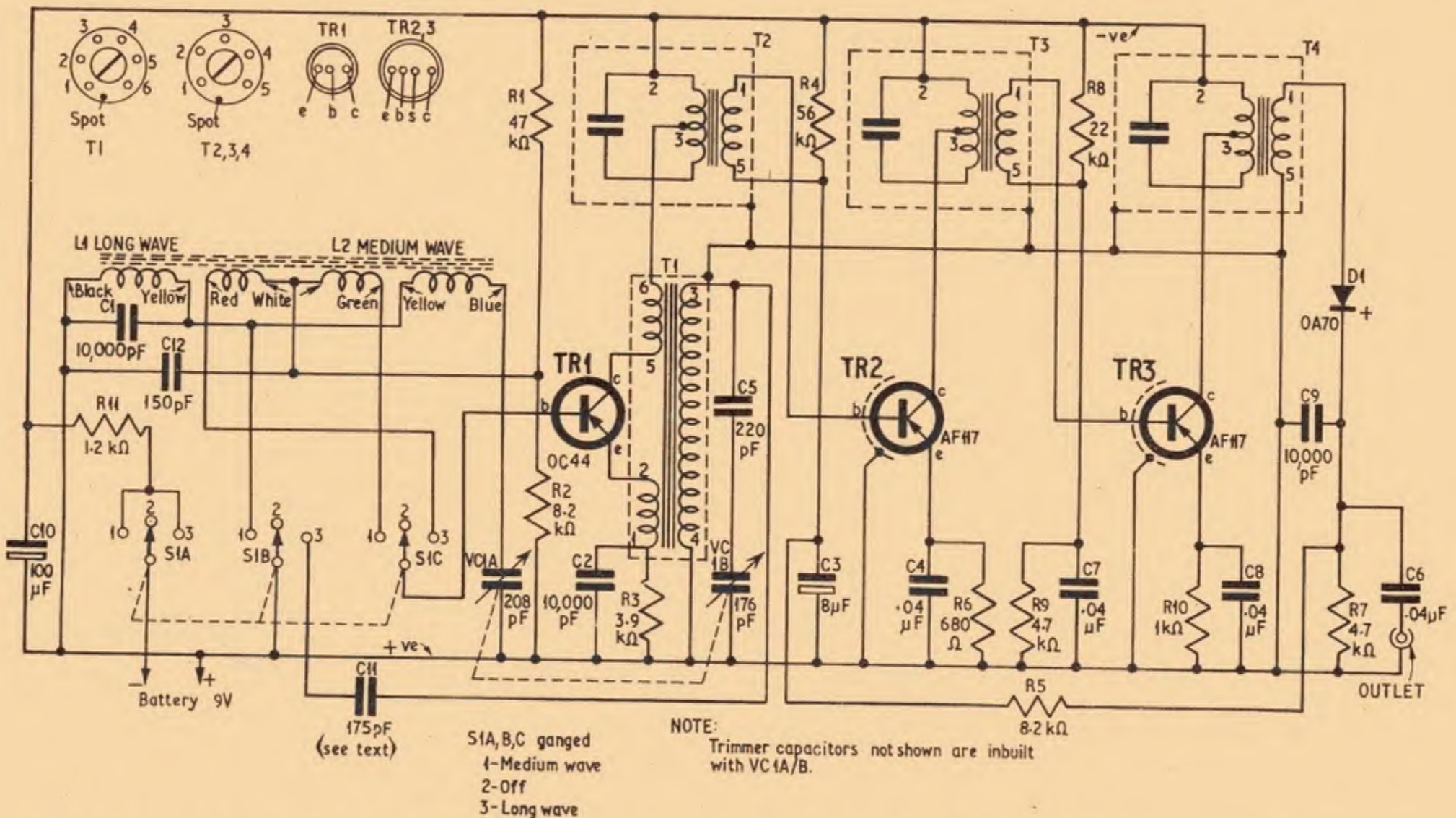

Fig. 2. Circuit diagram of the tuner. Undesignated capacitors on T2, T3, and T4 are supplied inside transformer cans

We could take the audio signals for our recorder via C6, where little signal distortion will have been introduced. If on the other hand, we connect a pair of high impedance headphones (say 4,000 ohms) to the output socket, signals may be plainly heard. Or, we could connect a suitable audio amplifier to the socket.

## CONSTRUCTION

The unit can be easily built by using a piece of Veroboard (approximately  $2\frac{3}{4} \times 3\frac{3}{4}$ in) with holes spaced 0.2in apart. It is thus very easy to link small low voltage components together to form a pseudo "printed wiring" assembly. The particular piece of board required should carry 14 conductor strips each having 19 holes; this is easily cut from a larger sheet by using a hacksaw, or a piece ready cut to size can be purchased.

various connections shown in Fig. 3 are then made exactly as shown.

Most of the components occupy the plain side of the board; their locations are shown in Fig. 5, which also shows the board correctly positioned for mounting on the inside of the front panel.

P.V.C. sleeving is fitted to each transistor wire, which is then held firmly with strong tweezers during the actual soldering process so that heat is shunted away from the transistor by conduction. Care is also required when connecting VC1 but no problems need arise if the plan in Fig. 4 is followed.

Note that four link wires are needed and also observe that six flying leads emanate from the plain side of the board for subsequent external connecting purposes. For these use flexible leads with different coloured insulation as an aid to recognition later; the length of these leads is initially made some 4in or so.



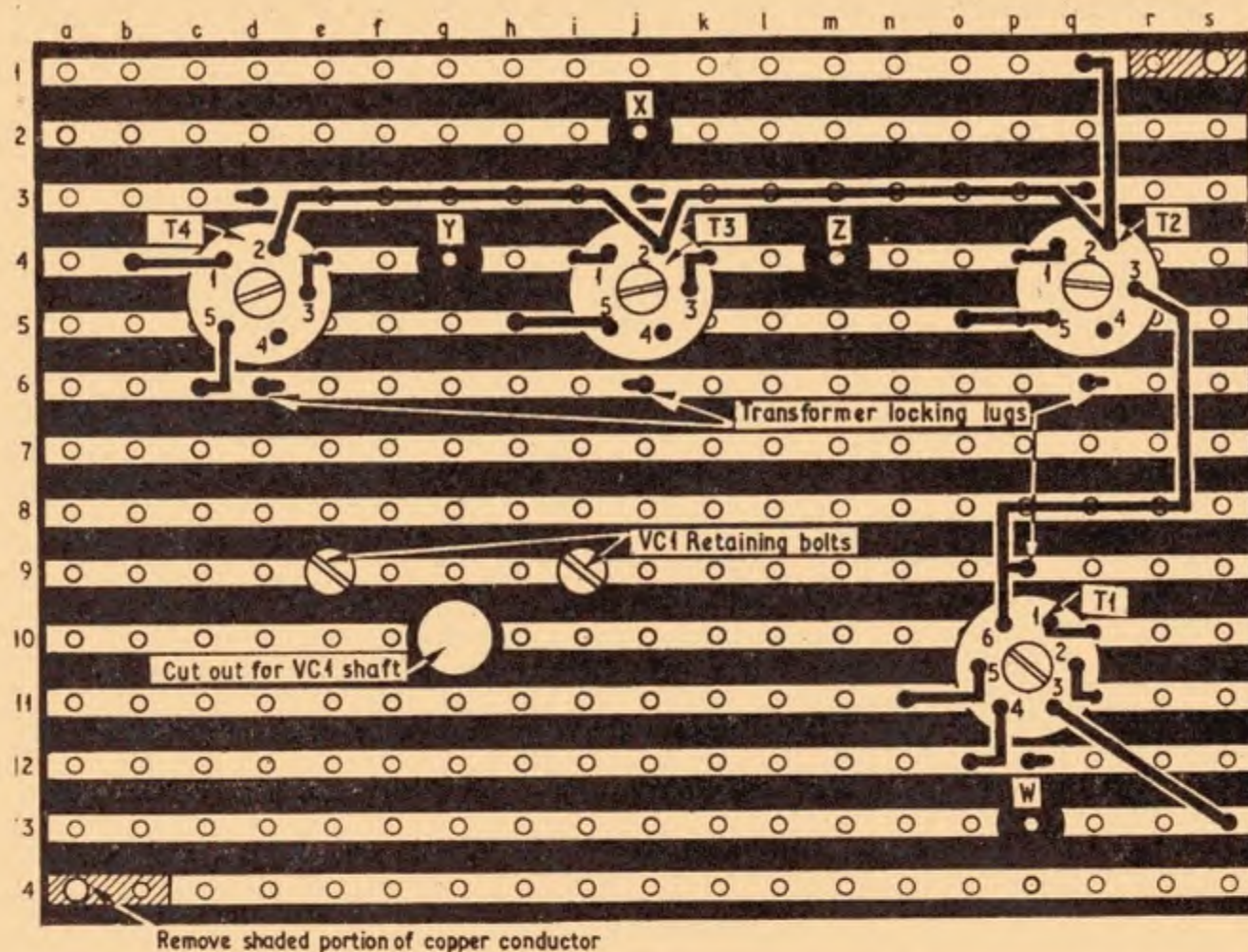

Fig. 3. The underside of the Veroboard panel showing the transformer wiring details. Note the cutting details and shaded areas (see text)

## FRONT PANEL

The front panel is now prepared using Figs. 5 and 6 as a guide.

Polished s.r.b.p. or ebonite is attractive (if unscratched) and easy to work with. This panel carries a pair of Terry clips to hold the aerial, the reduction drive dial, the rotary switch and outlet socket. Prior to mounting the switch check which of the outer "way" tags come under the influence of the central "pole" tags. There should be three "way" tags per "pole" and it is helpful to bend alternative sets flat as shown in Fig. 5. Shorten the shaft if necessary and file a "flat" for the knob. Arrange the flat so that the pointer will be upright at position 2, after which fix the switch in position.

Two wooden spacers ( $\frac{1}{2}$ in cube) are then glued to the inside of the panel at points x and y in Fig. 5—to agree with holes 14a and 1s. Later the board is screwed down to these spacers and the flying leads shortened and connected as indicated, but routing them as far as possible via the Terry clips to obtain both neatness and anchorage. It now remains necessary to solder positive and negative battery leads to the switch after ensuring that this is set to position 2.

## TESTING AND ALIGNING

If a milliammeter is available this should be set to read 0–10mA and inserted in the negative battery lead. When the rotary switch is moved to either of positions 1 or 3 a reading of approximately 2mA should be observed. If it is much higher, say 8–10mA, switch off and inspect for a fault.

If all is well the output can be connected to either an audio amplifier, the pick-up sockets of a suitable radio receiver or a pair of high impedance headphones. If a signal generator is available no alignment problems are likely. Adjust the cores of the i.f. transformers to 470kc/s, after which the medium and long wavebands are trimmed and padded for optimum results. It will

then be found that the cores and trimmers need only a slight adjustment since they do peak very sharply.

## ALIGNMENT WITHOUT A SIGNAL GENERATOR

The tuner can be aligned without a generator. A thin plastics knitting needle filed to form a small screwdriver can be used as a trimming tool. Steel needles and screwdrivers will upset the apparent tuned position by increasing the core volume and hence the inductance. This form of alignment is also most easily accomplished if the tuner can be connected to a suitable audio amplifier.

The first step consists of sweeping VC1 through its full range of travel with the switch set to position 1 and the core of T1 adjusted to a position just below the top of the metal can. While manipulating VC1 some sort of signal might be heard, although it may be rather weak (remember that the aerial is directional),

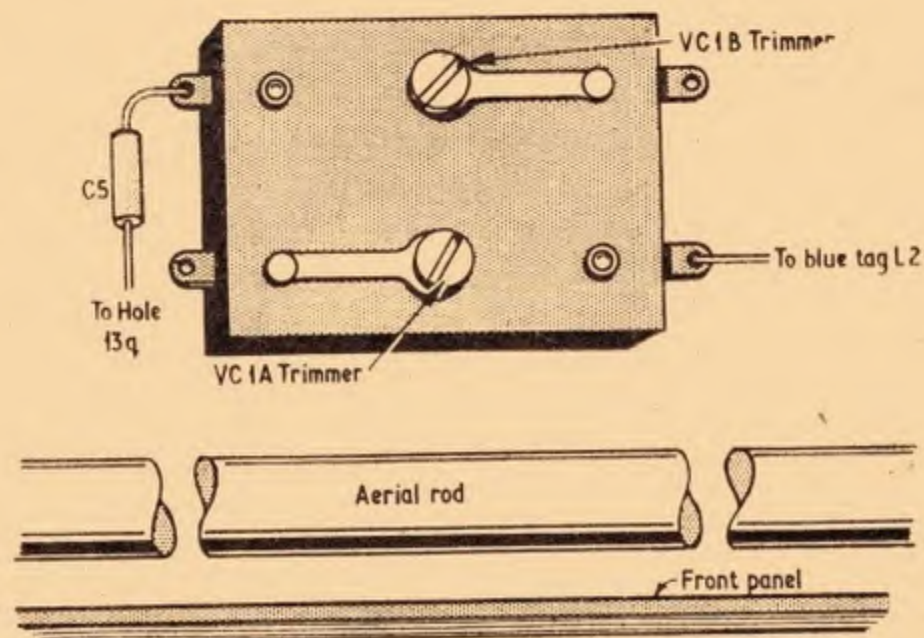

Fig. 4. Connections to the trimmers VC1a and VC1b



# COMPONENTS . . .

## Resistors

R1	47k $\Omega$	R6	680 $\Omega$
R2	8.2k $\Omega$	R7	4.7k $\Omega$
R3	3.9k $\Omega$	R8	22k $\Omega$
R4	56k $\Omega$	R9	4.7k $\Omega$
R5	8.2k $\Omega$	R10	1k $\Omega$
	R11	1.2k $\Omega$	

All resistors are 10%  $\frac{1}{4}$ W carbon

## Capacitors

C1	10,000pF ceramic
C2	10,000pF ceramic
C3	8 $\mu$ F 6V elect.
C4	0.04 $\mu$ F 150V paper
C5	220pF silver mica
C6	0.04 $\mu$ F 150V paper
C7	0.04 $\mu$ F 150V paper
C8	0.04 $\mu$ F 150V paper
C9	10,000pF ceramic
C10	100 $\mu$ F 9V elect.
C11	175pF silver mica (see text)
C12	150pF silver mica
VC1a/b	208 + 176pF Jackson type 00 with trimmers

## Semiconductors

TR1	OC44	} Mullard
TR2	AF117 (or OC170)	
TR3	AF117 (or OC170)	
DI	OA70	

## Transformers

T1	Oscillator	P50/1CC	} Weymouth Radio (Weyrad)
T2	I.F.	P50/2CC	
T3	I.F.	P50/2CC	
T4	I.F.	P50/3CC	

## Inductance

L1	} Aerial coil type RA2W (Weymouth Radio)
L2	

## Switch

SI	4-pole, 3-way rotary wafer switch
----	-----------------------------------

## Miscellaneous

Vernier Dial 2in (Eagle Products)  
 Battery PP3 9 volts  
 Veroboard  $2\frac{3}{4} \times 3\frac{3}{4}$ in (Alpha Radio, Leeds)  
 Terry clips  $\frac{3}{8}$ in  
 Panel—sheet of polished s.r.b.p. or ebonite  
 Pointer knob  
 Woodscrews, 6 B.A. nuts and bolts, wire, solder

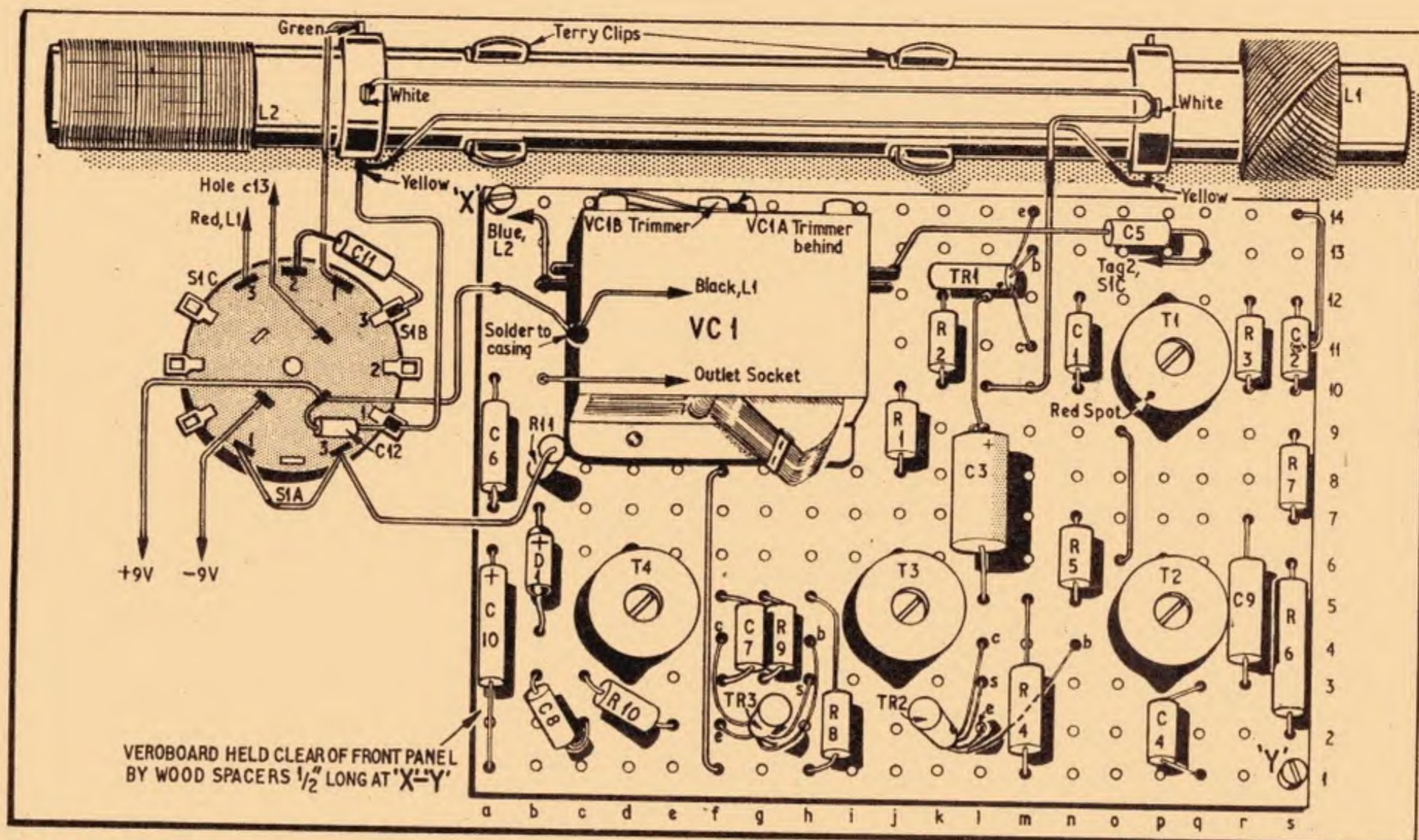

Fig. 5. The layout of components on the plain side of the board. Strip 3 is connected to strip 6 via the can of transformers T2, T3 and T4. Strip 9 and strip 12 are connected by the can of T1



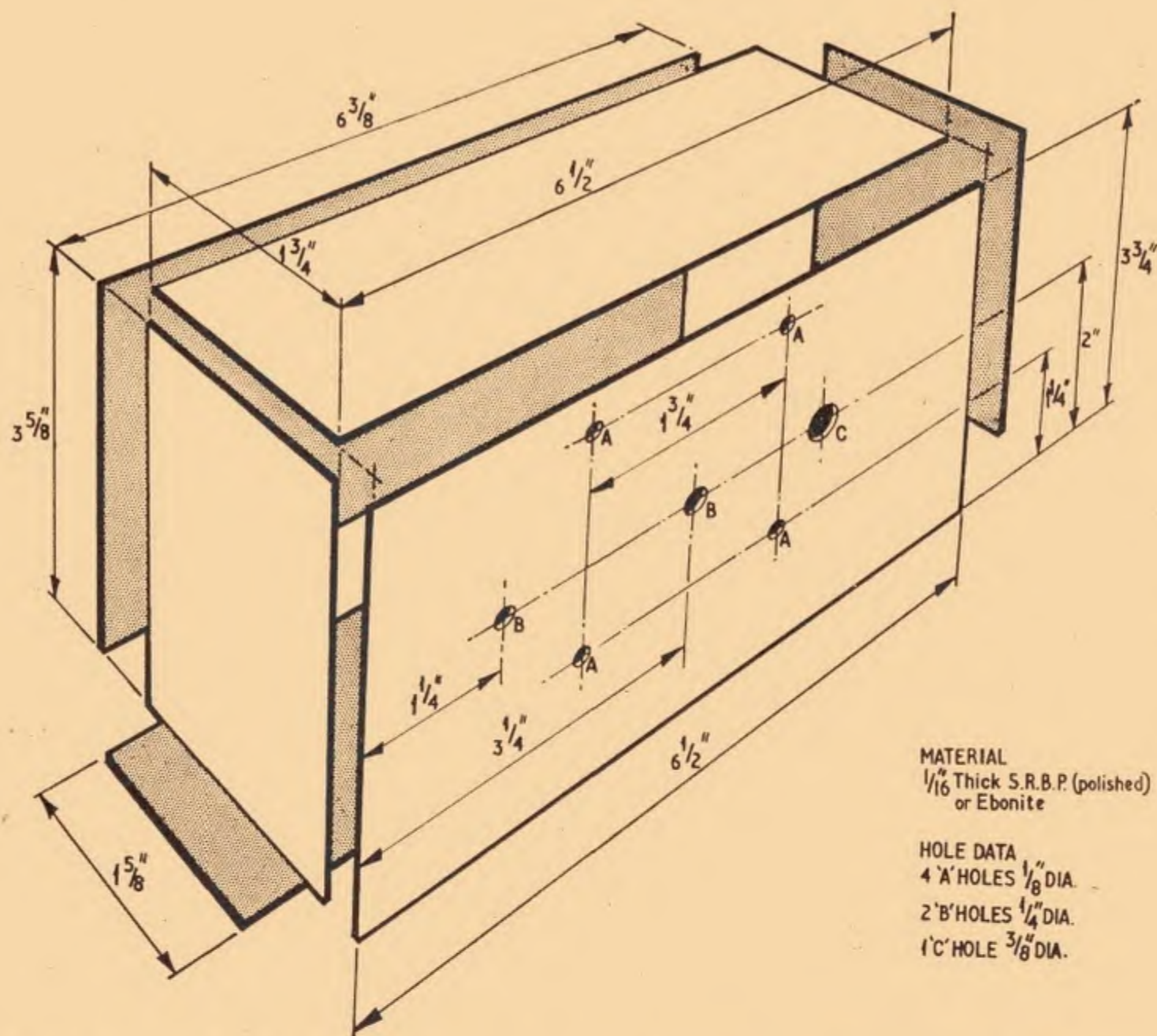

Fig. 6. Details of the cabinet and front panel. The parts are glued together but the back panel should be made removable for easy access to the interior for servicing

MATERIAL  
 $\frac{1}{16}$ " Thick S.R.B.P. (polished)  
 or Ebonite

HOLE DATA  
 4 'A' HOLES  $\frac{1}{8}$ " DIA.  
 2 'B' HOLES  $\frac{1}{4}$ " DIA.  
 1 'C' HOLE  $\frac{3}{8}$ " DIA.

but if no sound is heard adjust the core of T1 slightly. At all times use the knitting needle screwdriver when adjusting transformer cores. Immediately a signal is heard cease this activity and *very carefully* adjust the cores of T4, T3, then T2, in that order, for maximum response. Next try to identify the transmission, or alternatively search for a good BBC signal. Note the dial reading.

Now try moving L2 slightly along the aerial rod and leave it where the signal sounds strongest—this should be where L2 is just at the rod end. Search for a transmission at a point where the vanes of VC1 are almost fully engaged then reset (pad) L2 for maximum response. Next rotate the dial knob until the vanes of VC1 are almost fully open and on finding a signal very carefully adjust the trimmers on its base. Repeat these operations several times until no improvements can be made.

Radio Luxembourg can be received at a low dial reading (208m). If VC1 cannot be made to "open" enough to receive this station either the trimmers are screwed down too hard or the core of T1 needs a minute adjustment. If this has to be done it will be necessary to retrim and also repad. Finally, seal L2 in position with adhesive tape or beeswax.

On the other range it is usually adequate to search for the Light programme (Droitwich 1500m, 200kc/s) and adjust L1 for maximum signal strength. This station should be heard at approximately half-scale dial reading but in actual fact this might not result. The value of C11 is moderately critical and because the precise value of intermediate frequency is now unknown the station might not be tuneable. For quick results change the value of C11 to 150pF and connect a 60pF postage stamp type trimmer in parallel with it. Finally, seal L1 in position and carefully recheck to see that the

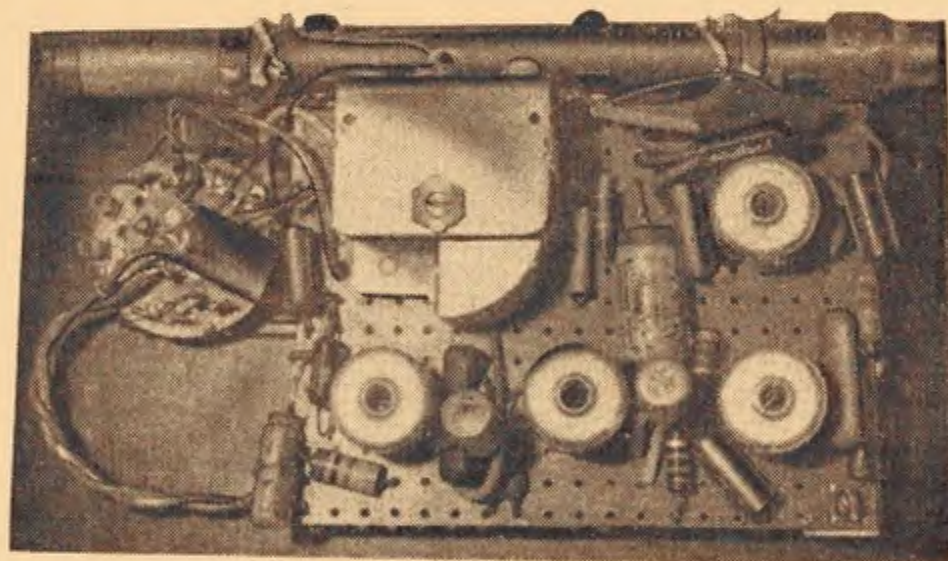

Fig. 7. A general view of the finished unit

i.f. transformer cores are peaked for maximum response, after which they should be sealed by dropping in molten wax.

The tuner can then be tested with a tape recorder by connecting the output of the tuner to a high impedance input socket. If the signals cannot be monitored from the recorder itself, either fit another outlet socket wired in parallel with the existing one, or better still connect a pair of high impedance headphones to the tape recorder output.

#### CONCLUSION

In use it will be found that this tuner will provide enough volume to modulate the recorder quite adequately. It now only remains to complete the casing along the lines shown in Fig. 6. The sides can be held together using wooden corner butts and a modern impact adhesive; the back should be made removable.





# the HALL effect

by  
P. D. FORSHAW,  
B.Sc.

## PART TWO

LAST month we found that if a current  $I_E$  is caused to flow through a conductor in the presence of a magnetic field of flux density  $B$  then a Hall voltage  $V_H$  is produced perpendicular to both  $I_E$  and  $B$  and of magnitude given by:

$$V_H = K_H I_E B \quad \dots (1)$$

Where  $K_H$  is known as the Hall constant.

We know that the passage of an electric current through a coil causes a magnetic field to be set up parallel to the axis of the coil as shown in Fig. 5. Assuming the permeability of the core and the number of turns on the coil is constant, the value of the flux density  $B$  can be shown to be directly proportional to the current  $I_1$  thus:

$$B = kI_1$$

where  $k$  is a constant depending upon permeability and the number of turns.

Moreover, if we wind a second coil on the core with exactly the same number of turns, and pass a current  $I_2$  through this second winding, then

$$B = k(I_1 + I_2) \quad \dots (2)$$

Suppose that we now apply this winding to the Hall element shown in Fig. 6. The magnitude of the Hall voltage is then given by combining equations (1) and (2) to give

$$V_H = K_H k I_E (I_1 + I_2)$$

$$\text{or} \quad V_H = K_1 I_E (I_1 + I_2) \quad \dots (3)$$

where  $K_1 = kK_H$

The arrangement of Fig. 6 and its circuit symbol in Fig. 7 is a simple form of Hall multiplier and equation (3) describes the basis of its operation. We shall now discuss various applications of the Hall multiplier while referring to this equation for a detailed explanation.

Fig. 6 (right). A simple form of Hall multiplier

Fig. 5. The passage of an electric current through a coil causes a magnetic field parallel to the coil axis

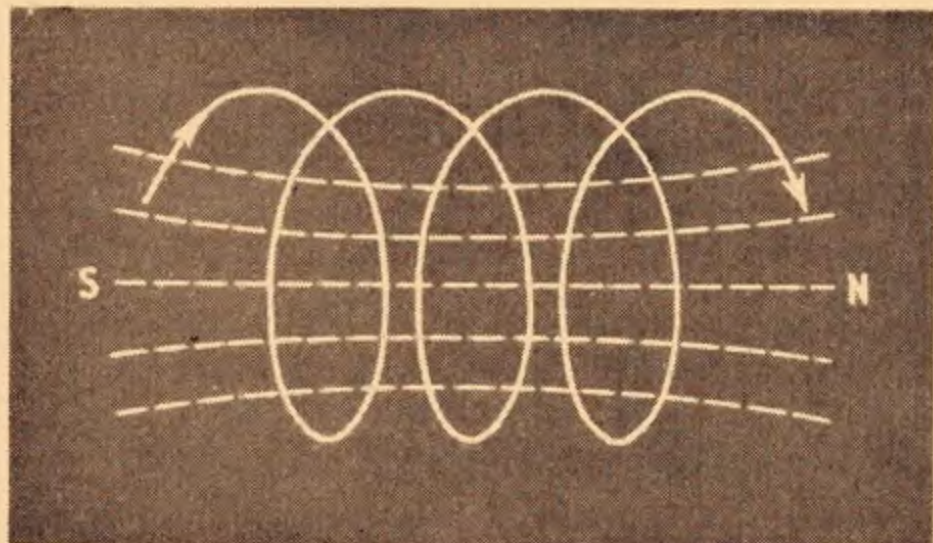

### THE HALL POWER METER

We know that the electrical power dissipated in a load is the product of the current flowing through the load  $I_L$  and the voltage appearing across it. We have seen that the output voltage of the Hall multiplier is the product of excitation current and coil current. If the load current flows through one of the multiplier coils and we arrange the load voltage to produce a proportional excitation current then the output voltage will be directly proportional to the power dissipated in the load.

Such an arrangement is shown in Fig. 8. The resistor  $R$  is given as high a value as possible in order that it may not appreciably shunt the load. At the present state of the art, it is possible to measure power from 100 watts upwards, at frequencies from d.c. to 50kc/s. A wattmeter relying upon this principle is illustrated in Fig. 9.

### ANALOGUE COMPUTING ELEMENT

Before we explain how the Hall multiplier behaves as a computing element, it may be as well if we explain just what we expect a computing element to do.

Analogue computers perform given mathematical operations upon one or more time varying voltage or current waveforms (sine, square, triangular, pulse waveforms, etc.) which are either applied to the computer or generated within the instrument itself.

For example, a computer may be required to perform the very simple operation of squaring the input signal. If we call the input  $A$ , then the output would be  $A^2$ . Or, again, with an inverting circuit the output would be  $1/A$ . We may wish to produce the square root of the input, when the output would be  $\sqrt{A}$ .

However, a word of warning here. *Do not confuse electronic and computing circuits!* A computer squaring or inverting circuit is quite different from an

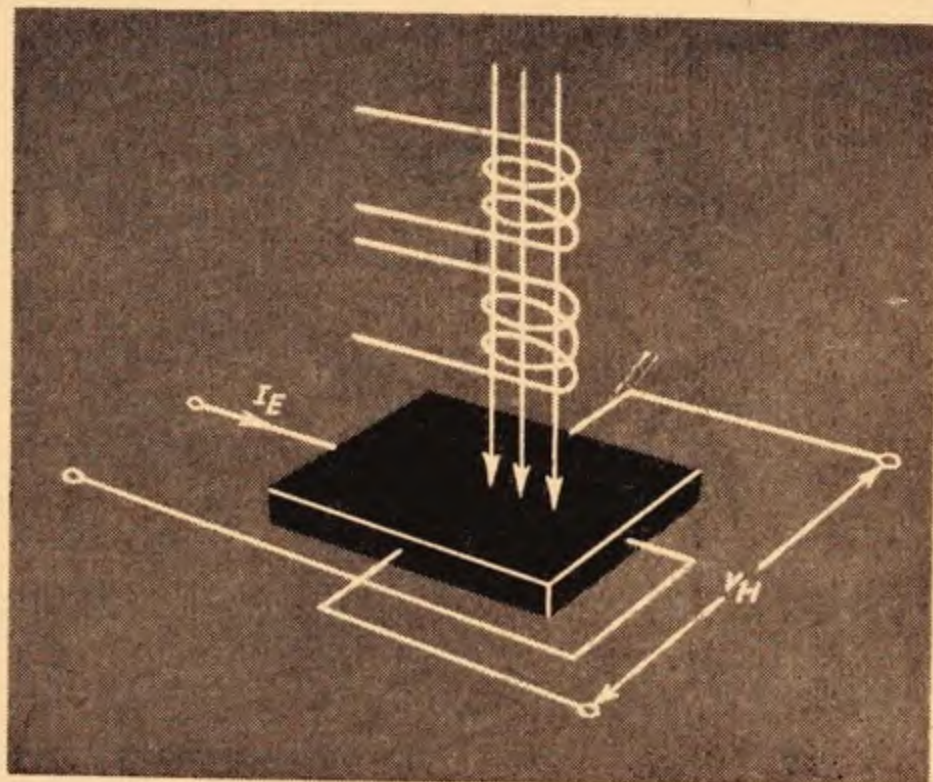



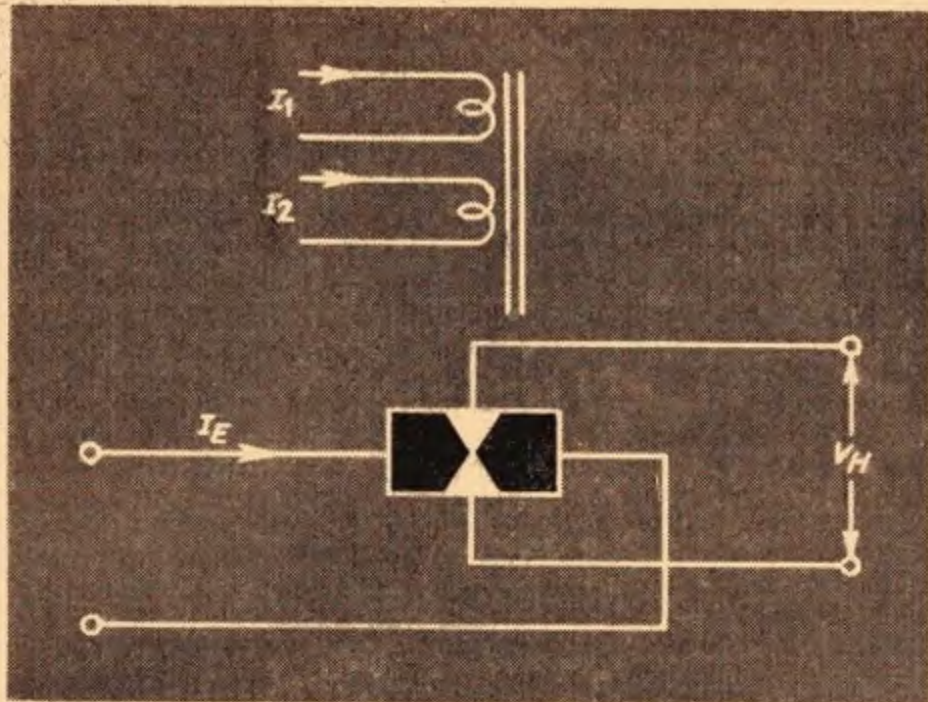

Fig. 7. Circuit symbol of the Hall multiplier

electronic squarer or inverter. If we applied a sine wave to a computing squaring circuit, we would certainly not expect a clipped sine wave output! In electronics we use the words to describe the *geometrical* properties of the waveforms we might see on an oscilloscope. In computing circuits we use the words to describe the *mathematical operation* which is performed on the input by the computer itself.

The Hall multiplier can, with suitable amplifiers, perform these several mathematical operations on one or more inputs. We shall, in due course, see how we can operate on two inputs,  $A$  and  $B$ , to produce an output defined by the equation

$$V_{out} = K_2(A^2 + AB + B^2)$$

As a start, let us consider the multiplying circuit, an obvious first choice. This is given in Fig. 10a. The coil and excitation currents are the two inputs  $A$  and  $B$ . Thus, from equation (3), where  $I_2 = 0$ ,  $I_1 = A$ , and  $I_E = B$

$$V_H = V_{out} = K_1AB$$

Thus the output voltage is proportional to the product of the two inputs. Squaring follows on from multiplication. By connecting the coil and element in series (Fig. 10b) we make  $I_1 = I_E = A$ . Thus:

$$V_{out} = K_1A.A = K_1A^2$$

Addition of two inputs is quite simple. We keep  $I_E$  constant and apply the two inputs to the two coil windings (Fig. 10c). Then  $I_1 = A, I_2 = B$ , thus:

$$V_{out} = K_1I_E(A + B) = K_2(A + B)$$

where  $K_2$  is a constant.

### INVERSION

Inversion is a little more complicated. Here we need a differential amplifier of very high gain with the Hall device placed in the feedback loop. (A differential amplifier produces an output which is equivalent to the difference of the two inputs, suitably amplified. If the two inputs were identical, the output would, of course, be zero). The circuit is given in Fig. 11. A constant valued function  $C$  (i.e. a d.c. signal) is applied to one input of the amplifier.

It can be shown that the output of the amplifier

$$V_{out} = \frac{K_3}{A} \text{ (inversion).}$$

Unfortunately, we must resort to mathematics to verify this. The appendix appearing at the end of this

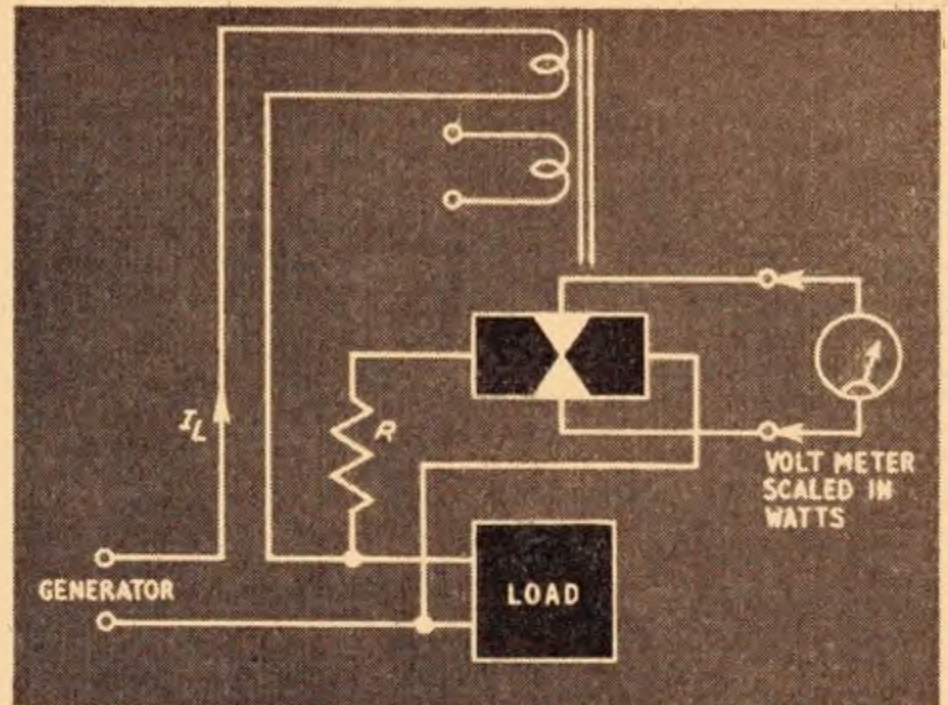

Fig. 8. Hall multiplier used to measure a.c. or d.c. power

article gives a proof of this relationship, for those who want to go further. The rest of us will pass on to the quadratic circuit. The equation

$$V_{out} = K_2(A^2 + AB + B^2)$$

is called a quadratic equation, and here again the Hall multiplier can do the job. This time, however, we use two multipliers connected as shown in Fig. 12. Verification of the equation is quite simple—there are no amplifiers to confuse the issue. Start with equation (3) and substitute values for  $I_E$ ,  $I_1$  and  $I_2$  dealing with the two elements separately and combining the two outputs  $V_{H1}$  and  $V_{H2}$  using  $V_{out} = V_{H1} + V_{H2}$ . (No prizes for correct solutions but see what you can do.)

Here we have only touched on the subject, space prevents us going further. However, we have seen how the Hall multiplier fulfils the requirements of elementary computing circuits and, of course, it can do much more complex computing jobs. We shall leave the subject here, and get back on to firmer ground.

### THE HALL CHOPPER

The chopping function of the Hall multiplier is obtained when the excitation current is interrupted in a square wave manner as shown in Fig. 13. The output waveform is a chopped replica of the input signal having zero output during the "off time" of the chopping signal.

Chopping circuits are used almost exclusively in high gain d.c. amplifiers where the d.c. input is first chopped to give an a.c. signal which is then amplified

Fig. 9. A Hall effect wattmeter





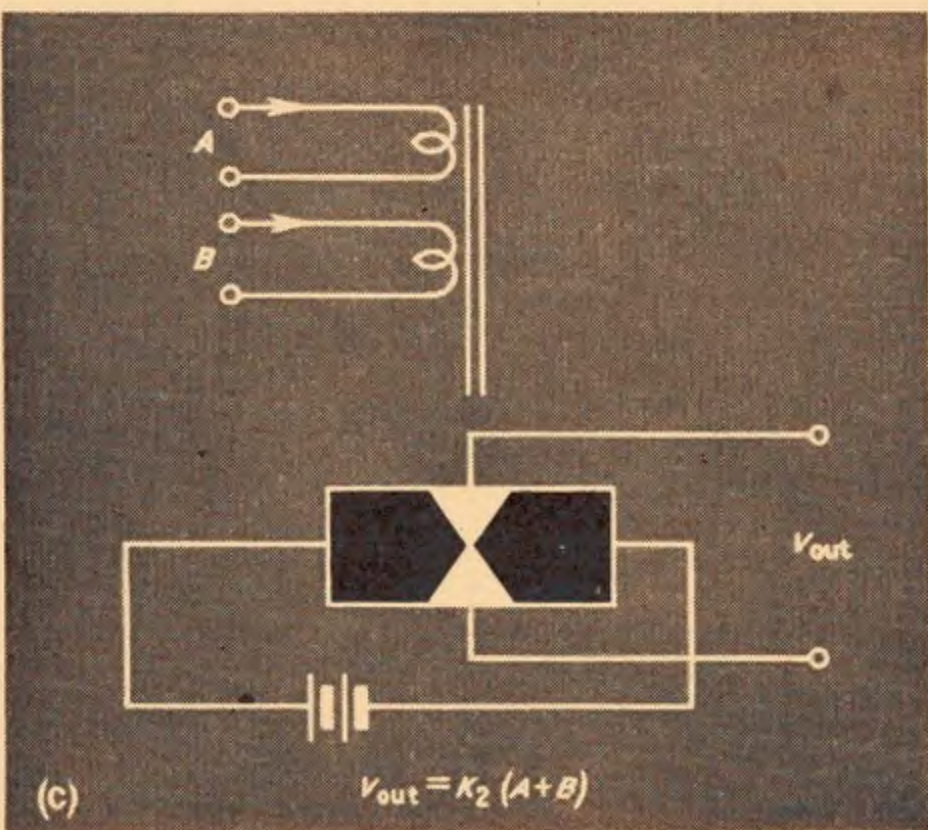
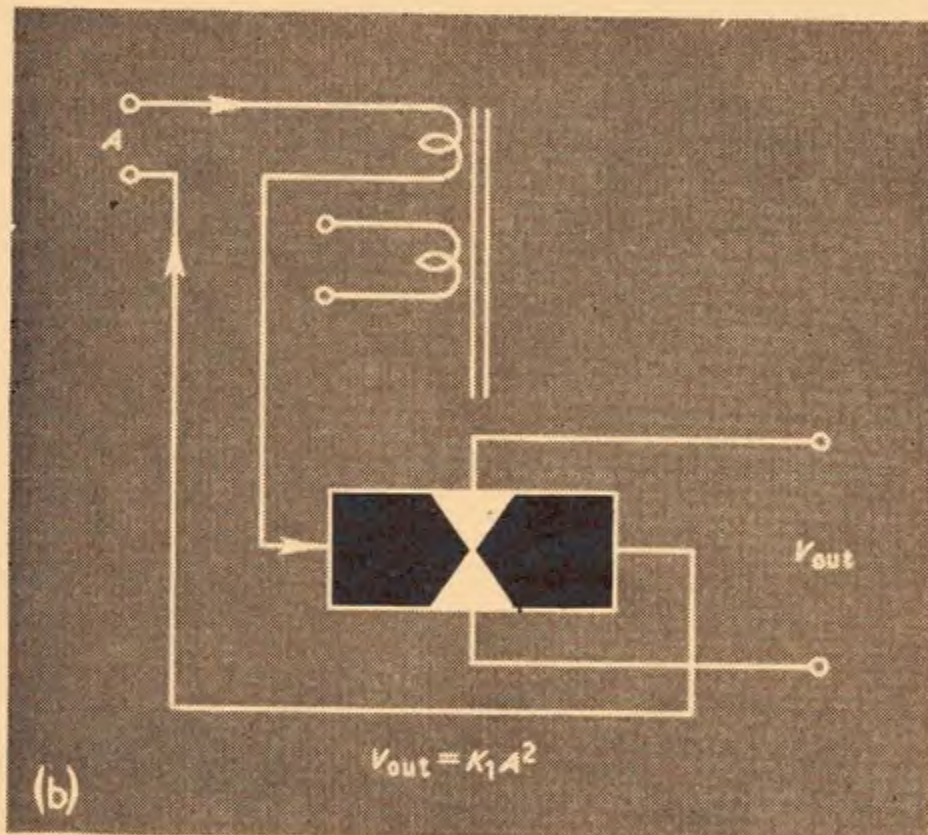
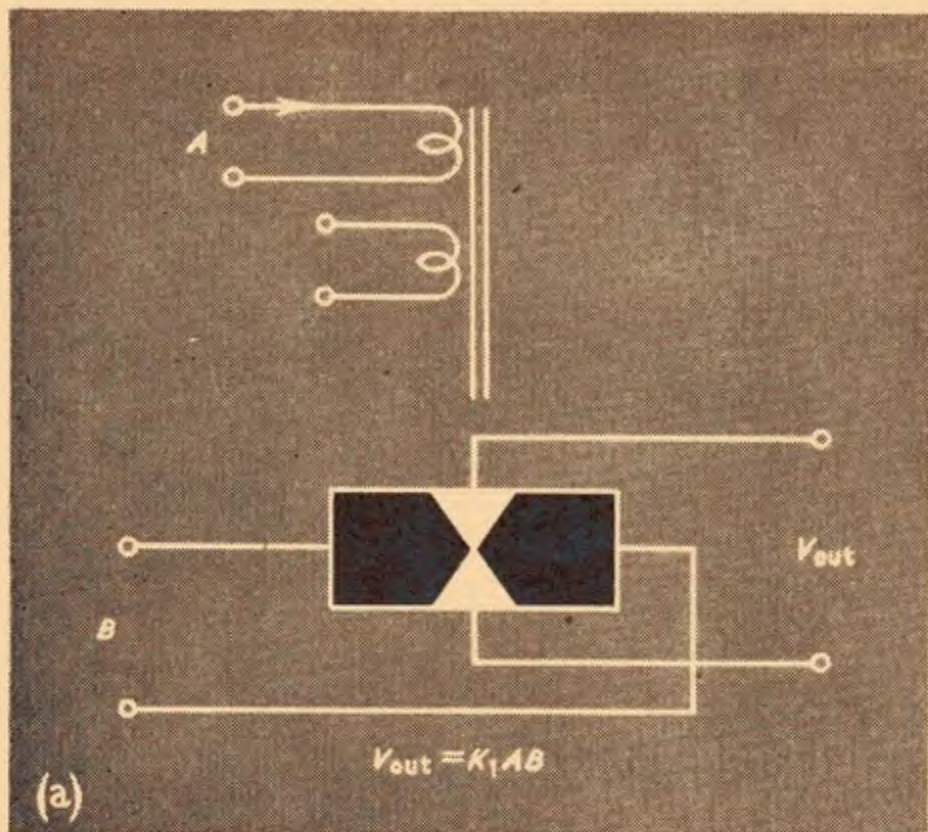

by a conventional tuned a.c. amplifier. Obviously, the output of the amplifier is an amplified version of the chopped input, which must be converted back to d.c. This latter function is fulfilled by an a.c. to d.c. converter—discussed under the next heading.

### THE FREQUENCY DOUBLER

Any a.c. sinusoidal signal may be represented by the equation

$$E = V \sin(2\pi ft + \theta)$$

Where  $E$  is the instantaneous value of the signal at any time,  $V$  is the *peak* value of the signal of frequency  $f$ , and  $\theta$  is the phase of the sine wave with respect to some arbitrary reference. We normally write  $2\pi f = \omega$ ,  $\omega$  being the angular frequency of the signal.

Let us apply two signals,  $A \sin \omega t$  and  $B \sin \omega t$ , of equal phase and frequency, as shown in Fig. 14. The output is thus

$$V_{out} = K_1 AB \sin^2 \omega t = \frac{1}{2} K_1 AB (1 + \cos 2\omega t)$$

thus  $V_{out} = \frac{1}{2} K_1 AB + \frac{1}{2} K_1 AB \cos 2\omega t$

$\frac{1}{2} K_1 AB$  is a d.c. term, and  $\frac{1}{2} K_1 AB \cos 2\omega t$  represents an a.c. term of *twice* the original frequency. Thus the Hall multiplier behaves as a *frequency doubler*. Alternatively, if we filter out this double frequency (a.c.) term, we are left with the d.c. term  $\frac{1}{2} K_1 AB$ . By keeping  $B$  constant, the magnitude of the d.c. output is thus proportional to the magnitude of the a.c. input  $A \sin \omega t$ , and we have what is essentially an a.c. to d.c. converter.

### SUPPRESSED CARRIER MODULATION

The circuit is identical to that shown in Fig. 14 except that in this case we supply a.c. signals of different frequencies.

Suppose one input is  $A \cos \omega_1 t$  (frequency  $f_1$ ), and  $B \cos \omega_2 t$  (frequency  $f_2$ ). Then the output will be

$$V_{out} = K_1 AB \cos \omega_1 t \cos \omega_2 t \text{ which leads to}$$

$$V_{out} = K_2 AB \cos(\omega_1 - \omega_2)t + K_2 AB \cos(\omega_1 + \omega_2)t$$

Thus we have a complex output signal composed of two sinusoidal signals whose frequencies are equal to the sum and difference of the two input frequencies.

Fig. 10a, b, c (left). Examples of computing elements using the Hall multiplier

Fig. 11. Generation of inverse function:  $V_{out} = K_3 \frac{I}{A}$

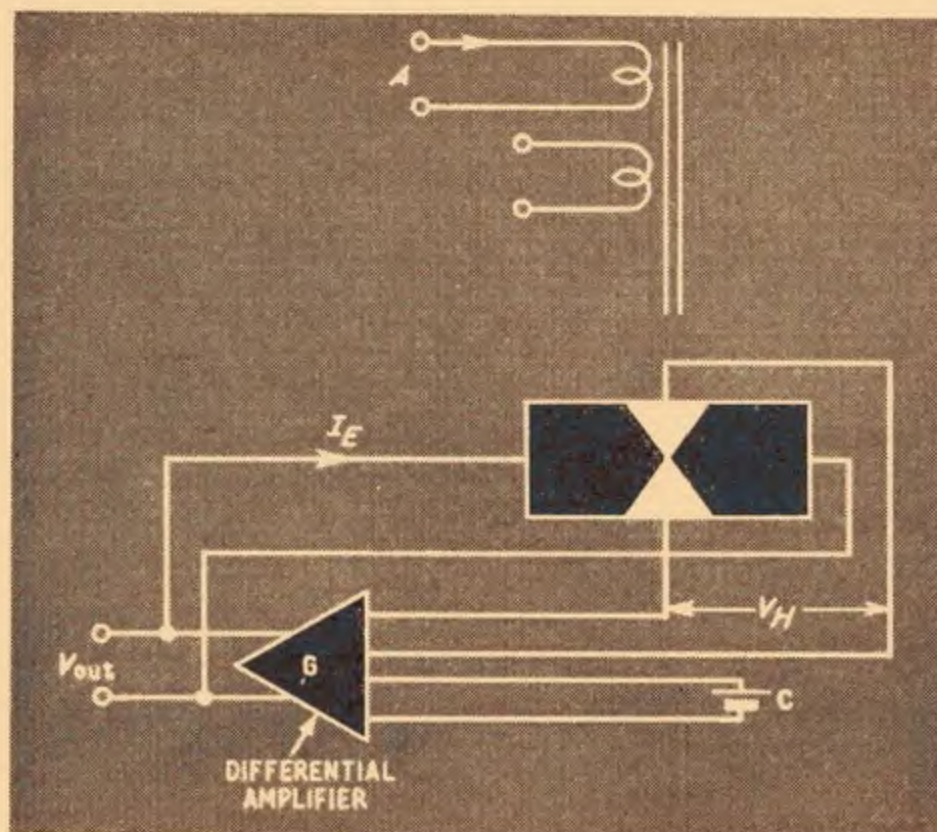



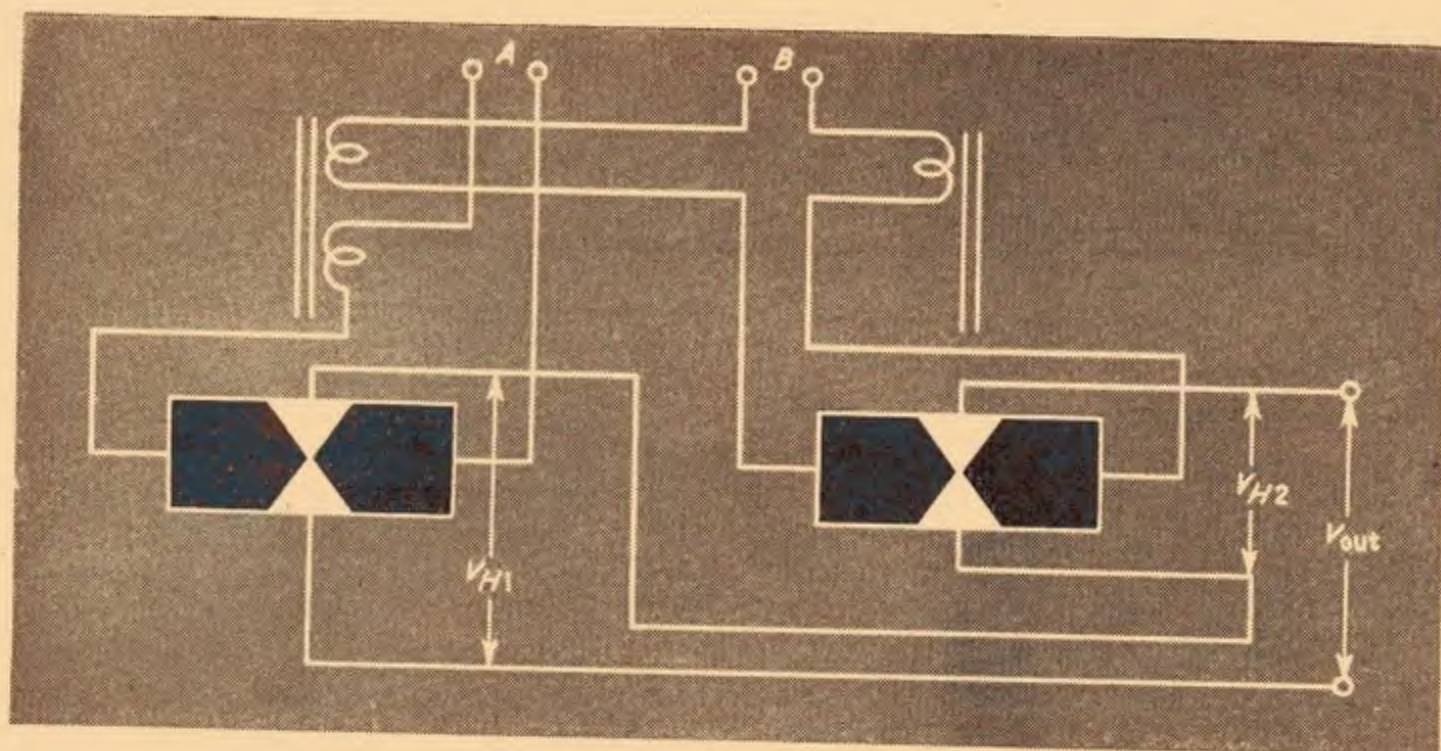

Fig. 12. Generating a quadratic function using two multipliers:  $V_{out} = K (A^2 + AB + B^2)$

If we make  $f_1$  the carrier frequency and  $f_2$  the signal frequency (of much lower value than  $f_1$ ) then it can be seen that the output consists of the upper and lower sidebands ( $f_1 + f_2$ ) and ( $f_1 - f_2$ ). Notice there is no carrier term in the output at a frequency  $f_1$ , the carrier frequency. We thus have double sideband suppressed carrier modulation.

Here we must stop. Much more can be said on the subject, and many more multiplier circuits could be introduced to illustrate the versatility of this unique device. However, we hope that in these two articles you have gained a basic appreciation of the Hall effect and its potentialities. At the present time, Hall multipliers range in price from £30-£100 each. As production techniques are improved and the device gains wider recognition, prices will most likely be reduced and the Hall multiplier will undoubtedly claim its rightful place.

#### APPENDIX

Referring to Fig. 11 and considering the Hall multiplier only. From equation (3)

$$V_H = K_1 I_E A$$

If  $R$  is the resistance of the Hall element then

$$V_{out} = I_E R$$

Fig. 13. The Hall multiplier as an electronic chopper

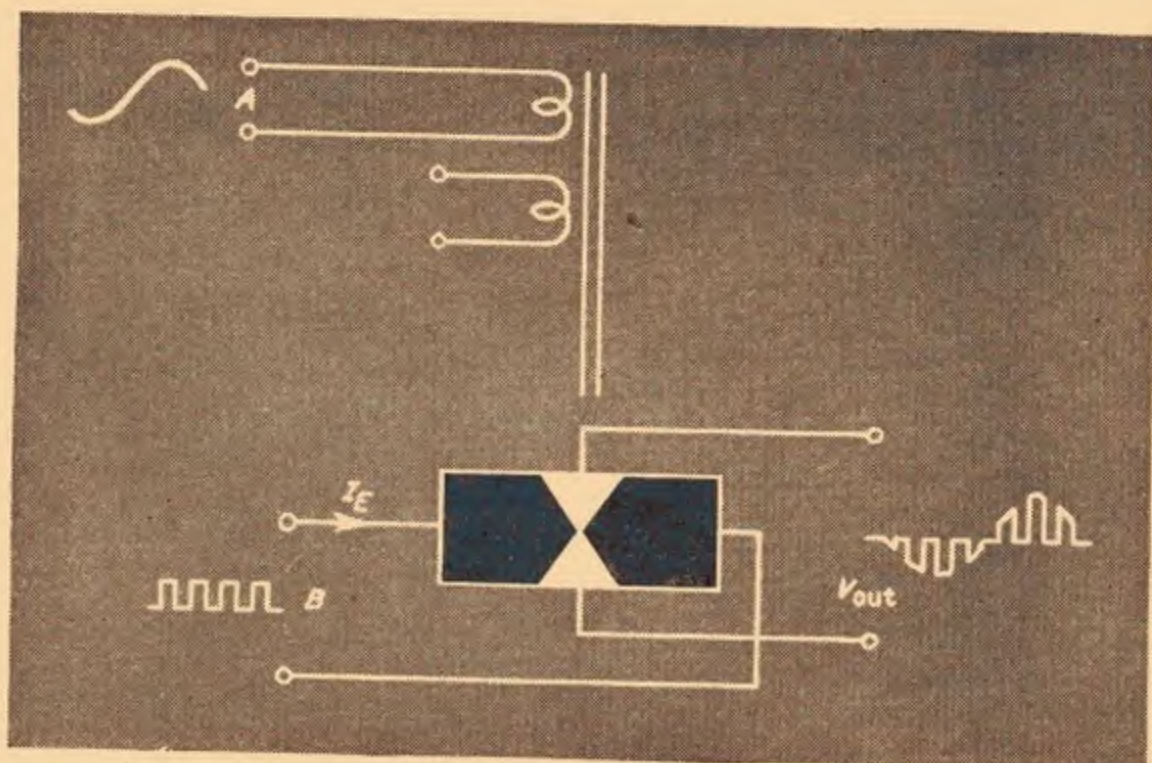

thus

$$V_H = \frac{K_1 V_{out} A}{R} \dots (4)$$

Considering now the amplifier of gain  $G$ :

$$V_{out} = (V_H - C)G$$

Substituting the value for  $V_H$  given by (4):

$$V_{out} = \frac{GK_1 V_{out} A}{R} - GC$$

$$V_{out} \left( \frac{GK_1 A}{R} - 1 \right) = GC$$

$$V_{out} = \frac{GCR}{GK_1 A - R}$$

$$V_{out} = \frac{C}{\frac{K_1 A}{R} - \frac{1}{G}}$$

If  $G$  is very large then we can write  $\frac{1}{G} = 0$  with little loss in accuracy, thus

$V_{out} = \frac{CR}{K_1} \cdot \frac{1}{A} = K_3 \cdot \frac{1}{A}$  since  $C$ ,  $R$  and  $K_1$  are all constant.



Fig. 14. The Hall multiplier as a frequency doubler and a.c./d.c. converter

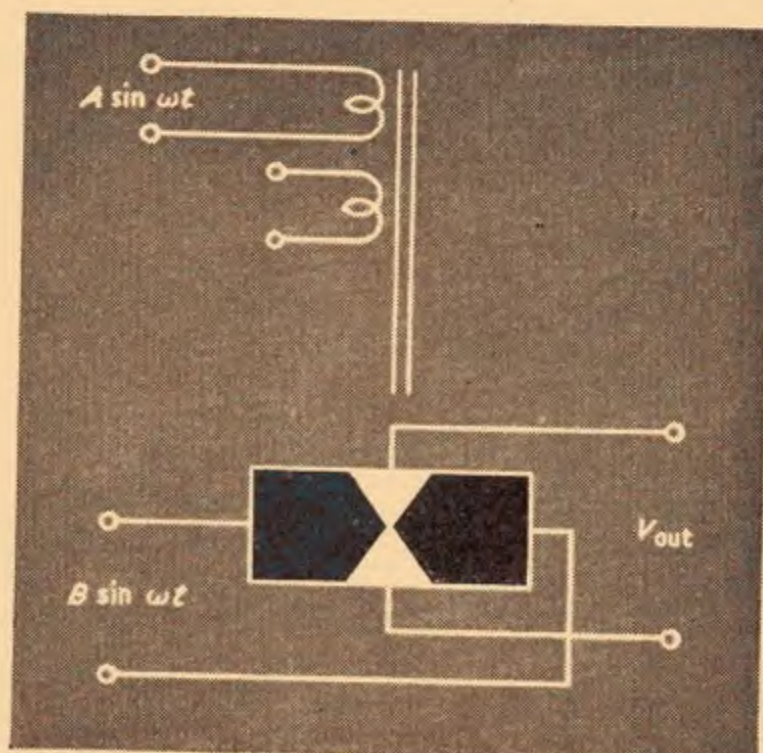



# DETACHED PARTICLES

By John Valence

## MUSIC GALORE

NOTWITHSTANDING the apparent usurpation of part of the electronics industry by the beat groups, there are still interesting and important happenings in the field of serious music—if beat fans will excuse the expression.

According to the Russian scientist Zaripov the composer will eventually be freed from the tedious part of his job which is writing the accompaniment to a melody: the accompaniment or harmonisation of the melody follows strict rules and so can be entrusted to a computer.

A future Tchaikovsky will have to divide his attention between a URAL-1 computer and the piano-forte. Production will rise. None of this retiring with a mere bagatelle of five or six symphonies to one's credit. I guess a century will become the norm.

Just imagine, there will be enough symphonies for the Third Programme to broadcast non stop for months without a repeat. And how those television producers will love this boundless store of music from which to draw the indispensable background sound.

## ASSISTED RESONANCE

FROM music in theory to music in practice. The Royal Festival Hall has just reopened after extensive alterations. Part of the work included the installation of "Assisted Resonance". Acoustic engineers from the Building Research Station have developed a system for lengthening the reverberation time using electronic means that is quite different to methods previously used.

A large number of frequency selective microphones are mounted in the ceiling. Each microphone is tuned to one narrow band of frequencies, and feeds an amplifier which in turn drives a loudspeaker. The loudspeakers are arranged to be nearer the source of sound than the microphones and so the listener hears the original sound before the amplified sound. The latter extends the duration of the original sound without being detectable by the listener.

## IN HARMONY

THE partnership between music and electronics will become increasingly closer at all stages, from the very composition of a score to its public performance—as the two examples just mentioned illustrate. Do we then have reason to fear the complete subjection of the individual composer or instrumentalist? It is worth recalling that thirty years ago Leopold Stokowski predicted that the traditional orchestral instruments would become obsolete in a matter of twenty years. Since this eminent conductor made this prediction it is true that a variety of electronic musical instruments have emerged, but these appear to be finding their own particular uses with individual performers and small groups. One cannot really imagine these instruments ever taking the place of the larger concert orchestras.

As for computer composed musical works: these will help satisfy the almost insatiable demand for innocuous but uninspiring tunes that arises from the increasing use of background music wherever we go.

On the other hand it seems at present difficult to produce melodies in a given style from a computer. We will therefore have to rely on human genius to create works of art to enthral appreciative audiences for a little longer yet.

## NOT FORGOTTEN

WHETHER visibly fuming or relaxed and quietly resigned behind the steering column, the unhappy motorist caught in a traffic jam in one of our cities can take comfort from the fact that he is not forgotten in the march of electronics.

The Ministry of Transport has been trying out a new system developed and produced by Decca Radar Ltd. This permits the rate of traffic flow at any selected area to be constantly monitored and the existence of a jam indicated by lights on a large scale wall map. Each vehicle movement is registered through pressure operated devices working in conjunction with small rubber tubes fixed to the surface of the road. If adopted as a permanent system, it is

likely that improved detecting devices, probably magnetic transducers, will be embedded in the road.

Close study of the map enables a traffic supervisor to anticipate a likely congestion. How effectively this intelligence can be applied to remedy the situation is not really clear. Still it will be nice to know you are not forgotten and that your predicament is being sympathetically observed by some official in a nice comfortable office somewhere in town.

## SAFE RETURN

LOOKING at the curious hieroglyphics which adorn the neck bands of my shirts I am more than a little amazed that so far none has failed to return to its rightful owner after each visit to the laundry. These seemingly meaningless marks do after all convey some sort of information to the sorter-outer, if not to me.

I know others have had less happy experiences with their weekly wash. To these I can offer some comfort: the British Launderers Research Association is working on an automatic sorting machine incorporating an electronic eye. The laundry mark—made presumably with magnetic ink—will be read by the "eye" and somehow or other the machine will gather together all articles belonging to one customer.



... having trouble with one of the bistables, eh?



# DESIGN OF CERAMIC PICK-UP CARTRIDGES

BY J. W. G. TAYLOR, Plessey-UK Ltd.



A RANGE of ceramic pick-up cartridges is manufactured in the Acoustics Division of Plessey-UK Limited at Havant, and marketed by Technical Ceramics Limited in association with the Sonotone Corporation. These include monaural and stereophonic cartridges for general usage, and types specially developed to provide high compliance and suitable for use with reproducers of the highest fidelity.

In pick-up cartridges of the ceramic type the transducer element is a flat strip of sandwich construction comprising metal or metallised electrodes and piezoelectric ceramic material, so arranged that an electric potential is developed between the electrodes which is proportional to deflection of the element.

Unlike other types of crystal transducer, the materials used are impervious to moisture and are not damaged by extremes of temperature. Thus the end product is suitable for use in all climates and is of particular interest to users of high-grade reproducing equipment, as the output characteristics do not vary significantly with normal variations in the conditions of use.

The source impedance presented across the output terminals is capacitive, typically several hundred picofarads. The cartridge is designed to provide a nearly linear frequency response into an amplifier with an input resistance of 2 megohm, shunted by 100pF to allow for the stray capacitance of the amplifier and the interconnecting leads. Typical frequency characteristics are shown in Fig. 1.

The introduction of the 9T series of high quality cartridges has extended the use of piezo-electric pick-ups into the high fidelity and transcription fields. Of particular interest is the type 9T AHC which provides very high compliance and thus permits the use of a low-mass pick-up arm with minimum pivot torque.

A tracking weight as low as one gram can be employed thus minimising wear and distortion, and the resonance attributable to arm mass and stylus compliance can be maintained at an acceptably low frequency.

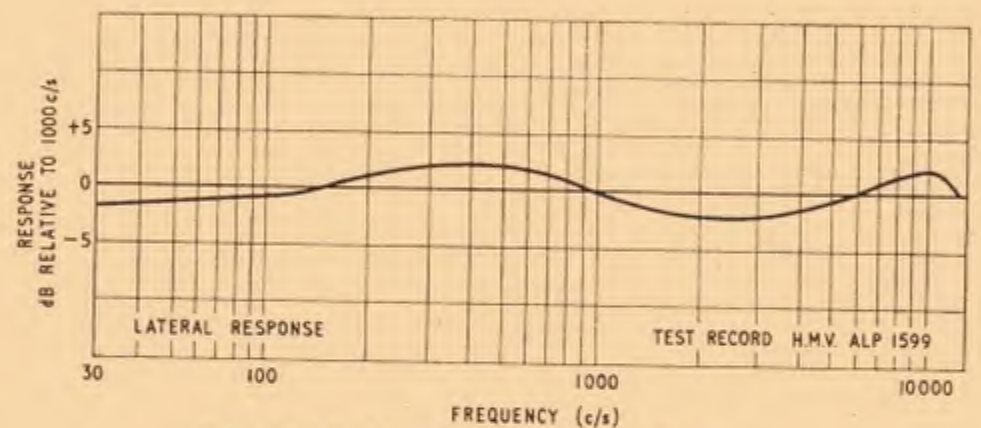

(a) Typical response curve (lateral)

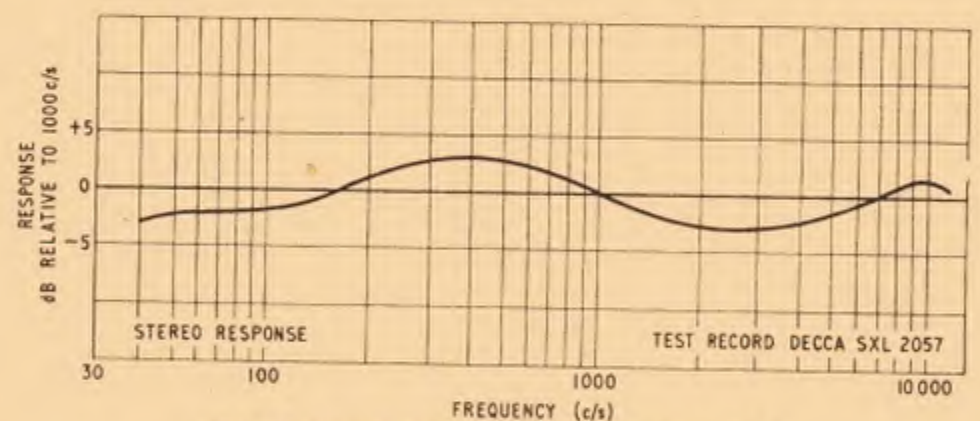

(b) Typical response curve (stereo)

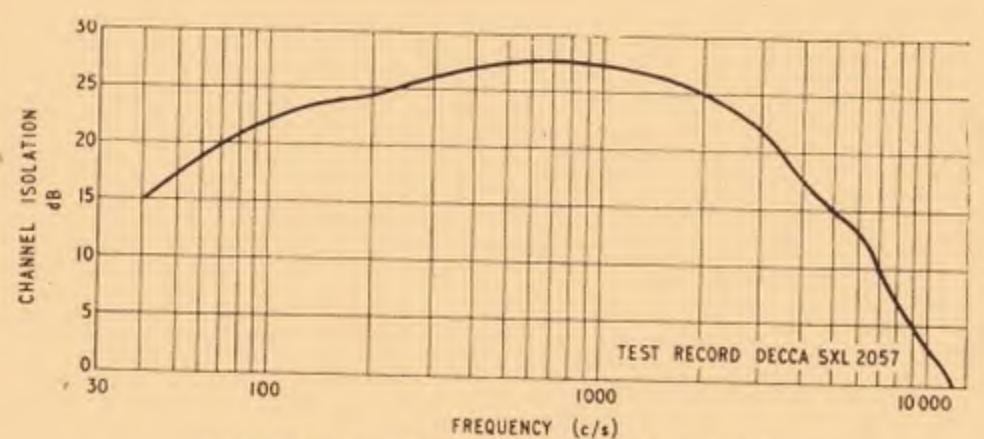

(c) Typical channel isolation curve

Fig. 1. Response curves of cartridge type 9TA. Electrical load  $2M\Omega$  and 100pF, stylus pressure 3gm



A typical application of this cartridge is seen in the Garrard model 3000 (see heading photograph) which combines the advantages of an automatic changer with some of the attributes of a transcription turntable.

In a monaural cartridge playing a normal recording the lateral movement of the stylus bends the element from side to side thus producing an output voltage. The movement is transmitted by a simple linkage coupling the stylus to the element. The opposite end of the element is held in a rubber insert in the cartridge housing. The characteristics of this rubber may be varied to provide different high frequency responses. This insert also protects the element from shock and prevents damage by mishandling.

In the stereo case a more complicated groove modulation has to be transmitted to the two elements, one providing a left-hand output and one a right-hand output. Separate modulation of each channel is obtained by rotating the planes of modulation through 45 degrees, so that movement of the stylus resulting from the left-hand channel is at right-angles to that, from the right-hand channel.

These movements have to be transmitted to the left-hand and right-hand elements in such a way that crosstalk (left-hand stylus motion producing right-hand element movement and vice versa) is minimised.

This is accomplished by a pantograph arrangement which can be seen clearly in the exploded view in Fig. 2; this also shows the method by which the pantograph is held to the housing and the method of supporting the ceramic elements in rubber blocks in the housing.

### MECHANICAL CHARACTERISTICS

We shall now analyse the mechanical characteristics of the type 8T4A cartridge in order to show how the desired characteristics are achieved in a typical general-purpose cartridge.

The mechanical circuit of the type 8T4A cartridge is shown in Fig. 3a together with an explanation of the various components. The formal equivalent is shown in Fig. 3b, using the convention that the lines of the circuit are ones of equal velocity.

If we now wish to draw an electrical equivalent circuit we have a choice of conventions, but the most convenient one in this case is to use current equivalent to force, and voltage equivalent to velocity. This is known as the mobility analogy, and is shown in Fig. 4. Here  $i_{out}$  is equivalent to the force applied against the stiffness of the element and is therefore proportional to the output voltage of the cartridge.

In order to determine the value of  $i_{out}$  we must first specify the input generator to be applied to the circuit of Fig. 4.

This is equivalent to the electrical input resulting from the deflection of the pick-up stylus as it travels along the groove of the gramophone record. The input generator therefore must be analogous to the recording characteristic used in practice. The British

Standard recording characteristic is shown in Fig. 5, and it can be seen that the amplitude  $A$  of groove deflection falls with increasing frequency. Since in the analogue circuit of Fig. 4, velocity is represented by voltage, the input generator should be one with an amplitude-frequency characteristic equal to the velocity-frequency characteristic of Fig. 5.

This can be seen by studying the simplified circuit of Fig. 6. Here we have assumed a large compliance  $S_1$ , zero compliance  $S_3$ , and a large compliance  $S_4$ , and, hence,  $L_1$ ,  $L_3$ , and  $L_4$  are omitted. In this case therefore the element is assumed to be actuated directly by the record and so if we were to use a constant amplitude recording the output voltage would be constant with respect to frequency. In the equivalent circuit this means that  $i_{out}$  would not vary with frequency.

In order to provide this, a generator with an output voltage rising 6dB per octave must be applied to the input, and this is the appropriate analogy of the velocity characteristic of constant amplitude recording.

The final circuit is as shown in Fig. 7, in which we have taken Fig. 4, added the appropriate input function and simplified the circuit by neglecting  $C_1$  and  $L_1$ . These components modify the load seen by the generator and therefore the force reaction of the stylus on the groove wall. The current delivered to  $L_2$  from the voltage source is not affected by their omission.

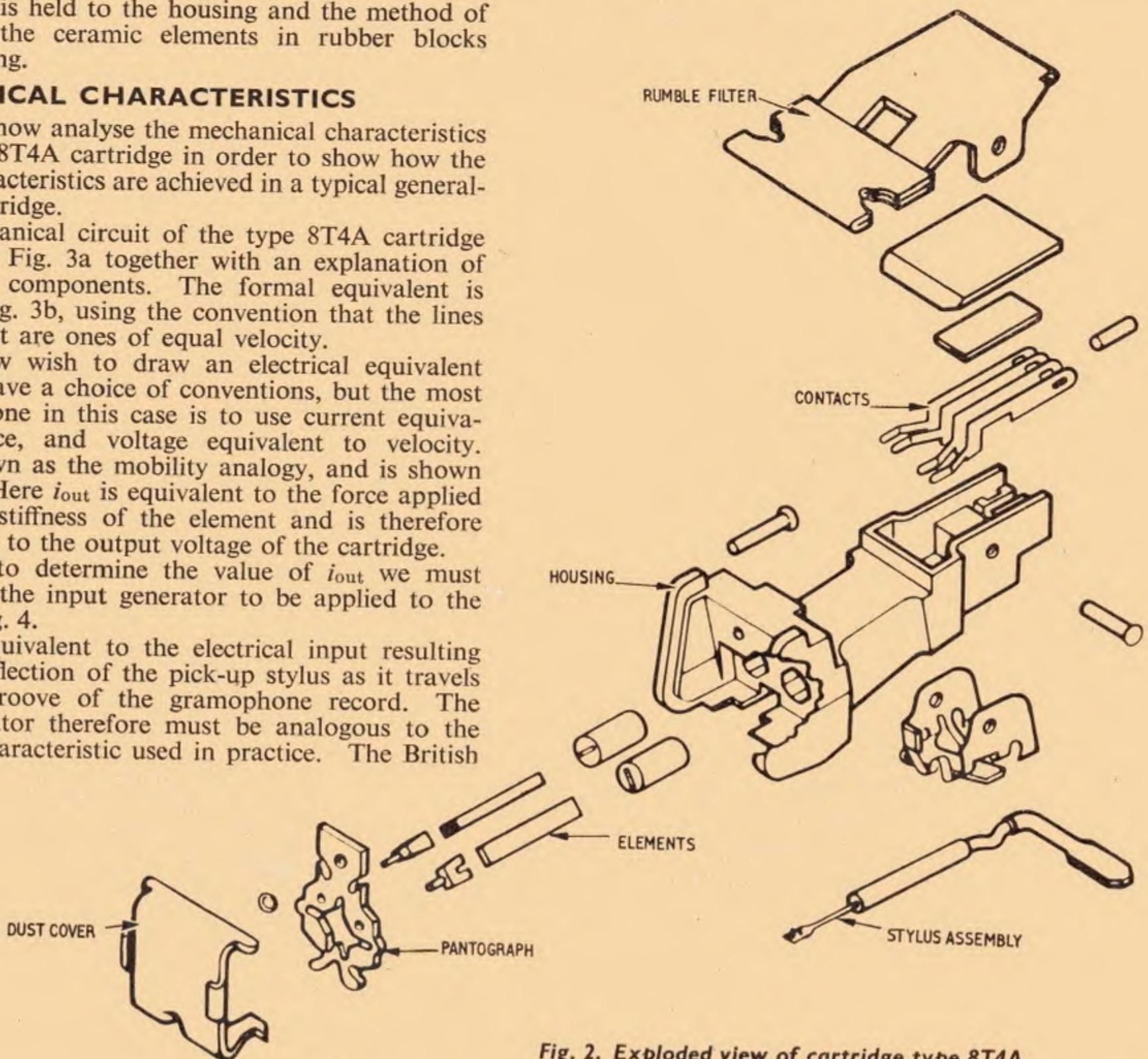
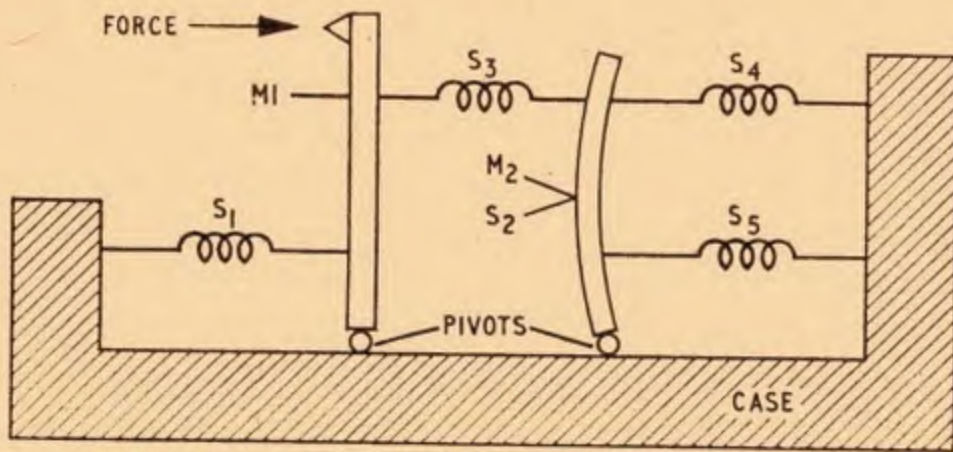
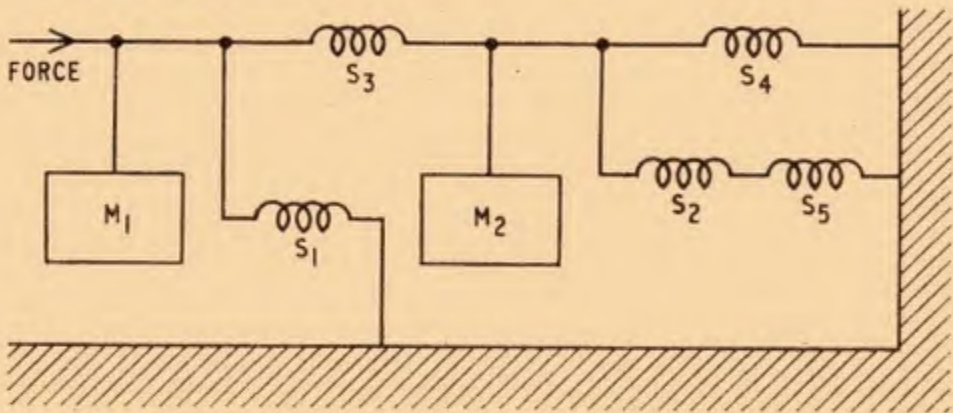

Fig. 2. Exploded view of cartridge type 8T4A





(a) Diagrammatic



(b) Formal

**Fig. 3. Mechanical circuits of cartridge type ST48**  
 $S_1$  Stylus shaft stiffness  $M_1$  Stylus shaft mass  
 $S_2$  Element stiffness  $M_2$  Element mass  
 $S_3$  Pantograph stiffness between stylus and element  
 $S_4$  Pantograph stiffness between element and support  
 $S_5$  Element clamp stiffness

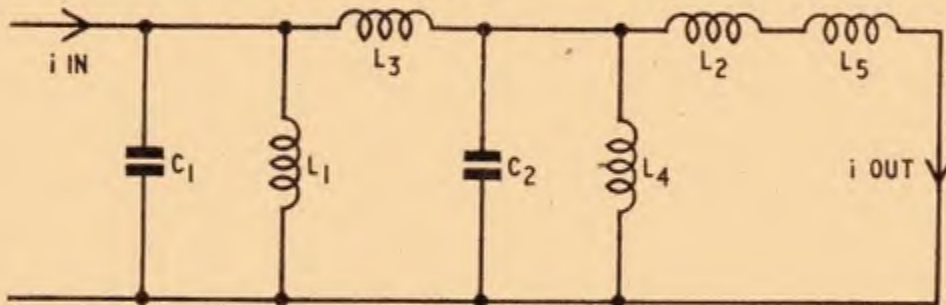

**Fig. 4. Electrical analogy of Fig. 3.**

Thus we have:

$$i_{out} = \frac{i_L L_4}{L_2 + L_4 + L_5}$$

and

$$i_L = \frac{V_0 f(\omega) \sin t}{(1 - \omega^2 L C_2) j \omega L_3 + j \omega L}$$

where

$$L = \frac{(L_2 + L_5) L_4}{L_2 + L_4 + L_5}$$

### CALCULATION OF VALUES

Referring to the mechanical circuit Fig. 3, we can measure the mechanical stiffness and weigh the elements. The dynamic mass of the element, since to a first approximation it is a beam pivoted at one end, is one-third the static mass. If we express the inverse

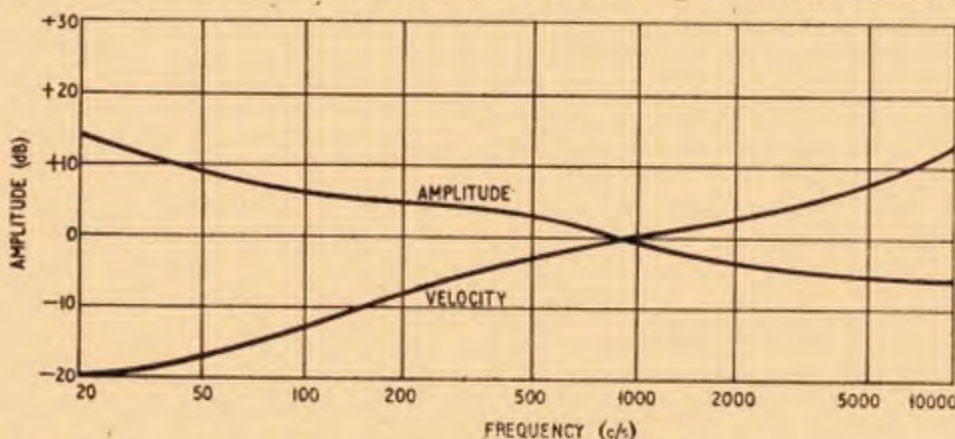

**Fig. 5. Recording characteristics to B.S. 1928**

stiffness, or compliance, in centimetres per dyne, and the mass in grams, then we can, in Fig. 7, set

$$L_{3e} = K C_{3m} = \frac{K}{S_{3m}} \quad C_{2e} = \frac{M_{2m}}{K}$$

$$L_{2e} = K C_{2m} = \frac{K}{S_{2m}}$$

where the suffix  $e$  refers to electrical components and  $m$  to mechanical components.

These relations preserve the equations

$$\omega^2 = \frac{1}{L_e C_e} = \frac{1}{M_m C_m}$$

The values of  $K$  and  $V_0 f(\omega)$  must be chosen such that  $i_{out}$  can be related to the cartridge output voltage for a given recording amplitude. We may set  $K = 1$ , and choose  $V_0 f(\omega)$  in the following way:

By selecting a suitable frequency we may neglect the component  $M_2$  in Fig. 3 and it can be shown that

$$V_{out} = \frac{k A N C}{(C_2 + C_5)(C + C_3)}$$

where

$$C = \frac{C_4(C_2 + C_5)}{C_2 + C_4 + C_5}$$

Here  $k$  is the leverage, expressed as a fraction less than one, between the pantograph and stylus movement,  $A$  is the recording amplitude and  $N$  is the volts per unit force of the element.

Inserting the measured values we obtain:  $V_{out} = 95mV$  at  $1kc/s$ ,  $1cm/sec$ , and this is close to the measured value. This value can now be used to set the vertical scale of the graph relating  $i_{out}$  with frequency. This graph is shown in Fig. 8 which compares the calculated response with the measured response.

Two regions of difference between the calculated and measured response can be seen.

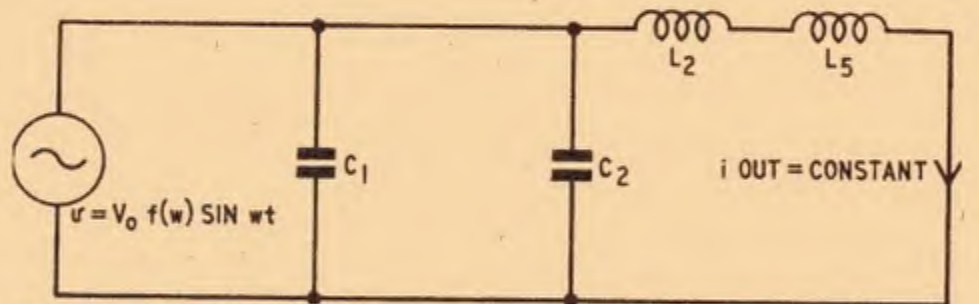

**Fig. 6. Simplified version of Fig. 4, giving constant current output**

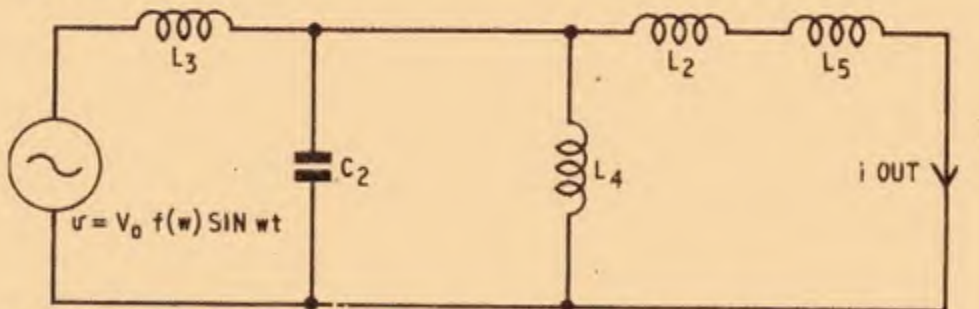

**Fig. 7. Overall equivalent circuit of practical case**

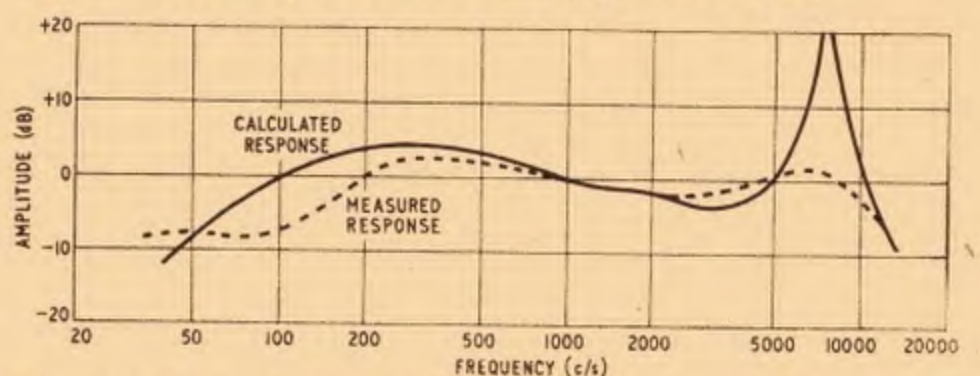
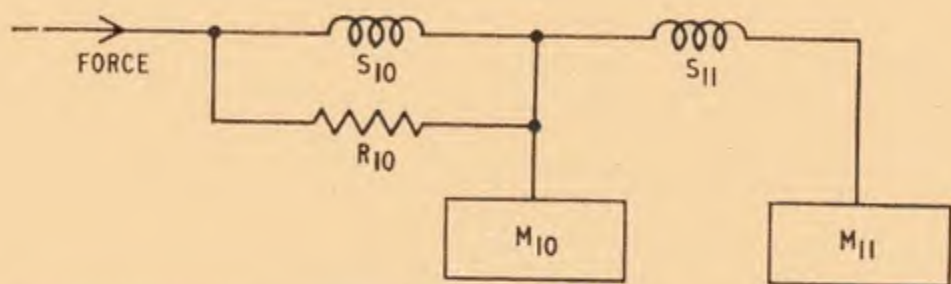

**Fig. 8. Comparison of calculated response with measured response**



1. *The high frequency region.* In the equivalent circuit under consideration no loss terms have been included. In practice, these have the effect of smoothing out the high frequency peak. In the 8T4A cartridge the additional high frequency damping is obtained by surrounding the elements with a silicone grease, inserted under pressure into the body of the cartridge.

2. *The low frequency region.* In this region there is a reduction in the output due to the action of the "rumble" filter. In order to simplify the analysis, the effect of this filter was ignored. In the 8T4A



(a) Mechanical circuit

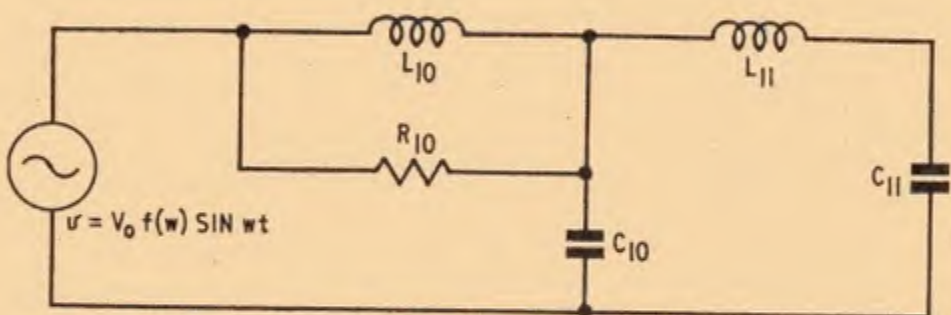

(b) Electrical analogy

Fig. 9. Equivalent circuit of rumble filter

- |                                  |                         |
|----------------------------------|-------------------------|
| $S_{10}$ Cartridge stiffness     | $M_{10}$ Cartridge mass |
| $S_{11}$ Rumble filter stiffness | $M_{11}$ Arm mass       |
| $R_{10}$ Stylus damping          |                         |

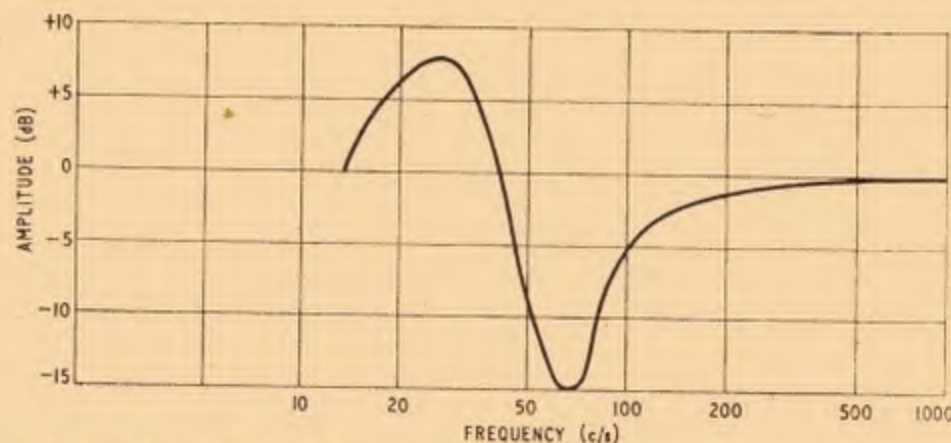

Fig. 10. Calculated frequency response of rumble filter

cartridge a resilient mounting bracket is used and this has the effect of reducing the output at low frequencies, for vertical movements of the stylus only. Thus, attenuation is provided of the voltage arising from unwanted low frequency movements of the turntable, i.e. "rumble".

Some attenuation of the wanted stereo signals is also experienced, as the movement of the element resulting from groove modulations contains a vertical as well as a horizontal component.

The effect of the rumble filter can be calculated in the same way as the main response, and the equivalent circuits are shown in Fig. 9 and the calculated response in Fig. 10. The electrical analogy of Fig. 9b has been proved by construction and measurement in the laboratory and has been used to predict the effect of design modifications.

The apparent peak at 20c/s in the rumble filter characteristic results from resonance of the stylus compliance and arm mass. Acoustically it has no significance as it is outside the normal passband of the reproducing system used with this class of cartridge.

In the case of the 9T series cartridge, higher compliance combined with a low mass arm ensures that the response is free from this effect down to very low frequencies, as can be seen in Fig. 1. ★

Your opportunity to gain experience  
of printed wiring boards

## NEXT MONTH'S PRACTICAL ELECTRONICS

Will include articles describing six  
simple electronic devices any one of  
which can be easily built on the

SMALL PRINTED WIRING BOARD

TO BE PRESENTED **FREE** WITH THE ISSUE

REMEMBER . . . . The April issue of PRACTICAL ELECTRONICS will be on sale March 11