

THE No 1 UK MAGAZINE FOR ELECTRONICS TECHNOLOGY & COMPUTER PROJECTS

EPE EVERYDAY PRACTICAL **ELECTRONICS**

www.epemag.co.uk

www.epemag.com

PIC DIGITAL GEIGER COUNTER



- * LCD Readout
- * USB Interface
- * Internal Real-Time Clock

PROGRAMMABLE ROBOT

Fully manoeuvrable with
programmable sound,
light sensing etc.

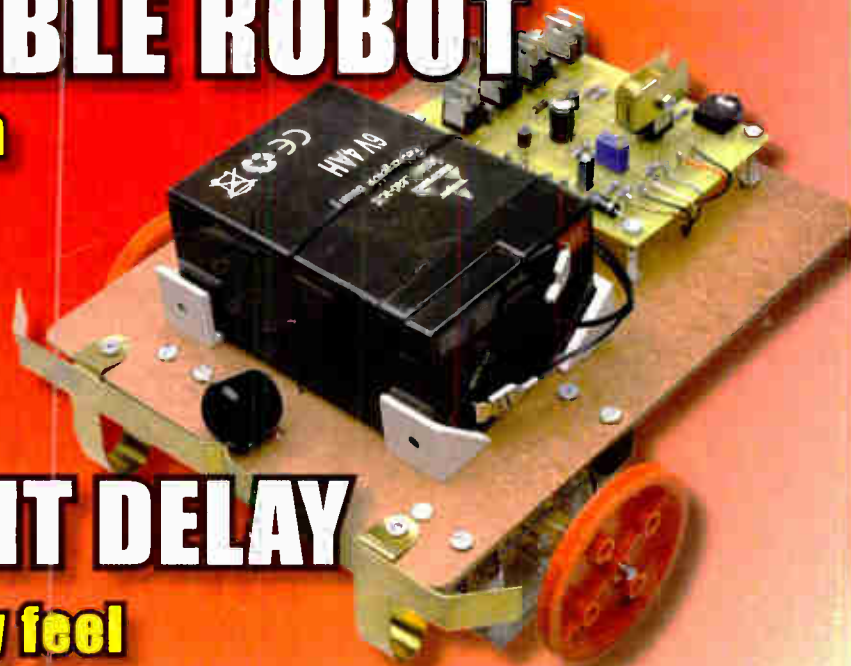

COURTESY LIGHT DELAY

Give your car that luxury feel

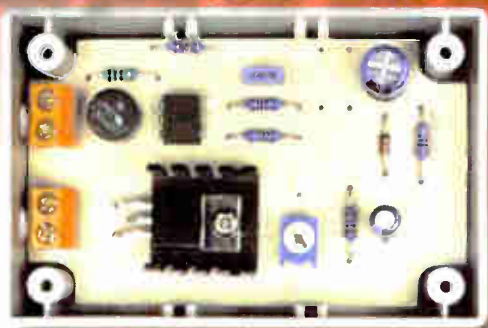

FEBRUARY 2007 £3.50



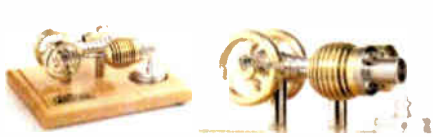

HB7 Stirling Engine

Base measurements: 128 mm x 108 mm x 170 mm, 1 kg
 Base plate: beech - Working rpm: 2000 rpm/min. (the engine has a aluminium good cooling Cylinder)
 Bearing application: 10 high-class ball-bearings
 Material: screw, side parts all stainless steel
 Cylinder brass. Rest aluminium and stainless steel.
 Available as a kit £80.75 or built £84.99
www.mamodspares.co.uk

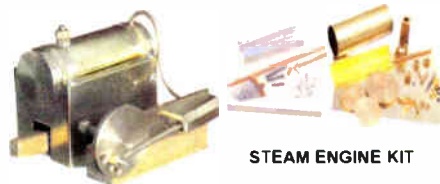

STEAM ENGINE KIT

Everything in the kit enables you to build a fully functional model steam engine. The main material is brass and the finished machine demonstrates the principle of oscillation. The boiler, uses solid fuel tablets, and is quite safe. All critical parts (boiler, end caps, safety vent etc.) are ready finished to ensure success. The very detailed instruction booklet (25 pages) makes completion of this project possible in a step by step manner. Among the techniques experienced are silver soldering, folding, drilling, fitting and testing. £29.70 ref STEAMKIT Silver solder/flux pack £3.50 ref SSK

www.mamodspares.co.uk

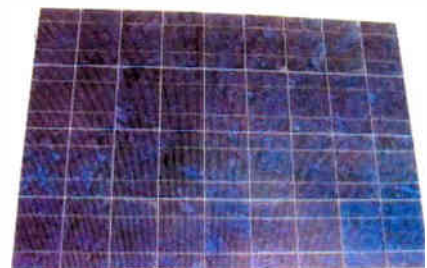

Solar Panels

We stock a range of solar photovoltaic panels. These are polycrystalline panels made from wafers of silicon laminated between an impact-resistant transparent cover and an EVA rear mounting plate. They are constructed with a lightweight anodised aluminium frame which is predrilled for linking to other frames/roof mounting structure, and contain waterproof electrical terminal box on the rear. 5 watt panel £29 ref 5wnav 20 watt panel £99 ref 20wnav 60 watt panel £249 ref 60wnav. Suitable regulator for up to 60 watt panel £20 ref REGNAV



HB9 Stirling engine

Base measurements: 156 mm x 108 mm x 130 mm, 0,6 Kg
 Base plate: beech Working rpm: approx. 2,000 min
 Bearing application: 6 high-class ball-bearings
 Material of the engine: brass, aluminium, stainless steel
 running time: 30-45 min.
 Available as a kit £97.75 or built £101.99
www.mamodspares.co.uk



HB14 Stirling Engine

Base measurements: 156 mm x 108 mm x 150 mm, 1 kg
 Base plate: beech Working rpm: 2000 - 2500 rpm/min, .
 Incl. drive-pulley for external drives Bearing application: 10 high-class ball-bearings Material: screw, side parts total stainless steel Cylinder brass Rest aluminium, stainless steel Available as a kit £140.25 or built £144.50
www.mamodspares.co.uk



HB10 Stirling Engine

Base measurements: 156 mm x 108 mm x 130 mm, 0,6 Kg
 Base plate: beech Working rpm: approx. 2,000 rpm
 Bearing application: 6 high-class ball-bearings
 Material of the engine: brass, aluminium, stainless steel
 running time: 30-45 min
 Available as a kit £97.75 or built £101.99
www.mamodspares.co.uk



HB15 Stirling Engine

Base measurements: 128 mm x 108 mm x 170 mm, 0,75 kg
 Base plate: beech Working rpm: 2000 rpm/min. (the engine has a aluminium good cooling Cylinder)
 Bearing application: 6 high-class ball-bearings
 Material: screw, side parts total stainless steel
 Cylinder brass Rest aluminium, stainless steel
 Available as a kit £97.75 or built £102
www.mamodspares.co.uk



HB11 Stirling Engine

Base measurements: 156 mm x 108 mm x 130 mm, 0,7 Kg
 Base plate: beech
 Working rpm: 2000 - 2500 rpm/min.run Bearing application: 4 high-class ball-bearings Material: screw, side parts total stainless steel Cylinder brass Rest aluminium, stainless steel.
 Available as a kit £97.75 or built £101.99
www.mamodspares.co.uk



HB16 Stirling Engine

Base measurements: 128 mm x 108 mm x 170 mm, 1 kg
 Base plate: beech Working rpm: 2000 rpm/min. (the engine has a aluminium good cooling Cylinder)
 Bearing application: 10 high-class ball-bearings
 Material: screw, side parts total stainless steel
 Cylinder brass Rest aluminium, stainless steel.
 Available as a kit £140.25 or built £144.50



HB12 Stirling Engine

Base measurements: 156 mm x 108 mm x 130 mm, 1 Kg
 Base plate: beech Working rpm: 2000 - 2500 rpm/min.Bearing application: 6 high-class ball-bearings
 Material: screw, side parts total stainless steel
 Cylinder brass Rest aluminium, stainless steel.
 Available as a kit £136 or built £140.25
www.mamodspares.co.uk



2kW WIND TURBINE KIT

The 2kW wind turbine is supplied as the following kit: turbine generator 48v three taper/ twisted fibreglass blades & hub 8m tower (four x 2m sections) guylines / anchors / tensioners / clamps foundation steel rectifier 2kW inverter heavy-duty pivot tower. £1,499

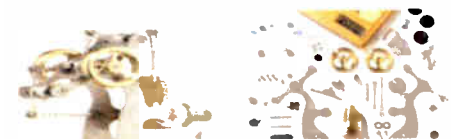

HB13 Stirling Engine

Base measurements: 156 mm x 108 mm x 150 mm, 0,75 kg
 Base plate: beech Working rpm: 2000 - 2500 rpm/min.
 Bearing application: 6 high-class ball-bearings Material: screw, side parts total stainless steel Cylinder brass
 Available as a kit £97.75 or built £101.99



Solar evacuated tube panels

(20 tube shown) These top-of-the-range solar panel heat collectors are suitable for heating domestic hot water, swimming pools etc - even in the winter! One unit is adequate for an average household (3-4people), and it is modular, so you can add more if required. A single panel is sufficient for a 200 litre cylinder, but you can fit 2 or more for high water usage, or for heating swimming pools or underfloor heating. Some types of renewable energy are only available in certain locations, however free solar heating is potentially available to almost every house in the UK! Every house should have one -really! And with an overall efficiency of almost 80%, they are much more efficient than electric photovoltaic solar panels (efficiency of 7-15%). Available in 10, 20 and 30 tube versions. 10 tube £199, 20 tube £369, 30 tube £549. Roof mounting kits (10/20 tubes) £12.50, 30 tube mounting kit £15



BENCH PSU 0-15V 0-2a Output
 and voltage are both smooth and can be regulated according to work, Input 230V, 21/2-number LCD display for voltage and current, Robust PC-grey housing Size 13x15x21cm, Weight 3,2kg £48 REF trans2

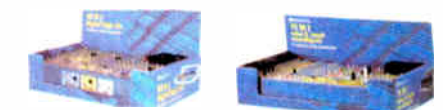

NEW ELECTRONIC CONSTRUCTION KITS

This 30 in 1 electronic kit includes an introduction to electrical and electronic technology. It provides components that can be used to make a variety of experiments including Timers and Burglar Alarms. Requires: 3 x AA batteries. £15.00 ref BET1803

AM/FM Radio This kit enables you to learn about electronics and also put this knowledge into practice so you can see and hear the effects. Includes manual with explanations about the components and the electronic principles. Req's: 3 x AA batts. £13 ref BET1801

This 40 in 1 electronic kit includes an introduction to electrical and electronic technology. It provides components that can be used in making basic digital logic circuits, then progresses to using Integrated circuits to make and test a variety of digital circuits, including Flip Flops and Counters. Req's: 4 x AA batteries. £17 ref BET1804

The 75 in 1 electronic kit includes an introduction to electrical and electronic technology. It provides components that can be used to make and test a wide variety of experiments including Water Sensors, Logic Circuits and Oscillators. The kit then progresses to the use of an integrated circuit to produce digital voice and sound recording experiments such as Morning Call and Burglar Alarm. Requires: 3 x AA batteries. £20 ref BET1806

www.slips.co.uk

BULL GROUP LTD
 UNIT D HENFIELD BUSINESS PARK
 HENFIELD SUSSEX BN5 9SL
 TERMS: C/ CARDS, CASH, PO, CHEQUE OR
 ONLINE ORDERING. PRICES PLUS VAT
 UK DELIVERY £5.50
 TEL 0870 7707520 FAX 01273 491813
sales@bullnet.co.uk

ISSN 0262 3617

PROJECTS ... THEORY ...
NEWS ... COMMENT ...
POPULAR FEATURES ...

VOL. 36. No. 2 FEBRUARY 2007

EPE EVERYDAY PRACTICAL ELECTRONICS

INCORPORATING ELECTRONICS TODAY INTERNATIONAL

www.epemag.co.uk

EPE Online: www.epemag.com



Projects and Circuits

- PIC DIGITAL GEIGER COUNTER** by Robert Lane and Steve Thompson
With LCD readout and USB interface 11
- COURTESY LIGHT DELAY** by John Clarke
Universal circuit fits all vehicles 26
- PROGRAMMABLE ROBOT** by Thomas Scarborough
Bump and respond; random motion; programmable sound; light sensing 44
- INGENUITY UNLIMITED – Sharing your ideas with others**
Alternating LED Flasher 54
- CHARGER FOR DEEP-CYCLE 12V BATTERIES – PART 2** by John Clarke
A 16A, 3-step PIC controlled design 58

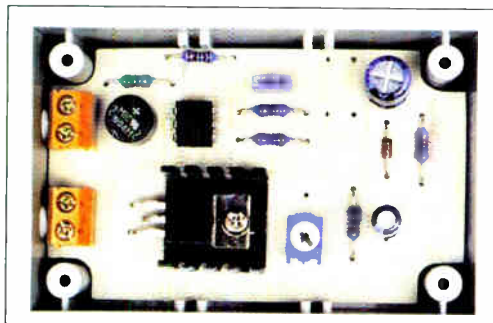

Series and Features

- TECHNO TALK** by Mark Nelson
Soldering Schadenfreude 10
- PIC N' MIX** by Keith Anderson
Implementing a software PLL for serious users of PICs – Part 2 24
- INTERFACE** by Robert Penfold
Improved Visual BASIC controls 32
- C FOR PICs – Part 4** by Mike Hibbett
A practical implementation of using C for USB control of LCDs 34
- CIRCUIT SURGERY** By Ian Bell
Line level – What it is 56
- NET WORK – THE INTERNET PAGE** surfed by Alan Winstanley
More Internet Explorer tips; Don't print it – PDF it! How to shop online smoothly 73

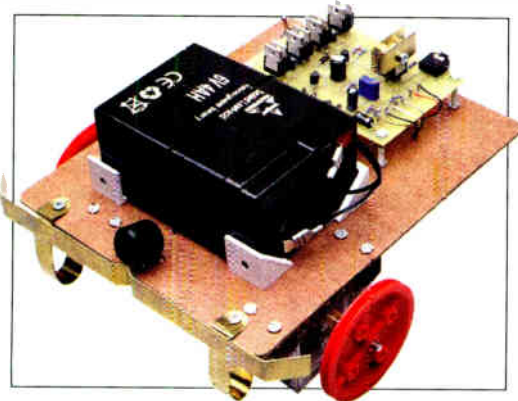

Regulars and Services

- EDITORIAL** 7
- NEWS** – Barry Fox highlights technology's leading edge
Plus everyday news from the world of electronics 8
- PIC RESOURCES CD-ROM** 21
EPE PIC Tutorial V2, plus PIC Toolkit Mk3 and a selection of PIC-related articles
- SUBSCRIBE TO EPE** and save money 22
- CD-ROMS FOR ELECTRONICS** 40
A wide range of CD-ROMs for hobbyists, students and engineers
- BACK ISSUES** 52
Did you miss these?
- ELECTRONIC MANUALS** 70
The *Modern Electronics Manual* and *Electronics Service Manual* on CD-ROM
- READOUT** John Becker addresses general points arising 71
- DIRECT BOOK SERVICE** 74
A wide range of technical books available by mail order, plus more CD-ROMs
- PIC PROJECTS** 77
A plethora of PIC projects on CD-ROM
- EPE PCB SERVICE** 78
PCBs for EPE projects
- ADVERTISERS' INDEX** 80



© Wimborne Publishing Ltd 2007. Copyright in all drawings, photographs and articles published in *EVERYDAY PRACTICAL ELECTRONICS* is fully protected, and reproduction or imitations in whole or in part are expressly forbidden.

Our March 2007 issue will be published on Thursday, 8 February 2007, see page 80 for details.

Readers' Services • Editorial and Advertisement Departments 7



08717 Credit Card Sales 177 168

PIC & ATMEL Programmers

We have a wide range of low cost PIC and ATMEL Programmers. Complete range and documentation available from our web site.

Programmer Accessories:

40-pin Wide ZIF socket (ZIF40W) £15.00
18Vdc Power supply (PSU010) £19.95
Leads: Parallel (LDC136) £4.95 / Serial (LDC441) £4.95 / USB (LDC644) £2.95

NEW! USB & Serial Port PIC Programmer



USB/Serial connection. Header cable for ICSP. Free Windows XP software. See website for PICs supported. ZIF Socket and USB lead extra. 18Vdc.

Kit Order Code: 3149KT - £37.95

Assembled Order Code: AS3149 - £49.95

NEW! USB 'All-Flash' PIC Programmer

USB PIC programmer for all 'Flash' devices. No external power supply making it truly portable. Supplied with box and Windows XP Software. ZIF Socket and USB lead not incl.



Assembled Order Code: AS3128 - £44.95

Assembled with ZIF socket Order Code: AS3128ZIF - £59.95

'PICALL' ISP PIC Programmer



Will program virtually all 8 to 40 pin serial-mode AND parallel-mode (PIC15C family) PIC microcontrollers. Free Windows software. Blank chip auto detect for super fast bulk programming. Optional ZIF socket.

Assembled Order Code: AS3117 - £24.95

Assembled with ZIF socket Order Code: AS3117ZIF - £39.95

ATMEL 89xxx Programmer

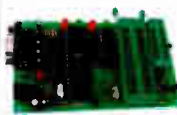

Uses serial port and any standard terminal comms program. 4 LED's display the status. ZIF sockets not included. Supply: 16Vdc.

Kit Order Code: 3123KT - £24.95

Assembled Order Code: AS3123 - £34.95

Introduction to PIC Programming

Go from complete beginner to burning a PIC and writing code in no time! Includes 49 page step-by-step PDF Tutorial Manual, Programming Hardware (with LED test section), Win 3.11—XP Programming Software (Program, Read, Verify & Erase), and 1rewritable PIC16F84A that you can use with different code (4 detailed examples provided for you to learn from). PC parallel port.



Kit Order Code: 3081KT - £16.95

Assembled Order Code: AS3081 - £24.95

ABC Maxi AVR Development Board

The ABC Maxi is ideal for developing new designs. Open architecture built around an ATMEL AVR AT90S8535 microcontroller. All circuits are embedded within the package and additional add-on expansion modules are available to assist you with project development.

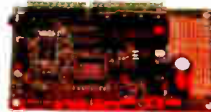

Features

8 Kb of In-System Programmable Flash (1000 write/erase cycles) • 512 bytes internal SRAM • 512 bytes EEPROM • 8 analogue inputs (range 0-5V) • 4 Opto-isolated Inputs (I/Os are bi-directional with internal pull-up resistors) • Output buffers can sink 20mA current (direct LED drive) • 4 x 12A open drain MOSFET outputs • RS485 network connector • 2-16 LCD Connector • 3.5mm Speaker Phone Jack • Supply: 9-12Vdc

The ABC Maxi STARTER PACK includes one assembled Maxi Board, parallel and serial cables, and Windows software CD-ROM featuring an Assembler, BASIC compiler and in-system programmer.

Order Code ABCMAXISP - £89.95

The ABC Maxi boards only can also be purchased separately at £69.95 each.

Controllers & Loggers

Here are just a few of the controller and data acquisition and control units we have. See website for full details. Suitable PSU for all units: Order Code PSU445 £8.95

Rolling Code 4-Channel UHF Remote

State-of-the-Art. High security. 4 channels. Momentary or latching relay output. Range up to 40m. Up to 15 Tx's can be learnt by one Rx (kit includes one Tx but more available separately). 4 indicator LED 's. Rx: PCB 77x85mm, 12Vdc/6mA (standby). Two & Ten Channel versions also available. Kit Order Code: 3180KT - £44.95
Assembled Order Code: AS3180 - £51.95



Computer Temperature Data Logger



Serial port 4-channel temperature logger. °C or °F. Continuously logs up to 4 separate sensors located 200m+ from board. Wide range of free software applications for storing/using data. PCB just 38x38mm. Powered by PC. Includes one DS1820 sensor and four header cables. Kit Order Code: 3145KT - £18.95
Assembled Order Code: AS3145 - £25.95
Additional DS1820 Sensors - £3.95 each

DTMF Telephone Relay Switcher

Call your phone number using a DTMF phone from anywhere in the world and remotely turn on/off any of the 4 relays as desired.



User settable Security Password, Anti-Tamper, Rings to Answer, Auto Hang-up and Lockout. Includes plastic case. 130 x 110 x 30mm. Power: 12Vdc.

Kit Order Code: 3140KT - £46.95

Assembled Order Code: AS3140 - £59.95

Serial Port Isolated I/O Relay Module



Computer controlled 8 channel relay board. 5A mains rated relay outputs and 4 opto-isolated digital inputs (for monitoring switch states, etc).

Useful in a variety of control and sensing applications. Programmed via serial port (use our new Windows interface, terminal emulator or batch files). Serial cable can be up to 35m long. Once programmed, unit can operate without PC. Includes plastic case 130x100x30mm. Power: 12Vdc/500mA.

Kit Order Code: 3108KT - £54.95

Assembled Order Code: AS3108 - £64.95

Infrared RC 12-Channel Relay Board



Control 12 onboard relays with included infrared remote control unit. Toggle or momentary. 15m+ range. 112 x 122mm. Supply: 12Vdc/0.5A

Kit Order Code: 3142KT - £47.95

Assembled Order Code: AS3142 - £59.95

PC / Standalone Unipolar Stepper Motor Driver

Drives any 5, 6 or 8-lead unipolar stepper motor rated up to 6 Amps max. Provides speed and direction control. Operates in stand-alone or PC-controlled mode. Up to six 3179 driver boards can be connected to a single parallel port. Supply: 9Vdc. PCB: 80x50mm. Kit Order Code: 3179KT - £11.95
Assembled Order Code: AS3179 - £18.95



Bi-Polar Stepper Motor Driver also available (Order Code 3158 - details on website)

DC Motor Speed Controller (100V/7.5A)



Control the speed of almost any common DC motor rated up to 100V/7.5A. Pulse width modulation

output for maximum motor torque at all speeds. Supply: 9-18Vdc. Box supplied. Dimensions (mm): 60Wx100Lx60H. Kit Order Code: 3067KT - £13.95
Assembled Order Code: AS3067 - £19.95

Bidirectional DC Motor Driver also available (Order Code 3166 - details on website)

Most items are available in kit form (KT suffix) or pre-assembled and ready for use (AS prefix).

Hot New Kits This Summer!

Here are a few of the most recent kits added to our range. See website or join our email Newsletter for all the latest news.

EPE Ultrasonic Wind Speed Meter



Solid-state design wind speed meter (anemometer) that uses ultrasonic techniques and has no moving parts and

does not need calibrating. It is intended for sports-type activities, such as track events, sailing, hang-gliding, kites and model aircraft flying, to name but a few. It can even be used to monitor conditions in your garden. The probe is pointed in the direction from which the wind is blowing and the speed is displayed on an LCD display.

Specifications

- Units of display: metres per second, feet per second, kilometres per hour and miles per hour
- Resolution: Nearest tenth of a metre
- Range: Zero to 50mph approx.

Based on the project published in Everyday Practical Electronics, Jan 2003. We have made a few minor design changes (see website for full details). Power: 9Vdc (PP3 battery). Main PCB: 50x83mm. Kit Order Code: 3168KT - **£36.95**

Audio DTMF Decoder and Display

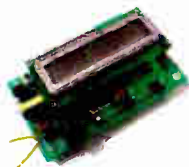

Detects DTMF tones via an onboard electret microphone or direct from the phone lines through an audio transformer. The numbers are displayed on a 16

character, single line display as they are received. Up to 32 numbers can be displayed by scrolling the display left and right. There is also a serial output for sending the detected tones to a PC via the serial port. The unit will not detect numbers dialled using pulse dialling. Circuit is microcontroller based. Supply: 9-12V DC (Order Code PSU445). Main PCB: 55x95mm.

Kit Order Code: 3153KT - **£20.95**

Assembled Order Code: AS3153 - **£29.95**

EPE PIC Controlled LED Flasher

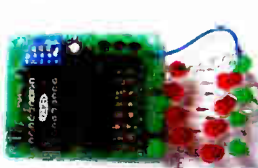

This versatile PIC based LED or filament bulb flasher can be used to flash from 1 to 176

LEDs. The user arranges the LEDs in any pattern they wish. The kit comes with 8 super bright red LEDs and 8 green LEDs. Based on the Versatile PIC Flasher, EPE Magazine Dec 02. See website for full details. Board Supply: 9-12Vdc. LED supply: 9-45Vdc (depending on number of LED used). PCB: 43x54mm. Kit Order Code: 3169KT - **£11.95**

Most items are available in kit form (KT suffix) or assembled and ready for use (AS prefix).

FM Bugs & Transmitters

Our extensive range goes from discreet surveillance bugs to powerful FM broadcast transmitters. Here are a few examples. All can be received on a standard FM radio and have adjustable transmitting frequency.

MMTX' Micro Miniature 9V FM Room Bug



Our best selling bug! Good performance. Just 25x15mm. Sold to detective agencies worldwide. Small enough to hide just about anywhere. Operates at the 'less busy' top

end of the commercial FM waveband and also up into the more private Air band.

Range: 500m. Supply: PP3 battery.

Kit Order Code: 3051KT - **£8.95**

Assembled Order Code: AS3051 - **£14.95**

HPTX' High Power FM Room Bug

Our most powerful room bug.

Very impressive performance. Clear and stable out-

put signal thanks to the extra

circuitry employed. Range:

1000m @ 9V. Supply: 6-12V

DC (9V PP3 battery clip supplied). 70x15mm.

Kit Order Code: 3032KT - **£9.95**

Assembled Order Code: AS3032 - **£17.95**

MMTX' Miniature Telephone Transmitter



Attach anywhere along phone line. Tune a radio into the signal and hear exactly what both parties are saying. Transmits only

when phone is used. Clear, stable signal.

Powered from phone line so completely

maintenance free once installed. Requires no

aerial wire - uses phone line as antenna

Suitable for any phone system worldwide.

Range: 300m. 20x45mm.

Kit Order Code: 3016KT - **£7.95**

Assembled Order Code: AS3016 - **£13.95**

Wide Band Synthesised FM Transmitter



PLL based crystal-locked wide band FM transmitter delivering a high quality, stable 10mW output. Accepts both MIC audio signal (10mV) and LINE input (1v p-p) for example

hi-fi, CD, audio mixer (like our kit 1052) or

computer sound card. Supply: 9-15Vdc.

Kit Order Code: 3172KT - **£19.95**

Assembled Order Code: AS3172 - **£32.95**

3 Watt FM Transmitter



Small, powerful FM transmitter. Audio pre-amp stage and three RF stages deliver 3 watts of RF power. Use with the

electret microphone supplied or any line level

audio source (e.g. CD or tape OUT, mixer,

sound card, etc). Aerial can be an open di-

pole or Ground Plane. Ideal project for the

novice wishing to get started in the fascin-

ating world of FM broadcasting. 45x145mm.

Kit Order Code: 1028KT - **£23.95**

Assembled Order Code: AS1028 - **£31.95**



QUASAR
electronics
Get Plugged In!

**Credit
Card
Sales
0871
717
7168**

Electronic Project Labs

Great introduction to the world of electronics. Ideal gift for budding electronics expert!

500-in-1 Electronic Project Lab

Top of the range. Complete self-contained electronics course. Takes you from beginner to 'A' level standard and beyond!

Contains all the hardware

and manuals to assemble

500 projects. You get 3

comprehensive course

books (total 368 pages) - *Hardware Entry*

Course, *Hardware Advanced Course* and a

microprocessor based *Software Program-*

ming Course. Each book has individual circuit

explanations, schematic and connection dia-

grams. Suitable for age 12+.

Order Code EPL500 - **£149.95**

Also available - 30-in-1 **£15.95** 130-in-1

£37.95 & 300-n-1 **£59.95** (details on website)



Tools & Test Equipment

We stock an extensive range of soldering tools, test equipment, power supplies, inverters & much more - please visit website to see our full range of products.

Precision Digital Multimeter (4.5 Digit)



A highly featured, high-precision digital multimeter with a large 4.5 digit LCD display. High accuracy (0.05%). Auto-zeroing, polarity selection and over-range indication. Supplied complete with shrouded test leads, shock-proof rubber holster, built-in probe holder and stand. Supplied fully assembled with holster,

battery and presentation box. Features include:

Capacitance • Audio Frequency • Data Hold • hFE / Diode Test • Auto Power Off

Technical Specifications

DC voltage: 200mV-1000V • AC voltage: 2V-700V • DC current: 2mA-20A • AC current: 20mA-20A • Resistance: 200Ω-200MΩ • Capacitance: 2nF-20μF • Frequency: 20kHz • Max display 19999

Order Code: MM463 - Was **£44.95** Now on sale at just **£29.95!**

See our website for more special offers!



www.QuasarElectronics.com

Secure Online Ordering Facilities • Full Product Listing, Descriptions & Photos • Kit Documentation & Software Downloads

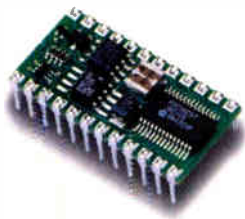

BS2-IC



BS2-SX

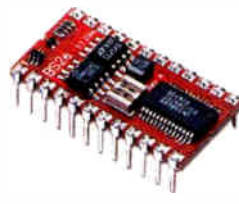

BS2E-IC



BS2P/24



BS2P/40

Parallax BASIC Stamps - still the easy way to get your project up and running!

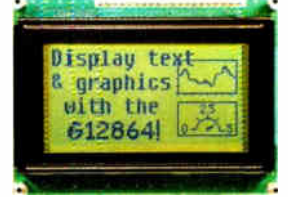

Serial Alphanumeric and Graphic Displays, Mini-Terminals and Bezel kits

www.milinst.com



Animated Head



3-Axis Machine

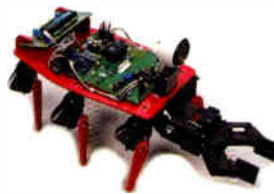

Six-Legged Walkers



Robotic Arms



Bipeds

Robotic models for both the beginner and the advanced hobbyist

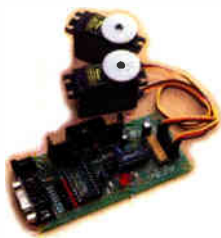

Servo Drivers

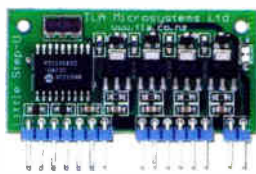

Motor Drivers



On-Screen Displays



DMX Protocol

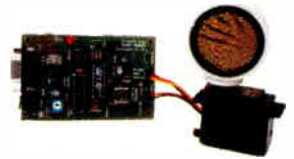

U/Sound Ranging

Animatronics and Specialist Interface-Control Modules



Quadravox MP3 & Speech Systems



SensoryInc Voice Recognition

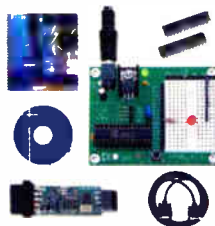

Parallax Ubicom Tool Kits



Tech-Tools PIC & Rom Emulators



BASICMicro PIC BASIC Compilers

Development Tools

Milford Instruments Limited Tel 01977 683665, Fax 01977 681465, sales@milinst.com

EPE PROJECT PICs

Programmed PICs for EPE Projects
 12C508/9-£3.90; 16F627/8 - £4.90
 16F84/71/ - £5.90
 16F876/877/ 18Fxxxx - £10.00
 All inc. VAT and Postage

1kV/500V Insulation Tester



Super design. Regulated output and efficient circuit. Dual scale meter, compact case. Reads up to 200 Megohms. Kit includes wound ferrite transformer, drilled and punched case, meter scale, PCB & ALL components. (Needs PP3 battery).

KIT 848...£32.95

DUAL OUTPUT TENS UNIT

An excellent kit for this project based on the EPE March'97 Design. Our Full Kit includes all components, hardware and an improved Magenta pcb. All hardware and electrodes are included. Designed for simple assembly and testing, providing a high level controlled dual output drive.

KIT 866 .. £32.90

Inc. 4 electrodes

Set of 4 Spare
 Electrodes £6.50

EPE MICROCHIP P.I.

Treasure Hunter

Stable Sensitive Pulse Induction detector. Easy to build and use. No ground effect - works in sea water. Detects Gold Silver, ferrous and non ferrous metals.

KIT 847 ... £63.95

Kit Includes Head-phones, coil and all Hardware

Ultrasonic PEST Scarers

Two Ultrasonic PEST Scarers. Kit 812 produces regular high level pulses of 32kHz. Kit 867 produces Random pulses and can work with an optional slave unit to give two separate ultrasound sources. Both kits need 9V supply.

Kit 812 ... £14.81 psu . 3.99

Kit 867 ... £19.99 867Slave £12.51

MOSFET MKII Bench PSU

0-25V 2.5A

Based on Mk1 design, with switching pre-regulator for high efficiency. Panel meters for A and V. Toroidal transformer. Variable Volts 0 - 25 AND Variable Current limit from 0 - 2.5A

Kit includes punched and labelled case. A classic and essential piece of test gear

Kit 845 ... £64.95



68000 Trainer Kit 621.. 99.95

Stepping & DC Motors

A range of motors for many applications:

Visit our website for more details

MD100 100 step Unipolar.... £9.99

MD200 200 step Unipolar.... £12.99

MD24 Type '23' size 200 step..£22.95

MAGENTA BRAINIBOT I & II

• Full kit with ALL hardware and electronics.

• As featured in EPE Feb '03 (KIT 910)

• Seeks light, beeps, and avoids obstacles

• Spins and reverses when 'cornered'

• Uses 8 pin PIC chip

• ALSO KIT 911 - As 910 PLUS programmable from PC serial port

leads and software CD included.

BRAINIBOT



KIT910..£16.99

KIT911..£24.99

PIC PIPE DESCALER

- SIMPLE TO BUILD
- SWEEP FREQUENCY OUTPUT
- HIGH POWER
- AUDIO & VISUAL MONITORING

An affordable circuit which sweeps the incoming water supply with varying frequency electromagnetic signals. May reduce scale formation, dissolve existing scale and improve the way salts in the water behave.

Kit includes case PCB coupling coil and all components.

High coil current ensures maximum effect. LED and piezo monitor.

PIC WATER DESCALER



KIT 868 .. £22.95 PSU £3.99

12V EPROM ERASER

A safe low cost eraser for up to 4 EPROMs or other UV erasable windowed devices at a time in 20 minutes.

Operates from a 12 Volt supply (400mA). Ideal for mobile work -and in educational applications where mains voltages are to be avoided. Safety interlock prevents contact with UV.

KIT 790 £29.90

PIC LCD DISPLAY DRIVER

16 Character x 2 Line display, pcb, programmed PIC16F84, software disk and all components to experiment with standard intelligent alphanumeric displays.

Includes full PIC source code which can be changed to match your application.

• Learn how to drive the display and write your own code.

• Ideal development base for meters, calculators, counters, timers --- just waiting for your application

• Top quality display with industry standard driver, data and instructions

KIT 860.£19.99

PIC STEPPING MOTOR DRIVER

PCB with components and PIC16F84 programmed with demonstration software to drive any 4 phase unipolar motor up to 24 Volts at 1 Amp. **Kit includes 100 Step Hybrid Stepping Motor** Full software source code supplied on disc. Use this project to develop your own applications. PCB allows 'simple PIC programmer' SEND' software to be used to reprogram chip.

KIT 863.....£18.99

8 CHANNEL DATA LOGGER

From Aug/Sept '99 EPE. Featuring 8 analogue inputs and serial data transfer to PC. Magenta redesigned PCB - LCD plugs directly onto board. Use as Data Logger or as a test bed for developing other PIC16F877 projects. Kit includes lcd, programmed chip, PCB, Case, all parts and 8 x 256k EEPROMs

KIT 877.....£49.95

SUPER PIC PROGRAMMER

Magenta's original parallel port programmer. Runs with downloaded WINDOWS 95 - XP software. Use standard Microchip HEX files. Read/Prog/Verify wide range of 18,28, and 40 pin PICs. Including 16F84/876/877, 627/8, (Inc. 'A' versions) + 16xx OTPs.

KIT 862. £29.99 Power Supply £3.99

ICEBREAKER

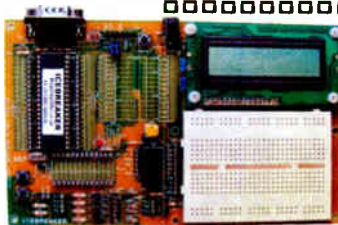

PIC Real Time In-Circuit Emulator

With serial lead & software disk, PCB, Breadboard, PIC16F877, LCD, all components and patch leads.

KIT 900..£34.99 PSU £3.99

ICEbreaker uses PIC16F877 in-circuit debugger functions.

• Featured in EPE Mar'00 Ideal for beginners & experienced users. Windows (95 to XP) Software included

20W Stereo Amp.

EPE May '05 -- Magenta Stereo/Mono Module

Wide band Low distortion 11W / channel Stereo 20W Mono. True (rms) Real Power

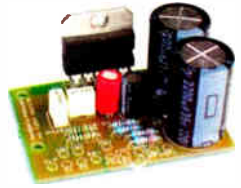

Short Circuit & Overheat Protected. Needs 8 to 18V supply.

Latest Technology - Stable, Reliable, high performance IC with local feedback.

KIT 914 £11.90

(includes all parts & heatsink for stereo or mono)

Magenta BrainiBorg

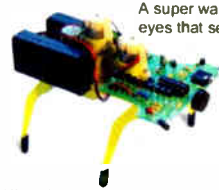

A super walking programmable robot with eyes that sense obstacles and daylight.

BrainiBorg comes with PC software CD (WIN95 & XP) with illustrated construction details, and can be programmed to walk and respond to light and obstacles on any smooth surface.

Kit includes all hardware, components, & 3 motor/gearboxes Uses 4 AA batteries (not supplied).

KIT 912 ... £29.99

KIT 913 ... £38.95

(Kit with CD Rom & Serial Lead)
 (As 912 but Built & Tested Circuit board)

EPE PIC Toolkit 3

As in EPE Apr/May/Jun '03 and on PIC Resources CD

- Magenta Designed Toolkit 3 board with printed component layout, green solder mask, places for 8,18, 28 (wide and slim), and 40 pin PICs. and many Magenta extras. Also runs with WinPic800 prog. Software.
- 16 x 2 LCD, PIC chip all parts and sockets included.
- Follow John Becker's excellent 'PIC tutorial 2' series.

KIT 880 ... £34.99 (With 16F84 Chip)

KIT 880 ... £39.99 (With 16F877 Chip)

OR - Built & Tested £49.99 & £55.99

EPE TEACH-IN 2004

COMPLETE 12 PART SERIES FROM NOV03 listed in 'misc.' Section (less RF modules, Lock, and Motor/g.box)

All parts to follow this Educational Electronics Course. Inc. Breadboard, and wire, as listed on p752 Nov 03'

KIT921.£12.99

KIT920..£29.99

Reprints £1.00 per part.

BAT DETECTORS

Magenta's Super Heterodyne Bat detectors. Our best selling kit 861 now includes a drilled case and front panel label. The MkIib and digital MkIII are supplied built & ready to go

KIT 861 .. £37.99

MkIib .. £49.95

Soft Zip Up Pouch for all 3...£5.99

MkIII .. £89.95

All Prices include VAT, Add £3.00 P&P per order, or £7.99 for next day.

Chqs. P.O. & Most major cards accepted.

See our Website for many more kits, products, & Secure On Line ordering.

Mail Order Only.

MAGENTA

ELECTRONICS LTD

135 Hunter Street Burton on Trent

Staffs DE14 2ST UK

email: sales@magenta2000.co.uk

www.magenta2000.co.uk

Tel: 01283 565435

Fax: 01283 546932

4000 Series	74HC153	£0.30	74LS244	£0.41	NE5532N	£0.48	L296	£4.42	Thyristors	BC179	£0.15	BF245B	£0.40	ZTX651	£0.39
4000B	£0.27	74HC154	£0.94	74LS245	£0.45	NE5534N	£0.54	L387A	£2.72	BC182B	£0.19	BF257	£0.37	ZTX653	£0.37
4001B	£0.16	74HC157	£0.22	74LS247	£0.22	NE5539N	£4.35	LM129-0CT5	£0.75	BC182C	£0.19	BF259	£0.33	ZTX689B	£0.40
4002B	£0.19	74HC158	£0.23	74LS252	£0.24	OP07	£0.80	LM129-1ZL	£0.25	BC183J	£0.65	BF337	£0.40	ZTX690B	£0.37
4008B	£0.23	74HC160	£0.64	74LS257	£0.24	OP27	£2.33	LM317T	£0.30	BC184	£0.36	BF422	£0.15	ZTX705	£0.39
4009UB	£0.24	74HC161	£0.27	74LS258	£0.24	OP90GP	£2.91	LM317K	£2.20	BC184L	£0.30	BF423	£0.12	ZTX750	£0.25
4010B	£0.23	74HC162	£0.45	74LS266	£0.14	OP97FP	£1.84	LM323K	£2.40	BC206B	£0.49	BF459	£0.33	ZTX751	£0.34
4011B	£0.16	74HC163	£0.26	74LS273	£0.32	OP113GP	£3.44	LM334Z	£0.96	BC208	£0.66	BF469	£0.72	ZTX753	£0.40
4012B	£0.16	74HC164	£0.23	74LS279	£0.24	OP176GP	£2.09	LM337T	£2.09	BC208B	£0.66	BF479	£0.72	ZTX790A	£0.41
4013B	£0.18	74HC165	£0.21	74LS283	£0.47	OP177GP	£2.18	LM338K	£2.18	BC212L	£0.51	BF484	£0.09	ZTX790B	£0.41
4014B	£0.30	74HC173	£0.38	74LS365	£0.21	OP200GP	£5.60	LM338T	£5.60	BC213J	£0.10	BF485	£0.33	ZTX851	£0.50
4015B	£0.27	74HC174	£0.27	74LS367	£0.21	OP213GP	£5.20	LM373	£5.20	BC214	£0.50	BF488	£0.27	ZTX853	£0.50
4016B	£0.20	74HC175	£0.35	74LS368	£0.21	OP275GP	£2.57	LM390	£2.57	BC225	£0.50	BF490	£0.10	ZTX931	£0.54
4017B	£0.20	74HC193	£0.39	74LS373	£0.39	OP282GP	£2.27	LM390CZ5	£2.27	BC225A	£0.50	BF511	£0.22	ZTX1048A	£0.48
4018B	£0.29	74HC195	£0.32	74LS374	£0.38	OP283GP	£5.20	REF100	£5.20	BC237B	£1.00	BF512	£0.24	ZTX1051A	£0.46
4019B	£0.25	74HC240	£0.32	74LS377	£0.62	OP290GP	£4.28	REF195GP	£3.04	BC238B	£1.20	BS107	£0.24	ZTX1053A	£0.45
4020B	£0.25	74HC241	£0.37	74LS390	£0.34	OP297GP	£4.64	TL431CP	£1.14	BC261B	£0.76	BS170	£0.15		
4021B	£0.31	74HC244	£0.40	74LS393	£0.33	OP400GP	£1.81		£1.81	BC262B	£0.96	BU208A	£0.30		
4022B	£0.32	74HC245	£0.34	74LS395	£0.26	OP495GP	£8.69		£8.69	BC267B	£0.93	BU208A	£0.30		
4023B	£0.23	74HC251	£0.25							BC267B	£0.93	BU208A	£0.30		
4024B	£0.22	74HC253	£0.25							BC267B	£0.93	BU208A	£0.30		
4025B	£0.20	74HC257	£0.25							BC267B	£0.93	BU208A	£0.30		
4026B	£0.67	74HC259	£0.29							BC267B	£0.93	BU208A	£0.30		
4027B	£0.21	74HC273	£0.32							BC267B	£0.93	BU208A	£0.30		
4028B	£0.21	74HC299	£0.61							BC267B	£0.93	BU208A	£0.30		
4029B	£0.38	74HC365	£0.28							BC267B	£0.93	BU208A	£0.30		
4030B	£0.17	74HC367	£0.38							BC267B	£0.93	BU208A	£0.30		
4035B	£0.31	74HC368	£0.38							BC267B	£0.93	BU208A	£0.30		
4037B	£0.19	74HC373	£0.35							BC267B	£0.93	BU208A	£0.30		
4041B	£0.31	74HC374	£0.34							BC267B	£0.93	BU208A	£0.30		
4042B	£0.19	74HC390	£0.52							BC267B	£0.93	BU208A	£0.30		
4043B	£0.35	74HC393	£0.36							BC267B	£0.93	BU208A	£0.30		
4044B	£0.35	74HC563	£0.56							BC267B	£0.93	BU208A	£0.30		
4046B	£0.35	74HC573	£0.27							BC267B	£0.93	BU208A	£0.30		
4047B	£0.24	74HC574	£0.30							BC267B	£0.93	BU208A	£0.30		
4048B	£0.34	74HC595	£0.27							BC267B	£0.93	BU208A	£0.30		
4049B	£0.29	74HC597	£0.22							BC267B	£0.93	BU208A	£0.30		
4049UB	£0.17	74HC688	£0.46							BC267B	£0.93	BU208A	£0.30		
4050B	£0.20	74HC4002	£0.31							BC267B	£0.93	BU208A	£0.30		
4051B	£0.23	74HC4017	£0.36							BC267B	£0.93	BU208A	£0.30		
4052B	£0.22	74HC4020	£0.36							BC267B	£0.93	BU208A	£0.30		
4053B	£0.22	74HC4040	£0.29							BC267B	£0.93	BU208A	£0.30		
4054B	£0.56	74HC4049	£0.31							BC267B	£0.93	BU208A	£0.30		
4055B	£0.34	74HC4051	£0.50							BC267B	£0.93	BU208A	£0.30		
4056B	£0.16	74HC4052	£0.34							BC267B	£0.93	BU208A	£0.30		
4063B	£0.41	74HC4053	£0.22							BC267B	£0.93	BU208A	£0.30		
4066B	£0.18	74HC4060	£0.23							BC267B	£0.93	BU208A	£0.30		
4067B	£0.20	74HC4075	£0.27							BC267B	£0.93	BU208A	£0.30		
4068B	£0.19	74HC4078	£0.32							BC267B	£0.93	BU208A	£0.30		
4069UB	£0.17	74HC4511	£0.64							BC267B	£0.93	BU208A	£0.30		
4070B	£0.20	74HC4514	£0.84							BC267B	£0.93	BU208A	£0.30		
4071B	£0.20	74HC4520	£0.41							BC267B	£0.93	BU208A	£0.30		
4072B	£0.18	74HC4543	£0.90							BC267B	£0.93	BU208A	£0.30		
4073B	£0.17									BC267B	£0.93	BU208A	£0.30		
4075B	£0.17									BC267B	£0.93	BU208A	£0.30		
4076B	£0.30									BC267B	£0.93	BU208A	£0.30		
4077B	£0.28									BC267B	£0.93	BU208A	£0.30		
4078B	£0.30									BC267B	£0.93	BU208A	£0.30		
4081B	£0.16									BC267B	£0.93	BU208A	£0.30		
4082B	£0.21									BC267B	£0.93	BU208A	£0.30		
4085B	£0.28									BC267B	£0.93	BU208A	£0.30		
4086B	£0.33									BC267B	£0.93	BU208A	£0.30		
4093B	£0.33									BC267B	£0.93	BU208A	£0.30		
4094B	£0.29									BC267B	£0.93	BU208A	£0.30		
4098B	£0.22									BC267B	£0.93	BU208A	£0.30		
4099B	£0.35									BC267B	£0.93	BU208A	£0.30		
4502B	£0.32									BC267B	£0.93	BU208A	£0.30		
4503B	£0.40									BC267B	£0.93	BU208A	£0.30		
4508B	£1.40									BC267B	£0.93	BU208A	£0.30		
4510B	£0.45									BC267B	£0.93	BU208A	£0.30		
4511B	£0.30									BC267B	£0.93	BU208A	£0.30		
4512B	£0.24									BC267B	£0.93	BU208A	£0.30		
4516B	£0.91									BC267B	£0.93	BU208A	£0.30		
4518B	£0.26									BC267B	£0.93	BU208A	£0.30		
4520B	£0.34									BC267B	£0.93	BU208A	£0.30		
4521B	£0.62									BC267B	£0.93	BU208A	£0.30		
4526B	£0.40									BC267B	£0.93	BU208A	£0.30		
4527B	£0.40									BC267B	£0.93	BU208A	£0.30		
4528B	£0.44									BC267B	£0.93	BU208A	£0.30		
4532B	£0.24									BC267B	£0.93	BU208A	£0.30		
4536B	£1.00									BC267B	£0.93	BU208A	£0.30		
4548B	£0.40									BC267B	£0.93	BU208A	£0.30		
4549B	£0.47									BC267B	£0.93	BU208A	£0.30		
4555B	£0.32									BC267B	£0.93	BU208A	£0.30		
4556B	£0.47									BC267B	£0.93	BU208A	£0.30		
4584B	£0.27									BC267B	£0.93	BU208A	£0.30		
4724B	£0.94									BC267B	£0.93	BU208A	£0.30		
41006B	£0.19									BC267B	£0.				

EPE EVERYDAY PRACTICAL ELECTRONICS

THE UK's No.1 MAGAZINE FOR ELECTRONICS TECHNOLOGY & COMPUTER PROJECTS

VOL. 36 No. 2 FEBRUARY 2007

Editorial Offices:
EVERYDAY PRACTICAL ELECTRONICS EDITORIAL
Wimborne Publishing Ltd., 408 Wimborne Road East, Ferndown,
Dorset BH22 9ND
Phone: (01202) 873872. Fax: (01202) 874562.
Email: enquiries@epemag.wimborne.co.uk
Web Site: www.epemag.co.uk
EPE Online (downloadable version of *EPE*): www.epemag.com
EPE Online Shop: www.epemag.wimborne.co.uk/shopdoor.htm
See notes on **Readers' Technical Enquiries** below – we regret technical enquiries cannot be answered over the telephone.
Advertisement Offices:
EVERYDAY PRACTICAL ELECTRONICS ADVERTISEMENTS
408 Wimborne Road East, Ferndown, Dorset BH22 9ND
Phone: 01202 873872 Fax: 01202 874562
Email: stewart.kearn@wimborne.co.uk

Windy!

Last month I discussed the ITER fusion project and how it might provide the world's energy needs in 100 years' time. I also mentioned wind power, and we have recently been investigating the possibility of publishing a wind-powered generator design. Whilst this is possible it does not seem to be very realistic.

The mechanical aspects are quite onerous – beside some sort of tower (mounted in concrete) which would need siting away from buildings etc. – there is also a requirement for high quality mountings and bearings to allow the whole thing to rotate to face the wind, and for the generator to be mounted. Add to this the need for an efficient generator and the whole thing becomes a rather complex task.

Even with one metre blades the actual amount of power that can be generated would be rather limited and could only charge 12V batteries, with an inverter to provide 230V AC. I guess if you live on a remote hillside with high levels of prevailing wind – not where most of the UK population live – then it might just be a worthwhile DIY project; otherwise it only seems sensible for experimentation.

Our advertiser Bull Group Ltd (see the inside front cover) sell a range of turbine kits that solve the mechanical construction problems, and that will provide much greater output from purpose designed generators than can be achieved using something like a car alternator or washing machine motor etc.

We could, however, come up with a design for those that are keen to experiment, have the ability to work, turn and weld the necessary metalwork, and who are prepared to spend a reasonable figure on a generator. All this, of course, without any guarantee that the energy produced will make it particularly cost effective. Let us know if it is a project you would be interested in, so we can judge if it is worthwhile publishing something in due course. Also bear in mind that planning permission would be required and that any close neighbours might well object.

As I indicated, taking all the metal bashing and potential problems into account, I wonder if it is a sensible *EPE* project – but maybe you feel differently!

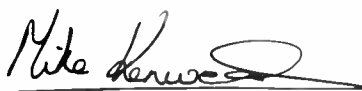

Editor: MIKE KENWARD
Consulting Editors: DAVID BARRINGTON
JOHN BECKER
Business Manager: DAVID J. LEAVER
Subscriptions: MARILYN GOLDBERG
General Manager: FAY KEARN
Editorial/Admin: (01202) 873872
Advertising Manager:
STEWART KEARN (01202) 873872
On-Line Editor: ALAN WINSTANLEY
EPE Online (Internet version) **Editors:**
CLIVE (MAX) MAXFIELD and ALVIN BROWN

READERS' TECHNICAL ENQUIRIES

E-mail: techdept@epemag.wimborne.co.uk
We are unable to offer any advice on the use, purchase, repair or modification of commercial equipment or the incorporation or modification of designs published in the magazine. We regret that we cannot provide data or answer queries on articles or projects that are more than five years' old. Letters requiring a personal reply *must* be accompanied by a **stamped self-addressed envelope or a self-addressed envelope and international reply coupons. We are not able to answer technical queries on the phone.**

PROJECTS AND CIRCUITS

All reasonable precautions are taken to ensure that the advice and data given to readers is reliable. We cannot, however, guarantee it and we cannot accept legal responsibility for it. A number of projects and circuits published in *EPE* employ voltages that can be lethal. **You should not build, test, modify or renovate any item of mains-powered equipment unless you fully understand the safety aspects involved and you use an RCD adaptor.**

COMPONENT SUPPLIES

We do not supply electronic components or kits for building the projects featured, these can be supplied by advertisers.
We advise readers to check that all parts are still available before commencing any project in a back-dated issue.

ADVERTISEMENTS

Although the proprietors and staff of EVERYDAY PRACTICAL ELECTRONICS take reasonable precautions to protect the interests of readers by ensuring as far as practicable that advertisements are *bona fide*, the magazine and its publishers cannot give any undertakings in respect of statements or claims made by advertisers, whether these advertisements are printed as part of the magazine, or in inserts.

The Publishers regret that under no circumstances will the magazine accept liability for non-receipt of goods ordered, or for late delivery, or for faults in manufacture.

TRANSMITTERS/BUGS/TELEPHONE EQUIPMENT

We advise readers that certain items of radio transmitting and telephone equipment which may be advertised in our pages cannot be legally used in the UK. Readers should check the law before buying any transmitting or telephone equipment, as a fine, confiscation of equipment and/or imprisonment can result from illegal use or ownership. The laws vary from country to country; readers should check local laws.

AVAILABILITY

Copies of *EPE* are available on subscription anywhere in the world (see opposite) and from all UK newsagents (distributed by SEYMOUR). *EPE* can also be purchased from retail magazine outlets around the world. An Internet on-line version can be purchased and downloaded for just \$15.99US (approx £9.00) per year available from www.epemag.com

SUBSCRIPTIONS

Subscriptions for delivery direct to any address in the UK: 6 months £18.75, 12 months £35.50, two years £66; Overseas: 6 months £21.75 standard air service or £30.75 express airmail, 12 months £41.50 standard air service or £59.50 express airmail, 24 months £78 standard air service or £114 express airmail. To subscribe from the USA or Canada call Express Mag toll free on 1877-363-1310

Online subscriptions, for downloading the magazine via the Internet, \$15.99US (approx £9.00) for one year available from www.epemag.com.

Cheques or bank drafts (in £ sterling only) payable to *Everyday Practical Electronics* and sent to EPE Subs, Dept., Wimborne Publishing Ltd, 408 Wimborne Road East, Ferndown, Dorset BH22 9ND. Tel: 01202 873872. Fax: 01202 874562. Email: subs@epemag.wimborne.co.uk. Also via the Web at: <http://www.epemag.wimborne.co.uk>. Subscriptions start with the next available issue. We accept MasterCard, Amex, Diners Club, Maestro or Visa. (For past issues see the *Back Issues* page.)

BINDERS

Binders to hold one volume (12 issues) are available from the above address. These are finished in blue p.v.c., printed with the magazine logo in gold on the spine. Price £7.95 plus £3.50 p&p (for overseas readers the postage is £6.00 to everywhere except Australia and Papua New Guinea which cost £10.50). *Normally sent within seven days but please allow 28 days for delivery – more for overseas.*

Payment in £ sterling only please. Visa, Amex, Diners Club, Maestro and MasterCard accepted. Send, fax or phone your card number, card expiry date and card security code (the last 3 digits on or just under the signature strip), with your name, address etc. Or order on our secure server via our UK web site. Overseas customers – your credit card will be charged by the card provider in your local currency at the existing exchange rate.



Colour CD Labels at Last?

Hewlett Packard may have solved the problem of laser printing CD labels for domestic use. Barry Fox reports.

PATENT Offices around the world remain the best source of inside information on what companies are planning to sell next. Hewlett Packard has for several years been promoting the Lightscribe system for printing high quality labels directly onto CDs and DVDs.

A graphics package on a PC programs the laser in a slightly modified recorder drive to burn an image into light sensitive dye on the label side of a specially coated blank disc. The graphics quality is high, but monochrome. The only way to introduce any colour is to use a blank that has been coated with coloured dye. But the image is still only in a single colour, black over slate or gold for instance.

Add to this the fact that the writing process is time consuming and it is not surprising that Lightscribe has been very slow to catch on. HP clearly recognises that the system will only take off, and make the sale of downloaded music real competition for pressed CDs, if Lightscribe drives can write a full colour,

high resolution label image. HP has been hinting that a full colour system launch is expected soon but a series of patents filed by the company already tell how it works (see US patent applications 2006/0132585 and 0132588).

Colour trick

The trick is to coat the label side of the blank disc with three colour-forming layers, one cyan, one magenta and one yellow. All three layers respond to heat, from the laser in the recorder, and heating is helped by *antenna particles*, small specks of metal that absorb laser light and radiate heat.

The laser is tightly focussed on the disc surface and antenna particles, so heats mainly the top layer. As the disc spins the laser pulses heat spots in the top, yellow layer, to write the yellow content of the picture. Then an ultraviolet lamp of frequency 420nm built into the disc drive shines down on the disc to 'fix' the top layer by inactivating any remaining yellow dye.

Spot heat

The laser now heats spots on the surface which represent the magenta content of the picture. The antenna particles and inactivated yellow layer transfer the heat down to the magenta layer underneath, so that it forms an image of the magenta content. Shining ultraviolet light of a different frequency (365nm) on the disc inactivates any remaining magenta dye.

Finally, the laser heats spots on the top surface which represent the cyan content of the picture. The heat drills down through the inactivated yellow and magenta layers to write the third colour layer. The result is a full colour label, printed with very fine resolution. The only extra hardware needed in the colour drive is the pair of UV lamps.

HP also suggests using a disc with frequency-dependent dyes and a drive with lasers of three different wavelengths, 980nm for magenta writing, 830nm for cyan and 780nm for yellow. But this will add cost and complexity.

Enter the Dragons

New from Rapid Electronics is the Golden Dragon family of power LEDs manufactured by Osram. The Golden Dragons use Osram's advanced thin film Indium Gallium Nitride technology to produce high levels of light output and efficiency from a miniature surface mount package.

Driven at 500mA, the cool white variant can emit 64 lumens of light (for comparison, a Luxeon I emits around 30 lumens). They have a wide viewing angle, with a half angle of 120 degrees. Optical efficiency is 40lm/W (lumens per watt) compared with a domestic light bulb at 12lm/w, halogen lamps at 18lm/W and fluorescent tubes at around 50lm/W. Under optimal conditions these devices will give 50,000 hours service.

Rapid has also introduced a brand new range of NIC surface mount power inductors. These inductors can be used as direct replacements for the Bourns - J. W. Miller products. You can purchase NIC products from Rapid in small quantities as required. As an added convenience, Rapid can also supply handy development kits for prototyping and design.

Their *Sound and Light* catalogue is also out now. They have teamed up with HQ Power and Velleman to bring you a wide range of high quality PA, Audio, DJ and lighting equipment.

With products suitable for amateurs, professionals, schools and colleges, Rapid say that they can now be your one stop Sound and Light shop. The price list, which accompanies the catalogue, contains all product codes, descriptions and prices and is available for download on the Rapid website: www.rapidonline.com.

Furthermore, Rapid's biggest-ever *Tools* catalogue has recently been published. It features hundreds of products including electronic and electrical tools, mechanical and power tools. Inside this catalogue you will find products from leading suppliers such as Stanley, Ryobi, AEG, CK, Milwaukee and Draper, alongside their own branded tools, which offer excellent value for money. Recently introduced have been DeWalt power tools and accessories, and Blackspur mechanical and electrical tools. The catalogue contains some special offers, including a Stanley heavy duty Jetcut saw for only £6.49 (excl. VAT).

There is a Milwaukee 18V cordless heavy duty combi drill on offer too, at £219.95 (excl. VAT). All purchases of the Milwaukee 18V cordless heavy duty combi drill will receive a Free Milwaukee Jobsite Radio worth over £100.

Contact details are Rapid Electronics Ltd, Dept EPE, Severalls Lane, Colchester, Essex CO4 5JS. Tel: 01206 751166. Fax: 01206 751188. Email: sales@rapidelec.co.uk. Web: www.rapidonline.com.

Alpha Micro Case Study

Suitable for both corporate and educational environments, 3Touch's solutions allow individuals to walk into any classroom, lecture theatre or boardroom and instantly access a networked presentation from a 3Touch lecturn or control panel. Eliminating the need for floppy disks, USB memory sticks and networked PCs or laptops.

Using NetPort's embedded web server, real-time communications and monitoring can be conducted via any standard web browser. NetPort is a 'plug and play' adaptor and can literally be plugged into a serial port of a machine and start sending and receiving information over the Ethernet in a matter of minutes.

Based on proven technology, NetPort utilises the popular XPort device server from Lantronix and is currently being used in a number of different applications from industrial sensors to vending machines.

For more information browse www.alphamicro.net. Tel: +44 (0) 1256 85 1770. Email: cristos@alphamicro.net. Please mention EPE if you get the opportunity.

FIRST MICROCHIP SHUNTS

Microchip has announced the first general-purpose Flash PIC microcontrollers with peripherals for more cost-effective control of fans or small motors. The 14-pin PIC16F616/610 and the 8-pin PIC12F615/609 microcontrollers can substantially reduce component count and cost with specialised peripherals such as full-bridge pulse-width modulation (PWM) with deadband control – Timer1 Gate Control for pulse width measurement, a comparator with hysteresis for Hall-effect sensor interfaces, and an A-to-D converter for temperature and other monitoring functions.

The PIC16HV616/610 and PIC12HV615/609 variants add an internal shunt regulator which allows the PIC to run from higher voltage rails without the addition of external voltage regulators. Specific application examples include home appliances, cooling fans and other motor control, power tools, system control and monitoring, battery chargers and power supplies.

For further information browse: www.microchip.com/startnow.

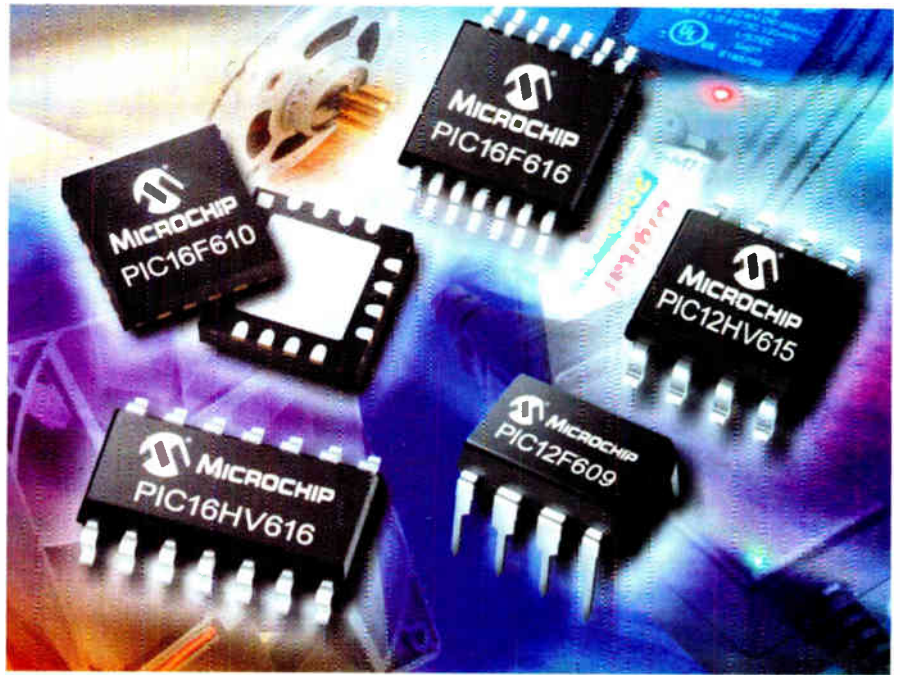

Underwater Comms Fallacy

Radio waves don't travel through water, do they? Isn't that why white vans drive round collecting environmental water samples and underwater vehicles surface and dock to deliver oil exploration results. Divers can't talk or text wirelessly, either, can they? British company Wireless Fibre Systems of Livingston in Scotland wants to update the perceived wisdom.

At a recent conference on *Unmanned Underwater Vehicles* held in Southampton, WFS unveiled a wireless modem that works underwater. Water, especially salt sea water, conducts electricity very well so short circuits the electrical component of any radio waves emitted by an underwater antenna.

Light can carry high rate data but is blocked by muddy water. Modulated sound waves carry a few hundred bits of data per second for several kilometres, but ice, turbulence and reflections from the sea bed and surface spoil transmission.

Loud sound signals can disturb marine life. Cold War systems used a transmitter of several megawatts, and huge land-based antennae to send signals at very low frequency, around 70Hz, round the world. But they could carry only a few bits of data per second – just enough to tell a submarine to surface and use ordinary radio to reply.

WFS exploits the fact that the magnetic component of a radio signal is not short circuited and can travel through water. An underwater antenna coil radiates magnetism which is detected by a sensitive receiver coil, just as a hearing aid picks up cinema or theatre sound radiated by magnetic coils around the hall.

Tests in the Firth of Forth, with funding from the UK's Defence Science and Technology Lab and a Scottish Executive SMART award, have shown that a five-metre loop antenna, radiating at 4kHz, can carry a 1kpbs signal through 200 metres of

sea water. Modern data compression techniques, developed for cellphones and digital radio systems, can squeeze speech into this signal. If the distance is reduced to one metre, the data rate can be 10Mbps. This lets a vehicle exchange survey data with a submerged dock without any physical connection.

For long-range high-rate communication the magnetic signal is beamed upwards, and escapes from the water. It is picked up by a dry land receiver and relayed by radio through the air to a distant transmitter which radiates magnetism down into the water again.

Says Gwyn Griffiths, Head of the Underwater Systems Lab at the National Oceanography Centre in Southampton, "I get an incredible sense of *deja vu* when I read the WFS paper. In 1975 my third year thesis was on electrical communication through seawater. It's been a neglected technology. The physics hasn't changed but the signal processing technology has. You can do more today with the same physics. What would kill this is being oversold on applications it can't deliver. Sound is still best for long distance communication in deep water. But they have seen and targeted niche applications. I can't help wondering what I could have done in the 1970s with today's signal processing"

Barry Fox

EMC RETROSPECT EXPRESS

Smith Micro Software has announced the arrival of EMC Retrospect Express – simple, reliable software to protect your PC.

The company states that when it comes to protecting your home computer, nothing beats EMC Retrospect Express HD. Built on award-winning technology that protects more than 10 million PCs worldwide, Retrospect backup and recovery software consistently takes top honours from experts.

Retrospect Express HD protects your music, photos, videos, email, games, tax returns, schoolwork, computer settings, important documents – everything by automatically backing up your PC to any available hard drive. Other backup software requires time-consuming full backups every week. Retrospect's award-winning technology captures just new or changed data. It is fast and efficient!

You can start your first backup in minutes. A wizard guides you through three simple steps: choose what to protect, select a hard drive to store your backups, and set a schedule.

Schedule your backups at a time convenient to you, or protect information instantly with a click of the Backup button. To guard against loss of a backup drive, use two external drives and rotate them. No matter which drive you use, Retrospect quickly adds new or changed data.

Restores remain fast and easy – the system rapidly restores a file, a folder, or your entire hard drive. If you accidentally delete a file, simply select a previous backup and locate the missing file.

If a virus or new software installation wreaks havoc on your PC, Retrospect returns your entire computer to its exact state at a prior point in time. You don't need to re-install applications, download updates, and personalise your settings.

System Requirements: 1.0 GHz or higher processor, 256MB of RAM (512MB recommended), Windows 2000 Professional or Windows XP (32-bit or x64), 500 MB of available hard drive for storing backups, including USB, FireWire (IEEE 1394), eSATA, or networked hard drives, TCP/IP networking if backing up to a network hard drive.

"Save over 20% off the regular retail price and buy EMC Retrospect Express HD today for only \$39.99", so say Smith in their press release. Browse www.stuffit.com.

Soldering Schadenfreude

If you enjoy irony, Schadenfreude may well appeal too. In case the word doesn't ring a bell, it's a borrowing from German that describes pleasure in other people's misfortune, not something that Mark Nelson would admit to personally. Or would he?

Of course I would. There's nothing better than seeing the biter bit and a backlash is already under way following the move to force us off using solder with a lead content. Of course, only a fool would deny the virtue and logic of European RoHS (restriction of hazardous substances) legislation, although the use of lead-free solder brings with it some problems for hobbyists, as we have mentioned here before.

But it appears distributors have underestimated the requirement for traditional solder and more important, components with traditional tin-lead dipped connections. Ironically, while some electronic component manufacturers have ceased making leaded components others are finding their business is booming. A report in trade newspaper *EE Times Europe* states that some of the largest component suppliers, such as Tyco Electronics (their well-known brand names include AMP, Bowthorpe, Raychem and Schrack) are actually boosting production of tin-lead parts.

The reason, the article explains, is that exempted firms that use these parts, such as the aerospace, defence and medical sectors, need to protect their stocks. In some cases they are even signing contracts with manufacturers that guarantee continued production, which makes like Tyco are happy to underwrite. However, Tyco is offering no assurance that prices remain constant, simply because pricing depends on volume and costs are inversely related to volume.

Eye candy book

Money always seems to be short in the months after Christmas (well, it is for me anyway!) but I'm still going to recommend a book to buy, simply because it's interesting, well-written and well seasoned with the kind of nuggets in it that you won't find elsewhere. It's called *Television Innovations: 50 Technological Developments*. Dicky Howett is the author of this large-format 128-page paperback published at £14.95 by Kelly Books.

Considering the number of words written on the subject of television technology, you might think it hard to come up with anything new. I myself have read far too many books on television, many of them poor or indifferent, to the extent that I did not believe anybody could write something genuinely new and worth printing. Fortunately, Howett's book manages this brilliantly and even better, it is jargon-free and readable.

I love the book: it is informative, honest, amusing and different enough to make it highly recommendable. The illustrations are not the hackneyed publicity shots that one has seen a hundred times before; instead they are either specially taken or resurrected from long-forgotten publications from days gone by.

The approach is sufficiently individual to make it can't-put-down-able. Obviously, there's no way you can condense the entire technology of television into a single book, particularly if you want to keep it 'accessible'. Howett doesn't try this; instead he has wisely gone for a selection and a good selection too. Whilst written from a British perspective, the book is not Anglo-centric, and presents a genuinely global view of television development.

Finally, however, it's the 'eye candy' or pictures that give this book the edge. If you get a warm feeling from looking at massive TV cameras that look the part, not like consumer toys, lavish studio scenes and lumbering old outside broadcast vans, this is the book for you.

You won't find it in many shops but you can order it instantly through the publisher's website (www.kellybooks.net).

Unbox arrives

Although I live in a parallel universe where names like Mullard and Radiospares are closer to reality than their new-fangled replacements, I am assured that I am not alone and that some of you readers inhabit that same world. So it may just be that you haven't heard of Unbox yet, which offers a potentially interesting way of taking the sting out of missing a programme on telly.

Whereas the BBC website offers an excellent 'Listen Again' facility for radio programmes, its 'Watch Again' facility for video clips covers only a limited selection and is nowhere near DVD quality. But if you visit the [Amazon.com](http://www.amazon.com) website and search for 'Unbox' you will discover a much wider choice of programmes that you can download in DVD quality at reasonable cost.

"If you can unwrap a DVD, you can do DVD-quality downloads. It's that easy, and less sticky," gushes Amazon. All told, there are thousands of DVD-quality movies, TV shows and more in the Unbox video store.

From the BBC alone there are already 41 popular BBC entertainment shows that you can view for \$1.99 an episode. The downloads are said to be in full DVD

quality and although I cannot see anything about saving (or not saving!) them, there is certainly software on the market that will ensure you can watch them a second time!

Go to www.amazon.com/unbox/ if you want to learn more about Unbox. If you feel like checking out programs that can capture streaming video – for academic interest of course – then try Replay A/V (<http://applian.com/replay-av/>) and WM Recorder (www.wmrecorder.com).

Quotable quotes

I'm a voracious reader, so it's not surprising that it takes a lot to stop me in my tracks as I devour the words. But every now and again I see statements that force me to stop and wonder. Perhaps you find the same thing. In any case, here are two examples.

The first was spoken by the famous author/broadcaster/academic C.S. Lewis some years ago but it is still as valid today as when he first uttered it. "When mediocrity is the norm, it is not long before mediocrity becomes the ideal." We see so much mediocrity nowadays.

The second quotation is much more recent. It's possibly equally profound, although I do wonder. According to Alain Levy, chairman of EMI Music, the CD will not last long, at least in its present form.

Speaking to an audience at the London Business School in October, he told them "The CD as it is right now is dead." Downloads are now the thing and 60 per cent of the consumers who still bought CDs did so in order to listen to them on digital music players.

This did not signify the end of physical media for music entirely, however, adding: "You're not going to offer your mother-in-law iTunes downloads for Christmas. But we have to be much more innovative in the way we sell physical content. By the beginning of next year, none of our content will come without additional material."

Really? I buy CDs for the music on them, not for mugsshots of the band or interviews. And will we get all this 'additional material' without price rises? Dream on!

As *Stereophile* magazine remarked afterwards, once again we have the spectacle of a major music mogul confessing that he doesn't have a clue what his customers want. Nothing new then, although to be fair, this affects every market sector that is forced to follow the changing tastes of the public.

PIC Digital Geiger Counter



There is something fascinating about an instrument that can sense that which is invisible and undetectable to all human senses. This article is about the design and building of a portable Digital Geiger Counter (DGC) device as shown in the photos with many unique features

By ROBERT LANE & STEVE THOMPSON

RADIATION is energy that comes from a source and travels through any kind of material and through space. Light, radio, and microwaves are types of radiation. The kind of radiation discussed in this article is called *ionizing* radiation because it can produce charged particles (ions) in matter.

Ionizing radiation

There are three types of ionizing radiation. An alpha particle consists of two protons and two neutrons (i.e. the nucleus of a helium atom). The two protons give the alpha particle a positive charge. A Beta particle is simply an electron from the nucleus of an atom.

A gamma ray is a packet of electromagnetic energy – a photon. Gamma photons have about 10,000 times as much energy as the photons in the visible range of the electromagnetic spectrum. Gamma rays can penetrate deeply into the human body.

There are both natural and man-made radionuclides. Potassium-40 and Carbon-14 are weak beta emitters that are found naturally in our bodies. Large amounts of man-made Sr-90 were produced during atmospheric

nuclear weapons tests conducted in the 1950s and 1960s and were dispersed worldwide. Sr-90 has a half-life of 28.8 years so about 77% of the Sr-90 from a nuclear weapon test in 1945 has already decayed.

Characteristics

- The 500V DC G-M tube biasing voltage is generated by a PIC microcontroller in a boost power supply configuration
- The display is menu driven with a four-line LCD digital readout
- Radiation measurements are date/time stamped by an internal real time clock
- Microprocessor 'sleep' mode is used to reduce power consumption
- Internal memory can store 125 radiation measurements using PIC18F2455, (375 using PIC18F2550)
- Built-in USB interface for data upload to a personal computer
- PIC firmware is written in freely available C language
- Personal computer software is written in latest version of Visual Basic.Net
- Device is portable, powered by four AA lithium hydride batteries (5 volts)

Hardware design

The state of the art for radiation detection for hobbyists has changed very little since Hans Geiger invented the gas filled radiation detector while working with Ernest Rutherford in 1908. The design of this device was later refined in the 1920s by Hans Geiger and Wilhelm Mueller. It is sometimes called simply a Geiger counter or a G-M counter and is the most commonly used portable radiation instrument.

A GM tube is a gas-filled device that, when a high voltage is applied, creates an electrical pulse when radiation interacts with the wall or gas in the tube. These pulses are converted to a reading on the instrument's meter.

The main drawback of the G-M counter is its inability to provide information on the energy of the radiation it detects. To count alpha particles the G-M tube must also have a very thin delicate mica window. G-M tubes come in a bewildering assortment of shapes and sizes. For this project we chose the model LND712 because of its small size and alpha sensitivity.

Take your PIC

The Microchip PIC18F2455 micro-processor was chosen for this project. Several features recommended this chip:

1. Built-in full speed USB capability
2. Multiple built-in 10-bit analogue to digital conversion capability
3. 24K of flash program memory (8K of program memory will be used to store data)
4. Built-in Inter-Integrated Circuit (I²C) bus capability
5. Speeds up to 48MHz
6. Small 28-pin footprint (also surface mount)
7. Self programmability
8. Four separate timers
9. Low cost
10. Free C compiler and subroutine libraries available

Because the full speed USB module clock must run at 48MHz, the Microchip PIC18F2455 has a flexible oscillator scheme that allows the microprocessor and peripherals to run at other clock speeds. This is accomplished

Fig.1: Complete circuit diagram for the PIC Digital Geiger Counter

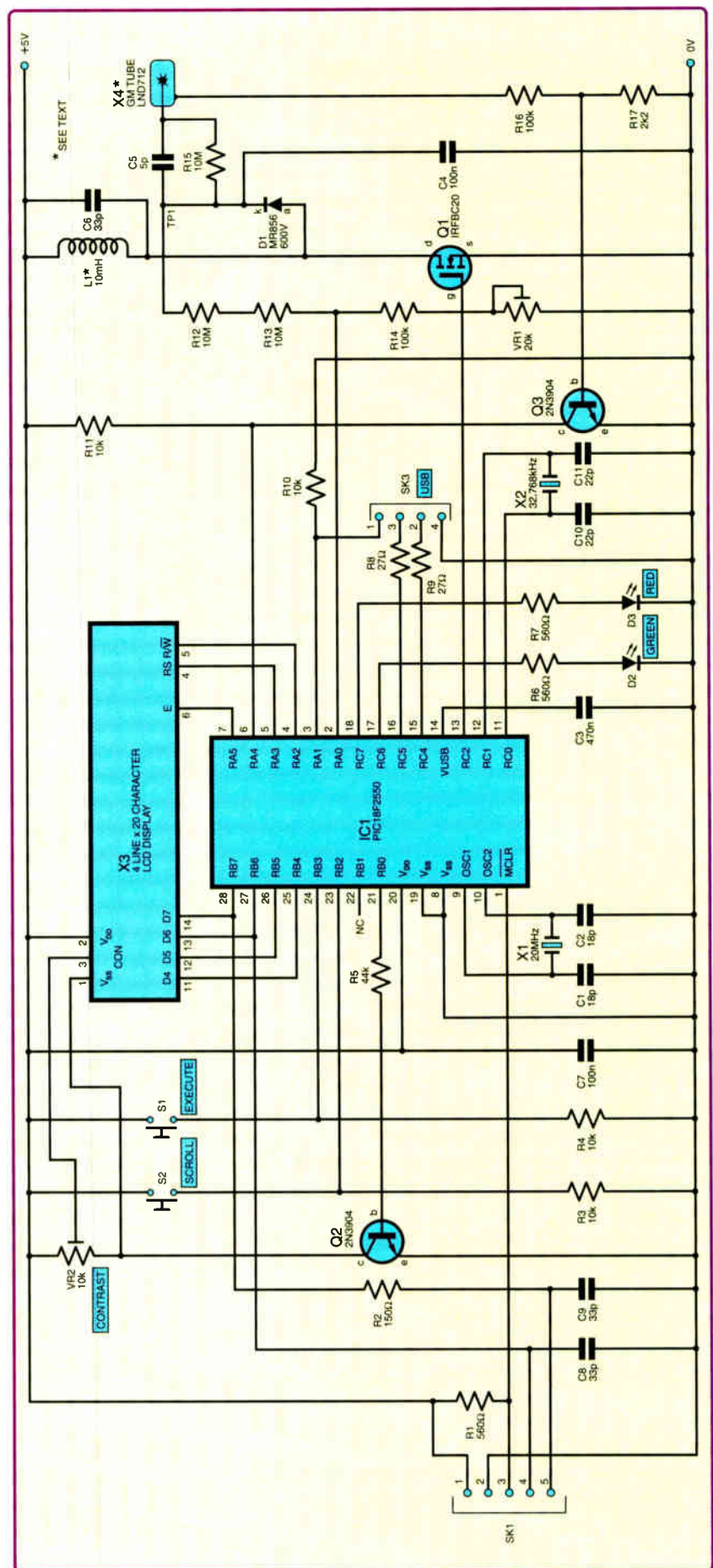

by a number of configuration bits that are set when the microprocessor is programmed.

These configuration bits allow the user to use almost any oscillator from 4MHz to 48MHz to drive the PIC18F2455. By setting these bits (PLLDIV=5, CPU_DIV=OSC1_PLL2, USBDIV=2 and FOSC=HSPLL_HS), we can use a 20MHz crystal to drive the microprocessor at 48MHz and the USB at full speed.

If you are going to program your own PIC18F2455, the circuit board has been designed with a programming connector that can be used to download the PIC firmware from a computer. If you use a preprogrammed chip, the programming connector and associated components can be deleted.

The PIC18F2550 can also be used for this project. The F2550 has 32K bytes of program memory and can store 250 additional radiation measurements.

Circuit

The full circuit diagram for the PIC Digital Geiger Counter is shown in Fig.1. The GM tube requires 500V to 1000V DC to operate. Always take extreme caution when working on high voltage circuits.

The LND Inc. 712 GM tube operates at 500V. To generate this we have used the built-in pulse width modulation (PWM) feature of the PIC18F2455 in a boost power supply configuration. This is used to generate a 4000Hz squarewave with a 50% duty factor output on pin 13 (RC2). This square-wave is used to switch the IRFBC20 MOSFET (Q1) on and off.

The inductor L1, diode D1, and capacitor C4 shown in Fig.1 are used as a boost power supply to increase the voltage from 5V DC to over 500V DC.

Radiation will cause the insulating property of the gas in the GM tube to momentarily break down, which will cause a voltage spike on the tube output. This voltage spike is sent to Q3, an 2N3904 NPN transistor. The positive pulse causes the transistor to switch and its collector (c) is brought to ground. Each negative transition on pin 6 of IC2 causes the TIMER0 value to increase by one, up to a maximum count of 65535.

One of the challenges was in getting the Digital Geiger Counter (DGC) to keep track of time. Microchip suggests

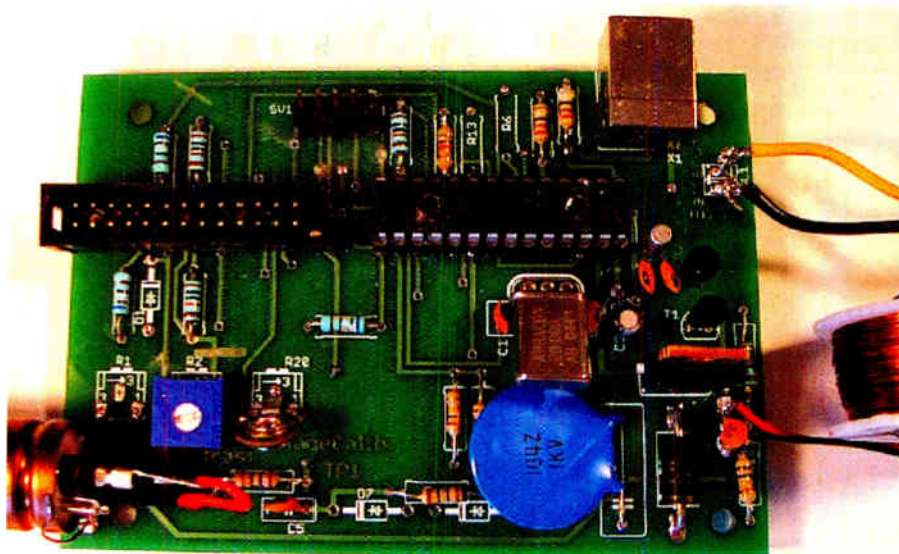

Component layout on the prototype double-sided PCB

Parts List – PIC Digital Geiger Counter

- 1 PC board, code 607, available from the *EPE PCB Service*, size 98mm x 70mm
- 1 plastic instrument case 152mm x 95mm x 57mm
- 1 LND712 or ZP1401 or similar 500V Geiger tube (Ref 1)
- 1 20MHz crystal
- 1 32.768kHz crystal
- 1 12mH inductor – see text – 60m of 36swg (32awg) enamelled copper wire
- 1 4-line x 20 character alphanumeric LCD – HJD44780 based
- 1 2-pin header
- 1 5-pin header
- 1 20-pin header
- 1 USB connector
- 1 4AA battery holder
- 1 20-pin IDC socket for LCD
- 2 square momentary contact switches
- Fixings for PCB and LCD, 18-way ribbon cable, connecting wire

Semiconductors

- 1 PIC18F2455 or PIC18F2550 (see text) preprogrammed microcontroller
- 1 IRFBC20 power MOSFET
- 2 2N3904 npn transistors
- 1 MR856 fast 600V diode
- 1 red LED
- 1 green LED

Capacitors

- 1 18pF ceramic
- 1 470nF ceramic
- 1 5pF ceramic
- 1 33pF ceramic
- 1 22pF ceramic

Resistors (0.25W 1%)

- 1 47k Ω
- 1 2.2k Ω
- 5 10k Ω
- 3 10M Ω
- 3 100k Ω
- 1 20 Ω
- 3 560k Ω
- 1 27 Ω
- 1 150k Ω
- 1 660 Ω

Potentiometers

- 1 10k carbon preset
- 1 100k carbon preset

implementing a simple low power real time clock on the PIC18F2455 by adding an external 32.768kHz crystal and two 22pF capacitors on Timer1 inputs (Ref.1).

In order to keep accurate time, microprocessor IC1 needs to be powered at all times. This eliminates the need for a manual power switch. The microprocessor uses an interrupt scheme and the 'sleep' operating mode to keep battery drain to a minimum.

When the microprocessor is put to sleep, the main 20MHz oscillator stops and IC1 executes no instructions. Transistor Q2 is used to turn off the LCD before entering sleep mode and turn on the LCD when the microprocessor wakes up.

In sleep mode, the 32.768kHz crystal connected to TIMER1 will continue to oscillate and TIMER1 will continue to increment. When TIMER1 overflows (once per second), an interrupt will occur and the microprocessor will wake up, increment the time and go back to sleep.

Constructional Project

In sleep mode with the display off, the DGC will use about 2mA of timekeeping current. In normal operating mode the DGC uses about 38mA. When the high voltage is being generated the total current used is 48mA.

When the microprocessor wakes up, once each second, it will also check to see if the EXECUTE menu button has been pressed. It will also check to see if the DGC has been plugged into a computer USB port.

If either of these conditions has occurred, the microprocessor will remain awake and the user can interact with the DGC through the menu system. If the DGC is unplugged from the USB port or the user selects the GEIGER COUNTER OFF menu option, the DGC will turn off the LCD and go back to sleep.

Building the counter

All components fit easily into a 100 x 60 x 150mm plastic box. Drill holes for the LEDs, menu buttons and LCD display in the box top and holes to mount the circuit board and battery pack in the bottom of the box. Since the plastic box is more than enough to block all alpha particles, a 12mm hole in the short side allows access for the G-M tube. A hole was also drilled for the USB connector.

Inductor L1 should be 10 to 12mH and this can be made from 60 metres of 36swg (32awg) enamelled copper wire wound on a plastic bobbin. The bobbin can be made from 10mm outside diameter plastic tubing 25mm long with two 25mm discs cut from a sheet of plastic.

The discs are epoxied onto the tubing 13mm apart, as shown in the photograph. Sixty metres of wire can be measured by creating a half metre wooden former and wrapping sixty times as shown in the background of the photo. The actual bobbin winding can be accomplished with an electric screwdriver. The final specification of the inductor is 12mH and 36 ohms.

Circuit board

Most of the components for the Geiger Counter are mounted on a double-sided printed circuit board (PCB). The component layout and full-size copper track masters are shown in Fig.2. This

Fig.2: Printed circuit board component layout and copper foil master patterns. Some copper pads/components need soldering on both sides of the PCB

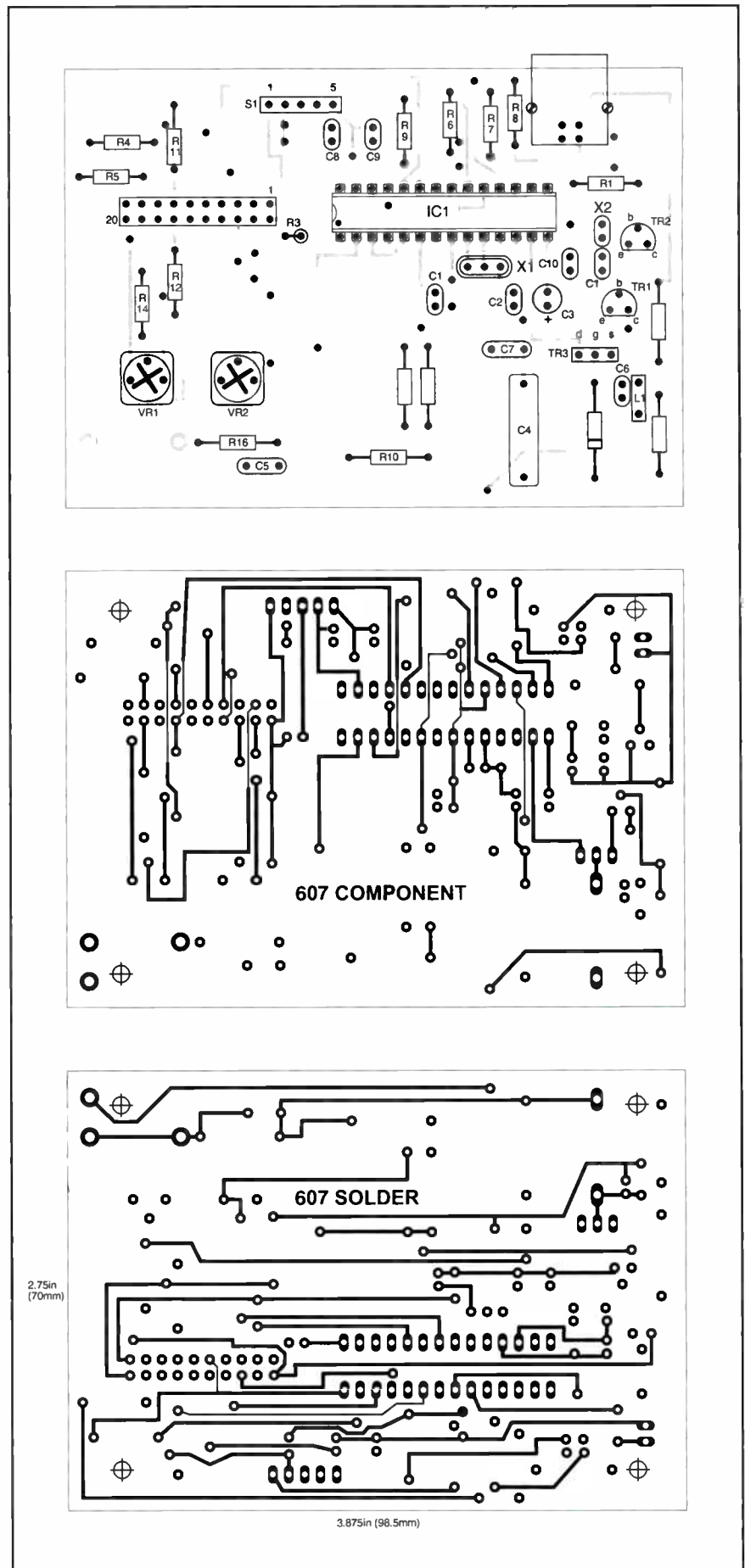

board is available from the *EPE PCB Service* code 607.

Begin the board construction by mounting the resistors and other low profile components to the top of the board as shown in Fig.2. The high voltage portion of the circuit is on the bottom half of the circuit board. Capacitors C3 and C6 are very important. If C3 is omitted then the microprocessor will not run reliably at USB full speed. If C6 is eliminated the counter will pick up noise from the 4000Hz PWM.

The board is connected to the front panel mounted components by SK2/PL2 (not shown on the circuit diagram to aid clarity). Fig.3 shows the wiring arrangement for this.

The photographs show the completed DGC with connections to the LCD display on the front panel. The case cutout for the GM tube is to the left of the GM tube and is covered by a nylon mesh screen to keep objects away from delicate mica window on the tube. The large inductor, L1, is not mounted on the circuit board, but is mounted on the case. Do not use a steel bolt to mount L1 because that will drastically change the inductance.

Software

Two programs were written for use with the DGC. The first program, GM_COUNTER, runs on the PIC18F2455 and performs all the Geiger counter functions. The second program, WINDGC, runs on a PC and handles the uploading of data from the DGC and data analysis.



The homemade, power booster inductor is made up from a plastic bobbin and 60 metres of 36swg (32awg) enamelled copper wire. The wire was measured out using a half-metre wooden former.

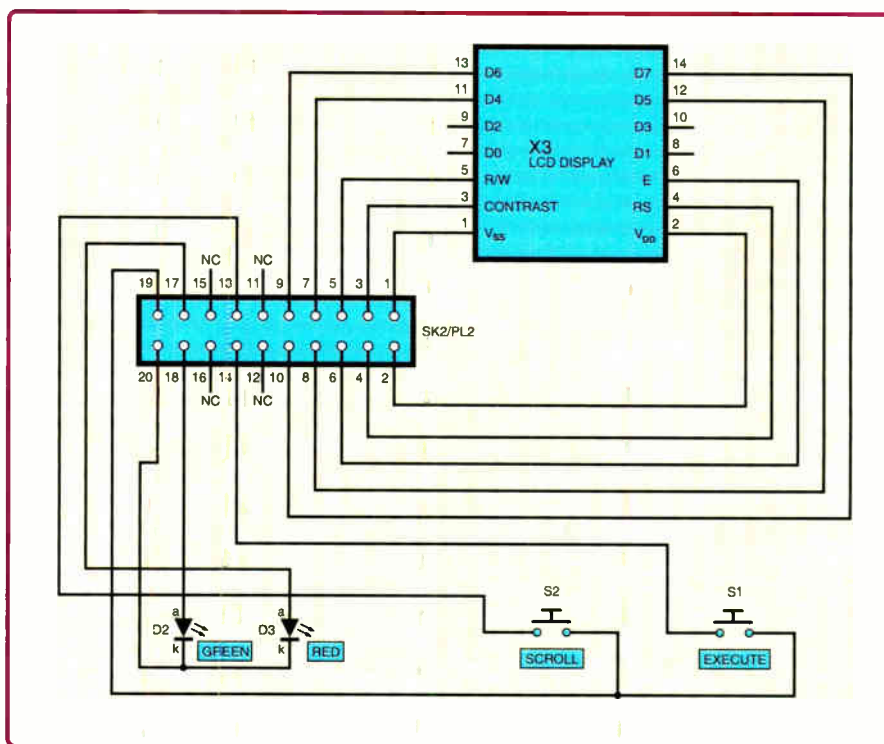

Fig.3: General wiring arrangement, in schematic form, to front panel mounted components

The software program on the DGC, GM_COUNTER, operates in two modes: DGC and USB. In DGC mode, the software is controlled by the user menu and choices are available to make and store radiation measurements. In DGC mode, the user can manually monitor the high voltage, erase the data memory, or set the time/date on the DGC.

In USB mode, the user menu inputs are disabled and all control is via the USB port. Data can be uploaded to the

PC, data can be erased on the DGC, and the time/date can be set on the DGC in USB mode. USB mode is automatically activated when the DGC is plugged into a USB port.

The program was written to handle all of the above functions using a freely available C compiler for the PIC18F2455 from Microchip. A free C18 student edition 'C' compiler program is available at – see reference 2. The C18 compiler integrates flawlessly into the MPLAB integrated development environment (Ref 3).

The C18 compiler also includes libraries of functions (Ref 4) that can be linked directly into your application using the MPLINK linker. These libraries provide simplified control of hardware peripheral functions like analogue-to-digital conversion, pulse-width modulation and timers. In addition, the libraries provide integer math functions, memory and string formatting functions, and character output functions. We made use of these functions to keep the C program short and concise.

All source code for the GM_COUNTER software is available from the *EPE* website under 'Downloads'. The compiled C program is called GM_COUNTER.HEX and it can be programmed into the microprocessor or a preprogrammed microprocessor can

Constructional Project

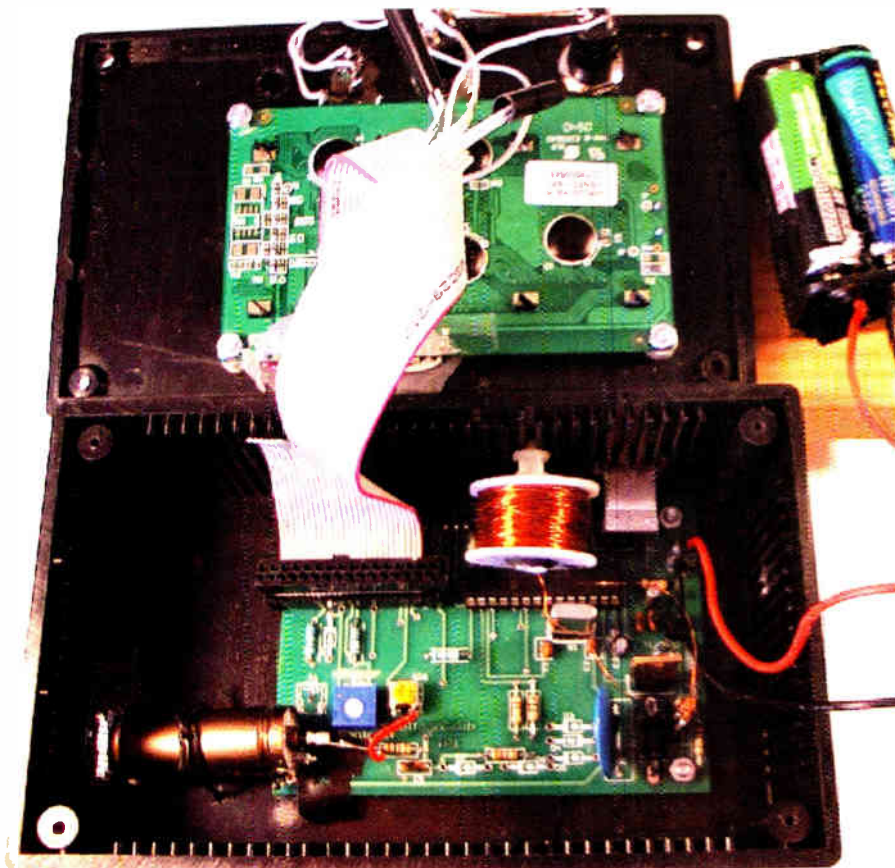

Prototype DGC showing general component positioning inside the plastic box. The lid-mounted components, including the LCD module, are interlinked to the PCB via the ribbon cable.

be obtained from Magenta Electronics or Reference 5.

The menu system is based on a number of different machine states. There is a unique machine state for each screen. Machine states of related screens are grouped together. For example, all machine states relating to the opening screen are in the 1 to 9 range. The machine state is controlled by the variable `MENUSTATE`. Generally, navigation between the different machine states is done with the `SCROLL` and `EXECUTE` pushbuttons.

Pulse counting

When the user begins the count, the `STARTCOUNT` routine is called. `STARTCOUNT` calculates the number of one second intervals in the desired count time and stores this value as `TIME_TARGET`. `TIME_ELAPSED` and the pulse count are cleared by writing 0 to `TIMER0`. G-M tube pulses provide the clock input to `TIMER0`. A `COUNTING` flag is set.

`TIMER1` will cause the interrupt routine to execute every second and

increment `TIME_ELAPSED`. If `TIME_ELAPSED` equals `TIME_TARGET`, then the desired count time has elapsed and `TIMER0` is closed to stop the counting. `MENUSTATE` is set to 60 to display the final count value and the `COUNTING` flag is cleared.

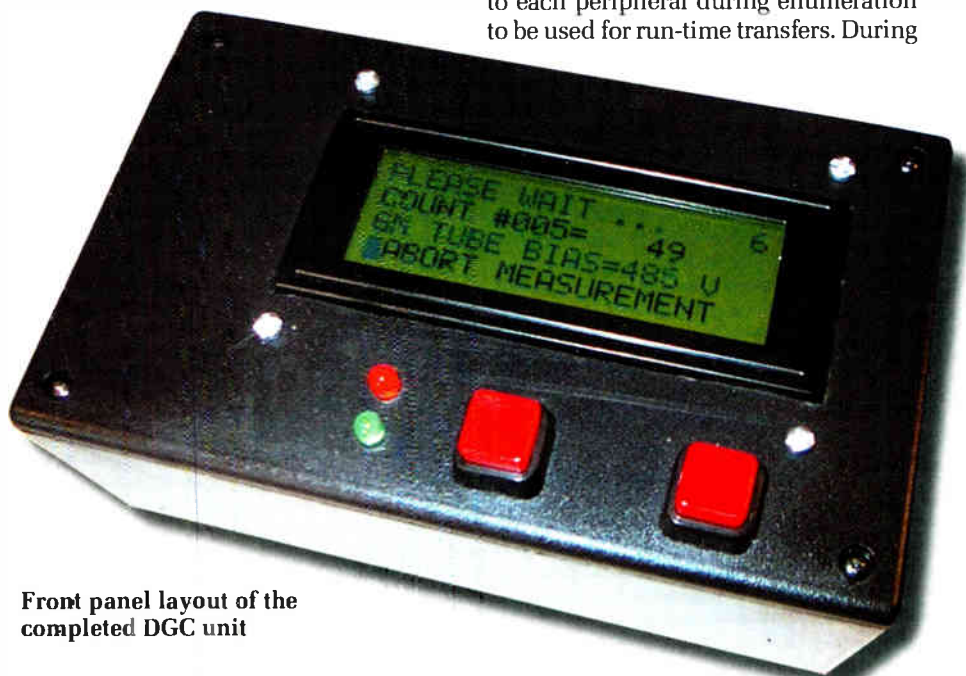

Front panel layout of the completed DGC unit

Automatic counting periods of 15, 30, 45 seconds and 1, 5 and 10 minutes can be selected from the menu. In addition, multiple measurements can be made by selecting the 'MULTIPLE SAMPLE' menu option.

Memory and USB interface

The program can remember up to 125 data measurements in flash program memory at addresses 0x5000 to 0x5fff. This memory is not volatile and measurements will not be lost when the DGC batteries are removed. When the batteries are installed, the DGC will determine the number of the next data point to be stored. The routines `MemcpyRam2Flash` and `MemcpyFlash2Ram` are used to store data in flash program memory and read data out of flash memory.

For the USB interface, we used the approach of Reference 6 which is to define the DGC as a USB communication device. This approach has two major advantages:

1. Microchip has written and freely distributes PIC software for the Communication Device class to emulate RS232 over a USB connection
2. From the PC side, the DGC will look as if it is connected to a standard COM port to the Windows software. This simplifies the PC software.

The USB specification allows peripherals to be plugged and unplugged without powering down the computer. The enumeration process involves communicating with the peripheral to discover the identity of the device driver that should be loaded. A unique address is assigned to each peripheral during enumeration to be used for run-time transfers. During

Table 1: USB Status is reported by the LEDs presented by the GM_COUNTER program

RED	GREEN	MODE	CONDITION
ON	OFF	USB	USB Device has been reset.
OFF	ON	USB	USB Device has been addressed.
ALTERNATE BLINKING	ALTERNATE BLINKING	USB	USB Device is configured. All descriptor information has been successfully received by the personal computer.
SYNCHRONISED BLINKING	SYNCHRONISED BLINKING	USB	USB device is in a suspended state
ON	NA	DGC	High voltage being generated for GM tube
NA	BLINKING 1 OUT OF 10 SECONDS	DGC	Timekeeping oscillator (32.768kHz) oscillator running.
OFF	OFF	See Condition	If LCD is off this means DGC is in sleep mode. If LCD is on this means timekeeping oscillator has not yet started oscillating after inserting batteries.

run-time, the host PC initiates transactions to specific peripherals and each peripheral accepts its transactions and responds accordingly. The data for the enumeration is contained in the USBDESC.C file.

Two free programs are useful for verifying that the USB connection is working: USBVIEW [Reference 7] and USB Command Verifier (USBCV) [Reference 8]. USBVIEW reports the results of the enumeration process as shown. USBCV is the compliance test tool which evaluates full-speed USB devices for conformance to the USB Device Framework, Chapter 9 of the USB specification.

The DGC device with GM_COUNTER software has passed all twenty-two of the USBCV tests. The output of the USBCV tests is available at the RESOURCES download site.

GM_COUNTER reports the status of the USB interface in LEDs as shown in Table 1. If the USB is in the configured state, then user data may be transferred to the PC. The GM_COUNTER program uses a very simple command/response protocol to communicate with the PC.

Sleep mode and real time clock

The menu item 'GEIGER COUNTER OFF' can be used to save power. This option turns off the LCD display, turns off the LCD power, and puts the microprocessor into power-saving sleep mode.

The one second interrupt from

TIMER1 wakes up the microprocessor if it is asleep and updates the real time clock. The microprocessor will go back to sleep if it has been sleeping, unless the DGC has been plugged into a USB port or the EXECUTE switch has been pressed.

If the EXECUTE switch has been pressed, the Geiger counter enters DGC mode. If the counter has been plugged into a USB port, it enters the USB mode.

PC software design

In order to upload and analyse data from the DGC, PC software is required. The WINDGC program presented here

is the latest incarnation of Visual Basic called VB.NET. As mentioned previously, by defining the DGC as a USB communication device class, the USB connection will appear as a standard COM serial port to the VB software. Microsoft has examples of VB.NET software that will communicate with COM serial port. The WINDGC PC software performs the following functions:

1. Uploads data from the DGC
2. Erases all data from the DGC
3. Sets date and time on DGC to system date and time on PC
4. Adds data to database
5. Plots data from database

Table 2: USB Commands and Responses used to transmit data between the DGC and a PC

COMMAND	PC SEND	DGC RESPONSE
QUERY	Q	nR
ERASE	E	R
SETCLOCK	Smdyhms	R or N
UPLOAD	Ux	xttccmmdyyhhmss zzzzzzzzzzzzzzR or N
Send N if proper # of characters are not received		

x is a specific datapoint
n is the total number of data points z bytes are currently unused

Lower case characters are binary bytes Upper case characters are ASCII characters.

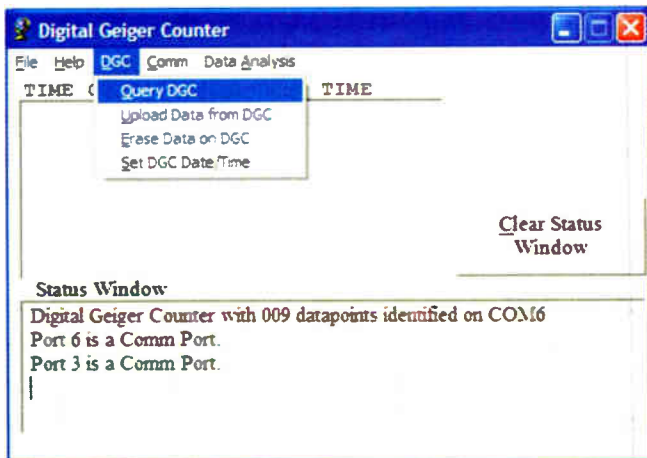

Fig.4: The WINDGC opening screen shows the result of the QUERY DGC menu item on COM6

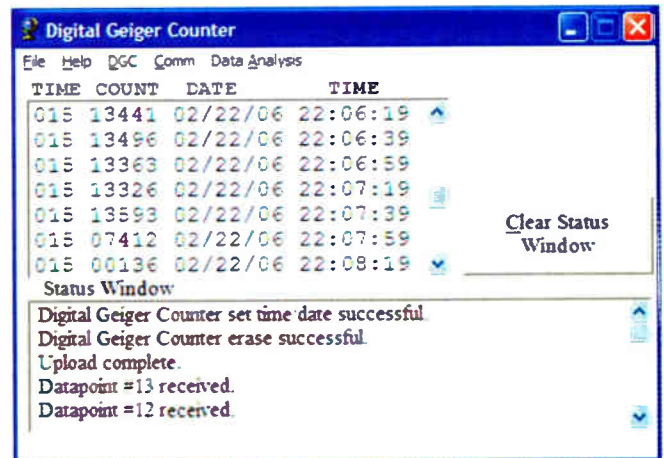

Fig.5: The WINDGC screen showing the result after an upload of 13 data points

6. Statistically analyses data

The complete source code for the WINDGC program is available from the *EPE* website. As you look through the source code, you will notice that there is never a call to any USB function. That is because, as far as the PC is concerned, the program is talking to a standard serial COM port, not a USB port. If you do not have a copy of VISUAL BASIC.NET, you can use the executable that is supplied on any PC running the Windows XP operating system.

The WINDGC program begins by testing for COM ports 1 through 9. When the program finds an active COM port, it reports it as shown above. The first step is to select a COM port using the Comm menu. The next step is to select the 'Query DGC' menu item on the DGC menu. This determines if the selected port is actually connected to a DGC. If a DGC is connected to the selected port, then the number of saved datapoints on the DGC will be reported in the status window as shown above.

There are menu items to erase the data on the DGC and to set the date/time on the DGC. The most important menu item is 'Upload Data from DGC'. Fig.5. is the result of an 'Upload Data from DGC' menu selection.

At this point the data can be plotted using the Data Analysis menu. We had originally planned to use the Excel component library to do the data plotting, but decided against this option because it would limit the of the program to only those users who had Microsoft Excel installed on their computer. The approach used was to write all the graphical and data

processing functions directly in Visual Basic.Net.

Writing the functions in VB.NET was more work, but resulted in a smaller program that everyone can use. The Data Analysis menu allows the user to plot and gather statistical data about selected points. Moving the mouse over a particular data point will report the X and Y coordinate in the MOUSE (X,Y) LOCATION textbox.



Fig.6: The LCD display after welcome on power-up

Testing phase 1

The first test is to verify that the LCD is working. Plug in the LCD and make sure the LCD contrast control, VR2, is set to midrange. Power up the unit and the welcome screen should appear followed by the main menu as shown in Fig.6. You should be able to set the real time clock using the menu system. If there is a problem with the 32.768kHz oscillator the LCD time display will not increment.

Once the display and clock are working properly, select the HIGH VOLTAGE screen from the UTILITY menu. You should measure approximately 500V DC at TP1. You should now be able to read 500 volts on the LCD display when the high voltage is

on. You can calibrate the display to your voltmeter by adjusting R20. Be aware that your voltmeter may reduce the high voltage output during the calibration. Now you are ready to connect the LND712 Geiger Mueller tube.

Select the 'GEIGER COUNTER OFF' menu option and plug the device into a PC using a USB cable. You should point the hardware wizard to the DGC.INF file supplied with the GM_COUNTER software. Reading the DGC.INF file will cause the Windows XP communication device drivers to be loaded.

Testing phase 2

After checking out the electronics, the first thing to do is to try to measure a radioactive source. Where do we get this radioactive source? For about £5 you can buy a one microcurie Americium-141 alpha source in the form of an ionizing smoke detector. Ionizing smoke detectors having a radioactive source will have a warning label stating the type and strength of the source.

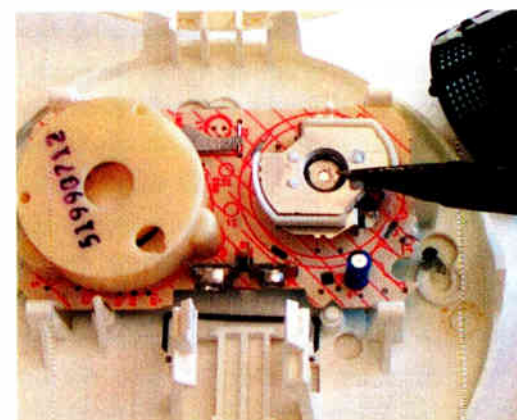

Locating the alpha source, under a black grid/cage, in a ionising smoke detector

As shown in the photograph, the alpha source, pointed to by the pencil, is located under a black grid. As far as danger is concerned, a sheet of paper or a few centimeters of air will reduce the radiation from this alpha particle source to a negligible level.



Fig.7: Measurement screen

You can check the previous statement for yourself. Place the Americium-141 alpha source (smoke detector) about 3mm from the G-M tube's mica window. Take a number of samples in MULTIPLE SAMPLE mode. Now insert one sheet of paper between the alpha source and the G-M tube and continue taking samples. Finally, remove the alpha source completely and take a few more samples.

Place the DGC in sleep mode by selecting the 'GEIGER COUNTER OFF' menu item and plug into the personal computer's USB port. The DGC will wake up when plugged into the USB port. Start the WINDGCG program on the PC. Query the DGC and then upload the data. Select the data analysis menu and display the data graphically. Your data should look like Fig.4.

By selecting different parts of the data to analyse, it was determined that the average count with the alpha source was 54168 counts/minute. With the sheet of paper inserted, the average count dropped to 536 counts/minute. Finally, when the alpha source was removed completely, the count dropped to a background average of 24 counts/minute. A sheet of paper is an effective shield (factor of 100 reduction) against alpha particles.

Trinity and ground zero

Living in New Mexico, I was aware that the first nuclear weapon was exploded at 5:29am on July 16, 1945, at the Trinity Site (33°40'30"N, 106°28'30"W). The site is about thirty miles southeast of Socorro, New Mexico on what is now the White Sands Missile Range.

The 1945 explosion was a test of an implosion-design plutonium bomb, the same type of weapon later dropped on Nagasaki, Japan. The detonation

was equivalent to an explosion of around 20 kilotons of TNT. This was where we decided to conduct the final test of the DGC.

We contacted White Sands and told them what we had in mind and they said we would be welcome to make measurements any time during the 12 hours a year that the Trinity ground zero site is open to the public [Reference 9]. On the appointed day, we began the 135 mile drive to the Trinity site.

After passing over the now only 20 foot wide Rio Grande and about twelve

miles East of San Antonio, there is a small wooden sign which says:

Trinity Site

World's first atomic explosion occurred here on July 16, 1945. This marked the beginning of the atomic age and the culmination of the Manhattan Project. The site is now part of the White Sands Missile Range and is closed to the public.

After a picture identification and weapons check at the White Sands Missile Test range Stallion Gate, we proceeded on Range Road 7. Approximately 18 miles from the Stallion Gate we arrived at the Trinity site nestling at the base of the Oscura Mountains rising 8600 feet towards the east. The half-mile diameter site is surrounded by a metal wire fence. We took some



Fig.9: Upload screen

References

Reference 1 Geiger Mueller tubes from LND Inc at <http://lndinc.com/product.htm>. Price \$79 (US) plus tax and shipping, email info@lndinc.com (UK shipping and export handling \$50, plus import duty if shipped to the UK). The Centronics (ZP1401) tube is available from Alrad Instruments at www.alrad.co.uk Tel: 07000 425723, email sue.parkin@alrad.co.uk, price £75.79 including UK p&p and VAT.

Reference 2 C18 C compiler (student edition) Version 3.0 free 22Mb download retrieved 10/28/2005 from http://www.microchip.com/stellent/idcplg?ldcService=SS_GET_PAGE&nodeId=1406&dDocName=en010014&part=SW006011

Reference 3 MPLAB IDE Version 7.22 free 31Mb download retrieved 10/28/2005 from http://www.microchip.com/stellent/idcplg?ldcService=SS_GET_PAGE&nodeId=1406&dDocName=en019469&part=SW007002

Reference 4 MPLAB C18 C Compiler Library Reference download retrieved 10/24/2005 from http://www1.microchip.com/downloads/en/DeviceDoc/MPLAB_C18_Libraries_51297f.pdf

Reference 5 Preprogrammed PIC18F2455 microprocessors are available from Magenta Electronics at www.magenta2000.co.uk and the Digital Geiger Counter website at <http://home.comcast.net/~rblang/dgc/dgc.htm>

Reference 6 Rojvanit, Rawin, 'Migrating Applications to USB from RS-232 UART with Minimal Impact on PC Software,' Microchip Application Note AN956 available at http://www.microchip.com/stellent/idcplg?ldcService=SS_GET_PAGE&nodeId=2121&fragment6_NextRow=151

Reference 7 The USBVIEW program is available at <http://www.ftdichip.com/Resources/Utilities.htm>

Reference 8 The USB Command Verifier test program (USBCV) is available at <http://www.usb.org/developers/tools/>

Reference 9 White Sands Missile Range website at <http://www.wsmr.army.mil/pao/TrinitySite/trinst.htm>

Constructional Project



The authors comparing results at the Trinity site ground zero marker
(Photo: Neal Ulevich)

DGC radiation measurements outside the fence and found the readings to be normal background, about 24 counts/minute.

We proceeded to walk the ¼ mile to the Trinity ground zero marker and took additional radiation measurements. We measured about 240 counts per minute or about ten times normal background radiation at ground zero.

Because the bomb was on a 100 foot tower, the explosion made a small depression instead of a crater. The heat of the blast vaporized all of the steel tower, except for one reinforced concrete footing and melted the desert sand into an ugly green glassy, porous, and brittle substance. After the blast, this green Trinitite completely covered the depression. The depression was later filled and

BIO

Robert Lang is a professional electrical engineer interested in embedded microprocessors, mechanical musical instruments and MIDI. He is a freelance writer for electronic hobbyist, computer and synthesizer magazines. He can be reached at rblang@comcast.net or by a GOOGLE search for HARPSITRON.

Steve Thompson is a nuclear engineer with experience in reactor core design.

He can be reached at sthompson@comcast.net.

much of the Trinitite was removed by the Atomic Energy Commission. Some Trinitite can still be found at the site. Our typical contact Trinitite readings were about 400 counts per minute.

As we were exiting the site, we noticed a sign that said the radiation at ground zero was about ten times background. We were pleased that we were able to confirm that sign with our measurements, 240 vs 24. The radiation level at ground zero was said to be about 1/1000 Roentgen Equivalent Man (REM) per hour. This provided us with a convenient conversion factor for our DGC (240 counts/minute = 1mREM/hour). To put this in perspective, a typical flight from London to New York gives a dose of 2mREM from cosmic rays. *EPE*



Get your magazine 'instantly' anywhere in the world – buy and download from the web.

A one year subscription (12 issues) costs just \$15.99 (US)

www.epemag.com

**TAKE A LOOK, A FREE ISSUE
IS AVAILABLE**

EPE PIC RESOURCES CD-ROM V2

VERSION 2 NOW AVAILABLE



Version 2 includes the EPE PIC Tutorial V2 series of Supplements (EPE April, May, June 2003)

ONLY £14.45
INCLUDING VAT and P&P

The CD-ROM contains the following Tutorial-related software and texts:

- EPE PIC Tutorial V2 complete series of articles plus demonstration software, John Becker, April, May, June '03
- PIC Toolkit Mk3 (TK3 hardware construction details), John Becker, Oct '01
- PIC Toolkit TK3 for Windows (software details), John Becker, Nov '01

Plus these useful texts to help you get the most out of your PIC programming:

- How to Use Intelligent L.C.D.s, Julyan Ilett, Feb/Mar '97
- PIC16F87x Microcontrollers (Review), John Becker, April '99
- PIC16F87x Mini Tutorial, John Becker, Oct '99
- Using PICs and Keypads, John Becker, Jan '01
- How to Use Graphics L.C.D.s with PICs, John Becker, Feb '01
- PIC16F87x Extended Memory (how to use it), John Becker, June '01
- PIC to Printer Interfacing (dot-matrix), John Becker, July '01
- PIC Magick Musick (use of 40kHz transducers), John Becker, Jan '02
- Programming PIC Interrupts, Malcolm Wiles, Mar/Apr '02
- Using the PIC's PCLATH Command, John Waller, July '02
- EPE StyloPIC (precision tuning musical notes), John Becker, July '02
- Using Square Roots with PICs, Peter Hemsley, Aug '02
- Using TK3 with Windows XP and 2000, Mark Jones, Oct '02
- PIC Macros and Computed GOTOs, Malcolm Wiles, Jan '03
- Asynchronous Serial Communications (RS-232), John Waller, unpublished
- Using I²C Facilities in the PIC16F877, John Waller, unpublished
- Using Serial EEPROMs, Gary Moulton, unpublished
- Additional text for EPE PIC Tutorial V2, John Becker, unpublished

NOTE: The PDF files on this CD-ROM are suitable to use on any PC with a CD-ROM drive. They require Adobe Acrobat Reader – included on the CD-ROM

Order on-line from
www.epemag.wimborne.co.uk/shopdoor.htm
or www.epemag.com (USA \$ prices)
or by Phone, Fax, Email or Post.

EPE PIC RESOURCES V2 CD-ROM ORDER FORM

Please send me (quantity) EPE PIC RESOURCES V2 CD-ROM

Price £14.45 each – includes postage to anywhere in the world.

Name

Address

.....

.....

..... Post Code

I enclose cheque/PO./bank draft to the value of £

Please charge my Visa/Mastercard/Amex/Diners Club/ Maestro

£

Card No.

Card Security Code (The last 3 digits on or just under the signature strip)

Valid From Expiry Date

Maestro Issue No.

SEND TO: **Everyday Practical Electronics,**
Wimborne Publishing Ltd.,
408 Wimborne Road East, Ferndown, Dorset BH22 9ND.
Tel: 01202 873872. Fax: 01202 874562.

Email: orders@epemag.wimborne.co.uk

Payments must be by card or in £ Sterling – cheque or bank draft drawn on a UK bank.

Normally supplied within seven days of receipt of order.

Send a copy of this form, or order by letter if you do not wish to cut your issue.

BECOME A PIC WIZARD WITH THE HELP OF EPE!



EPE EVERYDAY PRACTICAL ELECTRONICS



UK readers you can
SAVE 54p
on every issue of *EPE*

How would you like to pay £2.96 instead of £3.50 for your copy of *EPE*?
Well you can – just take out a one year subscription and save 54p an issue,
or £6.50 over the year

You can even save 75p an issue if you subscribe for two years
– a total saving of £18.00

Overseas rates also represent exceptional value

You also:

- Avoid any cover price increase for the duration of your subscription
- Get your magazine delivered to your door each month
- Ensure your copy, even if the newsagents sell out

Order by phone or fax with a credit card or by post with a cheque or postal order, or
buy on-line from www.epemag.co.uk (click on “Subscribe Now”)

EPE SUBSCRIPTION PRICES

Subscriptions for delivery direct to any address in the UK:
6 months £18.75, 12 months £35.50, two years £66; Overseas:
6 months £21.75 standard air service or £30.75 express airmail,
12 months £41.50 standard air service or £59.50 express airmail,
24 months £78 standard air service or £114 express airmail.
Cheques or bank drafts (in £ sterling only) payable to *Everyday Practical Electronics* and sent to *EPE* Subs. Dept., Wimborne Publishing Ltd., 408 Wimborne Road East, Ferndown, Dorset BH22 9ND. Tel: 01202 873872. Fax: 01202 874562. Email: subs@epemag.wimborne.co.uk. Also via the Web at <http://www.epemag.co.uk>. Subscriptions start with the next available issue. We accept MasterCard, Amex, Diners Club, Maestro or Visa. (For past issues see the *Back Issues* page.)

ONLINE SUBSCRIPTIONS

Online subscriptions, for downloading the magazine via the Internet, \$15.99US (approx. £9.00) for one year available from www.epemag.com.

USA/CANADA SUBSCRIPTIONS

To subscribe to *EPE* from the USA or Canada please telephone Express Mag toll free on 1877 363-1310 and have your credit card details ready. Or fax (514) 355 3332 or write to Express Mag, PO Box 2769, Plattsburgh, NY 12901-0239 or Express Mag, 8155 Larrey Street, Anjou, Quebec, H1J 2L5.
Email address: expsmag@expressmag.com.
Web site: www.expressmag.com.
USA price \$60(US) per annum, Canada price \$97(Can) per annum – 12 issues per year.
Everyday Practical Electronics, periodicals pending, ISSN 0262 3617 is published twelve times a year by Wimborne Publishing Ltd., USA agent USACAN at 1320 Route 9, Champlain, NY 12919. Subscription price in US \$60(US) per annum. Periodicals postage paid at Champlain NY and at additional mailing offices. POSTMASTER: Send USA and Canada address changes to *Everyday Practical Electronics*, c/o Express Mag., PO Box 2769, Plattsburgh, NY, USA 12901-0239.

SUBSCRIPTION ORDER FORM



- 6 Months: UK £18.75, Overseas £21.75 (standard air service), £30.75 (express airmail)
- 1 Year: UK £35.50, Overseas £41.50 (standard air service) £59.50 (express airmail)
- 2 Years: UK £66.00, Overseas £78.00 (standard air service) £114 (express airmail)

To: *Everyday Practical Electronics*,
Wimborne Publishing Ltd., 408 Wimborne Road East,
Ferndown, Dorset BH22 9ND

Tel: 01202 873872 Fax: 01202 874562
E-mail: subs@epemag.wimborne.co.uk

I enclose payment of £ (cheque/PO in £ sterling only), payable to *Everyday Practical Electronics*

My card number is:
Please print clearly, and check that you have the number correct

Signature

Card Security Code (The last 3 digits on or just under the signature strip)

Card Ex. Date Maestro Issue No.

Name

Address

Post code Tel.

Subscriptions can only start with the next available issue.

YOU WON'T GET YOUR FINGERS BURNT

It may surprise you but buying an Antex soldering iron costs less than you think in the long run. British made to exacting standards, they last significantly longer than imported brands. And with a wide range of thermally balanced soldering irons, you can pick up a "fixed temperature" or "in-handle" temperature model that will suit your needs perfectly.

None of which will burn a hole in your pocket.

If your hobby demands the best iron for the job but you don't want to get your fingers burnt by the cost, visit our website or your electronics retailer for the coolest models around.

Pick up an

ANTEX

Not just any old iron.



www.antex.co.uk

2 Westbridge Industrial Estate Tavistock
Devon PL19 8DE Tel 01822 613565

Build Your Own Weather Station

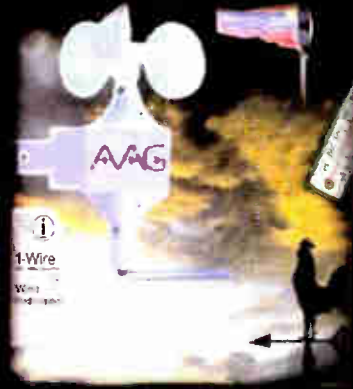

- ▶ Measure Wind Speed
- ▶ Measure Wind Direction
- ▶ Measure Temperature
- ▶ Easy Build Kit
- ▶ FREE Software
- ▶ USB or RS232
- ▶ Optional Humidity Module
- ▶ Optional Pressure Module
- ▶ Optional Rainfall Gauge
- ▶ Simple 1-wire® connection
- ▶ Build and add your own devices

Weather Starter Kit £59
RS232 Interface £25
USB Interface £29
Humidity Module £39
Pressure Module £49
Rainfall Gauge £59

Prices exclude VAT and delivery

For more information, manuals and downloads on this and other interesting products see www.audon.co.uk

AUDON Electronics

www.audon.co.uk | +44 (0)115 925 8412 | Fax +44 (0)115 925 9757

ByVac Electronics

Control hardware using simple text commands

Making complex tasks simple:

Using a few simple text commands you can control a wide range of hardware from a single microcontroller. This is just a small selection visit the web site for hints tips and free software

Connect using a °C RS232 or Microcontroller UART

*** All controlled with 2 wire serial bus ***	BV4103		<ul style="list-style-type: none"> ▶ Scrolling Text ▶ Backlight and contrast control ▶ Binary to text display ▶ Much more... 	LCD Display £22.90
	BV4108		<ul style="list-style-type: none"> ▶ Control any compatible LCD ▶ Up to 4 lines by 20 characters ▶ Scrolling text ▶ Much more... 	LCD Controller £11.00
	BV4102		<ul style="list-style-type: none"> ▶ 8 x 8 Bi Colour Red/Green ▶ Brightness control ▶ User defined bit patterns ▶ Switch on 'splash screen' 	Dot Matrix £14.95
	BV4106		<ul style="list-style-type: none"> ▶ 4 x Analogue to digital ▶ 4 x digital input or output ▶ Pulse width modulation ▶ Trigger control 	A/D Control £11.00
	BV4107		<ul style="list-style-type: none"> ▶ 4 x 4 matrix k-yypad controller ▶ 16 key buffer ▶ Row, column configurable ▶ Additional digital input 	Keypad Control £11.00
	BV305		<ul style="list-style-type: none"> ▶ 8052 8958252 based ▶ No programmer needed ▶ Includes Tiny BASIC ▶ On board power supply 	Microcontroller £14.95 KIT £4.50 RBT

MONEY BACK GUARANTEE
If you are not completely satisfied, return the goods within 30 days for a full refund

Purchase Options: On-Line at www.byvac.co.uk • Telephone 07905 734 348 • email sales@byvac.com • Cheque or Postal Order to ByVac, PO BOX 4049, Penistone, SHEFFIELD, S36 6WP

Post and packing UK £2.50 World Wide £3.50

www.byvac.co.uk



PIC N' MIX KEITH ANDERSON

Our periodic column for your PIC programming enlightenment

Implementing a software PLL for serious users of PICs – Part Two

LAST month we examined the basics of a software PLL. We conclude by looking at the detailed implementation

Detail

Assembly programs need a lot of house-keeping instructions and often it isn't easy to discover where they start. This program has three components. The label **Begin** is a tiny stub that just does: **goto Begin**. This is where the application specific procedures would go in a practical program.

The label **Interrupt** is the start of the interrupt procedure that does the work. To understand the program it is best to start here and to trust the third component, starting at the label **Startup**, to have set the special function registers properly so **Interrupt** will work.

The interrupt is generated by the analogue-to-digital converter (ADC) and occurs when the latest conversion completes and **PIR1,ADIF** is set. This might be unexpected. Although **TMR1** forms the voltage controlled oscillator (VCO), it does this by counting up to the value in **CCPR1H** and **CCPR1L**, and the capture compare module is set to mode **0x0B**, which automatically resets **TMR1** and triggers the ADC to start another conversion. The interrupt enable bit is set for the ADC but not for **TMR1** or the **CCPR** module.

At each interrupt, the specific sample is counted by the variable **TickCount**, and a computed goto is used to perform the appropriate action for the latest value of **TickCount**. It is possible to compact this code a lot for this demonstration, but it is useful to resist the temptation to do that. For a practical application the cost of replicating the appropriate 16-bit add and subtract instructions is much less important than being able to insert application specific actions easily and reliably at appropriate times within each cycle.

Macros

The 16-bit operations are implemented by macros defined in the appropriate Include files. For example, **AddVV16** adds a 16-bit variable to another 16-bit variable and is defined in the Include file **MathAddSub16.asm**. Hopefully, it is easy to guess that **SubVV16** subtracts 16-bit variables and that **AddKV16** adds a 16-bit constant to a 16-bit variable.

Macros have benefits and liabilities. They don't just save typing. They save reinventing wheels, and they reduce the opportunities for bugs to party, party, party! If the macro contains a bug and is used often, it makes

the bug conspicuous so it is fixed. They also help to focus on the application, rather than on the means to implement the application; the forest, rather than the trees. However, macros can make programs seem a little mysterious at first reading, and it is not easy to trust that they really do what they look like they might do.

When reading this program, the optimum strategy is to remember that it has been tested and does work, so it is more useful to trust mysterious statements to do what they claim to do than to wrestle with the details of how they do it. For example, the statement **SaveContext** looks like it might save context at the start of interrupt. It does. When all interrupt processing is complete, **RestoreContext** restores that context before returning from an interrupt. These macros are defined in the file **SystemContext.asm**.

It isn't always easy to follow the optimum strategy, and the macros can be found in an appropriate Include file when the temptation to examine the detail becomes irresistible.

Operations

As implied by the general description above, for phase **PLL00**, the ADC sample is ignored, and the variable **LatestCycleTot** is cleared.

The symbol **EdgeStrategy** is a hint of an alternative strategy that uses all samples and does not ignore the samples at **PLL00** and **PLL08**. This has been simulated in Excel but not tested in a PIC. The simulation indicates that it has no benefits and a few liabilities.

For phases **PLL01** to **PLL07**, the latest sample is added to **LatestCycleTot**. For phase **PLL08**, the ADC sample is ignored, and **LatestCycleTot** is not changed. For phases **PLL09** to **PLL15**, the latest sample is subtracted from **LatestCycleTot**.

Phase **PLL15** is where all the real work is done. Shift and add instructions are used to compute:

$$\begin{aligned} \text{PreviousCycleTot} = & \\ & ((3/2) \times \text{PreviousCycleTot}) \\ & - ((4/2) \times \text{LatestCycleTot}) \end{aligned}$$

The absolute value of this is a good indication of the phase error, and is tested. If it is suitably small, then the loop is probably locked. If it remains suitably small for several consecutive cycles, then the probability that the loop is locked increases. Specifically, if the error is less than **LoopError1K**, then the macro **DecToZ8** decrements **LoopCount** to, but not past, zero. If not, **LoopCount** is reset to **LoopError1K**. Testing indicates that this

lock detect strategy is very conservative.

The signed value in the variable **PreviousCycleTot** is scaled to be the amount by which the value in **CCPR1H** and **CCPR1L** needs to be adjusted to set the appropriate period for the next cycle. The new value for **CCPR1H** and **CCPR1L** is computed in **IW0** and **IW1**. The algorithm for the linear PLL does not attempt to correct all of the error in one cycle, it just makes relatively small adjustments each cycle until the error is reduced to zero. Other PLLs can lock faster, but are sensitive to noise.

In small PICs like the **12F683**, the temporary registers **IW0** and **IW1** are not strictly essential. They hint at a useful strategy for managing bank selection in larger PICs. The strategy is reasonably efficient and it is useful to resist the temptation to do something 'more efficient' in the smaller PICs.

Loading **CCPR1** depends upon a trick. If it is just loaded, **TMR1** might match prematurely and trigger a spurious ADC conversion and **TMR1** reset. Instead, **IW0,7** is set so that the value initially loaded will be much bigger than any value expected in **TMR1**. After both bytes of **CCPR1** have been loaded, **CCPR1H,7** is cleared.

For this application, **CCPR1** is not expected to exceed **0x0FFF**, so this strategy should be very safe.

Performance

PLLs aren't only difficult to analyse mathematically, they are difficult to test. It is easy to show that the loop is locked, but it isn't easy to introduce small disturbances to show the behaviour when the loop is disturbed.

For demonstration and debugging, the program provides two outputs. A signal that is in-phase with **VADC** and that consequently lags **VAC** by 90 degrees is provided at **GPIO,0** and is called **VcoP**. A signal that is in-phase with **VAC** is provided at **GPIO,1** and is called **VcoQ**. The names are mnemonic when referenced to **VADC**.

An oscilloscope can be used to confirm that the loop is suitably stable for a reasonable range of values of the loop filter parameter, **B**, and for a reasonable range of input voltages. For the recommended values, the loop reports lock in about one second, but most of this is due to the very conservative lock detect strategy. The loop is highly tolerant of gross distortion of the input waveform.

The signal at **GPIO,4** and called **PIITime** is used to test how busy the PIC is. The PLL is activated by the ADC each time a

fresh sample is available. There are 16 samples per cycle. For 15 interrupts, the new value is just added to or subtracted from the current total, and the interrupt completes in about 30 μ s. For the 16th interrupt, the latest result is filtered and the new value of CCPR is computed, and the interrupt completes in about 80 μ s. It is reasonable to hope that the loop might work for frequencies up to 500Hz, but there is a subtlety. The PLL needs accuracy as well as speed, and at high frequencies, CCPR might 'hunt' between values, neither of which is right.

Modifying the Program

The PLL strategy needs a capture compare module that can reset TMR1 and also trigger ADC conversions. The 12F683 is about the smallest PIC with this capability. Most PICs with a capture compare PWM module are probably suitable.

Although it is possible to build applications with one PIC dedicated to implementing the PLL program and another

implementing the application-specific program, this is usually unnecessary and extravagant. Instead, one PIC would normally implement both the PLL program and the application specific program.

If activities synchronised with the input power are needed, they can be triggered at any suitable phase of the input power. There are at least three strategies. Often it is suitable to set a flag within Interrupt to trigger action performed outside Interrupt. This minimizes congestion within Interrupt, but risks that some actions might be missed. When it is important to ensure that no actions are missed, and the action can be performed suitably quickly, then the action can be performed inside Interrupt, but this risks congesting Interrupt. Sophisticated applications might update a counter inside Interrupt and perform appropriate actions outside Interrupt. The counter can contain the information needed to compensate for missed actions.

The PLL does not use TMR0 or TMR2. These are available for other times that might or might not be synchronised with the input power.

It is possible to implement the PLL strategy with other than 16 samples per cycle. The number of samples should be even, but need not be a power of 2. The difficulty is that the appropriate value for the loop filter parameter, B, is not easy to discover. This is an opportunity for further investigation.

Some PICs have two capture compare modules, and in this case, it is CCPR2, not CCPR1 that triggers TMR1 and ADC conversion. The assignment of bits to the special purpose registers is not well standardized from PIC to PIC, so it is necessary to read the data sheets carefully to ensure that TMR1, the CCPR module, and the ADC are all configured correctly. The program was written initially for a 16F876 and then converted to a 12F683. The conversion was not unusually difficult, but revealed the need to examine the data sheets carefully.

Mike Hibbett returns next month

Please mention EPE when responding to advertisements.

To advertise in EPE please contact our Advertising Manager Stewart Kearn.

Tel: 01202 873872 email: stewart.kearn@wimborne.co.uk

PicoScope 3000 Series PC Oscilloscopes

The PicoScope 3000 series oscilloscopes are the latest offerings from the market leader in PC oscilloscopes combining high bandwidths with large buffer memories. Using the latest advances in electronics, the oscilloscopes connect to the USB port of any modern PC, making full use of the PCs' processing capabilities, large screens and familiar graphical user interfaces.

- High performance: 10GS/s sampling rate & 200MHz bandwidth
- 1MB buffer memory
- High speed USB 2.0 interface
- Advanced display & trigger modes
- Compact & portable
- Supplied with PicoScope & PicoLog software

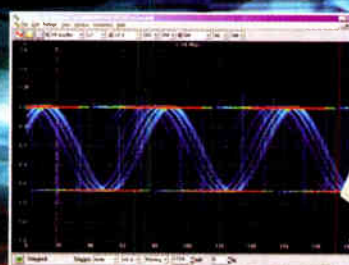

PicoScope	3204	3205	3206
Bandwidth	50MHz	100MHz	200MHz
Sampling rate (repetitive)	2.5GS/s	5GS/s	10GS/s
Sampling rate (single shot)	50MS/s	100MS/s	200MS/s
Channels	2+Ext trigger	2+Ext trigger;Sig gen	2+Ext trigger;Sig gen
Oscilloscope timebases	5ns/div to 50s/div	2ns/div to 50s/div	1ns/div to 50s/div
Timebase accuracy	50ppm	50ppm	50ppm
Spectrum ranges	0 to 25MHz	0 to 50MHz	0 to 100MHz
Buffer memory size	256KB	512KB	1MB
Resolution / accuracy	8 bits / 3%		
Ranges	±100mV to ±20V		
PC Connection	USB2.0 (USB1.1 compatible)		

Tel: 01480 396395

www.picotech.com/scope371

pico
Technology Limited

Universal circuit fits all vehicles

Courtesy light delay for cars

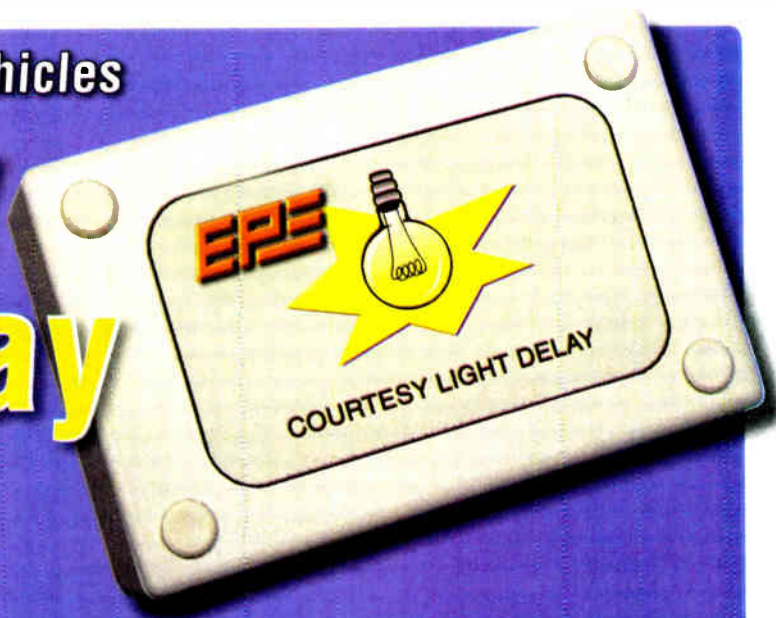

Give your car that luxury feel by extending the time that your interior lights remain on once the car doors have closed. For that extra touch of class, the lights fade to darkness at the end of the time period

By JOHN CLARKE

A COURTESY LIGHT DELAY is a great feature for your car. It enables you to see to insert the ignition key and find your seatbelt when it is dark outside, without having to leave the door open.

However, many cars lack this feature, particularly older models. When the car door is opened, the cabin lights do light up but as soon as the door is closed, the lights go out. This happens just when you are about to get settled into the seat. Of course, you can fumble around and find the interior light switch but wouldn't it be nice if the lights stayed on automatically for a short time instead?

And wouldn't it be classy if the lights faded out at the end of the timing period instead of a sudden switch off?

Another feature that would be useful is to have the courtesy light(s) automatically switch off whenever the parking lights are switched on. This would allow you to drive off if ready to go, before the courtesy lights had timed out.

The final feature of this design is its ease of installation. Past courtesy

light delay circuits have presented real problems for installation because of the various wiring combinations for courtesy lights in modern cars.

In presenting this design, we particularly wanted to solve the connection problems.

Courtesy light circuits

The automotive industry is renowned for its lack of standardisation when it comes to car wiring and this is certainly revealed when it comes to lighting circuits. Fig.1(a) and Fig.1(b) show how the courtesy lights can be wired. Some cars will have the lights connected to the +12V supply rail and the door switches connecting to the car chassis, while other cars will have the opposite connection, with the courtesy lights connecting to chassis and the door switches connecting to the +12V rail.

Note that we have shown only two lights and two switches. Some cars will have more switches (one in each door plus a manual courtesy switch inside) and more lights. The switches are all wired in parallel and extra lights are also wired together in parallel.

All of the courtesy lights switch on whenever one of the door switches is closed. This occurs when a door is opened. When all doors are closed, all the switches will be open and the courtesy lights will be off.

Similarly, the two possible tail light connections are shown in Fig.1(c) and Fig.1(d). The tail lights are on when the lights switch is closed. This switch would also power the side lights at the front of the car but this is not shown in this circuit.

For our Courtesy Light Delay circuit to work, we simply need to connect it across one of the door switches. We also need to connect it to the tail light wiring, so that the courtesy lights are immediately switched off if the tail lights are switched on during the timing period.

Main Features

- Adjustable delay period from 7 to 40s
- Lights fade out at end of time period
- Courtesy lights switch off if parking lights switched on
- No standby current drain from battery when lights are off
- Universal circuit works with any 12V car system (can be modified for 24V systems)
- Low parts count
- Easy to install

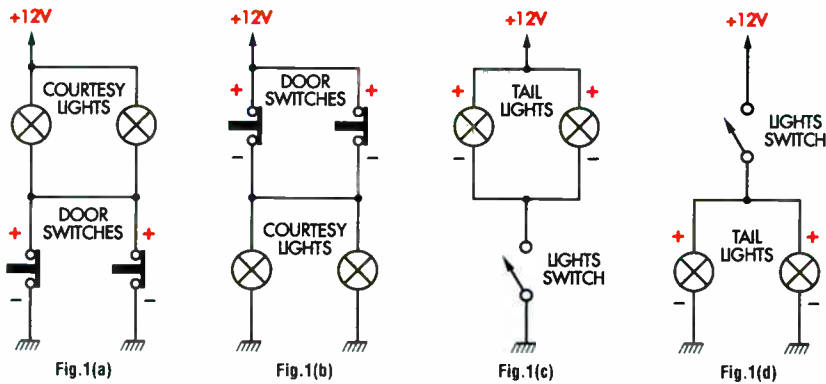

Fig. 1: the two possible wiring configurations for the courtesy lights are shown at Fig.1(a) and Fig.1(b), while Fig.1(c) and Fig.1(d) show the alternative tail light wiring configurations. (Door switches closed – car doors open).

In practice, this means that the Courtesy Light Delay requires just four connections to the car's wiring. Two wiring leads connect across the door switch, while the other two connect directly across one of the tail light filaments.

How it works

Fig.2 shows the full circuit details of the Courtesy Light Delay. It comprises a MOSFET (Q1), an optocoupler (OPTO1), a diode (D1), a diode bridge (BR1) and a few capacitors and resistors.

Q1 acts as a switch. It's effectively wired in parallel with the door switches and switches power to the courtesy lights during the timing period, when all door switches are open.

Note that the door switches are marked with plus and minus signs in Fig.1(a) and Fig.1(b). The positive rail of the delay circuit connects to the plus side of the door switch, while the negative rail connects to the minus side.

In operation, the circuit derives its power from the vehicle's 12V battery via the courtesy lamp filaments. As

a result, the lamps act as low-value resistors in series with the supply. However, because the circuit draws so little current when it is operating, there's very little voltage drop across the lamp filaments and so the circuit operates from almost the full battery voltage.

Note that the current flows via the courtesy lamp filaments – it doesn't matter whether the lamp filaments are connect directly to the +12V supply as shown in Fig.1(a) or to ground as in Fig.1(b).

The circuit operation is as follows. When a car door is opened, one of the door switches closes and the courtesy lights switch on as normal. During this time, the switch shorts out MOSFET Q1 and so there will be no voltage across the courtesy light delay circuit; ie, between its plus and minus terminals. As a result, capacitor C1 will be discharged via R1, while C3 will be discharged via resistors R3 and R4.

Subsequently, when the door switch opens again (ie, the door is closed), the courtesy lights will go out and there will be close to 12V across the drain (D) and source (S) of Q1. This voltage also immediately appears across a series connected network consisting of capacitor C1, diode D1 and capacitor C2.

Initially, C1 has a much lower impedance than C2, since it has 10 times greater capacitance – ie, 470µF vs 47µF. As a result, C2 is rapidly charged via C1 and so has almost the full supply voltage across it soon after power is applied to the circuit.

In practice, if we ignore the voltage drop across diode D1, capacitor C1 will initially have about 1.1V across it and C2 will have 10.9V across it.

What happens now is that C1 charges to the 12V supply via resistor R1. During charging, the voltage on the negative side of C1 gradually drops to the negative supply rail. At the same time, diode D1 prevents C2 from discharging since it is reverse biased. As a result, C2 remains with about 10.9V across it.

At this point we need to understand how MOSFET Q1 works. These devices have three terminals, called 'gate', 'drain' and 'source'.

When the gate voltage is at the same voltage as the source, the MOSFET is off and no current flows. However, when the gate voltage rises to its threshold of around 3 to 4V, the

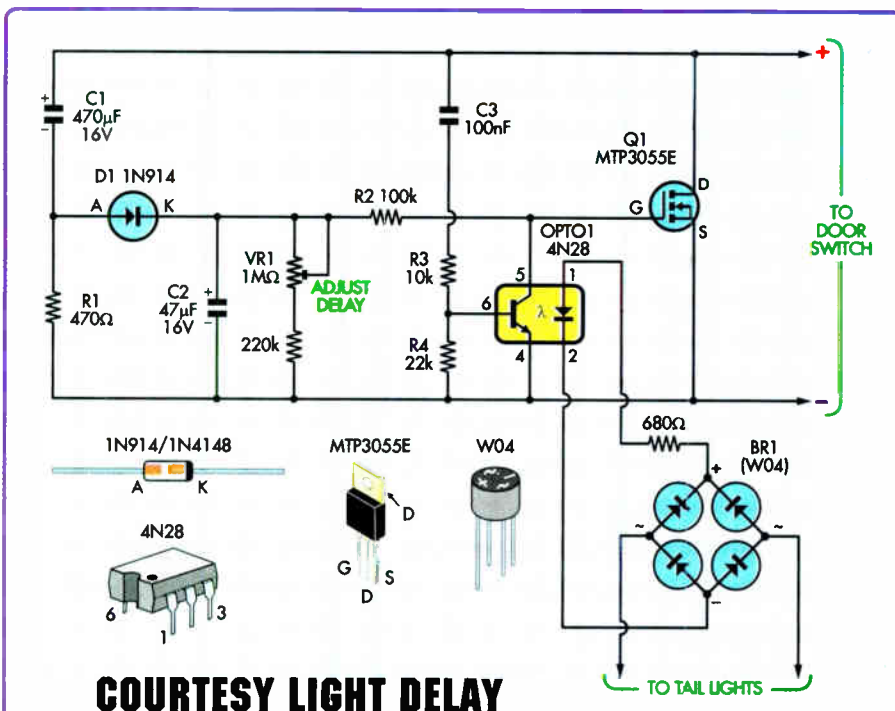

COURTESY LIGHT DELAY

Fig. 2: the circuit uses MOSFET Q1 to switch power to the courtesy lights when the car's door is closed (ie, the door switch opens). Trimpot VR1 sets the time delay, while bridge rectifier BR1 monitors the tail lights and switches off Q1 via optoisolator OPTO1 if the tail lights are switched on.

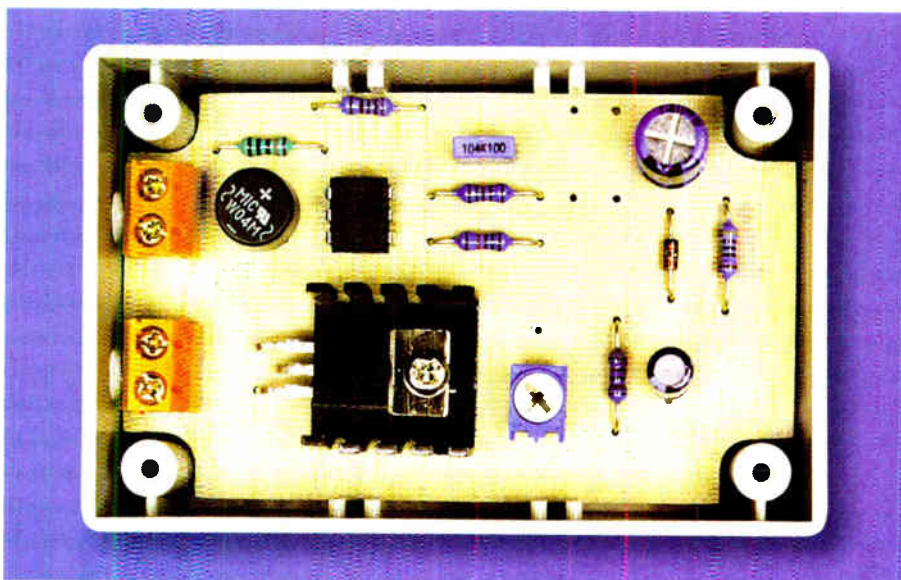

The completed PC board clips into the side pillars of a standard plastic case. Note the small heatsink fitted to MOSFET Q1, to keep it cool.

BR1, which ensures that the positive voltage rail is fed to the anode of the optocoupler's internal LED.

The wiring arrangement of the tail light circuit is also unimportant since the circuit simply monitors the voltage across the lamps.

Parts List

- 1 PC board, code 603, available from the *EPE PCB Service*, size 78 x 46mm
- 1 front panel label, see Fig.4
- 1 plastic box, 82 x 54 x 31mm
- 1 mini heatsink, 19 x 19 x 10mm
- 2 2-way PC board mount screw terminals, 5.08mm spacing
- 1 M3 x 10mm screw & nut
- 1 1M Ω trimpot (horizontal mount)

Semiconductors

- 1 MTP3055E 14A 60V MOSFET (Q1)
- 1 4N28 optocoupler (OPTO1)
- 1 W04 1.2A bridge rectifier (BR1)
- 1 1N914 or 1N4148 diode (D1)

Capacitors

- 1 470 μ F 16V PC electrolytic (C1)
- 1 47 μ F 16V PC electrolytic (C2)
- 1 100nF MKT polyester (C3)

Resistors (0.25W 1%)

- 1 220k Ω
- 1 100k Ω
- 1 22k Ω
- 1 10k Ω
- 1 680 Ω
- 1 470 Ω

Miscellaneous

Automotive wire, connectors, mounting brackets, etc.

Construction

All the parts for the Courtesy Light Delay are mounted on a PC board, coded 603 (78 x 46mm). This then clips into a standard plastic case measuring just 82 x 54 x 31mm.

Fig.3 shows the assembly details. Begin by checking the PC board for any shorts between tracks or breaks in the copper. That done, remove the corners of the PC board if this hasn't already been done, so that the board clears the four pillars inside the case.

Now for the parts assembly. First, install the resistors in the positions shown, followed by diode D1 and the optocoupler (OPTO1). Table 1 shows the resistor colour codes but it's also a good idea to check each one using a digital multimeter before installing it on the board.

Take care when installing D1 and OPTO1 – they must be oriented as shown (see also Fig.2 for the device pinouts).

Next, install trimpot VR1 (this may be coded 105), then install the three capacitors, bridge rectifier BR1 and the two 2-way terminals. Again, check to make sure that BR1 and the two electrolytic capacitors (C1 & C2) are oriented correctly.

Finally, install MOSFET Q1 by bending its leads at right angles so that they fit into their allocated holes. This device is fitted with a small U-shaped heatsink and the assembly is secured to the PC board with a screw and nut.

The PC board is mounted inside the case by simply clipping it into the mounting clips. Before doing this, you will have to mark out and drill two holes in one end of the case, to allow for wire entry to the screw terminals. These holes are located 11mm down from the lip and 18mm in from the outside edge of the case and are made using a 6mm drill.

Note: for 24V operation, change both C1 and C2 to 25V working and change the 680 Ω resistor to 1.2k Ω .

Installation

The Courtesy Light Delay can be mounted in any convenient location under the dashboard. It's up to you how you secure it, since the circumstances will vary from vehicle to vehicle.

To connect the unit, you will need to access one of the car door switches and the tail light connections. Note that some door switches will have two wires, while others will only have a single wire connection. In the latter case, one contact is connected directly to chassis at the switch mounting position.

Note also that it's important to get the door switch connections to the unit the right way around – ie, the positive door switch connection must go to the positive rail of the Courtesy Light delay. You can quickly determine which is the positive door switch connection by using your multimeter to measure the voltage across the door switch when it is pushed open.

If there's only a single wire running to the switch, this will be the positive (the chassis connection is negative).

It's a good idea to disconnect the vehicle's battery before running the wiring, to prevent any inadvertent short circuits. Note that all wiring should be run using proper automotive cable and connectors.

The 'Tail lights' terminals on the Courtesy Light Delay are simply connected across one of the tail lights. You can access this wiring either directly at the tail lights or at the lights switch or the fusebox.

Alternatively, you can connect these terminals across one of the side lights at the front of the car. It doesn't matter which way around you connect them, since the bridge rectifier automatically caters for both polarities (as explained previously).

Once the wiring is complete, reconnect the battery and check that the

Constructional Project

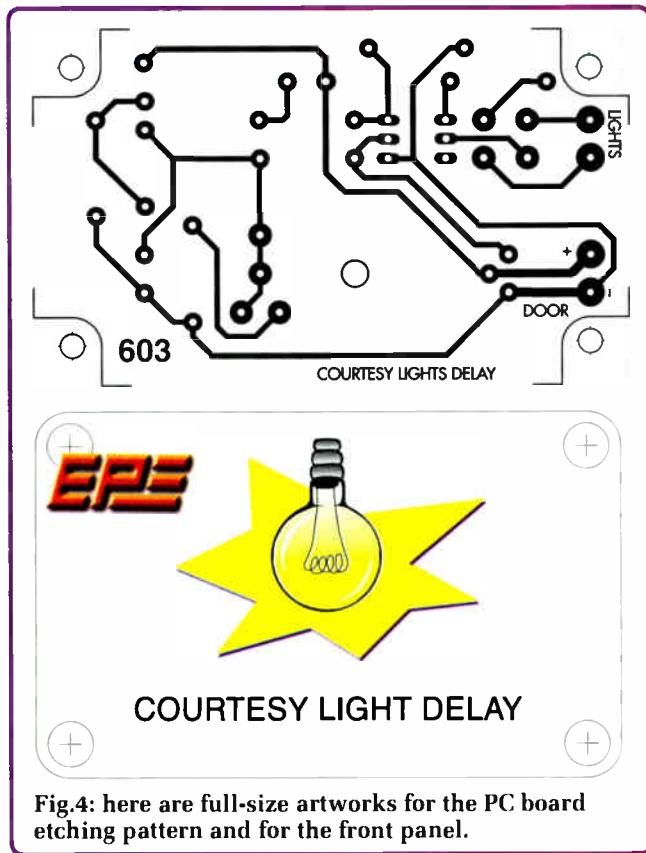

Fig.4: here are full-size artworks for the PC board etching pattern and for the front panel.

courtesy lights remain on after the door is closed. Now turn the side lights on – the courtesy lights should immediately go out again.

You can now trigger the courtesy lights again and set the 'lights-on' delay period using VR1. Turning VR1 clockwise will increase the delay period.

Troubleshooting

If the courtesy lights are always on, it may be because the door switch terminals have been connected with reverse polarity. If that happens, the courtesy lights turn on via the intrinsic reverse diode inside Q1. Simply swapping the leads to the door switch will fix this problem.

If the lights do not remain on after the door is closed (and the connections are correct), check that there is no voltage applied to the 'Tail light' terminals on the PC board. If there's no voltage here, the problem will be on the PC board itself.

The first step is to carefully check the copper side of the board for missed solder joints and solder bridges between adjacent tracks. That done, check that all components are oriented correctly and that they are in their correct positions.

Finally, check that there is 12V between the drain and source terminals of Q1 when the door switches are open (ie. with the doors closed). If there is no voltage here, check your wiring back to the door switch.

EPE

Reproduced by arrangement with SILICON CHIP magazine 2007. www.siliconchip.com.au

PLEASE ENSURE YOU TELEPHONE TO CHECK AVAILABILITY OF EQUIPMENT BEFORE ORDERING OR CALLING.

SPECIAL OFFERS

OSCILLOSCOPES

TEKTRONIX 2247A 4 Channel 100MHz Counter/Timer/ Voltmeter	£275
TEKTRONIX 2335 Dual Trace 100MHz Delay Sweep	£125
TEKTRONIX 485 Dual Trace 350MHz Delay Sweep	£300
IWATSU SS5711 4 Channel 100MHz Delay Sweep	£150
PHILIPS 3085 2+1 Channel 100MHz Dual TB Delay - Autoset £200	£200
PHILIPS 3085 2+1 Channel 60MHz Dual TB Delay - Autoset	£150
PHILIPS PM3217 Dual Trace 50MHz Delay Sweep	£125
KIKUSUI C056100 5 Trace 100MHz Delay	£150
TEKTRONIX 475A Dual Trace 250MHz Delay Sweep	£175
TEKTRONIX 475 Dual Trace 200MHz Delay Sweep	£150
TEKTRONIX 468B Dual Trace 100MHz Delay Sweep	£125
TEKTRONIX 465 Dual Trace 100MHz Delay Sweep	£95
PHILIPS PM3269 Dual Trace 40MHz Delay	£125
PHILIPS PM3215 Dual Trace 50MHz	£75
KENWOOD CS4035 Dual Trace 40MHz	£50
PANASONIC VP564A Dual Trace 40MHz	£50
HITACHI V525 Dual Trace 50MHz Cursors	£95
HITACHI V523 Dual Trace 50MHz Delay	£80
HITACHI V425 Dual Trace 40MHz Cursors	£75
HITACHI V422 Dual Trace 40MHz	£60
HITACHI V223 Dual Trace 20MHz Delay	£80
HITACHI V222 Dual Trace 20MHz	£50
HITACHI V212 Dual Trace 20MHz	£50
FARNELL DTV12-14 Dual Trace 12MHz	£40

STORAGE

PHILIPS PM3320 Dual Trace 200MHz 250Ms/S	£300
LECROY 9400 Dual Trace 125MHz	£325
TEKTRONIX 468 Dual Trace 100MHz Delay Sweep Digital Storage	£200
VELLEMAN HPSS 1MHz 5MHz Sampling Handheld Unused £60	£60

ANALYSERS

ADVANTEST R3265A 100Hz-8GHz	£4500
TEKTRONIX 492P 50kHz-21GHz	£2250
HP8560A 50Hz-2.9GHz Built in Tracking Gen	£3250
HP 8560A 50Hz-2.9GHz	£2950
HP 8569A 10MHz-22GHz	£950
HP 8565A 10MHz-22GHz	£750
HP 853A with 8559A 100kHz-21GHz	£1100
HP 182T with 8559A 100kHz-21GHz	£750
HP182T with 8558B 100kHz-1500MHz	£600

HP 182T with 8557A 10kHz-350MHz	£300-£400
HP 140T with 8555A 10MHz-18GHz	£500
ADVANTEST TR4131 10kHz-3.5GHz	£950
WAYNE KERR SSA1000A 150kHz-1GHz	£950
MARCONI 2382 200Hz-400MHz High Resolution	£1250
MARCONI 2370 30Hz-110MHz	£500
HP 8754A Network Analyser 4-1300MHz	£500
MARCONI 6500A Amplitude Analyser with head	£750
HP 334A Distortion Analyser 5Hz-600kHz	£100

SIGNAL GENERATORS

HP 8350B Sweeper with 8352B 10MHz-20GHz	£1500
HP 8350A Sweeper with 8352A 10MHz-20GHz	£1250
HP 8350B Mean Frame Only	£125
HP 8352B RIF Plug-in for 8350 0.01-8.4GHz	£500
HP 8350A RIF Plug-in for 8350 2.20GHz	£300
HP 8660C Sig Gen 1-3GHz	£450
HP 8660C Sig Gen 2.6GHz	£750
HP 86603A RIF Plug-in for 8660C 1-2600MHz	£
HP86631B Auxiliary Section for 8660C	£
HP86632B Modulation Section for 8660C	£
MARCONI 2017 0.01-124MHz Low Phase Noise	£500
MARCONI 2019 Synthesised AM/FM 80kHz-1040MHz	£325
FLUKE 6060B AM/FM Syn Sig Gen 10kHz-10500MHz	£300
LEADER LSC2219 Sig Gen 25-950MHz	£200
HP 8656B Synthesised 0.1-9900MHz	£500
HP 8656A Synthesised 0.1-9900MHz	£400
HP 8640A AM/FM 500kHz-512MHz	£150
HP 8620C Sweep Osc with 86209B 2-18.6GHz	£500
HP 8620C Sweep Osc with 86222B 0.01-2.4GHz	£400
HP8620C/B/A with any of the following plug-ins	£150-£200
HP 86220A Plug in 10-1300MHz	£
HP 86230B Plug in 1.5-4GHz	£
HP 86235A Plug in 1.7-4.3GHz	£
HP 86240A Plug in 2-8.5GHz	£
HP 86240C Plug in 3-6-8.6GHz	£
HP 86245A Plug in 5-9-12.4GHz	£
HP86250B Plug in 8-12.4GHz	£
HP 86250D Plug in 8-12.4GHz	£
HP 86260A Plug in 12.4-18GHz	£
MARCONI TT2015 AM/FM 10-5200MHz	£95
MARCONI TT2016 AM/FM 10kHz-120MHz	£95
PHILIPS PM5328 100kHz-180MHz with 200MHz Freq Counter IECE	£225
PANASONIC VP8117A AM/FM 100kHz-110MHz	£
FM 0-100kHz Digital Display etc Unused	£225

HP 8165A Programmable Signal Source 1MHz-50MHz (Pulse Function)	£325
HP 3325A Synthesised Function Gen 21MHz	£350
HP 3312A Function Gen 0.1Hz-13MHz AM/FM Sleep/TriBurst etc	£200
WAVETEK 21 Stabilised Function Gen 11MHz	£225
WAVETEK 23 Synthesised Function Gen 12MHz	£275
EXACT 529 AM/FM Function Gen 20MHz	£150
ANAL OGUE 2030 Synthesised Multi Function Waveform THANDER TG503 Pulse/Function Gen 5MHz	£195
THANDER TG502 Sweep/Function Gen 5MHz	£195
KROM-HITE 5200A Sweep Func Gen 0.00003Hz-3MHz	£150
HP 3310A Func Gen 0.005Hz-5MHz Sine/Sq/Tri/Ramp/Pulse	£200
PHILIPS PM5132 Function Gen 0.1Hz-2MHz	£95
PHILIPS PM5131 Function Gen 0.1Hz-2MHz	£75
FEEDBACK FG601 Func Gen 0.001Hz-1MHz	£60
HP 8112A Pulse Gen 50MHz	£750
HP 8111A Pulse Generator 20MHz	£400
LYONS PG73N Pulse Gen 20MHz	£50
LEADER LAG120B Sine/Sq Audio Generator 10Hz-1MHz	£60
FARNELL LF1M4 Sine/Sq Osc 10Hz-1MHz Low Distortion TTL Output, Amplitude Meter	£60
GOULD J3B Sine/Sq Osc 10Hz-100kHz Low Distortion	£50-£75
FARNELL LF1 Sine/Sq Oscillator 10Hz-1MHz	£50
MARCONI SANDERS 6055C Signal Source 850-2000MHz	£125
MARCONI SANDERS 6055B Signal Source 850-2150MHz	£125
MARCONI SANDERS 6056B Signal Source 2-4GHz	£125
MARCONI SANDERS 6057B Signal Source 4.5-8.5GHz	£125
MARCONI SANDERS 6058A Signal Source 12-18GHz	£125
MARCONI SANDERS 6070A Signal Source 400-1200MHz	£125
FLUKE 6011A Synthesised 11MHz	£125
PHILIPS 5514V Colour Bar Generator Video	£195
BLACK STAR ORION Colour Bar Gen	£50
BLACK STAR ORION Later Version Metal Case	£75

HP 5316A Universal Counter 0-100MHz HP/BI	£95
THANDER TF810 Frequency Counter 5Hz-200MHz Battery	£90
THANDER TF200 Frequency Meter 10Hz-200MHz 8 digit	£40
BLACK STAR Meteor 100 Counter 5Hz-100MHz	£50
BLACK STAR T1325 Counter Timer 1300MHz	£150
BECKMAN UC10A Universal Counter 120MHz	£90
LEADER LDC9043 Digital Counter 100MHz	£125

DIGITAL MULTIMETERS ETC

SOLARTRON 7150 6 1/2 digit True RMS IEEE	£75
SOLARTRON 7150Plus As Above - Temp Measurement	£100
DATRON 1065 5 1/2 digit Auto/Cal AC/DC Resistance IEEE	£95
FLUKE 77 3 1/2 digit Handheld	£35
FLUKE 77 Series 2 3/2 digit Handheld	£45
FLUKE 8060A 4 1/2 digit True RMS Handheld	£75
BECKMAN HD110 3 1/2 digit Handheld in Carry Case	£30
TTI 1995A 5 1/2 digit Bench	£50
SOLARTRON 7045 4 1/2 digit Bench	£30
AVO DA116 3 1/2 digit with Batteries & Leads	£20
AVO 8 Mk6 in Ever Ready Case with Leads etc	£75
AVO 8 Mk5 with Leads etc	£50
RACAL 9301A True RMS RIF Millivoltmeter	£175
RACAL 9300 True RMS Millivoltmeter 5Hz-20MHz usable to 60MHz	£30
RACAL 9300B as 9300	£45
GOODWILL GVT427 Dual Chan AC Millivoltmeter 10mV in 12 ranges 10Hz-1MHz Unused	£75
KEWOOD VT176 Dual Chan Millivoltmeter	£40

POWER SUPPLIES

FARNELL XA35-2T 0-35V 0-2A Twice Digital	£95
FARNELL LT30-2 0-30V 0-2A Twice	£110
FARNELL B30-20 30V 20A Variable No Meters	£110
FARNELL B30-10 30V 10A Variable No Meters	£55
FARNELL LT30-1 0-30V 0-1A Twice	£75
FARNELL L30-2 0-30V 0-2A	£55
FARNELL L30-1 0-30V 0-1A	£40
FARNELL E350 0-35V 0-200mA	£125
FARIBELL D30-2T 0-30V 0-2A Twice Digital	£95
THURLEY PL330 0-32V 0-3A Digital (Kerwood badged)	£75
THURLEY TS3021S 0-30V 0-2A LCD	£85
THURLEY PL320 0-30V 0-2A Digital	£55
TAKASAGO GMD35-3 0-35V 0-3A 2 Meters	£45
TAKASAGO TMD35-2 0-35V 0-2A 2 Meters	£35
ISOLATING TRANSFORMER - Yellow - 500VA with 13Amp Socket	£95

FREQUENCY COUNTERS/TIMERS

EIP 371 Source Locking Microwave Counter 10Hz-18GHz	£325
EIP 331 Autohet Microwave Counter 825MHz-18GHz	£195
HP 5396A Counter 10Hz-3GHz	£350
FEEDBACK SC290 Counter 1-3GHz	£75
RACAL 9916 Counter 10Hz-520MHz	£75
RACAL 9906 Universal Counter 200MHz	£95
RACAL 9904 Counter Timer 50MHz	£95
RACAL 1991 Counter/Timer 160MHz 9 digit	£195
MARCONI 2431A Frequency Meter 200MHz	£50
MARCONI 2437 Counter/Timer 100MHz	£75
HP 5340A Automt Microwave Counter 10Hz-18GHz	£250

STEWART OF READING

17A King Street, Mortimer, Near Reading RG7 3RS
 Telephone: (0118) 933 1111. Fax: (0118) 933 2375
www.stewart-of-reading.co.uk
 Open 9am-5.00pm Monday to Friday (other times by arrangement)



Used Equipment - GUARANTEED. Manuals supplied

This is a VERY SMALL SAMPLE OF STOCK. SAE or Telephone for lists. Please check availability before ordering. CARRIAGE all units £16. VAT to be added to Total of Goods and Carriage

SHERWOOD ELECTRONICS

FREE COMPONENTS

Buy 10 x £1 Special Packs and choose another one FREE

SP1 15 x 5mm Red LEDs	SP135 5 x Miniature slide switches
SP2 12 x 5mm Green LEDs	SP136 3 x BFY50 transistors
SP3 12 x 5mm Yellow LEDs	SP137 4 x W005 1.5A bridge rectifiers
SP5 25 x 5mm 1 part LED clips	SP138 20 x 2-2/63V radial elect. caps.
SP6 15 x 3mm Red LEDs	SP140 3 x W04 1.5A bridge rectifiers
SP7 12 x 3mm Green LEDs	SP142 2 x CMOS 4017
SP8 10 x 3mm Yellow LEDs	SP143 5 Pairs min. crocodile clips (Red & Black)
SP9 25 x 3mm 1 part LED clips	SP144 5 Pairs min. crocodile clips (assorted colours)
SP10 100 x 1N4148 diodes	SP146 10 x 2N3704 transistors
SP11 30 x 1N4001 diodes	SP147 5 x Stripboard 9 strips x 25 holes
SP12 30 x 1N4002 diodes	SP151 4 x 8mm Red LEDs
SP18 20 x BC182 transistors	SP152 4 x 8mm Green LEDs
SP20 20 x BC184 transistors	SP153 4 x 8mm Yellow LEDs
SP23 20 x BC549 transistors	SP154 15 x BC548 transistors
SP24 4 x CMOS 4001	SP156 3 x Stripboard, 14 strips x 27 holes
SP25 4 x 555 timers	SP160 10 x 2N3904 transistors
SP26 4 x 741 Op.Amps	SP161 10 x 2N3906 transistors
SP28 4 x CMOS 4011	SP164 2 x C106D thyristors
SP29 3 x CMOS 4013	SP165 2 x LF351 Op.Amps
SP33 4 x CMOS 4081	SP166 20 x 1N4003 diodes
SP34 20 x 1N914 diodes	SP167 5 x BC107 transistors
SP36 25 x 10/25V radial elect. caps.	SP168 5 x BC108 transistors
SP37 12 x 100/35V radial elect. caps.	SP171 8 Metres 18SWG solder
SP38 15 x 47/25V radial elect. caps.	SP172 4 x Standard slide switches
SP39 10 x 470/16V radial elect. caps.	SP173 10 x 220/25V radial elect. caps
SP40 15 x BC237 transistors	SP174 20 x 22/25V radial elect. caps
SP41 20 x Mixed transistors	SP175 20 x 1/63V radial elect. caps.
SP42 200 x Mixed 0.25W C.F. resistors	SP177 10 x 1A 20mm quick blow fuses
SP47 5 x Min. PB switches	SP178 10 x 2A 20mm quick blow fuses
SP49 4 x 5 metres stranded core wire	SP181 5 x Phono plugs - assid colours
SP101 8 Metres 22SWG solder	SP182 20 x 4.7/63V radial elect. caps.
SP102 20 x 6-pin DIL sockets	SP183 20 x BC547 transistors
SP103 15 x 14-pin DIL sockets	SP187 15 x BC239 transistors
SP104 15 x 16-pin DIL sockets	SP189 4 x 5 metres solid core wire
SP105 4 x 74LS00	SP192 3 x CMOS 4066
SP109 15 x BC557 transistors	SP195 3 x 10mm Yellow LEDs
SP112 4 x CMOS 4093	SP197 6 x 20 pin DIL sockets
SP115 3 x 10mm Red LEDs	SP198 5 x 24 pin DIL sockets
SP116 3 x 10mm Green LEDs	SP199 5 x 2.5mm mono jack plugs
SP118 2 x CMOS 4047	SP200 5 x 2.5mm mono jack sockets
SP124 20 x Assorted ceramic disc caps	
SP126 6 x Battery clips - 3 ea. PP3 + PP9	
SP130 100 x Mixed 0.5W C.F. resistors	
SP131 2 x TL071 Op.Amps	
SP133 20 x 1N4004 diodes	
SP134 15 x 1N4007 diodes	

RESISTOR PACKS - C.Film

RP3 5 each value - total 365 0.25W	£3.40
RP7 10 each value - total 730 0.25W	£4.65
RP10 1000 popular values 0.25W	£6.60
RP4 5 each value-total 345 0.5W	£4.30
RP8 10 each value-total 690 0.5W	£6.95
RP11 1000 popular values 0.5W	£8.95

2007 Catalogue available £1 inc. P&P or FREE with first order. P&P £1.75 per order. NO VAT Cheques and Postal Orders to: Sherwood Electronics, 7 Williamson St., Mansfield, Notts. NG19 6TD.

BatteryPlanet.co.uk



BATTERY PLANET

UK Battery Specialist
Brand new secure online shop
Trade & Bulk Enquiries Welcome!

Zinc Chloride Batteries		GP NiMH Rechargeable Batteries	
Memorex AA Zinc Chloride (4pk)	£0.49	GP NiMH 600mAh AAA (4pk)	£2.49
Memorex AAA Zinc Chloride (4pk)	£0.49	GP NiMH 750mAh AAA (4pk)	£3.29
Memorex C Zinc Chloride (2pk)	£0.59	GP NiMH 800mAh AAA (4pk)	£3.69
Memorex D Zinc Chloride (2pk)	£0.59	GP NiMH 850mAh AAA (4pk)	£3.99
Memorex 9v Zinc Chloride (1pk)	£0.59	GP NiMH 1300mAh AA (4pk)	£2.99
Panasonic Special Power AA (4pk)	£0.79	GP NiMH 2100mAh AA (4pk)	£3.99
Panasonic Special Power AAA (4pk)	£0.79	GP NiMH 2500mAh AA (4pk)	£6.49
Panasonic Special Power C (2pk)	£0.79	GP NiMH 2600mAh AA (4pk)	£6.99
Panasonic Special Power D (2pk)	£0.79	GP NiMH 2200mAh C (2pk)	£3.99
Panasonic Special Power 9v (1pk)	£0.79	GP NiMH 2200mAh D (2pk)	£3.99
		GP NiMH 170mAh PP3 (1pk)	£3.99
Alkaline Batteries		Lithium Coin Cells	
Memorex AA Alkaline (4pk)	£0.99	CR1216	£0.69
Memorex AAA Alkaline (4pk)	£0.99	CR1616	£0.69
Memorex C Alkaline (2pk)	£1.29	CR2016	£0.77
Memorex D Alkaline (2pk)	£1.29	CR2025	£0.77
Memorex 9v Alkaline (1pk)	£1.29	CR2032	£0.77
Panasonic Xtreme AA (4pk)	£1.49	CR2430	£0.95
Panasonic Xtreme AAA (2pk)	£1.49		
Panasonic Xtreme C (2pk)	£1.49	Alkaline Button Cells	
Panasonic Xtreme D (2pk)	£1.49	LR41/L736/AC3	£0.19
Panasonic Xtreme 9v (1pk)	£1.49	LR43/L1142/AG12	£0.19
		LR44/L1154/AG13	£0.19
Lithium/Camera Batteries		LR54/L1131/AG10	£0.19
Mitsubishi 6v Lithium 2CR5 (1pk)	£0.99	LR60/L621/AG1	£0.19
Mitsubishi 3v Lithium CR2 (1pk)	£0.99	Other Button/Coin Cells available	CallE
Mitsubishi 3v Lithium CR123A (1pk)	£0.99		
Mitsubishi 6v Lithium CR-P2 (1pk)	£0.99	Other Batteries & Accessories	
Energizer Ultimate Lithium AA (2pk)	£3.99	Battery Boxes (Switched/Unswitched)	CallE
Energizer Ultimate Lithium AAA (2pk)	£3.99	Battery Holders (PP3/Flying Leads)	CallE
Energizer Ultimate Lithium AAA (4pk)	£5.99	Battery Snaps (PP3/PP9)	CallE
		Battery Connectors (PP3/PP9/PCB)	CallE
		Tagged/PCB Batteries	CallE
Zinc Air Hearing Aid Batteries		GP Chargers also available	CallE
Rayovac 1.5v 10AE (Yellow) (6pk)	£2.99	(USmart, Smart2, Quick2 & Universal)	
Rayovac 1.5v 13AE (Orange) (6pk)	£2.99		
Rayovac 1.5v 312AE (Brown) (6pk)	£2.99		
Rayovac 1.5v 675AE (Blue) (6pk)	£2.99		

16 Field Street
Cannock
Staffs.
WS11 5QP
Tel: 0845 166 2314
Fax: 0845 166 2316
Sales@BatteryPlanet.co.uk



All prices include Vat @ 17.5%
UK P&P for batteries £1.00 for 1st item, then additional £0.25 per item.
Except C/D Cells. £1.50 for 1st item, then additional £0.50 per item.
Bulk orders please call to arrange carriage.
UK P&P for Battery Chargers is £2.95 each
Please allow upto 14 days for delivery.

PCB-POOL®

SERVICING YOUR COMPLETE PROTOTYPE NEEDS

1 EUROCARD
(160 x 100 mm)
+ Tooling
+ Photoplots
+ VAT
€49

Price example
Any size and contour possible!

Optional:

- Soldermask
- Fast-turnaround
- Silkscreen
- 4-Layer Multilayer
- 6-Layer Multilayer

DOWNLOAD OUR FREE LAYOUT SOFTWARE!

Freephone 0800-3898560
Tel: +353 (0)61 701170
Fax: +353 (0)61 701165
pcb-pool@bep.com

Simply send your files and order ONLINE: **PCB-POOL.COM**

SELL TO HOBBYISTS SCHOOLS COLLEGES AND UNIVERSITIES

through our
'Technology, Hobbies and Education Store'

There are huge educational budgets to be spent and accessing buyers has always been difficult. We can now get you directly to the people who influence the purchase, teachers and lecturers through our 'techno store'. As they use our educational software, they will find your site. **software.**

Visit eptsoft.com and try it now!

Installed in thousands of secondary schools, colleges and university departments worldwide as an integral part of all our download Educational Software and accessed by thousands of students, teachers, lecturers every day. We have long used integrated web browsers to promote our software. now you can add your own products.

Link your business website and begin selling to hobbyists and education for just **£20.83 + VAT per month**, see eptsoft.com for details.

Principles V9.2 Home Study Pack software

Principles V9.2! our top selling package for maths, computing, ICT, physics, CDT, electronics, electrical, mechanics, engineering, PICs, model railways, amateur radio, motor vehicle maintenance. GCSE, A-Level, HNC HND and Degree. Download and fully installed for less than 20p a day, you only pay for as long as you need it!

www.eptsoft.com

eptsoft limited, Glebe House, School Lane, East Kival, Spilsby, Lincolnshire. PE23 4AU
Tel: 01790 754037 email info@eptsoft.com

INTERFACE



Robert Penfold

COMPUTER-CONTROLLED POWER SUPPLY CONTROLS

RECENT *Interface* articles have covered ways of using Visual BASIC to produce virtual controls, panel meters, etc. This month's article continues this theme with an improved control program for a circuit that was featured in a previous *Interface* article (*EPE* September 2005).

The circuit in question is the computer-controlled power supply (Fig.1). This provides an output voltage that can be varied from 0 to 12.75 volts with a resolution of 50 millivolt (0.05 volts). Output currents of up to one amp can be accommodated.

The Circuit

Operation of the circuit will not be considered in detail here as it has been fully described in previous *Interface* articles. The basic scheme of things is to have IC2 provide a stable 5V supply to an 8-bit digital-to-analogue converter based on IC1. IC3 acts as a voltage amplifier that boosts the output of IC1 by a factor of five, giving a 0 to 12.75V output range from the 0 to 2.55V output from IC1. Variable preset (resistor) VR1 enables the voltage gain of IC1 to be adjusted so that precisely the required output voltage range is obtained.

TR1 is a power Darlington transistor that acts as a buffer stage so that high output currents can be accommodated. This device has to dissipate up to around 16 watts or so at high output currents and low output potentials, so it must be fitted on a large heatsink. Correct operation of the circuit is reliant upon the very high current gain of TR1, and there is no chance of the unit working properly if an ordinary power transistor is used here.

Transistor TR2 and resistor R3 act as a conventional current limiter that prevents output currents of more than about 20mA from being drawn. Two relays are controlled from handshake outputs of the

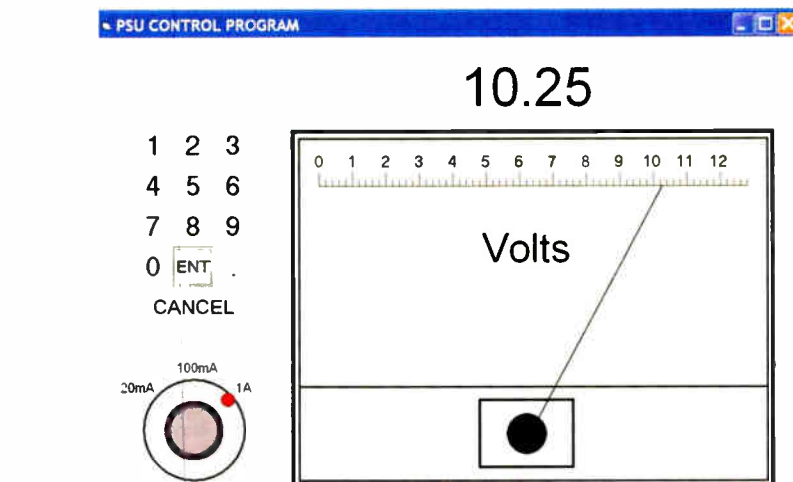

Fig. 2: The improved control program for the power supply has a keypad that is used to enter the required output voltage. A three-position virtual rotary switch is used to select the limit current

parallel port via switching transistors TR3 and TR4. The two sets of relay contacts (RLA1 and RLB1) can be used to shunt R4 or R5 across R3, providing respective limit currents of about 100mA and 1A.

The circuit must be powered from a reasonably stable 16V to 18V supply that can provide output currents of up to about 1.1A.

Software

The original control program used a scrollbar component to set the output voltage, plus three command buttons to enable the required limit current to be selected. This program works well enough, but using the techniques described in recent *Interface* articles it is possible to produce a more

professional control program. The final program is shown in operation in Fig.2.

A simple keypad is used to enter the required output potential. As each character is entered, it is added to the digital display. The Cancel button can be used to remove the last digit entered, and using multiple operations it is possible to remove several characters. The Enter button is operated once the correct voltage has been entered, and the virtual panel meter then changes to indicate that the output voltage has been changed. A different method of controlling the limit current is used in the new program. The three command buttons of the original have been replaced by a three position virtual rotary switch.

Operation of the numeric keypad will not

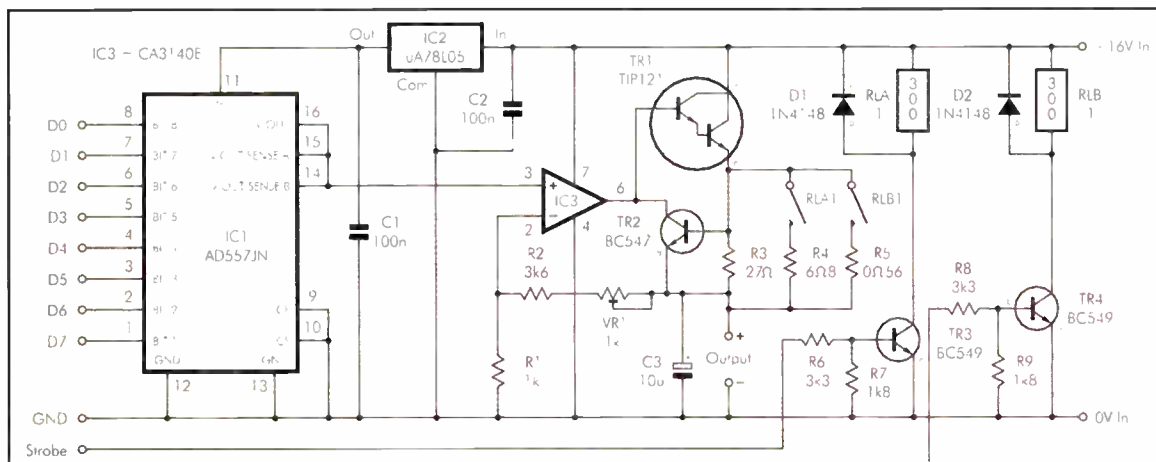

Fig. 1: The circuit diagram for the computer-controlled power supply. It provides an output voltage range of 0 to 12.75 volts with a resolution of 50 millivolts

be considered in detail here, since it is essentially the same as the one described in a previous *Interface* article. It was moved into the current program using the Copy and Paste method. It has to be borne in mind that reusing programs and sections of programs in this way can produce one or two problems. The usual cause of these is that component names in the new

material duplicate those already present in the program. In order to correct this it is just a matter of renaming the offending components, and then changing the program code to match.

Of course, it will usually be necessary to make changes to the program code in order to obtain the desired result. In this case the routine for the Enter key (Command11) includes an Out instruction that writes the appropriate value to the printer port. As usual, it is necessary for **Inpout32.dll** to be available to the program, and the BAS file supplied with it must be loaded into Visual BASIC 6 if you wish to experiment with or modify the program.

The number generated by the keypad is the required output potential in volts, but the output port requires an 8-bit value. In order to obtain a value in the range 0 to 255 it is merely necessary to multiply the value from the keypad by 20.

Meter

The meter was also taken from a previous program and merged into the current one using the Copy and Paste method. It will inevitably be necessary to make slight adjustments to the program to accommodate the fact that the 'pasted' meter will be in a different position on the form. The pointer of the virtual meter is provided by the Line66 component, and it is just a matter of using an appropriate value for its X2 parameter.

The basic X2 value is obtained by multiplying the value for the output port by 30. It is then necessary to add an appropriate offset to this value so that the pointer appears in the appropriate part of the screen. One way of obtaining the offset is to select the long horizontal line in the meter's scale, and then read its X1 value from the Properties Window. In this case the X1 value, and therefore the required offset, is equal to 3960.

A similar problem occurs when the virtual rotary switch is transferred to another program with a different form. Clicking one of its legends sets the appropriate limit current and moves the red dot to the appropriate position. This enables the user to see the currently selected current. The correct co-ordinates for the dot (Shape53) will be different when the switch is used at a new position on the form. The easy way to find the new co-ordinates is to move the dot into each of the three positions, making a note of the Top and Left parameters in the Properties Window for each position.

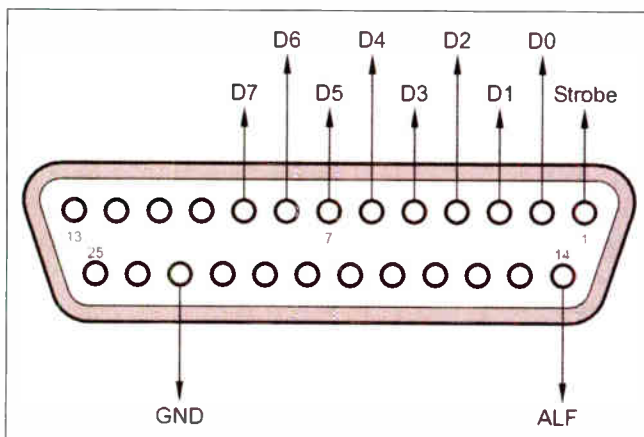

Fig.3: Connection details for the PC parallel port. The connections to the port are made via a 25-way male D-type connector.

Listing 1

```
Public output As Variant

Private Sub Command1_Click()
output = output & "1"
Label1.Caption = output
End Sub

Private Sub Command10_Click()
output = output & "0"
Label1.Caption = output
End Sub

Private Sub Command11_Click()
output = output * 20
output = output \ 1
If output > 255 Then Label1.Caption = "Error"
If output > 255 Then output = 0
Reading = output * 30
Reading = Reading + 3960
Line66.X2 = Reading
Out &H378, output
output = ""
End Sub

Private Sub Command12_Click()
output = output & "."
Label1.Caption = output
End Sub

Private Sub Command13_Click()
Length = Len(output)
If Length = 0 Then Exit Sub
Length = Length - 1
output = Left(output, Length)
Label1.Caption = output
End Sub

Private Sub Command2_Click()
output = output & "2"
Label1.Caption = output
End Sub

Private Sub Command3_Click()
output = output & "3"
Label1.Caption = output
End Sub

Private Sub Command4_Click()
output = output & "4"
Label1.Caption = output
End Sub

Private Sub Command5_Click()
output = output & "5"
Label1.Caption = output
End Sub

Private Sub Command6_Click()
output = output & "6"
Label1.Caption = output
End Sub

Private Sub Command7_Click()
output = output & "7"
Label1.Caption = output
End Sub

Private Sub Command8_Click()
output = output & "8"
Label1.Caption = output
End Sub

Private Sub Command9_Click()
output = output & "9"
Label1.Caption = output
End Sub

Private Sub Form_Load()
Shape53.Top = 6360
Shape53.Left = 960
Out &H37A, 3
End Sub

Private Sub Label2_Click (Index As Integer)
Shape53.Top = 6360
Shape53.Left = 960
Out &H37A, 3
End Sub

Private Sub Label3_Click (Index As Integer)
Shape53.Top = 6120
Shape53.Left = 1560
Out &H37A, 2
End Sub

Private Sub Label4_Click (Index As Integer)
Shape53.Top = 6360
Shape53.Left = 2160
Out &H37A, 1
End Sub
```

These values are then used at the appropriate points in the program (the routines for Label2, Label3, and Label4). The routines for these label components must also

output the appropriate values to the handshake output register of the parallel port, which will normally be at address &H37A.

A short routine sets the limit current at an initial setting of 20mA when the form loads. A different initial setting could be used, but the lowest current represents the safest default setting. As featured in an earlier *Interface* article, the virtual rotary switch actually had five positions. Converting it to three-way operation

for use in this program simply entailed deleting the label components for what were originally positions one and five.

Finally

Using Visual BASIC 6 it is quite easy to produce virtual controls and to integrate them into the controlling software for real-world devices. Reusing virtual controls, meters, etc., in other programs is generally quite straightforward, but some changes will usually be required. Problems with duplicate names are easily rectified, and can be avoided in the first place with careful naming of components.

In some cases it is necessary to alter the co-ordinates used in the program, but as we have seen, the Properties Window can usually be made to provide the information you require. Obviously, it will sometimes be necessary to add to an existing design or remove parts of it, but both types of operation are normally straightforward. Modifying an existing design should certainly be quicker and easier than starting from scratch.

C for PICs

A four part beginners guide to using the C programming language for PIC microcontrollers

Part 4 – A practical implementation of using C for USB control of LCDs

By Mike Hibbett

WE have covered some fairly dry material over the last three months, and possibly surprised some of you by the lack of code being discussed. Hopefully, however, you will agree that there is a lot going on 'under the hood' of a compiler, and that the journey has been worth the effort. Perhaps things are beginning to make some sense.

Compilers from the variety of vendors will take different approaches to implementing the various steps required to build your programs but they all have to deal with the same issues – they have a pre-processor, libraries, start-up code and linker files. They will just handle things in different ways, but you should be able to recognise the processes going on.

Constructional challenge

This month – finally – we get into a real C programming challenge. This is where you will get to see just how different high level programming and assembly language can be. We are going to take a complex project – a USB device – and create it from a standing start within a few hours.

Although this article is in effect a constructional project we are going to depart from the normal editorial style and instead concentrate on the thought processes that go on as the design is created. Programming efficiently in high level languages is often more of a construction process; finding and then studying existing blocks of freely available software and working out how to tie them together with a little glue logic.

This month, we set ourselves an arbitrary challenge – 'it would be nice to design a simple LCD display that can interface to a PC through the USB

interface. The USB interface can supply the power, so the unit should be small and require no external power supply. Let's put a couple of buttons on it too, so we can have an interactive display.'

That's not an unreasonable challenge – USB can work with cables up to 5 metres in length, so this could act as a remote display/interface to the PC.

What's available

Our first port of call will be the Microchip website to see what PICs support USB. The PIC18F4550 family look good; the PIC18F2550 in particular comes in a small DIP28 or SO28 package. Importantly, it is also available from the supplier Farnell in one-off quantities.

We downloaded the datasheet for the part and skimmed through it. It has the usual collection of I/O ports, but interestingly a higher clock frequency. This device can run at 48MHz – 20% faster than other PIC18F devices.

The datasheet indicates that the wiring for USB is simple, when bus powered: a 220nF capacitor and a USB connector. This is simpler than an RS232 interface, which will make our circuit very straight forward.

The section detailing the selection of the oscillator clock frequency is a little confusing, but it eventually becomes clear that while the USB peripheral must run at a particular frequency for full speed operation (48MHz) there are many options for the choice of external crystal frequency. We will opt for 20MHz, since a crystal of that frequency is to hand.

A search of the Microchip website for application notes on USB yields several, but one in particular catches

our eye – 'AN956 Migrating Applications to USB from RS-232 UART'. Sounds perfect. And there is an associated code download available, which we download.

The application note describes the set of USB functions provide by Microchip, functions which are implemented in C and freely available. Once the downloaded code file (**CDC_RS232_Emulation.exe**) is installed it will provide a complete MPLAB project with the USB functions and example code included. Perfect!

Simply running the downloaded program will start the installation process. Just click on 'Accept' and 'Next' at the various confirmation dialogs, and when finished a new directory structure will be created under **C:\MCHPFSUSB** containing all the source files.

The circuit

From studying the datasheet we now have a good idea of a design for the USB Interface, and the clock frequency that we should run the processor at. Next, we need to work out how best to interface an LCD display. Over the years there have been many designs in *EPE* which include LCDs, so we know all that is required is a 4.7kΩ trimmer to set the LCD voltage and a few wires to connect the data bus and control signals. The question is, however, to where should we connect the LCD?

As we will be using the C library LCD functions to control the display, we go and take a look in the C library manual for inspiration on which port pins to connect to. Sure enough, the section 'External LCD Functions', short as it is, gives a table showing the default port connections. To save complicating matters (you would have

```
#pragma config IESO=OFF,
FCMEM=OFF, FOSC=HSPLL_HS
#pragma config PWRT=OFF,
BOR=OFF, VREGEN=ON,
MCLRE=ON
#pragma config PBADEN=OFF,
STVREN=ON, LVP=OFF
#pragma config XINST=OFF,
DEBUG=OFF, WDT=OFF
```

The example code has several configuration options for different hardware designs. As we are going to be bus powered only, we do not need to implement code to check to see when the USB cable is plugged in – the board is not powered unless the cable is plugged in! To handle that design decision we must remove a line of code in the file `usbcfg.h`:

```
#define USE_USB_BUS_SENSE_
IO
```

Either remove it completely or simply comment it out, like this:

```
// #define USE_USB_BUS_SENSE_
IO
```

We are now at the stage where we can test the code to see if the simple example works.

In the IDE, right click over the entry `MCHPUSB.mcp` in the `mcw` window, and select 'Build All'. You may get a strange message about 'Different tool used last time'. Just accept the default alternative and continue; the message will not appear again.

Once the build has completed, check for any errors in the output window. You will get a few warning messages – 'expression is always true' and several 'suspicious pointer conversion', these are acceptable and are as a result of Microchip's design.

The `.hex` file will be found in the `_output` sub-directory. Program it into your PIC18F2550 using your favourite programmer, and then plug it into your circuit.

USB driver

When you connect your board to the PC, there will be a brief period of hard disk activity, then a driver installation wizard dialog box will appear prompting you to select the driver for the new USB device.

What the PC is looking for here is a driver information file (`.inf`) that will

describe to Windows how to talk to our hardware. Microchip have created such a file, and you can find it in the directory `C:\MCHPFSUSB\FW\CDC\INF\WIN2K_WINXP`. We will use the 'Wizard' to locate and install the file. This only needs to be done once. The steps vary slightly between Windows 2000 and Windows XP, but ultimately what you are doing is locating the `.inf` file and installing it.

Once the 'Found New Hardware Wizard' dialog appears, click Next, then Next again. (Under XP you will be asked if Windows can connect to Windows Update – select No to that option.) You should be prompted to tell Windows where to look for the driver; click on 'Specify a location', and click Next. Click on Browse, and then navigate to the directory specified above.

If prompted to do so, double click on the file `mchpcdc.inf`. Click Next, (you may be required to click on 'continue anyway') and the driver for mapping our USB device to a com port will complete. On Windows XP you will be prompted for the directory first, and the `.inf` file will be auto-discovered. You should end up with a message similar to that in Fig.2.

Click 'Finish', and your hardware will now be ready for use. You should be able to open up HyperTerminal and select the new com port. The com port parameters are irrelevant – this is a virtual com port – so just select 9600, 8 data bits, no parity, no stop bits. Press the buttons on the unit and you should see a message written to the HyperTerminal window.

Once you get to this stage you can be confident with adding some real functionality to the code; it's time to get the LCD working!

LCD Code

The first step will be to add the LCD initialisation code at the start of the program. In `main.c`, right at the beginning of the main function, add the (indented) code:



Fig.2: Final completion screen

```
OpenXLCD(FOUR_BIT & LINES_
5X7);
putsrXLCD("EPE USB DISPLAY");
while(BusyXLCD());
WriteCmdXLCD(BLINK_OFF &
CURSOR_OFF);
```

This will enable the display, and turn the cursor and blink functions off. As we are referencing LCD functions we will have to add the following include file at the top of `main.c` (put it at the end of the other include files):

```
#include <xlcd.h>
```

The LCD routines require three functions to be written by the user: `DelayFor18TCY()`, `DelayXLCD()` and `DelayPORXLCD()`. These three routines implement delays – 18 cycles, 5ms and 15ms respectively, to provide delay timings required by the LCD module. You can implement these anywhere in your code; we have added them in `main.c`. As these routines are commonly implemented you will find an explanation of how to write them in the C Library document. They are very simple.

In the file `user.c` we must remove the following lines of code, in the function `inituser()`

```
InitTempSensor();
InitializeUSART()
```

Obviously we do not have a USART or temperature sensor on our hardware, so these calls would only interfere with ours.

We can now add our actual code in the function `processio()` within `user.c`, just twenty lines of code to handle the keypresses and writing to the LCD.

To save printing the code here we have included all the modified source files (`main.c`, `user.c`, `io_cfg.h`, `usbcfg.h`) in the *Pic N' Mix* section of the download page on the *EPE* website (access via www.epemag.co.uk).

The code added to `processio()` is very simple; we look to see if either of the buttons have been pressed, and if so, print a '1' or '2' character over the virtual serial port back to the PC. That's four lines of code. A further 26 lines of code poll the virtual serial port for incoming characters; if a character is received, a simple if-else statement tests for special characters (0x0C – clear the LCD, 0x0D – move to next line), otherwise the character is simply printed to the LCD. This code is simple, short, clear – and required no knowledge of implementing USB firmware.

When you download the code onto the PIC and re-connect the hardware to your PC, the hardware will be detected automatically – no need to reload the driver.

If you run HyperTerminal now, pressing the keys on the unit should result in the characters '1' and '2' appearing on the HyperTerminal window. Any keys pressed on the PC keyboard will be displayed on the LCD. If you press the <enter> key

the LCD will move to the start of the second line. If you press <CTRL> and <L> simultaneously, the LCD display should clear. You can control the unit in Visual Basic or any other programming language by simply referring to the (virtual) com port.

That's a lot of functionality for about 30 lines of code!

Improvements

There are several ways in which this code could be easily improved. Adding control to the backlight by connecting it to a spare output port would be useful; you can add a new clause in the if-else statements in the function `ProcessIO()` that uses another non-printable character (0x07 perhaps) to toggle the backlight on and off. It wouldn't be difficult to add a piezo buzzer to the board – then you could use the device as a remote console to the PC, perhaps to buzz and display a notification when an email comes in.

There is another, very useful piece of software supplied by Microchip that can make software development very easy. You may have stumbled on the fact if you looked at the contents of the `.hex` file of our project – there is a big gap at the beginning of memory before the program starts. This is because the code written by Microchip has been designed to co-exist with a USB bootloader, another program freely available on the Microchip

website. A discussion of the use of the bootloader is beyond the scope of this series of articles, but you may like to download the bootloader code and examine it. The link to it is provided in the references. If there is sufficient interest we may cover this in a future article (let us know).

We hope you have found this to be an interesting series of articles, and that we have fired your enthusiasm for experimenting with C. Although complicated at the start, the rewards are high, and the language may make a welcome change from the challenges of assembly. If nothing else, it is another tool in your toolbox!

If you would like to discuss any of the topics raised in this series of articles, feel free to join the conversation on the *Chat Zone* forum, which can be accessed from the *EPE* website, as above. You may also contact the author, Mike Hibbett, directly at mike.hibbett@gmail.com

References

- PIC18F4550 datasheet: www.microchip.com
- RS232 Example Code – AN956 Source Code: www.microchip.com/stellent/idcplg?IdcService=SS_GET_PAGE&nodeId=2121&fragment6_NextRow=151
- USB Bootloader Firmware: www.microchip.com/stellent/idcplg?IdcService=SS_GET_PAGE&



NEWSAGENTS ORDER FORM

Please reserve/deliver a copy of *Everyday Practical Electronics* for me each month

Name and Address

..... Post Code Tel

Everyday Practical Electronics is published on the second Thursday of each month and distributed S.O.R. by SEYMOUR
Make sure of your copy each month – cut out or photocopy this form, fill it in and hand it to your newsagent

Get your mouth



Get your claws around our Free 410+ page catalogue from Australia. Visit our website www.jaycarelectronics.co.uk/catalogue All prices in £ Stg.



POST AND PACKING CHARGES:

Order Value	Cost	Order Value	Cost
£20 - £49.99	£5	£200 - £499.99	£30
£50 - £99.99	£10	£500+	£40
£100 - £199.99	£20		

Max weight 12lb (5kg). Heavier parcels POA. Minimum order £20.
Note: Products are dispatched from Australia, so local customs duty and taxes may apply.

Speedo Corrector MkII

KC-5435 £14.50 + post & packing

When you modify your gearbox, diff ratio or change to a large circumference tyre, it may result in an inaccurate speedometer. This kit alters the speedometer signal up or down from 0% to 99% of the original signal. With this improved model, the input set-up selection can be automatically selected and it also features an LED indicator to show when the input signal is being received. Kit supplied with PCB with overlay and all electronic components with clear English instructions.



Improved Model!

Magnetic Cartridge Pre-amp

KC-5433 £11.75 + post & packing

This kit is used to amplify the 3-4mV signals from a phono cartridge to line level, so you can use your turntable with the CD or tuner inputs on your Hi-Fi amplifier - most modern amps don't include a phono input any more. Dust off the old LP collection or use it to record your LPs on to CD. The design is suitable for 12" LPs, and also allows for RIAA equalisation of all the really old 78s. Please note that the input sensitivity of this design means it's only suitable for moving-magnet, not moving-coil cartridges. Kit includes PCB with overlay and all electronic components.
• Requires 12VAC power



Powertool Battery Charger Controller

KC-5436 £11.75 + post & packing

Enhance the performance of the charger supplied with your power tool with this controller. It incorporates charge timeout, min and max temperature monitoring, Delta charge detection, power and charge LED indicator, adjustable Delta V, temperature settings, and optional adjustable trickle charge. Suits both Ni-Cd and Ni-MH cells. Kit includes PCB with overlay, case, all electronic components and clear English instructions.

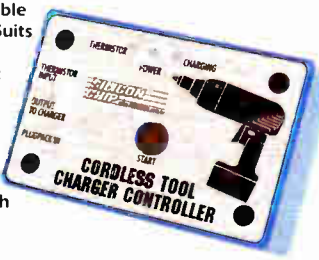

Two-Way SPDIF/Toslink Digital Audio Converter Kit

KC-5425 £7.25 + post, packing

This kit converts coaxial digital audio signals into optical or vice-versa. Use this bit stream converter in situations where one piece of equipment has an optical audio input and the other a coaxial digital output. Kit includes Toslink optical modules, PCB with overlay, case with screen printed lid, all electronic components and clear English instructions.



Requires 9-12VDC wall adaptor (Maplin #JC91Y £14.99)

Theremin Synthesiser MKII

KC-5426 £43.50 + post & packing

By moving your hand between the metal antennae, create unusual sound effects! The Theremin MKII improves on its predecessor by allowing adjustments to the tonal quality by providing a better waveform. With a multitude of controls, this instrument's musical potential is only limited by the skill and imagination of its player. Kit includes stand, PCB with overlay, machined case with silkscreen printed lid, loudspeaker, pitch antennae, all specified electronic components and clear English instructions.

Requires 9-12VDC wall adaptor (Maplin #UG01B £13.99)



Improved Model!

As used in the Beach Boys classic hit 'Good Vibrations'

Starship Enterprise™ Door Sound Simulator

KC-5423 £11.75 + post, packing

This easy-to-build kit emulates the unique noise made when the cabin doors on the Starship Enterprise™ open and close. The 'shut' noise is also duplicated. The sound emulator can be triggered by switch contacts (normally open), which means you can use a reed magnet switch, IR beam or PIR detector. Kit includes a machined, silkscreened and pre-drilled case, speaker and all electronics components with clear English instructions.

Requires 9-12VDC wall adaptor (Maplin #JC91Y £14.99)



For all you Trekkie fans

Radar Speed Gun

KC-5429 £29.00 + post & packing

This Doppler radar gun reads speed in km/h or mph up to 250 km/h or 155 mph. It has a resolution of 1 km/h or 1 mph with an accuracy of 1%, and also has a hold switch so you can freeze the reading. There's a jiffy box to mount the electronics in, and the enclosure for the radar gun assembly is made from 2 x coffee tins or similar. Details included. Kit includes PCB and all specified components with clear English instructions.
• Requires 12VDC power.



DC Relay Switch

KC-5434 £4.50 + post & packing

An extremely useful and versatile kit that enables you to use a tiny trigger current - as low as 400µA at 12V to switch up to 30A at 50VDC. It has an isolated input, and is suitable for a variety of triggering options. The kit includes PCB with overlay and all electronic components with clear English instructions.



Galactic Voice Kit

KC-5431 £13.25 + post & packing

Be the envy of everyone at the next Interplanetary Conference for Evil Beings with this galactic voice simulator kit. Effect and depth controls allow you to vary the effect to simulate everything from the metallic-challenged C-3PO, to the hysterical ranting of Daleks hell-bent on exterminating anything not nailed down. The kit includes PCB with overlay, enclosure, speaker and all components. For those who really need to get out of the house a lot more. Take me to your leader.
• Requires 9V battery



around our Catalogue!

Everyday Practical Electronics Feature Kits

Over the last 12 months and continuing into the New Year, Everyday Practical Electronics Magazine has been publishing a series of popular kits by the acclaimed Silicon Chip Magazine Australia. These projects are brilliantly designed 'bullet proof' and already tested down under. All Jaycar kits are supplied with specified board components, quality fibreglass tinned PCBs and have clear English instructions. Watch this space for future featured kits.

Automotive Courtesy Light Delay

KC-5392 £5.95 + post & packing

This kit provides a time delay in your vehicle's interior light, for you to buckle-up your seat belt and get organised before the light dims and fades out. It has a 'soft' fade-out after a set time has elapsed, and has universal wiring. Kit supplied with PCB with overlay, all electronic components and clear English instructions.

Recommended box UBS
HB-6015 £0.83



Featured in this month's Everyday Practical Electronics Magazine!

Delta Throttle Timer

KC-5373 £7.95 + post & packing

It will trigger a relay when the throttle is depressed or lifted quickly. There is a long list of uses for this kit, such as automatic transmission switching of economy to power modes, triggering electronic blow-off valves on quick throttle lifts and much more. It is completely adjustable, and uses the output of a standard throttle position sensor. Kit supplied with PCB and all electronic components.

• As published in Everyday Practical Electronics November 2006



Recommended box UBS
HB-6013 £1.05

Studio 350 High Power Amplifier Kit

KC-5372 £55.95 - post & packing

It delivers a whopping 350WRMS into 4 ohms, or 200WRMS into 8 ohms. Using eight 250V 200W plastic power transistors, it is super quiet, with a signal to noise ratio of -12.5dB(A) at full 8 ohm power. Harmonic distortion is just 0.002%, and frequency response is almost flat (less than -1dB) between 15Hz and 60kHz. Kit supplied in short form with PCB and electronic components. Kit requires heatsink and +/- 70V power supply (a suitable supply is described in the instructions).

• As published in Everyday Practical Electronics October & November 2006

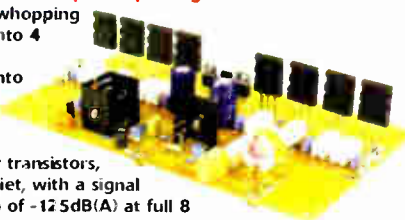

50MHz Frequency Meter Kit

KC-5369 £22.50 + post & packing

This meter is autoranging and displays the frequency in either hertz, kilohertz or megahertz. Features compact size (130 x 67 x 44mm), 8 digit LCD, high and low resolution modes, 0.1Hz resolution up to 150Hz, 1Hz resolution maximum up to 150Hz and 10Hz resolution above 16MHz. Kit includes PCB, case with machined and silkscreened lid, pre-programmed PIC and all electronic components with clear English instructions.

• As published in Everyday Practical Electronics September 2006

Requires 9VDC wall adaptor (Maplin #G574R £10.99).



2 Amp DC-DC Converter Kit

KC-5358 £13.75 + post & packing

This kit will step-up 12V to between 13.8 and 24VDC. Use it to charge 12V sealed lead acid batteries (6.5Ah or larger), run your laptop and many other devices from a 12V supply. It uses an efficient switchmode design, features fuse and reverse polarity protection, and an LED power indicator. Kit includes PCB, all electronic components, and silkscreened front panel.

• As published in Everyday Practical Electronics August 2006



Smart Card Reader and Programmer Kit

KC-5361 £15.95 + post & packing

Program both the microcontroller and EEPROM in the popular gold, silver and emerald wafer cards. Card used needs to conform to ISO-7816 standards, which includes ones sold by Jaycar. Powered by 9-12 VDC wall adaptor or a 9V battery. Instructions outline software requirements that are freely available on the internet. Kit supplied with PCB, wafer card socket and all electronic components. PCB measures: 141 x 101mm.

• As published in Everyday Practical Electronics May 2006

Requires 9-12VDC wall adaptor (Maplin #UG01B £13.99)



Jaycar cannot accept responsibility for the operation of this device, its related software, or its potential to be used in relation to illegal copying of smart cards in cable TV set top boxes.

Programmable Continuity Tester Kit

KC-5362 £8.70 + post & packing

This unit will test for continuity from 1-100ohms, making it ideal for measuring low resistance devices. It is accurate, reliable, and works extremely well. Kit supplied with PCB, case with silkscreened panel and all electronic components.

• As published in Everyday Practical Electronics April 2006



AC/DC Current Clamp Meter Kit for DMMs

KC-5368 £8.75 + post & packing

A great low cost alternative. It uses a simple hall effect sensor, an iron ring core and connects to your digital multimeter. It will measure AC and DC current and has a calibration dial to allow for any magnetising of the core. Kit supplied with PCB, clamp, case with silkscreened front panel and all electronic components.

• As published in Everyday Practical Electronics January 2006



Log on to
www.jaycarelectronics.co.uk/catalogue
for your FREE catalogue!

0800 032 7241

(Monday - Friday 09.00 to 17.30 GMT + 10 hours only).
For those who want to write: 100 Silverwater Rd
Silverwater NSW 2128 Sydney AUSTRALIA

410+ page
Catalogue

All prices
in £



Jaycar Electronics

EPE IS PLEASED TO BE ABLE TO OFFER YOU THESE ELECTRONICS CD-ROMS

ELECTRONICS PROJECTS



Logic Probe testing

Electronic Projects is split into two main sections: **Building Electronic Projects** contains comprehensive information about the components, tools and techniques used in developing projects from initial concept through to final circuit board production. Extensive use is made of video presentations showing soldering and construction techniques. The second section contains a set of ten projects for students to build, ranging from simple sensor circuits through to power amplifiers. A shareware version of Matrix's CADPACK **schematic capture, circuit simulation and p.c.b. design** software is included. The projects on the CD-ROM are: Logic Probe; Light, Heat and Moisture Sensor; NE555 Timer; Egg Timer; Dice Machine; Bike Alarm; Stereo Mixer; Power Amplifier; Sound Activated Switch; Reaction Tester. Full parts lists, schematics and p.c.b. layouts are included on the CD-ROM.

ELECTRONICS CAD PACK

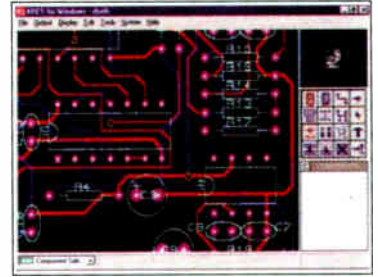

PCB Layout

Electronics CADPACK allows users to design complex circuit schematics, to view circuit animations using a unique SPICE-based simulation tool, and to design printed circuit boards. CADPACK is made up of three separate software modules. (These are restricted versions of the full Labcenter software.) **ISIS Lite** which provides full schematic drawing features including full control of drawing appearance, automatic wire routing, and over 6,000 parts. **PROSPICE Lite** (integrated into ISIS Lite) which uses unique animation to show the operation of any circuit with mouse-operated switches, pots, etc. The animation is compiled using a full mixed mode SPICE simulator. **ARES Lite** PCB layout software allows professional quality PCBs to be designed and includes advanced features such as 16-layer boards, SMT components, and an autorouter operating on user generated Net Lists.

ELECTRONIC CIRCUITS & COMPONENTS V2.0

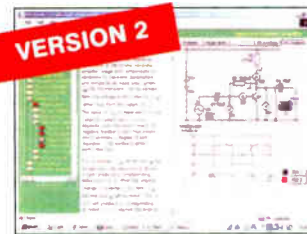

Circuit simulation screen

Provides an introduction to the principles and application of the most common types of electronic components and shows how they are used to form complete circuits. The virtual laboratories, worked examples and pre-designed circuits allow students to learn, experiment and check their understanding. Version 2 has been considerably expanded in almost every area following a review of major syllabuses (GCSE, GNVQ, A level and HNC). It also contains both European and American circuit symbols. Sections include: **Fundamentals:** units & multiples, electricity, electric circuits, alternating circuits. **Passive Components:** resistors, capacitors, inductors, transformers. **Semiconductors:** diodes, transistors, op.amps, logic gates. **Passive Circuits. Active Circuits. The Parts Gallery** will help students to recognise common electronic components and their corresponding symbols in circuit diagrams. Included in the Institutional Versions are multiple choice questions, exam style questions, fault finding virtual laboratories and investigations/worksheets.

ANALOGUE ELECTRONICS

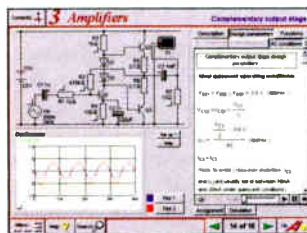

Complimentary output stage

Analogue Electronics is a complete learning resource for this most difficult branch of electronics. The CD-ROM includes a host of virtual laboratories, animations, diagrams, photographs and text as well as a SPICE electronic circuit simulator with over 50 pre-designed circuits. Sections on the CD-ROM include: **Fundamentals** – Analogue Signals (5 sections), Transistors (4 sections), Waveshaping Circuits (6 sections). **Op.Amps** – 17 sections covering everything from Symbols and Signal Connections to Differentiators. **Amplifiers** – Single Stage Amplifiers (8 sections), Multi-stage Amplifiers (3 sections). **Filters** – Passive Filters (10 sections), Phase Shifting Networks (4 sections), Active Filters (6 sections). **Oscillators** – 6 sections from Positive Feedback to Crystal Oscillators. **Systems** – 12 sections from Audio Pre-Amplifiers to 8-Bit ADC plus a gallery showing representative p.c.b. photos.

ROBOTICS & MECHATRONICS



Case study of the Milford Instruments Spider

Robotics and Mechatronics is designed to enable hobbyists/students with little previous experience of electronics to design and build electromechanical systems. The CD-ROM deals with all aspects of robotics from the control systems used, the transducers available, motors/actuators and the circuits to drive them. Case study material (including the NASA Mars Rover, the Milford Spider and the Furby) is used to show how practical robotic systems are designed. The result is a highly stimulating resource that will make learning, and building robotics and mechatronic systems easier. The Institutional versions have additional worksheets and multiple choice questions.

- Interactive Virtual Laboratories
- Little previous knowledge required
- Mathematics is kept to a minimum and all calculations are explained
- Clear circuit simulations

DIGITAL ELECTRONICS V2.0

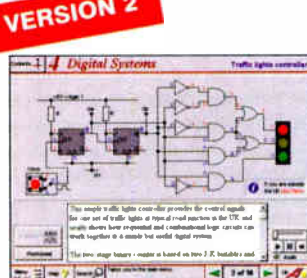

Virtual laboratory – Traffic Lights

Digital Electronics builds on the knowledge of logic gates covered in *Electronic Circuits & Components* (opposite), and takes users through the subject of digital electronics up to the operation and architecture of microprocessors. The virtual laboratories allow users to operate many circuits on screen. Covers binary and hexadecimal numbering systems, ASCII, basic logic gates, monostable action and circuits, and bistables – including JK and D-type flip-flops. Multiple gate circuits, equivalent logic functions and specialised logic functions. Introduces sequential logic including clocks and clock circuitry, counters, binary coded decimal and shift registers. A/D and D/A converters, traffic light controllers, memories and microprocessors – architecture, bus systems and their arithmetic logic units. Sections on Boolean Logic and Venn diagrams, displays and chip types have been expanded in Version 2 and new sections include shift registers, digital fault finding, programmable logic controllers, and microcontrollers and microprocessors. The Institutional versions now also include several types of assessment for supervisors, including worksheets, multiple choice tests, fault finding exercises and examination questions.

ANALOGUE FILTERS

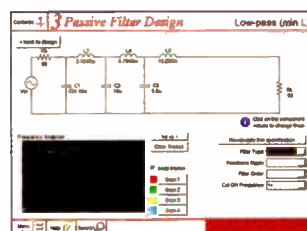

Filter synthesis

Analogue Filters is a complete course in designing active and passive filters that makes use of highly interactive virtual laboratories and simulations to explain how filters are designed. It is split into five chapters: **Revision** which provides underpinning knowledge required for those who need to design filters. **Filter Basics** which is a course in terminology and filter characterization, important classes of filter, filter order, filter impedance and impedance matching, and effects of different filter types. **Advanced Theory** which covers the use of filter tables, mathematics behind filter design, and an explanation of the design of active filters. **Passive Filter Design** which includes an expert system and filter synthesis tool for the design of low-pass, high-pass, band-pass, and band-stop Bessel, Butterworth and Chebyshev ladder filters. **Active Filter Design** which includes an expert system and filter synthesis tool for the design of low-pass, high-pass, band-pass, and band-stop Bessel, Butterworth and Chebyshev

PRICES

Prices for each of the CD-ROMs above are:

(Order form on third page)

(UK and EU customers add VAT at 17.5% to "plus VAT" prices)

Hobbyist/Student	£45 inc VAT
Institutional (Schools/HE/FE/Industry).....	£99 plus VAT
Institutional 10 user (Network Licence).....	£249 plus VAT
Site Licence.....	£499 plus VAT

PICmicro TUTORIALS AND PROGRAMMING

HARDWARE

VERSION 3 PICmicro MCU DEVELOPMENT BOARD

Suitable for use with the three software packages listed below.

This flexible development board allows students to learn both how to program PICmicro microcontrollers as well as program a range of 8, 18, 28 and 40-pin devices from the 12, 16 and 18 series PICmicro ranges. For experienced programmers all programming software is included in the PPP utility that comes with the development board. For those who want to learn, choose one or all of the packages below to use with the Development Board.

- Makes it easier to develop PICmicro projects
- Supports low cost Flash-programmable PICmicro devices
- Fully featured integrated displays – 16 individual I.e.d.s, quad 7-segment display and alphanumeric I.c.d. display
- Supports PICmicro microcontrollers with A/D converters
- Fully protected expansion bus for project work
- USB programmable
- Can be powered by USB (no power supply required)

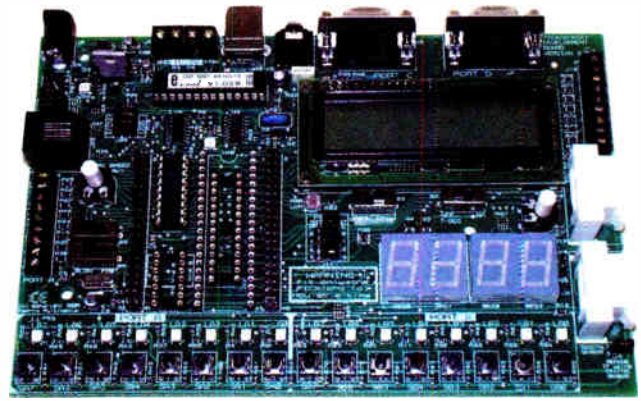

£158 including VAT and postage

supplied with USB cable and programming software

SOFTWARE

Suitable for use with the Development Board shown above.



ASSEMBLY FOR PICmicro V3 (Formerly PICtutor)

Assembly for PICmicro microcontrollers V3.0 (previously known as PICtutor) by John Becker contains a complete course in programming the PIC16F84 PICmicro microcontroller from Arizona Microchip. It starts with fundamental concepts and extends up to complex programs including watchdog timers, interrupts and sleep modes. The CD makes use of the latest simulation techniques which provide a superb tool for learning: the Virtual PICmicro microcontroller. This is a simulation tool that allows users to write and execute MPASM assembler code for the PIC16F84 microcontroller on-screen. Using this you can actually see what happens inside the PICmicro MCU as each instruction is executed which enhances understanding.

- Comprehensive instruction through 45 tutorial sections
- Includes Vlab, a Virtual PICmicro microcontroller: a fully functioning simulator
- Tests, exercises and projects covering a wide range of PICmicro MCU applications
- Includes MPLAB assembler
- Visual representation of a PICmicro showing architecture and functions
- Expert system for code entry helps first time users
- Shows data flow and fetch execute cycle and has challenges (washing machine, lift, crossroads etc.)
- Imports MPASM files.

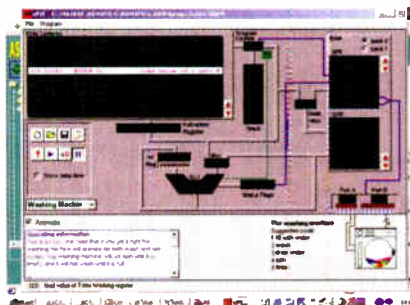

'C' FOR PICmicro VERSION 2

The C for PICmicro microcontrollers CD-ROM is designed for students and professionals who need to learn how to program embedded microcontrollers in C. The CD contains a course as well as all the software tools needed to create Hex code for a wide range of PICmicro devices – including a full C compiler for a wide range of PICmicro devices.

Although the course focuses on the use of the PICmicro microcontrollers, this CD-ROM will provide a good grounding in C programming for any microcontroller.

- Complete course in C as well as C programming for PICmicro microcontrollers
- Highly interactive course
- Virtual C PICmicro improves understanding
- Includes a C compiler for a wide range of PICmicro devices
- Includes full integrated Development Environment
- Includes MPLAB software
- Compatible with most PICmicro programmers
- Includes a compiler for all the PICmicro devices.

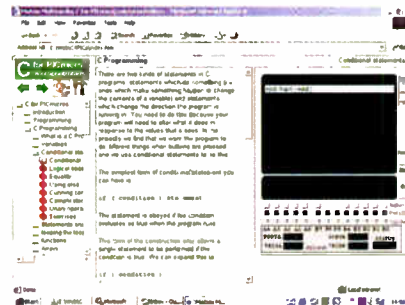

Minimum system requirements for these items: Pentium PC running Windows 98, NT, 2000, ME, XP; CD-ROM drive; 64MB RAM; 10MB hard disk space.

FLOWCODE FOR PICmicro V3

Flowcode is a very high level language programming system for PICmicro microcontrollers based on flowcharts. Flowcode allows you to design and simulate complex robotics and control systems in a matter of minutes.

Flowcode is a powerful language that uses macros to facilitate the control of complex devices like 7-segment displays, motor controllers and I.c.d. displays. The use of macros allows you to control these electronic devices without getting bogged down in understanding the programming. Flowcode produces MPASM code which is compatible with virtually all PICmicro programmers. When used in conjunction with the Version 3 development board this provides a seamless solution that allows you to program chips in minutes.

- Requires no programming experience
- Allows complex PICmicro applications to be designed quickly
- Uses international standard flow chart symbols (ISO5807)
- Full on-screen simulation allows debugging and speeds up the development process
- Facilitates learning via a full suite of demonstration tutorials
- Produces ASM code for a range of 18, 28 and 40-pin devices
- New features in Version 3 include 16-bit arithmetic, strings and string manipulation, improved graphical user interface and printing, support for 18 series devices, pulse width modulation, I2C, new ADC component and many more.

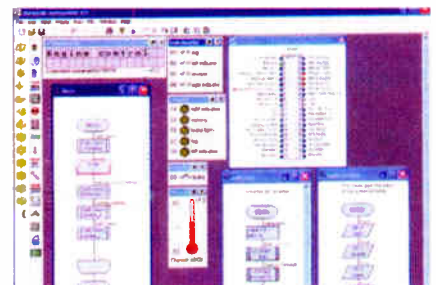

PRICES

Prices for each of the CD-ROMs above are:

(Order form on next page)

(UK and EU customers add VAT at 17.5% to "plus VAT" prices)

Hobbyist/Student
Institutional (Schools/HE/FE/Industry)
Institutional/Professional 10 user (Network Licence)
Site Licence
Flowcode 10 user (Network Licence)
Flowcode 50 user (Network Licence)

£45 inc VAT
£99 plus VAT
£300 plus VAT
£599 plus VAT
£350 plus VAT
£699 plus VAT

TEACH-IN 2000 – LEARN ELECTRONICS WITH EPE

EPE's own Teach-In CD-ROM, contains the full 12-part Teach-In 2000 series by John Becker in PDF form plus the Teach-In interactive software (Win 95, 98, ME and above) covering all aspects of the series. We have also added Alan Winstanley's highly acclaimed *Basic Soldering Guide* which is fully illustrated and which also includes *Desoldering*. The Teach-In series covers: Colour Codes and Resistors, Capacitors, Potentiometers, Sensor Resistors, Ohm's Law, Diodes and L.E.D.s, Waveforms, Frequency and Time, Logic Gates, Binary and Hex Logic, Op.amps, Comparators, Mixers, Audio and Sensor Amplifiers, Transistors, Transformers and Rectifiers, Voltage Regulation, Integration, Differentiation, 7-segment Displays, L.C.D.s, Digital-to-Analogue. Each part has an associated practical section and the series includes a simple PC interface (Win 95, 98, ME ONLY) so you can use your PC as a basic oscilloscope with the various circuits.



Sine wave relationship values

FREE TWO BOOKLETS PLUS CD-ROM WITH TEACH-IN 2000



A hands-on approach to electronics with numerous breadboard circuits to try out. £12.45 including VAT and postage. Requires Adobe Acrobat (available free from the Internet – www.adobe.com/acrobat).

FREE WITH EACH TEACH-IN CD-ROM – *Understanding Active Components* booklet, *Identifying Electronic Components* booklet and *The Best Of Circuit Surgery* CDROM.

DIGITAL WORKS 3.0

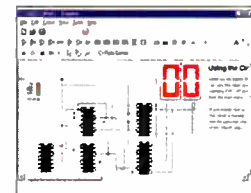

Counter project

Digital Works Version 3.0 is a graphical design tool that enables you to construct digital logic circuits and analyze their behaviour. It is so simple to use that it will take you less than 10 minutes to make your first digital design. It is so powerful that you will never outgrow its capability ● Software for simulating digital logic circuits ● Create your own macros – highly scalable ● Create your own circuits, components, and i.c.s ● Easy-to-use digital interface ● Animation brings circuits to life ● Vast library of logic macros and 74 series i.c.s with data sheets ● Powerful tool for designing and learning. **Hobbyist/Student £45 inc. VAT. Institutional £99 plus VAT. Institutional 10 user £249 plus VAT. Site Licence £599 plus VAT.**

NEW PROJECT DESIGN WITH CROCODILE TECHNOLOGY An Interactive Guide to Circuit Design

An interactive CD-ROM to guide you through the process of circuit design. Choose from an extensive range of input, process and output modules, including CMOS Logic, Op-Amps, PIC/PICAXE, Remote Control Modules (IR and Radio), Transistors, Thyristors, Relays and much more. Click Data for a complete guide to the pin layouts of i.c.s, transistors etc. Click More Information for detailed background information with many animated diagrams. Nearly all the circuits can be instantly simulated in Crocodile Technology* (not included on the CD-ROM) and you can customise the designs as required.

WHAT'S INCLUDED

Light Modules, Temperature Modules, Sound Modules, Moisture Modules, Switch Modules, Astables including 555, Remote Control (IR & Radio), Transistor Amplifiers, Thyristor, Relay, Op-Amp Modules, Logic Modules, 555 Timer, PIC/PICAXE, Output Devices, Transistor Drivers, Relay Motor Direction & Speed Control, 7 Segment Displays. Data sections with pinouts etc., Example Projects, Full Search Facility, Further Background Information and Animated Diagrams.

Runs in Microsoft Internet Explorer

*All circuits can be viewed, but can only be simulated if your computer has Crocodile Technology version 410 or later. A free trial version of Crocodile Technology can be downloaded from: www.crocodile-clips.com. Animated diagrams run without Crocodile Technology.

Single User £39.00 inc. VAT.

Multiple Educational Users (under 500 students) £59.00 plus VAT. Over 500 students £79.00 plus VAT.
(UK and EU customers add VAT at 17.5% to "plus VAT" prices)



Over 150 pages
Over 600 images

ELECTRONIC COMPONENTS PHOTOS

A high quality selection of over 200 JPG images of electronic components. This selection of high resolution photos can be used to enhance projects and presentations or to help with training and educational material. They are royalty free for use in commercial or personal printed projects, and can also be used royalty free in books, catalogues, magazine articles as well as worldwide web pages (subject to restrictions – see licence for full details). Also contains a **FREE** 30-day evaluation of Paint Shop Pro 6 – Paint Shop Pro image editing tips and on-line help included!



Price £19.95 inc. VAT

Minimum system requirements for these CD-ROMs: Pentium PC, CD-ROM drive, 32MB RAM, 10MB hard disk space. Windows 95/98/NT/2000/ME/XP, mouse, sound card, web browser.

Please send me: CD-ROM ORDER FORM

- Electronic Projects
- Electronic Circuits & Components V2.0
- Analogue Electronics
- Digital Electronics V2.0
- Analogue Filters
- Electronics CAD Pack
- Robotics & Mechatronics
- Assembly for PICmicro V3
- 'C' for PICmicro V2
- Flowcode V3 for PICmicro
- Digital Works 3.0

Version required:

- Hobbyist/Student
- Institutional
- Institutional/Professional 10 user
- Site licence



- PICmicro Development Board V3 (hardware)

- Teach-In 2000 + FREE BOOK
- Electronic Components Photos
- Project Design – Single User
- Project Design – Multiple User (under 500 students)
- Project Design – Multiple User (over 500 students)

Note: The software on each version is the same, only the licence for use varies.

Full name:

Address:

.....Post code:Tel. No:

Signature:

I enclose cheque/PO in £ sterling payable to WIMBORNE PUBLISHING LTD for £

Please charge my Visa/Mastercard/Amex/Diners Club/Switch: £

Valid From:Card expiry date:

Card No:Maestro Issue No.

Card Security Code (The last 3 digits on or just under the signature strip)

ORDERING ALL PRICES INCLUDE UK POSTAGE

Student/Single User/Standard Version price includes postage to most countries in the world
EU residents outside the UK add £5 for airmail postage per order

Institutional, Multiple User and Deluxe Versions – overseas readers add £5 to the basic price of each order for airmail postage (do not add VAT unless you live in an EU (European Union) country, then add 17½% VAT or provide your official VAT registration number).

Send your order to:
Direct Book Service
Wimborne Publishing Ltd
408 Wimborne Road East
Ferndown, Dorset BH22 9ND

To order by phone ring
01202 873872. Fax: 01202 874562

Goods are normally sent within seven days

E-mail: orders@wimborne.co.uk

Online shop:
www.epemag.wimborne.co.uk/shopdoor.htm



EasyPIC4 Development Board

with on-board USB 2.0 programmer and In Circuit Debugger

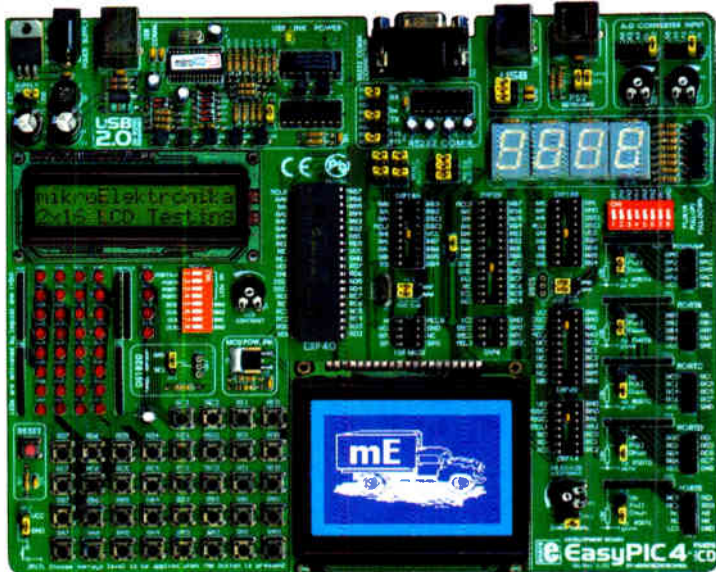

3 in 1
DEVELOPMENT SYSTEM

HARDWARE
LCD ON-BOARD
USB 2.0
ON-BOARD
PROGRAMMER
HIGH
PERFORMANCE
DEVELOPMENT
BOARD

EasyPIC4 development board: Following in the tradition of the EasyPIC3 as one of the best PIC development systems on the market, the EasyPIC4 has more new features for the same price. The system supports 8, 14, 18, 20, 28 and 40 pin PIC microcontrollers (it comes with a PIC16F877A). The ultra fast mikroICD (In-Circuit Debugger) enables very efficient debugging and faster prototype development. Many ready made examples guarantee successful use of the system. EasyPIC4 is fully optimized for fast prototype development. It allows the PIC microcontroller to be interfaced with external circuits to a broad range of peripheral devices, allowing the user to concentrate on just the software. On a screen there are labels beside every component. These marks describe connections to the microcontroller, operation modes, and some other useful notes.

Package contains:

- EasyPIC4 development system,
- USB cable,
- Serial cable
- User's Manual,
- PICFlash Manual,
- MikroICD Manual,
- CD with software, drivers and examples in C, BASIC and Pascal language.

Note LCD DS1820 temp sensor and GLCD are optional.



EasyPIC4 Development System	\$119.00 USD
Optional:	
2x16 LCD and DS1820 temperature sensor	\$15.00 USD
Graphic LCD 128x64 dots	\$17.00 USD

mikroBasic, mikroPascal and mikroC compilers



Supporting an impressive range of microcontrollers, an easy-to-use IDE, hundreds of ready-to-use functions and many integrated tools makes MikroElektronika compilers one of the best choices on the market today. Besides mikroICD, mikroElektronika compilers offer a statistical module, simulator, bitmap generator for graphic displays, 7-segment display conversion tool, ASCII table, HTML code export, communications tools for SD/MMC, UDP (Ethernet) and USB, EEPROM editor, programming mode management, etc.

Each compiler has many routines and examples such as EEPROM, FLASH and MMC, SD and CF card reading/writing, writing to character and graphic LCDs, manipulation of push-buttons, 4x4 keyboard and PS/2 keyboard input, generation of signals and sounds, character string manipulation, mathematical calculations, I2C, SPI, RS232, CAN, USB, RS485 and OneWire communications, Manchester coding management, logical and numerical conversion, PWM signals, interrupts, etc. The CD-ROM contains many ready-written and tested programs for use with our development boards.

Regular price:		Buy one of our compilers with one of our PIC development boards at up to 30% discount.	
mikroBasic(PIC)	\$149.00 USD	mikroBasic(PIC) (-30%)	\$99.00 USD
mikroPascal(PIC)	\$149.00 USD	mikroPascal(PIC) (-30%)	\$99.00 USD
mikroC(PIC)	\$249.00 USD	mikroC(PIC) (-30%)	\$175.00 USD

Please visit our web page for more info
<http://www.mikroe.com>

- All of our products are shipped in special protective boxes.
- On-line secure ordering provides a fast and safe way to buy our products.

Find your distributor: <http://www.mikroe.com/en/distributors/>



EasyPIC4 - Full-featured development board for the Microchip PIC MCU's. Now with on-board USB 2.0 programmer and In-Circuit Debugger.

Examples in C, BASIC and Pascal language: Printing text on LCD, LED blinking on PORTB, MMC/SD/CF card read and write example, USB communication, 4x4 Keypad example, PS2 keyboard example, software SPI/I2C/RS232 communications, AD conversion example Seven segment digit example, Timer 0 and Timer 1 time measuring, Measuring temperature with DS1820 and displaying on LCD, Graphic LCD example, examples for SPI communication, examples for CAN communication, examples for Sound generation, sending and receiving data over Ethernet, Interrupt upon PORTB state change, Detection of button pressed on port and many more...



- 36 buttons for program developing needs.
- PS2 (PC keyboard) connector.
- Digital thermometer DS1820.
- System can be easily configured via DIP switch.
- 4 seven-segment digits in multiplex mode.
- 36 diodes for displaying states of all pins.
- GLCD - Graphic LCD 128x64.
- All pins are connected to IDC connectors.
- Pull up or Pull down port defining.
- RS-232 communication available on-board.
- Crystal can be replaced by another one.
- USB connector for MCLR with on-chip USB comm.
- Character LCD support.
- Reset circuit.
- ADC inputs via two selectable potentiometers.

mikroICD - On-board In-Circuit Debugger - Prototype your designs more efficiently and effectively.

mikroICD is a highly effective tool for Real-Time debugging on a hardware level. The ICD debugger enables you to execute a mikroC/mikroPascal/mikroBasic program on a host PIC microcontroller and view variable values, Special Function Registers (SFR), memory and EEPROM as the program is running.

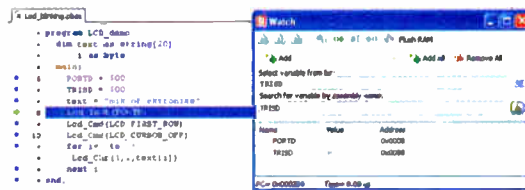

Step Into [F7] and Step Over [F8] are mikroICD debugger functions that are used in stepping mode. There is also Real-Time mode supported by mikroICD. Functions that are used in Real-Time mode are Run/ Pause Debugger [F6] and Run to cursor [F4]. Pressing F4 goes to the line selected by user. User just has to select line with cursor and press F4, and program will be executed until the selected line is reached. Breakpoints have been separated into two groups. There are hardware and software breakpoints. Hardware breakpoints are placed in PIC and they provide fast debug. Number of hardware breakpoints is limited (1 for P16 and up to 3 for P18). If all hardware breakpoints are used, new breakpoints that will be used as software breakpoints. Those breakpoints are placed inside mikroICD software, and they simulate hardware breakpoints.

USB 2.0 PICFlash2 - On-Board USB 2.0 In-Circuit Programmer - Very fast and reliable PIC programmer

On-board USB 2.0 PICFlash programmer - An ultra fast USB 2.0 programmer for fast MCU programming. Continuing its tradition as the fastest PIC programmer on the market, the new P.CFlash with mikroICD now supports more PIC MCUs giving the developer a wider choice of PIC MCU for further prototype development. There is no need for the use of external equipment during programming as EasyPIC4 development system has its own on-board USB programmer. All you need to do is connect the system to a PC using USB cable. Then, load your program into the microcontroller via the PICFlash2 programming software which is supplied with EasyPIC4.

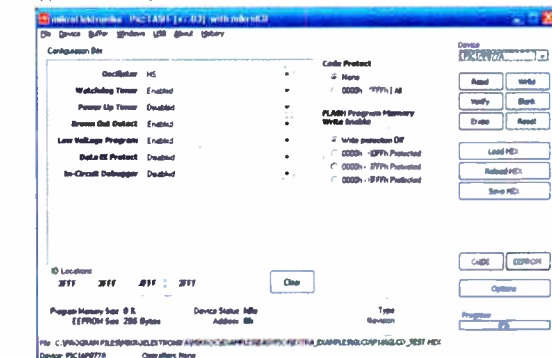

Programmable ROBOT

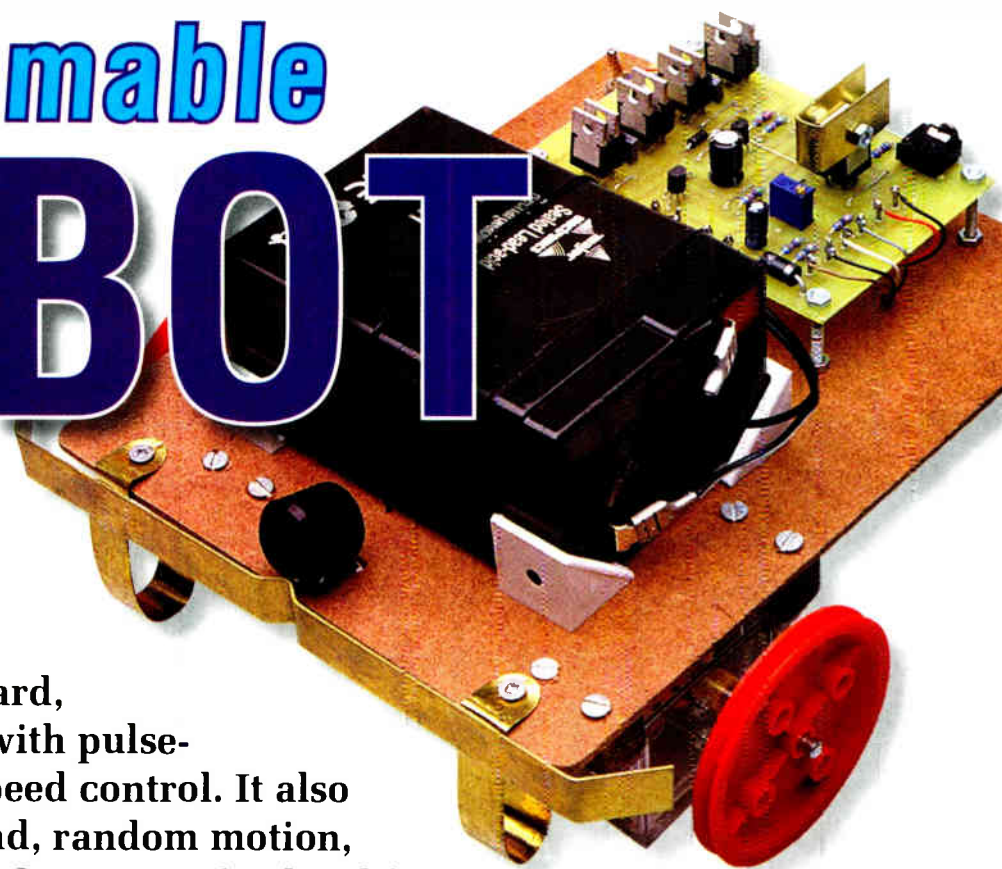

This Programmable Robot features full manoeuvrability – forward, reverse, turn and stop, with pulse-width modulation for speed control. It also sports bump-and-respond, random motion, programmable sound, light sensing (16 levels) and EEPROM byte-wise addressing.

By THOMAS SCARBOROUGH

THIS CIRCUIT lets you design your own robot to suit your own taste. It would not be difficult, for instance, to convert this design to a credible 'R2D2', without any modification to the PC board. With a little imagination, the possibilities would be even wider. The circuit could operate a pulley system, serve as a line-tracker or rotate motors in response to broken beams of varying intensity, without modification to the PC board.

The robot is programmable, therefore, the drive circuit is merely a slave to the software and is of a relatively simple design. The circuit is based on a PICAXE-08 micro. Although more limited than a 'raw' microcontroller, it is a little marvel nonetheless – both for cutting out the need for a program-

mer and for placing respectable power at the service of the constructor with great simplicity.

All that the Programmable Robot requires in its support is a PC and a serial cable. The programming software is free (www.rev-ed.co.uk) and comes in the form of a telegram-style BASIC and flowchart programming.

Note that the Programmable Robot's memory is limited – not all the features listed above can be used at the same time. However, with careful programming, the robot will perform most dual or even triple tasks with aplomb. As an example, light-seeking, bump-and-respond and sound can all be incorporated in a single program.

Since the PICAXE-08 microcontroller represents the Programmable

Robot's 'control room', this is where we shall begin. Unfortunately, the PICAXE-08 is confusing in its pin numbering, which has become something of a legend in its own time – therefore we shall resort to the standard IC pin numbering here; ie. pins 1-8, with pin 1 being situated next to the small indentation on top of the IC.

Circuit details

The complete circuit is shown in Fig.1. The PICAXE-08's pin 1 (+V) and pin 8 (0V) are connected to a 6V battery via switch S2 and diode D2. D2 serves a dual purpose – first, to prevent reverse polarity, which could do considerable damage. and second, to drop the supply voltage to about 5.4V, which is more suitable for the PICAXE-08.

Pin 7 (P0) is designated by the manufacturers for output only and is used to switch both of the motors on or off at the same time. It may also be used to pulse the motors on and off (pulse-width modulation) for speed control or special effects. When it is 'high', the motors are on; when it is 'low' they are off.

Pin 5 (P2) is designated for input or output. In this circuit, it is used for

Table 1: PICAXE Motor Control Outputs

	High	Low
Pin 7 (P0)	Both motors on	Both motors off
Pin 5 (P2)	Left motor backwards	Left motor forwards
Pin 3 (P4)	Right motor backwards	Right motor forwards

This table shows the most important PICAXE-08 outputs – ie. for motor control.

output only and controls the direction (forward or reverse) of the lefthand motor, as seen from the rear of the robot. Pin 3 (P4) is likewise designated for input or output and is used here to control the direction (forward or reverse) of the righthand motor.

Note that neither pin 5 nor pin 3 will accomplish anything unless both motors are switched on first via pin 7 (P0). Both pins 5 and 3 cause a wheel to roll forwards when it is 'low' and backwards when it is 'high'. Pins 7, 5 and 3 together may be used not only to make the robot drive forwards or reverse but also to turn, gyrate, wiggle, judder or do virtually anything else one may think of! These motions may also be strung together sequentially, as part of a programmed sequence (within limits, since memory is at a premium).

Pin 4 (P3) is designated for input only and is used to sense collisions through the robot's bumper bar. The robot need not only do a simple reverse-and-turn, but it may also be programmed to respond in various ways. Pin 6 (P1) is designated for output, input or analogue input. In this circuit, it is used only for output and analogue input.

In 'output' mode, it is used to drive a piezo sounder for programmable sound. The piezo sounder will beep, play tunes or, with a little ingenuity, create sound effects such as a police siren or a cat's purr.

In 'analogue' mode, pin 6 reads the light level at the front of the robot. Note that this first requires the correct adjustment of VR1 with the help of the LDR ADJUST program. The robot is capable of detecting sixteen levels of light which may be used for light-seeking (or light-avoidance), line tracking and day-night sensing.

Several short programs are provided, including a FIGURE-8 DEMO, LIGHT & BUMP DEMO, PWM DEMO, RANDOM DEMO and WALTZING MATILDA DEMO. these are available from the Downloads area on the EPE UK website.

The WALTZING MATILDA DEMO has been designed not only for fun but as a 'get you going' program during assembly, while the LIGHT & BUMP DEMO will give the best overall

Fig.1: a PICAXE-08 microcontroller, 10 MOSFETs and not much else comprise the circuit of this robot. All the intelligence is contained in the micro's software.

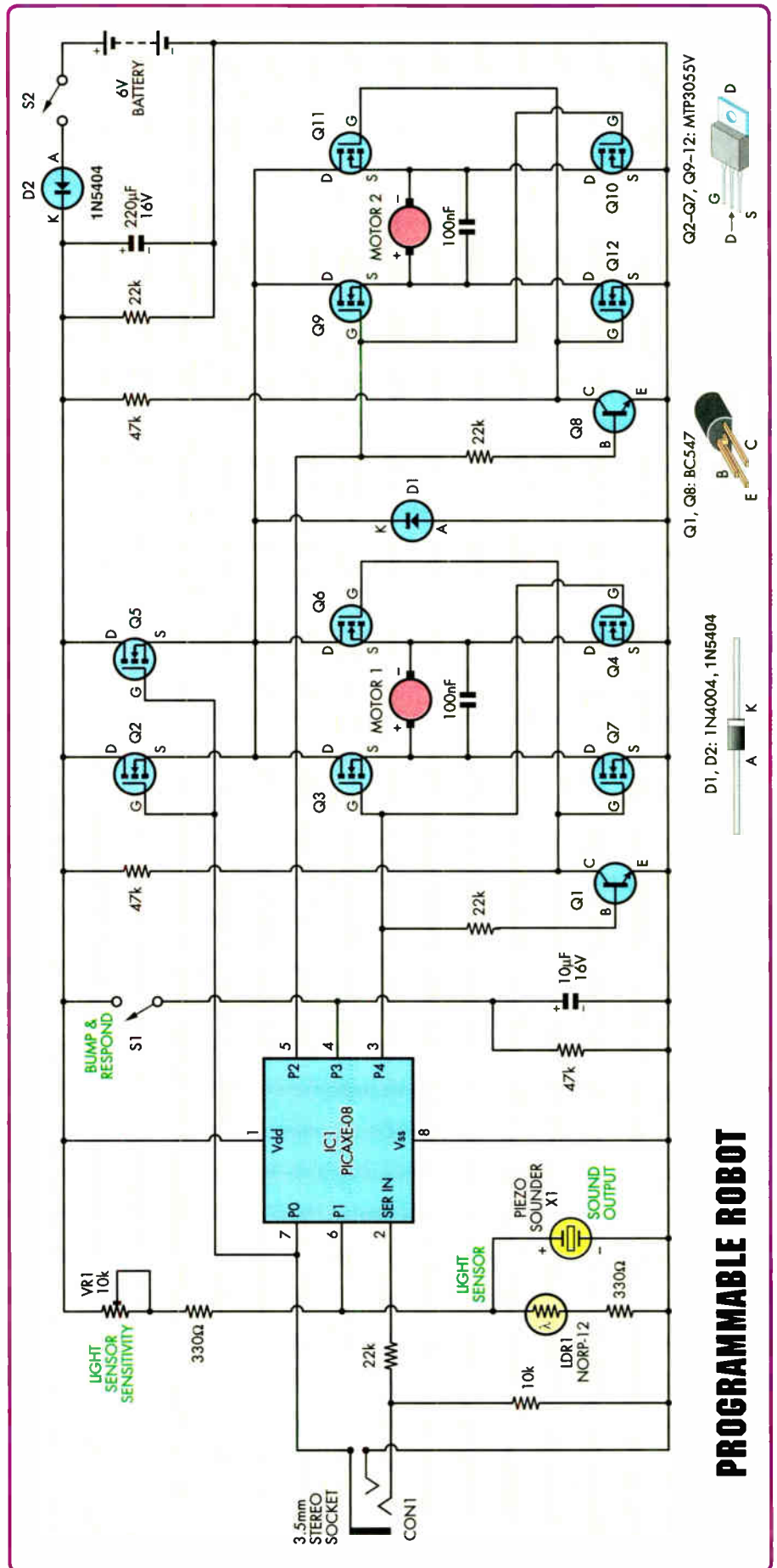

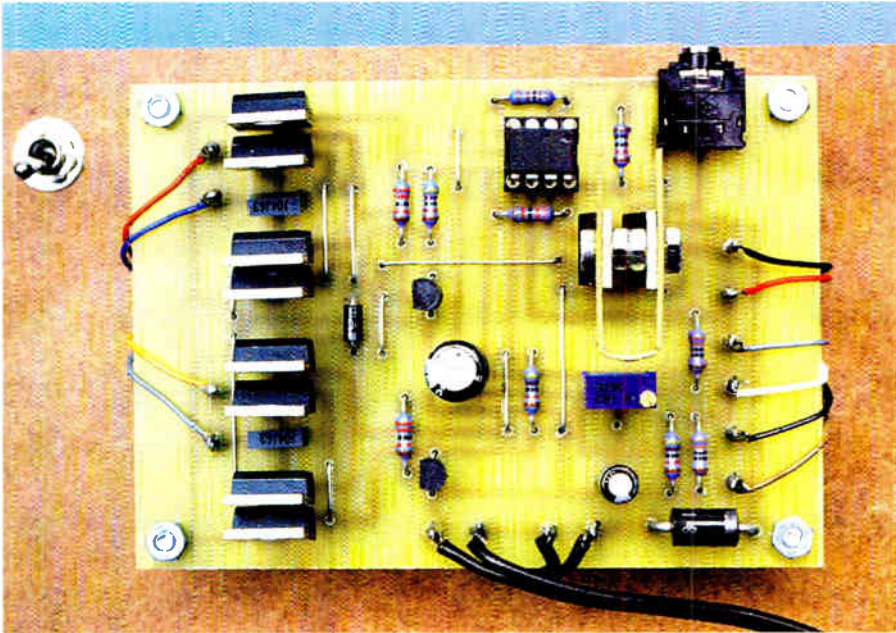

The completed PC board is secured to the base using machine screws and nuts. Note the heatsink that's fitted to the tabs of MOSFETs Q2 & Q5.

Pins 3 & 5 switch two power MOSFET H-bridges (Q3, Q4 and Q9, Q10) to control the direction of the motors (forward or reverse). The two 100nF capacitors and diode D1 are included to suppress interference.

Transistors Q1 and Q8 are used as inverters, so that when the 'forward motion' MOSFETs are disabled, the 'reverse motion' MOSFETs are activated. Pin 4 is normally held low by its 47k Ω resistor. When bump-and-respond switch S1 (the bumper bar) is closed, pin 4 is pulled high. The 10 μ F capacitor and the 47k Ω resistor determine how long a bump will be 'remembered' and the values of these components may be modified as desired. These components are required because the software, as it executes, may need a moment to reach the program line which monitors the status of S1 – and because there is bound to be some switch-bounce too.

Pins 2 (Serial In) and 7 (Serial Out) are used for downloading programs, with pin 7 doing double duty for switching the motors, as described earlier. Since pin 7 does double duty, the robot's motors may twitch a little as a program is downloaded or debugged.

A 220 μ F capacitor provides supply decoupling and the 22k Ω bleed resistor ensures that the circuit powers down properly when switched off, so that there will be no unpredictable behaviour when it is switched on

again. After switching off the robot, allow a few seconds for the 220 μ F capacitor to discharge before switching on again.

Board assembly

All the parts, with the exception of the bump switch, LDR, piezo sounder and battery, are mounted on a PC board coded 602, measuring 92 x 67mm. The component overlay is shown in Fig.2 and the wiring details in Fig.6.

PC board and hardware construction are inter-linked and both of these sections need to be read first before final construction of the robot is undertaken. The following procedure is recommended when soldering components to the PC board: (1) solder the 14 PC pins (insert these from the copper track side), as well as the wire links; (2) solder the 8-pin dual-in-line (DIP) socket (observe the correct orientation) and CON1; (3) solder the 10 resistors and preset potentiometer VR1; (4) install the two diodes and the two electrolytic capacitors, taking care with polarity; (5) install the two 100nF capacitors; (6) solder in the two transistors (Q1 & Q8) and the 10 MOSFETs; (7) fit a small heatsink to MOSFETs Q2 & Q5.

Robot platform

The physical construction of the Programmable Robot begins with a suitable baseboard to which everything else is attached. The

Parts List

- 1 Hardboard baseboard, 200 x 160mm
- 1 PC board, code 602, 92 x 67mm, available from the *EPE PCB Service*
- 1 piezo sounder (without integral electronics) (X1)
- 1 bumper switch (S1 – see text)
- 1 miniature toggle switch (S2)
- 1 10k Ω cermet trimpot (top adjust)
- 1 NORP-12 light dependent resistor (LDR1 – see text)
- 1 3.5mm PC-mount stereo jack socket (CON1)
- 2 reversible 6V geared motors (ideally <2W each under load)
- 1 8-pin DIP socket
- 1 6V 4Ah SLA battery
- 2 spade connectors to suit battery
- 14 PC stakes
- 2 60mm dia. wheels (to suit gearbox shafts)
- 1 40mm dia. rear wheel
- 130mm 2.5mm dia. steel wire for rear wheels
- 4 corner brackets for battery

Semiconductors

- 1 PICAXE-08 microcontroller (IC1)
- 10 MTP3055V N-channel MOSFETs (Q2-Q7, Q9-Q12)
- 2 BC547 NPN transistors (Q1, Q8)
- 1 1N4004 silicon diode (D1)
- 1 1N5404 silicon diode (D2)

Capacitors

- 1 220 μ F 16V PC electrolytic
- 1 10 μ F 16V PC electrolytic
- 2 100nF (0.1 μ F) MKT polyester or ceramic

Resistors (0.25W, 1%)

- 3 47k Ω 1 10k Ω
- 4 22k Ω 2 330 Ω

Also required

PICAXE Programming Editor software – available free from www.picaxe.co.uk

PICAXE download cable

prototype's baseboard measured 200mm from front to back and 160mm wide. The prototype used hardboard, a strong material that is easy to work with.

Constructional Project

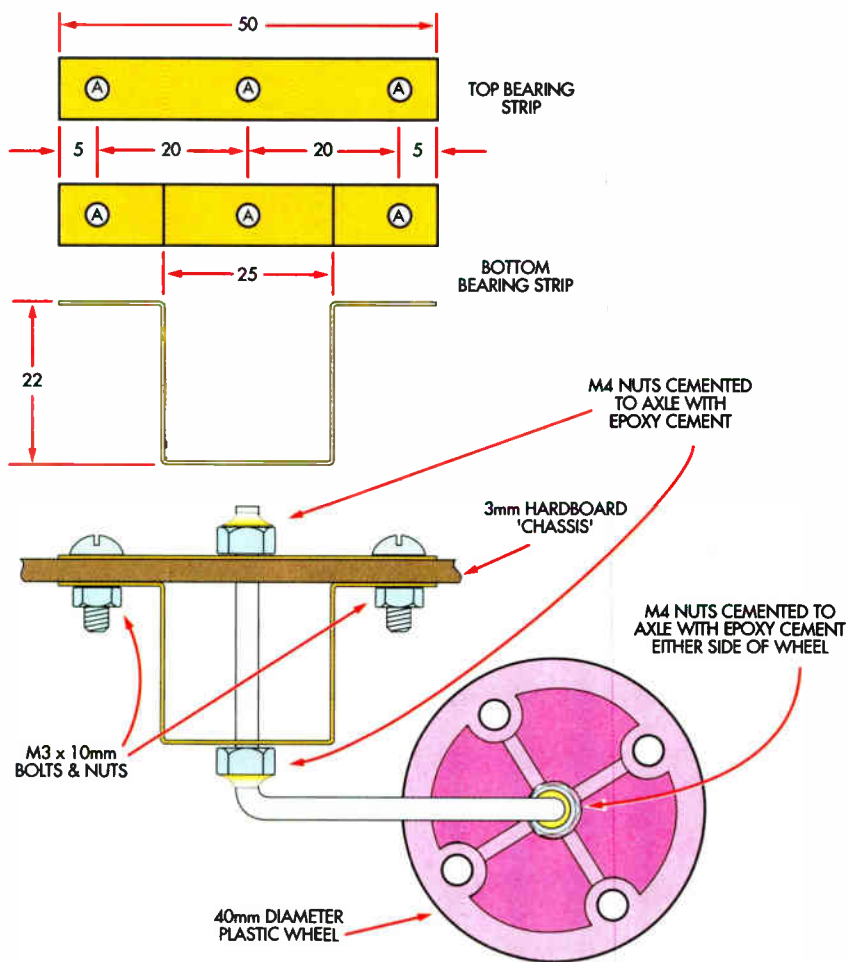

Fig.4: a swivel wheel is used at the rear of the robot for simplicity of steering.

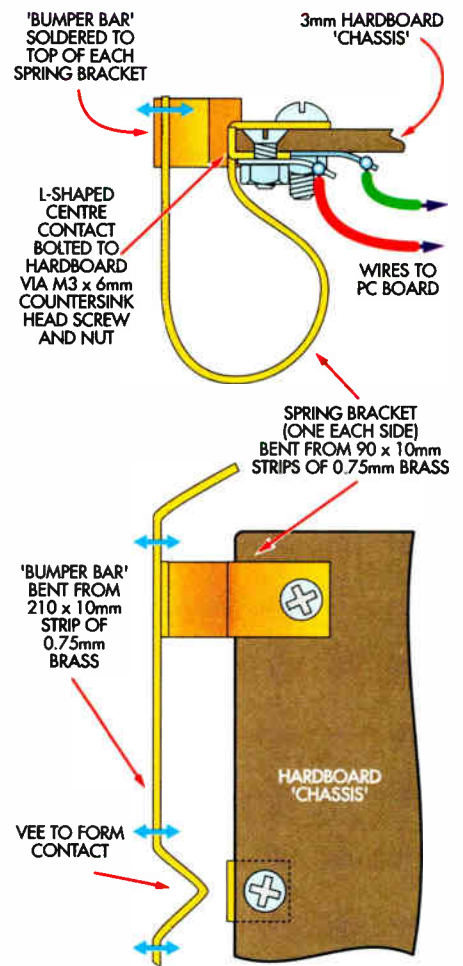

Fig.5: this diagram shows the details of the collision switch.

Two reversible 6V DC geared motors with 'through-shafts' were bolted to the baseboard. The platform of the prototype was raised a little above the motors with 10mm square wood battens, to provide more vertical room for the rear swivel-wheel.

The motors purchased use about 250mA under load and at 6V run free at about 6000 RPM. This is divided down to 70 RPM with the gearbox and this comes down to perhaps 50 RPM under load, when the voltage drop via D2 is taken into account.

60mm diameter gear wheels were used for the two drive wheels and these were simply pressed onto the drive shafts. The motors are mounted so that they each 'face the same way' as they turn – that is, their drive shafts both turn the same way when the robot is moving forward. This is

because there may be inequalities in the forward and reverse speeds of DC motors and this ensures that the robot will drive in a reasonably straight line when the motors are activated.

Next, attach leads with spade connectors to suit the battery and connect the motors as well. That done, attach LDR1 at the front of the robot by means of suitable wires. A short tube over LDR1 is required for directionality (see below). You also need to attach bump-and-respond switch S1 (ie, the bumper bar – see below), the piezo sounder and switch S2 using suitable leads.

Finally, insert the PICAXE (IC1) in the DIP socket.

Once the assembly is complete, carefully check the PC board for any solder bridges or dry joints, and check all components for correct placement and orientation.

More construction detail

The easiest way of working out the correct mounting of the motors will be through trial and error. First, wire them both up as shown, observing the correct polarity of the motors. That done, run the WALTZING-MATILDA DEMO.

Immediately after the first line of 'Waltzing Matilda', the wheels should both roll so as to propel the robot forwards – then there should be a beep and only the left motor (viewed from the rear of the robot) should reverse. If the motors do not rotate as described, then re-orientate them so that they do.

Once the drive motors have been fastened into place, the battery should be mounted on top of the platform – slightly back from the two drive shafts, so that the robot's load is slightly to

the rear of the platform. This gives it a good weight distribution and gives traction to the drive wheels, while not overburdening the rear swivel-wheel.

Four corner brackets were used to hold the battery in place and a length of telephone wire (or a cable tie) can be used to tie it to the platform through drilled holes.

The prototype used a rear swivel-wheel, and a 40mm diameter pulley wheel was used for the wheel. A sturdy 130mm length of 2.5mm diameter steel wire, together with a metal bracket, was used to attach the wheel to the platform. Nuts were slipped over this wire and glued into place as shown, to hold the wire in the bracket, and to hold the wheel in place.

It is important that this wheel should touch the ground at a point central to the other two wheels, otherwise the robot is likely to have a 'lean' to it, and this is why the steel wire is curved as it is. Together with the other wheels, the swivel-wheel should also, at all times, provide a three-point base on which the robot may rest, so as not to tip over.

Make sure that the swivel-wheel has the freedom to swivel through 360°. It should not, for instance, bump into the motors or the on-off switch, or be impeded by drooping wires. This robot has the potential for 'wild' motion and could run into trouble if the swivel-wheel snags.

Mounting the PC board

The PC board is mounted on top of the platform at the back, behind the battery, with the jack socket facing the rear for easy insertion of the serial cable. For neatness, holes may be drilled in the platform beneath the PC board, so that sheathed wires may be run underneath the platform. In the prototype, the PC board was raised above the platform on bolts, which made the wiring easier, as well as making room for the piezo sounder and the screws used to secure the swivel-wheel assembly.

A simple bumper bar is fixed to the front of the robot for the bumper switch S1. All that is required here is that S1's contacts should close on collision. The prototype used a brass strip that was 'sprung' on two brass loops, making contact with a brass stub on the platform when a collision took place.

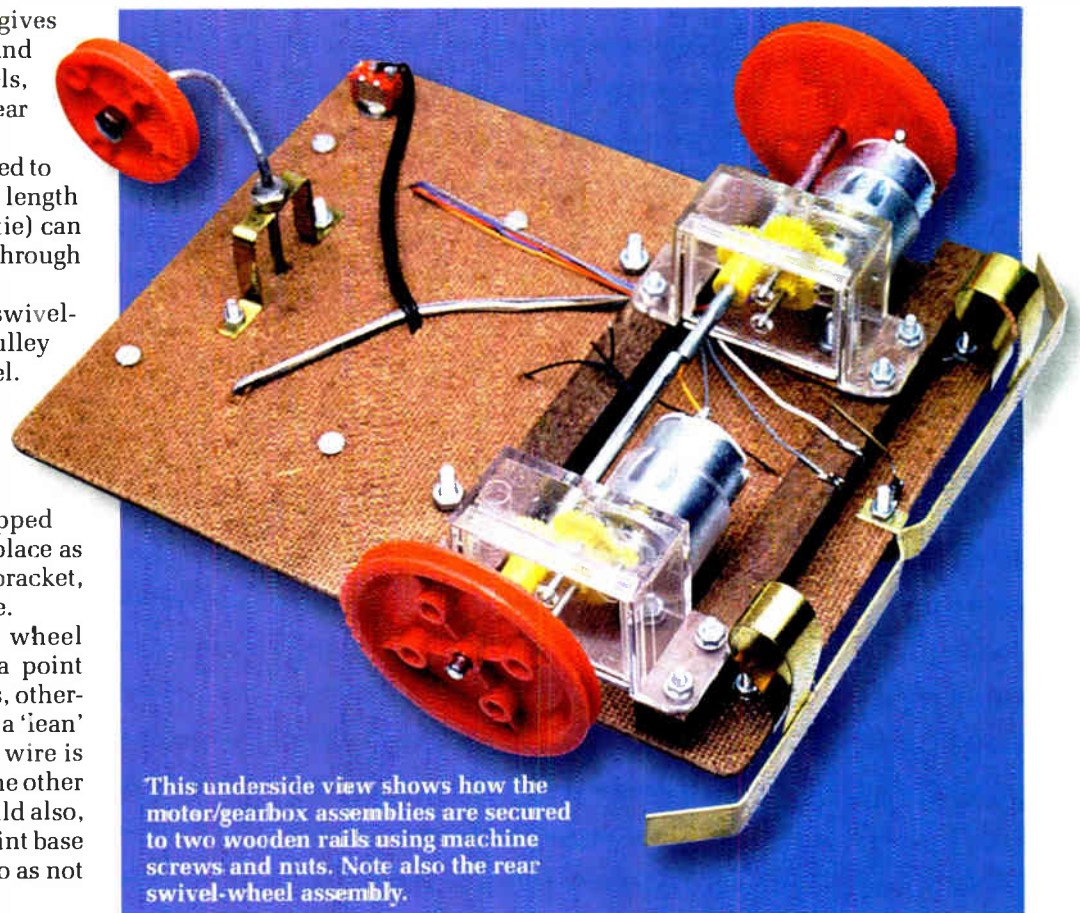

This underside view shows how the motor/gearbox assemblies are secured to two wooden rails using machine screws and nuts. Note also the rear swivel-wheel assembly.

Finally, switch S2, piezo sounder X1, and LDR1 are connected to the PC board. Switch S2 may be mounted on the hardboard platform. The piezo sounder may be fixed underneath the PC board with a little glue.

A short tube (say 15mm in length) should be slipped over the LDR and this should be mounted on the front of the robot with a clear view in front. Without this 'blinker' tube, the LDR does not have sufficient directionality to be of much use.

This close-up view shows how the LDR is housed in a short (15mm) length of tube. It sits just behind the collision switch.

Reproduced by arrangement with SILICON CHIP magazine 2007. www.siliconchip.com.au

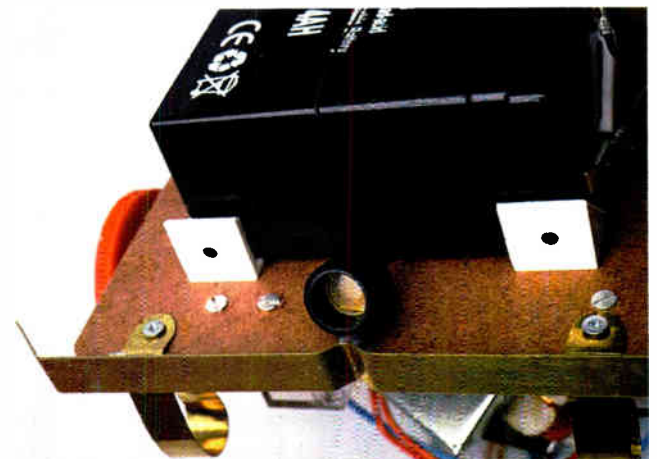

Constructional Project

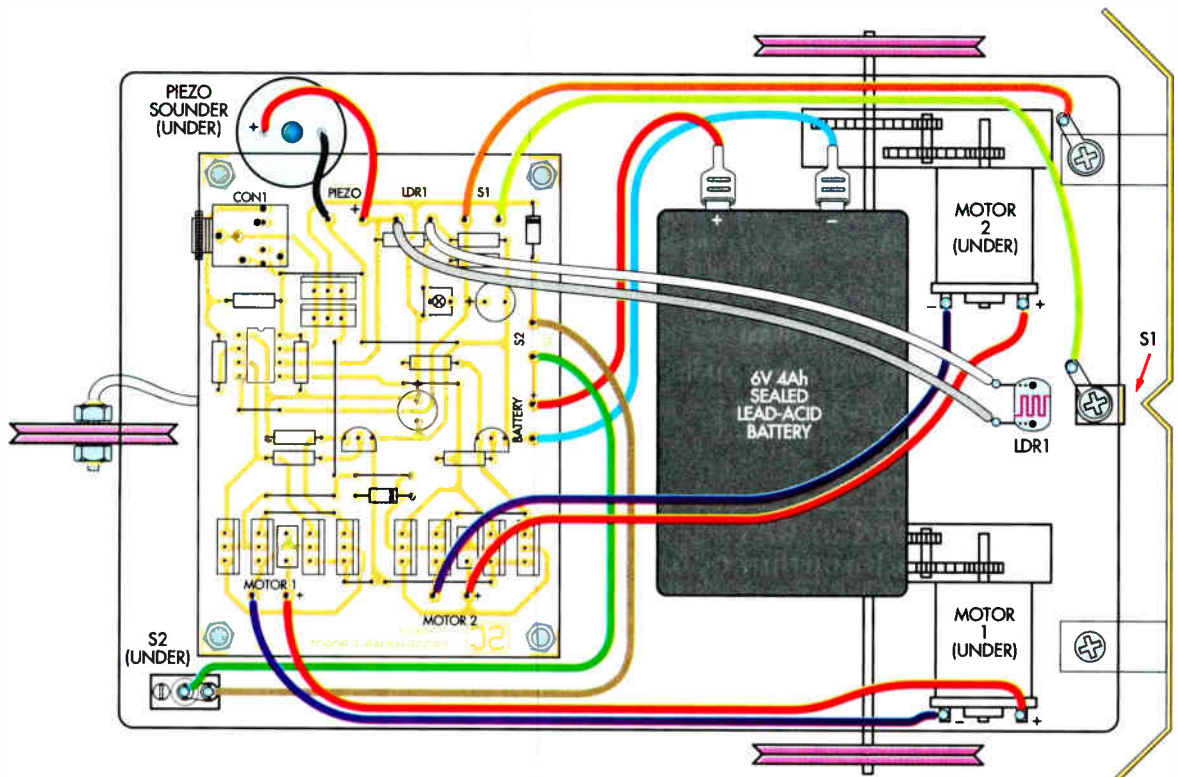

Fig.6: follow this diagram to complete the wiring for the Robot. Power comes from a 6V 4Ah sealed lead acid battery which is mounted just behind the front axle assembly

opening the WALTZING-MATILDA DEMO file and then pressing F5.

If the motors have been attached at this stage, the robot will wiggle briefly – then the first line of ‘Waltzing Matilda’ will play, and the robot will drive forwards. Then it will turn and repeat the sequence.

If the motors have not yet been attached, the sound of ‘Waltzing Matilda’ will give confirmation that a good deal is already working – the programming system, the serial cable, the PICAXE-08 IC and some of the surrounding components at the very least.

To adjust the PICAXE-08 to the surrounding light level, run the LDR ADJUST program, and keep the serial cable connected while you do so. Adjust VR1 and as you do, observe variable b3 on your computer screen. When the robot is aimed at the darkest areas of the room, b3 should read 160, while lighter areas should show lesser numbers.

What is most important is that there should be maximum variation in this number (b3) as the robot surveys different areas of a room.

Turning it loose!

Once complete, place the Programmable Robot on a hard floor and switch on. All being well, it will wiggle, then follow the rest of its programmed behaviour.

The best ‘general purpose’ program is the LIGHT & BUMP DEMO. Place a lamp on the floor, switch off any other lights, and then switch on the robot – facing any direction at all. This demo never fails to impress, with the Programmable Robot heading for the light like a moth to a flame.

EPE

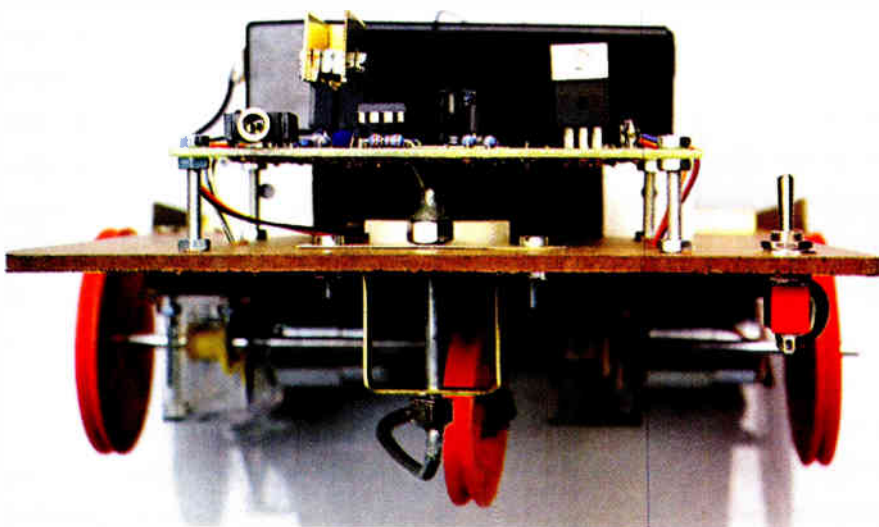

The PC board is elevated on its mounting bolts to allow the wiring to the motors, etc to pass through holes drilled through the baseboard beneath it.

PEAK

electronic design ltd

tel. 01298 70012
fax. 01298 70046
www.peakelec.co.uk
sales@peakelec.co.uk

Gift Vouchers now available, buy online, phone or post.

Any value or even *flexi-value* to allow the recipient to select their item up to a limit you choose!



Handheld Test Gear - Cool, Smart.

- Atlas ICA Semiconductor Analyser £55
- Atlas IUK Portable Component Analyser £79
- Atlas ESR Capacitance and ESR Meter £89
- Atlas SCR Triac/Thyristor Analyser £109

Prices include UK delivery and VAT



We can supply back issues of *EPE* by post, most issues from the past five years are available. An *EPE* index for the last five years is also available at www.epemag.co.uk or see order form below. Alternatively, indexes are published in the December issue for that year. Where we are unable to provide a back issue a photocopy of any *one article* (or *one part* of a series) can be purchased for the same price. Issues from Jan. 99 are available on CD-ROM – see next page – and back issues from recent years are also available to download from www.epemag.com.

Please make sure all components are still available before commencing any project from a back-dated issue.

DID YOU MISS THESE?

OCT '05

PROJECTS • Halloween Howler • PIC Based USB Interface • Photic Phone • Telephone Switch • Parking Radar
FEATURES • Introducing the Virtual DIY Calculator • Ingenuity Unlimited • Back To Basics – 7 • Circuit Surgery • Techno Talk • PIC 'N' Mix • Interface • NetWork – The Internet Page

NOV '05 Photocopies only

PROJECTS • Speed Camera Watch Mk2 • PIC Chromatone • Multi-Function R/C Switch • Noughts and Crosses Enigma • Weather Vane Repeater
FEATURES • Teach-In 2006 – Part 1 • Circuit Surgery • Back To Basics – 8 • Techno Talk • Practically Speaking • Ingenuity Unlimited • PIC 'N' Mix • NetWork – The Internet Page

DEC '05 Photocopies only

PROJECTS • Vehicle Frost Box Mk2 • Propeller Monitor • Solid-State Hammond • Solid State Valve Power Supply
FEATURES • Teach-In 2006 – Part 2 • Techno Talk • Viewing The Future • Circuit Surgery • Interface • PIC 'N' Mix • NetWork – The Internet Page

JAN '06 Photocopies only

PROJECTS • A "Tiptronic-Style" Gear Indicator • Sunset Switch • PIC Ambilux • Current Clamp Adapter For Multimeters
FEATURES • Teach-In 2006 – Part 3 • Circuit Surgery • Techno Talk • Practically Speaking • PIC 'N' Mix • NetWork – The Internet Page

FEB '06 Photocopies only

PROJECTS • Highly Flexible Keypad Alarm • Active 3-way Crossover • Status Monitor • Jazzy Heart.
FEATURES • Teach-In 2006 – Part 4 • Techno Talk • Circuit Surgery • Interface • PIC 'N' Mix • Network – The Internet Page



MAR '06 Photocopies only

PROJECTS • PortaPAL Public Address Amplifier – Part 1 • Telescope Interface • Power Up • Video – Audio Booster
FEATURES • Teach-In 2006 – Part 5 • Practically Speaking • Circuit Surgery • Techno Talk • PIC 'N' Mix • Net Work – The Internet Page

APR '06 Photocopies only

PROJECTS • A Programmable Continuity Tester • Omni Pendulum • PortaPAL Public Address Amplifier – Part 2 • 'Smart' Slave Flash Trigger
FEATURES • Teach-In 2006 – Part 6 • Consumer Electronics Show • E-Chip Review • Techno Talk • PIC-'N'-Mix • Net Work – The Internet Page

MAY '06

PROJECTS • LED Lighting For Your Car • Smart Card Reader and Programmer • Nail Sniffer and Volts Hound • Digital Reaction Timer.
FEATURES • Teach-In 2006 – Part 7 • Practically Speaking • Ingenuity Unlimited • Circuit Surgery • Techno Talk • PIC 'N' Mix • Net Work – The Internet Page

JUN '06

PROJECTS • Poor Man's Metal Locator • Widdy Box Distortion Effects For Your Guitar • Phone Ring & Test • Digital Instrument Display For Cars – Part 1.
FEATURES • Interface • Circuit Surgery • Ingenuity Unlimited • Techno Talk • PIC 'N' Mix • Teach-In 2006 – Part 8 • Net Work – The Internet Page

JUL '06 Photocopies only

PROJECTS • PIC Sudoku Unit • A Dirt Cheap High Current Bench Supply • PC Power Monitor • Digital Instrument Display For Cars – Part 2.
FEATURES • Teach-In 2006 – Part 9 • Ingenuity Unlimited • Practically Speaking • Circuit Surgery • Techno Talk • PIC 'N' MIX • Net Work – The Internet Page

AUG '06

PROJECTS • Loudspeaker Level Meter • Telephone Dialler for Burglar Alarms • Adjustable DC-DC Converter for Cars • High Intensity Torch
FEATURES • Circuit Surgery • Techno Talk • Teach-In 2006 – Part 10 • PIC 'N' Mix • Interface • Ingenuity Unlimited • Net Work – The Internet Page



SEPT '06

PROJECTS • Low Cost 50 MHz Frequency Meter • Smart Mixture Display for Your Car • Human Powered LED Torches • Water Level Gauge
FEATURES • Teach-In 2006 – Part 11 • Ingenuity Unlimited • Circuit Surgery • Techno Talk • PIC 'N' Mix • Practically Speaking • Net Work – The Internet Page

OCT '06

PROJECTS • Studio 350 Power Amplifier - Part 1 • Fridge Door-Open Alarm • Through-Glass Alarm • Linear Supply for 1W Star LEDs
FEATURES • Ingenuity Unlimited • Circuit Surgery • Techno Talk • PIC 'N' Mix • Interface • Net Work – The Internet Page

NOV '06

PROJECTS • Giant LED Message Display • Micropower Battery Protector • Quick Brake • Studio 350 Power Amplifier – Part 2
FEATURES • C For PICs – Part 1 • Ingenuity Unlimited • Circuit Surgery • Techno Talk • PIC 'N' Mix • Practically Speaking • Net Work – The Internet Page



DEC '06

PROJECTS • USB Power Injector • RGB To Component Video Converter • Lapel Microphone Adaptor For PA Systems • Mind Trainer
FEATURES • C For PICs – Part 2 • Circuit Surgery • Interface • Ingenuity Unlimited • Techno Talk • PIC 'N' Mix • Net Work – The Internet Page

JAN '07

PROJECTS • Balanced Microphone Preamp • Jumping Spider • High Efficiency Power Supply For 1W Luxeon Star LEDs • Charger For Deep-Cycle 12V Batteries – Part 1
FEATURES • C For PICs – Part 3 • Circuit Surgery • Practically Speaking • Techno Talk • PIC 'N' Mix • Net Work – The Internet Page

BACK ISSUES ONLY £4.00 each inc. UK p&p.

Overseas prices £4.75 each surface mail, £5.75 each airmail.

We can also supply issues from earlier years: 2001 (except Feb, May, Aug, to Nov), 2002 (except Feb, June, Aug, to Nov), 2003 (except June), 2004 (except June, July, Oct. and Dec.), 2005 (except Feb, Nov, Dec.), 2006 (except Jan, Feb, Mar, Apr, and July). Where we do not have an issue a photocopy of any *one article* or *one part* of a series can be provided at the same price.

ORDER FORM – BACK ISSUES – PHOTOCOPIES– INDEXES

- Send back issues dated
- Send photocopies of (article title and issue date)
- Send copies of last five years indexes (£4.00 for five inc. p&p – Overseas £4.75 surface, £5.75 airmail)

Name

Address

Tel:

I enclose cheque/PO/bank draft to the value of £

Please charge my Visa/Mastercard/Amex/Diners Club/Switch £

Card No. Maestro Issue No

Valid From Card Expiry Date Card Security Code

(The last 3 digits on or just under the signature strip)

SEND TO: Everyday Practical Electronics, Wimborne Publishing Ltd., 408 Wimborne Road East, Fenddown, Dorset BH22 9ND.

Tel: 01202 873872. Fax: 01202 874562.

E-mail: orders@epemag.wimborne.co.uk On-line Shop: www.epemag.wimborne.co.uk/shopdoor.htm

Payments must be in £ sterling – cheque or bank draft drawn on a UK bank. Normally supplied within seven days of receipt of order.

Send a copy of this form, or order by letter if you do not wish to cut your issue.

M02/07

STORE YOUR BACK ISSUES ON CD-ROMS



**VOL 15
NOW AVAILABLE**

**ONLY
£14.45** each
including VAT
and p&p

A great way to buy *EPE* Back Issues – our CD-ROMs contain back issues from our *EPE Online* website plus bonus articles, all the relevant PIC software and web links. Note: no free gifts are included. All this for just £14.45 each including postage and packing.

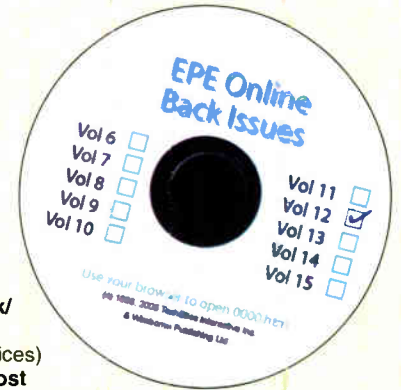

- VOL 1: BACK ISSUES** – January 1999 to June 1999
Plus some bonus material from Nov and Dec 1998
- VOL 2: BACK ISSUES** – July 1999 to December 1999
- VOL 3: BACK ISSUES** – January 2000 to June 2000
- VOL 4: BACK ISSUES** – July 2000 to December 2000
- VOL 5: BACK ISSUES** – January 2001 to June 2001
- VOL 6: BACK ISSUES** – July 2001 to December 2001
- VOL 7: BACK ISSUES** – January 2002 to June 2002
- VOL 8: BACK ISSUES** – July 2002 to December 2002
- VOL 9: BACK ISSUES** – January 2003 to June 2003
- VOL 10: BACK ISSUES** – July 2003 to December 2003
- VOL 11: BACK ISSUES** – January 2004 to June 2004
- VOL 12: BACK ISSUES** – July 2004 to December 2004
- VOL 13: BACK ISSUES** – January 2005 to June 2005
- VOL 14: BACK ISSUES** – July 2005 to December 2005
- VOL 15: BACK ISSUES** – January 2006 to June 2006

Order on-line from
[www.epemag.wimborne.co.uk/
shopdoor.htm](http://www.epemag.wimborne.co.uk/shopdoor.htm)
or www.epemag.com (USA \$ prices)
or by phone, Fax, E-mail or Post

NOTE: These CD-ROMs are suitable for use on any PC with a CD-ROM drive. They require Adobe Acrobat Reader (available free from the Internet – www.adobe.com/acrobat)

WHAT IS INCLUDED

All volumes include the *EPE Online* editorial content of every listed issue, plus all the available PIC Project Codes for the PIC projects published in those issues.

Note: Some supplements etc. can be downloaded free from the Library on the *EPE Online* website at www.epemag.com. No advertisements are included in Volumes 1 and 2; from Volume 5 onwards the available relevant software for *Interface* articles is also included.

EXTRA ARTICLES – ON ALL VOLUMES

BASIC SOLDERING GUIDE – Alan Winstanley's internationally acclaimed fully illustrated guide. **UNDERSTANDING PASSIVE COMPONENTS** – Introduction to the basic principles of passive components. **HOW TO USE INTELLIGENT L.C.D.s.** by Julian Ilett – An utterly practical guide to interfacing and programming intelligent liquid crystal display modules. **PhyzyB COMPUTERS BONUS ARTICLE 1** – Signed and Unsigned Binary Numbers. By Clive "Max" Maxfield and Alvin Brown. **PhyzyB COMPUTERS BONUS ARTICLE 2** – Creating an Event Counter. By Clive "Max" Maxfield and Alvin Brown. **INTERGRAPH COMPUTER SYSTEMS 3D GRAPHICS** – A chapter from Intergraph's book that explains computer graphics technology. **FROM RUSSIA WITH LOVE**, by Barry Fox – Russian rockets launching American Satellites. **PC ENGINES**, by Ernest Flint – The evolution of Intel's microprocessors. **THE END TO ALL DISEASE**, by Aubrey Scoon – The original work of Rife. **COLLECTING AND RESTORING VINTAGE RADIOS**, by Paul Stenning. **THE LIFE & WORKS OF KONRAD ZUSE** – a brilliant pioneer in the evolution of computers. A bonus article on his life and work written by his eldest son, including many previously unpublished photographs.

Note: Some of the EXTRA ARTICLES require WinZip to unzip them.

Everyday Practical Electronics, February 2006

BACK ISSUES CD-ROM ORDER FORM

Please send me the following Back Issue CD-ROMs. Volume Numbers:

Price £14.45 each – includes postage to anywhere in the world.

Name

Address

Post Code

I enclose cheque/P.O./bank draft to the value of £

Please charge my Visa/Mastercard/Amex/Diners Club/Maestro

£

Card No.

Card Security Code (The last 3 digits on or just under the signature strip)

Valid From Expiry Date

Maestro Issue No.

SEND TO: **Everyday Practical Electronics,
Wimborne Publishing Ltd.,
408 Wimborne Road East, Ferndown, Dorset BH22 9ND.**

Tel: 01202 873872. Fax: 01202 874562.
E-mail: orders@epemag.wimborne.co.uk

Payments must be by card or in £ Sterling – cheque or bank draft drawn on a UK bank.

Normally supplied within seven days of receipt of order.

Ingenuity Unlimited



WIN A PICO PC-BASED OSCILLOSCOPE WORTH £586

- 5GS/s Dual Channel Storage Oscilloscope
- 50MHz Spectrum Analyser
- Multimeter
- Frequency Meter
- USB Interface.

If you have a novel circuit idea which would be of use to other readers then a Pico Technology PC-based oscilloscope could be yours. Every 12 months, Pico Technology will be awarding a PicoScope 3205 digital storage oscilloscope for the best IU submission. In addition a DrDAQ Data Logger/Scope worth £59 will be presented to the runner up.

Our regular round-up of readers' own circuits. We pay between £10 and £50 for all material published, depending on length and technical merit. We're looking for novel applications and circuit designs, not simply mechanical, electrical or software ideas. Ideas *must be the reader's own work* and **must not have been published or submitted for publication elsewhere**. The circuits shown have NOT been proven by us. *Ingenuity Unlimited* is open to ALL abilities, but items for consideration in this column should be typed or word-processed, with a brief circuit description (between 100 and 500 words maximum) and include a full circuit diagram showing all component values. **Please draw all circuit schematics as clearly as possible**. Send your circuit ideas to: *Ingenuity Unlimited*, Wimborne Publishing Ltd., 408 Wimborne Road East, Ferndown, Dorset BH22 9ND. (We do not accept submissions for IU via email.) Your ideas could earn you some cash **and a prize!**

Alternating LED Flasher – *Reciprocating Warning*

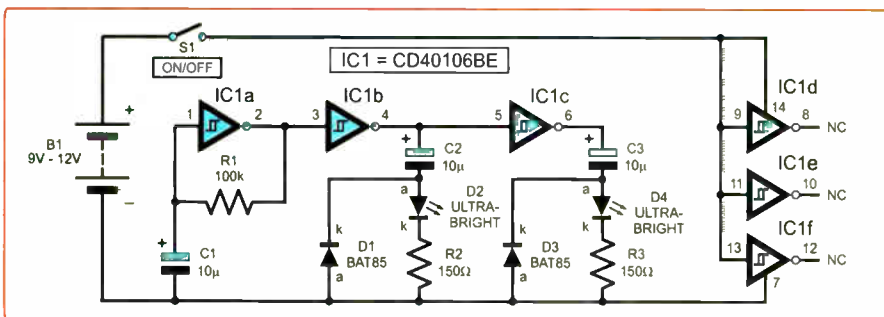

Fig. 1: Circuit diagram for the Alternating LED Flasher

An alternating LED flasher may be used to simulate aircraft lights for example, or to give a flash which seems more 'aggressive' than a single LED. The Flasher shown in Fig.1 flashes two LEDs alternately at a brisk pace, just over 1Hz for the full two-LED cycle.

IC1a is configured as a simple Schmitt inverter relaxation oscillator or clock generator. The full flash cycle is determined by resistor R1 and capacitor C1. The outputs of IC1b and IC1c go low alternately. When IC1b output pin 4 goes low, so C2 pushes a pulse of current through LED D2. When IC1b output pin 4 goes high, so C2 discharges, aided by the voltage limiting diode D1. The same applies to the identical circuit surrounding IC1c. Since IC1b and

IC1c switch alternately, they also cause the LEDs to flash alternately.

Both D2 and D4 should be ultrabright LEDs. Resistors R2 and R3 limit the current flowing through them. To change the speed of the flasher, change the value of R1 (lower resistance for a faster flash, and vice versa).

The CD40106BE hex Schmitt trigger IC was found to work best for IC1. Equivalent should work well, but may cause a slight residual glow after flashing. Current consumption is nearly 3mA. That is, it is modest but not small. A set of AA batteries should last for two to three weeks in continuous use.

Thomas Scarborough,
Cape Town, South Africa

TEACH-IN 2006 COMPETITION WINNERS

We are pleased to announce the prize winners for our *Teach-In 2006 Competition* for which the prizes were kindly donated by **Rapid Electronics**.

1st Prize: Jonathan N Crawford receives a magnificent 72-piece tool kit from Rapid Electronics, worth £323.00

Runners Up Prizes – each person receives a zipped case tool kit from Rapid Electronics, each worth £13.51: Lee Archer; Bill Smith; Jay Lister; Gary Bleds; Jeremy Peterson; Anderson Kho; Vic Gossage; Carlos Dahdah; Chai Chien Liang; Tiong Sie Liik; Robert Wilson; Rick Allsop; Emmanuel Poitier; George Guerin; Steven Dean; John Swales; Tim Dodds

Note: We have been unable to contact some of the prize winners. If your name appears above – and if you have not already done so – please let us have, via email only, your full postal address for the prize to be posted to you.

EPE EVERYDAY PRACTICAL ELECTRONICS

To advertise your company in
EPE Magazine

Please contact Stewart Kearn

Tel: 01202 873872 Email: stewart.kearn@wimborne.co.uk



agar
Circuits

Super Fast Service

PCB DESIGN & MANUFACTURE
for both the Hobbyist and Professional

PCBs designed and produced from :

- Notes
- Schematics
- Specifications
- Descriptions
- Print-outs
- Gerbers

Available With or without component assembly

* FREE * PCB PROTOTYPE With Quantity Orders

Email: adinfo@agarcircuits.com
Tel: 028 (90) 738 897

Laser 

Laser Business Systems Ltd
<http://www.laser.com>
<http://www.cb-us-shop.com>
Tel: +44 (0) 20 8441 9788
Fax: +44 (0) 20 8449 0430
Email: info@laser.com

C-Bus Shop
CLIPSAL C-Bus
New C-Bus Wireless
coming soon







We are an authorised distributor of C-Bus intelligent lighting and control system from Clipsal Integrated Systems with an extensive range of home automation related products. We also stock Barix Ethernet based MP3, communications and control products and CAT5e based KATS AV transmission and IR control system.

Why tolerate when you can automate?

www.epemag.co.uk

ANDRE LAMOTHE'S
XGAMESTATION
LEARN STEP-BY-STEP HOW TO DESIGN
AND BUILD YOUR OWN VIDEO GAME CONSOLE!
Design inspired by the Atari 800/2600,
Sinclair ZX Spectrum, Apple II & Commodore 64!





Complete Package eBook Integrated IDE

SX52 CPU 80 MIPS!

OPEN SOURCE!

FEATURES:

- Great for Hobbyists AND Students!
- Complete Software Development Kit!
- eBook on Designing the XGS Console!
- Parallax SX-Key Compatible!
- Fully Assembled XGS Micro Edition Unit!
- The Fun Way to Learn Embedded Systems!

RAL & NTSC COMPATIBLE!



WWW.XGAMESTATION.COM
SUPPORT@NURVE.NET | Ph: 925.736.2098 (usa)

All Major Credit Cards Accepted!

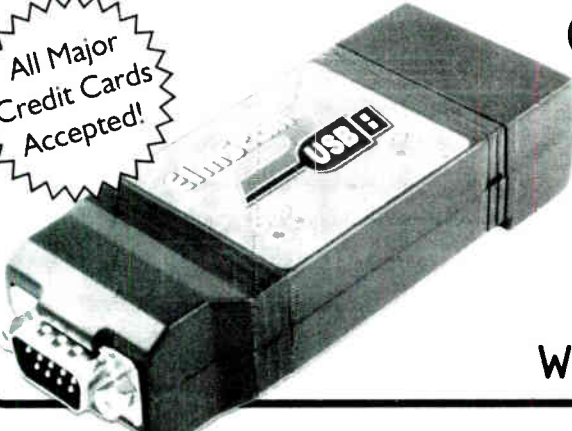

ElmScan 5 USB Scan Tool

- Diagnose any car with EOBD
- Based on the ELM327 IC
- Supports all EOBD and OBD-II protocols
 - ✓ ISO15765-4 (CAN)
 - ✓ ISO14230-4 (Keyword 2000)
 - ✓ ISO9141-2
 - ✓ J1850 VPW
 - ✓ J1850 PWM
- 9600 or 38400 baud
- Supported by more software than any other OBD interface
- Inexpensive
- Full Speed USB 1.1
- Automatic protocol detection
- Package includes cables, software CD, and Quick Start Guide
- Buy from your local UK distributors!

www.ElmScan5.com/epe

Circuit Surgery

Ian Bell



RECENTLY Alan Jones posed the question, "What level is Line Input?" on the EPE Chatzone forum (access via www.epemag.co.uk). He went on to say, "Perhaps this is a silly question, but I haven't found a definitive answer. According to which article you read, it can be 500mV, 707mV, 1V or even 1.414V. My computer's soundcard needs 1V to drive it: the output from my amplifier is 450mV (yet another value!). Is there a standard value, or is it (as I suspect) whatever the designer/manufacture decides to use?"

This prompted quite a few responses, including helpful pointers to standard signal level definitions. Here we will take up the general theme of measuring and defining signal levels, particularly in audio systems.

Matching

Matching is often mentioned when talking about audio signals, so we will start with a quick look at what this means (we will refer to it again later, as it is relevant to the definition of standard signal levels). Consider a source with impedance Z_S connected to load of impedance Z_L , as shown in Fig.1. The 'matching' problem is basically choosing the most appropriate Z_L given that we know Z_S .

The two impedances form a potential divider. Thus the voltage across the load is given by

$$V_L = \frac{Z_L}{(Z_S + Z_L)} V_S$$

We get this equation by using Ohm's law to get the current through the two impedances (V_S divided by the total impedance) and applying Ohm's law again to get the voltage drop across Z_L (multiplying Z_L by the current). From the equation we see that if we want V_L to be as large as possible then Z_L must be much larger than Z_S (we are assuming Z_S is fixed). If Z_L is very much larger than Z_S then the load voltage is effectively equal to the source voltage. This is the situation with most modern audio equipment, that is high input impedance and low output impedance. It is sometimes called *voltage matching*.

So what happens when $Z_S = Z_L$, and why might this be useful? The answer is that maximum power is transferred from source to load (in order to prove this you have to

Line Level – What It Is

use calculus). This was the case in old telephone systems which used 600Ω matched input and output impedances, and this in turn led to early audio equipment using the same standard, but this is no longer relevant to modern audio signals. However, the power transfer aspect of matching is important in other situations, such as power amplifier output to speakers.

Power

Next we need to look at power and its relationship to AC signal measurement. The power dissipated in a resistor when a constant voltage (DC) is applied is easy to calculate. It is

$$P = IV = I^2R = V^2/R$$

When we have any form of varying voltage or current (i.e. AC) the situation is

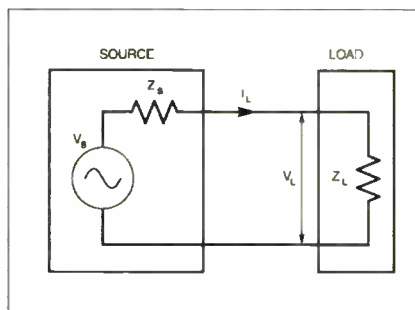

Fig.1: source and load connected together

more complicated. The power dissipated in a resistor driven by an AC wave varies from instant to instant in accordance with the equations above.

However, we often need to know what the average power dissipated (or average signal level) is over a period of time. This is not simply a matter of taking the average voltage or current – it is zero for a sine-wave, but practical experience quickly demonstrates that a resistor will get hot if an AC source of sufficient magnitude is connected to it – so the average power is obviously not zero. In fact, it is the heating effect produced in a resistor that forms the basis of the how we define power for non-DC signals.

To work out the power for an arbitrary cyclic waveform we need to add up all the contributions for instantaneous power and average them over the cycle. To find the

average height of a number of people you measure the height of each, add up all the heights and divide by the number of people. To find the average of the power it would seem to follow that we take I^2R for each instant of the waveform, add them all up and divide by the number of instants.

Integration

Unfortunately, there is an infinite number of instantaneous power values – the current varies continuously, unlike people where there is a finite number of individuals. So we have to use a special mathematical technique called *integration* to find our average power.

The average power dissipated in a resistor R , for a cyclically varying current i , over the cycle time T , of a waveform is given by the equation below. We integrate (indicated by the symbol \int) the waveform over one cycle (0 to T) to add up all the instantaneous contributions and divide by T to get the average. The dt in the equation represents an instant of time (t).

$$P = \frac{1}{T} \int_0^T i^2 R dt$$

If we compare this formula with $P = I^2R$ for DC we can find a value of DC current which would give the same heating effect (power dissipation) as i averaged over one cycle. This is obtained by dividing the above equation by R and taking a square root (if this is hard to follow note we would get I if we did the same to I^2R , which is our DC power value). The result is

$$I_{DC\text{equivalent}} = \sqrt{\frac{1}{T} \int_0^T i^2 dt}$$

So that $P = R \times I_{DC\text{equivalent}}$. This equivalent current is called the *Root Mean Square* or *RMS* value of the AC current. Observe that the current is being *squared* (i^2 in the equation), averaged by integration (hence *mean*) and square-rooted ($\sqrt{\quad}$ in the equation) – this is where the name comes from. We can define an RMS voltage in the same way.

If we have a sine wave then $i = I_{\text{peak}} \sin(2\pi t/T)$ where t is time and I_{peak} is the peak value of the AC current. Now we have to do some more maths – substitute the sinusoidal current into the equation above and perform the integration. We will not go into the details here, but we get

$$I_{DC\text{equivalent}} = I_{\text{peak}} \sqrt{2} \text{ or } 0.707 I_{\text{peak}}$$

This is a formula that may be well known to many readers – to find the RMS value of an AC voltage or current divide the peak value by the square root of 2.

The ratio of a waveform's peak value to its RMS value is known as the *crest factor*. The crest factor is $\sqrt{2}$ for sine waves. It is important to understand that $I_{RMS} = 0.707I_{peak}$ is only true for *pure* sine waves. For any other wave-shape we have to apply the RMS integration equation again from scratch.

Loudness perception

If we want to discuss audio measurements it is useful to start by considering hearing, and specifically human perception of loudness. The human ear is able to hear sounds of a very large range of intensities (which is measured in Watts per square meter – Wm^{-2}).

The quietest sound which can be perceived is called the threshold of hearing and is about $1(10^{-12} Wm^{-2})$. The threshold of pain is about 10,000,000,000,000 times more than this at about $10Wm^{-2}$ (these threshold figures are only approximate and vary with individuals and frequency).

An exponential increase in sound intensity from the quietest audible to the loudest tolerable sound is perceived by us as a basically linear increase in loudness. It is worth mentioning here that while sound intensity in Watts per square meter is rigidly defined, loudness is a matter of human perception and will vary between individuals and with frequency, however, the general exponential nature of the relationship just described remains valid.

We recently discussed exponential functions in some depth in the context of resistor-capacitor timing circuits. *Exponential* is the inverse of *logarithmic* – the intensity varies exponentially, our ears respond logarithmically, so we perceive a linear increase in loudness.

Put another way, each tenfold increase of sound intensity gives an equal step increase in loudness. We could also say each doubling of sound intensity gives an equal step increase in loudness – these would be smaller steps than for a tenfold increase of course.

Signal level

Sound intensity from an audio system is basically dependent on the signal level, specifically power, but for a more-or-less fixed load impedance we can consider voltage or current. So it follows that audio circuits need to handle signals over a very wide range of levels and hence we need a means of expressing and presenting signal measurements in a way that can cope with this massive range of values.

If we plot signal levels on an ordinary graph then we will only be able to see variations in the high signal levels; any variation at the lower end of the exponential range will be too small to see. However, the behaviour of our system at small signals may be very important, for example they may correspond with the quietest parts of a piece of music reproduced by a hi-fi system.

Similarly, if we plot the gain of a filter against frequency we may be interested in details of variations in gain in both the pass and stop bands, but these gains may differ

by a factor of 1000 or more and cannot both be shown on the same graph.

Decibels

We overcome this problem by scaling our signal levels or gains so that an exponential variation in original values translates to a linear variation in the scaled version. To do this we take a reference level (say the threshold of hearing for sound intensity) and the level we are interested in and find the ratio between them – that is we find by what factor our intensity is larger than the reference. Then if we take a logarithm of the ratio we get the scaled value.

For gain we have a ratio anyway (output referenced to input). For other measurements we take an agreed reference level, for example, threshold of hearing, if we are dealing with sound intensity, or a particular power level, say $1mW$, if we are dealing with audio signals. In fact, this approach is the basis of the commonly used decibel notation.

The definition of a decibel (dB) is based on the logarithm of the *power* ratio of two signals P1 and P2, such that the power ratio in decibels is given by $10 \times \log_{10}(P2/P1)dB$. The term *decibel* means one tenth (*deci*, hence *d*) of a bel (symbol B). The bel is named after Alexander Graham Bell.

One bel is $\log_{10}(P2/P1)$, but as we use $10 \times \log_{10}(P2/P1)$ we are counting in tenths of a bel. If we are expressing power gain (e.g. of an amplifier) then P1 would be the input power and P2 the output power. For measuring a power quantity relative to a reference, P1 would be the agreed reference level and P2 the value we are measuring.

Because power ratios are used in the decibel definition, it does not matter if P1 and P2 are expressed as peak or RMS values as long as both are expressed in the same way. As an example, if your mp3 player is delivering $2 \times 10^{-2} Wm^{-2}$ of sound power to your eardrums this would be 103dB relative to a threshold of hearing reference at $1 \times 10^{-12} Wm^{-2}$. The calculation is: $10 \times \log_{10}(2 \times 10^{-2} / 1 \times 10^{-12}) = 103$.

Note that if the measured value is equal to the reference, or the gain of the system is 1, then we get 0dB. If a circuit reduces power, i.e. it is an attenuator, then we get negative decibel values. For example, if the power output is 50 times smaller than the input then the 'gain' is -17dB. If the power is reduced by one half then the output is at -3dB.

This is a figure that many readers may be familiar with as the cut-off frequency of a filter (or the bandwidth of an amplifier) is usually quoted as the point where the gain falls 3dB below the value in the pass band. At this frequency the output power from the filter is half the value it is in the pass band (for equal input power).

Voltage and current gain

So far we have only discussed power ratios – this was obviously appropriate for sound intensities, but in circuits we often measure signals as voltages and currents. Power is related to the square of voltage or current. If we square something inside a logarithm it is equivalent to multiplying the log by two (without the square). That is

$\log(V^2) = 2\log(V)$. So to express a voltage gain ($V1/V2$) in decibels we use $20 \times \log_{10}(V2/V1)$.

Note that we are multiplying by 20, not by 10 as we did with the power gain. Strictly speaking this formula is only valid if the two voltages are applied across the same value of resistance, but in many cases we are only interested in the voltage gain (not the power gain) and the $20 \times \log_{10}(V2/V1)$ formula is widely used for this purpose (V2 is the output, V1 is the input). Similarly, current gains can be expressed in decibels using $20 \times \log_{10}(I2 / I1)$.

Power base

Gains in decibels are relatively easy to understand because the ratio is input to output, but for measuring signal level we need to make sure we know what reference level we are dealing with and whether it is power or voltage measurement.

If we work with *matched* systems, where the input and output impedances are all basically the same, then it makes sense to measure signals in power terms (the matching achieves maximum power transfer). This was the case with the old 600Ω matched systems. For the signals in these systems, one milliwatt was a convenient reference level for decibel power measurement, so the unit dBm (or dBmW) was used for this purpose. Given an impedance of 600Ω the 1mW reference power corresponds to a voltage of 0.775V (RMS). This is easily verified using $P = V^2 / R = 0.775^2 / 600 = 0.001mW$.

Under these conditions it made sense to use 0.775V RMS as a reference level for decibel voltage measurements. We have to use a different unit for this as dBm is a power measurement not a voltage measurement so dBu (or dBV) is used. As with other voltage-based decibel measurement, the resistance may be ignored or unspecified, although the dBu unit is often stated as referring to an open circuit situation, that is *unloaded* or *unterminated*, hence the *u*.

Note again that 0.775V RMS is about 1.1V peak (not 1.0V) for a sine wave signal, the value 0.775V RMS relates to power into a 600Ω load and not conversion from peak to RMS voltages.

If you are not using a 600Ω system then, apart from its historical precedence, the 0.775V RMS reference level seems very arbitrary. For this reason a reference using the *round number* of 1V RMS is sometimes used instead. The symbol for this is dBV. 1dBV is equal to 2.2dBu (from $20 \times \log_{10}(1/0.775)$) and 1dBu is equal to -2.2dBV (from $20 \times \log_{10}(0.775/1)$). The impedance is not specified for dBV measurements.

There are a couple of standard signal levels used for audio equipment. These are +4dBu and -10dBV. The +4dBu value, which is typical for professional audio equipment, is 1.23V RMS (from $0.775 \times 10^{(4/20)}$, or check that $20\log(1.23/0.775) = 4$). The -10dBV value, which is typical for consumer equipment, is 0.316V RMS (from $1 \times 10^{(-10/20)}$, or check that $20\log(0.316/1) = -10$). Meters on audio equipment will typically be calibrated to these levels (e.g. 0dB on the meter is +4dBu or 1.23V signal).

Pt.2 By JOHN CLARKE

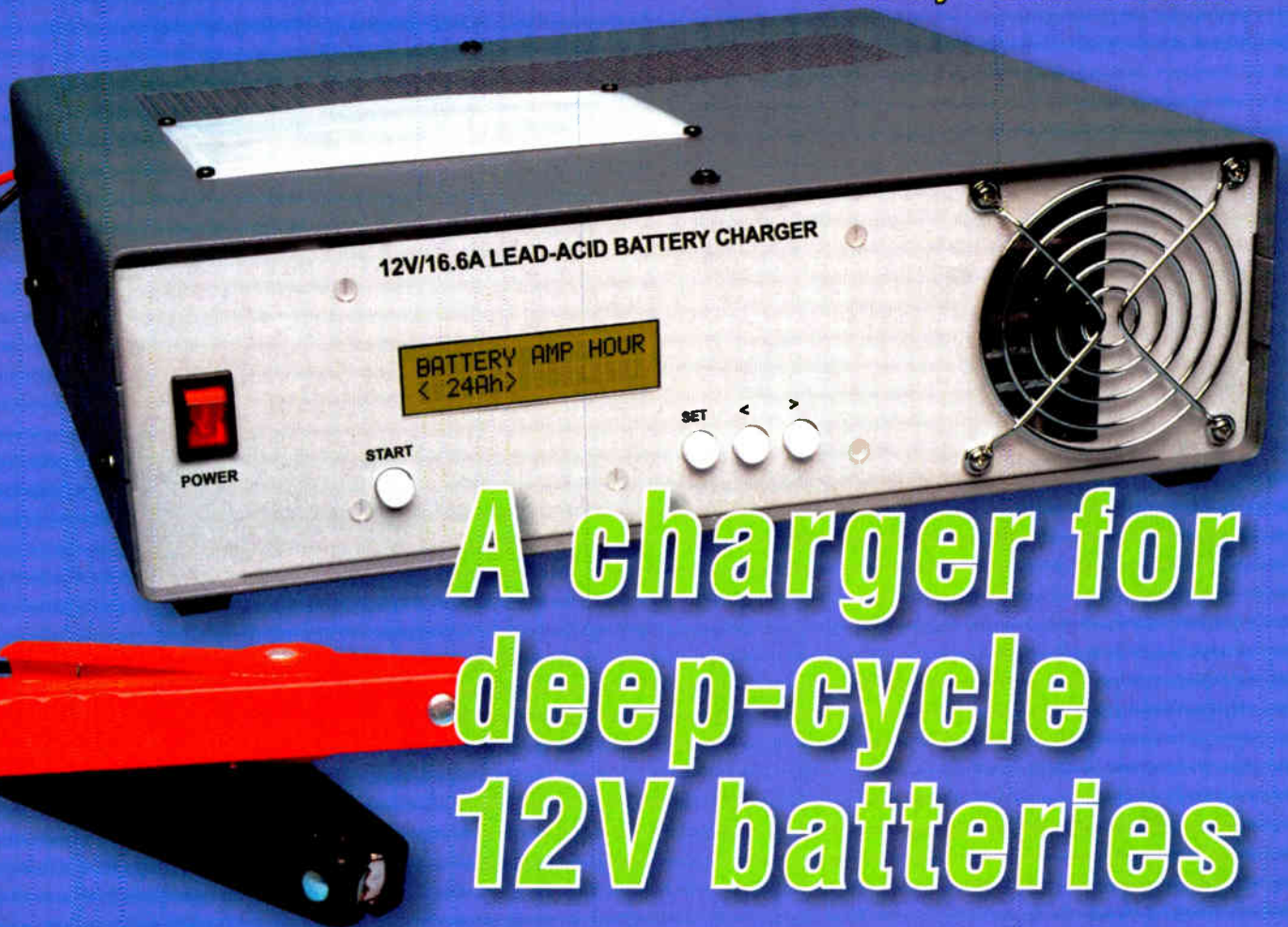

A charger for deep-cycle 12V batteries

In this second article on the 3-Step Battery Charger, we present the full construction details, the parts list and set-up procedure. It is designed to fully charge and maintain deep-cycle lead acid batteries, so that they can deliver their full capacity.

THE BATTERY CHARGER is built on three PC boards. These are the Power PC board code 604 and measuring 224 x 77mm, the Control PC board code 605 and measuring 92 x 69mm and the Display PC board code 606 and measuring 141 x 66mm; all available from the *EPE PCB Service*. These are housed inside a metal case measuring 88mm high x 279mm deep x 304mm wide. The Power Controller components are mounted on a fan-assisted heatsink which is cooled using

an 80mm 12V fan. The transformer is a 300VA toroid.

On the front panel are the power switch, control switches and the LCD module. At the rear of the case are the charger leads, the temperature sensor input socket, the fuses and the heat-sink fan. Also there is a finger guard to cover the fan blades.

Building the PC boards

Before installing any parts, check all the PC boards for any shorts

between the copper tracks or for breaks in the connections. Also check the hole sizes. You will need 3mm holes for the mounting screws and the regulator screw. The holes for the power connections at each side of sense resistor R1 and adjacent to transistor Q2 need to be 4mm in diameter to suit M4 screws. The component layouts for all three boards are shown in Fig.6.

Start by installing the PC stakes at the wiring and test points, then install the links and low-wattage resistors on the Power PC board. Use Table 1 as a guide to selecting each resistor and check each value using a multimeter.

Next, insert the diodes (taking care with their orientation), then install IC1 and IC2. Be sure to install the LM358 in the IC1 position, while IC2 must be the LM393. Both ICs must be installed with the correct orientation, as shown on Fig.6.



The trimpots, capacitors and 5W resistors can be inserted next. Note that the 5W resistors should be mounted about 1mm above the PC board to allow cooling. That done, insert and solder in the R1 sense resistor. When installing the capacitors, make sure that the polarised types are inserted the right way around and that they have the correct voltage ratings for each position.

Leave transistors Q1-Q5 off until the final assembly, to ensure they are set to the correct height for the heatsink mounting holes.

Three M4 x 10mm screws should now be soldered to the underside of the PC board – one on either side of R1 for the power connections and one adjacent to transistor Q2. Each screw is installed from the underside of the PC board and soldered to the large copper areas provided. This will make it easier to complete the connections

on the top of the PC board.

Now for the Display PC board assembly – see Fig.6. Begin by installing the diodes, the resistor, the capacitors and trimpot VR5. Note that the 10 μ F capacitor needs to lie on its side, as shown in the diagram. The pushbutton switches must be orientated with their flat sides facing up, as shown.

Positioning of the LCD will depend on the particular module. Three different LCD modules are generally available and their positions are shown in Fig.6. Type 1 is connected via a dual 7-way header strip, while Type 2 and Type 3 modules are each connected via a single in-line 14-pin header. Note that the Type 2 module reads upside down compared to the other two modules. This is solved simply by mounting the PC board upside down in the case.

The ends of the display adjacent to the header connection are supported

Main Features

- Suitable for 12V lead acid batteries
- LCD shows charging phase and settings
- Temperature, voltage and current metering
- 3-step charging
- Optional equalisation phase
- Battery temperature compensation
- 16.6A charge current capacity
- Initial trickle charge when battery voltage is low
- 4 preset battery chemistry settings
- 2 adjustable specific battery settings (can be set for 6V batteries)
- Correction for voltage drop across battery leads
- Wide battery capacity range (4-250Ah) in 18 steps

Table 1: Resistor Colour Codes

□	No.	Value	4-Band Code (1%)	5-Band Code (1%)
□	1	1MΩ	brown black green brown	brown black black yellow brown
□	1	910kΩ	white brown yellow brown	white brown black orange brown
□	1	100kΩ	brown black yellow brown	brown black black orange brown
□	1	43kΩ	yellow orange orange brown	yellow orange black red brown
□	4	22kΩ	red red orange brown	red red black red brown
□	5	10kΩ	brown black orange brown	brown black black red brown
□	1	5.6kΩ	green blue red brown	green blue black brown brown
□	2	3.3kΩ	orange orange red brown	orange orange black brown brown
□	1	1.8kΩ	brown grey red brown	brown grey black brown brown
□	5	1kΩ	brown black red brown	brown black black brown brown
□	1	330Ω	orange orange brown brown	orange orange black black brown
□	1	270Ω	red violet brown brown	red violet black black brown
□	1	150Ω	brown green brown brown	brown green black black brown
□	1	120Ω	brown red brown brown	brown red black black brown
□	1	10Ω	brown black black brown	brown black black gold brown

using M2.5 x 15mm screws and M2.5 nuts. The 4-way and 6-way header pins are right-angle types. Make up the plugs by terminating the 6-way and 4-way rainbow cable into the header clips and insert the clips into the header shells. The plugs are placed at each end of the wire cabling.

Note that the PC board overlays show a pin 1 orientation for these connectors. Ensure that their polarities are correct.

You can now start work on the Control PC board by installing the resistors, diodes and PC stakes. IC3 and IC4 are soldered directly to the PC board while IC5 (the PIC micro-controller) is mounted in a socket (don't plug IC5 in yet). The regulator mounts horizontally and is secured to the board using an M3 x 10mm screw and M3 nut.

Next, install trimpots VR3 and VR4, making sure the 200Ω trimpot goes into the VR4 position, near the regulator. The capacitors can then be installed, again making sure that the electrolytics are correctly orientated.

Testing the PC boards

The Control and Display PC boards can now be tested for correct operation. First, connect them together using the 4-way and 6-way cabling as shown in Fig.9. Make sure IC5 has not been installed and set trimpot VR4 fully anticlockwise.

Next, apply power (ie, any DC voltage between 12V and 25V) between

the +25V supply pin and the GND pin. That done, connect a multimeter set to read 10V between the GND pin and the tab on the regulator (REG1). Adjust VR4 for a 5.0V output.

Assuming all is OK, switch off the power, install IC5 into its socket and solder SENSOR 1 to the PC stakes. Wait a minute or so until the sensor cools after soldering, then install the shorting jumpers JP1 and JP2.

Re-apply power and adjust trimpot VR5 on the display PC board for best display contrast. Check that the display shows **BATTERY AMP HOUR** and **<60Ah>**. Also, press the Set switch and check that the display now shows **BATTERY TYPE** and **<LEAD ACID>**. Press Start and check that the display shows **BULK** and **26 Deg C 0.0V 0.0A** (for example).

Next, adjust trimpot VR3 so that the display shows the same temperature as the ambient (this can be measured using another thermometer). Note that the display reads in 2°C increments, so set the display to the nearest value available. This may need to be re-checked to be sure the reading tracks the ambient value correctly.

To test the Power PC board, apply between 12V and 25V DC to the +25V and GND pins. That done, check the voltage between pins 8 & 4 of IC1 and IC2 – this voltage should be similar to the input supply. The voltage across ZD3 should be close to 5.1V if the supply is around 25V but may be lower than this if the power supply is only 12V.

Table 2: Capacitor Codes

Value	µF Code	EIA Code	IEC Code
470nF	0.47µF	474	470n
220nF	0.22µF	224	220n
100nF	0.1µF	104	100n
1nF	0.001µF	102	1n

Drilling the case

You will need to drill quite a few holes and make cutouts in the case. We should note at the outset that the case used in our prototype has a drawback in that its bottom panel has a section of mesh right where we wanted to mount the transformer. This means that it needs an additional large metal plate underneath to provide secure anchoring for the transformer bolt.

On the rear panel, holes and cutouts are required for the fan and finger guards, mini XLR socket, bridge rectifier BR2, blade fuseholder, cable glands for the charger leads, mains cord-grip grommet and the fuseholder.

The fan is mounted towards the far edge of the panel. It requires a 75mm diameter cutout and this is made by drilling a series of holes around the perimeter and then knocking out the centre piece. File the cutout to shape.

On the front panel, cutouts and holes are required for the fan outlet and finger guard mounting, the LCD window, the control and power switches and the mounting pillars for Display

KEY TO HARDWARE CODES

- X M3 x 15mm SCREW, 6mm NYLON STANDOFF AND M3 NUT
- Y M3 x 15mm NYLON CSK SCREW, 10mm STANDOFF and M3 NUT
- Z M3 x 15mm SCREW with M3 NUT
- G M4 x 15mm SCREW, M4 STAR WASHER & M4 NUT, YELLOW SLEEVE SOLDER LUG
- H M4 x 15mm SCREW & M4 STAR WASHER
- I M4 x 15mm SCREW, M4 STAR WASHER & M4 NUT
- J M4 x 10mm SCREW & M4 NUT
- K M3 x 10mm SCREW & M3 STAR WASHER
- L M4 x 10mm SCREW & M4 STAR WASHER
- M M4 x 10mm SCREW SOLDERED TO PC BOARD, M4 STAR WASHER & M4 NUT, YELLOW SLEEVED SOLDERLUG(S)
- N M3 x 10mm SCREW, M3 STAR WASHER & M3 NUT
- O TOROIDAL TRANSFORMER MOUNTING BOLT, NUT & WASHERS
- P M4 x 12mm NYLON SCREWS (X6) WITH 0.5mm PLASTIC SHEET INSULATION (NOT SHOWN IN WIRING DIAGRAM - ATTACHES HEATSINK TO BASE PLATE)
- Q M2.5 x 15mm SCREWS & M2.5 NUTS (ATTACH LCD MODULE TO DISPLAY PC BOARD)
- R M3 x 10mm CSK NYLON SCREWS (6) (HOLDS 0.5mm PLASTIC INSULATION TO TOP OF HEATSINK)
- S M3 x 10mm SCREWS & M3 NUTS (FRONT PANEL GRILLE)
- T M3 x 10mm SCREWS & M3 NUTS (ATTACH FRONT & REAR PANELS TO BASEPLATE)
- U FEMALE INSULATED SPADE CONNECTOR FOR 6.4mm WIRE
- V FEMALE INSULATED SPADE CONNECTOR FOR 5.3mm WIRE

Fig.7: this diagram shows the hardware codes (above) for the main wiring diagram (Fig.9). At right are the wiring connections for an alternative transformer.

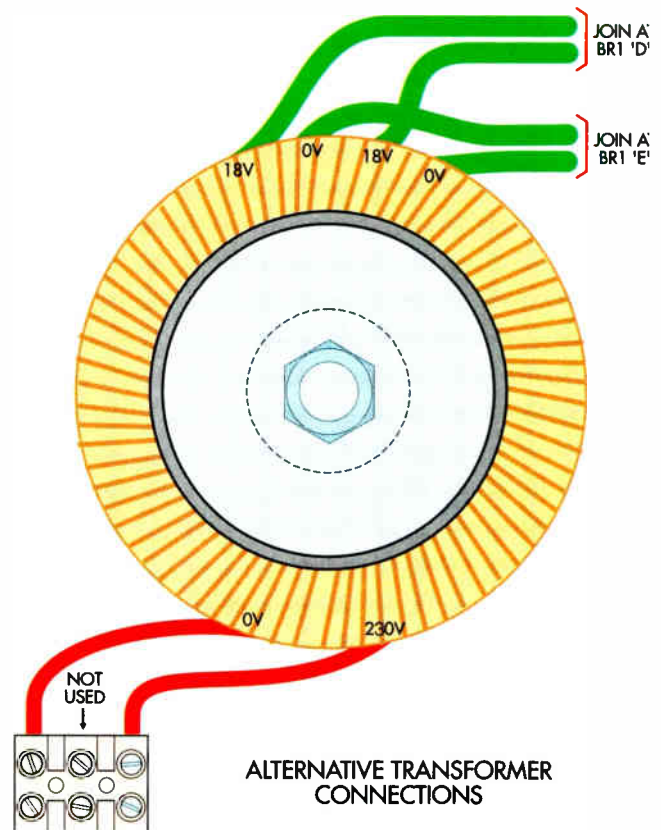

PC board. The latter holes for the PC board pillars need to be countersunk, to suit countersink screws.

The LCD window cutout required is 67 x 19mm, suitable for fitting the Perspex window. The fan cutout is half a circle and this is on the side where the heatsink is positioned. The cutout position for the LCD window depends on the particular module that is used. Fit the front panel label and the Perspex window to the front panel.

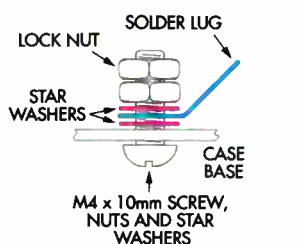

Fig.8: the mains earth solder lug must be securely attached to the metal chassis as shown here. Tighten the first nut very firmly before winding on the second 'lock nut'. Note: scrape away any paint or powder coating from around the mounting point, to ensure a good connection.

The front panel can be assembled now. Insert the M3 x 5mm Nylon countersunk screws for the Display PC board mounting and secure these with the 10mm tapped standoffs. The Display PC board is attached to these screws and held in place with M3 nuts. The fan guard is secured with M3 x 10mm screws and M3 nuts, while the the mains switch is simply clipped into its rectangular cutout (make sure that it is a tight fit, so that it doesn't come adrift).

Holes in the box baseplate are required for the mains earth solder lug mounting, the transformer mounting bolt and for mounting the PC boards and the heatsink. In addition, two holes are required for the 3-way mains terminal block.

Our prototype box included side panels which are used to increase the case height and these have side flanges. The panel for the transformer side of the box needs to have these flanges removed. We used a nibbling tool to cut these flanges away and filed the edges down to a smooth finish.

The flanges on the fan side also need to be removed near the fan to allow it to be positioned without fouling.

In addition, the front panel requires a 50 x 4mm notch adjacent to where the heatsink mounts on the top and bottom mounting flanges. These are required to allow the heatsink to fit without touching the panel.

Insulated heatsink mounting

An important aspect of the charger design is the heatsink which is completely insulated from the case. This was done so that no mica or silicone washers are required when mounting the bridge rectifier and the five power transistors (Q1-Q5) and this maximises heat transfer from those components.

In addition, it greatly simplifies the high-current power connections to the collectors of the five power transistors. The +18V output from the main bridge rectifier simply connects to the heatsink and since all the transistor collector tabs are also bolted to the heatsink, that makes the connection. Simple – but you do have to make sure the heatsink is properly isolated, so there is no chance of shorts between it and the case.

The heatsink requires tapped holes to mount the bridge rectifier (BR1), the

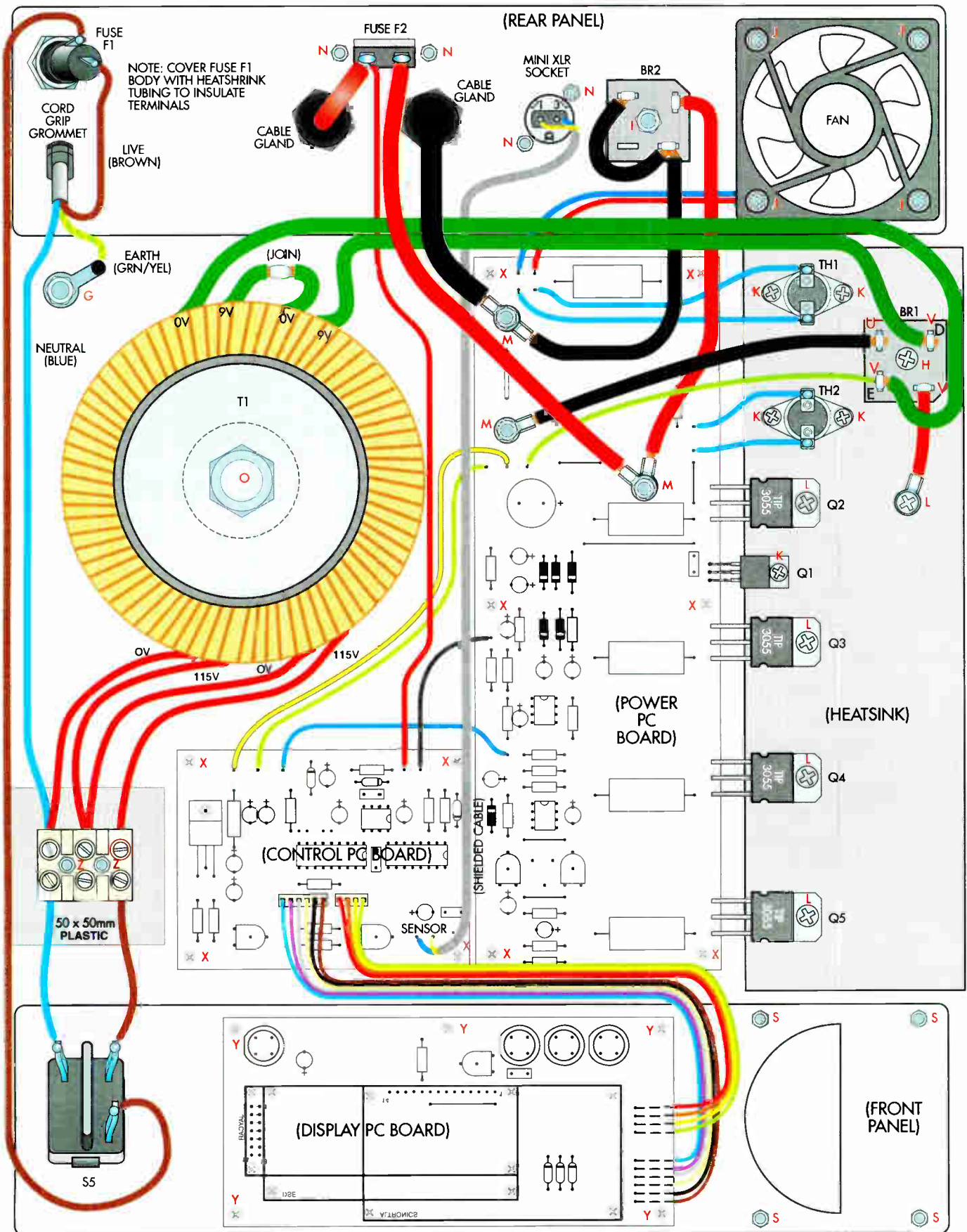
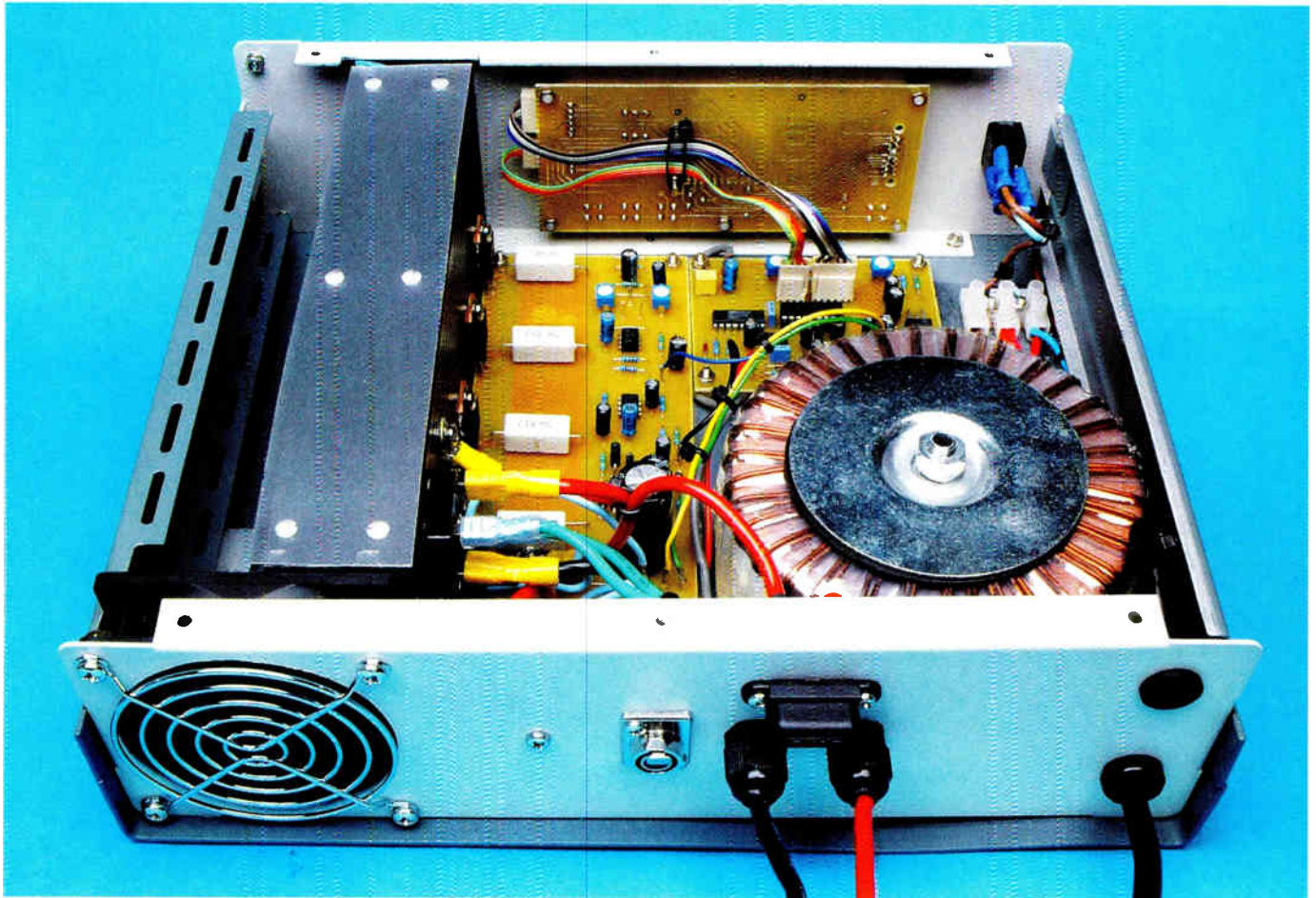

Fig.9: this is the main wiring diagram for the battery charger. Be sure to use heavy-duty cables where indicated (see text) and take care with the mains wiring. The terminals of switch S5 should all be insulated (see text), as should the terminals for Fuse F1 (using heatshrink). Once the wiring is in place, it should be secured using cable ties, as shown in the photos.



This view shows how the parts are arranged on the rear panel and also shows how the display board is mounted. Be sure to insulate the mains switch terminals and use cable ties to secure the wiring.

two thermostats, Q1-Q5 and the positive supply connection. In addition, the top and bottom surfaces require six holes each.

A sheet of 0.5mm plastic insulating sheet (225 x 45mm) is fixed to the top and bottom surfaces of the heatsink to ensure that it cannot short to either the base or the lid of the case. The bottom holes are tapped M4, so that the heatsink can be attached to the baseplate using Nylon M4 screws (the plastic sheet is sandwiched between the heatsink and the base of the case).

The holes in the top of the heatsink are tapped M3 so that the second 225 x 45 x 0.5mm plastic sheet can be secured using M3 countersunk Nylon screws. Do not use glue to secure the plastic sheeting.

Fig.10 shows the drilling and tapping details for the heatsink.

Attach the thermal cutouts to the heatsink using a smear of heatsink compound to the back of the sensors before securing them with M3 x 10mm screws and star washers. That

done, install the heatsink in the case. Check that it is isolated from the case by measuring the resistance between them with a multimeter – the meter should indicate an open circuit.

Installing the power board

Next, install the PC board standoffs onto the baseplate using the M3 tapped 6mm Nylon standoffs and the M3 x 15mm screws and place the Power PC board in place. That done, insert the five power transistors (Q1-Q5) and adjust their height above the PC board so that the holes in the transistor tabs line up with their respective tapped holes in the heatsink. You can then carefully lift the board out and solder the centre leg of each power transistor. When you've done this, replace the board and re-check alignment before soldering the other transistor leads.

The power transistors can now be bolted to the heatsink. To do this, first, apply a smear of heatsink compound to their mounting faces, then secure the Power PC board in place with M3

nuts. The power transistors can then be fastened to the heatsink using M4 x 10mm screws and star washers. Q1 (BD649) is secured using an M3 x 10mm screw and star washer.

Similarly, apply heatsink compound to the back of bridge rectifier BR1 before securing it in place with an M4 x 15mm screw and star washer. Make sure it is oriented with its positive ('+') terminal positioned as shown.

The Control PC board can now be attached to the baseplate using 6mm standoffs, M3 x 15mm screws and M3 nuts. Note that the lower right mounting point connects the 470nF capacitor to chassis via a solder lug. Check that this is earthed using a multimeter between chassis and this earth point (you should measure this as a short circuit).

Note that one of the extra securing points for connecting the rear panel to the baseplate is located beneath where the fan mounts. The M3 securing nut for this should be glued in place so as to make assembly easier.

Fig.9 shows how the hardware is installed on the rear panel. Secure the bridge rectifier (BR2), the blade

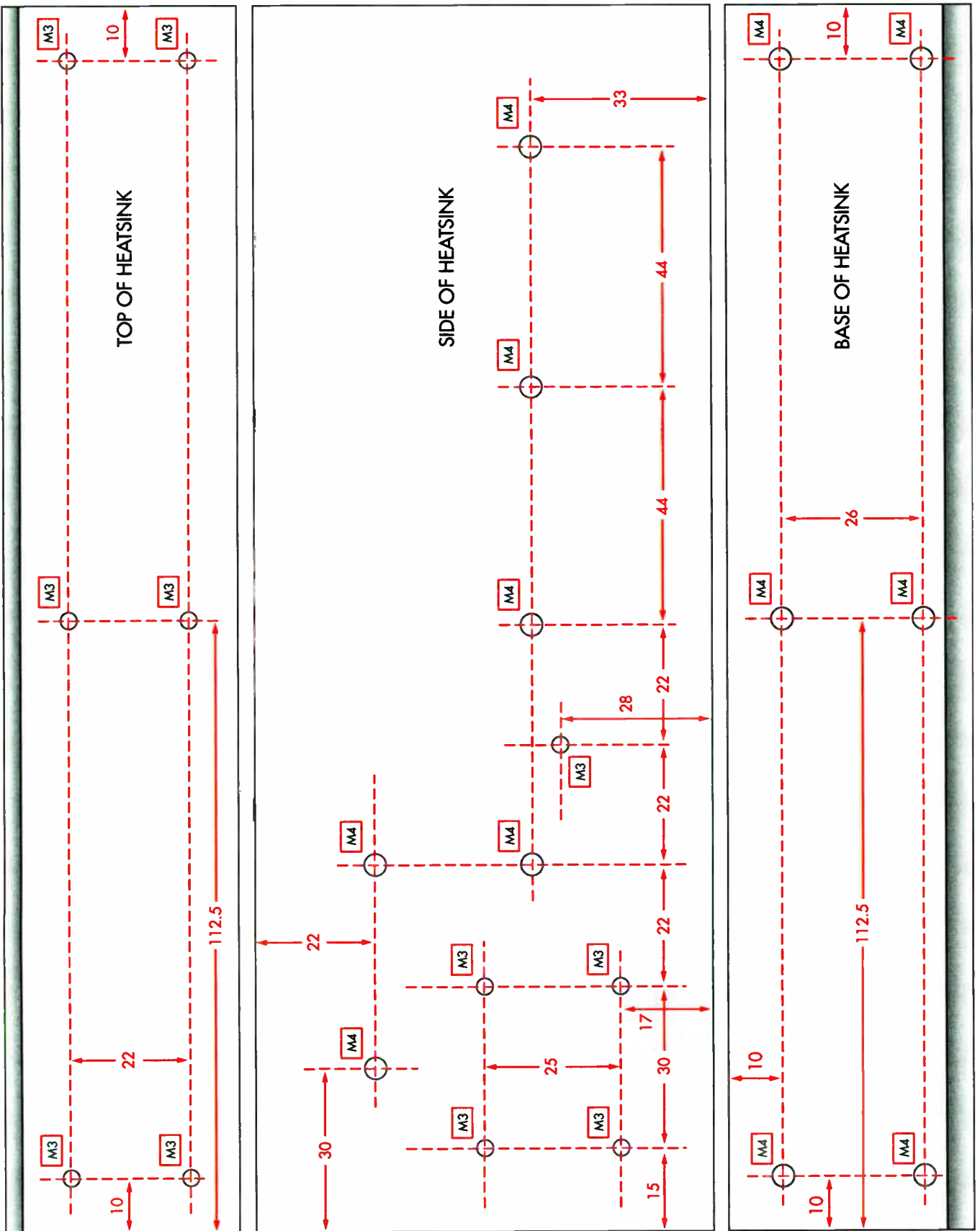

Fig.10: here are the drilling and tapping details for the heatsink. It is completely isolated from the chassis, to avoid using insulation washers for the power devices.

Parts List – Battery Charger

- | | | |
|---|---|---|
| <ul style="list-style-type: none"> 1 Power PC board code 604, 224 x 77mm 1 Control PC board code 605, 92 x 69mm 1 Display PC board code 606, 141 x 66mm. All PCBs are available from the <i>EPE PCB Service</i> 1 88.1mm high x 279mm deep x 304mm wide metal case 1 230V to 18V 300VA mains toroidal transformer (2 x 9V or 2 x 18V secondaries) (T1) 1 fan-assisted heatsink, 225 long 1 80mm 12V DC 2.4W fan 2 80mm fan finger guards 1 NO 50°C thermostat switch (TH1) 1 NO 70°C thermostat switch (TH2) 1 M205 panel-mount safety fuseholder (F1) 1 3A M205 slow blow fuse 1 30A chassis blade fuseholder (F2) 1 20A blade fuse 10 100mm long cable ties 6 20 x 20 x 8mm large adhesive rubber feet 2 4-8mm waterproof cable glands 1 cordgrip clamp for mains cord 1 7.5A mains cord and plug 1 3-way 10A terminal strip 2 50A insulated battery clips (1 red, 1 black) 2 2.54mm jumper shunts (JP1,JP2) 2 2-way header terminal strips 1 2-line, 16 characters per line alphanumeric LCD module 1 14-way SIL header strip for Type 1 and Type 2 LCD modules 1 14-way DIL header strip for Type 1 LCD module 1 6-way polarised header plug 1 6-way polarised right angle header plug | <ul style="list-style-type: none"> 2 6-way polarised header sockets 1 4-way polarised header plug 1 4-way polarised right angle header plug 2 4-way polarised header sockets 6 5.3mm ID eyelet crimp connectors suiting 6mm wire 9 female insulated 6.4mm spade connectors suiting 4.8mm wire 2 female insulated 6.4mm spade connectors suiting 6mm wire 1 solder lug 1 mini XLR 3-pin line plug 1 mini XLR 3-pin chassis mount socket 1 SPST neon illuminated 230V 6A rocker switch (S5) 4 White SPST PC board mount tactile snap action switches (S1-S4) 1 18-pin DIL IC socket 10 M3 tapped x 6mm Nylon standoffs 5 M3 tapped x 10mm standoffs 3 M4 x 15mm screws 12 M4 x 10mm screws 6 M4 x 12 Nylon screws 5 M4 nuts 19 M4 star washers 12 M3 x 15 screws 5 M3 x 15mm Nylon countersunk screw 12 M3 x 10mm screws 6 M3 x 6mm Nylon countersunk screws 10 M3 nuts 12 M3 star washers 2 M2.5 x 12mm screws 2 M2.5 nuts 23 PC stakes 1 50 x 50mm piece of plastic insulating material 1 67 x 19mm sheet of 2.5-3mm clear Acrylic or Perspex 2 225 x 45mm pieces of 0.5mm flexible sheet plastic to insulate | <ul style="list-style-type: none"> heatsink top and bottom (eg thin plastic chopping mat) 1 225 x 80mm piece of 0.5mm flexible sheet plastic to insulate below the power PC board 2 30 x 70mm pieces of 0.5mm flexible sheet plastic for covering ventilation holes in fan airway tunnel 1 1.5m length of single core shielded cable 1 200mm length of 6-way rainbow cable 1 200mm length of 4-way rainbow cable 1 200mm length of 0.7mm tinned copper wire 1 1.5m 3.3mm squared 30A red automotive wire (12G) 1 1.5m 3.3mm squared 30A black automotive wire (12G) 1 500mm length of 24 x 0.2mm red hookup wire 1 500mm length of 24 x 0.2mm black hookup wire 1 200mm length of 32 x 0.2mm brown hookup wire 1 200mm length of 32 x 0.2mm blue hookup wire 1 100mm length of 16mm heat-shrink tubing 1 100mm length of 10mm heat-shrink tubing 1 50mm length of 6mm heatshrink tubing <p>Semiconductors</p> <ul style="list-style-type: none"> 1 LM358 dual op amp (IC1) 1 LM393 dual comparator (IC2) 1 4051 analogue 1 of 8 selector (IC3) 1 TLC548 8-bit serial A/D converter (IC4) 1 PIC16F628A-20P microcontroller programmed with <i>battchrg.hex</i> (IC5) available for free download from the <i>EPE</i> website at: www.epemag.co.uk. |
|---|---|---|

fuseholder, the mini XLR panel socket, the fan and the fan guard, as shown in this diagram. That done, secure the cable glands for the battery leads and the M205 fuseholder.

The fan should be orientated so that it blows air inside the case. If you look closely, you will see arrows on the fan that indicate the blade direction and airflow (ours was installed with the labelled side facing inside the box).

Note that we have specified extra star washers in the parts list. This is so that you can place them under the screws attaching the panels to assemble the case. The star washers will bite into the metal to ensure the panels are earthed correctly to the baseplate. Note also that you should scrape away any paint or powder coating around the screw holes, to ensure good metal-to-metal contact.

Once the case has been assembled, each separate panel should be checked for a good connection to the baseplate using a multimeter set to read low ohms. Don't skip this step – it's vital to ensure that all panels are correctly earthed, to ensure safety.

Wiring

Fig.9 shows all the wiring details. First, strip back 250mm of the sheathing at

- Pre-programmed PICs are available from **Magenta Electronics**
- 1 BD649 NPN Darlington transistor (Q1)
 - 4 TIP3055 NPN power transistors (Q2-Q5)
 - 1 LM335Z temperature sensor (SENSOR1)
 - 1 50A 600V bridge rectifier (BR1)
 - 1 35A 400V bridge rectifier (BR2)
 - 3 1N4004 1A diodes (D1-D3)
 - 6 1N4148 diodes (D4-D9)
 - 2 15V 5W Zener diodes (ZD1,ZD2)
 - 1 5.1V 1W Zener diode (ZD3)

Capacitors

- 1 2200 μ F 50V PC electrolytic
- 1 220 μ F 50V PC electrolytic
- 4 100 μ F 25V PC electrolytic
- 1 22 μ F 63V PC electrolytic
- 11 10 μ F 35V PC electrolytic
- 2 1 μ F 35V PC electrolytic
- 1 470nF 50V MKT polyester
- 1 220nF 50V MKT polyester
- 1 100nF 50V MKT polyester
- 2 1nF 50V MKT polyester

Resistors (0.25W 1%)

- | | |
|------------------------|--------------------|
| 1 1M Ω | 4 1k Ω |
| 1 910k Ω | 1 1k Ω 0.5W |
| 1 100k Ω | 1 330 Ω 1W |
| 1 43k Ω | 1 270 Ω |
| 4 22k Ω | 1 120 Ω |
| 5 10k Ω | 1 56 Ω 5W |
| 1 5.6k Ω | 1 10 Ω |
| 2 3.3k Ω | 4 0.1 Ω 5W |
| 1 1.8k Ω | |
| 1 0.005 Ω 3W 1% | |

Trim pots

- 3 10k Ω horizontal trim pots (VR1,VR2,VR5)
- 1 20k Ω horizontal trim pot (VR3)
- 1 200 Ω horizontal trim pot (VR4)

Miscellaneous

Heatsink compound, solder.

the end of the 3-core mains cable. That done, secure the cord into the back panel using a cord-grip grommet. This grommet needs to be really tight, so that the cord cannot be pulled out. Cut the Live (brown) and the Earth (green/yellow) wires to 70mm length. **The earth wire connects to the solder lug – it should be soldered in place rather than crimped to ensure a good earth connection is made.** Also, scrape away the paint

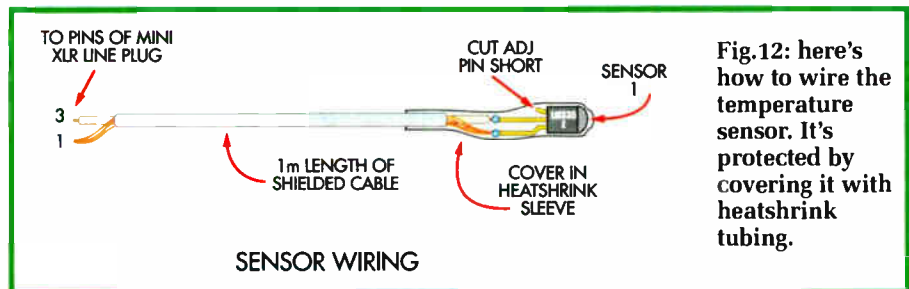

Fig.12: here's how to wire the temperature sensor. It's protected by covering it with heatshrink tubing.

from the earth position on the baseplate to ensure a reliable connection to the case and use an M4 x 15mm screw, a star washer and an M4 nut to attach the lug in place. A second M4 lock nut is then fitted, so that the assembly cannot possibly come undone.

Now measure the resistance between chassis and the earth pin on the mains plug. This should be zero ohms. If not, re-check the connections to chassis. Check also that you get a zero ohm reading between the earth pin of the mains plug and all case panels.

The Live lead is connected to the fuseholder by first passing the wire through a 50mm length of 16mm heatshrink tubing and then soldering it in place. The other terminal of the fuseholder also passes through the heatshrink tubing before it is soldered in place. Finally, slip the heatshrink tubing over the fuseholder before shrinking it down with a hot-air gun.

Note: be sure to use a safety fuseholder for fuse F1 (see parts list), so that there is no danger of receiving a shock if the fuse is removed while the unit is plugged into the mains.

Transformer mounting

Typically, the mains transformer will be supplied with two circular rubber washers, a dished metal mounting plate and a mounting bolt. As noted previously, the prototype's case required an additional plate underneath to provide secure anchoring for the transformer bolt.

The 3-way mains terminal block is placed over a 50 x 50mm piece of plastic insulating material and is held in place using two M3 x 15mm screws and M3 nuts. The wiring to the mains side of the power transformer depends on its windings (the power transformer will be supplied with one of two different winding arrangements).

The prototype transformer had 2 x 115V windings and 2 x 9V windings. This requires the two 115V windings

to be connected in series, suitable for a 230V mains input. The two 9V windings need to be connected in series to obtain 18V. Other transformers will have a single 230V winding and two 18V windings. The 18V windings will need to be connected in parallel. The different wiring arrangements are shown in Figs.7 & 9.

Use 250VAC-rated wire to connect between the power switch terminals and the terminal block. Insulated 6.3mm crimp spade lugs make the connections to the switch, while the remaining wiring is as shown in Fig.9. Note that heavy-duty 12-gauge wire is used for the connections to BR1 and BR2 and for the screw terminals on the PC board via crimp eyelets.

The battery leads are also run using 12-gauge wires. These leads must be exactly 880mm long and they pass through the cable glands in the rear panel and are terminated to the battery clips. The battery clips we used require the jaw to be first removed and the wire passed through the handle of its plastic clip before the lead is soldered.

Note: if you want leads longer than 880mm, you can use heavier gauge wire so that you get 0.01 Ω total resistance in both the positive and negative leads (**this exact resistance is required for the control circuit to accurately calculate the voltage loss in the battery leads**). For example, you can use 2m each of 8-gauge wire (8mm²).

Alternatively, the voltage sensing lead that connects to fuse F2 inside the unit can be extended to the full length of the charger lead and connected to the positive battery clip. This provides remote sensing in the positive lead. In this case, the negative lead could be 1.76m long using 12-gauge wire or 4m long using (thicker) 8-gauge wire.

Heavy-duty hookup wire is used to make the remaining connections to the PC boards, except for the shielded cable used for the temperature sensor lead. This runs from the back of the mini XLR socket to the control PC

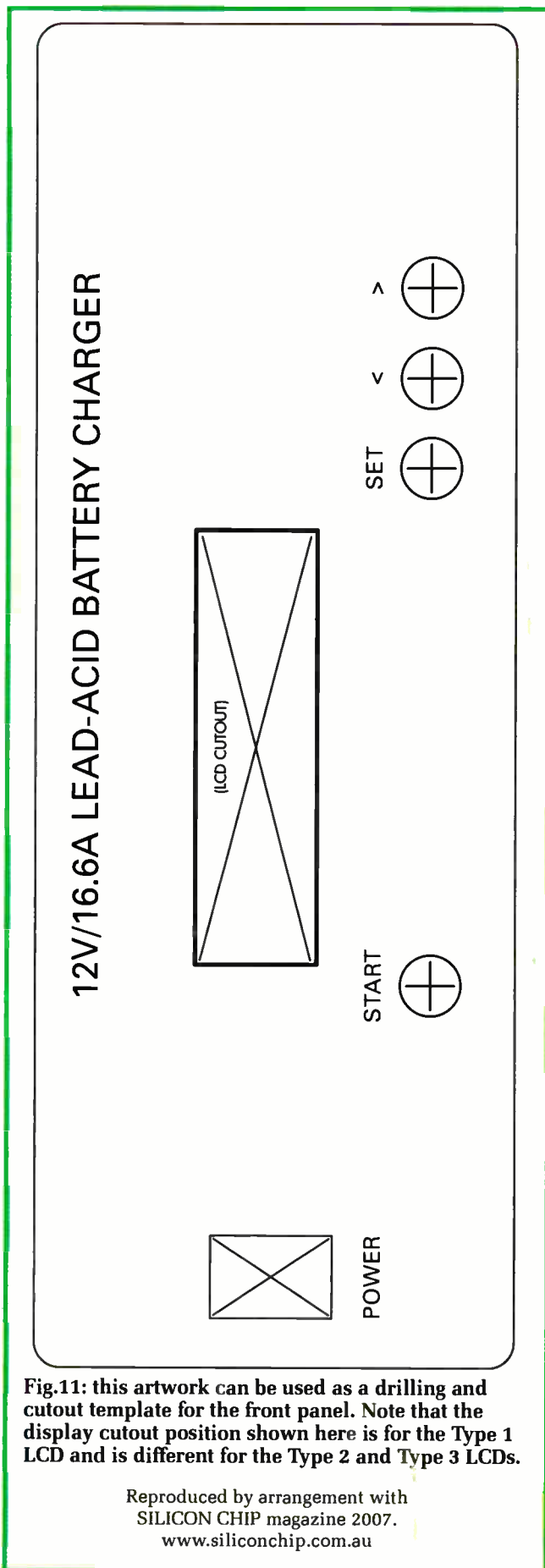

Fig.11: this artwork can be used as a drilling and cutout template for the front panel. Note that the display cutout position shown here is for the Type 1 LCD and is different for the Type 2 and Type 3 LCDs.

Reproduced by arrangement with
SILICON CHIP magazine 2007.
www.siliconchip.com.au

board. Cable ties are used to hold the wires together and stop them from coming adrift. This is important for the mains wires – use cable ties to secure the wires at the rear of fuse F1, at the mains switch and at the terminal block.

Temperature sensor

The temperature sensor (Sensor 1) is mounted at the end of a 900mm length of shielded cable. It can be inserted into a 5mm inside diameter tube and covered in heatshrink tubing. Alternatively, wire the sensor and cover it in heatshrink without the tube. Make sure the probe does not have exposed metal that can short to the battery terminals or to the case.

The other end of the wire connects to pins 1 and 3 of a mini XLR plug. Use the shield connection for pin 1.

Final tests

Do a thorough check of all your wiring, then fit the lid on the case before applying power. Check that the power switch lights up when on. The LCD should also be on.

Next, disconnect power and remove the lid. That done, reconnect power and measure the supply voltage between the GND pin and pin 8 of both IC1 and IC2. These should be around 30V and 25V respectively. Check also that ZD3 has 5.1V across it.

Adjust VR1 so that the voltage between TP1 and TP GND is 1.7V, then adjust VR2 for 1.8V between TP2 and TP GND. This sets the circuit over-voltage and over-current levels to 17V and 18A respectively.

The over-voltage adjustment sets the maximum allowable voltage when charging during equalisation. You may wish to raise this to allow the equalisation to operate for the full three hours. Alternatively, you can reduce the value to prevent damage to any equipment connected to the battery during equalisation. Note that the over-voltage value is restricted to 10-times the TP1 voltage.

Final points

The cooling fan will cycle on and off during charging, particularly at the higher currents. To ensure adequate cooling, the air inlet at the rear of the unit should not be blocked.

When using the charger, make sure that the battery clips are correctly connected to the battery terminals. Check the Ah setting for the battery. Remember that a battery with a reserve capacity (RC) rating will need this value to be multiplied by 0.42 to convert it to the Ah capacity. Also, be sure to set the correct battery type.

At the start of bulk charging, it will take a few seconds to bring the current up to the 25% of Ah current. Note that an already charged battery will cycle through to the float charge in a short space of time. This fast cycling through to float can also indicate a faulty battery, if it has not been charged recently.

The temperature sensor does not necessarily need to be placed on the battery case during charging. In most cases, the sensor can be located adjacent to the battery, to monitor the ambient temperature.

However, the sensor does need to be placed on the battery if it has been brought to the charger from a different temperature environment, such as a cold room. You can secure the sensor to the battery using masking tape. Alternatively, you can use adhesive-backed Velcro material if the battery is to be charged regularly.

EPE

SERIAL COMMUNICATIONS SPECIALISTS

Test and Measurement Solutions



featured products

CAN-USB

USB - CAN Bus adapter
£91.50

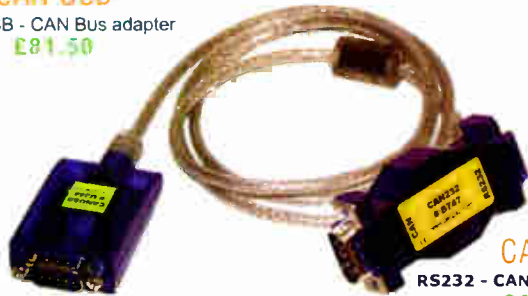

CAN-232

RS232 - CAN Bus Adapter
£61.00

Affordable CAN Bus Solutions from £61 (CAN 232)

CANUSB and CAN-232 are small adapters that plug into any PC USB / RS232 Port respectively to give instant CAN connectivity. These can be treated by software as a standard Windows COM Port. Sending and receiving can be done in standard ASCII format. These are high performance products for much less than competitive solutions.

Bronze Prize Winner
NASA Tech Briefs 2004
Products of the Year

£125.00

ANT16

16 channel logic analyzer
- probe set extra
£195.00



DS1M12

2 channel 1MS/s PC scope,
signal generator & data logger

USB Instruments - PC Oscilloscopes & Logic Analyzers

Our PC Instruments may be budget priced but have a wealth of features normally only found in more expensive instrumentation. Our oscilloscopes have sophisticated digital triggering including delayed timebase and come with application software and DLL interface to 3rd Party apps. Our ANT8 and ANT16 Logic Analyzers feature 8/16 capture channels of data at a blazing 500MS/S sample rate in a compact enclosure.

Low Profile Version
also available

uPCI-400HS

4 Port uPCI RS232 Serial Card
Spider Cable or COMBOX IO
(extra)
£15.00

£15.00



£10.00

uPCI Serial Cards from £15 (uPCI-100L)

Discover our great value for money range of multi-port uPCI serial cards. Supporting from one to eight ports, the range includes RS232, RS422, RS485 and opto-isolated versions. Our 4 port and 8 port models can connect through external cables or the innovative wall mounting COMBOX.

**** NEW LOW PRICE ****



USB-2COM-M

£36.00

2 Port Industrial USB RS232 Serial
with wall mount bracket and 5V
DC auxiliary output



USB-COM-PL

£12.50

Quality USB to RS232 converter
cable with detachable 10cm
extender cable. FTDI Chipset
and Drivers for superior
compatibility and O.S. support.

1 to 16 port USB to Serial Adapters from £12.50

With over 20 different models available, we probably stock the widest range of USB Serial Adapters available anywhere. We offer converter cables, multi-port enclosure style models in metal and plastic, also rack mount units with integral PSU such as the USB-16COM-RM. Serial interfaces supported include RS232, RS422 and RS485. We also supply opto-isolated RS422 and RS485 versions for reliable long distance communications. All our USB Serial products are based on the premium chipsets and drivers from FTDI Chip for superior compatibility, performance and technical support across Windows, MAC-OS, CE and Linux platforms.

NETCOM-813

£350.00



8 Port Industrial Ethernet RS232
/ RS422 / RS485 Serial Server
with wall mount bracket and
PSU.

ES-W-3001-M

£125.00



Single Port high performance
Industrial Wireless Ethernet
RS232 / RS422 / RS485 Serial
Server with PSU and wall mount
bracket. Connects wired also.

Ethernet & Wi-Fi 802-11b/g RS232/422/485 Serial Servers

One to eight port industrial strength Ethernet and Wireless ethernet serial RS232/RS422/RS485 Servers. Connect to your serial device remotely over your Wireless network, Ethernet or via the Internet. Based on the 32-bit ARM CPU these systems offer powerful serial connectivity and a wealth of features. WLAN models comply with IEEE 802.11b/g, max. 54 Mb/s and also offer a 10/100Mbps secondary ethernet connection. All models come complete with PSU. Prices start at only £85.00 (NetCOM 111).

EasySync Ltd

373 Scotland Street
Glasgow G5 8QB U.K.

Tel: +44 (141) 418-0181 Fax: +44 (141) 418-0110

Web : <http://www.easysync.co.uk>

E-Mail: sales@easysync.co.uk

* Prices shown exclude carriage and VAT where applicable

ELECTRONICS MANUALS ON CD-ROM £29.95 EACH

ELECTRONICS SERVICE MANUAL

THE MODERN ELECTRONICS MANUAL

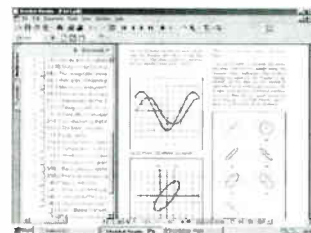
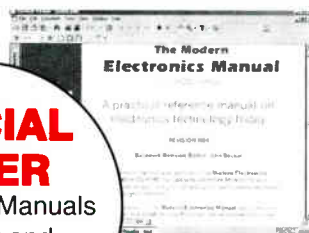
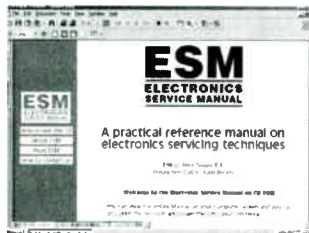

SPECIAL OFFER
Order both Manuals together and **SAVE £10**

Everything you need to know to get started in repairing electronic equipment

- Around 900 pages • Fundamental principles • Troubleshooting techniques • Servicing techniques • Choosing and using test equipment • Reference data • Manufacturers' web links
- Easy-to-use Adobe Acrobat format • Clear and simple layout
- Vital safety precautions • Professionally written • Supplements

SAFETY: Safety Regulations, Electrical Safety and First Aid.

UNDERPINNING KNOWLEDGE: Electrical and Electronic Principles, Active and Passive Components, Circuit Diagrams, Circuit Measurements, Radio, Computers, Valves and Manufacturers' Data, etc.

PRACTICAL SKILLS: Learn how to identify Electronic Components, Avoid Static Hazards, Carry Out Soldering and Wiring, Remove and Replace Components.

TEST EQUIPMENT: How to Choose and Use Test Equipment, Assemble a Toolkit, Set Up a Workshop, and Get the Most from Your Multimeter and Oscilloscope, etc.

SERVICING TECHNIQUES: The Manual includes vital guidelines on how to Service Audio Amplifiers. The Supplements include similar guidelines for Radio Receivers, TV Receivers, Cassette Recorders, Video Recorders, Personal Computers, etc.

TECHNICAL NOTES: Commencing with the IBM PC, this section and the Supplements deal with a very wide range of specific types of equipment – radios, TVs, cassette recorders, amplifiers, video recorders etc.

REFERENCE DATA: Diodes, Small-Signal Transistors, Power Transistors, Thyristors, Triacs and Field Effect Transistors. Supplements include Operational Amplifiers, Logic Circuits, Optoelectronic Devices, etc.

The essential reference work for everyone studying electronics

- Over 800 pages • In-depth theory • Projects to build • Detailed assembly instructions • Full components checklists • Extensive data tables • Manufacturers' web links
- Easy-to-use Adobe Acrobat format • Clear and simple layout • Comprehensive subject range • Professionally written • Supplements

BASIC PRINCIPLES: Electronic Components and their Characteristics; Circuits Using Passive Components; Power Supplies; The Amateur Electronics Workshop; The Uses of Semiconductors; Digital Electronics; Operational Amplifiers; Introduction to Physics, including practical experiments; Semiconductors and Digital Instruments.

CIRCUITS TO BUILD: The Base Manual describes 12 projects including a Theremin and a Simple TENS Unit.

ESSENTIAL DATA: Extensive tables on diodes, transistors, thyristors and triacs, digital and linear i.c.s.

EXTENSIVE GLOSSARY: Should you come across a technical word, phrase or abbreviation you're not familiar with, simply look up the glossary and you'll find a comprehensive definition in plain English.

The Manual also covers **Safety** and provides web links to component and equipment **Manufacturers and Suppliers**.

Full contents list available online at: www.epemag.wimborne.co.uk

SUPPLEMENTS: Additional CD-ROMs each containing approximately 500 pages of additional information on specific areas of electronics are available for £19.95 each. Information on the availability and content of each Supplement CD-ROM will be sent to you.

Presentation: CD-ROM suitable for any modern PC. Requires Adobe Acrobat Reader which is included on the CD-ROM.

Wimborne Publishing Ltd., 408 Wimborne Road East, Ferndown, Dorset BH22 9ND. Tel: 01202 873872. Fax: 01202 874562.

PLEASE send me



THE MODERN ELECTRONICS MANUAL CD-ROM

ELECTRONICS SERVICE MANUAL CD-ROM

I enclose payment of £29.95 (for one Manual) or £49.90 for both Manuals (saving £10 by ordering both together).

FULL NAME
(PLEASE PRINT)

ADDRESS

.....

.....

.....POSTCODE

SIGNATURE

I enclose cheque/PO in UK pounds payable to Wimborne Publishing Ltd.

Please charge my Visa/Mastercard/Amex/Diners Club/Switch/Maestro

Card No Switch/Maestro Issue No

Valid From Expiry Date

Card Security Code (The last 3 digits on or just under the signature strip)

ORDER FORM

Simply complete and return the order form with your payment to the following address:

Wimborne Publishing Ltd,
408 Wimborne Road East, Ferndown,
Dorset BH22 9ND

Price includes postage to anywhere in the World

We will happily exchange any *faulty* CD-ROMs but since the content can be printed out we do not offer a refund on these items.

Your CD-ROM(s) will be posted to you by first class mail or airmail, normally within four working days of receipt of your order

READOUT

WIN AN ATLAS LCR ANALYSER WORTH £79

Email: john.becker@wimborne.co.uk

John Becker addresses some of the general points readers have raised. Have you anything interesting to say? Drop us a line!

All letters quoted here have previously been replied to directly.

An Atlas LCR Passive Component Analyser, kindly donated by Peak Electronic Design Ltd., will be awarded to the author of the *Letter Of The Month* each month.

The Atlas LCR automatically measures inductance from 1µH to 10H, capacitance from 1pF to 10,000µF and resistance from 1Ω to 2MΩ with a basic accuracy of 1%.
www.peakelec.co.uk



PCB track widths

Recently there was a discussion on our Chat Zone (via www.epemag.co.uk) about PCB track widths and their current carrying ability. It's worth sharing with you some of the chat.

Jimbo: I have been reading previous threads about PCB production and although a fair bit is written about how small and close together the tracks can be etched, I've never seen anything about the design width of tracks to ensure that they can carry the required current without overheating. Obviously the thickness of the track (related to the copper weight per unit area) has a bearing as well, as will the resistivity of the copper itself.

My immediate interest is for PCBs using the 7812 regulators, so a maximum intended working current of 1A. Would the basis of a safe design width for the track be for 1A, 2A, or what?

I have seen many examples of 'burn-ups' in early PCBs for valve television sets so overheating of the track until it fails – just like a fuse – can occur.

For very heavy current PSUs, the regulators or pass transistors are frequently mounted on separate heatsinks remote from the PCB so an element of hard wiring is needed but wherever the hard wire meets the track Mr Ohm tells us that ' I^2 squared times R ' is going to create some heat!

I'd be grateful if anyone can point me in the right direction for some suitable data. Thank you.

Obiwan: You should design the PCB for the current that is going to be carried. Do you have a limiter, or fuse on that 7812, that cuts off at 1A?

However, copper traces can carry quite a bit of current. I was actually surprised at just how much. We had a new PCB design come back from the suppliers, after building one up, we finally (finally!) narrowed a fault down to a short in the power supply, somewhere. It was a large board, and no amount of looking would show up where. So we hooked up a PSU and decided to blow the trace, and then we could 'trace' it down. Nope, we got to 50A and it only got a little warm.

So, as long as you're not using very small traces, you should be fine. Many PCB design packages have design rules for stuff like that – when you select a trace from a power component, like V_{out} of that 7812, or mark a trace as POWER component, it will automatically select a

★ LETTER OF THE MONTH ★

EPE Magnetometer

After constructing the EPE magnetometer logger and using it for some time we became convinced that with more sophisticated software it would be possible to improve on the results we were getting. This set in motion a general search of what is available, 'free if possible'. This approach led us eventually to the web site of the Archaeology dept of the University of Sussex at www2.prestle.co.uk/aspensussex/snuffler.html

This freeware Geophysics software has image processing and many features only available on expensive commercial packages.

Output files of the EPE PIC Magnetometry Logger, with small modifications in Excel, can easily be imported into this snuffler software. Other users may be interested.

Graham Medlicott, via email

Thank you Graham. Readers, the project referred by Graham was in the July and August '04 issues.

suitable trace width. They're not perfect, but generally work as good guidelines.

You could probably Google and find what you are looking for under PCB trace amperage, or PCB current carrying capability, something like that. Maybe even 'What is the trace amperage for 2 oz copper clad board'. Who knows...

Dave Squibb: Try http://polysat.calpoly.edu/documents_cp1/systems/trace_capacity.pdf. Putting 'PCB track widths and current capacity' into Google gives several articles.

Ian Istedman: A search on IPC2221 or MIL-STD 275 will reveal more info on the standard data. As a guide, from these specifications, for 1oz copper weight the following track widths/current capacities can be used:

Track Width (in)	Current (Amps)
0.004 (0.1016mm)	0.4
0.006 (0.1524mm)	0.6
0.008 (0.2032mm)	0.72
0.010 (0.254mm)	0.8
0.012 (0.3048mm)	1.0
0.015 (0.381mm)	1.2
0.020 (0.508mm)	1.3
0.025 (0.635mm)	1.7
0.030 (0.762mm)	1.75
0.040 (1.016mm)	2.2
0.050 (1.270mm)	2.6
0.075 (1.905mm)	3.6
0.100 (2.54mm)	4.4
0.200 (5.08mm)	7.0
0.250 (6.35 mm)	9.0

Obiwan: One should also find the ratings for 2oz. copper, isn't that a bit more common? I know you can order 1oz, and

etching is a bit quicker, but around here at least (USA), most places stock more 2oz. I like the smaller, lighter, thinner PCBs and that's what I'll be using when/if I get the ability to make them, 1/64 in 1 oz (or 1/32 in? can't remember right off the bat now).

Epithumia: One thing I've learned is not to use dimensioned PCB tracks as low value resistors e.g. in current sensing. The theory is simple enough: if you know the resistivity of copper and track thickness, then you should be able to select a track length and width to get a known resistance. In practice the track resistance is nothing like the calculated value! PCB vendors I've talked to are no use: the best they could do was refer me to a page on the internet that gave the resistivity of copper, as if I didn't already know that.

Pat: I've found some old notes but cannot remember the source: for 1oz copper – 35 microns thick – using 4A per 1mm width will contain temperature rise to 15°C above ambient (and pro-rata for other widths). Thus for 6A use minimum 6mm wide.

Ian Istedman: I had access to IPC2221 when I compiled the data and I also used the online track width tools at: www.geocities.com/capecanaveral/lab/9643/TraceWidth.htm. As a guide, it is allowable for a 10°C temperature rise in a given track without long-term harm to the PCB.

Generic PIC PCB

Dear EPE,

A number of John B's PIC projects appear to have similar PCBs. I wonder if he could design a generic PIC 'basic

board' that contains the PIC, crystal, program connector, LCD, power supply connections etc, and then bring out the rest of what you normally use, to a daughter board connector.

The idea being, you wouldn't have to design the same board over and over, you and the users could make a whole stack of them at one time, maybe even justifying the cost of having them sent out and have some professional service, solder mask and all that.

Then when you design a project, you design from the daughter board connection up. Then the end user only needs to manufacture the daughter board. Plug the daughter board into the mother board and turn it on.

This should ease the board design on you and the end user. And if you played your cards right, you could re-use the same board (mother board only) for several projects, just the main board no daughter board needed. Those would be 'rare birds', but mostly ones like the graphics demo or the tape measure that were just a PIC, LCD and a few glue circuits.

Naturally, you couldn't do this for every project, only the ones that have a lot in common.

George Johnson (Obiwan on our Chat Zone), via email

George, you're the second person to suggest a 'universal' board. I told him I didn't wish to tie myself to a given design, and to feel free to change things as the needs arise – a universal board would inhibit me, though I agree that the occasional board is similar to another, and indeed will have been a mod of that previous design – graphics LCD designs in particular.

EPE has done multipurpose boards before, and indeed I've done at least one series that had the same board throughout, with different component values and positions depending on needs. But no, I basically need to be free! I can never really tell what I may come up with in the future.

On my current Polyphonium (yet to be published) I use two PCBs and three PICs, master controller and PC interface, top octave and note generator, and LED interface, similar to the recent Giant LED Message Display (Nov '06). It's all brand new, except that many of the concepts I've used before. And inevitably I have my own PCB layout style developed over 30+ years!

IP Cameras

Dear EPE,

I note the comments in *Net Work* December regarding IP cameras. They don't need a host PC, but without a host PC the device would be on public networks and hence open to cracking; look on Google to see the amount of open cameras available. Imagine if this was your own home and someone was watching your private moments.

The encryption stated in the article is purely the wireless encryption, and even that is flaky with only the simplest of tools

required to crack it. The TCP/IP element is open to the world, unless that too is encrypted or 'tunnelled'.

The best recommended installation would be to have a decent wireless router with all of the cameras on a local network scheme, I prefer the 192.168 scheme myself, then password protect and access control all the cameras, such that they can only be accessed from nominated machines.

It's pretty academic really, as even with a camera, what will it stop? Sadly, nothing. Someone can be in and out so fast if they are hungry for something.

Also, can you help the free world by talking about Linux sometime too please. I'm sure 99% of people think there is no choice outside the Microsoft empire.

Simon Topley, Silver Fox Computers, Folkestone, Kent.

As the author of Net Work, Alan replied to Simon:

Thanks for your feedback. Point taken, a camera with a dedicated IP is accessible on the open network, but they would have to know or find the IP address or URL, and even with that, they might still not know where the camera was physically situated. This is no consolation for those having a romantic night indoors!

There have been a couple of recent cases where homeowners have been alerted via webcams to break-in attempts and the local police caught the culprits in time. There have also been cases of 'open' cameras being found on Google, as you say. This can be done by searching for certain text strings (eg as commonly used in Axis network cam setups). I've just found via Google, an IP network cam overlooking a traffic intersection in Norway and then an empty machine-shop full of expensive looking gear, but I have no idea where it is! These cameras are inherently expensive and seem to appear mostly in commercial or industrial applications.

My point about the IP camera not needing a host PC (unlike a standard USB webcam) was only to get across the idea that IP Internet hardware has its own network address and operates as a standalone unit. I agree and have mentioned previously that a router is the best defense, with client machines operating on a LAN with their own private IP addresses (192..), all running behind the the router's firewall.

I understand the frustrations of Windows v. Linux (next month, I discuss MS IE7), but the best I can do is allude to Linux as an alternative OS because the magazine column is a general interest Internet feature, and the huge majority of readers (rightly or wrongly) have Windows OS. I couldn't do justice to Linux with such a small magazine space and Apple users feel the same way. I do agree though and would like to spend some time running up a Linux machine myself, but I never get the time to gain hands-on experience, and it would become a hobby challenge in itself. I will continue to bear it in mind though.

Alan Winstanley

To which I would add that I'll be happy to run a few letters on such in Readout if anyone cares to email me via the address at the top of the Readout page.

Extremely Good C Book

Dear EPE,

I have been reading Mike Hibbett's very interesting series on *C for PICs* and look forward to the next edition. In the meantime, I accidentally came across and purchased an extremely good book called *123 PIC Microcontroller Experiments for the Evil Genius* (from Amazon, standard UK price £14.99).

I did not know at the time that it is based on the HT-Soft PICC Lite C compiler and so should be OK for the Microchip C compiler. It contains a wealth of information and there are literally 123 worthwhile projects to do, eg IR sensing, Motor Control, Sound Detection, etc.

Stephen Alsop, via email

Thanks Stephen, I also passed your info on to Mike Hibbett.

Food Allergy

Dear EPE,

Quite right Bryon Epps (*Readout* Dec '06), your immune system can't react to anything in an insulated glass tube. The allergen has to get into the body sufficiently for the white cells to 'see' it. Unless there is a specific, rare and severe reaction called anaphylaxis, any allergy is going to take some time to manifest itself. Skin resistance depends on sweating, which does not correlate directly with allergy.

Sad but true, modern life makes people feel vaguely ill due to the stresses imposed. Evolution has not yet caught up with these rapid changes and so, unless the cause is recognised, people assume a medical condition and go looking for a diagnosis followed by a prescription. There is no disease that a medical test can show, but many patients are unwilling to try existing means of coping (such as anti-depressants). They derive some benefit from continuing to insist that they have a 'medical' condition and then become easy prey for unproven ideas. It's easy to become obsessed that some food allergy is the cause of all ills and spend great effort on strange and useless diets.

What a pity that society is sufficiently developed to change rapidly into a form that causes stresses, but not sufficiently civilised to recognise and deal with the underlying problem. A true allergy test is typically done by applying skin patches and reading the amount of any redness over several days. Whether or not the allergens thus detected are actually of everyday significance is still not clear even then.

Life is difficult enough, but until we admit to (rather than distract from) the problems, we cannot even begin to solve them.

Godfrey Manning via email

Thank you very much for that opinion Godfrey – soundly based I believe.

Net Work



Alan Winstanley

More Internet Explorer tips

Last month I introduced Microsoft's latest incarnation of their web browser, Internet Explorer 7. This major upgrade can be installed optionally as part of Windows Automatic Update, or can be downloaded from www.microsoft.com/windows/ie/. The browser interface has been restyled in line with the current fashion for shiny plastic and glassy buttons. The browser's online security has been tightened up to the point of becoming obstructive, but expert users can review settings in Tools/Internet Options/Security/Custom. The long overdue multi-tabbed browsing system works well, and at last several web sites can be opened side by side and compared easily.

Microsoft's IE7 includes a new anti-phishing tool, that in the author's experience has yet to prove its worth. Look for the tiny phishing bargraph 'scanning' (see screenshot). You can right-click it and disable the phishing filter (Turn Off Automatic Web Site checking) to speed up the loading of web pages. The phishing filter settings are accessed via the new Tools drop-down menu, and you can also report a phishing site to Microsoft the same way. This requires the user to interpret some incomprehensible 'ransom note' characters, which is intended to ensure that the submitter is not a malicious automated program. If you cannot decipher the characters, click the Refresh button nearby to generate another string.

Phishing attacks are continuing unabated though, and whilst Microsoft's phishing filter is a welcome addition, it does not seem to be sufficiently up to date to catch real-time phishing attempts. Readers could try the Netcraft toolbar as an alternative, from <http://toolbar.netcraft.com>.

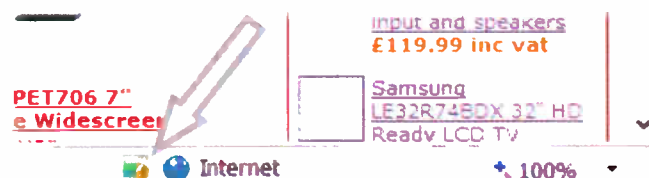

The Phishing Filter icon can be disabled by right-clicking the icon at the bottom of the browser screen

Don't print it – PDF it!

The IE7 Toolbar also has a new Page... dropdown button. Use this to make the text larger in most web pages, or send a URL link or even the entire page by email. As mentioned last month, one extremely welcome update is that IE7 now makes a decent fist of printing web pages, by reflowing them properly to fit the printer paper. Cropped printing is a thing of the past.

Here's a tip: instead of printing web pages, order acknowledgements or receipts onto paper, send them to a PDF document instead. You can always print it off-line later if you still need to, using Adobe Reader. This is especially useful for retaining online order confirmations. A free PDF driver is available from www.primopdf.com. After installing the software, choose the PDF driver as your "printer" and give the file a name, then save it to your hard disk.

You can also decide what information to include in the Headers and Footers of your web page printouts: see the Page Setup options via the IE7 Print menu. The character codes are described in the IE7 Help file under 'Headers, Printing Web pages'. For example, include '&u' in the string forces IE7 to print the URL on your web page printouts, and you can add your own header or footer plain text in there as well.

Finally, on the subject of Windows updates, readers may wish to consider updating Windows Media Player to Version 11. It has been given the same new look and some of the navigation buttons now match those of Internet Explorer 7. A free download is available at www.microsoft.com/windows/windowsmedia/. The program enables audio and video to be played, and it is a valuable tool for creating MP3s from a music CD or for playing your favourite collections. In the UK, as announced in the December 2006 Budget speech, the technical illegality of creating MP3s for personal use from one's own music collection is going to be relaxed in the future.



The new-look Windows Player Version 11 (minimised view)

How to shop online smartly

At the time of writing, several weeks remain before Christmas 2006 is upon us and the UK is experiencing something of an online shopping boom. UK shoppers are reportedly spending £180 million online per day during the festive season, a 38% rise over the previous year's peak. This is not surprising given the cost and hassle of travelling and parking, the increasing pressure on disposable income and the frequently indifferent or sub-standard service forced onto consumers by major retailers.

Unlike many retail store staff, a computer monitor gives you its undivided attention, and online shopping is personal and dedicated to you. Merchandise delivery systems are now in place (such as 'Home Delivery Network', hand-delivered by cheerful people in cars), and there are clear signs of online stores harnessing the increasing purchasing power of online buyers.

Clever web site programming and dynamic interaction affords customers a convenient and stress-free way of buying and customising their requirements via a web site (e.g. Amazon, or send a personalised chocogram via the glorious Hotel Chocolat). Online services inform customers of order progress and email them with timely special offers. Services such as 'Live Chat' offer teleprinter-style discussions with real customer service staff, on demand. Consumer confidence in buying online has been cemented.

A savvy buyer plans his requirements in advance, compares prices online, reads product reviews (see www.ciao.co.uk and www.reevo.com) and if necessary groups his requirements together to minimise the impact of P&P charges. The best advice the author can give is to get a 'feel' for prices by shopping around and flicking through brochures and web sites, then draw up a short-list based on reviews. Shop smartly and you can recognise a bargain when you see one, and hopefully avoid that feeling of having been 'mugged' when you see online prices at 20 to 50% cheaper than the price a High Street retailer just charged you for the same thing.

The downside of online shopping is with stock availability and deliveries. Amazon got it right at Christmas 2006 by showing confidence-boosting clear advice and the likely delivery dates. Also bear in mind the Distance Selling Regulations (in the UK), allowing a seven-day cooling off period for most goods bought at arm's length. You can return them as new and undamaged, for a full refund, though you may have to pay for return postage. Check the seller's terms before you buy.

You can contact Alan at: alan@epemag.demon.co.uk.

FREE Two booklets and a Circuit Surgery CD-ROM with Teach-In 2000 CD-ROM



EPE TEACH-IN 2000 CD-ROM

The whole of the 12-part *Teach-In 2000* series by John Becker (published in *EPE* Nov '99 to Oct 2000) is now available on CD-ROM. Plus the *Teach-In 2000* interactive software (Win 95, 98, ME and above) covering all aspects of the series and Alan Winstanley's *Basic Soldering Guide* (including illustrations and Desoldering).

Teach-In 2000 covers all the basic principles of electronics from Ohm's Law to Displays, including Op.Amps, Logic Gates etc. Each part has its own section on the interactive software where you can also change component values in the various on-screen demonstration circuits.

The series gives a hands-on approach to electronics with numerous breadboard circuits to try out, plus a simple computer interface (Win 95, 98, ME only) which allows a PC to be used as a basic oscilloscope.

ONLY £12.45 including VAT and p&p

Order code Teach-In CD-ROM

Robotics

INTRODUCING ROBOTICS WITH LEGO MINDSTORMS

Robert Penfold

Shows the reader how to build a variety of increasingly sophisticated computer controlled robots using the brilliant Lego Mindstorms Robotic Invention System (RIS). Initially covers fundamental building techniques and mechanics needed to construct strong and efficient robots using the various "click-together" components supplied in the basic RIS kit. Then explains in simple terms how the "brain" of the robot may be programmed on screen using a PC and "zapped" to the robot over an infra-red link. Also, shows how the more sophisticated Windows programming language such as Visual BASIC may be used to control the robots.

Details building and programming instructions provided, including numerous step-by-step photographs.

288 pages – large format Order code BP901 £14.99

MORE ADVANCED ROBOTICS WITH LEGO MINDSTORMS – Robert Penfold

Covers the Vision Command System

Shows the reader how to extend the capabilities of the brilliant Lego Mindstorms Robotic Invention System (RIS) by using Lego's own accessories and some simple home constructed units. You will be able to build robots that can provide you with 'waiter service' when you clap your hands, perform tricks, 'see' and avoid objects by using 'bats radar', or accurately follow a line marked on the floor. Learn to use additional types of sensors including rotation, light, temperature, sound and ultrasonic and also explore the possibilities provided by using an additional (third) motor. For the less experienced, RCX code programs accompany most of the featured robots. However, the more adventurous reader is also shown how to write programs using Microsoft's VisualBASIC running with the ActiveX control (Spirit.OCX) that is provided with the RIS kit.

Detailed building instructions are provided for the featured robots, including numerous step-by-step photographs. The designs include rover vehicles, a virtual pet, a robot arm, an 'intelligent' sweet dispenser and a colour conscious robot that will try to grab objects of a specific colour.

298 pages Order code BP902 £14.99

ANDROIDS, ROBOTS AND ANIMATRONS – Second Edition – John Iovine

Build your own working robot or android using both off-the-shelf and workshop constructed materials and devices. Computer control gives these robots and androids two types of artificial intelligence (an expert system and a neural network). A lifelike android hand can be built and programmed to function doing repetitive tasks. A fully animated robot or android can also be built and programmed to perform a wide variety of functions.

The contents include an Overview of State-of-the-Art Robots; Robotic Locomotion; Motors and Power Controllers; All Types of Sensors; Tilt; Bump; Road and Wall Detection; Light; Speech and Sound Recognition; Robotic Intelligence (Expert Type) Using a Single-Board Computer Programmed in BASIC; Robotic Intelligence (Neural Type) Using Simple Neural Networks (Insect Intelligence); Making a Lifelike Android Hand; A Computer-Controlled Robotic Insect Programmed in BASIC; Telepresence Robots With Actual Arcade and Virtual Reality Applications; A Computer-Controlled Robotic Arm; Animated Robots and Androids; Real-World Robotic Applications.

224 pages Order code MGH1 £16.99

DIRECT BOOK SERVICE

NOTE: ALL PRICES INCLUDE UK POSTAGE

The books listed have been selected by *Everyday Practical Electronics* editorial staff as being of special interest to everyone involved in electronics and computing. They are supplied by mail order to your door. Full ordering details are given on the last book

For a further selection of books see the next two issues of *EPE*.

Radio

BASIC RADIO PRINCIPLES AND TECHNOLOGY

Ian Poole

Radio technology is becoming increasingly important in today's high technology society. There are the traditional uses of radio which include broadcasting and point to point radio as well as the new technologies of satellites and cellular phones. All of these developments mean there is a growing need for radio engineers at all levels.

Assuming a basic knowledge of electronics, this book provides an easy to understand grounding in the topic.

Chapters in the book: Radio Today, Yesterday, and Tomorrow; Radio Waves and Propagation; Capacitors, Inductors, and Filters; Modulation; Receivers; Transmitters; Antenna Systems; Broadcasting; Satellites; Personal Communications; Appendix – Basic Calculations.

263 pages Order code NE30 £18.99

PROJECTS FOR RADIO AMATEURS AND S.W.L.S.

R. A. Penfold

This book describes a number of electronic circuits, most of which are quite simple, which can be used to enhance the performance of most short wave radio systems.

The circuits covered include: An aerial tuning unit; A simple active aerial; An add-on b.f.o. for portable sets;

A wavetrap to combat signals on spurious responses; An audio notch filter; A parametric equaliser; C.W. and S.S.B. audio filters; Simple noise limiters; A speech processor; A volume expander.

Other useful circuits include a crystal oscillator, and RTTY/C.W. tone decoder, and a RTTY serial to parallel converter. A full range of interesting and useful circuits for short wave enthusiasts.

92 pages Order code BP304 £4.45

AN INTRODUCTION TO AMATEUR RADIO

I. D. Poole

Amateur radio is a unique and fascinating hobby which has attracted thousands of people since it began at the turn of the century. This book gives the newcomer a comprehensive and easy to understand guide through the subject so that the reader can gain the most from the hobby. It then remains an essential reference volume to be used time and again. Topics covered include the basic aspects of the hobby, such as operating procedures, jargon and setting up a station. Technical topics covered include propagation, receivers, transmitters and aerials etc.

150 pages Order code BP257 £5.49

Computers and Computing

THE INTERNET FOR THE OLDER GENERATION

Jim Gatenby

Especially written for the over 50s. Uses only clear and easy-to-understand language. Larger type size for easy reading. Provides basic knowledge to give you confidence to join the local computer class.

This book explains how to use your PC on the Internet and covers amongst other things: Choosing and setting up your computer for the Internet. Getting connected to the Internet. Sending and receiving emails, photographs, etc., so that you can keep in touch with family and friends all over the world. Searching for and saving information on any subject. On-line shopping and home banking. Setting up your own simple web site.

228 pages Order code BP600 £8.99

BUILD YOUR OWN PC –

Fourth Edition

Morris Rosenthal

More and more people are building their own PCs. They get more value for their money, they create exactly the machine they want, and the work is highly satisfying and actually fun. That is, if they have a unique beginner's guide like this one, which visually demonstrates how to construct a state-of-the-art computer from start to finish.

Through 150 crisp photographs and clear but minimal text, readers will confidently absorb the concepts of computer building. The extra-big format makes it easy to see what's going on in the pictures. The author goes 'under the hood' and shows step-by-step how to create a Pentium 4 computer or an Athlon 64 or Athlon 64FX, covering: What first-time builders need to know; How to select and purchase parts; How to assemble the PC; How to install Windows XP. The few existing books on this subject, although badly outdated, are in steady demand. This one delivers the expertise and new technology that fledgling computer builders are eagerly looking for.

224 pages – large format Order code MGH2 £16.99

THE PIC MICROCONTROLLER

YOUR PERSONAL INTRODUCTORY COURSE – THIRD EDITION John Morton

Discover the potential of the PIC microcontroller through graded projects – this book could revolutionise your electronics construction work!

A uniquely concise and practical guide to getting up and running with the PIC microcontroller. The PIC is one of the most popular of the microcontrollers that are transforming electronic project work and product design.

Assuming no prior knowledge of microcontrollers and introducing the PICs capabilities through simple projects,

this book is ideal for use in schools and colleges. It is the ideal introduction for students, teachers, technicians and electronics enthusiasts. The step-by-step explanations make it ideal for self-study too; this is not a reference book – you start work with the PIC straight away.

The revised third edition covers the popular reprogrammable Flash PICs: 16F54/16F84 as well as the 12F508 and 12F675.

270 pages Order code NE36 £18.99

eBAY FOR BEGINNERS

Cherry Nixon

There are two kinds of people, those who are trading on eBay and the rest who are missing out. Though eBay has been embraced by entrepreneurs all over the world, it remains the peoples' site and offers the largest market for the smallest fee.

eBay presents an opportunity for everyone, the trick is to master it. This book shows you how to start trading on eBay UK. It also offers advice on getting organised and tips to put you ahead.

The book has been developed from Cherry's popular hands-on course "Buying and Selling on eBay for Technological Simpletons". In addition to fully explaining eBay and how to trade on it there are sections on Paypal, producing pictures of your sale items, fees and accounts, safety and security including what to do when things go wrong and what protection is provided.

178 pages Order code BP551 £8.99

NEWNES PC TROUBLESHOOTING POCKET BOOK – THIRD EDITION

Howard Anderson, Mike Tooley

All the essential data for PC fault-finding and upgrading. This book provides a concise and compact reference that describes, in a clear and straightforward manner, the principles and practice of fault-finding and upgrading PCs and peripherals. The book is aimed at anyone who is involved with the installation, configuration, maintenance, upgrading, repair or support of PC systems. It also provides non-technical users with sufficient background information, charts and checklists to enable the diagnosis of faults and help to carry out simple modifications and repairs. In order to reflect rapid changes in computer technology (both hardware and software) this new edition has been completely revised and rewritten.

256 pages Order code NE41 £19.99

Theory and Reference

ELECTRONIC CIRCUITS – FUNDAMENTALS & APPLICATIONS

Third Edition
Mike Tooley

A comprehensive reference text and practical electronics handbook in one volume – at an affordable price!
New chapter on PIC microcontrollers – the most popular chip family for use in project work by hobbyists and in colleges and universities.

New companion website: spreadsheet design tools to simplify circuit calculations; circuit models and templates to enable virtual simulation, a bank of on-line questions for lecturers to set as assignments, and on-line self-test multiple choice questions for each chapter with automatic marking, to enable students to continually monitor their progress and understanding.

The book's content is matched to the latest pre-degree level courses, making this the invaluable reference for all study levels, and its broad coverage is combined with practical case studies, based in real-world engineering contexts throughout the text.

The unique combination of a comprehensive reference text, incorporating a primary focus on practical applications, ensures this text will prove a vital guide for students and also for industry-based engineers, who are either new to the field of electronics, or who wish to refresh their knowledge.

400 pages

Order code NE43

£21.99

BEBOP TO THE BOOLEAN BOOGIE

Second Edition
Clive (Max) Maxfield

BOOK PLUS
CD-ROM

This book gives the "big picture" of digital electronics. This indepth, highly readable, up-to-the-minute guide shows you how electronic devices work and how they're made. You'll discover how transistors operate, how printed circuit boards are fabricated, and what the innards of memory ICs look like. You'll also gain a working knowledge of Boolean Algebra and Karnaugh Maps, and understand what Reed-Muller logic is and how it's used. And there's much, MUCH more. The author's tongue-in-cheek humour makes it a delight to read, but this is a REAL technical book, extremely detailed and accurate. Comes with a free CD-ROM which contains an eBook version with full text search plus bonus chapter – An Illustrated History of Electronics and Computing.

Contents: Fundamental concepts; Analog versus digital; Conductors and insulators; Voltage, current, resistance, capacitance and inductance; Semiconductors; Primitive logic functions; Binary arithmetic; Boolean algebra; Karnaugh maps; State diagrams, tables and machines; Analog-to-digital and digital-to-analog; Integrated circuits (ICs); Memory ICs; Programmable ICs; Application-specific integrated circuits (ASICs); Circuit boards (PWBs and DWBs); Hybrids; Multichip modules (MCMs); Alternative and future technologies.

500 pages

Order code BEB1

£27.50

BEBOP BYTES BACK (and the Bebooper Computer Simulator)

CD-ROM
Clive (Max) Maxfield and Alvin Brown

This follow-on to *Beboop to the Boolean Boogie* is a multimedia extravaganza of information about how computers work. It picks up where "Beboop 1" left off, guiding you through the fascinating world of computer design . . . and you'll have a few chuckles, if not belly laughs, along the way. In addition to over 200 megabytes of mega-cool multimedia, the CD-ROM contains a virtual microcomputer, simulating the motherboard and standard computer peripherals in an extremely realistic manner. In addition to a wealth of technical information, myriad nuggets of trivia, and hundreds of carefully drawn illustrations, the CD-ROM contains a set of lab experiments for the virtual microcomputer that let you recreate the experiences of early computer pioneers. If you're the slightest bit interested in the inner workings of computers, then don't dare to miss this!

Over 800 pages in Adobe Acrobat format

CD-ROM

Order code BEB2 CD-ROM

£21.95



including tests for transistors, thyristors, resistors, capacitors and diodes. Circuit testing is covered in Chapter 3, with subjects such as voltage, current and continuity checks being discussed.

In the main little or no previous knowledge or experience is assumed. Using these simple component and circuit testing techniques the reader should be able to confidently tackle servicing of most electronic projects.

96 pages

Order code BP239

£5.49

STARTING ELECTRONICS, THIRD EDITION

KEITH BRINDLEY

A punchy practical introduction to self-build electronics. The ideal starting point for home experimenters, technicians and students who want to develop the real hands-on skills of electronics construction.

A highly practical introduction for hobbyists, students, and technicians, Keith Brindley introduces readers to the functions of the main component types, their uses, and the basic principles of building and designing electronic circuits.

Breadboard layouts make this very much a ready-to-run book for the experimenter, and the use of multimeter, but not oscilloscopes, and readily available, inexpensive components makes the practical work achievable in a home or school setting as well as a fully equipped lab.

288 pages

Order code NE42

£10.99

THE AMATEUR SCIENTIST

CD-ROM – VERSION 2

CD-ROM

The complete collection of The Amateur Scientist articles from *Scientific American* magazine. Over 1,000 classic science projects from a renowned source of winning projects. All projects are rated for cost, difficulty and possible hazards. Plus over 1,000 pages of helpful science techniques that never appeared in *Scientific American*.

Exciting science projects in: Astronomy; Earth Science; Biology; Physics; Chemistry; Weather . . . and much more! The most complete resource ever assembled for hobbyists, and professionals looking for novel solutions to research problems. Includes extensive Science Software Library with even more science tools. Suitable for Mac, Windows, Linux or UNIX. 32MB RAM minimum, Netscape 4.0 or higher or Internet Explorer 4.0 or higher. Over 1,000 projects

CD-ROM

Order code AS1 CD-ROM

£19.95



GETTING THE MOST FROM YOUR MULTIMETER

R. A. Penfold

This book is primarily aimed at beginners and those of limited experience of electronics. Chapter 1 covers the basics of analogue and digital multimeters, discussing the relative merits and the limitations of the two types. In Chapter 2 various methods of component checking are described,

Music, Audio and Video

MAKING MUSIC WITH YOUR COMPUTER

Stephen Bennett

Nearly everyone with musical aspirations also has a computer. This same computer can double as a high quality recording studio capable of producing professional recordings. This book tells you what software and hardware you will need to get the best results.

You'll learn about recording techniques, software and effects, mixing, mastering and CD production.

Suitable for PC and Mac users, the book is full of tips, "how to do" topics and illustrations. It's the perfect answer to the question "How do I use my computer to produce my own CD?"

92 pages

Order code PC120

£10.95

QUICK GUIDE TO ANALOGUE SYNTHESIS

Ian Waugh

Even though music production has moved into the digital domain, modern synthesisers invariably use analogue synthesis techniques. The reason is simple – analogue synthesis is flexible and versatile, and it's relatively easy for us to understand. The basics are the same for all analogue synths, and you'll quickly be able to adapt the principles to any instrument, to edit existing sounds and create exciting new ones. This book describes: How analogue synthesis works; The essential modules every synthesiser has; The three steps to synthesis; How to create phat bass sounds; How to generate filter sweeps; Advanced synth modules; How to create simple and complex synth patches; Where to find soft synths on the Web.

If you want to take your synthesiser – of the hardware or software variety – past the presets, and program your own sounds and effects, this practical and well-illustrated book tells you what you need to know.

60 pages

Order code PC118

£7.45

QUICK GUIDE TO MP3 AND DIGITAL MUSIC

Ian Waugh

MP3 files, the latest digital music format, have taken the music industry by storm. What are they? Where do you get them? How do you use them? Why have they thrown record companies into a panic? Will they make music easier to buy? And cheaper? Is this the future of music?

All these questions and more are answered in this concise and practical book which explains everything

you need to know about MP3s in a simple and easy-to-understand manner. It explains:

How to play MP3s on your computer; How to use MP3s with handheld MP3 players; Where to find MP3s on the Web; How MP3s work; How to tune into Internet radio stations; How to create your own MP3s; How to record your own CDs from MP3 files; Other digital audio music formats.

Whether you want to stay bang up to date with the latest music or create your own MP3s and join the on-line digital music revolution, this book will show you how.

60 pages

Order code PC119

£7.45

THE INVENTOR OF STEREO – THE LIFE AND WORKS OF ALAN DOWER BLUMLEIN

Robert Charles Alexander

This book is the definitive study of the life and works of one of Britain's most important inventors who, due to a cruel set of circumstances, has all but been overlooked by history.

Alan Dower Blumlein led an extraordinary life in which his inventive output rate easily surpassed that of Edison, but whose early death during the darkest days of World War Two led to a shroud of secrecy which has covered his life and achievements ever since.

His 1931 Patent for a Binaural Recording System was so revolutionary that: most of his contemporaries regarded it as more than 20 years ahead of its time. Even years after his death, the full magnitude of its detail had not been fully utilized. Among his 128 patents are the principal electronic circuits critical to the development of the world's first electronic television system. During his short working life, Blumlein produced patent after patent breaking entirely new ground in electronic and audio engineering.

During the Second World War, Alan Blumlein was deeply engaged in the very secret work of radar development and contributed enormously to the system eventually to become 'H2S' – blind-bombing radar. Tragically, during an experimental H2S flight in June 1942, the Halifax bomber in which Blumlein and several colleagues were flying, crashed and all aboard were killed. He was just days short of his thirty-ninth birthday.

420 pages

Order code NE32

£17.99

VIDEO PROJECTS FOR THE ELECTRONICS CONSTRUCTOR

R. A. Penfold

Written by highly respected author R. A. Penfold, this book contains a collection of electronic projects specially designed for video enthusiasts. All the projects can be simply constructed, and most are suitable for the newcomer to project construction, as they are assembled on stripboard.

There are faders, wipers and effects units which will add sparkle and originality to your video recordings, an audio mixer and noise reducer to enhance your soundtracks and a basic computer control interface. Also, there's a useful selection on basic video production techniques to get you started.

Complete with explanations of how the circuit works, shopping lists of components, advice on construction, and guidance on setting up and using the projects, this invaluable book will save you a small fortune.

Circuits include: video enhancer, improved video enhancer, video fader, horizontal wiper, improved video wiper, negative video unit, fade to grey unit, black and white keyer, vertical wiper, audio mixer, stereo headphone amplifier, dynamic noise reducer, automatic fader, pushbutton fader, computer control interface, 12 volt mains power supply.

124 pages

Order code PC115

£10.95 £5.45

**ALL PRICES INCLUDE
UK POST & PACKING
FOR A FURTHER
SELECTION OF BOOKS
SEE THE NEXT TWO
ISSUES**

Data and Design

PRACTICAL ELECTRONIC FILTERS

Owen Bishop

This book deals with the subject in a non-mathematical way. It reviews the main types of filter, explaining in simple terms how each type works and how it is used.

The book also presents a dozen filter-based projects with applications in and around the home or in the constructor's workshop. These include a number of audio projects such as a rhythm sequencer and a multi-voiced electronic organ.

Concluding the book is a practical step-by-step guide to designing simple filters for a wide range of purposes, with circuit diagrams and worked examples.

88 pages **Order code BP299** **£5.49**

DIGITAL LOGIC GATES AND FLIP-FLOPS

Ian R. Sinclair

This book, intended for enthusiasts, students and technicians, seeks to establish a firm foundation in digital electronics by treating the topics of gates and flip-flops thoroughly and from the beginning.

Topics such as Boolean algebra and Karnaugh mapping are explained, demonstrated and used extensively, and more attention is paid to the subject of synchronous counters than to the simple but less important ripple counters. No background other than a basic knowledge of electronics is assumed, and the more theoretical topics are explained from the beginning, as also are many working practices. The book concludes with an explanation of microprocessor techniques as applied to digital logic.

200 pages **Order code PC106** **£9.95**

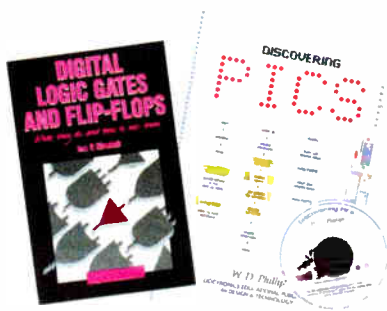

A BEGINNER'S GUIDE TO TTL DIGITAL ICs

R. A. Penfold

This book first covers the basics of simple logic circuits in general, and then progresses to specific TTL logic integrated circuits. The devices covered include gates, oscillators, timers, flip/flops, dividers, and decoder circuits. Some practical circuits are used to illustrate the use of TTL devices in the "real world".

142 pages **Order code BP332** **£5.45**

MICROCONTROLLER COOKBOOK

Mike James

The practical solutions to real problems shown in this cookbook provide the basis to make PIC and 8051 devices really work. Capabilities of the variants are examined, and ways to enhance these are shown. A survey of common interface devices, and a description of programming models, lead on to a section on development techniques. The cookbook offers an introduction that will allow any user, novice or experienced, to make the most of micro-controllers.

240 pages **Order code NE26** **£23.99**

RADIO BYGONES

We also carry a selection of books aimed at readers of *EPE's* sister magazine on vintage radio *Radio Bygones*. These books include the *Comprehensive Radio Valve Guides*. Also Jonathan Hill's excellent *Radio Radio*, a comprehensive book with hundreds of photos depicting the development of the British wireless set up to the late 1960s.

The four volumes of our own *Wireless For the Warrior* by Louis Meulstee are also available. These are a technical history of radio communication equipment in the British Army and clandestine equipment from pre-war through to the 1960s.

For details see the shop on our UK web site at www.epemag.co.uk or contact us for a list of *Radio Bygones* books.

Project Building & Testing

ELECTRONIC PROJECT BUILDING FOR BEGINNERS

R. A. Penfold

This book is for complete beginners to electronic project building. It provides a complete introduction to the practical side of this fascinating hobby, including the following topics:

Component identification, and buying the right parts; resistor colour codes, capacitor value markings, etc; advice on buying the right tools for the job; soldering; making easy work of the hard wiring; construction methods, including stripboard, custom printed circuit boards, plain matrix boards, surface mount boards and wire-wrapping; finishing off, and adding panel labels; getting "problem" projects to work, including simple methods of fault-finding.

In fact everything you need to know in order to get started in this absorbing and creative hobby.

135 pages **Order code BP392** **£5.49**

ELECTRONIC PROJECTS FOR EXPERIMENTERS

R. A. Penfold

Many electronic hobbyists who have been pursuing their hobby for a number of years seem to suffer from the dreaded "seen it all before" syndrome. This book is fairly and squarely aimed at sufferers of this complaint, plus any other electronics enthusiasts who yearn to try something a bit different. No doubt many of the projects featured here have practical applications, but they are all worth a try for their interest value alone.

The subjects covered include:- Magnetic field detector, Basic Hall effect compass, Hall effect audio isolator, Voice scrambler/descrambler, Bat detector, Bat style echo location, Noise cancelling, LED stroboscope, Infra-red "torch", Electronic breeze detector, Class D power amplifier, Strain gauge amplifier, Super hearing aid.

138 pages **Order code BP371** **£5.45**

PRACTICAL FIBRE-OPTIC PROJECTS

R. A. Penfold

While fibre-optic cables may have potential advantages over ordinary electric cables, for the electronics

enthusiast it is probably their novelty value that makes them worthy of exploration. Fibre-optic cables provide an innovative interesting alternative to electric cables, but in most cases they also represent a practical approach to the problem. This book provides a number of tried and tested circuits for projects that utilize fibre-optic cables.

The projects include:- Simple audio links, F.M. audio link, P.W.M. audio links, Simple d.c. links, P.W.M. d.c. link, P.W.M. motor speed control, RS232C data links, MIDI link, Loop alarms, R.P.M. meter.

All the components used in these designs are readily available, none of them require the constructor to take out a second mortgage.

132 pages **Order code BP374** **£5.45**

DISCOVERING PICS

W.D. Phillips

A good introduction to PIC programming, covering everything you need to know to get

you started. No previous knowledge of microcontrollers is required, but some previous experience with electronic circuits is assumed. Covers the basic concept of a microcontroller, fundamentals of a PIC-based circuit and using the MPLAB program. Further chapters introduce binary, PIC architecture, the instruction set, the PIC memory map and special registers plus real world programming. Four simple projects are also fully described; a Wavy Wand, an Electronic Dice, a Games Timer and a Pulse Monitor.

The associated CDROM contains the book in PDF format, MPLAB (plus instruction manuals in PDF format) and all the programs covered in the book as assembler (ASM) files. Those that wish to programme their own PICs will require a PIC programmer.

In addition a p.c.b. based hardware kit is also available that makes up into the Wavy Wand which will spell out a short message via a line of l.e.d.s when waved through the air.

190 pages, A4 spiral bound

Book + CDROM Order code DOC1 **£22.00**

Book + CDROM + Hardware Order code DOC2 **£28.50**

BOOK ORDERING DETAILS

All prices include UK postage. For postage to Europe (air) and the rest of the world (surface) please add £2 per book. For the rest of the world airmail add £3 per book. CD-ROM prices include VAT and/or postage to anywhere in the world. Send a PO, cheque, international money order (£ sterling only) made payable to **Direct Book Service** or card details, Visa, Mastercard, Amex, Diners Club or Maestro to:

**DIRECT BOOK SERVICE, WIMBORNE PUBLISHING LTD.,
408 WIMBORNE ROAD EAST, FERNDOWN, DORSET BH22 9ND.**

Orders are normally sent out within seven days of receipt, but please allow 28 days for delivery - more for overseas orders. *Please check price and availability (see latest issue of Everyday Practical Electronics) before ordering from old lists.*

For a further selection of books and CD-ROMs see the next two issues of *EPE*.

Tel 01202 873872 Fax 01202 874562. Email: dbs@epemag.wimborne.co.uk

Order from our online shop at: www.epemag.co.uk/shopdoor.htm

BOOK/CD-ROM ORDER FORM

Full name:

Address:

.....

.....

..... Post code: Telephone No:

Signature:

I enclose cheque/PO payable to DIRECT BOOK SERVICE for £

Please charge my card £ Card expiry date.....

Card Number Maestro Issue No.....

Card Security Code (The last 3 digits on or just below the signature strip)

Please send book/CD-ROM order codes:

.....

Please continue on separate sheet of paper if necessary
If you do not wish to cut your magazine, send a letter or copy of this form

EPE PIC PROJECTS VOLUME 1 MINI CD-ROM

A plethora of 20 "hand-PICKed" PIC Projects from selected past issues of *EPE*
Together with the PIC programming software for each project plus bonus articles

The projects are:

PIC-Based Ultrasonic Tape Measure

You've got it taped if you PIC this ultrasonic distance measuring calculator

EPE Mind PICKler

Want seven ways to relax? Try our PIC-controlled mind machine!

PIC MIDI Sustain Pedal

Add sustain and glissando to your MIDI line-up with this inexpensive PIC-controlled effects unit

PIC-based MIDI Handbells

Ring out thy bells with merry tolling – plus a MIDI PIC-up, of course!

EPE Mood PICKer

Oh for a good night's sleep! Insomniacs rejoice – your wakeful nights could soon be over with this mini-micro under the pillow!

PIC Micro-Probe

A hardware tool to help debug your PIC software

PIC Video Cleaner

Improving video viewing on poorly maintained TVs and VCRs

PIC Graphics LCD Scope

A PIC and graphics LCD signal monitor for your workshop

PIC to Printer Interface

How to use dot-matrix printers as data loggers with PIC microcontrollers

PIC Polywhatsit

A novel compendium of musical effects to delight the creative musician

PIC Magick Musick

Conjure music from thin air at the mere untouching gesture of a fingertip

PIC Mini-Enigma

Share encrypted messages with your friends — true spymaster entertainment

PIC Virus Zapper

Can disease be cured electronically? Investigate this controversial subject for yourself

PIC Controlled Intruder Alarm

A sophisticated multi-zone intruder detection system that offers a variety of monitoring facilities

PIC Big-Digit Display

Control the giant ex-British Rail platform clock 7-segment digits that are now available on the surplus market

PIC Freezer Alarm

How to prevent your food from defrosting unexpectedly

PIC World Clock

Graphically displays world map, calendar, clock and global time-zone data

PICAXE Projects

A 3-part series using PICAXE devices – PIC microcontrollers that do not need specialist knowledge or programming equipment

PIC-based Tuning Fork and Metronome

Thrill everyone by at long last getting your instrument properly tuned!

Versatile PIC Flasher

An attractive display to enhance your Christmas decorations or your child's ceiling



**ONLY
£14.45**

**INCLUDING
VAT and P&P**

Order on-line from

www.epemag.wimborne.co.uk/shopdoor.htm

or www.epemag.com (USA \$ prices)

or by Phone, Fax, Email or Post.

NOTE: The PDF files on this CD-ROM are suitable to use on any PC with a CD-ROM drive. They require Adobe Acrobat Reader.

EPE PIC PROJECTS CD-ROM ORDER FORM

Please send me (quantity) EPE PIC PROJECTS VOL 1 CD-ROM

Price £14.45 each – includes postage to anywhere in the world.

Name

Address

.....

.....

..... Post Code

I enclose cheque/P.O./bank draft to the value of £

Please charge my Visa/Mastercard/Amex/Diners Club/Maestro

£

Card No.

Card Security Code (The last 3 digits on or just under

the signature strip)

Start Date Expiry Date Maestro Issue No. ...

SEND TO: Everyday Practical Electronics,

Wimborne Publishing Ltd.,

408 Wimborne Road East, Ferndown, Dorset BH22 9ND.

Tel: 01202 873872. Fax: 01202 874562.

Email: orders@epemag.wimborne.co.uk

Payments must be by card or in £ Sterling – cheque or bank draft drawn on a UK bank.

Normally supplied within seven days of receipt of order.

Send a copy of this form, or order by letter if you do not wish to cut your issue.

BECOME A PIC PROJECT BUILDER WITH THE HELP OF EPE!

PCB SERVICE

Printed circuit boards for most recent *EPE* constructional projects are available from the PCB Service, see list. These are fabricated in glass fibre, and are fully drilled and roller tinned. All prices include VAT and postage and packing. Add £1 per board for airmail outside of Europe. Remittances should be sent to The PCB Service, *Everyday Practical Electronics*, Wimborne Publishing Ltd., 408 Wimborne Road East, Ferndown, Dorset BH22 9ND. Tel: 01202 873872; Fax 01202 874562; Email: orders@epemag.wimborne.co.uk. On-line Shop: www.epemag.wimborne.co.uk/shopdoor.htm. Cheques should be crossed and made payable to *Everyday Practical Electronics* (Payment in £ sterling only).

NOTE: While 95% of our boards are held in stock and are dispatched within seven days of receipt of order, please allow a maximum of 28 days for delivery – overseas readers allow extra if ordered by surface mail.

Back numbers or photocopies of articles are available if required – see the *Back Issues* page for details. We do not supply kits or components for our projects.

Please check price and availability in the latest issue. A large number of older boards are listed on our website.

Boards can only be supplied on a payment with order basis.

PROJECT TITLE	Order Code	Cost
Audio System AUG '05		
– Preamplifier	516	£6.02
– Mic. Supply Board	517	£5.23
– Power Amp	518	£6.02
★ Pain Monitor	519	£7.14
Motor Amp	520	£7.45
Back-To-Basics 5 – Kitchen Timer	521	£5.87
– Room Thermometer	522	£6.02
All-Band Radio – Full Version SEPT '05		
– Mini Version	523	£5.71
★ Multicore Cable Tester – Main	524	£5.23
– Active	525	£6.19
– Active	526	£5.55
Back-To-Basics 6 – Daily Reminder	527	£6.19
– Whistle Switch	528	£5.87
★ Model Railway Signal Control	529	£6.19
★ Snooker/Darts Scoreboard	530	£8.72
Photic Phone – Transmitter OCT '05		
– Receiver	531 } pair	£6.98
Back-To-Basics 7 – Parking Radar	532	£5.71
– Telephone Switch	533	£5.55
★ Halloween Howler	534	£6.02
★ PIC-Based USB Interface	535	£6.19
★ PIC Chromatone NOV '05		
Back-To-Basics 8 – Noughts and Crosses Enigma	537	£6.82
– Weather Vane Repeater	538	£6.66
★ Multi-Function R/C Switch	539	£6.18
★ Speed Camera Watch Mk2	540	£5.87
	541	£6.35
Solid-State Valve Power Supply DEC '05		
★ Vehicle Frost Box Mk2	542	£6.35
★ Propeller Monitor	543	£5.71
Solid-State Hammond	544	£6.02
	545	£6.18
★ PIC Ambilux JAN '06		
Sunset Switch	546	£5.71
Current Clamp Adaptor for Multimeters	547	£6.98
★ Tiptronic-Style Gear Indicator	548	£5.39
– Micro Board	549 } per set	£7.61
– Display Board	550	
– Hall Speed Board	551	
★ Keypad Alarm FEB '06		
3-Way Active Crossover	552	£6.02
Jazzy Heart	553	£9.20
Status Monitor – Transmitter	554	£6.02
– Receiver	555 } pair	£7.61
	556	
Power Up MAR '06		
Video/Audio Booster (double-sided)	557	£6.82
★ Telescope Interface	558	£12.00
	559	£6.50
'Smart' Slave Flash APR '06		
Programmable Continuity Tester	560	£6.18
PortaPAL	561	£5.87
– Microphone Board	562	£6.18
– Auxiliary Board	563	£5.87
– Main Board	564	£8.56
– Charger Board	565	£6.66
Omni Pendulum	566	£6.34
Smart Card Reader/Programmer MAY '06		
LED Lighting For Your Car (set of 15 boards)	567	£7.61
Digital Reaction Timer	568	£14.75
	569	£7.13
Poor Man's Metal Locator JUN '06		
★ Digital Instrument Display for Cars	570	£5.71
– Micro Board	571 } pair	£7.77
– Display Board	572	
Widgy Box	573	£7.29
Phone Ring & Test	574	£6.82
★ Sudoku Unit JUL '06		
PC Power Monitor	575	£6.66
	576	£6.50

PROJECT TITLE	Order Code	Cost
Home Theatre Sound Level Checker AUG '06		
Adjustable DC-DC Converter For Cars	577	£6.66
★ Telephone Dialler For Buglar Alarms	578	£6.50
★ High Intensity Torch	579	£6.97
	580	£5.39
★ Low Cost 50MHz Frequency Meter SEP '06		
Version 1	581	£6.66
Version 2	582	£6.66
Version 3	583	£6.66
Smart Mixture Display for your Car	584	£6.50
Water Level Gauge – Sensor	585 } pair	£6.98
– Display	586	
Fridge Door-Open Alarm OCT '06		
Linear Supply For 1W Star LEDs (Pair)	587	£5.71
Through-Glass Alarm	588a & b	£6.50
	589	£7.61
Quick Brake NOV '06		
Studio 350 Power Amplifier	590	£6.50
Micropower Battery Protector	591	£9.51
★ Giant LED Message Display – Master	592	£5.71
– Slave	594	£5.55
	595	£6.50
Lapel Microphone Adaptor DEC '06		
RGB To Component Video Converter (double sided)	593	£6.18
USB Power Injector	596	£12.69
★ Mind Trainer	597	£5.87
	598	£6.50
Balanced Microphone Preamp JAN '07		
High-Efficiency Power Supply for 1W Star LEDs	599	£6.82
Jumping Spider	600	£6.19
	601	£5.71
★ Programmable Robot FEB '07		
Courtesy Light Delay	602	£6.50
★ Deep Cycle Battery Charger	603	£5.87
Power Board	604 } set	£11.10
Control Board	605	
Display Board	606	
★ PIC Digital Geiger Counter (double sided)	607	£12.53

EPE SOFTWARE

★ All software programs for *EPE* Projects marked with an asterisk, and others previously published, can be downloaded free from our Downloads site, accessible via our home page at: www.epemag.co.uk.

PCB MASTERS

PCB masters for boards published from the March '06 issue onwards can also be downloaded from our UK website (www.epemag.co.uk); go to the "Downloads" section.

EPE PRINTED CIRCUIT BOARD SERVICE

Order Code Project Quantity Price

Name

Address

Tel. No.

I enclose payment of £..... (cheque/PO in £ sterling only) to:



Everyday Practical Electronics



MasterCard, Amex, Diners Club, Visa or Switch/Maestro



Card No

Valid From Expiry Date

Card Security Code Maestro Issue No
(The last 3 digits on or just under the signature strip)

Signature

NOTE: You can also order p.c.b.s by phone, Fax, Email or via our Web site on a secure server:

<http://www.epemag.wimborne.co.uk/shopdoor.htm>

Everyday Practical Electronics reaches more UK readers than any other UK monthly hobby electronics magazine, our sales figures prove it. We have been the leading monthly magazine in this market for the last twenty-two years.

If you want your advertisements to be seen by the largest readership at the most economical price our classified and semi-display pages offer the best value. The prepaid rate for semi-display space is £10 (+VAT) per single column centimetre (minimum 2.5cm). The prepaid rate for classified adverts is 40p (+VAT) per word (minimum 12 words).

All cheques, postal orders, etc., to be made payable to Everyday Practical Electronics. **VAT must be added.** Advertisements, together with remittance, should be sent to Everyday Practical Electronics Advertisements, 408 Wimborne Road East, Ferndown, Dorset BH22 9ND. Phone: 01202 873872. Fax: 01202 874562. Email: epeads@wimborne.co.uk. For rates and information on display and classified advertising please contact our Advertisement Manager, Stewart Kearn as above.

**www.
CONTROLBITZ
.com**

**BTEC ELECTRONICS
TECHNICIAN TRAINING**

NATIONAL ELECTRONICS
VCE ADVANCED ICT
HNC AND HND ELECTRONICS
FOUNDATION DEGREES
NVQ ENGINEERING AND IT
DESIGN AND TECHNOLOGY

LONDON ELECTRONICS COLLEGE
20 PENYWERN ROAD
EARLS COURT, LONDON SW5 9SU
TEL: (020) 7373 8721
www.lec.org.uk

BOWOOD ELECTRONICS LTD

Suppliers of Electronic Components
Place a secure order on our website or call our sales line
All major credit cards accepted
Web: www.bowood-electronics.co.uk
Unit 1, McGregor's Way, Turnoaks Business Park,
Chesterfield, S40 2WB. Sales: 01246 200222
Send 60p stamp for catalogue

**EPE EVERYDAY PRACTICAL
ELECTRONICS**

**VISIT OUR
ONLINE SHOP
TO ORDER
BACK ISSUES,
CD-ROMS,
BOOKS, PCBs
AND MANUALS**

www.epemag.co.uk



**Versatile Programmable PIC
On Screen Display System**

Free demo code
PAL - NTSC compatible
TEXT, GPS or DATA
● PIC 16F628 microcontroller
● 28 by 11 character screen
● Fully programmable
● Text over composite video
● Demo software available
● Free I/O for sensors or buttons
www.STV5730A.co.uk

**N.R. BARDWELL Ltd - est 1948
Electronic Component Supplies**

LED's, Semis, IC's Resistors, Caps, etc
send 44p for lists. 1000's bargains at our
secure site: www.bardwells.co.uk
288, Abbeydale Rd. Sheffield. S7 1FL
0845 166 2329 (local rate)

HEROS TECHNOLOGY LTD

<http://www.hercotechnology.co.uk>
● Electronic Components and Services.
● RF Components
● PIC microcontrollers practical applications never been
so simple with our Modules Boards and Software
● Peripheral modules for all microcontrollers
● Solution for Developers. Pre-production, Educational
and Hobby applications.

VVT TRANSFORMERS

Transformers and Chokes for all types
of circuits including specialist valve units
Custom design or standard range
High and low voltage

Variable Voltage Technology Ltd
Unit 3, Sheat Manor Farm, Chillerton,
Newport, Isle of Wight, PO30 3HP
Tel: 0870 243 0414 Fax: 01983 721572
email: sales@vvt-cowes.freemove.co.uk

www.vvttransformers.co.uk

Your own complete
eCommerce 24/7 site
for only £10 per week!
Domain, secure hosting, emails,
shopping basket, etc, included.
details: www.eConcept.co.uk

Miscellaneous

VALVES AND ALLIED COMPONENTS IN STOCK. Phone for free list. Valves, books and magazines wanted. Geoff Davies (Radio), tel. 01788 574774.

WANTED OLD HALF INCH FERRITE RODS. Must be half inch (12.7mm) in diameter and be six inches long or more, will pay very good money for the rods. Contact Peter Tankard on 0114 2316321 between 9am and 10pm.

FOR 1/2 PRICE VALVE CLEARANCE catalogue send £1.00 in 1st or 2nd class stamps **FOR COMBINED VALVE & COMPONENT CLEARANCE** list send £1.50 in 1st or 2nd class stamps. W. Burcher, 676 Foxhall Road, Ipswich, Suffolk, IP3 8NQ. Tel: 01473 272218.

EPE Online
www.epemag.com

**Get your magazine
"instantly" anywhere
in the world - buy
and download from
the web.**

**TAKE A LOOK, A
FREE ISSUE IS
AVAILABLE**

**A one year
subscription
(12 issues) costs just
\$15.99 (US)**

**Back issues are also
available**

EPE Online
www.epemag.com

Europe's Largest Surplus Store

20,000,000 Items on line NOW!
New items added daily

Established for over 25 years, UK company Display Electronics prides itself on offering a massive range of electronic and associated electro-mechanical equipment and parts to the Hobbyist, Educational and Industrial user. Many current and obsolete hard to get parts are available from our vast stocks, which include:

- ◆ 6,000,000 Semiconductors
- ◆ 5,000 Power Supplies
- ◆ 25,000 Electric Motors
- ◆ 10,000 Connectors
- ◆ 100,000 Relays & Contactors
- ◆ 2000 Rack Cabinets & Accessories
- ◆ 4000 Items of Test Equipment
- ◆ 5000 Hard Disk Drives

We Ship Worldwide

Surplus Wanted

www.distel.co.uk

Display Electronics
29 / 35 Osborne Road
Thornton Heath
Surrey UK CR7 8PD

Telephone
[44] 020 8653 3333
Fax **[44] 020 8653 8888**

Rechargeable Batteries With Solder Tags

NIMH	NICAD
AA 2000mAh£2.82	AA 650mAh..... £1.41
C 4Ah£4.70	C 2.5Ah£3.60
D 9Ah£7.60	D 4Ah£4.95
PP3 150mAh £4.95	

Instrument case with edge connector and screw terminals

Size 112mm x 52mm x 105mm tall

This box consists of a cream base with a PCB slot, a cover plate to protect your circuit, a black lid with a 12 way edge connector and 12 screw terminals built in (8mm pitch) and 2 screws to hold the lid on. The cream bases have minor marks from dust and handling price £2.00 + VAT(=£2.35) for a sample or £44.00+VAT (=£51.70) for a box of 44.

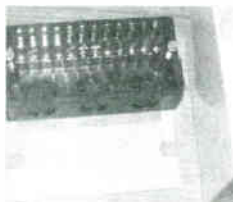

866 battery pack originally intended to be used with an orbital mobile telephone it contains 10 1.6Ah sub C batteries (42 x 22 dia. the size usually used in cordless screwdrivers etc.) the pack is new and unused and can be broken open quite easily £7.46 + VAT = £8.77



Please add £1.66 + VAT = £1.95 postage & packing per order

JPG Electronics

Shaws Row, Old Road, Chesterfield, S40 2RB.

Tel 01246 211202 Fax 01246 550959

www.JPGElectronics.com

Mastercard/Visa/Switch

Callers welcome 9.30 a.m. to 5.30 p.m. Monday to Saturday

EP EVERYDAY PRACTICAL ELECTRONICS

NEXT MONTH

PIC POLYPHONIUM

Visiting various steam fairs, such as the *Great Dorset Steam Fair*, the author has been fascinated by the grandeur of the sights and sounds of the superb showmans' fairground organs there in abundance. At last he has found a way to commemorate them – a novel, truly polyphonic, PIC-controlled musical design.

Music data is entered via a PC's keyboard and, aided by an extra font, is displayed on-screen in standard musical score format. Sheet music scores of any chosen themes can be keyed onto the screen, or musical users can also be creative and key in their own scores.

IR REMOTE CHECKER

Do your remote controls often fail? Is it due to dead batteries, poor contacts under the switch buttons or a more serious fault? How would you know if it was working anyway? Here is the answer – a Remote Control Checker.

SMS CONTROLLER

Would you like to be immediately informed when your burglar alarm is activated, as well as which sectors were tripped? What about if you could reset the alarm or even isolate one or more sectors? Well, this is just one of a huge number of possible applications for our SMS Controller. Other applications include switching home appliances, rebooting a server or locating your car in a car park.

MARCH '07 ISSUE ON SALE FEB 8

ADVERTISERS INDEX

AGAR	55
ANTEX	23
AUDON ELECTRONICS	23
BETA-LAYOUT	31
BULL GROUP	Cover (ii)
BYVAC	23
DISPLAY ELECTRONICS	80
EASYSYNC	69
EPT SOFTWARE	31
ESR ELECTRONIC COMPONENTS	6
JAYCAR ELECTRONICS	38/39
JPG ELECTRONICS	80
LABCENTER	Cover (iv)
LASER BUSINESS SYSTEMS	55
MAGENTA ELECTRONICS	5
MIKROELEKTRONIKA	43
MILFORD INSTRUMENTS	4
NURVE NETWORKS LLC	55
PALTRONIX	Cover (iii)
PEAK ELECTRONIC DESIGN	51
PICO TECHNOLOGY	25
QUASAR ELECTRONICS	2/3
SAFFRON ELECTRONICS	31
SCANTOOL	55
SHERWOOD ELECTRONICS	31
STEWART OF READING	30

ADVERTISEMENT OFFICES:

408 WIMBORNE ROAD EAST, FERNDOWN, DORSET BH22 9ND

PHONE: 01202 873872 FAX: 01202 874562

EMAIL: epeds@wimborne.co.uk

For Editorial address and phone numbers see page 7

Everyday Practical Electronics, ISSN 0262 3617 is published monthly (12 times per year) by Wimborne Publishing Ltd., USA agent USACAN Media Dist. Srv. Corp. at 26 Power Dam Way Suite S1-S3, Plattsburgh, NY 12901. Periodicals postage paid at Plattsburgh, NY and at additional mailing Offices. POSTMASTER: Send address changes to Everyday Practical Electronics, c/o Express Mag., PO Box 2769, Plattsburgh, NY, USA 12901-0239.

Microcontroller Development Tools

PICmicro Starter Pack now with ICD—still £99

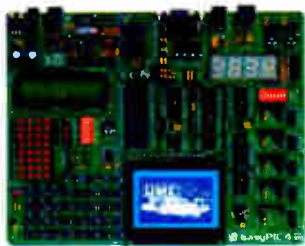

- High-quality development board with on-board USB programmer and built-in I/O devices.
- Supports 8, 14, 18, 20, 28 and 40-pin PICs in 10F, 12F, 16F and 18F families.
- Now features mikroICD in-circuit debugger.
- Supplied with PIC16F877A.

The new EasyPIC4 development board now supports even more PICs including 8, 14, 18, 20, 28 and 40-pin devices from the 10F, 12F, 16F and 18F families. With its on-board USB programmer, mikroICD in-circuit debugger and useful I/O devices, the EasyPIC4 must be the best-value development board on the market. Our Starter Pack includes the EasyPIC4 board, USB cable, 16x2 LCD, 128x64 GLCD, DS1820 temperature sensor and a starter's guide with example programs in assembly language, BASIC, C and Pascal.

PICmicro BASIC, C and Pascal Compilers—from £59.50

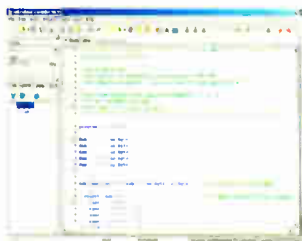

- Easy to use with user-friendly IDE.
- Features simulator and mikroICD in-circuit debugger.
- Plentiful ready-written routines and example programs.
- 30% discount for customers purchasing EasyPIC4/BIGPIC4 development boards.

MikroElektronika's popular mikroBASIC, mikroC and mikroPascal compilers now include the mikroICD in-circuit debugger for use with the EasyPIC4 and BIGPIC4 development boards—programs can now be executed on a target PIC with variable values, special function registers, memory and EEPROM viewed on the PC screen. Great value at £85 each for mikroBASIC/mikroPascal and £145 for mikroC, or when bought with an EasyPIC4/BIGPIC4 only £59.50 each for mikroBASIC/mikroPascal, and £101.50 for mikroC.

We also stock development tools for 8051, ARM, AVR, dsPIC, PICmicro, PSoC and other devices—please see our website for details

Educational Products

PICmicro Microcontroller Training System—£99



- Teaches both assembly language programming and interfacing.
- Based on the popular PIC16F877A.
- Includes USB programmer.
- Features built-in I/O devices and solderless breadboard.
- Supplied with tutorial and program examples.

The PICmicro Microcontroller Training System is an ideal platform for students and hobbyists alike to learn about PIC microcontrollers. The experiment board features a range of built-in I/O devices and a solderless breadboard on which experiments may be conducted. Circuits are connected using the provided jumper wires. A USB programmer is also supplied and connects to the experiment board to program the PIC. Also included are a mains power adapter, 16x2 character LCD, connecting leads and a tutorial with example programs.

Digital Logic Training System—£99



- Ideal for learning about and experimenting with digital logic devices.
- Built-in logic and pulse switches, LEDs, 7-segment displays, piezo speaker, pulse generator, logic probe and solderless breadboard.
- Supplied with useful range of ICs, jumper wire and mains adapter.

The Digital Logic Training System makes learning about digital logic and experimenting with discrete logic ICs easy. The experiment board features a range of built-in I/O devices and a solderless breadboard on which experiments may be conducted. Circuits are connected using the provided jumper wires and the system includes features such as a power supply, pulse generator and logic probe. Also included is a mains power adapter, selection of ICs and a tutorial with example circuits.

We also stock other trainers, circuit labs and solderless breadboards—please see our website for details

Robots and Accessories

Robo-BOX 3.0 Robot Kit—£99



- Complete robot kit including controller, programming software and all mechanical parts.
- Build different robot configurations from one kit, including wheel-based and track-based.
- Program intelligence to follow light, detect collisions and trace lines.

Learn about, experiment and have fun with robotics with Robo-BOX 3.0—an incredibly easy-to-build yet adaptable and expandable robot. Various wheel-based and track-based robots can be built from the standard kit including light-following, collision-detecting and line-tracing models. Programming is carried out in graphical Logo. A range of low-cost options allow for easy expansion and the development of more sophisticated robots. We also stock similar robot kits based on PICmicro, 8051 and 68HC11 microcontrollers.

Test Equipment

PoScope USB Oscilloscope/Logic Analyser—only £99



- Low-cost PC-based instrument featuring oscilloscope, spectrum analyser, logic analyser, pattern generator, and chart recorder.
- Decodes serial buses including UART, SPI, I2C and 1-wire.
- Supplied with logic analyser test lead set, two oscilloscope probes, USB cable and software.

PoScope has to be one of the best-value pieces of test equipment available and features a dual channel oscilloscope (100Hz to 200kHz sample rate), 16 channel logic analyser (1kHz to 8MHz sample rate), and 8-channel pattern generator (1kHz to 1MHz). What makes the PoScope really useful to those working with microcontrollers is its ability to decode serial communications including RS-232, I2C, SPI and 1-wire. Priced at only £99, the PoScope comes with a USB cable, logic analyser test lead set, two oscilloscope probes and software.

Tel: 0845 226 9451

Fax: 0845 226 9452

Email: sales@paltronix.com

All prices exclude UK delivery (£5 standard/£10 next-day) and VAT

Major credit and debit cards accepted.

Secure online ordering.

PROTEUS

ELECTRONIC DESIGN

FROM CONCEPT

TO COMPLETION

SCHEMATIC CAPTURE PROSPICE EMBEDDED SIMULATION PCB DESIGN

ISIS SCHEMATIC CAPTURE

A powerful capture package tailored for today's engineer and designed to allow rapid entry of complex schematics for simulation and PCB layout.

PROSPICE MIXED MODE SIMULATOR

A customised implementation of the industry standard Berkeley SPICE 3F5 engine with extensive optimisations and enhancements for true mixed mode simulation and circuit animation.

VSM VIRTUAL SYSTEM MODELLING

The world's first and best schematic based microcontroller co-simulation software. Proteus VSM allows you to simulate the interaction between software running on a microcontroller and any analog or digital electronics connected to it. This streamlines the project lifecycle and obviates the need for expensive hardware analysis tools.

ARES PCB DESIGN

A modern and professional layout package which seamlessly integrates with the ISIS capture software. Features such as autoplacement and autorouting, interactive DRC and an intuitive interface all serve to maximise productivity and reduce time to market.

LABCENTER ELECTRONICS LTD.

A technology pioneer in the EDA industry since 1988.
Technical support direct from the program authors.
Flexible packages and pricing tailored to customer requirements.

CONTACT US NOW
to discuss requirements or
request a **FREE** evaluation copy.

labcenter  www.labcenter.co.uk
Electronics

Tel: 01756 753440
Fax: 01756 752857
Email: info@labcenter.co.uk

Labcenter Electronics Ltd., 53-55 Main Street, Grassington,
North Yorks, BD23 5AA. Registered in England 4692454

World Radio History