

THE No 1 UK MAGAZINE FOR ELECTRONICS TECHNOLOGY & COMPUTER PROJECTS

# **EPE** EVERYDAY PRACTICAL **ELECTRONICS**

www.epemag.co.uk

www.epemag.com

## HIGH POWER AMPLIFIER **STUDIO 350**

**WIN  
A MICROCHIP PICSTART  
PLUS PROGRAMMER  
£500s WORTH OF  
PRIZES**

- \* **350W into 4Ω**
- \* **15Hz – 60kHz (-1dB)**
- \* **0.002% distortion**
- \* **-122dB S/N ratio**

**PLUS**

- \* **FRIDGE DOOR-OPEN ALARM**
- \* **LINEAR SUPPLY FOR LUXEON LEDS**
- \* **THROUGH-GLASS ALARM**



OCTOBER 2006 £3.30



9 770262 361133

10 >



## NEW ELECTRONIC CONSTRUCTION KITS



Alarms. Requires: 3 x AA batteries. £15.00 ref BET1803

**AM/FM Radio** This kit enables you to learn about electronics and also put this knowledge into practice so you can see and hear the effects. Includes manual with explanations about the components and the electronic principles. Req's: 3 x AA batts. £13 ref BET1801



This **40 in 1 electronic kit** includes an introduction to electrical and electronic technology. It provides components that can be used in making basic digital logic circuits, then progresses to using Integrated circuits to make

and test a variety of digital circuits, including Flip Flops and Counters. Req's: 4 x AA batteries. £17 ref BET1804

The **75 in 1 electronic kit**

includes an introduction to electrical and electronic technology. It provides components that can be used to make and test a wide variety of experiments including Water Sensors, Logic Circuits and Oscillators. The kit then progresses to the use of an integrated circuit to produce digital voice and sound recording experiments such as Morning Call and Burglar Alarm. Requires: 3 x AA batteries. £20 ref BET1806

## SOLAR PANELS

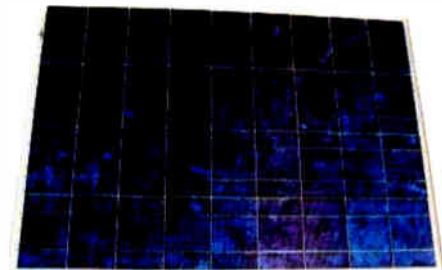

We stock a range of solar photovoltaic panels. These are polycrystalline panels made from wafers of silicon laminated between an impact-resistant transparent cover and an EVA rear mounting plate. They are constructed with a lightweight anodised aluminium frame which is predrilled for linking to other frames/roof mounting structure, and contain waterproof electrical terminal box on the rear. 5 watt panel £29 ref 5wnav 20 watt panel £99 ref 20wnav 60 watt panel £249 ref 60wnav. Suitable regulator for up to 60 watt panel £20 ref REGNAV

## EVACUATED TUBE SOLAR HOT WATER PANELS

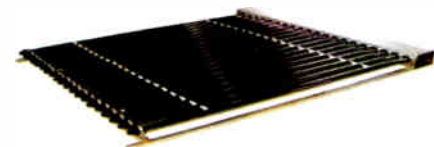

(20 tube shown) These top-of-the-range solar panel heat collectors are suitable for heating domestic hot water, swimming pools etc - even in the winter! One unit is adequate for an average household (3-4people), and it is modular, so you can add more if required. A single panel is sufficient for a 200 litre cylinder, but you can fit 2 or more for high water usage, or for heating swimming pools or underfloor heating. Some types of renewable energy are only available in certain locations, however free solar heating is potentially available to almost every house in the UK! Every house should have one -really! And with an overall efficiency of almost 80%, they are much more efficient than electric photovoltaic solar panels (efficiency of 7-15%). Available in 10, 20 and 30 tube versions. 10 tube £199, 20 tube £369, 30 tube £549. Roof mounting kits (10/20 tubes) £12.50, 30 tube mounting kit £15



## 2kW WIND TURBINE KIT

The 2kW wind turbine is supplied as the following kit: turbine generator 48v three taper/ twisted fibreglass blades & hub 8m tower (four x 2m sections) guylines / anchors / tensioners / clamps foundation steel rectifier 2kW inverter heavy-duty pivot tower. £1,499

Other sizes available from

200 watts (£299) up to 20kW (£13,999) The 200w system is complete apart from 2x12v batteries and concrete for the tower. These low cost systems can provide substantial amounts of power, even in average wind conditions.



## STEAM ENGINE KIT

The material in this pack enables you to build a fully functional model steam engine. The main material is brass and the finished machine demonstrates the principle of oscillation. The boiler, uses solid fuel tablets,



and is quite safe. All critical parts (boiler, end caps, safety vent etc.) are ready finished to ensure success. The very detailed instruction booklet (25 pages) makes completion of this project possible in a step by step manner. Among the techniques experienced are silver soldering, folding, drilling, fitting and testing. £29.70 ref STEAMKIT Silver solder/flux pack £3.50 ref SSK

## HOT AIR MOTOR (Stirling motor)

This is an interesting metal based project for pupils aged 15 plus. The material pack will enable them to make a fully functional hot air motor. All the critical parts (piston, working cylinder, flywheel and coolers) have been pre-made



and are ready for use. The detailed plans show all the important stages for the required metal working (Measuring with a vernier, sawing, silver soldering, drilling, marking out, thread making, silver soldering, sawing and filing, etc) At the same time the principles of the hot air motor are described in the wide ranging instructions. Technical data : Working cylinder stroke  $\varnothing$  12 x 10 mm Pressure cylinder stroke  $\varnothing$  13 x 11 mm Unloaded speed approx. 800 rpm Size: Flywheel dia. 55mm Base 130 x130 mm With sinter smooth bearings and ready shaped cooler. £29.70 ref STEAMKIT2 Silversolder pack £3.50 ref SSK

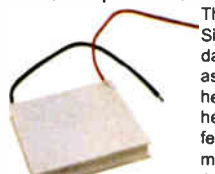

mW/K 22 g, 49 mV/K £14 ref TEL1

Die cast illuminated microscope set in plastic carry case Includes a handy carry case with a 1200x magnification microscope. Contents include test tubes, magnifier glass and probe. Requires 2 x AA batteries (not included). ultra-compact, lightweight, easy to use and comfortable to hold. An ideal microscope for the beginner offering a good magnification range. £25.99 ref MAG1200



**BENCH PSU 0-15V 0-2a** Output and voltage are both smooth and can be regulated according to work, Input 230V, 21/2-number LCD display for voltage and current, Robust PC-grey housing Size 13x15x21cm, Weight 3,2kg £48 REF trans2

## STIRLING ENGINES

**HB10** One of our range of Stirling engines The Bohm HB10 Stirling engine is available in both ready built and kit form. The power comes from a small spirit burner, once lit just watch this amazing Stirling engine run. HB10 in kit form is £97.95 or £101.99 built. Many other models in stock. Order online at [www.mamodspares.co.uk](http://www.mamodspares.co.uk)



**Rapidos** Mobile networking digital surveillance system. Plugs into USB port on computer, takes 4 cameras, NSTC or PAL, 352\*288 res, 1-30 f/s MPEG4 & MJPEG, motion detection, pre and post recording, watermark, date, time and location markings, alarm notice via FAX, FTP or email, Modes- continuous record, motion detection record, sheduled record, time lapse record, dynamic IP, can send live images to your mobile phone. £109 ref RAPIDOS



## HEAT PUMPS

A heat pump is a system that uses a refrigeration-style compressor to transfer heat from outside to inside, in order to heat offices or homes. Heat pumps can take heat from the air, water or ground. Ground source heat pumps are very efficient - in fact you will get 3-4 units of heat for every unit of electricity supplied to the heat-pump. Basic component parts of a GSHP:



- 1 A heat pump packaged unit: Water-Water type. (approx. the size of a small fridge) containing two cold water connections and two heated water connections.
  2. The heat source which is usually a closed loop of plastic pipe containing water with glycol or common salt to prevent the water from freezing. This pipe is buried in the ground in vertical bore holes or horizontal trenches. The trenches take either straight pipe or coiled (Slinky) pipe, buried about 1.5 to 2m below the surface. A large area is needed for this.
  3. The heat distribution system. This is either underfloor heating pipes or conventional radiators of large area connected via normal water pipes.
  4. Electrical input and controls. The system will be require an electrical input energy, single phase is perfectly adequate for smaller systems. A specialised controller will be incorporated to provide temperature and timing functions of the system.
- This type of installation offers many advantages.
- a) The water-water heat pump unit is a sealed and reliable self contained unit.
  - b) There are no corrosion or degradation issues with buried plastic pipes.
  - c) The system will continue to provide the same output even during extremely cold spells.
  - d) The installation is fairly invisible. i.e. no tanks or outside unit to see.
  - e) No regular maintenance required.

## Some tips

The efficiency of any system will be greatly improved if the heated water is kept as low as possible. For this reason, underfloor heating is preferred to radiators. It is vital to ensure that the underfloor layout is designed to use low water temperatures. i.e. plenty of pipe and high flow-rates. If radiators are to be used, they must be large enough. Double the normal sizing (as used with a boiler) is a good starting point.

5Kw (output) ground to air heat pump £1,099 ref HP5  
9kw (output) ground to water heat pump £1,999 ref HP9

## BULL GROUP LTD

UNIT D HENFIELD BUSINESS PARK

HENFIELD SUSSEX BN5 9SL  
TERMS: C/ CARDS, CASH, PO, CHEQUE OR  
ONLINE ORDERING. PRICES PLUS VAT

UK DELIVERY £5.50

TEL 0870 7707520 FAX 01273 491813

sales@bullnet.co.uk

[www.bullnet.co.uk](http://www.bullnet.co.uk)



ISSN 0262 3617

PROJECTS ... THEORY ...  
NEWS ... COMMENT ...  
POPULAR FEATURES ...

VOL. 35. No. 10 OCTOBER 2006

# EPE EVERYDAY PRACTICAL ELECTRONICS

INCORPORATING ELECTRONICS TODAY INTERNATIONAL

[www.epemag.co.uk](http://www.epemag.co.uk)  
EPE Online: [www.epemag.com](http://www.epemag.com)

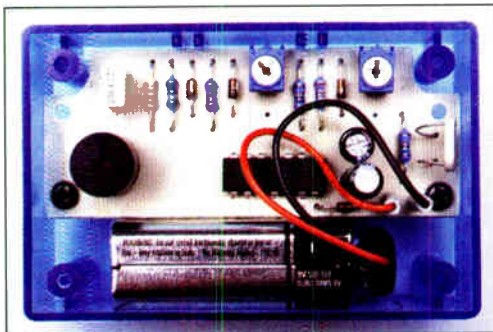
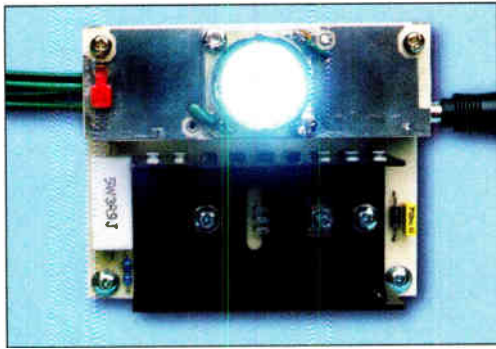
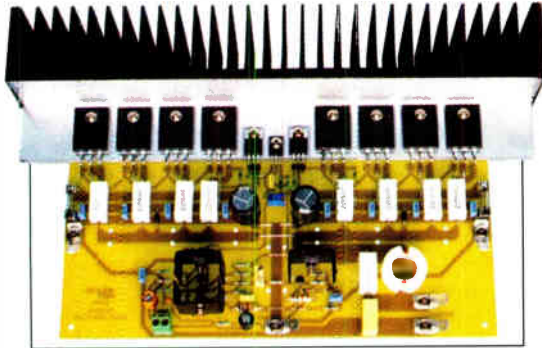

## Projects and Circuits

- STUDIO 350 POWER AMPLIFIER MODULE Part 1** 10  
by Leo Simpson and Peter Smith  
A really quiet, low distortion power amp with some real grunt
- FRIDGE DOOR-OPEN ALARM** by John Clarke 22  
Don't lose that chill!
- THROUGH-GLASS ALARM** by Godfrey Manning, BSc, MB BS, G4GLM 31  
Triggered by a hand against the glass of a door or window
- INGENUITY UNLIMITED - Sharing your Ideas with others** 40  
Random Colour Generator, Switch Mode LED Unit
- LINEAR SUPPLY FOR 1W STAR LEDs** by Peter Smith 46  
Run and dim one or more Luxeon 1W Star LEDs from 12V DC

## Series and Features

- TECHNO TALK** by Mark Nelson 18  
Mushroom Magic and the Quest for Green Volts
- PIC N' MIX** by Mike Hibbett 20  
Understanding PIC Datasheets
- INTERFACE** by Robert Penfold 28  
More on a Visual Approach to Producing Virtual Controls
- CIRCUIT SURGERY** By Ian Bell 56  
Timing Formulae for 555 Timers
- NET WORK - THE INTERNET PAGE** surfed by Alan Winstanley 60  
A Slipped Disk

## Regulars and Services

- EDITORIAL** 7
- NEWS** - Barry Fox highlights technology's leading edge 8  
Plus everyday news from the world of electronics
- CD-ROMS FOR ELECTRONICS** 42  
A wide range of CD-ROMs for hobbyists, students and engineers
- ELECTRONICS MANUALS** 45  
The Modern Electronics Manual and Electronics Service Manual on CD-ROM
- PICSTART Plus competition** 53  
Over £500s worth of prizes to be won
- BACK ISSUES** 54  
Did you miss these?
- PIC RESOURCES CD-ROM** 59  
EPE PIC Tutorial V2, plus PIC Toolkit Mk3 and a selection of PIC related articles
- SUBSCRIBE TO EPE** and save money 61
- READOUT** John Becker addresses general points arising 63
- DIRECT BOOK SERVICE** 66  
A wide range of technical books available by mail order, plus more CD-ROMs
- EPE PCB SERVICE** 69  
PCBs for EPE projects
- ADVERTISERS INDEX** 72

© Wimborne Publishing Ltd 2006. Copyright in all drawings, photographs and articles published in *EVERYDAY PRACTICAL ELECTRONICS* is fully protected, and reproduction or imitations in whole or in part are expressly forbidden.

Our November 2006 issue will be published on Thursday, 12 October 2006. See page 72 for details

**Readers Services • Editorial and Advertisement Departments** 7



**08717 Credit Card Sales 177 168**

### PIC & ATMEL Programmers

We have a wide range of low cost PIC and ATMEL Programmers. Complete range and documentation available from our web site.

#### Programmer Accessories:

40-pin Wide ZIF socket (ZIF40W) £15.00  
18Vdc Power supply (PSU010) £19.95  
Leads: Parallel (LDC136) £4.95 / Serial (LDC441) £4.95 / USB (LDC644) £2.95

#### NEW! USB & Serial Port PIC Programmer

USB/Serial connection  
Header cable for ICSP  
Free Windows XP software. See website for PICs supported. ZIF Socket and USB lead extra. 18Vdc.

Kit Order Code: 3149KT - £37.95

Assembled Order Code: AS3149 - £49.95

#### NEW! USB 'All-Flash' PIC Programmer

USB PIC programmer for all 'Flash' devices. No external power supply making it truly portable. Supplied with box and Windows XP Software ZIF Socket and USB lead not incl.

Assembled Order Code: AS3128 - £44.95

Assembled with ZIF socket Order Code: AS3128ZIF - £59.95

#### 'PICALL' ISP PIC Programmer

Will program virtually all 8 to 40 pin serial-mode AND parallel-mode (PIC15C family) PIC microcontrollers. Free Windows software. Blank chip auto detect for super fast bulk programming. Optional ZIF socket.  
Assembled Order Code: AS3117 - £24.95  
Assembled with ZIF socket Order Code: AS3117ZIF - £39.95

#### ATMEL 89xxx Programmer

Uses serial port and any standard terminal comms program. 4 LED's display the status. ZIF sockets not included. Supply: 16Vdc.

Kit Order Code: 3123KT - £24.95

Assembled Order Code: AS3123 - £34.95

#### Introduction to PIC Programming

Go from complete beginner to burning a PIC and writing code in no time! Includes 49 page step-by-step PDF Tutorial Manual, Programming Hardware (with LED test section), Win 3.11—XP Programming Software (Program, Read, Verify & Erase), and 1rewritable PIC16F84A that you can use with different code (4 detailed examples provided for you to learn from). PC parallel port.  
Kit Order Code: 3081KT - £16.95  
Assembled Order Code: AS3081 - £24.95

### ABC Maxi AVR Development Board

The ABC Maxi is ideal for developing new designs. Open architecture built around an ATMEL AVR AT90S8535 microcontroller. All circuits are embedded within the package and additional add-on expansion modules are available to assist you with project development.



#### Features

8 Kb of In-System Programmable Flash (1000 write/erase cycles) • 512 bytes internal SRAM • 512 bytes EEPROM • 8 analogue inputs (range 0-5V) • 4 Opto-isolated Inputs (I/Os are bi-directional with internal pull-up resistors) • Output buffers can sink 20mA current (direct LED drive) • 4 x 12A open drain MOSFET outputs • RS485 network connector • 2-16 LCD Connector • 3.5mm Speaker Phone Jack • Supply: 9-12Vdc

The ABC Maxi STARTER PACK includes one assembled Maxi Board, parallel and serial cables, and Windows software CD-ROM featuring an Assembler, BASIC compiler and in-system programmer.

Order Code ABCMAXISP - £89.95

The ABC Maxi boards only can also be purchased separately at £69.95 each.

### Controllers & Loggers

Here are just a few of the controller and data acquisition and control units we have. See website for full details. Suitable PSU for all units: Order Code PSU445 £8.95

#### Rolling Code 4-Channel UHF Remote

State-of-the-Art. High security. 4 channels. Momentary or latching relay output. Range up to 40m. Up to 15 Tx's can be learnt by one Rx (kit includes one Tx but more available separately). 4 indicator LED's.  
Rx: PCB 77x85mm, 12Vdc/6mA (standby).  
Two & Ten Channel versions also available.  
Kit Order Code: 3180KT - £44.95  
Assembled Order Code: AS3180 - £51.95



#### Computer Temperature Data Logger

Serial port 4-channel temperature logger. °C or °F. Continuously logs up to 4 separate sensors located 200m+ from board. Wide range of free software applications for storing/using data. PCB just 38x38mm. Powered by PC. Includes one DS1820 sensor and four header cables.  
Kit Order Code: 3145KT - £18.95  
Assembled Order Code: AS3145 - £25.95  
Additional DS1820 Sensors - £3.95 each



### DTMF Telephone Relay Switcher

Call your phone number using a DTMF phone from anywhere in the world and remotely turn on/off any of the 4 relays as desired. User settable Security Password, Anti-Tamper, Rings to Answer, Auto Hang-up and Lockout. Includes plastic case. 130 x 110 x 30mm. Power: 12Vdc.  
Kit Order Code: 3140KT - £46.95  
Assembled Order Code: AS3140 - £59.95



### Serial Port Isolated I/O Relay Module

Computer controlled 8 channel relay board. 5A mains rated relay outputs and 4 opto-isolated digital inputs (for monitoring switch states, etc). Useful in a variety of control and sensing applications. Programmed via serial port (use our new Windows interface, terminal emulator or batch files). Serial cable can be up to 35m long. Once programmed, unit can operate without PC. Includes plastic case 130x100x30mm. Power: 12Vdc/500mA.  
Kit Order Code: 3108KT - £54.95  
Assembled Order Code: AS3108 - £64.95



### Infrared RC 12-Channel Relay Board

Control 12 onboard relays with included infrared remote control unit. Toggle or momentary. 15m+ range. 112 x 122mm. Supply: 12Vdc/0.5A  
Kit Order Code: 3142KT - £47.95  
Assembled Order Code: AS3142 - £59.95



### PC / Standalone Unipolar Stepper Motor Driver

Drives any 5, 6 or 8-lead unipolar stepper motor rated up to 6 Amps max. Provides speed and direction control. Operates in stand-alone or PC-controlled mode. Up to six 3179 driver boards can be connected to a single parallel port. Supply: 9Vdc. PCB: 80x50mm.  
Kit Order Code: 3179KT - £11.95  
Assembled Order Code: AS3179 - £18.95



Bi-Polar Stepper Motor Driver also available (Order Code 3158 - details on website)

### DC Motor Speed Controller (100V/7.5A)

Control the speed of almost any common DC motor rated up to 100V/7.5A. Pulse width modulation output for maximum motor torque at all speeds. Supply: 9-18Vdc. Box supplied. Dimensions (mm): 60Wx100Lx60H.  
Kit Order Code: 3067KT - £13.95  
Assembled Order Code: AS3067 - £19.95



Bidirectional DC Motor Driver also available (Order Code 3166 - details on website)

Most items are available in kit form (KT suffix) or pre-assembled and ready for use (AS prefix).



## Hot New Kits This Summer!

Here are a few of the most recent kits added to our range. See website or join our e-mail Newsletter for all the latest news.

### EPE Ultrasonic Wind Speed Meter



Solid-state design wind speed meter (anemometer) that uses ultrasonic techniques and has no moving parts and does not need calibrating. It is intended for sports-type activities, such as track events, sailing, hang-gliding, kites and model aircraft flying, to name but a few. It can even be used to monitor conditions in your garden. The probe is pointed in the direction from which the wind is blowing and the speed is displayed on an LCD display.

#### Specifications

- Units of display: metres per second, feet per second, kilometres per hour and miles per hour
- Resolution: Nearest tenth of a metre
- Range: Zero to 50mph approx.

Based on the project published in *Everyday Practical Electronics*, Jan 2003. We have made a few minor design changes (see website for full details). Power: 9Vdc (PP3 battery). Main PCB: 50x83mm. Kit Order Code: 3168KT - **£36.95**

### Audio DTMF Decoder and Display



Detects DTMF tones via an onboard electret microphone or direct from the phone lines through an audio transformer. The numbers are displayed on a 16

character, single line display as they are received. Up to 32 numbers can be displayed by scrolling the display left and right. There is also a serial output for sending the detected tones to a PC via the serial port. The unit will not detect numbers dialled using pulse dialling. Circuit is microcontroller based. Supply: 9-12V DC (Order Code [PSU445](#)). Main PCB: 55x95mm.

Kit Order Code: 3153KT - **£20.95**  
Assembled Order Code: AS3153 - **£29.95**

### EPE PIC Controlled LED Flasher

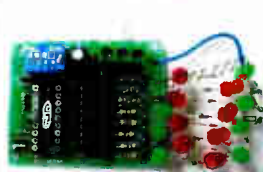

This versatile PIC based LED or filament bulb flasher can be used to flash from 1 to 176 LEDs. The user

arranges the LEDs in any pattern they wish. The kit comes with 8 super bright red LEDs and 8 green LEDs. Based on the *Versatile PIC Flasher*, *EPE Magazine* Dec 02. See website for full details. Board Supply: 9-12Vdc. LED supply: 9-45Vdc (depending on number of LED used). PCB: 43x54mm. Kit Order Code: 3169KT - **£11.95**

Most items are available in kit form (KT suffix) or assembled and ready for use (AS prefix).

## FM Bugs & Transmitters

Our extensive range goes from discreet surveillance bugs to powerful FM broadcast transmitters. Here are a few examples. All can be received on a standard FM radio and have adjustable transmitting frequency.

### MMTX' Micro-Miniature 9V FM Room Bug



Our best selling bug! Good performance. Just 25x15mm. Sold to detective agencies worldwide. Small enough to hide just about anywhere. Operates at the 'less busy' top

end of the commercial FM waveband and also up into the more private Air band. Range: 500m. Supply: PP3 battery. Kit Order Code: 3051KT - **£8.95**  
Assembled Order Code: AS3051 - **£14.95**

### HPTX' High Power FM Room Bug

Our most powerful room bug. Very impressive performance. Clear and stable output signal thanks to the extra circuitry employed. Range: 1000m @ 9V. Supply: 6-12V DC (9V PP3 battery clip supplied). 70x15mm. Kit Order Code: 3032KT - **£9.95**  
Assembled Order Code: AS3032 - **£17.95**



### MTTX' Miniature Telephone Transmitter



Attach anywhere along phone line. Tune a radio into the signal and hear exactly what both parties are saying. Transmits only

when phone is used. Clear, stable signal. Powered from phone line so completely maintenance free once installed. Requires no aerial wire - uses phone line as antenna. Suitable for any phone system worldwide. Range: 300m. 20x45mm. Kit Order Code: 3016KT - **£7.95**  
Assembled Order Code: AS3016 - **£13.95**

### Wide Band Synthesised FM Transmitter



PLL based crystal-locked wide band FM transmitter delivering a high quality, stable 10mW output. Accepts both MIC audio signal (10mV) and LINE input (1V p-p) for example

hi-fi, CD, audio mixer (like our kit 1052) or computer sound card. Supply: 9-15Vdc. Kit Order Code: 3172KT - **£19.95**  
Assembled Order Code: AS3172 - **£32.95**

### 3 Watt FM Transmitter



Small, powerful FM transmitter. Audio pre-amp stage and three RF stages deliver 3 watts of RF power. Use with the

electret microphone supplied or any line level audio source (e.g. CD or tape OUT, mixer, sound card, etc). Aerial can be an open dipole or Ground Plane. Ideal project for the novice wishing to get started in the fascinating world of FM broadcasting. 45x145mm. Kit Order Code: 1028KT - **£23.95**  
Assembled Order Code: AS1028 - **£31.95**



**QUASAR**  
electronics  
*Get Plugged In!*

**Credit Card Sales**  
**0871 717 7168**

## Electronic Project Labs

Great introduction to the world of electronics. Ideal gift for budding electronics expert!

### 500-in-1 Electronic Project Lab

Top of the range. Complete self-contained electronics course. Takes you from beginner to 'A' Level standard and beyond! Contains all the hardware and manuals to assemble 500 projects. You get 3 comprehensive course books (total 368 pages) - *Hardware Entry Course*, *Hardware Advanced Course* and a microprocessor based *Software Programming Course*. Each book has individual circuit explanations, schematic and connection diagrams. Suitable for age 12+.



Order Code EPL500 - **£149.95**  
**Also available - 30-in-1 £15.95, 130-in-1 £37.95 & 300-in-1 £59.95 (details on website)**

## Tools & Test Equipment

We stock an extensive range of soldering tools, test equipment, power supplies, inverters & much more - please visit website to see our full range of products.

### Precision Digital Multimeter (4.5 Digit)



A highly featured, high-precision digital multimeter with a large 4.5 digit LCD display. High accuracy (0.05%). Auto-zeroing, polarity selection and over-range indication. Supplied complete with shrouded test leads, shock-proof rubber holster, built-in probe holder and stand. Supplied fully assembled with holster,

battery and presentation box. Features include:  
Capacitance • Audio Frequency • Data Hold • hFE / Diode Test • Auto Power Off

#### Technical Specifications

DC voltage: 200mV-1000V • AC voltage: 2V-700V • DC current: 2mA-20A • AC current: 20mA-20A • Resistance: 200Ω-200MΩ • Capacitance: 2nF-20μF • Frequency: 20kHz • Max display: 19999

Order Code: MM463 - Was £44.95 **Now on sale at just £29.95!**

See our website for more special offers!



[www.QuasarElectronics.com](http://www.QuasarElectronics.com)

Secure Online Ordering Facilities • Full Product Listing, Descriptions & Photos • Kit Documentation & Software Downloads



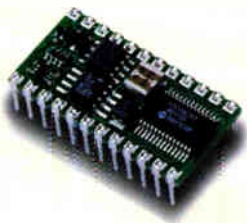

BS2-IC

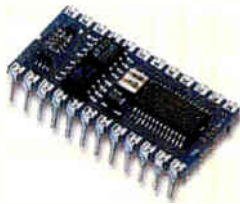

BS2-SX



BS2E-IC



BS2P/24



BS2P/40

**Parallax BASIC Stamps - still the easy way to get your project up and running!**

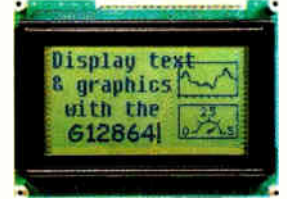
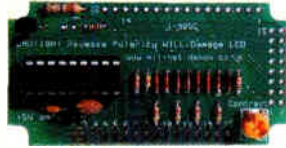

**Serial Alphanumeric and Graphic Displays, Mini-Terminals and Bezel kits**

# www.milinst.com



Animated Head



3-Axis Machine



Six-Legged Walkers



Robotic Arms



Bipeds

**Robotic models for both the beginner and the advanced hobbyist**

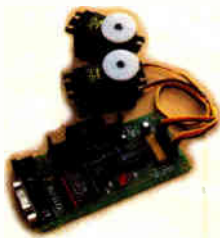

Servo Drivers

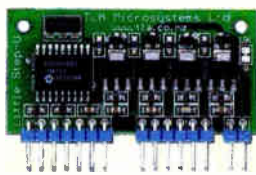

Motor Drivers



On-Screen Displays



DMX Protocol



U/Sound Ranging

**Animatronics and Specialist Interface-Control Modules**



Quadvox MP3 & Speech Systems



SensoryInc Voice Recognition

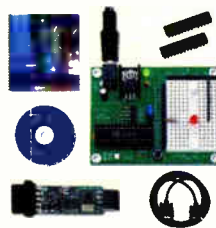

Parallax Ubicom Tool Kits



Tech-Tools PIC & Rom Emulators

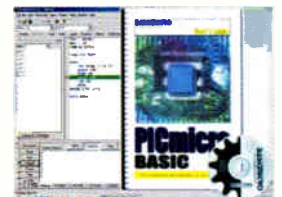

BASICMicro PIC BASIC Compilers

**Development Tools**

Milford Instruments Limited Tel 01977 683665, Fax 01977 681465, sales@milinst.com



## EPE PROJECT PICs

Programmed PICs for EPE Projects  
 12C508/9-£3.90; 16F627/8 - £4.90  
 16F84/71/ - £5.90  
 16F876/877/ 18Fxxxx - £10.00  
 All inc. VAT and Postage

## 1kV/500V Insulation Tester



Super design. Regulated output and efficient circuit. Dual scale meter, compact case. Reads up to 200 Megohms. Kit includes wound ferrite transformer, drilled and punched case, meter scale, PCB & ALL components. (Needs PP3 battery).

**KIT 848...£32.95**

## DUAL OUTPUT TENS UNIT

An excellent kit for this project based on the EPE March'97 Design. Our Full Kit includes all components, hardware and an improved Magenta pcb. All hardware and electrodes are included. Designed for simple assembly and testing, providing a high level controlled dual output drive.

**KIT 866 .. £32.90**  
 Inc. 4 electrodes

Set of 4 Spare  
 Electrodes £6.50

## EPE MICROCHIP P.I.

### Treasure Hunter

Stable Sensitive Pulse Induction detector. Easy to build and use. No ground effect - works in sea water. Detects Gold Silver, ferrous and non ferrous metals.

**KIT 847 ... £63.95**

Kit Includes Head-phones, coil and all Hardware

## Ultrasonic PESt Scarers

Two Ultrasonic PESt Scarers. Kit 812 produces regular high level pulses of 32kHz. Kit 867 produces Random pulses and can work with an optional slave unit to give two separate ultrasound sources. Both kits need 9V supply.

**Kit 812 ... £14.81 psu . 3.99**

**Kit 867 ... £19.99 867Slave £12.51**

## MOSFET MKII Bench PSU

0-25V 2.5A

Based on Mk1 design, with switching pre-regulator for high efficiency. Panel meters for A and V. Toroidal transformer. Variable Volts 0 - 25 AND Variable Current limit from 0 - 2.5A

Kit includes punched and labelled case. A classic and essential piece of test gear

**Kit 845 ... £64.95**



68000 Trainer Kit 621.. 99.95

## Stepping & DC Motors

A range of motors for many applications:

Visit our website for more details  
 MD100 100 step Unipolar..... £9.99  
 MD200 200 step Unipolar..... £12.99  
 MD24 Type '23' size 200 step..£22.95

## MAGENTA BRAINIBOT I & II

- Full kit with ALL hardware and electronics.
- As featured in EPE Feb '03 (KIT 910)
- Seeks light, beeps, and avoids obstacles
- Spins and reverses when "cornered"
- Uses 8 pin PIC chip
- ALSO KIT 911 - As 910 PLUS programmable from PC serial port leads and software CD included.

**BRAINIBOT**

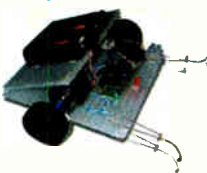

**KIT910..£16.99**

**KIT911..£24.99**

## PIC PIPE DESCALER

- SIMPLE TO BUILD
- SWEEPED FREQUENCY OUTPUT
- HIGH POWER
- AUDIO & VISUAL MONITORING

An affordable circuit which sweeps the incoming water supply with varying frequency electromagnetic signals. May reduce scale formation, dissolve existing scale and improve the way salts in the water behave.

Kit includes case PCB coupling coil and all components.

High coil current ensures maximum effect. LED and piezo monitor.

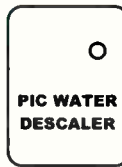

**KIT 868 .. £22.95 PSU £3.99**

## 12V EPROM ERASER

A safe low cost eraser for up to 4 EPROMs or other UV erasable windowed devices at a time in 20 minutes.

Operates from a 12 Volt supply (400mA). Ideal for mobile work -and in educational applications where mains voltages are to be avoided. Safety interlock prevents contact with UV.

**KIT 790 ..... £29.90**

## PIC LCD DISPLAY DRIVER

16 Character x 2 Line display, pcb, programmed PIC16F84, software disk and all components to experiment with standard intelligent alphanumeric displays. Includes full PIC source code which can be changed to match your application.

**KIT 860.£19.99**

- Learn how to drive the display and write your own code.
- Ideal development base for meters, calculators, counters, timers — just waiting for your application
- Top quality display with industry standard driver, data and instructions

## PIC STEPPING MOTOR DRIVER

PCB with components and PIC16F84 programmed with demonstration software to drive any 4 phase unipolar motor up to 24 Volts at 1 Amp. Kit includes 100 Step Hybrid Stepping Motor. Full software source code supplied on disc. Use this project to develop your own applications. PCB allows 'simple PIC programmer' 'SEND' software to be used to reprogram chip.

**KIT 863.....£18.99**

## 8 CHANNEL DATA LOGGER

From Aug/Sept.'99 EPE. Featuring 8 analogue inputs and serial data transfer to PC. Magenta redesigned PCB - LCD plugs directly onto board. Use as Data Logger or as a test bed for developing other PIC16F877 projects. Kit includes lcd, programmed chip, PCB, Case, all parts and 8 x 256k EEPROMs

**KIT 877.....£49.95**

## SUPER PIC PROGRAMMER

Magenta's original parallel port programmer. Runs with downloaded WINDOWS 95 - XP software. Use standard Microchip .HEX files. Read/Prog/Verify wide range of 18,28, and 40 pin PICs. Including 16F84/876/877, 627/8, (Inc. 'A' versions) + 16xx OTPs.

**KIT 862. £29.99 Power Supply £3.99**

## ICEBREAKER

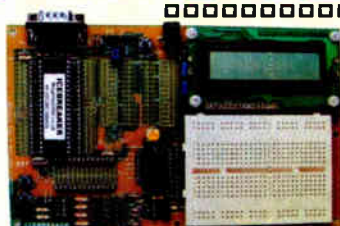

**PIC Real Time In-Circuit Emulator**

With serial lead & software disk, PCB, Breadboard, PIC16F877, LCD, all components and patch leads.

**KIT 900..£34.99 PSU £3.99**

ICEbreaker uses PIC16F877 in-circuit debugger functions.

• Featured in EPE Mar'00  
 Ideal for beginners & experienced users. Windows (95 to XP) Software included

## 20W Stereo Amp.

EPE May '05 -- Magenta Stereo/Mono Module

Wide band Low distortion 11W / channel Stereo 20W Mono. True (rms) Real Power



Short Circuit & Overheat Protected. Needs 8 to 18V supply.

Latest Technology - Stable, Reliable, high performance IC with local feedback.

**KIT 914 ..... £11.90**

(includes all parts & heatsink for stereo or mono)

## Magenta BrainiBorg

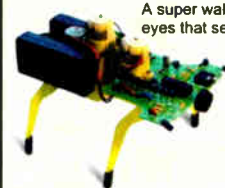

A super walking programmable robot with eyes that sense obstacles and daylight.

BrainiBorg comes with PC software CD (WIN95+ & XP) with illustrated construction details, and can be programmed to walk and respond to light and obstacles on any smooth surface.

Kit includes all hardware, components, & 3 motor/gearboxes Uses 4 AA batteries (not supplied).

**KIT 912 ... £29.99**

(Kit with CD Rom & Serial Lead)

**KIT 913 ... £38.95**

(As 912 but Built & Tested Circuit board)

## EPE PIC Toolkit 3

As in EPE Apr/May/Jun '03 and on PIC Resources CD

- Magenta Designed Toolkit 3 board with printed component layout, green solder mask, places for 8,18, 28 (wide and slim), and 40 pin PICs, and many Magenta extras. Also runs with WinPic800 prog. Software.
- 16 x 2 LCD, PIC chip all parts and sockets included.
- Follow John Becker's excellent 'PIC tutorial 2' series.

**KIT 880 ... £34.99**

(With 16F84 Chip)

**KIT 880 ... £39.99**

(With 16F877 Chip)

OR - Built & Tested £49.99 & £55.99

## EPE TEACH-IN 2004

COMPLETE 12 PART SERIES FROM NOV03

Additional Parts as listed in 'misc.' Section (less RF modules, Lock, and Motor/g.box)

All parts to follow this Educational Electronics Course. Inc. Breadboard, and wire, as listed on p752 Nov 03'

**KIT921.£12.99**  
 Reprints £1.00 per part.

**KIT920..£29.99**

## BAT DETECTORS

Magenta's Super Heterodyne Bat detectors. Our best selling kit 861 now includes a drilled case and front panel label. The MkIb and digital MkIII are supplied built & ready to go

**KIT 861 .. £37.99**

Soft Zip Up Pouch for all 3.....£5.99

**MkIb .. £49.95**

**MkIII .. £89.95**

All Prices Include VAT, Add £3.00 P&P per order, or £7.99 for next day. Chqs. P.O. & Most major cards accepted. See our Website for many more kits, products, & Secure On Line ordering. Mail Order Only.

# MAGENTA

ELECTRONICS LTD

135 Hunter Street Burton on Trent  
 Staffs DE14 2ST UK  
 email: sales@magenta2000.co.uk

www.magenta2000.co.uk Tel: 01283 565435 Fax: 01283 546932







**Editorial Offices:**  
EVERYDAY PRACTICAL ELECTRONICS EDITORIAL  
Wimborne Publishing Ltd., 408 Wimborne Road East, Ferndown,  
Dorset BH22 9ND  
Phone: (01202) 873872. Fax: (01202) 874562.

**Email:** enquiries@epemag.wimborne.co.uk

**Web Site:** www.epemag.co.uk

**EPE Online** (downloadable version of *EPE*): www.epemag.com

**EPE Online Shop:** www.epemag.wimborne.co.uk/shopdoor.htm

See notes on **Readers' Technical Enquiries** below – we regret technical enquiries cannot be answered over the telephone.

**Advertisement Offices:**

EVERYDAY PRACTICAL ELECTRONICS ADVERTISEMENTS

408 Wimborne Road East, Ferndown, Dorset BH22 9ND

Phone: 01202 873872 Fax: 01202 874562

**Email:** stewart.kearn@wimborne.co.uk

### One Door Closes . . .

Our *Teach-In 2006* series ended last month but if you are quick you can still enter the final On-Line Test, and if you obtain a score of 85% or more your name will go forward to the *Teach-In* prize draw. Prizes have been donated by Rapid Electronics – the first prize is an extensive tool kit worth £275, there are also 21 runner-up prizes. Entries to the prize draw will close at noon on 10 November, but the On-Line Test will remain for some time yet.

The *Teach-In* series has proved to be very popular and we are therefore planning to publish the whole series in book form. Plans for this are still being progressed but we are hoping to include an extra feature on using SPICE circuit simulation software and provide a free cover-mounted CDROM, with the software and interactive *Teach-In* Tests on it. More on this in a few months time.

### .....Another Opens

With *Teach-In* completed we now have room for a short series entitled *Using C*. This has been specially written for us – with hobbyists and students in mind – by Mike Hibbett of *PIC N' Mix* fame (amongst other things). The series will start next month by looking at why you might want to use C, the choice of compilers, and go on to cover such topics as how embedded C programs are structured, how to build them, special features/issues/problems, using Assembly in line with C and linking Assembly modules into C. The series will conclude with an example project using Microchip USB code to build a USB LCD display and simple keyboard for a PC.

Don't miss Part 1 next month, the November issue is on sale on October 12.

### Price

Please note that our cover price and subscription fees will have to be increased with effect from next month, so now is the time to subscribe to *EPE* to avoid the price rise (and get your copies for just £2.75 each) for another year – or two if you want to save even more. See page 61 for subscription details or visit our web site at [www.epemag.co.uk](http://www.epemag.co.uk)

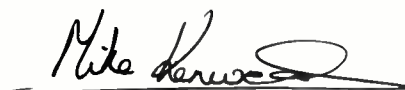

### AVAILABILITY

Copies of *EPE* are available on subscription anywhere in the world (see opposite), from all UK newsagents (distributed by SEYMOUR) and from the following electronic component retailers: Omni Electronics and Yebo Electronics (S. Africa). *EPE* can also be purchased from retail magazine outlets around the world. An Internet on-line version can be purchased and downloaded for just \$15.99US (approx £9.50) per year available from [www.epemag.com](http://www.epemag.com)

### SUBSCRIPTIONS

Subscriptions for delivery direct to any address in the UK: 6 months £17.50, 12 months £33, two years £61; Overseas: 6 months £20.50 standard air service or £29.50 express airmail, 12 months £39 standard air service or £57 express airmail, 24 months £73 standard air service or £109 express airmail. To subscribe from the USA or Canada see page 61.

Online subscriptions, for downloading the magazine via the Internet, \$15.99US (approx £9.50) for one year available from [www.epemag.com](http://www.epemag.com).

Cheques or bank drafts (in £ sterling only) payable to *Everyday Practical Electronics* and sent to EPE Subs, Dept., Wimborne Publishing Ltd, 408 Wimborne Road East, Ferndown, Dorset BH22 9ND. Tel: 01202 873872. Fax: 01202 874562. Email: subs@epemag.wimborne.co.uk. Also via the Web at: <http://www.epemag.wimborne.co.uk>. Subscriptions start with the next available issue. We accept MasterCard, Amex, Diners Club, Maestro or Visa. (For past issues see the *Back Issues* page.)

### BINDERS

Binders to hold one volume (12 issues) are available from the above address. These are finished in blue p.v.c., printed with the magazine logo in gold on the spine. Price £7.95 plus £3.50 p&p (for overseas readers the postage is £6.00 to everywhere except Australia and Papua New Guinea which cost £10.50). Normally sent within seven days but please allow 28 days for delivery – more for overseas.

Payment in £ sterling only please. Visa, Amex, Diners Club, Maestro and MasterCard accepted. Send, fax or phone your card number, card expiry date and card security code (the last 3 digits on or just under the signature strip), with your name, address etc. Or order on our secure server via our UK web site. Overseas customers – your credit card will be charged by the card provider in your local currency at the existing exchange rate.

**Editor:** MIKE KENWARD

**Consulting Editors:** DAVID BARRINGTON

JOHN BECKER

**Business Manager:** DAVID J. LEAVER

**Subscriptions:** MARILYN GOLDBERG

**General Manager:** FAY KEARN

**Editorial/Admin:** (01202) 873872

**Advertising Manager:**

STEWART KEARN (01202) 873872

**On-Line Editor:** ALAN WINSTANLEY

**EPE Online** (Internet version) **Editors:**

CLIVE (MAX) MAXFIELD and ALVIN BROWN

### READERS' TECHNICAL ENQUIRIES

**E-mail:** techdept@epemag.wimborne.co.uk

We are unable to offer any advice on the use, purchase, repair or modification of commercial equipment or the incorporation or modification of designs published in the magazine. We regret that we cannot provide data or answer queries on articles or projects that are more than five years old. Letters requiring a personal reply *must* be accompanied by a **stamped self-addressed envelope or a self-addressed envelope and international reply coupons. We are not able to answer technical queries on the phone.**

### PROJECTS AND CIRCUITS

All reasonable precautions are taken to ensure that the advice and data given to readers is reliable. We cannot, however, guarantee it and we cannot accept legal responsibility for it.

A number of projects and circuits published in *EPE* employ voltages that can be lethal. **You should not build, test, modify or renovate any item of mains powered equipment unless you fully understand the safety aspects involved and you use an RCD adaptor.**

### COMPONENT SUPPLIES

**We do not supply electronic components or kits for building the projects featured, these can be supplied by advertisers.**

**We advise readers to check that all parts are still available before commencing any project in a back-dated issue.**

### ADVERTISEMENTS

Although the proprietors and staff of EVERYDAY PRACTICAL ELECTRONICS take reasonable precautions to protect the interests of readers by ensuring as far as practicable that advertisements are *bona fide*, the magazine and its Publishers cannot give any undertakings in respect of statements or claims made by advertisers, whether these advertisements are printed as part of the magazine, or in inserts.

The Publishers regret that under no circumstances will the magazine accept liability for non-receipt of goods ordered, or for late delivery, or for faults in manufacture.

### TRANSMITTERS/BUGS/TELEPHONE EQUIPMENT

We advise readers that certain items of radio transmitting and telephone equipment which may be advertised in our pages cannot be legally used in the UK. Readers should check the law before buying any transmitting or telephone equipment as a fine, confiscation of equipment and/or imprisonment can result from illegal use or ownership. The laws vary from country to country; readers should check local laws.





## SKY'S BROADBAND

**Barry Fox reports that Sky has upset the applecart with a radical new approach to broadband pricing**

**A**NYONE who subscribes to any Sky Pay TV package *whether the basic £15 a month or top price HDTV can now get a free broadband connection.* "It's a landmark day", says James Murdoch, Sky's Chief Executive (and son of Rupert Murdoch). "Too many people have been paying too much for broadband for too long".

"The services which have recently been launched, promising cheaper broadband, are tied up with all kinds of catches and conditions" says Brian Sullivan, Sky's Director of Product Strategy and Management, and the man who launched Sky+ and Sky HD. "We asked our satellite customers what they wanted and they said something simple as well as cheap".

Everyone signing up with Sky broadband gets a wireless router free; and everyone gets McAfee security software and updates free. The Base package is free after a £40 activation fee, which covers the £40 cost of BT's charge to Sky for connection.

However, the free service is capped at 2Mbps speed and 2GB per month. The Mid package gives 8Mbps with 40GB per month and costs £5 per month after £20 activation. The Max package gives speeds up to 16Mbps for £10 per month with unlimited download and free activation. (Non-TV subscribers can pay £17 pm for 8Mbps.) Home installation of the router by an engineer is free for the Max package. Others can self-install or pay £50 for an engineer to call.

### Saving £200

Murdoch and Sullivan presented figures which show savings averaging around £200 a year over the competition. "We estimate customers can save £1bn over 18 months or two years. That's money that would be going into the pockets of BT and others", says Murdoch.

The move follows Sky's purchase of Internet Service Provider Easynet; 28%

of UK households are now covered by changes already made to BT exchanges and 50% will be ready by Christmas. Murdoch explains why Sky is investing £500m in the project over three years. The new Sky HD box is the first hybrid device, with MPEG-4 capability and Ethernet connectivity as well as satellite reception. "All future Sky receivers will be hybrid. In 2007 there will be software that lets subscribers plug a broadband connection into their satellite receivers. We can then offer video on demand and gaming. Sky is already the largest legal video download service in Europe".

Movie subscribers can download selected features free by broadband to their PCs. Sky's ace is that UK laws now oblige any broadband supplier to provide a MAC (Migration Authorisation Code) which lets a subscriber change service provider easily once their basic contract has expired.

## ARE YOU CO SURE?

If you have a Carbon Monoxide (CO) concern and need to know more, Lascar Electronics' EL-USB-CO carbon monoxide data logger could help in determining the nature of the problem.

Carbon monoxide is a poisonous gas which is both odourless and colourless. It is produced by equipment/machinery that isn't working correctly and can be found anywhere from construction sites and furnace rooms to office blocks and homes. Lascar's EL-USB-CO data logger monitors and records CO levels in an environment over a period of time. This can help the user to determine where and when peak levels of CO occur, allowing corrective action to be carried out to remedy the problem.

The EL-USB-CO stores over 32,000 readings and can record CO levels from 0 to 1000 ppm. Setup of the data logger is completed using the supplied EL-USB software, with the EL-USB-CO plugging directly into the USB port of a PC. Here the user can assign the logger a name, choose a sample rate (from a choice of once every: 10 secs, 30 secs, 1 min, 5 mins), as well as determining a high-alarm level. Once setup is complete the EL-USB-CO should be left in the environment where the study is to take place.



The EL-USB-CO is available for purchase at £49.00 from the Lascar website ([www.lascarelectronics.com](http://www.lascarelectronics.com)). If you have any queries regarding a potential

application or would like to discuss the EL-USB-CO further please contact the Lascar sales team on +44 01794 884567 or by email: [sales@lascar.co.uk](mailto:sales@lascar.co.uk).



## ROBOTIC FISH

When recently visiting the London Aquarium, this News editor was fascinated by the display of robotic fish which they have – they are so realistic.

They have been created by Jindong Liu and a team of scientists from the University of Essex, and are the world's first autonomously controlled robotic fish. The three robotic fish are equipped with sensors that allow them to navigate around the tank and learn about their environment. Ultimately, many kinds of sensor will be applied, such as camera and sonar.

Although robotic fish are nothing new, these ones are very lifelike. The way they move when they encounter obstacles or the tank floor, is remarkably similar to that of real fish.

Professor Huosheng Hu, who headed the team of robotics engineers, says that they mimic normal swimming and sharp turning, and that people get confused and think they are real fish.

The team spent three years working with staff at the London Aquarium learning about how different species of fish move and applied their knowledge to the robots, which have been designed to look like carp. Each one is around 50cm (20 inches) long and has shiny scales, and even barbels, like a real carp. The aim is to get the fish to swim as fast as tuna, one of the world's fastest swimming fish species. Members of the Department of Computer Science at the University are aiming to produce a one metre long autonomous robot fish.

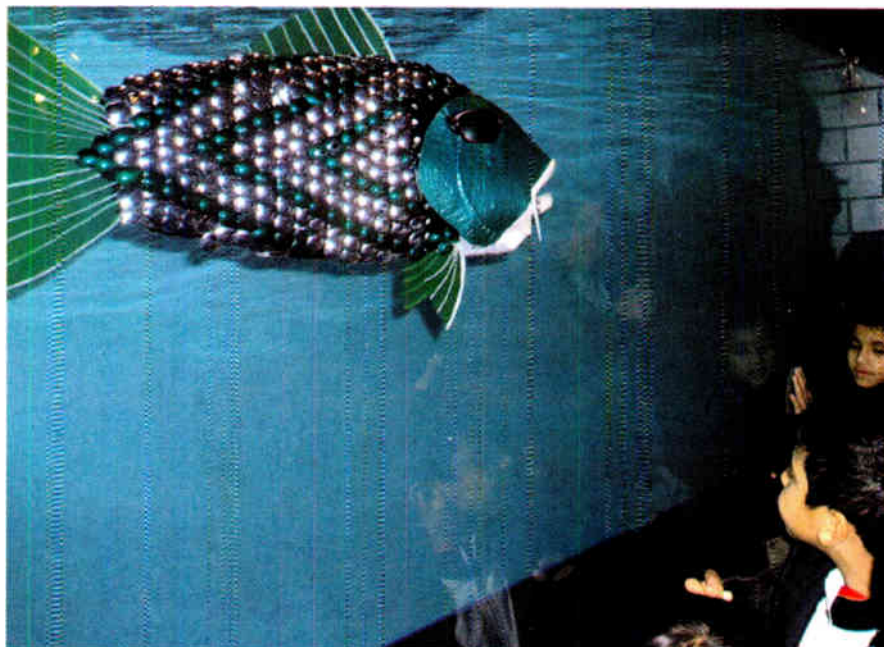

Photo courtesy of Jindong Liu

At the moment the fish are limited to five hours of swimming before their batteries run out.

Professor Hu is reported as saying they want the fish to have the ability to look for their own charging station, just like a real fish looking for food. Later models may be used for underwater exploration for such things as detecting oil pipe leaks or covert surveillance.

The fish are on display at the London Aquarium (close to the London Eye Big Wheel).

We are grateful to Jindong Liu for permission to use the photograph. He is a PhD Student under the supervision of Prof Huosheng Hu and may be contacted at the Department of Computer Science, University of Essex, Wivenhoe Park, Colchester, Essex CO4 3SQ. Tel: +44 1206 872150 (Lab). Fax: +44 01206 872788. Web: <http://privatewww.essex.ac.uk/~jliua>. Also browse the web via [www.google.co.uk](http://www.google.co.uk), searching on 'robotic fish'.

### New PIC16F Micros

Microchip announces two new 20-pin PIC microcontrollers. The PIC16F631 provides a cost-effective migration from 8- and 14-pin devices, while the PIC16F677 offers affordable hardware I<sup>2</sup>C and SPI capability. The devices are a compatible extension of the PIC16F685/687/689/690 series.

Both new microcontrollers feature nanoWatt technology to minimise power consumption – including a Precision Internal Oscillator (operating from 31kHz up to 8MHz), an ultra-low-power Wakeup function, an Enhanced low-power Watchdog Timer and an Enhanced low-power 16-bit Timer with Gate Control.

The key features of both devices include: up to 3.5 Kbytes of Flash Program memory; up to 128 bytes of RAM; two comparators with Set-Reset latch mode; 0.6V internal bandgap reference; in-circuit serial programming technology; brownout reset with software-control option; up to 18 I/O pins.

In addition, the PIC16F677 features 12-channel, 10-bit ADC plus SPI and I<sup>2</sup>C support with Address Mask option.

The new devices are supported by Microchip's suite of development tools, including the free MPLAB IDE (Integrated Development Environment),

the low-cost PICKit 2 starter kit, and the MPLAB ICD 2 (In-Circuit Debugger).

For more information on the availability of the PIC16F631 and PIC16F677 microcontrollers, in RoHS-compliant 20-pin PDIP, SOIC, SSOP and QFN packages, visit Microchip's Web site at [www.microchip.com](http://www.microchip.com).

### Miniature FM Transmitter

MK Consultants has introduced a new high power FM transmitter that delivers class leading long-range performance for a miniature narrow band module. The GT2HP-UHF operates at the UK license-free frequency of 458.85MHz and has a power output of 250mW. The module can be paired with the MK Consultants GR2 receiver.

The small size and high power output performance of the GT2HP-UHF make it ideal for use in the growing number of portable electronics products that require reliable, long range, wireless communications capability. The new module is able to work effectively over ranges of several kilometres in long range switching and telemetry applications such as wireless security, remote controls, paging systems and asset tracking.

The new transmitter uses the latest narrow band crystal technology and can achieve data rates of up to 9600 bits/s. The module requires a nominal DC supply of 5V and has a channel spacing of 25kHz. Although initially available with an operating frequency of 458.85MHz for the UK market, the GT2HP-UHF can be supplied with other frequencies if required.

Due to their high RF sensitivity, GR2 receiver modules are able to operate over long ranges complementing the performance of the GT2HP-UHF transmitter. A switchable data rate filter gives either 2400 baud with -119dBm sensitivity, or 9600 baud with -114dBm sensitivity. The receivers are housed in fully shielded SIL packages measuring 48mm x 17mm x 5mm and feature analogue, digital and true RSSI outputs. Supply voltage can range from 2.7V to 10V.

Both the GT2HP-UHF and the GR2 have an operating temperature range of -10°C to +55°C and are EN 300-220-2 compliant.

For further information contact MK Consultants (UK) Ltd., 288a-290 Queens Road, Halifax, West Yorks HX1 4NS. Tel: +44 01422 329002. Fax: +44 01422 353153. Email: [mo@mkconsultants.prestel.co.uk](mailto:mo@mkconsultants.prestel.co.uk). Web: [www.mkconsultants.eu](http://www.mkconsultants.eu).



# Studio 350 Power Amplifier Module

Want an audio power amplifier with some real grunt? Want an audio power amplifier which is really quiet and has very low distortion? Here is the one answer for both desires. The Studio 350 is a rugged power amplifier module capable of delivering 200 RMS watts into an 8-ohm load and 350 watts RMS into a 4-ohm load, at very low distortion.

Pt. 1: By LEO SIMPSON & PETER SMITH

**O**UR first approach on designing this amp was to decide on the target power output, given a likely supply rail. We decided to aim for 200 watts into an 8-ohm load. A few back-of-an-envelope calculations showed that we would need supply rails of about  $\pm 70\text{V}$  or a total of 140V.

Naturally, we would also want to drive 4-ohm loads and with those same supply rails we would expect to obtain around 350 watts. But how many output transistors and what type would be required? As you can see from the photos and circuit, we have used eight 250V 200W plastic power transistors: four MJL21193/4 complementary pairs. These are teamed with the high-performance MJL15030/31 complementary driver transistors.

In addition, we have used some high-voltage low-noise transistors in the input stage and highly linear high-voltage video transistors in the

voltage amplifier stage. The net result is a rugged power amplifier with very low residual noise and distortion.

## Load lines and power ratings

So why did we end up using eight 200W transistors in order to get just 200W into 8 $\Omega$  and 350W into 4 $\Omega$ ? It might seem like over-kill but it is not. To work out the dissipation in a transistor, you need to draw the load lines. These show power dissipation in the active device (in this case, one half of the output stage, consisting of four transistors). The vertical axis is in Amps while the horizontal axis is Volts. The various load lines for our amplifier are shown in Fig.1.

For a start, we plotted the lines for 8-ohm and 4-ohm resistive loads and these are straight lines, showing all possible conditions. The two resistive lines start at the 70V mark on the horizontal axis, corresponding to the supply voltage applied across one half

of the output stage (either the NPN or the PNP transistors). For the 4 $\Omega$  load, the load line runs up to 17.5A on the vertical axis, corresponding to the current delivered if the active device was fully turned on (ie.  $70\text{V}/4\Omega = 17.5\text{A}$ ).

Similarly, for an 8 $\Omega$  load, the load line runs up to 8.75A on the vertical axis (ie.  $70\text{V}/8\Omega = 8.75\text{A}$ ). These load lines show the instantaneous power dissipation at any possible signal condition (including an output short circuit).

Also shown on the diagram are two hyperbolas. One represents the maximum safe power (for one second!) dissipation of four parallel-connected MJL21193/94 transistors. Depending on the instantaneous voltage across the transistors, this can be more than 900W for low voltages, reducing to 720W at 80V, and ultimately to just 400W at 250V (not shown on the curve). This hyperbola represents the maximum dissipation the four



# er le

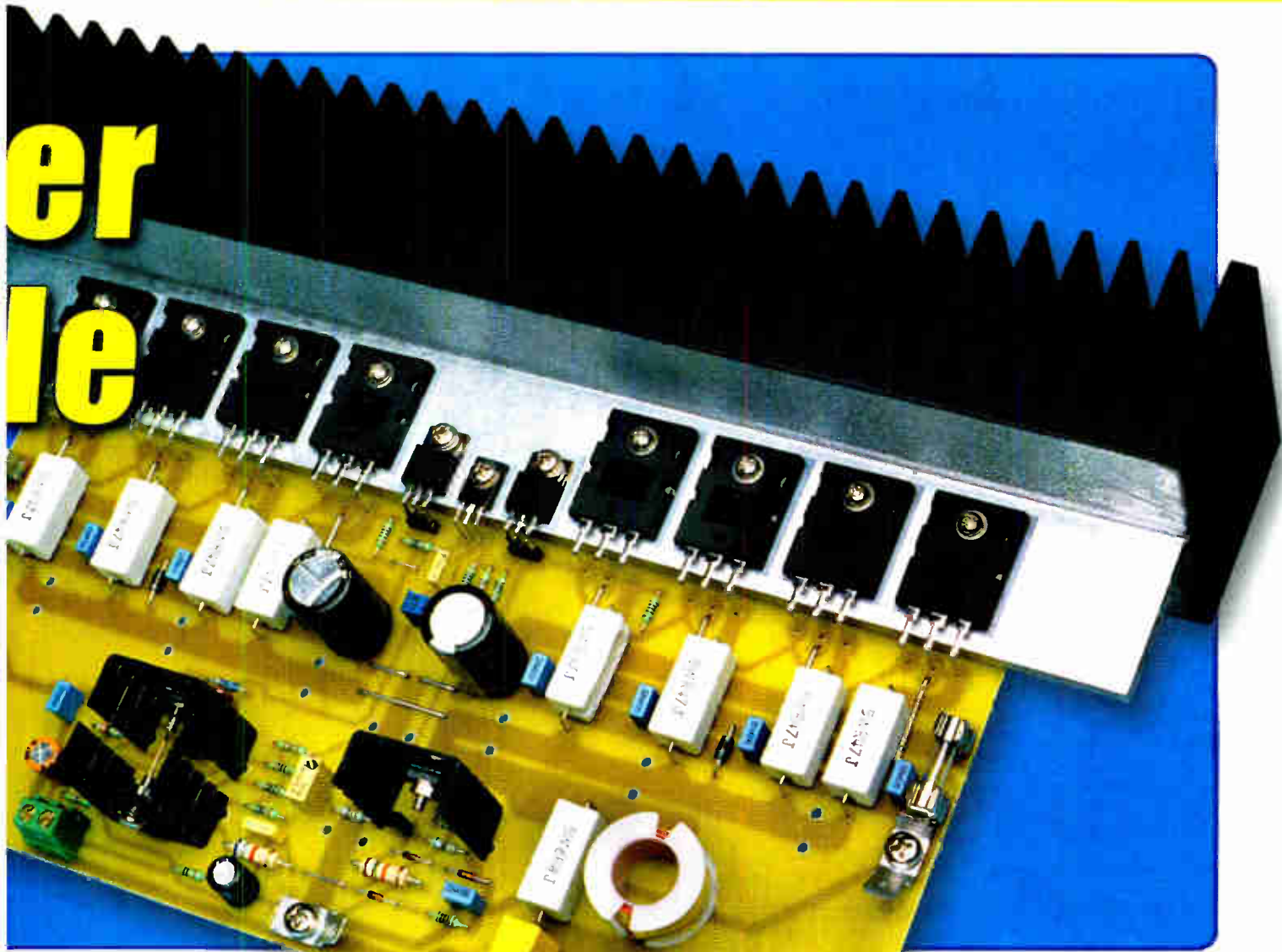

transistors can withstand under a non-repetitive one-second pulse, the so-called Safe Operating Area (SOA).

Since the resistive load lines are well below the one-second SOA hyperbola, you may think that the transistors are operating far below their maximum ratings and so they would be, if all they had to drive was resistive loads. Sadly, loudspeakers are not resistive; they can be resistive, inductive or capacitive, depending on the signal frequency. Usually they are inductive which means the load current lags the load voltage.

This has two effects. First, the voltage across the output transistors can go much higher than the half-supply value of 70V. Conceivably, it can run to the full supply voltage of 140V (or beyond, if driven into clipping on an inductive load). Second, the instantaneous power dissipation across the power transistors can go far in excess of that shown for a resistive load line.

To show this effect, we have drawn 8Ω and 4Ω reactive load lines which represent speakers with complex impedances of  $5.6\Omega + j5.6\Omega$  and  $2.83\Omega + j2.83\Omega$ , respectively. In the 8Ω case, the 5.6Ω represents the voice coil resistance while the  $j5.6\Omega$  is the coil inductance. The resulting curved load lines extend well beyond 70V (to almost 110V) and also show instantaneous dissipation figures far in excess of that for the resistive load lines. In fact, you can see that in the case of the 4Ω reactive case, there is far less power margin to spare.

We have also drawn the de-rated power hyperbola (50°C) for four transistors on Fig.1 and as you can see, it touches the 4Ω reactive curve. Does this mean there is a problem? Well no,

because the load lines show instantaneous power dissipation, not average or total power dissipation. As long as the load lines are below the SOA curve, everything is OK.

All of the foregoing is a shortened explanation of the process whereby we decided to use eight transistors. It shows that eight is a good conservative figure whereas six of these transistors would not be enough.

Finally, before we leave the discussion on load lines, we need to mention short circuit and overload protection. Apart from fuses, this amplifier circuit has no protection. We could have chosen to run with six power transistors if we had incorporated "load line" protection into the circuit. This uses a pair of transistors to monitor the output transistor voltage and current conditions and then limit the base drive signal when the load line is exceeded.



# Constructional Project

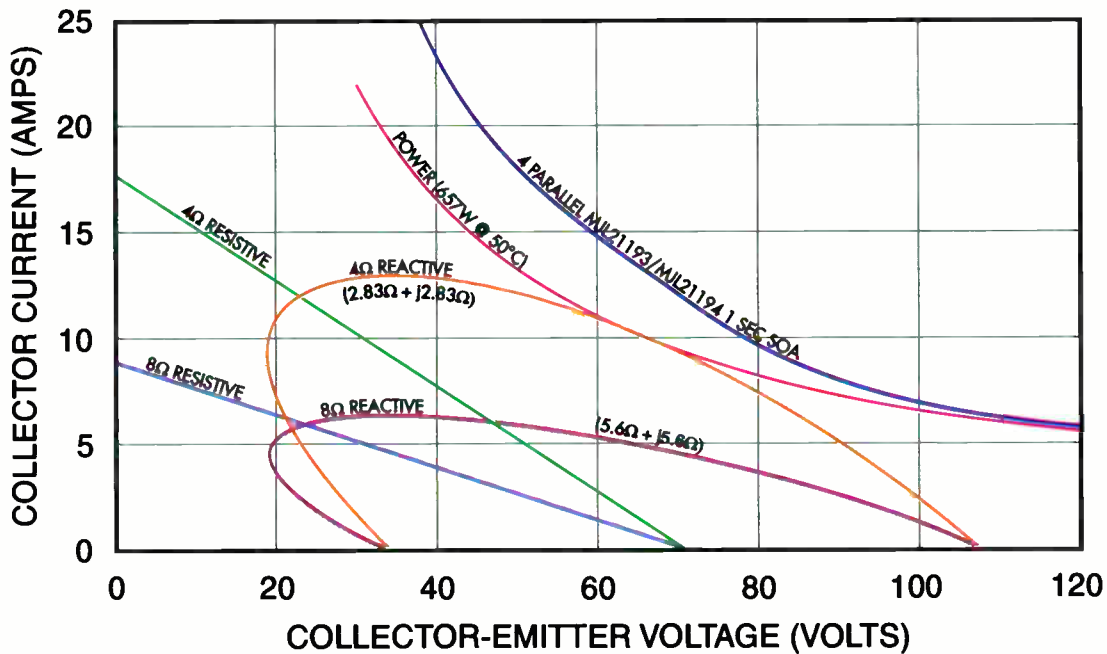

Fig.1: this diagram shows the resistive and reactive load lines for both 4Ω and 8Ω loads. Also shown are two hyperbolas. The blue curve shows the maximum safe operating area of four parallel-connected MJL21193/MJL21194 transistors, while the red curve shows the derated power curve for 50°C case temperature.

Such circuits can work quite well to protect the output stage but in practice their rapid switching action causes a burst of high frequency oscillation to be superimposed on the output signal. This means that not only do you get horrible distortion but the amplitude of the burst can be enough to overload and burn out tweeters if the overdrive situation persists.

Therefore, while we regard load line protection as important for PA amplifiers (which can easily have their output leads shorted), it is not desirable for a hifi amplifier. If you do short the outputs of this amplifier when it is under full drive, there will be a big spark and hopefully the only thing to be damaged will be the 5A fuses.

If the fuses were increased in rating, the amplifier could ostensibly drive a 2Ω resistive load without damage, so we think the 5A fuses should provide adequate short circuit protection. Oh, but we don't recommend driving a 2Ω load!

## Amplifier module

Two versions of this amplifier module are possible, both using the same PC board pattern. The one presented here employs a cast aluminium heatsink with an integral shelf which is convenient for mounting the power transistors. This heatsink is 300mm wide and the PC board itself is 240 × 136mm so the overall assembly is quite large.

The alternative approach is to mount the output transistors vertically on a single-sided or fan heatsink, in which case the PC board could be trimmed to 240mm wide by 100mm deep. This latter approach takes up less chassis space. Both approaches will be described in the constructional details to be presented next month.

## Performance

As already noted, the Studio 350 delivers up to 200W RMS into an 8-ohm load and up to 350W into a 4-ohm load. Music power figures are substantially higher, around 240W into an 8-ohm load and 480W into a 4-ohm load. These figures apply only for the suggested power supply, which we will come to later.



Fig.2: total harmonic distortion versus power at 1kHz into an 8-ohm load (10Hz-22kHz measurement bandwidth).

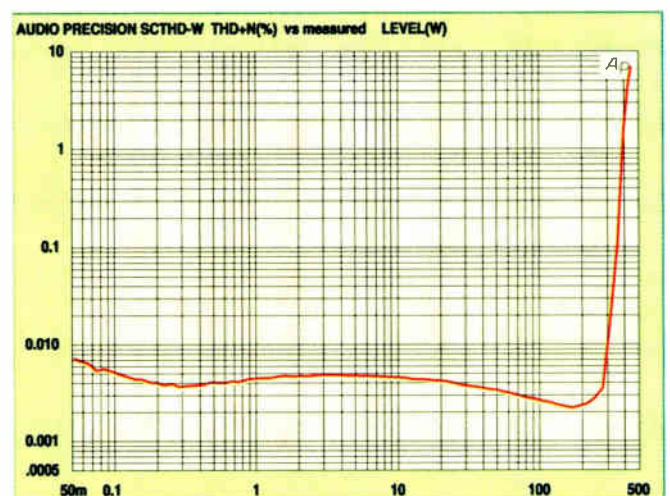

Fig.3: total harmonic distortion versus power at 1kHz into a 4-ohm load (10Hz-22kHz measurement bandwidth).





Fig.4: harmonic distortion versus frequency at 160W into an 8-ohm load (22Hz-80kHz measurement bandwidth).

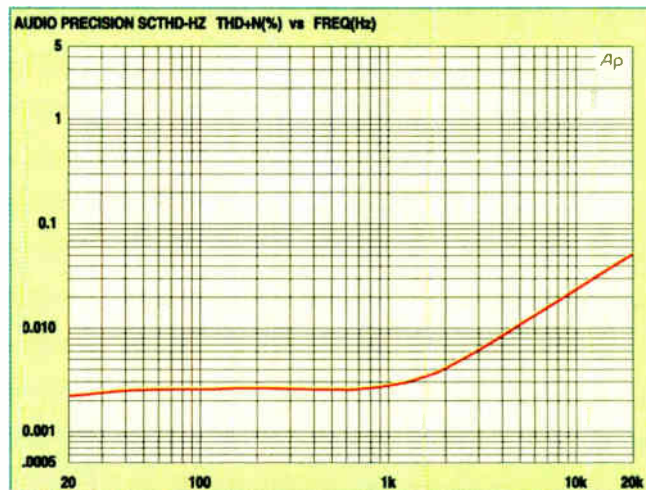

Fig.5: distortion versus frequency at 250W into a 4-ohm load (22Hz-80kHz measurement bandwidth).

Fig.2 shows the total harmonic distortion versus power at 1kHz into an 8-ohm load while Fig.3 shows distortion versus power at 1kHz into a 4-ohm load. As you can see, for an 8-ohm load, distortion is around 0.002% or less up to about 180W, rising to around 0.03% or thereabouts at 200W. At low powers, below 0.5W, the distortion figure rises but that is due to residual noise, not distortion. In reality, at low powers the distortion is well below 0.001%.

Similarly, for a 4-ohm load, distortion is around 0.0045% or less for powers up to around 280W, rising to 0.1% at around 350W. These figures were taken with a measurement bandwidth of 22Hz to 22kHz.

Fig.4 shows harmonic distortion versus frequency at 160W into an 8-ohm load while Fig.5 shows distortion versus frequency at 250W into a 4-ohm load. Both these curves were taken with a measurement bandwidth of 22Hz to 80kHz.

All of these distortion curves show a performance which is outstanding. This amplifier is also extremely quiet: -122dB unweighted (22Hz to 22kHz) or -125dB A-weighted. This is far quieter than any CD player!

Fig.6 shows the frequency response at 1W into 8Ω. It is 1dB down at 15Hz and 60kHz.

## Circuit description

The full circuit is shown in Fig.7 and employs 17 transistors and five diodes.

The input signal is coupled via a 1μF bipolar capacitor and a 2.2kΩ resistor to the base of Q2. Q2 and Q3

are a differential pair using Hitachi 2SA1084 low-noise transistors which have a collector-emitter voltage rating of 90V, necessary because we are using 70V rails. Transistor Q1 and diodes D1 & D2 make up a constant current source running at about 1mA to set the current through the differential pair at 0.5mA each.

Trimpot VR1 in the emitter circuit to the differential pair is provided to adjust the offset voltage and thereby trim the output DC voltage very close to 0V (within a millivolt or so). This is largely academic if you are driving normal 4-ohm or 8-ohm loudspeakers but is particularly desirable if you intend driving electrostatic speakers which usually have a high voltage step-up transformer with very low primary resistance.

The same comment applies if the amplifier is used to drive 100V line transformers. Just to explain that, if you have a transformer primary

resistance of 0.1Ω and a DC output offset from the amplifier of just 20mV, the resulting current through the transformer will be 200mA! Not only will this magnetise the core and degrade the transformer's performance, it will also result in additional power dissipation of 14W in one half of the amplifier's output stage. This is not good! Hence, trimpot VR1 has been included.

Signals from Q2 & Q3 drive another differential pair, Q4 & Q5, which have a "current mirror" as their collector loads. The current mirror comprises diode D3 and Q6, essentially a variation of a constant current load, which ensures high linearity in Q5. Q4, Q5 and Q6 are BF469 and BF470 types which are high-voltage (250V) video transistors, selected for their excellent linearity and wide bandwidth ( $F_T$  is 60MHz).

Q7 is a " $V_{be}$ -multiplier", so-called because it multiplies the voltage

Fig.6: this graph shows the frequency response at 1W into 8Ω. It is just 1dB down at 15Hz and 60kHz and is virtually flat between those frequencies.

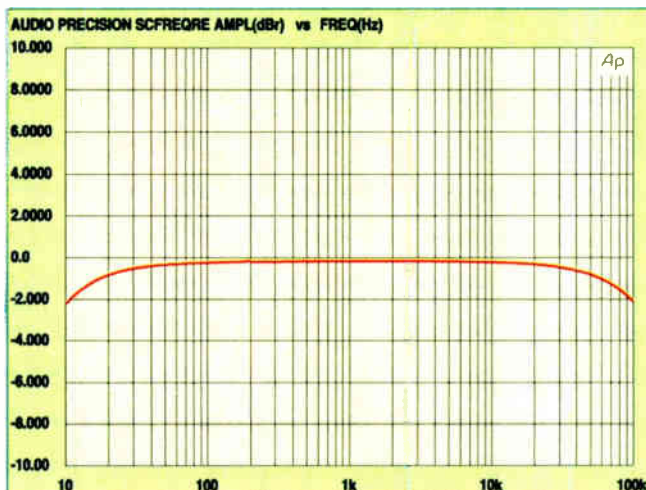

Reproduced by arrangement with SILICON CHIP magazine 2006. [www.siliconchip.com.au](http://www.siliconchip.com.au)







**Fig.7:** the circuit uses eight high-quality audio output transistors to give a rugged design with low distortion. The voltage readings on the circuit were taken with no input signal.

between its base/emitter to provide a floating voltage reference to bias the output stage and set the quiescent current. Quiescent current is needed in all class-B amplifiers, to minimise crossover distortion. In fact, this amplifier displays no trace of crossover distortion.

We use an MJE340 transistor for Q7 even though a small signal transistor could easily handle the task. The reason for using a power transistor is that its package and junction does a better job of tracking the temperature dependent changes in the junctions of the output power transistors and thereby gives better overall quiescent current control.

The driver transistors are the high performance MJE15030 and MJE15031 made by On Semiconductor (previously Motorola). These have a minimum current gain-bandwidth product ( $F_t$ ) of 30MHz. These drive the paralleled output stage MJL21193/94 transistors which themselves have a typical  $F_t$  of around 6MHz.

Each of the power transistors in the output stage has a 5W wirewound emitter resistor of 0.47Ω. This relatively high value has the disadvantage that it causes a slight reduction in power output but this has been done to provide improved current sharing between the output transistors – an important factor in a high-power design.

Performance	
Output Power	200W RMS into 8Ω; 350W RMS into 4Ω
Music Power	240W into 8Ω; 480W into 4Ω
Frequency Response	-1dB at 15Hz and 60kHz at 1W (see Fig.6)
Input Sensitivity	1.75V for 200W into 8Ω
Harmonic Distortion	Typically 0.002% at normal listening levels (see graphs)
Signal-to-Noise Ratio	-122dB unweighted (22Hz to 22kHz); -125dB A-weighted, both with respect to 200W into 8Ω
Damping Factor	75 at 10kHz, with respect to 8Ω
Protection	5A supply fuses (see text)
Stability	Unconditional

Although not shown in the photographs, one of our prototypes used non-inductive wirewound emitter resistors. These have been recommended in some past designs in magazines, in order to minimise secondary crossover distortion effects. Our tests showed no benefit in this design (probably because of the PC board layout) and so they are not specified – ordinary wirewound emitter resistors are OK in this design.

Two 1N4936 fast recovery diodes are reverse-connected across the output stage transistors. Normally, these do nothing but if the amplifier is driven into clipping when driving highly inductive speakers or transformers, the diodes safely clamp the resulting back-EMF spikes to the supply rails.

### Negative feedback

Overall negative feedback is applied from the output stage via the 22kΩ resistor to the base of Q3. The voltage

gain is set by the ratio of the 22kΩ resistor to the 1kΩ resistor also connected to the base of Q3. This gives a voltage gain of 23 (+27dB). The 47μF bipolar capacitor in series with the 1kΩ resistor sets the -3dB point of the frequency response to about 3Hz. The other factor in the amplifier's low frequency response is the 1μF bipolar input capacitor.

We have used non-polarised (NP) capacitors for the input and feedback coupling instead of conventional electrolytic capacitors because the low voltages present in this part of the circuit are insufficient to polarise conventional electrolytics. Incidentally, some readers may disagree with our choice of electrolytics in the signal path but the alternative of plastic dielectric capacitors is not very attractive; they are large and expensive and unavailable, in the case of 47μF. Nor do we think that electrolytic capacitors, properly used, are the cause of high distortion

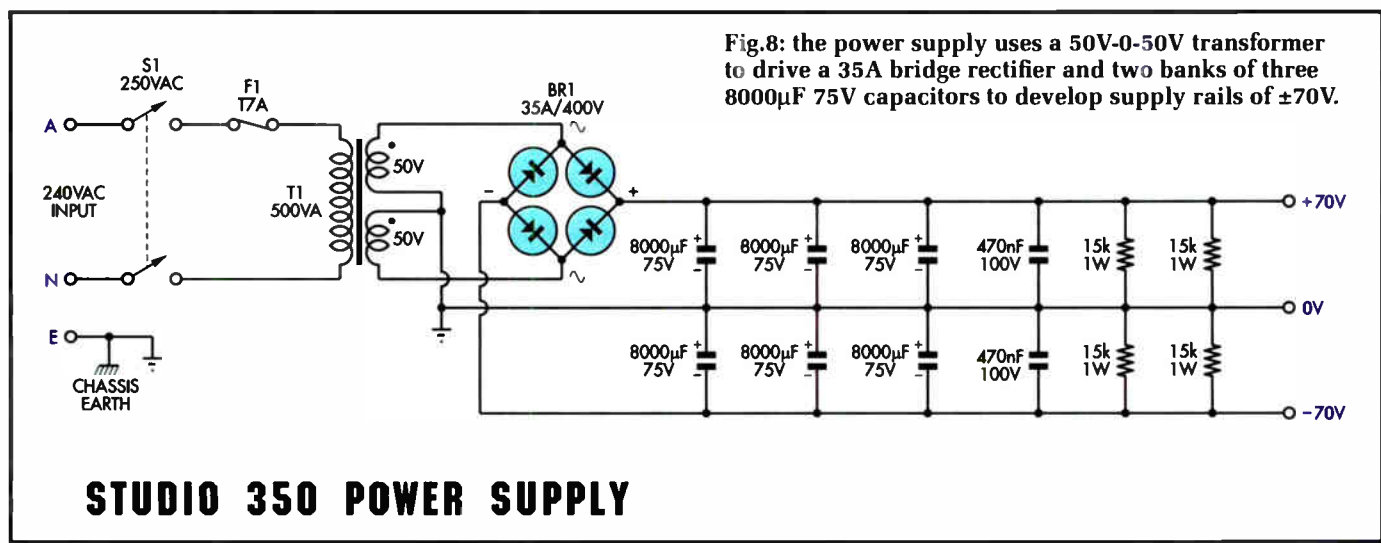
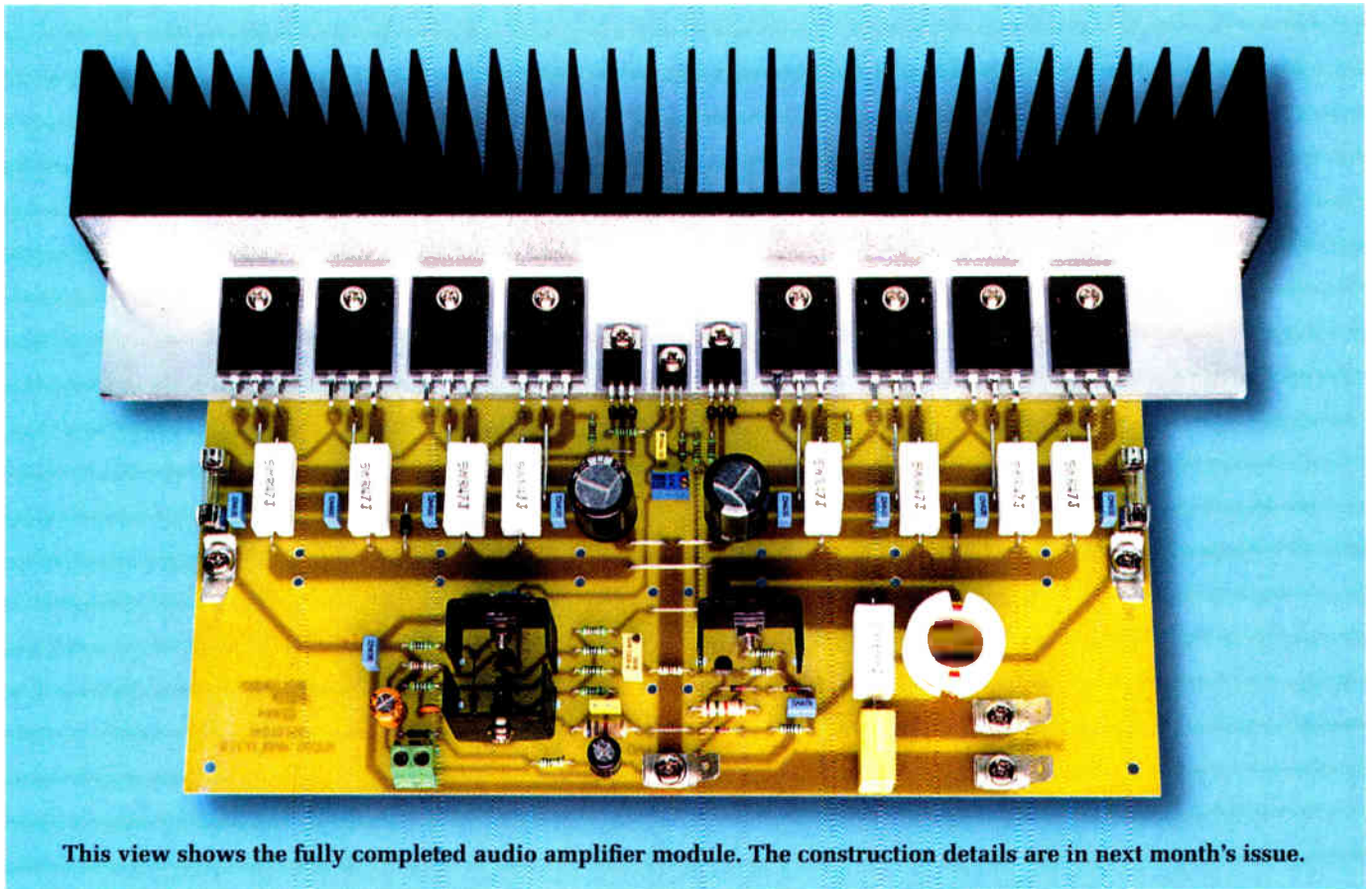

**Fig.8:** the power supply uses a 50V-0-50V transformer to drive a 35A bridge rectifier and two banks of three 8000μF 75V capacitors to develop supply rails of ±70V.

## STUDIO 350 POWER SUPPLY



# Constructional Project



This view shows the fully completed audio amplifier module. The construction details are in next month's issue.

in audio circuits; there's no evidence of it in the case of this circuit.

The 330pF shunt capacitor and 2.2k $\Omega$  resistor in series with the input signal constitute an RC low-pass filter, rolling off the high frequencies above 200kHz. The 68pF capacitor between Q5's base and collector rolls off the open loop gain to ensure stability with feedback applied.

Note that this capacitor can be ceramic or polystyrene but must have a rating of at least 250V. This is because the signal at this part of the circuit can be as high as 45V RMS (127V peak-to-peak). Other capacitor types (such as monolithics) are definitely not recommended.

The output signal to the loudspeaker is fed via an RLC filter consisting of a

6.8 $\mu$ H choke, a 6.8 $\Omega$  wirewound resistor and a 150nF 250V capacitor. This very well-proven filter network was originally developed by Neville Thiele and published in the September 1975 issue of the *Proceedings of the IREE*. The filter has two benefits: ensuring stability of the amplifier with reactive loads and as an attenuator of RF and mains-interference signals which are

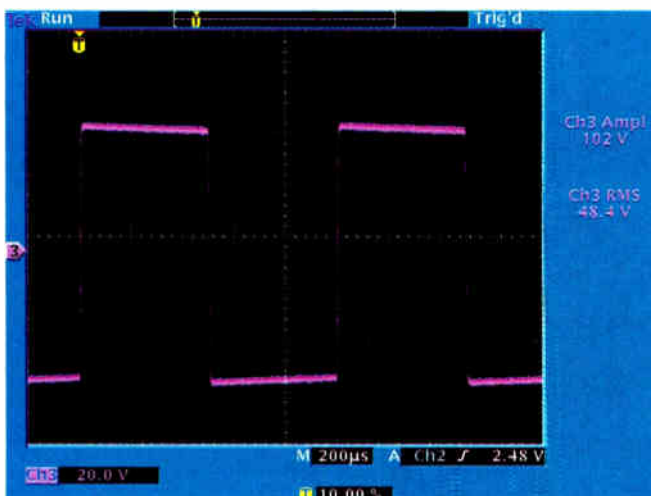

Scope1: this waveform shows the excellent square wave response of the amplifier, taken at 1kHz and 102V p-p into 8 $\Omega$ . This equates to a power output of about 300W RMS.

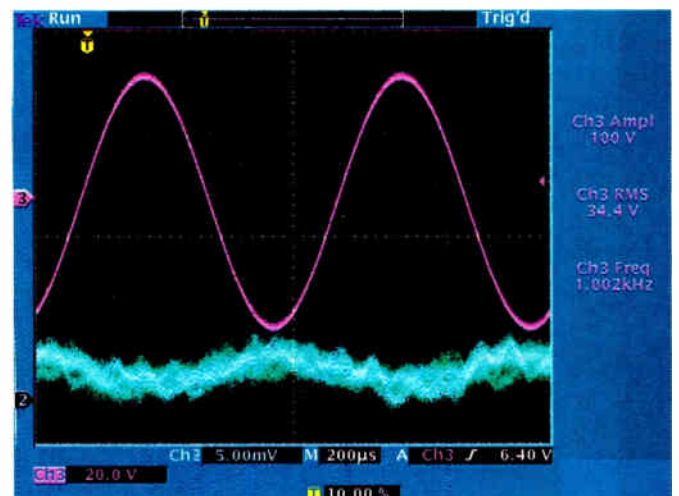

Scope2: these waveforms show a 150W sinewave at 1kHz and the resulting total harmonic distortion waveform (ie, noise and distortion) which is at about 0.0015%.



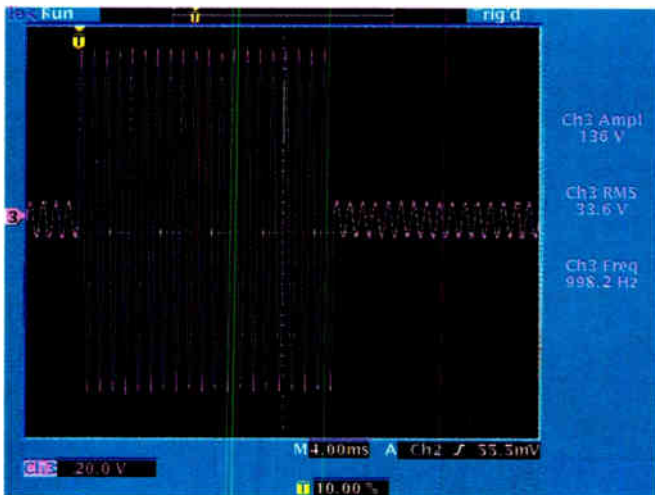

**Scope3:** this is the pulse waveform used to measure music clip power. Note the excellent stability of the amplifier, particularly the recovery after the pulse.

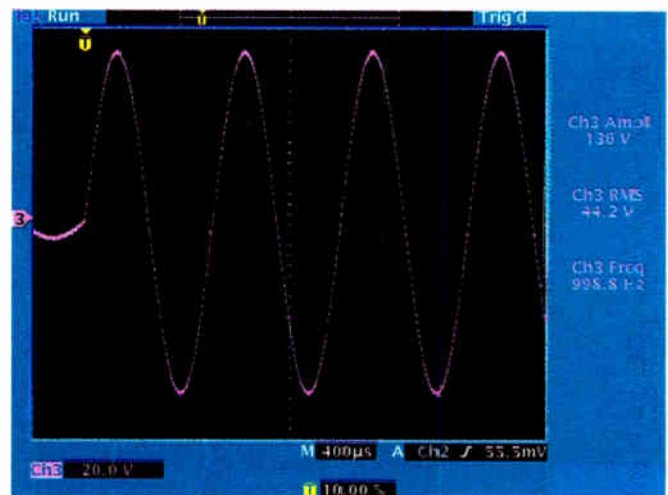

**Scope4:** the same waveform as in Scope3, but with the scope switched to a faster timebase. In this case, the amplifier is delivering over 240W RMS into an 8-ohm load.

inevitably picked up by long loud-speaker leads.

## Power supply

Fig. 8 shows the power supply and as you can see, we've "gone for broke" on this one. It's a vital part of the performance package and unfortunately, with all those big electrolytic capacitors, is likely to be more expensive than the amp module itself. The consolation is that the same power supply could be used for a stereo version with two amplifier modules, provided the power transformer was upgraded.

The 500VA transformer used has two 50V windings which are connected together to form a centre tap. This transformer drives a 35A bridge rectifier and

two banks of three 8000µF 75V capacitors to develop ±70V supply rails. The 470nF capacitors are used to provide high frequency bypassing, while the 15kΩ 1W resistors are used as "bleeders" across the electrolytic capacitors.

## PC board topology

Finally, the PC board has been laid out using distortion-cancelling topology. It also has "star" earthing whereby all earth currents come back to a single point on the board. This careful separation of output, supply and bypass currents avoids any interference with the signal currents and the distortion that this could cause.

As far as the "distortion cancelling" technique is concerned, this

involves laying the copper tracks so that the magnetic fields produced by the asymmetric currents in the output stage are cancelled out, as far as possible. These asymmetric currents (think of them as half-wave rectified output signals) and their resultant magnetic fields induce unwanted distortion signals into the input stage transistors Q2 and Q3.

This approach is very worthwhile and constructors will not have to worry about whether the performance of their module is as good as the prototype featured here. As long as you follow closely the wiring layout in the construction article next month, you can expect the results to be very good indeed. *EPE*



Get your magazine "instantly" anywhere in the world – buy and download from the web.

**TAKE A LOOK, A FREE ISSUE IS AVAILABLE**

A one year subscription (12 issues) costs just \$15.99 (US)

[www.epemag.com](http://www.epemag.com)

<b>ByVac Electronics</b>	 <p>Serial LCD controller, will control any HD44780 compatible displays, 1,2 or 4 lines up to 180 total characters, fully software configurable automatic Baud rate etc. Works from RS232 port, USB to serial converter or directly from a microcontroller. Simple two character text commands for full control. Very small will fit behind the display. Scrolling text, macro facility, and much more. £11.00</p>	 <p>General purpose Digital-Analogue input/output. Converts serial text commands into digital I/O, 4 digital I/O and 4 analogue input channels. PWM, Trigger and more £11.00</p>		
	 <p>Cool Blue 16x2 LCD fitted with the serial interface, illuminated white lettering can be seen in full daylight. Has the IASI module attached and ready to go. £22.90</p>	<p><b>MONEY BACK GUARANTEE</b></p> <p>If you are not completely satisfied, return the goods within 30 days for a full refund.</p>		
	<p>Visit <a href="http://www.byvac.co.uk">www.byvac.co.uk</a> for microcontroller kits, starting at £14.95 Free software and construction guides.</p>			
<p>To purchase: ■ Send Cheque or Postal Order ■ Buy on line at <a href="http://www.byvac.co.uk">www.byvac.co.uk</a> ■ Send email to <a href="mailto:sales@byvac.com">sales@byvac.com</a> ■ Telephone 07905 734384 ■ P&amp;P UK £2.50 World Wide £3.50</p>			<p>10% discount for purchase on line use coupon code PEK6 <a href="http://www.byvac.co.uk">www.byvac.co.uk</a></p>	<p><b>ByVac</b> PO BOX 4049, Penistone SHEFFIELD S36 6WP</p> 



## MUSHROOM MAGIC AND THE QUEST FOR GREEN VOLTS

**Every potential source of cheap electricity ought to be investigated. Researchers are turning button mushrooms into button cells (in a manner of speaking). But going off-grid can generate problems of its own.**

**F**IFTY years ago, on 17th October 1956, the Queen opened the world's first full-scale nuclear power station, at Calder Hall in Cumberland. With the opening ceremony attended by scientists and statesmen from almost 40 different countries, the eyes of the world were focused on this "epoch-making" event. The next day newspapers proudly stated that within ten years electricity would be so cheap to generate that it would not be worth metering.

This never happened of course, and when the station finally closed in 2003 the local MEP and Liberal Democrat party environment spokesman Chris Davies said, "When Calder Hall opened we were promised it would herald a new era of virtually free electricity. In practice it has been hugely expensive, surviving because of enormous subsidies from the taxpayer and extra charges on electricity bills."

### Magic Mushrooms

Electricity was by no means dear in 1956, but with bills now set to rocket, the race is on to find affordable new means of generating power that do not harm the environment. One suggestion is mushroom power.

Scientists at Oxford University have managed to use fungal enzymes to create a hydrogen fuel cell that can run a digital watch, with the promise of more elaborate devices that could power mobile phones or digital cameras. *New Scientist* reports that the enzymes replace the expensive metal catalysts required to drive the cell's chemical reactions.

The report quotes the University's Kylie Vincent, who indicates these enzyme-powered fuel cells could be smaller, simpler and cheaper to make than conventional ones. Most fuel cells rely on electrodes incorporating expensive metal catalysts, such as platinum. Whereas the Oxford cell uses an enzyme harvested from fungus for this task. "This should cut the cost of making a fuel cell," she says, "and the enzymes are also completely biodegradable."

Paul Allen, Development Director at the Centre for Alternative Technology in mid-Wales, praises this achievement and told *New Scientist*, "The batteries used in watches and cameras are energy-intensive to produce and contain heavy metals, making them difficult to dispose of."

### Cameron's Caper

Turning proven theory into practical reality can be hazardous, as Calder Hall demonstrated, and a non-toxic fuel cell still requires raw materials that may consume

considerable energy to produce. Paul Allen brings us back to earth, reminding: "We must remember that fuel cells are energy stores, not energy generators. Unless we develop renewable energy-generating capacity in the first place, there will still be a nett energy shortfall in the future."

Someone who has tried conspicuously to generate autonomous electricity is Conservative leader David Cameron, who has equipped his Edwardian home in west London with a 1.1 metre diameter wind turbine and solar panels. Admirable as this is, the 'free' electricity does not come cheap. The turbine cost him around £700 excluding carriage and installation (which is by no means child's play) and you still need inverters, batteries and switchgear on top of this.

Multiple store Curry's hit the headlines in August by becoming the first mainstream electric retailer to sell solar panels, but at a price that was by no means as cheap as chips. Their solar system, stated to cut energy bills by half and reduce annual carbon dioxide emissions by two tonnes, would cost £9,000 for the average three-bedroom home, although in this case the price includes installation.

Unfortunately, photovoltaic (solar) systems tend not to add value to a home. There's also the negative visual impact to consider and the long payback period means that homeowners will probably not be beating a path to Curry's door. You shouldn't ignore the substantial energy input that goes into manufacturing them either, meaning the systems may never pay off their true cost.

Curry's have competition too, with the launch of the Bournemouth Energy Trust. Campaigner Brendan McNamara states that for £1,000 less than what the Curry's product costs, the trust will pay for two megawatt-hours per year per investor for 20 years at the lowest market price for grid electricity. "This will save the client from the bother of installing and maintaining a solar panel system for 20 years," he argues. Nett profits will be invested in sunny developing countries, he adds.

### Off the Grid

Undeterred by all the disadvantages, there is a growing number of people (not all techies) who are determined to live "off the grid" by using locally generated power. One of them is Paul Allen, mentioned above. He is the designer of many non-mains power systems for the Centre for Alternative Technology (CAT) and its commercial subsidiary Dulas Ltd, and has himself lived for many years without mains

electricity. *Off the Grid* is in fact the title of a textbook he has co-written with Bob Todd for CAT ([www.cat.org.uk](http://www.cat.org.uk)). It's available from their online bookshop (but not from other e-tailers such as Amazon; they sell another one with the same title!)

Allen's book is low-priced and covers topics such as designing, installing and monitoring a system, as well as dealing with basic questions about energy generation. Effectively it's an indispensable resource guide for anyone wishing to fulfil their own electricity needs in an efficient and ecologically sound manner.

The other *Off The Grid* book, by Lori Ryker, is a glitzier, more generalist book on how to live off the grid (geothermal energy use, wind turbines, photovoltaic arrays, micro hydropower, rainwater collection and reclamation). Naturally, there are numerous websites that *Google* will find for you if you put "off-grid" or "off the grid" into your search. Not all are exactly scintillating but the joy of discovery will doubtless outweigh any minor disappointment!

### Feast or Famine

One of the fundamental problems of off-grid living is the "feast or famine" nature of homegrown energy. A letter to *The Guardian* earlier this year sums it up more eloquently than I can: "I've had solar panels for five years and except during conditions of very low cloud, they generated more than twice the electricity I need during the day. Also, there is no way to store the excess generation, which is fed back into the grid, and which I would prefer to have when the sun goes down."

Presumably the writer has not heard of storage batteries but the problems of photovoltaic systems goes deeper. A revealing article in the latest issue of *Clean Slate*, the CAT members' magazine, explains the dilemma.

The fundamental problem with photovoltaic power in the UK is the variation in sunlight. A solar panel array sized for mid-winter, when the power demand is highest, will deliver 20 times the requirement in mid-summer. As panel arrays do not come cheap users must settle for a compromise, such as an array that supplies sufficient power between March and September, augmented by a Whispergen generator in winter.

Whispergen is a novel and highly efficient replacement gas boiler that generates electricity to power lights and appliances, as well as supplying the home's central heating. I refer you to website: [www.greenconsumerguide.com/powergenminisite/index.htm](http://www.greenconsumerguide.com/powergenminisite/index.htm)



# PEAK

electronic design ltd

tel. 01298 70012  
fax. 01298 70046  
www.peakelec.co.uk  
sales@peakelec.co.uk



## Handheld Test Gear - Cool, Smart.

- Atlas DCA Semiconductor Analyser £55
- Atlas LCR Passive Component Analyser £79
- Atlas ESR Capacitance and ESR Meter £89
- Atlas SCR Triac/Thyristor Analyser £109

Prices include UK delivery and VAT



# PIC N' MIX

MIKE HIBBETT

Our periodic column for your PIC programming enlightenment

## Understanding PIC Datasheets

**W**HEN considering an IC for a new design, the first port of call should always be the datasheet. These documents can be a little intimidating at times, especially if they have been poorly translated from another language. Fortunately for us Microchip are very good at producing easy-to-read, well formatted specifications that follow a common format throughout their range of products. Datasheets still remain formidable though, especially for the hobbyist or occasional user. So this month we will attempt to unravel a typical datasheet.

Naturally, the Microchip website should be your main point of contact for datasheets and other material. The simple rule of thumb when using a part for the first time is to get all the information you possibly can, and read it. Some material will be irrelevant and quickly discarded but it can be surprising what gems of information can pop up – maybe a special initialisation routine required, advice on handling error conditions or just a different description of a topic that can help clarify the point. Application notes, also available from manufacturers' websites, give example circuits that can be used as the basis for your own – even for commercial use.

### Beware Errors

The Internet is a good source of additional examples but, as with most things found on the internet, take them with a pinch of salt! Even Microchip have been known to have the odd hiccup with processor designs or documentation.

When Microchip do discover an error, either in the IC itself or in a datasheet, rather than republishing the document they produce an Errata sheet. Check to see if there are any for the processor you are interested in, and make sure you mark up your paper copy of the datasheet with the corrections.

While paper copies of specifications are always handy – especially for recording errata details – it is often useful to study the electronic format, when searching for keywords for example. If you find yourself dipping in and out of PDF files frequently and find the loading time of Adobe slow, try the "Foxit Pdf Viewer". It's tiny, loads quickly, and is free. A web link is provided at the end of the article.

### Example Datasheet

Let's now take a look at a processor datasheet. We have chosen the PIC16F84A because it is a typical, fairly popular device. You can download this from the Microchip web site, see address list at the end of this article.

The document starts with an overview page, very handy for getting a quick grasp of the device; peripheral features, number of pins, voltage range etc. Nearby will be a table showing you the variants within the family which consist of different memory size and extra I/O pins.

The Pin Diagram pages are a very useful reference when wiring up a board; it is well worth making several paper copies of this page so that you can scribble on them. If you do use it as a wiring assistant, take the author's advice: cut off the diagrams relating to the packages you are not using. Many a project has been spoiled by accidentally looking at the wrong chip pinout! These pin diagrams are a high level, programmers view – the chip's dimensions are shown at the very end of the datasheet.

The device overview section will normally be several pages long and can often be the most intimidating aspect of a datasheet. References to 'alternate run modes' or 'on-the-fly switching' (found in the PIC18F family datasheets) can be very confusing, but as a general rule, remember that most features can be disabled. If the feature isn't of interest to you, ignore it for now. You will only need to make sure that the feature is disabled when configuring the chip in software.

A more detailed full page diagram called the Block Diagram normally follows. This is an excellent reference for programming and high level circuit design because it shows the features available and how they map to individual pins. In most cases pins will have dual functions, and this is the page where you normally discover that the feature you want to implement (perhaps 24 I/O pins) cannot be done on this part because the oscillator pins double as I/O lines. Now start the compromise tactics: can I use the internal RC oscillator to free up the pins, or do I need the stability of an external oscillator, and therefore a larger part?

The wiring on this diagram is largely superfluous; it shows that the device uses the Harvard architecture arrangement – separate data and instruction busses – but little else. More detailed and useful connection diagrams follow later on, in the datasheet.

### Basic Descriptions

The Pinout I/O Descriptions normally follow, and these tables contain very important information. There is typically one per processor variant so find yours and take a good look at it. There is a list under each pin to describe the type of electronics driving the pin in different modes. Yes, that's correct – each pin may have different electrical characteristics depending on how

it is configured, and this can have a major impact on your design.

The Pin Type parameter is quite straightforward; the pin may be input only (I), output only (O) or selected under software control (I/O). Not all I/O pins are actually I/O!

The Buffer Type describes the electrical implementation, typically summarised as Schmitt Trigger Input (ST), TTL compatible input (TTL), CMOS input (CMOS) or Analogue. Always read the description field in the table; some outputs, such as the RA4 pin on the many PIC16F devices, are open drain. This means that as outputs they can only pull down, and rely on an external pull-up to go high.

These various input types have subtle differences, the most important ones being the high/low voltage levels at which they switch at. These parameters are described right at the end of the datasheet under DC Electrical Characteristics which we will get to later.

The section on Memory Organisation provides a programmer's view of the processor; memory locations which are available to the user, and those which are reserved for special purposes. Being a Harvard architecture device, the PIC has separate code and data areas. So, for example, location 4 in the code space is allocated to the interrupt vector, whereas location 4 in data space is the FSR register. These diagrams are worth copying and keeping on display somewhere. You will be frequently referring to them. There is a third memory space, EEPROM data, which is essentially just another peripheral on the chip.

Data space memory is shared between general purpose variable locations (what we normally refer to as RAM – Random Access Memory) and special function registers, or SFRs. These registers are shown in a little more detail in the datasheet – just indicating the names of the bits within each byte. The registers are how you control all the features of the microcontroller, and again, this diagram is worth taking a copy of and keeping it within reach during programming. One or more SFRs are associated with a particular peripheral, such as an I/O port, timer, etc. Sometimes an SFR is used by more than one peripheral (INTCON, for example, is used by both timers and I/O ports) so take care when writing to an SFR to configure one peripheral that you do not accidentally change another's setup.

### Peripherals and Special Features

The datasheet now describes each peripheral unit in detail; EEPROM memory, I/O



Ports and Timer Module. These sections are to a large extent independent. They are self-contained, and if you do not intend to use them you can give those sections a quick read and then happily ignore.

In general, peripheral sections follow a standard format. A simple block diagram showing the functional components of the microcontroller that are associated with that feature; a list of the SFRs that are used to control that feature and a detailed description explaining how the peripheral can be controlled.

The block diagram often provides a very concise explanation and it is worth taking the time while reading the detailed description to cross refer to the block diagram. These diagrams are a common feature of all microcontroller datasheets and often provide a better explanation of how the peripheral will work than the actual text does.

Following the descriptions of peripheral features is a section called Special Features of the CPU, a mixed bag of features that are not specific to any one peripheral. Every PIC has one or more configuration registers, which are held in non-volatile memory outside of the data or code area and can only be changed by programming hardware. Setting these correctly is vital if your PIC is to operate. In the simpler parts like the PIC16F84, the Watchdog and Oscillator Settings are the most important to set correctly.

When you are first learning about a new processor it is always a good idea to keep the Watchdog feature disabled, especially if you do not know what it is used for. If you are using a 3.5MHz or higher frequency crystal or resonator to drive your PIC, then select the HS oscillator mode. This mode determines how hard the oscillator drives the crystal.

The section on Reset explains how it is possible to determine under which conditions the processor entered a device reset (i.e. power on, or as a result of the Watchdog timer) and importantly the state in which the SFRs are placed. It's obvious that some registers such as the Program Counter and the Status Register will have known values written, but several other do too. **Do not rely on this fact.**

The power supply rails are often quite noisy immediately following power-up, and registers may become corrupted. It is a good idea to pause for a few tens of milliseconds, then initialise all the SFRs to known values.

## Instruction Set

The next section in the datasheet is the Instruction Set description. A handy one-page summary is provided; this is also worth taking a copy of and keeping to hand. You will refer to this one so much it is even worth laminating the copy in plastic. The 10F, 12F, 16F and 18F PIC families have subtly different instruction sets so it is worth double-checking when using a new processor that there are no unexpected additions or deletions.

The instruction set section marks the end of the programming information in the datasheet. You will notice though that you are only half way through it – the rest details electrical and mechanical characteristics of the parts. The mechanical section can normally be skipped through; you will only want to confirm that your chosen package is the same basic size as the footprint your CAD package or artwork expects. Dual-in-line and surface mount packages are standardised.

## Electrical Characteristics

The electrical characteristics are split into three sections: absolute maximum ratings, DC parameters and AC parameters. Absolute maximum ratings define maximum voltages and currents the device can withstand – *Do not* design your circuit to operate up to these limits! The DC parameter section defines the more sensible working limits, such as power supply voltages, clock frequencies and the current drawn by the device under a variety of circuit conditions.

At the beginning of this article we mentioned how some pins may have different input types, namely Schmitt trigger, CMOS or TTL. This has an effect on the voltage levels at which an input will detect a low or a high. These levels, 'input high voltage' and 'input low voltage' are shown for each input type, and will help you work out whether an input

will be compatible with other devices – especially important if you are interfacing a 5V PIC to a 3V device. If you look at the specification for Input High Voltage you will see that TTL inputs get a high at 2V, but Schmitt inputs get a high at 0.8V<sub>dd</sub>. That's 4V, totally unsuitable for interfacing a 5V PIC to a 3V3 device. TTL inputs would be fine, however.

The final two parameters of interest are 'output high voltage' and 'output low voltage'. These define what actual voltage output level an output pin will drop (or rise) to when it is passing current. Remember, that an output pin is not a perfect switch; if, for example, you set it high and use it to power an LED, the current drawn will cause a small voltage drop across the 'on' FET transistor inside the PIC. The levels specified here are examples; you can draw more current (up to 25mA) but do not expect the pin to have an output of 5V – it will be lower!

The figures quoted are really a guideline for the maximum that you can draw from a pin if you intend to drive another device's input (especially if it has a Schmitt trigger input). You may notice that there is a lower voltage drop when the pin is sinking current (providing a path to ground) than acting as a source. This is quite common, and helps to explain why LEDs are normally connected from the I/O pin to the positive supply, rather than ground.

We have skipped very quickly through the example datasheet; if you have questions on an individual peripheral feature why not try out the *EPE Chat Zone* forum. You may also contact the author directly by email – see the references for web addresses and email contact information.

## References

Microchip PIC datasheet download <http://www.microchip.com>, follow the links on-site

Foxit PDF viewer <http://www.foxitsoftware.com/>

EPE Chatzone forum <http://www.chatzones.co.uk/discus>

Mike Hibbett [mike.hibbett@gmail.com](mailto:mike.hibbett@gmail.com)



## ElmScan 5 USB Scan Tool

- Diagnose any car with EOBD
- Based on the ELM327 IC
- Supports all EOBD and OBD-II protocols
  - ✓ ISO15765-4 (CAN)
  - ✓ ISO14230-4 (Keyword 2000)
  - ✓ ISO9141-2
  - ✓ J1850 VPW
  - ✓ J1850 PWM
- 9600 or 38400 baud
- Supported by more software than any other OBD interface
- Inexpensive
- Full Speed USB 1.1
- Automatic protocol detection
- Package includes cables, software CD, and Quick Start Guide
- Buy from your local UK distributors!

[www.ElmScan5.com/epe](http://www.ElmScan5.com/epe)

# DON'T LOSE THAT GRILL!

Is your fridge or freezer door often left open for too long? Or does it sometimes not close properly? Ensure it's closed when it should be by building this nifty Fridge Alarm.



# FRIDGE DOOR-OPEN ALARM

By JOHN CLARKE

**A** REFRIGERATOR OR freezer door that is left open or ajar may cause the food contents to spoil. In some cases, the internal temperature of the fridge or freezer will be maintained if the refrigeration system can cope with the open door.

But without the door sealing in the cold air, it may be a losing battle. Running costs will certainly rise.

Typically, refrigerators and freezers are in constant use in the summer months and so it is important to ensure that the door is not open for any longer than is necessary. Otherwise the fridge or freezer will not be able to keep the

contents cool. And it will cost more money to needlessly run the fridge's compressor in a futile effort to keep the contents cool.

Even the most diligent fridge user may sometimes leave the door of the fridge or freezer open without realising it. And tilting the fridge or freezer slightly backward so that the door will fall shut is not completely foolproof as there may be an obstruction inside the door. The obstruction could be caused by an item inside the compartment which has moved or fallen over or because the compartment is too full.

This is where the Fridge Alarm is useful. It warns when the door of the refrigerator or freezer is left open for longer than a preset time period. It is great for indicating when someone is standing with the door open for too long and a real asset in warning when the door looks shut but is still partially ajar.

The fridge alarm operates by detecting when any light enters the compartment area. Therefore it is just as useful for freezers (which normally do not have a light) as it is for fridges (which normally do). As long as there is some ambient light which the alarm can react to, it will operate.





You don't *have* to house it in a transparent box, as we did . . . but if you don't, you'll need another hole in the appropriate place on the box wall so light can strike the LDR inside.

The alarm will sound if the light is present for longer than the preset period and will continue to sound until the door is closed. In practice, the preset period is adjusted so that in normal use the alarm will not sound. It will sound when the door is left wide open for too long or if left slightly ajar.

### Commercial coolrooms and freezers

While the Fridge Alarm is primarily intended for domestic fridges, it has its applications for large (ie walk-in) commercial coolrooms and freezers. If you think that your fridge at home costs a lot of money to run, try paying the bill for one of those walk-in models that clubs and restaurants use. And in a busy club or restaurant, it is very common for staff to leave the door open. Because the door is so large, bulk cold escapes very quickly.

If the walk-in coolroom or freezer has a door-operated light, the Fridge Alarm will work in exactly the same way as in a domestic fridge. If the light switch is manual (as many are), it will warn that the light has been left on. And if it doesn't have a light inside, you could set it up near the doorway and have the alarm triggered by natural light from outside.

Note that the alarm cannot be used with display refrigerators or freezers that have a glass door.

### Does the light really go off?

Do you or members of your family have doubts whether the fridge light really goes off when the door is closed? Does the little man in the fridge really do his job? Or is he sitting in there goofing off?

This Fridge Alarm will finally dispel any doubts on this score. If you open the door and can hear the alarm sounding immediately, it means that the light has remained on while the door was closed. Disbelievers will say it's a fault in the alarm unit itself rather than the light remaining on. Perhaps, we will never know.

The Fridge Alarm is battery operated and so does not need to be connected to any wiring inside the compartment. It comprises a small transparent box with the alarm circuit and battery housed inside. The box is placed within the freezer or refrigerator near to the door opening. In this way it can monitor both the light from the internal lamp and also light entering from the outside. Monitoring light from the outside is important since it allows detection of the door being left only slightly ajar. Monitoring the internal

light only will not indicate when the door is left ajar since the internal light is switched off via the door switch before the door closes.

### The circuit

Circuitry for the Fridge Alarm (Fig.1) comprises a single IC package, a Light Dependent Resistor (LDR), a siren plus a few resistors, diodes and capacitors. The low temperature operation has meant that all components need to be rated for sub-zero temperatures. The IC is rated to  $-40^{\circ}\text{C}$ , while the piezo siren is rated to  $-20^{\circ}\text{C}$ . Other components, such as the capacitors, diodes, LDR and resistors will operate to below  $-20^{\circ}\text{C}$ .

The battery is specified as an alkaline type to provide the necessary current at lower temperatures. And current drain is not very high. When the circuit is in the dark, quiescent current is typically less than  $6\mu\text{A}$  and this low current will prevent the battery discharging before the end of its shelf life. Current consumption when the alarm is sounding is a mere  $2\text{mA}$ .

Operation of the alarm relies upon light detection using the LDR. This device has low resistance, below  $10\text{k}\Omega$ , when there is sufficient light on its surface and a high resistance of more than  $1\text{M}\Omega$  when in darkness.

We use this change in resistance in a voltage divider with a  $1\text{M}\Omega$  trimpot and a  $150\text{k}\Omega$  resistor across the 9V supply. Voltage across the LDR is monitored at the input of Schmitt trigger inverter IC1a (pin 1).

IC1a has two threshold voltages which are nominally  $1/3$ rd the supply and  $2/3$ rd the supply. These thresholds are 3V and 6V with a 9V supply. If the voltage at pin 1 is 6V or more then the output at pin 2 will be 0V. If the pin 1 voltage falls below 3V, then the output at pin 2 will be at 9V.

### In the dark

When the fridge or freezer door is closed, the LDR is in complete darkness and so it has a high resistance. The total resistance of the  $150\text{k}\Omega$  resistor and VR1 is now smaller than the LDR resistance and this causes the voltage at pin 1 to rise above the upper threshold of the Schmitt trigger. As a result, the output at pin 2 will be at 0V.

Capacitor C1 is held at 0V via diode D1 and the series connected  $2.2\text{k}\Omega$  resistor. Schmitt trigger IC1b monitors

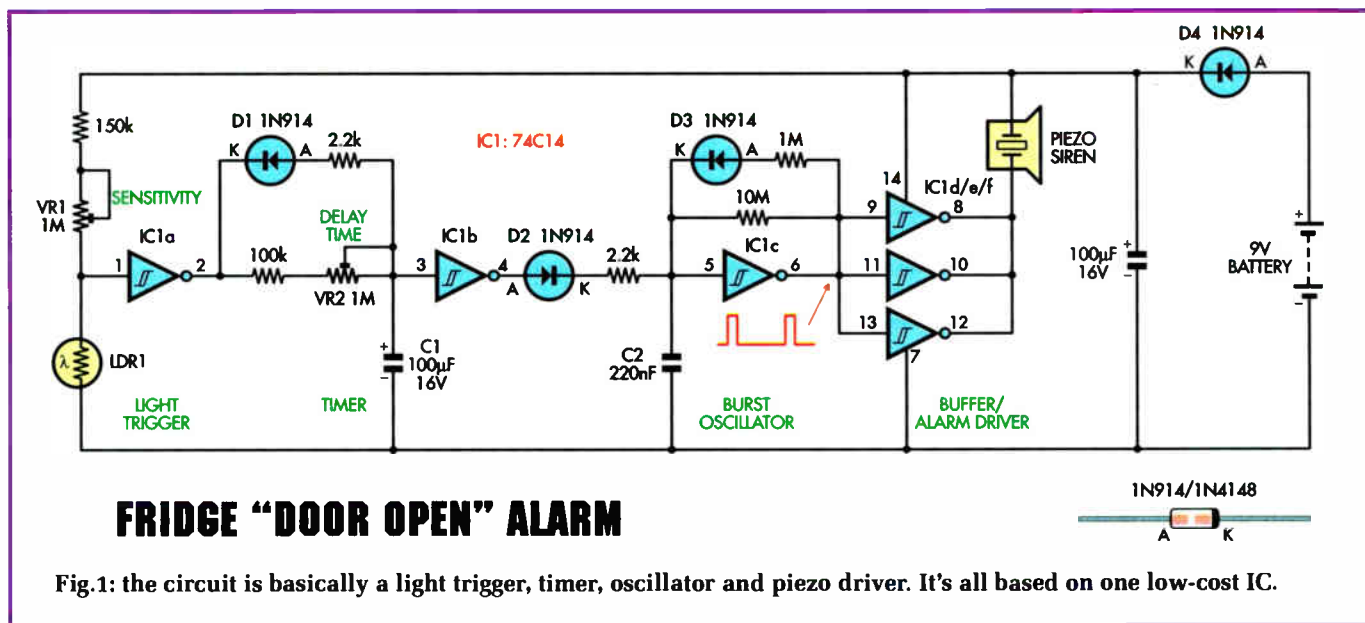

the voltage across C1 at its pin 3 input. Since pin 3 is at 0V, pin 4 is at 9V.

Diode D2 and the series 2.2kΩ resistor pull the pin 5 input to IC1c close to 9V and so pin 6 is at 0V. The output of IC1c drives paralleled Schmitt triggers IC1d, IC1e and IC1f and since IC1c's output is at 0V, the paralleled Schmitt outputs are at 9V. Outputs of IC1d, IC1e and IC1f at pins 8, 10 and 12 respectively drive the (-) side of the piezo siren. At this stage the siren will not be driven since the (+) terminal of the piezo siren connects to the 9V supply and the (-) terminal is at 9V.

This is the Fridge Alarm's normal state when in darkness. Current drain from the battery is very low and is caused by several current paths.

The first is the current flow through the LDR, VR1 and the 150kΩ resistor.

The LDR will be about 2MΩ or more in darkness and the current will be less than 4.5µA for this part of the circuit. Another current path is through diode D2, and the series connected 2.2kΩ resistor and the 10MΩ resistor connected between pins 5 and 6 of IC1c. Current flows because pin 4 of IC1b is at 9V and the pin 6 output of IC1c is at 0V. Current drain here is less than 1µA.

The final current drain is the supply to IC1 itself and the 100µF capacitor across the supply (after D4). For that reason we specify that both 100µF capacitors should be low-leakage types. IC1 is a CMOS device that has a very low supply current of typically below 0.05µA. The total current drain is therefore expected to be around 6 to 7µA.

## Door open

When the fridge or freezer door is opened, the resistance of the LDR drops and this pulls pin 1 of IC1a below its lower threshold and pin 2 goes to 9V. Diode D1 becomes reverse biased and so capacitor C1 now begins to charge via the 9V at pin 2 and through the 100kΩ resistor and VR2 trimpot. Charging time for C1 can be adjusted using VR2, which allows timing values from around 10s to 100s.

When capacitor C1's voltage reaches about 6V, the voltage becomes more than the positive going threshold for IC1b, and its output goes to 0V.

Diode D2 is now reverse biased and the already charged capacitor C2 now discharges via the 10MΩ resistor between pin 5 and pin 6. When C2

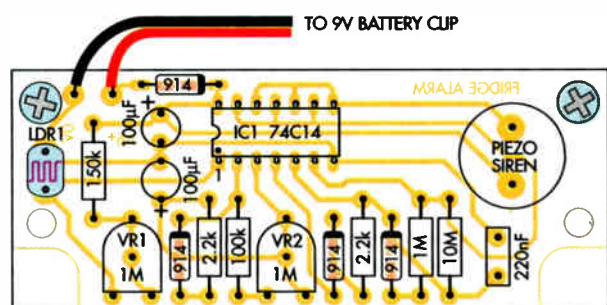
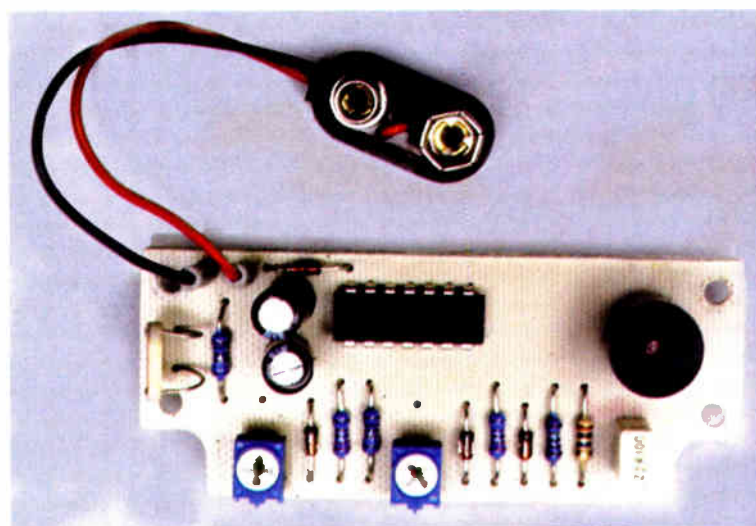
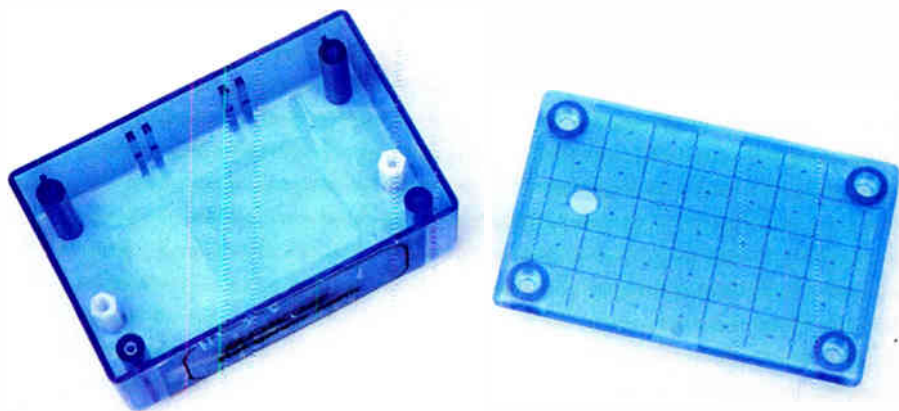

Fig.2: there's not much you can get back-to-front on the PC board – just the IC, diodes, electrolytic capacitors and the piezo siren (and of course the battery wires). The LDR is not polarised. Use this component layout along with the photo at right when putting it together.







The plastic box needs to have two holes drilled in the bottom (for the mounting pillars) and one in the top (to let the sound out).

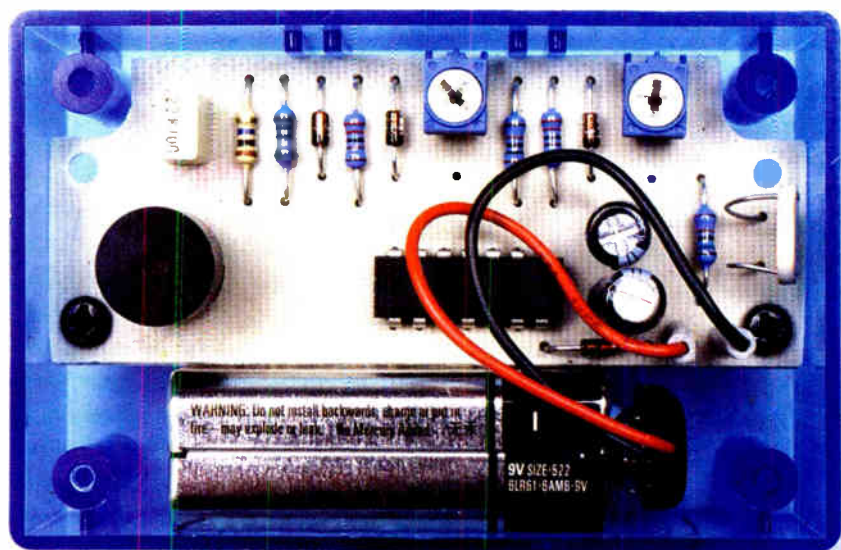

Here's how it all goes together in the box. It's a nice snug fit with the battery held in place by the PC board.

discharges to about 3V, it reaches the lower threshold voltage for Schmitt trigger IC1c and its output at pin 6 goes to 9V. Capacitor C2 now charges up via the  $1M\Omega$  resistor and diode D3. This charge time is about 10 times faster than the discharge time and when the voltage reaches the upper threshold of IC1c's input the output at pin 6 goes to 0V.

IC1c thus forms a burst oscillator where the output is at 9V for only a short time compared to its low output period.

When IC1c's output is at 9V, the resulting 0V output of IC1d, IC1e and IC1f drive the piezo siren with a 9V supply and the siren sounds. When IC1c's output goes to 0V, the IC1d, IC1e and IC1f inverter outputs are at 9V and the siren is off. This sequence

of signal drives the siren with bursts of sound.

When the refrigerator or freezer door closes again, the LDR goes to a high value of resistance. Thus pin 1 of IC1a rises toward the upper threshold of the Schmitt trigger. This may take several seconds because the dark resistance of the LDR slowly increases over time until it reaches its ultimate value.

It is a rather slow responding device to low ambient light levels. VR1 is included to adjust the sensitivity to darkness. It is adjusted so that the alarm will still operate even with very low light levels, which are typical when the door of the fridge or freezer is left ajar.

Ultimately, when in complete darkness, pin 1 of IC1a will reach 6V and the IC1a output will go low to

discharge C1. The resulting 9V at pin 4 of IC1b charges capacitor C2 via D2 and the  $2.2k\Omega$  resistor. This holds the burst oscillator off with the pin 6 output at 0V.

Power for the circuit is obtained from a 9V battery. Diode D4 provides reverse polarity protection if the battery is connected in reverse. A  $100\mu F$  capacitor decouples the supply and provides energy for the piezo siren when it draws bursts of current.

### Construction

Parts for the Fridge Door-Open Alarm are assembled on a PC board coded 587 and measures  $78 \times 32$ mm. The PC component layout and full-size underside copper foil master are shown in Figs 2 and 3 respectively. The PC board is mounted inside a translucent box measuring  $83 \times 54 \times 31$ mm. The box can either be uncoloured or tinted.

Begin construction by checking the PC board for any shorts between tracks or breaks in the copper. Check hole sizes and file out the corner section of the PC board on two corners if not already removed. These cutouts are required to allow access for the internal pillars in the box. The mounting holes need to be 3mm in diameter.

Now install the resistors, diodes and IC1. This IC and the diodes must be oriented as shown in Fig.2.

Resistors are marked with a colour code and these are shown in the accompanying resistor code table. You can use this table as a guide to selecting each value. Also it is a good idea to check the value with a digital multimeter. Install the two trim pots VR1 and VR2. These have a  $1M\Omega$  resistance and may have a 105 marking on the side.

The two  $100\mu F$  electrolytic capacitors should be *low leakage* types, as previously mentioned, and must be oriented with the polarity shown in the overlay diagram.

Place the PC stakes at the 9V battery lead connection points and in the holes allocated for the piezo siren. The siren is mounted by soldering its leads to the PC stakes. Note that the PC stakes and siren leads will need to be shortened so that when installed the top of the siren is 14mm above the top of the PC board.

The LDR is mounted by inserting its leads into the PC board leaving a 10mm length between the LDR and

## Parts List Fridge Door-Open Alarm

- 1 PC board, code 587, available from the *EPE PCB Service*, 78 x 32mm
- 1 UB5 translucent box, 83 x 54 x 31mm
- 1 panel label
- 1 piezo siren, 12mm diameter, 7.6mm pin spacing (–20°C operation)
- 1 9V alkaline battery
- 1 9V battery clip lead
- 1 LDR with greater than 1MΩ dark resistance
- 2 10mm M3 tapped spacers
- 2 M3 x 6mm countersunk screws
- 2 M3 x 6mm pan head screws
- 4 PC stakes

### Semiconductors

- 1 MM74C14, CD40106BC (–40°C to 85°C) hex Schmitt trigger (IC1)
- 4 1N914 or 1N4148 diodes (D1–D4)

### Capacitors

- 2 100μF 16V low leakage electrolytics
- 1 220nF MKT polyester (code 224 or 220n or 0.22μF)

### Resistors (0.25W, 1%)

- 1 10MΩ (10%)                    1 1MΩ
- 1 150kΩ    1 100kΩ    2 2.2kΩ
- 2 1MΩ horizontal trimpots (VR1, VR2)

PC board. After soldering, the LDR is carefully bent over at right angles to face the edge of the board.

The PC board is mounted within the case using two 10mm long spacers to support the outside edge of the PC board while the edge that has the pillar cutouts is held within the integral side supports on the case. Place the board in the case with its edge pressed into the side supports and mark out the hole positions for the outer edge mounting holes. Drill out these holes in the base of the case and countersink

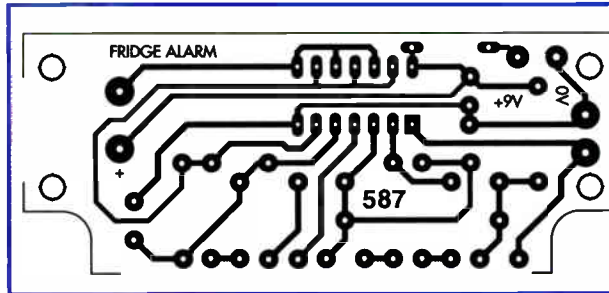

Fig.3. Full-size etching pattern for the Fridge Door-Open Alarm PC board.

Reproduced by arrangement with SILICON CHIP magazine 2006.  
www.siliconchip.com.au

them from the underside of the box suitable for countersunk screws.

The side supports on the other side of the case need to be removed to provide space for the battery to mount between the box side and PC board – see photo. These are removed with a pair of pliers twisting them sideways until they break out. Alternatively side cutters could be used or a chisel. Use safety goggles when doing this as pieces can fly out as they break.

Secure the 10mm tapped spacers to the base of the case with the countersunk screws. The PC board is secured to the top of the spacers using M3 pan head screws. Solder the battery leads to the supply PC stakes as shown on the overlay diagram (Fig.2).

Place the lid onto the case and mark out the centre position of the piezo siren. The hole in the lid needs to be about 6mm in diameter to ensure the full sound intensity can be emitted from the siren.

The alarm is now ready to be tested. Adjust VR1 to centre position and VR2 fully anticlockwise. Connect up the battery. The alarm should sound after about ten seconds, giving short bursts of sound. If this does not happen, make sure you are not working in the dark. Also check that the parts have been correctly placed on the PC board. Also measure the voltage at pin 2 of IC1. This should be close to 9V. Pin 4 of IC1b should be at 0V. The voltage between pin 7 and pin 14 of IC1 should be about 9V.

Adjust VR2 for the desired time-out before the alarm sounds. Fully

clockwise will provide a nominal 100 seconds before the alarm will sound.

The alarm needs to be placed in complete darkness before the siren can be silenced. Simply placing a finger over the LDR is not sufficient. Note also that the alarm may take some 10 to 20 seconds to switch off in darkness as the LDR slowly increases its dark resistance. In a freezer, this time might increase to several minutes!

You can test the alarm by placing it inside a drawer instead of the refrigerator. Adjust VR1 so that the alarm sounds if the drawer is opened slightly. Now place the alarm unit inside the fridge or freezer and check that it operates correctly after its temperature has stabilised.

You will need to readjust VR1 if the alarm is placed inside the freezer. This is because the threshold voltages for IC1a change with temperature. Also the dark resistance of the LDR does not rise to the same value found at room temperatures.

### Variations

If you want a longer delay time, increase the value of capacitor C1. A 220μF capacitor will double the delay time. If you want to increase the alarm burst rate, decrease C2 in value.

The Fridge Door-Open Alarm could also be used as a locker or drawer alarm. In this case, a shorter delay time may be better. Reducing C1 will reduce the time. Also an on and off switch could be placed in the supply to the battery to disable the alarm. *EPE*

## Resistor Colour Codes

	No.	Value	4-Band Code (1%)	5-Band Code (1%)
□	1	10MΩ (10%)	brown black blue silver	brown black black green silver
□	1	1MΩ	brown black green brown	brown black black yellow brown
□	1	150kΩ	brown green yellow brown	brown green black orange brown
□	1	100kΩ	brown black yellow brown	brown black black orange brown
□	2	2.2kΩ	red red red brown	red red black brown brown



## featured products

### CAN-USB

USB - CAN Bus adapter  
£81.50



### CAN-232

RS232 - CAN Bus Adapter  
£61.00

### Affordable CAN Bus Solutions from £61 ( CAN 232 )

CANUSB and CAN-232 are small adapters that plug into any PC USB / RS232 Port respectively to give instant CAN connectivity. These can be treated by software as a standard Windows COM Port. Sending and receiving can be done in standard ASCII format. These are high performance products for much less than competitive solutions.

Bronze Prize Winner  
NASA Tech Briefs 2004  
Products of the Year

£125.00

### ANT16

16 channel logic analyzer  
- probe set extra  
£195.00



DS1M12 2 channel 1MS/s PC scope,  
signal generator & data logger

### USB Instruments - PC Oscilloscopes & Logic Analyzers

Our PC Instruments may be budget priced but have a wealth of features normally only found in more expensive instrumentation. Our oscilloscopes have sophisticated digital triggering including delayed timebase and come with application software and DLL interface to 3rd Party apps. Our ANT8 and ANT16 Logic Analyzers feature 8/16 capture channels of data at a blazing 500MS/S sample rate in a compact enclosure.

Low Profile Version  
also available

### uPCI-400HS

4 Port uPCI RS232 Serial Card  
Spider Cable or COMBOX IO  
( extra )  
£65.00

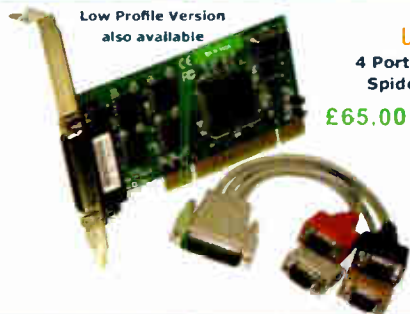

£10.00

### uPCI Serial Cards from £15 ( uPCI-100L )

Discover our great value for money range of multi-port uPCI serial cards. Supporting from one to eight ports, the range includes RS232, RS422, RS485 and opto-isolated versions. Our 4 port and 8 port models can connect through external cables or the innovative wall mounting COMBOX.

\*\* NEW LOW PRICE \*\*



USB-2COM-M £36.00

2 Port Industrial USB RS232 Serial  
with wall mount bracket and 5V  
DC auxiliary output



USB-COM-PL  
£12.50

Quality USB to RS232 converter  
cable with detachable 10cm  
extender cable. FTDI Chipset  
and Drivers for superior  
compatibility and O.S. support.

### 1 to 16 port USB to Serial Adapters from £12.50

With over 20 different models available, we probably stock the widest range of USB Serial Adapters available anywhere. We offer converter cables, multi-port enclosure style models in metal and plastic, also rack mount units with integral PSU such as the USB-16COM-RM. Serial interfaces supported include RS232, RS422 and RS485. We also supply opto-isolated RS422 and RS485 versions for reliable long distance communications. All our USB Serial products are based on the premium chipsets and drivers from FTDI Chip for superior compatibility, performance and technical support across Windows, MAC-OS, CE and Linux platforms.

### NETCOM-813

£350.00



8 Port Industrial Ethernet RS232  
/ RS422 / RS485 Serial Server  
with wall mount bracket and  
PSU.

### ES-W-3001-M

£125.00



Single Port high performance  
Industrial Wireless Ethernet  
RS232 / RS422 / RS485 Serial  
Server with PSU and wall mount  
bracket. Connects wired also.

### Ethernet & Wi-Fi 802-11b/g RS232/422/485 Serial Servers

One to eight port industrial strength Ethernet and Wireless ethernet serial RS232/RS422/RS485 Servers. Connect to your serial device remotely over your Wireless network, Ethernet or via the Internet. Based on the 32-bit ARM CPU these systems offer powerful serial connectivity and a wealth of features. WLAN models comply with IEEE 802.11b/g, max. 54 Mb/s and also offer a 10/100Mbps secondary ethernet connection. All models come complete with PSU. Prices start at only £85.00 ( NetCOM 111 ).

## EasySync Ltd

373 Scotland Street  
Glasgow G5 8QB U.K.

Tel: +44 (141) 418-0181 Fax: +44 (141) 418-0110

Web : <http://www.easysync.co.uk>

E-Mail: [sales@easysync.co.uk](mailto:sales@easysync.co.uk)

\* Prices shown exclude carriage and VAT where applicable

# INTERFACE



**Robert Penfold**

## MORE ON A VISUAL APPROACH TO PRODUCING VIRTUAL CONTROLS

IN the previous *Interface* article we made a start on the subject of using Visual BASIC 6 (VB6) to produce programs for use with your own add-on PC projects. Visual BASIC is well suited to producing virtual controls, meters, lights, and so on, and this subject will be explored further in the present article.

### Free Lunch

However, before continuing with VB6 programming, some clarification is required regarding Visual BASIC Express. One or two readers have queried the lack of Shape and Line components in Visual BASIC Express. These components make it easy to produce things like virtual control knobs and meters.

This shortcoming was pointed out in the article on Visual BASIC Express, and since this version is free, you have to accept that it will have some features omitted. However, it is possible to draw on-screen objects using Visual BASIC Express, but via conventional programming rather than using the visual approach. I will try to cover this subject in a future *Interface* article.

There is supposedly 'no such thing as a free lunch', but those who have yet to download Visual BASIC Express Edition might be interested to know that there has been a change in Microsoft's pricing policy on all the Visual Studio Express software. Visual BASIC Express Edition is, of course, one of these programs. Instead of being free for one year after release, these programs are now permanently free. Although the Express versions have some limitations, they do seem to disprove the free lunch theory!

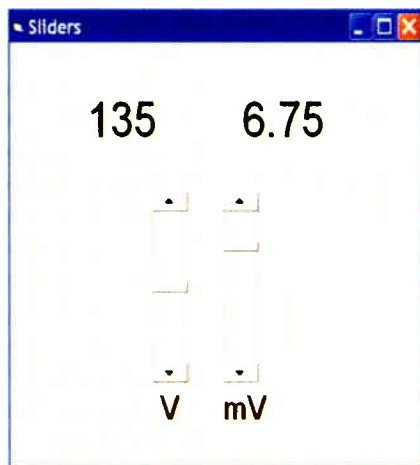

Fig. 1. Using two slider controls rather than one makes it easier to set the required output level. Line and Label components can be used to add scales to the controls

### On the Slide

Several circuits featured in previous *Interface* articles have used a simple program to set the value sent to an 8-bit port. Typically, this value is fed to a digital-to-analogue converter where it becomes an output voltage. For example, in a computer controlled power supply the value could be used to provide an output voltage from 0 to 12.75 volts with a resolution of 50 millivolts (0.05 volts). The example programs have relied on a slider control and a digital readout to control the output level.

The simple slider method works, but it can be tricky to set precisely the required output level. A simple solution to this type of thing is to have the output level set via two controls. In this example, there could be one control to set the number of whole volts and another to set the millivolts. Fig. 1 shows a simple demonstration program of this type.

There are two digital readouts, with the one on the left showing the raw 8-bit value and the one on the right providing the voltage display. Of course, in a real control program the raw value would be output to the appropriate port instead of being displayed.

### Listing 1

```
Private Sub Form_Load()  
VScroll1.Value = 12  
VScroll2.Value = 19  
End Sub  
  
Private Sub VScroll1_Change()  
Volts = 12 - VScroll1.Value  
Volts = Volts * 20  
Output = Volts + (19 - VScroll2.Value)  
If Output > 255 Then Output = 255  
Label1.Caption = Output  
Label2.Caption = Output / 20  
End Sub
```

This program requires a form that has two label components to provide the displays, two vertical scrollbars, and a further two label components to provide the legends for the two controls. The maximum values for the two scrollbars are 12 (volts) and 19 (millivolts). A maximum of 19 rather than 999 is used for the millivolt control because it provides increments of 50 millivolts and not one millivolt.

Listing 1 shows the routines for the form and VScroll1. The routine for VScroll2 is essentially the same as the one for VScroll1, and has therefore been omitted to save space.

One slight problem with vertical scrollbars is that they provide the minimum value at the top and the maximum value at

the bottom. This is presumably done to match the Visual BASIC co-ordinate system, but probably most people would find it more intuitive to have zero at the bottom. Some simple software tricks have therefore been used to make the controls operate in this fashion.

By default the scrollbars start at zero, which is with the slider knobs at the top. The two lines of code in the routine for the form set the knobs at the bottom. When one of the scrollbars is adjusted, the values from both scrollbars are read and mathematically manipulated to produce the appropriate port value and voltage readout. The value from VScroll1 is deducted from 12 to effectively invert the control and set zero at the bottom. Similarly, the value from VScroll2 is deducted from 19.

The value for the output port, which is actually used as the caption for Label1 here, is obtained by multiplying the value from VScroll1 by 20 and then adding it to the value from VScroll2. This value is divided by 20 to give the output voltage, which is then used as the caption for Label2.

### Error Handling

One advantage of using a single scrollbar is that it is impossible for the user to generate out-of-range values. The maximum and minimum values for the control are set at the appropriate figures by the programmer, and the control is then fool-proof.

The same is not true for all methods of control though, and it is often necessary to include some simple error trapping. Otherwise an erroneous value will be written to a port and the program will come to a halt with the appropriate error message being displayed.

In this case it is possible for an excessive value to be generated. The two controls can set output potentials of up to 12.95 volts, but the maximum valid value is 12.75 volts. Anything higher than 12.75 volts outputs a value of more than 255 to the port and generates an error message.

The simple solution is to have a program line that checks to see if the value for the port, which is held in the variable called Output, is greater than 255. If it is, the value stored in Output is made 255, and an error is avoided.

### Keypad Entry

Back in the days of GW BASIC it was normal to enter numeric data via the keyboard. It is still possible to do things this way, but the more modern alternative is to have an on-screen keypad that is used to enter the data. Things like virtual keypads are very easy to implement using Visual BASIC.



The demonstration program of Fig.2 has a keypad that is formed by a block of 12 command buttons plus a larger Cancel button. These have been given suitable captions, including a full stop to act as the decimal point, 'ENT' for the one that will be used as the Enter button, and Cancel for the large button.

There are two label components, and the upper one shows the output voltage that is keyed-in by the user. The lower one displays the value that would be written to the output port if the program was the genuine article.

Part of the program is shown in Listing 2. The first line declares 'output' as a Public variable, which means that it can be accessed by any subroutine. It is made a Variant, which basically means that Visual BASIC will set its type to suit whatever operation is being performed.

This is very convenient in the current application where it will initially hold a string of characters that provide the voltage display. The same variable then has to be treated as a numeric variable that is mathematically manipulated to produce the value for the second label. A Variant enables this to be achieved without the need for the program to provide any conversions.

The first subroutine is for the '1' key, but essentially the same routine is used for the others apart from the Enter and Cancel keys. Pressing this key adds the '1' character to the existing string of characters stored in 'output'. Of course, the appropriate character rather than '1' is used for each of the other keys.

Initially there will be no characters in the string, so the character for whatever key is pressed becomes the contents of 'output'. Pressing further keys results in the relevant characters being added to the string, as the required output voltage is entered. The contents of 'output' are written to the caption of Label1 each time a key is pressed, so that the user can check that they have entered the correct data.

### In Error

The next routine is for the Cancel button. This is used if an error is made when entering data. It simply clears the contents of 'output' by making it equal to an empty string, and then writes 'output' to the caption of Label1 so that the display is cleared. The user can then start again from scratch.

Visual BASIC has excellent string handling functions, and producing a Backspace key instead is very easy. A suitable subroutine is provided in Listing 3. This just detects the length of the string and replaces it with a substring that is one character shorter, deleting the most recently entered character.

The final routine is the one for the Enter key. First, this multiplies by 20 the voltage entered by the user, which gives the correct value for the output port. Some error checking is needed here, because it is possible to enter voltages in 10 millivolt steps, but the resolution of the system is actually 50 millivolts. Entering a value of (say) 12.14 volts would not produce an integer, and would produce an error message when it was written to the output port.

It is also possible to enter potentials greater than the maximum of 12.75 volts that the system can handle. Entering an excessive voltage would produce a value of

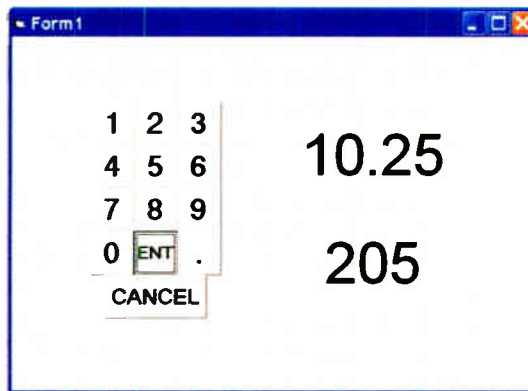

Fig.2. Since Visual BASIC6 has a button component, making a keypad is very straightforward. The Cancel button can be replaced with a Backspace type, or the keypad could incorporate both types of button

more than 255, which would again produce an error message when it was written to the output port. Dividing 'output' by one using the \ symbol instead of the more usual / symbol results in any decimals being stripped off.

The next two lines detect values of more than 255 and respectively write 'Error' to the caption of Label1 and set 'output' at zero. The value of 'output' is then written to the caption of Label2, but in a real control program it would be sent to the appropriate port instead. Assuming no errors have been detected, this sets the hardware to produce the correct output voltage. Finally, the contents of 'output' are cleared so that the program is ready for a new voltage to be entered.

### Panel Meter

A panel meter, such as the example in Fig.3, is easily produced using Visual BASIC. This reads from zero to 12.75 volts. The whole thing can be drawn using the Line, Shape, and Label components, and it is then just a matter of controlling the X2 co-ordinate of the line that acts as the pointer. This requires some simple mathematical manipulation in order to get the scaling right. In this program the meter is controlled by a horizontal scrollbar that mimics an 8-bit input port by providing values from 0 to 255. Listing 4 shows the routine for the scrollbar.

The voltage divisions of the meter's scale are spaced by 600 in the Visual BASIC co-ordinate system, and zero line is at an X value of 840. The resolution of the system is 50 millivolts (0.05 volts), which means that there are 20 increments per volt. Multiplication by 30 is therefore needed in order to match the output of the scrollbar to the Visual BASIC co-ordinate system ( $30 \times 20 = 600$ ).

Likewise, 840 must be added in order to compensate for the fact that zero on the meter is at 840 in the co-ordinate system. The modified value is in the variable called Reading, and this is

### Listing 2

```
Public output As Variant
Private Sub Command1_Click()
output = output & "1"
Label1.Caption = output
End Sub
Private Sub Command13_Click()
output = ""
Label1.Caption = output
End Sub
Private Sub Command11_Click()
output = output * 20
output = output \ 1
If output > 255 Then Label1.
Caption = "Error"
If output > 255 Then output = 0
Label2.Caption = output
output = ""
End Sub
```

### Listing 3

```
Private Sub Command13_Click()
Length = Len(output)
If Length = 0 Then Exit Sub
Length = Length - 1
output = Left(output, Length)
Label1.Caption = output
End Sub
```

### Listing 4

```
Private Sub HScroll1_Change()
Reading = HScroll1.Value
Reading = Reading * 30
Reading = Reading + 840
Line66.X2 = Reading
End Sub
```

used as the X2 co-ordinate of the line used as the pointer (Line66). As is often the case with Visual BASIC, very little conventional program code is needed in order to make it work properly.

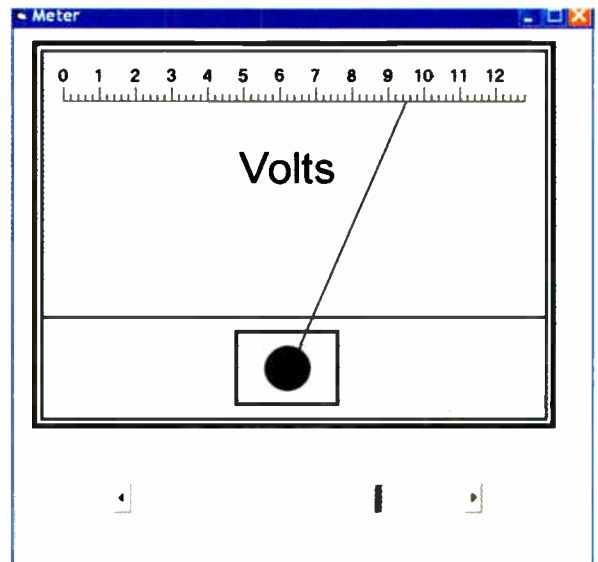

Fig.3. Provided the scale is straight rather than an arc, a virtual panel meter is easily drawn using the Line, Shape and Label components. Some simple mathematics is needed in order to get the scaling right, but little conventional programming is needed in order to make the meter work properly

# Helping You Succeed



## Does your business need more support and resources?

Successful organizations recognize the value of a strategic supplier relationship to help them deliver innovative products to their markets in a timely and cost-effective manner. Microchip Technology supports more than 45,000 customers worldwide, and we're

committed to helping you succeed. In addition to our high-performance silicon solutions, Microchip provides a long list of support functions that reduce time to market and lower your total system cost. And we have significantly expanded our local technical resources.

### Use microchipDIRECT to:

**Register today!**

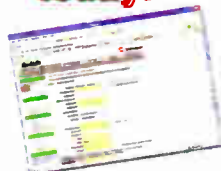

- Order directly from Microchip, 24 hours a day, 7 days a week with a credit card or credit line
- Receive competitive, direct volume pricing on all devices
- Check our product inventory
- Order broken reels at steep discounts
- Use fast and inexpensive production programming (now available)
- Place and maintain your order securely from any network connection
- Assign a PO number to your order
- Create a unique part number for any item ordered
- Receive e-mail notification of orders, deliveries, quote status and more

**microchip**  
**DIRECT**  
[www.microchipdirect.com](http://www.microchipdirect.com)

Now  
**Pb-free!**  
RoHS Compliant

 **MICROCHIP**  
[www.microchip.com](http://www.microchip.com)

The Microchip name and logo, PIC, and dsPIC are registered trademarks of Microchip Technology Incorporated in the USA and other countries. All other trademarks and registered trademarks are the property of their respective owners.  
© Microchip Technology 2006. All rights reserved. ME156Eng/05.06



# THROUGH-GLASS ALARM

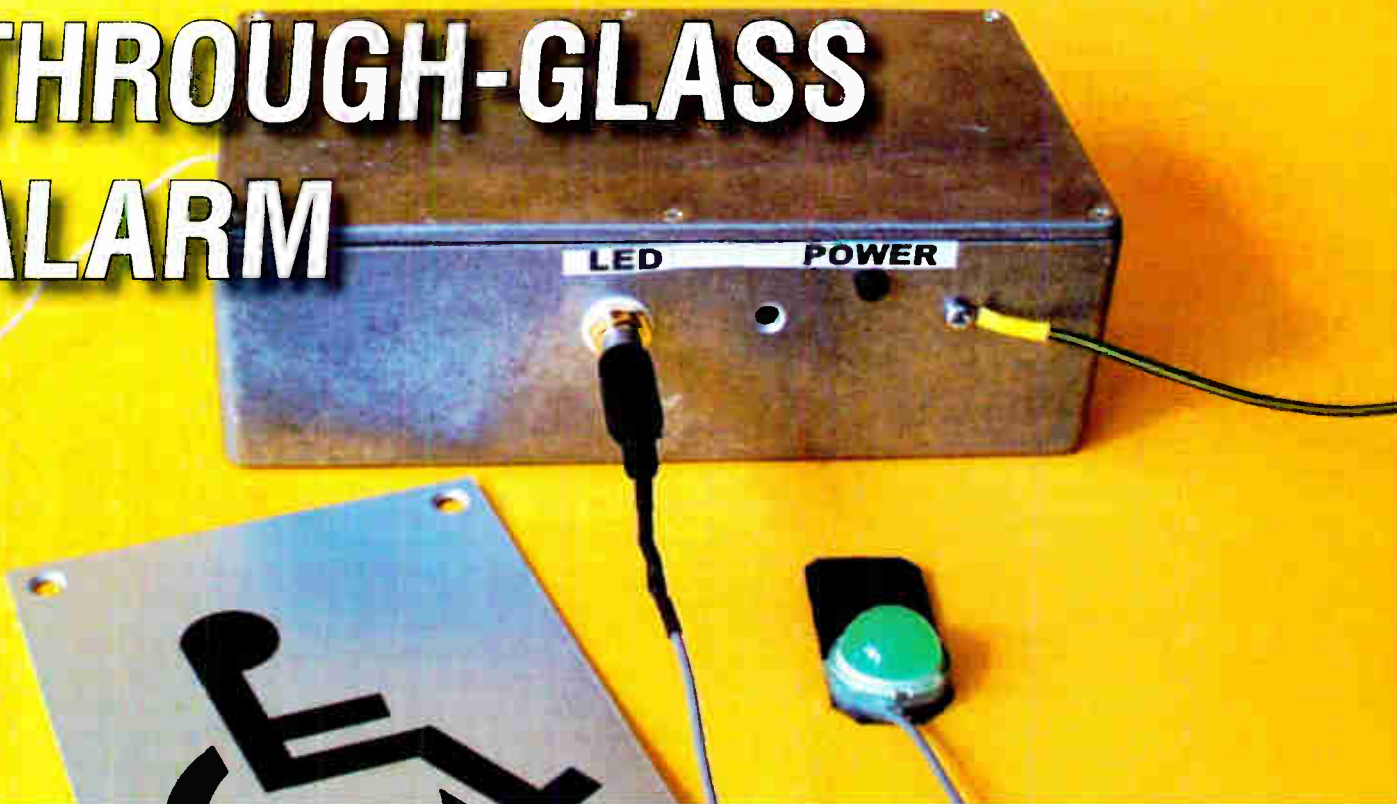

**Permits a disabled person to attract attention through a glass window**

By Godfrey Manning BSc, MB BS, G4GLM

**M**ODERN engineering can be subdivided into the disciplines of mechanical, electrical/electronic, software and socially-beneficial. This project is in the latter category.

When Chris, the author's girlfriend, opened a retail art gallery, compliance with the Disability Discrimination Act (1995) was a problem. Mobility-impaired people would have trouble with the steps and right-angle turn into the shop and, being a Grade Two listed building, structural alteration was not possible.

To save even drilling a hole for a doorbell wire, the author devised the circuit now described. Inside the window, which must be a single-glazed simple sheet of glass, is a metal plate with a notice inviting the disabled person to place their hand, or the cheek of their face, over it (from the outside). When sufficient cover is achieved, an alarm sounds inside and a light, also visible in the window, comes on to show the caller that attention is being drawn to them.

The sensor plate is one side of a capacitor, the window makes a dielectric

and the hand is part of the other, earthy (indifferent) side. Refer to Fig.1. By changing the capacitance, the balance of a radio-frequency bridge is altered. The bridge output is diode-detected and the resulting voltage compared to a fixed reference. When the changing bridge output voltage becomes sufficiently different to the reference, a monostable timer is triggered that activates the alarm.

Regard this design as an intermediate level project. The assembly is straightforward and the parts easy to find, but to make it reliable you need an oscilloscope, a high-impedance (digital) voltmeter, a source of mild heat (hairdryer or adjustable heatgun) and patience!

### Circuit operation

The complete circuit diagram for the Through-Glass Alarm is shown in Fig.2.

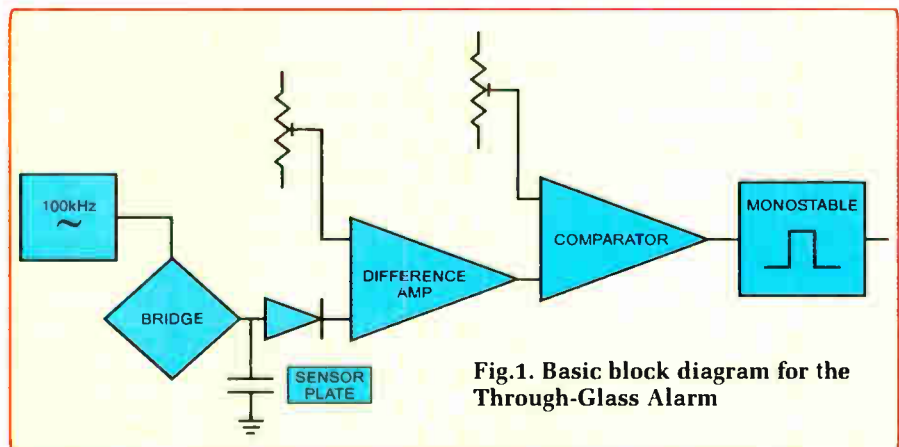
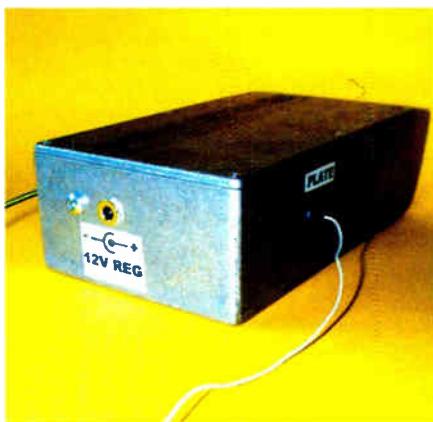

Fig.1. Basic block diagram for the Through-Glass Alarm



The unit is powered via socket SK1 with a regulated 12V DC supply, and decoupled by capacitors C1 and C2. Light emitting diode (LED) D2, current-limited by resistor R1, gives continuous reassurance that 12V is present.

If the worst comes to the worst (power supplies can fail with unregulated volts passed straight through), Zener diode D1 will conduct and blow fuse FS1, preventing damaging voltages reaching the rest of the circuit. Full crowbar protection of the circuit was not justified as the chips are cheap.

Being a radio amateur, the author knows not to cause electromagnetic compatibility interference and inductor L1 in the positive power supply lead keeps internal radio frequencies (RF) from appearing on the supply cable (which could act as an aerial).

## Wien Bridge

The RF signal that powers the circuit's measuring bridge is generated by IC1a. (Don't get confused, this part of the circuit is also called a bridge but is a totally different type: a Wien bridge.) This is directly derived from the *Low-Frequency Wien Oscillator* circuit by Edwin Chicken (May '04).

The original circuit is modified to have a fixed frequency around 100kHz, determined by R4, C4 and R5, C5. A mid-rail voltage is produced by R2 and R3 with C3 providing decoupling. The other components, R6 to R8, arrange the right amount of feedback for reliable but undistorted oscillation.

Note back-to-back diodes D3 and D4 in the feedback path. These achieve rapid changes in feedback according to the generated voltage. Other types of component that can do this include filament bulbs (not very professional-looking to have a delicate lamp bulb in the middle of the circuit board) or expensive, delicate glass-encapsulated thermistors.

## Parts List – Through-Glass Alarm

- 1 PC board, code 589, available from the *EPE PCB Service*, size 152mm x 89mm
- 1 diecast box, size 190mm x 110mm x 60mm
- 1 isolated phono socket, panel mounting (SK2)
- 1 phono plug (PL1)
- 1 2.1mm power socket, panel mounting (SK1), with matching plug
- 1 2.2mH 0.9A choke (L1)
- 1 4.7mH 500mA choke (L2)
- 1 20mm fuseholder, chassis mounting
- 1 20mm 500mA glass fuse
- 1 12V self-oscillating piezo sounder (WD1)
- 1 8-pin DIL socket
- 2 14-pin DIL sockets
- 1 12V DC 1A regulated, plug-in, mains adaptor
- 1 3-pin mains plug, see text
- 1 2-way fused mains multiplug
- 5 PCB supports, see text

### Semiconductors

- 1 1N5350B 13V 5W Zener diode
- 1 red LED, 5mm
- 1 green LED, 20mm high-brightness, high current
- 3 1N4148 signal diodes
- 2 BAT85 Schottky diodes
- 1 ZTX605 *npn* Darlington transistor
- 2 TL074 quad op amp ICs
- 1 555 timer IC

### Capacitors

- 2 100p ceramic disc, 2.5mm pitch
- 1 1n ceramic disc, 3mm pitch
- 6 100n ceramic disc, 5mm pitch
- 1 470n polyester, 15mm pitch
- 1 10 $\mu$  radial elect. 25V
- 2 47 $\mu$  radial elect. 25V
- 1 100 $\mu$  radial elect. 16V
- 1 220 $\mu$  radial elect. 16V

### Resistors (0.25W 5% carbon film, except R25 & R26)

- |                                |                |        |
|--------------------------------|----------------|--------|
| 1 110 $\Omega$                 | 1 510 $\Omega$ | 2 4k7  |
| 1 5k1                          | 1 6k8          | 3 10k  |
| 1 12k                          | 3 15k          | 1 27k  |
| 2 47k                          | 3 100k         | 1 200k |
| 1 680k                         | 2 1M           |        |
| 1 10k n.t.c. thermistor (R25)  |                |        |
| 1 100k n.t.c. thermistor (R26) |                |        |

### Potentiometers (All top adjust)

- 1 10k 25-turn cermet preset
- 3 20k 25-turn cermet preset
- 1 100k 25-turn cermet preset
- 2 500k 25-turn cermet preset

Multistrand connecting wire  
1mm terminal pins; nuts, bolts, washers; 20mm closed grommet; aluminium sensor plate, size to choice (or metal disabled toilet door sign); 1A mains plug fuse; solder, etc.

## Temperature compensation

For all their rugged simplicity, though, the diodes introduce a problem of their own. They are temperature-sensitive. Don't think you can leave this circuit in a shop window in full sunlight as it will heat up and false trigger.

However, the temperature compensation is adequate if the circuit is placed out of the window in a reasonably stable room-temperature environment. This is achieved by n.t.c. (negative-temperature coefficient) thermistor R25, a cheap and rugged type, whose influence on the feedback (and hence gain) of buffer amplifier IC1b is adjusted by presets VR1 and VR2.

The other gain-determining component is resistor R9. So, from IC1b pin 7, via C6, comes a stable, amplitude RF signal that is coupled to the (Charles) Wheatstone (inventor of the concertina!) measuring bridge.

## Bridge over the waves

Two arms of the bridge are formed by the two parts of the track of preset VR3, as defined by the wiper position. The other two arms are resistors R10 and R11, but the 'human capacitor' appears in parallel with R11 and reduces the AC voltage seen at the bridge output at capacitor C7. Again, a half-rail reference is provided (R12, R13, C9) as the PCB layout was easier this way than picking off from R2, R3.

A standard RF detector circuit then uses Schottky diodes D5 and D6 to derive a DC voltage across capacitor C8. This large(ish) capacitor offers a compromise time constant; the caller will be rewarded by a rapid response and yet transient noise will not cause a false alarm.

From here onwards, no more RF, everything's DC and easy! (sounds like an electronic version of the *Lambeth Walk!*)



# THROUGH-GLASS ALARM

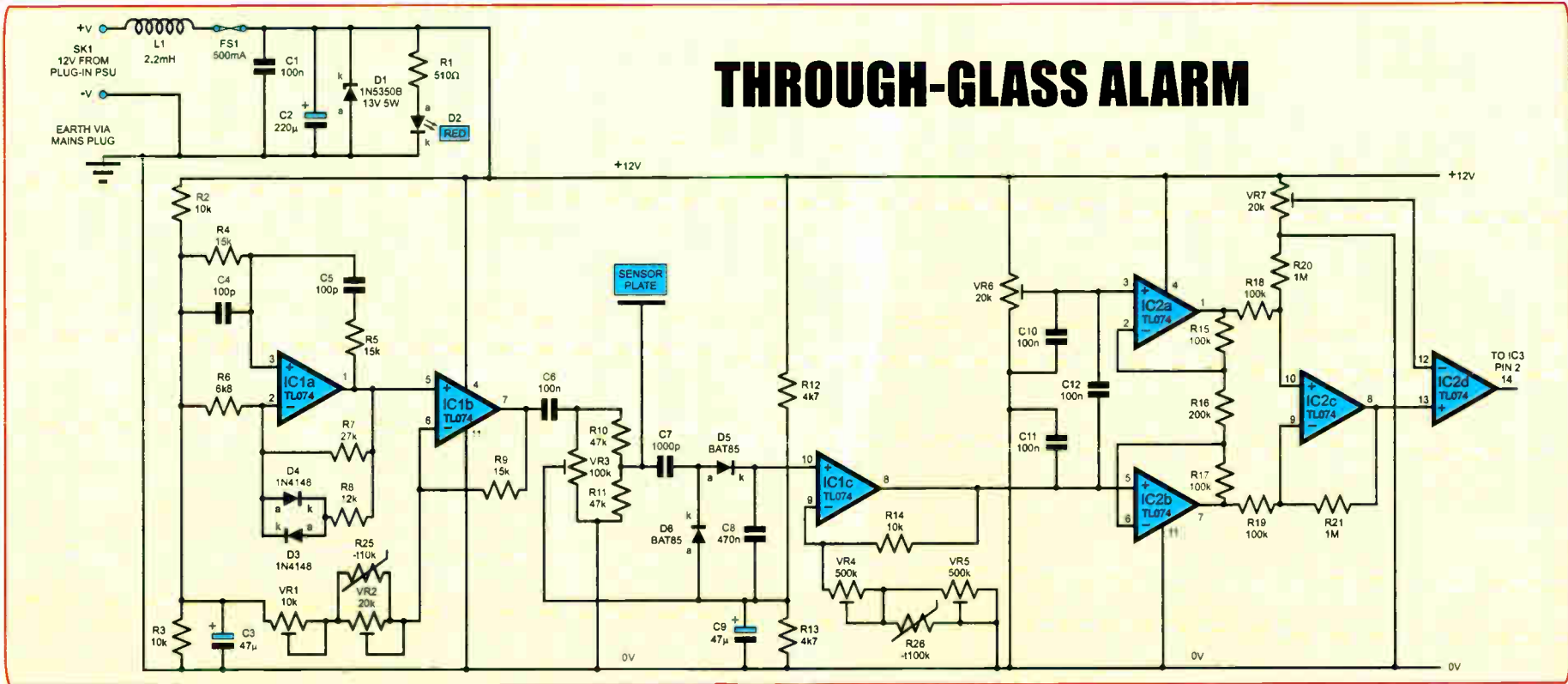
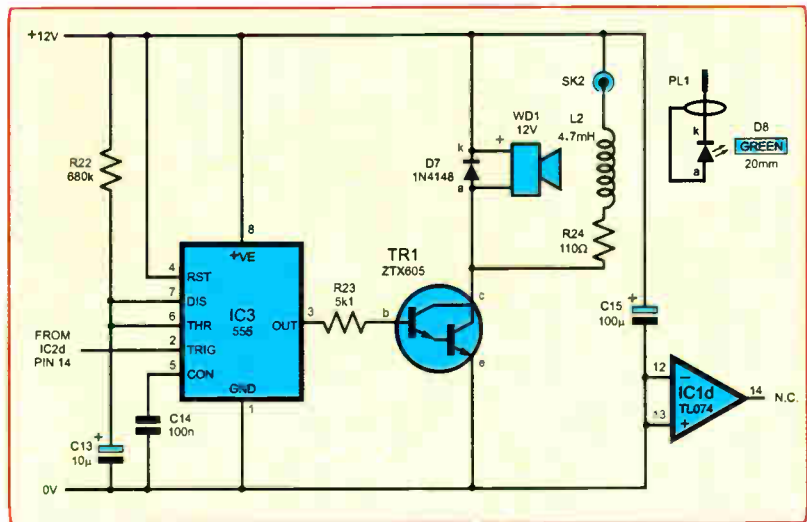

Fig. 2. Joining these two circuits together completes the full circuit diagram for the Through-Glass Alarm project



## Feeble problem

Of course, you say, that DC voltage is feeble, and that's why it is buffered by a high input impedance amplifier, IC1c. Here comes the next problem. First there was the crystal set, then point-contact germanium diodes which were more reliable and only wasted a tiny voltage drop (about 300mV). Even better, along came silicon but, unfortunately, 600mV is wasted so these aren't suitable for efficient detection of tiny signals. Luckily, the modern 'cat's whisker' is actually a sophisticated Schottky semiconductor that gives rise to alliterations, 300mV drop and temperature instability. Not so easy after all.

Diode characteristics change slightly with temperature, enough to matter here. This effect can even be used to measure temperature. Hence another thermistor, R26, its influence adjusted by presets VR4 and VR5, is needed along with R14 in the IC1c buffer's feedback loop. Schottky is the new germanium, if not cat's whisker! (It's not known if Wheatstone had a cat. No animals were harmed in the making of this project!)

## Instrument amplifier

Another instrument – not a musical one this time! Op amps IC2a, IC2b and IC2c form an instrumentation amplifier (the workings of which were 'amplified' in *Teach In 2002* March '02). The advantage of this type of amplifier, when the input changes by only a small amount, is that its output correctly follows the differential inputs while common-mode errors are minimised.

The buffered DC from the detector depends on the bridge balance. This voltage is applied to pin 5 of IC2b and compared to the reference from preset VR6 on IC2a pin 3. Input noise is eliminated by capacitors C10 to C12. Differential gain is determined by resistors R15 to R17.

The differential output swing is now large enough to reliably feed an open-loop 'bang-bang' comparator at IC2d pin 13. When the voltage exceeds that set by preset VR7 on IC2d pin 12, output pin 14 swings well below the trigger threshold of timer IC3 pin 2. This standard retriggerable monostable turns on Darlington transistor TR1 via output pin 3 and current limiter R23. The on-time (about nine seconds) being determined by components R22 and C13 (which can be varied for different timings).

The standard 555 timer used for IC3 is a chip that is known to place a pulsatile load on the supply when it triggers, so

locally-mounted capacitor C15 meets the demand and decouples the transient from the +12V rail.

Transistor TR1 should be capable of powering more than just the self-oscillating buzzer/bleeper, WD1, and LED D8 that tells the caller that they have successfully activated the alarm.

Because D8 is on the end of a long lead (plugged in via SK2) it is fed through RF choke L2 to reduce unwanted emissions. The internal resistance of the choke plus that of resistor R24 limits the current to the maximum 25mA allowed for the specified LED.

Diode D7 across the entire collector load of TR1 eliminates the back-EMF hazard of certain types of electromechanical buzzer or, if desired, a relay that could optionally be added. There's room at one end of the box for a relay, the coil of which would be wired to the same terminal pins as WD1.

Total TR1 load shouldn't take the overall circuit consumption too close to the 500mA rating of fuse FS1 and the interconnecting wire. If uprating these for a bigger load, remember that L1 is limited to 900mA and the voltage drop across it might become important.

IC1 and IC2, TL074 quad op amps, were chosen so as to minimise the package count. In fact, op amp IC1d is redundant and its inputs are tied safely to ground. The other feature of the TL074 is that it offers low noise, helpful in an environment where small signals are being measured. It is also cheap!

If the circuit is less sensitive than expected, the earth coupling (indifferent side of the 'human capacitor') can be increased

by simply connecting the 0V rail to mains earth as the only connection to a standard mains plug.

## Power supply

The power supply is ready-made and self-contained in what looks like an overgrown mains plug. The logic is unclear, but such devices have no fuse and so defeat the protection required of equipment plugged into a ring-main. The worst case would be to blow the 30A fuse (or 32A circuit breaker) back at the consumer unit; a frightening bang could occur!

Unfortunately, with imports of these power supplies in profusion, it seems to be 'commerce before safety'. So, the author recommends the addition of a fuse to restore safe conditions – simply place a 1A fuse in a fused two-way multiplug, then plug the power supply into the multiplug. This inserts a fuse into the circuit and also offers a second outlet for the earth connection referred to earlier.

## Construction

Printed circuit board component and track layout details are shown in Fig.3. This board is available from the *EPE PCB Service*, code 589.

Solder the five wire links first and then add the resistors. Build up with the larger components, the IC sockets, terminal pins, preset potentiometers and the capacitors. Finally, add the thermistors, diodes and transistor. You can mount Zener diode D1 flat to the board, not end-on as shown in the photograph. Observe the correct orientation of the electrolytic capacitors and the semiconductors.

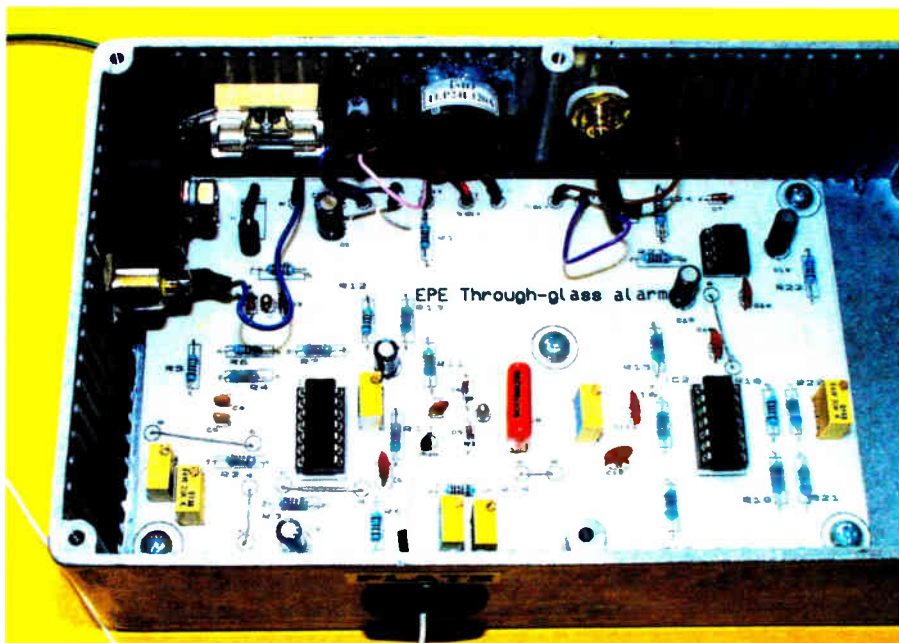



Do not insert the ICs in their sockets until the complete assembly has been checked for accuracy. Check that the soldering is free from bridges across tracks, all joints nice and shiny and none missed. An ohmmeter correctly polarised across the supply input pins should read around  $3k\Omega$  (not a short!), mainly due to the resistor networks that are across the supply.

Turn each 25-turn preset's adjuster (with a suitable trim tool) to the end of its range (feels stiffer and clicks) then back 12.5 turns to the half-way position.

## You know the drill

Drill the box and fit the parts that it carries. The five stand-offs needed are each held in the base of the box simply by  $M3 \times 6mm$  countersunk screws. The wire to the sensor plate passes through a 20mm blanking grommet, the standard size for electrical box knock-outs.

The box is continuous with earth because socket SK1 is not insulated. Throw away the socket's washer and install with just the nut.

Attach inductor L1 with an  $M5 \times 25mm$  panel-head bolt, introduced from the outside. Slide L1 over the bolt from the inside, followed by a fibre washer, a plain washer, a spring washer and a nut (all M5) and secure (not too tightly, don't crush the ferrite) with the connecting wires in a horizontal position. The wires are thus placed to solder easily to the centre terminal of SK1 and to the fuseholder.

Attach the fuseholder for fuse FS1 by M3 hardware, first slipping a shakeproof 'star' washer then a solder tag over an  $M3 \times 12mm$  panel-head bolt, introducing this stack through the box from the outside. Inside the box, slide the fuseholder over the bolt followed by a plain washer, a spring washer and a nut. Again, protect the plastic by not overtightening. Access is fiddly, locking forceps help with placement. The fuseholder sits horizontally. Correct tightness means that a spring washer is just compressed flat, but the underlying part is not deformed nor the bolt stretched.

LED D2 is self-contained and mounts in its hole in the conventional manner. Buzzer/sounder WD1 is held by a fillet of glue such as hot-melt. Socket SK2 *must be isolated* from the box, note that one of its plastic washers has a narrow shoulder. Slip this washer onto the socket with the shoulder pointing away from the mating end. Introduce into the hole and make sure that the shoulder seats within the hole. Slip the other plastic washer and then the solder tag onto the threaded body

from within the box, follow up with the nut and do not overtighten. Use an ohmmeter to prove that the body of the socket is *not* electrically connected to the box.

## Wiring up

Do NOT fit fuse FS1 in its holder, or any chip into its socket yet. Don't connect WD1 as the sound will get on your nerves during setting-up. Likewise, do not wire the solder tag side of SK2 yet as the current to D8 needs to be verified.

Otherwise, place the PC board into the box and attach loosely to one spacer, by an  $M3 \times 6mm$  panel head bolt over which has been slipped a plain then a nylon M3 washer. This is the attaching regime for all five points when complete, but if anything does not seem right, you might need to uproot the board again at this stage.

When wiring, use sleeving (preferably heatshrink) wherever possible and adopt a sensible colour-code;  $10 \times 0.1mm$  wire is ideal. Avoid excessive lead lengths. The centre terminal of SK1 should be in easy reach for soldering a wire from choke L1 to it. SK1's solder tag is wired to the 0V terminal pin. The other side of L1 is soldered to the fuseholder and the other side of the fuseholder goes to the 'From FS1' terminal pin.

LED D2 wires go straight to the appropriate PCB terminal pins but verify it first with an ohmmeter to get the polarity correct. L2 is soldered hard up to the centre terminal of SK2, its other end is now wired to the allocated board terminal pin.

## Sensor plate

The sensor plate wire ought to have sleeving where it passes through the grommet. A tie-wrap around the wire, close to the inside wall of the box, can prevent it from being pulled out. The other end attaches to the sensor plate by a solder tag. An  $M5 \times 6mm$  countersunk bolt is introduced through a corner hole of the plate from the front side, on the other side is slipped a solder tag and shakeproof 'star' washer and then a nut.

The bolt head might still stand proud and tend to lift the plate off the window, so slightly bend that corner of the plate backwards until the plate itself is a perfect flush fit against the glass. For convenience with the prototype, the author broke the connection with a 1mm plug/socket.

LED D8 is wired by a convenient length of lap-screened audio cable, soldered directly to it, screen to anode (a). The other end of the cable solders to a phono plug, PL1, screen to body and inner to tip. Hot-melt glue the LED to a small piece of

plastic sheet, which then acts as a means of mounting.

Lastly, sensitivity might be improved if the 0V rail (the box itself) is a true earth, for which purpose a wire from the external solder tag (adjacent to fuse FS1) is taken to the Earth pin of a mains plug (leave out the plug's fuse, loose live terminal and the neutral screw).

## Ready, go!

Insert fuse FS1 and check again for about  $3k\Omega$  resistance with an ohmmeter at socket SK1. Power up and, with reference to the box which is at 0V, check for +12V at the IC sockets, at IC1 pin 4, IC2 pin 4 and IC3 pins 4 and 8. Then, with reference to +12V at the output side of fuse FS1, check for 0V on IC1 pins 11, 12 and 13, IC2 pin 11 and IC3 pin 1. LED D2 should glow. Switch off.

Remove fuse FS1 and, with antistatic precautions, insert the three ICs. Bridge the fuseholder with a current meter and power up – around 40mA is normal. Switch off and replace the meter by the fuse. Switch on but leave the earthing mains plug disconnected, so as not to form a hum loop with the oscilloscope, which is now needed.

The scope should show a reasonable sine wave, around 100kHz and 2.5V peak-to-peak at IC1 pin 1 (all measurements referenced to the box). Switch off.

Temporarily link terminal pin for SK2 to the solder tag of SK2 via a current meter and plug in PL1, to which LED D8 was previously wired. Power up briefly and confirm that D8 lights, noting the current. This should be just below the maximum rating of 25mA and depends on the internal resistance of inductor L2 in series with resistor R24. Any great deviation from this current requires replacement of R24 with a value that correctly achieves the right current.

Complete the wiring of SK2's solder tag. You might now like to temporarily shunt resistor R22 with a  $10k\Omega$  resistor so that the alarm-sounding period becomes very short while testing. Ignore LED D8 for now as it might stay on continuously until further adjustments are made.

## Patience is appreciated

In cool ambient conditions, look at IC1 pin 7 output with the scope while adjusting presets VR1 and VR2. Turn VR2 clockwise (CW) to its end-stop, then adjust VR1 CW until the waveform shrinks and is no longer clipped (or anti-clockwise, (ACW), to expand the wave just prior to the point of clipping).





Now to compensate for temperature changes. You will need to apply quick blasts of hot air, observe the result, allow to cool (an air-duster aerosol helps), adjust a little, then repeat. Patience with this interactive process pays dividends.

It's like getting the right temperature in your bath. The two mixer taps can provide the same temperature but at different flow rates. If one tap is moved, the other can be altered to restore the temperature – but the total flow will be different. Eventually, one tap reaches the end of its range and further adjustment of the other will alter the temperature. So with VR1 and VR2.

A quick blast of hot air (from hair-dryer/heatgun/Parliamentary committee!) in the direction of diodes D3/D4 might make the waveform grow (causing insensitivity) so reduce the influence of thermistor R25 by turning VR2 ACW, initially by two turns, less when nearly right, and compensate by VR1 CW to prevent distortion. Eventually, there will be little change, but err on the side of growth-with-heat.

Insufficient influence from thermistor R25 causes reduced amplitude with heat and false triggering. With the prototype there was less than 100mV change.

## Sensitive touch

Dress the wire to the sensor plate along the bench, lay the plate out such that it and the wire are not near anything else. Put a small sheet of glass flush over the plate. Transfer the scope to the junction of resistors R10 and R11, and turn preset VR3 CW until the sinewave just vanishes.

Now turn slowly ACW until the trace reappears, keep going for maximum amplitude and two more turns beyond that. You will see about 2V peak-to-peak and this will reduce by perhaps 400mV when a hand is placed over the plate in contact with the outside of the glass.

Remove the scope, plug in the earth connection and take readings with a high-impedance voltmeter, starting at IC1 pin 8. Hopefully, the voltage here will drop by about 300mV when the hand covers the plate. Now, with preset VR5 fully CW and VR4 fully ACW, thermistor R26 has greatest influence.

If a blast of hot air over diodes D5 and D6 makes the voltage rise, VR5 needs to go one turn ACW and VR4 one turn CW. Conversely, for voltage fall with hot air. Eventually, it gets critical with just tiny adjustments. Remember the bath taps. Aim to minimise the temperature variation, better than 100mV either way.

That should set up the temperature compensation. Hopefully, none of the foregoing will need further adjustment even if the unit is moved to a different location. Allow the unit's temperature to equilibrate to ambient and place the box in its final position. Make sure that it is away from direct heat and sunlight (not actually in view in the window!) and secure, so it will not get moved around any further.

Attach the sensor plate flush with the inside of the glass with ultraviolet-proof 'all-weather' tape; likewise LED D8. Remember that wheelchair-bound people see the world from a sitting height, allow for this when deciding the position of the plate.

## Final adjustment

Right, we've worked hard for this, here comes the reward of seeing it work. Initially, the alarm can be triggered from inside by putting a hand over the plate. Final adjustment requires an assistant stationed where intended, outside the window.

With the prototype it was noted that at IC1 pin 8 the voltage was about 9.7V quiescent, 9.3V with the hand. You are allowed to differ! Adjust preset VR6 while monitoring IC2 pin 3, to get about half-way between these voltages, CW to increase. Now the voltage at IC2 pin 8 becomes the amplified difference between the reference at preset VR6's wiper and whatever is coming from the bridge. On the prototype, there was something like 1.3V quiescent (probably the minimum output possible from this type of op amp) going over 5V with the hand across the sensor plate.

Adjusting VR6 in 50mV steps can make a difference to the sensitivity. But the main chance to set a sensitivity threshold comes next, where IC2d makes a simple comparison between the reference at IC2d pin 12 from VR7, and the amplified difference signal on IC2d pin 13. The idea is that VR7 is set so that a concerted effort is needed to cross the threshold, avoiding false triggering, but that once the hand is placed over the plate, the threshold will be crossed with certainty and enable the caller to trigger the alarm with ease.

Start with VR7's wiper holding IC2d pin 12 at a voltage midway within the swing seen at IC2d pin 13. Make repeated triggerings and adjustments of VR7 until sensitivity seems acceptable.

That's it! If all's well, attach the PCB definitively, solder the wires to sounder WD1 and remove the shunt from across resistor R22. You now might like to wear ear defenders if you've chosen a loud sounder for WD1!

Test out the circuit a few more times (sounds for about nine seconds each time), drawing around 75mA from the supply (25mA of which is lighting LED D8) and then you can screw down the lid.

## Epilogue

As a radio amateur, the author is hardly likely to go causing interference if he can help it (would that commercial designers were this aware!). A wire antenna from his sensitive communications receiver, draped over the PCB, barely picked up the internal RF. It was just heard heterodyning in the background and almost swamped by the other noises arriving at the receiver.

The completed diecast box makes a good RF seal, unlike less-secure folded sheet aluminium enclosures.

Temperature compensation is possible over a sensible room-air range. The author got to the stage where he could heat the box such that it was too hot to touch, especially underneath where the PCB is mounted. It did not false trigger, but became slightly less sensitive to the hand. You would not plan to allow such equipment to get this hot in practice.

There is no reason to deny a wide range of experiences, including the world of fine art, to the less physically fortunate in our society. This project assists, but above all, what really matters is to converse with people as individuals and not consider them as unapproachable just on the grounds of a disability. Most medical conditions are a matter of chance; you might be one of the lucky ones, but never forget that it could happen to any of us and there's no way of predicting the future. *EPE*

## Acknowledgements

The author wishes to thank Christine Mlynek who let him use her shop as a test-bed (an example of what she's had to put up with over the 20 years that they've been together!). Also his cousin Norman who, much longer than 20 years ago, unwittingly helped him realise how significant hand-capacitance effects are at these frequencies.



# Get Your



For a FREE copy of our 410+ page catalogue from Australia (You won't want to let it go!), log on to our website [www.jaycarelectronics.co.uk/catalogue](http://www.jaycarelectronics.co.uk/catalogue) All prices in £ Stg



### POST AND PACKING CHARGES:

Order Value	Cost	Order Value	Cost
£20 - £49.99	£5	£200 - £499.99	£30
£50 - £99.99	£10	£500+	£40
£100 - £199.99	£20		

Max weight 12lb (5kg). Heavier parcels POA. Minimum order £20.

## Theremin Synthesiser MKII

KC-5426 £43.50 + post, packing & VAT

By moving your hand between the metal antennae, create unusual sound effects! The Theremin MkII improves on its predecessor by allowing adjustments to the tonal quality by providing a better waveform. With a multitude of controls, this instrument's musical potential is only limited by the skill and imagination of its player. Kit includes stand, PCB with overlay, machined case with silkscreened printed lid, loudspeaker, pitch antennae, all specified electronic components and clear English instructions.

**NEW FOR '06**

Requires 9-12VDC wall adaptor (Maplin #JC91Y £14.99)

**Improved Model!**



As used in the Beach Boys classic hit 'Good Vibrations'

## Starship Enterprise™ Door Sound Simulator

KC-5423 £11.75 + post, packing & VAT

This easy-to-build kit emulates the unique noise made when the cabin doors on the Starship Enterprise™ open and close. The 'shut' noise is also duplicated. The sound emulator can be triggered by switch contacts (normally open), which means you can use a reed magnet switch, IR beam or PIR detector. Kit includes a machined, silkscreened and pre-drilled case, speaker and all electronics components with clear English instructions.

**NEW FOR '06**

Requires 9-12VDC wall adaptor (Maplin #JC91Y £14.99)



For all you Trekkie fans

## Galactic Voice Kit

KC-5431 £13.25 + post, packing & VAT

Be the envy of everyone at the next Interplanetary Conference for Evil Beings with this galactic voice simulator kit. Effect and depth controls allow you to vary the effect to simulate everything from the metallic-challenged C-3PO, to the hysterical ranting of Daleks hell-bent on exterminating anything not nailed down. The kit includes PCB with overlay, enclosure, speaker and all components. For those who really need to get out of the house a lot more. Take me to your leader.

• Requires 9V battery

**NEW FOR '06**



## Remote Control Extender Kit

KC-5209 £7.50 + post, packing & VAT

This kit will let you control a DVD or Hi-Fi system using a remote control from another room. It picks up the signal from the remote control and sends it via 2-wire cable to an infrared LED located close to the DVD or IR receiving equipment. The kit is a breeze to construct and will work with virtually any remote control system. The Jaycar kit comes complete with case with silk screened front panel, PCB, hardware and all electronic components with clear English instructions.

• 2 wire cable required

Requires 9VDC wall adaptor (Maplin #G574R £9.99)



## Battery Zapper MKII

KC-5427 £29.00 + post, packing & VAT

This kit attacks a common cause of failure in wet lead acid cell batteries: sulphation. The circuit produces short bursts of high level energy to reverse the damaging sulphation effect. This new improved unit features a battery health checker with LED indicator, new circuit protection against badly sulphated batteries, test points for a DMM and connection for a battery charger. Kit includes case with screen printed lid, PCB with overlay, all electronic components and clear English instructions.

Suitable for 6, 12 and 24V batteries

• Powered by the battery itself

**NEW FOR '06**



## Two-Way SPDIF/Toslink Digital Audio Converter Kit

KC-5425 £7.25 + post, packing & VAT

This kit converts coaxial digital audio signals into optical or vice-versa. Use this bit stream converter in situations where one piece of equipment has an optical audio input and the other a coaxial digital output. Kit includes Toslink optical modules, PCB with overlay, case with screen printed lid, all electronic components and clear English instructions.

**NEW FOR '06**

Requires 9-12VDC wall adaptor (Maplin #JC91Y £14.99)



## Universal High Energy Ignition Kit

KC-5419 £27.75 + post, packing & VAT

A high energy 0.9ms spark burns fuel faster and more efficiently to give you more power! This versatile kit can be connected to conventional points, twin points or retractor ignition systems. Kit supplied with die-cast case, PCB and all electronic components.

**NEW FOR '06**



## Voltage Monitor Kit

KC-5424 £6.00 + post, packing & VAT

This versatile kit will allow you to monitor the battery voltage, the airflow meter or oxygen sensor in your vehicle. The kit features 10 LEDs that light up in response to the measured voltage, preset 9-16V, 0-5V or 0-1V ranges complete with a fast response time, high input impedance and auto dimming for night driving. Kit includes PCB with overlay, LEDs, all electronic components and clear English instructions.

• Requires 12VDC power

**NEW FOR '06**

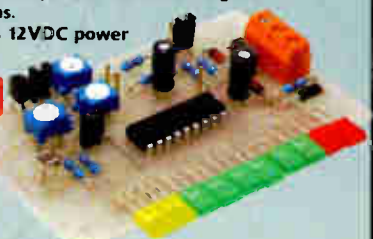

Recommended box UBS (HB-6015) £0.83 each

We stock an extensive range of quality automotive kits



# Jaws Around Our Catalogue

Once You Get Hold of It - You Won't Let Go!

## STOP PRESS STOP PRESS STOP PRESS

EPE had been publishing a series of popular kits by the acclaimed Silicon Chip Magazine Australia. These projects are brilliantly designed, 'bullet proof' and already tested down under. All Jaycar kits are supplied with specified board components, quality fibreglass tinned PCBs and have clear English instructions.

### 50MHz Frequency Meter Kit

KC-5369 £22.50 + post, packing & VAT

This meter is autoranging and displays the frequency in either hertz, kilohertz or megahertz. Features compact size (130 x 67 x 44mm), 8 digit LCD, high and low resolution modes, 0.1Hz resolution up to 150Hz, 1Hz resolution maximum up to 150Hz and 10Hz resolution above 16MHz. Kit includes PCB, case with machined and silkscreened lid, pre-programmed PIC and all electronic components with clear English instructions.

• As published in *Everyday Practical Electronics* September 2006



Requires 9VDC wall adaptor (Maplin #GS74R £9.99).

### Programmable Continuity Tester Kit

KC-5362 £8.70 + post, packing & VAT

This unit will test for continuity from 1-100ohms, making it ideal for measuring low resistance devices. It is accurate, reliable, and works extremely well. Kit supplied with PCB, case with silkscreened panel and all electronic components.

• As published in *Everyday Practical Electronics* April 2006



### Tiptronic Style Gear Indicator Kit

KC-5344 £20.30 + post, packing & VAT

This display indicates up to 9 gears, neutral and reverse. The unit is calibrated in setup, so it will work with almost any vehicle. Using a PIC microcontroller, it calculates the gear via the engine RPM and road speed. Gear indication is displayed on a 7 segment LED display, and features an automatic dimmer for night driving. Supplied with case, pre-punched silkscreened front panel, PCB and all electronic components. Hall effect sensor included!

• As published in *Everyday Practical Electronics* January 2006



### Smart Card Reader and Programmer Kit

KC-5361 £15.95 + post, packing & VAT

Program both the microcontroller and EEPROM in the popular gold, silver and emerald wafer cards. Card used need to conform to ISO-7816 standards, which includes ones sold by Jaycar. Powered by 9-12 VDC wall adaptor or a 9V battery. Instructions outline software requirements that are freely available on the internet. Kit supplied with PCB, wafer card socket and all electronic components. PCB measures: 141 x 101mm.

• As published in *Everyday Practical Electronics* May 2006

Requires 9-12VDC wall adaptor (Maplin #JC91Y £14.99)



Jaycar cannot accept responsibility for the operation of this device, its related software, or its potential to be used in relation to illegal copying of smart cards in cable TV set top boxes.

### AC/DC Current Clamp Meter Kit for DMM's

KC-5368 £8.75 + post, packing & VAT

A great low cost alternative. It uses a simple hall effect sensor, an iron ring core and connects to your digital multimeter. It will measure AC and DC current and has a calibration dial to allow for any magnetising of the core. Kit supplied with PCB, clamp, case with silkscreened front panel and all electronic components.

• As published in *Everyday Practical Electronics* January 2006



### Studio 350 High Power Amplifier Kit

KC-5372 £55.95 + post, packing & VAT

It delivers a whopping 350WRMS into 4 ohms, or 200WRMS into 8 ohms. Using eight 250V 200W plastic power transistors, it is super quiet, with a signal to noise ratio of -12.5dB(A) at full 8 ohm power. Harmonic distortion is just 0.002%, and frequency response is almost flat (less than -1dB) between 15Hz and 60kHz. Kit supplied in short form with PCB and electronic components. Kit requires heatsink and +/- 70V power supply (a suitable supply is described in the instructions).

As published in this month's *Everyday Practical Electronics Magazine*



### 2 Amp DC-DC Converter Kit

KC-5358 £13.75 + post, packing & VAT

This kit will step-up 12V to between 13.8 and 24VDC. Use it to charge 12V sealed lead acid batteries (6.5Ah or larger), run your laptop and many other devices from a 12V supply. It uses an efficient switchmode design, features fuse and reverse polarity protection, and an LED power indicator. Kit includes PCB, all electronic components, and silkscreened front panel.

• As published in *Everyday Practical Electronics* August 2006



### Audio Video Booster Kit

KC-5350 £31.95 + post, packing & VAT

This kit will boost your video and audio signals preserving them for the highest quality transmission to your projector or large screen TV. It boosts composite, S-Video and stereo audio signals. Kit includes case with silkscreened and punched panels, PCB and all electronic components.

• As published in *Everyday Practical Electronics* March 2006



Requires 9VAC wall adaptor (Maplin #GU09K £9.99).

Log on to  
[www.jaycarelectronics.co.uk/catalogue](http://www.jaycarelectronics.co.uk/catalogue)  
for your FREE catalogue!

0800 032 7241

(Monday - Friday 09.00 to 17.30 GMT + 10 hours only).  
For those who want to write: 100 Silverwater Rd  
Silverwater NSW 2128 Sydney AUSTRALIA

410+ page  
Catalogue

All prices  
in £



# Jaycar Electronics

# Ingenuity Unlimited



**WIN A PICO PC-BASED OSCILLOSCOPE WORTH £586**

- 5GS/s Dual Channel Storage Oscilloscope
- 50MHz Spectrum Analyser
- Multimeter
- Frequency Meter
- USB Interface.

If you have a novel circuit idea which would be of use to other readers then a

Pico Technology PC-based oscilloscope could be yours. Every 12 months, Pico Technology will be awarding a PicoScope 3205 digital storage oscilloscope for the best IU submission. In addition a DrDAQ Data Logger/Scope worth £59 will be presented to the runner up.

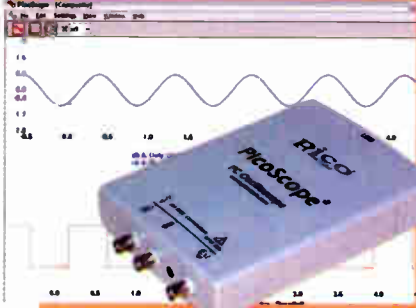

Our regular round-up of readers' own circuits. We pay between £10 and £50 for all material published, depending on length and technical merit. We're

looking for novel applications and circuit designs, not simply mechanical, electrical or software ideas. Ideas *must be the reader's own work* and must not have been published or submitted for publication elsewhere. The circuits shown have NOT been proven by us. *Ingenuity Unlimited* is open to ALL abilities, but items for consideration in this column should be typed or word-processed, with a brief circuit description (between 100 and 500 words maximum) and include a full circuit diagram showing all component values. Please draw all circuit schematics as clearly as possible. Send your circuit ideas to: *Ingenuity Unlimited*, Wimborne Publishing Ltd., 408 Wimborne Road East, Ferndown, Dorset BH22 9ND. (We do not accept submissions for IU via email.) Your ideas could earn you some cash and a prize!

## Random Colour Generator – *Rearranged Rainbows?*

**T**HE circuit diagram shown in Fig.1 was originally designed to illuminate a small translucent Santa Claus Christmas decoration, but could also be used in any number of applications, from a warning indication to a child's nightlight.

It controls one of the new RGB LEDs which contain separate red, green and blue

LEDs all housed in a single 5mm package, each having its own anode and common cathode connections, enabling you to theoretically produce any colour of the spectrum. To keep things simple, this circuit only uses seven different colours, made by having various combinations of the three LEDs illuminated at any one time at their

maximum intensity (red, green, yellow, blue, purple, cyan, white or off).

The circuit uses a 556 dual timer (although you could just as easily use two 555 timers) in astable mode. One output is at a high frequency, set by the combination of R3, R4 and C2, and is fed into the input of IC2, which is a 4040 12-stage binary count-

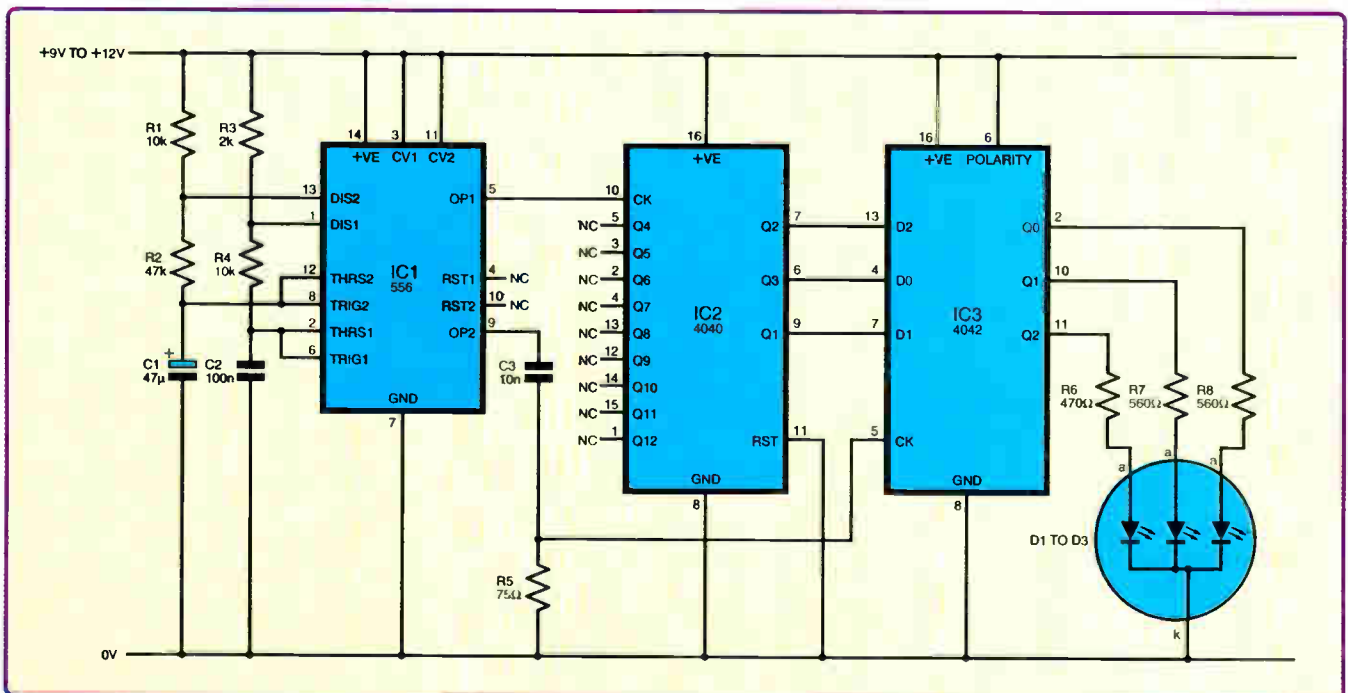

Fig.1. Complete circuit diagram for a Random Colour Generator using a tri-colour LED





# EPE IS PLEASED TO BE ABLE TO OFFER YOU THESE ELECTRONICS CD-ROMS

## ELECTRONICS PROJECTS

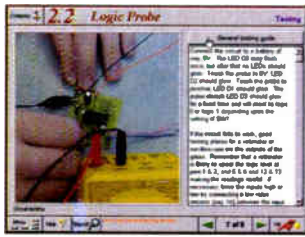

Logic Probe testing

*Electronic Projects* is split into two main sections: **Building Electronic Projects** contains comprehensive information about the components, tools and techniques used in developing projects from initial concept through to final circuit board production. Extensive use is made of video presentations showing soldering and construction techniques. The second section contains a set of ten projects for students to build, ranging from simple sensor circuits through to power amplifiers. A shareware version of Matrix's CADPACK schematic capture, circuit simulation and p.c.b. design software is included. The projects on the CD-ROM are: Logic Probe; Light, Heat and Moisture Sensor; NE555 Timer; Egg Timer; Dice Machine; Bike Alarm; Stereo Mixer; Power Amplifier; Sound Activated Switch; Reaction Tester. Full parts lists, schematics and p.c.b. layouts are included on the CD-ROM.

## ELECTRONICS CAD PACK

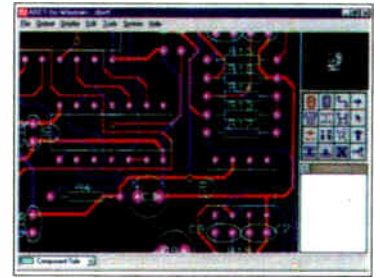

PCB Layout

Electronics CADPACK allows users to design complex circuit schematics, to view circuit animations using a unique SPICE-based simulation tool, and to design printed circuit boards. CADPACK is made up of three separate software modules. (These are restricted versions of the full Labcenter software.) **ISIS Lite** which provides full schematic drawing features including full control of drawing appearance, automatic wire routing, and over 6,000 parts. **PROSPICE Lite** (integrated into ISIS Lite) which uses unique animation to show the operation of any circuit with mouse-operated switches, pots, etc. The animation is compiled using a full mixed mode SPICE simulator. **ARES Lite** PCB layout software allows professional quality PCBs to be designed and includes advanced features such as 16-layer boards, SMT components, and an autorouter operating on user generated Net Lists.

## ELECTRONIC CIRCUITS & COMPONENTS V2.0

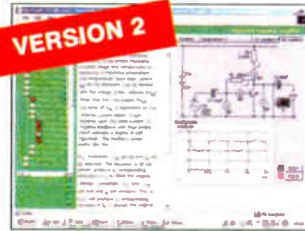

Circuit simulation screen

Provides an introduction to the principles and application of the most common types of electronic components and shows how they are used to form complete circuits. The virtual laboratories, worked examples and pre-designed circuits allow students to learn, experiment and check their understanding. Version 2 has been considerably expanded in almost every area following a review of major syllabuses (GCSE, GNVQ, A level and HNC). It also contains both European and American circuit symbols. Sections include: **Fundamentals:** units & multiples, electricity, electric circuits, alternating circuits. **Passive Components:** resistors, capacitors, inductors, transformers. **Semiconductors:** diodes, transistors, op.amps, logic gates. **Passive Circuits. Active Circuits. The Parts Gallery** will help students to recognise common electronic components and their corresponding symbols in circuit diagrams. Included in the Institutional Versions are multiple choice questions, exam style questions, fault finding virtual laboratories and investigations/worksheets.

## ANALOGUE ELECTRONICS

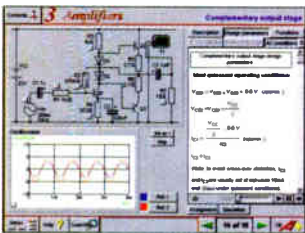

Complimentary output stage

*Analogue Electronics* is a complete learning resource for this most difficult branch of electronics. The CD-ROM includes a host of virtual laboratories, animations, diagrams, photographs and text as well as a SPICE electronic circuit simulator with over 50 pre-designed circuits. Sections on the CD-ROM include: **Fundamentals** – Analogue Signals (5 sections), Transistors (4 sections), Waveshaping Circuits (6 sections). **Op.Amps** – 17 sections covering everything from Symbols and Signal Connections to Differentiators. **Amplifiers** – Single Stage Amplifiers (8 sections), Multi-stage Amplifiers (3 sections). **Filters** – Passive Filters (10 sections), Phase Shifting Networks (4 sections), Active Filters (6 sections). **Oscillators** – 6 sections from Positive Feedback to Crystal Oscillators. **Systems** – 12 sections from Audio Pre-Amplifiers to 8-Bit ADC plus a gallery showing representative p.c.b. photos.

## ROBOTICS & MECHATRONICS



Case study of the Milford Instruments Spider

Robotics and Mechatronics is designed to enable hobbyists/students with little previous experience of electronics to design and build electromechanical systems. The CD-ROM deals with all aspects of robotics from the control systems used, the transducers available, motors/actuators and the circuits to drive them. Case study material (including the NASA Mars Rover, the Milford Spider and the Furby) is used to show how practical robotic systems are designed. The result is a highly stimulating resource that will make learning, and building robotics and mechatronic systems easier. The Institutional versions have additional worksheets and multiple choice questions.

- Interactive Virtual Laboratories
- Little previous knowledge required
- Mathematics is kept to a minimum and all calculations are explained
- Clear circuit simulations

## DIGITAL ELECTRONICS V2.0

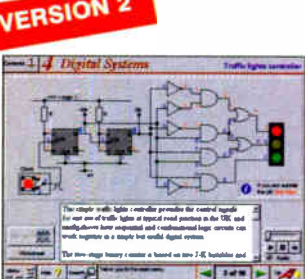

Virtual laboratory – Traffic Lights

*Digital Electronics* builds on the knowledge of logic gates covered in *Electronic Circuits & Components* (opposite), and takes users through the subject of digital electronics up to the operation and architecture of microprocessors. The virtual laboratories allow users to operate many circuits on screen. Covers binary and hexadecimal numbering systems, ASCII, basic logic gates, monostable action and circuits, and bistables – including JK and D-type flip-flops. Multiple gate circuits, equivalent logic functions and specialised logic functions. Introduces sequential logic including clocks and clock circuitry, counters, binary coded decimal and shift registers. A/D and D/A converters, traffic light controllers, memories and microprocessors – architecture, bus systems and their arithmetic logic units. Sections on Boolean Logic and Venn diagrams, displays and chip types have been expanded in Version 2 and new sections include shift registers, digital fault finding, programmable logic controllers, and microcontrollers and microprocessors. The Institutional versions now also include several types of assessment for supervisors, including worksheets, multiple choice tests, fault finding exercises and examination questions.

## ANALOGUE FILTERS

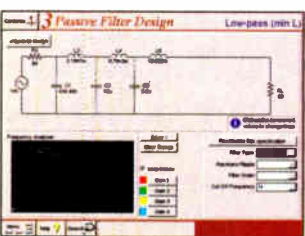

Filter synthesis

*Analogue Filters* is a complete course in designing active and passive filters that makes use of highly interactive virtual laboratories and simulations to explain how filters are designed. It is split into five chapters: **Revision** which provides underpinning knowledge required for those who need to design filters. **Filter Basics** which is a course in terminology and filter characterization, important classes of filter, filter order, filter impedance and impedance matching, and effects of different filter types. **Advanced Theory** which covers the use of filter tables, mathematics behind filter design, and an explanation of the design of active filters. **Passive Filter Design** which includes an expert system and filter synthesis tool for the design of low-pass, high-pass, band-pass, and band-stop Bessel, Butterworth and Chebyshev ladder filters. **Active Filter Design** which includes an expert system and filter synthesis tool for the design of low-pass, high-pass, band-pass, and band-stop Bessel, Butterworth and Chebyshev

## PRICES

Prices for each of the CD-ROMs above are:

(Order form on third page)

(UK and EU customers add VAT at 17.5% to "plus VAT" prices)

Hobbyist/Student .....	£45 inc VAT
Institutional (Schools/HE/FE/Industry).....	£99 plus VAT
Institutional 10 user (Network Licence).....	£249 plus VAT
Site Licence.....	£499 plus VAT



# PICmicro TUTORIALS AND PROGRAMMING

## HARDWARE

### VERSION 3 PICmicro MCU DEVELOPMENT BOARD

Suitable for use with the three software packages listed below.

This flexible development board allows students to learn both how to program PICmicro microcontrollers as well as program a range of 8, 18, 28 and 40-pin devices from the 12, 16 and 18 series PICmicro ranges. For experienced programmers all programming software is included in the PPP utility that comes with the development board. For those who want to learn, choose one or all of the packages below to use with the Development Board.

- Makes it easier to develop PICmicro projects
- Supports low cost Flash-programmable PICmicro devices
- Fully featured integrated displays – 16 individual I.e.d.s, quad 7-segment display and alphanumeric I.c.d. display
- Supports PICmicro microcontrollers with A/D converters
- Fully protected expansion bus for project work
- USB programmable
- Can be powered by USB (no power supply required)

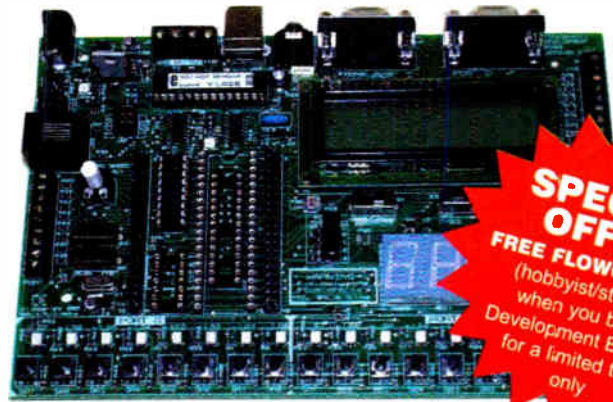

**SPECIAL OFFER**  
**FREE FLOWCODE V2**  
 (hobbyist/student)  
 when you buy a  
 Development Board –  
 for a limited time  
 only

£158 including VAT and postage

supplied with USB cable and programming software

## SOFTWARE

Suitable for use with the Development Board shown above.

### ASSEMBLY FOR PICmicro V3 (Formerly PICtutor)

Assembly for PICmicro microcontrollers V3.0 (previously known as PICtutor) by John Becker contains a complete course in programming the PIC16F84 PICmicro microcontroller from Arizona Microchip. It starts with fundamental concepts and extends up to complex programs including watchdog timers, interrupts and sleep modes. The CD makes use of the latest simulation techniques which provide a superb tool for learning: the Virtual PICmicro microcontroller. This is a simulation tool that allows users to write and execute MPASM assembler code for the PIC16F84 microcontroller on-screen. Using this you can actually see what happens inside the PICmicro MCU as each instruction is executed which enhances understanding.

- Comprehensive instruction through 45 tutorial sections
- Includes Viab, a Virtual PICmicro microcontroller: a fully functioning simulator
- Tests, exercises and projects covering a wide range of PICmicro MCU applications
- Includes MPLAB assembler
- Visual representation of a PICmicro showing architecture and functions
- Expert system for code entry helps first time users
- Shows data flow and fetch execute cycle and has challenges (washing machine, lift, crossroads etc.)
- Imports MPASM files.

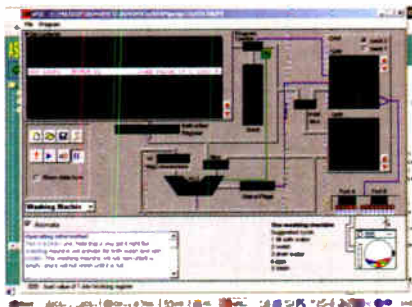

### 'C' FOR PICmicro VERSION 2

The C for PICmicro microcontrollers CD-ROM is designed for students and professionals who need to learn how to program embedded microcontrollers in C. The CD contains a course as well as all the software tools needed to create Hex code for a wide range of PICmicro devices – including a full C compiler for a wide range of PICmicro devices.

Although the course focuses on the use of the PICmicro microcontrollers, this CD-ROM will provide a good grounding in C programming for any microcontroller.

- Complete course in C as well as C programming for PICmicro microcontrollers
- Highly interactive course
- Virtual C PICmicro improves understanding
- Includes a C compiler for a wide range of PICmicro devices
- Includes full integrated Development Environment
- Includes MPLAB software
- Compatible with most PICmicro programmers
- Includes a compiler for all the PICmicro devices.

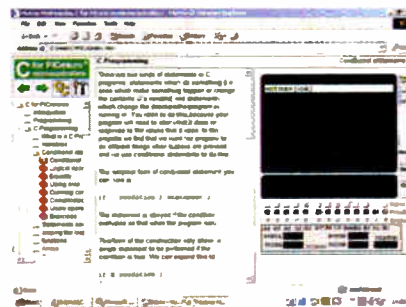

Minimum system requirements for these items: Pentium PC running Windows 98, NT, 2000, ME, XP; CD-ROM drive; 64MB RAM; 10MB hard disk space.

### FLOWCODE FOR PICmicro V2

Flowcode is a very high level language programming system for PICmicro microcontrollers based on flowcharts. Flowcode allows you to design and simulate complex robotics and control systems in a matter of minutes.

Flowcode is a powerful language that uses macros to facilitate the control of complex devices like 7-segment displays, motor controllers and I.c.d. displays. The use of macros allows you to control these electronic devices without getting bogged down in understanding the programming involved.

Flowcode produces MPASM code which is compatible with virtually all PICmicro programmers. When used in conjunction with the Version 2 development board this provides a seamless solution that allows you to program chips in minutes.

- Requires no programming experience
- Allows complex PICmicro applications to be designed quickly
- Uses international standard flow chart symbols (ISO5807)
- Full on-screen simulation allows debugging and speeds up the development process
- Facilitates learning via a full suite of demonstration tutorials
- Produces ASM code for a range of 18, 28 and 40-pin devices
- Professional versions include virtual systems (burglar alarm, buggy and maze, plus RS232, IrDa etc.).

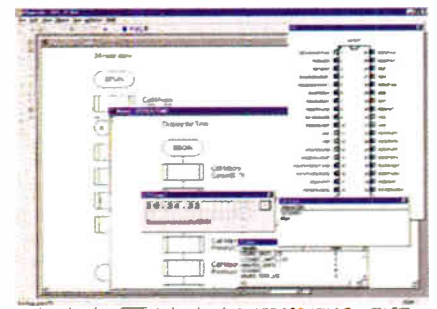

## PRICES

Prices for each of the CD-ROMs above are:

(Order form on next page)

(UK and EU customers add VAT at 17.5% to "plus VAT" prices)

Hobbyist/Student  
 Flowcode V2 Hobbyist/Student  
 Institutional (Schools/HE/FE/Industry)  
 Flowcode Professional  
 Institutional/Professional 10 user (Network Licence)  
 Site Licence

£45 inc VAT  
 £57 inc VAT  
 £99 plus VAT  
 £99 plus VAT  
 £300 plus VAT  
 £599 plus VAT

# TEACH-IN 2000 – LEARN ELECTRONICS WITH EPE

EPE's own Teach-In CD-ROM, contains the full 12-part Teach-In 2000 series by John Becker in PDF form plus the Teach-In interactive software (Win 95, 98, ME and above) covering all aspects of the series. We have also added Alan Winstanley's highly acclaimed Basic Soldering Guide which is fully illustrated and which also includes Desoldering. The Teach-In series covers: Colour Codes and Resistors, Capacitors, Potentiometers, Sensor Resistors, Ohm's Law, Diodes and L.E.D.s, Waveforms, Frequency and Time, Logic Gates, Binary and Hex Logic, Op.amps, Comparators, Mixers, Audio and Sensor Amplifiers, Transistors, Transformers and Rectifiers, Voltage Regulation, Integration, Differentiation, 7-segment Displays, L.C.D.s, Digital-to-Analogue. Each part has an associated practical section and the series includes a simple PC interface (Win 95, 98, ME ONLY) so you can use your PC as a basic oscilloscope with the various circuits.

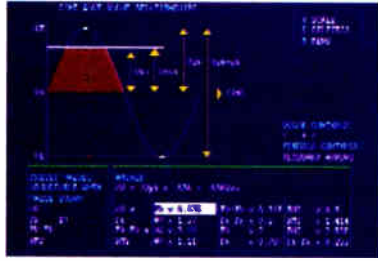

Sine wave relationship values

**FREE TWO BOOKLETS PLUS CD-ROM WITH TEACH-IN 2000**



**A hands-on approach to electronics with numerous breadboard circuits to try out. £12.45 including VAT and postage.** Requires Adobe Acrobat (available free from the Internet – [www.adobe.com/acrobat](http://www.adobe.com/acrobat)).

**FREE WITH EACH TEACH-IN CD-ROM** – *Understanding Active Components* booklet, *Identifying Electronic Components* booklet and *The Best Of Circuit Surgery* CDROM.

# DIGITAL WORKS 3.0

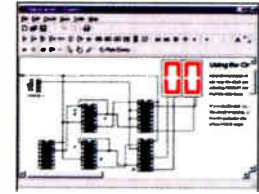

Counter project

*Digital Works Version 3.0* is a graphical design tool that enables you to construct digital logic circuits and analyze their behaviour. It is so simple to use that it will take you less than 10 minutes to make your first digital design. It is so powerful that you will never outgrow its capability ● Software for simulating digital logic circuits ● Create your own macros – highly scalable ● Create your own circuits, components, and i.c.s ● Easy-to-use digital interface ● Animation brings circuits to life ● Vast library of logic macros and 74 series i.c.s with data sheets ● Powerful tool for designing and learning. **Hobbyist/Student £45 inc. VAT. Institutional £99 plus VAT. Institutional 10 user £249 plus VAT. Site Licence £599 plus VAT.**

## PROJECT DESIGN WITH CROCODILE TECHNOLOGY

An Interactive Guide to Circuit Design

An interactive CD-ROM to guide you through the process of circuit design. Choose from an extensive range of input, process and output modules, including CMOS Logic, Op-Amps, PIC/PICAXE, Remote Control Modules (IR and Radio), Transistors, Thyristors, Relays and much more. Click Data for a complete guide to the pin layouts of i.c.s, transistors etc. Click More Information for detailed background information with many animated diagrams. Nearly all the circuits can be instantly simulated in Crocodile Technology\* (not included on the CD-ROM) and you can customise the designs as required.

### WHAT'S INCLUDED

Light Modules, Temperature Modules, Sound Modules, Moisture Modules, Switch Modules, Astables including 555, Remote Control (IR & Radio), Transistor Amplifiers, Thyristor, Relay, Op-Amp Modules, Logic Modules, 555 Timer, PIC/PICAXE, Output Devices, Transistor Drivers, Relay Motor Direction & Speed Control, 7 Segment Displays. Data sections with pinouts etc., Example Projects, Full Search Facility, Further Background Information and Animated Diagrams.

### Runs in Microsoft Internet Explorer

\*All circuits can be viewed, but can only be simulated if your computer has Crocodile Technology version 410 or later. A free trial version of Crocodile Technology can be downloaded from: [www.crocodile-clips.com](http://www.crocodile-clips.com). Animated diagrams run without Crocodile Technology.

**Single User £39.00 inc. VAT.**

**Multiple Educational Users (under 500 students) £59.00 plus VAT. Over 500 students £79.00 plus VAT.**

(UK and EU customers add VAT at 17.5% to "plus VAT" prices)

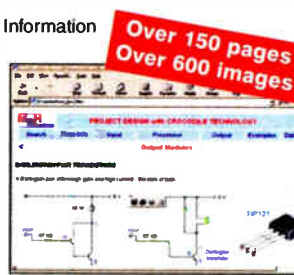

## ELECTRONIC COMPONENTS PHOTOS

A high quality selection of over 200 JPG images of electronic components. This selection of high resolution photos can be used to enhance projects and presentations or to help with training and educational material. They are royalty free for use in commercial or personal printed projects, and can also be used royalty free in books, catalogues, magazine articles as well as worldwide web pages (subject to restrictions – see licence for full details). Also contains a FREE 30-day evaluation of Paint Shop Pro 6 – Paint Shop Pro image editing tips and on-line help included!

**Price £19.95 inc. VAT**

Minimum system requirements for these CD-ROMs: Pentium PC, CD-ROM drive, 32MB RAM, 10MB hard disk space. Windows 95/98/NT/2000/ME/XP, mouse, sound card, web browser.

### Please send me: CD-ROM ORDER FORM

- Electronic Projects
- Electronic Circuits & Components V2.0
- Analogue Electronics
- Digital Electronics V2.0
- Analogue Filters
- Electronics CAD Pack
- Robotics & Mechatronics
- Assembly for PICmicro V3
- 'C' for PICmicro V2
- Flowcode V2 for PICmicro
- Digital Works 3.0

### Version required:

- Hobbyist/Student
- Institutional
- Institutional/Professional 10 user
- Site licence



- PICmicro Development Board V3 (hardware)

- Teach-In 2000 + FREE BOOK
- Electronic Components Photos
- Project Design – Single User
- Project Design – Multiple User (under 500 students)
- Project Design – Multiple User (over 500 students)

Note: The software on each version is the same, only the licence for use varies.

Full name: .....

Address: .....

..... Post code: ..... Tel. No: .....

Signature: .....

I enclose cheque/PO in £ sterling payable to WIMBORNE PUBLISHING LTD for £

Please charge my Visa/Mastercard/Amex/Diners Club/Switch: £

Valid From: ..... Card expiry date: .....

Card No: ..... Switch Issue No. ....

Card Security Code ..... (The last 3 digits on or just under the signature strip)

## ORDERING ALL PRICES INCLUDE UK POSTAGE

Student/Single User/Standard Version price includes postage to most countries in the world  
EU residents outside the UK add £5 for airmail postage per order

**Institutional, Multiple User and Deluxe Versions** – overseas readers add £5 to the basic price of each order for airmail postage (do not add VAT unless you live in an EU (European Union) country, then add 17½% VAT or provide your official VAT registration number).

Send your order to:  
**Direct Book Service**  
Wimborne Publishing Ltd  
408 Wimborne Road East  
Ferndown, Dorset BH22 9ND

To order by phone ring  
**01202 873872. Fax: 01202 874562**

Goods are normally sent within seven days

E-mail: [orders@wimborne.co.uk](mailto:orders@wimborne.co.uk)

Online shop:  
[www.epemag.wimborne.co.uk/shopdoor.htm](http://www.epemag.wimborne.co.uk/shopdoor.htm)



# ELECTRONICS MANUALS ON CD-ROM £29.95 EACH

## ELECTRONICS SERVICE MANUAL

## THE MODERN ELECTRONICS MANUAL

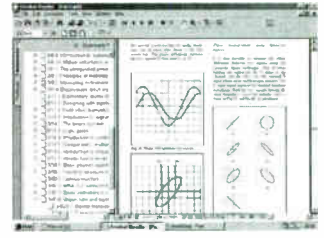
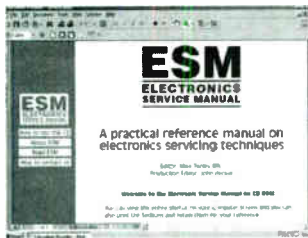

**SPECIAL OFFER**  
Order both Manuals together and **SAVE £10**

### Everything you need to know to get started in repairing electronic equipment

- Around 900 pages • Fundamental principles • Troubleshooting techniques • Servicing techniques • Choosing and using test equipment • Reference data • Manufacturers' web links
- Easy-to-use Adobe Acrobat format • Clear and simple layout
- Vital safety precautions • Professionally written • Supplements

**SAFETY:** Safety Regulations, Electrical Safety and First Aid.  
**UNDERPINNING KNOWLEDGE:** Electrical and Electronic Principles, Active and Passive Components, Circuit Diagrams, Circuit Measurements, Radio, Computers, Valves and Manufacturers' Data, etc.  
**PRACTICAL SKILLS:** Learn how to identify Electronic Components, Avoid Static Hazards, Carry Out Soldering and Wiring, Remove and Replace Components.  
**TEST EQUIPMENT:** How to Choose and Use Test Equipment, Assemble a Toolkit, Set Up a Workshop, and Get the Most from Your Multimeter and Oscilloscope, etc.  
**SERVICING TECHNIQUES:** The Manual includes vital guidelines on how to Service Audio Amplifiers. The Supplements include similar guidelines for Radio Receivers, TV Receivers, Cassette Recorders, Video Recorders, Personal Computers, etc.  
**TECHNICAL NOTES:** Commencing with the IBM PC, this section and the Supplements deal with a very wide range of specific types of equipment – radios, TVs, cassette recorders, amplifiers, video recorders etc.  
**REFERENCE DATA:** Diodes, Small-Signal Transistors, Power Transistors, Thyristors, Triacs and Field Effect Transistors. Supplements include Operational Amplifiers, Logic Circuits, Optoelectronic Devices, etc.

### The essential reference work for everyone studying electronics

- Over 800 pages • In-depth theory • Projects to build • Detailed assembly instructions • Full components checklists • Extensive data tables • Manufacturers' web links
- Easy-to-use Adobe Acrobat format • Clear and simple layout • Comprehensive subject range • Professionally written • Supplements

**BASIC PRINCIPLES:** Electronic Components and their Characteristics; Circuits Using Passive Components; Power Supplies; The Amateur Electronics Workshop; The Uses of Semiconductors; Digital Electronics; Operational Amplifiers; Introduction to Physics, including practical experiments; Semiconductors and Digital Instruments.

**CIRCUITS TO BUILD:** The Base Manual describes 12 projects including a Theremin and a Simple TENS Unit.

**ESSENTIAL DATA:** Extensive tables on diodes, transistors, thyristors and triacs, digital and linear i.c.s.

**EXTENSIVE GLOSSARY:** Should you come across a technical word, phrase or abbreviation you're not familiar with, simply look up the glossary and you'll find a comprehensive definition in plain English.

The Manual also covers **Safety** and provides web links to component and equipment **Manufacturers and Suppliers**.

Full contents list available online at: [www.epemag.wimborne.co.uk](http://www.epemag.wimborne.co.uk)

**SUPPLEMENTS:** Additional CD-ROMs each containing approximately 500 pages of additional information on specific areas of electronics are available for £19.95 each. Information on the availability and content of each Supplement CD-ROM will be sent to you.

**Presentation:** CD-ROM suitable for any modern PC. Requires Adobe Acrobat Reader which is included on the CD-ROM.

Wimborne Publishing Ltd., 408 Wimborne Road East, Ferndown, Dorset BH22 9ND. Tel: 01202 873872. Fax: 01202 874562.

**PLEASE** send me



THE MODERN ELECTRONICS MANUAL CD-ROM

ELECTRONICS SERVICE MANUAL CD-ROM

I enclose payment of £29.95 (for one Manual) or £49.90 for both Manuals (saving £10 by ordering both together).

FULL NAME .....  
(PLEASE PRINT)

ADDRESS .....

.....

.....

..... POSTCODE .....

SIGNATURE .....

I enclose cheque/PO in UK pounds payable to Wimborne Publishing Ltd.

Please charge my Visa/Mastercard/Amex/Diners Club/Switch/Maestro

Card No ..... Switch/Maestro Issue No .....

Valid From ..... Expiry Date .....

Card Security Code ..... (The last 3 digits on or just under the signature strip)

## ORDER FORM

Simply complete and return the order form with your payment to the following address:

Wimborne Publishing Ltd,  
408 Wimborne Road East, Ferndown,  
Dorset BH22 9ND

Price includes postage to anywhere in the World

We will happily exchange any faulty CD-ROMs but since the content can be printed out we do not offer a refund on these items.

**Your CD-ROM(s) will be posted to you by first class mail or airmail, normally within four working days of receipt of your order**

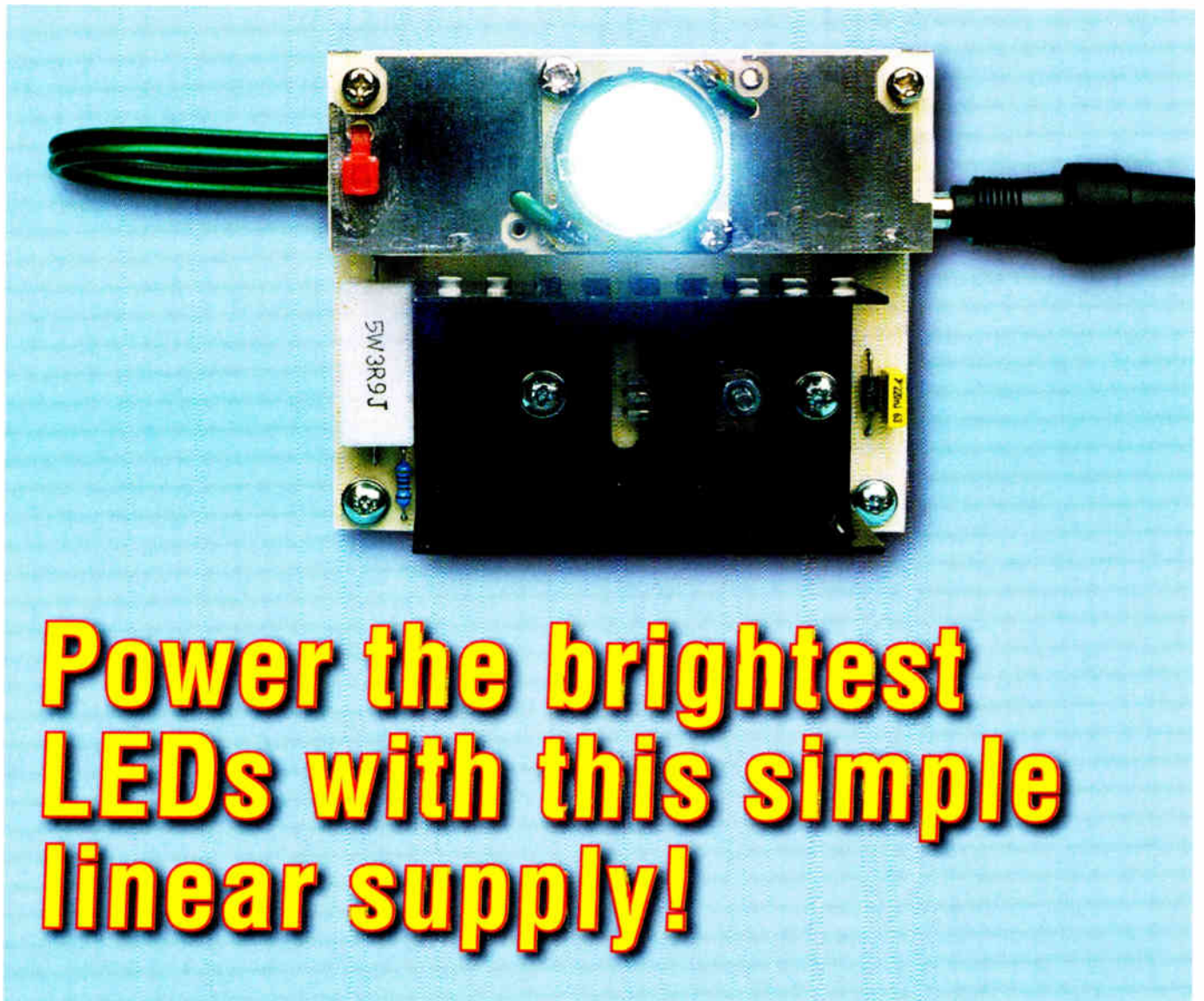

# Power the brightest LEDs with this simple linear supply!

**Want to run one or more Luxeon 1W Star/0 white LEDs from a 12V battery or a DC plugpack? This circuit allows you to do it and allows for dimming as well. It uses bog-standard parts, including a 555 timer and two three-terminal regulators.**

By PETER SMITH

**O**UR sophisticated *High Intensity Torch* project (published in our August 2006 issue) employed a PIC microcontroller to drive a Luxeon Star LED but the circuit was limited to a 3V to 6V supply. The simple design presented here uses conventional components, thus avoiding any programming, and can be supplied

with 7.5V to 24V DC; it will also drive up to four 1W Stars in series.

Unlike the (much) smaller 3mm and 5mm LEDs that we're all familiar with, driving these Luxeon Star devices with just a series current-limiting resistor can be a bit risky. A better way is to power them from a constant current source, to achieve full brightness with-

out exceeding maximum ratings.

This simple circuit will allow you to drive the 1W version (any colour) with the maximum rated current and keep it cool as well. It also gives you control over LED brightness, which can be varied from about 10% to 100% with an on-board potentiometer.

### How it works

The circuit diagram for the power supply appears in Fig.1. It consists of two main elements – a current source and a variable duty cycle oscillator. Let's examine the current source first – it uses a LM317 3-terminal regulator (REG1). Commonly, these regulators are programmed with two resistors to provide a particular output voltage, as shown in Fig.2. To maintain the programmed output voltage, the regulator keeps the difference between



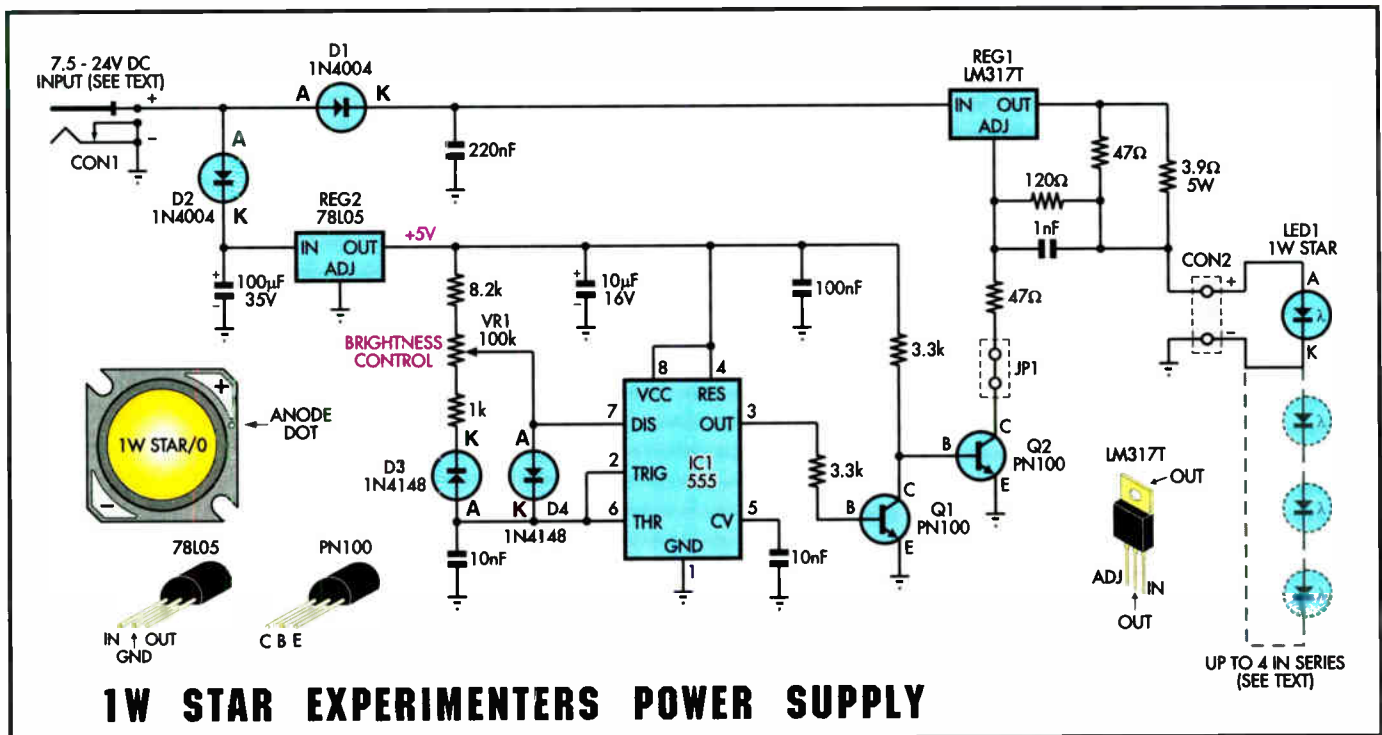

Fig.1: the "Star" power supply circuit is based on an LM317 regulator and a 555 timer IC. The regulator is connected as a 350mA constant current source, with its "on" time varied by the 555 to control LED brightness.

### Main Features

- Simple construction
- Variable LED brightness
- Plugpack or battery powered
- Drives 1 to 4 x 1W Luxeon Stars

its 'ADJ' and 'OUT' terminals equal to an internal 1.25V reference.

Fig.3 shows that without the resistor to ground (R2), the regulator still maintains 1.25V across R1. But rather than a regulated voltage, we now have a constant current source proportional to 1.25V/R1.

Calculating R1 for our 350mA Star is easy:

$$R1 = 1.25V / 350mA = 3.57\Omega$$

Referring again to the main circuit (Fig.1), you can see that "R1" consists of 3.9Ω and 47Ω resistors in parallel, for a total resistance of 3.6Ω. Unlike the simple schematic in Fig.3, the output is connected back to the 'ADJ' pin via a 120Ω resistor. This additional resistor has virtually no effect on the programmed current and its purpose will become clear in a moment.

For our description thus far, we've assumed that jumper link JP1 is open circuit. But what happens when it's shorted? Well, when transistor Q2 switches on, the LM317 begins to regulate the output voltage (instead of current), with the 120Ω and 47Ω resistors forming "R1" & "R2" as depicted in Fig.2. The output voltage will be:

$$V_{OUT} = 1.25V(1 + 47\Omega/120\Omega) = 1.7V$$

Taking into account Q2's collector to emitter saturation voltage, the output

voltage is slightly higher than our calculated value. However, it's still less than the minimum forward voltage of the red/amber and white/blue Stars (about 2.3V and 2.8V respectively), so the LED will be switched off.

### Pulse-width modulation

Rather than reducing drive current, Luxeon recommends using pulse width modulation (PWM) switching to reduce the brightness of the Star. This results in a much more colour-uniform light output, right down to minimum brightness. If you just vary the drive voltage in a linear fashion, the Star's light output tends to become yellowish as the drive voltage is reduced.

PWM switching is just a matter of switching the LED on and off at a fixed

frequency and varying the duty cycle (on/off time) to vary brightness. With a high enough frequency, the switching effects are invisible. This is due to the long persistence of the phosphors (in white LEDs) and the natural light integration of the human eye.

As you've probably guessed, transistor Q2 in our circuit is responsible for switching the current source (REG1) to give PWM control. Transistor Q2 is driven by Q1, which is simply a buffer and inverter stage. The real work is performed by IC1, an old 555 workhorse.

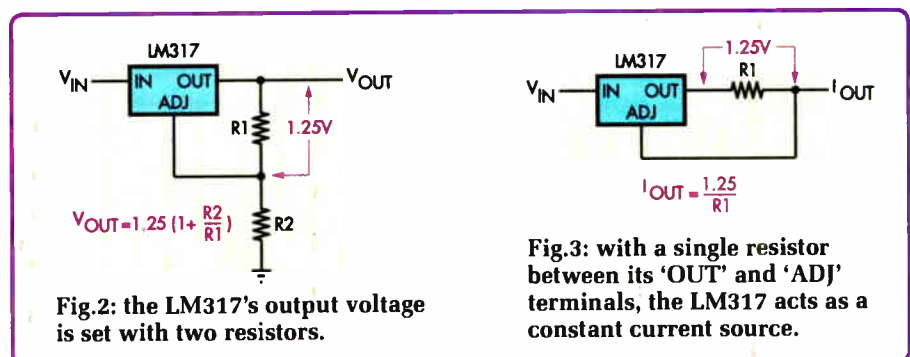

# Constructional Project

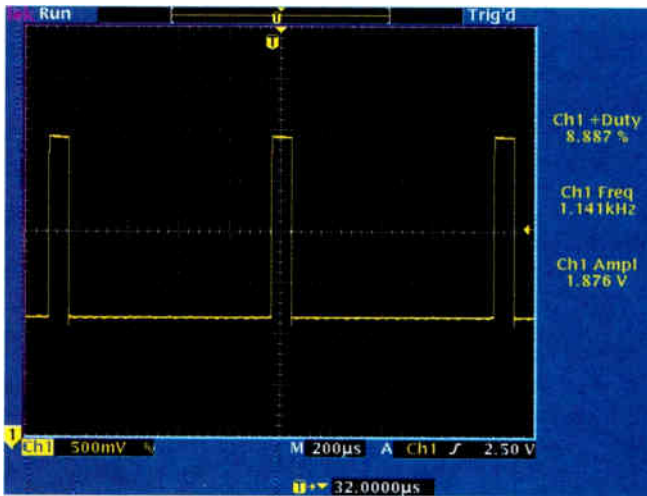

Fig.4: these two waveforms were captured at the output of the supply. With the brightness pot (VR1) set to minimum resistance, only 9% of the power is delivered to the LED.

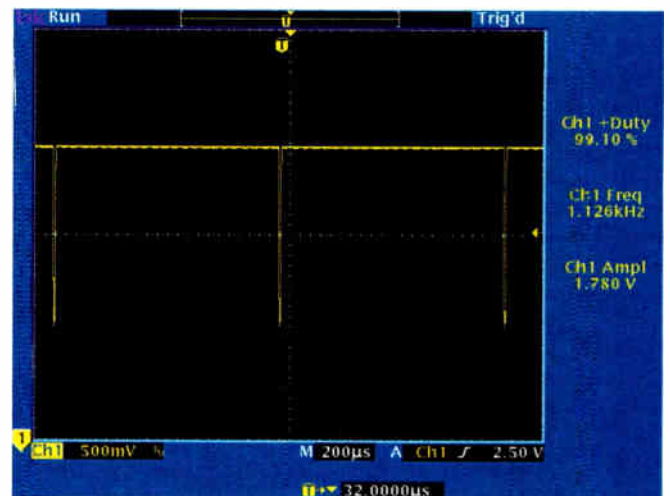

Fig.5: when trimpot VR1 is at the maximum setting, a duty cycle of 99% drives the LED at virtually full brilliance.

IC1 is configured as a free-running oscillator (or “astable multivibrator”) with a nominal frequency of about 1.1kHz. Diodes D3 & D4 provide independent charge and discharge paths for the 10nF capacitor, allowing the duty cycle to be controlled without much variation in the frequency of oscillation.

As a result, trimpot VR1 can vary the duty cycle from 9% to 99% (see Figs.4 & 5), resulting in an average current of between about 30mA and 346mA. Even at minimum brightness, you can still read a book by one of these little marvels!

When driving three or four LEDs in series, the circuit input voltage can exceed 18V (the 555’s max. supply voltage), so we’ve provided a separate +5V supply for IC1 and associated circuitry. This is generated by REG2, a 78L05 +5V low-power regulator.

Supply input to REG1 and REG2 is via series diodes D1 and D2, ensuring nothing bad happens if the supply is accidentally reversed.

### Input power (single LED)

For a single Star, the input voltage should be between 7.5V and 12.5V. This means that you can drive it from

a 7.5V or 9V plugpack (min. 500mA rating), or a 12V SLA battery. 12V plugpacks are generally not suitable, because they put out excessively high voltages when lightly loaded.

The maximum input voltage that can be applied is limited by available power dissipation. When properly mounted on the specified heatsink, the temperature rise of regulator REG1 is about 25°C above ambient with a 12.5V input. This is well within the regulator’s rating and the heatsink won’t burn your fingers or start a fire!

The minimum input voltage is governed by circuit overhead (about 3.9V) and the LED’s forward voltage (about 3.4V for white or blue Stars). So for a single white or blue Star, about 7.3V minimum is required to obtain full brilliance.

### Driving multiple Stars

Up to four stars (any colour) can be driven in series. The recommended voltage ranges are shown in Table 3. This should be considered as a rough guide only, as the total voltage across any LED string will vary considerably, according to LED colour and individual device characteristics.

The optimum input voltage can be established using a variable power supply. When the LEDs just reach maximum brilliance, the minimum input voltage has been established. Alternatively, monitor the voltage drop across the 3.9Ω resistor while slowly increasing the input voltage. When it reaches 1.25V, the LM317 is in regulation and therefore sourcing the full 350mA.

Using a lower voltage than recommended will result in less than maximum brightness, whereas higher voltages may (eventually) overheat the assembly.

The LM317 regulator has in-built over-temperature protection and can survive short-term abuse. However, extended high temperatures will eventually destroy it and burn (or delaminate) the PC board.

Table 2: Capacitor Codes

Value	µF Code	EIA Code	IEC Code
220nF	0.22µF	224	220n
100nF	0.1µF	104	100n
10nF	0.01µF	103	10n
1nF	0.001µF	102	1n

Table 1: Resistor Colour Codes

No.	Value	4-Band Code (1%)	5-Band Code (1%)
2	3.3kΩ	orange orange red brown	orange orange black brown brown
2	1kΩ	brown black red brown	brown black black brown brown
1	120Ω	brown red brown brown	brown red black black brown
2	47Ω	yellow violet black brown	yellow violet black gold brown



If the heatsink is too hot to touch, then the input voltage is too high!

**Note: do not attempt to drive these LEDs in parallel.** Although possible, parallel configurations require voltage-matched devices.

## Power supply board assembly

All parts (except for the LED) mount on a single PC board, code 588A/B. Using the overlay diagram in Fig.6 as a guide, begin by installing the two wire links, followed by the 0.25W resistors.

Diodes D1 to D4 can go in next, making sure that you have the cathode (banded) ends oriented as shown. Follow up with the two transistors (Q1 & Q2), 78L05 regulator (REG2) and trimpot (VR1).

All remaining components, apart from the LM317 (REG1) and its heatsink, can now be installed. Note that the 555 timer (IC1) and electrolytic capacitors (100µF & 10µF) must go in the right way around.

The final step involves mounting the heatsink and installing regulator REG1. To do this, first secure the heatsink firmly to the PC board with two M3 × 6mm screws, nuts and flat washers. Next, bend the regulator's leads at 90° about 3mm from the body and temporarily slip it into position, correctly orientated.

Verify that the hole in the regulator's tab lines up with the hole in the heatsink, which should in turn match the hole in the PC board underneath. If all is well, you can now remove the regulator and apply a thin smear of heatsink compound to both the rear of the metal tab and the mating area on the heatsink surface.

Finally, slip the regulator back into position and fasten it securely to the heatsink & PC board with an M3 × 10mm screw, nut and washer. Solder and trim the regulator leads to complete the job.

**Note: the metal tab of the regulator is internally connected to the "OUT" terminal, so the heatsink will be live. The LED (and any other uninsulated wiring) must not be allowed to make contact with the heatsink! If you don't like this idea, then you can mount the regulator on the heatsink using an insulating pad and washer. The down-side to this arrangement is higher regulator temperature.**

## LED mounting

The Star's emitter and collimating optics are mounted directly onto an

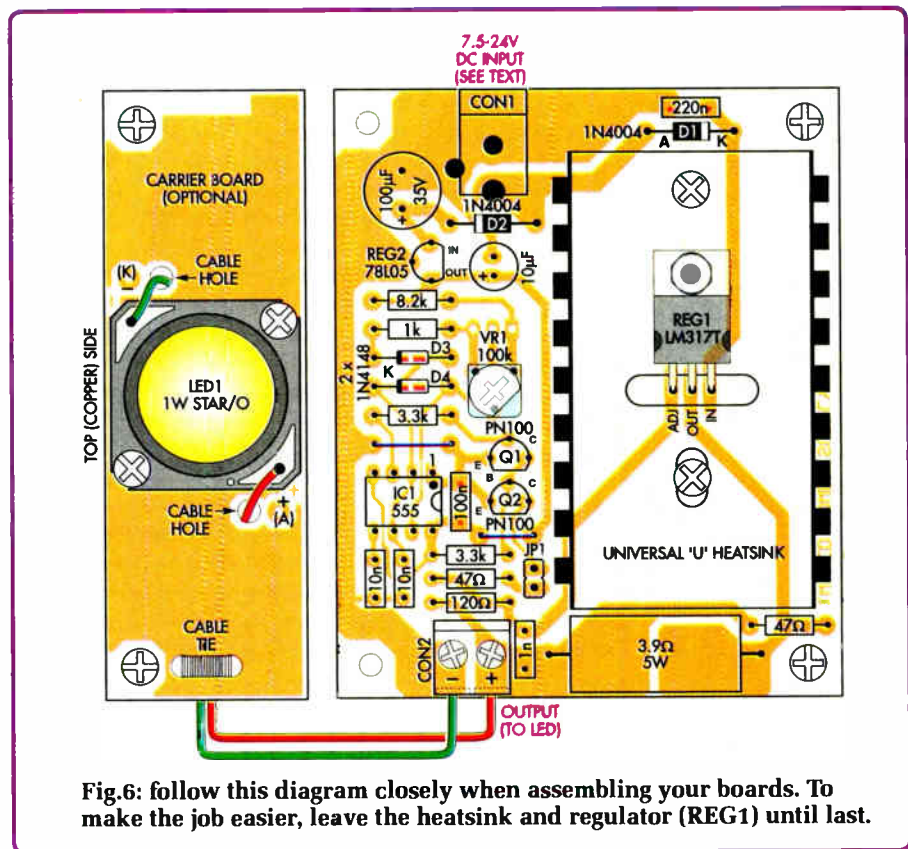

**Fig.6: follow this diagram closely when assembling your boards. To make the job easier, leave the heatsink and regulator (REG1) until last.**

This view shows the completed power supply PC board, prior to fitting the LED carrier board. The heatsink keeps REG1 cool.

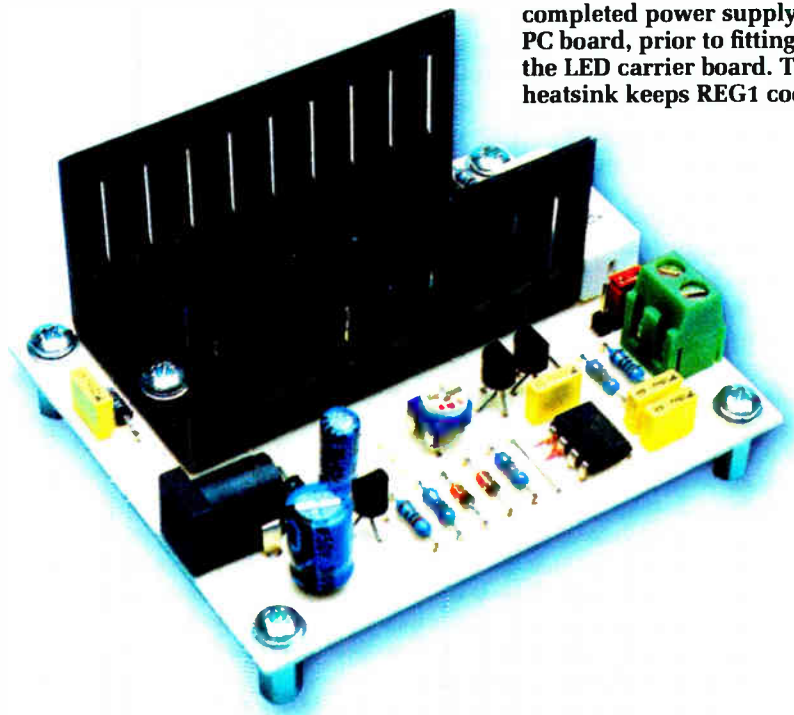

aluminium-cored PC board. In most cases, no additional heatsinking is required. However, a small heatsink reduces junction temperature sig-

nificantly and ensures maximum LED life.

Just about any small aluminium heatsink with a flat area large enough

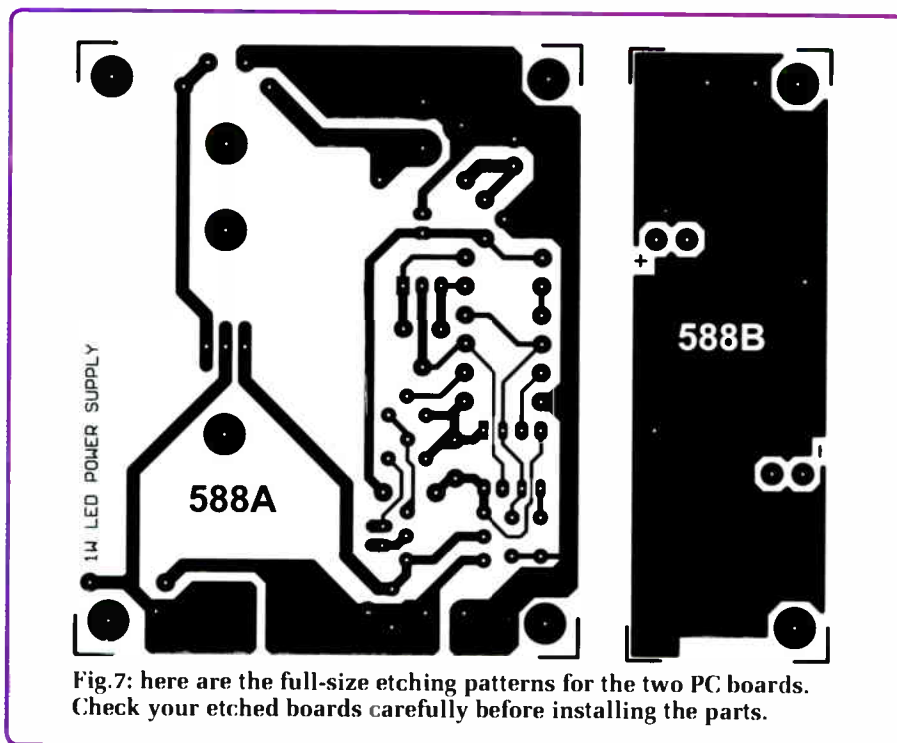
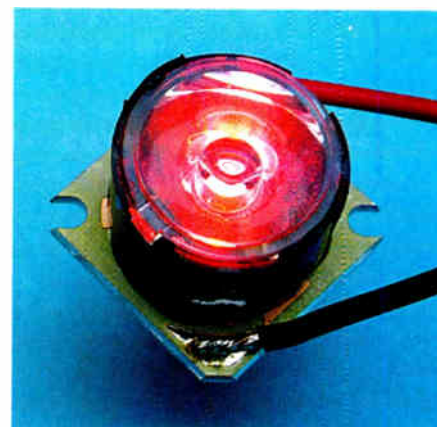

Fig.7: here are the full-size etching patterns for the two PC boards. Check your etched boards carefully before installing the parts.



The 1W Star/O LED module is available in seven colours: white, green, cyan, blue, royal blue, red and amber. They can all be driven by this constant current power supply.

to accommodate the Star's 25mm footprint can be pressed into service. For example, an old 486 PC processor heatsink would probably be ideal!

For experimentation purposes, an area of PC board copper also does the job nicely. This is the purpose of our simple "carrier" board, which also provides a convenient mounting and terminating method for the LED module.

### LED carrier board assembly

Before mounting the LED module, make sure that the mating surface is completely smooth. If there are any "lumps" of solder, then they must be removed using desoldering braid.

Apply a thin smear of heatsink compound to the rear of the LED module as well as to the mating surface (copper side) of the PC board. The module can then be attached to the PC board using two M3 x 6mm screws, nuts & washers.

With opposing corner holes (see photo), the module can be mounted one of two ways. To determine the correct orientation, look for a tiny copper "dot"

next to one of the corner solder pads. This indicates the anode (A) or positive (+) connection and should be aligned as shown on the overlay diagram (Fig.6).

Once mounted, all that remains is to wire up the LED anode (A) and cathode (K) terminals, provided in the form of two solder pads on opposite corners of the module's PC board.

Solder a short length (about 15cm) of wire to one of the pads and pass it through the neighbouring hole in the carrier board. Repeat for the opposite pad and then twist the two wires together under the board. Secure at the end of the carrier board with a small cable tie to ensure that no tension can be applied to the solder joints.

Before connecting your LED to the power supply output terminals, it's important to verify that the supply is working properly. A faulty supply could destroy your investment in a blinding flash!

### Testing

Connect a 10Ω 5W resistor directly across the power supply output terminals.

Position the body of the resistor so that it is clear of your workbench (and your pinkies!), as it could get extremely hot. If you fitted a jumper shunt on JP1 earlier, remove it for now.

Plug in your chosen DC power source and hit the "go" switch. Assuming there are no ominous bangs or puffs of smoke, use your multimeter to measure the voltage drop across the 10Ω resistor. If the supply is sourcing the expected 350mA (nominal) of current, your measurement should fall within the 3.2V to 3.8V range.

Power off, disconnect the test resistor and then re-apply power. Measure the voltage between pins 1 & 8 of the 555 (IC1). These are the power supply pins, so your meter should read 5V or thereabouts.

All done! Assuming your board passed the tests, hook up the LED leads to the output terminals. Be particularly careful that the anode (A) terminal of the LED connects to the positive (+) output, as the LED module will be destroyed if reverse voltage is applied.

Hold your breath and power up. **DO NOT** stare directly into the LED's beam at close range, as it is (according to Luxeon) bright enough to damage your eyesight!

### Brightness control

To enable brightness control, install a jumper shunt on JP1. Now by rotating trimpot VR1, you should be able to vary LED intensity from dim to almost full brightness.

### LED carrier board mounting

To make a neat "one-piece" module, the LED carrier board can be mounted

Table 3: A Rough Guide To Input Voltage Ranges

No. of Stars	Min. Voltage	Max. Voltage
1	7.3V	12.5V
2	10.7V	15.9V
3	14.1V	19.3V
4	17.5V	22.7V



## Parts List – 1W Star/O PSU

- 1 PC board, code 588A/B  
available from the *EPE PCB Service*, 80mm x 66mm
- 1 2.5mm PC-mount DC socket
- 1 2-way 2.54mm terminal block
- 1 2-way 2.54mm SIL header
- 1 jumper shunt
- 1 Universal 'U' heatsink
- 4 M3 x 10mm tapped spacers
- 1 M3 x 10mm pan-head screw
- 6 M3 x 6mm pan-head screws
- 6 M3 flat washers
- 3 M3 nuts
- Red & black light-duty hook-up wire
- Heatsink compound
- 1 9V DC 500mA (min.) plugpack  
(see text)
- 1 100k $\Omega$  miniature horizontal  
trimpot

### Semiconductors

- 1 LM317T adjustable voltage  
regulator (REG1)
- 1 78L05 +5V regulator (REG2)
- 1 555 timer IC (IC1)
- 2 PN100 NPN transistors (Q1,  
Q2)
- 2 1N4004 rect. diodes (D1, D2)
- 2 1N4148 signal diodes (D3, D4)
- 1 1W Luxeon Star/O LED  
w/optics (see text)

### Capacitors

- 1 100 $\mu$ F 35V PC electrolytic
- 1 10 $\mu$ F 16V PC electrolytic
- 1 220nF 63V MKT polyester
- 1 100nF 63V MKT polyester
- 2 10nF 63V MKT polyester
- 1 1nF 63V MKT polyester

### Resistors (0.25W, 1%)

- 2 3.3k $\Omega$       1 120 $\Omega$
- 1 8.2k          2 47 $\Omega$
- 1 1k $\Omega$         1 3.9 $\Omega$  5W 5%
- 1 10 $\Omega$  5W 5% (for testing)

### Parts for optional LED carrier

- 2 M3 x 15mm untapped brass or  
nylon spacers
- 2 M3 x 25mm pan-head screws
- 4 M3 x 6mm pan-head screws
- 6 M3 nuts
- 4 M3 flat washers
- 1 small cable tie

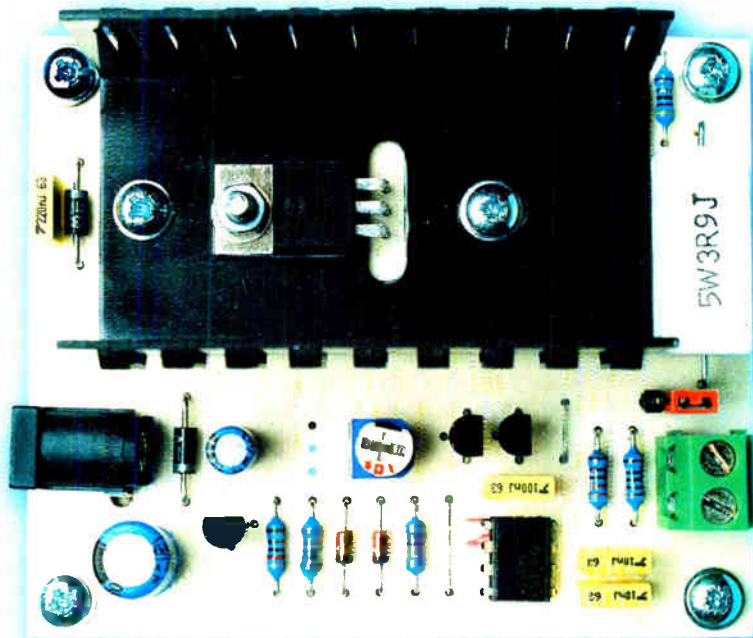

Take care to ensure that all polarised parts are correctly oriented when building the power supply PC board. Note that this prototype PC board differs slightly from the final version shown in Fig.6.

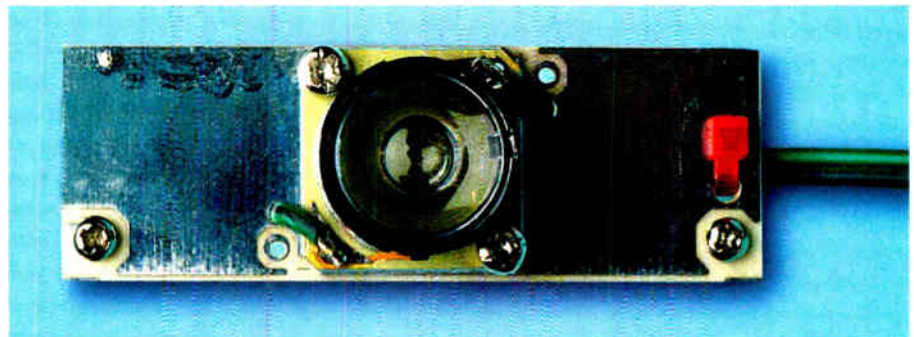

The completed LED carrier board provides a convenient method for mounting the 1W Star LED module and also provides heatsinking.

piggyback style on the power supply board. (See heading photograph.)

To do this, insert an M3 x 25mm screw in one corner hole and slide on a 15mm spacer from the bottom. Wind up an M3 nut to hold the spacer in place, then repeat for the other corner. The completed assembly can now be slipped into place in the two corner holes of the power supply board, replacing the existing M3 x 6mm screws (see photos).

With the carrier board installed, you'll note that the brightness trimpot (VR1) is no longer easily accessible. If you need to continually vary the brightness with the board in-situ, then you can either reposition the trimpot to the opposite (copper) side of the board or install an external potentiometer.

When installing an external pot, keep the wire lengths as short as possible (say, no more than about 50mm) and twist the three connecting wires tightly together.

Lumileds also manufacture higher output Stars. Naturally, these devices are more expensive than the 1W versions and require more elaborate heatsinking. Their higher current requirements (up to 700mA) make them unsuitable for use with this supply.

Detailed technical information on Luxeon Star LEDs can be obtained from the Lumileds web site at [www.lumileds.com](http://www.lumileds.com). **EPE**

Reproduced by arrangement with  
SILICON CHIP magazine 2006.  
[www.siliconchip.com.au](http://www.siliconchip.com.au)

# Build Your Own Weather Station



- ▶ Measure Wind Speed
- ▶ Measure Wind Direction
- ▶ Measure Temperature
- ▶ Easy Build Kit
- ▶ FREE Software
- ▶ USB or RS232
- ▶ Optional Humidity Module
- ▶ Optional Pressure Module
- ▶ Optional Rainfall Gauge
- ▶ Simple 1-wire® connection
- ▶ Build and add your own devices

Weather Starter Kit £59  
 RS232 Interface £25  
 USB Interface £29  
 Humidity Module £39  
 Pressure Module £49  
 Rainfall Gauge £59

Prices exclude VAT and delivery

For more information, manuals and downloads on this and other interesting products see [www.audon.co.uk](http://www.audon.co.uk)

**audon** Electronics

[www.audon.co.uk](http://www.audon.co.uk) | +44 (0)115 925 8412 | Fax +44 (0)115 925 9757

## SHERWOOD ELECTRONICS

### FREE COMPONENTS

Buy 10 x £1 Special Packs and choose another one FREE

SP1 15 x 5mm Red LEDs	SP135 5 x Miniature slide switches
SP2 12 x 5mm Green LEDs	SP136 3 x BFY50 transistors
SP3 12 x 5mm Yellow LEDs	SP137 4 x W005 1.5A bridge rectifiers
SP5 25 x 5mm 1 part LED clips	SP138 20 x 2-2/63V radial elect. caps.
SP6 15 x 3mm Red LEDs	SP140 3 x W04 1.5A bridge rectifiers
SP7 12 x 3mm Green LEDs	SP142 2 x CMOS 4017
SP8 10 x 3mm Yellow LEDs	SP143 5 Pairs min. crocodile clips (Red & Black)
SP9 25 x 3mm 1 part LED clips	SP144 5 Pairs min. crocodile clips (assorted colours)
SP10 100 x 1N4148 diodes	SP146 10 x 2N3704 transistors
SP11 30 x 1N4001 diodes	SP147 5 x Stripboard 9 strips x 25 holes
SP12 30 x 1N4002 diodes	SP151 4 x 8mm Red LEDs
SP18 20 x BC182 transistors	SP152 4 x 8mm Green LEDs
SP20 20 x BC184 transistors	SP153 4 x 8mm Yellow LEDs
SP23 20 x BC548 transistors	SP154 15 x BC548 transistors
SP24 4 x CMOS 4001	SP156 3 x Stripboard, 14 strips x 27 holes
SP25 4 x 555 timers	SP160 10 x 2N3904 transistors
SP26 4 x 741 Op.Amps	SP161 10 x 2N3906 transistors
SP28 4 x CMOS 4011	SP164 2 x C106D thyristors
SP29 3 x CMOS 4013	SP165 2 x LF351 Op.Amps
SP33 4 x CMOS 4081	SP166 20 x 1N4003 diodes
SP34 20 x 1N914 diodes	SP167 5 x BC107 transistors
SP36 25 x 10/25V radial elect. caps.	SP168 5 x BC108 transistors
SP37 12 x 100/35V radial elect. caps.	SP171 8 Metres 16SWG solder
SP38 15 x 47/25V radial elect caps	SP172 4 x Standard slide switches
SP39 10 x 470/16V radial elect. caps.	SP173 10 x 220/25V radial elect. caps
SP40 15 x BC237 transistors	SP174 20 x 22/25V radial elect. caps.
SP41 20 x Mixed transistors	SP175 20 x 1/63V radial elect. caps.
SP42 200 x Mixed 0.25W C.F. resistors	SP177 10 x 1A 20mm quick blow fuses
SP47 5 x Min. PB switches	SP178 10 x 2A 20mm quick blow fuses
SP49 4 x 5 metres stranded core wire	SP181 5 x Phono plugs - asstd colours
SP101 8 Metres 22SWG solder	SP182 20 x 4-7/63V radial elect. caps.
SP102 20 x 8-pin DIL sockets	SP183 20 x BC547 transistors
SP103 15 x 14-pin DIL sockets	SP187 15 x BC239 transistors
SP104 15 x 16-pin DIL sockets	SP189 4 x 5 metres solid core wire
SP105 15 x 74LS00	SP192 3 x CMOS 4066
SP109 15 x BC557 transistors	SP195 3 x 10mm Yellow LEDs
SP112 4 x CMOS 4093	SP197 6 x 20 pin DIL sockets
SP115 3 x 10mm Red LEDs	SP198 5 x 24 pin DIL sockets
SP116 3 x 10mm Green LEDs	SP199 5 x 2.5mm mono jack plugs
SP118 2 x CMOS 4047	SP200 5 x 2.5mm mono jack sockets
SP124 20 x Assorted ceramic disc caps	
SP126 6 x Battery clips - 3 ea. PP3 + PP9	
SP130 100 x Mixed 0.5W C.F. resistors	
SP131 2 x TL071 Op.Amps	
SP133 20 x 1N4004 diodes	
SP134 15 x 1N4007 diodes	

RESISTOR PACKS - C.Film

RP3 5 each value - total 365 0-25W	£3.30
RP7 10 each value - total 730 0-25W	£4.55
RP10 1000 popular values 0-25W	£6.45
RP4 5 each value-total 345 0-5W	£4.20
RP8 10 each value-total 690 0-5W	£6.85
RP11 1000 popular values 0-5W	£8.70

2006 Catalogue available £1 inc. P&P or FREE with first order. P&P £1.50 per order. NO VAT. Cheques and Postal Orders to: **Sherwood Electronics, 7 Williamson St., Mansfield, Notts. NG19 6TD.**

# PicoScope 3000 Series PC Oscilloscopes

The PicoScope 3000 series oscilloscopes are the latest offerings from the market leader in PC oscilloscopes combining high bandwidths with large buffer memories. Using the latest advances in electronics, the oscilloscopes connect to the USB port of any modern PC, making full use of the PC's processing capabilities, large screens and familiar graphical user interfaces.

- High performance: **10GS/s** sampling rate & **200MHz** bandwidth
- **1MB** buffer memory
- High speed **USB 2.0** interface
- Advanced display & trigger modes
- Compact & portable
- Supplied with PicoScope & PicoLog software

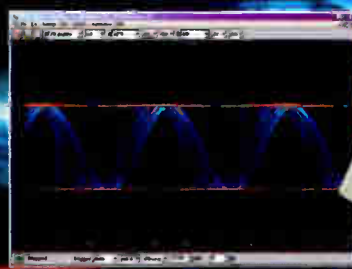

PicoScope	3204	3205	3206
Bandwidth	50MHz	100MHz	200MHz
Sampling rate (repetitive)	2.5GS/s	5GS/s	10GS/s
Sampling rate (single shot)	50MS/s	100MS/s	200MS/s
Channels	2-Ext trigger	2-Ext trigger Sig gen	2-Ext trigger Sig gen
Oscilloscope timebases	5ns div. to 50s div	2ns div to 50s div	1ns div to 50s div
Timebase accuracy	50ppm	50ppm	50ppm
Spectrum ranges	0 to 25MHz	0 to 50MHz	0 to 100MHz
Buffer memory size	256KB	512KB	1MB
Resolution accuracy		8 bit	3 <sup>rd</sup>
Ranges		±100mV to ±20V	
PC Connection		USB2.0 (USB1.1 compatible)	

Tel: 01480 396395

[www.picotech.com/scope364](http://www.picotech.com/scope364)

**pico**  
Technology Limited



# Win a Microchip PICSTART Plus Programmer!

OVER £500s  
WORTH OF  
PRIZES

**M**icrochip are offering readers of *Everyday Practical Electronics* the chance to win one of **five PICSTART Plus Programmers each worth £110!** The latest version of Microchip's popular microcontroller programmer kit includes the PICC Lite ANSI-C Compiler for use with the PIC16F84A Flash microcontroller. The PICSTART Plus supports all existing Microchip 8-bit OTP and Flash MCUs, including the popular PIC12CXXX, PIC16CXX and PIC17CXX devices.

Additionally, this kit includes a sample PIC16F84A MCU – an 18-pin 300 mil DIP package RISC controller with 68 bytes of RAM, 13 I/O ports and 1K x 14 of flash program memory which can operate at frequencies up to 20MHz.

## FEATURES

The PICSTART Plus operates on any PC-compatible machine running under the Windows 3.1 or greater operating system and is CE compliant. It features Microchip's MPLAB Integrated Development Environment with built-in editor, assembler and Windows-based MPLAB-SIM simulator. The MPLAB IDE allows developers to edit and compile from a single user interface and provides user-configurable tool and status bars for edit and debug information.

The MPASM macro assembler provides programmable memory data files, listing files, and special files required for symbolic debug. The MPLAB-SIM software simulator allows the user to isolate code problems and debug firmware designs on PICmicro MCUs. It simulates the core functions as well as most of the peripherals of the PICmicro MCU families. It is particularly suitable for optimising algorithms where real-time emulation is not required.

For the chance to win a PICSTART Plus, log onto [www.microchip-comp.com/epepicstart](http://www.microchip-comp.com/epepicstart) and enter your details into the online entry form.

## CLOSING DATE

The competition closes on December 11 and the names of the prizewinners will be published in the February '07 issue of *EPE*.



We can supply back issues of *EPE* by post, most issues from the past five years are available. An *EPE* index for the last five years is also available at [www.epemag.co.uk](http://www.epemag.co.uk) or see order form below. Alternatively, indexes are published in the December issue for that year. Where we are unable to provide a back issue a photocopy of any one article (or one part of a series) can be purchased for the same price. Issues from Jan. 99 are available on CD-ROM – see next page – and issues from the last six months are also available to download from [www.epemag.com](http://www.epemag.com).

Please make sure all components are still available before commencing any project from a back-dated issue.

## DID YOU MISS THESE?

### JUNE '05

**PROJECTS** • PIC Ultrasonic Radar • Radio Control Model Switcher • Super-Ear Audio Telescope • Electronic Scarecrow • Digital Lock  
**FEATURES** • Catch the Wave (Tsunami) • Back To Basics – 3 • Digital TV Switchover • Programming PIC 18F Interrupts • Circuit Surgery • Interface • Ingenuity Unlimited • Net Work – The Internet Page

### JULY '05

**PROJECTS** • Cybervox • LF and VLF Converter • Multi-Clap Switch • Doorchime • Electronic Dice  
**FEATURES** • Discovering PICs Reviewed • Back To Basics – 4 • Practically Speaking • Circuit Surgery • Interface • Net Work – The Internet Page

### AUG '05

**PROJECTS** • Motor Amplifier • Pain Monitor • Audio System-Communications • Kitchen Timer • Room Thermometer  
**FEATURES** • Back To Basics – 5 • Circuit Surgery • Interface • Ingenuity Unlimited • Techno Talk • PIC 'N' Mix • NetWork – The Internet Page

### SEPT '05

**PROJECTS** • All Band Radio • Snooker and Darts Scoreboard • Multicore Cable Tester • Controlling Model Railway Signals • Daily Reminder • Whistle Switch  
**FEATURES** • Back To Logic Basics – 6 • Circuit Surgery • Practically Speaking • Ingenuity Unlimited • Techno Talk • PIC 'N' Mix • Net Work – The Internet Page



### OCT '05

**PROJECTS** • Halloween Howler • PIC Based USB Interface • Photic Phone • Telephone Switch • Parking Radar  
**FEATURES** • Introducing the Virtual DIY Calculator • Ingenuity Unlimited • Back To Basics – 7 • Circuit Surgery • Techno Talk • PIC 'N' Mix • Interface • NetWork – The Internet Page

### NOV '05 Photocopies only

**PROJECTS** • Speed Camera Watch Mk2 • PIC Chromatone • Multi-Function R/C Switch • Noughts and Crosses Enigma • Weather Vane Repeater  
**FEATURES** • Teach-In 2006 – Part 1 • Circuit Surgery • Back To Basics – 8 • Techno Talk • Practically Speaking • Ingenuity Unlimited • PIC 'N' Mix • NetWork – The Internet Page

### DEC '05 Photocopies only

**PROJECTS** • Vehicle Frost Box Mk2 • Propeller Monitor • Solid-State Hammond • Solid State Valve Power Supply  
**FEATURES** • Teach-In 2006 – Part 2 • Techno Talk • Viewing The Future • Circuit Surgery • Interface • PIC 'N' Mix • NetWork – The Internet Page

### JAN '06 Photocopies only

**PROJECTS** • A "Tiptronic-Style" Gear Indicator • Sunset Switch • PIC Ambliux • Current Clamp Adapter For Multimeters  
**FEATURES** • Teach-In 2006 – Part 3 • Circuit Surgery • Techno Talk • Practically Speaking • PIC 'N' Mix • NetWork – The Internet Page



### FEB '06 Photocopies only

**PROJECTS** • Highly Flexible Keypad Alarm • Active 3-way Crossover • Status Monitor • Jazzy Hearst.  
**FEATURES** • Teach-In 2006 – Part 4 • Techno Talk • Circuit Surgery • Interface • PIC 'N' Mix • Net Work – The Internet Page

### MAR '06

**PROJECTS** • PortaPAL Public Address Amplifier – Part 1 • Telescope Interface • Power Up • Video – Audio Booster  
**FEATURES** • Teach-In 2006 – Part 5 • Practically Speaking • Circuit Surgery • Techno Talk • PIC 'N' Mix • Net Work – The Internet Page

### APR '06 Photocopies only

**PROJECTS** • A Programmable Continuity Tester • Omni Pendulum • PortaPAL Public Address Amplifier – Part 2 • 'Smart' Slave Flash Trigger  
**FEATURES** • Teach-In 2006 – Part 6 • Consumer Electronics Show • E-Chip Review • Techno Talk • PIC-'N'-Mix • Net Work – The Internet Page

### MAY '06

**PROJECTS** • LED Lighting For Your Car • Smart Card Reader and Programmer • Nail Sniffer and Volts Hound • Digital Reaction Timer.  
**FEATURES** • Teach-In 2006 – Part 7 • Practically Speaking • Ingenuity Unlimited • Circuit Surgery • Techno Talk • PIC 'N' Mix • Net Work – The Internet Page

### JUN '06

**PROJECTS** • Poor Man's Metal Locator • Widdy Box Distortion Effects For Your Guitar • Phone Ring & Test • Digital Instrument Display For Cars – Part 1.

**FEATURES** • Interface • Circuit Surgery • Ingenuity Unlimited • Techno Talk • PIC 'N' Mix • Teach-In 2006 – Part 8 • Net Work – The Internet Page

### JUL '06

**PROJECTS** • PIC Sudoku Unit • A Dirt Cheap High Current Bench Supply • PC Power Monitor • Digital Instrument Display For Cars – Part 2.

**FEATURES** • Teach-In 2006 – Part 9 • Ingenuity Unlimited • Practically Speaking • Circuit Surgery • Techno Talk • PIC 'N' MIX • Net Work – The Internet Page



### AUG '06

**PROJECTS** • Loudspeaker Level Meter • Telephone Dialler for Burglar Alarms • Adjustable DC-DC Converter for Cars • High Intensity Torch  
**FEATURES** • Circuit Surgery • Techno Talk • Teach-In 2006 – Part 10 • PIC 'N' Mix • Interface • Ingenuity Unlimited • Net Work – The Internet Page

### SEPT '06

**PROJECTS** • Low Cost 50 MHz Frequency Meter • Smart Mixture Display for Your Car • Human Powered LED Torches • Water Level Gauge  
**FEATURES** • Teach-In 2006 – Part 11 • Ingenuity Unlimited • Circuit Surgery • Techno Talk • PIC 'N' Mix • Practically Speaking • Net Work – The Internet Page

## BACK ISSUES ONLY £3.80 each inc. UK p&p.

Overseas prices £4.50 each surface mail, £5.50 each airmail.

We can also supply issues from earlier years: 2001 (except Feb., May, Aug., to Nov.), 2002 (except Feb., June, Aug. to Nov.), 2003 (except June), 2004 (except June, July, Oct. and Dec.), 2005 (except Feb., Nov., Dec.), 2006 (except Jan., Feb. and April) Where we do not have an issue a photocopy of any one article or one part of a series can be provided at the same price.

### ORDER FORM – BACK ISSUES – PHOTOCOPIES– INDEXES

- Send back issues dated .....
- Send photocopies of (article title and issue date) .....
- Send copies of last five years indexes (£3.80 for five inc. p&p – Overseas £4.50 surface, £5.50 airmail)

Name .....

Address .....

.....Tel: .....

I enclose cheque/P.O./bank draft to the value of £ .....

Please charge my Visa/Mastercard/Amex/Diners Club/Switch £ .....

Card No. .... Switch Issue No .....

Valid From ..... Card Expiry Date ..... Card Security Code .....

(The last 3 digits on or just under the signature strip)

SEND TO: Everyday Practical Electronics, Wimborne Publishing Ltd., 408 Wimborne Road East, Ferndown, Dorset BH22 9ND.

Tel: 01202 873872. Fax: 01202 874562.

E-mail: [orders@epemag.wimborne.co.uk](mailto:orders@epemag.wimborne.co.uk) On-line Shop: [www.epemag.wimborne.co.uk/shopdoor.htm](http://www.epemag.wimborne.co.uk/shopdoor.htm)

Payments must be in £ sterling – cheque or bank draft drawn on a UK bank. Normally supplied within seven days of receipt of order.

Send a copy of this form, or order by letter if you do not wish to cut your issue.

MOB/06



# STORE YOUR BACK ISSUES ON CD-ROMS



**VOL 14  
NOW AVAILABLE**

**ONLY  
£14.45** each  
including VAT  
and p&p

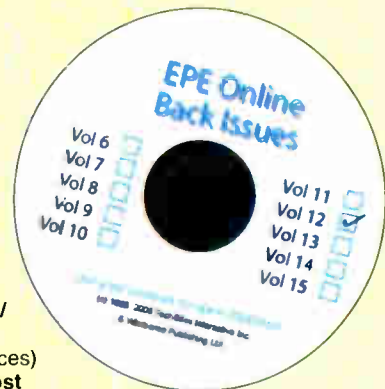

A great way to buy EPE Back Issues – our CD-ROMs contain back issues from our EPE Online website plus bonus articles, all the relevant PIC software and web links. Note: no free gifts are included. All this for just £14.45 each including postage and packing.

- VOL 1: BACK ISSUES** – January 1999 to June 1999  
Plus some bonus material from Nov and Dec 1998
- VOL 2: BACK ISSUES** – July 1999 to December 1999
- VOL 3: BACK ISSUES** – January 2000 to June 2000
- VOL 4: BACK ISSUES** – July 2000 to December 2000
- VOL 5: BACK ISSUES** – January 2001 to June 2001
- VOL 6: BACK ISSUES** – July 2001 to December 2001
- VOL 7: BACK ISSUES** – January 2002 to June 2002
- VOL 8: BACK ISSUES** – July 2002 to December 2002
- VOL 9: BACK ISSUES** – January 2003 to June 2003
- VOL 10: BACK ISSUES** – July 2003 to December 2003
- VOL 11: BACK ISSUES** – January 2004 to June 2004
- VOL 12: BACK ISSUES** – July 2004 to December 2004
- VOL 13: BACK ISSUES** – January 2005 to June 2005
- VOL 14: BACK ISSUES** – July 2005 to December 2005

Order on-line from  
[www.epemag.wimborne.co.uk/  
shopdoor.htm](http://www.epemag.wimborne.co.uk/shopdoor.htm)  
or [www.epemag.com](http://www.epemag.com) (USA \$ prices)  
or by phone, Fax, E-mail or Post

NOTE: These CD-ROMs are suitable for use on any PC with a CD-ROM drive. They require Adobe Acrobat Reader (available free from the Internet – [www.adobe.com/acrobat](http://www.adobe.com/acrobat))

## WHAT IS INCLUDED

All volumes include the EPE Online editorial content of every listed issue, plus all the available PIC Project Codes for the PIC projects published in those issues

Note: Some supplements etc. can be downloaded free from the Library on the EPE Online website at [www.epemag.com](http://www.epemag.com). No advertisements are included in Volumes 1 and 2; from Volume 5 onwards the available relevant software for Interface articles is also included.

## EXTRA ARTICLES – ON ALL VOLUMES

**BASIC SOLDERING GUIDE** – Alan Winstanley's internationally acclaimed fully illustrated guide. **UNDERSTANDING PASSIVE COMPONENTS** – Introduction to the basic principles of passive components. **HOW TO USE INTELLIGENT L.C.D.s**, by Julian Ilett – An utterly practical guide to interfacing and programming intelligent liquid crystal display modules. **Phyzyb COMPUTERS BONUS ARTICLE 1** – Signed and Unsigned Binary Numbers. By Clive "Max" Maxfield and Alvin Brown. **Phyzyb COMPUTERS BONUS ARTICLE 2** – Creating an Event Counter. By Clive "Max" Maxfield and Alvin Brown. **INTERGRAPH COMPUTER SYSTEMS 3D GRAPHICS** – A chapter from Intergraph's book that explains computer graphics technology. **FROM RUSSIA WITH LOVE**, by Barry Fox – Russian rockets launching American Satellites. **PC ENGINES**, by Ernest Flint – The evolution of Intel's microprocessors. **THE END TO ALL DISEASE**, by Aubrey Scoon – The original work of Rife. **COLLECTING AND RESTORING VINTAGE RADIOS**, by Paul Stenning. **THE LIFE & WORKS OF KONRAD ZUSE** – a brilliant pioneer in the evolution of computers. A bonus article on his life and work written by his eldest son, including many previously unpublished photographs.

Note: Some of the EXTRA ARTICLES require WinZip to unzip them.

## BACK ISSUES CD-ROM ORDER FORM

Please send me the following Back Issue CD-ROMs. Volume Numbers: .....

Price £14.45 each – includes postage to anywhere in the world.

Name .....

Address .....

Post Code .....

I enclose cheque/P.O./bank draft to the value of £ .....

Please charge my Visa/Mastercard/Amex/Diners

Club/Maestro

£ .....

Card No. ....

Card Security Code ..... (The last 3 digits on or just under the signature strip)

Valid From ..... Expiry Date .....

Maestro Issue No. ....

SEND TO: **Everyday Practical Electronics,  
Wimborne Publishing Ltd.,  
408 Wimborne Road East, Ferndown, Dorset BH22 9ND.**

Tel: 01202 873872. Fax: 01202 874562.  
E-mail: [orders@epemag.wimborne.co.uk](mailto:orders@epemag.wimborne.co.uk)

Payments must be by card or in £ Sterling – cheque or bank draft drawn on a UK bank.

Normally supplied within seven days of receipt of order.

# Circuit Surgery

Ian Bell



## Timing formulae for 555 timers

**T**HERE has been a bit of discussion of RC timing circuits on the *EPE Chatzone* (via [www.epemag.co.uk](http://www.epemag.co.uk)) recently, in particular user **CherryTree** posted a question about timing formulae for 555 timers.

*"I've got this diagram in a book (30 Simple Terminal Block Projects) and it gives equations on how the 555 timer sets its frequency:  $t1 = (R1 + R2) \times C1$ ,  $t2 = R2 \times C1$ , and  $T = t1 + t2$ . The  $t1 + t2$  in relation to the timer calculations is confusing me. Say that I wanted a 555 running at 900Hz, what would be  $R1$  and  $R2$  values, and also  $C1$ 's value? How did they arrive at that equation?"*

The RC circuit shown in Fig.1 is deceptively simple; a full mathematical analysis of its behaviour requires calculus, a maths topic which people will typically only have looked at in detail if they studied mathematics, science or engineering at an advanced level.

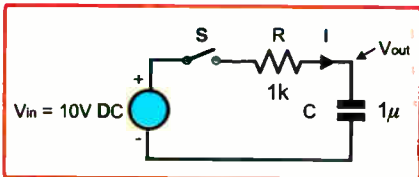
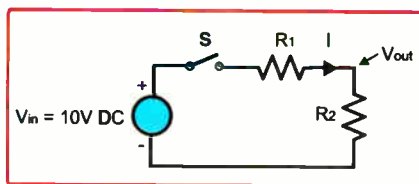

**Fig. 1.** RC circuit. Capacitor *C* charges through *R* when *S* is closed. *V*<sub>out</sub> is the voltage across the capacitor

In this month's *Circuit Surgery* we will attempt to give some insight into the behaviour and maths of the RC (resistor-capacitor) circuit and next month we will progress onto its use in timers such as the famous 555 chip and its derivatives. We will work step by step towards the basic structure and operation of the 555 circuit, which should make the formulae in books and data sheets a little more meaningful. Hopefully our look at the maths will not be too hard, we will really only be using basic algebra and arithmetic in this article – you do not have to know any calculus, so read on without fear!

### Circuit Basics

Comparing the RC circuit in Fig.1 with the potential divider in shown in Fig.2 might lead us to think that the RC circuit could be similarly simple. It is quite well



**Fig.2.** Potential divider – the circuit topology is very similar to that in Fig.1, but the maths is much simpler!

known that *V*<sub>out</sub> for the potential divider is given by the formula:

$$V_{out} = \frac{R2 V_{in}}{R1 + R2}$$

When we close switch *S* in Fig.2, *V*<sub>out</sub> goes to this voltage instantaneously and stays there. We are, of course, ignoring things like the speed at which the electric current travels through the wires and any imperfections in the components and wiring. That's OK, we will do the same thing for the RC circuit; it is not what we are concerned with here.

### Speed of Change

When we close *S* in Fig.1 the situation is very different from that in Fig.2: *V*<sub>out</sub> does not go to a fixed voltage – in fact it

never stops changing and the rate of change also varies continuously.

This varying rate of change is important here; it is the key reason why we have to resort to calculus to fully describe the RC circuit mathematically.

The real life situation in which we are probably most familiar with rate of change, is driving a car (or other vehicle). We know that acceleration is rate of change of speed. Car acceleration is often specified in terms of the time it takes to go from 0 to (say) 60mph. Here we assume that the driver 'floods' the accelerator (gas pedal) and that the car accelerates at its maximum rate (which we assume is constant) until the desired speed is reached.

Now, instead, imagine the driver initially applies maximum acceleration, but straight away starts to ease off. Imagine the driver decreases the acceleration more and more the nearer the car gets to the target speed. The acceleration is at all times decreased exactly proportionately with the difference between the current speed and the target speed. The car never reaches the target speed because as the speed gets closer, the rate of increase gets less and less, and hence the time required to make up the difference increases more and more.

If we plot a graph of speed against time for this thought experiment it would have the same shape as a graph of *V*<sub>out</sub> against time after *S* is closed in Fig.1. This graph

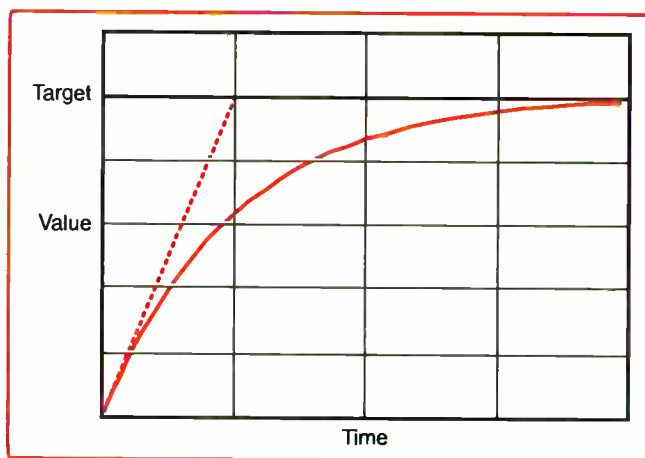

**Fig.3.** The solid line is the shape of the RC charging curve and also represents the speed of our thought experiment car with constantly decreasing acceleration (see text). The dashed line represents a constant rate of charging (or acceleration).



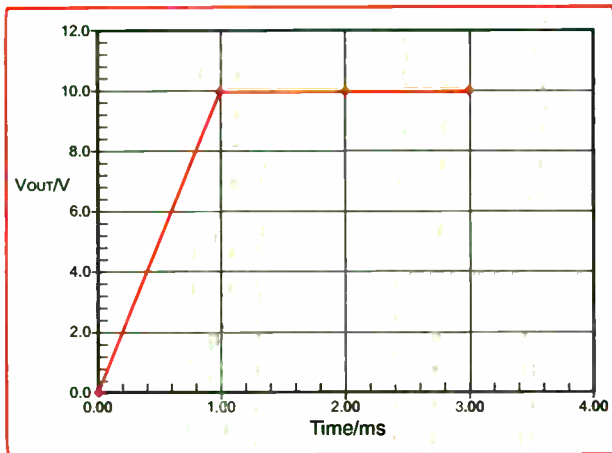

Fig. 4. Approximate graph of  $V_{out}$  in Fig. 1 using one voltage step of 10V

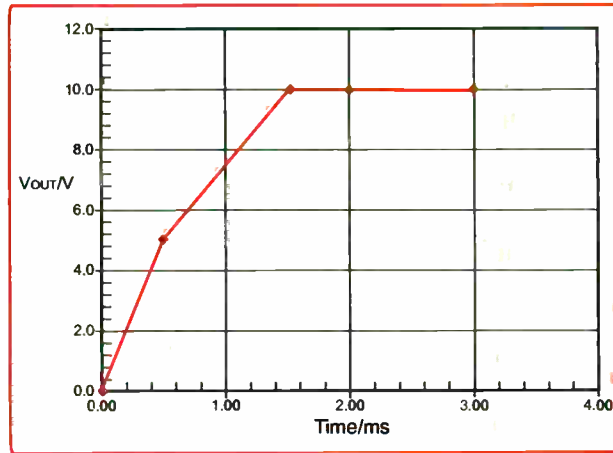

Fig. 5. Approximate graph of  $V_{out}$  in Fig. 1 using two voltage steps of 5V each.

is shown in Fig. 3 (solid curve) together with the constant maximum acceleration curve (dotted line).

The difference between our thought experiment and Fig. 1 is that the former requires the skill and intelligence of our imaginary driver, whereas the behaviour of the RC circuit is simply dependent on the physics of the situation. The rate at which a capacitor charges (and hence the rate of change of the voltage across it) is directly proportional to the current flowing into it. In the RC circuit (Fig. 1), as the capacitor charges the voltage  $V_{out}$  rises.

However, the current depends on the voltage drop across the resistor (R).  $V_{in}$  is fixed, so as  $V_{out}$  increases, the current decreases in proportion to the change in  $V_{out}$ . The larger  $V_{out}$  gets, the smaller the current and the slower the capacitor charges. Also,  $V_{out}$  never reaches  $V_{in}$  because the closer it gets the slower the change becomes. In practice, of course,  $V_{out}$  will reach a point where noise and instrument accuracy mean we cannot tell the difference between  $V_{out}$  and  $V_{in}$ .

### Fundamental Definitions

Now we know what to expect, let's see where we get when we try to apply some simple circuit theory to the RC circuit. We have to start with fundamental definitions of capacitance and current in terms of electrical charge. A capacitor of value C (in Farads) with a charge of Q (Coulombs) held on its plates has a voltage V (Volts) across it, given by:

$$V = \frac{Q}{C}$$

Electric current is defined as the rate of flow of charge. A current of I (Amps) occurs when an amount of charge  $\Delta Q$  (Coulombs) flows in time  $\Delta t$ . Note that we use the symbol  $\Delta$  (delta) because we are dealing with changes of values. So  $\Delta t$  represents a time interval – a change in time – rather than a specific instance in time, or the time elapsed since some starting point. We have:

$$I = \frac{\Delta Q}{\Delta t}$$

Although electronics is all about the movement of charge, we do not often deal with it directly, and the same is true here.

We combine the two equations using  $\Delta Q = C\Delta V$  from the first equation – relating a change of charge to a change in voltage (the capacitance is fixed) – and substituting  $C\Delta V$  for  $\Delta Q$  in the second equation. This gives:

$$I = C \frac{\Delta V_{out}}{\Delta t}$$

in which we have written  $V_{out}$  for V to more explicitly relate to Fig. 1.

We can find the current in Fig. 1 by using Ohm's law. The voltage drop across the resistor is  $V_{in} - V_{out}$ , so the current is:

$$I = \frac{V_{in} - V_{out}}{R}$$

The current in the resistor must be equal to the current flowing into the capacitor so we have:

$$\frac{V_{in} - V_{out}}{R} = C \frac{\Delta V_{out}}{\Delta t}$$

We will use this formula to try and predict the voltage on the capacitor. One way of doing this is to start with a known initial voltage on the capacitor ( $V_{out}$ ), and choose an amount of change that we want to consider (the value of  $\Delta V_{out}$ ) and work out how long this will take (the value of  $\Delta t$ ). We note that the values of R, C and  $V_{in}$  are fixed, it is only time and  $V_{out}$  that are changing. To do this we rearrange the equation above to get the value of  $\Delta t$ . We get:

$$\Delta t = RC \frac{\Delta V_{out}}{(V_{in} - V_{out})}$$

This equation contains the term RC, which should not be surprising if you have dealt with resistor-capacitor timing circuits, as this term always appears in the formulae. Using the values from Fig. 1:

$$RC = 1.0 \times 10^3 \times 1.0 \times 10^{-6} = 1.0 \times 10^{-3} = 1\text{ms}$$

Note that when we multiply resistance

and capacitance together we get a value with units of time.

### First Example

We assume that  $V_{out}$  starts at 0V (when S is closed), but what value should we take for  $\Delta V_{out}$ ? Let's start with 10V, which is the maximum change we could have, as the capacitor will not charge beyond the value of  $V_{in}$ . With this value we get:

$$\Delta t = 1\text{ms} \times 10 / (10 - 0) = 1\text{ms}$$

$V_{out}$  goes from 0V to 10V in 1ms.

We have plotted this in Fig. 4. We see immediately that the graph does not match the required RC charging curve, but note that we have produced the *constant acceleration* line from Fig. 3. We also note that the target voltage is reached at the time given by the product RC, which is known as the *time constant* of the circuit. If  $V_{out}$  in the RC circuit *continued to rise at its initial rate* it would reach  $V_{in}$  when  $t = RC$ .

Why has the formula given us the wrong curve? The answer is that we chose too large a value for  $\Delta V_{out}$ . Let's halve the value of  $\Delta V_{out}$  and see what happens. We do the calculation as follows.

We start with same initial condition, that is  $V_{out} = 0\text{V}$ , but choose  $\Delta V_{out} = 5\text{V}$ . The formula gives  $\Delta t = 1\text{ms} \times 5 / (10 - 0) = 0.5\text{ms}$ , so we get to 5V in 0.5ms. We then

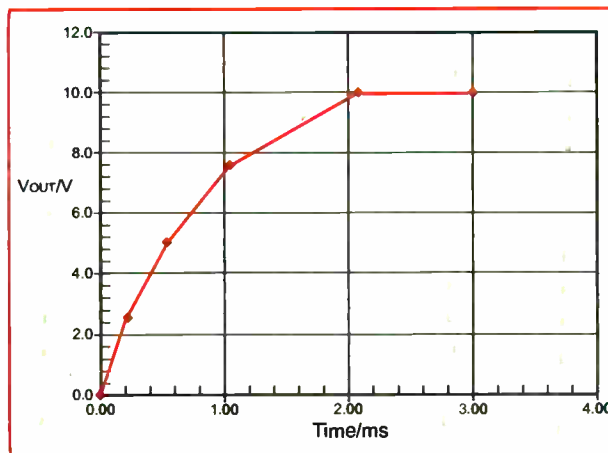

Fig. 6. Approximate graph of  $V_{out}$  in Fig. 1 using four voltage steps of 2.5V each.

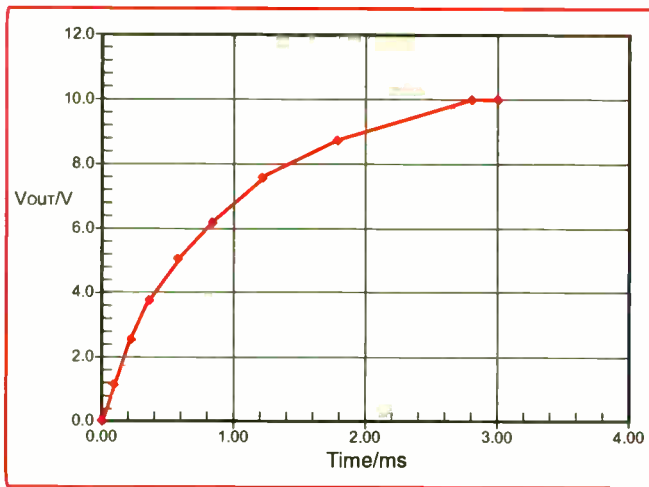

Fig.7. Approximate graph of  $V_{out}$  in Fig.1 using eight voltage steps of 1.25V each.

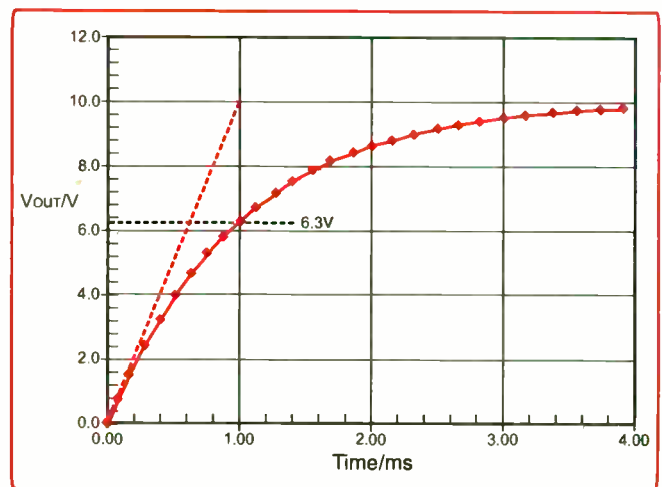

Fig.8. RC curve plotted using exponential equation. The initial rate of change line is also shown. This figure is similar to Fig.3 but has the actual times and voltages for Fig.1

need to apply the formula again. This time we start from 5V so  $V_{out} = 5V$  and again  $\Delta V_{out} = 5V$ . We get  $\Delta t = 1ms \times 5 / (10 - 5) = 1ms$ , so we go from 5V to 10V in 1ms. The resulting graph is plotted in Fig.5.

### More Steps

The curve in Fig.5 looks slightly more like the RC charging curve, but it is still a long way off. Let's try halving the value of  $\Delta V_{out}$  again (to 2.5V) to see if there is any improvement. We now have four steps in our calculation.

0V to 2.5V	$\Delta t = 1ms \times 2.5 / (10 - 0) =$ 0.25ms	total time = 0.25ms
2.5V to 5V	$\Delta t = 1ms \times 2.5 / (10 - 2.5) =$ 0.33ms	total time = 0.58ms
5V to 7.5V	$\Delta t = 1ms \times 2.5 / (10 - 5) =$ 0.5ms	total time = 1.08ms
7.5V to 10V	$\Delta t = 1ms \times 2.5 / (10 - 7.5) =$ 1.0ms	total time = 2.08ms

So we get to 2.5V at 0.25ms, 5V at 0.58ms, 7.5V at 1.08ms and 10V at 2.08ms. This is plotted in Fig.6, which clearly shows a better approximation to the curve in Fig.3 than that in Fig.5.

We can continue to reduce  $\Delta V_{out}$  and get ever better approximations. For example, Fig.7 shows the curve with eight steps of 0.125V. This was produced in the same way as that in Fig.6. The time values are 0.125ms, 0.268ms, 0.435ms, 0.635ms, 0.885ms, 1.218ms, 1.718ms and 2.718ms.

As we make  $\Delta V_{out}$  smaller and smaller, and hence perform more and more calculation steps, the curve we obtain gets closer and closer to what we observe in a real circuit. This approach to solving an equation is called a *numerical method* by mathematicians. There are many situations where this is the only possible approach for equations (or sets of equations) that cannot be solved by direct mathematical methods.

These numerical calculations are, of course, tedious to do by hand, but we can program computers to do the work very efficiently. It would take a modern PC virtually no time at all to use the

above method to calculate a 10,000 step version of the RC curve which would be a very close approximation to the real thing. However, in this case there is a full mathematical solution.

If we go back to the equation we had before:

$$\frac{V_{in} - V_{out}}{R} = C \frac{\Delta V_{out}}{\Delta t}$$

and rearrange it to get:

$$V_{in} = RC \frac{\Delta V_{out}}{\Delta t} + V_{out}$$

We have already seen that to get an accurate result  $\Delta V_{out}$ , and hence  $\Delta t$  must be as small as possible. So we can make them infinitely small. When we do this we rewrite them as  $dV_{out}$  and  $dt$  and the equation becomes:

$$V_{in} = RC \frac{dV_{out}}{dt} + V_{out}$$

which is a differential equation. We need calculus to solve this, which is beyond the scope of this article. In effect the calculus works out a series of steps on the curve algebraically (rather than numerically as we have done) and also algebraically reduces the step size towards zero to provide an accurate solution. The result of solving the equation is:

$$V_{out} = V_{in} \left[ 1 - \exp\left(\frac{-t}{RC}\right) \right]$$

in which  $exp$  is the exponential function. You will find it on scientific calculators written either as  $exp$  or  $e^x$ . Fig.8 shows this function plotted for the circuit in Fig.1, that is:  $10 \times (1 - \exp(-t))$  with  $t$  in milliseconds ( $V_{in} = 10V$  and  $RC = 1ms$  in this example). Note that when  $t = RC$  the voltage is 6.3V, which is 63% of the final value. In the formula we get  $V_{in} \times (1 - \exp(-1)) = V_{in} \times 0.63$  when  $t = RC$  (the  $RC$  and  $t$  cancel to give 1). This

63% rule applies whatever the value of  $RC$  and  $V_{in}$  because when  $t = RC$  we always get the exponential function of  $-1$ .

### Next Month

Next month we will take a short look at the  $exp$  function and then move on to more practical aspects of RC timing circuits.

**ANDRE LAMOTHE'S**  
**XGAMESTATION**  
LEARN STEP-BY-STEP HOW TO DESIGN  
AND BUILD YOUR OWN VIDEO GAME CONSOLE!  
Design Inspired by the Atari 800/2600,  
Sinclair ZX Spectrum, Apple II & Commodore 64!





**Complete Package**   **eBook**   **Integrated IDE**



**5X85 CPU**  
**80 MIPS!**   **OPEN SOURCE!**

**FEATURES:**

- Great for Hobbyists AND Students!
- Complete Software Development Kit!
- eBook on Designing the XGS Console!
- Parallax SX-Key Compatible!
- Fully Assembled XGS Micro Edition Unit!
- The Fun Way to Learn Embedded Systems!

**PAL & NTSC COMPATIBLE!**

**WWW.XGAMESTATION.COM**  
SUPPORT: @NURVE.NET | P: 925.736.2098 (USA)



**VERSION 2  
NOW AVAILABLE**

# EPE PIC RESOURCES CD-ROM V2

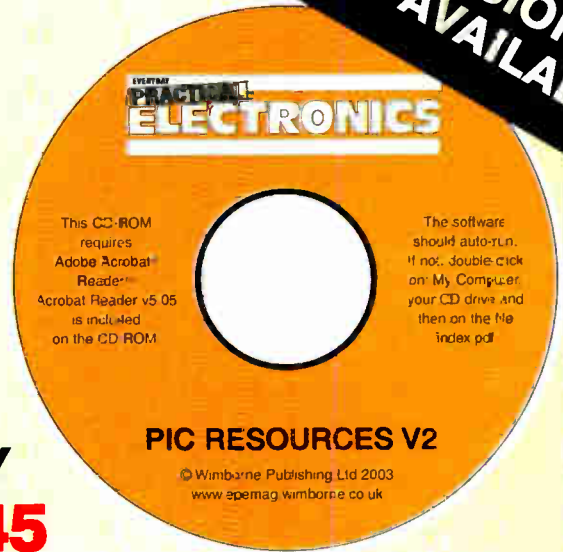

**Version 2 includes the EPE PIC Tutorial V2 series of Supplements (EPE April, May, June 2003)**

**ONLY  
£14.45**

**INCLUDING  
VAT and P&P**

**The CD-ROM contains the following Tutorial-related software and texts:**

- EPE PIC Tutorial V2 complete series of articles plus demonstration software, John Becker, April, May, June '03
- PIC Toolkit Mk3 (TK3 hardware construction details), John Becker, Oct '01
- PIC Toolkit TK3 for Windows (software details), John Becker, Nov '01

Plus these useful texts to help you get the most out of your PIC programming:

- How to Use Intelligent L.C.D.s, Julyan Ilett, Feb/Mar '97
- PIC16F87x Microcontrollers (Review), John Becker, April '99
- PIC16F87x Mini Tutorial, John Becker, Oct '99
- Using PICs and Keypads, John Becker, Jan '01
- How to Use Graphics L.C.D.s with PICs, John Becker, Feb '01
- PIC16F87x Extended Memory (how to use it), John Becker, June '01
- PIC to Printer Interfacing (dot-matrix), John Becker, July '01
- PIC Magick Musick (use of 40kHz transducers), John Becker, Jan '02
- Programming PIC Interrupts, Malcolm Wiles, Mar/Apr '02
- Using the PIC's PCLATH Command, John Waller, July '02
- EPE StyloPIC (precision tuning musical notes), John Becker, July '02
- Using Square Roots with PICs, Peter Hemsley, Aug '02
- Using TK3 with Windows XP and 2000, Mark Jones, Oct '02
- PIC Macros and Computed GOTOs, Malcolm Wiles, Jan '03
- Asynchronous Serial Communications (RS-232), John Waller, unpublished
- Using I<sup>2</sup>C Facilities in the PIC16F877, John Waller, unpublished
- Using Serial EEPROMs, Gary Moulton, unpublished
- Additional text for EPE PIC Tutorial V2, John Becker, unpublished

NOTE: The PDF files on this CD-ROM are suitable to use on any PC with a CD-ROM drive. They require Adobe Acrobat Reader – included on the CD-ROM

**Order on-line from  
www.epemag.wimborne.co.uk/shopdoor.htm  
or www.epemag.com (USA \$ prices)  
or by Phone, Fax, Email or Post.**

## EPE PIC RESOURCES V2 CD-ROM ORDER FORM

Please send me ..... (quantity) EPE PIC RESOURCES V2 CD-ROM

Price £14.45 each – includes postage to anywhere in the world.

Name .....

Address .....

.....

.....

..... Post Code .....

I enclose cheque/P.O./bank draft to the value of £ .....

Please charge my Visa/Mastercard/Amex/Diners Club/ Maestro

£ .....

Card No. ....

Card Security Code ..... (The last 3 digits on or just under the signature strip)

Valid From ..... Expiry Date .....

Maestro Issue No. ....

**SEND TO: Everyday Practical Electronics,  
Wimborne Publishing Ltd.,**

**408 Wimborne Road East, Ferndown, Dorset BH22 9ND.**

Tel: 01202 873872. Fax: 01202 874562.

Email: [orders@epemag.wimborne.co.uk](mailto:orders@epemag.wimborne.co.uk)

Payments must be by card or in £ Sterling – cheque or bank draft drawn on a UK bank.

Normally supplied within seven days of receipt of order.

Send a copy of this form, or order by letter if you do not wish to cut your issue.

**BECOME A PIC WIZARD WITH THE HELP OF EPE!**

# Net Work



Alan Winstanley

## A Slipped Disk

**A** RECENT documentary broadcast on BBC TV (*Real World* – see the BBC web site at <http://tinyurl.com/rsjpw>) highlighted some shocking examples of how personal computer data can find its way onto the open market without the owner's consent or knowledge. British consumers were naively dumping old unwanted PCs at their local authority landfill site, with the expectation that their machines would be scrapped in a proper manner.

Imagine their surprise when a BBC TV presenter knocked on their door several months later, armed with their complete personal profile – dates of birth, family names, addresses, passport details, bank account numbers, pets, school student records and much more besides. The source of all this information was, of course, the discarded hard disk. What was far more shocking was the fact that the entire computer system had mysteriously found its way to Nigeria, where PC components were on open sale in the country's largest surplus PC market, a ramshackle collection of huts.

The BBC presenter bought several used hard disks for £15 each and had them analysed by a data recovery specialist. A wide variety of highly confidential data was successfully recovered. One local authority (Essex County Council) reportedly denied any wrong-doing or negligence on its part, which begs the question of how discarded equipment found its way abroad to start with.

Deleting a file from a hard disk only removes the reference to it, rather like throwing away a library card index but the book remaining on the shelf, the computer file itself may remain intact. Neophyte PC users had no idea about File Allocation Tables or the insecurity of dumping files into the Recycle bin.

One obvious source of personal data is the email database and address book, but there could also be a wide range of reports, spreadsheets, word processor documents and family photographs. There may even be CVs, job applications, scanned copies of birth certificates, work contract details, log-ins and bank details. And if you use a form-filling program such as the excellent Roboform ([www.robiform.com](http://www.robiform.com)), then you would be giving thieves and fraudsters unfettered access to many secure websites if your disk fell into the wrong hands.

## Smash and Grab

The address book data is worth money as well: it contains highly prized live addresses that can be sold to spammers. The TV program showed Nigerian armed police and computer specialists 'busting' an Internet café that was used by an army of '419' fraudsters (the sort that entice you to send advance fees, in return for a split of a multi-million dollar bounty). The police faced a possible riot and had to shoot their way out after arresting the villains and confiscating dozens of modern Dell computers. It was evident that email extraction programs were being used to build lists, with millions of spam mails being generated per day in this most lucrative scam. As a genial Nigerian detective said, it certainly pays well.

If you have an old PC or Mac to dispose of, without doubt the best way of erasing data is to physically destroy the hard disk: open it up, remove and smash up the platters with a hammer, or take a high speed twist drill or angle grinder to it. (Some glass-like disk substrates will shatter, so wear suitable eye protection.)

Software products are available that will overwrite data with any combination of random characters, making data pretty much unrecoverable. Even so, the pattern of magnetic data can leave clues behind and the State University of New Jersey claims that specialised forensic software can recover data [or incriminating parts thereof], after more than 100 overwrites. You can never verify that data is completely unrecoverable of course, so the writer's advice is not to dump drives or sell them on eBay but drill them full of holes instead. The same applies to floppy, Zip and other removable media. Cheap electric CD destroyers can mechanically dapple a DVD or CD's surface, rendering them totally unreadable. USB Flash drives and memory cards often carry recoverable data, as well.

## Scrub Those Disks

Software products that wipe hard disks include Cyberscrub Privacy Suite from <http://www.cyberscrub.com>. It will take care of cookies, temporary Internet files and many 'last used' file drop-down lists in popular applications. The pattern of overwriting is configurable to exceed Dept. of Defense (DoD) standards if desired. For total disk deletion, their Cybercide program wipes a hard drive to USA corporate-accepted levels.

The well regarded Eraser 5.7 program can be downloaded free from [www.heidi.ie/eraser/](http://www.heidi.ie/eraser/) whilst the user-friendly Acronis Privacy Expert Suite 9.0 includes a Disk Cleanup utility, and a 30 day trial is downloadable from [www.acronis.com](http://www.acronis.com). Alternatively, East-Tec Eraser 2006 is available from East Technologies at [www.east-tec.com](http://www.east-tec.com).

If you need to *undelete* some lost data, O & O Software ([www.oosoftware.com](http://www.oosoftware.com)) supplies a number of interesting data recovery programs including Media Recovery, Disk Recovery, Format Recovery and UnErase.

To make life harder still for those trying to salvage disk data, you could consider using a data on-the-fly encryption system: even if someone managed to undelete your data, the encryption renders it as good as impossible to decipher anyway. Whole disk encryption programs include Pretty Good Privacy (PGP) Desktop Professional 9.0 from [www.pgp.com](http://www.pgp.com), or how about applying steganographic (hidden code) techniques and embedding important messages into, say, an innocent-looking JPG graphic file? For example, 4Hit Mail Privacy Lite is free from [www.4t-niagara.com](http://www.4t-niagara.com).

Once you have weighed up the risks, you can decide on the level of protection you need. A wide range of free and paid-for software utilities is available that offer varying levels of credibility, but using any of the major software titles mentioned will help ensure that your personal data really is gone for good, or 'tracked' for ever!

You can email the writer at [alan@pemag.demon.co.uk](mailto:alan@pemag.demon.co.uk)

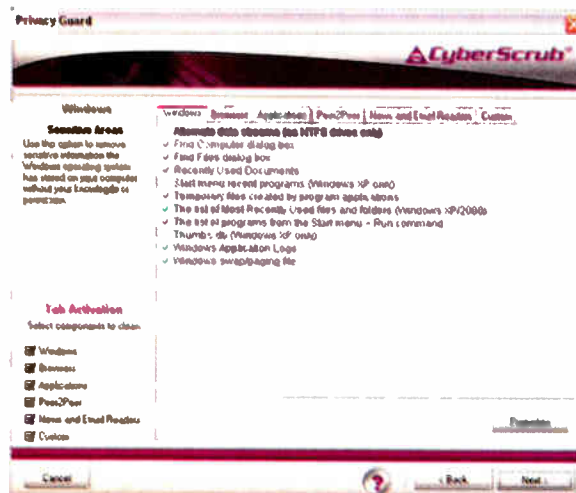

*Cyberscrub is a configurable privacy program that erases your tracks and destroys deleted data*





# EPE EVERYDAY PRACTICAL ELECTRONICS



UK readers you can  
**SAVE 55p**  
on every issue of *EPE*

**How would you like to pay £2.75 instead of £3.30 for your copy of *EPE*?  
Well you can – just take out a one year subscription and save 55p an issue,  
or £6.60 over the year**

You can even save over 75p an issue if you subscribe for two years  
– a total saving of £18.20

**Overseas rates also represent exceptional value**

**You also:**

- Avoid any cover price increase for the duration of your subscription
- Get your magazine delivered to your door each month
- Ensure your copy, even if the newsagents sell out

Order by phone or fax with a credit card or by post with a cheque or postal order, or buy on-line from [www.epemag.co.uk](http://www.epemag.co.uk) (click on “Subscribe Now”)

## EPE SUBSCRIPTION PRICES

Subscriptions for delivery direct to any address in the UK: 6 months £17.50, 12 months £33, two years £61; Overseas: 6 months £20.50 standard air service or £29.50 express airmail, 12 months £39 standard air service or £57 express airmail, 24 months £73 standard air service or £109 express airmail. Cheques or bank drafts (in £ sterling only) payable to *Everyday Practical Electronics* and sent to *EPE* Subs. Dept., Wimborne Publishing Ltd., 408 Wimborne Road East, Ferndown, Dorset BH22 9ND. Tel: 01202 873872. Fax: 01202 874562. Email: [subs@epemag.wimborne.co.uk](mailto:subs@epemag.wimborne.co.uk). Also via the Web at <http://www.epemag.co.uk>. Subscriptions start with the next available issue. We accept MasterCard, Amex, Diners Club, Maestro or Visa. (For past issues see the *Back Issues* page.)

## ONLINE SUBSCRIPTIONS

Online subscriptions, for downloading the magazine via the Internet, \$15.99US (approx. £9.50) for one year available from [www.epemag.com](http://www.epemag.com).

## USA/CANADA SUBSCRIPTIONS

To subscribe to *EPE* from the USA or Canada please telephone Express Mag toll free on 1877 363-1310 and have your credit card details ready. Or fax (514) 355 3332 or write to Express Mag, PO Box 2769, Plattsburgh, NY 12901-0239 or Express Mag, 8155 Larrey Street, Anjou, Quebec, H1J 2L5. Email address: [expsmag@expressmag.com](mailto:expsmag@expressmag.com). Web site: [www.expressmag.com](http://www.expressmag.com). USA price \$60(US) per annum, Canada price \$97(Can) per annum – 12 issues per year. *Everyday Practical Electronics*, periodicals pending, ISSN 0262 3617 is published twelve times a year by Wimborne Publishing Ltd., USA agent USACAN at 1320 Route 9, Champlain, NY 12919. Subscription price in US \$60(US) per annum. Periodicals postage paid at Champlain NY and at additional mailing offices. POSTMASTER: Send USA and Canada address changes to *Everyday Practical Electronics*, c/o Express Mag., PO Box 2769, Plattsburgh, NY, USA 12901-0239.

## SUBSCRIPTION ORDER FORM



- 6 Months: UK £17.50, Overseas £20.50 (standard air service), £29.50 (express airmail)
- 1 Year: UK £33.00, Overseas £39.00 (standard air service) £57 (express airmail)
- 2 Years: UK £61.00, Overseas £73.00 (standard air service) £109 (express airmail)
- To: *Everyday Practical Electronics*, Wimborne Publishing Ltd., 408 Wimborne Road East, Ferndown, Dorset BH22 9ND  
Tel: 01202 873872 Fax: 01202 874562  
E-mail: [subs@epemag.wimborne.co.uk](mailto:subs@epemag.wimborne.co.uk)

I enclose payment of £ ..... (cheque/PO in £ sterling only), payable to *Everyday Practical Electronics*

My card number is: .....  
Please print clearly, and check that you have the number correct

Signature .....

Card Security Code ..... (The last 3 digits on or just under the signature strip)

Card Ex. Date ..... Maestro Issue No. ....

Name .....

Address .....

Post code ..... Tel. ....

**Subscriptions can only start with the next available issue.**

# Learn About Microcontrollers

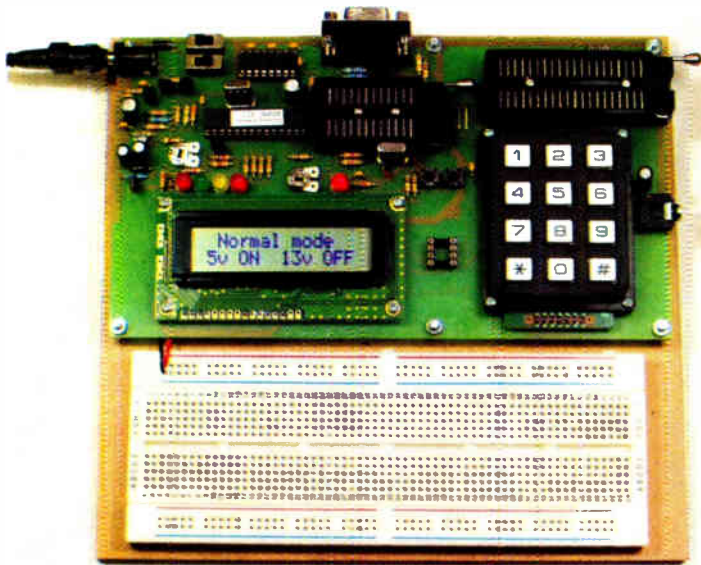

## PIC Training & Development System

The best place to start learning about microcontrollers is the PIC16F84 with its simple easy to understand internal structure. Then continue on using the more sophisticated PIC16F877 family.

At the heart of our system are two real books which lie open on your desk while you use your computer to type in the programme and control the hardware. Start with four simple programmes. Run the simulator to see how they work. Test them with real hardware. Follow on with a little theory.....

Our PIC training course consists of our mid range PIC programmer, a 298 page book teaching the fundamentals of PIC programming in assembly language, a 274 page book introducing the C programming language for PICs, and a suite of programmes to run on a PC. The module is an advanced design using a 28 pin PIC16F870 to handle the timing, programming and voltage switching requirements. Two ZIF sockets and an 8 pin socket allow most mid range 8, 18, 28 and 40 pin PICs to be programmed. The plugboard is wired with a 5 volt supply. The programming is performed at 5 volts, verified with 2 volts or 3 volts applied and verified again with 5.5 volts applied to ensure that the PIC is programmed correctly over its full operating voltage. UK orders include a plugtop power supply.

- Universal mid range PIC programmer module
  - + Book *Experimenting with PIC Microcontrollers*
  - + Book *Experimenting with PIC C*
  - + PIC assembler and C compiler software suite
  - + PIC16F84 and PIC16F870 test PICs. . . . . £159.00
- (Postage & insurance UK £10, Europe £15, Rest of world £25)

## Which Language to Learn

Everyone should start programming PICs using assembly language. That is the only way to fully understand what happens. Then there are good arguments in some applications to change over to using a high level language, but, BASIC or C? At the beginning BASIC is easy to learn while C can seem very strange, but the weakness of BASIC comes from its ease of use, while the power of C lurks in its strangeness. Once the early stages are past programmes are easier to write in C than in BASIC.

## Experimenting with PIC Microcontrollers

This book introduces PIC assembly language programming using the PIC16F84, and is the best way to get started for anyone who is new to PIC programming. We begin with four easy experiments, the first of which is explained over ten and a half pages assuming no starting knowledge of PICs. Then having gained some practical experience we study the basic principles of PIC programming, learn about the 8 bit timer, how to drive the liquid crystal display, create a real time clock, experiment with the watchdog timer, sleep mode, beeps and music, including a rendition of Beethoven's *Fur Elise*. Finally there are two projects to work through, using the PIC16F84 as a sinewave generator and investigating using the PIC16F88 (from the PIC16F877 family) to monitor the power taken by domestic appliances. In the space of 24 experiments, two projects and 56 exercises the book works through from absolute beginner to experienced engineer level.

Web site:- [www.brunningsoftware.co.uk](http://www.brunningsoftware.co.uk)

## PIC C Language

The second book *Experimenting with PIC C* starts with an easy to understand explanation of how to write simple PIC programmes in C. The first few programmes are written for a PIC16F84 to keep continuity with the first book *Experimenting with PIC Microcontrollers*. Then we see how to use the same C programmes with the PIC16F627 and the PIC16F877 family.

We study how to create programme loops using C, we experiment with the IF statement, use the 8 bit and 16 bit timers, write text, integer and floating point variables to the liquid crystal display, and use the keypad to enter numbers.

Then its time for 25 pages of pure study, which takes us much deeper into C than is directly useful with PICs as we know them - we are studying for the future as well as the present. We are not expected to understand everything that is presented in these 25 pages, the idea is to begin the learning curve for a deep understanding of C.

In chapter 9 we use C to programme the PIC to produce a siren sound and in the following chapter we create the circuit and software for a freezer thaw warning device. Through the last four chapters we experiment with using the PIC to measure temperature, create a torch light with white LEDs, control the speed of one then two motors, study how to use a PIC to switch mains voltages, and finally experiment with serial communication using the PIC's USART.

Some of the programmes towards the end of *Experimenting with PIC C* are shown in assembler and C to enable the process to be fully explained, and in the torch light experiments, due to the fast switching speed, the programmes are written only in assembler.

As you work through this book you will be pleasantly surprised how C makes light work of calculations and how easy it is to display the answers.

## Ordering Information

The programmer module connects to the serial port of your PC (COM1 or COM2). All our software referred to in this advertisement will operate within Windows 98, XP, NT, 2000 etc.

Telephone with Visa, Mastercard or Switch, or send cheque/PO. All prices include VAT if applicable.

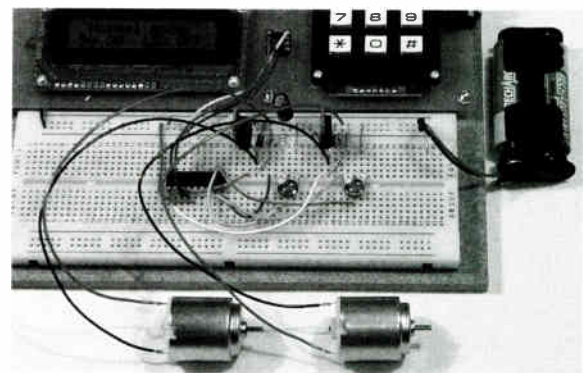

## White LED and Motors

Our PIC training system uses a very practical approach. Towards the end of the second book circuits need to be built on the plugboard. The 5 volt supply which is already wired to the plugboard has a current limit setting which ensures that even the most severe wiring errors will not be a fire hazard and are very unlikely to damage PICs or other ICs.

We use a PIC16F627 as a freezer thaw monitor, as a step up switching regulator to drive 3 ultra bright white LEDs, and to control the speed of a DC motor with maximum torque still available. A kit of parts can be purchased (£30) to build the circuits using the white LEDs and the two motors. See our web site for details.

Mail order address:

**Brunning Software** 138 The Street, Little Clacton, Clacton-on-sea, Essex, CO16 9LS. Tel 01255 862308



# READOUT

## WIN AN ATLAS LCR ANALYSER WORTH £79

Email: [john.becker@wimborne.co.uk](mailto:john.becker@wimborne.co.uk)

**John Becker addresses some of the general points readers have raised. Have you anything interesting to say? Drop us a line!**

All letters quoted here have previously been replied to directly.

An Atlas LCR Passive Component Analyser, kindly donated by Peak Electronic Design Ltd., will be awarded to the author of the *Letter Of The Month* each month.

The Atlas LCR automatically measures inductance from 1 $\mu$ H to 10H, capacitance from 1pF to 10,000 $\mu$ F and resistance from 1 $\Omega$  to 2M $\Omega$  with a basic accuracy of 1%.

[www.peakelec.co.uk](http://www.peakelec.co.uk)



## ★ LETTER OF THE MONTH ★

### Alphanumeric LCD Types

On our Chat Zone (access via [www.epemag.co.uk](http://www.epemag.co.uk)) recently, the subject of LCD types and their chip sets came up, the suggestion being that different chip sets require different programming protocols. Over the years I have received very rare reports of readers having difficulty with their LCD failing to initialise properly.

Obiwan said he'd had an LCD for which he'd had to alter my "standard" LCD initialisation program code (as used in my various PIC Tutorials and in my constructionals) to get it to work. I went on to request info from Obiwan and anyone who knew of LCD types which are different to those I regard as "industry standard".

A number of readers replied, and I entered into private discussion with Obiwan and Epithumia (George and

Rob). I think Rob may have hit the nail on the head when he said his interpretation of the datasheet for his LCD was that a minimum 39 $\mu$ s delay is needed between sending the two nibbles of the configuration code for setting the LCD into 4-bit operation mode. This is a timing factor which I had overlooked with my code, which had its origins in pre-PIC days, when I controlled LCDs purely through logic devices (EPROMS and things).

Rob's code is inserted between his new LCDOUT2 routine and the SENDIT routine:

```

LCDOUT2      movwf STORE
              call SENDITDELAY
              call SENDITDELAY
              return

SENDITDELAY  movlw 50

```

SENDDELAY

SENDIT  
;SENDIT

```

movwf LOOPA
decfsz LOOPA,F
goto SENDDELAY
swaph STORE,F
continues as before

```

This delay is only needed with the LCD initialisation routine, not for data sending once the LCD has been initialised.

I agree with Rob's suggestion. Thank you to everyone who entered into the discussion.

But I would emphasise that the reported LCD problems in the past have been very rare indeed, and the failure of an LCD to work correctly may be down to a constructional problem in some way, and such should be checked for first.

My future designs using LCDs will automatically have Rob's delay built in.

Rob deserves this month's Letter of the Month for his help.

### Extreme Electronics

Dear EPE,

In response to Frank Adams' comments (Extreme Electronics, *Readout* Aug '06), I remember when I was a child I used to stay with my aunt on the farm in Norfolk for my summer hols. On hot muggy summer evenings when I was ready for bed, she used to take me upstairs to a window overlooking the marshes as it became dark to look for the "will of the wisp".

Some evenings there was nothing but on other occasions faint glowing soft white balls of light appeared. They hovered and sometimes appeared to bob along a few feet above the ground and then disappear like they had popped. It was very exciting and my aunt looked on them as being good omens and nature's guardians, like fairies, although I've never seen one of those!

I asked her many years later if they were still there. She said no, because people had destroyed their home. I didn't think anything more of it at the time. Thinking about it now she was kind of right, the area was a water meadow with wild flowers and a high water table if you pushed a stick in a dyke bubbles of gas (methane) were released. This area is now mainly drained and under arable cultivation. The large amount of street

lighting and general background light pollution would make it difficult to see anything. Perhaps progress is not such a good thing.

**Dave Larner, Caister-on-Sea, via email**

*Dave, how lovely that you've seen the will 'o the wisp, but sad that Will's now lost his home. I wonder if in due course the phenomom may reappear in areas which are now being reflooded in places like East Anglia? But it may take generations for the conditions to become suitable again.*

*I'm originally from the fens and marshes of Lincolnshire, but it was not known in my areas - perhaps too many dykes had also drained and dried the region.*

### Mysterious Lights

I have just read Frank Adams' letter in Aug '06 about the mysterious lights. After watching a recent TV programme about lightning I was reminded of an incident like the one in Frank's letter, it was in the '40s too.

I was walking up a slope towards a bridge and there was a wall with those pointed glazed coping stones on top, and as far as I can recall the weather

was dry, but I do not remember if it was cloudy or bright. This ball of blue light appeared suddenly and travelled along the tiles and then just vanished. There was no sound or smell or any tingling, just the ball that vanished.

**Robert (anon), via email**

*That's weird Robert. Maybe it was "will of the wisp" again?*

### VB 2005 Express

Dear EPE,

Here are some sites that will be of help to the readers interested in VB 2005 Express, as discussed recently in *EPE*:

<http://msdn.microsoft.com/vstudio/express/default.aspx>

<http://msdn.microsoft.com/vstudio/express/support/install/>

<http://www.smart-projects.net/recover.htm>

I can also remember seeing something about free registration being only valid until mid-November 2006.

**Mike Von Der Heyden, South Africa, via email**

*Thanks Mike. It's getting a bit late for registration, but I think it might still be OK if readers are quick.*

## Screwdrivers

Dear EPE,

Increasingly, imported far-Eastern electronic equipment is held together by special security/tamper-proof screws, notably recessed triangular heads. Do not confuse with tri-wing! The necessary screwdriver will be a triangular prism in shape, about a Phillips 0 in size. No, none of my regular suppliers have these (e.g. RS, Farnell, CPC, Maplin, Screwfix, Rapid). The 'security bit sets', now sold cheaply in vast quantities, do not contain these bits. Without them, you can't service the equipment! Where can they be obtained?

I attach a photograph, in which the two recessed-triangular-head screws are #4 self-tappers, I've also placed an ordinary M3 machine screw alongside for comparison of scale. As the heads are 4.5mm diameter and down a deep counterbore, bits (machined from 6mm hex shanks) are unlikely to be of help, a genuine screwdriver would be more useful.

Godfrey Manning, via email



I didn't know the answer, so I asked via our Chat Zone. Here are extracts from some of the replies:

These security screws are the types used in mobile phone technology especially in repeaters and base stations. Regular tool suppliers supplying BETA or USAG tools will help, also if you have a Yamaha Service Centre near to you will help because Yamaha and Sony and Panasonic are adopting these types of screws to mount PCBs on chassis. These sites explain better:

[www.hudsonfasteners.com/sec/sec\\_tp3\\_trs\\_phsts.htm](http://www.hudsonfasteners.com/sec/sec_tp3_trs_phsts.htm)

[www.hudsonfasteners.com/sec/sec\\_tp3\\_bit.htm](http://www.hudsonfasteners.com/sec/sec_tp3_bit.htm)

Bernard (CZ name Dsaint)

I checked all of my tool kits and I haven't got one either! It should be easy enough to make your own, filing down a big hexagonal or Pozidriv bit to fit. Unsure how strong it would be though.

Alan Winstanley (CZ name ARW)

I agree with ARW, I just grind some old screwdrivers down and make my own. Sometimes it can take a bit of work, but it can be done most of the time.

George (CZ name Obiwan)

The following link (a reference from the Wikipedia article on screws) has pretty much every tamper-proof screw

bit on offer. Godfrey's triangular widget is the next-to-last one on the list, I think:

[www.lara.com/reviews/screwtypes.htm](http://www.lara.com/reviews/screwtypes.htm)

Graham (CZ name Grab)

Thank you kindly folks, I passed all your info on to Godfrey. Does anyone have info on UK suppliers?

## OEM Datasheets

I would be interested to know if anybody is able to get circuit diagrams for OEM (Original Equipment Manufacture) electronic equipment these days, because in my experience the whole system has been shut down to the amateur and even the professional has to pay through the nose to get any information at all. All blamed on the Health and Safety Act, but I would have thought the Freedom of Information Act should come first.

George Chatley, via email

George, ordinary (component) datasheets I just find generally by searching on the topic by name through Google ([www.google.com](http://www.google.com)), followed by the word "datasheet", and usually find what I want without problems.

There used to be companies who specialised in OEM product data, Mauritron for instance, but I don't see them now looking at a random copy of EPE. Again, Google might provide an answer about them. Anyway, let's see if readers can offer help.

## Fluorescent Lighting

We had a few replies to David Howton's fluorescent lighting problem quoted in Readout Aug '06. The replies were sent on to David. Thank you everyone.

Is the starter correct? The 6ft and 8ft fluorescent fittings have a different glow starter to all the other fittings.

Check the capacitor. On all of the 6ft and 8ft fittings that I have come across the capacitor is an essential part of the circuit. Yes, it does perform the function of power factor correction but it is also part of the main circuit. When the only function of a capacitor is to correct the power factor then it is connected directly across the mains supply. In the 6ft and 8ft fittings it is usually wired in series with the choke.

I have replaced these capacitors by the dozen, they appear to 'dry out' – capacitance value can fall to less than half the declared value. Replacing the capacitor with a new one is the best way out, but a rough and ready way to check is as follows:

Remove the capacitor from the fitting. Connect a 230V live wire to one capacitor terminal and a 13.8Ω 5W resistor (5R6 + 8R2) to the other capacitor terminal. The other resistor wire connects to the neutral of the supply (all in series). Connect a multimeter, on the AC volts range, to read the voltage across the resistor, see Fig.1. The reading will be 1V per microfarad, therefore a 6.8μF capacitor will read 6.8V. **Beware – the capacitor may remain charged after the mains is disconnected. It is not always the case that it will self-discharge.**

The supply voltage should not affect a fluorescent too badly. In England I guess we buy fittings to the same specification as Ireland but since we became harmonised with Europe we are now on 230V ±10% which is not so good as Ireland.

Robert Powell, via email

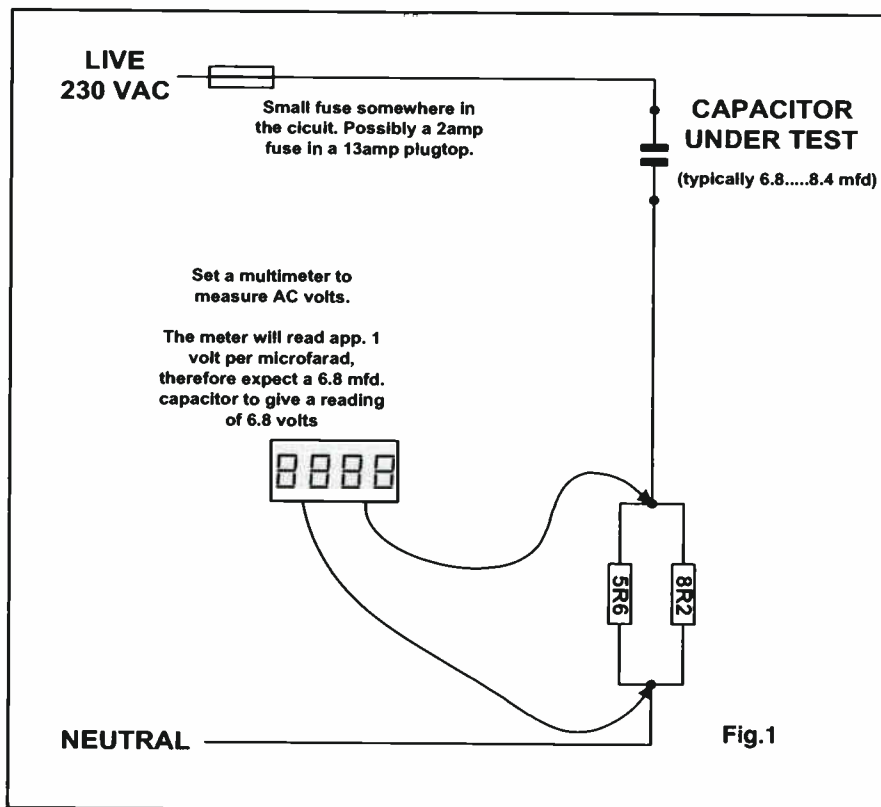



## More Fluorescent Lighting

This is a bit of a long shot, but I suspect that David Howton has a mains supply with a large superimposed 3rd and/or higher harmonic content. A poor quality choke will be sensitive to higher harmonics and will result in a reduced current for the same voltage. This can be checked by measuring the current change with a good quality RMS voltmeter across a suitable non-inductive resistor in series with the choke.

Remedy? Ask the supply authority to check the supply earthing, confront them with a request for harmonic content at or near the house, or try a good quality light fitting.

**Leon van der Merwe, via email**

Most of us in the UK have a high mains supply – it's not been dropped back to 230V from 240V, although the European "harmonised" supply is 230V.

Has David replaced old "fat" 1.5in diameter tubes by modern 1in tubes? These have a slightly different gas mix from the fat ones, which means they're more difficult to start (but more current goes through the mercury vapour when running, and less through the "starter" gasses that are needed to strike the tube and vapourise the mercury).

The modern thin tubes don't work reliably in what was called "resonant start" circuits where the power factor capacitor is wired between the tube heaters (cap and choke in series resonate at about 50Hz, doubling the line voltage across both cap and choke. With the high resonant current flowing through the tube's heaters, the tube lights, damping the resonant current and bringing the current down to the normal running value.)

The answer is to replace the power factor cap with a starter switch and put the power factor cap across the mains. Incidentally, it's worth paying quite highly for electronic starter switches – they don't shorten tube life like the cheap starters.

Or, is David using the right starters? Assuming they're switch-start fittings, 6ft tubes run at a higher voltage than the 3ft to 5ft (all about 100-105V across the lit tube) and a starter for a 5ft can re-ignite (i.e. re-start) on a 6ft tube. Try a starter for an 8ft tube (they run at 150V or so).

Switch-start 8ft fittings normally have the power factor cap in series with the tube and choke – this gives a greater degree of stability in operation, when the tube voltage is more than about half the mains voltage. So try rewiring the 6ft fitting to a series cap circuit.

Alternatively, if you want to be shot of the electricity supply company completely, the ability of compact fluorescents to operate at about 160V – and on DC – makes it possible to run solar cells in series to charge a bank of cells and, in effect, store sunlight for the dark hours –

rather better than trying to recover it from cucumbers, like the mad scientist in *Gulliver's Travels*! The capital cost is horrendous, but running cost almost nil.

**Dick Oliver, via fax**

## Smart Mixture

Dear EPE

I feel I must make some comments regarding the *Smart Mixture Display* project in September's *EPE*. With an automotive background of over 20 years, many of them spent in powertrain control system development, I believe I am in a position to give an informed view.

Basically, it's always been frowned upon if anyone suggests the addition of extra wiring to any engine management system (EMS) component on a road-going vehicle, particularly a sensor that's involved in fuelling control. And especially the oxygen sensor(s)!

The measurement components generally have unique supply and ground circuits back to the EMS ECU, and wiring is optimised with extensive EMC testing to ensure that interference is at an absolute minimum. Adding extra wiring can only compromise this process and new ground connections (which are required for the Mixture Display project) could lead to conditions that upset the balance of differential input measurement systems.

So – why are EMS designers so particular about their input circuitry?

Fuelling measurement is at the heart of the control of tail pipe emissions. Vehicles are extensively tested to ensure that these meet very strict limits and unless these are achieved, the manufacturer is not permitted to sell, and can be fined heavily if they then release vehicles that cannot conform in the 'real' world!

There are also implications for the components. For example, it's fascinating to see a catalyst that's caught fire because an engine was running too rich...not cheap either! The oxygen sensors not only control the fuelling process, but are also used to measure the levels of polluting gases that are coming out the rear end! If emissions limits are exceeded, the dreaded OBD light comes on in the instrument cluster, and manufacturers start to panic! The vehicle might even go into a limp-home mode.

The sensor signals are also used to take account of the 'ageing' of an engine during its lifetime, and can adapt the calibration to account for this, keeping the performance up to scratch and the emissions in line.

So – any errors in the signals can have wide-reaching (and expensive) effects on the car.

Air flow meters – some are PWM output, not voltage, and often have a thermistor incorporated to measure inlet air temp – another crucial fuelling parameter.

Oxygen sensors – sometimes there are four on a car – in the exhaust manifold for direct fuelling and downstream to measure catalyst performance. How do you know you're picking the right one? Many different types too, especially the universal type (definitely not cheap) that give an actual air fuel ratio rather than the 'simple' ones that switch rich/lean. Heater profiles are critical as well, especially considering the current they draw during warm-up.

OK – you may want to fit your own unique sensor(s) and keep clear of the car components. But, positioning of the oxygen sensor is another significant process – you have to know the gases composition map on the exit from the exhaust valve(s) and into the manifold, as you might end up in an area that has a gas mix that is totally unrepresentative of the actual air/fuel ratio. This could require extensive experimentation – even the professionals get it wrong. On one occasion, the 'mechanical' guys were blaming an air meter for 'dodgy' signals... then it was discovered that it was mounted in an area of the inlet manifold that was experiencing all sorts of turbulence over the engine speed range. They went away and did some flow modelling, moved it, and all was fine!

I'm not trying to put the dampers on experimentation and measurement here... many of my published circuits have been related to car systems monitoring. But – I've been very careful to ensure that none have had the potential to interfere with the car's basic systems, which I'm worried may happen with this circuit.

If you're really into the monitoring of car fuelling parameters, why not borrow a SCAN tool from your 'friendly' local dealer? Most vehicles built post-'96 are fitted with a J1962/OBD connector easily accessible under the fascia by the driver's or passenger's feet and this is where you can plug into the car systems in a way that is much safer! If this connector is fitted, the manufacturer must have provided a fixed set of measurements for the local garage to measure what's going on (and download fault codes, freeze frame data, etc.) without having to invest in a system unique to that model.

If you're thinking of doing a dedicated system such as something like the *Smart Mixture Display*, why not get your PIC development kit out and play with an 18F248 which has CAN capability – CAN is the network on the vehicle where you'll find messages that you can decode to give such signals as air flow and oxygen sensor output. Then play from there....

**Steve Dellow, via email**

*Thank you for this information which we are happy to bring to readers' attention. Steve has also informed us that in the USA it is illegal to modify the engine management system.*

# DIRECT BOOK SERVICE

NOTE: ALL PRICES INCLUDE UK POSTAGE

FREE Two booklets and a Circuit Surgery CD-ROM with Teach-In 2000 CD-ROM



## EPE TEACH-IN 2000 CD-ROM

The whole of the 12-part *Teach-In 2000* series by John Becker (published in *EPE* Nov '99 to Oct 2000) is now available on CD-ROM. Plus the *Teach-In 2000* interactive software (Win 95, 98, ME and above) covering all aspects of the series and Alan Winstanley's *Basic Soldering Guide* (including illustrations and Desoldering).

*Teach-In 2000* covers all the basic principles of electronics from Ohm's Law to Displays, including Op.Amps, Logic Gates etc. Each part has its own section on the interactive software where you can also change component values in the various on-screen demonstration circuits.

The series gives a hands-on approach to electronics with numerous breadboard circuits to try out, plus a simple computer interface (Win 95, 98, ME only) which allows a PC to be used as a basic oscilloscope.

ONLY **£12.45** including VAT and p&p

Order code Teach-In CD-ROM

## Circuits and Design

### A BEGINNER'S GUIDE TO TTL DIGITAL ICs

R. A. Penfold

This book first covers the basics of simple logic circuits in general, and then progresses to specific TTL logic integrated circuits. The devices covered include gates, oscillators, timers, flip/flops, dividers, and decoder circuits. Some practical circuits are used to illustrate the use of TTL devices in the "real world".

142 pages

Order code BP332

£5.45

### PRACTICAL ELECTRONICS CALCULATIONS AND FORMULAE

F. A. Wilson, C.G.I.A., C.Eng., F.I.E.E., F.I.E.R.E., F.B.I.M.

Bridges the gap between complicated technical theory, and "cut-and-try" methods which may bring success in design but leave the experimenter unfulfilled. A strong practical bias - tedious and higher mathematics have been avoided where possible and many tables have been included.

The book is divided into six basic sections: Units and Constants, Direct-Current Circuits, Passive Components, Alternating-Current Circuits, Networks and Theorems, Measurements.

256 pages

Order code BP53

£5.49

### MICROCONTROLLER COOKBOOK

Mike James

The practical solutions to real problems shown in this cookbook provide the basis to make PIC and 8051 devices really work. Capabilities of the variants are examined, and ways to enhance these are shown. A survey of common interface devices, and a description of programming models, lead on to a section on development techniques. The cookbook offers an introduction that will allow any user, novice or experienced, to make the most of microcontrollers.

240 pages

Order code NE26

£23.99

The books listed have been selected by *Everyday Practical Electronics* editorial staff as being of special interest to everyone involved in electronics and computing. They are supplied by mail order direct to your door. Full ordering details are given on the last book page.

FOR A FURTHER SELECTION OF BOOKS SEE THE NEXT TWO ISSUES OF EPE

All prices include UK postage

## Computing & Robotics

### WINDOWS XP EXPLAINED

N. Kantaris and P. R. M. Oliver

If you want to know what to do next when confronted with Microsoft's Windows XP screen, then this book is for you. It applies to both the Professional and Home editions.

The book was written with the non-expert, busy person in mind. It explains what hardware requirements you need in order to run Windows XP successfully, and gives an overview of the Windows XP environment.

The book explains: How to manipulate Windows, and how to use the Control Panel to add or change your printer, and control your display; How to control information using WordPad, Notepad and Paint, and how to use the Clipboard facility to transfer information between Windows applications; How to be in control of your filing system using Windows Explorer and My Computer; How to control printers, fonts, characters, multimedia and images, and how to add hardware and software to your system; How to configure your system to communicate with the outside world, and use Outlook Express for all your email requirements; How to use the Windows Media Player 8 to play your CDs, burn CDs with your favourite tracks, use the Radio Tuner, transfer your videos to your PC, and how to use the Sound Recorder and Movie Maker; How to use the System Tools to restore your system to a previously working state, using Microsoft's Website to update your Windows set-up, how to clean up, defragment and scan your hard disk, and how to backup and restore your data; How to successfully transfer text from those old but cherished MS-DOS programs.

268 pages

Order code BP514

£7.99

### INTRODUCING ROBOTICS WITH LEGO MINDSTORMS

Robert Penfold

Shows the reader how to build a variety of increasingly sophisticated computer controlled robots using the brilliant Lego Mindstorms Robotic Invention System (RIS). Initially covers fundamental building techniques and mechanics needed to construct strong and efficient robots using the various "click-together" components supplied in the basic RIS kit. Explains in simple terms how the "brain" of the robot may be programmed on screen using a PC and "zapped" to the robot over an infra-red link. Also, shows how a more sophisticated Windows programming language such as Visual BASIC may be used to control the robots.

Detailed building and programming instructions provided including numerous step-by-step photographs.

288 pages - large format

Order code BP901

£14.99

### MORE ADVANCED ROBOTICS WITH LEGO MINDSTORMS - Robert Penfold

Covers the Vision Command System

Shows the reader how to extend the capabilities of the brilliant Lego Mindstorms Robotic Invention System (RIS) by using Lego's own accessories and some simple home constructed units. You will be able to build robots that can provide you with 'waiter service' when you clap your hands, perform tricks, 'see' and avoid objects by using 'bats radar', or accurately follow a line marked on

the floor. Learn to use additional types of sensors including rotation, light, temperature, sound and ultrasonic and also explore the possibilities provided by using an additional (third) motor. For the less experienced, RCX code programs accompany most of the featured robots. However, the more adventurous reader is also shown how to write programs using Microsoft's VisualBASIC running with the ActiveX control (Spirit.OCX) that is provided with the RIS kit.

Detailed building instructions are provided for the featured robots, including numerous step-by-step photographs. The designs include rover vehicles, a virtual pet, a robot arm, an 'intelligent' sweet dispenser and a colour conscious robot that will try to grab objects of a specific colour.

298 pages

Order code BP902

£14.99

### PIC YOUR PERSONAL INTRODUCTORY COURSE

SECOND EDITION John Morton

Discover the potential of the PIC microcontroller through graded projects - this book could revolutionise your electronics construction work!

A uniquely concise and practical guide to getting up and running with the PIC Microcontroller. The PIC is one of the most popular of the microcontrollers that are transforming electronic project work and product design.

Assuming no prior knowledge of microcontrollers and introducing the PICs capabilities through simple projects, this book is ideal for use in schools and colleges. It is the ideal introduction for students, teachers, technicians and electronics enthusiasts. The step-by-step explanations make it ideal for self-study too: this is not a reference book - you start work with the PIC straight away.

The revised second edition covers the popular reprogrammable EEPROM PICs: P16C84/16F84 as well as the P54 and P71 families.

270 pages

Order code NE36

£16.99

### INTRODUCTION TO MICROPROCESSORS

John Crisp

If you are, or soon will be, involved in the use of microprocessors, this practical introduction is essential reading. This book provides a thoroughly readable introduction to microprocessors, assuming no previous knowledge of the subject, nor a technical or mathematical background. It is suitable for students, technicians, engineers and hobbyists, and covers the full range of modern microprocessors.

After a thorough introduction to the subject, ideas are developed progressively in a well-structured format. All technical terms are carefully introduced and subjects which have proved difficult, for example 2's complement, are clearly explained. John Crisp covers the complete range of microprocessors from the popular 4-bit and 8-bit designs to today's super-fast 32-bit and 64-bit versions that power PCs and engine management systems etc.

222 pages

Order code NE31

£21.99

### EASY PC CASE MODDING

R.A. Penfold

Why not turn that anonymous grey tower, that is the heart of your computer system, into a source of visual wonderment and fascination. To start, you need to change the case or some case panels for ones that are transparent. This will then allow the inside of your computer and it's working parts to be clearly visible.

There are now numerous accessories that are relatively inexpensive and freely available, for those wishing to customise their PC with added colour and light. Cables and fans can be made to glow, interior lights can be added, and it can all be seen to good effect through the transparent case. Exterior lighting and many other attractive accessories may also be fitted.

This, in essence, is case modding or PC Customising as it is sometimes called and this book provides all the practical details you need for using the main types of case modding components including: Electro luminescent (EL) 'go-faster' stripes; Internal lighting units; Fancy EL panels; Data cables with built-in lighting; Data cables that glow with the aid of 'black' light from an ultraviolet (UV) tube; Digital display panels; LED case and heatsink fans; Coloured power supply covers.

192 pages

Order code BP542

£8.99

### NEWNES PC TROUBLESHOOTING POCKET BOOK - THIRD EDITION

Howard Anderson, Mike Tooley

All the essential data for PC fault-finding and upgrading. This book provides a concise and compact reference that describes, in a clear and straightforward manner, the principles and practice of fault-finding and upgrading PCs and peripherals. The book is aimed at anyone who is involved with the installation, configuration, maintenance, upgrading, repair or support of PC systems. It also provides non-technical users with sufficient background information, charts and checklists to enable the diagnosis of faults and help to carry out simple modifications and repairs. In order to reflect rapid changes in computer technology (both hardware and software) this new edition has been completely revised and rewritten.

256 pages

Order code NE41

£19.99

### NEWNES INTERFACING COMPANION

Tony Fischer-Cripps

A uniquely concise and practical guide to the hardware, applications and design issues involved in computer interfacing and the use of transducers and instrumentation.

Newnes Interfacing Companion presents the essential information needed to design a PC-based interfacing system from the selection of suitable transducers, to collection of data, and the appropriate signal processing and conditioning.

Contents: Part 1 - Transducers; Measurement systems; Temperature; Light; Position and motion; Force, pressure and flow. Part 2 - Interfacing; Number systems; Computer architecture; Assembly language; Interfacing; A to D and D to A conversions; Data communications; Programmable logic controllers; Data acquisition project. Part 3 - Signal processing; Transfer function; Active filters; Instrumentation amplifier; Noise; Digital signal processing.

320 pages

Order code NE38

£26.99



# Testing, Theory and Reference

## THE AMATEUR SCIENTIST CD-ROM

The complete collection of The Amateur Scientist articles from *Scientific American* magazine. Over 1,000 classic science projects from a renowned source of winning projects. All projects are rated for cost, difficulty and possible hazards. Plus over 1,000 pages of helpful science techniques that never appeared in *Scientific American*.

Exciting science projects in: Astronomy; Earth Science; Biology; Physics; Chemistry; Weather . . . and much more! The most complete resource ever assembled for hobbyists, and professionals looking for novel solutions to research problems. Includes extensive Science Software Library with even more science tools.

Suitable for Mac, Windows, Linux or UNIX. 32MB RAM minimum, Netscape 4.0 or higher or Internet Explorer 4.0 or higher. Over 1,000 projects

Order code AS1 CD-ROM £19.95

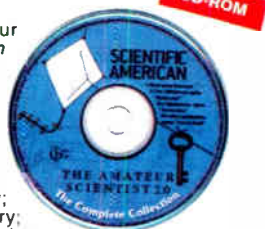

## BEBOP BYTES BACK (and the Beboputer Computer Simulator) CD-ROM

Clive (Max) Maxfield and Alvin Brown

This follow-on to *Bebop to the Boolean Boogie* is a multimedia extravaganza of information about how computers work. It picks up where "Bebop I" left off, guiding you through the fascinating world of computer design . . . and you'll have a few chuckles, if not belly laughs, along the way. In addition to over 200 megabytes of mega-cool multimedia, the CD-ROM contains a virtual microcomputer, simulating the motherboard and standard computer peripherals in an extremely realistic manner. In addition to a wealth of technical information, myriad nuggets of trivia, and hundreds of carefully drawn illustrations, the CD-ROM contains a set of lab experiments for the virtual microcomputer that let you recreate the experiences of early computer pioneers. If you're the slightest bit interested in the inner workings of computers, then don't dare to miss this!

Over 800 pages in Adobe Acrobat format Order code BEB2 CD-ROM £21.95



## GETTING THE MOST FROM YOUR MULTIMETER R. A. Penfold

This book is primarily aimed at beginners and those of limited experience of electronics. Chapter 1 covers the basics of analogue and digital multimeters, discussing the relative merits and the limitations of the two types. In Chapter 2 various methods of component checking are described, including tests for transistors, thyristors, resistors, capacitors and diodes. Circuit testing is covered in Chapter 3, with subjects such as voltage, current and continuity checks being discussed.

In the main little or no previous knowledge or experience is assumed. Using these simple component and circuit testing techniques the reader should be able to confidently tackle servicing of most electronic projects. 96 pages

Order code BP239 £5.49

## OSCILLOSCOPES – FIFTH EDITION Ian Hickman

Oscilloscopes are essential tools for checking circuit operation and diagnosing faults, and an enormous range of models are available.

This handy guide to oscilloscopes is essential reading for anyone who has to use a 'scope for their work or hobby; electronics designers, technicians, anyone in industry involved in test and measurement, electronics enthusiasts . . . Ian Hickman's review of all the latest types of 'scope currently available will prove especially useful for anyone planning to buy – or even build – an oscilloscope.

The contents include a description of the basic oscilloscope; Advanced real-time oscilloscope; Accessories; Using oscilloscopes; Sampling oscilloscopes; Digital storage oscilloscopes; Oscilloscopes for special purposes; How oscilloscopes work (1): the CRT; How oscilloscopes work (2): circuitry; How oscilloscopes work (3): storage CRTs; plus a listing of Oscilloscope manufacturers and suppliers. 288 pages

Order code NE37 £22.99

## PRACTICAL ELECTRONIC FAULT FINDING AND TROUBLESHOOTING Robin Pain

To be a real fault finder, you must be able to get a feel for what is going on in the circuit you are examining. In this book Robin Pain explains the basic techniques needed to be a fault finder.

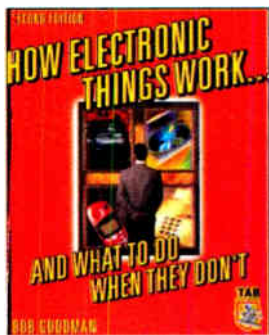
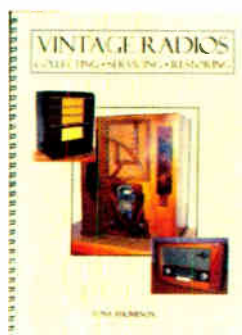

Simple circuit examples are used to illustrate principles and concepts fundamental to the process of fault finding. This is not a book of theory, it is a book of practical tips, hints and rules of thumb, all of which will equip the reader to tackle any job. You may be an engineer or technician in search of information and guidance, a college student, a hobbyist building a project from a magazine, or simply a keen self-taught amateur who is interested in electronic fault finding but finds books on the subject too mathematical or specialised.

The fundamental principles of analogue and digital fault finding are described (although, of course, there is no such thing as a "digital fault" – all faults are by nature analogue). This book is written entirely for a fault finder using only the basic fault-finding equipment: a digital multimeter and an oscilloscope. The treatment is non-mathematical (apart from Ohm's law) and all jargon is strictly avoided. 274 pages

Order code NE22 £25.99

## ELECTRONIC TEST EQUIPMENT HANDBOOK Steve Money

In most applications of electronics, test instruments are essential for checking the performance of a system or for diagnosing faults in operation, and so it is important for engineers, technicians, students and hobbyists to understand how the basic test instruments work and how they can be used.

The principles of operation of the various types of test instrument are explained in simple terms with a minimum of mathematical analysis. The book covers analogue and digital meters, bridges, oscilloscopes, signal generators, counters, timers and frequency measurement. The practical uses of these instruments are also examined. 206 pages

Order code PC109 £9.95

## DIGITAL GATES AND FLIP-FLOPS Ian R. Sinclair

This book, intended for enthusiasts, students and technicians, seeks to establish a firm foundation in digital electronics by treating the topics of gates and flip-flops thoroughly and from the beginning.

Topics such as Boolean algebra and Karnaugh mapping are explained, demonstrated and used extensively, and more attention is paid to the subject of synchronous counters than to the simple but less important ripple counters.

No background other than a basic knowledge of electronics is assumed, and the more theoretical topics are explained from the beginning, as also are many working practices. The book concludes with an explanation of micro-processor techniques as applied to digital logic. 200 pages

Order code PC106 £9.95

## UNDERSTANDING ELECTRONIC CONTROL SYSTEMS Owen Bishop

Owen Bishop has produced a concise, readable text to introduce a wide range of students, technicians and professionals to an important area of electronics. Control is a highly mathematical subject, but here maths is kept to a minimum, with flow charts to illustrate principles and techniques instead of equations.

Cutting edge topics such as microcontrollers, neural networks and fuzzy control are all here, making this an ideal refresher course for those working in Industry. Basic principles, control algorithms and hardwired control systems are also fully covered so the resulting book is a comprehensive text and well suited to college courses or background reading for university students.

The text is supported by questions under the headings Keeping Up and Test Your Knowledge so that the reader can develop a sound understanding and the ability to apply the techniques they are learning. 228 pages

Order code NE35 £20.99

## HOW ELECTRONIC THINGS WORK – AND WHAT TO DO WHEN THEY DON'T Robert Goodman

You never again have to be flummoxed, flustered or taken for a ride by a piece of electronics equipment. With this fully illustrated, simple-to-use guide, you will get a grasp on the workings of the electronic world that surrounds you – and even learn to make your own repairs.

You don't need any technical experience. This book gives you: Clear explanations of how things work, written in everyday language. Easy-to-follow, illustrated instructions on using test equipment to diagnose problems. Guidelines to help you decide for or against professional repair. Tips on protecting your expensive equipment from lightning and other electrical damage. Lubrication and maintenance suggestions.

Covers: colour TVs, VCRs, radios, PCs, CD players, printers, telephones, monitors, camcorders, satellite dishes, and much more! 394 pages

Order code MGH3 £21.99

## VINTAGE RADIOS – COLLECTING ● SERVICING ● RESTORING Tony Thompson

The essential guide to collecting, repairing and restoring vintage valve radios. These receivers are becoming ever more popular as collectibles, this is a good thing because it means that a very large piece of technological history is being reclaimed when at one time many thought it lost forever. If you look around, you will find plenty of valve radio sets just waiting for a loving restoration. They may not yet be the most highly prized, and they are unlikely to be in top condition, but they can be yours and, if you develop the skills outlined in this book, you will possess radio receivers to be proud of.

The book covers radio history, styling, faultfinding, chassis and cabinet restoration, types of set. 124 pages spiral bound

Order code TT1 £13.50

All prices include UK P&P

# Project Building

## ELECTRONIC PROJECT BUILDING FOR BEGINNERS

R. A. Penfold

This book is for complete beginners to electronic project building. It provides a complete introduction to the practical side of this fascinating hobby, including the following topics:

Component identification, and buying the right parts; resistor colour codes, capacitor value markings, etc; advice on buying the right tools for the job; soldering; making easy work of the hard wiring; construction methods, including stripboard, custom printed circuit boards, plain matrix boards, surface mount boards and wire-wrapping; finishing off, and adding panel labels; getting "problem" projects to work, including simple methods of fault-finding.

In fact everything you need to know in order to get started in this absorbing and creative hobby.

135 pages **Order code BP392** £5.49

## BUILDING VALVE AMPLIFIERS

Morgan Jones

The practical guide to building, modifying, fault-finding and repairing valve amplifiers. A hands-on approach to valve electronics – classic and modern – with a minimum of theory. Planning, fault-finding, and testing are each illustrated by step-by-step examples.

A unique hands-on guide for anyone working with valve (tube in USA) audio equipment – as an electronics experimenter, audiophile or audio engineer.

Particular attention has been paid to answering questions commonly asked by newcomers to the world of the vacuum tube, whether audio enthusiasts tackling their first build, or more experienced amplifier designers seeking to learn the ropes of working with valves. The practical side of this book is reinforced by numerous clear illustrations throughout.

368 pages **Order code NE40** £21.99

# Theory and Reference

## THE EMERGENCE OF BROADCASTING IN BRITAIN

Brian Hennessy

The beginning of any great enterprise should be recorded for posterity. Few knew that the *Children's Hour* "Uncles", Arthur, Jeff and Caractacus, were also the engineers who struggled by day to develop technical equipment – and would soon become Assistant Controller, Station Director and Organiser of Programmes for the BBC.

This is a very human account, from the dawn of radio to the attainment of a Royal Charter in the late 1920s. It tells of the struggles and frustrations of engineers in developing innovative equipment and of the great John Reith who battled with everyone to bring the BBC from a staff of four up to a Corporation of several hundred.

Brian Hennessy's book also describes the development of broadcasting equipment, the search for premises and looming bankruptcy before ending with the emergence of a firmly established Chartered Corporation – the BBC.

Meticulous research over many years, over a hundred photographs, plans and diagrams as well as interviews with many of those who were there at the time, make this a valuable and original work for those involved in media studies, for radio enthusiasts or simply for those interested in radio and the fascinating story of the emergence of broadcasting.

436 pages **Order code EBB** £26.00

## COIL DESIGN AND CONSTRUCTIONAL MANUAL

B. B. Babani

A complete book for the home constructor on "how to make" RF, IF, audio and power coils, chokes and transformers. Practically every possible type is discussed and calculations necessary are given and explained in detail. Although this book is now twenty years old, with the exception of toroids and pulse transformers little has changed in coil design since it was written.

96 pages **Order code BP160** £4.49

## PRACTICAL ELECTRONIC FILTERS

Owen Bishop

This book deals with the subject in a non-mathematical way. It reviews the main types of filter, explaining in simple terms how each type works and how it is used.

The book also presents a dozen filter-based projects with applications in and around the home or in the constructor's workshop. These include a number of audio projects such as a rhythm sequencer and a multi-voiced electronic organ.

Concluding the book is a practical step-by-step guide to designing simple filters for a wide range of purposes, with circuit diagrams and worked examples.

188 pages **Order code BP299** £5.49

## ELECTRONIC PROJECTS FOR EXPERIMENTERS

R. A. Penfold

Many electronic hobbyists who have been pursuing their hobby for a number of years seem to suffer from the dreaded "seen it all before" syndrome. This book is fairly and squarely aimed at sufferers of this complaint, plus any other electronics enthusiasts who yearn to try something a bit different.

The subjects covered include:- Magnetic field detector, Basic Hall effect compass, Hall effect audio isolator, Voice scrambler/descrambler, Bat detector, Bat style echo location, Noise cancelling, LED stroboscope, Infra-red "torch", Electronic breeze detector, Class D power amplifier, Strain gauge amplifier, Super hearing aid.

138 pages **Order code BP371** £5.45

## PRACTICAL FIBRE-OPTIC PROJECTS

R. A. Penfold

While fibre-optic cables may have potential advantages over ordinary electric cables, for the electronics enthusiast it is probably their novelty value that makes them worthy of exploration. Fibre-optic cables provide an innovative interesting alternative to electric cables, but in most cases they also represent a practical approach to the problem. This book provides a number of tried and tested circuits for projects that utilize fibre-optic cables.

The projects include:- Simple audio links, F.M. audio link, P.W.M. audio links, Simple d.c. links, P.W.M. d.c. link, P.W.M. motor speed control, RS232C data links, MIDI link, Loop alarms, R.P.M. meter.

All the components used in these designs are readily available, none of them require the constructor to take out a second mortgage.

132 pages **Order code BP374** £5.45

## STARTING ELECTRONICS, THIRD EDITION

KEITH BRINDLEY

A punchy practical introduction to self-build electronics. The ideal starting point for home experimenters, technicians and students who want to develop the real hands-on skills of electronics construction.

A highly practical introduction for hobbyists, students, and technicians. Keith Brindley introduces readers to the functions of the main component types, their uses, and the basic principles of building and designing electronic circuits.

Breadboarding layouts make this very much a ready-to-run book for the experimenter, and the use of multimeter, but not oscilloscopes, and readily available, inexpensive components makes the practical work achievable in a home or school setting as well as a fully equipped lab.

288 pages **Order code NE42** £10.99

## VIDEO PROJECTS FOR THE ELECTRONICS CONSTRUCTOR

R. A. Penfold

Written by highly respected author R. A. Penfold, this book contains a collection of electronic projects specially designed for video enthusiasts. All the projects can be simply constructed, and most are suitable for the newcomer to project construction, as they are assembled on stripboard.

There are faders, wipers and effects units which will add sparkle and originality to your video recordings, an audio mixer and noise reducer to enhance your soundtracks and a basic computer control interface. Also, there's a useful selection on basic video production techniques to get you started.

Circuits include: video enhancer, improved video enhancer, video fader, horizontal wiper, improved video wiper, negative video unit, fade to grey unit, black and white keyer, vertical wiper, audio mixer, stereo headphone amplifier, dynamic noise reducer, automatic fader, pushbutton fader, computer control interface, 12 volt mains power supply.

124 pages **Order code PC115** £5.45

## BOOK ORDERING DETAILS

All prices include UK postage. For postage to Europe (air) and the rest of the world (surface) please add £2 per book. For the rest of the world airmail add £3 per book. CD-ROM prices include VAT and/or postage to anywhere in the world. Send a PO, cheque, international money order (£ sterling only) made payable to **Direct Book Service** or card details, Visa, Mastercard, Amex, Diners Club or Maestro to:

**DIRECT BOOK SERVICE, WIMBORNE PUBLISHING LTD.,  
408 WIMBORNE ROAD EAST, FERNDOWN, DORSET BH22 9ND.**

Books are normally sent within seven days of receipt of order, but please allow 28 days for delivery – more for overseas orders. *Please check price and availability (see latest issue of Everyday Practical Electronics) before ordering from old lists.*

For a further selection of books see the next two issues of **EPE**.

Tel 01202 873872 Fax 01202 874562. Email: [dbs@wimborne.co.uk](mailto:dbs@wimborne.co.uk)

Order from our online shop at: [www.epemag.co.uk](http://www.epemag.co.uk)

## BOOK ORDER FORM

Full name: .....

Address: .....

.....

.....

..... Post code: ..... Telephone No: .....

Signature: .....

I enclose cheque/PO payable to DIRECT BOOK SERVICE for £ .....

Please charge my card £ ..... Card expiry date.....

Card Number ..... Switch/Maestro Issue No.....

Card Security Code ..... (the last three digits on or just under the signature strip)

Please send book order codes: .....

.....

Please continue on separate sheet of paper if necessary  
If you do not wish to cut your magazine, send a letter or copy of this form



# PCB SERVICE

Printed circuit boards for most recent *EPE* constructional projects are available from the PCB Service, see list. These are fabricated in glass fibre, and are fully drilled and roller tinned. All prices include VAT and postage and packing. Add £1 per board for *airmail* outside of Europe. Remittances should be sent to The PCB Service, *Everyday Practical Electronics*, Wimborne Publishing Ltd., 408 Wimborne Road East, Ferndown, Dorset BH22 9ND. Tel: 01202 873872; Fax 01202 874562; Email: [orders@epemag.wimborne.co.uk](mailto:orders@epemag.wimborne.co.uk). On-line Shop: [www.epemag.wimborne.co.uk/shopdoor.htm](http://www.epemag.wimborne.co.uk/shopdoor.htm). Cheques should be crossed and made payable to *Everyday Practical Electronics* (Payment in £ sterling only).  
**NOTE: While 95% of our boards are in stock and are dispatched within seven days of receipt of order, please allow a maximum of 28 days for delivery – overseas readers allow extra if ordered by surface mail.**  
**Back numbers or photocopies of articles are available if required – see the Back Issues page for details. We do not supply kits or components for our projects.**

**Please check price and availability in the latest issue. A large number of older boards are listed on our website.**

Boards can only be supplied on a payment with order basis.

PROJECT TITLE	Order Code	Cost
Spontaflex Radio– Tuner	494	£5.55
– Coil Pack	495	£5.71
– Audio Amplifier	496	£5.55
– Tuning Capacitor Board	406	£4.28
★ Safety Interface	497	£6.18
Back-To-Basics 1– Fridge/Freezer Door Alarm	498	£5.39
★ Crossword Solver	499	£6.66
20W Amplifier Module	500	£5.14
Back-To-Basics 2 – Water Level Alarm	501	£5.39
– Burglar Alarm	502	£5.87
★ PIC Ultrasonic Scanner	503	£6.66
★ Radio Control Model Switcher	504	£5.87
Back-To-Basics 3 – Scarecrow	505	£5.55
– Digital Lock	506	£6.66
CompactFlash Interface Board	507	£6.66
LF/VLF Converter	508	£5.71
– Fixed Capacitor Board	509	£5.86
– Mixer/Oscillator Board	510	£5.23
– Buffer Amplifier	511	£5.23
– Q-Multiplier	406	£4.28
– Tuning Capacitor Board	512	£6.34
Back-To-Basics 4 – Doorchime	513	£6.02
– Electronic Dice	514	£6.82
★ Cybervox	515	£6.66
Multi-Ciap Switch		
Audio System	516	£6.02
– Preampifier	517	£5.23
– Mic. Supply Board	518	£6.02
– Power Amp	519	£7.14
★ Pain Monitor	520	£7.45
MotorAmp	521	£5.87
Back-To-Basics 5 – Kitchen Timer	522	£6.02
– Room Thermometer		
All-Band Radio – Full Version	523	£5.71
– Mini Version	524	£5.23
★ Multicore Cable Tester – Main	525	£6.19
– Active	526	£5.55
Back-To-Basics 6 – Daily Reminder	527	£6.19
– Whistle Switch	528	£5.87
★ Model Railway Signal Control	529	£6.19
★ Snooker/Darts Scoreboard	530	£8.72
Photic Phone – Transmitter	531	£6.98
– Receiver	532	pair
Back-To-Basics 7 – Parking Radar	533	£5.71
– Telephone Switch	534	£5.55
★ Halloween Howler	535	£6.02
★ PIC-Based USB Interface	536	£6.19
★ PIC Chromatone	537	£6.82
Back-To-Basics 8 – Noughts and Crosses Enigma	538	£6.66
– Weather Vane Repeater	539	£6.18
★ Multi-Function R/C Switch	540	£5.87
★ Speed Camera Watch Mk2	541	£6.35
Solid-State Valve Power Supply	542	£6.35
★ Vehicle Frost Box Mk2	543	£5.71
★ Propeller Monitor	544	£6.02
Solid-State Hammond	545	£6.18
★ PIC Ambilux	546	£5.71
Sunset Switch	547	£6.98
Current Clamp Adaptor for Multimeters	548	£5.39
★ Tiptronic-Style Gear Indicator		
– Micro Board	549	per set
– Display Board	550	
– Hall Speed Board	551	
★ Keypad Alarm	552	£6.02
3-Way Active Crossover	553	£9.20
Jazzy Heart	554	£6.02
Status Monitor– Transmitter	555	pair
– Receiver	556	

PROJECT TITLE	Order Code	Cost
Power Up	MAR '06	557
Video/Audio Booster (double-sided)	558	£12.00
★ Telescope Interface	559	£6.50
'Smart' Slave Flash	APR '06	560
Programmable Continuity Tester	561	£5.87
PortaPAL		
– Microphone Board	562	£6.18
– Auxiliary Board	563	£5.87
– Main Board	564	£8.56
– Charger Board	565	£6.66
Omni Pendulum	566	£6.34
Smart Card Reader/Programmer	MAY '06	567
LED Lighting For Your Car (set of 15 boards)	568	£14.75
Digital Reaction Timer	569	£7.13
Poor Man's Metal Locator	JUN '06	570
★ Digital Instrument Display for Cars		
– Micro Board	571	pair
– Display Board	572	
Widgy Box	573	£7.29
Phone Ring & Test	574	£6.82
★ Sudoku Unit	JUL '06	575
PC Power Monitor	576	£6.50
Home Theatre Sound Level Checker	AUG '06	577
Adjustable DC-DC Converter For Cars	578	£6.50
★ Telephone Dialler For Buglar Alarms	579	£6.97
★ High Intensity Torch	580	£5.39
★ Low Cost 50MHz Frequency Meter	SEP '06	
Version 1	581	£6.66
Version 2	582	£6.66
Version 3	583	£6.66
Smart Mixture Display for your Car	584	£6.50
Water Level Gauge – Sensor	585	pair
– Display	586	£6.98
Fridge Door-Open Alarm	OCT '06	587
Linear Supply For 1W Star LEDs (Pair)	588a & b	£6.50
Through-Glass Alarm	589	£7.61

## EPE SOFTWARE

★ All software programs for *EPE* Projects marked with an asterisk, and others previously published, can be downloaded free from our Downloads site, accessible via our home page at: [www.epemag.co.uk](http://www.epemag.co.uk).

## PCB MASTERS

PCB masters for boards published from the March '06 issue onwards can also be downloaded from our UK website ([www.epemag.co.uk](http://www.epemag.co.uk)); go to the "Downloads" section.

## EPE PRINTED CIRCUIT BOARD SERVICE

Order Code      Project      Quantity      Price

Name .....

Address .....

Tel. No. ....

I enclose payment of £..... (cheque/PO in £ sterling only) to:



**Everyday Practical Electronics**



**MasterCard, Amex, Diners Club, Visa or Switch/Maestro**



Card No .....

Valid From ..... Expiry Date .....

Card Security Code ..... Maestro Issue No .....  
 (The last 3 digits on or just under the signature strip)

Signature .....

**NOTE:** You can also order p.c.b.s by phone, Fax, Email or via our Web site on a secure server:

<http://www.epemag.wimborne.co.uk/shopdoor.htm>

# PCB-POOL®

SERVICING YOUR COMPLETE PROTOTYPE NEEDS

**1 EUROCARD**  
(160 x 100 mm)  
+ Tooling  
+ Photoplots  
+ VAT

**€49**

Price example  
Any size and contour possible

**Optional:**

- Soldermask
- Fast-turnaround
- Silkscreen
- 4-Layer Multilayer
- 6-Layer Multilayer

**DOWNLOAD OUR FREE LAYOUT SOFTWARE!**

**Freephone** 0800-3898560  
Tel: +353 (0)61 201170  
Fax: +353 (0)61 201165  
pcb-pool@wimborne.co.uk

Over 18,000 Customers

LEAD FREE

Simply send your files and order ONLINE: **PCB-POOL.COM**

## Laser Business Systems Ltd

<http://www.laser.com>  
<http://www.cb-us-shop.com>  
Tel: +44 (0) 20 8441 9788  
Fax: +44 (0) 20 8449 0430  
Email: info@laser.com

## C-Bus Shop

**CLIPSAL C-Bus**  
New C-Bus Wireless coming soon

We are an authorised distributor of C-Bus intelligent lighting and control system from Clipsal Integrated Systems with an extensive range of home automation related products. We also stock Barix Ethernet based MP3, communications and control products and CAT5e based KATS AV transmission and IR control system.

**Why tolerate when you can automate?**

# EPE EVERYDAY PRACTICAL ELECTRONICS

To advertise your company in **EPE Magazine**

Please contact Stewart Kearn  
Tel: 01202 873872  
Email: [stewart.kearn@wimborne.co.uk](mailto:stewart.kearn@wimborne.co.uk)

**PLEASE ENSURE YOU TELEPHONE TO CHECK AVAILABILITY OF EQUIPMENT BEFORE ORDERING OR CALLING.**

### SPECIAL OFFERS

#### OSCILLOSCOPES

TEKTRONIX 2247A 4 Channel 100MHz Counter/Timer/Volmeter	£275
TEKTRONIX 2335 Dual Trace 100MHz Delay Sweep	£125
TEKTRONIX 485 Dual Trace 350MHz Delay Sweep	£300
WATSU SS5711 4 Channel 100MHz Delay Sweep	£150
PHILIPS 3065 2+1 Channel 100MHz Dual TB Delay - Autoset	£200
PHILIPS 3055 2+1 Channel 60MHz Dual TB Delay - Autoset	£150
PHILIPS PM3217 Dual Trace 50MHz Delay Sweep	£125
KIKUSUI COS6100 5 Trace 100MHz Delay	£150
TEKTRONIX 475A Dual Trace 250MHz Delay Sweep	£175
TEKTRONIX 475 Dual Trace 200MHz Delay Sweep	£150
TEKTRONIX 465B Dual Trace 100MHz Delay Sweep	£125
TEKTRONIX 465 Dual Trace 100MHz Delay Sweep	£95
PHILIPS PM3209 Dual Trace 40MHz Delay	£125
PHILIPS PM3215 Dual Trace 50MHz	£75
KENWOOD CS4035 Dual Trace 40MHz	£50
PANASONIC VP5564A Dual Trace 40MHz	£50
HITACHI V525 Dual Trace 50MHz Cursors	£95
HITACHI V523 Dual Trace 50MHz Delay	£80
HITACHI V425 Dual Trace 40MHz Cursors	£75
HITACHI V422 Dual Trace 40MHz	£60
HITACHI V223 Dual Trace 20MHz Delay	£50
HITACHI V212 Dual Trace 20MHz	£50
FARNELL DTV12-14 Dual Trace 12MHz	£40

#### STORAGE

PHILIPS PM3320 Dual Trace 200MHz 250Ms/S	£300
LECROY 9400 Dual Trace 125MHz	£325
TEKTRONIX 468 Dual Trace 100MHz Delay Sweep	£200
Storage	£200
VELLEMAN HP55 1MHz 5MHz Sampling Handheld Unused	£60

#### ANALYSERS

ADVANTEST R3256A 100Hz 6GHz	£4500
TEKTRONIX 492P 50MHz-21GHz	£2250
HP8560A 50Hz-2.9GHz Built In Tracking Gen	£3250
HP 8560A 50Hz-2.9GHz	£2950
HP 8569A 10MHz-22GHz	£950
HP 8565A 10MHz-22GHz	£750
HP 853A with 8559A 100Hz-21GHz	£100
HP 1827 with 8559A 100Hz-21GHz	£750
HP1827 with 8558B 100Hz-1500MHz	£600

HP 1827 with 8557A 100Hz-350MHz	£300-£400
HP 140T with 8555A 10MHz-18GHz	£500
ADVANTEST FR4131 10kHz-3.5GHz	£950
WAYNE KERR SSA100A 150kHz-1GHz	£950
MARCONI 2312 200Hz-400MHz High Resolution	£1250
MARCONI 2370 30Hz-100MHz	£500
HP 8754A Network Analyser 4-1300MHz	£500
MARCONI 6500A Amplitude Analyser with head	£750
HP 334A Discretion Analyser 5Hz-600kHz	£100

#### SIGNAL GENERATORS

HP 8350B Sweeper with i3592E 10MHz-20GHz	£1500
HP 8350A Sweeper with i3592A 10MHz-20GHz	£1250
HP 8350B Main Frame Only	£125
HP 83525B RF Plug-in for 8350 0.01-8 GHz	£500
HP 83590A RF Plug-in for 8350 2-20GHz	£300
HP 8660C Sig Gen 1-3.3Hz	£450
HP 8660C Sig Gen 2 6Hz	£750
HP 86603A RF Plug-in for 8660C 1-2500MHz	£
HP 86631B Auxiliary Section for 8660C	£
HP 86632B Modulation Section for 8660C	£
MARCONI 2017 0.01-1.4MHz Low Phase Noise	£500
MARCONI 2019 Synthesised AM/FM 80Hz-1040MHz	£325
FLUKE 6068B AM/FM Syn Sig Gen 10kHz-10500MHz	£300
LEADER LSG221B Sig Gen 25-950MHz	£200
HP 8656B Synthesised 11-9900MHz	£500
HP 8656A Synthesised 11-9900MHz	£400
HP 8640A AM/FM 500kHz-512MHz	£150
HP 8620C Sweep Osc with 86290B 2-19.9GHz	£500
HP 8620C Sweep Osc with 86222B 0.01-2.4GHz	£400
HP 8620C/B/A with any of the following plug-ins	£150-£200
HP 8620A Plug in 10-120MHz	£
HP 8620B Plug in 1.5-4MHz	£
HP 86235A Plug in 1.7-4.3MHz	£
HP 86240A Plug in 2-8.5GHz	£
HP 86240C Plug in 3-6.8GHz	£
HP 86245A Plug in 5.9-12.4GHz	£
HP 86250B Plug in 8-12.4MHz	£
HP 86250D Plug in 8-12.4MHz	£
HP 86260A Plug in 12-41.8GHz	£
MARCONI TF2015 AM/FM 10kHz-1050MHz	£95
MARCONI TF2016 AM/FM 10kHz-1050MHz	£95
PHILIPS PM5328 100kHz-180MHz with 200MHz Freq Counter IEEE	£225
PANASONIC VP8117A AM/FM 100kHz-110MHz	£
FM 0-100kHz Digital Display etc Unused	£225

HP 8165A Programmable Signal Source 1MHz-50MHz (Pulse Function)	£325
HP 3325A Synthesised Function Gen 21MHz	£350
HP 3312A Function Gen 0 1Hz-13MHz AM/FM Sleep Tri Burst etc	£200
WAVETEK 21 Stabilised Function Gen 11MHz	£225
WAVETEK 23 Synthesised Function Gen 12MHz	£275
EXACT 529 AM/FM Function Gen 20MHz	£150
ANALOGUE 2030 Synthesised Multi Function Waveform	£250
THANDER TG503 Pulse/Function Gen 5MHz	£195
THANDER TG502 Sweep Function Gen 5MHz	£195
KRON-HITE 5200A Sweep Func Gen 0.0003Hz-3MHz	£150
HP 3310B Info as 3310A + etc	£120
HP 3310A Func Gen 0.005Hz-5MHz Sine/Sq/Tri Ramp/Pulse	£80
PHILIPS PM5132 Function Gen 0 1Hz-2MHz	£95
PHILIPS PM5131 Function Gen 0 1Hz-2MHz	£75
FEEDBACK FG601 Func Gen 0.001Hz-1MHz	£750
HP 8112A Pulse Gen 50MHz	£600
HP 8111A Pulse Generator 20MHz	£400
LYONS PG73N Pulse Gen 20MHz	£50
LEADER LAG120B Sine/Sq Audio Generator 10Hz-1MHz	£80
FARNELL LF1M Sine/Sq Osc 10Hz-1MHz Low Distortion	£
TTI Output Amplitude Meter	£60
GOULD J3B Sine/Sq Osc 10Hz-100kHz Low Distortion	£50-£75
FARNELL LF1 Sine/Sq Oscillator 10Hz-1MHz	£50
MARCONI SANDERS 8056C Signal Source 850-2000MHz	£125
MARCONI SANDERS 8056B Signal Source 850-2150MHz	£125
HP 8111A Pulse Generator 20MHz	£400
MARCONI SANDERS 6057B Signal Source 4-5.8GHz	£125
MARCONI SANDERS 6059A Signal Source 12-18GHz	£125
MARCONI SANDERS 6070A Signal Source 400-1200MHz	£125
FLUKE 6011A Synthesised 11MHz	£125
PHILIPS 5514V Colour Bar Generator Video	£195
BLACK STAR ORION Colour Bar Gen	£50
BLACK STAR ORION Later Version Metal Case	£75

HP 3316A Universal Counter 0-100MHz HPIB	£95
THANDAR TF810 Frequency Counter 5Hz-200MHz Battery	£60
THANDAR TF200 Frequency Meter 10Hz-200MHz 8 digit	£40
BLACK STAR Meteor 100 Counter 5Hz-100MHz	£50
BLACK STAR 1325 Counter Timer 1300MHz	£150
BECKMAN UC10A Universal Counter 120MHz	£60
BECKMAN LDC9043 Digital Counter 100MHz	£125

#### DIGITAL MULTIMETERS ETC

SOLARTRON 7150 6 1/2 digit True RMS IEEE	£75
SOLARTRON 7150Plus As Above + Temp Measurement	£100
DATRON 1065 5 1/2 digit Auto/Cal DC Resistance IEEE	£95
FLUKE 77 3 1/2 digit Handheld	£35
FLUKE 77 Series 2 3 1/2 digit Handheld	£45
FLUKE 8060A 4 1/2 digit True RMS Handheld	£75
BECKMAN HD110 3 1/2 digit Handheld in Carry Case	£30
TTI 1905A 5 1/2 digit Bench	£60
SOLARTRON 7045 4 1/2 digit Bench	£30
AVO DA116 3 1/2 digit with Batteries & Leads	£20
AVO 8 Mk6 in Ever Ready Case with Leads etc	£75
AVO 8 Mk5 with Leads etc	£50
RACAL 9301A True RMS RF Millivoltmeter	£125
RACAL 9300 True RMS Millivoltmeter 5Hz-200MHz usable to 60MHz	£30
RACAL 9300B as 9300	£45
GOODMILL GW7427 Dual Chan AC Millivoltmeter 10mV in 12 ranges 10Hz-1MHz Unused	£75
KENWOOD VT176 Dual Chan Millivoltmeter	£40

#### POWER SUPPLIES

FARNELL XA35 2T 0-35V 0-2A Twice Digital	£95
FARNELL LT30-2 0-30V 0-2A Twice	£110
FARNELL B3020 30V 20A Variable No Meters	£110
FARNELL B3010 30V 10A Variable No Meters	£75
FARNELL LT30-1 0-30V 0-1A Twice	£55
FARNELL L30-2 0-30V 0-2A	£55
FARNELL L30-1 0-30V 0-1A	£40
FARNELL E350 0-350V 0-200mA	£125
FARNELL D36-2T 0-30V 0-2A Twice Digital	£95
THURLEY PL330 0-32V 0-3A Digital (Kenwood badged)	£75
THURLEY TS3021S 0-30V 0-2A LCD	£65
THURLEY PL320 0-30V 0-2A Digital	£55
TAKASAGO GM035-3 0-35V 0-3A 2 Meters	£45
TAKASAGO TM035-2 0-35V 0-2A 2 Meters	£35
ISOLATING TRANSFORMER - Yellow - 500VA with 13Amp Socket	£35

#### FREQUENCY COUNTERS/TIMERS

EIP 371 Source Locking Microwave Counter 10Hz-18GHz	£925
EIP 331 Autohet Microwave Counter 825MHz-18GHz	£195
HP 5366A Counter 10Hz-3GHz	£380
FEEDBACK SC290 Counter 1-3GHz	£75
RACAL 9916 Counter 10Hz-500MHz	£75
RACAL 9906 Universal Counter 200MHz	£95
RACAL 9904 Counter Timer 50MHz	£65
RACAL 1991 Counter/Timer 160MHz 9 digit	£195
MARCONI 2431A Frequency Meter 200MHz	£50
MARCONI 2437 Counter/Timer 100MHz	£75
HP 5340A Autonet Microwave Counter 10Hz-18GHz	£250

## STEWART OF READING

17A King Street, Mortimer, Near Reading RG7 3RS  
Telephone: (0118) 933 1111. Fax: (0118) 933 2375  
[www.stewart-of-reading.co.uk](http://www.stewart-of-reading.co.uk)



Open 9am-5.00pm Monday to Friday (other times by arrangement)

Used Equipment - GUARANTEED. Manuals supplied  
This is a VERY SMALL SAMPLE OF STOCK. SAE or Telephone for lists.  
Please check availability before ordering.  
CARRIAGE all units £16. VAT to be added to Total of Goods and Carriage



Everyday Practical Electronics reaches twice as many UK readers as any other UK monthly hobby electronics magazine, our sales figures prove it. We have been the leading monthly magazine in this market for the last twenty one years.

If you want your advertisements to be seen by the largest readership at the most economical price our classified and semi-display pages offer the best value. The prepaid rate for semi-display space is £10 (+VAT) per single column centimetre (minimum 2.5cm). The prepaid rate for classified adverts is 40p (+VAT) per word (minimum 12 words).

All cheques, postal orders, etc., to be made payable to Everyday Practical Electronics. VAT must be added. Advertisements, together with remittance, should be sent to Everyday Practical Electronics Advertisements, 408 Wimborne Road East, Ferndown, Dorset BH22 9ND. Phone: 01202 873872. Fax: 01202 874562. Email: epeads@wimborne.co.uk. For rates and information on display and classified advertising please contact our Advertisement Manager, Stewart Kearn as above.

**BOWOOD ELECTRONICS LTD**  
*Suppliers of Electronic Components*  
 Place a secure order on our website or call our sales line  
 All major credit cards accepted  
 Web: [www.bowood-electronics.co.uk](http://www.bowood-electronics.co.uk)  
 Unit 1, McGregor's Way, Turnoaks Business Park,  
 Chesterfield, S40 2WB. Sales: 01246 200222  
 Send 60p stamp for catalogue

**BTEC ELECTRONICS  
 TECHNICIAN TRAINING**  
**NATIONAL ELECTRONICS  
 VCE ADVANCED ICT  
 HNC AND HND ELECTRONICS  
 FOUNDATION DEGREES  
 NVQ ENGINEERING AND IT  
 DESIGN AND TECHNOLOGY**  
**LONDON ELECTRONICS COLLEGE**  
 20 PENYWERN ROAD  
 EARLS COURT, LONDON SW5 9SU  
 TEL: (020) 7373 8721  
[www.lec.org.uk](http://www.lec.org.uk)

**N.R. BARDWELL Ltd – est 1948**  
**Electronic Component Supplies**  
 LED's, Semis, IC's Resistors, Caps, etc  
 send 44p for lists. 1000's bargains at our  
 secure site: [www.bardwells.co.uk](http://www.bardwells.co.uk)  
 288, Abbeydale Rd. Sheffield. S7 1FL  
 0845 166 2329 (local rate)

**SAFFRON ELECTRONICS LTD**  
*Suppliers of High Quality Electronic Components*  
 Resistors, Caps, Batteries, Chargers, Semiconductors,  
 LED's, IC's, PCB's, Switches, Solder, Cable, Wire, Etc.  
 Online Catalogue and Shop available at  
[www.SaffronElectronics.co.uk](http://www.SaffronElectronics.co.uk)  
 16 Field Street, Cannock, Staffs. WS11 5QP  
 Telephone: 0845 166 2314 (local rate)

**BARGAIN PRICES.**  
 1000's of electrical components, motors, trans-  
 formers, switches, capacitors plus many more.  
 Please phone, write or email for a catalogue.  
**J & N Electrical, Pilgrims, Stairbridge  
 Lane, Bolney, West Sussex, RH17 5PA.**  
 Tel: 01444 881965.

**THIS SPACE COULD BE  
 YOURS FOR JUST £40**  
**Contact Stewart**  
**01202 873872**  
[stewart.kearn@wimborne.co.uk](mailto:stewart.kearn@wimborne.co.uk)

**Versatile Programmable PIC  
 On Screen Display System**



Free demo code  
 PAL - NTSC compatible

- PIC 16F628 microcontroller
- 28 by 11 character screen
- Fully programmable
- Text over composite video
- Demo software available
- Free I/O for sensors or buttons

TEXT, GPS or DATA

[www.STV5730A.co.uk](http://www.STV5730A.co.uk)

**WANT A PART TIME BUSINESS?**  
 Do not answer this ad, unless you are prepared to assemble an electronic unit and then demonstrate it to charities. (Names & addresses provided). They will introduce you to customers.  
**Genuinely interested?**  
**Details 02392 830158**

**HEROS technology Ltd**  
[www.herostechnology.co.uk](http://www.herostechnology.co.uk)  
 Introducing Modular Concept for microcontrollers  
 Suitable for Developers, Pre-production, Educational and Hobby applications.

- WinPIC2006 USB full speed programmer
- CPU microcontroller modules
- Peripheral modules for all microcontrollers

**VVT TRANSFORMERS**  
 Transformers and Chokes for all types of circuits including specialist valve units  
 Custom design or standard range  
 High and low voltage  
**Variable Voltage Technology Ltd**  
 Unit 3, Sheat Manor Farm, Chillerton,  
 Newport, Isle of Wight, PO30 3HP  
 Tel: 0870 243 0414 Fax: 01983 721572  
 email: [sales@vvt-cowes.freeserve.co.uk](mailto:sales@vvt-cowes.freeserve.co.uk)  
[www.vvttransformers.co.uk](http://www.vvttransformers.co.uk)

**Your own complete  
 eCommerce 24/7 site  
 for only £10 per week!**



Domain, secure hosting, emails, shopping basket, etc, included.  
 details: [www.eConcept.co.uk](http://www.eConcept.co.uk)

**Miscellaneous**

**VALVES AND ALLIED COMPONENTS IN STOCK.** Phone for free list. Valves, books and magazines wanted. Geoff Davies (Radio), tel. 01788 574774.

**WANTED OLD HALF INCH FERRITE RODS.** Must be half inch in diameter and be six inches long or more, will pay good money for the rods. Contact Peter Tankard on 0114 2316321 between 9am and 10pm.

**CHAFFINCH ENGINEERING.** Services to the electronics enthusiast and experimenter in science and technology. Custom made: spindles, pulley-wheels, small gear trains, probe bodies, mounting plates, mounting brackets, knobs, screws, nuts, washers etc.. Enclosures modified and assembled, to your requirements. One-off and short or long runs no problem. Cheap rates. Free quotations. Telephone: 020 8898 0933, any time, and leave a message.

**½ PRICE VALVES**  
 Over 1480 different valve numbers. Catalogue available for £1, refundable on 1st order. W. Burcher, 676 Foxhall Road, Ipswich, Suffolk, IP3 8NQ. Tel: 01473 272218



[www.epemag.com](http://www.epemag.com)

**Get your magazine  
 "instantly" anywhere  
 in the world – buy  
 and download from  
 the web.**

**TAKE A LOOK, A  
 FREE ISSUE IS  
 AVAILABLE**

**A one year  
 subscription  
 (12 issues) costs just  
 \$15.99 (US)**



[www.epemag.com](http://www.epemag.com)

# Europe's Largest Surplus Store

20,000,000 Items on line NOW!  
New items added daily

Established for over 25 years, UK company Display Electronics prides itself on offering a massive range of electronic and associated electro-mechanical equipment and parts to the Hobbyist, Educational and Industrial user. Many current and obsolete hard to get parts are available from our vast stocks, which include:

- ◆ 6,000,000 Semiconductors
- ◆ 5,000 Power Supplies
- ◆ 25,000 Electric Motors
- ◆ 10,000 Connectors
- ◆ 100,000 Relays & Contactors
- ◆ 2000 Rack Cabinets & Accessories
- ◆ 4000 Items of Test Equipment
- ◆ 5000 Hard Disk Drives

**We Ship Worldwide**

**Surplus Wanted**

[www.distel.co.uk](http://www.distel.co.uk)

Display Electronics  
29 / 35 Osborne Road  
Thornton Heath  
Surrey UK CR7 8PD

Telephone  
**[44] 020 8653 3333**  
Fax [44] 020 8653 8888

## Rechargeable Batteries With Solder Tags

NIMH	NICAD
AA 2000mAh .....£2.82	AA 650mAh..... £1.41
C 4Ah .....£4.70	C 2.5Ah .....£3.60
D 9Ah .....£7.60	D 4Ah .....£4.95
PP3 150mAh ..... £4.95	

Instrument case with edge connector and screw terminals

Size 112mm x 52mm x 105mm tall

This box consists of a cream base with a PCB slot, a cover plate to protect your circuit, a black lid with a 12 way edge connector and 12 screw terminals built in (8mm pitch) and 2 screws to hold the lid on. The cream bases have minor marks from dust and handling price £2.00 + VAT(=£2.35) for a sample or £44.00+VAT (=£51.70) for a box of 44.

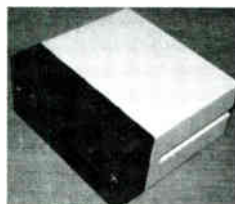
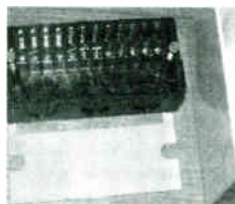

866 battery pack originally intended to be used with an orbital mobile telephone it contains 10 1.6Ah sub C batteries (42 x 22 dia. the size usually used in cordless screwdrivers etc.) the pack is new and unused and can be broken open quite easily £7.46 + VAT = £8.77



Please add £1.66 + VAT = £1.95 postage & packing per order

**JPG Electronics**

Shaws Row, Old Road, Chesterfield, S40 2RB.

Tel 01246 211202 Fax 01246 550959

[www.JPGElectronics.com](http://www.JPGElectronics.com)

Mastercard/Visa/Switch

Callers welcome 9.30 a.m. to 5.30 p.m. Monday to Saturday

**EP** EVERYDAY PRACTICAL ELECTRONICS

**NEXT MONTH**

### GIANT LED MESSAGE DISPLAY

Proclaim your message loud and clear with this Giant LED Message Display unit. It provides the following functions:

- ★ Moving message and graphics display
- ★ Static message display
- ★ Animation display

It is in modular form and can be built pretty much to what ever size (up 128 display modules) and format one prefers. It is PIC microcontroller controlled, programmable for its display.

### QUICK BRAKE

Are you concerned about the risk of a rear end collision when driving in traffic? With QuickBrake, your brake lights come on faster than you could ever apply them, giving you literally metres more safety. Find out how it's done in this nifty project.

### USING C

The start of a four part series on using C with particular reference to programming PIC microcontrollers. Written with hobbyist and students in mind, the series covers everything from choosing a compiler to linking assembly modules into C. The final part includes an example project using Microchip USB code

**NOVEMBER '06 ISSUE ON SALE OCT 12**

## ADVERTISERS INDEX

AUDON ELECTRONICS .....	52
BETA-LAYOUT .....	70
BRUNNING SOFTWARE .....	62
BULL GROUP .....	Cover (ii)
BYVAC .....	17
DISPLAY ELECTRONICS .....	72
EASYSYNC .....	27
ESR ELECTRONIC COMPONENTS .....	6
JAYCAR ELECTRONICS .....	38/39
JPG ELECTRONICS .....	72
LABCENTER .....	Cover (iv)
LASER .....	70
MAGENTA ELECTRONICS .....	5
MICROCHIP .....	30
MILFORD INSTRUMENTS .....	4
NURVE NETWORKS LLC .....	58
PEAK ELECTRONIC DESIGN .....	19
PICO TECHNOLOGY .....	52
QUASAR ELECTRONICS .....	2/3
RAPID ELECTRONICS .....	Cover (iii)
SCANTOOL .....	21
SHERWOOD ELECTRONICS .....	52
STEWART OF READING .....	70

### ADVERTISEMENT OFFICES:

408 WIMBORNE ROAD EAST, FERNDOWN, DORSET BH22 9ND

PHONE: 01202 873872 FAX: 01202 874562

EMAIL: [epeds@wimborne.co.uk](mailto:epeds@wimborne.co.uk)

For Editorial address and phone numbers see page 7

Everyday Practical Electronics, periodicals pending, ISSN 0262 3617 is published twelve times a year by Wimborne Publishing Ltd., USA agent USACAN at 1320 Route 9, Champlain, NY 12919. Subscription price in US \$60(US) per annum. Periodicals postage paid at Champlain NY and at additional mailing offices. POSTMASTER: Send USA and Canada address changes to Everyday Practical Electronics, c/o Express Mag., PO Box 2769, Plattsburgh, NY, USA 12901-0239.



# Rapid

Proud to be this year's prize sponsor for the Teach-In series

## Microswitches

Order code 78-0867  
From **19p**

From **10p**  
5mm white LED  
Order code 55-1886

## Light Dependent Resistors

From **61p**  
Order code 58-0132

## LED Displays

Kingbright  
From **30p**  
Order code 57-0140

**NO MINIMUM ORDER VALUE**

## Colour cycling LEDs

Order code 55-1904  
From **26p**

## 1N4148 Signal Diode

Order code 47-3308  
From **0.6p**

## High voltage ceramic capacitors

Order code 08-1530  
From **2p**

## LCD Displays

Now only **£2.00**  
Order code 57-0905 (not RC)

## 20 x 5mm Time lag glass fuses

Order code 26-0570  
From **4p**

## Darlington transistors

From **6p**  
Order code 81-0172

## 7805 V-reg

Order code 47-3290  
From **9p**

## MICROCONTROLLERS PICs

From **30p**  
Order code 73-1950

## Multilayer ceramic chip capacitors

From **1.1p**  
Order code 71-0501

**ORDER OUR 1,000 PAGE CATALOGUE TODAY TO SEE OUR FULL RANGE OF PRODUCTS**

0402 Multilayer ceramic chip capacitors  
TruCap  
From **50p**  
Pack 100  
Order code 71-1883

## TruXtal Quartz Crystal

Order code 90-3151  
From **6p**

## NE555 Timer ICs

From **8p**  
Order code 82-0336

## 5mm Ceramic trimmer capacitor

Order code 12-0210

From **9.5p**  
TruCap

## 1/4in Single turn potentiometers

TruOhm  
From **30p**  
Order code 68-0280

## 1/4in Single turn cermet potentiometers

TruOhm  
From **14p**  
Order code 68-0041

**SAME DAY DESPATCH**

**01206 751166 • www.rapidonline.com**

## Heatsinks

From **22.5p**  
Order code 36-0235

**FREE DELIVERY**

On all orders over £25 (excluding VAT) UK mainland only

## SMD Power inductors

Order code 88-1241

From **14p**

## Dual colour LED illuminated switches

RVFM  
From **£1.42**  
Order code 78-2335

## Square illuminated PCB switches

Order code 78-2332

From **£2.30**  
RVFM

## Data entry keypads

RVFM  
Order code 78-0305  
From **£1.10**

## SPST LED Tip toggle switch

Order code 78-0374  
From **95p**

## SPST Oval LED rocker switch

Order code 75-0356  
From **69p**

Rapid Electronics Limited  
Severalls Lane, Colchester, Essex CO4 5JS  
Tel: 01206 751166. Fax: 01206 751188  
Email: sales@rapidelec.co.uk  
Website: www.rapidonline.com

*defining the standard*

# PROTEUS

## ELECTRONIC DESIGN



FROM CONCEPT

TO COMPLETION

**SCHEMATIC CAPTURE    PROSPICE    EMBEDDED SIMULATION    PCB DESIGN**

### ISIS SCHEMATIC CAPTURE

A powerful capture package tailored for today's engineer and designed to allow rapid entry of complex schematics for simulation and PCB Layout.

### PROSPICE MIXED MODE SIMULATOR

A customised implementation of the industry standard Berkeley SPICE 3F5 engine with extensive optimisations and enhancements for true mixed mode simulation and circuit animation.

### VSM VIRTUAL SYSTEM MODELLING

The world's first and best schematic based microcontroller co-simulation software. Proteus VSM allows you to simulate the interaction between software running on a microcontroller and any analog or digital electronics connected to it. This streamlines the project lifecycle and obviates the need for expensive hardware analysis tools.

### ARES PCB DESIGN

A modern and professional layout package which seamlessly integrates with the ISIS capture software. Features such as autoplacement and autorouting, interactive DRC and an intuitive interface all serve to maximise productivity and reduce time to market.

### LABCENTER ELECTRONICS LTD.

A technology pioneer in the EDA industry since 1988.  
Technical support direct from the program authors.  
Flexible packages and pricing tailored to customer requirements.

### CONTACT US NOW

to discuss requirements or  
request a **FREE** evaluation copy.

**labcenter**  [www.labcenter.co.uk](http://www.labcenter.co.uk)  
Electronics

Tel: 01756 753440  
Fax: 01756 752857  
Email: [info@labcenter.co.uk](mailto:info@labcenter.co.uk)

Labcenter Electronics Ltd., 53-55 Main Street, Grassington,  
North Yorks, BD23 5AA. Registered in England 4692454

World Radio History