

THE No.1 MAGAZINE FOR ELECTRONICS TECHNOLOGY & COMPUTER PROJECTS

EVERYDAY

MAY 2005

# PRACTICAL ELECTRONICS

£3.10

**CROSSWORD SOLVER**  
57,000 words plus anagrams

BUY EP/E  
ON THE WEB  
**EP**  
epemag.com

## 20W AMPLIFIER MODULE

Versatile, wide band,  
low distortion

## DAB AERIAL

Inexpensive quarter-wave design

**SPECIAL SERIES**

## BACK TO LOGIC BASICS

Water Level Detector  
Burglar Alarm



[www.epemag.co.uk](http://www.epemag.co.uk)



Colour CCTV camera, 8mm lens, 12vdc 200mA a 582X628 Res 380 lines Automatic aperture lens Mirror function PAL Back Light Comp MLR, 100x40x40mm ref EE2 £75.90

Built in Audio .15lux CCD camera 12vdc 200mA 480 lines s/n ratio >48 db 1v P-P output 110x60x50mm ref EE1 £108.90



Metal CCTV camera housings for internal or external use. Made from aluminium and plastic they are suitable for mounting body cameras in. Available in two sizes 1-100x70x170mm and 2-100x70x280mm Ref EE6 £22 EE7 £26 Multi position brackets Ref EE8 £8.80



Excellent quality multi purpose TV/TFT screen, works as just a LCD colour monitor with any of our CCTV cameras or as a conventional TV ideal for use in boats and caravans 49.75mhz-91.75mhz VHF channels 1-5, 168.25mhz-222.75mhz VHF channels 6-12, 471.25mhz-869.75mhz, Cable channels 112.325mhz-166.75mhz Z1-Z7, Cable channels 224.25mhz-446.75mhz Z8-Z35 5" colour screen, Audio output 150mW, Connections, external aerial, earphone jack, audio/video input, 12vdc or mains, Accessories supplied Power supply Remote control Cigar lead power supply Headphone Stand/bracket, 5" model £139 Ref EE9.



Self cocking pistol p1c002 crossbow with metal body. Selfcocking for precise string alignment Aluminium alloy construction High tec fibre glass limbs Automatic safety catch Supplied with three bolts Track style for greater accuracy Adjustable rear sight 50lb draw weight 150ft/sec velocity Break action 17" string 30m range £23.84 Ref PLCR002



Fully cased IR light source suitable for CCTV applications. The unit measures 10x10x150mm, is mains operated and contains 54 infra red LEDs. Designed to mount on a standard CCTV camera bracket. The unit also contains a daylight sensor that will only activate the infra red lamp when the light level drops below a preset level. The infrared lamp is suitable for indoor or exterior use, typical useage would be to provide additional IR illumination for CCTV cameras. £53.90 ref FF 11



Colour CCTV Camera measures 60x45mm and has a built in light level detector and 12 IR leds. 2 lux 12 IR leds 12vdc Bracket Easy connect leads £75.90 Ref EE15



A high quality external colour CCTV camera with built in Infra red LEDs measuring 60x60x60mm Easy connect leads colour Waterproof PAL 1/4" CCD 542x588 pixels 420 lines .05lux 3.6mm F2.78 deg lens 12vdc 400mA Built in light level sensor. £108.90 Ref EE13



A small colour CCTV camera just 35x28x30mm Supplied with bracket, easy connect leads. Built in audio. Colour 380 line res. PAL 0.2lux +18db sensitivity Effective pixels 628x582 6-12vdc Power 200mw £39.60 Ref EE16

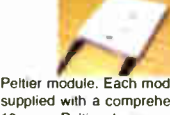

Peltier module. Each module is supplied with a comprehensive 18 page Peltier design manual featuring circuit designs, design information etc etc. The Peltier manual is also available separately Maximum watts 56.2 40x40mm Imax 5.5A Vmax 16.7 Tmax (-dry N2) 72 £32.95 (inc manual) REF PELT1, just manual £4.40 ref PELT2



GASTON SEALED LEAD ACID BATTERIES  
1.3AH 12V @ £5.50 GT1213  
3.4AH 12V @ £8.80 GT1234  
7AH 12V @ £8.80 GT127  
17AH 12V @ £19.80 GT1217

COMPAQ 1000mA 12vdc power supplies, new and boxed. 2 metre lead DC power plug 2.4mmx10mm £5.25 each, 25+ £3.50 100+ £2.50

All new and boxed, bargain prices. Good quality sealed lead acid batteries



1.2ghz wireless receiver Full cased audio and video 1.2ghz wireless receiver 190x140x30mm metal case, 4 channel, 12vdc Adjustable time delay, 4s, 8s, 12s, 16s. £49.50 Ref EE20

The smallest PMR446 radios currently available (54x87x37mm). These tiny handheld PMR radios look great, user friendly & packed with features including VOX, Scan & Dual Watch. Priced at £59.99 PER PAIR they are excellent value for money. Our new favourite PMR radios! Standby: - 35 hours Includes: - 2 x Radios, 2x Belt Clips & 2 x Carry Strap £59.95 Ref ALAN1 Or supplied with 2 sets of rechargeable batteries and two mains chargers £93.49 Ref Alan2

The TENS mini Microprocessors offer six types of automatic programme for shoulder pain, back/neck pain, aching joints, Rheumatic pain, migraines headaches, sports injuries, period pain. In fact all over body treatment. Will not interfere with existing medication. Not suitable for anyone with a heart pacemaker. Batteries supplied. £21.95 Ref TEN327 Spare pack of electrodes £6.59 Ref TEN327X

Dummy CCTV cameras These motorised cameras will work either on 2 AA batteries or with a standard DC adapter (not supplied) They have a built in movement detector that will activate the camera if movement is detected causing the camera to 'pan' Good deterrent. Camera measures 20cm high, supplied with fixing screws. Camera also has a flashing red led. £10.95 Ref CAMERAB

INFRA RED FILM 6" square piece of flexible infra red film that will only allow IR light through Perfect for converting ordinary torches, lights, headlights etc to infrared output using standard light bulbs Easily cut to shape. 6" square £16.50 ref IRF2 or a 12" sq for £34.07 IRF2A

THE TIDE CLOCK These clocks indicate the state of the tide. Most areas in the world have two high tides and two low tides a day, so the tide clock has been specially designed to rotate twice each lunar day (every 12 hours and 25 minutes) giving you a quick and easy indication of high and low water. The Quartz tide clock will always stay calibrated to the moon. £23.10 REF TIDE C

LINEAR ACTUATORS 12-36VDC BUILT IN ADJUSTABLE LIMIT SWITCHES POWDER COATED 18" THROW UP TO 1,000 LB THRUST (400LB RECOMMENDED LOAD) SUPPLIED WITH MOUNTING BRACKETS DESIGNED FOR OUTDOOR USE These brackets originally made for moving very large satellite dishes are possibly more suitable for closing gates, mechanical machinery, robot wars etc. Our first sale was to a company building solar panels that track the sun! Two sizes available, 12" and 18" throw. £32.95 REF ACT12.

Samarium magnets are 57mm x 20mm and have a hole (5/16th UNF) in the centre and a magnetic strength of 2.2 gauss. We have tested these on a steel beam running through the offices and found that they will take more than 170lbs (77kgs) in weight before being pulled off. With keeper. £21.95 REF MAG77

New transmitter, receiver and camera kit. £69.00

Kit contains four channel switchable camera with built in audio, six IR leds and transmitter, four channel switchable receiver, 2 power supplies, cables, connectors and mounting bracket. £69.00 Wireless Transmitter Black and white camera (75x50x55mm) Built in 4 channel transmitter (switchable) Audio built in 6 IR Leds Bracket/stand Power supply 30 m range Wireless Receiver 4 channel (switchable) Audio/Video leads and scart adapter Power supply and Manual £69.00 ref COP24

This miniature Stirling Cycle Engine measures 7" x 4-1/4" and comes complete with built-in alcohol burner. Red flywheels and chassis mounted on a green base, these all-metal beauties silently running at speeds in excess of 1,000 RPM attract attention and create awe wherever displayed. This model comes completely assembled and ready to run. £106.70 REF SOL1

High-power modules using 125mm square multi crystal silicon solar cells with bypass diode. Anti reflection coating and BSF structure to improve cell conversion efficiency: 14%. Using white tempered glass, EVA resin, and a weatherproof film along with an aluminum frame for extended outdoor use. system Lead wire with waterproof connector. 80 watt 12v 500x1200 £315.17, 123w 12vdc 1499x662x46 £482.90 165 w 24v 1575x826x46mm £652.30

**BULL GROUP LTD**  
UNIT D HENFIELD BUSINESS PARK  
HENFIELD SUSSEX BN5 9SL  
TERMS: CASH, PO, CHEQUE PRICES+VAT  
WITH ORDER PLUS £5.50 P&P (UK) PLUS VAT.  
24 HOUR SERVICE £7.50 (UK) PLUS VAT.  
OVERSEAS ORDERS AT COST PLUS £3.50  
Tel: 0870 7707520 Fax 01273491813  
Sales@bullnet.co.uk  
www.bullnet.co.uk



Ultra-compact, lightweight, easy to use and comfortable to hold, the new NVMT is unique for a night scope in offering a tactile, sure grip plastic body shell and, for extra protection/grip, partial rubber armouring. Currently the top of the range model, the NVMT G2+ features a 'commercial' grade Gen 2+ Image Intensifier Tube (IIT). The NVMT has a built-in, powerful Infrared (IR) illuminator for use in very low light/total darkness. Power for the scope and IR is provided by 1 x 3V Lithium CR123A battery (not supplied). A green LED next to the viewfinder indicates when the Image Intensifier Tube is switched on while a red LED indicates when the IR illuminator is switched on. Type Gen Weight Size Lens Mag 2x, Weight 400g, 125x82x35mm angle of view 30deg, built in infra red, rang 3 - 400m, supplied with batteries £849 ref COB24023.

55 - 200 WATT INFRA RED TORCHES  
Search guard 1 infrared torch Plastic bodied waterproof infrared rechargeable lamp. 100mm diameter lens, 200mm body length. 55 watt bulb, 1,000,000 candle power (used as an indication of relative power) Supplied complete with a 12v car lighter socket lead/charger and a 240v mains plug in charger. £49 REF Sguard 1. Also available, 70watt @ £59, 100 watt @ £79, 200watt @ £99.



B2 AIR RIFLE Available in .177 and .22-19" Tapered Rifled Barrel Adjustable Rear Sight Full Length Wooden Stock Overall Length 43" approx Barrel Locking Lever Also available in CARBINE Grooved for Telescopic Sight model with 14" barrel - no front sight for use with scope. Weight approximately 6lbs Extremely powerful .22 £28.90, .177 £24.70, pellets (500) £2.55, sights 4x20 £6.80, 4x28 £15.32 Other models available up to £250 www.airspistol.co.uk

12V SOLAR PANELS AND REGULATORS  
9 WATT £58.75  
15 WATT £84.25  
22 WATT £126.70  
Regulator up to 60 watt £21.25  
Regulator up to 135 watt £38.25

The combination of multi-crystal cells and a high-reliability module structure make this series of solar panels the ideal solar module. For large-scale power generation hundreds or even thousands of modules can be connected in series to meet the desired electric power requirements. They have a high output, and highly efficient, extremely reliable and designed for ease of maintenance. Separate positive negative junction boxes and dual by-pass diodes are a few examples of some of its outstanding features. Supplied with an 8 metre cable. Perfect for caravans, boats, etc. Toughened glass.



LOCK PICK SETS 16, 32 AND 60 PIECE SETS  
This set is deluxe in every way! It includes a nice assortment of balls, rakes, hooks, diamonds, two double ended picks, a broken key extractor, and three tension wrenches. And just how do you top off a set like this? Package it in a top grain leather zippered case. Part: LP005 - Price £45.00  
This 32 piece set includes a variety of hooks, rakes, diamonds, balls, extractors, tension tools... and comes housed in a zippered top grain leather case. If you like choices, go for this one! Part: LP006 - Price £65.00  
If you want to run toward the biggest pick set you can find, here it is. This sixty piece set includes an array of hooks, rakes, diamonds, balls, broken key extractors, tension wrenches, and even includes a warded pick set! And the zippered case is made, of course, of the finest top grain leather. First Class! Part: LP007 - Price £99.00

Mamod steam roller, supplied with fuel and everything you need (apart from water and a match!) £85 REF 1312 more models at www.mamodspares.co.uk

Mamod steam roller, supplied with fuel and everything you need (apart from water and a match!) £130 REF 1318 more models at www.mamodspares.co.uk

PEANUT RIDER STIRLING ENGINE This all metal, black and brass engine with red flywheel is mounted on a solid hardwood platform, comes complete with an alcohol fuel cell, extra wick, allen wrenches, and Owner's Manual. Specifications: Base is 5-1/4" x 5-1/4", 4" width x 9" height, 3/4" stroke, 3-1/2" flywheel £141.90

SHOP ONLINE  
WWW.BULLNET.CO.UK

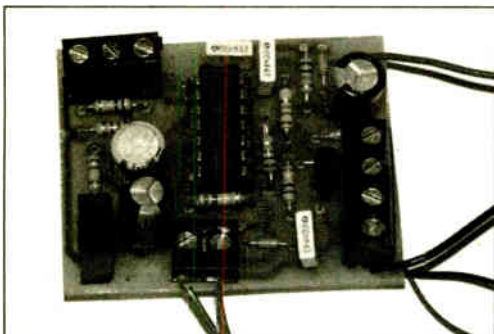
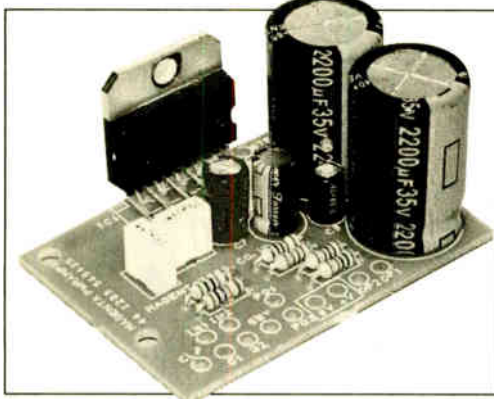

© Wimborne Publishing Ltd 2005. Copyright in all drawings, photographs and articles published in EVERYDAY PRACTICAL ELECTRONICS is fully protected, and reproduction or imitations in whole or in part are expressly forbidden.

Our June 2005 issue will be published on Thursday, 12 May 2005. See page 307 for details

## Projects and Circuits

- CROSSWORD SOLVER** by Mike Hibbett **316**  
Even *The Times* could become a doddle!
- INGENUITY UNLIMITED - Sharing your Ideas with others** **322**  
Adjustable Constant Current Source; Multi-Level Lock; Electrical Field Detector
- BACK TO BASICS - 2 Water Level Detector; Burglar Alarm** **329**  
by Bart Trepak  
Continuing our series of simple, easy-to-build circuits based on one or two CMOS logic chips
- 20W AMPLIFIER MODULE** by Mark Stuart **336**  
Low-cost, single-chip, 20W wide-band low distortion mono/stereo amplifier module
- SMART KARTS - 8 SK-4 Software** by Owen Bishop **364**  
Discussing the final software routines for our mobile buggy
- DAB RADIO AERIAL** by Stef Niewiadomski **360**  
A loft-mounted quarter-wave ground plane antenna for digital radio reception

## Series and Features

- TECHNO TALK** by Mark Nelson **320**  
Green for Go - but why? It's not so obvious!
- CIRCUIT SURGERY** by Alan Winstanley and Ian Bell **333**  
CompactFlash memory cards; and more about thermistors
- PASSIVE COMPONENT TESTING** by Mike Tooley BA **348**  
Getting the most out of your passive component analyser
- PRACTICALLY SPEAKING** by Robert Penfold **354**  
A novice's guide to switches
- NET WORK - THE INTERNET PAGE** surfed by Alan Winstanley **372**  
More on phishing and other Internet fraud, and software safeguards; Chat Zone update

## Regulars and Services

- PIC RESOURCES CD-ROM** Invaluable to all PICkers! **310**
- EDITORIAL** **315**
- NEWS** - Barry Fox highlights technology's leading edge **326**  
Plus everyday news from the world of electronics
- READOUT** John Becker addresses general points arising **342**
- SHOPTALK** with David Barrington **344**  
The *essential* guide to component buying for *EPE* projects
- BACK ISSUES** Did you miss these? **346**
- BACK ISSUE CD-ROMS** single-source shopping for issues you've missed **347**
- CD-ROMS FOR ELECTRONICS** **357**  
A wide range of CD-ROMs for hobbyists, students and engineers
- ELECTRONICS MANUALS** **363**  
CD-ROM reference works for hobbyists, students and service engineers
- DIRECT BOOK SERVICE** **369**  
A wide range of technical books available by mail order, plus more CD-ROMs
- PRINTED CIRCUIT BOARD AND SOFTWARE SERVICE** **373**  
PCBs for *EPE* projects. Plus *EPE* project software
- ADVERTISERS INDEX** **376**

**Readers Services • Editorial and Advertisement Departments 315**

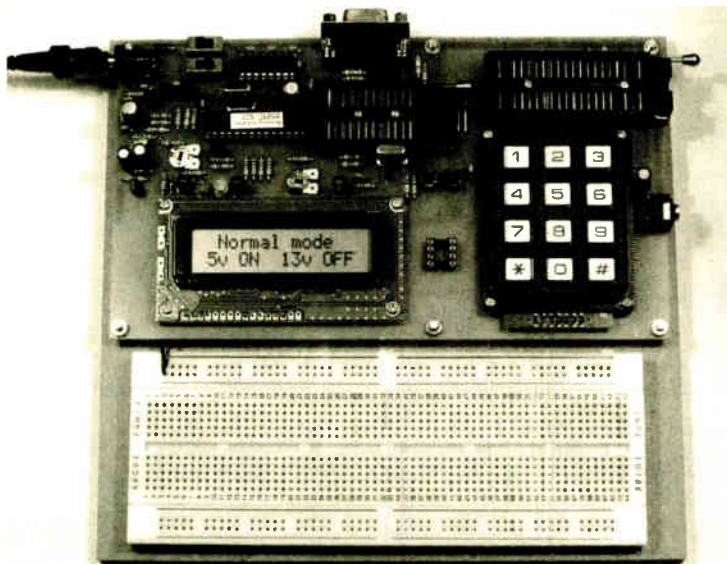

## PIC Training & Development System

The best place to start learning about microcontrollers is the PIC16F84. This is easy to understand and very popular with construction projects. Then continue on using the more sophisticated PIC16F877 family.

The heart of our system is two real books which lie open on your desk while you use your computer to type in the programme and control the hardware. Start with four very simple programmes. Run the simulator to see how they work. Test them with real hardware. Follow on with a little theory....

Our complete PIC training and development system consists of our universal mid range PIC programmer, a 306 page book covering the PIC16F84, a 262 page book introducing the PIC16F877 family, and a suite of programmes to run on a PC. The module is an advanced design using a 28 pin PIC16F870 to handle the timing, programming and voltage switching requirements. The module has two ZIF sockets and an 8 pin socket which between them allow most mid range 8, 18, 28 and 40 pin PICs to be programmed. The plugboard is wired with a 5 volt supply. The software is an integrated system comprising a text editor, assembler disassembler, simulator and programming software. The programming is performed at 5 volts, verified with 2 volts or 3 volts applied and verified again with 5.5 volts applied to ensure that the PIC is programmed correctly over its full operating voltage. DC version for UK, battery version for overseas. UK orders include a plugtop power supply.

- Universal mid range PIC programmer module
  - + Book Experimenting with PIC Microcontrollers
  - + Book Experimenting with the PIC16F877 (2nd edition)
  - + Universal mid range PIC software suite
  - + PIC16F84 and PIC16F870 test PICs. . . . . £159.00
- (Postage & insurance UK £10, Europe £15, Rest of world £25)

## Experimenting with PIC Microcontrollers

This book introduces the PIC16F84 and PIC16C711, and is the easy way to get started for anyone who is new to PIC programming. We begin with four simple experiments, the first of which is explained over ten and half a pages assuming no starting knowledge except the ability to operate a PC. Then having gained some practical experience we study the basic principles of PIC programming, learn about the 8 bit timer, how to drive the liquid crystal display, create a real time clock, experiment with the watchdog timer, sleep mode, beeps and music, including a rendition of Beethoven's *Für Elise*. Finally there are two projects to work through, using the PIC16F84 to create a sinewave generator and investigating the power taken by domestic appliances. In the space of 24 experiments, two projects and 56 exercises the book works through from absolute beginner to experienced engineer level.

## Hardware & Ordering Information

The programmer module for both systems connects to the serial port of your PC (COM1 or COM2). All our software referred to in this advertisement will operate within Windows 98, XP, NT, 2000 etc.

Telephone with Visa, Mastercard or Switch, or send cheque/PO. All prices include VAT if applicable.

## PIC Project Modules

Our PIC Training & Development System is the ideal way for any newcomer to start learning about PIC microcontrollers. Now we have created our PIC Project Modules System to help with your next stage of learning.

The new system consists of five modules, a new book featuring one of the latest PIC Microcontrollers, software to run on your PC with ready made library routines, interconnecting cables and plugtop power supply (UK only):-

- Module 1 - Programmer Module  
with PIC programming software. . . £49.50
- Module 2 - Display Driver Module. . . £43.30
- Module 3 - Motor Control Module. . . £28.50
- Module 4 - General I/O Module. . . . £24.70
- Module 5 - RS-232 Module  
with PC assembler software. . . . . £37.60

- Book PIC Project Modules. . . . . £20.00
- Plugtop PSU for UK. . . . . £ 4.00
- PC serial lead (9 way D). . . . . £ 3.80
- Two 10 way interconnecting leads. . . £ 6.00

Total price for the complete system. . £135.00

The Motor Control Module although only 70mm by 42mm is the powerful king pin. Two outputs can each control a DC motor up to 12 volts at 4 amps continuous (or be used to switch DC for any other use such as mains switching relays). The speed of the two motors can be remotely controlled using the onboard serial port to connect directly to the Display Driver Module with its 16 character by 2 line display and keypad, or connected to your PC via the RS-232 module (40mm x 45mm). If you want to remotely control more motors or switch more relays that is no problem – daisy chain modules into the serial link and programme each of them with a unique code. The book explains how to do it.

The General I/O Module also has a serial port for daisy chaining into the same system. It has 3 CMOS or analogue inputs (connecting to the 10 bit analogue to digital converter), and two high current 5 volt outputs for switching relays or motors, or which can be linked to on board inductors for generating step up voltages or TENS or muscle exercise waveforms.

Modules 1, 2 and 3 have a DC input socket and regulator. One input will run the whole chain.

For the latest information and pictures see our web site. Only sold as a complete system.

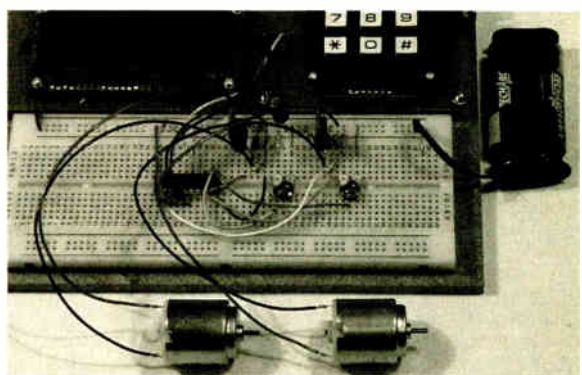

## Experimenting with the PIC16F877

The second PIC book starts with the simplest of experiments to give us a basic understanding of the PIC16F877 family. Then we look at the 16 bit timer, efficient storage and display of text messages, simple frequency counter, use a keypad for numbers, letters and security codes, and examine the 10 bit A/D converter.

The PIC16F627 is then introduced as a low cost PIC16F84. We use the PIC16F627 as a step up switching regulator, and to control the speed of a DC motor with maximum torque still available. We study how to use a PIC to switch mains power using an optoisolated triac driving a high current triac. Finally we study how to use the PICs USART for serial communication to a PC.

**Brunning Software** 138 The Street, Little Clacton, Clacton-on-sea,  
Essex, CO16 9LS. Tel 01255 862308

# NEXT MONTH

## PIC ULTRASONIC RADAR

Listen to the landscape – this PIC controlled Ultrasonic Radar scanning module is intended for use with mobile robots. It uses a PIC microcontroller and a stepper motor, with optional serial interfacing to a modern PC (Win 95, 98, ME or XP compatible) with Visual Basic 6 (VB6) providing a sophisticated visual display.

Whilst the design can be used as a standalone system, with or without PC interfacing, it is intended for use as a basic electronic framework whose software can be modified by readers to tailor it for use with their own mobile robot models. It is, for example, ripe for integrating with Owen Bishop's recent Smart Karts robot buggies.

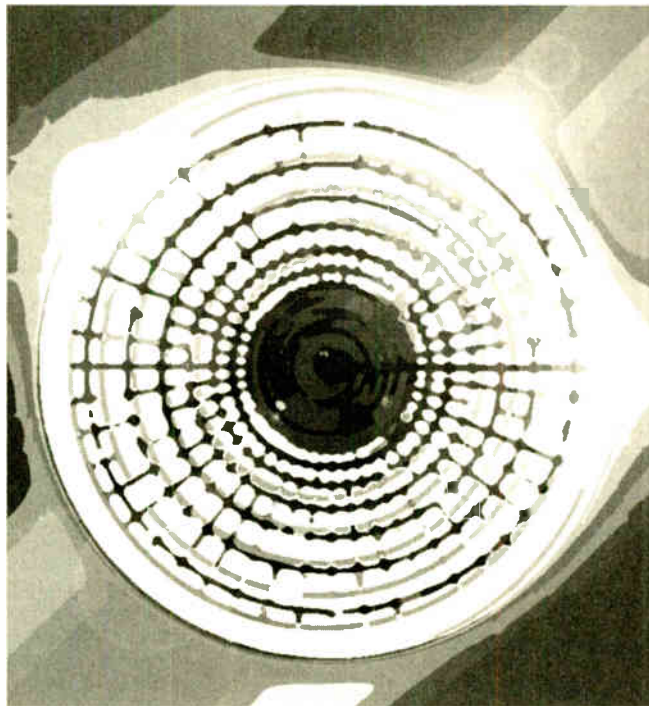

## SUPER-EAR AUDIO TELESCOPE

Super-Ear has been designed to incorporate a home-constructed parabolic element which boosts the sensitivity of an electret microphone for picking up sound at a distance. For example, as utilised in wildlife studies and, dare it be said, for eavesdropping on conversations from afar!

Most readers will be familiar with satellite dish antennas in the shape of a parabola. Whereas a true parabola has a precise mathematical definition, most items approximating to this shape and with a reflective surface can be used to "catch" sound. Sound waves travelling more or less parallel from a distant source strike or "illuminate" the parabolic element. These in turn are re-directed to a focal point at which the microphone is placed. In effect, this captures the targeted audio. The received input signal is then amplified as smoothly as possible by a sensitive circuit.

## BACK TO BASICS - 3

### • Scarecrow • Digital Switch

## RADIO CONTROLLED MODEL SWITCHER

This radio controlled (RC) switcher has been designed for use on a spare RC transceiver channel to effect on/off power switching to an RC model or other device. The maximum switching current is set to about 1A, at a safe maximum supply voltage of 24V d.c. A larger current could be controlled with the additional use of a relay. The author's previous designs for RC switchers included a number of monostables to control the circuit trigger timing. These circuits had no hysteresis and were prone to jitter at the trigger point. The circuit presented here is PIC controlled and has been designed to avoid this problem, and to generally improve performance and reliability.

# NO ONE DOES IT BETTER

**EVERYDAY  
PRACTICAL  
ELECTRONICS**

**DON'T MISS AN  
ISSUE – PLACE YOUR  
ORDER NOW!**

see page 368

Or take out a subscription and save money.

See page 376

**JUNE 2005 ISSUE ON SALE THURSDAY, MAY 12**



Quasar Electronics Limited  
PO Box 6935, Bishops Stortford,  
CM23 4WP  
Tel: 0870 246 1826  
Fax: 0870 460 1045  
E-mail: sales@quasarelectronics.com

Postage & Packing Options (Up to 2kg gross weight): UK standard 3-7 Day Delivery - £3.95; UK Mainland Next Day Delivery - £8.95; Europe (EU) - £6.95; Rest of World - £9.95 (Order online for reduced price UK Postage)  
We accept all major credit/debit cards. Make cheques/POs payable to Quasar Electronics Limited.  
Prices include 17.5% VAT. MAIL ORDER ONLY.  
Call now for our FREE CATALOGUE with details of over 300 high quality kits, projects, modules and publications.



# QUASAR 0871 CREDIT CARD SALES 717 7168

Helping you make the right connections!

## PIC & ATMEL Programmers

We have a wide range of low cost PIC and ATMEL Programmers. Complete range and documentation available from our web site.

### Programmer Accessories:

40-pin Wide ZIF socket (ZIF40W) £15.00  
18VDC Power supply (PSU010) £19.95  
Leads: Parallel (LDC136) £4.95 / Serial (LDC441) £4.95 / USB (LDC644) £2.95

## NEW! USB 'All-Flash' PIC Programmer

USB PIC programmer for all 'Flash' devices. No external power supply making it truly portable. Supplied with box and Windows Software. ZIF Socket and USB Plug A-B lead not incl.



Kit Order Code: 3128KT - £34.95

Assembled Order Code: AS3128 - £44.95

## Enhanced "PICALL" ISP PIC Programmer

Will program virtually ALL 8 to 40 pin PICs plus certain ATMEL AVR, SCENIX SX and EEPROM 24C devices. Also supports In System Programming (ISP) for PIC and ATMEL AVRs. Free software. Blank chip auto detect for super fast bulk programming. Requires a 40-pin wide ZIF socket (not included)

Assembled Order Code: AS3144 - £54.95

## ATMEL 89xxx Programmer

Uses serial port and any standard terminal comms program. 4 LEDs display the status. ZIF sockets not included. Supply: 16VDC.



Kit Order Code: 3123KT - £29.95

Assembled Order Code: AS3123 - £34.95

## NEW! USB & Serial Port PIC Programmer

USB/Serial connection. Header cable for ICSP. Free Windows software. See website for PICs supported. ZIF Socket and USB Plug A-B lead extra. 18VDC.

Kit Order Code: 3149KT - £34.95

Assembled Order Code: AS3149 - £49.95

## Introduction to PIC Programming

Go from a complete PIC beginner to burning your first PIC and writing your own code in no time! Includes a 49-page step-by-step Tutorial Manual. Programming Hardware (with LED bench testing section), Win 3.11-XP Programming Software (will Program, Read, Verify & Erase), and a rewritable PIC16F84A that you can use with different code (4 detailed examples provided for you to learn from). Connects to PC parallel port.

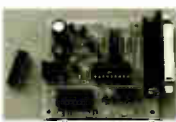

Kit Order Code: 3081KT - £14.95

Assembled Order Code: AS3081 - £24.95

## ABC Maxi AVR Development Board

The ABC Maxi board has an open architecture design based on Atmel's AVR



AT90S8535 RISC microcontroller and is ideal for developing new designs.

### Features:

- 8Kb of In-System Programmable Flash (1000 write/erase cycles) • 512 bytes internal SRAM • 512 bytes EEPROM
- 8 analogue inputs (range 0-5V)
- 4 Opto-isolated Inputs (I/Os are bi-directional with internal pull-up resistors)
- Output buffers can sink 20mA current (direct i.e.d. drive) • 4 x 12A open drain MOSFET outputs • RS485 network connector • 2-16 LCD Connector
- 3-5mm Speaker Phone Jack
- Supply: 9-12VDC.

The ABC Maxi STARTER PACK includes one assembled Maxi Board, parallel and serial cables, and Windows software CD-ROM featuring an Assembler, BASIC compiler and in-system programmer.

Order Code ABCMAXISP - £99.95

The ABC Maxi boards only can also be purchased separately at £79.95 each.

## Controllers & Loggers

Here are just a few of the controller and data acquisition and control units we have. See website for full details. Suitable PSU for all units: Order Code PSU445 - £8.95

## Rolling Code 4-Channel UHF Remote

State-of-the-Art. High security.

4 channels. Momentary or latching relay output. Range up to 40m. Up to 15 TXs can be learned by one Rx (kit includes one Tx but more available separately).

4 indicator LEDs.

Rx: PCB 77x85mm, 12VDC/6mA (standby).

Two & Ten Channel versions also available.

Kit Order Code: 3180KIT - £41.95

Assembled Order Code: AS3180 - £49.95



## Computer Temperature Data Logger

Serial port 4-channel temperature logger. °C or °F. Continuously logs up to 4 separate sensors located 200m+ from board. Wide range of free software applications for storing/using data. PCB just 38x38mm. Powered

by PC. Includes one DS1820 sensor and four header cables.

Kit Order Code: 3145KT - £19.95

Assembled Order Code: AS3145 - £26.95

Additional DS1820 Sensors - £3.95 each



## NEW! DTMF Telephone Relay Switcher

Call your phone number using a DTMF phone from anywhere in the world and remotely turn on/off any of the 4 relays as desired. User settable



Security Password, Anti-Tamper, Rings to Answer, Auto Hang-up and Lockout.

Includes plastic case. 130 x 110 x 30mm. Power: 12VDC.

Kit Order Code: 3140KT - £39.95

Assembled Order Code: AS3140 - £49.95

## Serial Port Isolated I/O Module

Computer controlled 8-channel relay board. 5A mains rated relay outputs and 4 opto-isolated digital inputs (for monitoring switch

states, etc). Useful in a variety of control and sensing applications. Programmed via serial port (use our new Windows interface, terminal emulator or batch files). Serial cable can be up to 35m long. Includes plastic case 130 x 100 x 30mm. Power: 12VDC/500mA.

Kit Order Code: 3108KT - £54.95

Assembled Order Code: AS3108 - £64.95

## Infra-red RC 12-Channel Relay Board

Control 12 on-board relays with included infra-red remote control unit. Toggle or momentary. 15m+ range. 112 x 122mm.

Supply: 12VDC/0.5A.

Kit Order Code: 3142KT - £41.95

Assembled Order Code: AS3142 - £51.95

## PC Data Acquisition & Control Unit

Monitor and log a mixture of analogue and digital inputs and control external devices via the analogue and digital outputs. Monitor pressure, temperature, light intensity, weight, switch state, movement, relays, etc. with the appropriate sensors (not supplied). Data can be processed, stored and the results used to control devices such as motors, sirens, relays, servo motors (up to 11) and two stepper motors.



### Features

- 11 Analogue Inputs - 0-5V, 10 bit (5mV/step)
- 16 Digital Inputs - 20V max. Protection 1K in series, 5-1V Zener
- 1 Analogue Output - 0-2.5V or 0-10V. 8 bit (20mV/step)
- 8 Digital Outputs - Open collector, 500mA, 33V max
- Custom box (140 x 110 x 35mm) with printed front & rear panels
- Windows software utilities (3-1 to XP) and programming examples
- Supply: 12V DC (Order Code PSU203)

Kit Order Code: 3093KT - £69.95

Assembled Order Code: AS3093 - £99.95

Most items are available in kit form (KT suffix) or pre-assembled and ready for use (AS prefix).

## Hot New Kits This Summer!

Here are a few of the most recent kits added to our range. See website or join our email Newsletter for all the latest news.

### NEW! EPE Ultrasonic Wind Speed Meter



Solid-state design wind speed meter (anemometer) that uses ultrasonic techniques and has no moving parts and does not need calibrating. It is intended for sports-type activities, such as track events, sailing, hang-gliding, kites and model aircraft flying, to name but a few. It can even be used to monitor conditions in your garden. The probe is pointed in the direction from which the wind is blowing and the speed is displayed on an LCD display.

#### Specifications

- Units of display: metres per second, feet per second, kilometres per hour and miles per hour
- Resolution: Nearest tenth of a metre
- Range: Zero to 50mph approx.

Based on the project published in Everyday Practical Electronics, Jan 2003. We have made a few minor design changes (see website for full details). Power: 9VDC (PP3 battery or Order Code PSU345). Main PCB: 50 x 83mm. Kit Order Code: 3168KT – £34.95

### NEW! Audio DTMF Decoder and Display



Detects DTMF tones via an on-board electret microphone or direct from the phone lines through the onboard audio transformer. The

numbers are displayed on a 16-character, single line display as they are received. Up to 32 numbers can be displayed by scrolling the display left and right. There is also a serial output for sending the detected tones to a PC via the serial port. The unit will not detect numbers dialled using pulse dialling. Circuit is microcontroller based. Supply: 9-12V DC (Order Code PSU345). Main PCB: 55 x 95mm. Kit Order Code: 3153KT – £17.95. Assembled Order Code: AS3153 – £29.95

### NEW! EPE PIC Controlled LED Flasher



This versatile PIC-based LED or filament bulb flasher can be used to flash from 1 to 160

LEDs. The user arranges the LEDs in any pattern they wish. The kit comes with 8 superbright red LEDs and 8 green LEDs. Based on the Versatile PIC Flasher by Steve Challinor, EPE Magazine Dec '02. See website for full details. Board Supply: 9-12V DC. LED supply: 9-45V DC (depending on number of LED used). PCB: 43 x 54mm. Kit Order Code: 3169KT – £10.95

Most items are available in kit form (KT suffix) or assembled and ready for use (AS prefix)

## FM Bugs & Transmitters

Our extensive range goes from discreet surveillance bugs to powerful FM broadcast transmitters. Here are a few examples. All can be received on a standard FM radio and have adjustable transmitting frequency.

### MMTX' Micro-Miniature 9V FM Room Bug



Our best selling bug! Good performance. Just 25 x 15mm. Sold to detective agencies worldwide. Small enough to hide just about anywhere.

Operates at the 'less busy' top end of the commercial FM waveband and also up into the more private Air band. Range: 500m. Supply: PP3 battery. Kit Order Code: 3051KT – £8.95. Assembled Order Code: AS3051 – £14.95

### HPTX' High Power FM Room Bug



Our most powerful room bug. Very impressive performance. Clear and stable output signal thanks to the extra circuitry employed. Range: 1000m @ 9V. Supply: 6-12V DC (9V PP3 battery clip supplied). 70 x 15mm. Kit Order Code: 3032KT – £9.95. Assembled Order Code: AS3032 – £17.95

### MTTX' Miniature Telephone Transmitter



Attach anywhere along phone line. Tune a radio into the signal and hear exactly what both parties are saying. Transmits only when phone is used. Clear, stable signal. Powered from phone line so completely maintenance free once installed. Requires no aerial wire – uses phone line as antenna. Suitable for any phone system worldwide. Range: 300m. 20 x 45mm. Kit Order Code: 3016KT – £7.95. Assembled Order Code: AS3016 – £13.95

### 3 Watt FM Transmitter



Small, powerful FM transmitter. Audio preamp stage and three RF stages deliver 3 watts of RF power. Can be used with the electret microphone supplied or any line level audio source (e.g. CD or tape OUT, mixer, sound card, etc). Aerial can be an open dipole or Ground Plane. Ideal project for the novice wishing to get started in the fascinating world of FM broadcasting. 45 x 145mm. Kit Order Code: 1028KT – £22.95. Assembled Order Code: AS1028 – £34.95

### 25 Watt FM Transmitter

Four transistor based stages with a Philips BLY89 (or equivalent) in the final stage. Delivers a mighty 25 Watts of RF power. Accepts any line level audio source (input sensitivity is adjustable). Antenna can be an open dipole, ground plane, 5/8, J, or YAGI configuration. Supply 12-14V DC, 5A. Supplied fully assembled and aligned – just connect the aerial, power and audio input. 70 x 220mm. Order Code: 1031M – £124.95



**QUASAR**  
electronics

Helping you make the right connections!

**CREDIT  
CARD  
SALES  
0871  
717  
7168**

## Electronic Project Labs

Great introduction to the world of electronics. Ideal gift for budding electronics expert!

### 500-In-1 Electronic Project Lab



This is the top of the range and is a complete electronics course taking you from beginner to 'A' level standard and beyond! It contains all the parts and instructions to assemble 500 projects. You get three comprehensive course books (total 368 pages) – *Hardware Entry Course*, *Hardware Advanced Course* and a micro-computer based *Software Programming Course*. Each book has individual circuit explanations, schematic and assembly diagrams. Suitable for age 12 and above. Order Code EPL500 – £149.95. 30, 130, 200 and 300-In-1 project labs also available – see website for details.

## Number 1 for Kits!

With over 300 projects in our range we are the UK's number 1 electronic kit specialist. Here are a few other kits from our range.

- 1046KT – 25W Stereo Car Booster £29.95
- 3087KT – 1W Stereo Amplifier £4.95
- 3105KT – 18W BTL mono Amplifier £9.95
- 3106KT – 50W Mono Hi-fi Amplifier £19.95
- 3143KT – 10W Stereo Amplifier £10.95
- 1011-12KT – Motorbike Alarm £12.95
- 1019KT – Car Alarm System £11.95
- 1048KT – Electronic Thermostat £9.95
- 1080KT – Liquid Level Sensor £6.95
- 3003KT – LED Dice with Box £7.95
- 3006KT – LED Roulette Wheel £8.95
- 3074KT – 8-Ch PC Relay Board £29.95
- 3082KT – 2-Ch UHF Relay £26.95
- 3126KT – Sound-Activated Relay £7.95
- 3063KT – One Chip AM Radio £10.95
- 3102KT – 4-Ch Servo Motor Driver £15.95
- 3155KT – Stereo Tone Controls £8.95
- 1096KT – 3-30V, 5A Stabilised PSU £32.95
- 3029KT – Combination Lock £6.95
- 3049KT – Ultrasonic Detector £13.95
- 3130KT – Infra-red Security Beam £12.95
- SG01MKT – Train Sounds £6.95
- SG10 MKT – Animal Sounds £5.95
- 1131KT – Robot Voice Effect £9.95
- 3007KT – 3V FM Room Bug £6.95
- 3028KT – Voice-Activated FM Bug £12.95
- 3033KT – Telephone Recording Adpt £9.95
- 3112KT – PC Data Logger/Sampler £18.95
- 3118KT – 12-bit Data Acquisition Unit £52.95
- 3101KT – 20MHz Function Generator £69.95

**www.quasarelectronics.com**

Secure Online Ordering Facilities ● Full Product Listing, Descriptions & Photos ● Kit Documentation & Software Downloads

**No.1  
FOR  
KITS**

# EPE PIC RESOURCES CD-ROM V2

**VERSION 2 NOW AVAILABLE**



**Version 2 includes the EPE PIC Tutorial V2 series of Supplements (EPE April, May, June 2003)**

**ONLY £14.45**  
INCLUDING VAT and P&P

The CD-ROM contains the following Tutorial-related software and texts:

- EPE PIC Tutorial V2 complete series of articles plus demonstration software, John Becker, April, May, June '03
- PIC Toolkit Mk3 (TK3 hardware construction details), John Becker, Oct '01
- PIC Toolkit TK3 for Windows (software details), John Becker, Nov '01

Plus these useful texts to help you get the most out of your PIC programming:

- How to Use Intelligent L.C.D.s, Julyan Ilett, Feb/Mar '97
- PIC16F87x Microcontrollers (Review), John Becker, April '99
- PIC16F87x Mini Tutorial, John Becker, Oct '99
- Using PICs and Keypads, John Becker, Jan '01
- How to Use Graphics L.C.D.s with PICs, John Becker, Feb '01
- PIC16F87x Extended Memory (how to use it), John Becker, June '01
- PIC to Printer Interfacing (dot-matrix), John Becker, July '01
- PIC Magick Musick (use of 40kHz transducers), John Becker, Jan '02
- Programming PIC Interrupts, Malcolm Wiles, Mar/Apr '02
- Using the PIC's PCLATH Command, John Waller, July '02
- EPE StyloPIC (precision tuning musical notes), John Becker, July '02
- Using Square Roots with PICs, Peter Hemsley, Aug '02
- Using TK3 with Windows XP and 2000, Mark Jones, Oct '02
- PIC Macros and Computed GOTOs, Malcolm Wiles, Jan '03
- Asynchronous Serial Communications (RS-232), John Waller, unpublished
- Using I<sup>2</sup>C Facilities in the PIC16F877, John Waller, unpublished
- Using Serial EEPROMs, Gary Moulton, unpublished
- Additional text for EPE PIC Tutorial V2, John Becker, unpublished

NOTE: The PDF files on this CD-ROM are suitable to use on any PC with a CD-ROM drive. They require Adobe Acrobat Reader – included on the CD-ROM

**Order on-line from**  
[www.epemag.wimborne.co.uk/shopdoor.htm](http://www.epemag.wimborne.co.uk/shopdoor.htm)  
or [www.epemag.com](http://www.epemag.com) (USA \$ prices)  
or by Phone, Fax, Email or Post.

## EPE PIC RESOURCES V2 CD-ROM ORDER FORM

Please send me ..... (quantity) EPE PIC RESOURCES V2 CD-ROM

Price £14.45 each – includes postage to anywhere in the world.

Name .....

Address .....

..... Post Code .....

I enclose cheque/P.O./bank draft to the value of £ .....

Please charge my Visa/Mastercard/Amex/Diners Club/Switch/Maestro

£ .....

Card No. ....

Card Security Code ..... (The last 3 digits on or just under the signature strip)

Valid From ..... Expiry Date .....

Switch Issue No. ....

SEND TO: **Everyday Practical Electronics,**  
**Wimborne Publishing Ltd.,**  
408 Wimborne Road East, Ferndown, Dorset BH22 9ND.  
Tel: 01202 873872. Fax: 01202 874562.  
Email: [orders@epemag.wimborne.co.uk](mailto:orders@epemag.wimborne.co.uk)

Payments must be by card or in £ Sterling – cheque or bank draft drawn on a UK bank.

Normally supplied within seven days of receipt of order.

Send a copy of this form, or order by letter if you do not wish to cut your issue.

**BECOME A PIC WIZARD WITH THE HELP OF EPE!**



# Forest Electronics - PIC and AVR C Compiler Products

## FED's ANSI C Compiler for PIC or AVR processors

- \* Fully integrated editor with syntax highlighting, multiple pages etc.
- \* Full project support - include and manage multiple source files, simulator, assembler files and notes/comments within one project
- \* Fully integrated simulator and waveform analyser step from C line to C line, or examine code in assembler form. View device pins using a logic analyser application.
- \* Simulator supports LCD modules, keypad, buttons, LED's, displays, analogue inputs, serial and asynchronous data and more.
- \* Designed to ANSI C standards
- \* PIC - Supports 18xxx, 16xxx, 12xxx series 14 and 16 bit core processors
- \* AVR - Supports standard and MEGA core processors
- \* Generates MPLAB/AVR Studio projects and source files and completely standard hex output files.

## WIZ-C / AVIDICY

Drag and Drop rapid application development using ANSI C for PIC and AVR

- \* Rapid Application Development for the PIC or AVR microcontroller using the C language (WIZ- C for the PIC, AVIDICY for the AVR)
- \* Drag and drop your software component selections on to your design
- \* Included components support timers, serial interfaces, I2C, LCD, 7 Seg displays, keypads, switches, port controls, many bus interfaces including IIC and Dallas IButton, AVR/PIC Hardware, and more.
- \* Connect software components to MCU pins by point & click
- \* Parameters set from drop down list boxes, check boxes, or text entry
- \* Links your code automatically into library events (e.g. Button Pressed, Byte Received etc.)

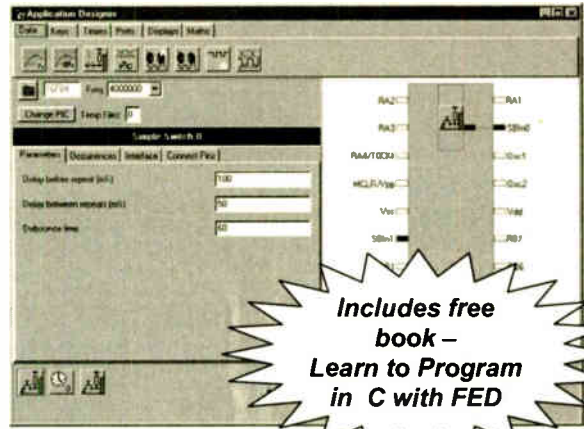

Includes free book - Learn to Program in C with FED

- \* Automatically generates your base application including full initialisation, interrupt handling and main program loop
- \* The complete C Compiler and AVR Simulator programs are integrated into AVIDICY - total editing / compilation / assembly / simulation support in one program
- \* Also includes the Element Editor to enable you to create your own components with ease.
- \* Demonstration available from our web site

Prices from £45.00 - details & demo from [www.fored.co.uk](http://www.fored.co.uk)



Forest Electronic Developments  
01590-681511 (Voice/Fax)

email : [info@fored.co.uk](mailto:info@fored.co.uk)



[www.fored.co.uk](http://www.fored.co.uk)

Also programmers, ICE, & development systems

## PLEASE ENSURE YOU TELEPHONE TO CHECK AVAILABILITY OF EQUIPMENT BEFORE ORDERING OR CALLING.

### MISCELLANEOUS CLEARANCE STOCK

<b>OSCILLOSCOPES</b>	POWER SUPPLY Model 12030 0-20V 0-30A - On Wheels	£95
TEKTRONIX 465B Dual Trace 100 MHz Delay fitted into 19in. rack frame	HARMER SIMMONS 50/25/11 Input 240V 10A Output 50V 25A	£100
HP 1740A Dual Trace 100 MHz delay (no lock)	CENTRONIC M100 Regavolt Input 240V 250 VA Output 240V 1000VA	£50
HP 1740A Dual Trace 100 MHz Delay	DRANETZ 606 Line Distribution Analyser	£35
HP 1744A Dual Trace 100 MHz Analogue Storage	WAYNE KERR B601 Radio Frequency Bridge	£25
PHILIPS PM3264 4 Ch. 100 MHz	FEEDBACK TFA607 Transfer Function Analyser	£25
GOULD CS3000A Dual Trace 40 MHz	WAVETEK 52 Data Multimeter	£60
THO CS1040 Dual Trace 40 MHz	GOULD SG200 RF Signal Generator	£20
GOLDSTAR OS9020P Dual Trace 20 MHz	CHATLOW Force Meter	£15
INATSU SS5702 Dual Trace 20 MHz	ALFRED E105 Variable Attenuator 4-9GHz	£20
KIKUSUI COS5020 Dual Trace 20 MHz	CAMMETRIC 6 Decade Resistance Box	£15
	SULLIVAN C8710 Precision 5 Decade Capacitor Box	£20
	MARCONI 60333 Waveguide	£20
<b>POWER SUPPLIES</b>	MARCONI 2169 Pulse Modulator	£30
FARNELL L30AT 0-30V 0-1A Twice	MARCONI 2430A Frequency Meter 80MHz	£30
FARNELL L30AT 0-50V 0-500MA	MARCONI 6950 RF Power Meter - No head	£35
FARNELL L30-1 0-30V 0-1A Twice Scruffy	MARCONI 6960 RF Power Meter - No head - Digital	£50
FARNELL L30-2 0-30V 0-2A Scruffy	HP X382A Variable Attenuator Waveguide	£20
FARNELL L30-1 0-30V 0-1A Scruffy	HP 5316A Counter	£50
FARNELL L30B 0-30V 0-1A	HP 8750A Storage Normalizer	£50
FARNELL L30AT 0-50V 0-500MA	HP 907A Coaxial Sliding Load	£20
FARNELL C1 0-50V 0-1A - 2 Meters	PROGRAMMA TM2 Timer	£20
Farnell TOPS1 5V 1A ±15V 200MA	RACAL 9008 Modulation Meter	£40
COUTANT LB500.2 0-30V 0-5A - 2 Meters	RACAL 9009A Modulation Meter	£50
COUTANT LA200.2 0-3V 0-2A - 2 Meters	TEXCAN SA50 102dB in 1dB steps	£15
COUTANT LQ7200 0-15V 0-2A - Twice	BIRD Attenuator etc in box 30dB	£15
COUTANT LQ75050 0-50V 0-500MA	BIRD 8341-200 Coaxial Attenuator 20dB 40W 50ohm	£25
WEIR 781 0-30V 2A or 0-15V 4A	BIRD 81 Wattmeter 6 & 30W 50ohm 30-50MHz	£40
WEIR 782 0-30V 2A or 0-15V 4A	TELEONIC TTPF5-5-6EE Tunable Band Pass Filter	£20
WEIR 4310 0-30V 1A - 5V 4A	TELEONIC 190-3EE Tunable Band Reject Filter 125-250	£15
WEIR 400 0-0V 0.3A - 10V 1A	TELEONIC 95-3EE Tunable Band Reject Filter 60-125	£15
WEIR 480 0-60V 0.3A - 20V 1A	HELPER INST CM1 Solder	£30
HP 8268B 0-40V 0-5A 2 Meters	HELPER INST S103 Solder 3	£30
HP 8256B 0-10V 0-2A 2 Meters	SXP100 Parallel to Serial Converter	£10
HP 6111A 0-20V 0-1A	MICROMASTER LV	£40
HP 6235A ±6V 1A ±15V 200MA	DATAMAN S3 Programmer	£50
KINGSHILL 36V2C 0-36C 0-2A	RS 424-103 Logic Pulser	£5
MARCONI TP2158 0-30V 0-2A Twice	GLOBAL SQ Shortcircuiter	£20
LAMBDA 422FM 0-40V 0-1A Twice 4 Meters	RS 180-112Z Conductivity Meter	£30
LAMBDA LX345A FM 0-60V 0-10A 2 Meters	EAGLE DC30 Probe 30kV DC	£75
SYSTRON DORNER SHR40-2 0-40V 0-2A - 2 Meters	AVO 100AMP Shunt for AVO 8	£5
SONENSON SBL80 0-80V 0-4A	SOUTHERN CALIFORNIA BTRAM-S-10 2000.0 MHz	£50
GRENSON BPU4 ±5V 2.5A & ±15V 0.5A	MOTOROLA R2001D Communication System Analyser	£250
RS 813-901 2 x 5V 2.5A or 2 x 12V 1.5A or 2 x 5V 1A	WESTON 1149 Standard Cell 1.01659 ABS Volts at 20C	£10
RS 208-197 Line Voltage Conditioner - Output 240V 0.65A	MURKHEAD A-8-B Resistance Box	£10
POWER CONVERSION PLC1000 Line Cond. 1000VA	RACAL 9917A UHF Frequency Meter 10Hz-560 MHz	£45
HARLYN AUTOMATION IPPS5200 System Power Supply	RACAL 9917 UHF Frequency Meter 10Hz-560 MHz	£40
POWERLINE LAB807 0-300V AC 0.75A	RACAL 9915M UHF Frequency Meter 10Hz-520 MHz	£30

RACAL 9901 Universal Counter Timer DC-50 MHz	£15
RACAL 9900 Universal Counter Timer 30 MHz DC-30 MHz	£15
WAVETEK 136 VCG/VCA Generator	£20
HP 435A Power Meter - No lead no head	£15
HP 8015A Pulse Generator	£30
HP 403B AC Voltmeter	£15
D-LOG PR415 Phase Rotation Indicator	£10
MAYWOOD 02000 Digital Indicator	£10
HP 3720A HPiB Extender	£10
HATFIELD 2115 Attenuator 75ohm 100dB	£10
HATFIELD 2115R Attenuator 75ohm 100dB	£10
HATFIELD 2118R Attenuator 75ohm 10dB	£10
HATFIELD 2135 Attenuator 600ohm 100dB	£20
TEKTRONIX 1103 Tekprobe Power Supply	£10
SYSTRON DOWNER 6243A Freq Counter 20Hz-1250 MHz	£30
LEYELL TG301 Function Generator 1 MHz Sine/Sq/Tri	£30
SOLARTRON 7045 Digital Multimeter	£15
HP 8404A Leveling Amplifier	£15
HP 3455A Digital Voltmeter	£50
FEEDBACK FM610 Digital Frequency Meter	£25
FARNELL T88 True RMS RF Millivoltmeter	£40
THURLEY 503 Digital Multimeter	£15
SULLIVAN 6666 Multimeter	£15
K&L Tunable Bank Reject Filter	£15
BARR & STROUD EF4-01 Bank Pass Filter 1Hz-100KHz	£15
BARR & STROUD EF4-02 LPH/P Filter 1Hz-100KHz	£15
FLUKE 8810A Digital Multimeter	£25
FLUKE 8820A Digital Multimeter	£25
ELECTRONIC VISUAL EV4040 TV Waveform Monitor	£20
TRACOR NORTHERN TM1750	£30
RS 575-17 UV Exposure Unit	£10
MICRODYNE CORP. Receiver	£60
VARIAN V2L-6941F1 Travelling Wave Tube Amplifier	£50
MOORE READ SFC50001 AUXR Static Frequency Converter	£50
120 Volts 400 Hz	£50
DRAGER 21/31 Multi Gas Detector	£10
PHILIPS PM8237B Multipoint Data Recorder	£20
EDELCO 4417 Signal Conditioner X 2	£10
PULSTER 132 DC Current Calibrator	£30
PM1038-014 Display with 1038-N10 Network Analyser, No Head	£50
MEGGER M4M4M2 Wind Up 1000V Mohm	£10
METROHM 250V Pat Tester	£15
SULLIVAN AC1012 4 Decade Resistance Box 0.05%	£10
BRANDENBURGH O20 Static Freq Converter 110/240V Input 3000Hz Output 115V 400Hz 20VA	£40
NARDA 76B Attenuator	£10
ANALOGUE ASSOCIATES X800 Audio Amplifier 800watt (400w or Channel no DC Protection)	£40
W&G PCG PCM Channel Generator	£30
SPERS LAB 12400 - 18000 MHz	£10
SPERS LAB 8212 2500 - 4000 MHz+C204	£10
CROPICO VS10 DC Standard 10V	£30

### EXTRA SPECIAL OFFERS

H.G.P. 8560A Spectrum Analyser, 50Hz-2.9GHz	£3,250
H.P. 8569B Spectrum Analyser, 10MHz-22GHz	£1,500
MARCONI 2382 Spectrum Analyser, 200Hz-400MHz	£1,250
TEKTRONIX 2465A Oscilloscope, 4-ch, 350MHz	£750
TEKTRONIX 2246 Oscilloscope, 4-ch, 100MHz	£375
H.P. 8640A AM/FM Signal Gen, 500kHz-512MHz	£175

### SPECIAL OFFERS

OSCILLOSCOPES	
LECROY 9400A dual trace, 170MHz, 5GS	£500
Lecroy 9400 dual trace, 125MHz	£400
TEKTRONIX 468 dual trace, 100MHz, digital storage	£300
TEKTRONIX 475 dual trace, 200MHz, delay sweep	£250
TEKTRONIX 465B dual trace, 100MHz, delay sweep	£250
TEKTRONIX 465 dual trace, 100MHz, delay sweep	£175
PHILIPS PM3217 dual trace, 50MHz, delay sweep	£150
THURLEY PL320CMD 0-30V 0-2A twice digital PSU	£160
H.P. 8612A 0-20V 0-2A Communications PSU	£200
H.P. 8626A Precision High Resolution PSU, 4 outputs, 0-7V 0-15A or 0-50V 0-0.5A twice, 0-16V 0-0-2A or 0-50V 0-2A twice	£500
CIRRUS CRL254 Sound Level Meter with calibrator	£50
80-120dB LED	£30
WAYNE KERR B424 Component Bridge	£95
RACAL 9300 True RMS Voltmeter, 5Hz-20MHz usable to 60MHz, 10V-316V	£50
RACAL 9300B True RMS Voltmeter, 5Hz-20MHz usable to 80MHz, 10V-316V	£75
AVO DA116 Digital Avometer with battery and leads	£20
FARNELL LF36A Sine/Sq Oscillator, 10Hz-1MHz, low distortion TTL output amplitude meter	£75
FARNELL J38 Sine/Sq Oscillator, 10Hz-100kHz, low dist.	£30
HEIME 1000 LCD Clamp Meter, 0-1000A, in carrying case	£85
FLUKE 77 Multimeter 3 1/2 digit handheld with battery & leads	£45
KENWOOD VT175 2-Channel Multimeter	£50
KENWOOD PL140 Wow and Flutter Meter	£50
KENWOOD PL180A Wow and Flutter Meter	£75
KENWOOD PL180 Wow and Flutter Meter, unused	£125
MARCONI 6960B Power Meter with 6920 head, 10MHz-20GHz±450	£50
SOLARTRON 7150 DMM 6 1/2-digit True RMS IEEE	£75
SOLARTRON 7150 Plus As 7150 ± temp measurement	£100
IEEE Cables	£5
H.P. 3312A Function Gen, 0-1Hz-13MHz, AM/FM Sweep/Sync/Burst etc	£200
H.P. 3318A Function Gen, 0-0.05Hz-6MHz, Sine/Sq/Tri/Ramp/Pulse	£80
RACAL 9008 Automatic Modulation Meter, 1.5MHz-2GHz	£30
ISOLATING Transformer, input 250V, output 500VA, unused	£30
RACAL 1732 Receiver	£325

## STEWART of READING

17A King Street, Mortimer, Near Reading RG7 3RS

Telephone: (0118) 933 1111. Fax: (0118) 933 2375

[www.stewart-of-reading.co.uk](http://www.stewart-of-reading.co.uk)

Open 9am-5.00pm Monday to Friday (other times by arrangement)



Used Equipment - GUARANTEED. Manuals supplied

This is a VERY SMALL SAMPLE OF STOCK. SAE or Telephone for lists. Please check availability before ordering.

CARRIAGE all units £16. VAT to be added to Total of Goods and Carriage

**MAIL ORDER ONLY • CALLERS BY APPOINTMENT**

**EPE PROJECT PICS**

Programmed PICs for \*EPE Projects

12C508/9 - £3.90; 16F627/8 - £4.90

16C84/16F84/16C71 - £5.90

16F876/877 - £10.00

All inc. VAT and Postage

(\*Some projects are copyright)

**EPE MICROCONTROLLER P.I. TREASURE HUNTER**

The latest MAGENTA DESIGN - highly stable & sensitive - with I.C. control of all timing functions and advanced pulse separation techniques.

- High stability drift cancelling
- Easy to build & use
- No ground effect, works in seawater



- Detects gold, silver, ferrous & non-ferrous metals

- Efficient quartz controlled microcontroller pulse generation.
- Full kit with headphones & all hardware

**KIT 847 .....£63.95**

**PIC PIPE DESCALER**

- SIMPLE TO BUILD
- HIGH POWER OUTPUT
- AUDIO & VISUAL MONITORING
- SWEPT FREQUENCY

An affordable circuit which sweeps the incoming water supply with variable frequency electromagnetic signals. May reduce scale formation, dissolve existing scale and improve lathering ability by altering the way salts in the water behave.

Kit includes case, P.C.B., coupling coil and all components. High coil current ensures maximum effect. L.E.D. monitor.



**KIT 868 ..... £22.95 POWER UNIT.....£3.99**

**MICRO PEST SCARER**

Our latest design - The ultimate scarer for the garden. Uses special microchip to give random delay and pulse time. Easy to build reliable circuit. Keeps pets/pests away from newly sown areas, play areas, etc. uses power source from 9 to 24 volts.

- RANDOM PULSES
- HIGH POWER
- DUAL OPTION



Plug-in power supply £4.99

**KIT 867. ....£19.99**

**KIT + SLAVE UNIT. ....£32.50**

**WINDICATOR**

A novel wind speed indicator with LED readout. Kit comes complete with sensor cups, and weatherproof sensing head. Mains power unit £5.99 extra.

**KIT 856. ....£28.00**

**★ TENS UNIT ★**

**DUAL OUTPUT TENS UNIT**

As featured in March '97 issue.

Magenta have prepared a FULL KIT for this excellent new project. All components, PCB, hardware and electrodes are included. Designed for simple assembly and testing and providing high level dual output drive.

**KIT 866. . Full kit including four electrodes £32.90**

Set of 4 spare electrodes £6.50

**1000V & 500V INSULATION TESTER**



Superb new design. Regulated output, efficient circuit. Dual-scale meter, compact case. Reads up to 200 Megohms.

Kit includes wound coil, cut-out case, meter scale, PCB & ALL components.

**KIT 848. ....£32.95**

**EPE TEACH-IN 2000**

Full set of top quality NEW components for this educational series. All parts as specified by EPE. Kit includes breadboard, wire, croc clips, pins and all components for experiments, as listed in introduction to Part 1.

\*Batteries and tools not included.

**TEACH-IN 2000 -**

**KIT 879 £44.95**

**MULTIMETER £14.45**

**SPACEWRITER**

An innovative and exciting project. Wave the wand through the air and your message appears. Programmable to hold any message up to 16 digits long. Comes pre-loaded with "MERRY XMAS". Kit includes PCB, all components & tube plus instructions for message loading.

**KIT 849 .....£16.99**

**12V EPROM ERASER**

A safe low cost eraser for up to 4 EPROMS at a time in less than 20 minutes. Operates from a 12V supply (400mA). Used extensively for mobile work - updating equipment in the field etc. Also in educational situations where mains supplies are not allowed. Safety interlock prevents contact with UV.

**KIT 790 .....£29.90**

**SUPER BAT DETECTOR**

1 WATT O/P, BUILT IN SPEAKER, COMPACT CASE 20kHz-140kHz NEW DESIGN WITH 40kHz MIC.

A new circuit using a 'full-bridge' audio amplifier i.c., internal speaker, and headphone/tape socket. The latest sensitive transducer, and 'double balanced mixer' give a stable, high performance superheterodyne design.

**KIT 861 .....£34.99**

ALSO AVAILABLE Built & Tested... £48.99



**68000 DEVELOPMENT TRAINING KIT**

- NEW PCB DESIGN
- 8MHz 68000 16-BIT BUS
- MANUAL AND SOFTWARE
- 2 SERIAL PORTS
- PIT AND I/O PORT OPTIONS
- 12C PORT OPTIONS

**KIT 621**

**£99.95**

- ON BOARD 5V REGULATOR
- PSU £6.99
- SERIAL LEAD £3.99

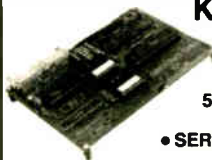

**Stepping Motors**

**MD100...Std 100 step...£9.99**

**MD200...200 step...£12.99**

**MD24...Large 200 step...£22.95**



**MOSFET MkII VARIABLE BENCH POWER SUPPLY 0-25V 2.5A**

Based on our Mk1 design and preserving all the features, but now with switching pre-regulator for much higher efficiency. Panel meters indicate Volts and Amps. Fully variable down to zero. Toroidal mains transformer. Kit includes punched and printed case and all parts. As featured in April 1994 EPE. An essential piece of equipment.



**Kit No. 845 .....£64.95**

**ULTRASONIC PEST SCARER**

Keep pets/pests away from newly sown areas, fruit, vegetable and flower beds, children's play areas, patios etc. This project produces intense pulses of ultrasound which deter visiting animals.

- KIT INCLUDES ALL COMPONENTS, PCB & CASE
- EFFICIENT 100V TRANSDUCER OUTPUT
- COMPLETELY INAUDIBLE TO HUMANS



- UP TO 4 METRES RANGE
- LOW CURRENT DRAIN

**KIT 812. ....£15.00**

**SIMPLE PIC PROGRAMMER**

**KIT 857... £12.99**

Includes PIC16F84 chip disk, lead, plug, p.c.b., all components and instructions

Extra 16F84 chips £3.84 Power Supply £3.99

## PIC LCD DISPLAY DRIVER

16 Character x 2 Line display, pcb, programmed PIC16F84, software disk and all components to experiment with standard intelligent alphanumeric displays. Includes full PIC source code which can be changed to match your application.

**KIT 860.....£19.99**

- Learn how to drive the display and write your own code.
- Ideal development base for meters, calculators, counters, timers --- just waiting for your application!
- **Top quality display** with industry standard driver, data and instructions

## PIC STEPPING MOTOR DRIVER

PCB with components and PIC16F84 programmed with demonstration software to drive any 4 phase unipolar motor up to 24 Volts at 1 Amp. **Kit includes 100 Step Hybrid Stepping Motor.** Full software source code supplied on disc.

Use this project to develop your own applications. PCB allows 'simple PIC programmer' 'SEND' software to be used to reprogram chip.

**KIT 863.....£18.99**

## 8 CHANNEL DATA LOGGER

From Aug/Sept '99 *EPE*. Featuring 8 analogue inputs and serial data transfer to PC. Magenta redesigned PCB - LCD plugs directly onto board. Use as Data Logger or as a test bed for developing other PIC16F877 projects. Kit includes lcd, prog. chip, PCB, Case, all parts and 8 x 256k EEPROMs

**KIT 877.....£49.95**

## PIC16F84 MAINS POWER CONTROLLER & 4 CHANNEL LIGHT CHASER / DIMMER

- Zero Volt Switching
- Opto-Isolated 5 Amp **HARD FIRED TRIACS**
- 12 Way keypad Control

- With program source code disk.
- Chase Speed and dimming potentiometer controls.
- Reprogram for other applications

**KIT 855.....£39.95**

## PIC TUTOR 1 EPE MARCH APRIL MAY '98 PIC16F84 STARTER SERIES

The original PIC16F84 series by John Becker. Magenta's Tutor board has individual switches and leds on all portA and PortB lines, plus connectors for optional 4 digit seven segment led display, and 16 x 2 intelligent lcd. Written for newcomers to PICs this series. Disk has over 20 tutorial programs. Connect to a PC parallel port, send, run, and experiment by modifying test programs - [Then Write and Program your Own](#)

**KIT 870... £27.95, Built...£42.95**

16x2 LCD..£7.99. LED display..£6.99. 12VPSU..£3.99

## SUPER PIC PROGRAMMER

Magenta's original parallel port programmer. Runs with downloaded WINDOWS 95 - XP software. Use standard Microchip .HEX files. Read/Prog/Verify wide range of 18,28, and 40 pin PICs. Including 16F84/876/877, 627/8, (Inc. 'A' versions) + 16xx OTPs.

**KIT 862... £29.99** Power Supply £3.99

## ICEBREAKER

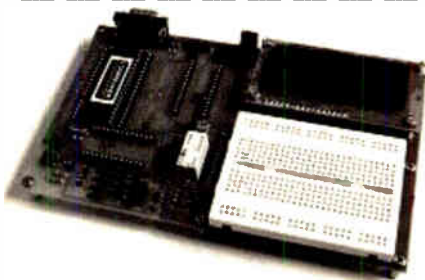

### PIC Real Time In-Circuit Emulator

- ICEbreaker uses PIC16F877 in-circuit debugger.
- Links to standard PC Serial port (lead supplied).
- Windows (95 to XP) Software included
- Works with MPASM assembler
- 16 x 2 LCD display, Breadboard, Relay, I/O devices and patch leads.

Featured in *EPE Mar'00* Ideal for beginners & experienced users.

**KIT 900...£34.99** With serial lead & software disk, PCB, Breadboard, PIC16F877, LCD, all components and patch leads.  
POWER SUPPLY - £3.99 STEPPING MOTOR 100 Step £9.99

Programs can be written, downloaded, and then tested by single-stepping, running to breakpoints, or free run at up to 20Mhz.  
**Full emulation means that all ports respond immediately - reading and driving external hardware.**  
Features include: Run; set Breakpoint; View & change registers, EEPROM, and program memory; load program; 'watch window' registers.

## 20W Amp. Module

**EPE May '05 -- Superb Magenta Stereo/Mono Module**

**Wide bandwidth Low distortion 11W/channel Stereo 20W Mono True (rms) Real Power**

**Short Circuit & Overheat Protected. Needs 8 to 18V supply.**

**Stable Reliable design**

**Latest Technology IC with local feedback gives very high performance.**

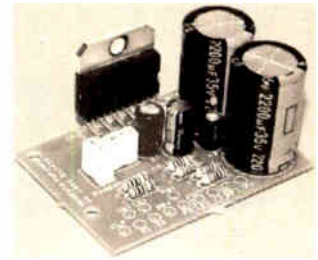

**KIT 914** (all parts & heatsink for stereo or mono) **£11.90**

## Magenta BrainiBorg

A super walking programmable robot with eyes that sense obstacles and daylight: BrainiBorg comes with superb PC software CD (WIN95+ & XP) and can be programmed to walk and respond to light and obstacles on any smooth surface.

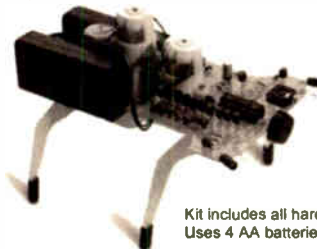

CD contains illustrated constructional details, operating principles, circuits and a superb Educational Programming Tutorial.

Test routines give real-time 'scope traces of sensor and motor signals. Connects to PC via SERIAL port with the lead supplied.

Kit includes all hardware, components, 3 motor/gearboxes. Uses 4 AA batteries (not supplied). *An Ideal Present!*

**KIT 912** Complete Kit with CD rom & serial lead **£49.99**

**KIT 913** As 912 but built & tested circuit board **£58.95**

## EPE PIC Tutorial

**EPE Apr/May/June '03 and PIC Resources CD**

- Follow John Becker's excellent PIC toolkit 3 series.
- Magenta Designed Toolkit 3 board with printed component layout, green solder mask, places for 8,18, 28 (wide and slim), and 40 pin PICs. and Magenta extras.
- 16 x 2 LCD, PIC chip all components and sockets included.

**KIT 880** (with 16F84) **£34.99**, built & tested **£49.99**

**KIT 880** (with 16F877) **£39.99**, built & tested **£55.99**

## EPE TEACH-IN 2004

**THE LATEST NOV 03 SERIES**  
All parts to follow this new Educational Electronics Course.

**Additional Parts** as listed in 'misc.' Section (less RF modules, Lock, and Motor/g.box)

Inc. Breadboard, and wire, as listed on p752 Nov. Issue.

Reprints: £1.00 per part.

**KIT 920.....£29.99**

**KIT921.....£12.99**

## MAGENTA BRAINIBOT I & II

- Full kit with ALL hardware and electronics.
- As featured in *EPE Feb '03* (KIT 910)
- Seeks light, beeps, and avoids obstacles
- Spins and reverses when 'cornered'
- Uses 8 pin PIC chip
- ALSO KIT 911 - As 910 PLUS programmable from PC serial port leads and software CD included.



**KIT 910....£16.99** **KIT 911....£24.99**

# MAGENTA

All prices include VAT. Add £3.00 p&p. Next day £6.99

Tel: 01283 565435 Fax: 01283 546932 email: sales@magenta2000.co.uk

**052005**



**ESR ELECTRONIC COMPONENTS**

**Station Road, Cullercoats, Tyne & Wear, NE30 4PQ**

Prices Exclude Vat @17½%.  
UK Carriage £2.50 (less than 1kg)  
£5.50 greater than 1kg

Cheques / Postal orders payable to  
ESR Electronic Components.

\*PLEASE ADD CARRIAGE & VAT TO ALL ORDERS

See Next / Last Months Ad. for  
**ELECTRONIC COMPONENTS**

**RF Connectors**



BNC Plug 50Ω Solder £0.90  
BNC Plug 50Ω Crimp £0.68  
BNC Plug 75Ω Solder £1.08  
BNC Plug 75Ω Crimp £0.69  
BNC Chassis Socket £0.76  
F Plug - Twist £0.20  
F Plug - Crimp £0.20  
TNC Plug 50Ω Solder £1.08  
TNC Plug 50Ω Crimp £1.04  
TNC Plug 75Ω Solder £1.17  
TNC Plug 75Ω Crimp £0.96  
UHF Plug 5mm Cable £0.63  
UHF Plug 1mm Cable £0.72  
UHF Chassis Skt - Sqr £0.54  
UHF Chassis Skt - Rnd £0.75

**Terminals**



Colours Red, Black, Green,  
Blue, White or Yellow  
2mm Solder Plugs £0.23  
2mm Chassis Sockets £0.28  
4mm Plugs - Solder £0.34  
4mm Plugs - Crimp £0.38  
4mm Stackable Plugs £0.40  
4mm Shrouded Plugs £0.74  
4mm Chassis Sockets £0.48  
4mm Binding Posts £0.21  
33mm Crocodile Clips £0.10

**Push Switches**



**Miniature Round**  
250mA 125V 28 x 10mm  
7mm Ø Mounting Hole  
Non Latching Push to Make  
Black, Red, Yellow, Green,  
Blue or White £0.23  
Non Latching Push to Break  
Black P/B £0.24

**Standard Square**



1A 250V £2.67  
39 x 15MM £3.50  
12mm Ø Mounting Hole  
Non Latching Push to Make  
Black or Red £0.60  
Latching - push On push Off  
Black or Red £0.65

**Boxes & Cases**



Many more sizes available

**General Purpose Plastic**

75 x 56 x 25mm £0.99  
75 x 51 x 22mm £0.99  
111 x 57 x 22mm £1.12  
79 x 61 x 40mm £1.79  
118 x 76 x 41mm £1.79  
118 x 76 x 45mm £2.08  
150 x 100 x 60mm £2.77  
150 x 80 x 50mm £2.72

**Diecast Aluminium**

50 x 50 x 31mm £2.67  
100 x 50 x 25mm £3.50  
112 x 62 x 31mm £4.18  
120 x 65 x 40mm £4.61  
150 x 80 x 50mm £6.56  
121 x 95 x 61mm £7.06

3.579545MHz	£0.41
3.6864MHz	£0.41
4.0MHz	£0.45
4.194304MHz	£0.37
4.433619MHz	£0.41
4.9152MHz	£0.41
6.0MHz	£0.34
6.144MHz	£0.41
7.3728MHz	£0.53
8.0MHz	£0.49
8.867238MHz	£0.31
10.0MHz	£0.31
11.0MHz	£0.40
11.0592MHz	£0.41
12.0MHz	£0.41
14.7456MHz	£0.41
16.0MHz	£0.41
20.0MHz	£0.34

**Low Profile Crystals, 2 & 3 Pin Ceramic Resonators**

**Details on our web site**

**Opto Electronics**

Full details on Web site

3mm White 600mcd	£0.64
3mm White 900mcd	£2.13
3mm Red Led	£0.06
3mm Green Led	£0.09
3mm Yellow Led	£0.09
3mm Orange Led	£0.10
3mm Blue 40mcd	£0.78
3mm Blue 60mcd	£0.78
3mm Blue 550mcd	£0.96
3mm White 300mcd	£0.69
5mm White 1100mcd	£2.05
5mm White 3000mcd	£0.65
5mm White 3200mcd	£0.94
3mm Bi-Colour	£1.15
3mm Tri-Colour	£0.24
5mm Red Led	£0.07
5mm Green Led	£0.08
5mm Yellow Led	£0.08
5mm Orange Led	£0.10
5mm Blue 100mcd	£0.78
5mm Blue 600mcd	£0.78
5mm Blue 550mcd	£1.12
5mm Blue 1400mcd	£1.02
5mm Blue 2200mcd	£1.02
5mm Red Flashing	£0.37
5mm Green Flashing	£0.37
5mm Yellow Flashing	£0.37
5mm Bi-Colour Led	£0.15
5mm Tri-Colour Led	£0.15

**DIL Sockets**



**Stamped Pin**

6 Pin DIL 0.3" £0.07  
8 Pin DIL 0.3" £0.06  
14 Pin DIL 0.3" £0.11  
16 Pin DIL 0.3" £0.11  
18 Pin DIL 0.3" £0.12  
20 Pin DIL 0.3" £0.12  
24 Pin DIL 0.3" £0.12  
28 Pin DIL 0.3" £0.13  
28 Pin DIL 0.6" £0.13  
32 Pin DIL 0.6" £0.13  
40 Pin DIL 0.6" £0.19

**Turned Pin**

8 Pin DIL 0.3" £0.11  
14 Pin DIL 0.3" £0.20  
16 Pin DIL 0.3" £0.23  
18 Pin DIL 0.3" £0.25  
20 Pin DIL 0.3" £0.28  
24 Pin DIL 0.3" £0.32  
24 Pin DIL 0.6" £0.35  
28 Pin DIL 0.3" £0.39  
28 Pin DIL 0.6" £0.39  
32 Pin DIL 0.6" £0.43  
40 Pin DIL 0.6" £0.64

**ZIF Sockets**

Universal ZIF DIL Sockets

24 Way 0.3-0.6" £6.74  
28 Way 0.3-0.6" £7.80  
32 Way 0.3-0.6" £7.25  
40 Way 0.3-0.6" £10.63

**Transistor Sockets**

T018-4 Base Socket £0.24  
T05 Base Socket £0.24

**IDC Cable Sockets**



10 Way Socket £0.27  
14 Way Socket £0.35  
16 Way Socket £0.38  
20 Way Socket £0.37  
26 Way Socket £0.36  
34 Way Socket £0.39  
40 Way Socket £0.55  
50 Way Socket £0.80

**Transition Headers**

10 Way Transition £0.42  
14 Way Transition £0.42  
16 Way Transition £0.48  
20 Way Transition £0.48  
26 Way Transition £0.52  
34 Way Transition £0.56  
40 Way Transition £0.63  
50 Way Transition £0.84

Large Range of Connectors  
in stock - New Connectors  
Catalogue now available  
see our web site for details.

**D Type Connectors**



**Solder Bucket**

9 Way Mole Plug £0.20  
9 Way Female Socket £0.15  
15 Way Mole Plug £0.27  
15 Way Female Socket £0.23  
15 Way H.D. Plug £0.42  
15 Way H.D. Socket £0.36  
23 Way Mole Plug £0.60  
23 Way Female Socket £0.66  
25 Way Mole Plug £0.30  
25 Way Female Skt £0.35

**IDC Ribbon Mounting**

9 Way Mole Plug £1.08  
9 Way Female Socket £0.93  
15 Way Mole Plug £1.30  
15 Way Female Socket £1.32  
25 Way Mole Plug £1.13  
25 Way Female Socket £1.80

**Right Angled PCB**



9 Way Mole Plug £0.35  
9 Way Female Socket £0.33  
15 Way Mole Plug £0.32  
15 Way H.D. Socket £0.58  
25 Way Mole Plug £0.43  
25 Way Female Socket £0.50

**Plastic D Covers**

9 Way Cover - Grey £0.27  
9 Way Cover - Black £0.25  
15 Way Cover - Grey £0.40  
15 Way Cover - Black £0.38  
25 Way Cover - Grey £0.34  
25 Way Cover - Black £0.37  
9 to 9 Cover / Case £0.80  
25 to 25 Cover / Case £0.84  
9 to 25 Cover / Case £0.80

**Power Connectors**

**DC Low Voltage**

DC Plug 0.7ID 2.35OD £0.50  
DC Plug 1.3ID 3.40OD £0.14  
DC Plug 1.7ID 4.00OD £0.34  
DC Plug 1.7ID 4.75OD £0.50  
DC Plug 2.1ID 5.00OD £0.24  
DC Plug 2.5ID 5.00OD £0.23  
DC Plug 3.1ID 6.30OD £0.56  
DC Line Socket 2.1mm £0.66  
DC Line Socket 2.5mm £0.68  
DC Chassis Skt 2.1mm £0.44  
DC Chassis Skt 2.5mm £0.44

**IEC Mains 6A 250Vac**



3 Pin IEC Line Socket £0.87  
3 Pin IEC Line Plug £1.20  
3 Pin Chassis Socket £0.56  
3 Pin Chassis Plug £0.56

**8 Way Bulgin**



Line Plug P551 £3.85  
Line Socket P956 £3.99  
Chassis Plug P959 £3.24  
Chassis Socket P552 £1.28

**Toggle Switches**



**Sub-Miniature**

3A 125V 1A 250V  
5mm Ø Mounting Hole  
SPST 5 x 10mm £0.47  
SPDT 5 x 10mm £0.53  
DPDT C/Off 5 x 10mm £1.01  
DPDT 9.2 x 10mm £0.63

**Miniature**

6A 125V 3A 250V  
6.2mm Ø Mounting Hole  
SPST 8 x 13mm £0.58  
SPDT 8 x 13mm £0.55  
SPDT c/off 8 x 13mm £0.65  
SPDT c/o Biased 2 way £0.84  
SPDT c/o Biased 1 way £1.15  
DPDT 12 x 13mm £0.65  
DPDT c/off 12 x 13mm £0.88  
DPDT c/o Biased 2W £1.20  
DPDT c/o Biased 1W £1.28

**Standard**

1A 250V Push on terminals  
12mm Ø Mounting Hole  
SPST 18 x 30mm £1.05  
SPDT 18 x 30mm £1.18  
SPDT c/off 18 x 30mm £1.18  
DPDT 21 x 30mm £1.78  
DPDT c/off 21 x 30mm £1.78

**Rockers Switches**

**Miniature**

13 x 9mm Mounting Hole

SPST 4A 250V £0.57  
SPST 6A Red Neon £1.65  
SPST 3A Red LED £1.92  
SPDT 6A 250V £0.75  
DPST 4A 250V £0.81  
DPST 4A Red Neon £1.10  
DPST 3A Amber Neon £1.40  
DPST 3A Green Neon £1.32

**Standard**

10(SP), 22(DP) x 30mm  
Mounting Hole

SPST 10A 250V £0.60  
SPST 16A 250V £0.75  
SPST 15A Red Neon £0.90  
SPDT 16A 250V £0.75  
DPST 10A 250V £0.90  
DPST 15A Red Neon £1.18  
DPST Amber Neon £1.25  
DPST Green Neon £1.25  
DPDT 10A 250V £0.90

**Relays**

PCB Mounting

1A 24Vdc DPDT 5V £1.38  
1A 24Vdc DPDT 12V £1.35  
3A 110V SPDT 6V £0.58  
3A 110V SPDT 12V £0.60  
5A 110V SPDT 6V £0.72  
5A 110V SPDT 12V £0.72  
5A 110V DPDT 6V £0.93  
5A 110V DPDT 12V £0.93  
5A 240V DPDT 6V £1.76  
5A 240V DPDT 12V £1.76  
10A 240V SPDT 6V £1.20  
10A 240V SPDT 12V £1.24  
10A 240V SPDT 24V £1.44

**Computer Accessories Adaptors**



9M Gender Changer £1.73  
9F Gender Changer £1.73  
25M Gender Changer £2.20  
25F Gender Changer £2.43  
9 Mole - 25 Female £1.73  
9 Female - 25 Mole £1.71  
9M - 6 Mini Din Mole £2.16  
9F - 6 Mini Din Female £2.13  
5M Din - 6F Mini Din £1.73  
5F Din - 6M Mini Din £1.73

**Testers / Patch Boxes**

Mini Tester 7 LEDs £4.72  
Check Tester 18 LEDs £6.32  
Enhanced Switches £15.18  
25D Patch Box M.F. £2.64  
Anti-Static Wrist Strap £4.92  
5A Surge Protector £5.20  
13A Surge Protector £10.00  
4 Gong Surge Block £10.50

**Leads & Cables**



1.5m Printer Lead £2.55  
2m BD Printer Lead £2.98  
5m BD Printer Lead £4.98  
10m BD Printer Lead £9.88  
2m IEEE1284 Printer L £4.38  
2m IEEE1284 Printer R £8.90  
10m IEEE1284 Printer L £16.13  
Serial Printer 25M-25FE £4.38

**Null Modem Leads**

9 Female - 9 Female £4.38  
25 Female - 25 Female £6.48  
9 Female - 25 Female £4.38  
9 & 25F to 9 & 25F £4.88

**Modem Leads**

25Mole to 9Female £4.08  
25Mole to 25Female £3.78

**PC Link Leads**

Interlink 25M to 25M £3.88

**Patch Lead**

25Mole to 25Mole £3.60  
36Mole to 36Mole £2.60

**Internal Leads**

Floppy Cable A/B £2.28  
Hard Disk 2xIDE £1.65  
Hard Disk 2xATA66 £3.38  
Power 5/2 x 3/2 £1.88  
Power 5/2 x 3/2 £1.50  
Power 5/2 x 3/2 £1.88  
Power 5/2 x 3/2 £1.88

**Wire & Cable Ribbon Cable**

Price per 305mm (1ft)

10 Way Grey Ribbon £0.10  
16 Way Grey Ribbon £0.17  
20 Way Grey Ribbon £0.24  
26 Way Grey Ribbon £0.29  
34 Way Grey Ribbon £0.38  
40 Way Grey Ribbon £0.49  
50 Way Grey Ribbon £0.52  
60 Way Grey Ribbon £0.64

**Enamelled Copper Wire**

Per 50g (2oz) Reel

500g reels available

14 SWG Enamelled £1.03  
16 SWG Enamelled £1.03  
18 SWG Enamelled £1.03  
20 SWG Enamelled £1.06  
22 SWG Enamelled £1.03  
24 SWG Enamelled £1.18  
26 SWG Enamelled £1.29  
28 SWG Enamelled £1.29  
30 SWG Enamelled £1.35  
32 SWG Enamelled £1.35  
34 SWG Enamelled £1.35  
36 SWG Enamelled £1.63  
40 SWG Enamelled £1.96

**Tinned Copper Wire**

Per 50g (2oz) Reel

500g reels available

14 SWG Tinned £1.03  
16 SWG Tinned £1.03  
18 SWG Tinned £1.03  
20 SWG Tinned £1.06  
22 SWG Tinned £1.06  
24 SWG Tinned £1.08  
26 SWG Tinned £1.08

**Equipment Wire**

Black, Brown, Red, Orange,  
Yellow, Green, Blue, Purple,  
Grey & White. Per 100m

Solid 1/0.6mm £2.67  
Stranded 1/0.2mm £2.44

**Extra Flex Cable**

Black, Brown, Red, Yellow,  
Green, Blue & White.

25m 55/0.1mm Cable £2.16  
Block & Red 20A 1kV Dou-  
ble Insulated. £7.20  
10m 26/0.07mm £7.20

**Crystals**

**DT-38 Small Can**

32.768kHz £0.39

**HC-49/U Case**

1.8432MHz £1.08  
2.0MHz £1.46  
2.4576MHz £0.84  
3.2768MHz £0.35

**7 Segment Displays**

0.56" Red C-Cathode £0.65  
0.56" Red A-Cathode £0.65  
0.3" Red C-Cathode £0.65  
0.3" Red A-Cathode £0.65

**Infra Red Devices**

3mm IR Emitter £0.15  
5mm IR Emitter £0.30  
3mm Photo-Transistor £0.15  
5mm Photo Diode £0.76  
BPW41 Pin Diode £0.58  
4N25 Opto-Coupler £0.25  
4N26 Opto-Coupler £0.30  
4N32 Opto-Coupler £0.36  
6N135 Opto-Coupler £0.96  
6N136 Opto-Coupler £0.85  
6N137 Opto-Coupler £0.85  
6N138 Opto-Coupler £0.84  
6N139 Opto-Coupler £0.90  
CNY17-1 O-Coupler £0.38  
CNY17-2 O-Coupler £0.32  
CNY17-3 O-Coupler £0.48  
IS-74 Opto-Coupler £1.02  
ISD-74 Opto-Coupler £1.40  
1.8432MHz £1.08  
MOC3020 Opto-Triac £0.39  
MOC3041 Opto-Triac £0.50  
MOC3042 Opto-Triac £0.45  
ORP12 LDR £1.10

**IDC Cable Plugs**

10 Way Plug £0.52  
14 Way Plug £0.58  
16 Way Plug £0.63  
20 Way Plug £0.68  
26 Way Plug £0.70  
34 Way Plug £0.92  
40 Way Plug £0.92  
50 Way Plug £1.15

**PCB Box Headers**



10 Way Straight £0.21  
14 Way Straight £0.33  
16 Way Straight £0.32  
20 Way Straight £0.41  
26 Way Straight £0.52  
34 Way Straight £0.68  
40 Way Straight £0.68  
50 Way Straight £1.03  
10 Way 90° £0.32  
14 Way 90° £0.39  
16 Way 90° £0.35  
20 Way 90° £0.63  
26 Way 90° £0.68  
34 Way 90° £0.81  
40 Way 90° £1.17  
50 Way 90° £1.14

**PCB Latch Headers**



10 Way Straight £0.12  
14 Way Straight £0.45  
16 Way Straight £0.51  
20 Way Straight £0.54  
26 Way Straight £0.73  
34 Way Straight £0.88  
40 Way Straight £0.92  
50 Way Straight £1.27  
10 Way 90° £0.46  
14 Way 90° £0.48  
16 Way 90° £0.54  
20 Way 90° £0.58  
26 Way 90° £0.81  
34 Way 90° £1.03  
40 Way 90° £1.23  
50 Way 90° £1.41

**Audio Connectors**



2.5mm Jack Plug £0.25  
2.5mm Line Socket £0.24  
2.5mm Chassis Socket £0.12  
3.5mm Mono Line Skt £0.24  
3.5mm Mono Chassis Skt £0.14  
3.5mm Stereo Plug £0.35  
3.5mm Stereo Line Skt £0.27  
3.5mm Stereo Chassis Skt £0.22  
1/4" Mono Plug £0.30  
1/4" Mono Line Socket £0.36  
1/4" Mono Chassis Skt £0.29  
1/4" Stereo Plug £0.32  
1/4" Stereo Line Socket £0.32  
1/4" Stereo Chassis Skt £0.36

**Phono Series**



Plastic Line Plug £0.20  
Plastic Line Socket £0.20  
Metal Line Plug £0.50  
Metal Line Socket £0.31  
Gold Plated Chassis Socket £0.20

**XLR Series - metal**



3 Pin Line Plug £0.96  
3 Pin Line Socket £0.96  
3 Pin Chassis Plug £0.97  
3 Pin Chassis Socket £1.18

**Neutrik Connectors**

NC3MX XLR Line Plug £1.80  
NC3FX XLR Line Skt £2.10  
NC3MDL Chassis Plug £2.10  
NC3FDL Chassis Skt £2.55  
NL2FC 2 way Speakon £1.53  
NL4FX 4 way Speakon £2.93  
NL2MF Speakon Skt £1.13  
NL4MF Speakon Skt £1.16  
NP2C Mono Jack £1.80  
NP3C Stereo Jack £2.48

**Slide Switches**



**Miniature**

300mA 125V  
7 x 15mm Mounting Hole  
DPDT 7 x 23mm £0.14

**Standard**

1A 125V  
5.5 x 12mm Mounting Hole  
DPDT 12 x 35mm £0.27  
DPDT c/o 12 x 35mm £0.25

**Rotary Switches**



150mA 250V Make before  
Break 22mm Ø

9.8mm Ø Mounting Hole

1 Pole 12 Way £0.84  
2 Pole 6 Way £0.84  
3 Pole 4 Way £0.84  
4 Pole 3 Way £0.84

**Technical Books & CD ROMs**

Data Table & Equivalent charts from **EEA**  
Characteristics, pin outs, equivalents & selector tables for semiconductor. Demo version of the CD ROMs & full details of the complete range are available from our web site.

**Semiconductors Equivalents & Reference**

Covering: Transistors, Diodes, Thyristors, Triacs & ICs. These reference books series covers more than 115,000 types with more than 200,000 equivalent types. Each type is provided with information as to device family, short form description and the salient electrical data, along with the dimensioned outline drawing and pin assignments. Split into two paper volumes or available on one CDROM.

**vrt volume 1 A...Z Device Codes**  
ISBN3937469001, 1184 Pages, 2005 Version  
**vrt volume 2 1N...60,000...u Device Codes** £13.34  
ISBN393746901X, 720 Pages, 2005 Version

These books are zero vat rated, carriage for one OR both £5.50+vat



**vrt-disk 2005 CD ROM** £29.88+vat  
ISBN393746908 Windows 95/98/NT/2000/XP  
The software version of the vrt books. In addition to pin assignments of all discrete semiconductor this CD-ROM version contains the pin assignments for all standard CMOS 4000/7400, TTL 7400 circuits, many operational amplifiers and some Audio- and Video IC's. Extensive search facility, Manufacturers Details, a "Note-Function" to add your own data for each device. Carriage for CD only £2.50+vat

**Full details of UK, European or Worldwide Order information on our web site.**

EVERYDAY  
**PRACTICAL**  
**ELECTRONICS**

THE No.1 MAGAZINE FOR ELECTRONICS TECHNOLOGY & COMPUTER PROJECTS

**VOL. 34 No. 5 MAY 2005**

**Editorial Offices:**  
EVERYDAY PRACTICAL ELECTRONICS EDITORIAL  
WIMBORNE PUBLISHING LTD, 408 WIMBORNE ROAD EAST,  
FERNDOWN, DORSET BH22 9ND  
Phone: (01202) 873872. Fax: (01202) 874562.

Email: enquiries@epemag.wimborne.co.uk  
Web Site: www.epemag.co.uk  
EPE Online (downloadable version of EPE): www.epemag.com  
EPE Online Shop: www.epemag.wimborne.co.uk/shopdoor.htm  
See notes on Readers' Technical Enquiries below – we regret lengthy technical enquiries cannot be answered over the telephone.

**Advertisement Offices:**  
EVERYDAY PRACTICAL ELECTRONICS ADVERTISEMENTS  
MILL LODGE, MILL LANE,  
THORPE-LE-SOKEN, ESSEX CO16 0ED  
Phone/Fax: (01255) 861161 Email: epeads@aol.com

## Windoze

In a way it's reassuring to know that others have problems with computers – see my *Editorial* last month – and when those "others" are none other than Bill Gates and Microsoft then, I'm sorry, but it is quite pleasing. They have, after all, been responsible for the world of computer crashes – along with plenty of other software providers.

I'm referring to the multimedia demonstration that Bill Gates presided over – or rather got red-faced over – at the giant *Consumer Electronics Show* in Las Vegas recently. Bill was using the platform to promote Windows for all forms of entertainment but everything went wrong and all the Microsoft IT support engineers – amongst the best in the world(?) – who had set up the demonstration finished with egg on their faces and presumably a major dressing down from their boss.

Little wonder that the idea of using a PC to view TV, DVDs, play CDs etc., seems to generate little interest. You can read the story in our *News* pages this month.

## Coathanger Aerials

One of our projects this month is a little unusual for us in that it employs no "electronic" components and is, in fact, little more than the coathanger "aerials" you sometimes see on cars where the original telescopic aerial has been broken or vandalised. Having said that, the design of our DAB aerial is quite sophisticated and will yeald excellent results for little effort and outlay.

It is, in fact, quite surprising what can be achieved with five lengths of enamelled copper wire, a small piece of p.c.b. material and a connector. With the increasing popularity of easy to use DAB receivers this project will no doubt prove to be very popular.

You don't necessarily need a microcontroller and a host of components to achieve something useful. A point also amply illustrated by the *Burglar Alarm* in our *Back To Basics* series. However, just try designing our *Crossword Solver* without a microcontroller to see why we find them so useful for some projects – horses for courses.

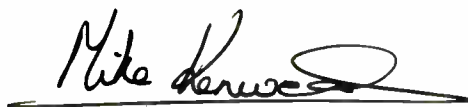

### AVAILABILITY

Copies of *EPE* are available on subscription anywhere in the world (see opposite), from all UK newsagents (distributed by COMAG) and from the following electronic component retailers: Omni Electronics and Yebo Electronics (S. Africa). *EPE* can also be purchased from retail magazine outlets around the world. An Internet on-line version can be purchased and downloaded for just \$10.99US (approx £7) per year available from [www.epemag.com](http://www.epemag.com)

### SUBSCRIPTIONS

Subscriptions for delivery direct to any address in the UK: 6 months £16.50, 12 months £31, two years £57; Overseas: 6 months £19.50 standard air service or £28.50 express airmail, 12 months £37 standard air service or £55 express airmail, 24 months £69 standard air service or £105 express airmail. To subscribe from the USA or Canada see the last magazine page. Online subscriptions, for downloading the magazine via the Internet, \$14.99US (approx £8) for one year available from [www.epemag.com](http://www.epemag.com). Cheques or bank drafts (in £ sterling only) payable to *Everyday Practical Electronics* and sent to EPE Subs. Dept., Wimborne Publishing Ltd, 408 Wimborne Road East, Ferndown, Dorset BH22 9ND. Tel: 01202 873872. Fax: 01202 874562. Email: subs@epemag.wimborne.co.uk. Also via the Web at: <http://www.epemag.wimborne.co.uk>. Subscriptions start with the next available issue. We accept MasterCard, Amex, Diners Club, Maestro or Visa. (For past issues see the *Back Issues* page.)

### BINDERS

Binders to hold one volume (12 issues) are available from the above address. These are finished in blue p.v.c., printed with the magazine logo in gold on the spine. Price £6.95 plus £3.50 p&p (for overseas readers the postage is £6.00 to everywhere except Australia and Papua New Guinea which cost £10.50). Normally sent within seven days but please allow 28 days for delivery – more for overseas.

Payment in £ sterling only please. Visa, Amex, Diners Club, Maestro and MasterCard accepted. Send, fax or phone your card number, card expiry date and card security code (the last 3 digits on or just under the signature strip), with your name, address etc. Or order on our secure server via our UK web site. Overseas customers – your credit card will be charged by the card provider in your local currency at the existing exchange rate.

**Editor:** MIKE KENWARD

**Deputy Editor:** DAVID BARRINGTON

**Technical Editor:** JOHN BECKER

**Business Manager:** DAVID J. LEAVER

**Subscriptions:** MARILYN GOLDBERG

**Administration:** FAY KENWARD

**Editorial/Admin:** (01202) 873872

**Advertisement Manager:**

PETER J. MEW, (01255) 861161

**On-Line Editor:** ALAN WINSTANLEY

**EPE Online** (Internet version) **Editors:**

CLIVE (MAX) MAXFIELD and ALVIN BROWN

### READERS' TECHNICAL ENQUIRIES

E-mail: techdept@epemag.wimborne.co.uk

We are unable to offer any advice on the use, purchase, repair or modification of commercial equipment or the incorporation or modification of designs published in the magazine. We regret that we cannot provide data or answer queries on articles or projects that are more than five years old. Letters requiring a personal reply *must* be accompanied by a **stamped self-addressed envelope** or a **self-addressed envelope and international reply coupons**.

### PROJECTS AND CIRCUITS

All reasonable precautions are taken to ensure that the advice and data given to readers is reliable. We cannot, however, guarantee it and we cannot accept legal responsibility for it. A number of projects and circuits published in *EPE* employ voltages than can be lethal. You should not build, test, modify or renovate any item of mains powered equipment unless you fully understand the safety aspects involved and you use an RCD adaptor.

### COMPONENT SUPPLIES

We do not supply electronic components or kits for building the projects featured, these can be supplied by advertisers (see *Shoptalk*). We advise readers to check that all parts are still available before commencing any project in a back-dated issue.

### ADVERTISEMENTS

Although the proprietors and staff of EVERYDAY PRACTICAL ELECTRONICS take reasonable precautions to protect the interests of readers by ensuring as far as practicable that advertisements are *bona fide*, the magazine and its Publishers cannot give any undertakings in respect of statements or claims made by advertisers, whether these advertisements are printed as part of the magazine, or in inserts.

The Publishers regret that under no circumstances will the magazine accept liability for non-receipt of goods ordered, or for late delivery, or for faults in manufacture.

### TRANSMITTERS/BUGS/TELEPHONE EQUIPMENT

We advise readers that certain items of radio transmitting and telephone equipment which may be advertised in our pages cannot be legally used in the UK. Readers should check the law before buying any transmitting or telephone equipment as a fine, confiscation of equipment and/or imprisonment can result from illegal use or ownership. The laws vary from country to country; readers should check local laws.



# Crossword Solver

Mike Hibbett

Even doing *The Times* could become a doddle!



**I**F, LIKE the author, you are a crossword puzzle fan, you will have frequently found yourself stuck on words where you have a few letters but no ideas. A dictionary is of little use if you do not have the letters at the beginning of the word.

The Crossword Solver was created to help out, while demonstrating how easy it is for a PIC to index large memory devices quickly and efficiently. The Crossword Solver stores a large dictionary – over 57,000 words – in a small flash memory i.c. Using a simple keypad you can enter the letters you do know for a word and the Crossword Solver will scan the dictionary and display all the words that match. It's very fast, taking only a few milliseconds to find each word.

Another feature is the anagram solver – type in the letters of the anagram, and the Crossword Solver will display all the words that use combinations of those letters. The results can be surprising – “Elvis” for example gives “Evils Lives”!

The device is handheld and battery powered. It uses an efficient 3V to 5V converter which enables the device to operate from two AAA cells (3V), giving over 100 hours of continuous use.



## Optimisation

If the list of words were to be stored in the memory in simple alphabetical order, as in a dictionary, it would take the PIC several seconds to find each word. Some optimisation is required! The first optimisation comes from the fact that the length of the unknown word is known, so the words are stored in length order.

A small table at the beginning of memory holds the index of the start of each word list, so the PIC can quickly jump to the first word of a given length. Then the PIC simply reads each word in turn, and compares the word against the “template” entered by the user.

The PIC takes just 16 instructions to read a character from memory. Running at 20MHz, as set by crystal X1, it can test a five letter word every 16µs – fast enough that you are unlikely to notice the delay!

## How It Works

The circuit diagram for the main aspect of the Crossword Solver is shown in Fig.1.

Device IC3 is a step-up voltage converter that gives a regulated 5V supply from two 1.5V cells. Switch S5 turns on this supply. The MAX619 used for IC3 is a wonderfully simple voltage step-up chip to use because it only requires four capacitors – no inductors or special diodes.

Microcontroller IC1 is a PIC16F877 that manages the user input, searching of the dictionary and display of the results on the alphanumeric l.c.d., X2.

Preset VR1 is used to adjust the l.c.d.'s screen contrast.

IC2 is a non-volatile EPROM (Electrically Programmable Read Only Memory) chip that holds the dictionary. The dictionary is coded into the chip in a special format, more on that later. The memory has a capacity of over 500,000 characters, more than enough for a 57,000 word dictionary. The chip is a flash device that can be programmed in circuit if required, via connector J5.

The PIC is very well utilised in this design; all I/O pins have been assigned. The “keyboard”, switches S1 to S4, is accessed via connector J2 multiplexed with the memory and l.c.d. data bus by using transistors TR1 to TR4 as open collector drivers. IC1 pin RA5 is used to keep the keys effectively high-impedance during l.c.d. or flash accesses to avoid corrupting data transfers.

Ports B, D and E of the PIC are used exclusively as the address bus to the memory chip, but there is an almost random assignment of pin connections to the memory chip's address bus. This is to allow for the simplest p.c.b. layout between the two devices. The actual order of the memory pins is of no importance to the software. Port C provides the I/O (input/output) data connections to the memory.

## Construction

The component and track layout details for the printed circuit board are shown in Fig.2. This board is available from the *EPE PCB Service*, code 499.

When assembling the p.c.b., start by placing the four wire links, then the i.c. sockets, resistors, capacitors and the remaining components, including switches, but excluding the l.c.d. module at this stage. Pin header terminals should be fitted for the power, l.c.d., EPROM Flash Mode, and switches S1 to S4 connections. The l.c.d. requires two headers, since this also simplified the p.c.b. design. Do not fit the i.c.s. or connect the l.c.d. yet

Once the board has been built and thorough checked, apply 3V to the supply pins (connector J1) and check that +3V appears at IC3 pin 2. Remove power and fit IC3. Apply power, and check for +5V at output pin 3 of IC3, at IC1 socket pins 11 and 32, and IC2 socket pin 32.

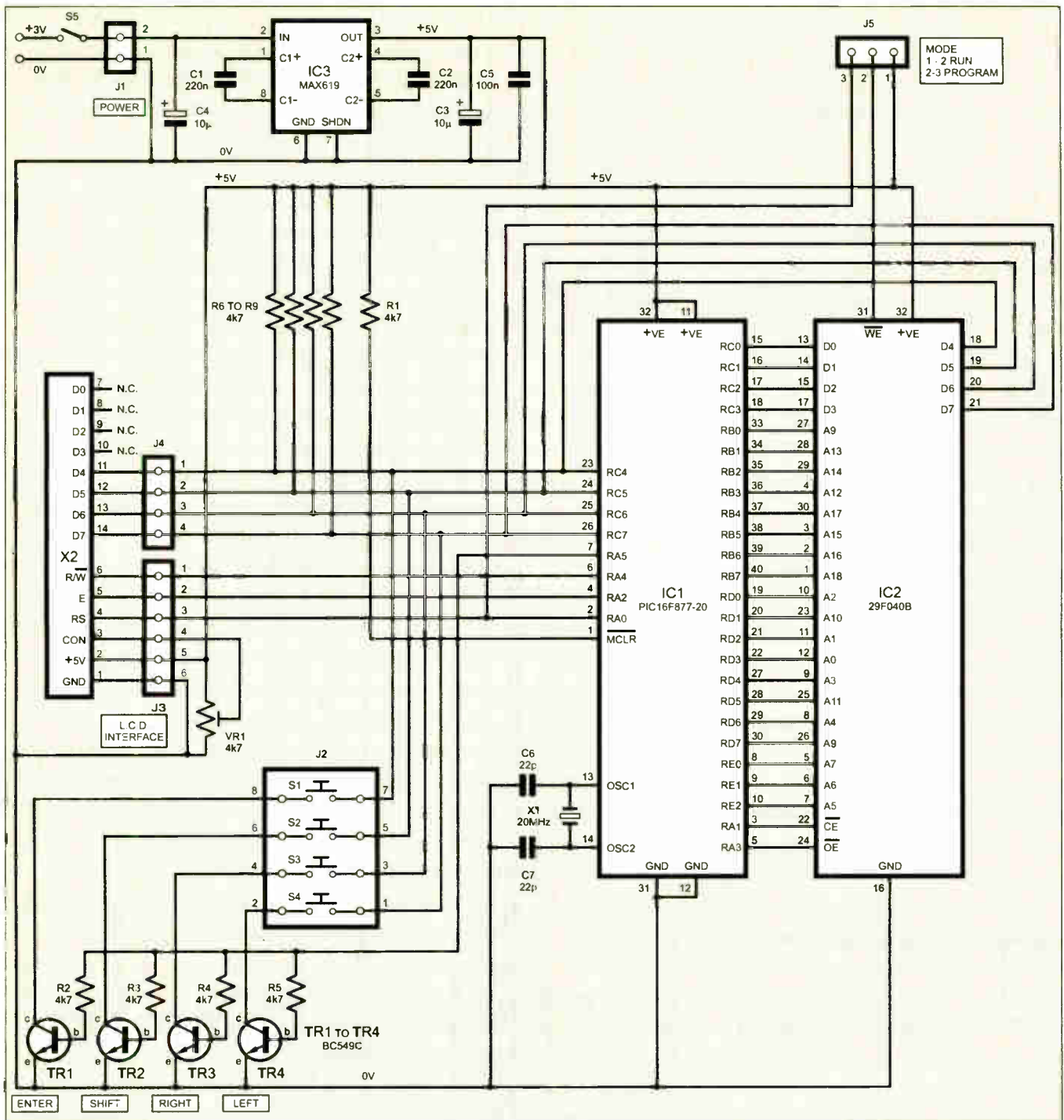

Fig. 1. Complete circuit diagram for the Crossword Solver

## COMPONENTS

### Main Unit

#### Resistors

R1 to R9 4k7 (9 off)  
All 0.25W 5% carbon film

#### Potentiometer

VR1 4k7 min. preset, round

#### Capacitors

C1, C2 220n ceramic disc, 5mm pitch (2 off)  
C3, C4 10 $\mu$  elect or tantalum, radial, 16V (2 off)

See  
**SHOP**  
**TALK**  
page

### Semiconductors

TR1 to TR4 BC549C npn transistor (4 off)  
IC1 PIC16F877-20 microcontroller, pre-programmed (see text)  
IC2 29F040B EPROM, 120ns or 90ns. programmed (see text)  
IC3 MAX619 step-up voltage converter

### Miscellaneous

X1 20MHz crystal

X2 2-line, 16 character (per line), alphanumeric l.c.d. module  
S1 to S4 s.p. push-to-make switch (4 off)  
S5 min. s.p.s.t. switch, slide or toggle

Printed circuit board, available from the *EPE PCB Service*, code 499; 8-pin d.i.l. socket; 32-pin d.i.l. socket; 40-pin d.i.l. socket; pin headers (or terminal pins) to suit; plastic case approx 145mm x 80mm x 35mm; connecting wire; solder, etc.

Approx. Cost  
Guidance Only

**£30**

Excl. case

If all is well, remove power and fit the pre-programmed PIC and memory chip (see later), and the l.c.d.

Normally, on power up, the display will briefly show a title and then display the main menu. The display will probably be blank when you first build the unit. Adjust preset VR1 to give a suitable screen contrast.

When ready to use the unit, a link should be made between pins 1 and 2 of connector J5.

### In Use

The four push-button switches, S1 to S4, provide a simple user interface. The LEFT and RIGHT buttons (S4 and S3) are used to select menu options, enter word lengths and move through a word; ENTER (S1) is used to accept an option; SHIFT (S2) is used in combination with the LEFT/RIGHT keys to enter letters.

Pressing SHIFT and then LEFT or RIGHT will scroll through the letters. Pressing SHIFT and then ENTER selects the "escape" option, which allows you to go back to the previous option entered.

At switch on, the screen will briefly display this message:



Followed by the main menu, offering two choices, Word Search and Anagram Generator.



### Word Search

From the main menu, use the LEFT or RIGHT keys to highlight the "Word" option (it should be displayed as <Word>), then press ENTER.



Use the LEFT/RIGHT keys to enter the length of the word you want to look for (LEFT = decrement, RIGHT = increment). When you have selected the correct length, press ENTER. The display will now briefly show:

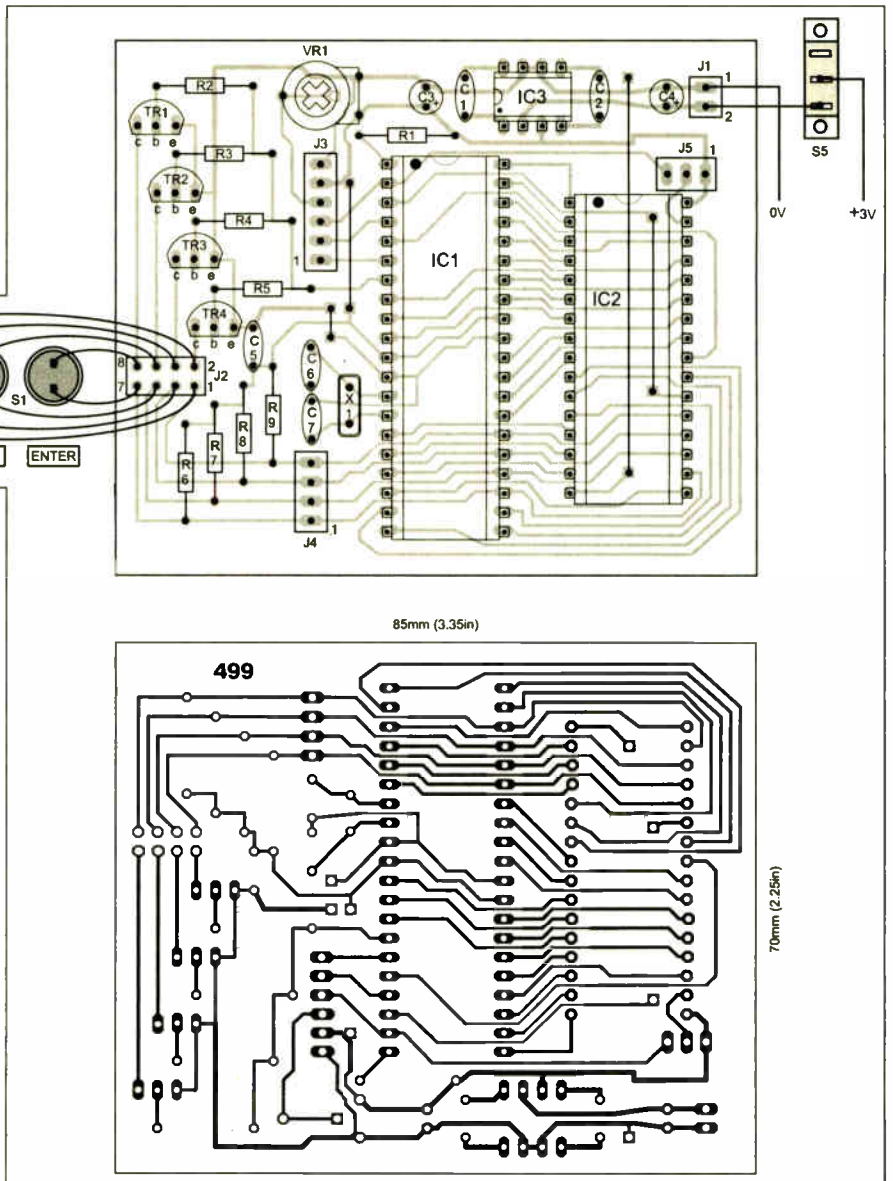
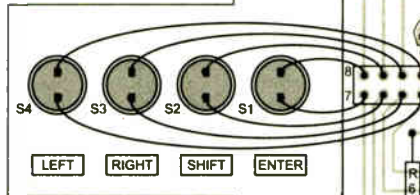
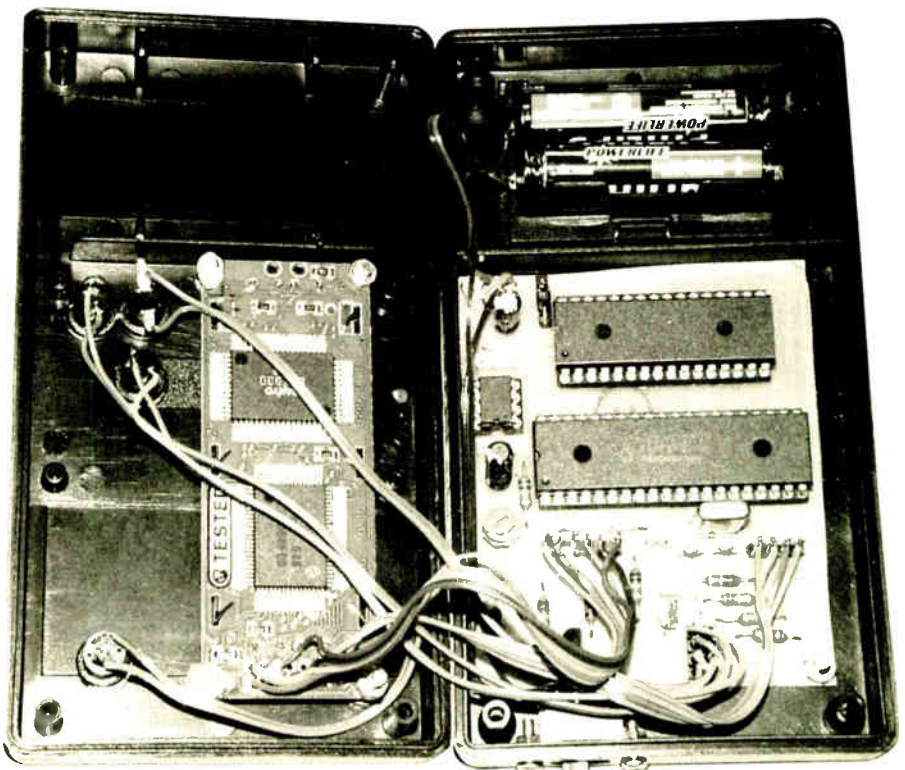
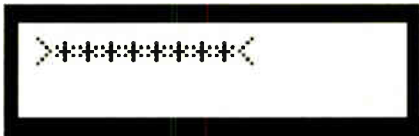

Fig.2. Component and track layouts for the Crossword Solver







followed by a display similar to that above in which the number of asterisks indicates the number of letters.

Use LEFT or RIGHT to position the cursor over a letter you know, then use SHIFT plus LEFT/RIGHT to choose the letter. Repeat for any other letters you know or guess, leaving the unknown letters as "\*\*". When you have finished, press ENTER.

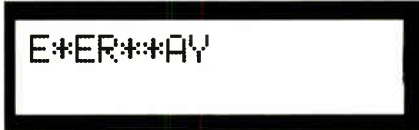

The display will now show the first word that matches. Press ENTER to continue through the word list. When it reaches the end the display will show "No more words" and return to the main menu.

For instance, entering FA\*, results in the following offerings: FAD, FAG, FAN, FAR, FAT, FAX, FAY.

### Anagram Generator

From the main menu select the <Anagram> option. The display will ask you to enter the length of the word: do so and press ENTER. Now enter the letters, in any order. You must enter letters in all positions; you cannot have any "unknown" letters. When you have finished press ENTER and the display will show the first match, if any. Press ENTER to continue through the list of words.

### Going further

The project uses very little of the code and data space in the PIC so there is plenty of room for extra features. You could improve the anagram system to try combinations of letters rather than all the letters, and trying to make several words out of a list of letters. Or perhaps add a compression algorithm so that more words could be added.

### Flash Programming

To program the EPROM, IC2, you need to construct an RS232 interface whose circuit diagram is shown in Fig.3. No constructional details are offered, but the simple circuit can be readily assembled on a piece of stripboard.

There is a choice of files for use with the EPROM, dic.bin and dic.uns. Dic.bin is a binary file suitable for use with an external EPROM programmer. Dic.uns is used if the EPROM is to be programmed in circuit. These files are generated by the dic.exe utility. This program and the original source list of words can be found in the Crossword folder on the EPE downloads site (see later).

The list of words is a simple text file; if you want to change or add to your dictionary simply edit this file through a simple text editor such as Notepad, and then run dic.exe. The program will create new dic.bin and dic.uns files which you can program back into the memory chip.

Then run FPROG.EXE and press PC keyboard key "5" or "6" to select your COM port. Connect the RS232 interface to your COM port and plug the other lead into

connector J3 on the main p.c.b., making sure that the l.c.d. is not connected to J3 or J4.

Connect together pins 2 and 3 on connector J5, leaving pin 1 unconnected. Press one of the switches on the unit, hold it pressed and switch on the power, then release it. Back on the PC, press key "1" to erase the EPROM. Erasing takes 64 seconds, the program will tell you when it has finished.

Switch the unit off, turn it back on again with a switch (S1 to S4) pressed, as before. Run the

FPROG.EXE program again, select your COM port and then press key "2" to download the dictionary to the memory. The PC indicates download progress, which takes about 12 minutes. When it has finished, switch off power to the unit, disconnect the RS232 interface, and refit the l.c.d. Remove the link on J5 pins 2 and 3, and now link pins 1 and 2 again.

The EPROM may be reprogrammed at any point, just remove the l.c.d. connections at J4 before repeating the above procedure. The FPROG utility can also verify the contents and even save them to disk. The options are given on-screen.

### Resources

Software, including source code files, for the PIC and EPROM, is available on 3.5inch disk from the Editorial office (a small handling charge applies – see the EPE PCB Service page) or it can be downloaded free from the EPE Downloads page, accessible via the home page at [www.epemag.co.uk](http://www.epemag.co.uk). It is held in the PICs folder, under Crossword. Download all the files within that folder.

The run-time assembly is supplied as an MPASM HEX file, which has configurations embedded in it (crystal XT, WDT off, POR on, all other values off).

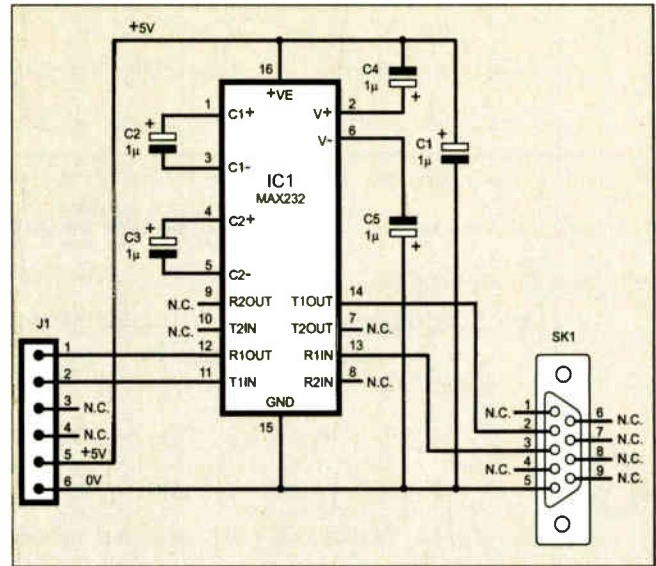

Fig.3. Circuit diagram for the optional RS232 interface

## COMPONENTS

### RS232 Interface (see text)

- C1 to C5 1 $\mu$  radial elect, 25V (5 off)
- IC1 MAX232 RS232 interface
- SK1 9-pin D-type serial connector, female

Stripboard to suit; 16-pin d.i.l. socket; pin header (or terminal pins) to suit; connecting wire; solder, etc.

Approx. Cost  
Guidance Only

£5

This month's *Shoptalk* provides information about obtaining pre-programmed PICs. The memory chip, however, is not available pre-programmed. It can be programmed either in a suitable EPROM programmer, or by your own PC as described earlier

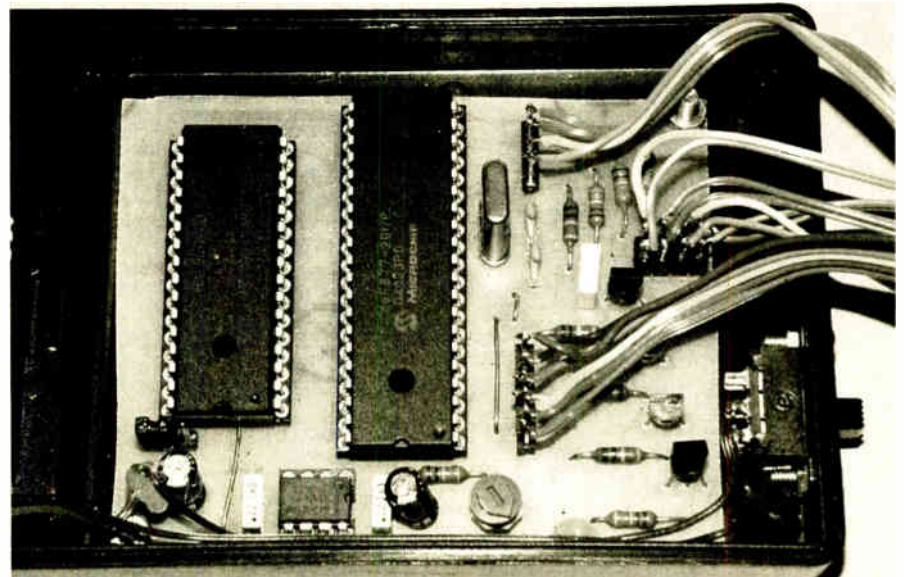

### GREEN FOR GO

**Red for stop, green for go; red for port, green for starboard. Pretty obvious really – or is it? Mark Nelson explains.**

**G**REEN means go and red means stop. All over the world people make decisions based on visual signals but the underlying mechanisms are far less obvious than the results.

Whether these are natural colours for delivering warnings is pretty irrelevant now, since all over the world these signals are understood and recognised by motorists, train drivers, seafarers and in fact everyone (or at least by all except the colour-blind).

But precisely why red should be associated with danger (something to do with blood or fire perhaps), why green should denote safety and why yellow should indicate caution is by no means clear. Nor was it always so and a different scheme appeared “natural” when coloured lights were first used for railway signals in the 1840s.

Red certainly stood for stop in those days but a white light indicated “line clear”, whilst green meant “caution”. The risk of missing coloured lamp glasses was soon appreciated and to prevent a broken red glass giving the mistaken impression of safety, the green indication was transferred to “go” and a new yellow colour was assigned to caution.

Since then, however, the colours red, green and yellow have become standardised worldwide to become triggers for all kinds of activity beyond controlling vehicles. One of the latest is the Stock Orb, a kind of executive office ornament that glows in different colours to monitor movements in the stock exchange. Not all ornaments are useful but this one, conceived by Ambient Devices in the USA, gradually turns green as the index rises and red when stocks are falling.

#### Awesome Orb

Crazy as it may sound, the Stock Orb certainly makes sense if it can impart information in an intuitive way and the fact that outlets like Amazon are selling it adds weight to the proposition. As you can see at [www.ambientdevices.com/cat/orb/orborder.html](http://www.ambientdevices.com/cat/orb/orborder.html), the orb can display all manner of other information such as individual stock portfolios or even the weather forecast – in fact any kind of metric where the trend is more important than the actual value. Other possibilities for tracing include pollen forecasts, instant messaging presence and even the probability of news events with the NewsFutures’ channel.

All of this is achieved without an Internet connection. Users simply plug the orb into any standard power outlet and their Orb is up and running on a nationwide wireless network that in the USA shares the airwaves with radio pagers. If that sounds “kinda neat” from a technical point of view, then the physical aspect of

the Stock Orb is equally elegant. Photos on the website show an object looking like a luminous egg made of frosted glass with a lead that plugs into any mains socket; “plug and play” was never simpler!

User reaction among the smart set has been pretty favourable too. “The Ambient Orb may look like a crystal ball on acid, but it’s really more of a giant mood ring – plugged straight into the fluctuations of the stock market or anything else you care to track,” declares *Time* magazine. But the really smart (and radically different) thing about Stock Orb is the MMI or man-machine interface.

#### Glanceable

“People want information, but they don’t want to invest a lot of time in getting it,” says Ambient president David Rose. “This makes getting information a ‘glanceable’ thing.” The *New York Times* is equally impressed, declaring: “This is ‘ambient information’ – the newest concept in how to monitor everyday data. We’ve been cramming stock tips, horoscopes and news items onto our computers and cellphones – forcing us to peer constantly at little screens. What if we’ve been precisely wrong?”

This idea of glanceable displays is catching on with other manufacturers and information providers. Adam Oliver, head of access to information at BT Global Services, is working on a similar kind of device that has even greater potential to deliver ambient information.

Under development in BT’s Broadband Applications Research Centre at Adastral Park, Ipswich, is what might just become the desirable design icon of the decade. Says Adam, “Everyone who sees it is amazed with the beauty of the display. We are keen to make the attractiveness of the design paramount in order to create a piece of technology that you would be proud of having in your own living or working environment.”

Users can personalise what information the Ambient Service Portal monitors and how the information is displayed on the device. It can play polyphonic melodies, present a display of coloured, flashing pinpoints of lights on its central display through its matrix of 45 i.e.d. multicolour pixels. The device can display patterns and flows of colours that alert people to the arrival of new information from the services to which they have subscribed.

#### No Plaything

The device is far more than a yuppie plaything, however. According to Adam it also has great uses in the health and well-being market, for instance to remind its owner to take medication or act as a silent carer when it reaches the shops in the next

18 months. “I believe it is the most advanced device of its kind in the world,” he says. “For the visually impaired, it can speak to them and for the hearing impaired it can bring information through colour change, which is capable of displaying complex patterns which can remind the users of information.”

If ambient information devices take off there will need to be some consensus between manufacturers on colour codes. This could well open a debate on standardisation – and what constitutes a logical relationship between hues and the message they are intended to impart. Human factors research will come into play, along with some thoughtful investigation into colours that will not confuse people with defective sight.

Here a lesson may be learnt from electrical wiring, where the now virtually worldwide agreement on brown, blue and green/yellow came about only after lengthy discussion. The colours were chosen not for their apparent association, otherwise brown would be earth (E) and in fact the earth (ground) wire had to be distinguished and making it striped was an inspired choice. The other two colours had to be clearly distinguishable, even by people who suffer colour-blindness, and blue and brown were judged the most clearly different shades by experts in this field.

#### Colourful World

These are some of the colour combinations the now-standard system replaced (all combinations are given in the order L, N, E – in other words line/live, neutral and earth/ground):

Belgium:	Red, yellow or blue, Grey, Black
Germany:	Usually Grey, Black, Red
Great Britain:	Red, Black, Green
Netherlands:	Any colour but grey or red, Red, Grey
Russia:	Red, Grey, Black
Switzerland:	Red, Grey, Yellow or Yellow/Red
USA, Canada:	Black, White, Green

All this should make it clear why a unified colour coding of wires was necessary. Green is by no means the obvious colour for earth either: before standard colours were adopted, earth was red in Austria, Finland, Germany, Norway, and Sweden; black in Belgium and Russia, grey in the Netherlands and Poland, yellow in Switzerland and green in Britain and North America. Three cheers for standardisation!

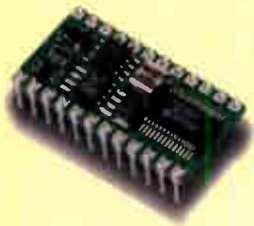

BS2-IC

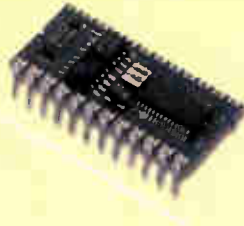

BS2-SX

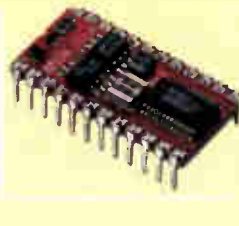

BS2E-IC

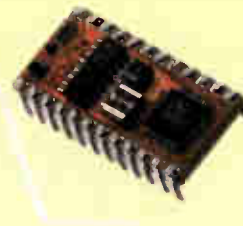

BS2P/24



BS2P/40

**Parallax BASIC Stamps - still the easy way to get your project up and running!**



**Serial Alphanumeric and Graphic Displays, Mini-Terminals and Bezel kits**

# www.milinst.com



Animated Head



3-Axis Machine



Six-Legged Walkers



Robotic Arms



Bipeds

**Robotic models for both the beginner and the advanced hobbyist**

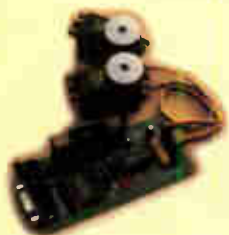

Servo Drivers

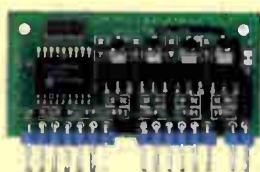

Motor Drivers



On-Screen Displays



DMX Protocol



U/Sound Ranging

**Animatronics and Specialist Interface-Control Modules**



Quadravox MP3 & Speech Systems



SensoryInc Voice Recognition



Parallax Ubicom Tool Kits



Tech-Tools PIC & Rom Emulators



BASICMicro PIC BASIC Compilers

**Development Tools**

Milford Instruments Limited Tel 01977 683665, Fax 01977 681465, sales@milinst.com

World Radio History

# INGENUITY UNLIMITED

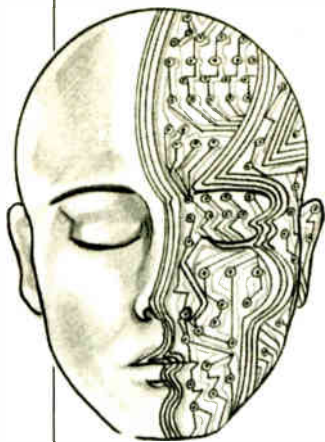

Our regular round-up of readers' own circuits. We pay between £10 and £50 for all material published, depending on length and technical merit. We're looking for novel applications and circuit designs, not simply mechanical, electrical or software ideas. Ideas *must be the reader's own work and must not have been published or submitted for publication elsewhere.* The circuits shown have NOT been proven by us. *Ingenuity Unlimited* is open to ALL abilities, but items for consideration in this column should be typed or word-processed, with a brief circuit description (between 100 and 500 words maximum) and full circuit diagram showing all component values. **Please draw all circuit schematics as clearly as possible.**

Send your circuit ideas to: *Ingenuity Unlimited*, Wimborne Publishing Ltd., 408 Wimborne Road East, Ferndown Dorset BH22 9ND. (We do not accept submissions for *IU* via E-mail.) Your ideas could earn you some cash and a prize!

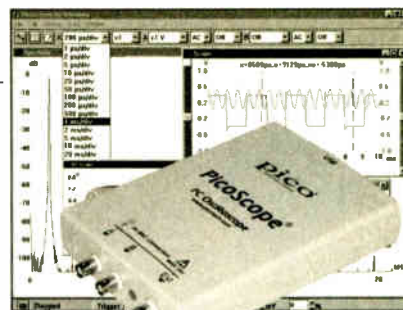

## WIN A PICO PC BASED OSCILLOSCOPE WORTH £599

- 5GS/s Dual Channel Storage Oscilloscope ●
- 50MHz Spectrum Analyser
- Multimeter ● Frequency Meter
- USB Interface

If you have a novel circuit idea which would be of use to other readers then a Pico Technology PC based oscilloscope could be yours. Every 12 months, Pico Technology will be awarding a PicoScope 3205 digital storage oscilloscope for the best IU submission. In addition, a DrDAQ Data Logger/Scope worth £59 will be presented to the runner up.

## Adjustable Constant Current Source – Setting the Flow

**C**ONSTANT current sources are often used as elements within circuits, but are relatively rare as items of stand-alone equipment. However, they find application in, for example, the measurement of low resistances by the “four wire” method, and the investigation of current-voltage, noise, and other characteristics of diodes and transistors. The circuit described here has an output current  $I_{out}$  which can be set accurately between 100nA and 10mA.

### Circuit Details

Referring to Fig.1, diode D6 is a bandgap reference which behaves like a nearly-ideal 2.5V Zener diode. Preset VR1 allows the voltage at IC1's non-inverting input, pin 3, to be adjusted to 0.1V, while IC1 gain is selected from unity to ten by the “Multiplier” switch S1 in conjunction with resistors R5 to R13. These circuit elements produce a stable reference voltage,  $V_{ref}$ , of 0.1V, 0.2V ... 1.0V at the non-inverting input of IC2.

However,  $V_{ref}$  is not referred to the 0V rail. Instead, buffer IC3 is used to allow  $V_{ref}$  to be generated relative to the (unknown) potential produced by  $I_{out}$  flowing through the load. Meanwhile, relative to this same load potential, the inverting input of IC2 sees a voltage of  $I_{out} \times R_{dec}$ , where  $R_{dec}$  is the decade resistance selected by switch S1. In normal operation, feedback around IC2 ensures that  $I_{out} \times R_{dec} = V_{ref}$  so that the output current of the circuit is just  $V_{ref}/R_{dec}$ , independent of the load resistance.

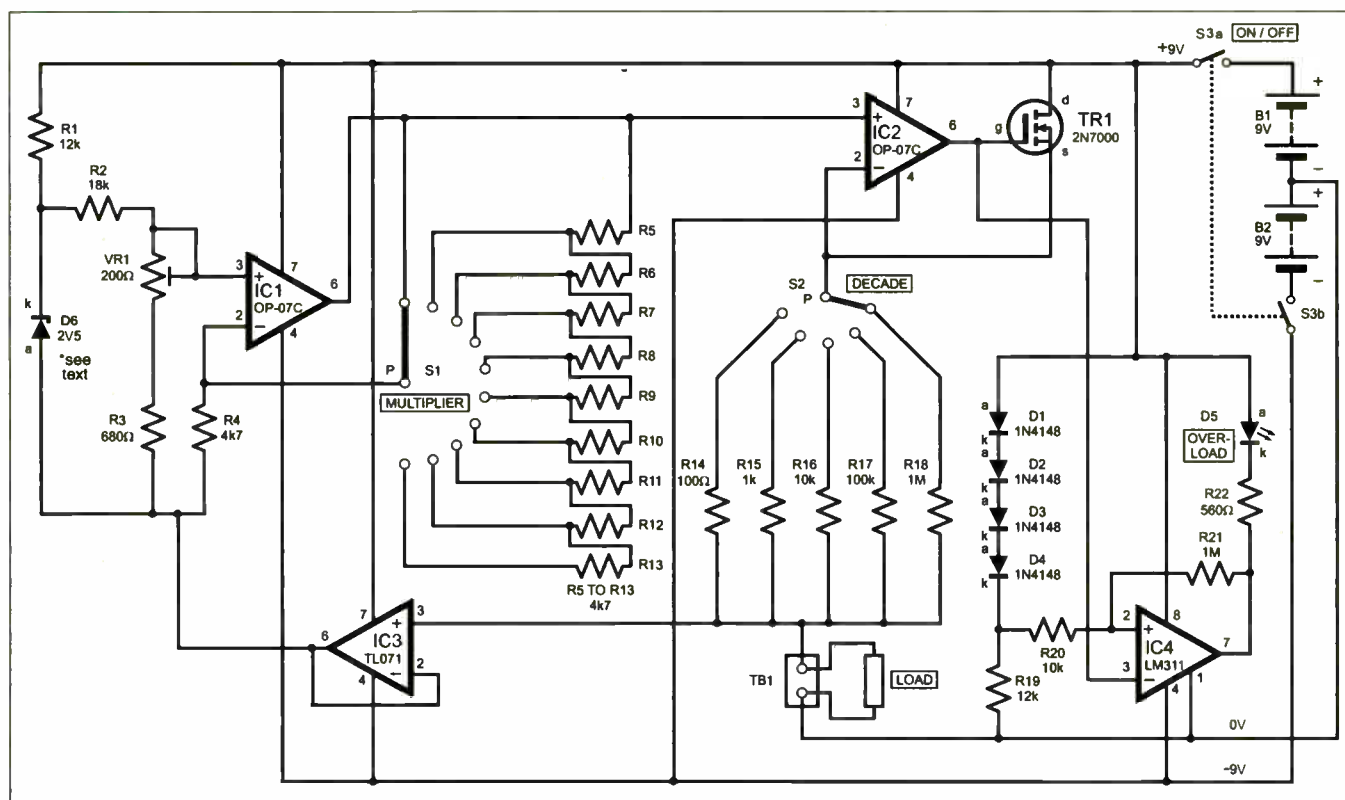

Fig.1. Circuit diagram for the Adjustable Constant Current Source

If the load resistance is too large, IC2 will not be able to turn TR1 on enough to supply the nominal constant current, and its output will saturate at about 2.5V to 3V below the positive supply rail voltage. This state of affairs is detected by the comparator IC4. As the supply voltage in the (battery-powered) prototype was variable, diodes D1 to D4 were used rather than a resistive divider to provide the comparator threshold voltage. When IC2 saturates, IC4 output goes low and turns

on i.e.d. D5 to indicate that  $I_{out}$  is no longer at its expected value.

In the prototype, diode D6 is a ZREF25 device, but this part is now obsolete. A similar 2.5V reference diode, such as the ZRC250R01, should be a suitable replacement, although not tried by author. To ensure accuracy and stability of output current, the Multiplier and Decade resistors were 0.1% types.

Initially, all op.amps were OP-07 devices, chosen for their good d.c. performance at low

cost. However, on the lowest current settings, IC3 bias current (typical 1.8nA, maximum 7nA for OP-07C) can become a significant source of error. Using a JFET-input TL071 for IC3 (typical bias current of 0.2nA) improved accuracy on the prototype. But note that bias currents for the TL071 and similar devices increase exponentially with temperature! As constructed, the circuit had less than 2% error in currents of 100nA and 200nA and less than 1% error on all other settings.

Mike Toohey, Manchester

## Multi-Level Lock - A Lock-Out

**T**HE two circuit diagrams shown in Fig.2 and Fig.3 are suitable for forming the basis of an inductively coupled Lock and Key set-up. In their present form they are merely intended as a demonstration of the basic principle, with a single "channel" for one door. Potentially, however, they form the basis of a fairly sophisticated lock system with several levels of operation.

### Lock and...

Circuit diagram Fig.2 represents the Lock, which momentarily closes a solenoid, thus opening a door. This is based on a CMOS 4060 oscillator/divider, IC1.

When electromagnetic pulses are received by coil L1, the divider is clocked at pin 11. If the correct number of pulses is received, output Q6 goes "high" and stays high, illuminating i.e.d. D1. This charges capacitor C2, which closes the solenoid via n-channel power MOSFET TR1.

At the same time, capacitor C3 charges, which shortly after this resets IC1, once more opening solenoid S1. Thus the door opens with a click-click. Diode D2 prevents C2 and C3 from charging before output Q6 has come to rest.

### ...Key

The Key is represented by circuit diagram Fig.3. This emits electromagnetic pulses at  $f=1/4.4 \times C5 \times C5$  (about 23kHz) when switch S2 pushbutton is pressed. As it does so, capacitor C6 begins to charge through preset VR1, so that if VR1 is correctly adjusted, IC2 resets and the pulse-train stops as IC1 output Q6 goes "high". These pulses are transmitted through inductive coupling from coil L2 - Key (Fig.3) to coil L1 - Lock (Fig.2).

All in all, therefore, when switch S2 is pressed, solenoid S1 closes momentarily, and opens the door. Then IC1 resets, awaiting the next input from the key.

In practice, coil L2 needs to be placed directly on top of coil L1 for good coupling to take place, then S2 pushbutton is pressed. For discreet operation, coil L1 may be hidden behind the veneer of a door, or otherwise concealed.

### Expansion

Let us now consider some enhancements to the present circuit.

Supposing that instead of employing IC1 output Q6 alone, we employ outputs Q4 to Q6. That is, IC1 now outputs a three-digit binary number.

Depending on the length of the pulse-train

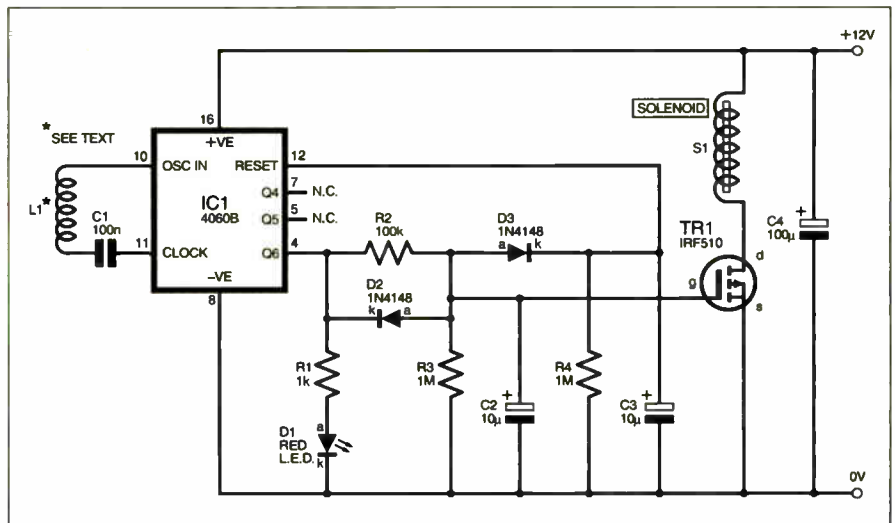

Fig.2. Lock circuit diagram for the Multi-Level Lock

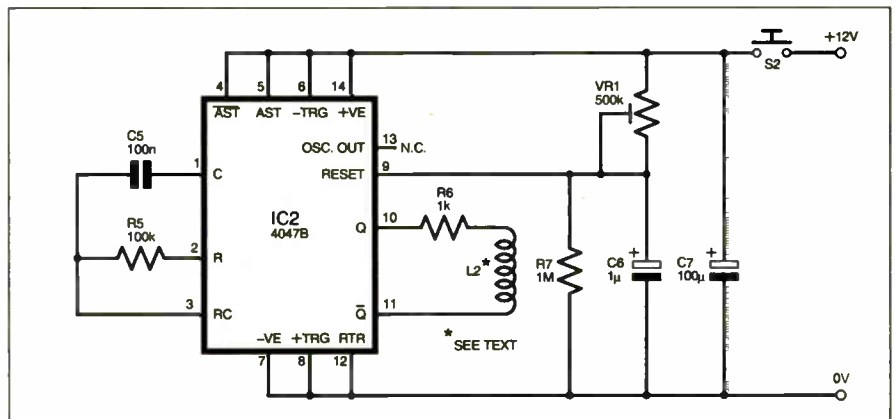

Fig.3. Key circuit diagram for Multi-Level Lock

generated by the Key (IC2), any given three-digit binary number is generated by IC1. That is, depending on the length of the pulse-train, IC2 might stop the count at (for instance) 101, 011, or 100. Thus a single key would open any preferred combination of three doors, e.g. the front door, back door and the laboratory door, while another key might open the front door only.

In this case, a further enhancement would be preferred. A suitable monostable timer could detect activity at IC1 output Q4, resetting IC1 after a given period by taking reset pin 12 "high". This would be helpful if the wrong key were used on a given door, which might otherwise leave

the vital output of IC1 (the one which switches solenoid S1) "low" without IC1 having reset.

Coils L1 and L2 may be almost any two coils, on condition that they have sufficient turns. For the prototype, the author used 25mm diameter coils using 100 turns of 30s.w.g. enamelled copper wire.

Thomas Scarborough,  
Cape Town, South Africa.

**MORE**

# Electrical Field Detector – The Nearness of You?

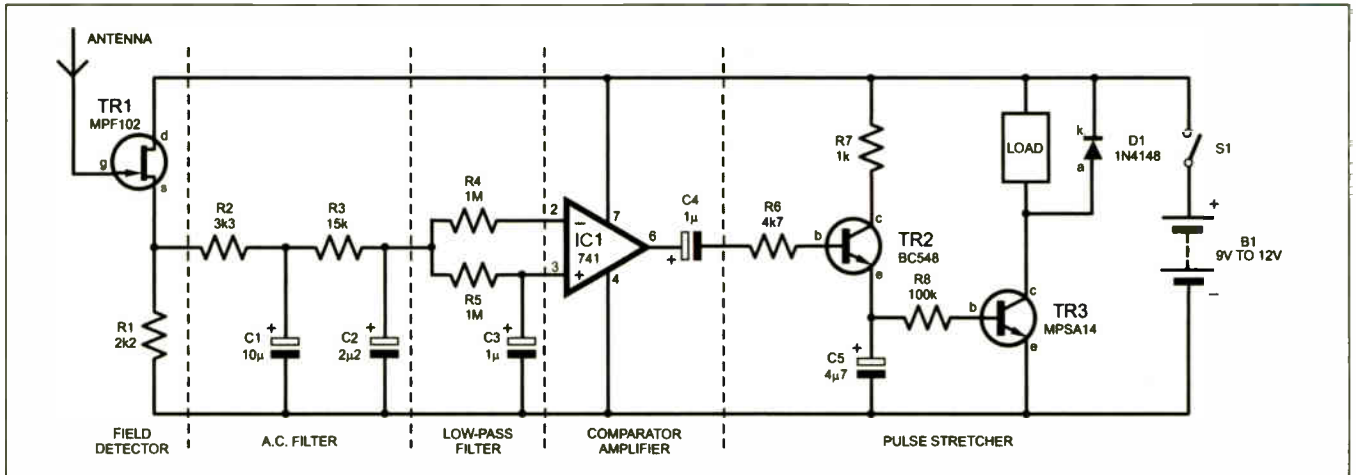

Fig.4. Circuit diagram for the Electrical Field Detector

**T**HE SIMPLE proximity detector whose circuit diagram is shown in Fig.4 exhibits some unique features. Unlike other techniques such as infra-red, ultrasonic, light-activated, microwave Doppler, etc., it does not use a sensing device other than a short piece of wire that acts as the pickup. It is omni-directional and requires no setting up. It will detect movement up to a distance of ten feet, subject to environmental conditions.

Electric fields exist almost everywhere in various patterns and strengths, depending to a great extent on conducting objects, including people and animals, within the immediate area. If left undisturbed, the field changes very slowly over a long period of time but if, say, a human body moves through this static field, it causes turbulence, resulting in a change in the geometry and strength of the field.

## Sensitivity

The degree of sensitivity of this instrument is subject to the environment in which it is located. It is especially excited by synthetic materials found in furnishings and clothing, such as vinyl and polyester. The device therefore adjusts to the surroundings within its operating range and these conditions become its static reference against which it compares any fairly fast changes that may occur.

If, now, a person comes within its sensing range and stands still, the device will signal the change then return to its quiescent state after adjusting to the new conditions, that is, the modified field strength and pattern. Because the signal is only fleeting, it is necessary to capture it through a pulse stretcher to make it of practical use.

## Circuit Details

In this design an antenna, comprising a short length of wire, insulated or bare, is connected in an upright position to the gate(g) of a field effect transistor, TR1, which has very high input impedance and a low output impedance. TR1 therefore amplifies the field potential detected by the antenna. The next stage is a 50Hz a.c. filter which screens out most of the a.c. field from mains wiring.

The output from this filter is split into two paths. One is connected to the inverting input of voltage comparator IC1; the other is connected to the non-inverting input via a low-pass filter. This filter, comprising R5 and C3 serves as a reference voltage against which the signal voltage arriving at the inverting input is compared. The filter accepts only very slow voltage changes but blocks fairly rapid changes resulting from a moving conducting body within its sensing area.

The amplified signal at the output of the comparator switches on transistor TR2 via coupling capacitor C4 and buffer resistor R6. This in turn triggers a simple R/C timing circuit (C5 and R8) to operate a relay or other device via Darlington transistor TR3. The stated values of C5 and R8 provide a delay of approximately ten seconds, but one or both values can be increased for longer periods.

No setting up is involved but there is plenty of room for experimentation, particularly in regard to the antenna. Generally, one having a length of six to eight inches will give satisfactory results. To test the instrument, attach a voltmeter to the output, preferably with a load, and switch on. Stand well back and remain still.

The meter should immediately indicate a voltage close to the supply rail, which will slowly decay to zero after about one minute. The instrument is now primed to detect any movement within its radius of operation.

Keep connecting leads short to the battery, relay, etc. Use an i.c. socket for the op.amp and try several 741s, they do vary.

Tony Lee,  
Old Reynells, S. Australia

## INGENUITY UNLIMITED BE INTERACTIVE

IU is your forum where you can offer other readers the benefit of your Ingenuity. Share those ideas, earn some cash and possibly win a prize.



ANDRE LAMOTHE'S  
**XGAMESTATION**  
LEARN STEP-BY-STEP HOW TO DESIGN  
AND BUILD YOUR OWN VIDEO GAME CONSOLE!  
Design inspired by the Atari 800/2600,  
Sinclair ZX Spectrum, Apple II & Commodore 64!

Complete Package eBook Integrated IDE

SX52 CPU  
80 MIPS!

OPEN SOURCE!

**FEATURES:**

- Great for Hobbyists AND Students!
- Complete Software Development Kit!
- eBook on Designing the XGS Console!
- Parallax SX-Key Compatible!
- Fully Assembled XGS Micro Edition Unit!
- The Fun Way to Learn Embedded Systems!

PAL & NTSC COMPATIBLE!

WWW.XGAMESTATION.COM  
SUPPORT@NURVE.NET | PH: 925.736.2098 (USA)

# DrDAQ Data Logger

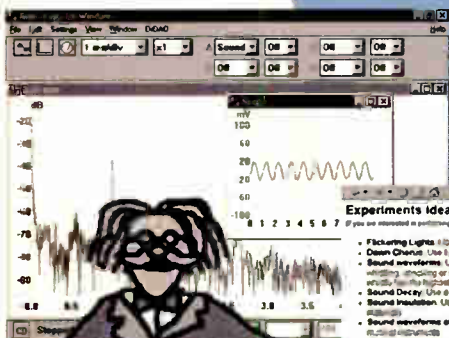

- Output
- Resistance
- Voltage
- Light level
- Temperature

**Experiments Ideas for DrDAQ**

- **Fluorescing Lights:** Use a light sensor to look at how lights, computer monitors and TV Screens
- **Ocean Currents:** Use IFT and level sensors to measure the ocean depth
- **Sound waveforms:** Use PicoScope software to show the soundwaveforms produced by someone whistling, singing or talking. Switch on the spectrum analyser to see the frequency components - what's the loudest frequency, who can whistle the loudest?
- **Sound Decay:** Use a speaker source with a constant level and plot how it decays with distance
- **Sound Resonance:** Use a speaker source with a constant level and experiment with different vibrating materials
- **Sound waveforms of musical instruments:** Look at the scope waveforms and FFT spectrum of different musical instruments
- **Light decay by inverse square law:** How does light level decay with distance? Best source
- **Light Intensity:** Experiment with different materials to see which cuts out the most light. Does using two bits of material have twice the effect?
- **Acid Base Titration:** Measure the pH and Temperature
- **Acid Rain:** Measure the pH of collected rainwater. Needs careful calibration
- **Exothermic Reactions:** Measure the temperature and pH as sodium hydroxide is dropped in
- **Endothermic Reactions:** Measure the temperature as ammonium nitrate is dropped in water
- **Oil and Heat:** Measure the temperature of glass oilings or a compost heap
- **Formulation:** Experiment with different fuels and describe
- **Fun:** Experiment with different materials with various components effect

pH  
Microphone

External sensors: Humidity  
Temperature  
O2 In Air  
Reed Switch

- Low cost- under £80 (+VAT)
- Built in sensors for light, temperature and sound (level and waveforms)
- Use DrDAQ to capture fast signals
- Outputs for control experiments
- Supplied with both PicoScope (oscilloscope) and PicoLog (data logging) software

For more information on DrDAQ, please visit:

[www.picotech.com/drdaq118](http://www.picotech.com/drdaq118)

# PC Oscilloscopes



- Scope and spectrum analyser functions
- A fraction of the cost of benchtop scope
- Save multiple setups, for ease of use
- Save, print and e-mail your traces
- FREE technical support for life
- FREE software and upgrades
- Automated measurements

For more information on our scopes, please visit:

[www.picotech.com/scope262](http://www.picotech.com/scope262)

Tel: 01480 396395 Fax: 01480 396296 E-mail: [sales@picotech.com](mailto:sales@picotech.com)

**PICO**  
Technology Limited

## BATTERY CHARGING FOR ALL

The concept of universal battery chargers has been realised, but what of the commercial implications? Barry Fox examines the state of play

**H**OMES now brim with portable phones, games and cameras that all have one thing in common – they rely on re-chargeable batteries that all need different chargers. So what the world needs now is a universal charger that copes with different devices, at the same time, and no need to find the right plug.

Splashpower, a small British start-up based in Cambridge, has for three years been promising a catch-all solution called SplashPad – a contact-less plate, like a mouse pad, that charges anything placed on its surface.

“It was a tougher challenge than we thought”, Splashpower’s co-founder James Hay recently admitted. “This is ground-breaking technology. That always takes time.”

### Background

In 2001 James Hay, George Georghiu and Lily Cheng created the ZapPad, a plate which charged portable devices by induction. The idea won a cash prize in the Cambridge University Entrepreneurs competition, and a company called Zap Wireless was set up to develop the technology. Zap stalled, with Lily Cheng later describing it as “just a simple concept”. In May 2002 she joined with James Hay and Pilgrim Beart to file patents and form Splashpower.

The idea of contact-less induction charging is old. Electric toothbrushes contain a coil which works as the secondary of a transformer to suck power from the primary coil in a separate charger. But the two halves of the transformer must fit precisely.

The idea of charging from a flat pad is not new either. While checking one of Splashpower’s applications, an examiner at the British Patent Office found a web site with a colourful description of a wireless mouse pad charger, told in the parodied words of *Terminator* Arnie Schwarzenegger: [www.afrotechmods.com/cheap/arnoldpad/arnoldpad.htm](http://www.afrotechmods.com/cheap/arnoldpad/arnoldpad.htm).

But Arnie had to put his mouse in just the right position to catch the flux.

If the magnetic power of the charger is increased to induce current in devices at random positions, the charger erases nearby credit cards and cooks metal objects by inducing eddy currents in them.

### Coiled Power

Splashpower has been promising a “drop and charge” pad that works at safe

low power, with different devices and no need for alignment, but has released little information on how this can be done. “Anyone who wants to know can look at our patents”, says James Hay.

This is a tall order because there are around twenty detailed patents. They reveal variations on the basic theme of spreading a low power magnetic field low and wide over a flat surface, with the flux lines carefully patterned so that a device on the surface can pick up flux regardless of position.

The pad has numerous flat primary coils embedded under the surface. The coils are of different size and shape; rectangular, star-shaped, triangular, circular, oval and ellipsoid. Some coils are small and some large, with small coils nested inside larger ones. The a.c. power is fed to the coils with continually changing phase so that the magnetic flux pattern continually changes too.

The device to be charged has a thin flat receiver stuck to the rear. The receiver is a sheet of amorphous magnetic alloy, like a stick of chewing gum, with a secondary coil wound round it and connected to the device’s charger circuitry.

The theory is that when the device is put anywhere on the pad, its secondary coil always picks up power. The amount of power depends on the size of the receiver coil, and thus how many primary coils it can take flux from. The charging pad may also detect the position and type of device on the surface, and adjust the amount of power fed to the coils to suit the device’s charging needs.

Devices may also be able to “talk” to each other. A mobile phone can directly charge a portable game console, or take power from a camera. A camera can start wirelessly downloading pictures to a PC or printer as soon as the camera senses that it is close to the charger.

### Game Plan

Splashpower has now dropped its original plan to sell charger pads direct to consumers, along with receiver coils that can be stuck on the back of existing devices. The new strategy is to licence the technology to makers of portable devices, initially mobile phones, Bluetooth headsets and digital cameras. The factory will build a receiver into the device. The owner can then buy a pad charger for home use or pay to use one while in a bar or restaurant. This dilutes the original dream of one charger for

many devices, but makes the drop and charge concept more practical to realise.

Six companies have been evaluating the system for at least two years, and Splashpower has been using photos of Nokia and Palm products on a SplashPad. James Hay admits no firm deals for manufacture have yet been signed.

“It will definitely happen, though”, he insists. “We are in the middle of negotiations and hoping for something solid soon. Once a deal is signed it should only take six months for the first drop and charge devices to appear. So we could see devices before the end of the year”.

The trick of the invention – as revealed by the patents – is to get a combination of different sized and shaped coils in the pad, all radiating different magnetic field patterns, so that the single coil on the battery pack always catches just enough field from one or more pad coils, regardless of the pack’s position on the pad.

The amount of power that the receiver coil catches and delivers to the battery depends on the size of the coil, and number of turns in its winding. So one charger pad can deliver the right power – anything up to 10 watts – for the battery.

The relative size and positioning of the coils is proprietary know-how. The decision to go the licensing route, with factory-fitted receiver coils, makes this easier to achieve. But it also dilutes the original “universal” concept.

It also remains to be seen how effectively the system works when finally released for sale.

### FLUKE’S CAT

Fluke, a world leader in compact, professional electronic tools has recently released its 2005 Test Tool Catalogue. Always packed with useful information, the catalogue has become a standard work of reference for engineers, technicians and troubleshooters everywhere. The 2005 edition is even better than before, and has 76 pages in a new colour-coded layout.

Fluke are also offering a free interactive oscilloscope training CD. Designed to operate on a standard PC, the guide provides illustrated lessons regarding standard analogue and digital oscilloscopes and their use.

CD copies can be requested via the Fluke website at [www.fluke.co.uk](http://www.fluke.co.uk). Email: [industrial@uk.fluke.nl](mailto:industrial@uk.fluke.nl). Tel: 0207 942 0700. Fax: 0207 942 0701.



# GATES OF ENTERTAINMENT

Barry Fox wonders if Microsoft really does demonstrate what the home entertainment market wants

**M**ICROSOFT and Intel want the world to listen to music, record TV and watch movies on a Windows PC, instead of using "old fashioned" TV sets, CD and DVD players and VCRs. To prove how easy it all is, slick demonstrations of Windows Media PCs are carefully set up beforehand by skilled IT support engineers.

The real world can only guess what happens when the slick demonstrator is at home alone, without any corporate IT support, and has to wait while the PC grinds into gear before doing anything useful, then demands software upgrades and falls over because of program conflicts or the viruses that flood in from the Internet.

Does the demonstrator perhaps secretly give up and go back to using a TV set, hifi and disc player that switches on (and off) at the flick of a switch and does one thing properly, not a whole range of things not very well.

Mr Microsoft himself, Bill Gates, gave the keynote speech at the giant *Consumer Electronics Show* in Las Vegas recently. As usual he used it to promote Windows for home entertainment. Unfortunately for Bill everything that could go wrong did go wrong. A slide show of his pictures from the airport repeatedly refused to show.

"Who's in charge of this company" quipped the presenter, late-night TV comedy host Conan O'Brien, as Gates looked all at sea and pushed buttons to no avail.

"Let me mention that there's gambling in this town", O'Brien continued, trying to keep things moving as there were more blank screens. "If anyone wants, they can hit the tables and come back when we get this thing working".

Consumers can only guess whether Bill went back home to his mansion to enjoy home entertainment the easy old-fashioned way.

## ANTEX LEAD-FREE IRONS

Most of us will be aware that under new legislation the use of lead for soldering is to be banned. As we have discussed previously in *EPE*, the lead-free solder which will replace the traditional types, is not totally compatible with standard soldering irons and the coated surfaces of many components which they are intended to solder.

To meet some of the new challenges presented by the legislation, leading soldering-iron manufacturers Antex have introduced a range of lead-free soldering-irons, tips and solder. The tips are available with Antex' new CSL and XSL irons, and they can be interchanged with existing lead-mode tips, which will make life easy for us all when we do have to go lead-free.

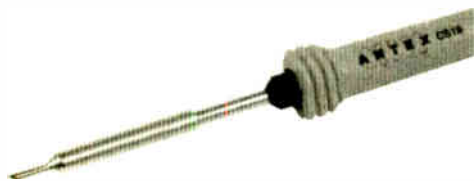

Lead-free solders melt at a temperature approximately 40°C higher than conventional tin/lead solders and can take slightly longer to melt when making a good soldered joint. However, the melting point of Antex lead-free solders is between 217°C and 227°C and the tip temperature of the new CSL and XSL irons is close to 400°C.

Also worth noting is that lead-free solders are more aggressive and erode the plating on soldering iron tips much more quickly than tin/lead solders. To increase tip life, Antex have developed a new plating process that gives much greater protection and increased life to their new lead-free range of tips. These tips if used with conventional solder would last twice as long.

A further good thing about the new tips is the way in which they attach to the soldering iron. They now have an internal shim that holds them securely to the iron. This now enables faster and less-complicated tip replacement. (Great, thinks this news writer, who knows the pitfalls of conventional tip replacement all too well!)

With these new products and reassurances from Antex, it is beginning to look like moving over to lead-free could be more hassle-free than perhaps some of you might fear.

For more information contact Antex (Electronics) Ltd., Dept EPE, 2 Westbridge Industrial Estate, Tavistock, Devon PL19 8DE. Tel: 01822 613565. Fax: 01822 617598. Email: sales@antex.co.uk. Web: [www.antex.co.uk](http://www.antex.co.uk) (on which you will find a specification for Antex' lead-free solders).

## NEWHAVEN RALLY

Sunday 19 June sees this year's Summer Rally at Newhaven Fort, which is being hosted by the Worthing and District Amateur Radio Club (WADARC), from 10.30am to 2.30pm. A special entrance fee of £2.50 has been agreed which will give amateurs access to all other Fort facilities, including GB2NFM and the display of radio equipment from the past. Profits from the rally will go towards enhancing the radio museum at the Fort.

Newhaven is in Sussex midway between Brighton and Eastbourne and the Fort is signposted from the centre of the town.

The WADARC meets every Wednesday at Lancing Parish Hall from 8pm. Anyone with an interest in communications and related subjects is welcome to come along. For more information on the Club's events and activities browse their site at [www.wadarc.org.uk](http://www.wadarc.org.uk), or contact Roy G4GPX on 01903 753893.

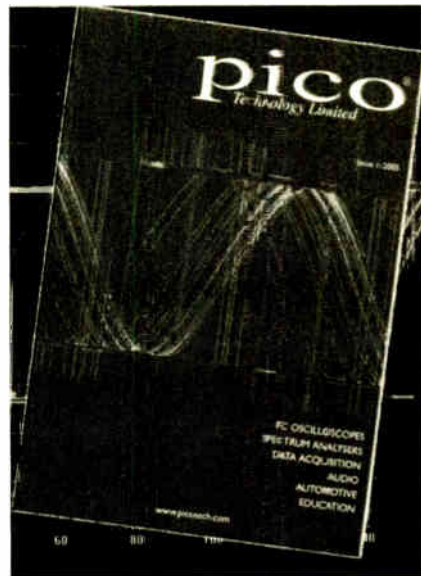

## PICO'S CAT

Pico Technology have released their latest catalogue, along with the chance to win a mini iPod. The A5, 52-page colour catalogue is free and features a selection of innovative new products, including the USB TC-08 Thermocouple Data Logger and the PicoScope 3000 Series PC Oscilloscopes, along with their extensive test and measurement portfolio.

A copy of the catalogue can be obtained direct from Pico by logging onto [www.picotech.com/brochure](http://www.picotech.com/brochure), emailing [enquiry@picotech.com](mailto:enquiry@picotech.com), or calling 01480 396395. All requests for the catalogue will be entered into Pico's prize draw for the chance to win a mini iPod.

## ROBOTIC MICE RETURN

Following the success of the UK's 2004 micro-robotic competition, known as Micromouse, the event is set to return to Birmingham's Millennium Point on Saturday 11 June.

Hosted by the University of Central England's Technology Innovation Centre, *Micromouse 2005* will see robotic mice racing in Thinktank's theatre. Around 70 microrobotic enthusiasts, from the UK and overseas, are expected to compete in one of the competition's three classes. Micromice will race within their class against both each other and the clock. The aim is to win one of the coveted solid brass "cheese" trophies.

Micromouse has been running for over 20 years. It was originally instigated by the Institution of Electrical Engineers (IEE) as a project challenge for students, to stimulate interest in the application of microprocessor technologies.

Micromouse is open to anyone with a suitable robot. The three classes are Maze-Solver, Non-Contact Wall-Follower and Contact Wall-Follower. Entries are anticipated from individuals, schools, colleges and universities.

So come on all of you who have been "doing your own thing" with Owen Bishop's *Smart Karts* - visit [www.tic.ac.uk/micromouse](http://www.tic.ac.uk/micromouse) to find out how to enter Micromouse 2005!



# Back to Basics – CMOS Logic Devices

Bart Trepak

## Part 2 – Water Level Detector and Burglar Alarm

This short series of articles illustrates how useful circuits can be designed simply using CMOS logic devices as the active components

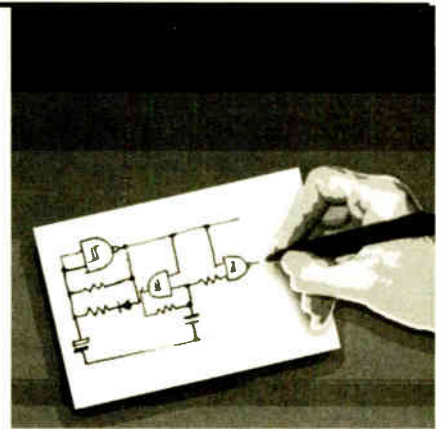

**T**HERE are many instances around the house where a liquid level detector circuit is useful, such as detecting if a rain water tank is almost empty or the toilet cistern is about to overflow.

Perhaps the simplest liquid level detector is the one sometimes described as a rain detector. This consists of a pattern of conductive strips on a p.c.b. or stripboard connected between the base of a transistor and the power supply. The operation is simple – when water bridges the tracks, base current flows and switches on the transistor, sounding the alarm.

The problem with this kind of circuit for detecting the level of water in a tank is that a direct current (d.c.) flows through the sensor electrodes and the water, causing electrolysis. Deposits are formed on the surface of the probes, which effectively insulates them or causes corrosion problems.

### Basic Operation

The answer to this is to use an alternating current (a.c.) instead and here an oscillator is required. The signal from this is fed to

one of the probes via a blocking capacitor and another probe immersed in the liquid picks up the signal. Since only a.c. flows through the liquid, no deposits are formed on the probes.

The circuit principle is shown in the block diagram in Fig.2.1. The a.c. signal is picked up by the receiver probe and rectified to obtain a steady d.c. voltage. This voltage is then used to keep a second “alarm” oscillator switched off so that no output signal is produced.

Should the liquid level in the tank fall below the level of the probes, the oscillator signal will no longer be received and the rectified d.c. voltage will decay. When the voltage reaches a certain threshold value, the second oscillator is enabled, producing an alarm signal from its output. The signal can be fed to a speaker or piezo sounder. It may also be fed to an l.e.d., which by suitable choice of components can be made to flash.

Should a warning be required when the level in the tank gets too high, the probes can be positioned above the level of the

liquid, and a logic inverter placed between the rectifier and oscillator. In this way, as long as the a.c. signal is not received at the probe and there is no d.c. level following the rectifier, the inverter ensures that the alarm oscillator remains disabled.

If the liquid level rises and touches the probes, the a.c. signal will get through, causing the alarm oscillator to switch on and sound the alarm.

### Circuit Diagram

Referring to the circuit diagram in Fig.2.2, Schmitt NAND gate IC1a is configured as the probe oscillator, with its squarewave frequency set by the values of capacitor C1 and resistor R1. The signal is coupled to the probe via C2 and picked up by the other probe to produce a corresponding signal across R2 via C3, and at the input to IC1b, which is used as an inverting buffer. The two capacitors ensure that no d.c. component appears at the probes.

The resulting signal at the output of IC1b is rectified by diode D1 to produce a

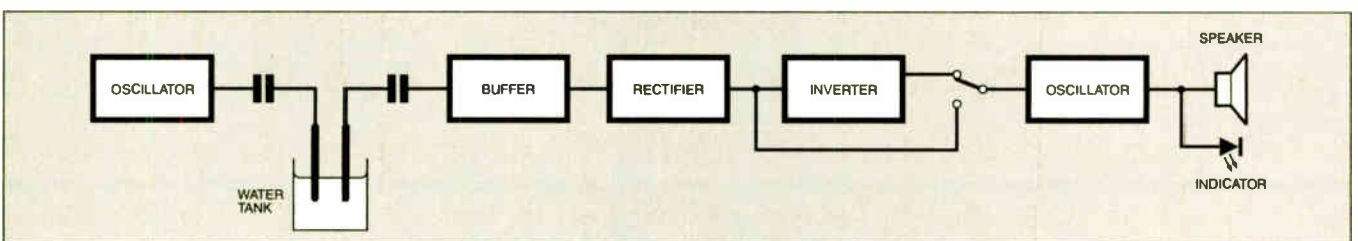

Fig.2.1. Block diagram for the Water Level Detector

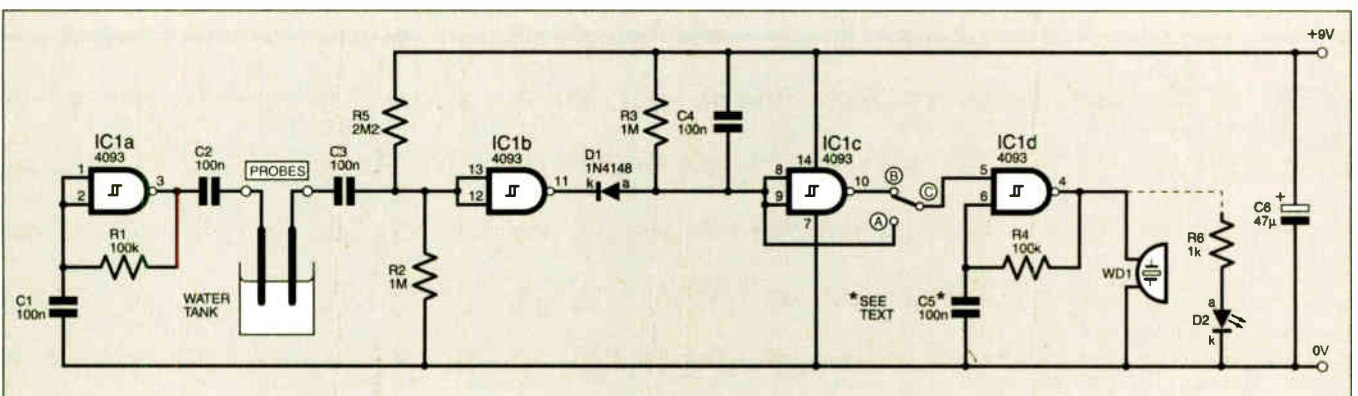

Fig.2.2. Complete circuit diagram for the Water Level Detector

logic low voltage at point A, and inverted by IC1c to provide a logic high voltage at point B. A link wire between either of these points connects the selected one to IC1d input pin 5 and point C.

This gate is configured as an oscillator with its frequency determined by C5 and R4. A high logic level on IC1d input pin 5 turns on the oscillator, a low level turns it off. The gate's oscillating output at pin 4 results in an audio signal from piezo sounder WD1, or a visual indication via l.e.d. D2, buffered by resistor R6.

The circuit can be run from a 9V PP3 battery. In the stand-by condition, the current drain on the battery is about 0.5mA.

## Construction

Printed circuit board component and track layouts for the Water Level Detector are shown in Fig.2.3. This board is available from the *EPE PCB Service*, code 501.

Construction should proceed taking normal precautions and ensuring all polarity sensitive components, such as diodes, electrolytic capacitors etc., are inserted correctly. As with the other projects in this series, use a socket for the i.c., which should be fitted only after all soldering has been carried out and the assembly fully checked for errors. Touch something earthed before handling it, to discharge static electricity from your body, which could kill the i.c.

The sounder and the battery are the only components which are not mounted on the board. Note that if only an l.e.d. indicator is required, without the sounder, the frequency of the oscillator can be reduced by increasing the value of C5 to 47µF. This causes the l.e.d. to flash at a slower more observable rate.

## Probes

The probes can be attached directly to the board, or by means of flying leads. They can take many forms, such as two stiff wires or two parallel tracks etched onto a piece of printed circuit laminate. Much will depend on how and where the unit is mounted, so these details are left to the individual.

The distance between the probes is not too important, but for best results it should be as small as possible consistent with the requirement that water drops cannot bridge

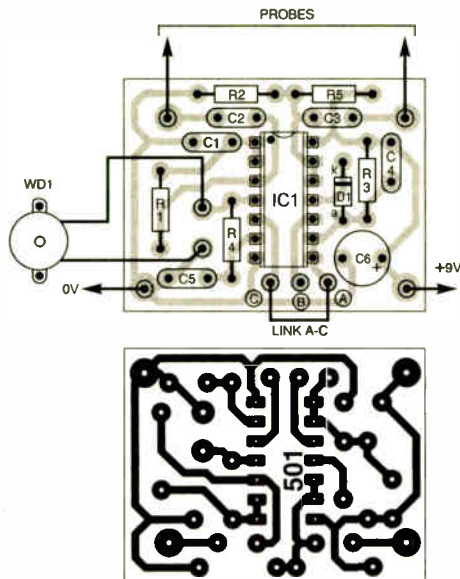
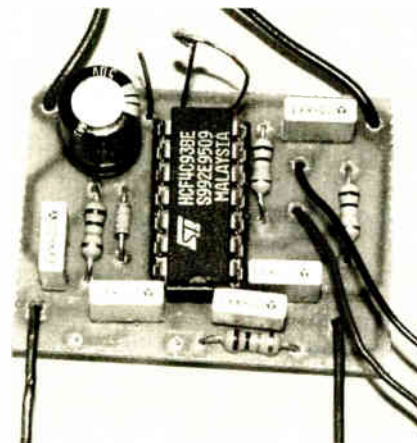

Fig.2.3. Component and full-size track layout details for the Water Level Detector



the gap. If the device is to be used as a "liquid low" indicator, the probes should be immersed to the point at which an alarm warning would be expected, the link on the p.c.b. connected between points C and B.

Alternatively, the unit may be used to indicate the presence of a liquid or an overflow condition by placing the probes just above the surface of the liquid and connect-

# COMPONENTS

### Water Level Detector

**Resistors**

R1, R4	100k (2 off)
R2, R3	1M (2 off)
R5	2M2
R6	1k

All 0.25W 5% carbon film

**Capacitors**

C1 to C4	100n ceramic disc, 5mm pitch (4 off)
C5	100n ceramic disc, 5mm pitch (see text)
C6	47µ radial elect. 16V

**Semiconductors**

D1	1N4148 signal diode
D2	red l.e.d.
IC1	4093 quad Schmitt trigger NAND gate

**Miscellaneous**

WD1	passive piezo sounder
-----	-----------------------

Printed circuit board, available from the *EPE PCB Service*, code 501; 9V battery and connector; probes (see text); plastic case (see text); connecting wire; solder, etc.

Approx. Cost  
Guidance Only

## £9

excl. case and batts

ing the link from point C to point A so that the alarm sounds when the probes become immersed.

The finished unit may be enclosed in a plastic case, the choice of which is up to you!

**This device is best suited to liquids such as water and must not be used with petrol or other volatile liquids where even the smallest spark could cause an explosion.**

# Burglar Alarm

**O**F all the consumer electronics products available, burglar alarms are probably the most over-complicated and over-priced, presumably because we all feel that the more expensive the system and the more features it has, the better the protection it will offer. This is not necessarily the case, because the main purpose of an alarm is to *deter*.

A complex system, apart from looking no different to a simpler system to a potential burglar, may also be more prone to false alarms, which is probably worse than having no alarm at all.

## Basic Operation

A large part of the cost of a system is the control unit and it is here that the biggest savings can be made without compromising the effectiveness of the alarm. Many commercially built units come in a strong steel box festooned with switches, l.e.d.s, keypads and buzzers, which probably impress the purchaser more than the intruder!

A control unit has a few *basic* requirements: it must accept inputs from both normally open (N/O) sensors, such as pressure mats, and normally closed (N/C)

sensors, such as door contacts. All other sensors, no matter how complex or "high-tech" are one of these.

The controller must hold the alarm inactive for a short while following switch on to allow the owner to leave, and to switch off the alarm on return (Exit and Entry delay). It must allow connection of a bell or siren and continue to sound the external alarm, but only for a limited period. Finally, it must be capable of being switched on and off by the owner but not by the burglar!

This last requirement can be responsible

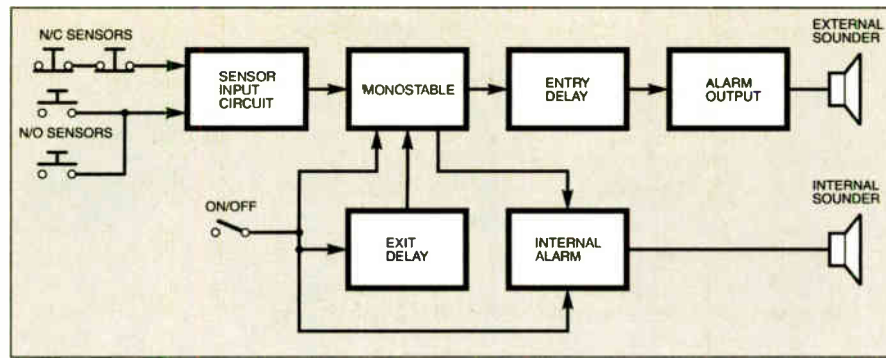

Fig.2.4. Block diagram for the Burglar Alarm

for a large portion of the cost of many units. This circuit, though, uses an ordinary switch to do the job – as it is disguised as something else!

### Circuit Description

The main elements of the burglar alarm control unit described here are shown in Fig.2.4, and its circuit implementation in Fig.2.5. All the functions are basically performed by a single inexpensive i.c.

The heart of the unit consists of two Schmitt trigger NAND gates, IC1a and IC1b. These are connected as a monostable having a time constant of around nine minutes, defined by the value of capacitor C2 divided by the total value of resistor R4 in series with preset VR1 ( $T = C2 / (R4 + VR1)$ ).

The output of IC1b is normally high but goes low in an alarm condition. Resistors R1 and R2 are chosen so that when the N/O and N/C contacts (represented by S1 and S2) are not activated, the input to IC1a is at a high level. Any activation of either set of contacts will then cause this level to go low.

If further N/C sensors are required, these should be connected in series with the S1 position. Further N/O sensors can be connected in parallel with the S2 position. If no N/C sensors are fitted, the N/C input should be shorted (linked) to the point marked COM, while if N/O sensors are not fitted, the N/O input should be left open.

Resistor R3 and capacitor C1 are included to suppress spurious activation due to interference, which could be picked up on the normally long wires leading to the sensors.

### Alarm On

The alarm is switched on by opening switch S3, which allows capacitor C3 to charge via resistor R5 (constituting the exit delay). S3 could be a keypad operated electronic switch, a key operated switch or an ordinary on/off switch disguised as something else. Until the capacitor is charged, the output of IC1b will be held high preventing the external alarm from sounding.

AND gate IC1c is configured as an oscillator which drives piezo sounder WD1, activated by the low-going output of IC1a, via diode D1, whenever any of the sensors are disturbed, warning the owner that the alarm is on and will soon be triggered if it is not switched off. In the off condition, with switch S3 closed, IC1c is disabled by the low logic level on its input. Operation of any sensors in this condition does not sound the alarm.

Once capacitor C3 has charged up (the owner having left), any activation of the sensors will cause the output of IC1a to go high (activating the internal sounder WD1) and the output of IC1b to go low. This condition is latched by feedback from IC1b's output to IC1a so that even if the sensor is returned to its original undisturbed state, the alarm will continue to sound.

With IC1b output low, capacitor C5 will begin to charge via resistor R8 (constituting the entry delay) and if the alarm is not reset by closing switch S3, the voltage on it will eventually fall to the threshold level of IC1d, which will switch on the external sounder via transistor TR1.

## COMPONENTS

### Burglar Alarm

See SHOP TALK page

#### Resistors

R1	2M7
R2, R6	10M (2 off)
R3, R4, R7	100k (3 off)
R5, R8	1M (2 off)
R9	1k
R10	see text

#### Potentiometer

VR1	4M7 vertical pre-set, side adjusting
-----	--------------------------------------

#### Capacitors

C1, C4	100n ceramic disc, 5mm pitch (2 off)
C2	100µ radial elect. 16V
C3, C5	47µ radial elect. 16V (2 off)

#### Semiconductors

D1 to D4	1N4148 signal diode (4 off)
TR1	BC548 npn transistor, or similar
IC1	4093 quad Schmitt trigger NAND gate

#### Miscellaneous

WD1	passive piezo sounder
WD2	external sounder (see text)
S1, S2	sensors (see text)
S3	s.p.s.t. toggle switch (see text)

Printed circuit board, available from the EPE PCB Service, code 502; 2-way terminal block, p.c.b. mounting; battery connector; d.c. power supply (see text), case (see text); connecting wire; solder, etc.

Approx. Cost Guidance Only

**£10**

excl. external sounder, case and batts

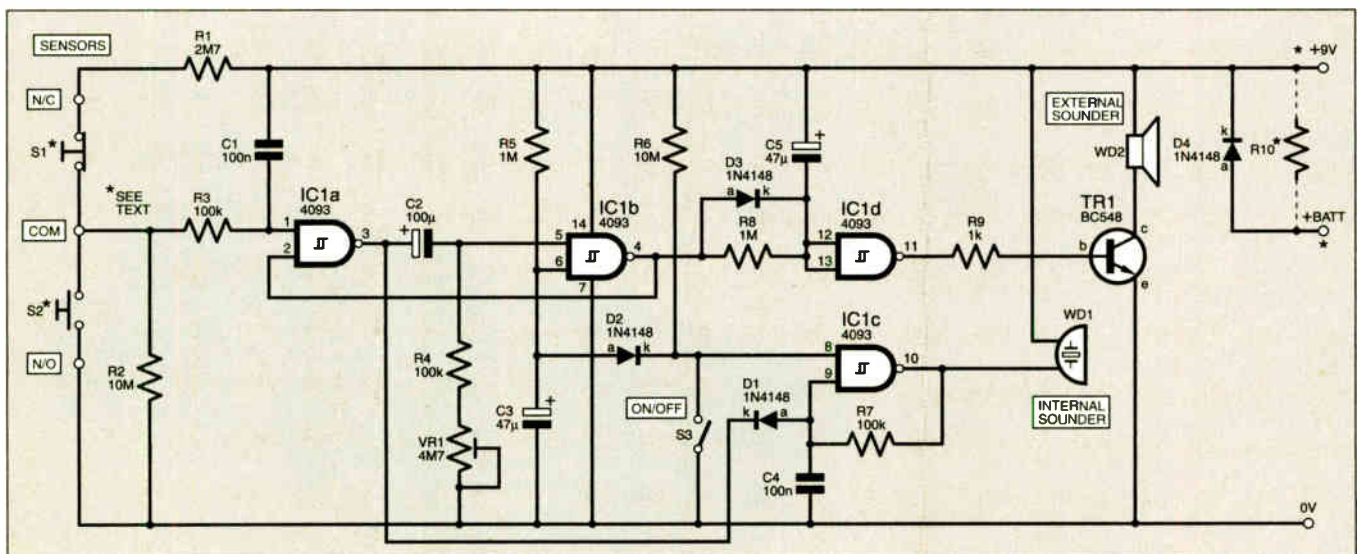

Fig.2.5. Complete circuit diagram for the Burglar Alarm

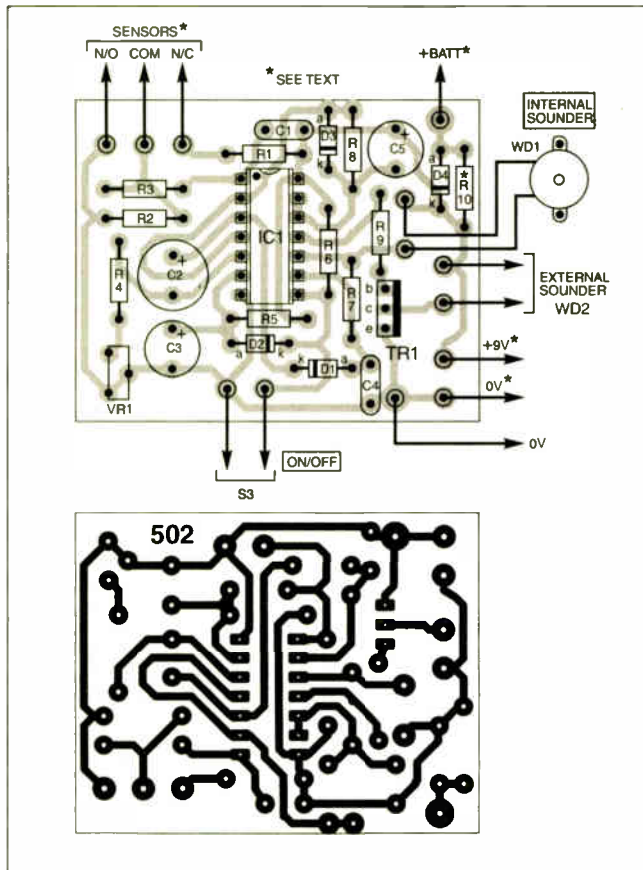
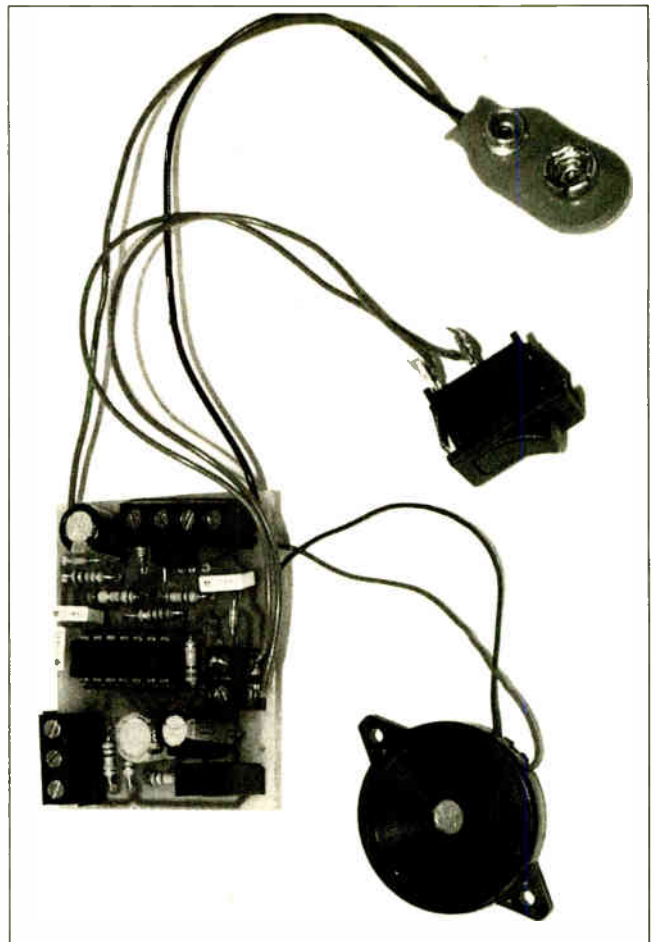

Fig.2.6. Component and full-size track layout details for the Burglar Alarm



## Alarm Off

The alarm may be switched off or reset at any time by closing S3. This will discharge C3, switch off the internal alarm and force the output of IC1b high, so discharging C5 rapidly via D3, thus switching off the external sounder if this has been activated.

The entry and exit delays are preset to about 30 seconds but may be varied by altering the values of C5/R8 and C3/R5. The time for which the alarm will sound once activated can be varied between about one and nine minutes by means of VR1.

If a longer alarm time is felt desirable, C2 may be increased to 220 $\mu$ F, which will enable the alarm to sound for up to about 15 minutes. Note that in the UK there are legal limits to the length of time that an external alarm may sound, and C2 should not be increased above 220 $\mu$ F.

## Construction

Printed circuit board components and track layouts for the Burglar Alarm are shown in Fig.2.6. This board is available from the *EPE PCB Service*, code 502.

As before, construction should proceed taking normal precautions and ensuring all polarity sensitive components, such as diodes, electrolytic capacitors etc., are inserted correctly. Use a socket for the i.c., which should be fitted only after all soldering has been carried out and the assembly fully checked for errors.

The p.c.b. accommodates all the components except the sensors, on/off switch S3, power supply/battery and the external sounder. There is provision for mounting terminal blocks to enable external connections to be easily made.

The only adjustment required is to set the alarm time by means of preset VR1.

As mentioned, the case housing the unit and the on/off switch are best disguised as something else, and the choice is left to you. Alternatively a key-operated switch could be used for S3 but this will add to the cost of the unit. The internal piezo sounder, WD1, should be mounted separately so as not to draw attention to the unit.

The external alarm should be a wall mounted weather proofed bell or siren, and possibly a strobe light. The more sophisticated versions incorporate internal batteries with a trickle charging mains supply facility.

## Power Supply

The circuit draws a minute current in stand-by mode, rising to a few milliamps when the internal sounder is activated.

A normal battery of 9V to 12V may be used to power the unit, a small mains supply adaptor with a rechargeable 9V battery would be the best solution. For this reason,

a diode and resistor (D4 and R10) have been included in the circuit. Resistor R10 should be chosen to pass a current of around 1mA to trickle charge the battery from the mains supply.

If a non-rechargeable battery is used, R10 should not be fitted. Note that the battery should be connected to terminals 0V and +BATT on the p.c.b., whilst the d.c. output of the mains supply should go to terminals 0V and +9V. If a small plug-in d.c. supply is used, a suitable d.c. connector should be mounted on flying leads and connected to these points. The output voltage of the mains power supply should be between 10V and 15V d.c.

## Next Month

In Part Three next month we present a *Scarecrow* and a *Digital Switch*. □

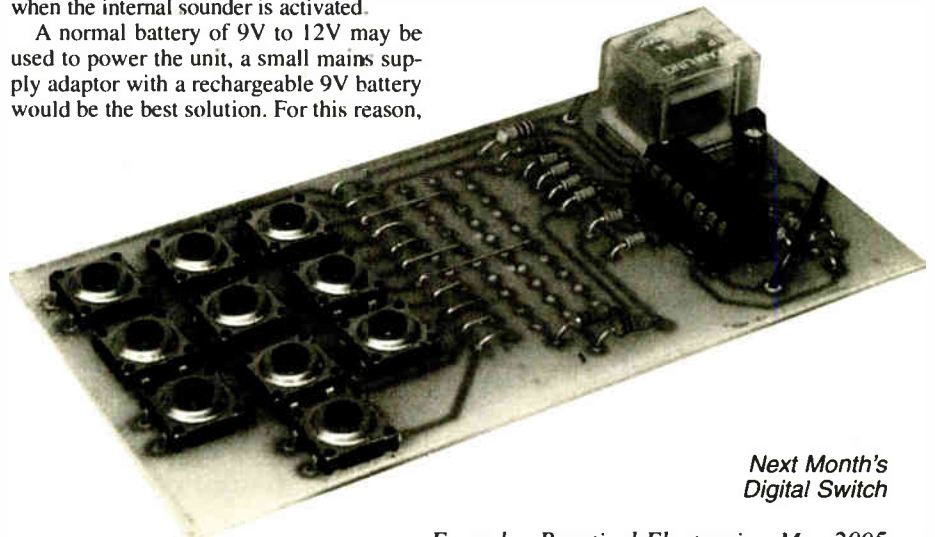

Next Month's  
Digital Switch

# Circuit Surgery



Alan Winstanley and Ian Bell

This month's column introduces CompactFlash (CF) memory cards, starting with the mechanical aspects of using these data storage devices. We also continue our primer on thermistors and offer some simple temperature control ideas

**T**HIS month we commence a *Circuit Surgery* mini series that examines CompactFlash memory cards and how they can be used in your own electronics projects – a topic that was raised on the *EPE Chatzone* website message board. We start with a look at exactly what a CompactFlash card is, and consider some of the mechanical aspects of using them

## Get Started With CompactFlash

A CompactFlash memory card (see Photo 1) is a solid state (no moving parts) electronic memory built to standardized electrical and physical specifications. It was first introduced in 1994 by SanDisk. The standard specification means that manufacturers of equipment can easily include the capability to use the card for data storage, and manufacturers of cards can make sure that their cards will function in all equipment.

The most common use of CompactFlash memory cards is probably in digital cameras, but they can be used in a wide variety of applications where removable, "non-volatile" mass data storage is required. CompactFlash memory is described as non-volatile because no power is required for its data to be retained.

There are two types of CompactFlash card which differ only in their physical thickness. The dimensions are 43mm (1.7in) x 36mm (1.4in) x 3.3mm (0.13in) for the CF Type I card, and 43mm (1.7in) x 36mm (1.4in) x 5mm (0.19in) for the CF Type II card.

A CF Type I card will operate both in a CF Type I and a CF Type II slot, but a CF Type II card will only fit into a CF Type II slot. Most CompactFlash cards are Type I. Microdrives, which are miniaturised magnetic disk-based storage devices that look like CompactFlash drives, are type II.

CompactFlash cards have 50 pins and connect via a socket that looks similar to the PCMCIA (Personal Computer Memory Card International Association – or, People Can't Memorise Computer Industry Acronyms!) connector typically used for

interfacing memory and I/O cards to laptop computers. However, the PCMCIA interface uses more pins (68 rather than 50). The PCMCIA interface has proven reliability and durability in those applications where frequent insertions and ejections of the card are required.

At the time of writing, the capacities of CompactFlash memory cards range from 16MB to 12GB, but the CF Specification can support capacities up to 137GB. The cards can operate from either 3.3V or 5V supplies and can be moved between systems operating on different voltages. More importantly, CompactFlash memory cards have built-in dynamic defect management and error correction technologies so they provide a very reliable means of data storage.

## Compatibility and Use

CompactFlash cards are compatible with the IDE (Integrated Drive Electronics) interface, which is also called ATA (Advanced Technology Attachment), and is used for connecting internal hard drives and optical drives in personal computers. CompactFlash memory cards can easily be attached to an IDE bus in a PC and used as a disk drive. However, this is not the only mode of operation for CompactFlash memory



Photo 2 (above). Memory card header for linking to circuit board

Photo 1 (left). Typical CompactFlash memory card

Photo 3 (below). CompactFlash card in header, with ejector mechanism



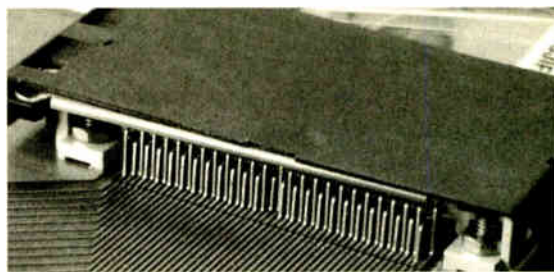
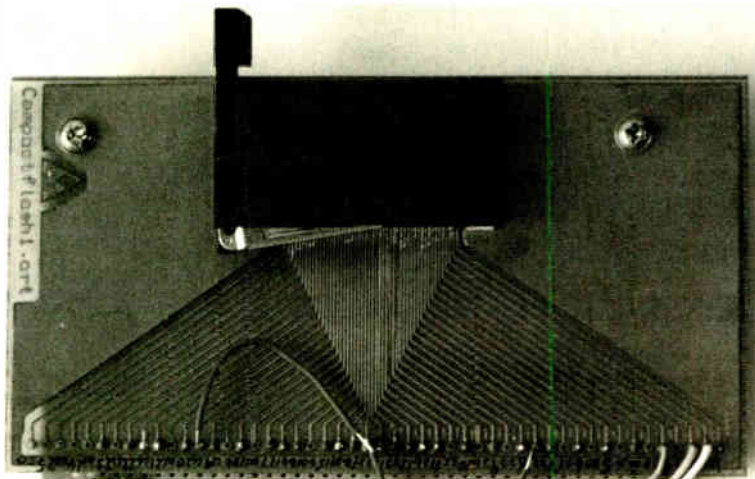

Photo 5 (above). Close-up of card header soldered to interface circuit board

Photo 4 (left). Prototype of the CompactFlash card interface printed circuit board (more detail next month)

cards and you do not have to implement a fully IDE interface to make use of them.

To use a CompactFlash memory card in your own circuit, electrical connections between the memory card and the circuit board need to be provided. To do this a memory card socket or "header" is needed, for example see Photo 2, which is a header from the manufacturer 3M.

The socket can be paired with a separate ejection mechanism to facilitate removal of the card. This is illustrated in Photo 3 which shows the ejector combined with the header from Photo 2, with a card inserted. The button that the user pushes to eject the card is clearly visible. CompactFlash memory card headers and ejectors are available from a number of mainstream electronic component distributors.

The header shown in Photo 2 has 50 surface mount pins for connection to a printed circuit board (p.c.b.). Photo 4 shows a handy interface p.c.b. that was designed specially for the purpose of experimenting with CompactFlash card circuits (more details next month). The header was manually soldered to the card – the connections are shown in more detail in Photo 5. Soldering of surface mount connections with fine pitches is difficult, but not impossible, to do manually with a fine tip soldering iron and, as has been discussed in *EPE* in the past, is within the capabilities of the more experienced hobbyist.

In forthcoming articles, the principles of electrical interfacing of CompactFlash cards and some of the associated data handling routines will be explained. *I.M.B.*

## Thermostatic Control

Last month we introduced the basic principles behind *thermistors*, or thermally-sensitive resistors. A negative-temperature coefficient (n.t.c.) type has a resistance that *falls* when the detected temperature *rises*, and these types are commonly used as sensors in temperature sensing and control systems. Conversely, a positive temperature coefficient (p.t.c.) thermistor will be seen mostly in anti-surge protection circuitry, to help prevent damaging surge currents at switch-on.

We also showed the straightforward calculations that can be used to determine the resistance of a particular device at a given

temperature. If we know the beta value of a thermistor and the specified resistance at a given temperature, then we are well on the way to designing some useful temperature control circuits.

An n.t.c. thermistor can be put to work in a simple circuit based around a voltage divider, see Fig. 1. Here, the output voltage  $V_o$  will *fall* when the temperature *increases*, because the thermistor resistance falls and pushes the output towards the 0V rail. By transposing the fixed resistor R1 and thermistor RTH1, an opposite effect can be obtained – the output voltage will now *rise* towards +V supply when the temperature increases.

One problem with a voltage divider is that its output voltage is related to the supply voltage. The formula is

$$V_o = R_{TH1} / (R1 + R_{TH1}) \times V_s \text{ Volts}$$

If R1 and RTH1 have identical resistance values, then the output voltage is 50% of the supply. However, if the voltage rail varies for any reason, then the

output voltage of our temperature sensor will change in sympathy. One helpful workaround is to stabilise the supply rails, using a regulator chip or, say, a Zener diode.

An alternative configuration is based on the *Wheatstone Bridge* as shown in Fig. 2. Here it is the voltage across the centre of the bridge that is of interest, because now we are simply comparing the ratio of two voltage dividers. It matters less whether the supply voltage rises or falls, as this affects both voltage dividers equally, and  $V_{out}$  across the centre is unaffected. Wheatstone bridges may be found in measurement circuits where the idea is to "null" (make zero) the centre voltage, in an attempt to find the value of an unknown component in the bridge, for example.

The thermistor can form part of a temperature control circuit by *interfacing* it with a heating or cooling system. Most people know how a thermostatically controlled electric heater works (similar principles being found in some soldering irons): a sensor (e.g. a thermostat) detects that the temperature has dropped below a desired *set point*, so it switches on a heater until the temperature meets the set point again (the thermostat having received *feedback* from the heating system), and the heater switches off again. The simplest systems operate like this, locked into a "closed loop" on/off control system.

## Simple Thermostat

In this world of microcontrollers and programming, it is worth remembering that simple and interesting circuits can still be built at component level using just a handful of cheap discrete parts. A transistor can be used in conjunction with a thermistor to control a heating element, as depicted in Fig. 3a.

An npn transistor such as TR1 requires its base (b) terminal to be approximately 0.7V more positive than its emitter (e) and it will then conduct heavily from collector to emitter. This completes the circuit to the relay RLA, which turns the heater on and off through a *separate* set of electrical contacts. (Diode D1 shorts out any reverse voltage or "back electromotive force" (e.m.f.) generated by the relay coil when it turns off again.)

If we use the correct values for resistor R1 and thermistor RTH1, a primitive control

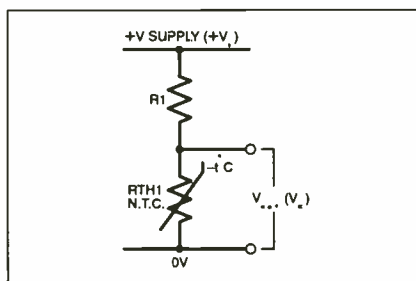

Fig.1. Simplest form of temperature sensor using a voltage divider

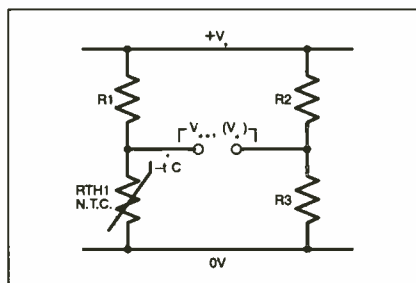

Fig.2. Using a negative temperature coefficient thermistor as part of a Wheatstone Bridge.





# Subscribe to *EPE*, SAVE money and choose a FREE Antex Soldering Iron



Take out a new one or two year subscription to *EPE* before 1 August 2005 and we will send you a free Antex soldering iron. You can choose your iron from the three different types shown here.

In addition to this incredible free iron offer UK readers can also save £6.20 on the normal news-stand price of *EPE* for one year, or £17.40 over two years. That is over 50p (on one year or 72p on two years) an issue off the cover price, plus a free soldering iron.

Overseas prices also represent exceptional value – check them out below.

Don't miss this incredible offer on new subscriptions.

Fill in the form below and send it to us NOW!



Get a FREE Antex C15 240V 15W Soldering Iron

Worth £17.52



or a FREE Antex CS18 12V 18W Soldering Iron

Worth £18.55

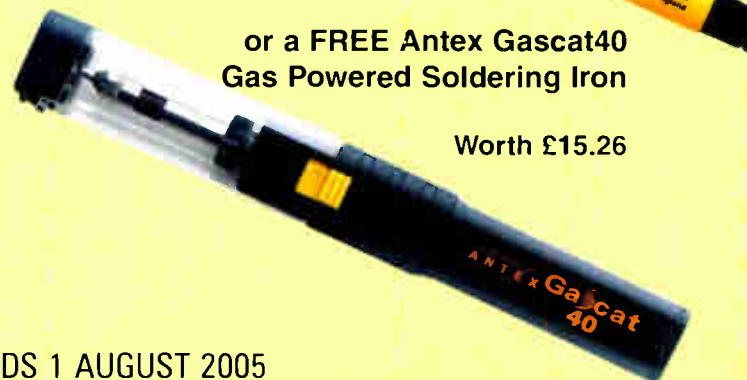

or a FREE Antex Gascat40 Gas Powered Soldering Iron

Worth £15.26



OFFER ENDS 1 AUGUST 2005

**Subscription rates:**

- 1 Year: UK £31.00, Overseas £37.00 (standard air service) £55 (express airmail)
- 2 Years: UK £57.00, Overseas £69.00 (standard air service) £105 (express airmail)

To: Everyday Practical Electronics,  
Wimborne Publishing Ltd., 408 Wimborne Road East, Ferndown,  
Dorset BH22 9ND  
Tel: 01202 873872 Fax: 01202 874562  
E-mail: subs@epemag.wimborne.co.uk

Name .....

Address .....

Post code ..... Tel. ....



**TAKE ADVANTAGE NOW!**

**SUBSCRIPTION ORDER FORM**



Please send me (tick ONE box) my free soldering iron

- an Antex C15 240V 15W soldering iron
- an Antex CS18 12V 18W soldering iron
- an Antex Gascat40 gas soldering iron

I enclose payment of £ .....  
(cheque/PO in £ sterling only),  
payable to *Everyday Practical Electronics*

My card number is: .....  
Please print clearly, and check that you have the number correct

Signature .....

Card Security Code ..... (The last 3 digits on or just under the signature strip)

Card Ex. Date ..... Maestro Issue No. ....

Subscriptions can only start with the next available issue.



OFFER ENDS 1 AUGUST, 2005



system can be produced that will power the relay on and off depending on the temperature detected by the thermistor. For experimentation purposes, this effect can be mocked up on a breadboard (*do not* connect any mains electricity anywhere whatsoever!) using junk box components.

The practical disadvantages of basic circuits like this soon become apparent. Ordinary bead, disc or rod thermistors are a little slow to respond to changes so the circuit operation lags slightly behind any temperature variation. Worse is the fact that the circuit passes through a transition when the temperature is *just* starting to cause the circuit to change state. This is not helped by the slow response of the thermistor.

In reality there will be a period when the relay is hesitating between two states – causing relay chatter, contact noise, contact arcing and radio interference. The circuit is too crude to be of practical use.

### Schmitt Trigger

A critical modification is to add an additional transistor as outlined in Fig 3b, to form a *Schmitt trigger* – a very useful circuit that produces a clean on-off switching action as follows. As the temperature increases, the resistance of thermistor RTH1 falls; transistor TR1 starts to conduct harder between emitter (e) and collector (c) because the voltage at its base (b) is rising.

With TR1 collector falling towards 0V, it takes TR2 base with it, so TR2 starts to turn off. The emitter of TR2 is sent towards 0V, also taking TR1 emitter with it. This increases the forward bias of TR1 which accelerates the switching action even more. This “avalanche” effect results in a very rapid switch-over. The difference in switch-on and switch-off voltage levels is called hysteresis.

It is necessary to add further circuitry (e.g. a *npn* transistor driver connected to TR2 collector) to drive a relay. You can experiment for yourself, using a breadboard and some general-purpose *npn* transistors and spare parts.

### Op.amp Thermostat

A more elegant way of obtaining a clean “snap action” circuit is to compare the temperature-dependent voltage against a high quality *reference voltage*. A practical op.amp-based thermostat circuit using a CMOS operational amplifier is shown in

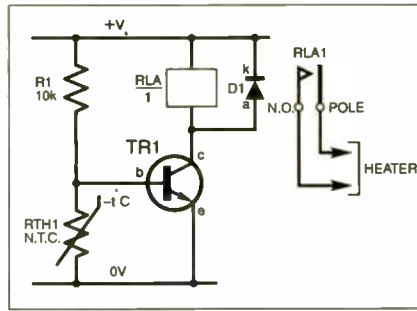

Fig. 3a. Basic transistor switching circuit using a thermistor as a sensor

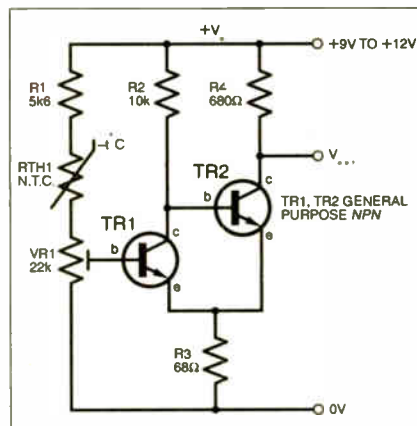

Fig. 3b. Demonstration circuit diagram for a “snap-action” Schmitt trigger

Fig. 4a. It can be divided into several easily recognisable sections or stages.

This circuit measures the difference between the thermistor voltage and a fixed reference voltage. A stable reference has been produced using a programmable voltage chip, in this example a TL431 (IC1). The values of resistors R1 and R2 have been chosen so that precisely 6V

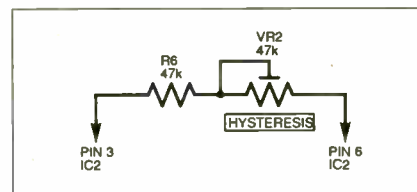

Fig. 4b. Just two additional components provides hysteresis – different on/off switching points

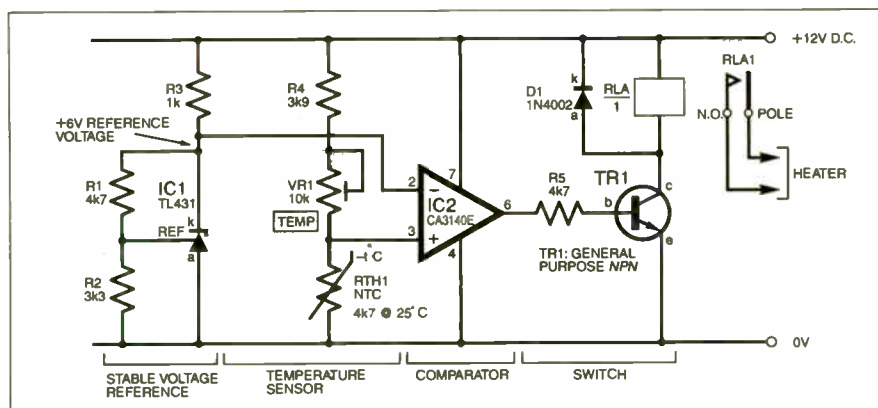

Fig. 4a. Full circuit diagram for a “practical” op.amp-based Thermostat

appears across IC1. This connects to the inverting input of the op.amp (IC2 pin 2).

An n.t.c. thermistor (RTH1) is used in a voltage divider network, and this time a preset potentiometer (wired as a variable resistor) VR1 is included, which acts as a temperature control. The thermistor output voltage can therefore be adjusted as desired, in order to obtain a temperature set point.

The temperature-dependent voltage connects to the non-inverting input (pin 3) of IC2. If the non-inverting voltage is higher than the inverting input then the output swings high (towards +12V). Conversely, when the inverting input is greater than the non-inverting pin, the output swings towards 0V.

Op.amps have a high gain (say 20 to 30,000) and they amplify the difference in voltage between pins 2 and 3. Therefore, a tiny difference between the 6V reference voltage and thermistor voltage will be amplified by IC1 which responds rapidly.

A transistor switch TR1 powers a relay that connects or disconnects the heating element from the mains. By adjusting VR1, the trigger threshold of IC2 can be altered so that the temperature setting can be changed.

Like the simple transistor circuit of Fig. 3, this circuit has a switching threshold where the circuit *just* starts to change state, though the high gain of the amplifier helps to reduce any switching transitions. The optional resistor network of Fig 4b introduces positive feedback that turns the simple comparator into a Schmitt trigger circuit.

The resulting *hysteresis* means that the temperature must fall back by a few degrees before the circuit will switch on again. The optional rotary potentiometer control VR2 allows users to adjust the difference between these switching points.

### In Benefit

As added benefits, the TL431 reference voltage i.c. (available from [www.squirestools.com](http://www.squirestools.com)) has an excellent temperature stability rating, so the circuit's reference voltage won't drift adversely. The chosen op.amp has high impedance MOSFET inputs, which implies that lower currents can be used in the thermistor section, reducing any self-heating effects.

A reverse-action (cooling) thermostat can be produced by reversing the thermistor network or the op.amp inputs, or try using *normally closed* (n.c.) contacts of a relay to operate a fan or cooling unit. Better still is to replace the relay with a solid state optically-isolated interface, such as the useful *Safety Interface* project featured in *EPE* April 2005.

Newcomers to electronics might also be interested in our new series called *Back To Logic Basics*, which uses traditional CMOS logic gates to form simple but useful circuits; a thermistor-based *Fridge/Freezer Door Alarm*, which uses an n.t.c. thermistor to operate an audible warning tone, was also shown in the April 2005 issue. This series is a great place for electronics novices to practice constructing their first practical projects. A.R.W.

# 20W Amplifier Module

Mark Stuart

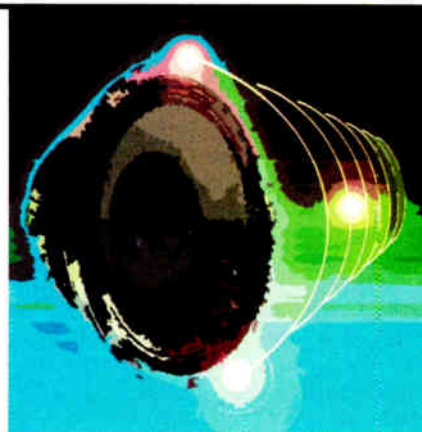

A low-cost, single chip, 20 Watt wide-band low distortion Mono/Stereo amplifier module

**T**HIS single chip stereo amplifier module delivers a maximum power of 11 Watts per channel into 2 ohms, or 20 Watts into 4 ohms in mono full-bridge mode. It will also drive all higher impedance (such as 8 ohm) loads at reduced power levels.

Using the STA7360 Stereo/Bridge amplifier i.c. and using very few external components, this easy-build project should fall well within most constructors' budgets. A general run-down on this low-distortion, wide frequency range chip is outlined in the Specification panel.

The circuit board has been designed to allow operation in stereo or mono (bridge) mode – selectable by a wire link. Operating voltage can be between 8V and 18V so the circuit is perfect for use in car systems. The power output ratings are *continuous average power* and assume a suitable heatsink is fitted.

## Circuit Details

The internal structure of the STA7360 20W Bridge/Stereo Amplifier i.c. and its pinout information is shown in Fig.1. The full circuit diagram of the amplifier module in stereo configuration is shown in Fig.2, and in mono "bridge" mode in Fig.3.

In stereo mode (Fig.2) all components are required and pins 4 and 8 of IC1 *must* be linked together. Loudspeakers LS1 and LS2 are connected between output terminals OP1 and PW-GND1 (Channel 1) and OP2 and PW-GND2 (Channel 2).

The power supply connections *must* be made to the +V and 0V terminals. Although there are several connection points to the circuit "ground" (0V) it is important that the negative supply and the speaker PW-GND1 and PW-GND2 connections are made as shown. The peak currents in the speaker and power lines can exceed 4A and the voltage drop across even short lengths of printed circuit board (p.c.b.) copper track can be enough to cause distortion and instability.

The chip has independent signal (S-GND) and power (PW-GND) ground pins so that the high power circuit currents are separated from the input circuits. It seems a contradiction to add a connection between S-GND and PW-GND on the circuit diagram – but the p.c.b. track layout is arranged very carefully with a gap in the

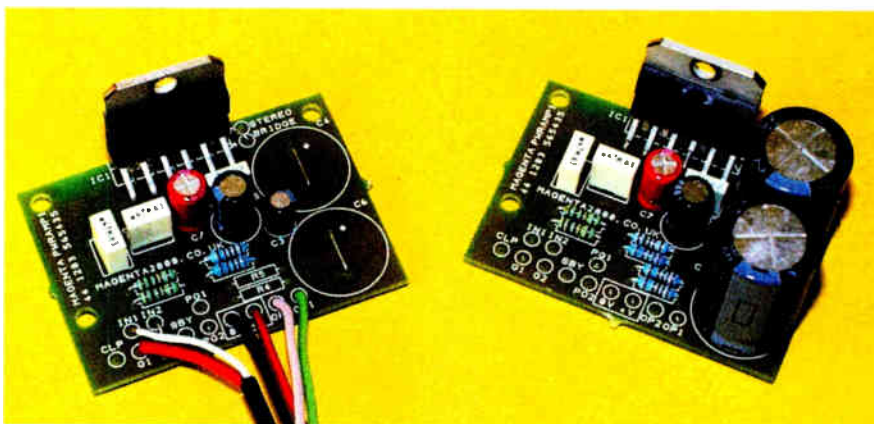

Two versions of the STA7360 audio amplifier; mono bridge (left) and stereo (right)

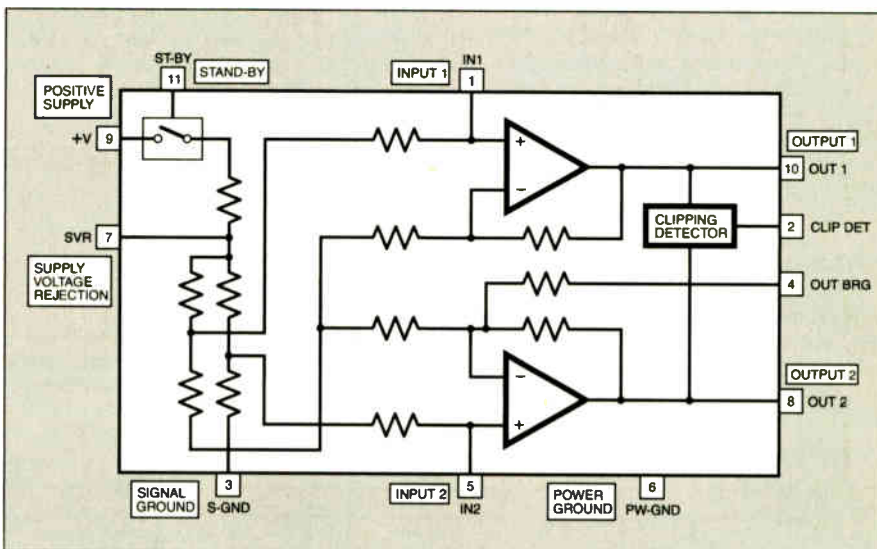
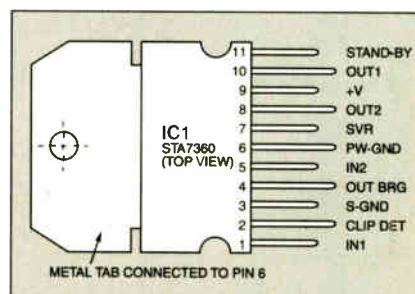

Fig. 1. Basic internal structure of the STA7360 stereo/bridge amplifier. The i.c. pinout details are shown below.

ground area so that the high current only flows in and out of PW-GND and is separated from the small input signal currents flowing into S-GND.

## Stereo Mode

In Stereo mode (Fig.2) the two amplifiers within the chip operate independently as standard single-ended push-pull amplifiers. Without an input signal each output sits at mid-rail (half of the supply voltage) and swings up towards the positive supply



## Specification . . .

<b>Frequency Response:</b>	From 10Hz to well over 100kHz
<b>Distortion:</b>	Less than 0.03% at 1kHz.
<b>Output:</b>	11W per channel stereo into 2 ohms, 20W into 4 ohms mono full-bridge – see text
<b>Loudspeaker Protection:</b>	Both outputs shut off in any overload condition
<b>Clipping Detector:</b>	Output shows if either channel is overdriven
<b>Standby:</b>	Switch off function – very low standby current
<b>Chip Overheat:</b>	Shut down protection

**Plus:** Output a.c. and d.c. short circuit protection – to ground and to supply voltage; wide output voltage swing makes maximum use of the available supply; delayed turn-on mute circuit eliminates switch on/off noises (pops); high supply ripple rejection.

simply by a single-pole switch. It has the disadvantage that there will be around 1mA flowing via resistor R6 in standby mode, more than ten times the chip current! To avoid this disconnect R6 and connect ST-BY to the positive supply line (+V) for normal operation, and to 0V for standby. Capacitor C3 provides a short time delay to hold the circuit in standby mode when power is applied. It helps prevent turn-on “pops”.

Capacitor C7 decouples the internal bias circuits so that the circuit is insensitive to supply noise and ripple. It also controls the switch-on “pop” prevention delay.

Stereo input signals are connected to inputs IN1 and IN2, via capacitors C1 and C2, and the corresponding ground (0V) connections must be made to points S-GND1 and S-GND2. The input coupling capacitors C1 and C2 are necessary because IC1 input pins have a d.c. bias and so are not at 0V.

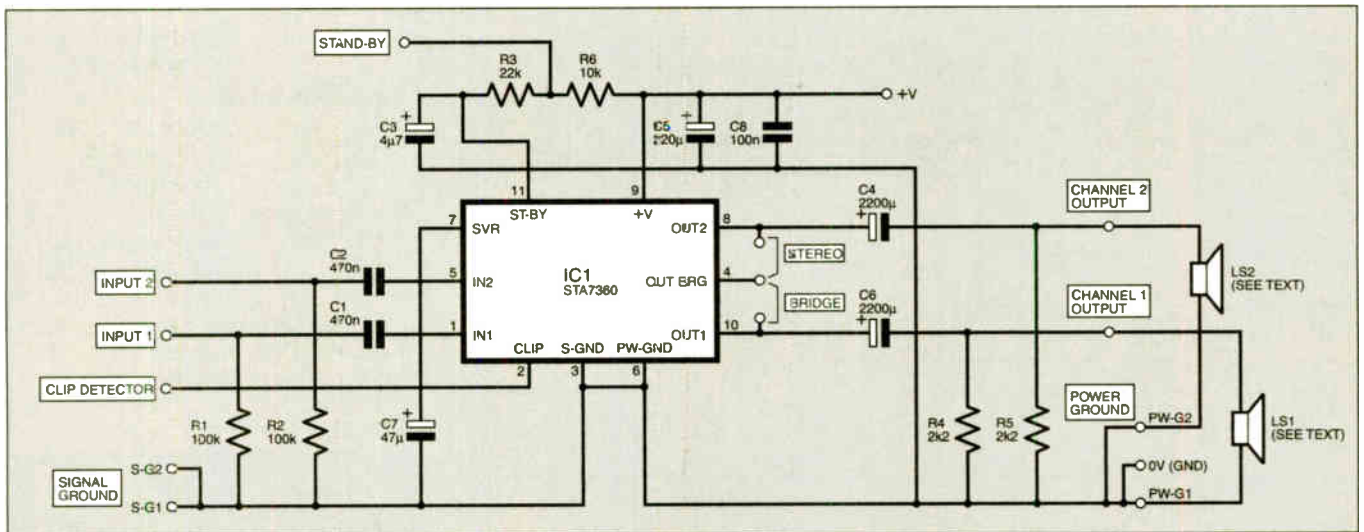

Fig.2. Full circuit diagram for the Amplifier Module in stereo configuration

and down towards 0V when driven by an input signal. The output swing is limited by the supply voltage and by the voltage drop across the internal output transistors.

In previous i.c.s. the difficulty of making good *pnp* power devices meant that more complicated asymmetrical circuits using *nnp* devices had to be used, often dropping 2V or more. However, the STA7360 uses new technology which make it possible to include fast, high gain *pnp* output transistors. These allow a fully symmetrical output configuration enabling the output voltage to swing within 0.3V of both the positive and negative rails.

This additional output voltage swing is significant because output power is proportional to the square of the voltage. So, for example, with a 10V supply and 2V dropped from each rail the power is proportional to  $6 \times 6 = 36$ . If the drop is just 0.3V from each rail, the swing is 9.4V so the power is proportional to  $9.4 \times 9.4 = 88$  – almost 2.5 times the power!

Output coupling capacitors C4 and C6 block the mid-rail d.c. voltage but have very low impedance at signal frequencies above a few tens of Hertz. Resistors R4 and R5 provide a charge path for C6 and C4 in case loudspeakers LS1 and LS2 are not connected, ensuring that the d.c. voltage at outputs OP1 and OP2 is held to zero.

They can be omitted if speakers are wired permanently to the circuit board.

Capacitors C5 and C8 decouple the power supply providing a low impedance even if long supply leads are used. Film type capacitor C8 is added in parallel with the electrolytic C5 to make sure that the decoupling is effective at high frequencies where electrolytic capacitors are not so good.

### On Standby

The amplifier module has a low current “Standby” mode controlled by resistors R6, R3, and capacitor C3. For normal operation IC1 pin 11 is connected to the positive supply via R6 and R3 in series. If the ST-BY terminal is connected to 0V the positive current via R6 is shunted to ground, and IC1 pin 11 is grounded via R3, shutting off the circuit and reducing the supply current to  $100\mu\text{A}$ .

This arrangement was chosen so that the ST-BY point could be controlled

Resistors R1 and R2 provide charge paths for C1 and C2 to keep the input terminals at 0V even when input circuits are not connected. If they are omitted there will be unavoidable clicks and pops when inputs leads are plugged in. It is surprising how many commercial designs don't bother with this simple precaution.

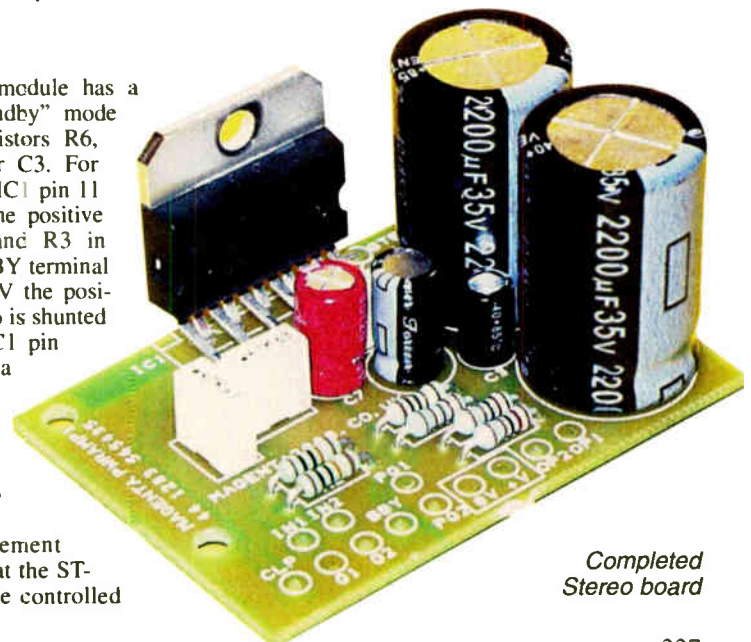

Completed Stereo board

The input impedance of each amplifier is 50k (kilohms). It will be reduced slightly by the parallel effect of resistors R1 or R2, but in most cases this will be unimportant. If the full 50k is needed R1 and R2 can be taken out of circuit.

## Bridge Mode

In Bridge mode (Fig.3) the two independent stereo amplifiers are combined to drive a single loudspeaker LS1. The loudspeaker is connected between one amplifier output (OP1) and the other (OP2) as shown in Fig. 3.

As the two amplifier outputs are at the same mid-rail voltage there is no d.c. voltage difference and so there is no need for output coupling capacitors C4 and C6, used in the stereo version. Resistors R4 and R5 are also redundant.

If the two amplifier inputs were driven with the same signal, the outputs would

## Reverse Polarity

The circuit has no protection from a reverse polarity power supply connection. The i.c. is able to withstand 10A of reverse current for what the data sheet describes as "as long as it takes to blow a 2A fuse".

Using a series protection diode would reduce the output swing by about 1V, and possibly introduce output distortion, so putting a fuse in the power line is efficient, practical and effective, and is strongly recommended.

## Clip Detector

An internal open collector *npn* transistor turns on if the circuit is driven into clipping. The output current from the transistor is 70 $\mu$ A for approximately 1% distortion, and rises at higher levels.

If the circuit supplying the input signal has some type of d.c. volume control, it could be connected so that the output is

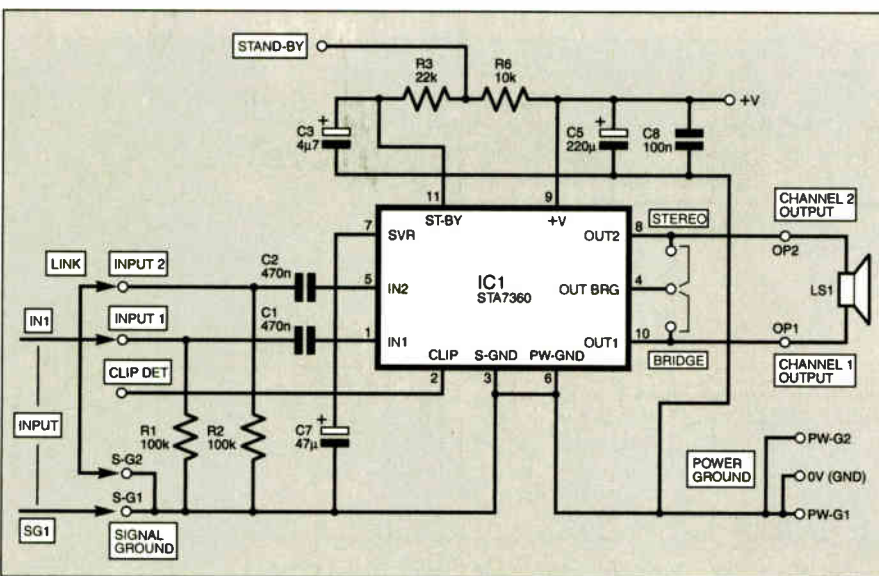

Fig.3. Complete circuit diagram for the Bridge mode Amplifier Module

also be the same, driving both terminals of loudspeaker LS1 up and down together so that the voltages would cancel each other and there would be no voltage difference across the speaker – and no sound!

For bridge mode the output of one amplifier is inverted so that instead of cancelling each other the voltage across the speaker is doubled. This is achieved in IC1 by removing the link between pin 8 and pin 4 (Stereo mode), and instead linking pins 10 and 4 (Bridge mode).

The output voltage swing in bridge mode is doubled compared with the single-ended stereo mode because the speaker can be driven almost to the full supply voltage in one direction when output OP1 (pin 10) is high and OP2 (pin 8) is low, and similarly in the opposite direction when output OP2 is high and OP1 low. This results in a much higher output especially at lower supply voltages.

Only one input (IN1) needs to be connected to the input signal, whilst the other input (IN2) can be connected to its input ground (S-G2), via its coupling capacitor C2. If the other input is not grounded, it works as an inverting input, and can be used to cancel some types of interference and noise.

automatically reduced to avoid overload distortion. Alternatively the current could be amplified to drive an l.e.d.

## Construction

The Amplifier Module uses only a few components, and is built on a small single-sided printed circuit board (p.c.b.). The topside component layout and full-size underside copper track master are shown in Fig.4. This board is available from the *EPE PCB Service*, code 500.

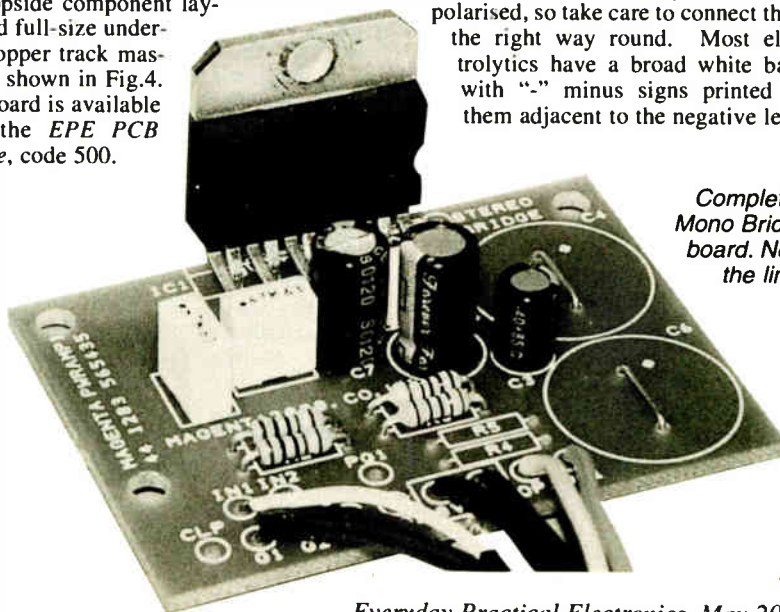

Completed Mono Bridge board. Note the links

# COMPONENTS

## Resistors

R1, R2	100k (2 off)
R3	22k
R4, R5	2k2 (2 off)
R6	10k

All 0.25W 5% metal film

See  
SHOP  
TALK  
page

## Capacitors

C1, C2	470n box polyester 63V (2 off)
C3	4 $\mu$ 7 min. radial elect. 25V
C5	220 $\mu$ min. radial elect. 25V
C4, C6	2,200 $\mu$ radial elect. (2 off)
C7	47 $\mu$ min. radial elect. 25V
C8	100n box polyester 63V

## Semiconductors

IC1	STA7360 20W bridge/stereo audio amplifier
-----	---

## Miscellaneous

LS1, LS2	2 $\Omega$ to 8 $\Omega$ loudspeaker, see text (2 off)
----------	--

Printed circuit board available from the *EPE PCB Service*, code 500; finned heatsink, see text; single-core link wire; multistrand connecting wire; solder; etc.

Approx. Cost  
Guidance Only

**£12**

excl speaker & power supply

## Link Up

A single wire link selects Stereo or Bridge mode. In Bridge mode capacitors C4 and C6 are omitted and wire links fitted instead. Amplifier module IC1 is fitted on the p.c.b. with its metal tab parallel to the edge of the board so that it, together with the p.c.b., can be mounted onto a flat metal heatsink plate just by the heatsink screw. Three other mounting holes are provided in the board for more conventional mounting arrangements.

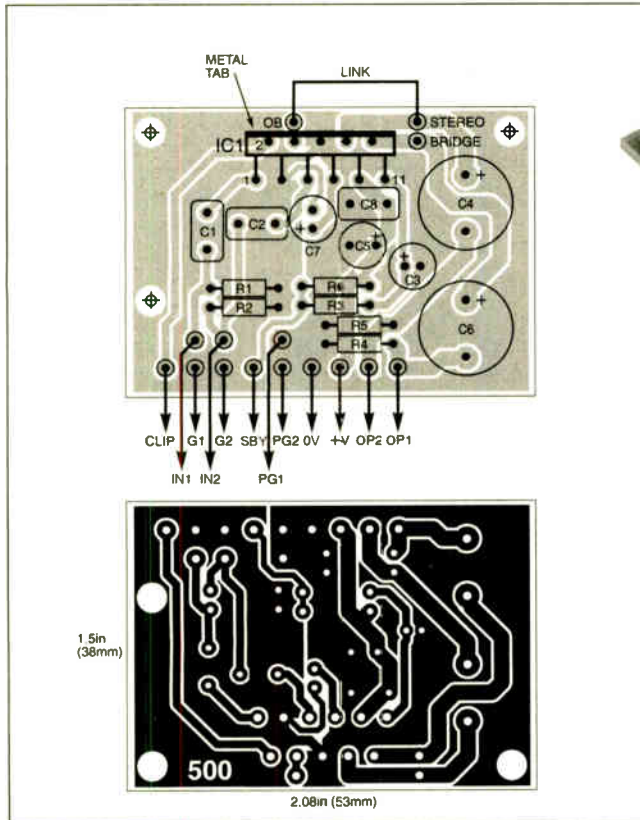

Fig.4. Printed circuit board component layout and full-size copper foil master for the Amplifier Module in Stereo mode. For Bridge mode capacitors C4 and C6 are omitted and replaced with wire links – see photos.

Many different types of heatsink can be used, and the over-temperature protection will soon start complaining if the output is too big or the heatsink too small! The heatsink tab is connected internally to the chip power ground 0V pin (6) so might not need insulating in some applications. It is certainly not advisable to power the chip via the metal tab, as there is a danger of instability or distortion due to possible ground loops.

The holes in the p.c.b. for mounting IC1 are quite tight so a little care might be necessary to jiggle them into position. The pins need to be about 1mm proud of the copper side of the board to be soldered correctly. It is not necessary to force them through any further. The chip has ESD (electrostatic discharge) protection, so there should be no need for special handling.

The wire link selecting Bridge/Stereo operation runs between IC1 pins and the edge of the board. Use a straight bare wire link and bend it just at the end if Bridge mode is to be used. Make sure that it does not short to any of other the pins, and that it cannot contact the heatsink.

## Heatsink

The accompanying photograph shows a heatsink that was used for all of the following tests. This was more than adequate for operation at continuous maximum output using a 14.4V supply. For listening to most kinds of music the average output power will be much lower and a smaller or thinner heatsink rated at around 20°C

per watt is sufficient. If heavier work is anticipated then more substantial extruded types giving 10°C per watt

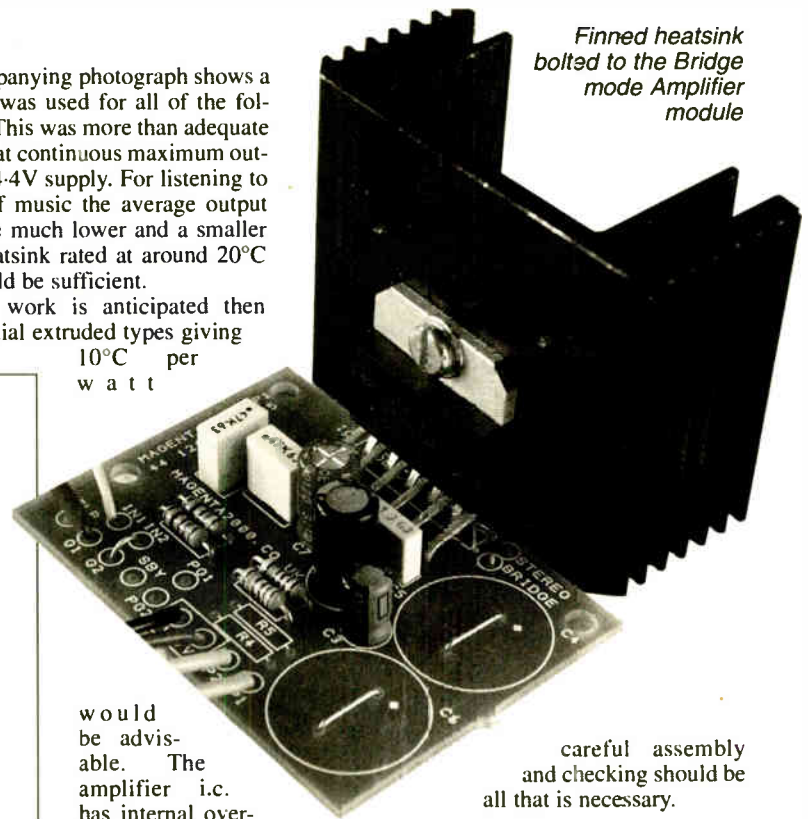

Finned heatsink bolted to the Bridge mode Amplifier module

would be advisable. The amplifier i.c. has internal over-temperature protection and so "thermal runaway" is not possible. If the chip's temperature rises too far the output is limited by the protection circuits and shows itself as very harsh distortion.

## Testing

As always, start the testing procedure by inspecting the board for dry joints, solder bridges and for any reverse polarity of components. Also, before connecting loudspeakers, make sure that the wire "bridging" link is in place to select the required Stereo or Bridge mode of operation.

Next, apply the power supply to the 0V and +V terminals of the board (making sure it is connected the right way round!) via some sort of current limiting device. An ideal current limiting device is a car tail lamp bulb – it both limits the current, and lights up dimly or brightly depending on the overload!

Once power is connected successfully, check across the loudspeaker terminals to make sure there is no d.c. voltage present. In Stereo mode the d.c. voltage will decay to zero in a few seconds as the output capacitors C4 and C6 charge through resistors R4 and R5. In Bridge mode the two outputs will be at half of the supply voltage, but the voltage between them will be small. A few hundred millivolts of "d.c. offset" is possible and acceptable.

Connect the loudspeaker(s), and then apply a suitable input signal at a low level (using a 10kΩ log. potentiometer if necessary). As there are so few components,

careful assembly and checking should be all that is necessary.

## Power Supplies

The amplifier operates correctly at between 8V and 18V. At 14.4V in Bridge mode and at full power into 4 ohms, a supply capable of delivering 3A is required. In Stereo mode using 8 ohm speakers the supply needs are more modest and a 1.5A supply is sufficient.

The circuit is ideally suited to operation from a car battery, and also has good supply ripple rejection so that it can work satisfactorily from an unregulated mains transformer with a bridge rectifier and smoothing capacitor. Make sure that the unloaded supply voltage does not exceed 20V. A transformer delivering 12V a.c. with a bridge rectifier and a 4,700μF 25V electrolytic smoothing capacitor should be acceptable, but check the "off load" voltage.

Computer power supplies often have suitable 12V or 15V outputs and provide enough power to run two separate circuits in bridge mode to give 40W stereo output.

## Performance Matters

As stated earlier, the operating supply voltage range is 8V to 18V. Quiescent current (with no input signal) is between 65mA and 120mA which is quite high, and the STA7360 i.c. is certainly not intended for operation from batteries, (except car batteries of course) however in applications such as loudhailers, where there is a "push-to-talk" switch, the Standby pin (11) can be used effectively, and the standby current is less than 100μA.

Most of the manufacturer's performance curves are shown at 14.4V, the nominal voltage of a car battery. Higher power can be obtained with the maximum 18V supply, but make sure the power supply is regulated because the "absolute maximum" supply is only 20 volts so there is not much room for errors.

The distortion at 1kHz with a 14.4V supply in Bridge mode, at medium power levels, is less than 0.03%, rising to 0.1% at 13W output. The frequency response is considered remarkable because the circuit

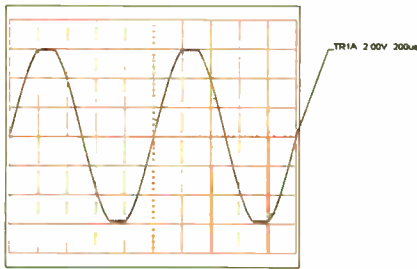

Fig.5. Stereo mode 12V no load

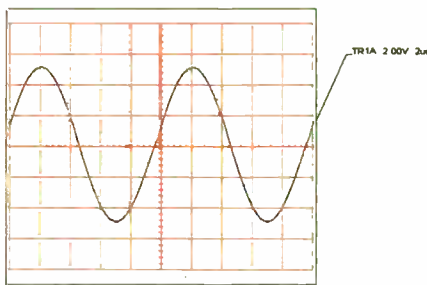

Fig.6. Stereo mode 12V 100kHz 4Ω load

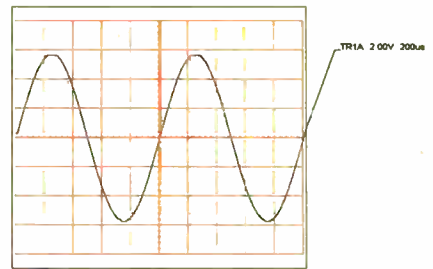

Fig.7. Bridge mode 14.4V 1kHz 4Ω load. Supply current 2A. OP1 shown, 11.5V p-p (4.1V r.m.s.), input is 600mV p-p

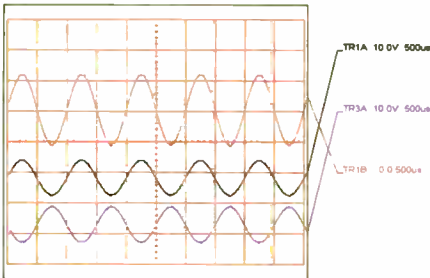

Fig.8. Bridge mode lower trace OP1, middle trace OP2, upper trace OP1-OP2

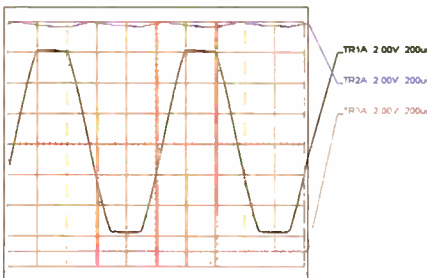

Fig.9. Bridge mode 14.4V 1kHz 4Ω. Overdriven to show OP1 max output. Lower trace 0V, upper +14.4V supply

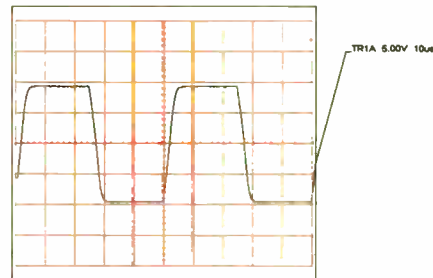

Fig.10. Bridge mode 14.4V 20kHz square wave response 4Ω load. 20 Watts output, 2µs rise and fall time

uses "local" feedback in the output stage, and so has a low overall open loop gain (just like a valve amplifier in fact!). The result is that external compensation components are not needed, and at medium signal levels the response is flat to 200kHz.

Low frequency response is determined by the input and output coupling capacitors. The values shown give a low frequency -3dB point of 18Hz in Stereo mode. In Bridge mode the speaker is d.c. coupled so only the input capacitors have any effect and the low frequency response extends well below 10Hz.

The amplifier voltage gain is 20dB or 10:1 in Stereo mode and 26dB or 20:1 in Bridge mode. This means that the normal Auxiliary signal levels - most audio sources including Digital TV tuners, Computer sound cards, DVD and CD players - will be able to drive the output up to clipping levels.

## A Measured Performance

The measured performance of the circuit in Stereo and Bridge mode is illustrated by the oscilloscope plots shown in Fig.5 to Fig.10. These were recorded by a fast DSO (Digital Sampling Oscilloscope).

The output of one channel with a 12V supply and no load is shown in Fig.5. The vertical scale is 2V/cm, and it can be seen that the output voltage swings very close to the positive and negative rails which are three divisions above and below the mid line. With a 4 ohm load the output still swings within 0.6V of the supply rails - when delivering a peak current approaching 1.4 amps!

Still in Stereo mode, with the input turned down to just below the clipping point at 1kHz and the frequency increased, Fig.6 gives an indication of the frequency response into 4 ohms. At 100kHz the amplitude is almost unchanged. There is just a tiny amount of crossover distortion visible at the centre of the screen where the waveform passes through zero.

## On the Bridge

The result from one of the amplifier's outputs, OP1, when connected in bridge mode, at 14.4 volts and 4 ohms load, is shown in Fig.7. The other output OP2 is producing the same waveform but with the opposite polarity.

The positive peak output voltage from OP1 is approximately 5.75V, so the corresponding negative output from OP2 is -5.75V giving a peak voltage across the 4 ohm load of 11.5V and so the peak output current is 11.5/4 or just under 3A. The output power is 17 Watts.

At this current level the output voltage swings to within 1.4V of each supply rail - which is still an impressive performance.

The output voltage across the load - obtained by subtracting the OP2 trace from the OP1 trace - is shown in Fig.8. The Vertical scale has been reduced to 10V per division.

The maximum output swing of OP1 is shown more clearly in Fig.9. Here the output has been overdriven, to give flat tops and bottoms, and two traces have been added showing the 0V rail and the +14.4V supply.

The trace shows that the voltage reaches within 1.4V of each rail, and also shows how the positive supply voltage drops as the circuit draws high current at the peaks of each waveform. This voltage drop is surprising because the amplifier is being powered from a regulated supply via just 40cm of 16/0.2 connecting wire. It shows a voltage drop of 300mV or so during the peaks when the output current is 3A and corresponds to an effective supply resistance of 0.3/3 or 0.1 ohms.

This illustrates the need to provide good power connections (and more importantly ground connections). Note that the ground line shows no voltage drop but that is because the 0V reference point was taken where the wire connects to the board. If the reference point had been the power supply terminal, the 0V line would also show the same voltage drop as the positive rail.

To demonstrate the frequency response it is useful to see the amplifier's performance with a square wave input. The resulting waveform in Fig.10 shows the square wave performance at 20kHz. Note that the amplifier is not being overdriven, so the flat top is due to the input signal and not to any clipping effects. The output power is 20 Watts. The circuit shows perfect symmetry of the rising and falling edges which have a 2 microsecond rise and fall time.

## Summing-Up

The board has separate connecting points for loudspeaker, power, and input ground connections. *Do not* be tempted to economise by combining any of these - even though they all "go to the same place"! Ground loops can cause instability, and introduce distortion that the chip designers have worked hard to eliminate! If the i.c. metal tab is being connected to a chassis heatsink, don't rely on the connection to provide the power, and ideally use an insulation kit.

The specification and measured performance of the circuit are impressive, it uses very few components and provides an effective power amplifier for many audio applications. The short-circuit protection, clipping indicator, shut down mode, and switch on/off "pop" reduction features make this circuit very versatile.

## Real Power!

The power output of these modules is real continuous "average power" (sometimes incorrectly called r.m.s. power) which heats up the load resistors! It should not be confused with things like "80 Watt" computer speakers - powered from a wall transformer rated at 6 Watts!!

The author doesn't have "golden ears" and has deliberately avoided making any subjective observations. The specification speaks for itself, and we look forward to hearing from readers who have built, tested, and listened. □



# Electronics from Down Japan



**FREE**  
400+ page  
Catalogue

JUST ONE OF OUR MANY  
GREAT PRE-BUILT & TESTED  
CONSUMER PRODUCTS!

### Store Your Video Memories Forever

**XC-4869 £41.75 + post and packing**  
Transfer all of your Betamax, VHS, and camcorder tapes to DVD using your computer's DVD writer. It includes powerful editing software to add colour and transitional effects, as well as sound tracks if desired. The box measures just 1 3/8(W) x 3 3/4(H) x 9/16(D)" and supports S-Video and composite inputs from NTSC or PAL sources.



## We Stock...

Electronic Components

Electronic Project Kits

Test & Measurement Equipment

Power Products and Accessories

Audio & Video Equipment & Accessories

Computer & Telecoms Accessories

Security & Surveillance Equipment

Get Your **FREE UK Pounds Sterling Priced Catalogue** - all 400+ pages!  
Just fill out the catalogue request form at [www.jaycarelectronics.co.uk/catalogue](http://www.jaycarelectronics.co.uk/catalogue)

### Check our website!

- All of our 6,000+ products with search facilities.
- 128-bit secure on-line ordering - safe & secure.
- Over 3,500 product datasheets & application notes.
- And we're from Australia, so you can trust us!
- Postage and Packing includes airmail to the UK.



[www.jaycarelectronics.co.uk](http://www.jaycarelectronics.co.uk)

*Post and Packing Charges:	
Order Value Cost	£5
£20 - £49.99	£10
£50 - £99.99	£20
£100 - £199.99	£30
£200 - £499.99	£40
£500+	£40
Max weight 12lb (5kg) heavier parcels POA. Minimum order £20.	

### Radio Frequency Identity (RFID) Triggered Relay Kit

**KC-5393 £26.25 + post and packing**

RFID systems can operate much like a conventional lock and key but wireless. The RFID 'tag' transmits a unique code when energised by the receiver's magnetic field. As long as the tag has been pre-programmed into the receiver, access is granted. This project provides a normally open and a normally closed electrically switched output triggered by a tag. Kit includes circuit board, one Keyfob style RFID tag, electronic components, and clear English instructions.

Extra RFID Tags

Keyfob style:	Measures 1 3/16(W) x 1 9/16(L) x 3/16(H)"	<b>ZZ-8950 £3.00</b>
Card style:	Measures 3 5/16(W) x 2 5/32(H) x 1/16(T)"	<b>ZZ-8952 £1.75</b>
Clear smart style:	Measures 13/16(Dia) x 1/16(T)"	<b>ZZ-8954 £1.50</b>



### Dual 12V Battery Controller Kit

**KA-1782 £14.50 + post and packing**

This project connects an auxiliary battery in an SUV to the charging system when your engine is running, then disconnects it when switched off. This prevents your main vehicle battery from going flat. You can safely leave inverters, fridges etc. running overnight with no problems in the morning. It can handle around 100 amps of current at 12VDC. Kit includes circuit board, a weatherproof diecast aluminum case, heavy duty battery binding posts, electronic components, and clear English instructions.



### Get the Video Quality You Paid For With Our Doctor Video Kit

**KC-5390 £29.00 + post and packing**

Copy protection is put in place on videos and DVDs for a good reason, but this robs you of the true high quality reproduction that it is capable of. Get the quality you paid for and strip out these annoying signals! It supports composite and S-video signals and can be configured for NTSC or PAL format. Kit includes case, circuit board, all electronic components, and clear English instructions. Note: Some SMD soldering required.

Caution: During signal conditioning, this unit removes copyright protection. It is a crime, & Jaycar Electronics takes no responsibility for its potential for unlawful use.



### Universal High Energy Ignition Kit

**KC-5247 £15.40 + post and packing**

Get better fuel efficiency and performance from your car! It produces a very intense 0.9ms spark which results in more complete fuel burning, lower emissions, and increased performance. It works with points, twin points, and retractor ignition systems. Kit supplied with weatherproof diecast aluminium case, circuit board, and all electronic components.



- Works great on points ignition (ie. older cars) Can be used on newer cars with Hall-effect sensor.

### Explanation of icons used for kits

Requires an appropriate construction site for each project. For a complete constructor, it does not however include any installation instructions that may be required.

**60 mins**



**SIMPLE**



**DETAILED**

Requires a fair amount of assembly. Generally suitable for the beginner. Requires basic electronics and soldering skills.

Requires a good knowledge of electronics to understand its operation, and troubleshooting techniques may be required.

### 3 Stage FM Transmitter Kit

**KJ-8750 £5.80 + post and packing**

The circuit board may measure just 2"(L) x 1 1/16(W)", but it can transmit signals over half a mile in the open. It has flexible power requirements, with 6 to 12VDC input voltage (so a 9V battery would be suitable). It is quick to build, and fun to use. Kit supplied with circuit board, electronic components, and clear English instructions.



Log on to

[www.jaycarelectronics.co.uk/catalogue](http://www.jaycarelectronics.co.uk/catalogue)

for your **FREE** catalogue!

**0800 032 7241**

(Monday - Friday 09.00 to 17.30 GMT + 10 hours only) For those that want to write:  
100 Silverwater Rd Silverwater NSW 2128 Sydney Australia

# Jaycar

Electronics

# READOUT

Email: [john.becker@wimborne.co.uk](mailto:john.becker@wimborne.co.uk)

**John Becker addresses some of the general points readers have raised. Have you anything interesting to say? Drop us a line!**

All letters quoted here have previously been replied to directly.

## WIN AN ATLAS LCR ANALYSER WORTH £69

An Atlas LCR Passive Component Analyser, kindly donated by Peak Electronic Design Ltd., will be awarded to the author of the *Letter Of The Month* each month.

The Atlas LCR automatically measures inductance from 1 $\mu$ H to 10H, capacitance from 1pF to 10,000 $\mu$ F and resistance from 1 $\Omega$  to 2M $\Omega$  with a basic accuracy of 1%.



## ★ LETTER OF THE MONTH ★

### Spontaflex Radio

Dear EPE,

I enjoyed reading Raymond Haigh's article on the *Spontaflex Radio Receiver* (Apr '05). Some readers might think this article is an elaborate April Fool. It most certainly is not: a Google search for "Sir Douglas Hall" will find a lot of references to his work. The original Spontaflex radio article and many more of his radio circuits can be found at <http://freespace.virgin.net/spontaflex.reflex/>.

In the 60s, transistors cost much more in comparison to today's offerings – I do not know the exact rate of inflation, but I imagine it was the equivalent of buying a transistor today priced at £15 or even more – so it was essential to get the last bit of work out of the device. Sir Douglas Hall's ingenious circuits would do just that.

I have been searching for another

piece by Sir Douglas Hall but with no success. I am convinced that I read an article in *Radio Constructor* sometime in 1968 or 1969 by Sir Douglas on a five watt class A amplifier, but can find no reference to it anywhere. Five watts may not sound much in today's hifi world but as the average domestic setting rarely needs anything more than two or three watts (J. Linsley Hood, *Wireless World*, Apr '69) five watts was perfectly adequate.

I wonder if someone can confirm that my memory is not playing tricks on me, and that this article was by Sir Douglas Hall and not by another author.

Alan Jones, London, via email

*Readers, can you help Alan on this? My copies of RC went out years back I regret.*

*And it's years back since we last did an "April"!*

scanning in old newsletters and articles sent to me and I thought the experience of the people in the membership section might be of some use to hobbyists. I hope for people to send some more articles and to scan in more old newsletters. The site is at: <http://members.tripod.com/~baec>

Membership is now free. You can include a note in *EPE* describing the site and requesting members and articles if you wish.

David Ledgard, BAEC Webmaster, via email

*That's great David, I hope you get a good response through the exposure here. We send our best wishes.*

### Seeking Tony Lee

Dear EPE,

I was interested in the *Readout* Feb '05 letter from Tony Lee of Old Reynella, S. Australia. As a "mature age" electronics student, I have come to realise that such students are very thin on the ground.

I would very much like to contact Tony and ask if you would kindly pass on my email address to him. I would really appreciate that. As a mature novice I am beginning to understand "the loneliness of the long distance runner".

Dave (over-ripe) Jones, Australia, via email

*Tony, having had a major crash on one PC and lost many filed emails, I no longer have yours. If you'd like to chat with Dave, would you care to email me? john.becker@wimborne.co.uk.*

*Dave, in fact "mature age electronics students" are somewhat thicker on the ground than you might suppose. Many people who used to follow us in their younger days before job and family involvements came to dominate, are now retiring and returning to hobbyist electronics, and us.*

### Component Choice

Dear EPE,

I am a student in the UK and am doing some research on r.f. transceiver modules. I have chosen to build the *EPE Minder* (Jan '03). My task is to compare the transceivers for this design with others available on the market. Why did *EPE* choose the ones quoted in the article?

Usma Ali, via email

*That's not a straightforward question to answer, Usma. All designs published in *EPE* are designed by freelance contributors*

### Conformality

Dear EPE,

Is it just me (or my leading-brand-name solder), or has anyone else noted how difficult it is to wet the tracks of Veroboard? I feel that the resulting big mound of solder is excessive, it climbs high up the component lead but takes persuasion to spread across the copper track. Thorough cleaning doesn't make any difference, despite the received wisdom. There's no solder resist between the tracks, as you know, but then it isn't needed as it's so hard to spread the solder over a track, let alone force it to bridge to the adjacent one.

Another brand, new to me, is Multicomp. CPC sell just one size of this stripboard at a price that is quite acceptable compared to Vero. I was pleased to receive some of this and find that it comes pretinned. My next project will use this as a trial – wonder if it will solve the problem?

Another matter – your answer to "Windication" (Ken Wood, *Readout* Feb '05) mentions conformal spray and I once used this, reassuringly labelled Mil Spec. When it was discontinued I asked the maker about alternatives and it turned out that the conformal spray was not fully effective unless cured by oven-baking! John's potter's kiln (same *Readout*) might have been suitable, but I hate to think what it'd do to the components on the finished board!

I now use HPA (High Performance Acrylic) which goes off in 24 hours at room temperature. Having said that, both materials have prevented external bolts rusting on my car (and I never baked it...).

Godfrey Manning, G4GLM, Edgware, Middx, via email

*We must open up your question to the wider world Godfrey. Having my own professional p.c.b. making equipment, I have not used stripboard in decades and cannot comment. Readers, what's your experience on this?*

*I didn't bake my Weather Centre either, yet the conformal spray cured the devastating corrosion of the p.c.b. tracks which had previously occurred over several weeks of outdoor exposure to night-time dampness.*

### BAEC Web Site

*Some time ago we reported in News that the BAEC (British Amateur Electronics Club) had ceased. However, there was a recent posting on our Chat Zone which suggested otherwise. I emailed the author of the posting, David Ledgard, expressing interest in this development. David replied:*

John, you are correct the BAEC has ceased. But I decided to keep the website going. I have put quite a lot of work into

(myself in that context too). We all design according to what is available to us and within our budget, and within our own criteria which will change from person to person. An additional factor in this case is that the rf. modules used by hobbyist constructors must conform to certain legal criteria regarding the transmission frequency and its stability and accuracy.

A handful of companies in the UK manufacture and/or distribute rf. modules that conform to UK requirements, and which company's products are chosen by a designer is frequently determined by what that designer has seen used before, or has been persuaded by advertising is the one to use.

There is no "general rule" that can be applied to such choices. I regret I cannot offer more "scientific" advice.

On a wider component choice level, many of us tend to standardise on using devices which have previously been found to be suitable for a particular type of application. Such devices effectively become part of a component "library" and which are used repeatedly in similar applications. Only if those devices become obsolete, or an improved type is introduced, do we then change, and then that new device is added to the library.

But unless there is a good reason to change, there is nothing to be gained by doing so. Even devices which were first introduced some years ago and still available have their roles for current designs. For example, the 741 op.amp which I first used over 30 years ago, is still in production and is very much suitable for some general-purpose applications.

### P.C.B. Scaling

Dear EPE,

I can't copy and paste the p.c.b. track layouts in the *EPE* electronic versions because the PDF files are copy-protected. When I print the full page from the PDF, the track layout's size is a little smaller than the size as declared at borders of the track layout image. I cannot print with any printer options such as enlarge or reduce. I need a perfect size image from which to make my p.c.b. due to the critical distance between i.c. holes. Apart from buying a ready-made board, what can I do?

Geena, via email

I made two suggestions to Geena:

1. Print it out as is and then get it photocopied to the right size.

2. With the image on screen, press the Print Screen key to put the whole screen image onto the Windows clipboard. Then click the Start button at the bottom left of the desktop screen, select Programs then Accessories, then Paint. In Paint click Edit then Paste to paste the clipboard image into it. You can then use Paint's scaling, printing and other editing options.

To which Geena responded:

Thank you, John, thank you! A kiss!

Oh how I enjoy the benefits of being *EPE* Tech Ed!

Everyday Practical Electronics, May 2005

### Synthesisers

Dear EPE,

I'm trying to find out if there are any synthesizer kits (like Moog, Arp etc) that you may have either used as one of your projects or have been placed as an advert in one of your editions. I am interested in building up a synthesizer from modules (including keyboard) and plugging the output into a MIDI interface on my computer.

Lawrence Gertig, via email

It's many years since we did such things, Lawrence, the hobbyist constructional market for them having been effectively killed off by cheap Far-Eastern ready-mades, and the resulting lack of keyboard-only availability at low cost. A vicious circle!

However, in 1998 *EPE* was sent a copy of *The A-Z of Analogue Synthesisers*, by Peter Forrest. I don't know if it's been updated, or even still available, but its ISBN was 0-9524377-2-4. Your library might be able to help you. But, of course, a [www.google.com](http://www.google.com) search for synthesiser kits might be beneficial.

For your interest, it was our erstwhile older-sister Practical Electronics, which published the very first *DIY synthesiser*, back in 1972. I and several other suppliers made a good living from its kit sales, and from the derivatives that emerged, such as the PE Minisonic in about 1974.

### GPS Validity

Dear EPE,

I have been able to reproduce Frank Butler's problem with the *Speed Camera Watch* (Jan '05) which you referred to me. Sometimes the software "looses lock" on a GPS signal, even though the GPS module is actually still in lock.

I have traced this to the fact the "Valid" flag in the GPGGA message can take values other than "1" and "0". It seems there are other possible "locked" states, presumably to do with the number of satellites in view. Some NMEA documentation mentions it, and some doesn't.

I have made a very simple change to fix this – rather than test for "in lock", I now test for "not in lock". Frank has confirmed that this solves the problem.

Mike Hibbett, via email

Thanks Mike, your updated files have been placed on our Downloads site (at the end of Feb), and sent to Magenta, who sell the pre-programmed PICs.

In fact my Garmin GPS gives "A" for valid, "V" for invalid!

### Blood Pressure Monitoring

Dear EPE,

I read with interest George Chatley's email about electronic blood pressure monitors (*Readout* Apr '05). I use an Omron M5-I self-inflating device with arm cuff. It is one of the monitors recommended by the British Hypertension Society.

The only way I know of checking accuracy is comparison with a known reliable instrument. If he has not already done so, perhaps George could arrange a 24-hour ambulatory blood pressure monitor test. These tests can be useful

when blood pressure readings vary a lot from reading to reading. The test print out gives an overview of pressures and would be useful for comparison with home monitor readings.

I would welcome an *EPE* feature on these monitors but I assume that a calibration instrument would have to be a complex PC interface project.

John Anderson, via email

Thanks for that John. If I had the basic information about such monitors and the readings they are supposed to generate, I feel sure that a PIC microcontroller design with liquid crystal display read-out could do the job without recourse to PC use, except in the case of wishing to download recorded data for further longterm analysis.

### Static Flashing

Dear EPE,

I thought you may be interested in a fault I've found. I constructed a project (not an *EPE* one) in a plastic box using a flashing i.e.d. as a power-on indicator. When fed from halfwave rectified a.c. these i.e.d.s flash at 50Hz.

I glued this one to a plastic box. The day was very cold and dry. Testing the device I picked up the box, and the i.e.d. went off. I put it down and the i.e.d. came on. A dry joint I thought. I changed the i.e.d. No. Still the same. Then I noticed as I moved my hand near the i.e.d. it went out.

It was a static charge on the box causing the problem. The flashing i.e.d. probably contains FETS, which are sensitive to static. A 10kΩ resistor across the i.e.d. seemed to help.

Jim Littler, G4HPH, Wigan, Lancs, via email

How intriguing! Anyone else had Jim's problem?

### Camera Watch Again

Dear EPE,

Firstly I would like to thank you for passing my emailed *Camera Watch* (Jan '05) enquiry on to the author Mike Hibbett, and to him for a helpful response.

From Mike's reply I have now got the *Camera Watch* working. Many thanks to him and to *EPE* for such a good project to build. I would encourage Mike or anyone else to develop this project further with some of the ideals listed at the end of his article.

I myself don't yet know enough to be able to take it any further, but your project has given me the incentive to look more into PIC programming, something which I have never done before, with a view to increase the size of the memory.

Peter Newton, Dundee, via email

I'm glad you are so pleased with the unit Peter, and with all of us, including Mike, who has been admirable above and beyond expectation in dealing so helpfully with the readers who contacted us about his excellent design. It has generated far more correspondence than any other project recently.

And do take up PICs – they're fun!

# SHOP TALK

with David Barrington

## Crossword Solver

Looking down the components listing for the *Crossword Solver* project, just a couple of items stand out as being candidates for sourcing problems. These are the flash memory EPROM and the step-up voltage converter i.c.

The "dictionary" chip, IC2, is a non-volatile flash memory AM29F040B-120PC EPROM. We have found only one listing for this device and that is from Farnell (☎ 0870 1200 100 or [www.farnellnone.co.uk](http://www.farnellnone.co.uk)), code 302-0230. The same company also list the MAX619 d.c. to d.c. step-up voltage converter i.c. This should be ordered as code 702-614.

As advised in the article, the EPROM memory chip is not available preprogrammed. However, it can be programmed either in a suitable EPROM programmer or by your own PC as described. To program the memory chip you will need to construct the simple RS232 Interface circuit (Fig.3) or equivalent. The MAX232 used is one of the more popular interface i.c.s and most component suppliers should have "off-the-shelf" stocks.

For those readers unable to program their own PICs, fully programmed PIC16F877-20 (20MHz) microcontrollers can be purchased from Magenta Electronics (☎ 02083 565435 or [www.magenta2000.co.uk](http://www.magenta2000.co.uk)) for the inclusive price of £10 each (overseas add £1 for p&p). The software, including source code files, is available on a 3.5in. PC-compatible disk (Disk 8) from the *EPE Editorial Office* for a sum of £3 each (UK), to cover admin costs (for overseas charges see page 373). The software is also available for Free download via the Downloads link on our UK website at [www.epemag.co.uk](http://www.epemag.co.uk).

The printed circuit board is available from the *EPE PCB Service*, code 499 (see page 373). The 2-line 16-character (per line) alphanumeric display is a standard i.c.d. module and most of our components advertisers should be able to offer a suitable device.

## 20W Amplifier Module

The STA7360 stereo/bridge amplifier i.c., used in the *20W Amplifier Module* project, is being offered to readers by Magenta

Electronics (☎ 02083 565435 or [www.magenta2000.co.uk](http://www.magenta2000.co.uk)) for the all inclusive price of £3.80 each. They are also producing a complete kit of parts, including a printed circuit board and suitable heatsink, for the sum of £11.90. A post and packing charge needs to be added to the kit price, see their advertisement on page 313.

The printed circuit board is available from the *EPE PCB Service*, code 313 (see page 373).

## DAB Radio Aerial

Some readers may experience difficulty in purchasing the connectors and cable that go to make up the *DAB Radio Aerial* project. They are certainly listed by Squires (☎ 01243 842424 or [www.squiresools.com](http://www.squiresools.com)) in their current catalogue. The SO239 u.h.f. chassis-mounting socket is coded 562-350; the PL259 u.h.f. plug, code 562-320. They also supply satellite TV coaxial cable, although they do not indicate type i.e. RG6U cable.

The author has suggested Moonraker (☎ 01908 281705 or [www.amateurantennas.com](http://www.amateurantennas.com)) as a possible source for parts.

For the small "ground plane" board, ESR Components (☎ 0191 251 4363 or [www.esr.co.uk](http://www.esr.co.uk)) are currently listing copper-clad fibreglass board at reasonable prices. You will, of course, have to cut a larger piece down to the required size.

## Back to Logic Basics – Part 2 Water Level Detector/Burglar Alarm









No "special" components to report on for the *Water Level Detector* or *Burglar Alarm*, this month's two *Back to Logic Basics* projects. One very important point to repeat is that the Level Detector should only be used to detect water levels. **It must not be used with petrol or any other volatile liquids where even the smallest of sparks could cause an explosion.**

The 4093 quad Schmitt trigger NAND gate is from the CMOS 4000 series of i.c.s and should be widely stocked. The "passive" piezoelectric sounder – one without any internal drive/oscillator circuit – should also be easy to obtain.

For the *Burglar Alarm*, the choice of "trip" switches/sensors is left to readers' individual needs. Some advertisers carry a range of sensors, including reed/magnet switches, microswitches, tilt/vibration switches and pressure mat/pad switches.

The two printed circuit boards are obtainable from the *EPE PCB Service*, codes 501 (Water Level) and 502 (Burglar Alarm), see page 373.

# Professional Security Products

 <p><b>Colour Night Vision Camera</b> – Fully weatherproof with 10m IR range. ¼" CCD with automatic IR switching, 380 TV lines Resolution &amp; 12v operation.</p> <p><b>Only £69.00</b></p>	 <p><b>Miniature Colour Camera</b> – with wide angle lens &amp; audio 1/3" C-Mos, 330 TV lines Resolution, 6-12v operation &amp; only 20 x 31mm.</p> <p><b>Only £35.00</b></p>	 <p><b>Video Receiver</b> – Mini 2.4Ghz A/V receiver with antenna. 4 Channel selection, RCA output &amp; 12v operation.</p> <p><b>Only £69.00</b></p>
 <p><b>Colour Pinhole Bullet Camera</b> Fully weatherproof with Pinhole lens. ¼" CCD, 380 TV lines Resolution, 12v operation &amp; only 21.5 x 62.5mm.</p> <p><b>Only £69.00</b></p>	 <p><b>Colour Pinhole PCB Camera.</b> ¼" CCD, 380 TV lines Resolution, 12v operation &amp; only 22 x 26mm.</p> <p><b>Only £59.00</b></p>	 <p><b>GSM Alarm</b> – Alerts you by SMS when an alarm has been triggered. 2 inputs &amp; 2 outputs, up to 5 mobile numbers can be stored and operates between 6-15v.</p> <p><b>Only 199.00</b></p>
 <p><b>Colour Bullet Camera</b> – Fully weatherproof with standard lens. ¼" CCD, 420 TV lines Resolution, 12v operation &amp; only 20 x 74mm.</p> <p><b>Only £65.00</b></p>	 <p><b>Hi-Power Video Transmitter</b> – Mini 2.4Ghz A/V transmitter with built on microphone. 4 Channel selection &amp; 12v operation.</p> <p><b>Only £35.00</b></p>	<p><b>More Products Available on</b> <b><a href="http://WWW.SPystoreuk.COM">WWW.SPystoreuk.COM</a></b></p>

\*\*\*\*\* ALL PRICES EXCLUDE P&P and VAT \*\*\*\*\*

- Bitz Technology Ltd •
- 344 Kilburn Lane • London W9 3EF •
- Tel: +44 (0) 208 968 0227 • Fax: +44 (0) 208 968 0194 •
- E-Mail: [info@spystoreuk.com](mailto:info@spystoreuk.com) • Web: [www.spystoreuk.com](http://www.spystoreuk.com) •



**the Atlas DCA**

- Automatically analyse most 2 and 3 leaded semiconductors.
- Automatically identify all leads, just connect any way round!
- Measures lots of parameters too such as gain,  $V_{BE}$ ,  $V_{GS}$ , etc...



**LCR40**  
£69.00

**DCA55**  
£49.00

**SCR100**  
£99.00

Passive components, semiconductors,  
power devices, network cabling  
**Choose your perfect analyser**

**New Low Prices!**

limited time only

**the Atlas LCR**

- Automatically identify Inductors, Capacitors and Resistors.
- Inductors from 1 $\mu$ H to 10H.
- Capacitors from 1pF to 10,000 $\mu$ F.
- Resistors from 1 $\Omega$  to 2M $\Omega$
- 1% Basic accuracy.
- Automatic frequency selection.



"Star Pack"  
LCR and DCA  
in carry case  
£118.00

Carry cases  
£15.00

SMD Tweezer  
Probes for LCR  
£19.00

Spare Battery  
£1.75

accessories & carry cases



Triac and Thyristor Testing

ESR Measurement



Triac and Thyristor Testing



Cat5 Cable Testing



We can supply back issues of *EPE* by post, most issues from the past three years are available. An *EPE* index for the last five years is also available at [www.epemag.wimborne.co.uk](http://www.epemag.wimborne.co.uk) or see order form below. Alternatively, indexes are published in the December issue for that year. Where we are unable to provide a back issue a photocopy of any *one article* (or *one part* of a series) can be purchased for the same price. Issues from Nov. 98 are available on CD-ROM – see next page – and issues from the last six months are also available to download from [www.epemag.com](http://www.epemag.com). Please make sure all components are still available before commencing any project from a back-dated issue.

## DID YOU MISS THESE?

### JAN '04

**PROJECTS** • Car Computer • Practical Radio Circuits-8 (Dual-Conversion SW Receiver) • Bedside Nightlight • PIC Watering Timer.  
**FEATURES** • GPS to PIC and PC Interface • Practically Speaking • Teach-In 2004 – Part 3 • Ingenuity Unlimited • Techno Talk • Circuit Surgery • New Technology Update • Net Work – The Internet Page.

### FEB '04

**PROJECTS** • PIC LCF Meter • Sonic Ice Warning • Jazzy Necklace • PIC Tug-of-War.  
**FEATURES** • Surface Mount Devices • Circuit Surgery • Teach-In 2004 – Part 4 • Interface • Ingenuity Unlimited • Techno Talk • Net Work – The Internet Page.

### MAR '04

**PROJECTS** • Bat-Band Convertor • Emergency Stand-by Light • MIDI Health Check • PIC Mixer for RC Planes.  
**FEATURES** • Teach-In 2004 – Part 5 • New Scientist CD-Rom Review • Circuit Surgery • Techno Talk • Ingenuity Unlimited • Practically Speaking • Net Work – The Internet Page.



### SEPT '04

**PROJECTS** • EPE Wart Zapper • Radio Control Failsafe • Rainbow Lighting Control • Alphamouse Game.  
**FEATURES** • Light Emitting Diodes – Part 1 • High Speed Binary-To-Decimal For PICs • Practically Speaking • Ingenuity Unlimited • Techno-Talk • Circuit Surgery • PIC-N'-Mix • Network – The Internet Page

### OCT '04

**PROJECTS** • EPE Theremin • Smart Karts – Part 1 • Volts Checker • Moon and Tide Clock Calendar.  
**FEATURES** • Light Emitting Diodes – 2 • Circuit Surgery • Interface • Ingenuity Unlimited • Techno Talk • PIC-N'-Mix • Network – The Internet Page • ROBOTS – Special Supplement

### NOV '04

**PROJECTS** • Thunderstorm Monitor • M.W. Amplitude Modulator • Logic Probe • Smart Karts - 2.  
**FEATURES** • Light Emitting Diodes-3 • Floating Point Maths for PICs • Ingenuity Unlimited • PE 40th Anniversary • Circuit Surgery • Techno Talk • PIC-N'-Mix • Net Work – The Internet Page.

### DEC '04

#### Photocopies only

**PROJECTS** • Super Vibration Switch • Versatile PIC Flasher • Wind Direction Indicator • Smart Karts - 3.  
**FEATURES** • Light Emitting Diodes-4 • Ingenuity Unlimited • Circuit Surgery • Interface • PIC 'N' Mix • Techno Talk • Net Work – The Internet Page • INDEX Vol. 33.

### JAN '05

**PROJECTS** • Speed Camera Watch • Gate Alarm • Light Detector • Smart Karts - 4.  
**FEATURES** • Practically Speaking • 32-Bit Signed Integer Maths for PICs • Ingenuity Unlimited • Circuit Surgery • Techno Talk • PIC 'N' Mix • Picoscope 3205 Review • Net Work – The Internet Page

### FEB '05

**PROJECTS** • PIC Electric Mk2 Pt1 • Sneaky • Sound Card Mixer • Smart Karts - 5.  
**FEATURES** • Interface • Circuit Surgery • Ingenuity Unlimited • Techno Talk • PIC 'N' Mix • E-Blocks and Flowcode V2.0 Reviews • Net Work – The Internet Page



### MAR '05

**PROJECTS** • Cat Flap • Stereo Headphone Monitor • PIC Electric Mk2 Pt2 • Smart Karts - 6 • Bingo Box.  
**FEATURES** • TK3 Simulator and PIC18F Upgrade • Circuit Surgery • Ingenuity Unlimited • Techno Talk • PIC 'N' Mix • Practically Speaking • Net Work – The Internet Page

### APRIL '04

**PROJECTS** • EPE Experimental Seismograph Logger 1 • Infra-Guard Monitor • Loft Light Alarm • PIC Moon Clock.  
**FEATURES** • USB To PIC Interface • Ingenuity Unlimited • Teach-In 2004 Part 6 • Interface • Techno Talk • Circuit Surgery • New Technology Update • Net Work – The Internet Page • Pull-Out – Semiconductor Classification Data.

### MAY '04

**PROJECTS** • Beat Balance Metal Detector • In-Car Laptop PSU • Low-Frequency Wien Oscillator • EPE Experimental Seismograph Logger-2.  
**FEATURES** • Coping With Lead-Free Solder • Teach-In 2004 – Part 7 • Ingenuity Unlimited • Techno Talk • Circuit Surgery • Practically Speaking • Pic-N'-Mix • Net Work – The Internet Page.

### JUNE '04

**PROJECTS** • PIC Quickstep • Crafty Cooling • MIDI Synchronome • Body Detector Mk2.  
**FEATURES** • Clinical Electrotherapy • Ingenuity Unlimited • Teach-In 2004 – Part 8 • Interface • Circuit Surgery • Techno Talk • PIC-N'-Mix • Net Work – The Internet Page.

### JULY '04

**PROJECTS** • Portable Mini Alarm • Bongo Box • Hard Drive Warbler • EPE PIC Magnetometry Logger-1.  
**FEATURES** • Making Front Panel Overlays • Practically Speaking • Teach-In 2004 – Part 9 • Ingenuity Unlimited • Circuit Surgery • Techno Talk • PIC-N'-Mix • Net Work – The Internet Page.

### AUG '04

**PROJECTS** • EPE Scorer • Keyring L.E.D. Torch • Simple F.M. Radio • EPE PIC Magnetometry Logger – 2.  
**FEATURES** • PIC To PS/2 Mouse and Keyboard Interfacing • Techno Talk • Circuit Surgery • Teach-In 2004 – Part 10 • Interface • Ingenuity Unlimited • PIC-N'-Mix • Net Work – The Internet Page.

## BACK ISSUES ONLY £3.50 each inc. UK p&p.

Overseas prices £4 each surface mail, £5.50 each airmail.

We can also supply issues from earlier years: 1999 (except Feb., May, Aug., Sept., Dec.), 2000 (except Feb., Mar., July, Oct.), 2001 (except Feb., May, Aug., to Nov.), 2002 (except Feb., June, Aug. to Nov.), 2003 (except June) Where we do not have an issue a photocopy of any *one article* or *one part* of a series can be provided at the same price.

### ORDER FORM – BACK ISSUES – PHOTOCOPIES– INDEXES

- Send back issues dated .....
- Send photocopies of (article title and issue date) .....
- Send copies of last five years indexes (£3.50 for five inc. p&p – Overseas £4 surface, £5.50 airmail)

Name .....

Address .....

.....Tel: .....

I enclose cheque/P.O./bank draft to the value of £ .....

Please charge my Visa/Mastercard/Amex/Diners Club/Switch £ .....

..... Switch Issue No.

Card No. ....

Valid From ..... Card Expiry Date ..... Card Security Code .....

(The last 3 digits on or just under the signature strip)

SEND TO: Everyday Practical Electronics, Wimborne Publishing Ltd., 408 Wimborne Road East, Ferndown, Dorset BH22 9ND.

Tel: 01202 873872. Fax: 01202 874562.

E-mail: [orders@epemag.wimborne.co.uk](mailto:orders@epemag.wimborne.co.uk) On-line Shop: [www.epemag.wimborne.co.uk/shopdoor.htm](http://www.epemag.wimborne.co.uk/shopdoor.htm)

Payments must be in £ sterling – cheque or bank draft drawn on a UK bank. Normally supplied within seven days of receipt of order.

Send a copy of this form, or order by letter if you do not wish to cut your issue.

M05/05

# STORE YOUR BACK ISSUES ON MINI CD-ROMS



**VOL 11  
NOW AVAILABLE**

**ONLY  
£14.45 each**  
including VAT  
and p&p

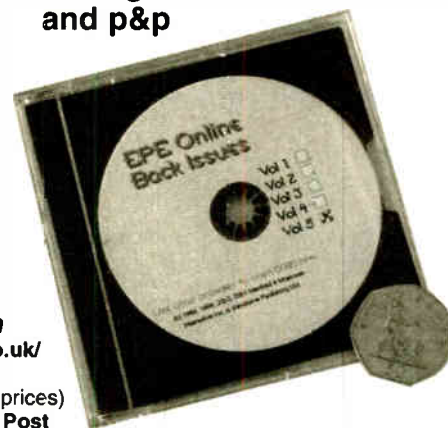

A great way to buy *EPE* Back Issues – our mini CD-ROMs contain back issues from our *EPE Online* website plus bonus articles, all the relevant PIC software and web links. Note: no free gifts are included. All this for just £14.45 each including postage and packing.

- VOL 1: BACK ISSUES** – January 1999 to June 1999  
Plus some bonus material from Nov and Dec 1998
- VOL 2: BACK ISSUES** – July 1999 to December 1999
- VOL 3: BACK ISSUES** – January 2000 to June 2000
- VOL 4: BACK ISSUES** – July 2000 to December 2000
- VOL 5: BACK ISSUES** – January 2001 to June 2001
- VOL 6: BACK ISSUES** – July 2001 to December 2001
- VOL 7: BACK ISSUES** – January 2002 to June 2002
- VOL 8: BACK ISSUES** – July 2002 to December 2002
- VOL 9: BACK ISSUES** – January 2003 to June 2003
- VOL 10: BACK ISSUES** – July 2003 to December 2003
- VOL 11: BACK ISSUES** – January 2004 to June 2004

**Order on-line from**  
[www.epemag.wimborne.co.uk/  
shopdoor.htm](http://www.epemag.wimborne.co.uk/shopdoor.htm)  
or [www.epemag.com](http://www.epemag.com) (USA \$ prices)  
or by phone, Fax, E-mail or Post

NOTE: These mini CD-ROMs are suitable for use on any PC with a CD-ROM drive. They require Adobe Acrobat Reader (available free from the Internet – [www.adobe.com/acrobat](http://www.adobe.com/acrobat))

## WHAT IS INCLUDED

All volumes include the *EPE Online* editorial content of every listed issue, plus all the available PIC Project Codes for the PIC projects published in those issues.

Note: Some supplements etc. can be downloaded free from the Library on the *EPE Online* website at [www.epemag.com](http://www.epemag.com). No advertisements are included in Volumes 1 and 2; from Volume 5 onwards the available relevant software for *Interface* articles is also included.

## EXTRA ARTICLES – ON ALL VOLUMES

**BASIC SOLDERING GUIDE** – Alan Winstanley's internationally acclaimed fully illustrated guide. **UNDERSTANDING PASSIVE COMPONENTS** – Introduction to the basic principles of passive components. **HOW TO USE INTELLIGENT L.C.D.s**, by Julyan Ilett – An utterly practical guide to interfacing and programming intelligent liquid crystal display modules. **PhyzyB COMPUTERS BONUS ARTICLE 1** – Signed and Unsigned Binary Numbers. By Clive "Max" Maxfield and Alvin Brown. **PhyzyB COMPUTERS BONUS ARTICLE 2** – Creating an Event Counter. By Clive "Max" Maxfield and Alvin Brown. **INTERGRAPH COMPUTER SYSTEMS 3D GRAPHICS** – A chapter from Intergraph's book that explains computer graphics technology. **FROM RUSSIA WITH LOVE**, by Barry Fox – Russian rockets launching American Satellites. **PC ENGINES**, by Ernest Flint – The evolution of Intel's microprocessors. **THE END TO ALL DISEASE**, by Aubrey Scoon – The original work of Rife. **COLLECTING AND RESTORING VINTAGE RADIOS**, by Paul Stenning. **THE LIFE & WORKS OF KONRAD ZUSE** – a brilliant pioneer in the evolution of computers. A bonus article on his life and work written by his eldest son, including many previously unpublished photographs.

Note: Some of the **EXTRA ARTICLES** require WinZip to unzip them.

## BACK ISSUES MINI CD-ROM ORDER FORM

Please send me ..... (quantity) BACK ISSUES CD-ROM VOL 1  
Please send me ..... (quantity) BACK ISSUES CD-ROM VOL 2  
Please send me ..... (quantity) BACK ISSUES CD-ROM VOL 3  
Please send me ..... (quantity) BACK ISSUES CD-ROM VOL 4  
Please send me ..... (quantity) BACK ISSUES CD-ROM VOL 5  
Please send me ..... (quantity) BACK ISSUES CD-ROM VOL 6  
Please send me ..... (quantity) BACK ISSUES CD-ROM VOL 7  
Please send me ..... (quantity) BACK ISSUES CD-ROM VOL 8  
Please send me ..... (quantity) BACK ISSUES CD-ROM VOL 9  
Please send me ..... (quantity) BACK ISSUES CD-ROM VOL 10  
Please send me ..... (quantity) BACK ISSUES CD-ROM VOL 11  
Price £14.45 each – includes postage to anywhere in the world.

Name .....

Address .....

..... Post Code .....

I enclose cheque/P.O./bank draft to the value of £ .....

Please charge my Visa/Mastercard/Amex/Diners

Club/Maestro

£ .....

Card No. ....

Card Security Code ..... (The last 3 digits on or just under the signature strip)

Valid From ..... Expiry Date .....

Maestro Issue No. ....

**SEND TO: Everyday Practical Electronics,  
Wimborne Publishing Ltd.,  
408 Wimborne Road East, Ferndown, Dorset BH22 9ND.  
Tel: 01202 873872. Fax: 01202 874562.  
E-mail: [orders@epemag.wimborne.co.uk](mailto:orders@epemag.wimborne.co.uk)**

Payments must be by card or in £ Sterling – cheque or bank draft drawn on a UK bank.

Normally supplied within seven days of receipt of order

# Passive Component Testing

Mike Tooley BA

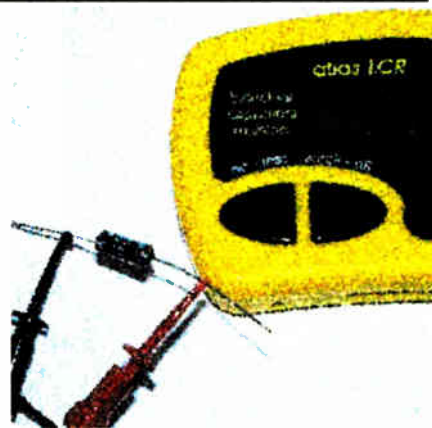

## Getting the most out of your passive component analyser

**A** COMPONENT analyser is an instrument that greatly simplifies the testing of passive or active components. Not only is such an instrument capable of carrying out a variety of tests it can also identify a component automatically.

Traditional LCR (inductance-capacitance-resistance) bridges are inherently complex and very time consuming to use. Apart from connecting the component on test to the instrument, a modern passive component analyser (such as Peak Electronic Design's Atlas LCR Analyser) does everything automatically. Not only will the device tell you what type of component is being tested but it will also display relevant additional data, such as the measured self-inductance of a low-value wirewound resistor.

The Atlas LCR Passive Component Analyser offers the following features:

- ☆ Automatic Component Identification
- ☆ Automatic Test Frequency Selection (DC, 1kHz, 15kHz and 200kHz)
- ☆ Delayed or Instant Analysis (for "hands-free operation")
- ☆ Auto Power-Off
- ☆ Probe and Test Lead Compensation
- ☆ Interchangeable Probe Sets
- ☆ Automatic Ranging and Scaling
- ☆ 1% Basic Accuracy

The passive component analyser automatically selects the best signal level and frequency for the particular component under test. The instrument uses "intelligent software" and, in order to ensure precision, all internal calculations are performed with floating point mathematics and values are displayed in properly formatted and easy-to-read engineering units, e.g. 15.9pF, 11.05Ω, etc.

The specifications of the Atlas LCR passive component analyser are as shown in Table 1.

Passive component analysers are primarily designed for carrying out measurements of components "out of circuit". They *should not* be used to carry out "in circuit" measurements as the readings obtained are likely to be significantly affected by the presence of other components. If, in spite of this, you are tempted to make measurements of components in-circuit it is absolutely *essential* to ensure that the power is removed from the circuit (or batteries disconnected) and any residual charge is removed from any capacitors that might be present.

A passive component analyser (of any type) should *never* be connected to powered equipment/components or to equipment/components with any stored energy (e.g. charged capacitors). Failure to

comply with this warning may result in personal injury and damage to the equipment under test, as well as damage to the component analyser itself.

The Atlas LCR Analyser is designed to operate with components connected on an individual basis. Testing of other components that are outside the supported range or that are part of component networks may give erroneous and misleading results.

By default, the analyser uses "delayed analysis". If you press the "On-Test" button to begin an analysis the instrument will power-up and then delay its measurement for five seconds in order to provide you with an opportunity to connect to the component on test. This is a useful facility but it can be somewhat time wasting if you have already made the necessary connections before switching the unit on!

If this is the case you should press the On-Test button a second time when the instrument indicates that the delay period has started. This will bypass the delay and start the measurement process. Once a set of measurements is complete (and before the results are displayed) the component on test can be disconnected from the analyser.

Results are displayed on screen one at a time and pressing the "Scroll-Off" button allows you to move from one screen to the next. If you reach the last screen of results, pressing Scroll-Off will return you to the first results screen again. The component analysis can be started again at any time by pressing the On-Test button.



After carrying out a probe compensation routine, the first stage in making a measurement with the LCR Analyser involves connecting it to the component on test



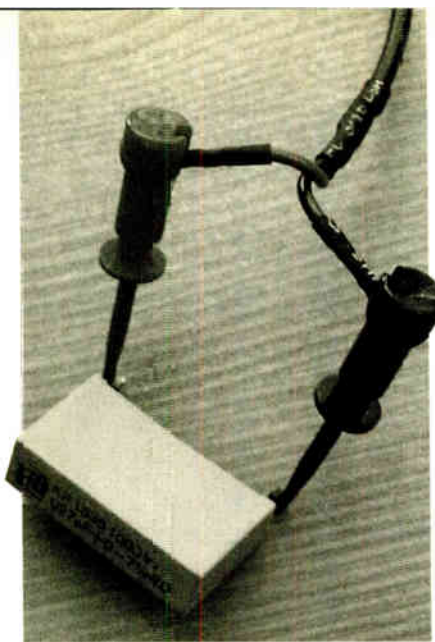

A variety of different probes are provided for use with the Analyser. These include long-reach grabbers (shown here), SMD clips and crocodile clips

**Table 1: Specifications of the Atlas LCR Passive Component Analyser**

<b>Inductance:</b>	Range	1 $\mu$ H to 10H
	Resolution	0.4 $\mu$ H min., 0.8 $\mu$ H typ.
	Accuracy	$\pm$ 1% $\pm$ 0.8 $\mu$ H
<b>Capacitance:</b>	Range	0.4pF to 10,000 $\mu$ F
	Resolution	0.1pF min., 0.3pF typ.
	Accuracy	$\pm$ 1% $\pm$ 0.3pF
<b>Resistance:</b>	Range	1 $\Omega$ to 2M $\Omega$
	Resolution	0.3 $\Omega$ min., 0.6 $\Omega$ typ.
	Accuracy	$\pm$ 1% $\pm$ 0.6pF
<b>Peak Test Voltage:</b>	$\pm$ 1.05V	
<b>Peak Test Current:</b>	$\pm$ 3.25mA	
<b>Test Frequency:</b>	1kHz $\pm$ 11%, 15kHz $\pm$ 11%, 200kHz $\pm$ 200ppm	
<b>Sine Purity:</b>	-60dB second harmonic	

If you change the probes on any analyser, it is good practice to run through the short compensation procedure. This ensures that the probes' own inductance, capacitance and resistance are automatically taken into account when making subsequent measurements. The recommended procedure is described later.

## Testing Resistors

The analyser can be used to test most common types of resistor. Depending on the value of the component on test, it will automatically select the most suitable test frequency. Low frequencies (e.g. 1kHz) are used to test large value inductors whilst high frequencies (e.g. 200kHz) are used to test small value inductors.

### Large Value Resistors

For resistance values of greater than about 10 $\Omega$  the following values are displayed on the instrument:

- Resistance value (10 $\Omega$  to 2M $\Omega$  with a minimum resolution of 0.5 $\Omega$ )
- Typical readings for various types of resistor are listed in Table 2.

### Low value resistors

For resistance values of less than 10 $\Omega$  the following values are displayed when the instrument's scroll button is pressed:

- Resistance value (0.5 $\Omega$  to 10 $\Omega$  with a minimum resolution of 0.5 $\Omega$ )
- Inductance value (with a minimum resolution of 0.1 $\mu$ H)
- Test frequency (1kHz, 15kHz or 200kHz)

Typical readings for various types of low value resistor are listed in the Table 3. Probe compensation is very important when analysing low value resistors, as discussed later.

Low value inductors (less than 10 $\mu$ H) and low value resistors (less than 10 $\Omega$ ) are treated as a special case by the Atlas LCR analyser. This is because low value inductors and low value resistors can exhibit very similar characteristics at the test frequencies generated by the instrument.

Pressing the Scroll button will display the values of resistance and inductance that the analyser has measured. Note that the test frequency displayed is the frequency used for the measurement of the resistor's self-inductance (not for the measurement of resistance).

**Table 2: Typical readings for large value resistors**

Component On Test	Measured Resistance
15 $\Omega$ 15W metal clad resistor	14.9 $\Omega$
33 $\Omega$ 2W carbon film	33.1 $\Omega$
100 $\Omega$ 2.2W vitreous enamelled	101.1 $\Omega$
620 $\Omega$ 0.25W metal oxide film	616.6 $\Omega$
4.7k $\Omega$ 0.25W metal oxide film	4.702k $\Omega$
1.8M $\Omega$ 0.25W carbon film	1.761M $\Omega$

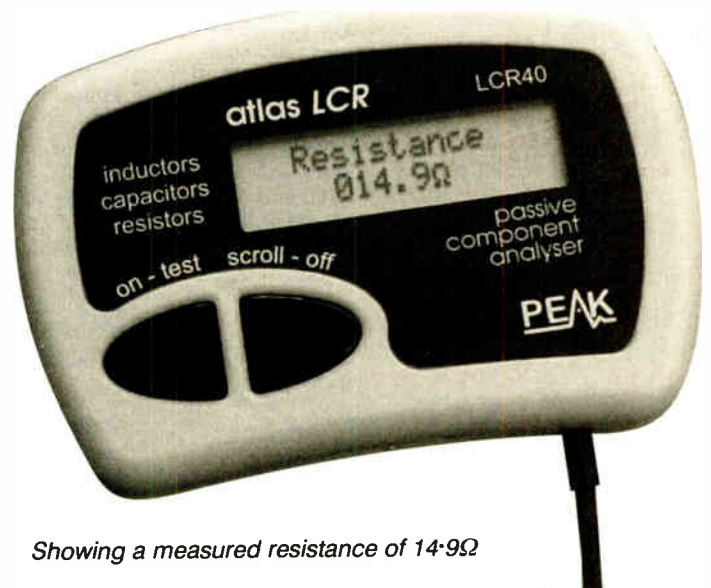

Showing a measured resistance of 14.9 $\Omega$

**Table 3: Typical readings for low value resistors**

Component On Test	Measured Resistance	Inductance	Test Frequency
0.1 $\Omega$ 2.2W vitreous enamelled wirewound	0.1 $\Omega$	0.4 $\mu$ H	200kHz
1 $\Omega$ 7W ceramic coated wirewound	1.0 $\Omega$	0.4 $\mu$ H	200kHz

## Testing Inductors

The analyser can be used to test most common types of inductors, coils and chokes. It is also possible to carry out some basic tests on transformers (including detecting short circuit turns).

Depending on the value of the component on test, the analyser will automatically select the most suitable test frequency. Low frequencies (e.g. 1kHz) are used to test large value inductors whilst high frequencies (e.g. 200kHz) are used to test small value inductors.

The following values are displayed on the instrument when the scroll button is pressed:

- Inductance value (1 $\mu$ H to 10H with a minimum resolution of 0.5 $\mu$ H)
- D.C. resistance (0.5 $\Omega$  to 1k $\Omega$  with a minimum resolution of 0.5 $\Omega$ )
- Test frequency (1kHz, 15kHz or 200kHz)

Typical values for various types of inductor are listed in Table 4.

Probe compensation is very important when analysing low value inductors, as discussed later.

## Capacitance Measurement

The component analyser uses two different methods to analyse capacitors, a.c. impedance analysis for low value capacitors (less than about 1 $\mu$ F) and d.c. transient analysis for larger capacitors (about 1 $\mu$ F to 10,000 $\mu$ F). The unit will automatically identify the type of capacitor being tested and apply the most appropriate test method.

### Low Value Capacitors

Low value capacitors include ceramic, polyester, polystyrene, mylar and mica dielectric capacitors with values generally less than 1 $\mu$ F, or so. Such capacitors tend to be unpolarised (though some tantalum electrolytic capacitors are available with values as low as 100nF or 0.1 $\mu$ F). The minimum capacitance resolution of the instrument is about 0.1pF.

The component analyser uses a high purity sinewave signal of 1kHz, 15kHz or 200kHz to analyse low value capacitors. Following analysis of the capacitor, the capacitance value is displayed first. Thereafter, pressing the Scroll-Off button will display the frequency at which the capacitance was measured.

Depending on the value of the component on test, the analyser will automatically select the most suitable test frequency. Low frequencies (e.g. 1kHz) are used to test large value capacitors whilst high frequencies (e.g. 200kHz) are used to test small value capacitors.

For capacitance values of less than about 1 $\mu$ F the following values are displayed on the instrument when the scroll button is pressed:

- Capacitance value (0.1pF to 1 $\mu$ F with a minimum resolution of 0.1pF)
- Test frequency (1kHz, 15kHz or 200kHz)

**Table 5: Example low value capacitor readings**

Component On Test	Measured Capacitance	Test Frequency
47pF 100V ceramic	44.1pF	200kHz
200pF 100V ceramic	186.4pF	200kHz
470pF 250V polystyrene	487.2pF	200kHz
1nF 250V ceramic	791.2pF	200kHz
10nF 50V ceramic	7.345nF	15kHz
27nF 1kV polyester	26.1nF	1kHz

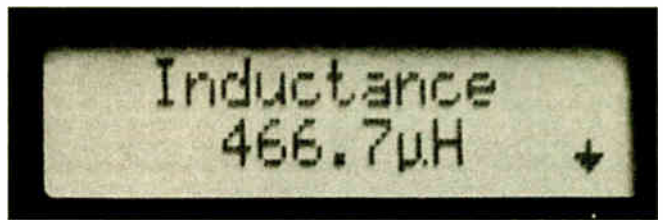

The measured value (466.7 $\mu$ H) of a 470 $\mu$ H inductor is displayed on the instrument's LCD screen. In order to obtain the d.c. resistance of the inductor (and to determine its Q-Factor) it is necessary to press the Scroll-Off button

**Table 4 Typical values for various types of inductor**

Component On Test	Measured Inductance	D.C. Resistance	Test Frequency
100 $\mu$ H ferrite-cored inductor	86.4 $\mu$ H	0.0 $\Omega$	200kHz
470 $\mu$ H ferrite-cored inductor	469.2 $\mu$ H	0.3 $\Omega$	200kHz
10mH miniature ferrite pot-cored inductor	10.0mH	4.2 $\Omega$	1kHz
10mH standard ferrite pot-cored inductor	10.33mH	18.9 $\Omega$	1kHz
2H iron-cored inductor	2.05H	206 $\Omega$	1kHz



Here the value of a capacitor is displayed on the instrument's LCD screen. The arrow displayed in the bottom right corner indicates the availability of more information which will be displayed when the Scroll-Off button is pressed

Typical values for various types of low value capacitor are listed in Table 5. Probe compensation is very important when analysing low value capacitors, as discussed later.

### Large Value Capacitors

Capacitors larger than about 1 $\mu$ F are treated differently, instead of being tested with an a.c. signal, they are tested with d.c. The following information is displayed when the Scroll button is pressed:

**Table 6: Example high value capacitor readings**

Component On Test	Measured Capacitance	Test Frequency
1 $\mu$ F 63V polycarbonate	1.023 $\mu$ F	d.c.
4.7 $\mu$ F 63V axial electrolytic	4.718 $\mu$ F	d.c.
22 $\mu$ F 10V tantalum electrolytic	21.62 $\mu$ F	d.c.
47 $\mu$ F 16V radial electrolytic	47.96 $\mu$ F	d.c.
1,000 $\mu$ F 16V radial electrolytic	1.056mF	d.c.

- Capacitance value (1μF to 10mF with a minimum resolution of 1nF)

- Test frequency (d.c.)

Typical values for various types of capacitor are listed in Table 6.

## Measuring Characteristic Impedance

Provided you have a reasonable length of transmission line or coaxial cable (say 5m to 10m, or more) available, one interesting use of a passive component analyser is that of providing an estimate of the characteristic impedance of the cable or line. Two separate measurements are required:

1. The inductance of the cable or line is measured with the far end short-circuit, and

2. The capacitance of the cable or line is measured with the far end open-circuit.

The characteristic impedance can be determined from the following formula:

$$Z_0 = \sqrt{\frac{L}{C}}$$

where  $Z_0$  is the characteristic impedance (in  $\Omega$ ),  $L$  is the measured value of inductance (in H), and  $C$  is the measured value of capacitance (in F).

To simplify the arithmetic a little, the formula can be expressed in terms of  $\mu\text{H}$  and pF, as follows:

$$Z_0 = 31.6 \times \sqrt{\frac{L}{C}}$$

where  $Z_0$  is the characteristic impedance (in  $\Omega$ ),  $L$  is the measured value of inductance (in  $\mu\text{H}$ ), and  $C$  is the measured value of capacitance (in nF).

The following example is based on measurements made on a drum (of unknown length) of RG213 coaxial low-loss feeder cable:

Inductance (measured with far end of cable short circuit): 22.5 $\mu\text{H}$

Capacitance (measured with far end of cable open circuit): 7.5nF

Using the formula stated previously:

$$\begin{aligned} Z_0 &= 31.6 \times \sqrt{\frac{L}{C}} = 31.6 \times \sqrt{\frac{22.5}{7.5}} \\ &= 31.6 \times \sqrt{3} = 31.6 \times 1.732 = 54.7\Omega \end{aligned}$$

This next example is based on measurements made on a 10m length of standard TV coaxial downlead cable:

Inductance (measured with far end of cable short circuit): 2.9 $\mu\text{H}$

Capacitance (measured with far end of cable open circuit): 560pF (= 0.56nF). Using the formula stated previously:

$$\begin{aligned} Z_0 &= 31.6 \times \sqrt{\frac{L}{C}} = 31.6 \times \sqrt{\frac{2.9}{0.56}} \\ &= 31.6 \times \sqrt{5.2} = 31.6 \times 2.3 = 73\Omega \end{aligned}$$



In this screen shot the d.c. resistance (0.3 $\Omega$ ) of an inductor is displayed

## Measuring Q-Factor

Although the passive component analyser does not indicate Q-factor directly, a rough estimate of the Q-factor of an inductor can easily be obtained. The value obtained will be sufficient to provide an indication of the "goodness" of the component as well as its suitability for use in a filter or resonant circuit application. The determination of Q-factor requires knowledge of:

1. The inductance of the inductor
2. The d.c. resistance (loss resistance) of the inductor

The approximate Q-factor (see later) of the inductor can be determined from the following formula:

$$Q = \frac{2\pi fL}{R}$$

where  $Q$  is the approximate Q-factor of the inductor,  $f$  is the frequency of the current applied to the inductor (i.e. its operating frequency),  $L$  is the measured value of inductance (in H), and  $R$  is the measured value of resistance (in  $\Omega$ ).

To simplify the arithmetic a little, the formula can be expressed in terms of mH and kHz (or  $\mu\text{H}$  and MHz) as follows:

$$Q = 6.28 \times \frac{fL}{R}$$

where  $f$  is the frequency in kHz or MHz,  $L$  is the measured value of inductance (in either mH or  $\mu\text{H}$ ), and  $R$  is the measured value of resistance (in  $\Omega$ ).

The following example is based on measurements made on a 10mH inductor used in a switched-mode power supply operating at 15kHz:

Inductance: 10.37mH

d.c. resistance: 18.9 $\Omega$

Using the formula stated previously, and working in units of mH and kHz gives:

$$\begin{aligned} Q &= 6.28 \times \frac{fL}{R} = 6.28 \times \frac{15 \times 10.37}{18.9} \\ &= 6.28 \times \frac{155.55}{18.9} = 51.7 \end{aligned}$$



Pressing the Scroll-Off button displays the test frequency (200kHz) on the instrument's screen

The next example is based on measurements made on a long-wave (200kHz) aerial coil:

Inductance: 1.087mH

D.C. resistance: 27.2Ω

Using the formula stated previously, and once again working in units of mH and kHz gives:

$$Q = 6.28 \times \frac{fL}{R} = 6.28 \times \frac{200 \times 1.087}{27.2}$$

$$= 6.28 \times \frac{217.4}{27.2} = 50.2$$

The following example is based on measurements made on the search coil of a metal detector working in a phase-locked loop at a frequency of 1MHz:

Inductance: 80.8μH

D.C. resistance: 2.2Ω

Using the formula stated previously, and this time working in units of μH and MHz gives:

$$Q = 6.28 \times \frac{fL}{R} = 6.28 \times \frac{1 \times 80.8}{2.2}$$

$$= 6.28 \times 36.73 = 231$$

It is important to note that the assessment of Q-factor based on passive component analyser readings makes use of the d.c. loss resistance of the component, and not the true loss resistance of the component at whatever operating frequency is present with the component connected "in circuit". This true loss resistance is made up from the sum of the d.c. and a.c. loss resistances and thus the true working Q-factor for an inductor will always be less than the Q-factor based on a measurement of its d.c. loss resistance.

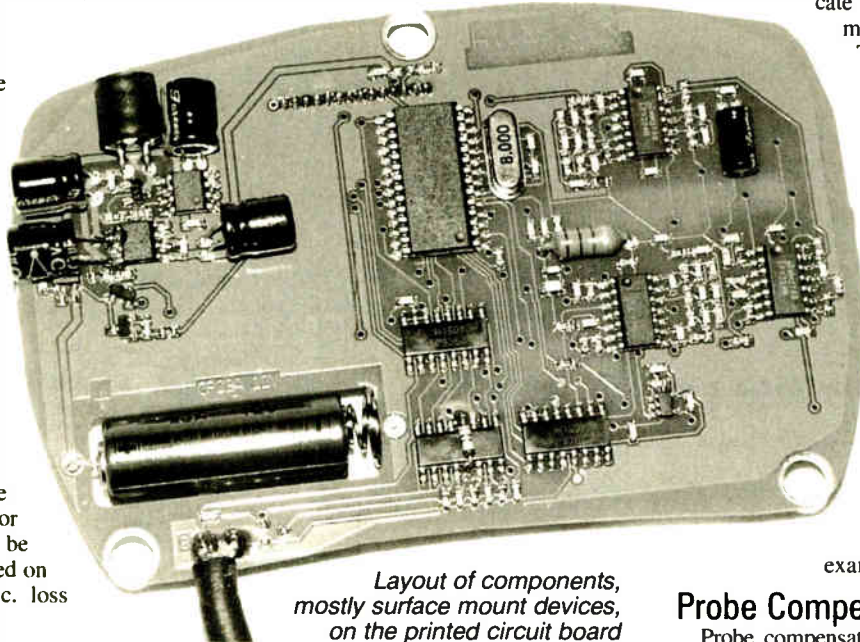

Layout of components, mostly surface mount devices, on the printed circuit board

Table 7: Testing Transformers

Inductance Measured	Measured Inductance	DC Resistance	Test Frequency
Known good component			
Primary (220V) winding	2.134H	226Ω	1kHz
Short-circuited primary turns			
Primary (220V) winding	320.3μH	207.2Ω	1kHz
Short-circuited secondary turns			
Primary (220V) winding	866.3μH	226Ω	1kHz



Checking the inductance of a metal detector pulse induction search coil

In most cases, however, the a.c. loss resistance will be significantly lower than the d.c. loss resistance and thus can usually be neglected when only an approximation of Q-factor is required. Despite this, it is worth remembering that the Q-factor obtained by the method described earlier represents a "best case" or "most optimistic" scenario!

### Testing Transformers

A passive component analyser can be used to carry out some basic tests on transformers as well as detecting short circuit turns. The inductance of each winding can be measured and compared with a "known good" component. Where a significant reduction in inductance is detected this will indicate the presence of one or more short circuited turns.

The data in Table 7 is based on "known good" and "known faulty" components (12VA transformers with 230V primaries and 12V secondaries rated at 1A) and will serve as an illustration.

It is interesting to note how the presence of shorted turns can be much more easily detected by using inductance measurement than by using resistance measurement – as the examples in Table 7 show!

### Probe Compensation

Probe compensation is needed to ensure that the Atlas LCR Analyser takes the probe characteristics into account when analysing components. The probe's inductance, capacitance and resistance are effectively subtracted from all subsequent measurements so that displayed readings relate to the component under test rather than the probes as well.

It is generally not necessary to perform probe compensation unless you are changing the probe types or the readings for an open circuit are more than ±2pF or the readings for a short circuit are more than 1Ω and/or ±2μH. Simply removing the probes and re-attaching them does not require a probe compensation procedure.

If you change the analyser's probes (perhaps to facilitate connection with a

## Tips For Better Results

- Ensure that you carry out the recommended probe compensation procedure whenever you change the probes used with the component analyser or before making measurements on low value components (e.g. resistors of less than 10Ω)
- Ensure that the components on test are within the measurement range of the instrument
- Be aware that measurements of low inductance, capacitance and resistance will be performed to a reduced resolution when compared with larger values
- Remember that, once measurements have been made, the results can be scrolled through without the need for the component on test to remain connected to the analyser
- Replace the analyser's battery on a regular basis (at least once every 12 months is recommended by the manufacturer)
- Do not hold the probe tips or component leads when making the measurements
- **Do not** attempt to make any measurements on a *live* network or circuit (this may cause irreversible damage to the instrument and the results are highly likely to be erroneous!)
- Remember to fully discharge large value capacitors before connecting them to the analyser

different type of component), it is good practice to run through the short compensation procedure. This ensures that the probes' own inductance, capacitance and resistance are automatically taken into account for subsequent measurements.

A typical probe compensation procedure is as follows:

1. To start the compensation procedure, simply press and hold the On-Test button until the start of the calibration routine is indicated on the display.
2. After a short delay, the unit will then prompt you to short the probes together. Note that if you are using the Atlas LCR's optional SMD tweezers, you should short the tips using the supplied dummy short circuit (Atlas describes this as a "dog tag").
3. After shorting the probes the unit will ask you to open the probes. If this procedure has been successful, the unit will simply display the message "OK" before switching itself off.

At this point the parasitic and stray characteristics associated with the test leads (and indeed the component analyser itself) will be stored in non-volatile memory. All further tests will have these values subtracted from the measured values, therefore displaying the characteristics of the component alone.

The foregoing procedure will cope with most situations. However, the following enhanced procedure is recommended in cases where you might need to ensure a more repeatable compensation result (for example when making repeated high-precision measurements on low-value components):

1. Ensure that the component analyser is switched off.
2. Clip the test leads to a short length of clean tinned copper wire.
3. Ensure that you are not touching the tinned copper wire, test clips or connections and that these are placed on an insulated surface.
4. Press and hold the On-Test button until the display shows "Probe Compensation". Once again, ensure that you are not touching the test clips or connections. The analyser will ask you to "short the probes" but there is no need to do this as the short-circuit is already in place. Simply wait a few seconds until the next instruction appears!
5. Follow the instruction to "open the probes" by unclipping the red clip from the tinned copper wire and then let go of the test leads and connections. The display will then show "OK" within a couple of seconds.

Finally, the probe compensation sequence should be tested using steps 6 to 9:

6. Ensure that nothing is connected to the test clips.
7. Briefly press the On-Test button. The analyser should then measure and display a capacitance value that is very close to 0pF ( $\pm 1$ pF).
8. Now connect the two clips to the tinned copper wire and briefly press the On-Test button again. The analyser should display "Low resistance and inductance" and then, after pressing the "Scroll-Off" button should display a resistance of close to 0Ω (i.e. less than 1Ω) and an inductance of close to 0μH ( $\pm 0.5$ μH).

9. If the readings in steps 7 and 8 are not obtained it is essential to repeat steps 1 to 5 of the compensation procedure before once again rechecking the effectiveness of the probe compensation.

## Obtaining the Atlas LCR

The Atlas LCR passive component analyser is available from Peak Electronic Design Ltd, Dept EPE, Atlas House, Kiln Lane, Harpur Industrial Estate, Buxton, Derbys SK17 9JL. Tel: 01298 70012. Further details of the instrument can also be obtained from [www.peakelec.co.uk](http://www.peakelec.co.uk). Its current price is £69, including UK delivery and VAT. □

## electronic surveillance equipment

- ◆ Professional quality UHF crystal equipment
- ◆ Cost effective VHF FM equipment
- ◆ SENSIBLE prices from a long established, discreet and reputable company
- ◆ Everything designed, developed and manufactured by us in-house and under our control
- ◆ We are dedicated to surveillance products... we make *nothing else*
- ◆ Latest surface mount technology on all modules for maximum performance and micro size
- ◆ We ship worldwide and accept cards, cash and cheques

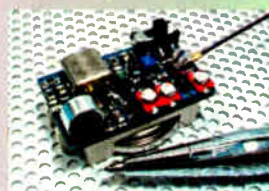

**SDX-2005**  
Ultra-miniature UHF crystal controlled surveillance bug  
£69.95 + p&p

A couple of our audio room devices shown complete with battery fitted. The pen tip is shown for size comparison....

Yes they really are this small...

Get hold of a copy of our catalogue for full details of these and many other audio surveillance devices. Full of interesting info.

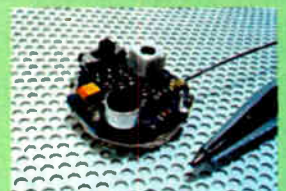

**SDV-2**  
Ultra-miniature VHF surveillance bug  
£29.95 + p&p

**suma**  
designs

Phone, fax or e-mail [sales@suma-designs.co.uk](mailto:sales@suma-designs.co.uk) for our free 2005 illustrated catalogue of audio surveillance equipment, or visit us on-line at [www.suma-designs.co.uk](http://www.suma-designs.co.uk).

The Workshops, 95 Main Road, Baxterley, Warwickshire, CV9 2LE UK  
Tel/Fax: 01827 714476  
[www.suma-designs.co.uk](http://www.suma-designs.co.uk)

# PRACTICALLY SPEAKING

Robert Penfold looks at the Techniques of Actually Doing It!

WITH the possible exception of connectors, there are probably no components that are lower-tech than switches. Although switches are low-tech, getting them connected correctly can be something of a Chinese puzzle.

Also, like many other types of component, the range of switches on offer seems to have grown quite dramatically over the years. Due care needs to be taken in order to ensure that you buy the right thing in the first place.

## Toggle and Slider

Most of the switches used in electronic projects are relatively simple types that provide a basic two-way action, such as an on/off switch. The most popular choices for this type of thing are toggle and slider switches. A toggle switch is operated via a small lever that is called a "dolly". Standard toggle switches have their origins in the early days of electronics, and are too large for use in most of today's projects. However, there are miniature and even smaller sub-miniature types that are well suited to use in even the smallest of electronic gadgets.

As its name suggests, a slider switch has a sliding control knob, usually with a very short travel. Slider switches are mostly very cheap, but are the less popular option as they often have rather awkward mounting requirements. Making the rectangular hole for the control knob is not particularly difficult, but making a neat job of it is a bit tricky. Many years of experience with slider switches suggests that they are not the most reliable of components.

Two-way switches exist in other forms, but the only other common types are the rotary and pushbutton varieties. A rotary switch has a standard control shaft, much like a potentiometer, that is fitted with a control knob. Rotary switches used to be popular for use as on/off switches, but their relatively large size makes them far from ideal for most modern projects. They also tend to be quite expensive and are difficult to obtain these days.

## Mind of its Own

Pushbutton switches are available in two basic forms, which are the biased and normal types. A biased switch is one that the user moves to one position, but the switch springs back to its original position as soon as it is released. A typical application for this type of component is as a reset switch. The equipment is held in a reset state while the switch is pressed, but it returns to normal operation when the switch is released. Switches of this type are sometimes referred to as "momentary operation" switches in component catalogues.

Simple pushbutton switches are available in two basic types, which are the "push-to-make" and "push-to-break" varieties. The former is the more common type, where the switch is normally open (off), and pressing the button produces a connection between its two tags. A "push-to-break" switch operates the other way round, with the contacts closed (on) until the button is operated. A project article should make it clear which type is needed. Where no guidance is given, it will almost certainly be a "push-to-make" switch that is required.

Note that some of the more complex pushbutton switches have this biased operation, as do a few special toggle types. These are rather specialist switches though, that are little used in projects.

Most pushbutton switches have what is normally termed "successive operation". This means that the switch changes state each time it is operated. For example, pressing an on/off switch the first time would switch the gadget on, operating the switch again would switch it off, a third press would switch it on again, etc.

## Contact Arrangements

When dealing with two-way switches you are certain to encounter terms such as d.p.s.t. and s.p.d.t.. These indicate the contact arrangement of the switch, and there are four types of simple switch. The terms used to describe them and their normal abbreviations are:

Contact Arrangement	Abbreviation
Single-pole, single-throw	s.p.s.t.
Single-pole, double-throw	s.p.d.t.
Double-pole, single-throw	d.p.s.t.
Double-pole, double-throw	d.p.d.t.

The simplest of these is the s.p.s.t. variety. This has just two tags and is a simple on/off switch. The d.p.s.t. switches are basically just two on/off switches in a single case and operated in unison. An s.p.d.t. switch has three tags rather than the two of an s.p.s.t. type, and these days it is often called a changeover switch. The middle tag is called the "pole", and it connects to one or other of the other two, depending on the setting of the switch.

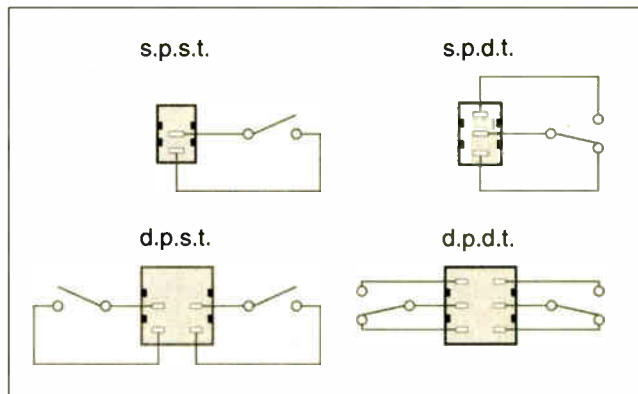

Fig.1. Switch tag arrangement and equivalent circuit symbols.

A switch of this type is used for selecting one or other of two functions. For example, a changeover switch can be used on a radio to switch between medium and long-wave operation. A d.p.d.t. switch is effectively just two s.p.d.t. switches in a single case and operating in unison. The tag arrangements normally used for all four types of switch, and how they relate to the circuit symbols, are shown in Fig.1.

## Continuity Test

Although most simple two-way switches use the arrangements shown in Fig.1, there are some exceptions. When dealing with any switch of an unfamiliar type there is a lot to be said for using a continuity tester to determine which tags are connected together at each setting of the switch. Even something as basic as a tester based on a battery and torch bulb is adequate for this type of testing.

Simply guessing and hoping is definitely not a good tactic when dealing with switches. Mistakes can result in faults such as short-circuits on the supply lines, which could result in damage to components and are potentially dangerous.

With toggle switches there is an additional trap for the unwary. Try to avoid the classic mistake of getting the two positions of the switch confused. Presumably the mistake would soon be spotted if this should happen with an on/off switch, but the problem could be far from obvious with a switch that is used to control some other function.

There have certainly been instances in the past where readers had problems with projects due to confusion about which mode the device was actually set to. A transistor tester had a number of constructors claiming that the design did not work, when the problem was simply a case of mistaken identity with device's *npn* and *pn* modes.

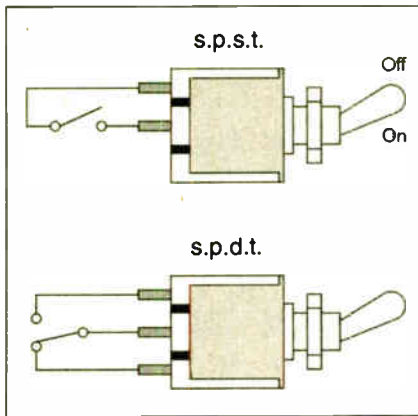

Fig.2. Toggle switch function

Fig.2 (top) shows the normal on and off positions for single-throw toggle switches. With double-throw switches the middle and lower tags are connected together when the dolly is in the "up" position, as in the lower drawing of Fig.2. Unhelpfully, slider switches have simpler mechanisms that operate in the opposite fashion. The middle and upper tags are connected together when the control knob is in the "up" position. There could be some exceptions, and it is a good idea to check using a continuity tester before connecting a switch.

### Rational Thinking

Many component ranges have been rationalised in recent years, and you might find that some switches are not offered in all four types. This does not really matter too much, because a d.p.d.t. switch can be used in place of any of the other three types. For example, if an s.p.d.t. switch is required, it is just a matter of using one pole of a d.p.d.t. type and leaving three tags unconnected. The other two types of switch can also be emulated by ignoring the tags that are not required.

Potentiometers having built-in d.p.s.t. are available, and are mainly used as a combined volume and on/off control. The tag arrangement of these switches gives little clue to the correct method of connection, but

Fig.3 should help to clarify matters. In battery powered circuits it is normal for only one supply to be switched. One pole of the switch will then be left unused, as in the lower diagram of Fig.3.

### Multi-way

Obviously some applications require more than two-way operation. With something like a piece of test gear that has six measuring ranges, it is necessary to have some form of six-way switch to enable the user to select the desired range. One approach to this type of switch is to have a bank of linked pushbutton switches. Operating a switch deselects the one that was selected previously, effectively turning the individual switches into a single multi-way type. This is in many ways a neat way of handling things, but banks of pushbutton switches tend to be awkward to use and quite expensive.

The more common approach for electronic projects is to use a multi-way rotary switch. These are available in 12-way 1-pole, 6-way 2-pole, 4-way 3-pole, and 3-way 4-pole versions, and all four types look much the same. Getting this type of switch connected correctly can be a bit tricky, but modern rotary switches are marked with letters and numbers that make things a bit easier. The pole tags are usually marked with letters from "A" to "D", and the other tags are numbered from "1" to "12", as shown in Fig.4.

As an example of how these switches operate, in position one (set fully counter clockwise) tags "A" and "B" of a 6-way switch respectively connect to tags "1" and "7". Moving the switch to position two connects tags "A" and "B" to tags "2" and "8" respectively, then tags "3" and "9" at position 3, and so on.

Wiring diagrams usually have the tag markings, so in practice it is just a matter of carefully duplicating the wiring in the diagram. The small size of the markings on the switches tends to make things a little awkward, and it is easy to get all the wiring to the outer ring shifted one tag along from where it should be. A useful ploy is use a small blob of ink or paint on the body of the component to mark tags "1" and "7". This makes it much easier to navigate your way around the switch and avoid errors.

Standard rotary switches have adjustable end-stops so that they can be used with less than the maximum number of ways. In many projects one or more poles of a

rotary switch are left unused. This means that it is often possible to use more than one type of rotary switch for a given application.

Suppose a 5-way 1-pole switch is required. You could use a 6-way 2-pole type with the end-stop set for 5-way operation and one pole left unused. It would be equally valid to use a 12-way single pole switch set for 5-way operation. However, unless you are sure you know what you are doing it is best to use the type of switch specified in the components list.

Adjusting the end-stop of a rotary switch is a bit fiddly but is not difficult. First remove the fixing nut and washer from the switch, and the metal end-stop can be dislodged using the blade of a small screwdriver or a penknife. The end-stop is then relocated in the appropriate slot and pushed right down into place. The switch is then ready to be mounted on the project's front panel.

### Make or Break

In component catalogues there are usually two ranges of multi-way rotary switch on offer. The two ranges are "break-before-make" and "make-before-break" switches. With a make-before-break switch the pole is still connected to one tag when it makes contact with the next. This produces a brief short-circuit between two non-pole tags as the switch is adjusted from one position to the next. With a break-before-make switch the pole is disconnected from the one tag before it is connected to the next, leaving the pole tag momentarily connected to nothing.

A components list will not necessarily specify one type or the other, and in many cases either will do. It is not advisable to use the wrong version if a components list does specify a certain type. In particular, using a make-before-break switch instead of a break-before-make type is likely to have dire consequences.

For example, each time the switch is operated it is possible that there will be a brief short-circuit across supply lines, two outputs will be momentarily connected together, or something similar. The switch would probably be short-lived, and there could be costly damage to the project.

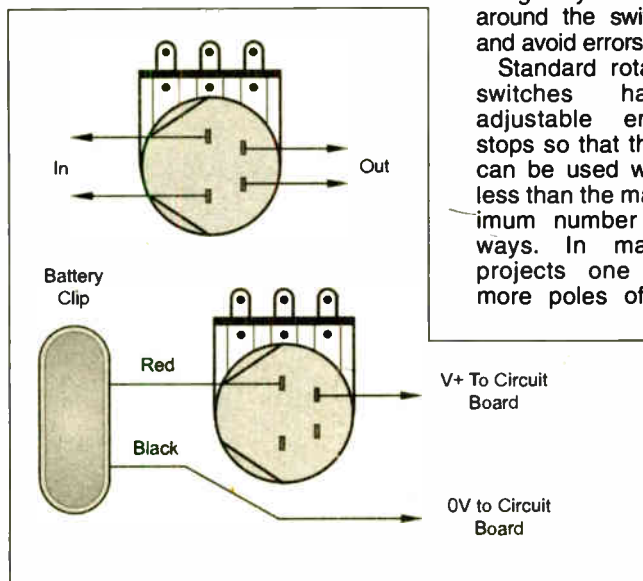

Fig.3. Connections for rotary potentiometer switches

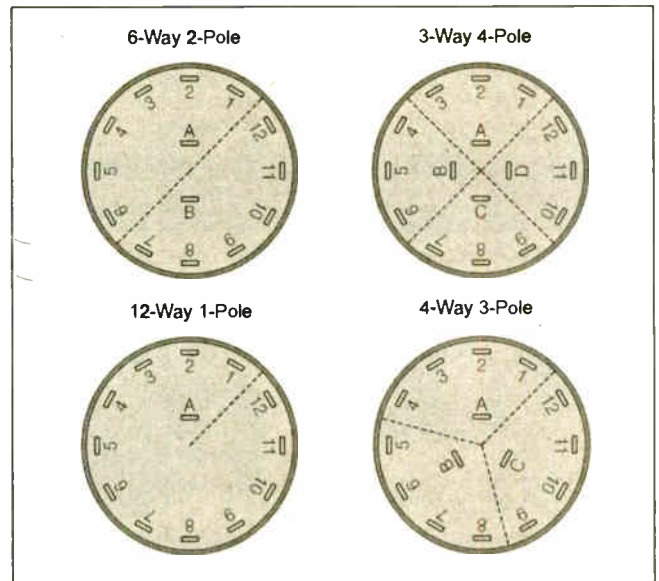
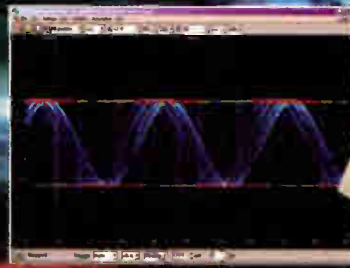

Fig.4. Tag notations on multiway rotary switches (tag view)

# PicoScope 3000 Series PC Oscilloscopes

The PicoScope 3000 series oscilloscopes are the latest offerings from the market leader in PC oscilloscopes combining high bandwidths with large buffer memories. Using the latest advances in electronics, the oscilloscopes connect to the USB port of any modern PC, making full use of the PC's processing capabilities, large screens and familiar graphical user interfaces.



- High performance: 10GS/s sampling rate & 200MHz bandwidth
- 1MB buffer memory
- High speed USB 2.0 interface
- Advanced display & trigger modes
- Compact & portable
- Supplied with PicoScope & PicoLog software

PicoScope	3204	3205	3206
Bandwidth	50MHz	100MHz	200MHz
Sampling rate (repetitive)	2.5GS/s	5GS/s	10GS/s
Sampling rate (single shot)	50MS/s	100MS/s	200MS/s
Channels	2+Ext Trigger	2+Ext Trigger Sig gen	2+Ext trigger Sig gen
Oscilloscope timebases	5ns/div to 50s/div	2ns/div to 50s/div	1ns/div to 50s/div
Timebase accuracy	50ppm	50ppm	50ppm
Spectrum ranges	0 to 25MHz	0 to 50MHz	0 to 100MHz
Buffer memory size	256KB	512KB	1MB
Resolution accuracy		8 bits, 3 <sup>rd</sup>	
Ranges		±100mV to ±20V	
PC Connection		USB2.0 (USB1.1 compatible)	

Tel: 01480 396395

[www.picotech.com/scope261](http://www.picotech.com/scope261)

**pico**  
Technology Limited

## For rapid development of electronic systems...

**E-BLOCKS™**

E-blocks are small circuit boards each of which contains a block of electronics typically found in an electronic system. E-blocks can be programmed in C, Assembly and are tightly integrated with Flowcode - which instantly converts flow charts into PICmicro code.



Low cost USB PIC programmers  
(Starting at £27, model shown £65)



...plus a wide range of add-on boards and accessories...



.....plus incredibly easy to use software based on flow charts...

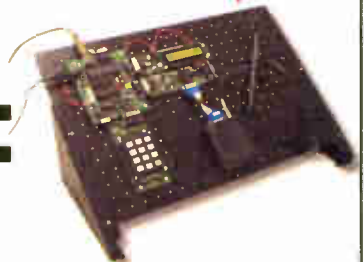

...equals extremely rapid system development: like this mobile text messaging system built from E-blocks.

## ...and solutions for learning and development...

Hands on training courses



training courses in PICmicro(R) programming, CPLD programming and ECAD

Resources for learning CPLD programming



Complete courses in electronics and programming



Equipment for datalogging, control and PC scopes



...and more at:

**mim**  
**www**

...see [www.matrixmultimedia.co.uk](http://www.matrixmultimedia.co.uk)

Matrix Multimedia Limited  
sales@matrixmultimedia.co.uk  
t. 0870 700 1831 f. 0870 700 1832



# EPE IS PLEASED TO BE ABLE TO OFFER YOU THESE ELECTRONICS CD-ROMS

## ELECTRONICS PROJECTS



Logic Probe testing

*Electronic Projects* is split into two main sections: **Building Electronic Projects** contains comprehensive information about the components, tools and techniques used in developing projects from initial concept through to final circuit board production. Extensive use is made of video presentations showing soldering and construction techniques. The second section contains a set of ten projects for students to build, ranging from simple sensor circuits through to power amplifiers. A shareware version of Matrix's CADPACK **schematic capture, circuit simulation and p.c.b. design software** is included. The projects on the CD-ROM are: Logic Probe; Light, Heat and Moisture Sensor; NE555 Timer; Egg Timer; Dice Machine; Bike Alarm; Stereo Mixer; Power Amplifier; Sound Activated Switch; Reaction Tester. Full parts lists, schematics and p.c.b. layouts are included on the CD-ROM.

## ELECTRONICS CAD PACK

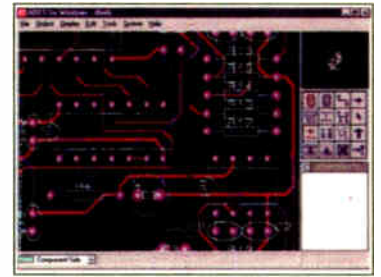

PCB Layout

Electronics CADPACK allows users to design complex circuit schematics, to view circuit animations using a unique SPICE-based simulation tool, and to design printed circuit boards. CADPACK is made up of three separate software modules. (These are restricted versions of the full Labcenter software.) **ISIS Lite** which provides full schematic drawing features including full control of drawing appearance, automatic wire routing, and over 6,000 parts. **PROSPICE Lite** (integrated into ISIS Lite) which uses unique animation to show the operation of any circuit with mouse-operated switches, pots, etc. The animation is compiled using a full mixed mode SPICE simulator. **ARES Lite** PCB layout software allows professional quality PCBs to be designed and includes advanced features such as 16-layer boards, SMT components, and an autorouter operating on user generated Net Lists.

## ELECTRONIC CIRCUITS & COMPONENTS V2.0

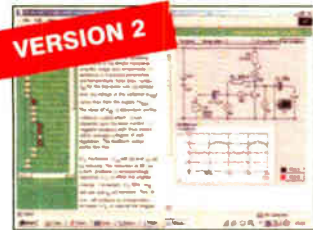

Circuit simulation screen

Provides an introduction to the principles and application of the most common types of electronic components and shows how they are used to form complete circuits. The virtual laboratories, worked examples and pre-designed circuits allow students to learn, experiment and check their understanding. Version 2 has been considerably expanded in almost every area following a review of major syllabuses (GCSE, GNVQ, A level and HNC). It also contains both European and American circuit symbols. Sections include: **Fundamentals**: units & multiples, electricity, electric circuits, alternating circuits. **Passive Components**: resistors, capacitors, inductors, transformers. **Semiconductors**: diodes, transistors, op.amps, logic gates. **Passive Circuits**. **Active Circuits**. **The Parts Gallery** will help students to recognise common electronic components and their corresponding symbols in circuit diagrams. Included in the Institutional Versions are multiple choice questions, exam style questions, fault finding virtual laboratories and investigations/worksheets.

## ANALOGUE ELECTRONICS

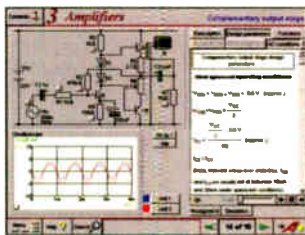

Complimentary output stage

*Analogue Electronics* is a complete learning resource for this most difficult branch of electronics. The CD-ROM includes a host of virtual laboratories, animations, diagrams, photographs and text as well as a SPICE electronic circuit simulator with over 50 pre-designed circuits. Sections on the CD-ROM include: **Fundamentals** – Analogue Signals (5 sections), Transistors (4 sections), Waveshaping Circuits (6 sections). **Op.Amps** – 17 sections covering everything from Symbols and Signal Connections to Differentiators. **Amplifiers** – Single Stage Amplifiers (8 sections), Multi-stage Amplifiers (3 sections). **Filters** – Passive Filters (10 sections), Phase Shifting Networks (4 sections), Active Filters (6 sections). **Oscillators** – 6 sections from Positive Feedback to Crystal Oscillators. **Systems** – 12 sections from Audio Pre-Amplifiers to 8-Bit ADC plus a gallery showing representative p.c.b. photos.

## ROBOTICS & MECHATRONICS

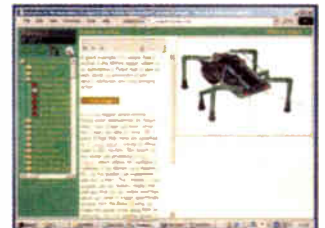

Case study of the Milford Instruments Spider

Robotics and Mechatronics is designed to enable hobbyists/students with little previous experience of electronics to design and build electromechanical systems. The CD-ROM deals with all aspects of robotics from the control systems used, the transducers available, motors/actuators and the circuits to drive them. Case study material (including the NASA Mars Rover, the Milford Spider and the Furby) is used to show how practical robotic systems are designed. The result is a highly stimulating resource that will make learning, and building robotics and mechatronic systems easier. The Institutional versions have additional worksheets and multiple choice questions.

- Interactive Virtual Laboratories
- Little previous knowledge required
- Mathematics is kept to a minimum and all calculations are explained
- Clear circuit simulations

## DIGITAL ELECTRONICS V2.0

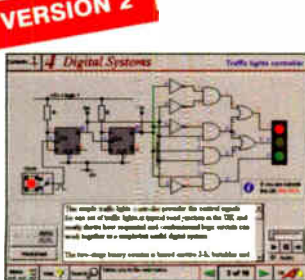

Virtual laboratory – Traffic Lights

*Digital Electronics* builds on the knowledge of logic gates covered in *Electronic Circuits & Components* (opposite), and takes users through the subject of digital electronics up to the operation and architecture of microprocessors. The virtual laboratories allow users to operate many circuits on screen. Covers binary and hexadecimal numbering systems, ASCII, basic logic gates, monostable action and circuits, and bistables – including JK and D-type flip-flops. Multiple gate circuits, equivalent logic functions and specialised logic functions. Introduces sequential logic including clocks and clock circuitry, counters, binary coded decimal and shift registers. A/D and D/A converters, traffic light controllers, memories and microprocessors – architecture, bus systems and their arithmetic logic units. Sections on Boolean Logic and Venn diagrams, displays and chip types have been expanded in Version 2 and new sections include shift registers, digital fault finding, programmable logic controllers, and microcontrollers and microprocessors. The Institutional versions now also include several types of assessment for supervisors, including worksheets, multiple choice tests, fault finding exercises and examination questions.

## ANALOGUE FILTERS

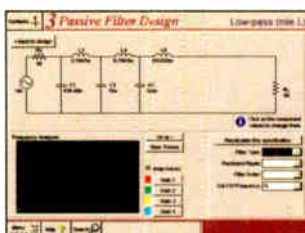

Filter synthesis

*Analogue Filters* is a complete course in designing active and passive filters that makes use of highly interactive virtual laboratories and simulations to explain how filters are designed. It is split into five chapters: **Revision** which provides underpinning knowledge required for those who need to design filters. **Filter Basics** which is a course in terminology and filter characterization, important classes of filter, filter order, filter impedance and impedance matching, and effects of different filter types. **Advanced Theory** which covers the use of filter tables, mathematics behind filter design, and an explanation of the design of active filters. **Passive Filter Design** which includes an expert system and filter synthesis tool for the design of low-pass, high-pass, band-pass, and band-stop Bessel, Butterworth and Chebyshev ladder filters. **Active Filter Design** which includes an expert system and filter synthesis tool for the design of low-pass, high-pass, band-pass, and band-stop Bessel, Butterworth and Chebyshev

## PRICES

Prices for each of the CD-ROMs above are:

(Order form on third page)

(UK and EU customers add VAT at 17.5% to "plus VAT" prices)

Hobbyist/Student .....	£45 inc VAT
Institutional (Schools/HE/FE/Industry).....	£99 plus VAT
Institutional 10 user (Network Licence).....	£249 plus VAT
Site Licence.....	£499 plus VAT

# PICmicro TUTORIALS AND PROGRAMMING

## HARDWARE

### VERSION 2 PICmicro MCU DEVELOPMENT BOARD

Suitable for use with the three software packages listed below.

This flexible development board allows students to learn both how to program PICmicro microcontrollers as well as program a range of 8, 18, 28 and 40-pin devices. For experienced programmers all programming software is included in the PPP utility that comes with the development board. For those who want to learn, choose one or all of the packages below to use with the Development Board.

- Makes it easier to develop PICmicro projects
- Supports low cost Flash-programmable PICmicro devices
- Fully featured integrated displays – 13 individual I.e.d.s, quad 7-segment display and alphanumeric I.c.d. display
- Supports PICmicro microcontrollers with A/D converters
- Fully protected expansion bus for project work
- All inputs and outputs available on screw terminal connectors for easy connection

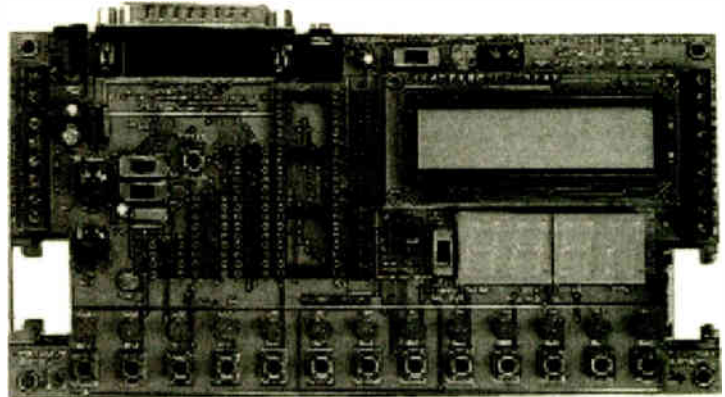

£145 including VAT and postage

12V 500mA plug-top PSU (UK plug) £7

25-way 'D' type connecting cable £5

## SOFTWARE

### NEW V3

Suitable for use with the Development Board shown above.

### ASSEMBLY FOR PICmicro V3 (Formerly PICtutor)

Assembly for PICmicro microcontrollers V3.0 (previously known as PICtutor) by John Becker contains a complete course in programming the PIC16F84 PICmicro microcontroller from Arizona Microchip. It starts with fundamental concepts and extends up to complex programs including watchdog timers, interrupts and sleep modes. The CD makes use of the latest simulation techniques which provide a superb tool for learning: the Virtual PICmicro microcontroller. This is a simulation tool that allows users to write and execute MPASM assembler code for the PIC16F84 microcontroller on-screen. Using this you can actually see what happens inside the PICmicro MCU as each instruction is executed which enhances understanding.

- Comprehensive instruction through 45 tutorial sections
- Includes Vlab, a Virtual PICmicro microcontroller: a fully functioning simulator
- Tests, exercises and projects covering a wide range of PICmicro MCU applications
- Includes MPLAB assembler
- Visual representation of a PICmicro showing architecture and functions
- Expert system for code entry helps first time users
- Shows data flow and fetch execute cycle and has challenges (washing machine, lift, crossroads etc.)
- Imports MPASM files.

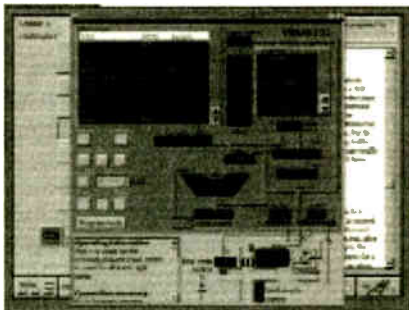

Virtual PICmicro

### 'C' FOR PICmicro VERSION 2

The C for PICmicro microcontrollers CD-ROM is designed for students and professionals who need to learn how to program embedded microcontrollers in C. The CD contains a course as well as all the software tools needed to create Hex code for a wide range of PICmicro devices – including a full C compiler for a wide range of PICmicro devices.

Although the course focuses on the use of the PICmicro microcontrollers, this CD-ROM will provide a good grounding in C programming for any microcontroller.

- Complete course in C as well as C programming for PICmicro microcontrollers
- Highly interactive course
- Virtual C PICmicro improves understanding
- Includes a C compiler for a wide range of PICmicro devices
- Includes full Integrated Development Environment
- Includes MPLAB software
- Compatible with most PICmicro programmers
- Includes a compiler for all the PICmicro devices.

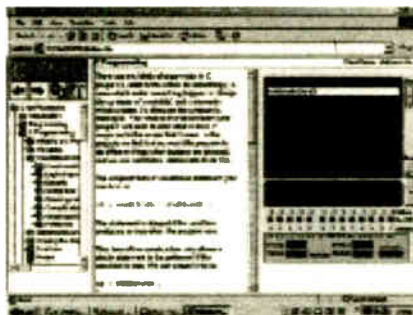

Minimum system requirements for these items: Pentium PC running Windows 98, NT, 2000, ME, XP; CD-ROM drive; 64MB RAM; 10MB hard disk space.

### FLOWCODE FOR PICmicro V2

Flowcode is a very high level language programming system for PICmicro microcontrollers based on flowcharts. Flowcode allows you to design and simulate complex robotics and control systems in a matter of minutes.

Flowcode is a powerful language that uses macros to facilitate the control of complex devices like 7-segment displays, motor controllers and I.c.d. displays. The use of macros allows you to control these electronic devices without getting bogged down in understanding the programming involved.

Flowcode produces MPASM code which is compatible with virtually all PICmicro programmers. When used in conjunction with the Version 2 development board this provides a seamless solution that allows you to program chips in minutes.

- Requires no programming experience
- Allows complex PICmicro applications to be designed quickly
- Uses international standard flow chart symbols (ISO5807)
- Full on-screen simulation allows debugging and speeds up the development process
- Facilitates learning via a full suite of demonstration tutorials
- Produces ASM code for a range of 18, 28 and 40-pin devices
- Professional versions include virtual systems (burglar alarm, buggy and maze, plus RS232, IrDa etc.).

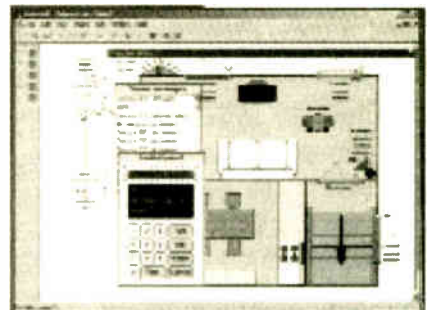

Burglar Alarm Simulation

## PRICES

Prices for each of the CD-ROMs above are:

(Order form on next page)

(UK and EU customers add VAT at 17.5% to "plus VAT" prices)

Hobbyist/Student  
Flowcode V2 Hobbyist/Student  
Institutional (Schools/HE/FE/Industry)  
Flowcode Professional  
Institutional/Professional 10 user (Network Licence)  
Site Licence

£45 inc VAT  
£57 inc VAT  
£99 plus VAT  
£99 plus VAT  
£300 plus VAT  
£599 plus VAT

# TEACH-IN 2000 – LEARN ELECTRONICS WITH EPE

EPE's own *Teach-In* CD-ROM, contains the full 12-part *Teach-In* series by John Becker in PDF form plus the *Teach-In* interactive software (Win 95, 98, ME and above) covering all aspects of the series. We have also added Alan Winstanley's highly acclaimed *Basic Soldering Guide* which is fully illustrated and which also includes *Desoldering*. The *Teach-In* series covers: Colour Codes and Resistors, Capacitors, Potentiometers, Sensor Resistors, Ohm's Law, Diodes and L.E.D.s, Waveforms, Frequency and Time, Logic Gates, Binary and Hex Logic, Op.amps, Comparators, Mixers, Audio and Sensor Amplifiers, Transistors, Transformers and Rectifiers, Voltage Regulation, Integration, Differentiation, 7-segment Displays, L.C.D.s, Digital-to-Analogue. Each part has an associated practical section and the series includes a simple PC interface (Win 95, 98, ME ONLY) so you can use your PC as a basic oscilloscope with the various circuits.

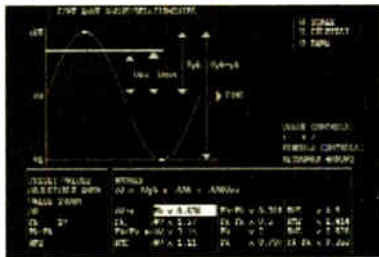

Sine wave relationship values

**A hands-on approach to electronics with numerous breadboard circuits to try out.**

**£12.45 including VAT and postage.** Requires Adobe Acrobat (available free from the Internet – [www.adobe.com/acrobat](http://www.adobe.com/acrobat)).

**FREE WITH EACH TEACH-IN CD-ROM – *Electronics Hobbyist Compendium*** 80-page book by Robert Penfold. Covers Tools For The Job: Component Testing; Oscilloscope Basics.

**FREE BOOK WITH TEACH-IN 2000 CD-ROM**

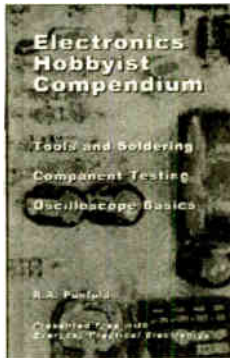

# DIGITAL WORKS 3.0

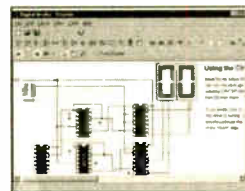

Counter project

*Digital Works Version 3.0* is a graphical design tool that enables you to construct digital logic circuits and analyze their behaviour. It is so simple to use that it will take you less than 10 minutes to make your first digital design. It is so powerful that you will never outgrow its capability ● Software for simulating digital logic circuits ● Create your own macros – highly scalable ● Create your own circuits, components, and i.c.s ● Easy-to-use digital interface ● Animation brings circuits to life ● Vast library of logic macros and 74 series i.c.s with data sheets ● Powerful tool for designing and learning. **Hobbyist/Student £45 inc. VAT. Institutional £99 plus VAT. Institutional 10 user £249 plus VAT. Site Licence £599 plus VAT.**

## ELECTRONICS IN CONTROL

Two colourful animated courses for students on one CD-ROM. These cover Key Stage 3 and GCSE syllabuses. **Key Stage 3:** A pictorial look at the Electronics section featuring animations and video clips. Provides an ideal introduction or revision guide, including multi-choice questions with feedback. **GCSE:** Aimed at the Electronics in many Design & Technology courses, it covers many sections of GCSE Electronics. Provides an ideal revision guide with Homework Questions on each chapter. Worked answers with an access code are provided on a special website.

**Single User £29 inc. VAT. Multiple User £39 plus VAT**  
**Student copies (available only with a multiple user copy) £6 plus VAT**  
 (UK and EU customers add VAT at 17.5% to "plus VAT" prices)

## MODULAR CIRCUIT DESIGN

**VERSION 3**

Contains a range of tried and tested analogue and digital circuit modules, together with the knowledge to use and interface them. Thus allowing anyone with a basic understanding of circuit symbols to design and build their own projects. Version 3 includes data and circuit modules for a range of popular PICs; includes PICAXE circuits, the system which enables a PIC to be programmed without a programmer, and without removing it from the circuit. Shows where to obtain free software downloads to enable BASIC programming. Essential information for anyone undertaking GCSE or "A" level electronics or technology and for hobbyists who want to get to grips with project design. Over seventy different Input, Processor and Output modules are illustrated and fully described, together with detailed information on construction, fault finding and components, including circuit symbols, pinouts, power supplies, decoupling etc.

**Single User £19.95 inc. VAT. Multiple User £34 plus VAT**  
 (UK and EU customers add VAT at 17.5% to "plus VAT" prices)

Minimum system requirements for these CD-ROMs: Pentium PC, CD-ROM drive, 32MB RAM, 10MB hard disk space. Windows 95/98/NT/2000/ME/XP, mouse, sound card, web browser.

### Please send me: CD-ROM ORDER FORM

- Electronic Projects
- Electronic Circuits & Components V2.0
- Analogue Electronics
- Digital Electronics V2.0
- Filters
- Electronics CAD Pack
- Robotics & Mechatronics
- Assembly for PICmicro V2
- 'C' for PICmicro V2
- Flowcode V2 for PICmicro
- Digital Works 3.0

- Version required:
- Hobbyist/Student
  - Institutional
  - Institutional/Professional 10 user
  - Site licence



- PICmicro Development Board V2 (hardware)
- Development Board UK plugtop power supply
- Development Board 25-way connecting lead

- Teach-In 2000 + FREE BOOK
- Electronic Components Photos
- Electronics In Control – Single User
- Electronics In Control – Multiple User
- Modular Circuit Design – Single User
- Modular Circuit Design – Multiple User

Note: The software on each version is the same, only the licence for use varies.

Full name: .....

Address: .....

Post code: ..... Tel. No: .....

Signature: .....

I enclose cheque/PO in £ sterling payable to WIMBORNE PUBLISHING LTD for £

Please charge my Visa/Mastercard/Amex/Diners Club/Switch: £

Valid From: ..... Card expiry date: .....

Card No: ..... Switch Issue No. ....

Card Security Code ..... (The last 3 digits on or just under the signature strip)

## ORDERING

**ALL PRICES INCLUDE UK POSTAGE**

Student/Single User/Standard Version price includes postage to most countries in the world  
 EU residents outside the UK add £5 for airmail postage per order

Institutional, Multiple User and Deluxe Versions – overseas readers add £5 to the basic price of each order for airmail postage (do not add VAT unless you live in an EU (European Union) country, then add 17½% VAT or provide your official VAT registration number).

Send your order to:

**Direct Book Service  
 Wimborne Publishing Ltd  
 408 Wimborne Road East  
 Ferndown, Dorset BH22 9ND**

To order by phone ring

**01202 873872. Fax: 01202 874562**

Goods are normally sent within seven days

E-mail: [orders@wimborne.co.uk](mailto:orders@wimborne.co.uk)

Online shop:

[www.epemag.wimborne.co.uk/shopdoor.htm](http://www.epemag.wimborne.co.uk/shopdoor.htm)

# DAB Radio Aerial

Stef Niewiadomski

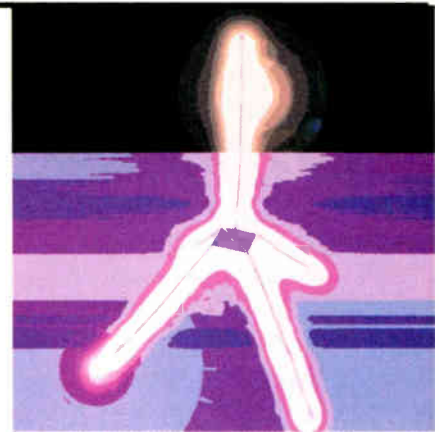

## A loft-mounted quarter-wave ground plane antenna for digital radio reception

**T**HE cost of Digital Audio Broadcast (DAB) receivers has dropped dramatically and they are becoming very popular. Most rely on telescopic aerials and in most areas two or three DAB multiplexes (also called "ensembles") can be received, but the transmitter coverage is still evolving and some areas do not get good coverage.

This article describes an easy-build omni-directional antenna suitable for room or loft mounting. Details are also given for mounting the antenna outside and it can be easily modified for use on other v.h.f./u.h.f. bands, for instance the 2m and 70m amateur bands.

The prototype aerial was conceived and successfully constructed in just over the hour. Buying all the parts new, the antenna should cost under £10 and many of the bits may already be to hand.

As described here, the cable from the antenna plugs into a 75Ω F-type socket in the author's Pure Evoke-1 DAB radio, but other plugs can be fitted as necessary if needed.

### Digital Radio in the UK

Digital audio broadcast transmissions use vertical polarisation, in the old Band III VHF TV range of frequencies, in the range 174MHz to 240MHz which is divided into 41 channels identified as 5A to 13F. Table 1 shows the complete set of DAB Band III channel numbers and their exact frequencies. The UK DAB stations transmit in the range 11B to 12D.

Because of the multiplexed nature of the DAB signal, each channel can accommodate many stations. For example, the BBC multiplexes Radios 1, 2, 3, 4, Five Live, Sports Extra, 6 Music, 7, 1Xtra, BBC Asian Network and BBC World Service onto channel 12B. This service is known as the BBC National DAB.

Non-BBC stations have their own multiplexes. For example, channel 11D is the Digital One Network and contains Classic FM, Virgin Radio, talkSport, Planet Rock, and many other commercial stations. Big cities have their own multiplexes containing local programmes.

Multiplexes and stations have labels (i.e. names) which are used to identify them, rather than frequencies as used in v.h.f.

f.m. broadcasting. A typical DAB radio will scan for DAB multiplexes with sufficient signal strength and display the multiplex numbers and the names of the stations within those multiplexes. The listener only has to select the stations by name, and does not need to know the frequencies involved.

One clever feature of the DAB multiplexing scheme is that each station within the multiplex can be dynamically allocated a different bandwidth, depending on the nature of the programme content and the audio quality needed. For example, a popular stereo music station (such as Radio 2) is typically given 128kb/s, whereas a mainly talk mono station (such as talkSPORT) is given only 64kb/s. A high quality stereo station (such as Radio 3) is given 192kb/s.

Stations can also broadcast their identity and nature of their broadcast. For example, the type of material, name of the programme, the broadcaster's name and identity of the music being played are often broadcast for display on the receiver.

There are several web sites where you can type in your post code and check the range of DAB stations you should be able to receive. For example:

<http://www.bbc.co.uk/digitalradio/index.shtml?digitalradio>

Unlike the v.h.f. f.m. radio network where directional antennas pointing at a single specific transmitter are used, DAB antennas should be omni-directional and reception from several directions actually helps.

Table 1. Band III DAB Radio Channel Numbers and Transmission Frequencies

5A	174.928MHz	8B	197.648MHz	11B	218.640MHz
5B	176.640MHz	8C	199.360MHz	11C	220.352MHz
5C	178.352MHz	8D	201.072MHz	11D	222.064MHz
5D	180.064MHz	9A	202.928MHz	12A	223.936MHz
6A	181.936MHz	9B	204.640MHz	12B	225.648MHz
6B	183.648MHz	9C	206.352MHz	12C	227.360MHz
6C	185.360MHz	9D	208.064MHz	12D	229.072MHz
6D	187.072MHz	10A	209.936MHz	13A	230.784MHz
7A	188.928MHz	10B	211.648MHz	13B	232.496MHz
7B	190.640MHz	10C	213.360MHz	13C	234.208MHz
7C	192.352MHz	10D	215.072MHz	13D	235.776MHz
7D	194.064MHz	11A	216.928MHz	13E	237.488MHz
8A	195.936MHz			13F	239.200MHz

Tint area indicates UK DAB stations allocation

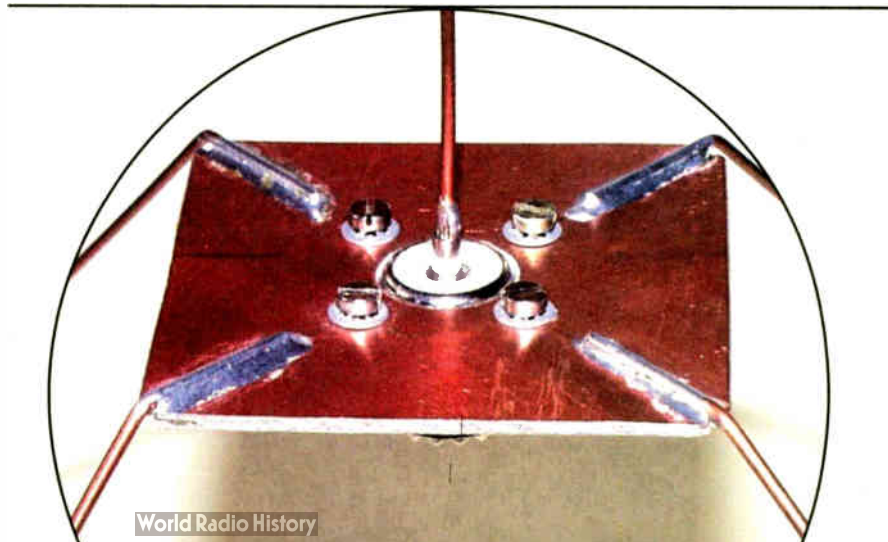

## Quarter-Wave Antenna

The general arrangement of the quarter-wave ground plane antenna described here is shown in Fig.1 and the accompanying photographs. The "active" portion of the antenna is a vertical element soldered to the centre pin of a SO239 u.h.f. socket. The length of the vertical element is one quarter of the wavelength of the frequency to be received. Of course, in our application here, we want to receive a range of frequencies, and in practice this doesn't give a problem because the antenna's response isn't so sharp that frequencies at the band edges are noticeably attenuated.

The length (L) in mm of the vertical element is given by the formula:

$$L = 71323 / f$$

Where: *f* is the frequency in MHz.

Not being sure of the DAB transmission range in the author's location (Oxfordshire area), the antenna's nominal centre frequency was set at 225MHz, which gives the value of L of 317mm, as shown in the diagrams. Using the prototype antenna, DAB signals could be received at 220.35MHz (11C), 222.06MHz (11D), 225.64MHz (12B) and 229.07MHz (12D), which shows that an element length of 317mm is probably a good compromise value.

The small loop at the top of the vertical element is simply to enable the antenna to be hung by some non-conducting medium, for example nylon string, in a loft. It also acts as a safety feature, avoiding the chance of eye damage by a sharp end on the vertical rod.

The "ground plane" consists of a small piece of copper clad board, forming the ground plate, and four ground plane element wires bent down 45° to the horizontal. It is this bending down that adjusts the impedance of the antenna from about 36Ω if they were left horizontal (or if a big ground plane plate were used) to 50Ω at the 45° angle.

## Construction

Commence construction by first cutting a piece of 16s.w.g. (1.5mm) hard-drawn (stretched) element wire to a length of about 350mm and forming a small loop at one end to make the antenna easy to hang in the loft. The other end of the wire is gradually trimmed, trying it in the protruding pin of the SO239 socket (see Fig.1), until the overall height of the element is 317mm. This sounds more difficult than it is in practice, and in fact the exact length of the vertical element is not too critical as long as it is within a few millimetres of the calculated value. Now solder the vertical element into the SO239 socket as indicated in Fig.1.

The general procedure for making the ground plane of the antenna is shown, in Fig.2. The ground plane plate itself is formed from a 60mm square piece of single-sided copper-clad board, the centre of which is drilled to accommodate the chassis-mounting SO239 socket which supports the vertical element.

The 15mm diameter hole for the socket was cut with a Q-max cutter, which makes

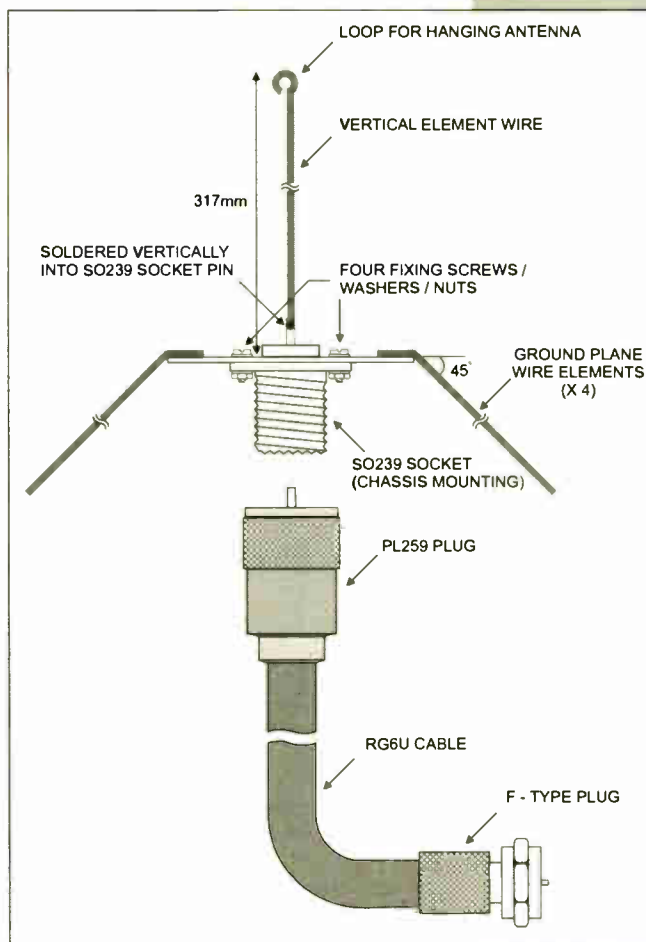

Fig.1. General construction of the DAB radio quarter-wave, ground plane antenna

a very neat hole, but if you do not have such a cutter, you will have to drill the largest hole you can and then file the hole to its final size using a round file. Once this hole has been made, place the socket in the hole, and mark and drill the four fixing holes, see Fig.2.

Next, the four corners of the ground plate are chamfered and a half-round indent is filed at each corner with a needle file. These indents allow the ground plane elements to fit neatly into the four corners, though they are not necessary for the correct functioning of the final antenna.

## COMPONENTS

Approx. Cost  
Guidance Only **£10**  
Excl cable

### LOFT VERSION

A piece of single-sided copper-clad board, size 60mm x 60mm; approximately 2m 16s.w.g. (1.5mm) hard-drawn copper wire for antenna elements or similar copper wire; SO239 u.h.f. chassis-mounting socket; PL259 u.h.f. plug; F-type plug; RG6U satellite TV coaxial cable, length according to siting of antenna and radio; screws nuts and washers for SO239 socket mounting; solder etc.

### OUTDOOR MOUNTING. *As above, plus:*

section of 40mm outside diameter polythene tubing (plumbing pipe), length to suit mounting location; resin glue (Araldite); silicone bathroom sealant.

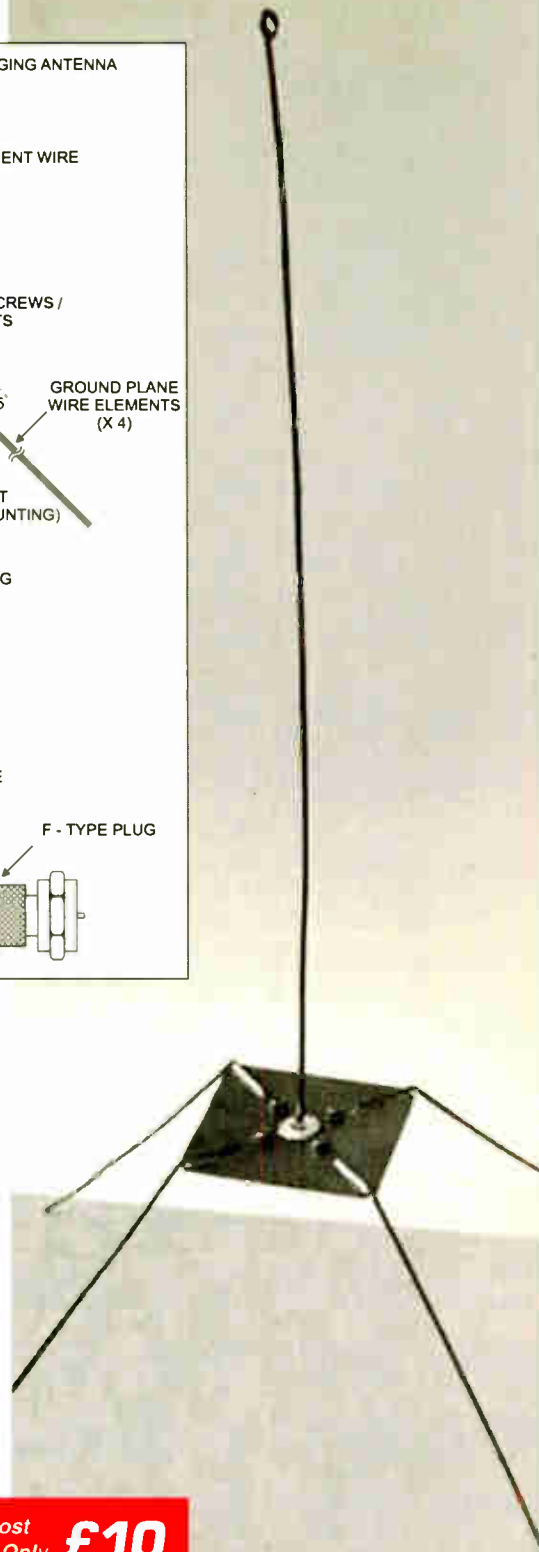

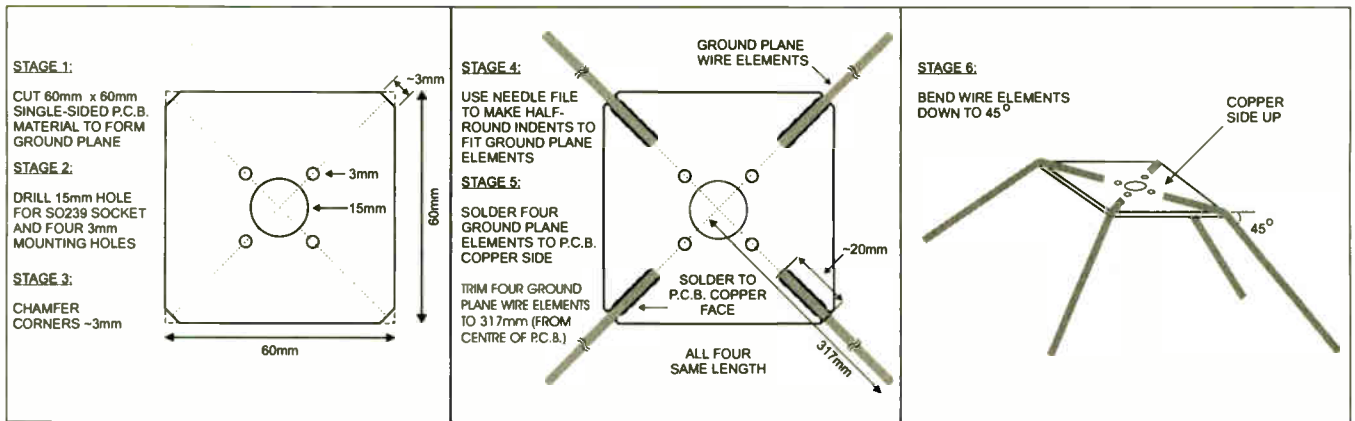

Fig.2. Suggested procedure for making the antenna's ground plane. The copper-faced plate measures just 60mm (2.36in) square

Four lengths of 16s.w.g. (1.5mm) ground plane element wire are cut to about 320mm, and each one soldered to the ground plate copper surface as shown in Fig.2. An overlap of about 20mm on the board is sufficient to give a mechanically sound joint, and avoid the SO239 socket fixing holes. All four elements should now be cut down to lengths of 317mm (i.e. the same length as the vertical element), as measured from the centre of the ground plate, as shown in Fig.2.

With the copper side of the ground plate facing upwards, the four ground element wires should be bent downward by 45°.

The SO239 socket, with the vertical element already soldered onto it, is now inserted from below into the centre hole in the ground plane plate and fixed with four 6BA screws, washers and nuts. If you have them, use star washers so that they "bite" into the copper material slightly and ensure good electrical contact between the metal outer of the SO239 socket and the ground plane.

## Making up the Cable

A length of RG6U 75Ω satellite cable is used to connect the antenna to the DAB radio. A PL259 u.h.f. plug is attached to one end of the cable, which plugs into the SO239 socket supporting the vertical element. The other end of the cable is fitted with an F-type plug for connection to the radio. The suggested method involved in fitting the PL259 plug onto the cable is shown in Fig.3.

The way the F-type plug is mounted on the cable is less obvious, and at first sight it looks like the plug has a piece missing. First a small section of the outer insulation of the RG6U cable is removed and the braid and tape which form the outer electrical shield are folded back. Next, the inner dielectric insulator is trimmed back to about 6mm, leaving about 15mm of the solid inner conductor core exposed – see Fig.4.

The plug is then "screwed" onto the cable over the folded-back braid, and any excess braid trimmed off. The protruding inner conductor wire is now cut to be level with the end of plug's nut, it is this that forms the "pin" of the plug. This is a process which takes longer to describe than to actually do.

Strictly speaking, we have an impedance mis-match between the

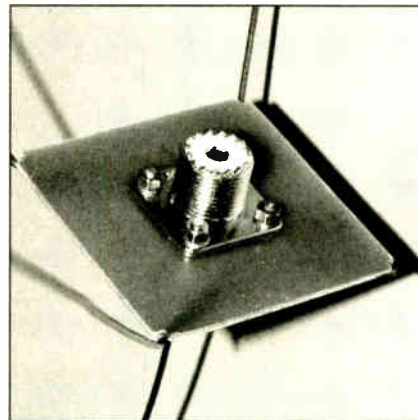

Underside view of the ground plate showing the chassis-mounting SO239 socket, which takes the PL259 plug end of the interconnecting cable

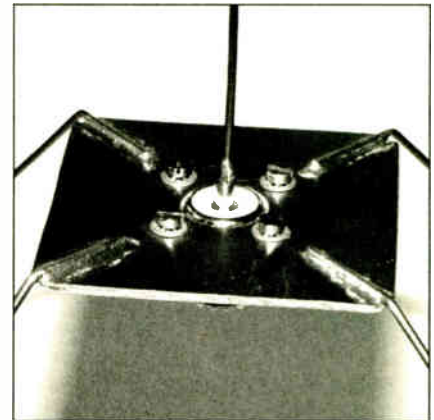

Topside (copper face) view of the ground plate showing the vertical element soldered to the centre pin of the SO239 socket

75Ω RG6U cable and the 50Ω vertical element (SO239/PL259) combination, however in practice this does not make a great deal of difference. The author used 10m of cable in his set-up and it did not suffer any noticeable attenuation from this length of cable.

## Practical Results

The antenna has been in use for several months and has produced excellent results. DAB signals which previously had signal strengths of only 40% to 50% using the receiver's extendable antenna, are now at a solid 100% strength with the loft antenna.

Extra multiplex frequencies, which could not previously be accessed, are now received.

Overall, the results have been excellent, considering the simplicity and low-cost of the design.

## Weather-proofing the Antenna

As originally conceived, this antenna was intended for internal use in a loft. How the design can be weather-proofed and made suitable for mounting on an outside wall is shown in Fig.5. A length of 40mm outside diameter plastic plumbing pipe is glued, using Araldite-type adhesive, to the underside of the ground plate. Apply the

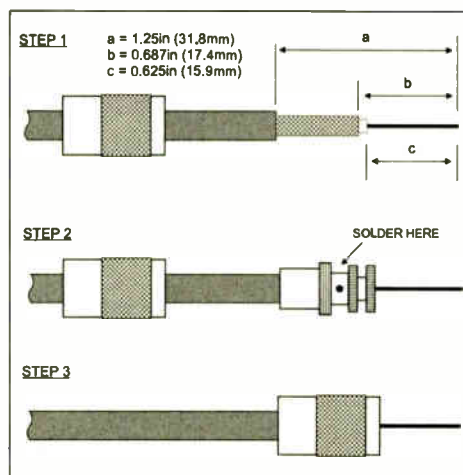

Fig.3. Stripping and fitting the u.h.f. PL259 plug to one end of the 75Ω satellite cable

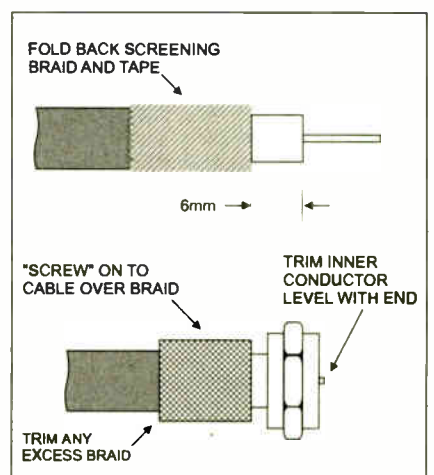

Fig.4. Preparing and fitting the F-type plug to the "free" end of the cable

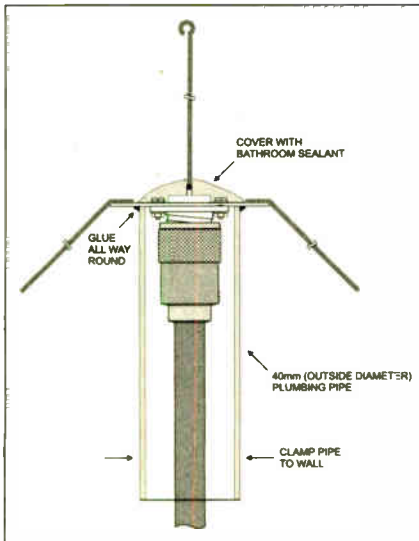

Fig.5. Weather-proofing the antenna for mounting on an outside wall

adhesive all the way round the top end of the pipe so that a weather-proof seal is created, as well as a sound mechanical joint. Make sure the PL259 plug and cable have been

plugged into the SO239 socket *before* gluing the pipe on, or else you have a problem!

The SO239 socket and the joint between it and the top-side of the ground plate need to be waterproofed with silicone bathroom sealant around the base of the vertical element and covering the SO239 connector and securing screws (Fig.5). This will ensure that no water gets into the SO239/PL259 joint and the cable. Once the adhesive has set and everything looks sound, the plastic pipe can be clamped to an outside wall and the cable, exiting the bottom end of the pipe, passed through a suitable hole in the wall, or under the eaves of the house and run to a suitable position for the DAB radio.

### Use On Other Bands

This design for a quarter-wave antenna is suitable for use on other v.h.f./u.h.f. bands, by simply adjusting the lengths of the vertical and ground plane elements. As given previously, the formula:

$$L = 71323 / f$$

(where: L is the length and f is the frequency in MHz) can be used to calculate new values of L.

For example, the amateur 2m (144MHz

to 146MHz) and 70cm (430MHz to 440MHz) bands can be covered by making L equal to:

- 492mm for the 2m band;
- and:
- 164mm for the 70cm band.

Note that this is the length of the vertical element and the four ground plane elements, which are always the same length. The size of the ground plane plate stays the same.

The connector at the receiver-end of the cable will need to suit the equipment into which it is being plugged. The use of a BNC connector is a common standard type used in u.h.f. equipment.

Although the omni-directional nature of this design tends to lessen the effective power transmitted compared with dipoles and multi-element Yagis, the antenna is also suitable for transmission, with the use of an appropriate transmitting license, of course. In this case the cable should be changed for high quality 50Ω type, such as RG58, to ensure a good impedance match between the transmitter and the antenna. □

# ELECTRONICS MANUALS ON CD-ROM £29.95 EACH

## ELECTRONICS SERVICE MANUAL

## THE MODERN ELECTRONICS MANUAL

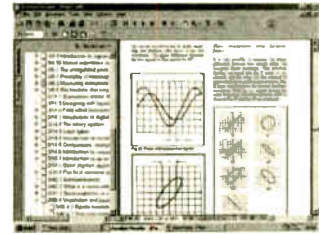
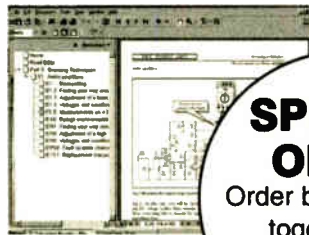
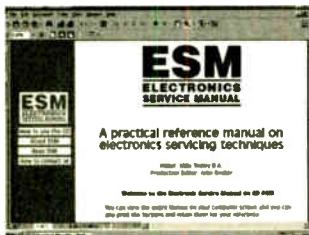

**SPECIAL OFFER**  
Order both Manuals together and **SAVE £10**

Everything you need to know to get started in repairing electronic equipment

The essential reference work for everyone studying electronics

Full contents list available online at: [www.epemag.co.uk](http://www.epemag.co.uk)

Wimborne Publishing Ltd., Dept Y05, 408 Wimborne Road East, Ferndown, Dorset BH22 9ND. Tel: 01202 873872. Fax: 01202 874562.

**PLEASE** send me

THE MODERN ELECTRONICS MANUAL CD-ROM

ELECTRONICS SERVICE MANUAL CD-ROM

I enclose payment of £29.95 (for one Manual) or £49.90 for both Manuals (saving £10 by ordering both together).

FULL NAME .....  
(PLEASE PRINT)

ADDRESS .....  
.....  
.....

.....POSTCODE .....

SIGNATURE .....

I enclose cheque/PO in UK pounds payable to Wimborne Publishing Ltd.

Please charge my Visa/Mastercard/Amex/Diners Club/Switch/Maestro

Card No ..... Switch/Maestro Issue No .....

Valid From ..... Expiry Date .....

Card Security Code ..... (The last 3 digits on or just under the signature strip)

**ORDER FORM**

Simply complete and return the order form with your payment to the following address:

Wimborne Publishing Ltd,  
Dept. Y05,  
408 Wimborne Road East, Ferndown,  
Dorset BH22 9ND

Price includes postage to anywhere in the World

We will happily exchange any faulty CD-ROMs but since the content can be printed out we do not offer a refund on these items.

**Your CD-ROM(s) will be posted to you by first class mail or airmail, normally within four working days of receipt of your order**

# Smart Karts

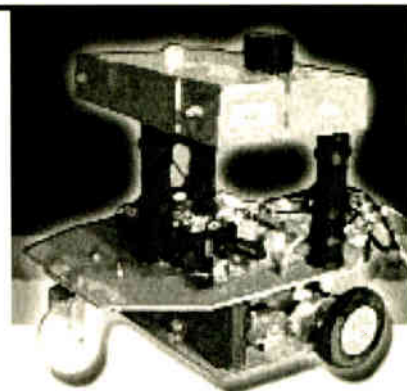

Owen Bishop

## Part 8 Discussing the software for SK-4 and *Son et Lumière*

**I**N Part 7 last month we described the circuits and assembly of this final variant, SK-4, of our Smart Kart mobile buggy. There are two modes of behaviour for SK-4, dancer and talker. These are selected by having S1 open (off, lever down) for dancer or closed (on, lever up) for talker.

### PIC Configuration

Before we deal with the programs for these behaviours, just a few words on the PICs for those who wish to program their own. Before PICs can run any sort of program, they must be configured. If you buy PICs that are already programmed for SK-4, you do not have to concern yourself with this.

The base file names are SK41-1 for PIC1, and SK42-1 for PIC2 (as named last month, also see below). Both PICs should be configured with the watchdog timer off, power up timer on, and code protection off. They differ in the setting for the type of oscillator, though. Select RC (resistor-capacitor) for PIC1 and XT (crystal) for PIC2. This means that the configuration word for PIC1 is h3FF3 and that for PIC2 is h3FF1.

### Working Together

This is the only project in this series to have two PICs. We need two because the robot is doing two complicated things at the same time – moving about and making sounds. Making sounds means that the processor must precisely generate oscillations of a given frequency and for a given length of time. It cannot (easily) at the same time switch the drive motors on or off, and respond to the inputs from the sensors. So the tasks have been split between two PICs.

The tasks are allocated like this:

PIC1 (Middle deck): controls the drive motors, and receives and acts on input from the bumpers and the light sensor.

PIC2 (Upper deck) generates the sounds, turns the l.e.d.s on and off, receives and acts on input from the sound sensor (when it is not generating sound itself).

The inputs and outputs of the two PICs are listed in Table 8.1.

If the two PICs are to work together, they must be able to communicate. This is

why terminals RB3 to RB6 of PIC1 are directly connected to the same-numbered terminals of PIC2. When dancing, PIC2 takes the lead, playing the music to dance to. At the beginning of each bar, it sends a signal to PIC1, telling it to execute the next step of the dance. In this way, the tune and the dance are synchronised. The signal is sent from PIC2 to PIC1 by making the mark line (RB6) high.

When talking, PIC1 takes the lead, driving the robot over a prescribed course,

modified when it bumps into something (backs away and spins) or it senses a bright light (heads towards it). At all stages on its wanderings it sends signals to PIC2, telling it what it is doing and what inputs it has received from the bumpers and light sensor. PIC2 then makes appropriate sounds and turns on one or two l.e.d.s.

### Lining Them Up

The two PICs are lined up ready to go by the handshaking routine illustrated by the

Table 8.1. Bit allocations for SK-4

PIC	Bit	Input/Output	Connection	Action	
				Low (0)	High (1)
PIC1	RA0-RA3	O	Power Board	See Table 2, Oct '04	
	RA4	–	Not used	–	–
	RB0	I	Left Bumper	Unpressed	Pressed
	RB1	I	Right Bumper	Unpressed	Pressed
	RB2	I	Switch S1	Open	Closed
	RB3	O	Data0 to PIC2	Transfer data PIC1 to PIC2	
	RB4	O	Data1 to PIC2	Transfer data PIC1 to PIC2	
	RB5	O	Data ready, or Data2 to PIC2	Transfer data PIC1 to PIC2	
	RB6	I	Mark from PIC2	Timing signal from PIC2 to PIC1	
		(when dancing)			
	RB7	I	Light Sensor	Low Light	High Light
PIC2	RA0	O	Speaker	Sound Signal	
	RA1	O	D1 Red l.e.d.	Off	On
	RA2	O	D2 Green l.e.d.	Off	On
	RA3	O	D3 Blue l.e.d.	Off	On
	RA4	–	Not used	–	–
	RB0	I	Sound switch flip-flop output	No Sound (reset)	Sound detected
	RB1	O	Sound switch reset input	Resets flip-flop	Normal level
	RB2	I	Behaviour select switch, S1	Switch Open (down)	Switch Closed (up)
	RB3-RB6		See entries above for same-numbered bits in PIC1 (reverse action)		
	RB7	–	Not used	–	–



flow chart in Fig.8.1. The dashed arrows indicate when one PIC is waiting to receive a signal on the mark line (PIC1) or the ready line (PIC2). Following power-on or reset, both processors go through the usual initialisation stages, PIC2 with its 4MHz crystal running a lot faster than PIC1.

As soon as PIC2 is initialised, it places a logic high level on the mark line. PIC1 waits in a loop to receive it. PIC1 being slower, it will probably find that mark is already high, so will drop straight through the loop and put a high level on the ready line. PIC2 is waiting in a loop to receive this.

reads the level on RB0 and copies it to a variable **trig**. If a sound has been detected, **trig** has the value 1 and PIC2 drops through to the **cycle** routine.

**Cycle** provides a way of selecting what is to happen next. It switches on the red,

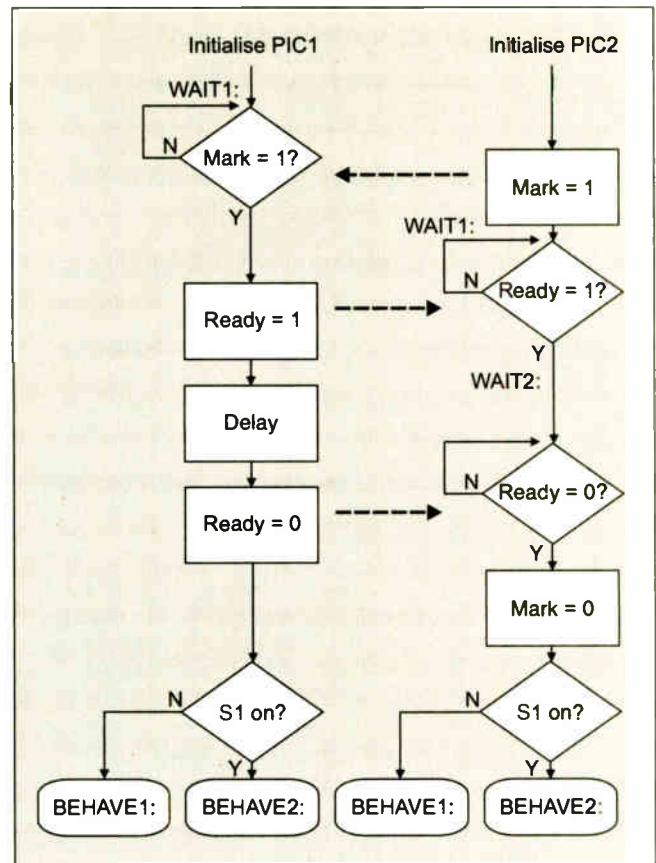
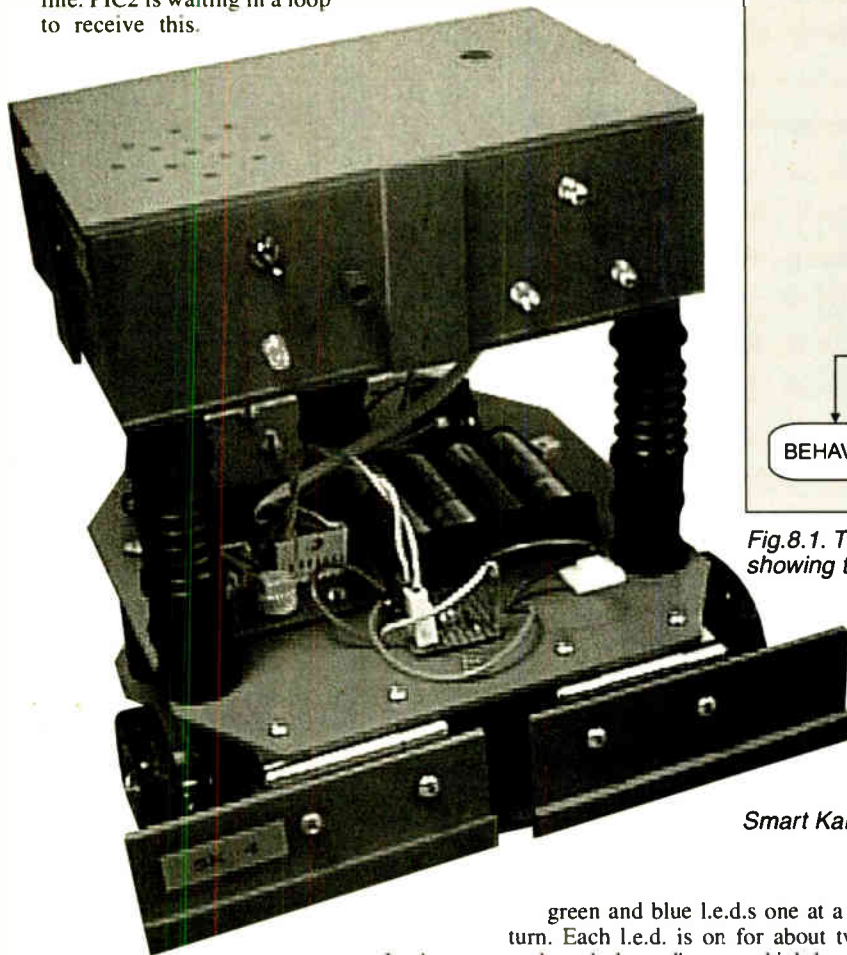

Fig.8.1. The first stages of the programs of PIC1 and PIC2, showing the initial handshaking



Smart Kart SK-4

It then waits in a second loop for PIC1 to end the ready signal. PIC1 is now ready to read S1. Knowing that PIC1 is ready, PIC2 ends its mark signal and is ready to read S1. Both processors have confirmed with each other that they are ready to run the selected program.

## Song and Dance

Nothing happens in the song and dance mode until a sound is detected. The idea of this is that the robot can be quietly switched on in an empty room and left there. Later, when an unsuspecting person enters the room and by chance makes a noise, the robot springs suddenly into action with loud music and a lively dance.

The sound sensor is so sensitive that it can be triggered even by a whisper (or by sounds from other rooms in a noisy house!). As shown in Fig.8.2, **Behave1** first calls a subroutine (**trigger**) to find out if a sound has set the flip-flop (IC3a and IC3b in Part 7 Fig.7.2). The flip-flop has already been reset during the initialisation stage by clearing Port B and then making RB1 high. The **trigger** subroutine simply

green and blue l.e.d.s one at a time in turn. Each l.e.d. is on for about two seconds and, depending on which l.e.d. is on, when you clap or make some other noise, different things happen.

To get SK-4 to dance, clap when the red l.e.d. is on. Fig.8.2 shows how this action is programmed. First, the red l.e.d. is switched on by making RA1 high. It was found when testing the robot that switching on the relatively large current required by the red l.e.d. caused a spike on the supply line, which set the flip-flop. Attempts to eliminate this by adding a capacitor to the circuit were not reliable, so a software solution was adopted. A short routine, **reset**, called immediately after switching the l.e.d. on, resets the flip-flop by making RB1 low, then high.

A delay then allows time for a sound to be detected. Making a sound during the delay period sets the flip-flop and, at the end of the delay period, a call to **trigger** discovers this. If there has been a sound while the red l.e.d. has been on, the program branches to **Saints**. The song and dance begins.

If there has been no sound, the program continues through two more sequences that are similar before looping back to cycle again. In the first of these, the green l.e.d.

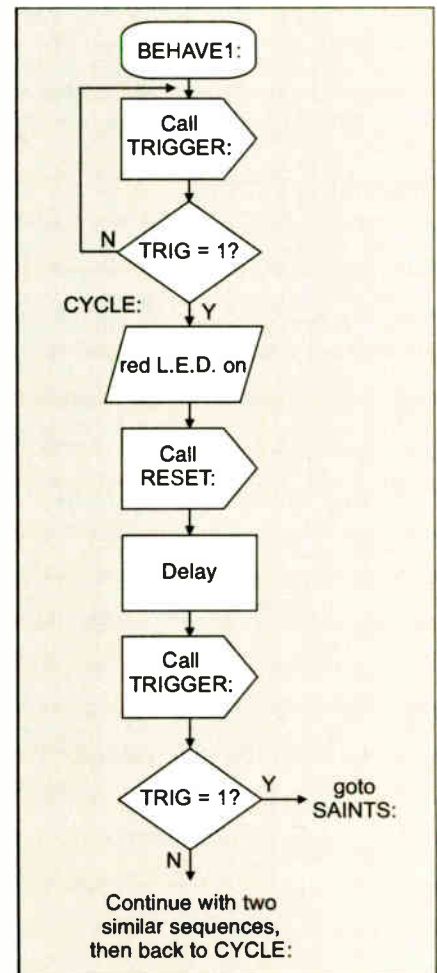

Fig.8.2. The first part of the **Cycle** routine in the **Behave1** program for PIC2. **Cycle** controls its music and dance actions

## CALCULATING VALUES

There is no space here to go into details but, if you want to program your own tunes, this is how to work out the values:

1. Begin with the frequency of the note and find the length of the half-period in microseconds.

$$\text{Half-period} = 500000/\text{frequency}$$

Assuming a 4MHz crystal, a processor cycle is one microsecond

2. Find a pair of values for **slowdata** and **fastdata** such that:

$$(50 \times \text{slowdata}) + (3 \times \text{fastdata}) + 15 = \text{half-period}$$

3. Calculate the value of **oscddata** that produces a note lasting one quaver:

$$\text{oscddata} = \text{frequency} \times 0.073$$

For longer or dotted notes, multiply by 1.5, 2, 4 etc. Then round to the nearest whole number. To increase the tempo, reduce the factor 0.073 to, say 0.6. If any values come to 254 or more, reduce the factor for all notes.

Example: To play a C' quaver:

$$\text{Frequency} = 523.3\text{Hz}$$

$$\text{half-period} = 500000/523.3 = 956\mu\text{s}$$

$$\text{By trial, } (50 \times 16) + (3 \times 47) + 15 = 956$$

$$\text{so slowdata} = 16 \text{ and fastdata} = 47$$

$$\text{Oscdata} = 523.3 \times 0.073 = 38$$

comes on and the robot makes a two-tone beep (its word for "green"). In the second stage, the blue l.e.d. comes on and the robot says "blue".

If you are adapting the program yourself, you could introduce other tunes and dances into the cycle loop instead of the two-tone sounds.

## Marching Orders

The flow chart in Fig.8.3 outlines the routine for playing the tune, *When the Saints Come Marching In*. The tune is coded as a subroutine named **seq1**. This appears at the very beginning of the listing. It has to be put there so that it is all within the first 256 program lines. Data blocks that spread across the boundaries between one 256-word block and the next make the programming more complicated.

Here are the first eight lines of **seq1** :

```
seq1: addwf pcl,f
      retlw 0FEh ; Mark.
      retlw 014h ; G
      retlw 057h
      retlw 01Fh ; 1 quaver
      retlw 0Eh ; B'
      retlw 063h
      retlw 028h ; 1 quaver
```

It continues for a further 110 lines, all consisting of **retlw** followed by a value.

The **Saints** subroutine (Fig.8.3) begins by setting the **pointer** variable to zero. This variable indicates (or "points to") the next

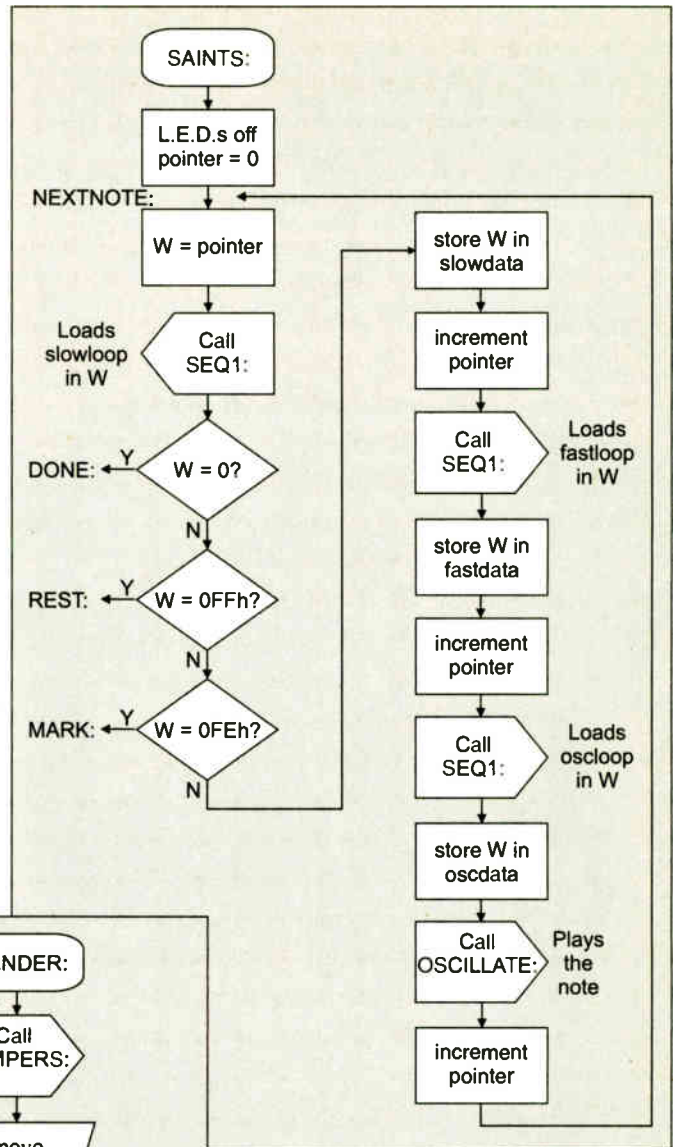

Fig.8.3. Playing the music; the Saints: subroutine for PIC2

item of data to be read from **seq1**. **Pointer** is loaded into the working register (**W**) and then **seq1** is called.

The first line of this (see listing just given) adds the present content of the program counter (**PCL**) to **W** and stores the result in the program counter. The program counter is then incremented, as usual, for the next instruction to be read. Because **pointer** is zero, the processor simply reads the next line **retlw 0FEh** and returns to the main program with this value in **W**. As can be seen in Fig.8.3 the program examines the value in **W** and if it is one of 0h, 0FFh, or 0FEh (0, 255, 254), identifies it as a code. The effect of the codes is:

- If it is zero (0h), the end of the tune has been reached; go to the **done** subroutine for a short pause and then back to the **cycle** routine.

- Code 255 (0FFh) indicates a "rest"; a period of silence equal in length to one quaver. The PIC1 then goes back to the beginning of the loop to play the next note.

- Code 254 (0FEh) indicates the beginning of a bar; a pulse (mark) is sent to PIC2. Then PIC1 loops back to play the next note.

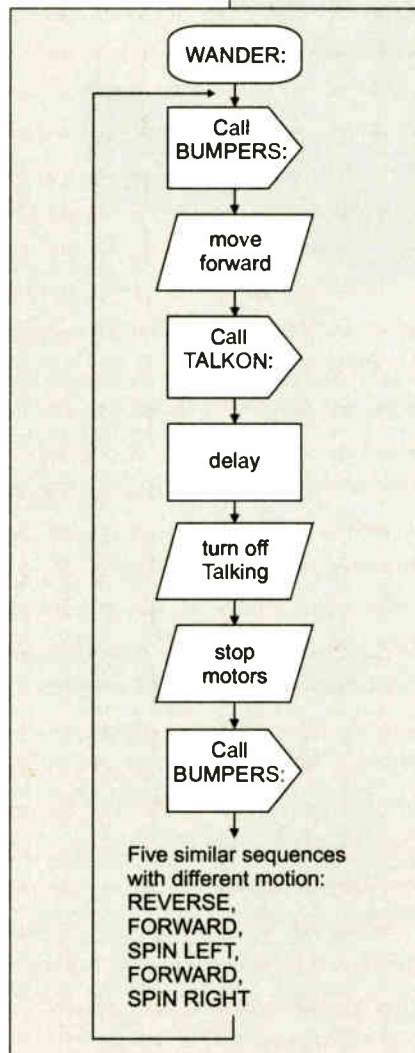

Fig.8.4. PIC1 controls the robot's actions using its Wander: routine

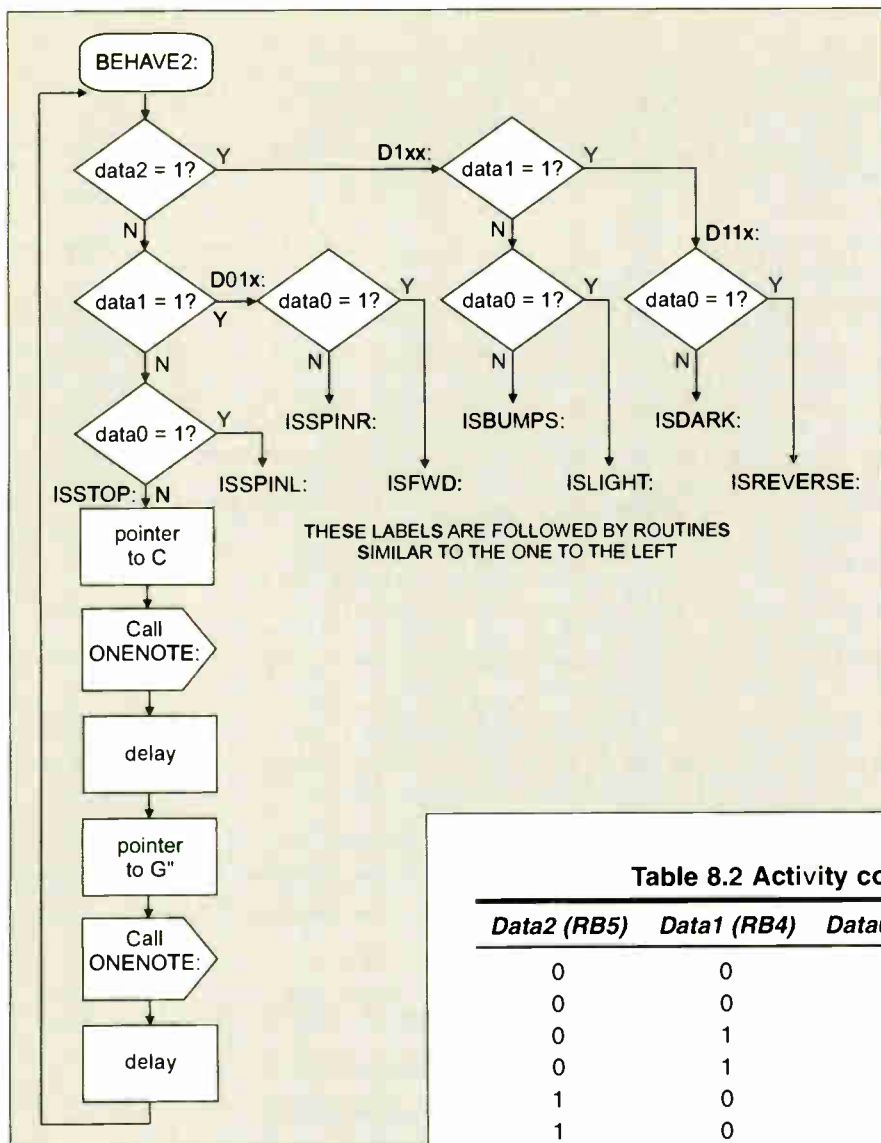

Fig.8.5. The way PIC2 sorts out the signals from PIC1 in the Talker program

If the value in **W** is not a code, it is the first of three values that define the note. These are loaded in turn as **pointer** is incremented and stored as three variables, **slowdata**, **fastdata** and **oscddata**. The first two of these are the values to be used in the timing loops to obtain the required frequency (pitch). **Oscdata** is the number of oscillations to be produced, so it determines the length of the note.

With these three values stored, we call **Oscillate** to make the sound. It consists of a conventional double loop counter, using a constant in the outer loop counter and **oscddata** in the inner loop to switch the current to the speaker on and off the required number of times.

It calls a conventional timing subroutine **pause3** to determine the length of each on and off period. On returning from **Oscillate**, PIC2 increments **pointer** to the first value in the next note, and then loops back to the beginning.

### Over to PIC1

While PIC2 is busy producing the tune, PIC1 is waiting to respond to the "mark" signal (a short high pulse) being sent to it whenever PIC2 encounters an 0FEh code. PIC1 runs through a programmed series of

movements stored in a subroutine named **Seq3**. Like **Seq1** in the PIC2 program, this consists of a first line to set the program counter followed by lines defining which motion to effect during each bar of the tune:

```
seq1: addwf pcl,f
      retlw 0Ah ; Forward
      retlw 05h ; Reverse
      retlw 09h ; Spin left
```

There are eight more lines listing the remaining eight steps of the dance. The routine starts by clearing **pointer**, to point PIC1 to the first step of the dance. When the first "mark" is received, PIC1 goes to **seq1**: and loads 0Ah into **W**. This is one of the codes that we have been using in previous versions of the robot to control the drive motors.

This code is sent to the motors and SK4 runs forward for about one second. It then stops the motors and increments **pointer** before going back to the beginning of the loop to wait for the next "mark" and the next step. The value of **pointer** is tested at

the end of each loop and, if it has reached 10, the program branches back to **Behave1**: ready to begin another dance.

### Talkabout

**Talkabout** is the second behaviour mode, in which SK-4 wanders about the room while telling you what it is doing. This behaviour is decided by the signals being sent to the motors and being received from the bumpers and light sensor, so we will begin by looking at the program for PIC1, **Behave2**: which begins by making PIC1 ready to respond to interrupts (but not yet) and clears the **bumps** counter:

```
Behave2:    bcf intcon.7 ; Disable
             all interrupts (GIE = 0)
             bsf intcon.3 ; Enable int
             on change (RBIE = 1)
             movf porth.W ; Read
             Port B
             bcf intcon.0 ; Clear
             interrupt flag (RBIF = 0)
             clrf bumps
             ; (see Fig.8.5)

Wander:
```

The flowchart of Fig.8.4 shows that SK-4 wanders about the room according to a set pattern, but that this may be modified

Table 8.2 Activity codes sent by PIC1 to PIC2

Data2 (RB5)	Data1 (RB4)	Data0 (RB3)	Meaning
0	0	0	Robot has stopped
0	0	1	Spinning left
0	1	0	Spinning right
0	1	1	Moving forward
1	0	0	Has bumped 5 times
1	0	1	Is seeing light
1	1	0	Is not seeing light
1	1	1	Reversing

when the robot bumps into objects, such as walls and furniture. When the routine calls **bumpers**: the input from the bumpers is checked to see if the robot is pressed against an object. If so, it reverses away, spins left or right (depending on which bumper made contact), then stops. It counts the number of bumps experienced and stores this in **bumps**.

This far the routine is the same as for **bumpers**: in the software for SK-2 (Jan '05). In addition, this version of the routine tells PIC2 what has happened. It does this by means of a 3-bit activity code, which is sent to PIC2 on RB3 (Data0), RB4 (Data1) and RB5 (Data2). Table 8.2 lists all the codes and their meaning.

The **bumper** subroutines include lines for sending the binary code "100" to PIC2. Actually the full 8-bit code that is sent is "00010000" (10h in hex) including bits 0 to 2 and 6 to 7.

After checking the bumpers, PIC1 issues instructions to the motors to move the robot forward. It puts the usual forward motion code (0Ah) on Port A. This code, still in the working register, is then converted to the corresponding activity code (as in Table 8.2) by calling **Talkon**. This subroutine performs the conversion

and puts the appropriate activity code on Port B.

Next comes a delay while the robot moves or spins and, at the same time PIC2 receives the activity code and makes the appropriate response (see later). Then the motors are stopped and **bumpers**: is called to see if the robot has collided with an object.

The above sequence is repeated five times, but with a different motion, as listed in Fig.8.4. In addition, interrupts are enabled when the robot is spinning, and disabled afterward. We use the "interrupt on change" feature, which interrupts processing when there is a change of input to any one of bits 4 to 7 of Port B.

In this application, Port B bits 4 and 5 are outputs (see Table 8.1) so are not affected. Bit 6 receives the mark signal from PIC2, but this is not used in the **talker** program, so remains low and does not cause an interrupt. Therefore, if there is an interrupt it must be a change of input at RB7, which receives the signal from the light sensor.

The interrupt service routine is straightforward. It first stores the contents of **W**, the **Status** register, and the two ports. Next, it reads the light sensor at RB7. If it is high (light detected) the motors drive the robot forward in the direction of the light. The code for "is seeing light" is sent to

PIC2 (see Table 8.2). If RB7 is low (no light detected), the robot spins left, to put it on a new course. The code for "is not seeing light" is sent to PIC2.

Finally, the stored values are put back where they came from, the interrupt flag (**RBF**) is cleared and PIC1 returns to the main program.

## Back to PIC2

When in **Talker** mode, PIC2 does nothing but read the signals from PIC1 and immediately act on them. Fig.8.5 shows how it analyses the signals. It could happen that the signals are being changed while they are being read. In this case, the reading will be in error and the wrong sounds and l.e.d. display will be produced. But the time taken to read the signals is so much less than the time taken by the routine for generating sounds and l.e.d. activity, that such errors will seldom occur. We do not need handshaking here.

The signals are analysed by a tree-like routine based on testing the data bits one at a time. For example, the first test is:

```
Behave2: btfsc portb,5 ; Read data2
          goto data1xx ; To analyse
          signals that begin with "1"
          btfsc portb,4 ; Read data1
```

goto data01x ; To analyse signals that begin with "01"

and so on.

Eventually, when the signal is completely analysed, PIC2 is brought to one of eight subroutines. One of these (**Isstop**) is shown in full in Fig. 8.5. The robot is stopped so it emits a two-tone sound middle C followed by E.

The **pointer** variable is first pointed to the data for C in **seq2**. Then we call the subroutine **Onewote** to play it. **Onewote** is similar to **Saints**, which we used in **Dancer** mode, but it calls on **Seq2** instead of **Seq1**. It does not have to cope with zero, 255 or 254 codes as these do not occur. The **Isstop** subroutine then sets the pointer to a different note (E') and calls **Onewote** again to play it.

The other subroutines, not shown in Fig. 8.5, play different pairs of notes and may switch on one or two l.e.d.s. We are not saying exactly what they do, but they all represent different "words" in SK-4's vocabulary. You can find out which by examining the downloaded listing.

It is good fun to watch the robot in action and tie up its sounds and flashing l.e.d.s with its activities. So as we close this series, our final words to you are:

*Learn to sing like a Smart Kart!*

## Obtaining EPE

A new initiative in the UK is designed to help you obtain your favourite magazines from newsagents. Called Just Ask! its aim is to raise awareness that newsagents can stock, order and often home deliver magazines.

To raise awareness we will be including the Just Ask! logo in the pages of this and future issues and have included a newsagent order form to help you to obtain copies.

So keep a look out for the logo and next time you visit your newsagent remember to Just Ask! about obtaining copies of your chosen magazines.



**It's a "listening" issue next month! - ORDER YOUR COPY NOW!**  
**★ PIC Ultrasonic Radar ★ Super-Ear Audio Telescope ★**  
**Plus - Back to Logic Basics Part Three**



## NEWSAGENTS ORDER FORM

Please reserve/deliver a copy of *Everyday Practical Electronics* for me each month

Signed .....

Name and Address .....

.....

..... Post Code .....

*Everyday Practical Electronics* is published on the second Thursday of each month and distributed S.O.R. by COMAG  
Make sure of your copy of *EPE* each month - cut out or photostat this form, fill it in and hand it to your newsagent.

FREE *Electronics Hobbyist Compendium* book with Teach-In 2000 CD-ROM



## EPE TEACH-IN 2000 CD-ROM

The whole of the 12-part *Teach-In 2000* series by John Becker (published in *EPE* Nov '99 to Oct 2000) is now available on CD-ROM in PDF form. Plus the *Teach-In 2000* interactive software (Win 95, 98, ME and above) covering all aspects of the series and Alan Winstanley's *Basic Soldering Guide* (including illustrations and Desoldering).

*Teach-In 2000* covers all the basic principles of electronics from Ohm's Law to Displays, including Op.Amps, Logic Gates etc. Each part has its own section on the interactive software where you can also change component values in the various on-screen demonstration circuits.

The series gives a hands-on approach to electronics with numerous breadboard circuits to try out, plus a simple computer interface (Win 95, 98, ME ONLY) which allows a PC to be used as a basic oscilloscope.

ONLY **£12.45** including VAT and p&p

### THE AMATEUR SCIENTIST CD-ROM

The complete collection of The Amateur Scientist articles from *Scientific American* magazine. Over 1,000 classic science projects from a renowned source of winning projects. All projects are rated for cost, difficulty and possible hazards.

Plus over 1,000 pages of helpful science techniques that never appeared in *Scientific American*.

Exciting science projects in: Astronomy; Earth Science; Biology; Physics; Chemistry; Weather . . . and much more! The most complete resource ever assembled for hobbyists, and professionals looking for novel solutions to research problems.

Includes extensive Science Software Library with even more science tools.

Suitable for Mac, Windows, Linux or UNIX. 32MB RAM minimum, Netscape 4.0 or higher or Internet Explorer 4.0 or higher.

Over 1,000 projects

CD-ROM

CD-ROM

£19.95

## PROJECT CONSTRUCTION

### IC 555 PROJECTS

E. A. Parr

Every so often a device appears that is so useful, that one wonders how life went on before without it. The 555 timer is such a device. Included in this book are over 70 circuit diagrams and descriptions covering basic and general circuits, motor car and model railway circuits, alarms and noise makers as well as a section on 556, 558 and 559 timers. (Note. No construction details are given.) A reference book of invaluable use to all those who have any interest in electronics, be they professional engineers or designers, students or hobbyists.

167 pages

Temporarily out of print

### POWER SUPPLY PROJECTS

R. A. Penfold

This book offers a number of power supply designs, including simple unregulated types, and variable voltage stabilised designs, the latter being primarily intended for use as bench power supplies for the electronics workshop. The designs provided are all low voltage types for semiconductor circuits. The information in this book should also help the reader to design his own power supplies. Includes cassette PSU, Ni-Cad charger, voltage step-up circuit and a simple inverter.

91 pages

Temporarily out of print

### HOW TO USE OSCILLOSCOPES AND OTHER TEST EQUIPMENT

R. A. Penfold

This book explains the basic function of an oscilloscope, gives a detailed explanation of all the standard controls, and provides advice on buying. A separate chapter deals with using an oscilloscope for fault finding on linear and logic circuits, plenty of example waveforms help to illustrate the control functions and the effects of various fault conditions. The function and use of various other pieces of test equipment are also covered, including signal generators, logic probes, logic pulsers and crystal calibrators.

104 pages

Order code BP267

£5.49

### ELECTRONIC PROJECT BUILDING FOR BEGINNERS

R. A. Penfold

This book is for complete beginners to electronic project building. It provides a complete introduction to the practical side of this fascinating hobby, including the following topics:

Component identification, and buying the right parts; resistor colour codes, capacitor value markings, etc; advice on buying the right tools for the job; soldering; making easy work of the hard wiring; construction methods, including stripboard, custom printed circuit boards, plain matrix boards, surface mount boards and wire-wrapping; finishing off, and adding panel labels; getting "problem" projects to work, including simple methods of fault-finding.

In fact everything you need to know in order to get started in this absorbing and creative hobby.

135 pages

Temporarily out of print

### TEST EQUIPMENT CONSTRUCTION

R. A. Penfold

This book describes in detail how to construct some simple and inexpensive but extremely useful, pieces of test equipment. Stripboard layouts are provided for all designs, together with wiring diagrams where appropriate, plus notes on construction and use.

The following designs are included:-

AF Generator, Capacitance Meter, Test Bench Amplifier, AF Frequency Meter, Audio Multivoltmeter, Analogue Probe, High Resistance Voltmeter, CMOS Probe, Transistor Tester, TTL Probe. The designs are suitable for both newcomers and more experienced hobbyists.

104 pages

Order code BP248

£4.49

## COMPUTING

### COMPUTING FOR THE OLDER GENERATION

Jim Gatenby

Especially written for the over 50s, using plain English and avoiding technical jargon. Large clear type for easy reading.

Among the many practical and useful ideas for using your PC that are covered in this book are: Choosing, setting up and understanding your computer and its main components. Writing letters, leaflets, invitations, etc., and other word processing jobs. Keeping track of your finances using a spreadsheet. Recording details of holidays and other ideas using a database. Using the Internet to find useful information, and email to keep in touch with family and friends. Making 'back-up' copies of your work and checking for viruses. How to use Windows XP to help people with impaired vision, hearing or mobility.

Provides the basic knowledge so you can gain enough confidence to join the local computer class.

308 pages

Order code BP601

£8.99

### THE INTERNET FOR THE OLDER GENERATION

Jim Gatenby

Especially written for the over 50s. Uses only clear and easy-to-understand language. Larger type size for easy reading. Provides basic knowledge to give you confidence to join the local computer class.

This book explains how to use your PC on the Internet and covers amongst other things: Choosing and setting up your computer for the Internet. Getting connected to the Internet. Sending and receiving emails, photographs, etc., so that you can keep in touch with family and friends all over the world. Searching for and saving information on any subject. On-line shopping and home banking. Setting up your own simple web site.

228 pages

Order code BP600

£8.99

# DIRECT BOOK SERVICE

The books listed have been selected by *Everyday Practical Electronics* editorial staff as being of special interest to everyone involved in electronics and computing. They are supplied by mail order direct to your door. Full ordering details are given on the last book page.

FOR A FURTHER SELECTION OF BOOKS  
SEE THE NEXT TWO ISSUES OF EPE.

All prices include UK postage

## RADIO

### SETTING UP AN AMATEUR RADIO STATION

I. D. Poole

The aim of this book is to give guidance on the decisions which have to be made when setting up any amateur radio or short wave listening station. Often the experience which is needed is learned by one's mistakes, however, this can be expensive. To help overcome this, guidance is given on many aspects of setting up and running an efficient station. It then proceeds to the steps that need to be taken in gaining a full transmitting licence.

Topics covered include: The equipment that is needed; Setting up the shack; Which aerials to use; Methods of construction; Preparing for the licence.

86 pages

Order code BP300

£4.45

### EXPERIMENTAL ANTENNA TOPICS

H. C. Wright

Although nearly a century has passed since Marconi's first demonstration of radio communication, there is still research and experiment to be carried out in the field of antenna design and behaviour.

The aim of the experimenter will be to make a measurement or confirm a principle, and this can be done with relatively fragile, short-life apparatus. Because of this, devices described in this book make liberal use of cardboard, cooking foil, plastic bottles, cat food tins, etc.

Although primarily a practical book with text closely supported by diagrams, some formulae which can be used by straightforward substitution and some simple graphs have also been included.

72 pages

Order code BP278

£4.00

### 25 SIMPLE INDOOR AND WINDOW AERIALS

E. M. Noll

Many people live in flats and apartments or other types of accommodation where outdoor aerials are prohibited, or a lack of garden space etc. prevents aerials from being erected. This does not mean you have to forgo shortwave-listening, for even a 20-foot length of wire stretched out along the skirting board of a room can produce acceptable results. However, with some additional effort and experimentation one may well be able to improve performance further.

This concise book tells the story, and shows the reader how to construct and use 25 indoor and window aerials that the author has proven to be sure performers.

50 pages

Order code BP136

£2.25

### TICKLING THE CRYSTAL Domestic British Crystal Sets of the 1920's

Ian L. Sanders

The first book dedicated to the topic of British crystal sets to be published in the last 25 years. For a very brief period during the early 1920's, these simple receivers played a crucial role in the expansion of domestic wireless throughout the United Kingdom. For many families, rich and poor, the crystal set provided an introduction to the new pastime of listening-in to broadcast programmes. Rapidly made obsolete from homes as suddenly as it had arrived, but not without leaving its mark on the history of wireless.

Written by a long-time authority and enthusiast, *Tickling the Crystal* is the most comprehensive work on the subject ever assembled. Containing almost two hundred excellent quality photographs and a wealth of previously unpublished material, it cannot fail to be an invaluable reference for anyone interested in the history of early wireless receivers.

256 pages hardback

Order code TC1

£34.00

# THEORY AND REFERENCE

## BEBOP TO THE BOOLEAN BOOGIE

Second Edition

Clive (call me Max) Maxfield

This book gives the "big picture" of digital electronics. This in-depth, highly readable, up-to-the-minute guide shows you how electronic devices work and how they're made. You'll discover how transistors operate, how printed circuit boards are fabricated, and what the innards of memory ICs look like. You'll also gain a working knowledge of Boolean Algebra and Karnaugh Maps, and understand what Reed-Muller logic is and how it's used. And there's much, MUCH more. The author's tongue-in-cheek humour makes it a delight to read, but this is a REAL technical book, extremely detailed and accurate.

**Contents:** Fundamental concepts; Analog versus digital; Conductors and insulators; Voltage, current, resistance, capacitance and inductance; Semiconductors; Primitive logic functions; Binary arithmetic; Boolean algebra; Karnaugh maps; State diagrams, tables and machines; Analog-to-digital and digital-to-analog; Integrated circuits (ICs); Memory ICs; Programmable ICs; Application-specific integrated circuits (ASICs); Circuit boards (PCBs and DWBs); Hybrids; Multichip modules (MCMs); Alternative and future technologies.

470 pages - large format **Order code BEB1 £26.95**

## BEBOP BYTES BACK (and the Boboputer Computer Simulator)

CD-ROM

Clive (Max) Maxfield and Alvin Brown

This follow-on to *Bebop to the Boolean Boogie* is a multimedia extravaganza of information about how computers work. It picks up where "Bebop I" left off, guiding you through the fascinating world of computer design... and you'll have a few chuckles, if not belly laughs, along the way. In addition to over 200 megabytes of mega-cool multimedia, the CD-ROM contains a virtual microcomputer, simulating the motherboard and standard computer peripherals in an extremely realistic manner. In

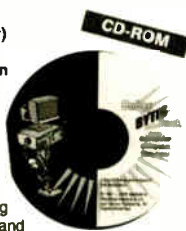

addition to a wealth of technical information, myriad nuggets of trivia, and hundreds of carefully drawn illustrations, the CD-ROM contains a set of lab experiments for the virtual microcomputer that let you recreate the experiences of early computer pioneers. If you're the slightest bit interested in the inner workings of computers, then don't dare to miss this!

Over 800 pages in Adobe Acrobat format

CD-ROM **Order code BEB2 CD-ROM £21.95**

## ELECTRONICS MADE SIMPLE

Ian Sinclair

Assuming no prior knowledge, *Electronics Made Simple* presents an outline of modern electronics with an emphasis on understanding how systems work rather than on details of circuit diagrams and calculations. It is ideal for students on a range of courses in electronics, including GCSE, C&G and GNVQ, and for students of other subjects who will be using electronic instruments and methods.

**Contents:** waves and pulses, passive components, active components and ICs, linear circuits, block and circuit diagrams, how radio works, disc and tape recording, elements of TV and radar, digital signals, gating and logic circuits, counting and correcting, microprocessors, calculators and computers, miscellaneous systems.

199 pages **Order code NE23 £13.99**

## SCROGGIE'S FOUNDATIONS OF WIRELESS AND ELECTRONICS - ELEVENTH EDITION

S. W. Amos and Roger Amos

Scroggie's Foundations is a classic text for anyone working with electronics, who needs to know the art and craft of the subject. It covers both the theory and practical aspects of a huge range of topics from valve and tube technology, and the application of cathode ray tubes to radar, to digital tape systems and optical recording techniques.

Since *Foundations of Wireless* was first published over 60 years ago, it has helped many thousands of readers to become familiar with the principles of radio and electronics. The original author Sowerby was succeeded by Scroggie in the 1940s, whose name became

synonymous with this classic primer for practitioners and students alike. Stan Amos, one of the fathers of modern electronics and the author of many well-known books in the area, took over the revision of this book in the 1980s and it is he, with his son, who have produced this latest version.

400 pages

Temporarily out of print

## GETTING THE MOST FROM YOUR MULTIMETER

R. A. Penfold

This book is primarily aimed at beginners and those of limited experience of electronics. Chapter 1 covers the basics of analogue and digital multimeters, discussing the relative merits and the limitations of the two types. In Chapter 2 various methods of component checking are described, including tests for transistors, thyristors, resistors, capacitors and diodes. Circuit testing is covered in Chapter 3, with subjects such as voltage, current and continuity checks being discussed.

In the main little or no previous knowledge or experience is assumed. Using these simple component and circuit testing techniques the reader should be able to confidently tackle servicing of most electronic projects.

96 pages

**Order code BP239 £5.49**

## DIGITAL GATES AND FLIP-FLOPS

Ian R. Sinclair

This book, intended for enthusiasts, students and technicians, seeks to establish a firm foundation in digital electronics by treating the topics of gates and flip-flops thoroughly and from the beginning.

Topics such as Boolean algebra and Karnaugh mapping are explained, demonstrated and used extensively, and more attention is paid to the subject of synchronous counters than to the simple but less important ripple counters.

No background other than a basic knowledge of electronics is assumed, and the more theoretical topics are explained from the beginning, as also are many working practices. The book concludes with an explanation of microprocessor techniques as applied to digital logic.

200 pages

**Order code PC106 £9.95**

# MUSIC, AUDIO AND VIDEO

## QUICK GUIDE TO ANALOGUE SYNTHESIS

Ian Waugh

Even though music production has moved into the digital domain, modern synthesisers invariably use analogue synthesis techniques. The reason is simple - analogue synthesis is flexible and versatile, and it's relatively easy for us to understand. The basics are the same for all analogue synths, and you'll quickly be able to adapt the principles to any instrument, to edit existing sounds and create exciting new ones. This book describes: How analogue synthesis works; The essential modules every synthesiser has; The three steps to synthesis; How to create phat bass sounds; How to generate filter sweeps; Advanced synth modules; How to create simple and complex synth patches; Where to find soft synths on the Web.

If you want to take your synthesiser - of the hardware or software variety - past the presets, and program your own sounds and effects, this practical and well-illustrated book tells you what you need to know.

60 pages

**Order code PC118 £7.45**

## QUICK GUIDE TO MP3 AND DIGITAL MUSIC

Ian Waugh

MP3 files, the latest digital music format, have taken the music industry by storm. What are they? Where do you get them? How do you use them? Why have they thrown record companies into a panic? Will they make music easier to buy? And cheaper? Is this the future of music?

All these questions and more are answered in this concise and practical book which explains everything you need to know about MP3s in a simple and easy-to-understand manner. It explains:

How to play MP3s on your computer; How to use MP3s with handheld MP3 players; Where to find MP3s on the Web; How MP3s work; How to tune into Internet radio stations; How to create your own MP3s; How to record your own CDs from MP3 files; Other digital audio music formats.

60 pages

**Order code PC119 £7.45**

## ELECTRONIC PROJECTS FOR VIDEO ENTHUSIASTS

R. A. Penfold

This book provides a number of practical designs for video accessories that will help you get the best results from your camcorder and VCR. All the projects use inexpensive components that are readily available, and they are easy to construct. Full construction details are provided, including stripboard layouts and wiring diagrams. Where appropriate, simple setting up procedures are described in detail; no test equipment is needed.

The projects covered in this book include: Four channel audio mixer, Four channel stereo mixer, Dynamic noise limiter (DNL), Automatic audio fader, Video faders, Video wipers, Video crispener, Mains power supply unit.

109 pages

**Order code BP356 £5.45**

## ELECTRONIC MUSIC AND MIDI PROJECTS

R. A. Penfold

Whether you wish to save money, boldly go where no musician has gone before, rekindle the pioneering spirit, or simply have fun building some electronic music gadgets, the designs featured in this book should suit your needs. The projects are all easy to build, and some are so simple that even complete beginners at electronic project construction can tackle them with ease. Stripboard layouts are provided for every project, together with a wiring diagram. The mechanical side of construction has largely been left to individual constructors to sort out, simply because the vast majority of project builders prefer to do their own thing in this respect.

None of the designs requires the use of any test equipment in order to get them set up properly. Where any setting up is required, the procedures are very straightforward, and they are described in detail.

**Projects covered:** Simple MIDI tester, Message grabber, Byte grabber, THRU box, MIDI auto switcher, Auto/manual switcher, Manual switcher, MIDI patchbay, MIDI controlled switcher, MIDI lead tester, Program change pedal, Improved program change pedal, Basic mixer, Stereo mixer, Electronic swell pedal, Metronome, Analogue echo unit. **£10.95**

124 pages

**Order code PC116 £5.45**

## THE INVENTOR OF STEREO - THE LIFE AND WORKS OF ALAN DOWER BLUMLEIN

Robert Charles Alexander

This book is the definitive study of the life and works of one of Britain's most important inventors who, due to a cruel set of circumstances, has all but been overlooked by history.

Alan Dower Blumlein led an extraordinary life in which his inventive output rate easily surpassed that of Edison, but whose early death during the darkest days of World War Two led to a shroud of secrecy which has covered his life and achievements ever since.

His 1931 Patent for a Binaural Recording System was so revolutionary that most of his contemporaries regarded it as more than 20 years ahead of its time. Even years after his death, the full magnitude of its detail had not been fully utilized. Among his 128 patents are the principal electronic circuits critical to the development of the world's first electronic television system. During his short working life, Blumlein produced patent after patent breaking entirely new ground in electronic and audio engineering.

During the Second World War, Alan Blumlein was deeply engaged in the very secret work of radar development and contributed enormously to the system eventually to become 'H2S' - blind-bombing radar. Tragically, during an experimental H2S flight in June 1942, the Halifax bomber in which Blumlein and several colleagues were flying, crashed and all aboard were killed. He was just days short of his thirtieth birthday.

420 pages

**Order code NE32 £17.99**

## VIDEO PROJECTS FOR THE ELECTRONICS CONSTRUCTOR

R. A. Penfold

Written by highly respected author R. A. Penfold, this book contains a collection of electronic projects specially designed for video enthusiasts. All the projects can be simply constructed, and most are suitable for the newcomer to project construction, as they are assembled on stripboard.

There are faders, wipers and effects units which will add sparkle and originality to your video recordings, an audio mixer and noise reducer to enhance your soundtracks and a basic computer control interface. Also, there's a useful selection on basic video production techniques to get you started.

Complete with explanations of how the circuit works, shopping lists of components, advice on construction, and guidance on setting up and using the projects, this invaluable book will save you a small fortune.

**Circuits include:** video enhancer, improved video enhancer, video fader, horizontal wiper, improved video wiper, negative video unit, fade to grey unit, black and white keyer, vertical wiper, audio mixer, stereo headphone amplifier, dynamic noise reducer, automatic fader, pushbutton fader, computer control interface, 12 volt mains power supply. **£10.95**

124 pages

**Order code PC115 £5.45**

## PC MUSIC - THE EASY GUIDE

Robin Vincent

How do I make music on my PC? Can I record music onto my PC? What's a sequencer? How can I get my PC to print a music score? What sort of a soundcard do I need? What hardware and software do I need? How do I connect a keyboard to my PC?

Just a few of the questions you've probably asked. Well, you'll find the answers to all these questions, and many more, in this book. It will show you what can be done, what it all means, and what you will need to start creating your own music on your PC. It's an easy read, it's fully illustrated and it will help you understand how a computer can be used as a creative music tool.

It covers soundcards, sequencers, hard disk digital audio recording and editing, plug-ins, printing scores with notation software, using your PC as a synthesiser, getting music onto and off the Internet, using Windows, sample PC music setups, FAQs, a glossary, advice on hardware and software, and a list of industry contacts.

116 pages

**Order code PC117 £11.95**

## HIGH POWER AUDIO AMPLIFIER CONSTRUCTION

R. A. Penfold

Practical construction details of how to build a number of audio power amplifiers ranging from about 50 to 300/400 watts r.m.s. includes MOSFET and bipolar transistor designs.

96 pages

Temporarily out of print

# FAULT FINDING, CIRCUITS AND DESIGN

## AN INTRODUCTION TO PIC MICROCONTROLLERS

Robert Penfold

Designing your own PIC based projects may seem a daunting task, but it is really not too difficult providing you have some previous experience of electronics.

The PIC processors have plenty of useful features, but they are still reasonably simple and straightforward to use. This book should contain everything you need to know.

Topics covered include: the PIC register set; numbering systems; bitwise operations and rotation; the PIC instruction set; using interrupts; using the analogue to digital converter; clock circuits; using the real time clock counter (RTCC); using subroutines; driving seven segment displays.

166 pages

Temporarily out of print

## PRACTICAL OSCILLATOR CIRCUITS

A. Flind

Extensive coverage is given to circuits using capacitors and resistors to control frequency. Designs using CMOS, timer i.c.s and op.amps are all described in detail, with a special chapter on "waveform generator" i.c.s. Reliable "white" and "pink" noise generator circuits are also included.

Various circuits using inductors and capacitors are covered, with emphasis on stable low frequency generation. Some of these are amazingly simple, but are still very useful signal sources.

Crystal oscillators have their own chapter. Many of the circuits shown are readily available special i.c.s for simplicity and reliability, and offer several output frequencies. Finally, complete constructional details are given for an audio sine wave generator.

133 pages

Order code BP393

£5.49

## PRACTICAL ELECTRONICS HANDBOOK -

Fifth Edition. Ian Sinclair

Contains all of the everyday information that anyone working in electronics will need.

It provides a practical and comprehensive collection of circuits, rules of thumb and design data for professional engineers, students and enthusiasts, and therefore enough background to allow the understanding and development of a range of basic circuits.

Contents: Passive components, Active discrete components, Circuits, Linear I.C.s, Energy conversion components, Digital I.C.s, Microprocessors and micro-processor systems, Transferring digital data, Digital-analogue conversions, Computer aids in electronics, Hardware components and practical work, Micro-controllers and PLCs, Digital broadcasting, Electronic security.

440 pages

Order code NE21

£19.99

## PIC IN PRACTICE

David W. Smith

A graded course based around the practical use of the PIC microcontroller through project work. Principles are introduced gradually, through hands-on experience, enabling hobbyists and students to develop their understanding at their own pace. The book can be used at a variety of levels.

Contents: Introduction to the PIC microcontroller; Programming the 16F84 microcontroller; Using inputs; Keypad scanning; Program examples; The 16C54 microcontroller; Alphanumeric displays; Analogue to digital conversion; Radio transmitters and receivers; EEPROM data memory; Interrupts; The 12C5XX 8-pin microcontroller; The 16F87X microcontroller; The 16F62X microcontroller; Projects; Instruction set, files and registers; Appendices; Index.

272 pages

Order code NE39

£17.49

## COIL DESIGN AND CONSTRUCTIONAL MANUAL

B. B. Babani

A complete book for the home constructor on "how to make" RF, IF, audio and power coils, chokes and transformers. Practically every possible type is discussed and calculations necessary are given and explained in detail. Although this book is now twenty years old, with the exception of toroids and pulse transformers little has changed in coil design since it was written.

96 pages

Order code BP160

£4.49

## PRACTICAL ELECTRONIC FAULT FINDING AND TROUBLESHOOTING

Robin Pain

To be a real fault finder, you must be able to get a feel for what is going on in the circuit you are examining. In this book Robin Pain explains the basic techniques needed to be a fault finder.

Simple circuit examples are used to illustrate principles and concepts fundamental to the process of fault finding. This is not a book of theory, it is a book of practical tips, hints and rules of thumb, all of which will equip the reader to tackle any job. You may be an engineer or technician in search of information and guidance, a college student, a hobbyist building a project from a magazine, or simply a keen self-taught amateur who is interested in electronic fault finding but finds books on the subject too mathematical or specialised.

The fundamental principles of analogue and digital fault finding are described (although, of course, there is no such thing as a "digital fault" - all faults are by nature analogue). This book is written entirely for a fault finder using only the basic fault-finding equipment: a digital multimeter and an oscilloscope. The treatment is non-mathematical (apart from Ohm's law) and all jargon is strictly avoided.

274 pages

Order code NE22

£25.99

## OPERATIONAL AMPLIFIER USER'S HANDBOOK

R. A. Penfold

The first part of this book covers standard operational amplifier based "building blocks" (integrator, precision rectifier, function generator, amplifiers, etc), and considers the ways in which modern devices can be used to give superior performance in each one. The second part describes a number of practical circuits that exploit modern operational amplifiers, such as high slew-rate, ultra low noise, and low input offset devices. The projects include: Low noise tape preamplifier, low noise RIAA pre-amplifier, audio power amplifiers, d.c. power controllers, opto-isolator audio link, audio millivolt meter, temperature monitor, low distortion audio signal generator, simple video fader, and many more.

120 pages

Order code BP335

£5.45

## A BEGINNERS GUIDE TO CMOS DIGITAL ICs

R. A. Penfold

Getting started with logic circuits can be difficult, since many of the fundamental concepts of digital design tend to seem rather abstract, and remote from obviously useful applications. This book covers the basic theory of digital electronics and the use of CMOS integrated circuits, but does not lose sight of the fact that digital electronics has numerous "real world" applications.

The topics covered in this book include: the basic concepts of logic circuits; the functions of gates, inverters and other logic "building blocks"; CMOS logic i.c. characteristics, and their advantages in practical circuit design; oscillators and monostables (timers); flip/flops, binary dividers and binary counters; decade counters and display drivers.

119 pages

Order code BP333

£5.45

# AUDIO AMPS

## VALVE & TRANSISTOR AUDIO AMPLIFIERS

John Linsley Hood

This is John Linsley Hood's greatest work yet, describing the milestones that have marked the development of audio amplifiers since the earliest days to the latest systems, including classic amps with valves at their heart and exciting new designs using the latest components, this book is the complete world guide to audio amp design.

Contents: Active components; Valves or vacuum tubes; Solid-state devices; Passive components; Inductors and transformers; Capacitors, Resistors, Switches and electrical contacts; Voltage amplifier stages using valves; Valve audio amplifier layouts; Negative feedback; Valve operated power amplifiers; Solid state voltage amplifiers; Early solid-state audio amplifiers; Contemporary power amplifier designs; Preamplifiers; Power supplies (PSUs); Index.

250 pages

Order code NE24

£25.99

## AUDIO AMPLIFIER PROJECTS

R. A. Penfold

A wide range of useful audio amplifier projects, each project features a circuit diagram, an explanation of the circuit operation and a stripboard layout diagram. All constructional details are provided along with a shopping list of components, and none of the designs requires the use of any test equipment in order to set up properly. All the projects are designed for straightforward assembly on simple circuit boards.

Circuits include: High impedance mic preamp, Low impedance mic preamp, Crystal mic preamp, Guitar and GP preamplifier, Scratch and rumble filter, RIAA pre-amplifier, Tape preamplifier, Audio limiter, Bass and treble tone controls, Loudness filter, Loudness control, Simple graphic equaliser, Basic audio mixer, Small (300mW) audio power amp, 6 watt audio power amp, 20/32 watt power amp and power supply, Dynamic noise limiter.

A must for audio enthusiasts with more sense than money!

116 pages

Order code PC113

£10.95 £5.45

## VALVE AMPLIFIERS

Second Edition. Morgan Jones

This book allows those with a limited knowledge of the field to understand both the theory and practice of valve audio amplifier design, such that they can analyse and modify circuits, and build or restore an amplifier. Design principles and construction techniques are provided so readers can devise and build from scratch, designs that actually work.

The second edition of this popular book builds on its main strength - exploring and illustrating theory with practical applications. Numerous new sections include: output transformer problems; heater regulators; phase splitter analysis; and component technology. In addition to the numerous amplifier and preamplifier circuits, three major new designs are included: a low-noise single-ended LP stage, and a pair of high voltage amplifiers for driving electrostatic transducers directly - one for headphones, one for loudspeakers.

288 pages

Order code NE33

£32.99

## BOOK ORDERING DETAILS

All prices include UK postage. For postage to Europe (air) and the rest of the world (surface) please add £2 per book. For the rest of the world airmail add £3 per book. CD-ROM prices include VAT and/or postage to anywhere in the world. Send a PO, cheque, international money order (£ sterling only) made payable to **Direct Book Service** or card details, Visa, Mastercard, Amex, Diners Club or Switch/Maestro to: **DIRECT BOOK SERVICE, WIMBORNE PUBLISHING LIMITED, 408 WIMBORNE ROAD EAST, FERNDOWN, DORSET BH22 9ND.**

Books are normally sent within seven days of receipt of order, but please allow 28 days for delivery - more for overseas orders. Please check price and availability (see latest issue of *Everyday Practical Electronics*) before ordering from old lists.

For a further selection of books see the next two issues of *EPE*.

Tel 01202 873872 Fax 01202 874562. E-mail: [dbs@epemag.wimborne.co.uk](mailto:dbs@epemag.wimborne.co.uk)

Order from our online shop at: [www.epemag.co.uk/shopdoor.htm](http://www.epemag.co.uk/shopdoor.htm)

## BOOK ORDER FORM

Full name: .....

Address: .....

.....

.....

..... Post code: ..... Telephone No: .....

Signature: .....

I enclose cheque/PO payable to DIRECT BOOK SERVICE for £ .....

Please charge my card £ ..... Card expiry date.....

Card Number ..... Switch/Maestro Issue No.....

Card Security Code ..... (the last three digits on or just below the signature strip)

Please send book order codes: .....

.....

Please continue on separate sheet of paper if necessary

# Net Work

## The Internet Page

Alan Winstanley



### Down with Ads

**I**n spite of taking precautions verging on complete paranoia, an irritating piece of spyware managed to drop itself onto the writer's PC, which is currently causing highly annoying pop-ups to be launched when certain web sites are visited (including eBay and Microsoft). Perversely, it warns that the machine may have been infected by spyware (it has been: it's the pop-up adware itself). The "Cancel" button does anything but.

The word "Advertisement" is bottom left, off-screen because you have to scroll down a few millimetres before it becomes apparent. The only saving grace is a tiny link stating that the advertisement is not brought to you by the web site you are visiting. After closing the window, surfing is interrupted again by pop-ups for online gambling.

The first removal tool of choice is Ad-aware ([www.lavasoft.de](http://www.lavasoft.de)), a product that should be a compulsory piece of kit for everyday Internet users. 117 million downloads in nine months can't be wrong. Also become familiar with Spybot Search and Destroy ([www.safer-networking.org/en/download/](http://www.safer-networking.org/en/download/)).

Recently, Microsoft entered the fray by offering, presently free of charge, new Microsoft Windows AntiSpyware (Beta), which after authenticating your Windows software online can be downloaded from [www.microsoft.com](http://www.microsoft.com). This is a very attractive-looking product that is quite thorough and the technology has a respectable pedigree. It is doubtful that any single product will ever catch all spyware though, so become accustomed to using several removal products, and keep them updated with the latest adware profiles.

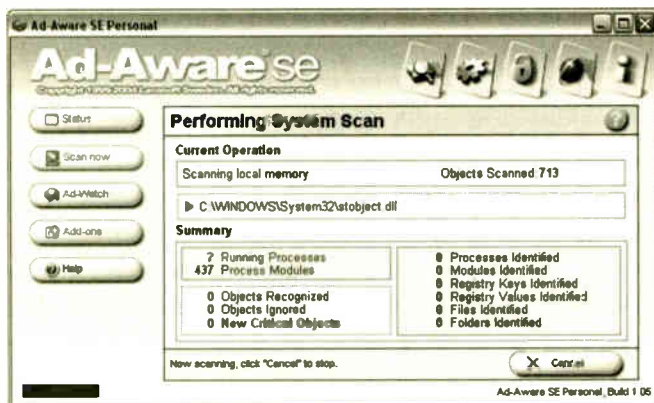

### A Phish Pharm

The principles of "phishing" have been widely reported in the news and hopefully *EPE* readers are now on their guard against attempts to trick them into revealing private security information to fraudsters. These "phishing" attacks are usually emails imploring users to log in somewhere to revalidate their security details. The emails appear to hail from popular banks, building societies, credit card companies, PayPal, eBay and so on.

Whilst some emails are just plain risible in their attempts to deceive, sometimes they have been very skilfully composed and resemble the real thing. Even the writer had to stop and think about a PayPal phishing email that arrived the other day.

Last month we highlighted the free anti-phishing toolbar supplied by [www.netcraft.com](http://www.netcraft.com), and although its effectiveness

depends on the fraud having already been recorded in the toolbar's database, it is worth trying. The popular Eudora email client currently used by the author ([www.eudora.com](http://www.eudora.com)) now has an "anti scam" feature that highlights possible phishing problems as well.

The economics behind phishing are quite startling. If say ten million emails are sent out, and only 0.001% is tricked into replying, that yields 100 customer log-ins – a handsome reward for the perpetrators and their money-laundering operations. It is reported that earlier this year Symantec software products were detecting phishing attacks running at a rate of 33 million *per week*.

Worse still is the new prospect of "pharming" which is several leagues nastier than any audacious phishing attack. A trojan takes root in a suspect's PC, where it lies waiting for the moment that the user decides to access their online banking system. At this point the virus silently diverts the web browser to a fake web site, which is an imitation of the genuine bank's service. After logging in as normal, the user has then gifted their confidential access details to the fraudsters.

A quick look at Symantec's web site (<http://securityresponse.symantec.com>) reveals the latest threat to be **PWSteal.Bancos.R** which it says is "a password-stealing Trojan horse program that steals information entered into certain banking Web sites and logs keystrokes. It may also take screenshots of certain banking web pages to collect passwords and other sensitive information from a compromised computer."

This Trojan has been aimed at Brazilian banking institutes and one Brazilian master criminal has reportedly been convicted of online fraud to the tune of nearly \$40 million, a result of sending out some three million phishing mails per day.

Other ways in which supposedly secure banking systems are being infiltrated include the planting of keylogging software and hardware into an institution's network, perhaps via a pliant IT subcontractor or by using "inside" bank staff. The London office of the Sumitomo Mitsui Banking Corporation was recently the subject of a failed attempt to transfer fraudulently a total of £220 million (\$418 million) to various overseas accounts, aided by software that sniffed out account passwords and log-ins.

The system of simple log-ins and passwords is approaching its sell-by date. Just as a modern car has a security transponder embedded in the ignition key that is recognised by the car, it is probable that electronics hardware will increasingly be used to improve online security in years to come. It might start with the use of smartcards to be inserted into a reader to verify identity prior to logging in. Biometric ID might become the norm: fingerprint recognition is already built into some Sony USB memory cards and Samsung laptop computers, and one day a USB palmprint reader device might be needed to log in. Perhaps we may all finish up with iris scanners perched on top of our computer screens, hoping that a Trojan hasn't been developed that sends snapshots halfway round the world.

### EPE Chat Zone

Regular readers will have noted the temporary withdrawal of the *EPE Chat Zone* on our web site. A series of failures beyond our control crashed the forum as quickly as it was restored. Many dozens of users have entered their email address at the *Chat Zone* to receive an alert when a replacement forum is launched, which is hopefully during April. There will be plenty of help on hand for new users, but I must ask readers to be patient, and in the meantime we have been asked to link to the Unofficial *EPE Forum* at [www.epeforum.net](http://www.epeforum.net).



# PCB SERVICE

Printed circuit boards for most recent *EPE* constructional projects are available from the PCB Service, see list. These are fabricated in glass fibre, and are fully drilled and roller tinned. All prices include VAT and postage and packing. Add £1 per board for airmail outside of Europe. Remittances should be sent to The PCB Service, *Everyday Practical Electronics*, Wimborne Publishing Ltd., 408 Wimborne Road East, Ferndown, Dorset BH22 9ND. Tel: 01202 873872; Fax 01202 874562; Email: [orders@epemag.wimborne.co.uk](mailto:orders@epemag.wimborne.co.uk). On-line Shop: [www.epemag.wimborne.co.uk/shopdoor.htm](http://www.epemag.wimborne.co.uk/shopdoor.htm). Cheques should be crossed and made payable to *Everyday Practical Electronics* (Payment in £ sterling only).

**NOTE:** While 95% of our boards are held in stock and are dispatched within seven days of receipt of order, please allow a maximum of 28 days for delivery – overseas readers allow extra if ordered by surface mail. Back numbers or photostats of articles are available if required – see the *Back Issues* page for details. We do not supply kits or components for our projects.

**Please check price and availability in the latest issue.**  
**A large number of older boards are listed on our website.**  
 Boards can only be supplied on a payment with order basis.

PROJECT TITLE	Order Code	Cost
Anyone At Home – Logic Board	NOV '03 421	Pair £6.35
– Relay Board	422	
Radio Circuits–6 Direct Conversion SW Receiver	423	£6.02
★PIC Random L.E.D. Flasher	424	£4.60
★PIC Virus Zapper Mk2	DEC '03 425	£5.72
Radio Circuits–7 SW Superhet Tuner/Mixer	426	£5.70
Christmas Cheeks (double-sided)	427	£4.44
★PIC Nim Machine – Software only	–	–
Bedside Nightlight (Top Tenner)	JAN '04 417	£4.44
Sound Trigger	418	£4.60
Timing/Lamp	428	£5.71
Radio Circuits–8 Dual Conversion SW Rec. – I.F. Amp	429	£4.45
– Signal-Strength Meter	430	£4.75
– B.F.O./Prod. Detector	431	£7.61
★Car Computer (double-sided)	–	–
★PIC Watering Timer – Software only	–	–
★GPS to PIC and PC Interface – Software only	–	–
Jazzy Necklace	FEB '04 432 pair	£5.40
Sonic Ice Warning	433	£5.39
★LCF Meter	434	£5.00
★PIC Tug-of-War	435	£5.00
Bat-Band Converter	MAR '04 436	£4.76
★MIDI Health Check – Transmitter/Receiver	437 pair	£7.61
Emergency Stand-by Light	438	£5.55
★PIC Mixer for RC Planes – Software only	–	–
★Teach-In '04 Part 5 – Software only	–	–
Infra-Guard	APR '04 439	£5.07
★Moon Clock	442	£5.71
★Teach-In '04 Part 6 – Software only	–	–
★EPE Seismograph Logger	440	pair £6.50
Control Board	441	
Sensor Amp. Board	443	£4.60
In-Car Lap-Top PSU	444	£4.60
Beat Balance Metal Detector	445	£4.91
Teach-In '04 Part 7 – Transmitter	446	£4.75
Receiver	447	£4.44
Moisture	448	£5.71
★PIC Quickstep	JUNE '04 449	£4.91
Body Detector MkII	–	–
★Teach-In '04 Part 8 – Software only	–	–
★MIDI Synchronome – Software only	–	–
Hard Drive Warbler	JULY '04 450	£4.60
★Bongo Box	451	£6.02
Portable Mini Alarm – Sensor	452	£5.23
– Counter	453	£5.07
★Teach-In '04 Part 9	454	£5.07
PIC Combination Lock Alarm Monitor	455	£5.71
★EPE Magnetometry Logger	456	£4.12
Keyring L.E.D. Torch	AUG '04 457	£5.39
★Teach-In '04 Part 10 – PIC Curtain or Blind Winder	458	£5.07
Simple F.M. Radio – F.M. Tuner	459	£4.75
– Tone Control	347	£4.60
– Audio Power Amp (TDA2003)	460	£5.39
– Power Supply	461	£6.66
★EPE Scorer	462	£7.93
– Control Board	463	£5.55
– Display Board	–	–
– Slave Board	–	–
★PIC to Mouse/Keyboard – Software only	–	–
EPE War Zapper	SEPT '04 464	£4.60
★Radio Control Failsafe	465	£4.76
★AlphaMouse Game	466	£4.60
★Rainbow Lighting Controller – Software only	–	–
★Moon and Tide Clock Calendar	467	£5.55
Volts Checker	468	£4.20
★Smart Karts – Software only	–	–
Logic Probe	NOV '04 469	£4.76
Thunderstorm Monitor	470	£5.39
MW Amplitude Modulator	471	£4.76
– V.F.O./Buffer	472	£5.07
– Modulator/PA	473	£4.76
– Power Supply	–	–

PROJECT TITLE	Order Code	Cost
Super Vibration Switch	DEC '04 474	£4.75
Wind Direction Indicator	475	£6.18
★PIC Flasher Mk2	476	£4.75
– Control Board	477	£4.44
– Transmitter	478	£4.75
– Multipurpose Board	479	£4.44
– Simple Cycler	480	£4.44
– Luxeon V Controller	473	£4.76
– Power Supply	–	–
Light Detector	JAN '05 481	£4.44
★Camera Watch	482	£6.03
Gate Alarm – Oscillator	483	£4.92
– Delay/Timer	484	£4.92
★Sneaky – Transmitter	FEB '05 485	£4.60
– Receiver	486	£4.91
★PIC Electric Mk2 – Control	487	£5.87
– Sensor	488	£5.71
489	–	£7.29
Sound Card Mixer	490	£5.71
Headphone Monitor	MAR '05 491	£6.02
EPE Cat Flap	492	£9.04
★Bingo Box – Main	493	£10.31
– Big Digit Display	–	–
Spontaflex Radio– Tuner	APR '05 494	£5.55
– Coil Pack	495	£5.71
– Audio Amplifier	496	£5.55
– Tuning Capacitor Board	406	£4.28
★Safety Interface	497	£6.18
Back-To-Basics 1– Fridge/Freezer Door Alarm	498	£5.39
★Crossword Solver	MAY '05 499	£6.66
20W Amplifier Module	500	£5.14
Back-To-Logic Basics 2	501	£5.39
Water Level Alarm	502	£5.87
Burglar Alarm	–	–

## EPE SOFTWARE

Software programs for *EPE* projects marked with a single asterisk ★ are available on 3.5 inch PC-compatible disks or free from our Internet site. The following disks are available: **PIC Tutorial V2** (Apr-June '03); **EPE Disk 3** (2000); **EPE Disk 4** (2001 – excl. PIC Toolkit TK3); **EPE Disk 5** (2002); **EPE Disk 6** (2003 – excl. Earth Resistivity and Met Office); **EPE Disk 7** (2004); **EPE Disk 8** (Jan 2005 to current cover date); **EPE Earth Resistivity Logger** (Apr-May '03); **EPE PIC Met Office** (Aug-Sept '03); **EPE Seismograph** (Apr-May '04); **EPE Magnetometry Logger** (July-Aug '04); **EPE Teach-In 2000**; **EPE Spectrum**; **EPE Interface Disk 1** (October '00 issue to current cover date). **EPE Toolkit TK3** software is available on the **EPE PIC Resources** CD-ROM, £14.45. Its p.c.b. is order code 319, £8.24. ★★ The software for these projects is on its own CD-ROM. The 3.5 inch disks are £3.00 each (UK), the CD-ROMs are £6.95 (UK). Add 50p each for overseas surface mail, and £1 each for airmail. All are available from the *EPE PCB Service*. All files can be downloaded free from our Internet FTP

## EPE PRINTED CIRCUIT BOARD SERVICE

Order Code	Project	Quantity	Price
Name .....			
Address .....			
Tel. No. ....			
I enclose payment of £..... (cheque/PO in £ sterling only) to:			
		<b>Everyday Practical Electronics</b> 	
		<b>MasterCard, Amex, Diners Club, Visa or Switch/Maestro</b>  	
Card No. ....			
Valid From .....		Expiry Date .....	
Card Security Code ..... Switch/Maestro Issue No .....			
(The last 3 digits on or just under the signature strip)			
Signature .....			
<p><b>NOTE:</b> You can also order p.c.b.s by phone, Fax, Email or via our Internet site on a secure server:</p> <p><a href="http://www.epemag.wimborne.co.uk/shopdoor.htm">http://www.epemag.wimborne.co.uk/shopdoor.htm</a></p>			

Everyday Practical Electronics reaches twice as many UK readers as any other UK monthly hobby electronics magazine, our sales figures prove it. We have been the leading monthly magazine in this market for the last twenty years.

If you want your advertisements to be seen by the largest readership at the most economical price our classified and semi-display pages offer the best value. The prepaid rate for semi-display space is £10 (+VAT) per single column centimetre (minimum 2.5cm). The prepaid rate for classified adverts is 40p (+VAT) per word (minimum 12 words).

All cheques, postal orders, etc., to be made payable to Everyday Practical Electronics. **VAT must be added.** Advertisements, together with remittance, should be sent to Everyday Practical Electronics Advertisements, Mill Lodge, Mill Lane, Thorpe-le-Soken, Essex CO16 0ED. Phone/Fax (01255) 861161.

For rates and information on display and classified advertising please contact our Advertisement Manager, Peter Mew as above.

**BOWOOD ELECTRONICS LTD**  
*Suppliers of Electronic Components*  
 Place a secure order on our website or call our sales line  
 All major credit cards accepted  
 Web: [www.bowood-electronics.co.uk](http://www.bowood-electronics.co.uk)  
 Unit 1, McGregor's Way, Turnoaks Business Park,  
 Chesterfield, S40 2WB. Sales: 01246 200222  
 Send 60p stamp for catalogue

**The Versatile, Programmable On Screen Display System**  
[www.STV5730A.co.uk](http://www.STV5730A.co.uk)



PAL - NTSC compatible

- Fully programmable
- PIC 16F628 microcontroller
- Demo software code available
- OSD IC 28 by 11 screen
- I/O lines free to connect sensors or buttons
- Serial or PC keyboard interface versions

TEXT, GPS or DATA

**X-10® Home Automation**  
 We put you in control™

**Why tolerate when you can automate?**  
 An extensive range of 230V X-10 products and starter kits available. Uses proven Power Line Carrier technology, no wires required.  
 Products Catalogue available Online.  
 Worldwide delivery.

**Laser Business Systems Ltd.**  
 E-Mail: [info@laser.com](mailto:info@laser.com)  
<http://www.laser.com>  
 Tel: (020) 8441 9788  
 Fax: (020) 8449 0430



**VVT TRANSFORMERS**

Transformers and Chokes for all types of circuits including specialist valve units  
 Custom design or standard range  
 High and low voltage

**Variable Voltage Technology Ltd**  
 Unit 3, Sheat Manor Farm, Chillerton,  
 Newport, Isle of Wight, PO30 3HP  
 Tel: 0870 243 0414 Fax: 01983 721572  
 email: [sales@vvt-cowes.freemove.co.uk](mailto:sales@vvt-cowes.freemove.co.uk)  
[www.vvttransformers.co.uk](http://www.vvttransformers.co.uk)

**TOTALROBOTS**

**ROBOTICS, CONTROL & ELECTRONICS TECHNOLOGY**

High quality robot kits and components  
 UK distributor of the OOPic microcontroller

Secure on-line ordering  
 Rapid delivery  
 Highly competitive prices

Visit [www.totalrobots.com](http://www.totalrobots.com)  
**Tel: 0208 823 9220**

**Component Kits!**

<p>£4.99</p>  <p>CAP-001 93pcs Electrolytic Capacitor Kit (1-2200uF 16-63V)</p>	<p>£9.99</p>  <p>RES-001 1000pcs Metal Film Resistor Kit (10R-1M 0.25W 1%)</p>
<p>£4.99</p>  <p>CAP-002 100pcs Polyester Capacitor Kit (1-470nF 63V)</p>	<p>£4.99</p>  <p>CAP-003 240pcs Ceramic Capacitor Kit (22pf-100nF 50V)</p>

Mail order P&P: £2.50 (Free P&P orders over £20)  
[www.fastcomponents.co.uk](http://www.fastcomponents.co.uk)  
 Tel: 0870 750 4468 Fax: 0870 137 6005  
 Winchester House, Winchester Rd,  
 Walton-on-Thames, Surrey, KT12 2RH

**PROSCHEMATIC**

A shareware schematic drawing tool.  
 Draw in different styles, print, publish, netlist and generate a Bill of Materials.

Visit: [www.hobbyace.co.uk](http://www.hobbyace.co.uk)  
 Free plugin modules available.  
 from SATURN SOFT LTD

**BTEC ELECTRONICS TECHNICIAN TRAINING**

VCE ADVANCED ENGINEERING ELECTRONICS AND ICT  
 HNC AND HND ELECTRONICS  
 NVQ ENGINEERING AND IT  
**PLEASE APPLY TO COLLEGE FOR NEXT COURSE DATE**  
 FULL PROSPECTUS FROM

**LONDON ELECTRONICS COLLEGE**  
 (Dept EPE) 20 PENYVERN ROAD  
 EARLS COURT, LONDON SW5 9SU  
 TEL: (020) 7373 8721

**ByVac**

29 Springwood View, Penistone S36 6SX

Microcontroller, no development tools needed, runs BASIC will run stand alone  
 KIT £14.95 + £1.81 P & P

[www.byvac.com](http://www.byvac.com)



**Miscellaneous**

**MICRO CHIP DEVICES** for home and business. Projects and Products on Microchip and 1-wire technologies. Visit our WEB site at: [www.microchipdevices.com](http://www.microchipdevices.com)

**VALVES AND ALLIED COMPONENTS IN STOCK.** Phone for free list. Valves, books and magazines wanted. Geoff Davies (Radio), tel. 01788 574774.

**FREE! PROTOTYPE PRINTED CIRCUIT BOARDS!** Free prototype p.c.b. with quantity orders. Call Patrick on 028 9073 8897 for details. Agar Circuits, Unit 5, East Belfast Enterprise Park, 308 Albertbridge Road, Belfast BT5 4GX.

**PRINTED CIRCUIT BOARDS - QUICK SERVICE.** Prototype and production artwork raised from magazines or draft designs at low cost. PCBs designed from schematics. Production assembly, wiring and software programming. For details contact Patrick at Agar Circuits, Unit 5, East Belfast Enterprise Park, 308 Albertbridge Road, Belfast BT5 4GX. Phone 028 9073 8897, Fax 028 9073 1802, Email [agar@argonet.co.uk](mailto:agar@argonet.co.uk)

**KITS, TOOLS, COMPONENTS.** S.a.e. catalogue: Sir-Kit Electronics, 52 Severn Road, Clacton, CO15 3RB.  
[www.geocities.com/sirkituk](http://www.geocities.com/sirkituk)

**Computer Software**

**FREE DOWNLOADABLE SOFTWARE:** Electronics, Electrical and Computing V8.2. Computer Science V8.2 and GCSE Maths V8.2. Still selling at £120 each on CDROM is now available to download and fully install to your hard drive **COMPLETELY FREE OF CHARGE.** Latest update includes the new Web Links feature. Visit [www.eptsoft.com](http://www.eptsoft.com) for details.

**TO ADVERTISE IN EPE**  
 contact  
 Peter Mew  
 01255 861161

## N. R. BARDWELL LTD (Est. 1948)

100	Signal Diodes 1N4148	£1.00	80	Assid. capacitors 1nF to 1µF	£1.00
75	Rectifier Diodes 1N4001	£1.00	200	Assid. disc ceramic capacitors	£1.00
50	Rectifier Diodes 1N4007	£1.00	50	Assid. Skel Presets (sm, stand, cermet)	£1.00
10	W01 Bridge Rectifiers	£1.00	50	Assid. RF chokes (inductors)	£1.00
10	555 Timer I.C.s	£1.00	25	Assid. trimmers	£1.00
4	741 Op Amps	£1.00	8	Assid. di switches	£1.00
50	Assorted Zener Diodes 400mW	£1.00	8	Assid. push-button switches, multi-bank, multi-pole	£1.00
12	Assorted 7-segment Displays	£1.00	30	Assid. oil sockets up to 40 way	£1.00
35	Assorted L.e.d.s, var. shapes, colours & sizes	£1.00	10	TV coax plugs, plastic	£1.00
25	5mm L.e.d.s, red or green or yellow	£1.00	40	metres very thin connecting wire, red	£1.00
25	3mm L.e.d.s, red or green or yellow	£1.00	20	1in. glass reed switches	£1.00
75	5mm L.e.d.s, green, 6-5mm legs	£1.00	100	Any one value ¼W 5% c/ resistors range 1R to 10M	£0.45
50	Axial L.e.d.s, 2mod red Diode Package	£1.00	10	7812 Voltage Regulators	£1.00
25	Assid. High Brightness L.e.d.s, var coils	£1.00	300	Assid resistors, ¼W/½W, mostly on tapes	£1.00
20	BC182L Transistors	£1.00			
25	BC212L Transistors	£1.00			
30	BC237 Transistors	£1.00			
20	BC327 Transistors	£1.00			
30	BC328 Transistors	£1.00			
30	BC547 Transistors	£1.00			
20	BC547B Transistor	£1.00			
30	BC548 Transistors	£1.00			
30	BC549 Transistors	£1.00			
25	BC557 Transistors	£1.00			
30	BC558 Transistors	£1.00			
25	BC559 Transistors	£1.00			
20	2N3904 Transistors	£1.00			
100	1nF 50V wkq Axial Capacitors	£1.00			
80	Assid capacitors electrolytic	£1.00			

288 Abbeydale Road, Sheffield S7 1FL

Phone (local rate): 0845 166 2329

Fax: 0114 255 5039

e-mail: sales@bardwells.co.uk

web: www.bardwells.co.uk

Prices include VAT, Postage £1.85

44p stamp for lists or disk

POs, Cheques and Credit Cards accepted

SEE OUR WEB PAGES FOR MORE

COMPONENTS AND SPECIAL OFFERS



Get your magazine "instantly" anywhere in the world – buy from the web.

TAKE A LOOK, A FREE ISSUE IS AVAILABLE

A one year subscription (12 issues) costs just \$14.99 (US)

www.epemag.com

# Europe's Largest Surplus Store

20,000,000 Items on line NOW!  
New items added daily

Established for over 25 years, UK company Display Electronics prides itself on offering a massive range of electronic and associated electro-mechanical equipment and parts to the Hobbyist, Educational and Industrial user. Many current and obsolete hard to get parts are available from our vast stocks, which include:

- ◆ 6,000,000 Semiconductors
- ◆ 5,000 Power Supplies
- ◆ 25,000 Electric Motors
- ◆ 10,000 Connectors
- ◆ 100,000 Relays & Contactors
- ◆ 2000 Rack Cabinets & Accessories
- ◆ 4000 Items of Test Equipment
- ◆ 5000 Hard Disk Drives

We Ship Worldwide

Surplus Wanted

www.distel.co.uk

Display Electronics  
29 / 35 Osborne Road  
Thornton Heath  
Surrey UK CR7 8PD

Telephone  
[44] 020 8653 3333  
Fax [44] 020 8653 8888

## EPE BINDERS KEEP YOUR MAGAZINES SAFE – RING US NOW!

This ring binder uses a special system to allow the issues to be easily removed and re-inserted without any damage. A nylon strip slips over each issue and this passes over the four rings in the binder, thus holding the magazine in place.

The binders are finished in hard-wearing royal blue p.v.c. with the magazine logo in gold on the spine. They will keep your issues neat and tidy but allow you to remove them for use easily.

The price is £6.95 plus £3.50 post and packing. If you order more than one binder add £1 postage for each binder after the initial £3.50 postage charge (overseas readers the postage is £6.00 each to everywhere except Australia and Papua New Guinea which costs £10.50 each).

Send your payment in £'s sterling cheque or PO (Overseas readers send £ sterling bank draft, or cheque drawn on a UK bank or pay by card), to **Everyday Practical Electronics, Wimborne Publishing Ltd, 408 Wimborne Road East, Ferndown, Dorset BH22 9ND. Tel: 01202 873872. Fax: 01202 874562.**

E-mail: editorial@epemag.wimborne.co.uk. Web site: http://www.epemag.co.uk

Order on-line from www.epemag.co.uk/shopdoor.htm

We also accept card payments. Mastercard, Visa, Amex, Diners Club or Maestro.

Send, fax or phone your card number, card expiry date and card security code (the last 3 digits on or just under the signature strip), plus Maestro Issue No. with your order.



# SQUIRES

## MODEL & CRAFT TOOLS

A COMPREHENSIVE RANGE OF MINIATURE HAND AND POWER TOOLS AND AN EXTENSIVE RANGE OF ELECTRONIC COMPONENTS

FEATURED IN A FULLY ILLUSTRATED

704 PAGE MAIL ORDER CATALOGUE

## 2005 ISSUE

**SAME DAY DESPATCH  
FREE POST AND PACKAGING**

Catalogues: FREE OF CHARGE to addresses in the UK. Overseas: CATALOGUE FREE, postage at cost charged to credit card

SHOP EXTENSION NOW OPEN

Squires, 100 London Road,  
Bognor Regis, West Sussex, PO21 1DD



TEL: 01243 842424  
FAX: 01243 842525



## Rechargeable Batteries With Solder Tags

### NIMH

AA 2000mAh .....	£2.82
C 4Ah .....	£4.70
D 9Ah .....	£7.60
PP3 150mAh .....	£4.95

### NICAD

AA 650mAh .....	£1.41
C 2.5Ah .....	£3.60
D 4Ah .....	£4.95

### Instrument case with edge connector and screw terminals

Size 112mm x 52mm x 105mm tall

This box consists of a cream base with a PCB slot, a cover plate to protect your circuit, a black lid with a 12 way edge connector and 12 screw terminals built in (8mm pitch) and 2 screws to hold the lid on. The cream bases have minor marks from dust and handling price £2.00 + VAT(=£2.35) for a sample or £44.00+VAT(=£51.70) for a box of 44.

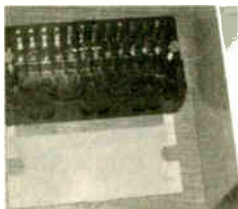

866 battery pack originally intended to be used with an orbital mobile telephone it contains 10 1.6Ah sub C batteries (42 x 22 dia. the size usually used in cordless screwdrivers etc.) the pack is new and unused and can be broken open quite easily £7.46 + VAT = £8.77



Please add £1.66 + VAT = £1.95 postage & packing per order

## JPG Electronics

Shaws Row, Old Road, Chesterfield, S40 2RB.  
Tel 01246 211202 Fax 01246 550959

www.JPGElectronics.com

Mastercard/Visa/Switch

Callers welcome 9.30 a.m. to 5.30 p.m. Monday to Saturday

## SHERWOOD ELECTRONICS

### FREE COMPONENTS

Buy 10 x £1 Special Packs and choose another one FREE

SP1 15 x 5mm Red LEDs	SP135 6 x Miniature slide switches
SP2 12 x 5mm Green LEDs	SP136 3 x BFY50 transistors
SP3 12 x 5mm Yellow LEDs	SP137 4 x W005 1.5A bridge rectifiers
SP5 25 x 5mm 1 part LED clips	SP138 20 x 2.2/63V radial elect. caps.
SP6 15 x 3mm Red LEDs	SP140 3 x W04 1.5A bridge rectifiers
SP7 12 x 3mm Green LEDs	SP142 2 x CMOS 4017
SP8 10 x 3mm Yellow LEDs	SP143 5 Pairs min. crocodile clips (Red & Black)
SP9 25 x 3mm 1 part LED clips	SP144 5 Pairs min. crocodile clips (assorted colours)
SP10 100 x 1N4148 diodes	SP146 10 x 2N3704 transistors
SP11 30 x 1N4001 diodes	SP147 5 x Stripboard 9 strips x 25 holes
SP12 30 x 1N4002 diodes	SP151 4 x 8mm Red LEDs
SP18 20 x BC182 transistors	SP152 4 x 8mm Green LEDs
SP20 20 x BC184 transistors	SP153 4 x 8mm Yellow LEDs
SP23 20 x BC549 transistors	SP154 15 x BC548 transistors
SP24 4 x CMOS 4001	SP156 3 x Stripboard, 14 strips x 27 holes
SP25 4 x 555 timers	SP160 10 x 2N3904 transistors
SP26 4 x 741 Op.Amps	SP161 10 x 2N3906 transistors
SP28 4 x CMOS 4011	SP164 2 x C106D thyristors
SP29 3 x CMOS 4013	SP165 2 x LF351 Op.Amps
SP33 4 x CMOS 4081	SP166 20 x 1N4003 diodes
SP34 20 x 1N914 diodes	SP167 5 x BC107 transistors
SP36 25 x 10/25V radial elect. caps.	SP168 5 x BC108 transistors
SP37 12 x 100/35V radial elect. caps.	SP171 8 Meters 18SWG solder
SP38 15 x 47/25V radial elect. caps.	SP172 4 x Standard slide switches
SP39 10 x 470/16V radial elect. caps.	SP173 10 x 220/25V radial elect. caps.
SP40 15 x BC237 transistors	SP174 20 x 22/25V radial elect. caps.
SP41 20 x Mixed transistors	SP175 20 x 1/63V radial elect. caps.
SP42 200 x Mixed 0.25W C.F. resistors	SP177 10 x 1A 20mm quick blow fuses
SP47 5 x Min. PB switches	SP178 10 x 2A 20mm quick blow fuses
SP49 4 x 5 metres stranded core wire	SP181 5 x Phono plugs - assdtd colours
SP101 8 Meters 22SWG solder	SP182 20 x 4.7/63V radial elect. caps.
SP102 20 x 8-pin DIL sockets	SP183 20 x BC547 transistors
SP103 15 x 14-pin DIL sockets	SP187 15 x BC238 transistors
SP104 15 x 16-pin DIL sockets	SP189 4 x 5 metres solid core wire
SP105 4 x 74LS00	SP192 3 x CMOS 4066
SP109 15 x BC557 transistors	SP195 3 x 10mm Yellow LEDs
SP112 4 x CMOS 4093	SP197 6 x 20 pin DIL sockets
SP115 3 x 10mm Red LEDs	SP198 5 x 24 pin DIL sockets
SP116 3 x 10mm Green LEDs	SP199 5 x 2.5mm mono jack plugs
SP118 2 x CMOS 4047	SP200 5 x 2.5mm mono jack sockets
SP124 20 x Assorted ceramic disc caps	
SP126 6 x Battery clips - 3 ea. PP3 + PP9	
SP130 100 x Mixed 0.5W C.F. resistors	
SP131 2 x TL071 Op.Amps	
SP133 20 x 1N4004 diodes	
SP134 15 x 1N4007 diodes	

### RESISTOR PACKS - C.Film

RP3 5 each value - total 365 0.25W	£3.30
RP7 10 each value - total 730 0.25W	£4.55
RP10 1000 popular values 0.25W	£6.45
RP4 5 each value-total 345 0.5W	£4.20
RP8 10 each value-total 690 0.5W	£6.85
RP11 1000 popular values 0.5W	£8.70

2005 Catalogue now available £1 inc. P&P or FREE with first order.

P&P £1.50 per order. NO VAT

Cheques and Postal Orders to:

**Sherwood Electronics,**  
7 Williamson St., Mansfield,  
Notts. NG19 6TD.

## ADVERTISERS INDEX

AUTOTRAX .....	Cover (iv)
N. R. BARDWELL .....	375
BITZ TECHNOLOGY .....	344
BRUNNING SOFTWARE .....	306
BULL GROUP .....	Cover (ii)
CRICKLEWOOD ELECTRONICS .....	328
DISPLAY ELECTRONICS .....	375
ESR ELECTRONIC COMPONENTS .....	314
FOREST ELECTRONIC DEVELOPMENTS .....	311
JAYCAR ELECTRONICS .....	341
JPG ELECTRONICS .....	376
LABCENTER .....	Cover (iii)
MAGENTA ELECTRONICS .....	312/313
MATRIX MULTIMEDIA .....	356
MILFORD INSTRUMENTS .....	321
NURVE NETWORKS LLC .....	324
PEAK ELECTRONIC DESIGN .....	345
PICO TECHNOLOGY .....	325/356
QUASAR ELECTRONICS .....	308/309
SHERWOOD ELECTRONICS .....	376
SQUIRES .....	375
STEWART OF READING .....	311
SUMA DESIGNS .....	353

ADVERTISEMENT MANAGER: PETER J. MEW

ADVERTISEMENT OFFICES:

EVERYDAY PRACTICAL ELECTRONICS, ADVERTISEMENTS,  
MILL LODGE, MILL LANE, THORPE-LE-SOKEN,  
ESSEX CO16 0ED. Phone/Fax: (01255) 861161

For Editorial address and phone numbers see page 315

## EPE SUBSCRIPTIONS

SAVE 51p AN ISSUE OVER UK NEWSTAND PRICES  
ON A UK ONE YEAR SUBSCRIPTION

Subscriptions for delivery direct to any address in the UK: 6 months £16.50, 12 months £31, two years £57; Overseas: 6 months £19.50 standard air service or £28.50 express airmail, 12 months £37 standard air service or £55 express airmail, 24 months £69 standard air service or £105 express airmail. Cheques or bank drafts (in £ sterling only) payable to *Everyday Practical Electronics* and sent to *EPE* Subs. Dept., Wimborne Publishing Ltd., 408 Wimborne Road East, Ferndown, Dorset BH22 9ND. Tel: 01202 873872. Fax: 01202 874562. Email: subs@epemag.wimborne.co.uk. Also via the Web at <http://www.epemag.wimborne.co.uk>. Subscriptions start with the next available issue. We accept MasterCard, Amex, Diners Club, Switch or Visa. (For past issues see the Back Issues page.)

## ONLINE SUBSCRIPTIONS

Online subscriptions, for downloading the magazine via the Internet, \$14.99US (approx. £8) for one year available from [www.epemag.com](http://www.epemag.com).

## USA/CANADA SUBSCRIPTIONS

To subscribe to *EPE* from the USA or Canada please telephone Express Mag toll free on 1877 363-1310 and have your credit card details ready. Or fax (514) 355 3332 or write to Express Mag, PO Box 2769, Plattsburgh, NY 12901-0239 or Express Mag, 8155 Larrey Street, Anjou, Quebec, H1J 2L5.

Email address: [expmag@expressmag.com](mailto:expmag@expressmag.com).

Web site: [www.expressmag.com](http://www.expressmag.com).

USA price \$60(US) per annum, Canada price \$97(Can) per annum - 12 issues per year.

*Everyday Practical Electronics*, periodicals pending, ISSN 0262 3617 is published twelve times a year by Wimborne Publishing Ltd., USA agent USACAN at 1320 Route 9, Champlain, NY 12919. Subscription price in US \$60(US) per annum. Periodicals postage paid at Champlain NY and at additional mailing offices. POSTMASTER: Send USA and Canada address changes to *Everyday Practical Electronics*, c/o Express Mag., PO Box 2769, Plattsburgh, NY, USA 12901-0239.

# PROTEUS

*The Complete Electronics Design System*



## Schematic & PCB Layout

- Powerful & flexible schematic capture.
- Auto-component placement and rip-up/retry PCB routing.
- Polygonal gridless ground planes.
- Libraries of over 8000 schematic and 1000 PCB parts.
- Bill of materials, DRC reports and much more.

## Mixed Mode SPICE Circuit Simulation

- Berkeley SPICE3F5 simulator with custom extensions for true mixed mode and interactive simulation.
- 6 virtual instruments and 14 graph based analysis types.
- 6000 models including TTL, CMOS and PLD digital parts.
- Fully compatible with manufacturers' SPICE models

## Proteus VSM Co simulation and debugging for popular Micro-controllers

- Supports PIC AVR 8051 HC11 and ARM micro-controllers
- Co-simulate target firmware with your hardware design.
- Includes interactive peripheral models for LED and LCD displays, switches, keypads, virtual terminal and much, much more.
- Provides source level debugging for popular compilers and assemblers from Crownhill, IAR, Keil, and others.

## New Features in Version 6

- Drag and drop toolbars.
- Visual PCB packaging tool.
- Improved route editing.
- Point and click DRC report.
- Multiple design rules (per net).
- Multiple undo/redo.

*Call Now for Upgrade Pricing*



labcenter

Electronics  
53-55 Main Street, Grassington. BD23 5AA

Tel: 01756 753440  
Fax: 01756 752857

Contact us for  
**Free Demo CD**

[www.labcenter.co.uk](http://www.labcenter.co.uk)  
[info@labcenter.co.uk](mailto:info@labcenter.co.uk)

# Autotrax<sup>TM</sup>

Electronic Design Automation



Schematic Capture  
SPICE Simulation  
PCB Layout  
Auto-Layout/Router  
3D PCB Visualization  
Database Support

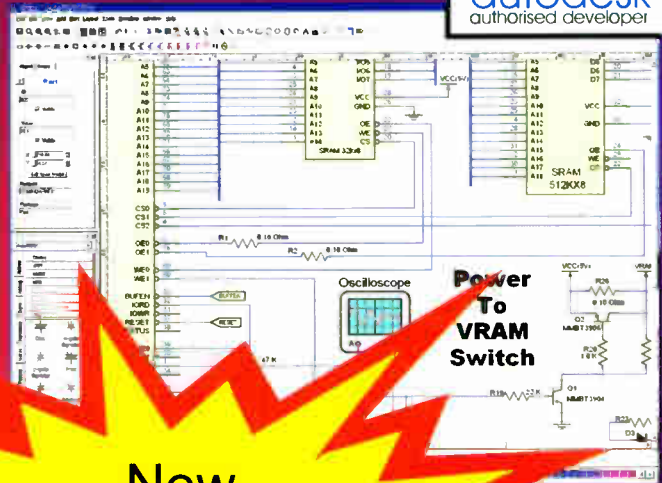

## New ELECTRA Autorouter

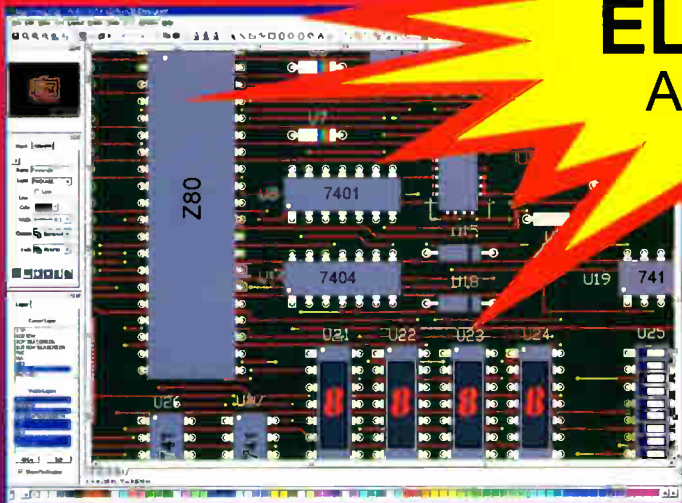

- Drag and drop parts onto your schematic. Connect them together.
- Add virtual instruments such as scopes and function generators.
- Use the PCB design wizard to create your PCB.
- Autolayout and autoroute the board.
- View the board in 3D.
- Output to Gerber and AutoCAD/Solidworks.

**Over 45,000 users**

To find out more go to  
[www.autotraxEDA.com](http://www.autotraxEDA.com)

AutoTRAX now now comes with the shape based autorouter. Super fast and not grid based. Saves you time and money by rapidly and accurately routing your PCB

Free version available for small scale projects.  
(only pin limited)

**Why wait? Download 4.00 AutoTRAX EDA NOW!**

**[www.autotraxEDA.com](http://www.autotraxEDA.com)**

**Connect EDA**

**Coming soon, AutoTRAX on Apple OSX and Linux**