

FREE
MICROCHIP ONLINE
COMPETITION WIN PIC TOOLS
WORTH \$2100 (US)

THE No.1 MAGAZINE FOR ELECTRONICS TECHNOLOGY & COMPUTER PROJECTS

EVERYDAY

OCTOBER 2004

PRACTICAL ELECTRONICS

**FREE
INSIDE**

£3.10

ROBOTS - SPECIAL SUPPLEMENT

EPE THEREMIN

Modern
version
of this
weird
instrument

NEW SERIES SMART KARTS

An extendable
buggy with a
PIC brain

BUY EPE
ON THE WEB
EPE
www.epemag.com

MOON & TIDE CLOCK CALENDAR

Wax & wane,
ebb & flow,
time & date



<http://www.epemag.wimborne.co.uk>

World Radio History



Colour CCTV camera, 8mm lens, 12V d.c. 200mA 582x628 Resolution 380 lines Automatic aperture lens Mirror function PAL Back Light Compensation MLR, 100x40x10mm. Ref EE2 £75.90

Built-in Audio 15lux CCD camera 12V d.c. 200mA 480 lines s/n ratio >48db 1V P-P output 110mm x 60mm x 50mm. Ref EE1 £108.90



Metal CCTV camera housings for internal or external use Made from aluminium and plastic they are suitable for mounting body cameras in. Available in two sizes 1 - 100 x 70 x 170mm and 2 - 100 x 70 x 280mm. Ref EE6 £24.20 EE7 £28.60 multi-position brackets. Ref EE8 £8.80

Excellent quality multi-purpose TV/TFT screen, works as just a LCD colour monitor with any of our CCTV cameras or as a conventional TV. Ideal for use in boats and caravans 49.7MHz-91.75MHz VHF channels 1.5, 168-25MHz-222.75MHz VHF channels 6-12, 471.25MHz-869.75MHz, Cable channels 112-325MHz-166.75MHz Z1-Z7, Cable channels 224-25MHz-446.75MHz Z8-Z35 5" colour screen. Audio output 150mW. Connections, external aerial, earphone jack, audio/video input, 12V d.c. or mains. Accessories supplied Power supply, Remote control, Cigar lead power supply, Headphone Stand bracket 5" model £152.90 Ref EE9, 6" model £163.90. Ref EE10



Self-cocking pistol picr002 crossbow with metal body. Self-cocking for precise string alignment Aluminium alloy construction High tec fibre glass limbs Automatic safety catch Supplied with three bolts Track style for greater accuracy. Adjustable rear sight 50lb drawweight 150ft sec velocity Break action 17" string 30m range £23.84 Ref PLCR002

Fully cased IR light source suitable for CCTV applications. The unit measures 10 x 10 x 150mm, is 12V d.c. operated and contains 54 infra-red LEDs. Designed to mount on a standard CCTV camera bracket. The unit also contains a daylight sensor that will only activate the infra-red lamp when the light level drops below a preset level. The infra-red lamp is suitable for indoor or exterior use, typical usage would be to provide additional IR illumination for CCTV cameras. £53.90. Ref EE11



Mains operated and designed to be used with any CCTV camera causing it to scan. The clips can be moved to adjust the scan angle, the motor reversing when it detects a clip. With the clips removed the scanner will rotate constantly at approx 2.3rpm. 75 x 75 x 80mm £25.30. Ref EE12

Colour CCTV Camera measures 60x45mm and has a built-in light level detector and 12 IR LEDs 0.2 lux 12 IR LEDs 12V d.c. Bracket Easy connect leads £75.90. Ref EE15



A high quality external colour CCTV camera with built-in infra-red LEDs measuring 60 x 60 x 60mm Easy connect leads colour Waterproof PAL 1/4in. CCD 542 x 588 pixels 420 lines 0.05 lux 3.6mm F2 78 deg lens 12V d.c. 400mA Built-in light level sensor. £108.90. Ref EE13

Colour pinhole CCTV camera module with audio. Compact, just 20x20x20mm, built-in audio and easy connect leads PAL CMOS sensor 6-9V d.c. Effective Pixels 628x582 Illumination 2 lux Definition >240 Signal/noise ratio >40db Power consumption 200mW £38.50. Ref EE21



A small colour CCTV camera measuring just 35 x 28 x 30mm. Supplied complete with bracket, microphone and easy connect leads. Built-in audio. Colour 380 line resolution PAL 0.2 lux +18db sensitivity. Effective pixels 628 x 582 Power source 6-12V d.c. Power consumption 200mW £39.60. Ref EE16

Complete wireless CCTV system with video. Kit comprises pinhole colour camera with simple battery connection and a receiver with video output. 380 lines colour 2.4GHz 3 lux 6-12V d.c. manual tuning Available in two versions, pinhole and standard. £86.90 (pinhole) Ref EE17, £86.90 (standard). Ref EE18



Small transmitter designed to transmit audio and video signals on 2.4GHz. Unit measures 45 x 35 x 10mm. Ideal for assembly into covert CCTV systems Easy connect leads Audio and video input 12V d.c. Complete with aerial Selectable channel switch £33. Ref EE19



2.4GHz wireless receiver Fully cased audio and video 2.4GHz wireless receiver 190x140x30mm, metal case, 4 channel, 12V d.c. Adjustable time delay, 4s, 8s, 12s, 16s. £49.50. Ref EE20

The smallest PMR446 radios currently available (54x87x37mm). These tiny handheld PMR radios not only look great, but they are user friendly & packed with features including VOX, Scan & Dual Watch. Priced at £64.90 PER PAIR they are excellent value for money. Our new favourite PMR radios! Standby: - 35 hours Includes: - 2 x Radios, 2 x Belt Clips & 2 x Carry Strap £64.90 Ref ALAN1 Or supplied with 2 sets of rechargeable batteries and two mains chargers £93.49. Ref Alan2



Betronics BEL550 Euro radar and GATSO detector Claimed Detection Range: GATSO up to 400m. Radar & Laser guns up to 3 miles. Detects GATSO speed cameras at least 200 metres away, plenty of time to adjust your speed £350.90. Ref BEL550

The TENS mini Microprocessors offer six types of automatic programme for shoulder pain, back/neck pain, aching joints, Rheumatic pain, migraines headaches, sports injuries, period pain. In fact all over body treatment. Will not interfere with existing medication. Not suitable for anyone with a heart pacemaker. Batteries supplied. £21.95 Ref TEN327 Spare pack of electrodes £6.59. Ref TEN327X



Dummy CCTV cameras These motorised cameras will work either on 2 AA batteries or with a standard DC adapter (not supplied) They have a built-in movement detector that will activate the camera if movement is detected causing the camera to pan! Good deterrent. Camera measures 20cm high, supplied with fixing screws. Camera also has a flashing red l.e.d. built in. £10.95. Ref CAMERAB

INFRA-RED FILM 6" square piece of flexible infra-red film that will only allow IR light through Perfect for converting ordinary torches, lights, headlights etc to infra-red output only using standard light bulbs Easily cut to shape, 6" square £16.50. Ref IRF2 or a 12" sq for £34.07 IRF2A



GASTON SEALED LEAD-ACID BATTERIES



1-3AH 12V @ £5.50 REF GT1213
3-4AH 12V @ £8.80 REF GT1234
7AH 12V @ £8.80 REF GT127
17AH 12V @ £19.80 REF GT1217

All new and boxed, bargain prices. Good quality sealed lead-acid batteries

SOLAR PANEL 10 watt silicon solar panel, at least 10 year life, 365 x 26mm, waterproof, ideal for fixing to caravans, boat, motorhomes etc. Nicely made unit with fixing holes for secure fittings. Complete with leads and connectors. Anodised frame. Supplied with two leads, one 3M lead is used for the op with two croc clips, the other lead is used to connect extra panels. Panels do NOT require a blocking diode, they can be left connected at all times without discharging the battery. £93.49. REF PAN



8A solar regulator 12V, 96 watt, 150mm x 100mm x 25mm, £30. REF SOLREG2



High-power modules (80W+) using 125mm square multi crystal silicon solar cells with bypass diode. Anti-reflection coating and BSF structure to improve cell conversion efficiency, 14%. Using white tempered glass, EVA resin, and a weatherproof film along with an aluminium frame for extended outdoor use. system Lead wire with waterproof connector. Four sizes, 80W 12V d.c. 1200 x 530 x 35mm, £315.17. REF NE80, 123W 12V d.c., 1499 x 662 x 46mm, £482.90. REF NDL3, 125W 24V, 1190 x 792 x 46mm, £482.90. REF NEL5 and 165W 24V, 157 x 826 x 46mm, £652.30.

BULL GROUP LTD
UNIT D, HENFIELD BUSINESS PARK,
HENFIELD, SUSSEX BN5 9SL
TERMS: CASH, PO, CHEQUE PRICES + VAT
WITH ORDER PLUS £5.50 P&P (UK) PLUS VAT.
24 HOUR SERVICE £7.50 (UK) PLUS VAT.
OVERSEAS ORDERS AT COST PLUS £3.50
Tel: 0870 7707520 Fax 01273 491813
Sales@bullnet.co.uk
www.bullnet.co.uk

THE TIDE CLOCK. These clocks indicate the state of the tide. Most areas in the world have two high tides and two low tides a day, so the tide clock has been specially designed to rotate twice each lunar day (every 12 hours and 25 minutes) giving you a quick and easy indication of high and low water. The Quartz tide clock will always stay calibrated to the moon. £23.10 REF TIDEC

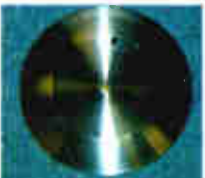

LINEAR ACTUATORS 12-36V D.C. BUILT-IN ADJUSTABLE LIMIT SWITCHES. POWER COATED 1 1/2in THROW UP TO 1.000lb. THRUST (400lb. RECOMMENDED LOAD). SUPPLIED WITH MOUNTING BRACKETS DESIGNED FOR OUTDOOR USE. These brackets originally made for moving very large satellite dishes are possibly more suitable for closing gates, mechanical machinery, robot wars etc. Our first sale was to a company building solar panels that track the sun! Two sizes available, 12in. and 18in. throw. £32.95. REF ACT12. £38.45 REF ACT18.



POWERSAFE DEEP CYCLE BATTERIES
12V 51AH, NOW ONLY £29.95 EACH
YUASA 6V 100AH NOW ONLY £25 + £5 POSTAGE EACH



BRAND NEW MILITARY ISSUE DOSE METERS (radiation detectors). Current NATO issue. Standard emergency services unit. Used by most of the world's military personnel. New and boxed. £75.90. REF SIEM69

NIGHT VISION SYSTEM. Superb hunting rifle sight to fit most rifles, grooved for a telescopic sight. Complete with infra-red illuminator. Magnification 2.7x. Complete with rubber eye shield and case. Opens up a whole new world! Russian made. Can be used as a hand-held or mounted on a rifle. £108.90. REF PN1



These Samarium magnets measure 57mm x 20mm and have a threaded hole (5/16th UNF) in the centre and magnetic strength of 2.2 gauss. We have tested these on a steel beam running through the offices and found that they will take more than 170lb. (77kg) in weight before being pulled off. With keeper. £21.95. REF MAG77.

Peltier Effect heat pump. Semiconductor thermoelectric device which works on the Peltier effect. When supplied with a suitable electric current, can either cool or heat. Also when subject to an externally applied temperature gradient can produce an electric current. Ideal for cooling or controlling the temperature of sub assemblies. Each module is supplied with a comprehensive 18 page Peltier design manual featuring circuit designs, design information etc., etc. The Peltier manual is also available separately. Maximum watts 56.2 40 x 40mm Imax, 5.5A Vmax, 16.7 Tmax (c-dry H2), 72. £32.95 (inc. manual. REF PELT1. Just manual £4.40 REF PELT2.

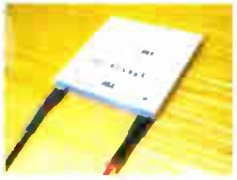

New transmitter, receiver and camera kit. £75.90. Kit contains four channel switchable camera with built-in audio, six IR l.e.d.s and transmitter, four channel switchable receiver, 2 power supplies, cables, connectors and mounting bracket. £75.90. Wireless Transmitter. Black and white camera (75 x 50 x 55mm). Built-in 4 channel transmitter (switchable). Audio built-in 6 IR l.e.d.s. Bracket/stand. Power supply 30m range Wireless Receiver 4 channel (switchable). Audio/video leads and scart adapter. Power supply and manual. £75.90. REF COP24.



This miniature Stirling Cycle Engine measures 7in. x 4 1/2in. and comes complete with built-in alcohol burner. Ref flywheels and chassis mounted on a green base, these all-metal beauties silently running at speeds in excess of 1,000 r.p.m., attract attention and create awe wherever displayed. This model comes completely assembled and ready to run. £106.70. REF SOL!



SHOP ONLINE
WWW.BULLNET.CO.UK

ISSN 0262 3617
PROJECTS ... THEORY ... NEWS ...
COMMENTS ... POPULAR FEATURES ...

VOL. 33. No. 10 OCTOBER 2004

Cover illustration: A/fred Pasiaka/Science Photo Library

EVERYDAY PRACTICAL ELECTRONICS

INCORPORATING ELECTRONICS TODAY INTERNATIONAL

www.epemag.wimborne.co.uk
EPE Online: www.epemag.com

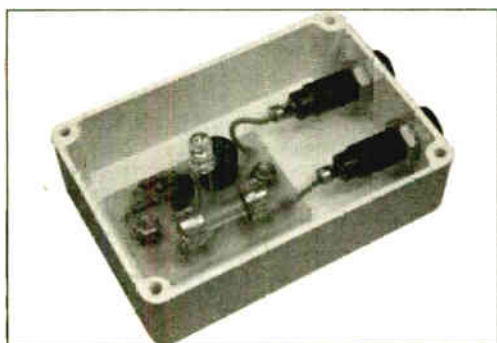
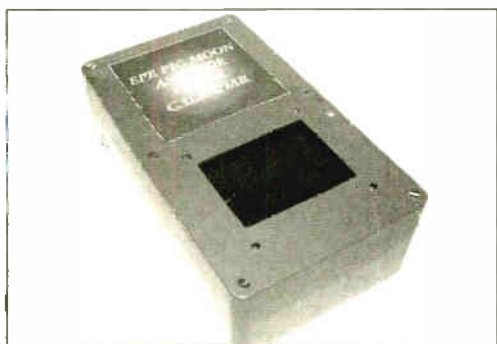
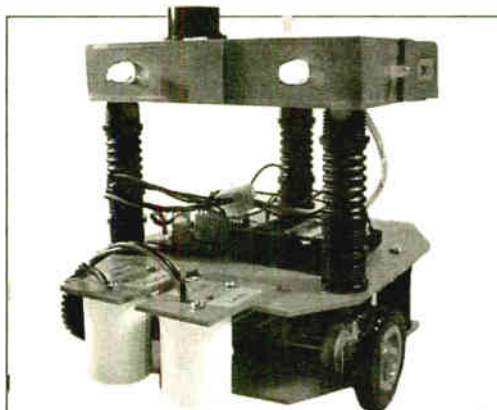
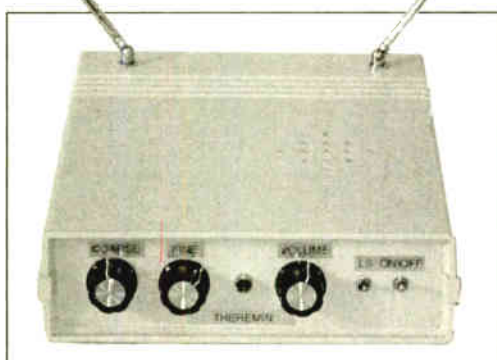

Projects and Circuits

- MOON AND TIDE CLOCK CALENDAR** by John Becker 680
A pictorial guide to tracking moon and tide states throughout the year
- INGENUITY UNLIMITED - Sharing your ideas with others** 694
High-Efficiency L.E.D. Torch; Temperature Controller; Glitch-Free Switching
- VOLTS CHECKER** by Anthony H. Smith, BSc (Hons) 700
A handy tester suitable for universal a.c. and d.c. supplies
- EPE THEREMIN** by Robert Penfold 704
Create "handsfree" weird and wonderful music!
- SMART KARTS - 1 Basic Construction** by Owen Bishop 724
Commencing construction of a PIC-based mobile buggy with various sensors and actuators. Suitable for tailoring to *your* needs!

Series and Features

- TECHNO TALK** by Andy Emmerson 690
Daddy or Chips? Coping with telephone bandwidth choices
- INTERFACE** by Robert Penfold 698
Introducing VB.Net and VB 2005 Express
- NET WORK - THE INTERNET PAGE** surfed by Alan Winstanley 714
King of the Domains; DIY Domains
- PIC N' MIX** by Andrew Jarvis 715
Hex files reopened: Record Viewer and running repairs
- CIRCUIT SURGERY** by Alan Winstanley and Ian Bell 722
Component marking explained; More on Super Glue; Electrical Mains Safety
- LIGHT EMITTING DIODES - OPERATION AND APPLICATIONS - 2**
Blasing and Interfacing by Anthony H. Smith, BSc. (Hons) 734
Continuing our short series intended to answer all those I.e.d. questions you've longed to ask

Regulars and Services

- PIC PROJECTS VOL 1 CD-ROM** 674
A plethora of 20 "hand-PICked" EPE past projects
- EDITORIAL** 679
- NEWS** - Barry Fox highlights technology's leading edge 687
Plus everyday news from the world of electronics
- BACK ISSUES** Did you miss these? Many now on CD-ROM 691
- FREE MICROCHIP ONLINE COMPETITION** 696
Win Microchip Development Tools!
- READOUT** John Becker addresses general points arising 713
- SHOPTALK** with David Barrington 716
The *essential* guide to component buying for *EPE* projects
- PLEASE TAKE NOTE** 716
Teach-In 2004 Pt 10; Water Safety Lock (I/U Sept '04)
- CD-ROMS FOR ELECTRONICS** 718
A wide range of CD-ROMs for hobbyists, students and engineers
- DIRECT BOOK SERVICE** 741
A wide range of technical books available by mail order, plus more CD-ROMs
- PRINTED CIRCUIT BOARD AND SOFTWARE SERVICE** 744
PCBs for *EPE* projects. Plus *EPE* project software
- ELECTRONICS MANUALS** 745
Essential CD-ROM reference works for hobbyists, students and service engineers
- ADVERTISERS INDEX** 748
- ROBOTS - SPECIAL SUPPLEMENT** **Between pages 708 and 709**

© Wimborne Publishing Ltd 2004. Copyright in all drawings, photographs and articles published in **EVERYDAY PRACTICAL ELECTRONICS** is fully protected, and reproduction or imitations in whole or in part are expressly forbidden.

Our November 2004 issue will be published on Thursday, 14 October 2004. See page 671 for details

Readers Services • Editorial and Advertisement Departments 679

Visit our website
www.distel.co.uk

THE ORIGINAL SURPLUS WONDERLAND!

THIS MONTH'S SELECTION FROM OUR VAST EVER CHANGING STOCKS

Surplus always
wanted for cash!

GIANT 10" 7-SEGMENT DISPLAYS

A bulk purchase enables us to bring to you these GIANT 7-segment digital displays at a now affordable price! The 10" character size gives exceptional readability at long distances and enables a host of applications including score boards, digital clocks, counters, event timers etc. As the units are a simple electro-mechanical device and operate from 12V DC, simple switching via switches, relays, PIC or PC may be used to control single or multiple digits. Units feature integral Zero Power memory which greatly simplifies design. For an excellent DIY practical article, see the May issue of 'Everyday Practical Electronics' magazine. Ideal School / College construction project. Supplied in good RFE condition, complete with data sheet.



Less than 30% of makers price
Only £29.95(B) or 4 / £99.00(D)
Order FW44 Order PH26

THE AMAZING TELEBOX



TV SOUND & VIDEO TUNER
CABLE COMPATIBLE

Converts your colour monitor into a QUALITY COLOUR TV!!
The TELEBOX is an attractive fully cased mains powered unit, containing all electronics ready to plug into a host of video monitors or AV equipment which are fitted with a composite video or SCART input. The composite video output will also plug directly into most video recorders, allowing reception of TV channels not normally receivable on most television receivers* (TELEBOX MB). Push button controls on the front panel allow reception of 8 fully tuneable 'off air' UHF colour television channels. TELEBOX MB covers virtually all television frequencies VHF and UHF including the HYPERBAND as used by most cable TV operators. Ideal for desktop computer video systems & PIP (picture in picture) setups. For complete compatibility - even for monitors without sound - an integral 4 watt audio amplifier and low level Hi Fi audio output are provided as standard. Brand new - fully guaranteed.

TELEBOX ST for composite video input type monitors £36.95
TELEBOX STL as ST but fitted with integral speaker £39.50
TELEBOX MB Multiband VHF/UHF/Cable/Hyperband tuner £69.95
For overseas PAL versions state 5.5 or 6 MHz sound specification.
*For cable / hyperband signal reception Telebox MB should be connected to a cable type service. Shipping on all Telebox's, code (B)

NEW State of the art PAL (UK spec) UHF TV tuner module with composite TV pp video & NICAM hi fi stereo sound outputs. Micro electronics all on one small PCB only 73 x 160 x 52 mm enable full tuning control via a simple 3 wire link to an IBM pc type computer. Supplied complete with simple wiring program and documentation. Requires +12V & +5V DC to operate.
BRAND NEW - Order as MY00. Only £39.95 code (B)
See www.distel.co.uk/data_my00.htm for picture & full details.

HARD DISK DRIVES 2 1/2" - 14"

2 1/2" TOSHIBA MK1002MAV 1.1Gb laptop (12.5 mm H) New £59.95
2 1/2" TOSHIBA MK4313MAT 4.3Gb laptop (8.2 mm H) New £105.00
2 1/2" TOSHIBA MK6409MAV 6.1Gb laptop (12.7 mm H) New £98.00
2 1/2" TOSHIBA MK1614GAV 18 Gb laptop (12 mm H) New £149.95
2 1/2" to 3 1/2" conversion kit for PC's, complete with connectors £15.95
3 1/2" COMPAQ 313706-B21 (IBM) 9 gb ULT/SCSI3 New £199.00
3 1/2" FUJI FK-309-26 20mb MFM I/F RFE £59.95
3 1/2" CONNER CP3024 20 mb IDE I/F (or equiv.) RFE £59.95
3 1/2" CONNER CP3044 40 mb IDE I/F (or equiv.) RFE £69.00
3 1/2" QUANTUM UXC Prodriv ve 42mb SCSI I/F, New RFE £49.00
5 1/4" MINISCRIBE 3425 20mb MFM I/F (or equiv.) RFE £49.95
5 1/4" SEAGATE ST-238R 30 mb RLL I/F Refurb £69.95
5 1/4" CDC 94205-51 40mb HM MFM I/F RFE tested £69.95
5 1/4" HP 97548 850 Mb SCSI RFE tested £99.00
5 1/4" HP C3010 2 Gbyte SCSI differential RFE tested £195.00
8" NEC D2246 85 Mb SMD interface. New £99.00
8" FUJITSU M2322K 160Mb SMD I/F RFE tested £195.00
8" FUJITSU M2392K 2 Gb SMD I/F RFE tested £345.00
Many other floppy & H drives, IDE, SCSI, ESDI etc from stock, see website for full stock list. Shipping on all drives is code

IC's - TRANSISTORS - DIODES

OBSOLETE - SHORT SUPPLY - BULK
10,000,000 items EX STOCK

For MAJOR SAVINGS
CALL or see web site www.distel.co.uk

COMPUTER MONITOR SPECIALS

Legacy products
High spec genuine multisync.
CGA, EGA, VGA, SVGA

Mitsubishi FA3415ETKL 14" SVGA Multisync colour monitor with fine 0.28 dot pitch tube and resolution of 1024 x 768. A variety of inputs allows connection to a host of computers including IBM PC's in CGA, EGA, VGA & SVGA modes, BBC, COMMODORE (including Amiga 1200), ARCHIMEDES and APPLE. Many features: Etched faceplate, text switching and LOW RADIATION MPR specification. Fully guaranteed, in EXCELLENT little used condition. Tilt & Swivel Base £475

VGA cable for IBM PC included. Only £129 (E) Order as CG73

External cables for other types of computers available - CALL

Generic LOW COST SVGA Monitors

We choose the make, which includes Compaq, Mitsubishi, IBM, etc. Supplied ready to run with all cables, Standard RTB 90 day guarantee.

14"	15"	17"
£59.00	£69.00	£79.00

Supplied in good used condition. Shipping code (D)

VIDEO MONITORS

PHILIPS HCS35 (same style as CM8833) attractively styled 14" colour monitor with both RGB and standard composite 15.625 KHz video inputs via SCART socket and separate phono jacks. Integral audio power amp and speaker for all audio visual uses. Will connect direct to Amiga and Atari BBC computers. Ideal for all video monitoring / security applications with direct connection to most colour cameras. High quality with many features such as front concealed flap controls, VCR correction button etc. Good used condition - fully tested - guaranteed
Only £99.00 (E)
Dimensions: W14" x H12 3/4" x D 9"

PHILIPS HCS31 Ultra compact 9" colour video monitor with standard composite 15.625 KHz video input via SCART socket. Ideal for all monitoring / security applications. High quality, ex-equipment fully tested & guaranteed (possible minor screen burns). In attractive square black plastic case measuring W10" x H10" x 1 1/2". D. 240 V AC mains powered.
Only £79.00 (D)

INDUSTRIAL COMPUTERS

Tiny shoebox sized industrial 40 Mhz 386 PC system measuring only (mm) 266 w X 88 h X 272 d. Ideal for dedicated control applications running DOS, Linux or even Windows! Steel case contains 85 to 265 V AC 50 / 60 Hz 70 Watt PSU, a 3 slot ISA passive backplane and a Rocky 318 (PC104) standard, single board computer with 8 MByte NON-VOLATILE solid state 'Disk On Chip' RAMDISK. System comprises: Rocky 318 (PC104) SBC ISA card with 40MHz ALI 3665X CPU, 72 pin SIMM slot with 16 MByte SIMM, AMI BIOS, battery backed up real time clock, 2 x 9 pin D 16550 serial ports, EPP/ECP printer port, mini DIN keyboard connector, floppy port, IDE port for hard drives up to 528 MByte capacity, watchdog timer and PC/104 bus socket. The 8 MByte solid state 'disk on a chip' has its own BIOS, and can be fdisked, formatted & booted. Supplied BRAND NEW fully tested and guaranteed. For full data see featured item on website. Order as OG36
100's of applications inc: firewalls, routers, robotics etc
Only £99.00 (D)

TEST EQUIPMENT & SPECIAL INTEREST ITEMS

MITSUBISHI FA3445ETKL 14" Ind. spec SVGA monitors £245
FARNELL 0-60V DC @ 50 Amps, bench Power Supplies £995
FARNELL AP3080 0-180V DC @ 80 Amps, bench Supply £1850
KINGSBILL C24031-0 5-0V @ DC 200 Amps - NEW £3950
1KW to 400 kW - 400 Hz 3 phase power sources - ex stock £POA
IBM 8230 Type 1, Token ring base unit driver £760
Wayne Kerr RA200 Audio frequency response analyser £2500
INFODEC 1U, 24 port, RJ45 network patchpanels. #TH93 £49
3COM 16670 12 Port Ethernet hub - RJ45 connectors #LD97 £69
3COM 16671 24 Port Ethernet hub - RJ45 connectors £89
3COM 16700 8 Port Ethernet hub - RJ45 connectors NEW £39
IBM 53F5501 Token Ring ICS 20 port lobe modules £POA
IBM MAU Token ring distribution panel 828-23-5050N £45
AIM 501 Low distortion Oscillator 9Hz to 330KHz, IEEE I/O £550
ALLGON 8661 11805-1880 MHz hybrid power combiners £250
Trend DSA 274 Data Analyser with G703(2M) 64 i/o £POA
Marconi 6310 Programmable 2 to 22 GHz sweep generator £4500
Marconi 2022C 10KHz-1GHz RF signal generator £1550
HP1650B Logic Analyser £3750
HP3781A Pattern generator & HP3782A Error Detector £1800
HP6621A Dual Programmable GPIB PSU 0-7 V 160 watts £1800
HP6264 Rack mount variable 0-20V @ 20A metered PSU £475
HP54121A DC to 22 GHz four channel test set £POA
HP8130A opt 020 300 MHz pulse generator, GPIB etc £7900
HP A1, A0 8 pin HPGI high speed drum plotters - from £1750
HP DRAFTMASTER 1 8 pin high speed plotter £1800
EG+G Brookdale 95035C Precision lock in amp £750
Keithley 590 CV capacitor / voltage analyser £POA
Racal ICR40 dual 40 channel voice recorder system £1750
Fiskers 45KVA 3 ph On Line UPS - New batteries £4500
Emerson AP130 2.5KVA industrial spec. UPS £1499
Mann Tally MT645 High speed line printer £2200
Intel SBC 886/133SE Multibus 486 system. 8Mb Ram £945

Unless marked NEW, items in this section are pre-owned.
HP6030A 0-200V DC @ 17 Amps bench power supply £1950
Intel SBC 486/125C08 Enhanced Multibus (MSA) New £1150
Nikon HFX-11 (Ephiphot) exposure control unit £1450
PHILIPS PM5518 pro. TV signal generator £1250
Motorola VME Bus boards & Components List. SAE / CALL £POA
Trio 0-18 vdc linear, metered 30 amp bench PSU. New £550
Fujitsu M3041R 600 LPM high speed bench printer £1950
Fujitsu M3041D 600 LPM printer with network interface £1250
Siemens K4400 24Kb to 140Mb demux analyser £2950
Perkin Elmer 999B infrared spectrophotometer £500
Perkin Elmer 597 infrared spectrophotometer £3500
VG Electronics 1035 TELETEXT Decoding Margin Meter £3250
LightBand 60 output high spec 2u rack mount Video VDA's £495
Sekonic SD 150H 18 channel digital Hybrid card recorder £1995
B&K 2633 Microphone pre amp £300
Taylor Hobson Tallysurf amplifier / recorder £750
ADC SS200 Carbon dioxide gas detector / monitor £1450
BBC AM203 PPM Meter (Ernest Turner) + drive electronics £75
ANRITSU 9654A Optical DC-2.5Gb/waveform monitor £5650
ANRITSU ML93A optical power meter £990
ANRITSU Fibre optic characteristic test set £POA
R&S FTDZ Dual sound unit £650
R&S SBUF-E1 Vision modulator £775
WILTRON 6630B 12.4 / 20GHz RF sweep generator £1250
TEK 2445 150 MHz 4 trace oscilloscope £1955
TEK 2465 300 Mhz 300 MHz oscilloscope rack mount £1955
TEK TDS380 400MHz digital realtime + disk drive, FFT etc £2900
TEK TDS524A 500MHz digital realtime + colour display etc £5100
HP3585A Opt 907 20Hz to 40 MHz spectrum analyser £3950
PHILIPS PW173010 60KV XRAY generator & accessories £POA
VARIACS - Large range from stock - call or see our website
CLAUDE LYONS 12A 240V single phase auto. volt. regs £325

19" RACK CABINETS

Save £££'s
Europe's Largest Stocks of quality rack cabinets, enclosures and accessories. Over 1000 Racks from stock

This month's special
33 / 42 / 47 U - High Quality
All steel Rack Cabinets

BIG £ SAVER

Made by Eurocraft Enclosures Ltd to the highest possible spec, rack features all steel construction with removable side, front and back doors. Front and back doors are hinged for easy access and all lockable with five secure 5 lever barrel locks. The front door is constructed of double walled steel with a 'designer style' smoked acrylic front panel to enable status indicators to be seen through the panel, yet remain unobtrusive. Internally the rack features fully slotted reinforced vertical fixing members to take the heaviest of 19" rack equipment. The two movable vertical fixing struts (extras available) are pre punched for standard 'cage nuts'. A mains distribution panel internally mounted to the bottom rear, provides 8 x IEC 3 pin Euro sockets and 1 x 13 amp 3 pin switched utility socket. Overall ventilation is provided by fully louvered back door and double skinned top section with top and side louvers. The top panel may be removed for fitting of integral fans to the sub plate etc. Other features include: fitted castors and floor levelers, pre-punched utility panel at lower rear for cable / connector access etc. Supplied in excellent, slightly used condition with keys. Colour Royal blue. some grey available - CALL - Can be supplied in many other configurations.



33U Order as BC44 External dimensions mm=1625H x 635D x 603 W. (64" H x 25" D x 23 3/4" W) Only £245	42U Order as DT20 External dimensions mm=2019H x 635D x 603 W. (79.5" H x 25" D x 23 3/4" W) Only £345	47U Order as RV36 External dimensions mm=2019H x 635D x 603 W. (88" H x 25" D x 23 3/4" W) Only £410
--	--	--

Call for shipping quotation

COLOUR CCD CAMERAS

Undoubtedly a miracle of modern technology & our special buying power! A quality product featuring a fully cased COLOUR CCD camera at a give away price! Unit features full auto lensing for use in low light & high light applications. A 10 mm fixed focus wide angle lens gives excellent focus and resolution from close up to long range. The composite video output will connect to any composite monitor or TV (via SCART socket) and most video recorders. Unit runs from 12V DC so ideal for security & portable applications where mains power not available. Overall dimensions 66 mm wide x 117 deep x 43 high. Supplied BRAND NEW & fully guaranteed with user data, 100's of applications including Security, Home Video, Web TV, Web Cams etc, etc.

Order as LK33 ONLY £79.00 or 2 for £149.00 (B)

SOFTWARE SPECIALS

NT4 WorkStation, complete with service pack 3 and licence - OEM packaged. ONLY £89.00 (B)
ENCARTA 95 - CDROM, Not the latest - but at this price! £7.95
DOS 5.0 on 3 1/2" disks with concise books c/w QBasic. £14.95
Windows for Workgroups 3.11+ No Doc 6.22 on 3.5" disks £55.00
Windows 95 CDROM Only - No Licence - £19.95

Wordperfect 6 for DOS supplied on 3 1/2" disks with manual £24.95

SOLID STATE LASERS

Visible red, 670nm laser diode assembly. Unit runs from 5 V DC at approx 50 mA. Originally made for continuous use in industrial barcode scanners, the laser is mounted in a removable solid aluminium block, which functions as a heatsink and rigid optical mount. Dims of block are 50 x 50 x 15 mm. Integral features include over temperature shutdown, current control, laser OK output, and gated TTL ON / OFF. Many uses for experimental optics, comms & lightshows etc. Supplied complete with data sheet.
Order as TD91 ONLY £24.95 (A)

DC POWER SUPPLIES

Virtually every type of power supply you can imagine. Over 10,000 Power Supplies
Ex Stock - Call or see our web site.

RELAYS - 200,000 FROM STOCK

Save £££'s by choosing your next relay from our Massive Stocks covering types such as Military, Octal, Cradle, Hermetically Sealed, Continental, Contactors, Time Delay, Reed, Mercury Wetted, Solid State, Printed Circuit Mounting etc., CALL or see our web site www.distel.co.uk for more information. Many obsolete types from stock. Save £££'s

distel

electronics

ALL MAIL TO
Dept PE, 29 / 35 Osborne Rd
Thornton Heath
Surrey CR7 8PD
Open Mon - Fri 9.00 - 5:30

18 Million Items On Line Now!
Secure ordering, Pictures, Information
www.distel.co.uk
email = admin@distel.co.uk

ALL ENQUIRIES
0208 653 3333
FAX 0208 653 8888

All prices for UK Mainland. UK customers add 17.5% VAT to TOTAL order amount. Minimum order £10. Bona Fide account orders accepted from Government, Schools, Universities and Local Authorities - minimum account order £50. Cheques over £100 are subject to 7 working days clearance. Carriage charges (A)-£3.50, (B)-£6.50, (C)-£10, (D)-£15.00, (E)-£18.00, (F)-CALL. Allow approx 3 days for shipping - faster CALL. All goods supplied to our Standard Conditions of Sale which can be viewed at our website and unless stated guaranteed for 90 days. All guarantees on a return to base basis. All rights reserved to change prices / specifications without prior notice. Orders subject to stock. Discounts for volume. Top CASH prices paid for surplus goods. All trademarks, tradenames etc acknowledged. © Display Electronics 2002. E & O E..

NEXT MONTH

THUNDERSTORM MONITOR

Lightning poses a significant risk to us all, it causes more deaths than do most other natural hazards, including hurricanes and tornados.

This "early warning system" monitors atmospheric charge and indicates when an unusually high potential difference between the atmosphere and earth occurs. Under test this inexpensive unit regularly picked up the possibility of a thunderstorm well in advance of any thunder or lightning. The monitor will greatly reduce the risk of injury or death by lightning strike.



LOGIC PROBE

When troubleshooting digital circuits, a logic probe provides a quick and easy way of determining the logic level at a particular node. Unlike voltmeters and oscilloscopes which are able to display a range of analogue voltage levels, the logic probe is essentially a digital instrument that provides a simple yet unambiguous "yes" or "no" indication of the node's logic level.

Unlike many commercially available logic probes, the one described next month is a precision instrument, in that it uses analogue techniques to sense the voltage levels, thereby providing an accurate indication of the true logic state. It is a pocket-sized instrument which is easy to construct and simple to use.

The probe is powered from the circuit under test. Any supply in the range 3V to 15V can be accommodated, thus allowing the probe to be used on a wide range of TTL and CMOS logic families. The logic level at any node in the circuit is detected simply by touching the probe tip to the appropriate point.

FLOATING POINT FOR PICS

An introduction to the use of Microchip's floating point maths routines for the PIC16F series of microprocessors. The article takes a quick look at the theory of fixed and floating point number representations, and then descriptions are given of several customised files and utility programs which can be downloaded from the EPE Downloads site, and which together comprise everything necessary to use the floating point code. The routines include floating point add, subtract, multiply and divide together with some auxiliary functions.

MW AMPLITUDE MODULATOR

A popular pastime amongst amateurs is renovating old valve or transistor radios. These radios are usually a.m. only, tuning the medium and long wave bands, with maybe a shortwave band. With the advent of high-quality stereo f.m. transmissions on v.h.f. and more recently DAB radio a great deal of music and other material is unavailable to these radios. The unit described here takes its input from the audio output of the f.m. or DAB receiver and regenerates it into an a.m. modulated format in the medium wave band. No modifications to the f.m. or DAB radio or the radio receiving the output from the unit are necessary. The unit will also take the output from an amplifier connected to CD, tape or record players, and again make this available to a.m. m.w. radios via a screened lead.

NO ONE DOES IT BETTER

EVERYDAY
PRACTICAL
ELECTRONICS

**DON'T MISS AN
ISSUE - PLACE YOUR
ORDER NOW!**
Demand is bound to be high



Quasar Electronics Limited
 PO Box 6935, Bishops Stortford,
 CM23 4WP
 Tel: 0870 246 1826
 Fax: 0870 460 1045
 E-mail: sales@quasarelectronics.com

Add £2.95 P&P to all UK orders or 1st Class Recorded – £4.95.
 Next day (insured £250) – £7.95. Europe – £5.95. Rest of World – £9.95
 (order online for reduced price UK Postage).
 We accept all major credit/debit cards. Make cheques/POs
 payable to Quasar Electronics Limited.
 Prices include 17.5% VAT. MAIL ORDER ONLY.
 Call now for our FREE CATALOGUE with details of over 300
 high quality kits, projects, modules and publications.



QUASAR 0871 CREDIT CARD SALES 717 7168

electronics

Helping you make the right connections!

PIC & ATMEL Programmers

We have a wide range of low cost PIC and ATMEL Programmers. Complete range and documentation available from our web site.

Programmer Accessories:

40-pin Wide ZIF socket (ZIF40W) £15.00
 18VDC Power supply (PSU010) £19.95
 Leads: Parallel (LEAD108) £4.95 / Serial (LEAD76) £4.95 / USB (LEADUAB) £2.95

NEW! USB 'All-Flash' PIC Programmer

USB PIC programmer for all 'Flash' devices. No external power supply making it truly portable. Supplied with box and Windows Software. ZIF Socket and USB Plug A-B lead not incl.



Kit Order Code: 3128KT – £29.95

Assembled Order Code: AS3128 – £39.95

Enhanced "PICALL" ISP PIC Programmer

Will program virtually ALL 8 to 40 pin PICs plus certain ATMEL AVR, SCENIX SX and EEPROM 24C devices. Also supports In System Programming (ISP) for PIC and ATMEL AVRs. Free software. Blank chip auto detect for super fast bulk programming. Requires a 40-pin wide ZIF socket (not included)

Assembled Order Code: AS3144 – £54.95

ATMEL 89xxx Programmer

Uses serial port and any standard terminal comms program. 4 LEDs display the status. ZIF sockets not included. Supply: 16VDC.



Kit Order Code: 3123KT – £29.95

Assembled Order Code: AS3123 – £34.95

NEW! USB & Serial Port PIC Programmer

USB/Serial connection. Header cable for ICSP. Free Windows software. See website for PICs supported. ZIF Socket and USB Plug A-B lead extra. 18VDC.

Kit Order Code: 3149KT – £29.95

Assembled Order Code: AS3149 – £44.95

Introduction to PIC Programming

Go from a complete PIC beginner to burning your first PIC and writing your own code in no time!

Includes a 49-page step-by-step Tutorial Manual, Programming Hardware (with LED bench testing section), Win 3.11-XP Programming Software (will Program, Read, Verify & Erase), and a rewritable PIC16F84A that you can use with different code (4 detailed examples provided for you to learn from). Connects to PC parallel port.

Kit Order Code: 3081KT – £14.95

Assembled Order Code: AS3081 – £24.95



ABC Maxi AVR Development Board

The ABC Maxi board has an open architecture design based on Atmel's AVR AT90S8535 RISC microcontroller and is ideal for developing new designs.



Features:

8Kb of In-System Programmable Flash (1000 write/erase cycles) • 512 bytes internal SRAM • 512 bytes EEPROM
 • 8 analogue inputs (range 0-5V)
 • 4 Opto-isolated Inputs (I/Os are bi-directional with internal pull-up resistors)
 • Output buffers can sink 20mA current (direct i.e.d. drive) • 4 x 12A open drain MOSFET outputs • RS485 network connector • 2-16 LCD Connector
 • 3-5mm Speaker Phone Jack
 • Supply: 9-12VDC.

The ABC Maxi STARTER PACK includes one assembled Maxi Board, parallel and serial cables, and Windows software CD-ROM featuring an Assembler, BASIC compiler and in-system programmer.

Order Code ABCMAXISP – £79.95

The ABC Maxi boards only can also be purchased separately at £59.95 each.

Controllers & Loggers

Here are just a few of the controller and data acquisition and control units we have. See website for full details. Suitable PSU for all units: Order Code PSU445 – £8.95

Rolling Code 4-Channel UHF Remote

State-of-the-Art. High security. 4 channels. Momentary or latching relay output. Range up to 40m. Up to 15 TXs can be learned by one Rx (kit includes one Tx but more available separately). 4 indicator LEDs.



Rx: PCB 77x85mm, 12VDC/6mA (standby).

Two & Ten Channel versions also available.

Kit Order Code: 3180KIT – £41.95

Assembled Order Code: AS3180 – £49.95

Computer Temperature Data Logger

Serial port 4-channel temperature logger. °C or °F. Continuously logs up to 4 separate sensors located 200m+ from board. Wide range of free software applications for storing/using data. PCB just 38x38mm. Powered



by PC. Includes one DS1820 sensor and four header cables.

Kit Order Code: 3145KT – £19.95

Assembled Order Code: AS3145 – £26.95

Additional DS1820 Sensors – £3.95 each

NEW! DTMF Telephone Relay Switcher

Call your phone number using a DTMF phone from anywhere in the world and remotely turn on/off any of the 4 relays as desired. User settable Security Password, Anti-Tamper, Rings to Answer, Auto Hang-up and Lockout. Includes plastic case. 130 x 110 x 30mm. Power: 12VDC.



Kit Order Code: 3140KT – £39.95

Assembled Order Code: AS3140 – £49.95

Serial Port Isolated I/O Module

Computer controlled 8-channel relay board. 5A mains rated relay outputs and 4 opto-isolated digital inputs (for monitoring switch

states, etc). Useful in a variety of control and sensing applications. Programmed via serial port (use our new Windows interface, terminal emulator or batch files). Serial cable can be up to 35m long. Includes plastic case 130 x 100 x 30mm. Power: 12VDC/500mA.

Kit Order Code: 3108KT – £54.95

Assembled Order Code: AS3108 – £64.95

Infra-red RC 12-Channel Relay Board

Control 12 on-board relays with included infra-red remote control unit. Toggle or momentary. 15m+ range. 112 x 122mm. Supply: 12VDC/0-5A.



Kit Order Code: 3142KT – £41.95

Assembled Order Code: AS3142 – £51.95

PC Data Acquisition & Control Unit

Monitor and log a mixture of analogue and digital inputs and control external devices via the analogue and digital outputs. Monitor pressure, temperature, light intensity, weight, switch state, movement, relays, etc. with the appropriate sensors (not supplied). Data can be processed, stored and the results used to control devices such as motors, sirens, relays, servo motors (up to 11) and two stepper motors.

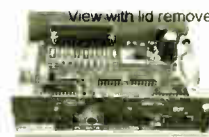

Features

- 11 Analogue Inputs – 0-5V, 10 bit (5mV/step)
- 16 Digital Inputs – 20V max. Protection 1K in series, 5-1V Zener
- 1 Analogue Output – 0-2.5V or 0-10V. 8 bit (20mV/step)
- 8 Digital Outputs – Open collector, 500mA, 33V max
- Custom box (140 x 110 x 35mm) with printed front & rear panels
- Windows software utilities (3-1 to XP) and programming examples
- Supply: 12V DC (Order Code PSU203)

Kit Order Code: 3093KT – £69.95

Assembled Order Code: AS3093 – £99.95

Most items are available in kit form (KT suffix) or pre-assembled and ready for use (AS prefix).

Hot New Kits This Summer!

Here are a few of the most recent kits added to our range. See website or join our email Newsletter for all the latest news.

NEW! EPE Ultrasonic Wind Speed Meter



Solid-state design wind speed meter (anemometer) that uses ultrasonic techniques and has no moving parts and does not need

calibrating. It is intended for sports-type activities, such as track events, sailing, hang-gliding, kites and model aircraft flying, to name but a few. It can even be used to monitor conditions in your garden. The probe is pointed in the direction from which the wind is blowing and the speed is displayed on an LCD display.

Specifications

- Units of display: metres per second, feet per second, kilometres per hour and miles per hour
- Resolution: Nearest tenth of a metre
- Range: Zero to 50mph approx.

Based on the project published in *Everyday Practical Electronics*, Jan 2003. We have made a few minor design changes (see website for full details). Power: 9VDC (PP3 battery or Order Code PSU345).

Main PCB: 50 x 83mm.

Kit Order Code: 3168KT – £34.95

NEW! Audio DTMF Decoder and Display



Detects DTMF tones via an on-board electret microphone or direct from the phone lines through the onboard audio transformer. The

numbers are displayed on a 16-character, single line display as they are received. Up to 32 numbers can be displayed by scrolling the display left and right. There is also a serial output for sending the detected tones to a PC via the serial port. The unit will not detect numbers dialled using pulse dialling. Circuit is microcontroller based.

Supply: 9-12V DC (Order Code PSU345). Main PCB: 55 x 95mm.

Kit Order Code: 3153KT – £17.95

Assembled Order Code: AS3153 – £29.95

NEW! EPE PIC Controlled LED Flasher



This versatile PIC-based LED or filament bulb flasher can be used to flash from 1 to 160

LEDs. The user arranges the LEDs in any pattern they wish. The kit comes with 8 superbright red LEDs and 8 green LEDs. Based on the *Versatile PIC Flasher* by Steve Challinor, *EPE Magazine* Dec '02. See website for full details. Board Supply: 9-12V DC. LED supply: 9-45V DC (depending on number of LED used). PCB: 43 x 54mm. Kit Order Code: 3169KT – £10.95

Most items are available in kit form (KT suffix) or assembled and ready for use (AS prefix)

FM Bugs & Transmitters

Our extensive range goes from discreet surveillance bugs to powerful FM broadcast transmitters. Here are a few examples. All can be received on a standard FM radio and have adjustable transmitting frequency.

MMTX' Micro-Miniature 9V FM Room Bug



Our best selling bug! Good performance. Just 25 x 15mm. Sold to detective agencies worldwide. Small enough to hide just about anywhere.

Operates at the 'less busy' top end of the commercial FM waveband and also up into the more private Air band. Range: 500m. Supply: PP3 battery. Kit Order Code: 3051KT – £8.95
Assembled Order Code: AS3051 – £14.95

HPTX' High Power FM Room Bug

Our most powerful room bug.



Very Impressive performance. Clear and stable output signal thanks to the extra circuitry employed. Range: 1000m @ 9V. Supply: 6-12V DC (9V PP3 battery clip supplied). 70 x 15mm. Kit Order Code: 3032KT – £9.95
Assembled Order Code: AS3032 – £17.95

MTTX' Miniature Telephone Transmitter



Attach anywhere along phone line. Tune a radio into the signal and hear

exactly what both parties are saying. Transmits only when phone is used. Clear, stable signal. Powered from phone line so completely maintenance free once installed. Requires no aerial wire – uses phone line as antenna. Suitable for any phone system worldwide. Range: 300m. 20 x 45mm. Kit Order Code: 3016KT – £7.95
Assembled Order Code: AS3016 – £13.95

3 Watt FM Transmitter



Small, powerful FM transmitter. Audio preamp stage and three RF stages deliver 3 watts of RF power. Can be used with the electret

microphone supplied or any line level audio source (e.g. CD or tape OUT, mixer, sound card, etc). Aerial can be an open dipole or Ground Plane. Ideal project for the novice wishing to get started in the fascinating world of FM broadcasting. 45 x 145mm. Kit Order Code: 1028KT – £22.95
Assembled Order Code: AS1028 – £34.95

25 Watt FM Transmitter

Four transistor based stages with a Philips BLY89 (or equivalent) in the final stage. Delivers a mighty 25 Watts of RF power. Accepts any line level audio source (input sensitivity is adjustable). Antenna can be an open dipole, ground plane, 5/8, J, or YAGI configuration. Supply 12-14V DC, 5A. Supplied fully assembled and aligned – just connect the aerial, power and audio input. 70 x 220mm. Order Code: 1031M – £124.95



QUASAR
electronics

Helping you make the right connections!

**CREDIT
CARD
SALES
0871
717
7168**

Electronic Project Labs

Great introduction to the world of electronics. Ideal gift for budding electronics expert!

500-in-1 Electronic Project Lab

This is the top of the range and is a complete electronics course taking you from beginner to 'A' level standard and beyond! It contains all the parts and instructions to assemble 500 projects. You get three comprehensive course books (total 368 pages) – *Hardware Entry Course*, *Hardware Advanced Course* and a micro-computer based *Software Programming Course*. Each book has individual circuit explanations, schematic and assembly diagrams. Suitable for age 12 and above. Order Code EPL500 – £149.95
30, 130, 200 and 300-in-1 project labs also available – see website for details.



Number 1 for Kits!

With over 300 projects in our range we are the UK's number 1 electronic kit specialist. Here are a few other kits from our range.

1046KT – 25W Stereo Car Booster £29.95

3087KT – 1W Stereo Amplifier £4.95

3105KT – 18W BTL mono Amplifier £9.95

3106KT – 50W Mono Hi-fi Amplifier £19.95

3143KT – 10W Stereo Amplifier £9.95

1011-12KT – Motorbike Alarm £12.95

1019KT – Car Alarm System £11.95

1048KT – Electronic Thermostat £9.95

1080KT – Liquid Level Sensor £6.95

3003KT – LED Dice with Box £7.95

3006KT – LED Roulette Wheel £8.95

3074KT – 8-Ch PC Relay Board £29.95

3082KT – 2-Ch UHF Relay £26.95

3126KT – Sound-Activated Relay £7.95

3063KT – One Chip AM Radio £10.95

3102KT – 4-Ch Servo Motor Driver £15.95

3155KT – Stereo Tone Controls £8.95

1096KT – 3-30V, 5A Stabilised PSU £32.95

3029KT – Combination Lock £6.95

3049KT – Ultrasonic Detector £13.95

3130KT – Infra-red Security Beam £12.95

SG01MKT – Train Sounds £6.95

SG10 MKT – Animal Sounds £5.95

1131KT – Robot Voice Effect £9.95

3007KT – 3V FM Room Bug £6.95

3028KT – Voice-Activated FM Bug £12.95

3033KT – Telephone Recording Adpt £9.95

3112KT – PC Data Logger/Sampler £18.95

3118KT – 12-bit Data Acquisition Unit £52.95

3101KT – 20MHz Function Generator £69.95

www.quasarelectronics.com

Secure Online Ordering Facilities ● Full Product Listing, Descriptions & Photos ● Kit Documentation & Software Downloads



NEW

EPE PIC PROJECTS VOLUME 1 MINI CD-ROM



A plethora of 20 "hand-PICked" PIC Projects from selected past issues of EPE

Together with the PIC programming software for each project plus bonus articles

The projects are:

PIC-Based Ultrasonic Tape Measure

You've got it taped if you PIC this ultrasonic distance measuring calculator

EPE Mind PICKler

Want seven ways to relax? Try our PIC-controlled mind machine!

PIC MIDI Sustain Pedal

Add sustain and glissando to your MIDI line-up with this inexpensive PIC-controlled effects unit

PIC-based MIDI Handbells

Ring out thy bells with merry tolling – plus a MIDI PIC-up, of course!

EPE Mood PICKer

Oh for a good night's sleep! Insomniacs rejoice – your wakeful nights could soon be over with this mini-micro under the pillow!

PIC Micro-Probe

A hardware tool to help debug your PIC software

PIC Video Cleaner

Improving video viewing on poorly maintained TVs and VCRs

PIC Graphics LCD Scope

A PIC and graphics LCD signal monitor for your workshop

PIC to Printer Interface

How to use dot-matrix printers as data loggers with PIC microcontrollers

PIC Polywhatsit

A novel compendium of musical effects to delight the creative musician

PIC Magick Musick

Conjure music from thin air at the mere untouching gesture of a fingertip

PIC Mini-Enigma

Share encrypted messages with your friends — true spymaster entertainment

PIC Virus Zapper

Can disease be cured electronically? Investigate this controversial subject for yourself

PIC Controlled Intruder Alarm

A sophisticated multi-zone intruder detection system that offers a variety of monitoring facilities

PIC Big-Digit Display

Control the giant ex-British Rail platform clock 7-segment digits that are now available on the surplus market

PIC Freezer Alarm

How to prevent your food from defrosting unexpectedly

PIC World Clock

Graphically displays world map, calendar, clock and global time-zone data

PICAXE Projects

A 3-part series using PICAXE devices – PIC microcontrollers that do not need specialist knowledge or programming equipment

PIC-based Tuning Fork and Metronome

Thrill everyone by at long last getting your instrument properly tuned!

Versatile PIC Flasher

An attractive display to enhance your Christmas decorations or your child's ceiling

**ONLY
£14.45
INCLUDING
VAT and P&P**

Order on-line from

www.epemag.wimborne.co.uk/shopdoor.htm

or www.epemag.com (USA \$ prices)

or by Phone, Fax, Email or Post.

NOTE: The PDF files on this CD-ROM are suitable to use on any PC with a CD-ROM drive. They require Adobe Acrobat Reader.

EPE PIC PROJECTS CD-ROM ORDER FORM

Please send me (quantity) EPE PIC PROJECTS VOL 1 CD-ROM

Price £14.45 each – includes postage to anywhere in the world.

Name

Address

..... Post Code

I enclose cheque/P.O./bank draft to the value of £

Please charge my Visa/Mastercard/Amex/Diners Club/Switch

£

Card No.

Card Security Code (The last 3 digits on or just under the signature strip)

Start Date Expiry Date Switch Issue No.

**SEND TO: Everyday Practical Electronics,
Wimborne Publishing Ltd.,**

408 Wimborne Road East, Ferndown, Dorset BH22 9ND.

Tel: 01202 873872. Fax: 01202 874562.

Email: orders@epemag.wimborne.co.uk

Payments must be by card or in £ Sterling – cheque or bank draft drawn on a UK bank.

Normally supplied within seven days of receipt of order.

Send a copy of this form, or order by letter if you do not wish to cut your issue.

BECOME A PIC PROJECT BUILDER WITH THE HELP OF EPE!

Learn About Microcontrollers

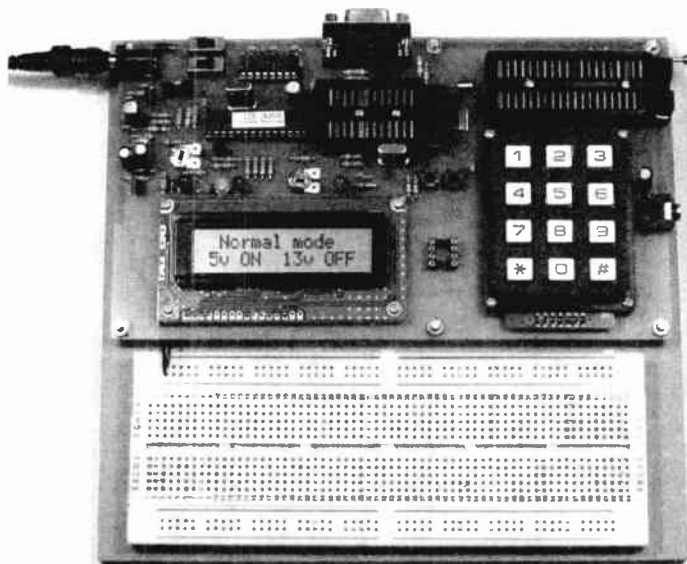

PIC Training & Development System

The best place to start learning about microcontrollers is the PIC16F84. This is easy to understand and very popular with construction projects. Then continue on using the more sophisticated PIC16F877 family.

The heart of our system is two real books which lie open on your desk while you use your computer to type in the programme and control the hardware. Start with four very simple programmes. Run the simulator to see how they work. Test them with real hardware. Follow on with a little theory....

Our complete PIC training and development system consists of our universal mid range PIC programmer module, a 306 page book covering the PIC16F84, a 262 page book introducing the PIC16F877 family, and a suite of programmes to run on a PC. The module is an advanced design using a 28 pin PIC16F870 to handle the timing, programming and voltage switching requirements. The module has two ZIF sockets and an 8 pin socket which between them allow most mid range 8, 18, 28 and 40 pin PICs to be programmed. The plugboard is wired with a 5 volt supply. The software is an integrated system comprising a text editor, assembler disassembler, simulator and programming software. The programming is performed at 5 volts, verified with 2 volts or 3 volts applied and verified again with 5.5 volts applied to ensure that the PIC is programmed correctly over its full operating voltage. DC version for UK, battery version for overseas. UK orders include a plugtop power supply.

- Universal mid range PIC programmer module
 - + Book *Experimenting with PIC Microcontrollers*
 - + Book *Experimenting with the PIC16F877 (2nd edition)*
 - + Universal mid range PIC software suite
 - + PIC16F84 and PIC16F870 test PICs. £159.00
- (Postage & insurance UK £10, Europe £15, Rest of world £25)

Experimenting with PIC Microcontrollers

This book introduces the PIC16F84 and PIC16C711, and is the easy way to get started for anyone who is new to PIC programming. We begin with four simple experiments, the first of which is explained over ten and half a pages assuming no starting knowledge except the ability to operate a PC. Then having gained some practical experience we study the basic principles of PIC programming, learn about the 8 bit timer, how to drive the liquid crystal display, create a real time clock, experiment with the watchdog timer, sleep mode, beeps and music, including a rendition of Beethoven's *Für Elise*. Finally there are two projects to work through, using the PIC16F84 to create a sinewave generator and investigating the power taken by domestic appliances. In the space of 24 experiments, two projects and 56 exercises the book works through from absolute beginner to experienced engineer level.

Hardware & Ordering Information

Our latest programmer module connects to the serial port of your PC (COM1 or COM2), which enables our PIC software to operate directly within Windows 98, XP, NT, 2000 etc.

Telephone with Visa, Mastercard or Switch, or send cheque/PO for immediate despatch. All prices include VAT if applicable.

Web site:- www.brunningssoftware.co.uk

Mail order address:

Brunning Software 138 The Street, Little Clacton, Clacton-on-sea, Essex, CO16 9LS. Tel 01255 862308

NEW 32 bit PC Assembler

Experimenting with PC Computers with its kit is the easiest way ever to learn assembly language programming. If you have enough intelligence to understand the English language and you can operate a PC computer then you have all the necessary background knowledge. Flashing LEDs, digital to analogue converters, simple oscilloscope, charging curves, temperature graphs and audio digitising.

Kit now supplied with our 32 bit assembler with 84 page supplement detailing the new features and including 7 experiments PC to PIC communication. Flashing LEDs, writing to LCD and two way data using 3 wires from PC's parallel port to PIC16F84.

- Book + made up kit 1a + software..... £73.50
- Book + unmade kit 1u + software..... £66.50
- (PP UK £4, Europe £10, Rest of world £14)

C & C++ for the PC

Experimenting with C & C++ Programmes teaches us to programme by using C to drive the simple hardware circuits built using the materials supplied in the kit. The circuits build up to a storage oscilloscope using relatively simple C techniques to construct a programme that is by no means simple. When approached in this way C is only marginally more difficult than BASIC and infinitely more powerful. C programmers are always in demand. Ideal for absolute beginners and experienced programmers.

- Book + made up kit 2a + software £57.50
- Book + unmade kit 2u + software £51.50
- Book + top up kit 2t + software £37.98
- (PP UK £4, Europe £10, Rest of world £14)

The Kits

The assembler and C & C++ kits contain the prototyping board, lead assemblies, components and programming software to do all the experiments. The 'made up' kits are supplied ready to start. The 'top up' kit is for readers who have already purchased kit 1a or 1u.

Assembler and C & C++

Click on 'Special Offers' on our website for details of how to save by buying a combined kit for assembler and C & C++.

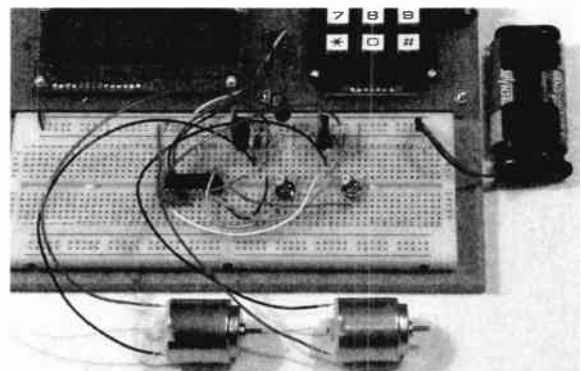

Experimenting with the PIC16F877

The second PIC book starts with the simplest of experiments to give us a basic understanding of the PIC16F877 family. Then we look at the 16 bit timer, efficient storage and display of text messages, simple frequency counter, use a keypad for numbers, letters and security codes, and examine the 10 bit A/D converter.

The PIC16F627 is then introduced as a low cost PIC16F84. We use the PIC16F627 as a step up switching regulator, and to control the speed of a DC motor with maximum torque still available. We study how to use a PIC to switch mains power using an optoisolated triac driving a high current triac. Finally we study how to use the PICs USART for serial communication to a PC.



MAIL ORDER ONLY • CALLERS BY APPOINTMENT

EPE PROJECT PICS

Programmed PICs for *EPE Projects
 12C508/9 - £3.90; 16F627/8 - £4.90
 16C84/16F84/16C71 - £5.90
 16F876/877 - £10.00
 All inc. VAT and Postage
 (*Some projects are copyright)

EPE MICROCONTROLLER P.I. TREASURE HUNTER

The latest MAGENTA DESIGN - highly stable & sensitive - with I.C. control of all timing functions and advanced pulse separation techniques.

- High stability drift cancelling
- Easy to build & use
- No ground effect, works in seawater



- Detects gold, silver, ferrous & non-ferrous metals

- Efficient quartz controlled microcontroller pulse generation.
- Full kit with headphones & all hardware

KIT 847£63.95

68000 DEVELOPMENT TRAINING KIT

- NEW PCB DESIGN
- 8MHz 68000 16-BIT BUS
- MANUAL AND SOFTWARE
- 2 SERIAL PORTS
- PIT AND I/O PORT OPTIONS
- 12C PORT OPTIONS

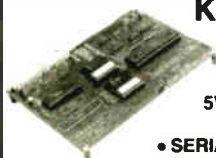

KIT 621

£99.95

- ON BOARD 5V REGULATOR
- PSU £6.99
- SERIAL LEAD £3.99

Stepping Motors



MD100...Std 100 step...£9.99
 MD200...200 step...£12.99
 MD24...Large 200 step...£22.95

PIC PIPE DESCALER

- SIMPLE TO BUILD
- HIGH POWER OUTPUT
- AUDIO & VISUAL MONITORING
- SWEPT FREQUENCY

An affordable circuit which sweeps the incoming water supply with variable frequency electromagnetic signals. May reduce scale formation, dissolve existing scale and improve lathering ability by altering the way salts in the water behave.

Kit includes case, P.C.B., coupling coil and all components. High coil current ensures maximum effect. L.E.D. monitor.



KIT 868 £22.95 POWER UNIT.....£3.99

MICRO PEST SCARER

Our latest design - The ultimate scarer for the garden. Uses special microchip to give random delay and pulse time. Easy to build reliable circuit. Keeps pets/pests away from newly sown areas, play areas, etc. uses power source from 9 to 24 volts.

- RANDOM PULSES
- HIGH POWER
- DUAL OPTION



Plug-in power supply £4.99

KIT 867.....£19.99

KIT + SLAVE UNIT.....£32.50

WINDICATOR

A novel wind speed indicator with LED readout. Kit comes complete with sensor cups, and weatherproof sensing head. Mains power unit £5.99 extra.

KIT 856.....£28.00

★ TENS UNIT ★

DUAL OUTPUT TENS UNIT
 As featured in March '97 issue.

Magenta have prepared a FULL KIT for this excellent new project. All components, PCB, hardware and electrodes are included. Designed for simple assembly and testing and providing high level dual output drive.

KIT 866. . Full kit including four electrodes £32.90

Set of 4 spare electrodes £6.50

1000V & 500V INSULATION TESTER



Superb new design. Regulated output, efficient circuit. Dual-scale meter, compact case. Reads up to 200 Megohms.

Kit includes wound coil, cut-out case, meter scale, PCB & ALL components.

KIT 848.....£32.95

ULTRASONIC PEST SCARER

Keep pets/pests away from newly sown areas, fruit, vegetable and flower beds, children's play areas, patios etc. This project produces intense pulses of ultrasound which deter visiting animals.

- KIT INCLUDES ALL COMPONENTS, PCB & CASE
- EFFICIENT 100V TRANSDUCER OUTPUT
- COMPLETELY INAUDIBLE TO HUMANS

- UP TO 4 METRES RANGE
- LOW CURRENT DRAIN



KIT 812.....£15.00

EPE TEACH-IN 2000

Full set of top quality NEW components for this educational series. All parts as specified by EPE. Kit includes breadboard, wire, croc clips, pins and all components for experiments, as listed in introduction to Part 1.

*Batteries and tools not included.

TEACH-IN 2000 -

KIT 879 £44.95

MULTIMETER £14.45

SPACEWRITER

An innovative and exciting project. Wave the wand through the air and your message appears. Programmable to hold any message up to 16 digits long. Comes pre-loaded with "MERRY XMAS". Kit includes PCB, all components & tube plus instructions for message loading.

KIT 849£16.99

12V EPROM ERASER

A safe low cost eraser for up to 4 EPROMS at a time in less than 20 minutes. Operates from a 12V supply (400mA). Used extensively for mobile work - updating equipment in the field etc. Also in educational situations where mains supplies are not allowed. Safety interlock prevents contact with UV.

KIT 790£29.90

SUPER BAT DETECTOR

1 WATT O/P, BUILT IN SPEAKER, COMPACT CASE 20kHz-140kHz

NEW DESIGN WITH 40kHz MIC.

A new circuit using a 'full-bridge' audio amplifier i.c., internal speaker, and headphone/tape socket. The latest sensitive transducer, and 'double balanced mixer' give a stable, high performance superheterodyne design.



KIT 861£34.99

ALSO AVAILABLE Built & Tested... £48.99

MOSFET MKII VARIABLE BENCH POWER SUPPLY 0-25V 2.5A

Based on our Mk1 design and preserving all the features, but now with switching pre-regulator for much higher efficiency. Panel meters indicate Volts and Amps. Fully variable down to zero. Toroidal mains transformer. Kit includes punched and printed case and all parts. As featured in April 1994 EPE. An essential piece of equipment.



Kit No. 845£64.95

SIMPLE PIC PROGRAMMER

KIT 857... £12.99

Includes PIC16F84 chip disk, lead, plug, p.c.b., all components and instructions

Extra 16F84 chips £3.84 Power Supply £3.99

MAGENTA BRAINIBOT I & II

- Full kit with ALL hardware and electronics
- As featured in *EPE* Feb '03 – KIT 910
- Seeks light, beeps, avoids obstacles
- Spins and reverses when 'cornered'
- Uses 8-pin PIC
- ALSO KIT 911 – As 910 PLUS programmable from PC serial port – leads and software CD provided

NEW

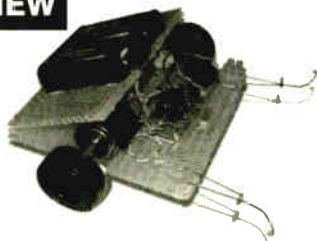

KIT 910 £16.99 KIT 911 £24.99

PIC 16F84 MAINS POWER 4-CHANNEL CONTROLLER & LIGHT CHASER

- ZERO VOLT SWITCHING
- OPTO ISOLATED 5 Amp
- 12 KEYPAD CONTROL
- HARD-FIRED TRIACS
- WITH SOURCE CODE
- SPEED & DIMMING POT.
- EASILY PROGRAMMED

Kit 855 £39.95

PIC 16F84 LCD DISPLAY DRIVER

INCLUDES 1-PIC16F84 WITH DEMO PROGRAM SOFTWARE DISK, PCB, INSTRUCTIONS AND 16-CHARACTER 2-LINE

LCD DISPLAY

Kit 860 £19.99

Power Supply £3.99

FULL PROGRAM SOURCE CODE SUPPLIED – DEVELOP YOUR OWN APPLICATION!

Another super PIC project from Magenta. Supplied with PCB, industry standard 2-LINE x 16-character display, data, all components, and software to include in your own programs. Ideal development base for meters, terminals, calculators, counters, timers – Just waiting for your application!

8-CHANNEL DATA LOGGER

As featured in Aug./Sept. '99 *EPE*. Full kit with Magenta redesigned PCB – LCD fits directly on board. Use as Data Logger or as a test bed for many other 16F877 projects. Kit includes programmed chip, 8 EEPROMs, PCB, case and all components.

KIT 877 £49.95 inc. 8 x 256K EEPROMS

ICEBREAKER

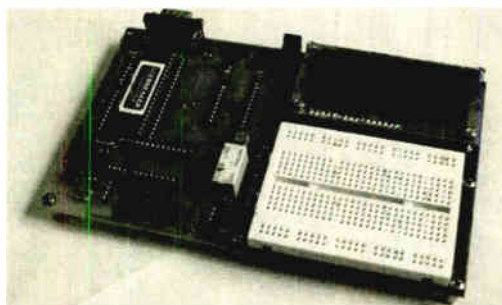

PIC Real Time In-Circuit Emulator

- Icebreaker uses PIC16F877 in circuit debugger
- Links to Standard PC Serial Port (lead supplied)
- Windows™ (95+) Software included
- Works with MPASM and MPLAB Microchip software
- 16 x 2 L.C.D., Breadboard, Relay, I/O devices and patch leads supplied

As featured in March '00 *EPE*. Ideal for beginners AND advanced users. Programs can be written, assembled, downloaded into the microcontroller and run at full speed (up to 20MHz), or one step at a time. Full emulation means that all I/O ports respond exactly and immediately, reading and driving external hardware.

Features include: Reset; Halt on external pulse; Set Breakpoint; Examine and Change registers, EEPROM and program memory; Load program, Single Step with display of Status, W register, Program counter, and user selected 'Watch Window' registers.

KIT 900 . . . £34.99

POWER SUPPLY £3.99 STEPPING MOTOR 100 STEP £9.99

EPE TEACH-IN 2004

THE LATEST SERIES – STARTED NOV '03
ALL PARTS INCLUDING PROTOTYPE BREADBOARD AND WIRE – AS LISTED ON p752 NOV. ISSUE (EXCL MISC.)
"A BRILLIANT NEW ELECTRONICS COURSE"

KIT 920 . . . £29.99

ADDITIONAL PARTS – AS LISTED UNDER MISCELLANEOUS – BUT LESS RADIO MODULES, SOLENOID LOCK AND MOTOR/ GEARBOX.

KIT 921 . . . £12.99

EPE PIC Tutorial V2

EPE APR/MAY/JUNE '03 and PIC RESOURCES CD

FOLLOW THIS SERIES WITH EPE PIC TOOLKIT 3

- THE LATEST TOOLKIT BOARD – 8, 18, 28 AND 40-PIN CHIPS
- MAGENTA DESIGNED P.C.B. WITH COMPONENT LAYOUT AND EXTRAS
- L.C.D. BREADBOARD AND PIC CHIP INCLUDED
- ALL TOP QUALITY COMPONENTS AND SOFTWARE SUPPLIED

KIT 880 . . . £34.99 WITH 16F84 OR BUILT £49.99

KIT 880 . . . £39.99 WITH 16F877 OR BUILT £55.99

PIC TUTOR 1

**MARCH - APRIL - MAY '98
EPE SERIES 16F84**

PIC TUTOR BOARD KIT

Includes: PIC16F84 Chip, TOP Quality PCB printed with Component Layout and all components* (*not ZIF Socket or Displays). Included with the Magenta Kit is a disk with Test and Demonstration routines.

KIT 870 £27.95, Built & Tested £42.95

Optional: Power Supply – £3.99, ZIF Socket – £9.99

LCD Display £7.99 LED Display £6.99

Reprints Mar/Apr/May 98 – £3.00 set 3

SUPER PIC PROGRAMMER

- READS, PROGRAMS, AND VERIFIES
- WINDOWS™ SOFTWARE
- PIC16C AND 16F – 6X, 7X, AND 8X
- USES ANY PC PARALLEL PORT
- USES STANDARD MICROCHIP • HEX FILES
- DISASSEMBLER SOFTWARE
- PCB, LEAD, ALL COMPONENTS, TURNED-PIN SOCKETS FOR 18, 28, AND 40 PIN ICs

• SEND FOR DETAILED INFORMATION – A SUPERB PRODUCT AT AN UNBEATABLE LOW PRICE.

Kit 862 £29.99

Power Supply £3.99

PIC STEPPING MOTOR DRIVER

INCLUDES PCB, PIC16F84 WITH DEMO PROGRAM, SOFTWARE DISC, INSTRUCTIONS AND MOTOR.

Kit 863 £18.99

FULL SOURCE CODE SUPPLIED ALSO USE FOR DRIVING OTHER POWER DEVICES e.g. SOLENOIDS

Another Magenta PIC project. Drives any 4-phase unipolar motor – up to 24V and 1A. Kit includes all components and 100 step motor. Chip is pre-programmed with demo software, then write your own, and re-program the same chip! Circuit accepts inputs from switches etc and drives motor in response. Also runs standard demo sequence from memory.

MAGENTA

All prices include VAT. Add £3.00 p&p. Next day £6.99

Tel: 01283 565435

Fax: 01283 546932

E-mail: sales@magenta2000.co.uk

102004



Station Road, Cullercoats, Tyne & Wear, NE30 4PQ

Prices Exclude Vat @17%.
UK Carriage £2.50 (less than 1kg)
£5.50 greater than 1kg
Cheques / Postal orders payable to
ESR Electronic Components.
PLEASE ADD CARRIAGE & VAT TO ALL ORDERS



See Next / Last Months Ad. for
ELECTRONIC COMPONENTS

DIL Sockets

6 Pin DIL 0.3"	£0.07
6 Pin DIL 0.3"	£0.06
14 Pin DIL 0.3"	£0.11
14 Pin DIL 0.3"	£0.11
18 Pin DIL 0.3"	£0.12
20 Pin DIL 0.3"	£0.12
24 Pin DIL 0.3"	£0.12
24 Pin DIL 0.3"	£0.12
28 Pin DIL 0.3"	£0.13
28 Pin DIL 0.6"	£0.13
32 Pin DIL 0.6"	£0.13
40 Pin DIL 0.6"	£0.19

Stamped Pin

6 Pin DIL 0.3"	£0.07
6 Pin DIL 0.3"	£0.06
14 Pin DIL 0.3"	£0.11
14 Pin DIL 0.3"	£0.11
18 Pin DIL 0.3"	£0.12
20 Pin DIL 0.3"	£0.12
24 Pin DIL 0.3"	£0.12
24 Pin DIL 0.3"	£0.12
28 Pin DIL 0.3"	£0.13
28 Pin DIL 0.6"	£0.13
32 Pin DIL 0.6"	£0.13
40 Pin DIL 0.6"	£0.19

Turned Pin

8 Pin DIL 0.3"	£0.11
14 Pin DIL 0.3"	£0.20
15 Pin DIL 0.3"	£0.23
15 Pin DIL 0.3"	£0.25
20 Pin DIL 0.3"	£0.28
24 Pin DIL 0.3"	£0.32
24 Pin DIL 0.6"	£0.35
28 Pin DIL 0.3"	£0.39
28 Pin DIL 0.6"	£0.39
32 Pin DIL 0.6"	£0.43
40 Pin DIL 0.6"	£0.64

ZIF Sockets

Universal ZIF DIL Sockets	
24 Way 0.3-0.6"	£6.74
28 Way 0.3-0.6"	£7.80
32 Way 0.3-0.6"	£7.25
40 Way 0.3-0.6"	£10.63

Transistor Sockets

TQ18-4 Base Socket	£0.24
T05 Base Socket	£0.24

IDC Cable Sockets

10 Way Socket	£0.27
12 Way Socket	£0.35
16 Way Socket	£0.38
20 Way Socket	£0.37
24 Way Socket	£0.36
34 Way Socket	£0.39
40 Way Socket	£0.55
50 Way Socket	£0.80

IDC Cable Plugs

10 Way Plug	£0.52
14 Way Plug	£0.58
16 Way Plug	£0.62
20 Way Plug	£0.66
26 Way Plug	£0.70
40 Way Plug	£0.92
50 Way Plug	£1.12

PCB Box Headers

10 Way Straight	£0.21
14 Way Straight	£0.23
16 Way Straight	£0.32
20 Way Straight	£0.41
26 Way Straight	£0.52
34 Way Straight	£0.68
40 Way Straight	£0.68
50 Way Straight	£1.03
10 Way 90	£0.32
14 Way 90	£0.39
16 Way 90	£0.43
20 Way 90	£0.43
26 Way 90	£0.68
34 Way 90	£0.81
40 Way 90	£1.17
50 Way 90	£1.14

PCB Latch Headers

10 Way Straight	£0.39
14 Way Straight	£0.45
16 Way Straight	£0.51
20 Way Straight	£0.54
26 Way Straight	£0.73
34 Way Straight	£0.88
40 Way Straight	£0.92
50 Way Straight	£1.27
10 Way 90	£0.46
14 Way 90	£0.48
16 Way 90	£0.54
20 Way 90	£0.58
26 Way 90	£0.81
34 Way 90	£1.03
40 Way 90	£1.23
50 Way 90	£1.41

DIL Headers

14 Way DIL	£0.51
16 Way DIL	£0.53
24 Way DIL	£0.90
40 Way DIL	£1.37

Transition Headers

10 Way Transition	£0.42
14 Way Transition	£0.42
16 Way Transition	£0.48
20 Way Transition	£0.48
26 Way Transition	£0.52
34 Way Transition	£0.56
40 Way Transition	£0.63
50 Way Transition	£0.84

Large Range of Connectors
in stock - New Connectors
Catalogue now available
see our web site for details.

D Type Connectors

DC Plug 0.7ID 2.35OD	£0.47
DC Plug 1.3ID 3.4OD	£0.14
DC Plug 1.7ID 4.75OD	£0.30
DC Plug 2.1ID 5.0OD	£0.24
DC Plug 2.5ID 5.0OD	£0.23
DC Plug 3.1ID 6.3OD	£0.53
DC Line Socket 2.1mm	£0.66
DC Line Socket 2.5mm	£0.68
DC Chassis Skt 2.1mm	£0.44
DC Chassis Skt 2.5mm	£0.44

Solder Bucket

9 Way Male Plug	£0.20
9 Way Female Socket	£0.20
15 Way Male Plug	£0.27
15 Way Female Socket	£0.23
15 Way H.D. Plug	£0.42
15 Way H.D. Socket	£0.45
23 Way Male Plug	£0.60
23 Way Female Socket	£0.60
25 Way Male Plug	£0.60
25 Way Female Skt	£0.35

IDC Ribbon Mounting

9 Way Male Plug	£1.08
9 Way Female Socket	£0.93
15 Way Male Plug	£1.30
15 Way Female Socket	£1.32
25 Way Male Plug	£1.10
25 Way Female Socket	£1.13
IDC Crimp Tool	£11.80

Right Angled PCB

9 Way Male Plug	£0.33
9 Way Female Socket	£0.33
15 Way Male Plug	£0.37
15 Way Female Socket	£0.37
25 Way Male Plug	£0.58
25 Way Female Socket	£0.43
25 Way Male Socket	£0.50

Plastic D Covers

9 Way Covers - Grey	£0.27
9 Way Covers - Black	£0.25
15 Way Cover - Grey	£0.30
23 Way Cover - Grey	£0.40
23 Way Cover - Black	£0.38
25 Way Cover - Grey	£0.34
25 Way Cover - Black	£0.37
9 to 9 Cover / Case	£0.80
25 to 25 Cover / Case	£0.84
9 to 25 Cover / Case	£0.80

Audio Connectors

2.5mm Jack Plug	£0.25
2.5mm Line Socket	£0.24
2.5mm Stereo Socket	£0.12
3.5mm Mono Plug	£0.24
3.5mm Mono Line Skt	£0.24
3.5mm Mono Chassis	£0.14
3.5mm Stereo Plug	£0.35
3.5mm Stereo Line Skt	£0.27
3.5mm Stereo Chassis	£0.22
4 Mono Plug	£0.30
4 Mono Line Socket	£0.36
4 Mono Chassis Skt	£0.46
4 Stereo Plug	£0.34
4 Stereo Line Socket	£0.32
4 Stereo Chassis Skt	£0.38

Phono Series

Plastic Line Plug	£0.20
Plastic Line Socket	£0.20
Metal Line Plug	£0.50
Metal Line Socket	£0.31
Gold Plated Plug	£0.68
Chassis Socket	£0.20

XLR Series - metal

3 Pin Line Plug	£0.96
3 Pin Line Socket	£0.96
3 Pin Chassis Plug	£1.02
3 Pin Chassis Socket	£1.22

Neutrik Connectors

NC3MX XLR Line Plug	£1.80
NC3FX XLR Line Skt	£2.10
NC3MDL Chassis Plug	£2.10
NC3FDL Chassis Skt	£2.55
NL2FC 2 way Speakon	£1.53
NL4FX 4 way Speakon	£2.93
NL2MP Speakon Skt	£1.13
NL4MP Speakon Skt	£1.16
NP2C Mono Jack	£1.80
NP3C Stereo Jack	£2.48

RF Connectors

BNC Plug 50Ω Solder	£0.90
BNC Plug 50Ω Crimp	£0.68
BNC Plug 75Ω Solder	£1.08
BNC Plug 75Ω Crimp	£0.69
BNC Chassis Socket	£0.76
F Plug - Twist	£0.20
F Plug - Crimp	£0.20
TNC Plug 50Ω Solder	£1.08
TNC Plug 50Ω Crimp	£1.04
TNC Plug 75Ω Solder	£1.17
TNC Plug 75Ω Crimp	£0.96
UHF Plug 5mm Cable	£0.63
UHF Plug 11mm Cable	£0.72
UHF Chassis Skt - Sqr	£0.54
UHF Chassis Skt - Rnd	£0.75

Terminals

Colours Red, Black, Green, Blue, White or Yellow 2mm Solder Plugs	£0.23
2mm Chassis Sockets	£0.28
4mm Plugs - Solder	£0.34
4mm Plugs - Screw	£0.38
4mm Shrouded Plugs	£0.40
4mm Shrouded Plugs	£0.74
4mm Chassis Sockets	£0.21
4mm Binding Posts	£0.48
33mm Crocodile Clips	£0.10

Power Connectors

DC Low Voltage	
DC Plug 0.7ID 2.35OD	£0.47
DC Plug 1.3ID 3.4OD	£0.14
DC Plug 1.7ID 4.75OD	£0.30
DC Plug 2.1ID 5.0OD	£0.24
DC Plug 2.5ID 5.0OD	£0.23
DC Plug 3.1ID 6.3OD	£0.53
DC Line Socket 2.1mm	£0.66
DC Line Socket 2.5mm	£0.68
DC Chassis Skt 2.1mm	£0.44
DC Chassis Skt 2.5mm	£0.44

IEC Mains 6A 250Vac

3 Pin IEC Line Socket	£0.87
3 Pin IEC Line Plug	£1.20
3 Pin Chassis Socket	£0.50
1 Pin Chassis Plug	£0.56

8 Way Bulgin

Line Plug P551	£3.38
Line Socket P956	£3.99
Chassis Plug P959	£3.24
Chassis Socket P552	£1.20

Toggle Switches

3A 125V 1A 250V	
5mm Ø Mounting Hole	
SPST 5 x 10mm	£0.47
SPDT 5 x 10mm	£0.53
SPDT C/O/H 5 x 10mm	£1.01
DPDT 9.2 x 10mm	£0.63

Miniature

6A 125V 3A 250V	
6.2mm Ø Mounting Hole	
SPST 8 x 13mm	£0.58
SPDT 8 x 13mm	£0.55
SPDT c/off 8 x 13mm	£0.65
SPDT c/o Biased 2 way	£0.84
SPDT c/o Biased 1 way	£1.15
DPDT 12 x 13mm	£0.65
DPDT c/off 12 x 13mm	£0.88
DPDT c/o Biased 2W	£1.20
DPDT c/o Biased 1W	£1.28

Standard

10A 250V Push on terminals	
12mm Ø Mounting Hole	
SPST 18 x 30mm	£1.05
SPDT 18 x 30mm	£1.18
SPDT c/off 18 x 30mm	£1.18
DPDT 21 x 30mm	£1.78
DPDT c/off 21 x 30mm	£1.78

Slide Switches

Miniature	
300mA 125V	
7 x 15mm Mounting Hole	
DPDT 7 x 23mm	£0.17

Standard

1A 125V	
5.5 x 12mm Mounting Hole	
DPDT 12 x 35mm	£0.27
DPDT c/o 12 x 35mm	£0.25

Rotary Switches

150mA 250V Make before Break 22mm Ø	
9.8mm Ø Mounting Hole	
2 Pole 12 Way	£0.84
2 Pole 6 Way	£0.84
3 Pole 4 Way	£0.84
4 Pole 3 Way	£0.84

Push Switches

Miniature Round	
250mA 125V 28 x 10mm	
7mm Ø Mounting Hole	
Non Latching Push to Make	
Black, Red, Yellow, Green, Blue or White	£0.23
Non Latching Push to Break	
Black PTB	£0.24

Standard Square

1A 250V	
39 x 15MM	
12mm Ø Mounting Hole	
Non Latching Push to Make	
Black or Red	£0.60
Latching - Push On push Off	
Black or Red	£0.65

Rocker Switches

Miniature	
19 x 19mm Mounting Hole	
SPST 4A 250V	£0.57
SPST 6A Red Neon	£1.65
SPST 3A Red LED	£1.92
SPST 6A 250V	£0.75
DPST 4A 250V	£0.81
DPST 4A Red Neon	£1.10
DPST 3A Amber Neon	£1.40
DPST 3A Green Neon	£1.32

Standard

10(SP)/22(DP) x 30mm	
AC Mounting Hole	
SPST 10A 250V	£0.60
SPST 16A 250V	£0.75
SPST 15A Red Neon	£0.90
SPDT 16A 250V	£0.75
DPST 10A 250V	£0.90
DPST 15A Red Neon	£1.18
DPST Amber Neon	£1.25
DPST Green Neon	£1.25
DPDT 10A 250V	£0.90

Relays

PCB Mounting	
1A 24Vdc DPDT 5V	£1.38
1A 24Vdc DPDT 12V	£1.35
3A 110V SPDT 6V	£0.60
5A 110V SPDT 12V	£0.72
5A 110V SPDT 6V	£0.72
5A 110V SPDT 12V	£0.93
5A 110V DPDT 6V	£0.93
5A 110V DPDT 12V	£0.93
5A 240V DPDT 6V	£1.76
5A 240V DPDT 12V	£1.50
10A 240V SPDT 6V	£1.20
10A 240V SPDT 12V	£1.44
10A 240V SPDT 24V	£1.44

Computer Accessories

Adaptors	
9M Gender Changer	£1.73
9F Gender Changer	£1.73
25M Gender Changer	£2.20
25F Gender Changer	£2.43
9 Male - 25 Female	£1.73
9 Female - 25 Male	£1.71
9M - 6 Mini Din Male	£2.16
9F - 6 Mini Din Female	£2.13
5M Din - 6M Mini Din	£1.73
5F Din - 6M Mini Din	£1.73

Testers / Patch Boxes

Mini Tester 7 LEDs	£4.72
Check Tester 18 LEDs	£6.32
Enhanced+ Switches	£15.18
25D Patch Box W/F	£2.64
Anti-Static Mist Strip	£4.76
6A Surge Protector	£5.20
13A Surge Protector	£10.00
4 Gang Surge Block	£10.50

Leads & Cables

1.5m Printer Lead	£2.55
2m BD Printer Lead	£2.98
5m BD Printer Lead	£4.98
10m BD Printer Lead	£9.88
2m IEEE1284 Printer L	£4.38
5m IEEE1284 Printer L	£8.90
10m IEEE1284 Printer L	£16.13
Serial Printer 25M-25FE	£4.38
9 Female - 9 Female	£4.38
25 Female - 25 Female	£6.48
9 Female - 25 Female	£4.38
98.25F to 98.25F	£4.88
Modem Leads	
25Mole to 9Female	£4.08
25Mole to 25Female	£3.78

PC Link Leads

InterLink 25M to 25M	£3.88
25Mole to 25Mole	£3.60
36Mole to 36Mole	£2.60

Internal Leads

Floppy Cable A/B	£2.28
Hard Disk 2xIDE	£1.65
Hard Disk 2xATA66	£3.38
Power 3/2 - 2 x 3	£1.88
Power 5/2 - 2 x 3	£1.50
Power 5/2 - 3 x 5	£1.88
Power 5/2 - 3 x 5	£1.88

Networking

Now in stock	
Full range of CAT5 cables, outlets, switches & routers.	

See our web site for details
including our lowest prices
& quantity discounts.

Boxes & Cases

Many more sizes available

3.579545MHz	£0.41
3.8864MHz	£0.41
4.0MHz	£0.45
4.194304MHz	£0.37
4.433619MHz	£0.41
4.9152MHz	£0.41
6.0MHz	£0.34
6.144MHz	£0.41
7.3728MHz	£0.53
8.0MHz	£0.49
8.867238MHz	£0.39
10.0MHz	£0.40
11.0MHz	£0.40
11.0592MHz	£0.41
12.0MHz	£0.41

EVERYDAY
PRACTICAL
ELECTRONICS

THE No.1 MAGAZINE FOR ELECTRONICS TECHNOLOGY & COMPUTER PROJECTS

VOL. 33 No. 10 OCTOBER 2004

Robots

Robot – automaton with human appearance; automatic mechanical device; machine-like person.

Robot – a mechanical man; a more than humanly efficient automaton; an automatic traffic signal. [Czech *robot*, statute labour; from Karel Capek's play *R.U.R.* (1920).]

Robot – a mechanical device that can be programmed to perform a variety of tasks of manipulation and locomotion under automatic control.

Three different interpretations of the word *robot*. The first from *The New Little Oxford Dictionary*, the second from *Chambers Twentieth Century Dictionary* and the third from *McGraw-Hill Dictionary of Scientific and Technical Terms*. The first two give what could perhaps be described as a popular, non-technical interpretation of the word. They are, however, not what I and, I guess, most other "technical" people think of as a robot. My own view is that a robot is essentially a programmable device as described in the third definition. This means that the robots in "Robot Wars" type encounters are not really robots at all but remote controlled fighting machines.

Of course, the meanings or interpretations of words change over time and no doubt many youngsters will think of Robot Wars devices when talking about robots, whilst older, non-technical, people may think of "a mechanical man". It is obvious that the word is used in different ways and covers a multitude of devices from humanoid automatons (androids), with or without intelligence, to buggies like our *Smart Karts*, fighting radio controlled machines, robot arms and various walking platforms etc. even to "an automatic traffic signal" – not sure where that one came from.

Our *Robots – Special Supplement* in this issue demonstrates the wide variety of devices now available for what we know as robotics applications.

Smart Kart

Although our own *Smart Kart* presently lacks any manipulative ability it can be programmed, has "locomotion under automatic control" and will be extended over the coming months to give it better vision and limited manipulation abilities. The designer, Owen Bishop, is planning a range of developments which should see *Smart Kart* playing interactive games and learning about its environment. The PIC brain used in the design comes from Microchip and constructors might be interested in the Free Online Competition in this issue where Microchip have provided over \$2100 of PIC development tools as prizes.

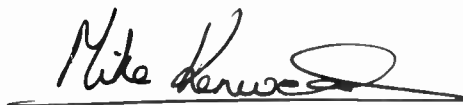

AVAILABILITY

Copies of *EPE* are available on subscription anywhere in the world (see opposite), from all UK newsagents (distributed by COMAG) and from the following electronic component retailers: Omni Electronics and Yebo Electronics (S. Africa). *EPE* can also be purchased from retail magazine outlets around the world. An internet on-line version can be purchased and downloaded for just \$10.99US (approx £7) per year available from www.epemag.com

SUBSCRIPTIONS

Subscriptions for delivery direct to any address in the UK: 6 months £16.50, 12 months £31, two years £57; Overseas: 6 months £19.50 standard air service or £28.50 express airmail, 12 months £37 standard air service or £55 express airmail, 24 months £69 standard air service or £105 express airmail. To subscribe from the USA or Canada see the last magazine page. Online subscriptions, for downloading the magazine via the Internet, \$10.99US (approx £7) for one year available from www.epemag.com. Cheques or bank drafts (in £ sterling only) payable to *Everyday Practical Electronics* and sent to EPE Subs. Dept., Wimborne Publishing Ltd, 408 Wimborne Road East, Ferndown, Dorset BH22 9ND. Tel: 01202 873872. Fax: 01202 874562. Email: subs@epemag.wimborne.co.uk. Also via the Web at: <http://www.epemag.wimborne.co.uk>. Subscriptions start with the next available issue. We accept MasterCard, Amex, Diners Club, Maestro or Visa. (For past issues see the *Back Issues* page.)

BINDERS

Binders to hold one volume (12 issues) are available from the above address. These are finished in blue p.v.c., printed with the magazine logo in gold on the spine. Price £6.95 plus £3.50 p&p (for overseas readers the postage is £6.00 to everywhere except Australia and Papua New Guinea which cost £10.50). Normally sent within seven days but please allow 28 days for delivery – more for overseas.

Payment in £ sterling only please. Visa, Amex, Diners Club, Maestro and MasterCard accepted. Send, fax or phone your card number, card expiry date and card security code (the last 3 digits on or just under the signature strip), with your name, address etc. Or order on our secure server via our UK web site. Overseas customers – your credit card will be charged by the card provider in your local currency at the existing exchange rate.



Editorial Offices:

EVERYDAY PRACTICAL ELECTRONICS EDITORIAL
WIMBORNE PUBLISHING LTD., 408 WIMBORNE ROAD EAST,
FERNDOWN, DORSET BH22 9ND
Phone: (01202) 873872. Fax: (01202) 874562.

Email: enquiries@epemag.wimborne.co.uk

Web Site: www.epemag.wimborne.co.uk

EPE Online (downloadable version of EPE): www.epemag.com

EPE Online Shop: www.epemag.wimborne.co.uk/shopdoor.htm

See notes on Readers' Technical Enquiries below – we regret lengthy technical enquiries cannot be answered over the telephone.

Advertisement Offices:

EVERYDAY PRACTICAL ELECTRONICS ADVERTISEMENTS
MILL LODGE, MILL LANE,
THORPE-LE-SOKEN, ESSEX CO16 0ED
Phone/Fax: (01255) 861161 Email: epeads@aol.com

Editor: MIKE KENWARD

Deputy Editor: DAVID BARRINGTON

Technical Editor: JOHN BECKER

Business Manager: DAVID J. LEAVER

Subscriptions: MARILYN GOLDBERG

Administration: FAY KENWARD

Editorial/Admin: (01202) 873872

Advertisement Manager:

PETER J. MEW, (01255) 861161

Advertisement Copy Controller:

PETER SHERIDAN, (01202) 873872

On-Line Editor: ALAN WINSTANLEY

EPE Online (Internet version) Editors:

CLIVE (MAX) MAXFIELD and ALVIN BROWN

READERS' TECHNICAL ENQUIRIES

E-mail: techdept@epemag.wimborne.co.uk

We are unable to offer any advice on the use, purchase, repair or modification of commercial equipment or the incorporation or modification of designs published in the magazine. We regret that we cannot provide data or answer queries on articles or projects that are more than five years old. Letters requiring a personal reply *must* be accompanied by a stamped self-addressed envelope or a self-addressed envelope and international reply coupons.

PROJECTS AND CIRCUITS

All reasonable precautions are taken to ensure that the advice and data given to readers is reliable. We cannot, however, guarantee it and we cannot accept legal responsibility for it.

A number of projects and circuits published in *EPE* employ voltages that can be lethal. You should not build, test, modify or renovate any item of mains powered equipment unless you fully understand the safety aspects involved and you use an RCD adaptor.

COMPONENT SUPPLIES

We do not supply electronic components or kits for building the projects featured, these can be supplied by advertisers (see *Shoptalk*). We advise readers to check that all parts are still available before commencing any project in a back-dated issue.

ADVERTISEMENTS

Although the proprietors and staff of EVERYDAY PRACTICAL ELECTRONICS take reasonable precautions to protect the interests of readers by ensuring as far as practicable that advertisements are *bona fide*, the magazine and its Publishers cannot give any undertakings in respect of statements or claims made by advertisers, whether these advertisements are printed as part of the magazine, or in inserts.

The Publishers regret that under no circumstances will the magazine accept liability for non-receipt of goods ordered, or for late delivery, or for faults in manufacture.

TRANSMITTERS/BUGS/TELEPHONE EQUIPMENT

We advise readers that certain items of radio transmitting and telephone equipment which may be advertised in our pages cannot be legally used in the UK. Readers should check the law before buying any transmitting or telephone equipment as a fine, confiscation of equipment and/or imprisonment can result from illegal use or ownership. The laws vary from country to country; readers should check local laws.

Moon and Tide Clock Calendar

John Becker

A pictorial guide to tracking moon and tide states throughout the year.



THIS article describes a novel design in which the phases of the moon and the ebb and flow of the tide are shown on a graphics liquid crystal display (GLCD), along with clock and calendar data. It also illustrates how a PS/2 PC keyboard can be interfaced to a PIC-controlled circuit which only infrequently needs to have its settings adjusted, thus saving on the cost of the pushbutton switches which would otherwise be required.

A detailed discussion of interfacing a PIC to a PS/2 keyboard, and also to a PS/2 mouse, was published in *EPE* August '04 (*PIC to PS/2 Mouse and Keyboard Interfacing*).

In the application described now, the keyboard is basically only required to set the real-time factors for the Moon, tide, clock and calendar, after which it can be returned to the PC to which it belongs. It may be re-attached to the PIC circuit at a later date if required, to adjust clock timing accuracy, for example. The various factors

to be set are selected by pressing given keyboard keys, such as "M" for minutes or "Y" for years etc, and then correcting the selected values up or down by the use of the "+" or "-" keys.

Current clock time is shown in 24-hour mode, calendar information is displayed as weekday, day of the month, month and year. It automatically corrects itself for different month lengths, and for leap years. It is not Millennium compatible as such things do not actually bother us now (and the Millennium Bug never significantly intruded on our lives anyway!)

Well Phased

Moon status is displayed graphically, mimicking what you actually see in real life. Most Moon displays normally show only four or eight phases per month – this design provides a more detailed simulation, having 256 separate progressions from full Moon to full Moon. With this degree of resolution, you are unlikely to ever see the change from one phase to the next, unless you actually wait to see it, and that could mean a really long wait (around three hours!)

Tide display is in a form of bargraph. When the tide is rising, a black triangle slowly enlarges from nil near the bottom of the screen, expanding until its peak reaches the top of the screen. As the tide then starts to fall, the peak of the triangle is slowly flattened,

the flatness progressively descending the screen, until the tide has fully receded, prior to rising again. Even from a distance you can see the current state of the tide and whether it is rising or falling

Just for fun, there is also an optional little gimmick when high tide occurs – revealed later! Simultaneously, the current time is also shown below the tide triangle, to the right, where it stays until changed at the next high tide point.

Moon Calculations

We are (or should be!) aware that the Moon orbits the Earth in an easterly direction, in a period which we know as one month. As a rule of thumb, we probably regard this period as taking 28 days. In fact it is nearer to 29.53 days, although it varies over the year, depending upon complex gravitational factors, principally caused by the Sun and our varying distance from it.

In the author's *Canute Tide Predictor* of June 2000, such factors were taken into account for its assessment of the tides, which are, of course, caused mainly by the Moon, as further discussed shortly. This Moon-Tide clock's calculations are done more simply, and are based on a continuous unchanging Moon cycle, taken as 29.53 days, or 42524.05 minutes, or 2551443.0 seconds per lunar month.

As said, the graphics display is capable of showing 256 Moon states. A single Moon state (segment) thus lasts for $2551443/256 = 9966.5738$ seconds (2 hours, 46 minutes, 6.57 seconds). In the PIC program, a counter is set with the whole number of seconds (9967) for one segment. The counter is decremented (a value of 1 deducted) every second. Each time the counter rolls over to zero, it is reset to 9967, and another counter is incremented (a value of 1 added). Simultaneously, the screen's Moon display is updated to show the new phase status.

Each of the 256 Moon segments has a different curvature, to simulate the observed changing shape of the Moon. The mathematics behind this simulation are complex, and based upon the sines of an angle of rotation, of which there are 360 degrees in a full cycle. Whilst it is possible (just about!) to program a PIC to calculate sines, it was decided that a simpler technique should be employed, using a lookup table.



QuickBASIC was used to do the actual calculations, outputting to a disk file the individual integer (whole number) results for a simple curve of given diameter in relation to 180 degrees. These results were prefixed by the PIC command RETLW, so that the PIC software simply uses a looped counter having 180 steps (angle positions) and then accesses a table which returns the value associated with that angle.

In fact, two tables are used, because what is needed are the coordinates (x and y) at which the screen should have a single pixel set (black) or reset (normal clear background).

Lunamatics!

Hopefully, some of you will be interested in the maths behind this, especially if you want to draw a circle or ellipse on a GLCD screen. In Fig.1 is shown a circle and a right-angled triangle drawn from the circle's centre to the perimeter. The angle used for the calculation is that shown marked as A. The line marked H is the hypotenuse of the triangle and, irrespective of the angle, its length is always the same as the radius of the circle.

The vertical line descending from the point at which line H meets the circumference is opposite the angle and marked Y. The horizontal line from the bottom of Y to the centre is marked X, and is the angle's adjacent side.

Standard geometry tells us that the sine of an angle has a value equal to the length of the opposite side (Y) divided by the length of the hypotenuse (H), i.e.:

$$\sin A = Y / H$$

We know the length of H, the radius of the circle, but we need to know Y. The above equation can be rearranged so that:

$$Y = \sin A \times H$$

This value represents coordinate Y at which we wish to set or reset a pixel. But we still need to know the horizontal position for this pixel, coordinate X. This can be calculated using tangents, but can equally well be calculated using the formula:

hypotenuse² = opposite² + adjacent². In Fig.1 the adjacent side is X, the value we need to know, so the above equation can be rewritten as:

$$X = \sqrt{H^2 - Y^2}$$

We now have the X coordinate (the GLCD's horizontal line of pixels) and the Y coordinate (the GLCD's vertical line of pixels). In the program, the X and Y coordinates for angles 0° to 179° are held in two separate tables. The software's angle counter simply accesses the tables in turn and returns with the two screen coordinates of the pixel to be accessed.

For angles between 180° and 359° the software uses the same values as those between 0° and 179°, the resulting X coordinate being taken as a negative value.

It is worth commenting that the entire suite of software routines for using a GLCD was discussed in the author's feature article *Using PICs with Graphic L.C.D.s* (Feb '01). Those routines have been imported to the Moon-Tide program as a complete library file.

Flattening the Curve

When we view the Moon's face, the boundary (terminator) between light and dark is seen as a curve whose radius changes as the Moon orbits the earth. Simulating this is actually somewhat easier than might be supposed.

In the software, a multiplying factor changes for each of the 256 phase positions. For the full external curve of the Moon, the resulting answer is that for the normal radius of the Moon (48 pixels wide). At each subsequent phase, the resulting value decreases horizontally (the X coordinate gets smaller, while leaving the Y coordinate intact).

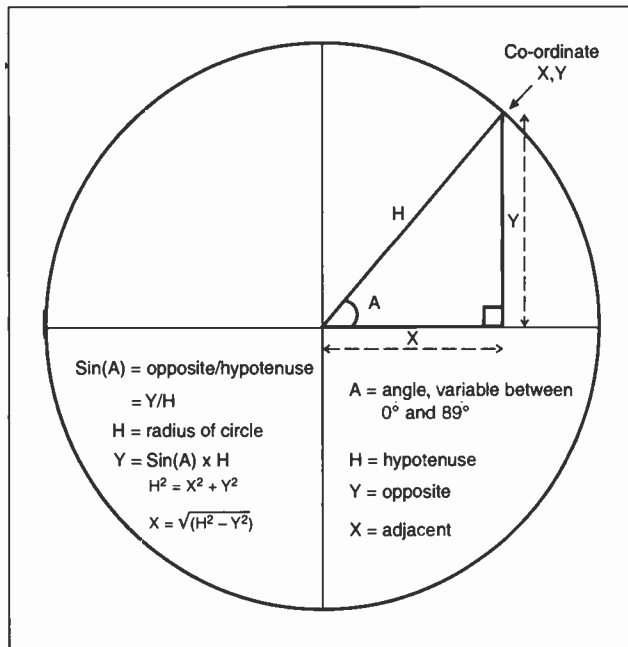

Fig.1. Geometric principle used in the PIC's software for calculating Moon curves.

The multiplying value is also relative to which "quarter" of the Moon is being processed: no Moon seen, first quarter (right side illuminated), full Moon, last quarter (right side dark), no Moon, etc.

Note that even though the Moon's screen diameter is only 48 pixels, it is still necessary to use a loop that plots the curve positions for 180 degrees. This is because some sections of the curve (those nearer the top and bottom) need more than one pixel set/reset on a given line.

Incidentally, in an early version of the software, the Moon phases were originally set at eight variants, as represented by Jonathan Hare's interestingly simple *PIC Moon Clock* of April '04. Putting that type of image coding into a PIC turned out to be complex, involving images first created through Windows' Paint and digitised into lookup tables. Such techniques were discussed in the author's *PIC World Clock* of Aug '02.

Having successfully done so, though, there was a nagging feeling that a smoother transition between phases could be achieved with a bit of thought – which turned out to be a lot of thought when temptation was succumbed to!

The software files include the QuickBASIC file (*Circlst.bas*) which was used to obtain the coordinates for the GLCD circle plot.

Tideometry!

The relationship between the Moon and the tides is, at one level, very straightforward – the Moon orbits the Earth while the Earth rotates beneath the Moon. It should be capable of software simulation using simple equations, the Earth's oceans always being pulled towards the Moon's gravitational field, and swept around the globe as a wave front. (In fact, it's two tidal wave fronts that actually exist, one on either side of globe.)

Several factors prevent this simplistic modelling portraying the true situation – principally the influence of the Sun's gravity, and the land masses above and below the seas and oceans. This was explained more fully in the *Canute* article, and the software of that design reflected this greater complexity.

As with the Moon phase values, for this simple Moon-Tide clock, a fixed average period between tides has been used, without reference to the Sun or Moon. Using the same basic figures as with *Canute*, the average period between one high tide and the next has been taken as 745.2361 minutes, i.e. 12 hours 25 minutes 14 seconds, or 44714.166 seconds.

On the GLCD screen, 47 horizontal lines have been allocated to display the tide condition, rising and falling. The full cycle from one high tide point to the next thus takes $47 \times 2 = 94$ positions. Each position (segment) thus represents $44714.166 / 94 = 475.683$ seconds (just under eight minutes). To simplify the calculations, this has been taken as the integer value of 476, representing a theoretical accuracy of 0.0666%

(bare in mind that in nature the tides vary by far greater amounts than this).

However, the program also takes into account the timing between the high tide points as well as individual segments, resetting the tide segment counter in synchronisation with the high tide period counter, so effectively doubling the theoretical accuracy to about 0.032%.

At fully low tide, the tide display area of the screen is blank. At the first tide segment increment, a single pixel is activated at the middle of the allocated tide area on the lowest line, the apex of the forthcoming triangle. At the next step, the first pixel moves up one line, and the second line displays three pixels, followed by five pixels at the next step. The triangle continues to expand upwards by one pixel, and outwards by two pixels. The maximum base width of the triangle is 64 pixels. Once this has been reached, the upper triangle continues to rise to its maximum of 47 pixels, but the base width remains at 64, so a rectangle begins to form in the lower part.

At the moment that the tide triangle peaks at the top of the screen (high tide), the current time in hours and minutes is displayed at the bottom right of the triangle, and then remains unchanged until the next high tide point, approximately 12 and a half hours later.



Example display for a rising tide, with a fairly new-ish Moon.

Once the triangle has peaked at the top, its apex becomes progressively flattened as the tide falls, a condition which continues right down to the lowest display line, which then disappears until the tide starts to rise again, as described.

It is stressed that the tide displays on the screen should never be used for any situation which might endanger life. If you really need to know the predicted tide times for a particular location, consult the Coast Guard (many seaside resorts also have tide charts on view at seafront information centres).

The tide displays on this clock are purely for general interest, indicating, for instance, whether a morning or afternoon trip to the coast might suit you better.

Keyboard Control

The Moon-Tide clock has been designed solely for external adjustment via a PS/2 keyboard. No switches have been provided, nor has the software been written to make use of them. It is emphasised that the keyboard *must* be a PS/2 type. This is the type used with most modern PCs. They can also be bought inexpensively from a PC retailer.

The principle of interfacing a PIC to PS/2 keyboard and PS/2 mouse was described in the author's article referred to earlier. A practical example of interfacing a PS/2 mouse to a PIC was described in his *AlphaMouse Game* of September '04. The Moon-Tide clock is the follow-up design to show a practical circuit controlled by a PS/2 keyboard.

In essence, a keyboard can be interfaced to any two PIC input/output pins. The pins are buffered by two resistors of about $1k\Omega$ and biased normally high via two other resistors, of about $10k\Omega$. The keyboard has two bidirectional lines, DATA and CLK (clock), which are connected to the allocated PIC pins via the buffering resistors. Power to the keyboard is supplied by the PIC unit's 5V power supply.

Data is exchanged serially between the keyboard and PIC, and the keyboard's CLK line synchronises its transfer. The PIC itself does not generate any clock signals, it simply reads the status of the CLK line and responds accordingly, inputting or outputting serial data from/to the DATA line. In many applications, including this Moon-Tide clock, the PIC is simply required to input keyboard data.

Keyboard data is coded in a complex manner and requires a lookup table to

allocate those codes to their respective keyboard notations and ASCII equivalent values. To the untrained observer, the relationship might seem bizarre! It is, though, the method that has been widely adopted, and is known as the Scan Table 2 code.

In the Moon-Tide clock the various correction functions have been allocated specific keyboard keys. On receipt of the codes for those keys, the lookup table routes the program to the required routine. The function modes are listed and discussed later.

While running, the program reads the status of the two keyboard connection lines. These are normally both held high by the biasing resistors (allowing the keyboard to be disconnected when finished with). If either line goes low, the software assumes the keyboard wishes to send data and immediately enters the keyboard data receive routine. On receipt of the keyboard scan code data, the lookup table is called and the appropriate correction routine is entered.

Keyboard data is continuously looked for and processed accordingly. Any time the ENTER key is pressed, the program stores the new correction values to the PIC's non-volatile EEPROM (electrically erasable read-only memory). Even while processing keyboard data, the PIC's clock and calendar (etc) routines continue to be updated as usual.

Clock Counting

The PIC's TMR0 timer is set to rollover 50 times a second. Effectively (see later), at each fiftieth rollover a seconds counter is incremented, and if it has reached 60 (one minute), it is reset to zero. A ripple effect now ensues, in which the values for the minutes, hours, days, weekday, month and year are incremented as appropriate to the value of the preceding counter.

The months counter when incremented uses a table to set the number of days for that month for the sake of the days counter's maximum limit. While doing so, the years value is checked to see if a leap year is current and, if the month is February, sets the days limit to either 28 or 29 as necessary.

When the seconds counter is incremented, the tide and Moon counters are decremented, and when either has reached zero, it is reset to its starting value and the corresponding tide or Moon phase display is updated.

While the main program is waiting for the TMR0 timer to

rollover, it constantly reads the status of the keyboard lines and immediately responds to any change, so that there is an immediate response to any keyboard press.

The action of plugging in or disconnecting the keyboard does not interfere with the program timing routines.

Further keyboard matters will be discussed after the Moon-Tide circuit diagram and its printed circuit board assembly have been described.

Circuit Description

The complete circuit diagram for the Moon-Tide Clock Calendar is shown in Fig.2. It is worth noting that it is almost identical to that for the author's *PIC World Clock* referred to earlier. The only differences are that four extra resistors (R2 to R5) have been added to suit the keyboard input, and that the four previous switches have been dropped. Indeed, the author's prototype Moon-Tide clock was actually proved on the *World Clock's* printed circuit board, hard-wiring the extra resistors to it, and ignoring the switches.

A PIC16F877 microcontroller (IC1) is the active heart of the circuit. It is run at 3.2768MHz, as set by crystal X1 in conjunction with capacitors C1 and C2. Keyboard input is via socket SK2, with the DATA line connected to PIC pin RA0 via buffering resistor R4, and the CLK line connected via R5 to pin RA1. Resistors R2 and R3, provide the required pull-up bias.

The GLCD display module (X2) is controlled by PIC ports C and D. The pin use order is identical not only to the *World Clock*, but also to the original demo circuit employed when the use of GLCDs was described in the author's *Using Graphics L.C.D.s* of Feb '01.

The GLCD requires a negative voltage as well as a positive supply. This is generated by the voltage inverter IC3, which outputs a negative voltage of approximately $-5V$ when powered at $+5V$. Capacitor C7 smooths IC3's output, and preset VR1 then sets the current flow between IC3 and the GLCD's contrast setting pin, CX, so allowing the screen display intensity to be adjusted.

Provision has been made for the circuit to be jointly powered by an internal 9V PP3 battery (B1) and an external 9V to 12V d.c. mains adaptor connected via socket SK1. Normally, the circuit would receive its main power from the adaptor, with the battery supplying power in the event of a



Example display of a falling tide, with a nearly full Moon.

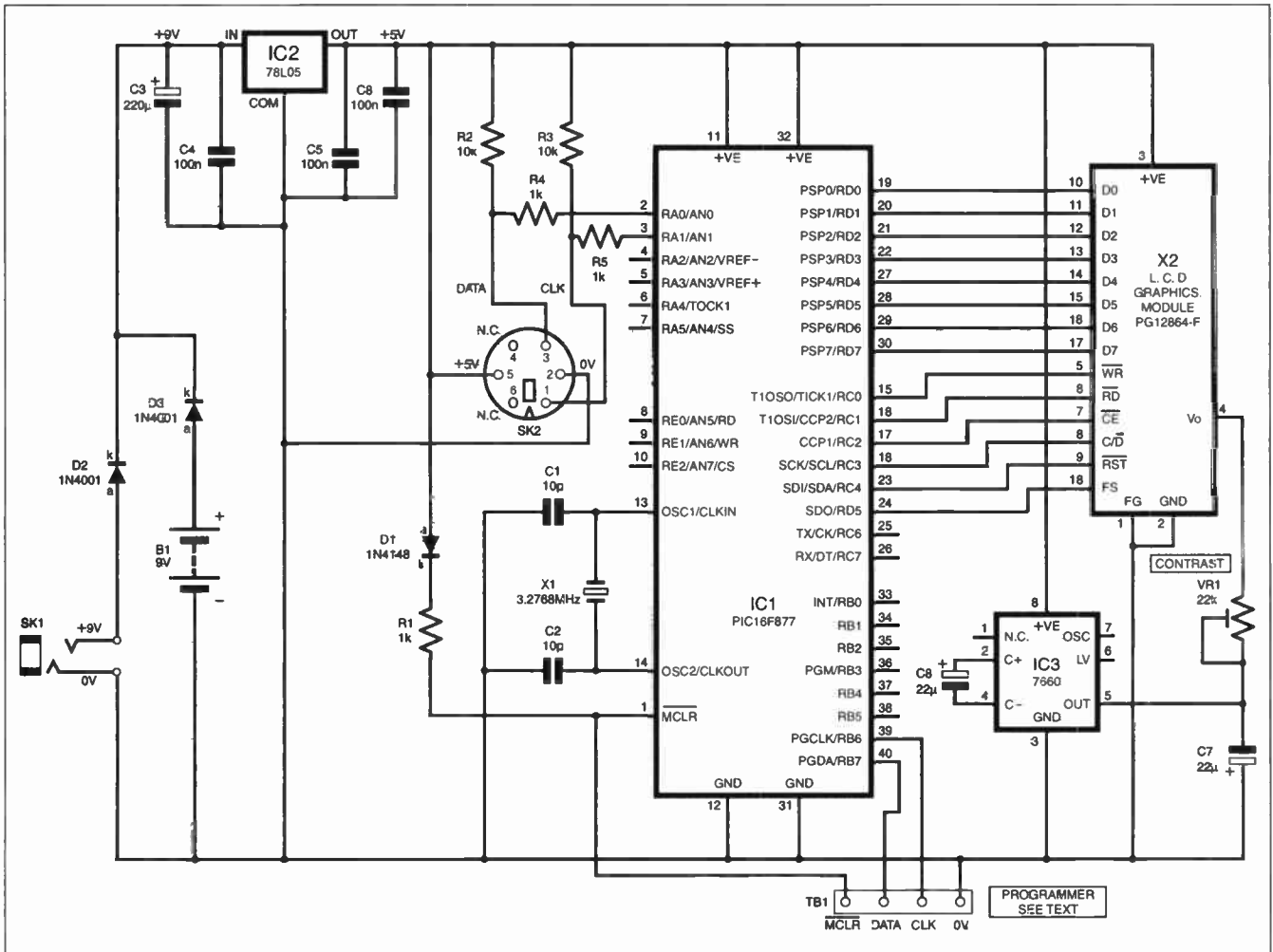

Fig.2. Complete circuit diagram for the Moon and Tide Clock Calendar.

mains power failure. Diodes D2 and D3 ensure that neither power source feeds into the other. Capacitors C3 and C4 smooth the input power supply.

Regulator IC2 reduces the input supply to +5V, to suit IC1, IC3 and the GLCD. Capacitors C5 and C8 help to stabilise the 5V supply lines. Power consumption is around 22mA. The keyboard when connected is also powered at 5V from the regulated supply, typically taking about another 80mA.

Following the publication of the *World Clock*, a few readers questioned why a lower power regulator had not been used in preference to the 78L05 regulator in that design. They also wondered why the GLCD and inverter IC3 could not be switched off when the display was not required for viewing. In principle, both actions would help to conserve battery power if the clock was in transit.

The answer is that the GLCD cannot be powered-down without it subsequently needing to be put through its initialisation routine, the length of which could disrupt the accuracy of the PIC's clock timing routines. It is acknowledged, of course, that another chip (PIC or dedicated real-time clock timer) could allow this option without timing disruption, but this option was/has not been taken.

If anyone were to consider redesigning the *World* or *Moon-Tide* clocks, there are several real-time clock chips that could be considered and the software amended to suit them, and provide the standby power-down option.

Because of the GLCD high power consumption, the use of a lower power regulator was not felt to be significantly beneficial. It should also be noted that a 7805 1A regulator has been used in this design in order to provide sufficient current to power the keyboard when connected.

As usual, the author has provided a programming connector (TB1) for those who wish to modify the software to suit their own needs using his *Toolkit TK3* programmer. Components D1 and R1 protect the power line against adverse voltages during programming. They should be

COMPONENTS		Approx. Cost Guidance Only	£58
Resistors	R1, R4, R5 1k (3 off) R2, R3 10k (2 off)	See SHOP TALK page	IC3 7660 d.c.-to-d.c. voltage converter
Potentiometer	VR1 22k min. round preset		Miscellaneous
Capacitors	C1, C2 10p ceramic disc, 5mm pitch (2 off) C3 220µradial elect. 16V C4, C5, C8 100n ceramic disc, 5mm pitch (3 off) C6, C7 22µ radial elect. 16V		SK1 power socket for 9V battery adaptor, p.c.b. mounting SK2 6-pin mini-DIN socket, panel mounting X1 3.2768MHz crystal X2 PG12864-F (or similar) graphics l.c.d. module, T6963-based)
Semiconductors	D1 1N4148 signal diode D2, D3 1N4001 rectifier diode (2 off) IC1 PIC16F877 microcontroller, pre-programmed (see text) IC2 7805 5V 1A voltage regulator		Printed circuit board, available from the <i>EPE PCB Service</i> , code 467; 8-pin d.i.l. socket; 40-pin d.i.l. socket; PP3 battery holder, p.c.b. mounting; 9V battery; 9V battery adaptor, mains powered; plastic case, 190mm x 110mm x 60mm (see text); PS/2 keyboard (see text); 18-way ribbon cable or pin-header connector pair, p.c.b. mounting; mounting bolts to suit; 1mm terminal pins; solder, etc.

retained even if re-programming is not contemplated.

Construction

The Moon-Tide clock is assembled on a single-sided printed circuit board, whose component layout and tracking details are shown in Fig.3. This board is available from the *EPE PCB Service*, code 467.

Assemble in the usual order of component size, starting with the few link wires, noting that some go under the IC1 and IC3 socket positions. Leave the battery holder until last. Correctly observe the orientation of the polarity sensitive components as indicated. Do not insert IC1, IC3 or connect the GLCD until the correctness of the 5V regulated supply has been proved. Use 1mm terminal pins for all off-board connections.

Thoroughly check the assembled board for component positioning errors and poor soldering.

Any suitably sized plastic case can be used; the prototype was housed in a simple one measuring 190mm x 110mm x 60mm. A rectangular cutout is needed in the lid to suit the mounting of the GLCD, and two holes are needed in the base to accept the sockets for the power supply and keyboard connector.

First Tests

When power is applied, the PIC software initialises various factors, including the GLCD. These factors include retrieving from the PIC's internal EEPROM the initial values relating to the clock, calendar, Moon and tide display. Having done so, the main screen is formatted. All factors at this time are those last set by the author within the source code (ASM file).

The bottom two text lines show the clock and calendar data, the Moon display shows the first segment of a new Moon, the tide is shown initially rising fast from zero to nearly full (just for display interest), and is then set to a half-way rise position. The clock is now in full running mode. You will probably need to adjust the GLCD's screen contrast setting preset, VR1, for the display to be visible.

Connect a PS/2 keyboard, whose l.e.d.s will flash the moment that connection is made and the keyboard's own circuitry receives power. Clock, Calendar and Moon/Tide displays can now be set for the current time and date.

The first keyboard key worth using is the question mark key ("?"). Repeatedly pressing and releasing this causes the full cycle of correction mode headings to be shown at the right of GLCD text line 7 (out of eight).

In addition to the mode heading itself, the symbol of the key that individually calls up that mode is displayed to its right. These are the mode headings displayed:

Mode	Key	Function
TIDE	T	Tide height adjust
MOON	#	Moon phase adjust
HOURS	H	Hours adjust
MINS	M	Minutes adjust
SECS	S	Seconds adjust
DAYS	D	Days of month adjust
MONTH	L	Month (Lunar) name/number adjust
YEAR	Y	Year adjust
W-DAY	W	Weekday adjust

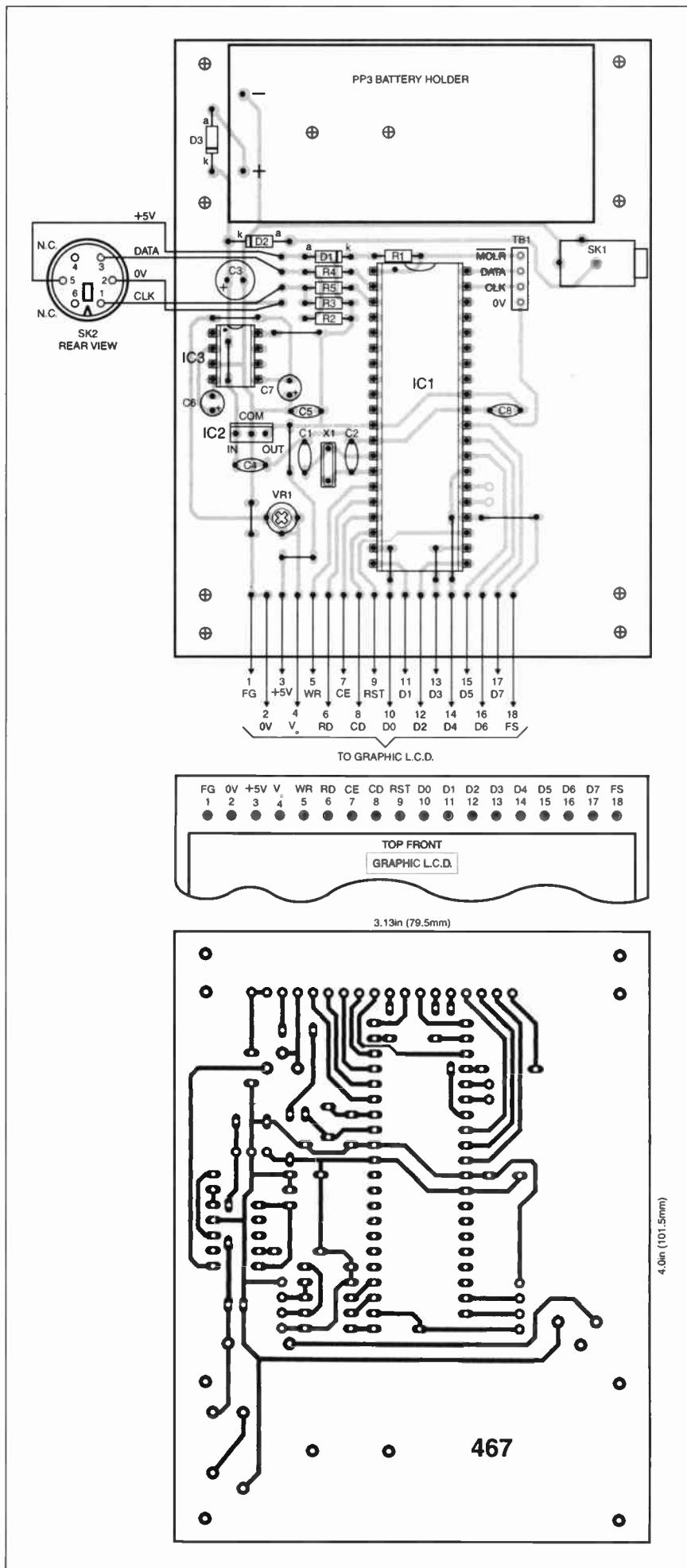
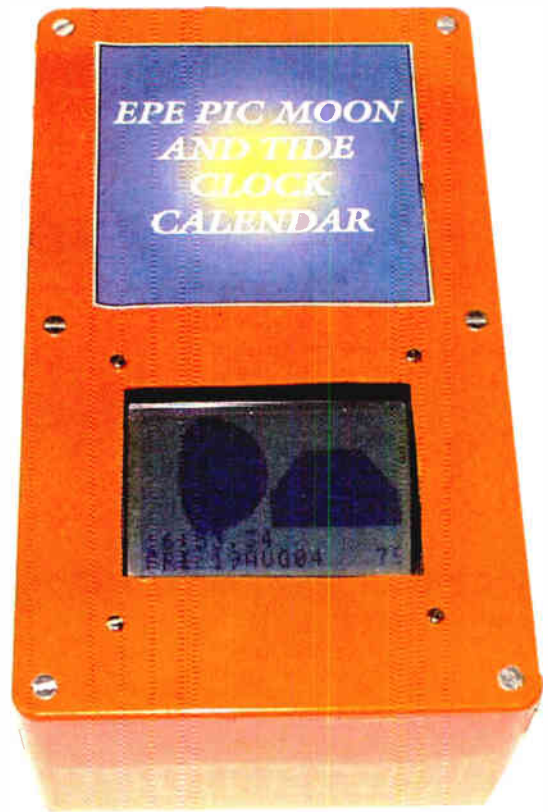
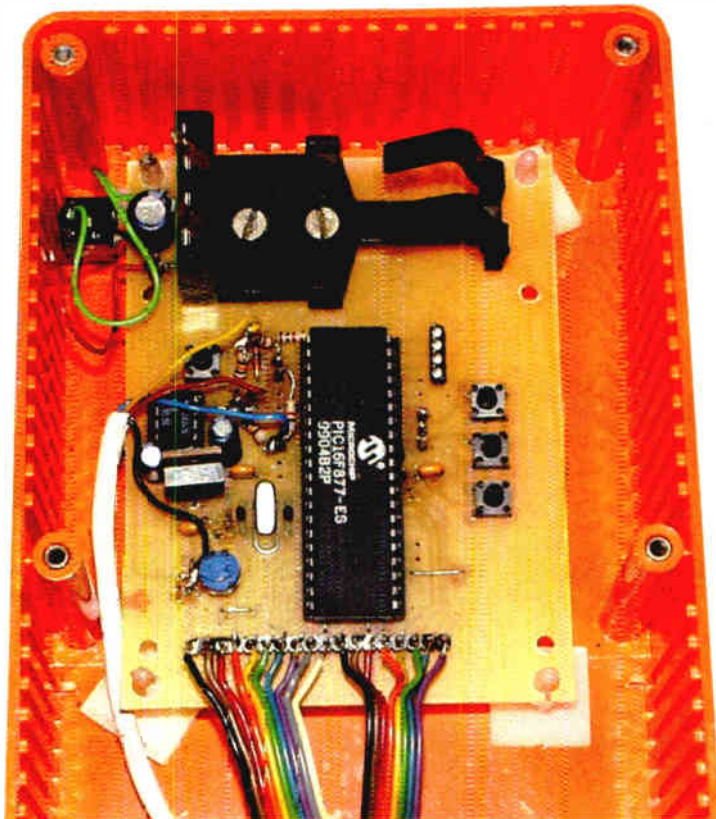

Fig.3. Component layout and master track pattern for the Moon and Tide Clock Calendar.



The modified World Clock p.c.b. used by the author when developing the Moon and Tide Clock Calendar. It differs slightly from the published p.c.b. shown in Fig.3.

T-ADJ	%	Clock timing accuracy adjust
C-ADJ	C	(C for sea!) tide timing accuracy adjust
M-ADJ	O	(O for orbit) Moon timing accuracy adjust

There are also five other functions whose key notations are not displayed:

+	Increment value of selected function
-	Decrement value of selected function
Z	Reset seconds to zero
B	Bird novelty display on/off (see later!)
ENTER	Store new values to PIC's EEPROM registers

It will be seen from the above that the modes are mainly called by their initial letter keys. Because some modes have the same initial letter, though, other keys have been allocated to access them.

When any heading is shown, the values associated with that correction option can be adjusted up or down by using the plus (+) and minus (-) keys.

When changing values using the + and - keys, note that there is a built-in restriction which keeps the rate of change to a maximum of two per second. Whilst either key can be held down to repeat the change of value, this option should be treated cautiously as it has been found that on rare occasions the keyboard's own repetition rate has exceeded the ability of the PIC's half-second data reading to maintain synchronisation, and brief "lock-up" has occurred.

The reason is not known, but the PIC's restriction has to be maintained in order to keep the change rate at a reasonable speed

that can be readily seen and reacted upon by the user.

Setting Values

It is recommended that the values are set in the following order:

YEAR (Y): The year value can be cycled through 100 years, from 0 to 99. The century prefix of "20" is not used or displayed. The year should be set first since a check is made for each value to determine whether or not it is a leap year, which affects the maximum number of days permitted when the month is February (28 or 29). When the year count reaches 99, the next increment via the "+" key causes the year number to roll over to zero; when it is at zero, the next decrement via the "-" key causes a rollover to 99.

MONTH (M): The month can be incremented or decremented and is indicated by the first three letters of its name, from JAN to DEC, with the selection of February being noted in relation to a leap year. Rollovers are from DEC to JAN, and from JAN to DEC.

DAYS (D): The day of the month can be changed up or down. The maximum upper limit is that appropriate to the month. At the upper limit, the upwards rollover is to a value of 1. Downwards rollover from a value of 1 is to the maximum number of days for that month. As said, February's maximum count is leap year dependent.

WEEKDAY (W): Weekdays are shown by the first three letters of their name, with appropriate rollovers on a continuous 7-step cycle.

HOURS (H): Hours are on a 24-hour basis, rollovers 23 to 0, and 0 to 23.

MINUTES (M): Minutes rollovers are from 59 to 0 and 0 to 59.

SECONDS (S): Seconds rollovers are also 59 to 0 and 0 to 59.

MOON (#): The Moon phase can be changed forwards or backwards. The progression is slower than with the clock/calendar changes as the software has to plot 180 points on the screen for each change of value. There are 256 steps to the complete phase cycle.

TIDE (T): Tide height can be changed up or down and there are two program routines for it. One is for when the tide state is being progressed forwards in time, the other for when it is being receded backwards in time. This is because of the different way in which the display is shown with regard to the upper section of the tide triangle.

As said previously, when the tide is rising, the triangle peak rises up the screen; when the tide is falling, the peak is progressively flattened. The rate of change in response to the + and - keys is also slower than with clock/calendar changes, again because of the number of software steps required.

At the bottom right of the screen is shown a number relative to the tide position. When the tide rises from nil to full, the number progressively decrements from 47 to 0, and a rollover to 93 (one less than 94 because zero is also a used value), at which point the tide is considered to be falling. The countdown is then from 93 to 48, the lowest point of tide-fall, and at 47 the tide starts to rise again, back to zero count.

It should be appreciated that the + and - keys do not directly indicate the raising or lowering of the tide display's upper lines. Rather, they should be regarded as tide *time travel forwards* (+), or tide *time travel backwards* (-)! It will become apparent when you use this mode.

ZERO SECONDS (Z): Seconds can be reset to zero simply by pressing key Z.

Timing Adjustments

As for any clock (unless triggered by the frequency of the mains power supply) adjustment to the actual rate at which the seconds are incremented has to be adjusted for accuracy. Even though this design is crystal controlled, the true rate at which the crystal oscillates can vary between individual units. For most applications these minor tolerance differences do not matter. But for a real-time clock they can become significant over time.

A similar technique to that used in some of the author's previous designs has been included with this Moon-Tide clock. As mentioned previously, the PIC's TMR0 timer has been set for a rollover every fiftieth of a second. An initial counter counts these rollovers in batches of 25, i.e. it counts half-seconds.

At each half second, a 24-bit value is added to another counter. The uncorrected value is hexadecimal number H'80 00 00' (three bytes). When H'80' (decimal 128) is added to H'80' the result is 256. With an 8-bit byte, this results in the counting byte being reset to zero, and a "Carry" flag is set. In this clock, at each addition of the three basic bytes, the Carry flag is read and if it is set, the clock's seconds counter is incremented. If this rolls over from 59 seconds to 0, a chain reaction takes place, with subsequent clock/calendar values being incremented as appropriate.

It will be seen that if the value added is increased from H'80 00 00' to H'80 00 01', the rate at which the seconds are incremented is now speeded up slightly. On the other hand, if the additive value is decreased by one unit to H'7F FF FF' the seconds rate of increment is slightly slowed.

The value of H'80 00 00' is decimal 8388608. It can be changed upwards to 16777216, or decreased to just 1 (zero is not allowed, because there would then be no change following addition). The effect of this range of possible additive values is that the accuracy of the clock timing can be very finely changed, by as little as 100/8388608% (0.0000119%).

When clock timing accuracy adjustment is called using the "%" key (mode display T-ADJ %), at the right of the bottom line is displayed the difference between H'80 00 00' and the value actually set. Without correction, a value of 0 will be shown. Using the + and - keys, this correction can be changed up or down in steps of one unit, with a + or - symbol alongside.

In the first few days or weeks of putting the Moon-Tide clock into service, do not change the correction value. Instead, having set the clock/calendar values to a known time, periodically check the GLCD time display against the current true time. In due course, calculations can be made on the difference between the two values, and the correction counter set accordingly.

Moon Rate Adjustment

The rate at which the Moon-Tide clock triggers the Moon counter is dependent upon the main clock timing routine's accuracy just discussed. However, the rate at

which the Moon counters change in response to the main timer can also be changed.

When "M-ADJ O" is selected using key "O", the right of the bottom screen line shows the number of seconds between each Moon phase segment (9967 unless previously changed). Should you ever find that you wish to alter the Moon's rate of change, you can increase or decrease the seconds base value to whatever value you deem necessary.

Tide Rate Adjustment

As with the Moon rate, the tide rate can also be adjusted if you ever wish to. When "C-ADJ C" is selected using key "C", the value of 44714 seconds (or the previously changed value) is displayed at the bottom right of the last line. The value may be changed to whatever you prefer.

Storing Values

When the ENTER key is pressed, all current settings are stored to the PIC's EEPROM registers, where they remain even if power is disconnected. In the unlikely event that power is lost (your battery backup should keep the clock running correctly for quite some time if mains power is lost), when power is re-applied, the stored values are retrieved from the EEPROM and become the current values. While you will have to plug in the keyboard and change the clock values, the others will likely be still relevant.

What is particularly important is that you will not have lost the correction factors for the clock, tide and Moon timings.

Novelty Ducking!

Just as a gimmick (and to entertain himself) the author decided to add a silly picture to the tide display at high tide – a bird (duck or seagull?) taking advantage of the high water. It's a descendent of the swimming bird shown in Demo 8 of the *Using Graphics L.C.D.s* article referred to earlier. It's something that might entertain kids (as well as the author!).

At the moment of high tide, this image is superimposed on the tide display area. As the tide then falls, the bird is gradually erased until it is totally gone at low water ("Mummy – help – Quacky's drowning!" Oh dear – ah well . . .). But it reappears at the next high tide!

There is, though, the option to "exterminate" the bird so that it does not appear. Simply press keyboard letter B (for bird) and the flag which activates the display at high tide is toggled between on and off for each pressing. If the bird is "active", the letter B is shown immediately prior to the time of the last high tide, on line 7.

Final Ebb

Predicted tide times for your favourite coastal area are usually posted on public notice boards along the promenade at the nearest resort. Yearly tide tables for selected regions are available from local newspaper shops in that locality. National daily newspapers frequently publish information in respect of tide times at London Bridge, along with "tidal constant" differences between there and selected coastal towns. Any of these sources will help you to set the tide factor for the UK region of your choice.

Valuable UK tide information can also be obtained from the Proudman Oceanic Laboratory (POL) via www.pol.ac.uk. POL is the UK's official tide prediction organisation.

Additionally, there is an excellent web site which has downloadable tide data software for thousands of locations worldwide, and which includes graphical displays of real-time tide predictions. Browse www.geocities.com/SiliconValley.Horizon/1195/wxtide32.html.

Moon phase data is obtainable from all the above sources, with the possible exception of POL.

Old Moore's Almanac is also a useful source for UK tide and Moon state predictions throughout the year.

Finally, do note the use of the word *prediction* in the above. Precise statements about forthcoming tide states can never be given. The actual states depend on many natural phenomena, including weather conditions, the erosion of the coasts, and the silting of river estuaries.

All any tide predictor can ever be is a *guide* to likely conditions. Fortunately, Moon phase prediction is likely to be far more reliable, at least in terms of conditions over the next several thousand millennia!

Resources

Software, including source code files, for the PIC Moon-Tide clock is available on 3.5-inch disk from the Editorial office (a small handling charge applies – see the *EPE PCB Service* page). It can also be downloaded *free* from the *EPE* Downloads page, accessible via the home page at www.epemag.wimborne.co.uk. It is held in the PICs folder, under PIC MoonTide. Download all the files within that folder.

This month's *ShopTalk* provides information about obtaining pre-programmed PICs, and the sourcing of components.

The PIC program source code (ASM) was written using *Toolkit TK3* software (also available via the Downloads page) and a variant of the TASM dialect. It may be translated to MPASM via *TK3* if preferred.

The run-time assembly is supplied as an MPASM HEX file, which has configurations embedded in it (XT oscillator, WDT off, POR on, all other values off). If you wish to program the PIC yourself, simply load this HEX file into the PIC using your own PIC programming software and hardware. □



Showing the optional novelty "duck" that can be set to appear at high tide!

PHONES THEY ARE A'CHANGING – AGAIN!

The old “dog n’ bone” is undergoing a 21st century makeover, as Barry Fox reports

THIS is the first time Alexander Graham Bell would look at a phone system and ask “what have you done to my idea? – I don’t recognise it”, admits Matt Beal, the man now responsible for making BT’s phone system unrecognisable to the inventor of the telephone.

After 18 months of secret planning, BT is spending £10 billion over five years on becoming the first telecoms giant in the world to convert a traditional PSTN (public switched telephone network) to an IP (Internet Protocol) network. Instead of switching direct voice connections between users, the new 21st Century Network will carry speech end-to-end as packets of Internet data.

To make it more reliable, the 21CN will be quite separate from the Internet.

Market analyst Gartner Dataquest spots this as a “major lift” for Marconi, because the once-beleaguered company has been chosen to supply equipment.

BT says the sea change will improve the quality of service for those people who install new equipment, and cause no problems for people who want to stick with what they have got.

Emergency Problem?

But BT admits there is one key problem still unsolved – how to guarantee an emergency phone service if the lights go, during a power cut or after a terrorist attack.

21CN trials start in Cambridge and London this October, with full UK changeover beginning in 2006 and finished by 2009. Extending the change worldwide will be easy because BT’s Global network already uses IP to let large organisations share data through 126 countries in Europe, the Americas, Far East and Australasia.

Anyone with an Internet PC can already use it with a microphone or modified phone to make free voice calls to anyone else with a similar system (*New Scientist* 11 Oct '03, p 24). Speech is sent as packets of data, like instant email messages. Enterprising third parties, such as Comcast or Vonage in the US, charge a few cents a minute to connect IP calls to existing PSTN networks and phones. It is not even necessary to use a PC to make IP calls; a standalone Internet Access Device plugs by Ethernet network cable between a broadband modem and an ordinary telephone handset.

Money Talks

The incumbent telecoms giants have still been making money, because people were paying them by the minute to connect to the

Internet. But all-you-can-eat broadband services, charged by the month at a flat fee, is cutting the telecoms operators out of the VOIP revenue stream. It also puts an ever-heavier burden on the Internet. Voice over IP calls can sound disjointed and distorted as packets of data are delayed and lost by congestion.

“The holistic change from PSTN to IP is now inevitable. So let’s attack it and make it happen. All the other majors, like France Telecom and Deutsche Telecom are sitting on the touchlines. But once BT does it, the rest of the world will follow”, says Matt Beal, who came to BT as Director, 21CN implementation and strategy, “bleeding” from the experience of running a small VOIP start-up company in the US, called NexBell.

By using its own IP network, and not relying on the Internet, BT hopes to sell the promise of a more reliable and cheaper voice service, along with broadband access, video on demand, FM quality radio, automatic re-direction of speech calls and data to mobiles – all down a single pipe into the home or office. Voice messages left on a network store can be listened to by phone, sent as sound files to an email address, or converted by speech recognition software into a text message in the same or different language.

The IP pipe can be existing copper wire, as used for ADSL, or fibre, or a Wi-fi 802.11 radio link, or even a 3G phone. New phones, looking and behaving like existing phones, will have computer and modem chips inside to decode IP data into analogue speech.

Surround Sound Phones?

Because 21CN is independent of the Internet, it can use the new IP Version 6, which allows more user addresses and gives speech priority over other data. Initially all BT’s VOIP calls will get the same 64Kbps data rate used for today’s digital PSTN calls. Higher data rates will upgrade mono to stereo or even surround sound, with FM radio quality.

Who could possibly want surround sound for a phone call? A conference call makes a lot more sense when speech from different callers comes from different parts of the room.

If people do not want to be part of the brave new IP world, the local exchange can convert IP to analogue and send it down existing copper wires, to ordinary phones.

If an IP network subscriber wants to call a phone in a country which is still in the PSTN age, the call is converted into PSTN format by gateways at the edge of the IP network.

Power-Loss Emergencies

But what happens when mains power is lost? Conventional phones are powered by a 50V low current supply fed down the copper wire. So they work in a power cut.

Glass fibres cannot carry power, so need copper wires wrapped round them. But VOIP phones and PCs will often need more current than the current PSTN system delivers. Wireless links need power for reception as well as IP decoding, so will fail completely in a power cut.

BT is now researching the use of rechargeable batteries, to go in all consumer IP hardware. The batteries are continually topped up from the mains. But rechargeable batteries degrade; after a year or so they hold less charge. People cannot be relied on to replace them.

“We are confronting the issue and are confident we can solve it”, says Matt Beal. But BT is not yet sure how.

Telecoms regulator OFCOM is blunt. “It is an absolutely essential legal obligation that anyone using a telephone phone service must be able to access lifeline services like 999, 112, the operator or directory enquiries” says Matt Peacock, OFCOM’s Director of Communications. “We don’t care how they solve the problem but they have to do it to stay within the law. This is not a grey area. It is not negotiable”.

FLIPPER DISC

The music industry now has the green light for a new kind of hybrid disc, nicknamed the “flipper”, that plays like a music or data CD from one side and a video or data DVD from the other.

At a meeting in Seattle recently the DVD Forum formally approved the idea of bonding a thinner-than-usual CD, back to back with a thinner-than-usual DVD. The complete sandwich is still thicker than ordinary CDs or DVDs, though, and may jam in some players. The laser optics in the player may not be able to focus accurately.

The Forum is still trying to decide whether the new discs can carry the familiar DVD logo. Philips, which controls CD licensing, has already decided.

Says Philips: “A CD of about 0.9mm thickness does not comply with the CD specification. So the CD logo cannot be used. We strongly advise the (record) labels and disc manufacturers to apply a clear warning on the package that informs consumers of possible playback problems.”

METER POWER

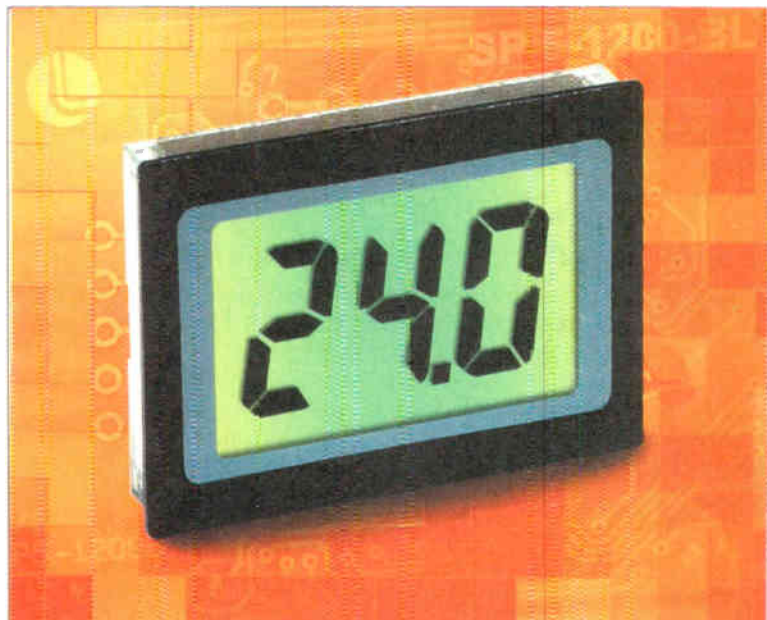

Lascar Electronics has recently launched a meter module that can measure any voltage from 4V to 25V d.c. with no extra supply needed. As the meter is signal powered, most applications can be measured using only two connections to the easy-to-use terminal blocks located on the rear of the module.

Housed in an attractive slimline design, the meter also has a vivid l.e.d. backlight that can be powered from an external 5V source. The l.c.d. features an 18mm digit height. The basic price is £24.95 + VAT, with discounts available for volume orders. The SP5 1200-BL is IP67 rated and splashproof.

For more information contact Lascar Electronics Ltd, Dept. EPE, Module House, Whiteparish, Salisbury, Wilts SP5 2SJ. Tel: 01794 884567. Fax: 01794 884616. Web: www.lascar.co.uk.

FAST COMPONENTS

FAST Components Ltd is a new component supplier targeting hobbyists with its brand new range of component kits, offering "a fresh and more economic way to buy components".

"We sell brand new component kits," say co-founders Thomas Arundel and Tsuyoshi Kihara. "As former product designers we were frustrated with the time and effort it took to build up a decent stock of bench-top components. Once we started investigating a supply chain, we realised that we could sell kits of commonly required components at one-third of the price that those same components would cost separately."

Fast Components have opened their range with kits containing 1000 1% metal film resistors spread over 93 values; 240 50V ceramic capacitors spread over 24 values; 93 radial electrolytic capacitors spread over 12 values; 100 miniature polyester capacitors spread over nine values. The resistor kit retails at £9.99, and the capacitor kits at £4.99. "We plan to follow-up with more passives, SM kits, mechanical hardware and semiconductors", says Thomas.

For more information contact Fast Components Ltd, Dept EPE, Winchester House, Winchester Road, Walton-on-Thames, Surrey KT12 2RH. Tel: 0870 750 4468.

Fax: 0870 137 6005.

Email: sales@fastcomponents.co.uk.

Web: www.fastcomponents.co.uk.

PicoScope 3000 Series PC Oscilloscopes

The PicoScope 3000 series oscilloscopes are the latest offerings from the market leader in PC oscilloscopes combining high bandwidths with large record memories. Using the latest advances in low power electronics, the oscilloscopes draw their power from the USB port of any modern PC, eliminating the need for mains power.

- High performance: 10GS/s sampling rate & 200MHz bandwidth
- 1MB buffer memory
- Advanced display & trigger modes
- Compact & portable
- Supplied with PicoScope (oscilloscope/spectrum analyser) & PicoLog (data acquisition) software.

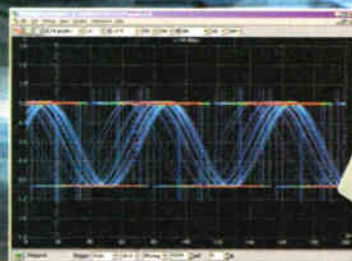

PicoScope	3004	3006	3006
Bandwidth	50MHz	100MHz	200MHz
Sampling rate (repetitive)	2.5GS/s	5GS/s	10GS/s
Sampling rate (single shot)	50MS/s	100MS/s	200MS/s
Channels	2+Ext trigger	2+Ext trigger/Sig gen	2+Ext trigger/Sig gen
Oscilloscope timebases	5ns/div to 50ns/div	2ns/div to 50ns/div	1ns/div to 50ns/div
Timebase accuracy	50ppm	50ppm	50ppm
Spectrum ranges	0 to 25MHz	0 to 50MHz	0 to 100MHz
Record length	256k	512k	1MB
Resolution accuracy	8 bits / 2%		
Ranges	10mV to 2V/div		
PC Connection/Power supply	USB 2.0 / USB 1.1 compatible		

Tel: 01480 396395

www.picotech.com/scope204

pico
Technology Limited

atlas LCR

Passive Component Analyser

**Automatic Identification
and Measurement**

Inductance: 1 μ H to 10H
Capacitance: 1pF to 10,000 μ F
Resistance: 1 Ω to 2M Ω
Basic accuracy: 1%

*"Astonishingly, this little unit
seems to pack most of the punch
of a large and very expensive
automated LCR bridge
into its tiny case."*

Andy Flind - EPE Magazine

features high contrast green-mode LCD



£79

fully inclusive UK price

£60

fully inclusive UK price



enclosure colours may vary

atlas DCA

Semiconductor Analyser

**Automatic Pin-out Identification:
Just connect any way round!**

Transistor gain measurement
MOSFET gate threshold measurement
PN junction characteristics measurement
Shorted Junction identification
Transistor leakage measurement
Auto power on/off

Bipolar transistors, Darlington transistors,
Diode protected transistors, Resistor shunted transistors,
Enhancement mode MOSFETs, Depletion mode MOSFETs,
Junction FETs, Diodes and diode networks,
LEDs (+bicolours)

star pack!

£134!

LCR40 and DCA55 Pack
Why not order both analysers in the
NEW special edition carry case
and save yourself £20!!



You Save
£20!

Atlas LCR	£60
Atlas DCA	£70
Carry Case	£15
Normal Total	£145

Visit www.peakelec.co.uk to download the data sheets, user guides and copies of independent reviews. You can pay using a cheque, postal order, credit or debit card and even pay securely online. Please contact us for your volume requirements.

Also available from Farnell,
Maplin, Rapid and CPC
(prices vary)

Daddy or Chips?

With rich content and bloatware demanding ever more bandwidth – how can we cope? asks Andy Emmerson.

FOR the little girl in the TV commercial, the choice was simple – daddy or chips. As decisions go, it was a tough one but at least she had all the facts at her fingertips. The choice for people looking to cable their homes and offices is one of three alternatives, not two, in a world where the technology options are by no means clear-cut.

Glossy Home Automation

A look along the shelves of most newsagents will reveal at least two glossy monthlies devoted to the automated home, a key element of which is some kind of fancy network systems for audiovisual entertainment, PC networking, Internet access and general domestic automation of heating, lighting and alarms.

The appeal is largely “aspirational” and for many readers the notion of fully-equipped homes is little more than a distant dream, but there’s enough trade in these systems to keep a number of firms in business. On a smaller scale, many computer users have already data-networked their homes using either cables or a wireless system and of course the same applies to just about every commercial business.

But where is this all leading? Are cabled solutions old hat? Is wireless the answer? Or should we be looking along the lines of optical fibre? And is the answer the same for all users?

One Size Fits All?

Much as everyone might like, where networking’s concerned, the universal solution doesn’t exist. The separate technologies of copper cable, optical fibre and wireless networking exist in their own right for a mighty good reason, simply because each solution has its own merits and applications where neither of the others would be as appropriate. Each also has its limitations.

Let’s take wireless first. It’s sexy and has considerable appeal to anyone looking for an easy, quick-fix solution. There’s no drilling through walls and if you move, you just unplug the wireless kit and go. It’s great for home users and even better for commercial users, eliminating the spaghetti junction of under-desk cabling, making offices tidier and avoiding the cost and time overheads that moves and changes bring.

Equipping two or three PCs at home for wireless networking won’t break the bank for most people, but Wi-Fi systems are not cheap to install on a commercial scale. Industrial-quality kit is not cheap and to achieve rock-solid wireless coverage additional apparatus is often needed to eliminate “black hole” reception areas.

What’s more, wireless LANs lag behind copper and fibre in terms of data rate capacity and there are no signs of this changing. Many users find difficulty in managing the security aspects of WLANs too, making them a decidedly risky option.

Fibre is Good For You

This is true, although few nutritionists would advocate an all-fibre diet. The same applies to networking and most observers consider a system using optical fibre cabling technically elegant but otherwise unwieldy. For home users optical cable is hardly a practical proposition; the connections require skills that only trained installers possess. In the office environment an all-optical system, with fibre cable installed from the server all the way to the desk or workstation could make economic sense if not for the cost of the adapter equipment that interfaces user devices to the fibre.

Most active equipment (switches and servers) ship currently with copper interfaces, as does nearly all desktop equipment. The cost of fitting fibre adaptors to all this equipment would wipe out any operational benefits.

This is not to say that fibre has no place at all in the commercial networking environment and fibre is definitely the appropriate solution for the “backbone” links between floors of a building and from one building to another on larger sites. In other applications copper still dominates the world market for voice and data cabling and all indications point to this tried and trusted technology remaining the safest strategy for most users.

Copper Bottomed

Copper has in fact been synonymous with cabling from the very beginning of electrical communication in the 1830s. Some 150 years later copper began to lose out to optical fibre and its greater bandwidth, which was fine for inter-city and intercontinental communication but hardly the tool for cabling homes or offices.

This summer copper caught up to a major extent and the launch of a copper cabling system delivering 10 Gigabit/s (Gbit/s) data transmission now means that copper is neck-and-neck with fibre for speed for local networking. Factor in the installation advantages of copper and you can see why commercial users are having to reconsider their networking strategies.

Brand-named CopperTen and made by the international company Krone, this remarkable cabling product is able to carry 10Gbit/s Ethernet signals for spans of 100 metres, adequate for any normal office or industrial application. Being a direct

replacement for the existing standard for office systems, Category 6, full backward compatibility is assured. No new installation techniques are involved, so deployment will not be delayed by the need to learn new skills.

If, like me, you were wondering just how many applications for 10Gbit/s networking exist in the real world right now, I’ll tell you the honest answer is probably none. But that’s irrelevant. Moore’s law, stating that computing power doubles every 18 months, has a powerful knock-on effect on networking. Computers are being changed every two to four years, and active network equipment replaced every four years.

You wouldn’t expect to change your plumbing this frequently, though, and nor do users want to change their cabling infrastructure, simply because of the disruption that renewal creates. In fact most organisations find the opportunity to cable a building or floor only once every seven to ten years, meaning they must seize any available opportunity to futureproof their installation. On that basis, installing data cable that’s good for 10Gbit/s makes sound economic sense, particularly when you realise that cabling costs are only a minor factor in the total cost of networking.

Wider World

So much for communication within the home or office – what about the world outside? The answer once again is horses for courses.

A decade or so ago technology guru Nicholas Negroponte set the cat among the pigeons when he claimed that wires and wireless would change place. Tasks traditionally performed by radio (such as broadcast entertainment distribution) would turn increasingly to cable, he argued, whilst a wirefree future beckoned for communication functions previously handled exclusively by wired means.

Modestly, he called this turnabout the “Negroponte Switch” and to a degree his prediction has come true. More recently he has clarified his reasoning and now he argues that both wired and wireless technologies have their place, with wireless being the ideal “transport mechanism” for short-haul communication that’s essentially personal or private.

And this of course just has to be right. There’s a huge network of copper cable installed already and the huge success of ADSL delivery of broadband shows that there’s plenty of potential left in copper. For users on the move there’s no real alternative to wireless; no other technology can satisfy customers’ growing demands for access to an increasing range of services while retaining their personal mobility.

STORE YOUR BACK ISSUES ON MINI CD-ROMS



**VOL 10
NOW AVAILABLE**

**ONLY
£14.45 each**
including VAT
and p&p

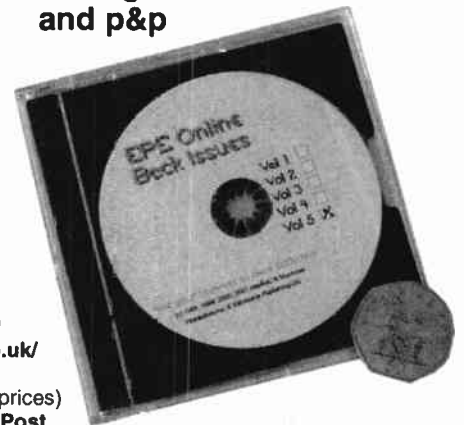

A great way to buy *EPE* Back Issues – our mini CD-ROMs contain back issues from our *EPE Online* website plus bonus articles, all the relevant PIC software and web links. Note: no free gifts are included. All this for just £14.45 each including postage and packing.

- VOL 1: BACK ISSUES** – January 1999 to June 1999
Plus bonus material from November and December 1998
- VOL 2: BACK ISSUES** – July 1999 to December 1999
- VOL 3: BACK ISSUES** – January 2000 to June 2000
- VOL 4: BACK ISSUES** – July 2000 to December 2000
- VOL 5: BACK ISSUES** – January 2001 to June 2001
- VOL 6: BACK ISSUES** – July 2001 to December 2001
- VOL 7: BACK ISSUES** – January 2002 to June 2002
- VOL 8: BACK ISSUES** – July 2002 to December 2002
- VOL 9: BACK ISSUES** – January 2003 to June 2003
- VOL 10: BACK ISSUES** – July 2003 to December 2003

Order on-line from
[www.epemag.wimborne.co.uk/
shopdoor.htm](http://www.epemag.wimborne.co.uk/shopdoor.htm)
or www.epemag.com (USA \$ prices)
or by phone, Fax, E-mail or Post

NOTE: These mini CD-ROMs are suitable for use on any PC with a CD-ROM drive. They require Adobe Acrobat Reader (available free from the Internet – www.adobe.com/acrobat)

WHAT IS INCLUDED

All volumes include the *EPE Online* editorial content of every listed issue, plus all the available **PIC Project Codes** for the PIC projects published in those issues.

Note: Some supplements etc. can be downloaded free from the Library on the *EPE Online* website at www.epemag.com. No advertisements are included in Volumes 1 and 2; from Volume 5 onwards the available relevant software for *Interface* articles is also included.

EXTRA ARTICLES – ON ALL VOLUMES

BASIC SOLDERING GUIDE – Alan Winstanley's internationally acclaimed fully illustrated guide. **UNDERSTANDING PASSIVE COMPONENTS** – Introduction to the basic principles of passive components. **HOW TO USE INTELLIGENT L.C.D.s**, by Julian Ilett – An utterly practical guide to interfacing and programming intelligent liquid crystal display modules. **PhyzyB COMPUTERS BONUS ARTICLE 1** – Signed and Unsigned Binary Numbers. By Clive "Max" Maxfield and Alvin Brown. **PhyzyB COMPUTERS BONUS ARTICLE 2** – Creating an Event Counter. By Clive "Max" Maxfield and Alvin Brown. **INTERGRAPH COMPUTER SYSTEMS 3D GRAPHICS** – A chapter from: Intergraph's book that explains computer graphics technology. **FROM RUSSIA WITH LOVE**, by Barry Fox – Russian rockets launching American Satellites. **PC ENGINES**, by Ernest Flint – The evolution of intel's microprocessors. **THE END TO ALL DISEASE**, by Aubrey Scoon – The original work of Rife. **COLLECTING AND RESTORING VINTAGE RADIOS**, by Paul Stenning. **THE LIFE & WORKS OF KONRAD ZUSE** – a brilliant pioneer in the evolution of computers. A bonus article on his life and work written by his eldest son, including many previously unpublished photographs.

Note: Some of the **EXTRA ARTICLES** require WinZip to unzip them.

BACK ISSUES MINI CD-ROM ORDER FORM

- Please send me (quantity) BACK ISSUES CD-ROM VOL 1
 - Please send me (quantity) BACK ISSUES CD-ROM VOL 2
 - Please send me (quantity) BACK ISSUES CD-ROM VOL 3
 - Please send me (quantity) BACK ISSUES CD-ROM VOL 4
 - Please send me (quantity) BACK ISSUES CD-ROM VOL 5
 - Please send me (quantity) BACK ISSUES CD-ROM VOL 6
 - Please send me (quantity) BACK ISSUES CD-ROM VOL 7
 - Please send me (quantity) BACK ISSUES CD-ROM VOL 8
 - Please send me (quantity) BACK ISSUES CD-ROM VOL 9
 - Please send me (quantity) BACK ISSUES CD-ROM VOL 10
- Price £14.45 each** – includes postage to anywhere in the world.

Name

Address

..... Post Code

I enclose cheque/P.O./bank draft to the value of £

Please charge my Visa/Mastercard/Amex/Diners Club/Switch

£

Card No.

Card Security Code (The last 3 digits on or just under the signature strip)

Valid From Expiry Date

Switch issue No.

**SEND TO: Everyday Practical Electronics,
Wimborne Publishing Ltd.,**

408 Wimborne Road East, Ferndown, Dorset BH22 9ND.

Tel: 01202 873872. Fax: 01202 874562.

E-mail: orders@epemag.wimborne.co.uk

Payments must be by card or in £ Sterling – cheque or bank draft drawn on a UK bank.

Normally supplied within seven days of receipt of order.

Send a copy of this form, or order by letter if you do not wish to cut your issue.

We can supply back issues of *EPE* by post, most issues from the past three years are available. An *EPE* index for the last five years is also available at www.epemag.wimborne.co.uk or see order form below. Alternatively, indexes are published in the December issue for that year. Where we are unable to provide a back issue a photocopy of any *one article* (or *one part* of a series) can be purchased for the same price. Issues from Nov. 98 are available on CD-ROM – see next page – and issues from the last six months are also available to download from www.epemag.com. Please make sure all components are still available before commencing any project from a back-dated issue.

DID YOU MISS THESE?

JUNE '03

PROJECTS • Fido Pedometer • PICronos L.E.D. Wall Clock-Part 1 • Back-To-Basics-5 (Mini Theremin, Twilight Switch) • Radio Circuits-1 (Crystal Set, MK484 TRF Receiver, Headphone Amplifier).
FEATURES • Ingenuity Unlimited • Techno Talk • Interface • Circuit Surgery • New Technology Update • Net Work – The Internet Page • **SPECIAL SUPPLEMENT** – EPE PIC Tutorial V2 – Part 3.

JULY '03

PROJECTS • EPE Mini Metal Detector • Low Range Ohmmeter Adaptor Mk2 • Radio Circuits-2 (Q-Multiplier, MW Reflex Radio, Speaker Amplifier) • Ultimate Egg Timer • PICronos L.E.D. Wall Clock – Part 2.
FEATURES • Ingenuity Unlimited • Circuit Surgery • Techno Talk • Practically Speaking • Flowlog Lite Review • Net Work – The Internet Page.

AUG '03

PROJECTS • EPE PIC Met Office-1 • Alarm System Fault Finder • Master/Slave Intercom • Electronic Two-Up • Radio Circuits-3 (Regenerative Receivers).
FEATURES • Digital Command Control for Model Trains • Ingenuity Unlimited • Circuit Surgery • Interface • Techno Talk • New Technology Update Net Work – The Internet Page.



SEPT '03

PROJECTS • PIC-A-Colour • Vibration Alarm • Priority Referee • EPE PIC Met Office-2 • Radio Circuits-4 (Tuning Systems).
FEATURES • Using the PIC's "High" Operator • Practically Speaking • Ingenuity Unlimited • Circuit Surgery • Net Work – The Internet Page.

OCT '03

PROJECTS • RC Car Wars • Serial Interface for PICs and VB6 • Practical Radio Circuits-5 (Super Regen. Receiver) • Spooky Bug.
FEATURES • PIC Breakpoint • Ingenuity Unlimited • Interface • Techno-Talk • New Technology Update • Net Work – The Internet Page.

NOV '03

PROJECTS • PIC Random L.E.D. Flasher • Cardboard Clock • Practical Radio Circuits-6 (S.S.B. and Direct Conversion Receiver) • Anyone At Home?
FEATURES • Teach-In 2004 – Part 1 • Ingenuity Unlimited • Practically Speaking • Techno Talk • Circuit Surgery • New Technology Update • Net Work – The Internet Page.

DEC '03

PROJECTS • PIC Nim Machine • Practical Radio Circuits-7 (Superhet Tuner) • PIC Virus Zapper Mk2 • Christmas Cheeks.
FEATURES • Teach-In 2004 – Part 2 • Electrotherapy • Circuit Surgery • Ingenuity Unlimited • Techno Talk • High-Speed Decimal To Binary For PICs • Interface • Network – The Internet.

JAN '04

PROJECTS • Car Computer • Practical Radio Circuits-8 (Dual-Conversion SW Receiver) • Bedside Nightlight • PIC Watering Timer.
FEATURES • GPS to PIC and PC Interface • Practically Speaking • Teach-In 2004 – Part 3 • Ingenuity Unlimited • Techno Talk • Circuit Surgery • New Technology Update • Net Work – The Internet Page.



FEB '04

PROJECTS • PIC LCF Meter • Sonic Ice Warning • Jazzy Necklace • PIC Tug-of-War.
FEATURES • Surface Mount Devices • Circuit Surgery • Teach-In 2004 – Part 4 • Interface • Ingenuity Unlimited • Techno Talk • Net Work – The Internet Page.

MAR '04

PROJECTS • Bat-Band Converter • Emergency Stand-by Light • MIDI Health Check • PIC Mixer for RC Planes.
FEATURES • Teach-In 2004 – Part 5 • New Scientist CD-Rom Review • Circuit Surgery • Techno Talk • Ingenuity Unlimited • Practically Speaking • Net Work – The Internet Page.

APRIL '04

PROJECTS • EPE Experimental Seismograph Logger 1 • Infra-Guard Monitor • Loft Light Alarm • PIC Moon Clock.
FEATURES • USB To PIC Interface • Ingenuity Unlimited • Teach-In 2004 Part 6 • Interface • Techno Talk • Circuit Surgery • New Technology Update • Net Work – The Internet Page • Pull-Out – Semiconductor Classification Data.

MAY '04

PROJECTS • Beat Balance Metal Detector • In-Car Laptop PSU • Low-Frequency Wien Oscillator • EPE Experimental Seismograph Logger-2.
FEATURES • Coping With Lead-Free Solder • Teach-In 2004 – Part 7 • Ingenuity Unlimited • Techno Talk • Circuit Surgery • Practically Speaking • Pic-N'-Mix • Net Work – The Internet Page.

JUNE '04

PROJECTS • PIC Quickstep • Crafty Cooling • MIDI Synchronome • Body Detector Mk2.
FEATURES • Clinical Electrotherapy • Ingenuity Unlimited • Teach-In 2004 – Part 8 • Interface • Circuit Surgery • Techno Talk • PIC-N'-Mix • Net Work – The Internet Page.

JULY '04

PROJECTS • Portable Mini Alarm • Bongo Box • Hard Drive Warbler • EPE PIC Magnetometry Logger-1.
FEATURES • Making Front Panel Overlays • Practically Speaking • Teach-In 2004 – Part 9 • Ingenuity Unlimited • Circuit Surgery • Techno Talk • PIC-N'-Mix • Net Work – The Internet Page.



AUG '04

PROJECTS • EPE Scorer • Keyring L.E.D. Torch • Simple F.M. Radio • EPE PIC Magnetometry Logger – 2.
FEATURES • PIC To PS/2 Mouse and Keyboard Interfacing • Techno Talk • Circuit Surgery • Teach-In 2004 – Part 10 • Interface • Ingenuity Unlimited • PIC-N'-Mix • Net Work – The Internet Page.

SEPT '04

PROJECTS • EPE Wart Zapper • Radio Control Failsafe • Rainbow Lighting Control • Alphamouse Game.
FEATURES • Light Emitting Diodes – Part 1 • High Speed Binary-To-Decimal For PICs • Practically Speaking • Ingenuity Unlimited • Techno-Talk • Circuit Surgery • PIC-N'-Mix • Network – The Internet Page.

BACK ISSUES ONLY £3.50 each inc. UK p&p. Overseas prices £4 each surface mail, £5.50 each airmail.

We can also supply issues from earlier years: 1999 (except Feb., May, Aug., Sept., Dec.), 2000 (except Feb., Mar., July, Oct.), 2001 (except May, Aug. to Nov.), 2002 (except June, Aug. to Nov.) Where we do not have an issue a photocopy of any *one article* or *one part* of a series can be provided at the same price.

ORDER FORM – BACK ISSUES – PHOTOCOPIES – INDEXES

- Send back issues dated
- Send photocopies of (article title and issue date)
- Send copies of last five years indexes (£3.50 for five inc. p&p – Overseas £4 surface, £5.50 airmail)

Name

Address

..... Tel:

I enclose cheque/PO/bank draft to the value of £

Please charge my Visa/Mastercard/Amex/Diners Club/Switch £ Switch Issue No.

Card No.

Valid From Card Expiry Date Card Security Code

(The last 3 digits on or just under the signature strip)

SEND TO: Everyday Practical Electronics, Wimborne Publishing Ltd., 408 Wimborne Road East, Ferndown, Dorset BH22 9ND.

Tel: 01202 873872. Fax: 01202 874562.

E-mail: orders@epemag.wimborne.co.uk On-line Shop: www.epemag.wimborne.co.uk/shopdoor.htm

Payments must be in £ sterling – cheque or bank draft drawn on a UK bank. Normally supplied within seven days of receipt of order.

Send a copy of this form, or order by letter if you do not wish to cut your issue.

MTO04



BS2-IC



BS2-SX



BS2E-IC

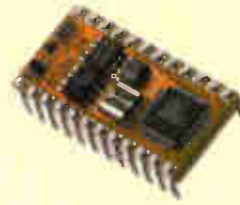

BS2P/24

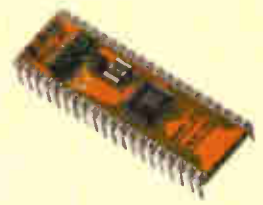

BS2P/40

Parallax BASIC Stamps - still the easy way to get your project up and running!



**Serial Alphanumeric and Graphic Displays,
Mini-Terminals and Bezel kits**

www.milinst.com



Animated Head



3-Axis Machine



Six-Legged Walkers



Robotic Arms



Bipeds

Robotic models for both the beginner and the advanced hobbyist

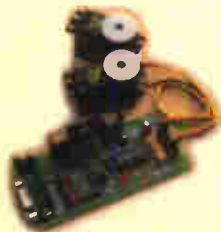

Servo Drivers

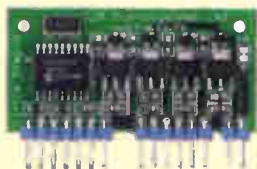

Motor Drivers



On-Screen Displays



DMX Protocol

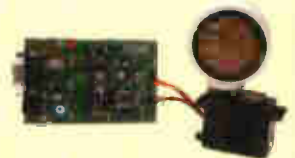

U/Sound Ranging

Animatronics and Specialist Interface-Control Modules



Quadravox
MP3 & Speech Systems



SensoryInc
Voice Recognition



Parallax
Ubicom Tool Kits



Tech-Tools
PIC & Rom Emulators



BASICMicro
PIC BASIC Compilers

Development Tools

Milford Instruments Limited Tel 01977 683665, Fax 01977 681465, sales@milinst.com

INGENUITY UNLIMITED



Our regular round-up of readers' own circuits. We pay between £10 and £50 for all material published, depending on length and technical merit. We're looking for novel applications and circuit designs, not simply mechanical, electrical or software ideas. Ideas *must be the reader's own work and must not have been published or submitted for publication elsewhere*. The circuits shown have NOT been proven by us. *Ingenuity Unlimited* is open to ALL abilities, but items for consideration in this column should be typed or word-processed, with a brief circuit description (between 100 and 500 words maximum) and full circuit diagram showing all component values. **Please draw all circuit schematics as clearly as possible.**

Send your circuit ideas to: *Ingenuity Unlimited*, Wimborne Publishing Ltd., 408 Wimborne Road East, Ferndown Dorset BH22 9ND. (We do not accept submissions for *IU* via E-mail.) Your ideas could earn you some cash and a prize!



WIN A PICO PC BASED OSCILLOSCOPE WORTH £586

- 100MS/s Dual Channel Storage Oscilloscope
- 50MHz Spectrum Analyser
- Multimeter • Frequency Meter
- Signal Generator

If you have a novel circuit idea which would be of use to other readers then a Pico Technology PC based oscilloscope could be yours. Every 12 months, Pico Technology will be awarding an ADC200-100 digital storage oscilloscope for the best *IU* submission. In addition, a DrDAQ Data Logger/Scope worth £69 will be presented to the runner up.

High-Efficiency L.E.D. Torch – Doubly Flashy

THE high forward voltage of l.e.d.s is a challenge for efficient battery use. In the circuit shown in Fig.1a, a 74HC14 inverter is used to “double” the voltage of a 6V rechargeable ex-mobile-phone battery and drive a string of three 5mm l.e.d.s. The oscillator around IC1a and IC1b generates a square wave at about 2.8kHz, and its output is buffered by IC1c and IC1d used in parallel to maximise current to the doubler.

Booster

Using a 6V supply and with 1N4148 diodes in the rectifier, which comprises D1 and D2 plus capacitors C2 to C4, results in a rectified voltage of 9.6V having a 12mA output capability for a 24mA supply current – an electrical efficiency of over 80%. Using a 6.3V battery the output voltage is 10V and the available current increases to 16mA.

If Schottky diodes are used for D1 and D2, there is an increase in voltage of 100mV, resulting in a 20% increase in available current, to 19mA (6.3V supply), at similar efficiency, and a much brighter light. Using these diodes there might be benefit in increasing the oscillator frequency substantially. This is set by the values of R1 and C1.

At night, the torch casts a pool of white light two metres wide to a range of over 6m without a reflector, perfect to walk by. Side leakage is useful but seal the l.e.d.s at the rear as back-scatter is irritating. Nearby colours are vibrant compared with the gloomy monochrome of incandescent torches.

Pulsed Light

Anecdotal evidence suggests that a subjectively brighter light is obtained by low-frequency pulsing the l.e.d.s at currents higher than their continuous rating. There are

two spare inverters, IC1e and IC1f, which can be wired as shown in Fig.1b. They provide variable-duty voltage pulses which directly drive a logic-level MOSFET and the string of three l.e.d.s, D7 to D9, via current limiting resistor R8.

With resistor R7 and potentiometer VR1 setting a total resistance of 3.9MΩ, the frequency is 15Hz at 20% duty cycle. At 3m

distance from the subject the illumination appears continuous, but closer in the flicker is very obvious, like a strobe. Negotiating confined spaces, e.g. a spiral staircase, by this light is a challenge as the walls move as you climb. The output voltage is about 10.8V with a 0.8V ripple at the pulse frequency. The output current is limited by the inefficiency of the doubler.

Increasing the frequency to 35Hz (R7 + VR1 = 1.6MΩ) results in 35Hz, producing a good light, even to read by, though some flicker can still be seen as the duty cycle is 30%. Average current consumption is 21mA at 6.3V, with an l.e.d. current about 28mA.

Right Choice

In this application, 40106 or 74HC14 CMOS chips are so markedly inferior to the 74HC14 that they are unsuitable. The published maximum voltage rating of an 74HC14 is 7.0V. The high initial voltage of a freshly charged battery may be tamed to within this limit by switching in a diode (e.g. 1N4001) until the terminal voltage has fallen somewhat.

John Crichton,
Orange 2800, Australia

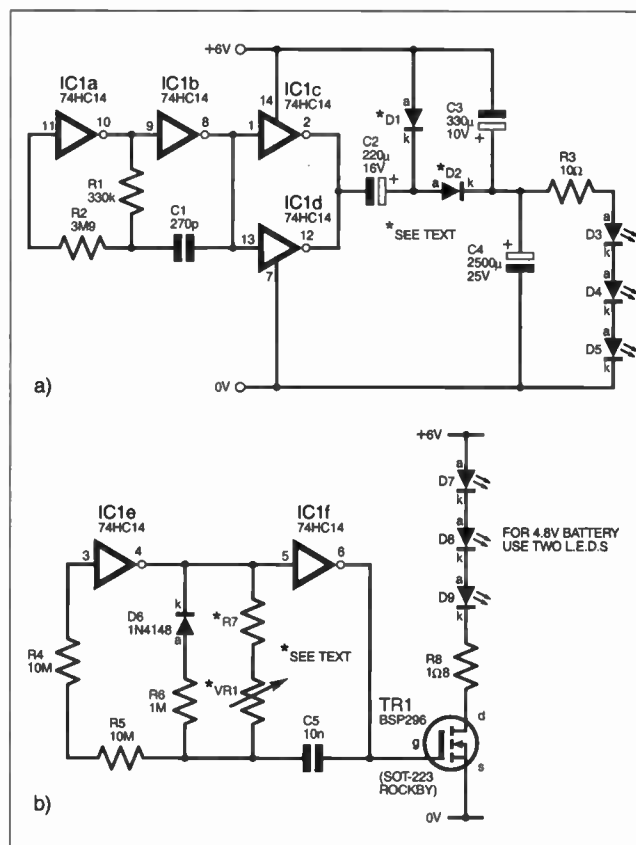

Fig.1. Circuit diagram for a High Efficiency L.E.D. Torch. a) basic circuit. b) pulsed circuit.

Warning

Be warned that flashing at frequencies in the 7Hz to 10Hz range is irritating and should be avoided as it could trigger an epileptic attack.

Temperature Controller – Hot Savings

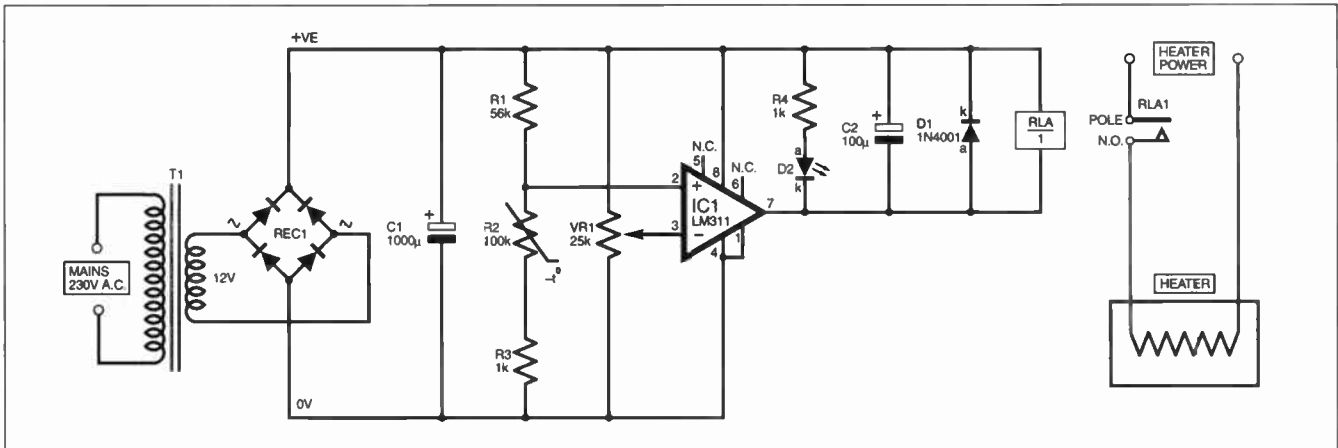

Fig.2. Circuit diagram for a water Temperature Controller. The relay contacts must be rated according to the appliance being controlled.

THE circuit diagram in Fig.2 shows a simple yet highly efficient circuit for controlling water temperature. The heart of the controller is an LM311 op.amp used as a comparator, and having an open-collector output, allowing a relay to be driven directly from it. The op amp senses the voltage across thermistor R2, which is a 100kΩ at 25°C device. Potentiometer VR1 sets the comparator's "window" for a temperature

between 5°C and 95°C. The set temperature can be maintained within a variation of ±0.2°C.

Initially adjust VR1's wiper towards the 0V end. To set a temperature of, say, 40°C, heat the water to this temperature, measuring it with a normal thermometer. Then carefully adjust the wiper of VR1 slowly towards the +VE end until the output state of IC1 pin 7 goes low.

Once fully wired up, the circuit will turn on the relay when the temperature is below the set point, and turn it off again once the temperature has reached the required setting. If desired, the potentiometer's knob can be calibrated.

This mains electricity circuit must only be constructed by those who are suitably qualified or supervised.

Ejaz ur Rehman,
Islamabad, Pakistan

Glitch-Free Switching – Clean Toggling

A REQUIREMENT in an aircraft simulation project was to produce a short but clean clock pulse each time the operator changed the position of a single-pole changeover switch (actually the undercarriage lever in a cockpit). This resulted in the development and verification of the simple circuit shown in Fig.3.

It has generalised application to any situation where events must be triggered from a changeover switch, especially if the designer is obliged to use whatever switch already exists and has no choice regarding its specification.

Switch S1 is the toggle, its two detented positions being referred to as Up and Down. To the human eye, it appears to be functionless as either position will connect the selected output pole to 0V (ground). However, ingenuity in the design recognises that logic circuits react vastly more quickly than humans. What is actually seen at IC1 pin 1 (trigger input) is a low voltage changing briefly but significantly to a high while the switch is in transit (the pull-up resistor R2 sees to this) and then reverting to low again when the switch once more comes to rest.

Each high to low transition triggers the monostable IC1 whose output Q̄ is normally high. The monostable's output pulse here is low and very short, determined by capacitor C1 and resistor R3. This is still long enough to cover S1's contact-bounce, the monostable being a non-retriggerable type.

Summary

In summary, the instant that S1's moveable contact touches a pole, it triggers a negative-going pulse, typically of many tens of milliseconds, from IC1. This pulse can then trigger any further logic as required, such as a 555 timer to produce a long time period, for example. The positive-going pulse from output Q can also be used, depending on the application.

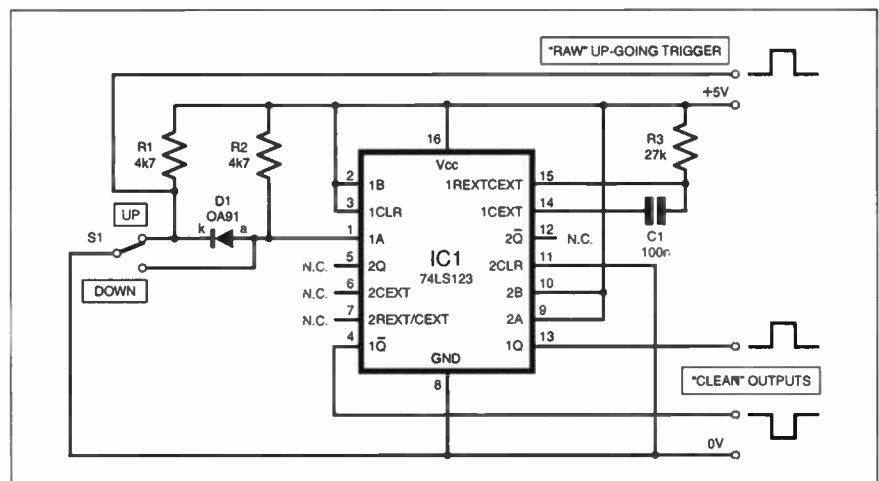

Fig.3. Glitch-Free Switching circuit diagram.

To demonstrate the flexibility stemming from this approach, another (non-clean, "raw") trigger has been tapped off from the UP side of S1. This means that another monostable could be triggered selectively at the up-going switch movement, isolated from the effects of the down-going movement by

diode D1. Whilst in isolation, this signal is still pulled up by R1. A similar extension could offer selective triggering on down-going movements only.

Godfrey Manning G4GLM,
Edgware, Middx

INGENUITY UNLIMITED BE INTERACTIVE

IU is *your* forum where you can offer other readers the benefit of your Ingenuity. Share those ideas, earn some cash and possibly a prize!

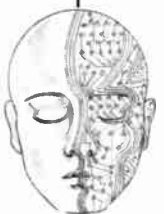

EPE READER ONLINE COMPETITION

WIN MICROCHIP DEVELOPMENT TOOLS!

Everyday Practical Electronics is offering its readers the chance to win five development tools from Microchip. Worth over \$2,100

The first prize is an MPLAB ICE2000 In-Circuit Emulator (ICE) and the four runner up prizes are Microchip's new PICkit 1 Flash Starter Kits.

For the chance to win one of these development tools, log onto www.microchip-comp.com/epe and enter your details in the on-line entry form.

All entries must be made on-line before November 15th 2004



The **Microchip MPLAB ICE2000** is a high-end, full-featured emulator that provides higher-performance emulation capability for PICmicro MCUs, reducing development and debugging time.

MPLAB-ICE 2000 is worth \$2000 and is small, portable and lightweight. It offers real-time in-circuit emulation to maximum speeds of up to 33MHz and emulation down to 2.0 volts. It is CE compliant, features full speed emulation, low voltage operation, software configurable voltage and clock, parallel port interface, interchangeable processor modules and device adapters, and unlimited software breakpoints. It has a 32K by 238-bit trace, and includes sophisticated trace analysis, complex breakpoints, and the ability to monitor internal registers.

The emulator system runs on the Windows-based MPLAB Integrated Development Environment (IDE), which gives devel-

opers the capability to edit, compile and emulate from a single user interface. The MPLAB desktop provides the development environment and tools for developing and debugging applications as a project, allowing quick movement between different development and debugging modes.

The new **PICkit 1 Flash Starter Kit** is a low-cost (\$36), easy-to-use programmer, evaluation and development kit for the company's 8-pin and 14-pin Flash-based microcontrollers. Supporting the PIC12F629, PIC12F675, PIC16F630 and PIC16F676 devices, the PICkit 1 Flash Starter Kit gives users the benefits of creating advanced microcontroller designs for a very low price.

The kit includes a 3-inch by 4.5-inch printed circuit board featuring a USB-powered programming tool that runs on a personal computer. The board's evaluation area features eight l.e.d.s, one potentiometer, one switch and a sample 8-pin PIC12F675 Flash device. The development area features a snap-off prototype board that enables users to connect external circuitry to the microcontroller for quick set-up of an application-specific prototype. Programming the PICmicro Flash microcontroller is provided by the standalone graphical user interface.

The kit also includes a CD-ROM containing a user's guide with tutorials and example software code, the MPLAB Integrated Development Environment with HI-TECH PICC Lite C compiler, Microchip's *Software and Hardware Tips n' Tricks for 8-Pin Microcontrollers* and a USB interface cable.



Competition entries must be made on-line before November 15th 2004.

The names of the prizewinners will be published in the January 2005 issue of *EPE*.

**Thought you couldn't use a
microcontroller in your design?
Think again!**

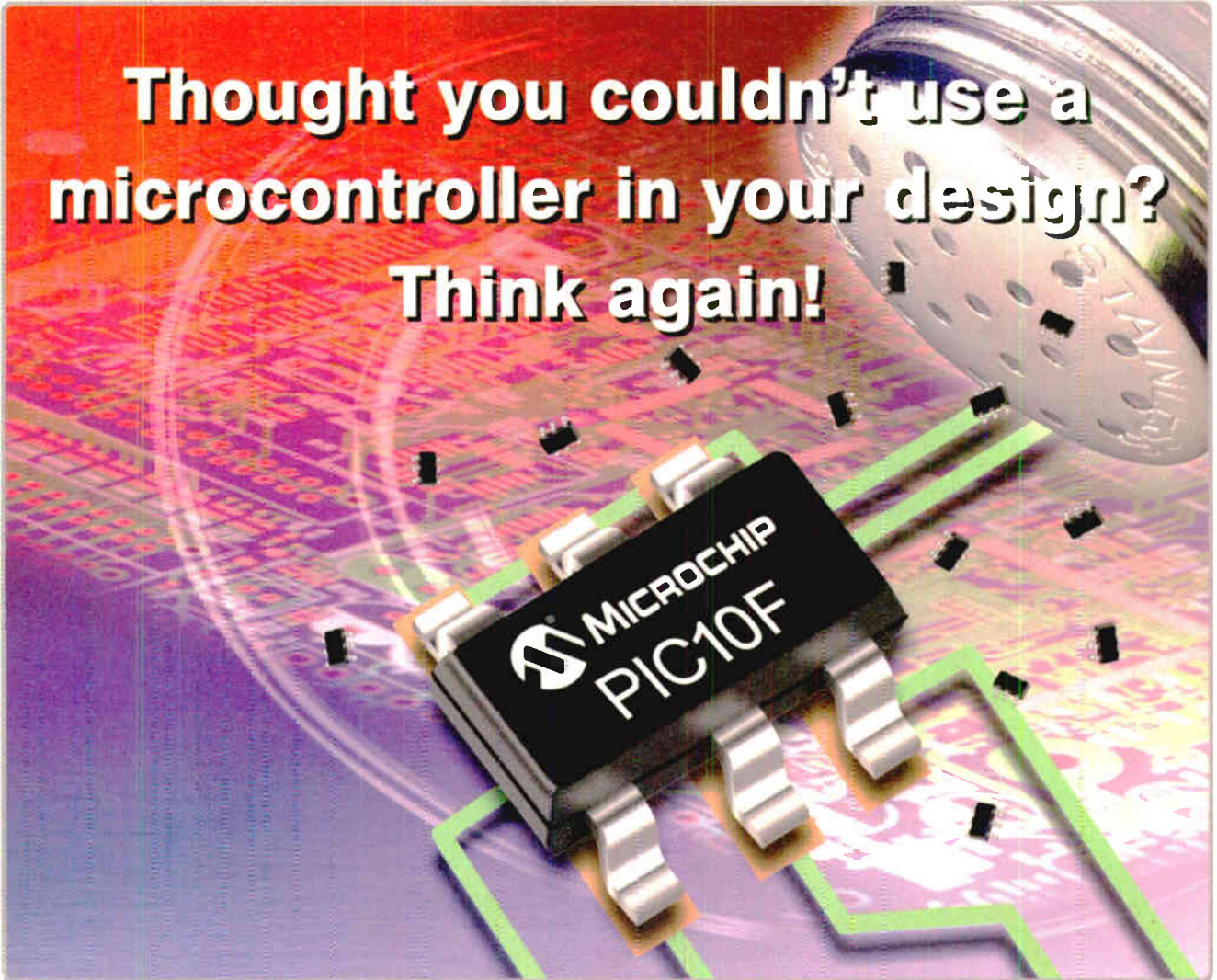

The World's Smallest 8-Bit Microcontroller - The Microchip PIC10F Family

Product	Memory	Bytes	RAM	Pins	Comparators	Timers/WDT	Packages	Internal ICSP**	OSC
PIC10F200	Flash	384	16	6	0	1-8 bit, 1-WDT	SOT-23	yes	4 MHz
PIC10F202	Flash	768	24	6	0	1-8 bit, 1-WDT	SOT-23	yes	4 MHz
PIC10F204	Flash	384	16	6	1	1-8 bit, 1-WDT	SOT-23	yes	4 MHz
PIC10F206	Flash	768	24	6	1	1-8 bit, 1-WDT	SOT-23	yes	4 MHz

Thought you couldn't use a microcontroller in your design? Think again! Microchip has packed a high-performance 8-bit PIC[®] microcontroller into a tiny 6-pin SOT-23 package. The PIC10F solves cost or board space problems in your applications. Fully code-compatible with larger PIC microcontrollers, you can start developing today with Microchip's existing

development tools, including the MPLAB[®] Integrated Development Environment (IDE) that can be downloaded FREE from the Microchip website. First choose the PIC10F and then create your design!

Go to buy.microchip.com or contact your local distributor today.

**buy.
MICROCHIP**
www.buymicrochip.com

Arrow Electronics
Tel: 01279 626777
Fax: 01279 455777

**FARNELL
in one**
Farnell In One
Tel: 08701 200200
Fax: 08701 200201

**FUTURE
ELECTRONICS**
Future Electronics
Tel: 01753 763000
Fax: 01753 767745

Memec
Memec Unique
Tel: 01296 332376
Fax: 01844 210929

MICROCHIP
www.microchip.com/pic10F

INTERFACE

Robert Penfold



INTRODUCING VB.NET AND VB 2005 EXPRESS

It was originally intended to start a series of parallel port add-ons this month, but developments on the software front have delayed the start until next time. The *Interface* articles have been dominated by software issues for some time now, and this has been mainly in response to requests from readers for information or help in sorting out problems.

It has to be pointed out that much of the requested information has been covered in previous *Interface* articles. In particular, the basics of using various versions of Visual BASIC with add-on projects have been given a lot of coverage in the past. Delving through back issues will provide answers to many of the questions we are asked.

VB.Net

As regular readers of these articles will know, most of the example software is written using Visual BASIC 6.0. This is well suited to our purposes, as is Visual BASIC 5.0.

There is a slight problem with these languages in that they are no longer current, and have been replaced by Visual Basic Net (VB.Net). Unfortunately, the new version has gained features that are irrelevant to project interfacing, and lost some that were very useful in this application.

As explained briefly in reply to last month's *Readout* letter "Interfacing to VB", it is difficult to use VB.Net with an add-on such as *Inpout32.dll* that permits the ports to be easily accessed. The problem is simply that VB.Net seems to have no way of importing the BAS file that is used to tell the program how to use the added commands.

In the case of *Inpout32.dll*, there are just two added commands. These are the *Inp* and *Out* commands, which are used in exactly the same way as the same commands in GW BASIC, QBASIC, and Quick BASIC. Unless the BAS file is imported into VB.Net, it cannot use the routines in *Inpout32.dll*, and trying to use the *Inp* and *Out* commands will just produce error messages.

Through the Backdoor

A ploy "borrowed" from the Internet seems to find a way around this problem, and gets the BAS file loaded "via the backdoor". The basic idea is to load into VB.Net any program that uses *Inpout32.dll*, and already has the BAS file imported. A program such as this will not be compatible with VB.Net, but it can still be loaded. VB.Net will convert the program into its own format and then load it.

Once the program is in VB.Net it can be "fine tuned" in much the same way as it was in Visual BASIC 6.0. Things can be taken a stage further, and you can

obliterate most of the original program and use the remaining shell as the basis of your own program.

Converting

The conversion process is quite straightforward, and it starts by opening the project via the usual route (File - Open - Project). Using the browser to select and open the project results in the program detecting that it was written using Visual BASIC 6, and it then automatically launches the Visual BASIC Upgrade Wizard.

After the usual Welcome screen, you have to select the type of project that you wish to upgrade to, and the EXE option must be selected (see Fig.1). The upgraded project does not overwrite the original version, so the next screen is used to specify a location for the new version (see Fig.2).

After a warning that the process is about to start and may take a few minutes, the conversion begins. If all goes well, the conversion should end with the upgraded project loaded in VB.NET. In Fig.3 the demonstration program provided with

the new version of *Inpout32.dll* has been successfully loaded into VB.Net.

The process does not always go entirely smoothly, and on one occasion it caused the mouse to "freeze". However, when experimentally upgrading several simple projects the process never actually failed.

Once a project has been upgraded and loaded into VB.Net, it is possible to use it

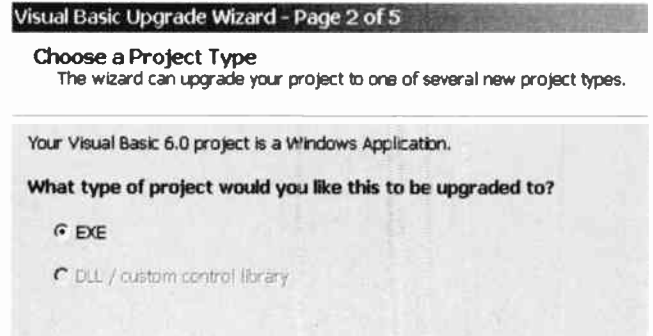

Fig.1. The EXE option must be selected when this page of the wizard appears.

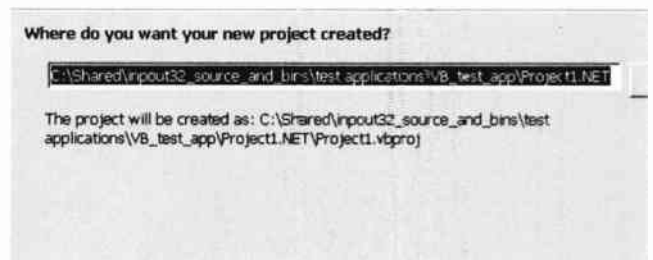

Fig.2. Choose a folder for the files produced by the upgrade. Several files and folders will probably be generated.

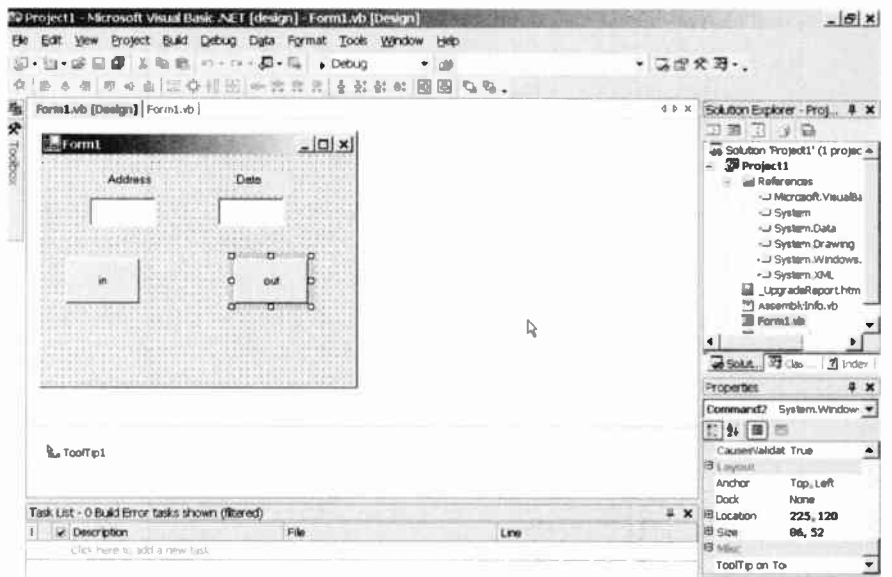

Fig.3. The *Inpout32* test program has been successfully loaded into VB.Net. Upgraded programs can be edited and compiled in the usual way

much like a "real" VB.Net project. It can be edited, and there seem to be no problems if further Inp and Out instructions are added to the code. Compiling projects, or "building" them as it becomes in VB.Net terminology, seems to produce fully working EXE files, although I have not given this aspect of things extensive testing.

From Scratch

This method is fine if, for example, you would like to modify the software for an EPE project, or use it as the basis for one of your own projects. It is less satisfactory when starting from scratch. It then becomes necessary to delete everything in the program that you do not need, while being careful not to damage any code that is important.

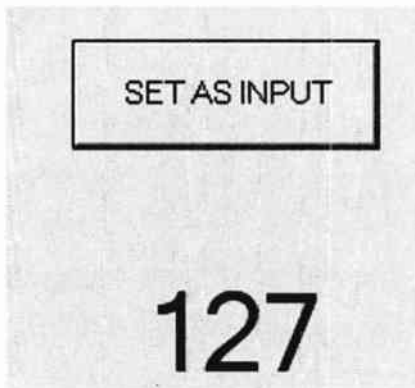

Fig.5. A simple test program based on the "empty" VB.Net program has compiled and run successfully

In use VB Express looks much like VB.Net (see screen shot Fig.6). It presumably lacks many of the more advanced features of VB.Net, but it has plenty of features, including a full range of components that can be added to forms.

It will upgrade and load VB6 and VB.Net programs. It worked fine with the test application provided with the new version of **Inpout32.dll**, and this is shown loaded in Fig.6. When the finished version is available it should provide a low cost way of writing the support software for PC projects.

INPOUTV4.BAS

Loading **Inpout32.dll**'s supporting BAS file seems to cause more than its fair share of correspondence. The file for the new version of **Inpout32.dll** is called

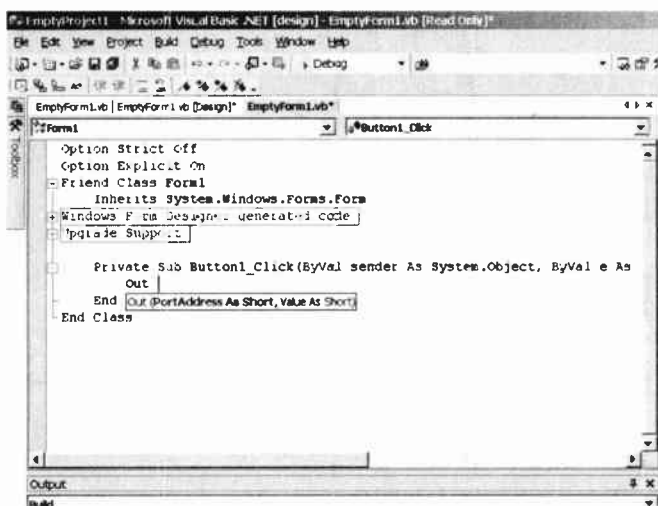

Fig.4. Using the Out command has caused VB.Net to respond with the appropriate hint-text

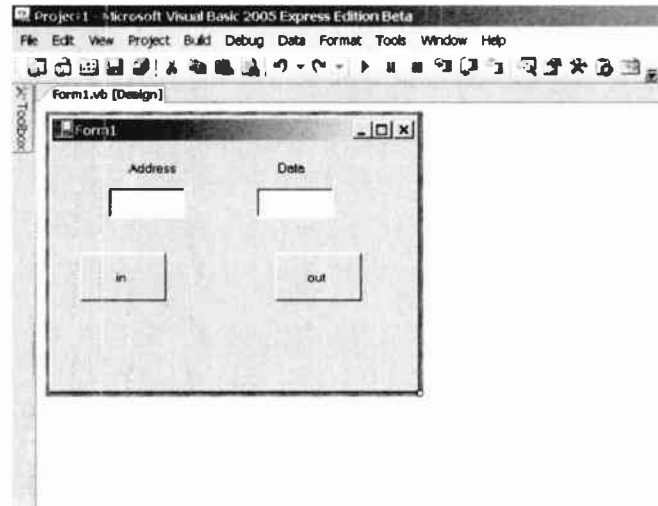

Fig.6. The Inpout32 test program can be loaded into VB Express, which is essentially a cut-down version of VB.Net

Life would be much easier if an "empty" program complete with the BAS file could be loaded. This would remove the need to delete anything before starting to add your own code. It would also guarantee that there would be no "left-overs" that could give problems with your program.

I tried loading the supporting BAS file for **Inpout32.dll** into VB6, and saving the otherwise empty program. This was then loaded into VB.Net, upgraded, and saved. The resultant project gives the desired result. It can be loaded into VB.Net, which will then recognise and use the Inp and Out commands. The screen shot in Fig.4 shows that the BAS file is listed in the Window near the top right-hand corner of the screen (**INPOUTV4.vb**), and typing "Out" into the code window has resulted in VB.Net responding with the correct hint-text for this command.

Proof of Pudding

As an initial experiment I tried producing a simple program that sets the printer port to operate as an input type when a button is pressed. It also displays a fresh reading from the printer port's data lines ten times per second. The program therefore uses both the Inp and Out instructions.

There were no problems when adding the code for the program, but VB.Net does seem to insist on adding brackets that would not be required when using Visual BASIC 6.0. The test program

compiled properly and the resultant EXE program file ran perfectly on a computer running Windows XP (see screen shot Fig.5).

In fact everything seems to work well whether using the "empty" program or upgrading a complete Visual BASIC 6 program. There is obviously no guarantee of perfect results every time, but this method appears to be a practical approach for users of VB.Net.

The files for the "empty" program will be made available on the EPE web site in the Interface folder, and this should provide an easy starting point for anyone wishing to experiment with VB.Net and interfacing.

VB 2005 Express

One of the problems with VB.Net is that it is an extremely complex piece of software that uses large amounts of hard disk space. Microsoft seems to have realised that it is a bit "over the top" for many purposes, and a simpler version called **VB 2005 Express** should be available in due course. Information about downloading a free beta test version was given in last month's *Readout* feature. It is well worth downloading and trying this new program, but do bear in mind that it is a beta test program, and that it is not guaranteed to be fully working and stable. Just the opposite in fact, and it is guaranteed to contain a few bugs. Never run beta software on a PC that is used for any important purpose.

INPOUTV4.BAS and after unzipping the downloaded file it will be found in the \inpout32_source_and_bins\test applications\vb_test_app subfolder.

When using Visual BASIC 6.0, it is loaded by selecting Add File from the Project menu and then using the browser to locate and open the file. Once loaded, it will be listed in the Project window as a module called "inpout".

It is possible to use **Inpout32.dll** with VBA (Visual BASIC for Applications), as supplied with various programs such as Microsoft Word and Excel, Autocad, etc. Obviously VBA is not intended for making standalone executable files, so there will be limitations on the ways in which it can be used.

There should be an Import or Import File option available from the File menu, and this is used to load **INPOUTV4.BAS**. If there is no Import function available, it is unlikely that **Inpout32** can be used with that version of VBA. Note that there are differences between VB and VBA code, so most VB programs will have to be modified in order to run under VBA.



Volts Checker

Anthony H. Smith, BSc. (Hons)

A handy tester suitable for universal a.c. and d.c. supplies



WHEN measuring voltages around the home, in the lab, or out in the field, some kind of voltmeter – either a traditional moving coil type, or a digital “multimeter” version – is usually indispensable. However, there are many instances where a basic “go/no go” indication is more than sufficient. For example, when tracing a fault in a car electrical system, or when checking a mains circuit to see whether it is “live”, a simple “yes” or “no” visual indication can be the easiest and quickest way of checking for a healthy voltage supply.

In this respect, an l.e.d. (light emitting diode) provides an ideal solution. Unlike an incandescent filament bulb, the l.e.d. does not require much power, and it can operate at very low voltages where traditional neon indicators have not got a chance.

However, using an l.e.d. to indicate the presence of a voltage ranging from less than 3V to more than 200V – both d.c. and a.c. – requires something more than just a resistor and a suitable l.e.d.

Handy Size

Housed in a small plastic case, the Volts Checker is a handy, pocket-sized instrument that can be used to check an a.c. or d.c. voltage as low as 3V or as high as 240V r.m.s. (root-mean-square). Using the unit could not be easier – just connect the two leads to the circuit under test and the l.e.d. will illuminate if there is a healthy voltage present.

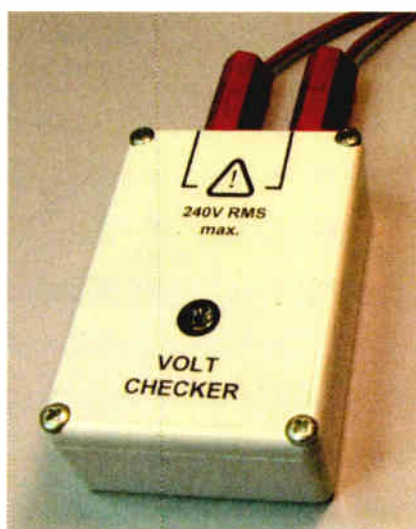

Furthermore, there is no need to worry about which node is positive and which is negative, the unit automatically senses any d.c. voltage regardless of polarity. Alternating voltages, such as those produced by step-down transformers in consumer equipment or high-voltage mains domestic circuits, are dealt with just as easily.

The circuit is based on the two-transistor l.e.d. current regulator described in *Light Emitting Diodes – Operation and Applications Part Two* (elsewhere in this issue), and makes good use of a “low current” l.e.d. to minimise power consumption and permit operation at high voltages. The circuit diagram of this Volts Checker, shown in Fig.1, is almost identical to the aforementioned circuit, but with some important additions, the most obvious of which is bridge rectifier, REC1.

A.C./D.C.

Full-wave a.c. to d.c. conversion is a familiar function in many mains-operated power supplies, where a bridge rectifier, comprising

four power diodes, converts each cycle of the mains sinusoidal waveform to a unipolar voltage. In Fig.1, REC1 provides just the same function, in that an a.c. voltage waveform applied to the circuit’s inputs via sockets SK1 and SK2, will be full-wave rectified so as to present a unipolar voltage to the current regulator.

This is illustrated by the graph in Fig.2, where the full-wave rectified waveform (dashed line) has a “half-sinewave” shape and reaches a peak on every half cycle of the mains waveform.

For a sinewave, the peak value, V_{PK} , of the waveform is given by:

$$V_{PK} = \sqrt{2} \times V_{RMS} \text{ (V)}$$

where V_{RMS} is the root-mean-square value of the waveform, represented by a solid line in Fig.2.

Clearly, for a mains voltage with $V_{RMS} = 240V$, the waveform will peak at around 340V. The full-wave rectified waveform peaks at roughly the same value (actually, just slightly less due to the voltage drop across the bridge rectifier diodes).

Note that the bridge also ensures that a d.c. voltage of any polarity will also be “rectified” such that the l.e.d., D1, will illuminate regardless of the polarity presented via SK1 and SK2. The only price to be paid for this convenience is a slight increase in the minimum operating voltage due to the voltage drop across the rectifier diodes.

Current Regulator

Transistors TR1 and TR2 combine to provide the negative feedback loop required to maintain a constant current in l.e.d. D1. However, bias resistors R1 and R2, and transistor TR2 must be chosen very carefully to accommodate mains voltages safely.

At each peak of the mains waveform, when the “+” terminal of bridge rectifier REC1 is at 340V with respect to the “-” terminal, the voltage across the collector-emitter terminals of TR2 is given by:

$$V_{CE2} = 340V - V_F - V_{BE1} \text{ (V)}$$

where V_F is the l.e.d.’s forward voltage, and V_{BE1} is the base-emitter voltage drop of TR1.

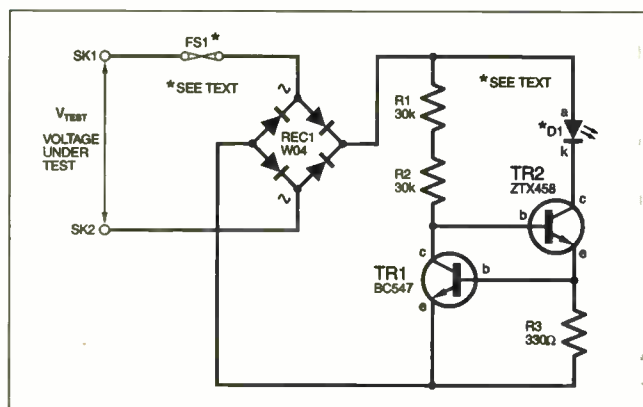

Fig.1. Circuit diagram for the Volts Checker.

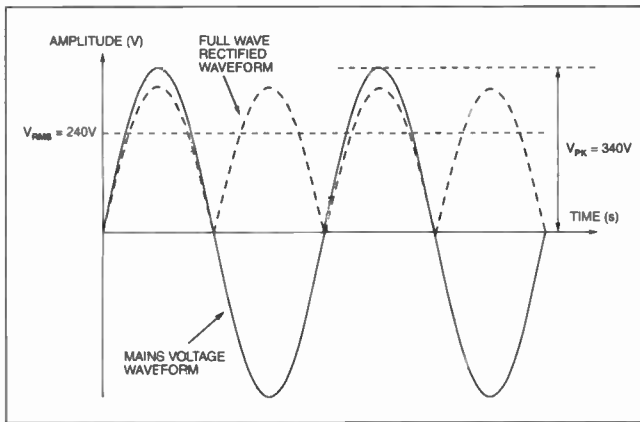

Fig.2. Effect of full-wave rectification on mains voltage waveform.

Assuming V_F is around 2V, and taking $V_{BE1} = 0.7V$, we see that TR2 must be able to withstand a maximum collector-emitter voltage, $V_{CE(max)}$, of around 337V! This demands a *high-voltage* device for TR2; **common-or-garden devices like the BC108 and BC547 simply will not do.** Fortunately, there are several high-voltage *npn* transistors on the market, and the one best suited to this application is the Zetex ZTX458.

Important Characteristics

The ZTX458 has a maximum collector-emitter voltage rating of $V_{CE(max)} = 400V$, allowing it to handle peak a.c. voltages of 340V with plenty of margin. However, power dissipation is also an important consideration; the ZTX458 has a maximum power rating, $P_{D(max)}$, of 1W, quite impressive for a relatively small package. The power dissipated in TR2 is given by:

$$PD = I_{C2} \times V_{CE2} \text{ (W)}$$

where I_{C2} and V_{CE2} are the r.m.s. values of collector current and collector-emitter voltage, respectively. To see why power dissipation is important, we can rearrange this equation to determine the maximum permissible collector current when $V_{CE2} = 240V$:

$$I_{C2(max)} = P_{D(max)} / V_{CE2} = 1W / 240V = 4.17mA$$

In practice, the collector current is set much lower than this to allow a healthy safety margin. The value of resistor R3 determines the magnitude of I_{C2} by the simple relationship:

$$I_{C2} = V_{BE1} / R3 \text{ (A)}$$

where V_{BE1} is TR1's base-emitter voltage. With $R3 = 330\Omega$, and taking $V_{BE1} = 0.7V$, the nominal collector current in TR2 is:

$$I_{C2} = 0.7V / 330\Omega = 2.12mA$$

Low Current Diet

These results highlight the need for a low current l.e.d. Attempting to use a standard l.e.d. needing a forward current of, say, 15mA for adequate brightness, would require a transistor capable of dissipating over 3.6W when measuring mains voltage! Instead, by using a low current device for l.e.d. D1, the required power rating is reduced enormously. In fact, with $I_{C2} =$

2.12mA, the dissipation in TR2 is just over half a watt when $V_{CE2} = 240V$ r.m.s., well below the 1W maximum rating of the ZTX458, thereby allowing plenty of margin.

CAUTION: do not substitute another transistor for the ZTX458 unless it can match or exceed the $V_{CE(max)}$ and $P_{D(max)}$ specifications!

Power and voltage ratings must also be considered when selecting bias resistors R1 and R2. Using two equal-value resistors in series rather than just a single resistor has two advantages.

First, it means that the required maximum voltage rating is effectively halved. Since the peak voltage appearing across R1 + R2 is roughly the same as that across TR2, namely 340V, it follows that each of the two resistors need only be rated to 170V.

The second advantage concerns the resistors' power rating, which itself is dictated by the total resistance value required to ensure adequate bias current for TR2. As we shall see in a moment, connecting two resistors in series halves the dissipation in each one, *provided* they are equal in value.

Biased opinion

For proper, reliable operation, the bias current flowing into the junction of TR1's collector and TR2's base should be at least twice the maximum base current, $I_{B2(max)}$, required by TR2.

Now, $I_{B2(max)} = I_{C2} / h_{FE2(min)}$, where $h_{FE2(MIN)}$ is the minimum base-collector current gain of TR2. Since the ZTX458 has $h_{FE(min)} = 100$, it follows that $I_{B2(max)} = 2.12mA / 100 = 21.2\mu A$. Therefore, the current flowing in R1 and R2 should be at least $42.4\mu A$. However, in order to calculate the values of R1 and R2, we need to know the *minimum* voltage across them.

If we follow the current path from terminal SK1, through one of the diodes in REC1, through R1 and R2, through the base-emitter junctions of TR2 and TR1, respectively, then through the opposite diode in REC1 out to terminal SK2, we see that the voltage across R1 + R2 is:

$$V_{R1+R2} = V_{TEST} - 2V_D - V_{BE2} - V_{BE1} \text{ (V)}$$

where V_{TEST} is the terminal voltage, $2V_D$ is the voltage drop across the two bridge diodes, and V_{BE2} and V_{BE1} are the transistors' base-emitter voltages.

If we take a minimum value of 5V for V_{TEST} , and with V_D , V_{BE2} and V_{BE1} each equal to 0.7V, we find that $V_{R1+R2} = 2.2V$. Therefore, it follows that the required total value of R1 + R2 equals $2.2V / 42.4\mu A = 51.8k\Omega$. This suggests that we make R1 and R2 each equal to around 26k Ω . However, we must first check the power rating.

Power and Voltage Ratings

We know that the maximum r.m.s. voltage across R1 + R2 is roughly 240V, or

120V r.m.s. across each resistor. Therefore, the *minimum permissible* resistance value (for each resistor) is given by:

$$R_{min} = 120^2 / P_{D(max)} \text{ (\Omega)}$$

where $P_{D(max)}$ is the maximum power rating of the resistor. If we use 0.5W types, we find that $R_{min} = 120^2 / 0.5 = 28.8k\Omega$. The nearest larger preferred value is 30k Ω . Although this is some 4k Ω greater than the ideal value (26k Ω) calculated above, it is essential to use a value of 30k Ω to ensure R1 and R2 do not overheat when the unit is being used to test mains voltage.

Maximum ratings must also be considered when selecting an appropriate bridge rectifier for REC1. Thanks to the current regulator, the maximum current through the bridge will never be more than around 2.5mA under normal circumstances, so current ratings are not an issue. The bridge's peak reverse voltage rating, however, is most important.

Bridge rectifiers are used in linear power supplies where they are usually found on the secondary side of a mains transformer, and in this role they rarely have to deal with reverse voltages greater than 100V, or so. However, in the Volts Checker, the diodes in REC1 may encounter peak reverse voltages as high as 340V, and so a suitably rated bridge is essential.

The recommended part, a W04, can tolerate maximum reverse voltages of 400V, which is more than sufficient. **It is important not to substitute a bridge rectifier with inferior voltage specifications as it could break down when checking mains voltages!**

Protection

Fuse FS1 may seem unnecessary given that the circuit regulates the current to just a few milliamperes. However, a circuit fault, such as a short-circuit in the bridge rectifier, could result in catastrophically high current flow, even when testing relatively low voltages. Therefore, the fuse, connected "upstream" of all other components, provides an essential safety function and will rupture in the unlikely event of a circuit fault.

Component Types

Resistors R1 and R2 may be 0.5W parts, such as the Welwyn MFR4 series, or 0.6W such as the Philips MRS25 series. A 0.25W resistor is adequate for R3, although a 330 Ω part from the MFR4 series or MRS25 series will fit just as well.

Most small-signal *npn* transistors with good current gain are suitable for TR1; although a BC547 has been specified, other types such as the BC108 should be suitable. The device specified for TR2, however, should not be substituted for another type.

A low-value, quick blow fuse should be used for FS1. The exact rating is not critical, but should be in the range 50mA to 100mA. Higher values should *not* be used.

The white, molded ABS case used for the prototype is inexpensive and was chosen because it accommodates the p.c.b. and 4mm connectors without crowding and is easily machined. If a smaller case is desired, it may be necessary to omit the connectors and, instead, hard wire the test leads directly to the board.

CAUTION: The case must be a plastic type with no metal parts passing through it.

A metal case, such as diecast aluminium, is not suitable since a fault within the unit could cause the case to become "live" when testing mains voltages.

An Agilent HLMP-D155, 5mm red l.e.d. is recommended for D1, although other low current types could be used. The HLMP-D155 provides very good intensity at the nominal 2mA operating current, although it suffers somewhat from a relatively narrow viewing angle, typically 24°.

Some alternative low current Agilent and Kingbright l.e.d.s are shown in Table 1. This list is not exhaustive – several other manufacturers produce low current l.e.d.s which may be suitable. Whichever part is used will depend on personal preference, but the chosen type should have low forward voltage, V_F , and good luminous intensity, I_V , at 2mA.

Construction

Assembly of the p.c.b. is straightforward and requires no special techniques. The component positioning and track layout details are shown in Fig.3. This board is available from the *EPE PCB Service*, code 468.

Solder the three resistors in place first, then the transistors and bridge rectifier. Take care with the orientation of REC1 – make sure the positive ("+") terminal is next to the l.e.d.

Fit the fuse clips next, then solder the l.e.d. in place leaving approximately 15mm of lead length between the top surface of the board and the base of the l.e.d. Take care with polarities, ensure all component leads are properly cropped and check carefully for solder splashes.

Testing and Troubleshooting

When assembly is finished, and *thoroughly* checked, the circuit should be tested before fixing the board in its case. Fit the fuse into the fuse clips and connect leads via sockets SK1 and SK2 to a d.c. voltage source, such as a bench power supply or battery of around 5V to 10V. The l.e.d. should illuminate. If it does not, check that the fuse is intact and that the l.e.d. has been inserted with correct polarity. If the l.e.d. still does not light, check that the bridge rectifier has been inserted correctly.

Next, reverse the polarity of the voltage source and check that the l.e.d. still glows. If it does not, the problem is almost

Table 1: A selection of l.e.d. comparisons

L.E.D. Type	Colour	Luminous Intensity, I_V (mcd)	Forward Voltage, V_F (V)	Viewing Angle
Agilent HLMP-D150	Diffused red	3 typ. @ 1mA	1.8 max. @ 1mA	65°
Agilent HLMP-D155	Clear red	10 typ. @ 1mA	1.8 max. @ 1mA	24°
Agilent HLMP-4700	Diffused red	2.3 typ. @ 2mA	2.0 max. @ 2mA	50°
Agilent HLMP-4719	Diffused yellow	2.1 typ. @ 2mA	2.5 max. @ 2mA	50°
Agilent HLMP-4740	Diffused green	2.3 typ. @ 2mA	2.2 max. @ 2mA	50°
Kingbright W53LID	Diffused red	5 typ. @ 2mA	2.5 max. @ 20mA	30°
Kingbright W53LGD	Diffused green	2 typ. @ 2mA	2.5 max. @ 20mA	30°
Kingbright W53LYD	Diffused yellow	2 typ. @ 2mA	2.5 max. @ 20mA	30°
Kingbright W53LSRD	Diffused red	20 typ. @ 2mA	2.5 max. @ 20mA	30°

certainly a faulty bridge rectifier. It is advisable to check the operating current, especially if the l.e.d. seems very dim or too bright. Connect a d.c. ammeter in series with one of the supply leads and measure the current. It should be in the region of 1.5mA to 2.5mA; if the value is outside this range, check that R3 is the correct value.

Completion

When the p.c.b. has been successfully tested it can be bolted into place in the plastic case. First, four holes must be drilled in the base of the case. Positioning of the two holes in the bottom is fairly critical to ensure correct alignment of the l.e.d. The two small holes should be approximately 3mm in diameter – countersink if required. The single lid hole should be just over 5mm in diameter so as to accommodate a 5mm l.e.d.

In the short side of the base at the opposite end to the p.c.b., drill two holes to accommodate the 4mm sockets. The holes should be symmetrically spaced, approximately 20mm apart, with a diameter of about 8mm.

Solder two wires each approximately 20mm long to the supply terminals on the p.c.b., then screw the board into place using nylon screws and nuts, fitting two nylon or fibre washers underneath it, then solder the wires to the sockets. Position the lid on the case to check that the l.e.d. protrudes through the hole correctly.

If the lid cannot be seated properly, remove the board, de-solder the l.e.d., shorten the lead length above the board, re-solder and repeat the process until the l.e.d. is at the correct height. If this process proves troublesome, there is no reason why the l.e.d. should not be connected to the

COMPONENTS

Resistors

R1, R2

30k 1%,
0.5W (or
0.6W),
200V (or
greater), metal film
(2 off)

R3

330Ω 1%, 0.25W metal film

Semiconductors

D1

red l.e.d., 5mm low current (see text)

TR1

BC547 (or similar) npn transistor

TR2

ZTX458 high voltage npn transistor (see text)

REC1

W04 bridge rectifier, 400V

Miscellaneous

FS1

fuse, quick blow, 20mm x 5mm (see text)

SK1, SK2

4mm socket (2 off)

Printed circuit board, available from the *EPE PCB Service*, code 468; 20mm p.c.b.-mounting fuse clips (pair); 6BA 12mm countersunk screws, non-metallic (2 off); 6BA nuts (2 off); 6BA fibre (or nylon) 1mm-thick washers (2 off); 6BA lock washers (2 off); plastic case, 25mm x 73mm x 51mm (see text); connecting wire, solder etc.

Approx. Cost
Guidance Only

£9

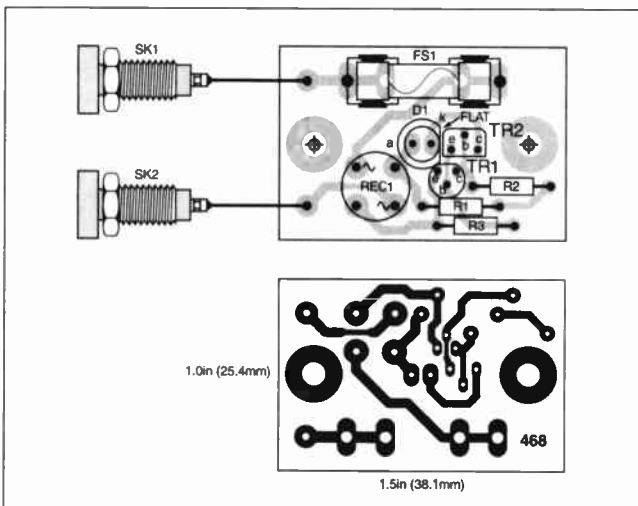
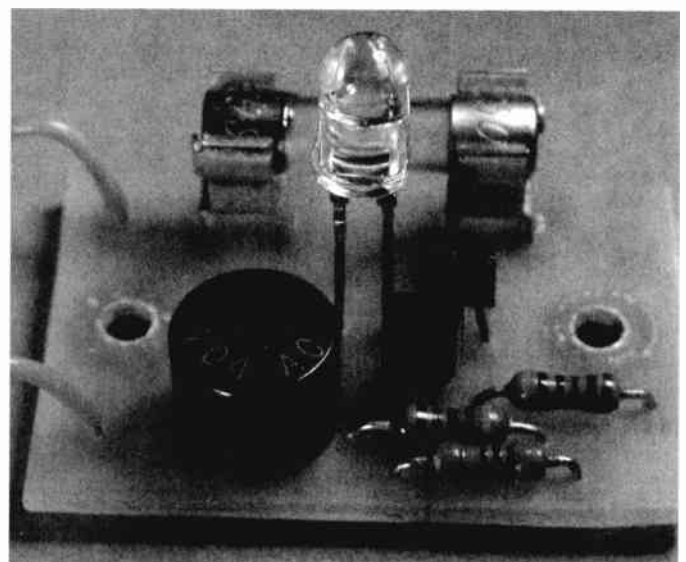

Fig.3. Component layout and master track pattern for the Volts Checker.



board using short flying leads and fixed into the lid using either adhesive or a suitable 5mm mounting clip.

Before screwing the lid into place, labelling and symbols could be applied to it as desired. Having screwed down the lid, the Volts Checker is then ready to use.

In Use

Measuring of a.c. mains voltages should only be carried out by those who are suitably qualified or supervised.

No special techniques are required to operate the Volts Checker, although the following precautions must be observed when testing high voltages, especially mains supplies.

Only properly insulated sockets, plugs and test leads should be fitted, and on no account should the unit be used to test high voltages with the lid removed. Furthermore, the l.e.d. is effectively at a very high potential when the unit is connected to mains voltage. Normally, this is not a problem, since the l.e.d.'s plastic casing provides adequate insulation. However,

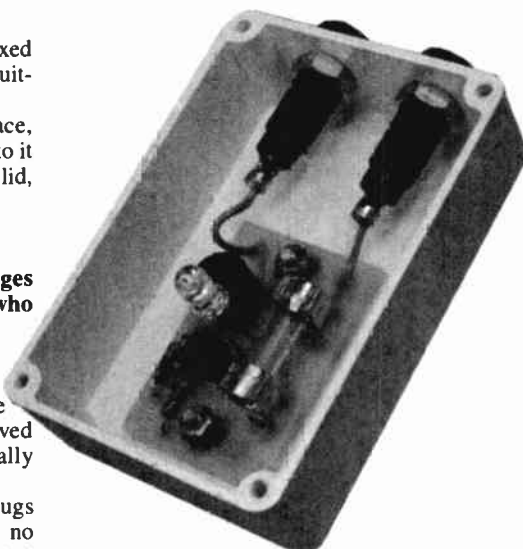

a faulty l.e.d. could cause the insulation to break down. As a precaution, it is best to avoid touching the l.e.d. when testing high voltages.

Tests on the prototype showed that the l.e.d.'s forward current, I_F , remained

extremely stable over a wide range of terminal voltages. For example, at 5V, I_F was 1.66mA, whereas at 50V, the forward current was 1.91mA. In other words, for a ten-fold (900%) increase in terminal voltage, I_F increased by just 15%.

Note that I_F was slightly lower than the nominal 2.12mA calculated earlier because TR1's base-emitter voltage was found to be somewhat lower than the assumed value of 700mV. When measuring the Volts Checker's operating current, remember that the terminal current equals the sum of I_F plus the bias current through R1 and R2. However, even at 50V, the terminal current was just 2.7mA. Even though this is much higher than the input current taken by high impedance voltmeters, it is still small enough to be negligible when checking most voltage sources.

The prototype unit worked well down to a minimum terminal voltage of 3.5V, where the l.e.d.'s forward current was 1.23mA. At 3.0V, I_F was just 0.48mA, and the l.e.d. was fairly dim, whereas at 2.5V, it was barely visible.

NEXT MONTH WE ARE ABOUT TO STIR UP A STORM – SO STRIKE NOW AND ORDER YOUR COPY !

- ★ THUNDERSTORM MONITOR ★
- ★ LOGIC PROBE ★
- ★ MW AMPLITUDE MODULATOR ★
- ★ SMART KARTS – 2 ★

Annual subscription rates:

6 Months: UK £16.50, Overseas £19.50 (standard air service),
£28.50 (express airmail)

1 Year: UK £31.00, Overseas £37.00 (standard air service)
£55 (express airmail)

2 Years: UK £57.00, Overseas £69.00 (standard air service)
£105 (express airmail)

To: Everyday Practical Electronics,
Wimborne Publishing Ltd., 408 Wimborne Road East,
Ferndown, Dorset BH22 9ND

Tel: 01202 873872 Fax: 01202 874562

E-mail: subs@epemag.wimborne.co.uk

Order from our online shop at:
www.epemag.wimborne.co.uk/shopdoor.htm

Name

Address

Post code Tel.

If you do not wish to cut your issue, send a letter or copy of this form.

EVERYDAY
**PRACTICAL
ELECTRONICS**

TAKE ADVANTAGE NOW!

SUBSCRIPTION ORDER FORM

To subscribe from the USA or Canada
see the last magazine page

I enclose payment of £
(cheque/PO in £ sterling only),
payable to Everyday Practical Electronics

My card number is:
Please print clearly, and check that you have the number correct

Signature

Card Security Code (The last 3 digits on or just under
the signature strip)

Valid From Ex. Date

Switch/Maestro Issue No.

Subscriptions can only start with the next available issue.
For back numbers see the *Back Issues* page.

10/04

EPE Theremin

Robert Penfold

Create your very own weird and wonderful music with this modern-day version of Leon Theremin's famous, "handsfree", 20s sound machine



THE ORIGINAL Theremin was produced in the 1920s by Leon Theremin, and the basic idea has been periodically reborn since then. The Theremin is probably more popular now than at any time in the past, and still manages to keep some of its mystique in this technological age when just about anything seems possible.

A Theremin is an electronic musical instrument that is played without any physical contact being made with the instrument. The pitch is controlled by moving one hand closer to an "aerial" or sensor plate to produce an increase, or moving it further away to provide a reduction in pitch.

A similar method is used to vary the volume. Moving the other hand closer to a second aerial gives an increase in volume, and moving it further away produces a reduction in volume.

Hand Capacitance

Changes in pitch and volume are reliant on "hand capacitance", which is something that is normally a problem and has to be avoided when designing radio frequency equipment. In this case hand capacitance is exploited and aerials are used to greatly increase the effect.

Each "capacitor" is comprised of an aerial and one of the user's hands. These are effectively the plates of the capacitor with the air between each hand and its aerial acting as the dielectric. Placing a hand closer to an aerial gives an increase in capacitance.

This gives a form of variable capacitor, but the maximum capacitance obtained is extremely small. It is far too small to permit an audio oscillator to be tuned over a sufficiently wide range of frequencies. In order to obtain a wide enough pitch range it is necessary to use two high frequency oscillators with one operating at a fixed frequency and the other being "pulled" by hand capacitance. The general scheme of things used for a Theremin's tone generator is shown in Fig.1.

Sum Difference

The output signals of the two oscillators are fed to a mixer

where sum and difference frequencies are generated. For example, suppose the oscillators are operating at 900kHz and 901kHz. The sum frequency is 900 plus 901 = 1801kHz, and the difference frequency is 901 minus 900 = 1kHz.

The sum frequency is very high and is of no use in the current context. It is therefore removed, together with signals at the input frequencies, by a simple lowpass filter at the output of the tone generator.

The difference frequency is at an audio frequency, and provides the required audio tone. Placing a hand close to the aerial results in more capacitance being introduced to the tuned circuit of one oscillator, which slightly reduces its output frequency.

On the face of it, the user's body must be "earthed" for this to work properly, but in practice this is not necessary. The user's body acts as a sort of miniature artificial earth, and the extra capacitance is added across the existing capacitance in the tuned circuit.

The reduction in frequency will not be very high in percentage terms, but even 0.1 percent or so will give a reduction of about 1kHz. This is the point of using high frequency oscillators and mixing their outputs to produce the difference frequency via what is called the heterodyne effect. A small change in the frequency of one oscillator gives a large shift in the pitch of the audio output.

Suppose the 900kHz oscillator is the one that is altered. Its output frequency will reduce to 899kHz, giving a difference

frequency of 901 minus 899 = 2kHz. This represents a *doubling* of the output frequency from only a minute change in the frequency of one oscillator. In practice this system enables a range of several octaves to be obtained from small changes in hand capacitance.

In this example a reduction in the frequency of one oscillator was used to provide an increase in pitch at the output. Moving a hand towards the aerial sensor would therefore produce an increase in pitch. Probably most people find this more instinctive than having the pitch reduce as their hand is moved towards the aerial, but both methods are possible. It is just a matter of adjusting the oscillators for suitable starting frequencies.

If the 900kHz oscillator was set at 903kHz initially this would give a difference frequency of 903 minus 901 = 2kHz. Reducing its frequency to 902kHz would reduce the output frequency to 902 minus 901 = 1kHz. In other words, the same frequency range as before, but with the pitch reducing as the user's hand approached the aerial.

Volume Control

A real world Theremin tends to be substantially more complex than the block diagram of Fig.1 would suggest, mainly due to the inclusion of circuitry to control the volume via the second aerial. The full block diagram for the EPE Theremin design is shown in Fig.2.

The tone generator has two high frequency LC Oscillators with one having variable tuning and the other incorporating the aerial. The tuning control enables the required tone range to be set, and in practice a range of around 100Hz to a few kilohertz can be achieved. The outputs of the oscillators are mixed, filtered, and then amplified to produce a strong tone signal.

This is fed to a VCA (voltage controlled amplifier), a buffer stage, and then a small power amplifier that drives an internal loudspeaker. The volume is governed by the control voltage applied to the VCA. There is approximately unity voltage gain

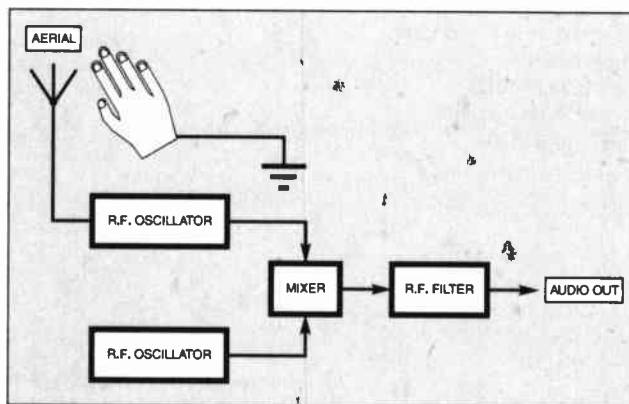

Fig.1. Block diagram for a basic Theremin.

when the control voltage is equal to the supply potential. Reducing the control voltage produces increasing losses, and the output signal is cut off when the voltage falls to about 0.5V.

There are numerous ways of generating a suitable control voltage, and some of them do not involve hand capacitance at all. For example, the amount of reflected light or infra-red from a pulsed l.e.d. can be used. In this case the design is reasonably true to the original concept and it does use hand capacitance to control the volume.

Like the original, it is also based on a damped oscillator. In this case the oscillator is a CR type operating at an ultrasonic frequency. It has a Gain control that is adjusted so that the circuit is barely able to sustain oscillation.

and it gives a finished unit that is based on the same principles as the original Theremin. One drawback is that when applied to a low voltage semiconductor design it does not give very precise control of the volume. The range of hand movement needed to vary the volume from maximum to minimum is quite small.

On the upside, this makes it easy to produce rapid changes in volume and to produce a tremolo effect by wiggling one's hand. There is a potential problem of interaction when using any dual aerial system. In other words, varying the volume tends to produce small changes in the pitch of the output signal. This does not seem to be a major problem with this design, and it is probably aided by having the volume controlled by a relatively limited amount of hand movement.

the circuit a reasonably quick response time. Using a mid-audio frequency it can take a second or two for oscillations to build up or die away.

The "aerial" is coupled to the CR network via capacitor C4, and the hand capacitance is effectively in parallel with C3. Increased hand capacitance pulls the operating frequency slightly lower, but of greater importance it tends to damp oscillations. The damping will have no significant effect if the circuit oscillates strongly, as it will be insufficient to reduce the amplitude of the oscillations.

Potentiometers VR1 and VR2 control the amount of negative feedback applied to IC1, and therefore control its closed loop voltage gain. In practice the amount of gain has to be critically adjusted so that the

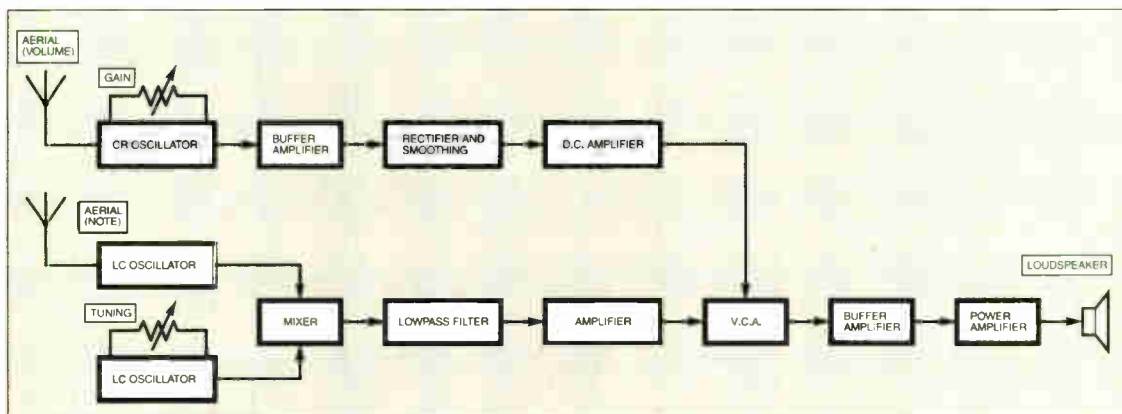

Fig.2. The full block schematic diagram for the EPE Theremin showing a general breakdown of the "Volume" and "Pitch" sections.

The aerial and hand capacitance are used to damp oscillations as the user's hand approaches the aerial. This gives reduced output from the oscillator, and oscillation will actually cease if the user's hand is placed very close to the aerial.

The output of the CR oscillator is fed to a buffer amplifier and then to a rectifier and smoothing circuit. The output from the smoothing circuit is a positive d.c. voltage that is roughly proportional to the strength of the oscillations from the CR oscillator.

This signal is fed to a d.c. amplifier that has only a low level of voltage gain. An inversion is provided by this amplifier, and it therefore provides practically zero output voltage under standby conditions. The output voltage from the rectifier circuit falls when the oscillations subside, causing the output voltage from the amplifier to increase. The output voltage reaches maximum when oscillations cease.

This gives zero audio output under standby conditions, with increasing volume as the user's hand is placed closer to the aerial. For most users this gives a more natural form of control than having the volume decrease as their hand is moved towards the aerial.

Using a damped oscillator is a relatively simple means of controlling the volume,

Circuit Operation

The full circuit diagram for the EPE Theremin is shown in Fig.3. The top half of the circuit contains the volume control and audio output stages, and the tone generator section in the bottom half.

Starting with the volume control circuit, the CR oscillator is a Wien type that is based on IC1. Positive feedback is provided via the network comprised of resistors R3, R6 and capacitors C3 and C5. This controls the operating frequency, which is not too important in this application.

However, the operating frequency needs to be above the audio range in order to give

closed loop voltage gain of IC1 is only just sufficient to sustain oscillation. VR1 and VR2 respectively operate as Fine and Coarse Gain controls.

Loading on the output of the CR oscillator can result in the circuit being reluctant to resume oscillations after they have ceased, which gives an awkward control characteristic. The buffer stage, IC2, ensures that there is minimal loading on the output of the oscillator and thus helps to avoid this problem.

Capacitor C6 couples the output signal of IC2 to a basic half-wave rectifier circuit based on diodes D1 and D2. Germanium diodes are used due to their lower forward voltage drop than the silicon variety. Schottky diodes should also work well in this circuit.

The smoothing circuit is comprised of resistor R7 and capacitor C7, and the values have been chosen to give reasonably fast attack and decay times. The circuit responds quite rapidly to variations in the output level from the oscillator, enabling rapid changes in volume to be obtained.

The d.c. amplifier is based on IC3, which is an operational amplifier used in a standard inverting mode circuit. Diode D3 is an l.e.d. indicator that switches on when the output of IC3 goes high. It is not essential, but it can be



useful when adjusting controls VR1 and VR2.

Voltage Controlled Amplifier

The VCA is a conventional design that is based on operational transconductance amplifier IC4. Like an ordinary operational amplifier it has inverting (pin 2) and non-inverting (pin 3) inputs, but it is current rather than voltage operated.

The output current is a function of the relative input currents and the bias current fed to pin 5. This bias input has no equivalent in an ordinary operational amplifier, and it enables the gain of the device to be controlled.

Although IC5 is current operated, resistors R13 and R18 are respectively used in series with the bias and audio inputs, effectively converting them to voltage operation. Resistor R17 is used as a load resistor at the output of IC4, giving an output voltage that is proportional to the output current that flows through R17. IC5 is a simple voltage follower buffer stage at the output of the VCA.

Some lowpass filtering is provided in the tone generator circuit, but R19 and C9 are used to provide some additional filtering. VR3 is a conventional volume control that is used to set the required maximum volume from the instrument.

The output signal from the wiper (moving contact) of VR3 is fed to the non-inverting input (pin 2) of a simple audio power amplifier based on IC6, which is the ever popular LM380N. This normally drives a miniature built-in loudspeaker (LS1), which, if preferred, can be switched off using S2. The signal available at output socket SK1 can then be fed to an external amplifier and loudspeaker. The direct output from IC6 is likely to be slightly excessive for use with an external amplifier, so resistors R21 and R22 are used to provide a modest amount of attenuation.

Tone Generator

The two high frequency oscillators in the tone generator circuit are based on transistors TR1 and TR2, and they are essentially the same. Operation of the circuit based on TR2 will be described here, but obviously they both operate in the same manner.

A form of Colpitts oscillator is used, and this relies on a capacitive tapping on the tuned circuit. This avoids the need for a tapping on the inductor, which can therefore be a standard "off the shelf" item. Inductor L2, with the series capacitance of C20 and C21, provides the tuning capacitance and the capacitive tapping. The latter connects to earth.

The tuned circuit acts as a basic single-wound transformer, and the important point is that a signal fed to one end of the tuned circuit produces an out-of-phase signal at the other end. It is connected between the input and output of a common emitter amplifier based on TR2. The input and output of a common emitter amplifier are out-of-phase, but the inversion through the tuned circuit results in positive feedback being provided. The circuit therefore oscillates at the resonant frequency of the tuned circuit, where the most feedback is produced.

Capacitor C23 couples the tone generator's aerial (Aerial 2) to the output end of

COMPONENTS

Approx. Cost
Guidance Only

£30

excl. case & batts.

Resistors

R1, R2, R14, R15, R24, R28	6k8 (6 off)
R3, R6	470k (2 off)
R4, R7, R9	100k (3 off)
R5	150k
R8	3M3
R10	56k
R11	4M7
R12	2k2
R13	27k
R16	270Ω
R17	22k
R18, R19, R21	10k (3 off)
R20	2Ω7
R22	3k3
R23, R27	1M8 (2 off)
R25, R29	4k7 (2 off)
R26, R30	560Ω (2 off)
R31, R33	39k (2 off)
R32	2M2
R34	3k9

All 0.25W 5% carbon film

Potentiometers

VR1	10k rotary carbon, lin
VR2	22k rotary carbon, lin
VR3	10k rotary carbon, log.
VR4	1k rotary carbon, lin

Capacitors

C1, C25	100μ axial elect. 10V (2 off)
C2	100μ radial elect. 10V
C3, C5, C16	22p ceramic plate (3 off)
C4, C18, C24	330p ceramic plate (3 off)
C6	220n polyester
C7, C26	1μ radial elect. 50V (2 off)
C8	220μ radial elect. 10V
C9, C27	4n7 polyester (2 off)
C10	2μ2 radial elect. 50V
C11, C28, C29	100n ceramic (3 off)

See
**SHOP
TALK**
page

C12	100n polyester
C13	470μ radial elect. 10V
C14, C19	47μ radial elect. 25V (2 off)
C15, C21	47p polystyrene (2 off)
C17, C22	1n mylar (2 off)
C20	33p polystyrene
C23	100p ceramic plate
VC1	5.6 to 65p miniature polypropylene dielectric, single turn, preset trimmer

Semiconductors

D1, D2	OA91 germanium signal diode (2 off)
D3	red panel l.e.d.
TR1, TR2, TR3	BC549 npn silicon transistor (3 off)
IC1, IC2, IC5	TL071CN j.f.e.t. op.amp (3 off)
IC3	CA3140E MOSFET op.amp
IC4	CA3080E transconductance op.amp
IC6	LM380N audio amp i.c.
IC7	78L05 +5V 100mA voltage regulator

Miscellaneous

L1, L2	1mH radial inductor (2 off)
S1, S2	min. s.p.s.t. toggle switch (2 off)
SK1	phono socket
LS1	miniature 8 ohm loudspeaker
B1	9V battery pack (6 x AA size cells in holder)

Stripboard, size 34 copper strips by 82 holes; 8-pin d.i.l. socket (5 off); 14-pin d.i.l. socket; telescopic radio aerial (see text) – 2 off; PP3 type battery connector; control knob (4 off); large plastic case (see text); connecting wire; solder pins; nuts, bolts and spacers; solder etc.

the tuned circuit. The hand capacitance is therefore in parallel with C21 and tends to pull this oscillator lower in frequency.

One of the oscillators must be tuneable so that the required starting pitch can be set. Trimmer capacitor VC1 enables the operating frequency of the oscillator based on transistor TR1 to be tuned over a fairly wide range of frequencies. In theory it should be sufficient to set the required tone using this trimmer, and then make no further adjustment.

In practice, even though the two oscillators are basically the same, their frequencies are likely to drift apart over time. It is therefore advisable to have an externally accessible tuning control so that the tuning can be periodically readjusted.

Unfortunately, suitable variable capacitors, at a reasonable price, are difficult to obtain these days. Therefore, capacitor C16 and potentiometer VR4 are used to effectively provide a crude variable capacitance in parallel with trimmer VC1.

This arrangement gives only a relatively limited tuning range, but it is perfectly adequate in this respect. Coarse

tuning is carried out using VC1, with VR4 only being needed to make minor adjustments.

Be Stabilised

There can be a major problem with any circuit that uses two oscillators operating on similar frequencies. Any coupling between the two oscillators tends to lock them onto the same frequency.

This has to be largely avoided with a Theremin circuit as it would prevent an audio beat note from being produced. In this case any coupling is minimised by using the low impedance output signals at the emitters of TR1 and TR2, plus a simple passive mixing circuit that uses relatively high value series resistors (R31 and R33).

Transistor TR3 is used as a common emitter amplifier that compensates for the losses through the passive mixer. The slight non-linearity of TR3 helps to generate the sum and difference frequencies, with capacitor C27 filtering the input and sum frequencies to leave the required difference signal.

EPE THEREMIN - CIRCUIT

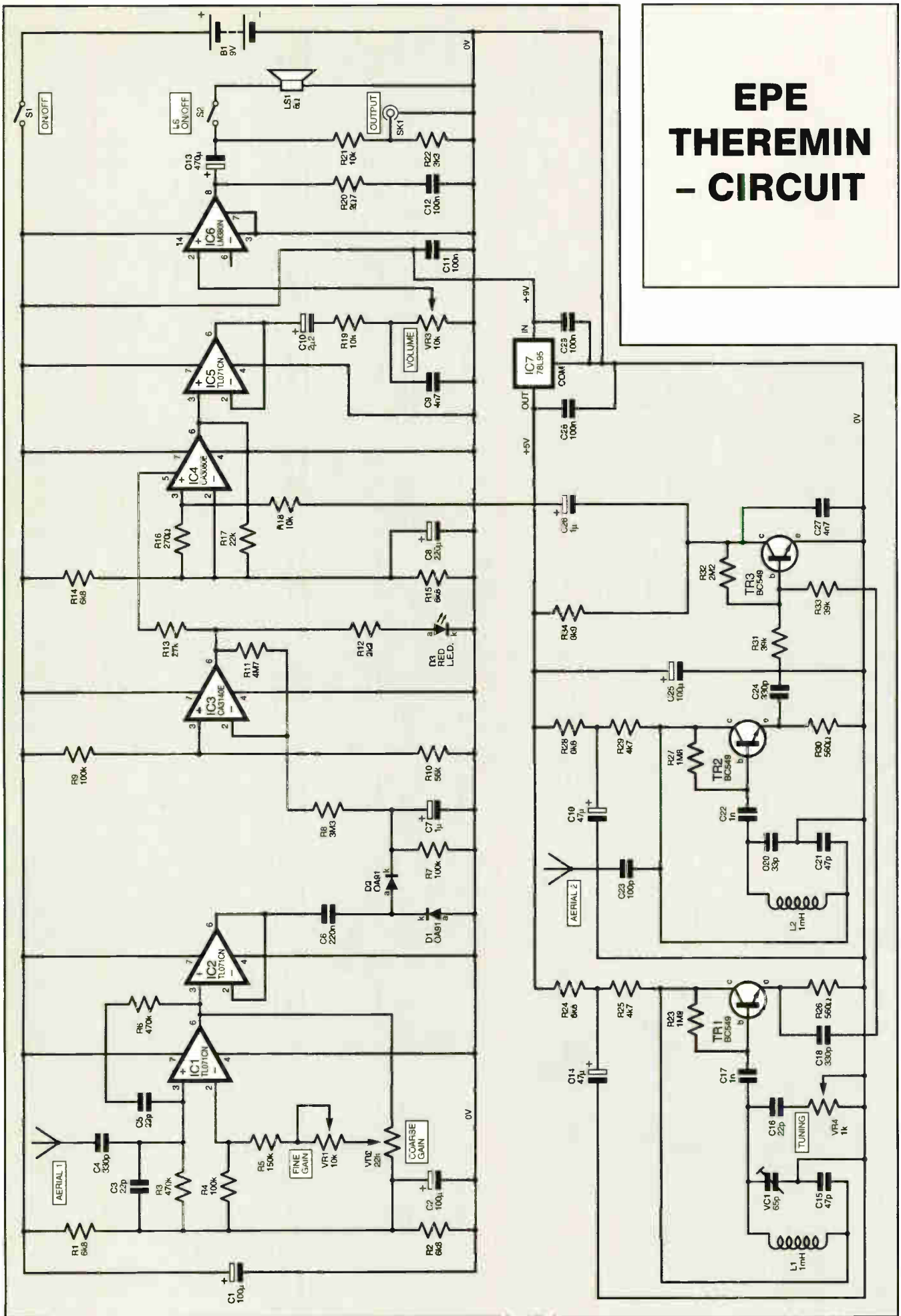

Fig.3. Complete circuit diagram for the EPE Theremin. The two distinct sections of the "instrument" can be seen.

EPE THEREMIN – CIRCUIT

A stabilised 5V supply for the tone generator is provided by voltage regulator IC7. Using a well stabilised supply for the oscillators helps to minimise any problems with tuning drift. The supplies to the oscillators have separate decoupling networks (R24/C14 and R28/C19), which helps to avoid problems with the oscillators locking on to the same frequency.

The basic current consumption of the Theremin circuit is a little less than 20mA, but it rises considerably when the "instrument" is played at high volumes. It is therefore advisable to use a fairly high capacity 9V battery, such as six AA size cells in a holder.

Construction

The EPE Theremin is constructed on large piece of 0.1 inch pitch stripboard having 82 holes by 34 copper strips. This is not a standard size for stripboard so a larger piece must be trimmed to size. The top-side component layout for the board appears in Fig.4, together with details of the cuts required in the copper tracks on the underside.

Stripboard is easily cut along rows of holes using a hacksaw, but some boards are quite brittle so it is advisable to proceed gently. Cutting along rows of holes tends to leave rough edges, but these can be carefully filed flat. If you use a board that has around 36 to 39 copper strips it is probably not worthwhile trimming off the extra strips. Just ignore the unnecessary strips along one edge of the board.

The cuts or breaks in the copper can be made using a hand-held twist drill bit of about 5mm in diameter or you can purchase a special tool for track cutting. A substantial number of cuts are required so make sure that none are overlooked and be careful with their placement. Double-check the placement of each one before actually cutting the strip. Do not cut deeply into the board, but make sure that each cut fully severs the copper strip.

Board Assembly

Construction of the board is not particularly difficult and it presents little that is out of the ordinary. However, with a board of this size it is obviously very easy to make positional errors when fitting the components, so take due care with the placement of each component; working from the smallest up to the largest. Dual in-line (d.i.l.) sockets are recommended for all the i.c.s.

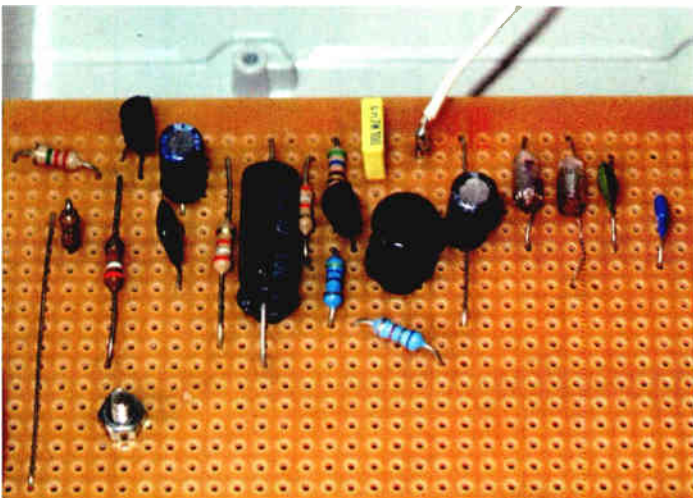
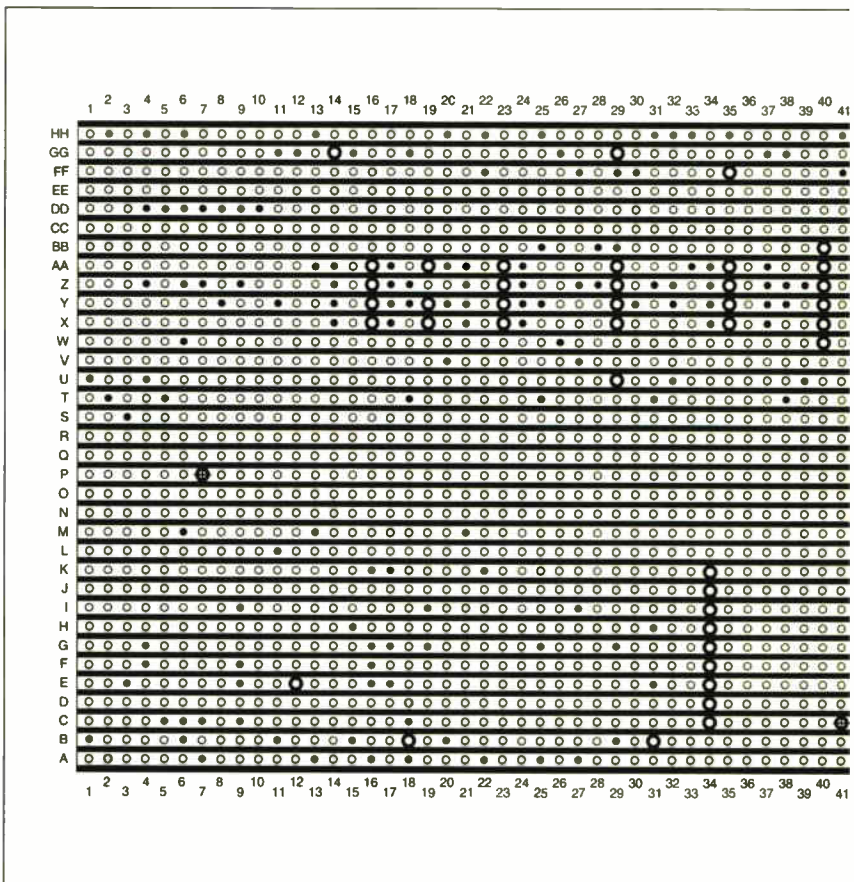
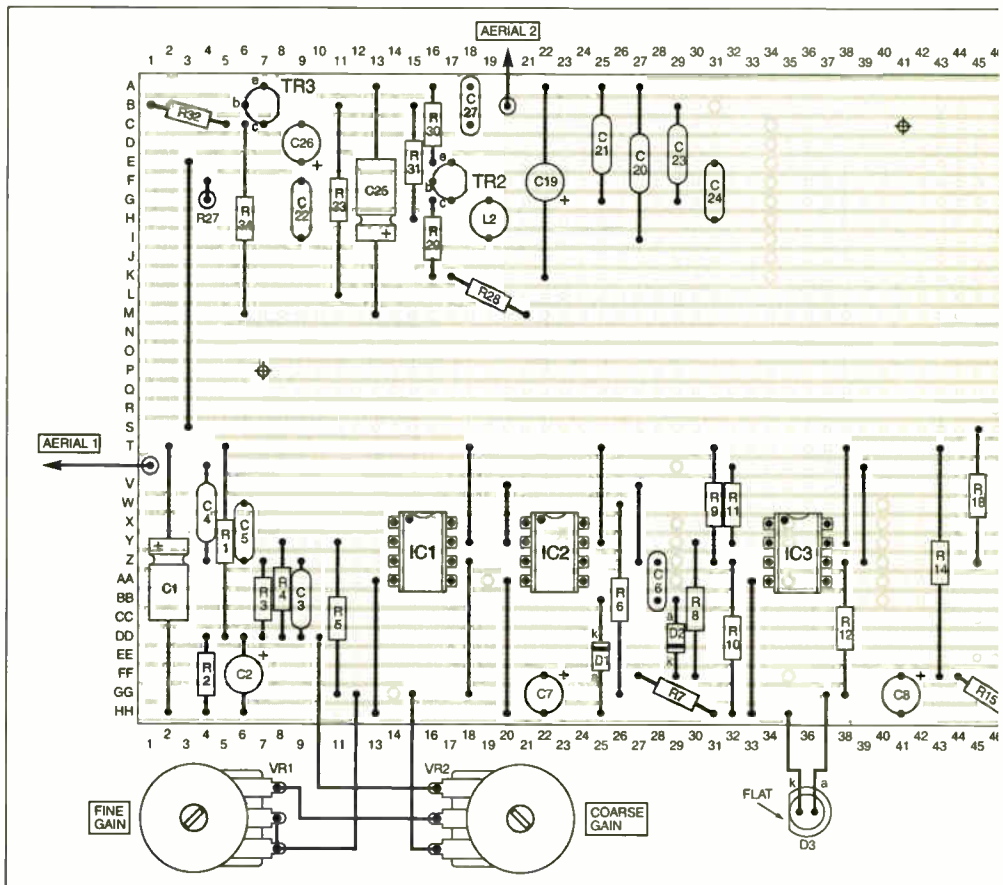

Top-left of the circuit board showing component layout for the tone generator.

Fig.4. Stripboard topside component layout, interwiring details to off-board copper tracks. Double-check all copper breaks and positioning of

ROBOTS

SPECIAL SUPPLEMENT

**An Android's eye view of what's
what and where and available
to the Hobbyist Constructor.**

**With a closer look at products
from various suppliers**

**Plus internet contact details for
many other robotics suppliers
around the globe**

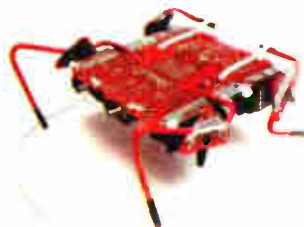

JAYCAR – A SOURCE FOR ROBOTICS PERIPHERALS (AND OTHER PRODUCTS)

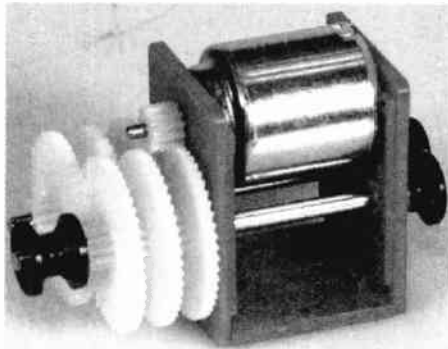

YG-2730
Low Cost Motor & Gearbox Set £5.20
 This set comes with a 3VDC 12,000r.p.m. motor and a set of plastic gears that enable various ratios to be assembled. Output speeds vary depending on the gears selected.
 Approx. output speeds
 3,000/750/187/46/12/9r.p.m.
 Shaft diameter 0-12in.



YG-2734
High Torque 12VDC Reversible Geared Motor £5.50
 This powerful 12V motor features a hardened steel shaft and sintered bronze bearings for a long service life and will deliver plenty of torque. Great for driving wheels or other traction devices.

Torque	10-4lb/in.
Gearing ratio	244:1
Approximate length	2in.
Current at full load	1380mA
Output shaft speed	36r.p.m.
Output shaft dia.	0.16in.

Other models are also available that will deliver up to 43-3lb/in.

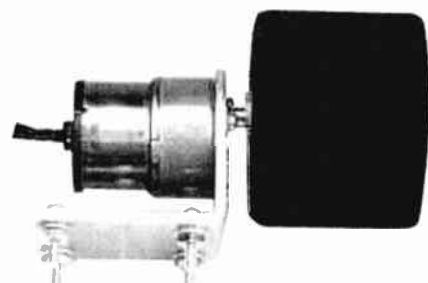

YG-2796
Robot Wheel Kit £27.50
 Designed to simplify mechanical assembly and provide an easy solution for skid-steering systems.
 Torque 3-2lb/in.
 Wheel dia. 2.5in.
 Gear ratio 30:1
 No load speed 200r.p.m.
 Operating voltage 4.5VDC to 12VDC

YG-2783
Spider Coupler Set £1.80
 Allows connection of a motor and a shaft that may be slightly misaligned or short. Also provides torsional shock absorption.
 Accepts a 1/4in. shaft
 1.2in. overall length



YM-2776
High Power 12VDC Motor £5.50
 This un-geared motor has a hardened shaft, sintered bronze bearings and direct drive output.

Torque	0-37lb/in.
Approximate length	3-5in.
Current at full load	4-7A
Output shaft speed	9,800r.p.m.
Output shaft diameter	0-12in.

Other models are available that operate on voltages of 6V or 12VDC

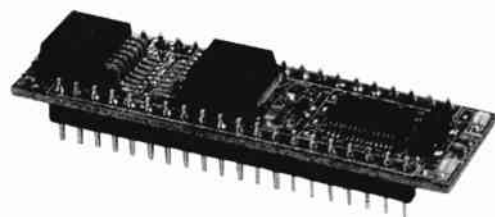

YG-2792
Motor Mind DC Motor Controller £30.25
 This module is ideal for small robotic applications and will control 2 x 10-24VDC brushless motors. The motor outputs can be paralleled to control a single, larger motor if desired.
 4 amps max continuous current
 Over current and over temperature protected

BT-1363
Book – Combat Robots Complete £16.00
 Covers subjects such as electronics and wiring, R/F remote control, wheels, batteries, chassis, armour, weapons, and much more. Includes a CD with three robot plans.

Other titles include:
BT-1370
Robotics, Mechatronics and Artificial Intelligence £35.20

BT-1365
Robot Builder's Sourcebook £39.97

BT-1367
PIC Robotics – A Beginner's Guide to Robots £39.97



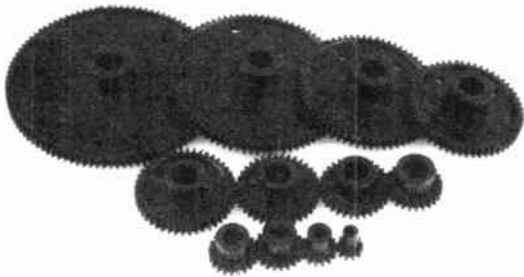

**YG-2780
12 Piece Gear Set (48 Pitch) £22.00**

A versatile range of 12 gears ranging from 10 to 100 teeth. The set enables a vast range of ratios to be assembled and are made from industrial quality nylon. They do not require lubrication.

**YG-2786
14 Piece Sprocket set £16.50**

Made from industrial grade nylon, these sprockets are ideal for driving parallel shafts that are too far apart to be gear driven. size range from 3 to 48 teeth. Max chain load 2-4lb.

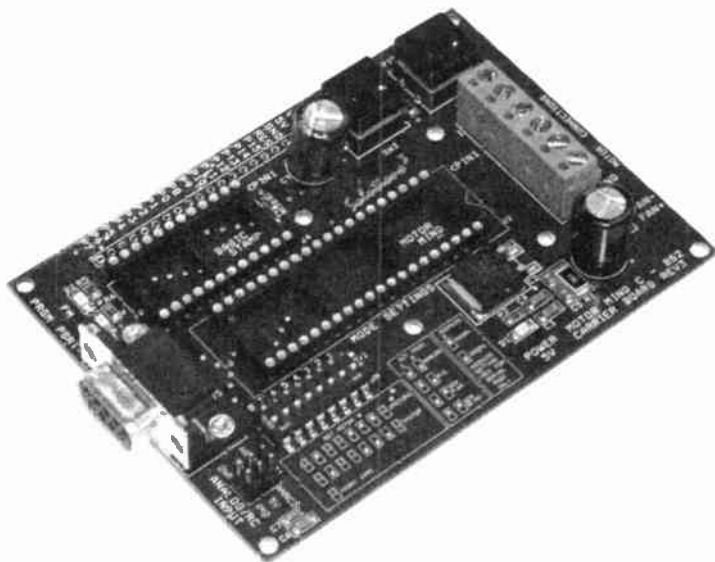
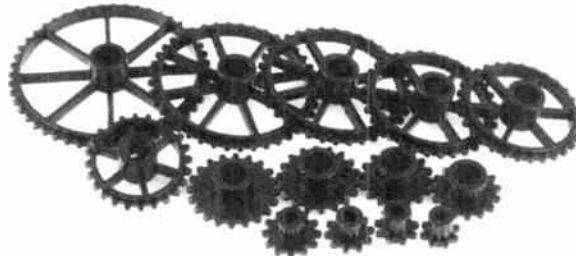

**YG-2794
Carrier Board for Motor Mind and BASIC Stamp Controller £33.00**

With the Motor Mind C carrier board your development shifts into overdrive as all connections are accounted for, a programming port for the BS2 is in place and all I/O pins are brought out to wiring points. Screw terminals for motor connection 7VDC to 30VDC

JAYCAR ELECTRONICS

Log on to
www.jaycarelectronics.co.uk/catalogue
for your FREE catalogue!

TOLL FREE ORDERING 0800 032 7241
100 Silverwater Road, Silverwater, NSW 2128,
Sydney, Australia

WCN SUPPLIES

Specialists in bargain value offers

A selection of stepper motors currently on special offer at £1 each

The Old Grain Store
Rear of 62 Rumbridge Street
Totton, Southampton SO40 9DS
Telephone or Fax on: Southampton 023 8066 0700
Email: info@wcnsupplies.fsnet.co.uk
www.wcnsupplies.com



MILFORD INSTRUMENTS SPECIALISING IN ROBOTIC BASES



BigFoot £76.38

BigFoot is a low cost walking biped model using only two servos and the Stamp1 derivative controller. The control board is supplied pre-assembled and tested and all the body parts are precision cut for simple mechanical assembly. BigFoot is supplied with a standard programme that may be modified by the user using the Parallax editor software.



Alex-Animated Head £123.38

A simple but highly effective introduction to animatronics. The Alex head uses four servos and a pre-built control board with sound recording/playback facilities to generate unconvincingly realistic head-like actions. No computer is required as the sequence is recorded action by action in real time from the controller board.

Boe-Bot £217.38

A very popular roving robot using the Stamp2. Used extensively in education and well supported in terms of user code and add-on sensors and accessories. Incorporates a breadboard area for user experimentation.

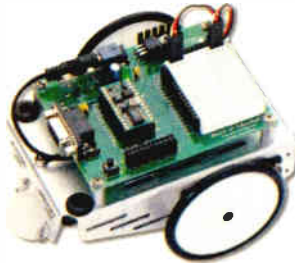

Toddler £276.13

Toddler is a Stamp2 biped based on the original BigFoot design. The body parts are from aluminium for durability and the kit comes complete with extensive documentation and code samples.



Tec-Arm – Robotic Arm £299.63

Tec-Arm uses powerful RC servos to provide 6 degrees of rotation in this robotic arm. The Tec-Arm runs under Windows with the supplied software and allows movements to be controlled and recorded in real time. The arm components are pre-cut for ease of assembly and the control board is supplied assembled and tested. The maximum working reach of the arm is approximately 250mm.

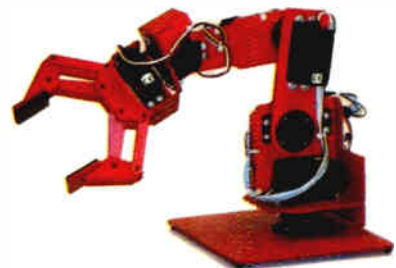

StampBug2 £111.63

This is the latest Stamp2 based version of the popular walking insect kit. The kit is supplied pre-soldered and just requires simple mechanical assembly. StampBug is provided with sample code routines to make the Bug walk forwards, backwards, stop and turn which can be incorporated into the user's own programmes. StampBug uses a Windows programming environment and programming is achieved using a standard serial port or from a USB port with suitable adaptor.



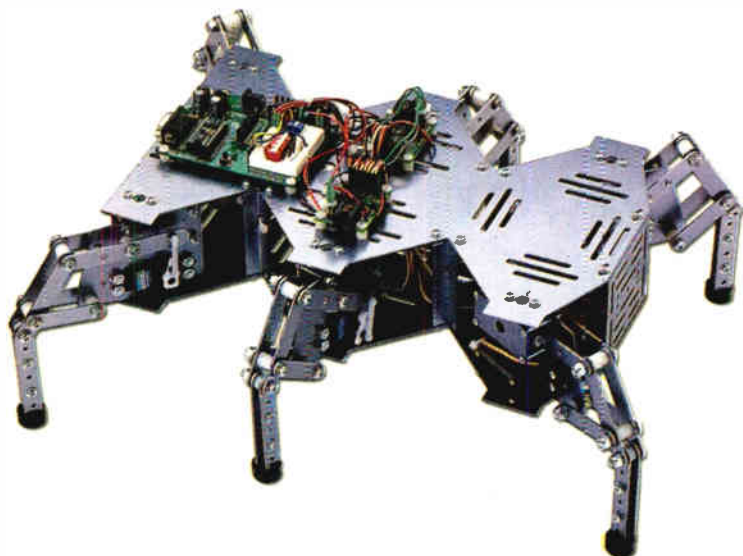

HexCrawler £706.18

Stamp2 based walking robot for serious walking studies. Sturdy aluminium chassis and two servos per leg for complex walking patterns. Extensive documentation and code samples.

MILFORD INSTRUMENTS LTD

Tel: 01977 683665 Fax 01977 681465

Sales@milinst.com

www.milinst.com

Prices include shipping and VAT

TWO EPE ROBOTS

ADDING CYBERNETIC FUN TO YOUR
HOBBYIST ELECTRONICS ACHIEVEMENTS!

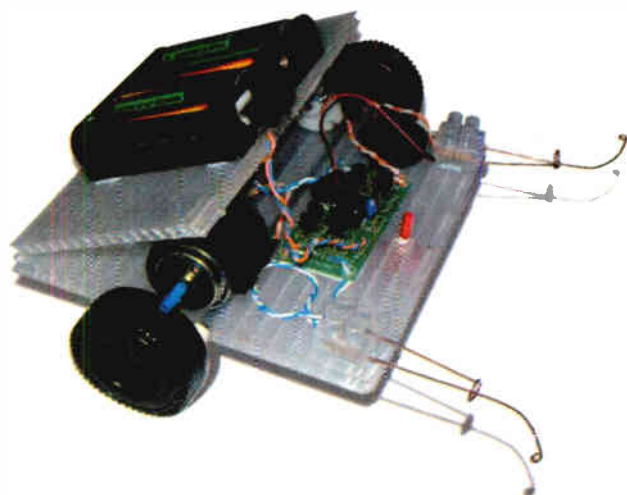

BRAINIBOT BUGGY

An easy-build design with a mind of its own!

By Mark Stuart and Peter Balch

Published in *EPE* February '03

Kit available from Magenta Electronics,
price £16.99.

Tel: 01283 565435 Fax 546932

sales@magenta2000.co.uk

www.magenta2000.co.uk

SMART KART

By Owen Bishop

Educational and programmable mobile
robot with "bells and whistles" and more!
Series commencing in *EPE* October '04

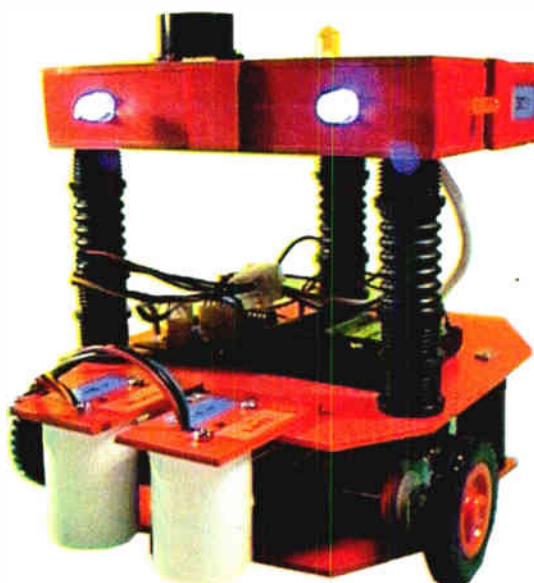

TOTAL ROBOTS ROBOTICS, CONTROL AND ELECTRONICS TECHNOLOGY SPECIALISTS

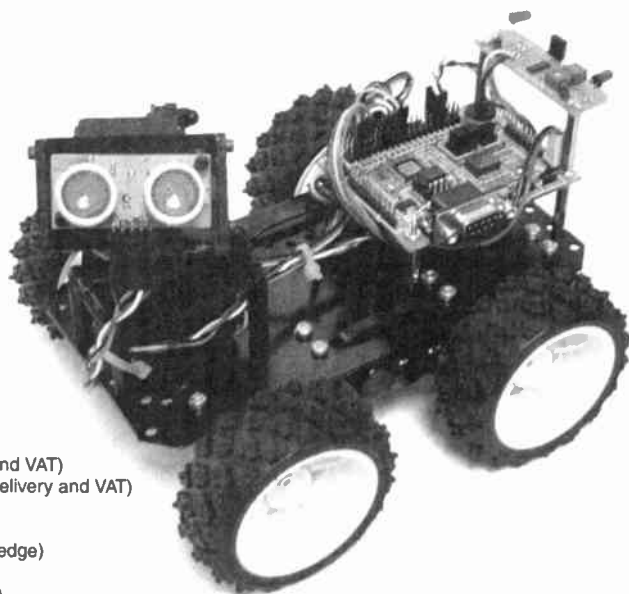

X4e
Kit Price: £259.00 (ex delivery and VAT)
Assembled Price: £289.00 (ex delivery and VAT)
Spec (approx.):
Height: 135mm
Width: 160mm (wheel to wheel-edge)
Length: 240mm
Weight: 815g (with battery pack)
View more details here:
http://www.totalrobots.com/program_files/x4e_rover.htm



Lynx 6 Arm
Lynx 6 Arm Combo Kit: £240.00 (ex delivery and VAT)
Lynx 6 Arm Assembled: £300.00 (ex delivery and VAT)
Spec:
No. of axis: 5 + Gripper
Servo motion control: local closed loop
Height (arm parked): 140mm
Height (reaching up): 458mm
Reach (forward): 368mm
Gripper opening: 51mm
Lift weight (arm extended): approx. 85.05g
Range of motion per axis: 180°
Accuracy of motion per axis: Servo controller dependant (SSC 0.72°)
Servo voltage: 6 VDC
View more details here:
http://www.totalrobots.com/program_files/robot_arm.htm

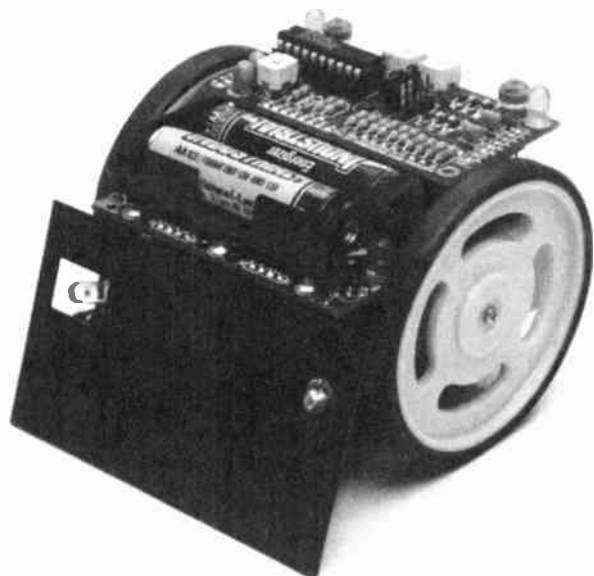

Sumovore
Single price: £56.00
Pair Price: £106.00
(Prices exclude delivery and VAT)
The Solarbotics Sumovore is a strong, modular design with over 500 man-hours of development and 21 prototypes behind it.
View more details here:
<http://www.totalrobots.com/beam.htm#minisumo>

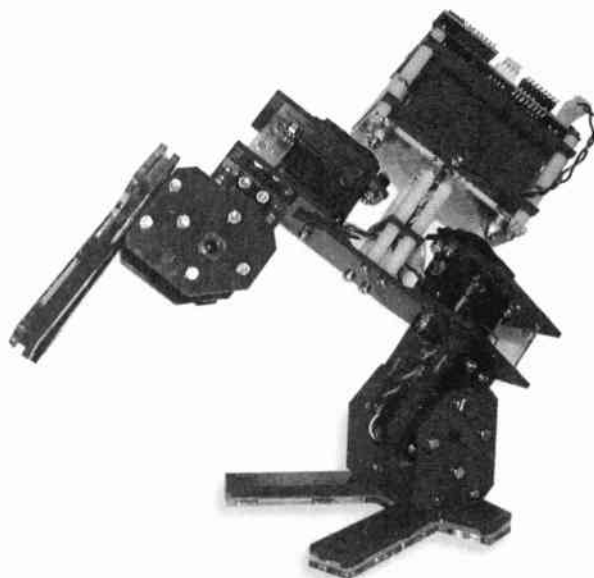

Sted-E-man
Prices:
Sted-E-Man Kit (without OOPic-R microcontroller):
£155.00 (ex delivery and VAT)
Sted-E-Man Kit (with OOPic-R): £224.00 (ex delivery and VAT)
Sted-E-Man Kit (24-pin micro version – no micro):
£185.00 (ex delivery and VAT)
Spec (approx):
Height: 230mm; Width: 200mm; Length: 150mm; Weight: 860g
View more details here:
http://www.totalrobots.com/stedeman_files/stede-man.htm

H2

View video clips here:

http://www.totalrobots.com/program_files/hexapod.htm

Price: £310.50 (ex delivery and VAT)

Spec:

Servo motion control: local closed loop

Motion speed: more than 12in. per second

Height: 140mm

Width: 432mm (leg to leg)

Length: 343mm

Ground clearance: 89mm

Weight (without batteries): 1247.4g

Servo voltage: 6 VDC (Std servos used at 7.2 VDC)

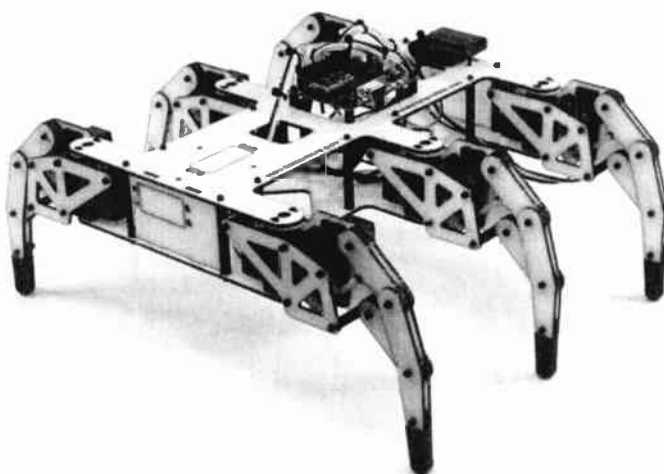

TR Rover

If you're looking for a programmable mobile robot suitable for a beginner, with the potential to add increasingly sophisticated features, the TR Rover is the product for you.

http://www.totalrobots.com/program_files/tr_rover.htm

Dimensions (approx.): Height: 125mm, Width: 220mm, Length: 220mm.

The TR Rover comes with an OOPic-C microcontroller mounted to the Robotics Control Board Version2 (RCBV2).

In the image, a Linetracker sensor and Infra Red Control Module have been added, enabling the TR Rover to be controlled by a TV remote control in manual mode, or follow a black on white line in autonomous mode.

Kit Price: £140.00 (ex delivery and VAT)

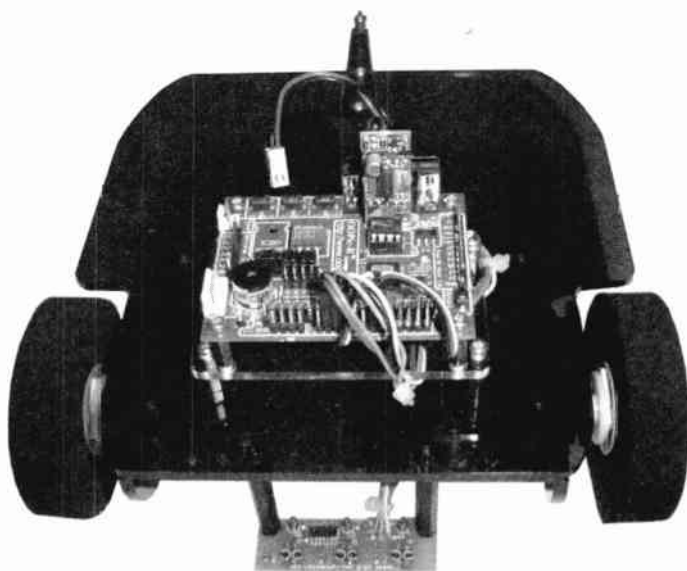

SRF04 Mount

(This is part of the X4e Kit but is also available separately)

View more details here:

http://totalrobots.com/access_files/sensors.htm#srf04_ultra

The SRF04 Ultrasonic Range Module is a high quality ultrasonic range finder which can easily be connected to the OOPic (or other) microcontroller to measure/detect the presence of obstacles. Price: £14.50 (Price excludes delivery and VAT)

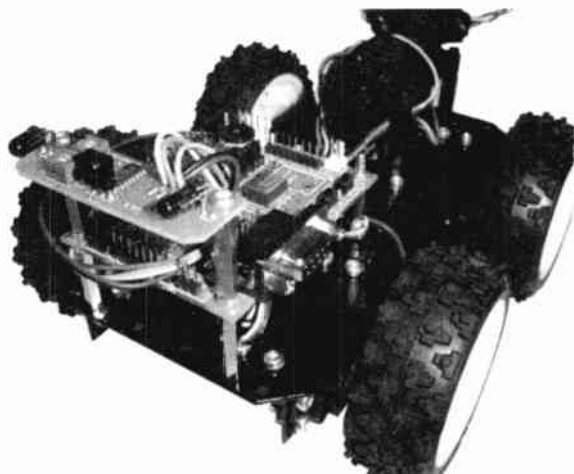

IRPD_Mount (This is part of the X4e Kit but is available separately)

http://www.totalrobots.com/access_files/sensors.htm#irproxdetect

When you have perfected the use of snap switches as whiskers on your small mobile robot, then it's time to move up to a no contact method of obstacle detection. The IRPD coupled with a microcontroller is the next step in obstacle detection and avoidance

Price: £25.00

(Price excludes delivery and VAT)

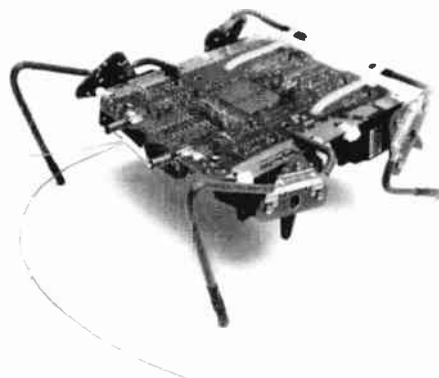

KIT-KSW2001

The Scoutwalker 2

This kit produces a very capable four motor battery-powered walking robot with forward/backward/left/right capabilities controlled by a pair of tactile sensors – all without a microprocessor!

Kit Price: £80.00

Assembled Price: £230.00

(Prices exclude delivery and VAT)

View more details here:

<http://www.totalrobots.com/beam.htm#scoutwalker2>

USEFUL ROBOTICS WEB LINKS

Active-Robots. www.active-robots.com
Robot kits, controllers and accessories

Android World. www.androidworld.com
Site devoted to androids, with links

Arrick Robotics. www.robotics.com
Masses of robotics information and links

Channel4 Robots.
www.channel4.com/science/microsites/R/robots
Channel 4 TV's robotics site

Chaoskids. <http://chaoskids.com>
Photographs and other images of toy robots

Commotion. www.commotiengroup.com
Motors, gearboxes, wheels, gears, construction materials, etc

Cybermarket. www.cybermarket.co.uk
Robot kits, etc

Dangerous Machines. www.dmachine.tv
Radio control interfaces, mainly for Robot Wars robots, etc

Devantech Ltd. www.robot-electronics.co.uk
H-bridge drivers, servos, etc

Dr Gavin Miller's Snake Robots. www.snakerobots.com
Descriptions and photos of snake robots, with links

Fischertechnik. www.sciencekits.com
Construction kits, motors, sensors, controllers, etc

GoRobotics. www.gorobotics.net
Robot links and more

Greenweld. www.greenweld.co.uk
Robot components, motors, gears, caterpillar tracks, pneumatics, etc

GT Electronics. www.gt-electronics.freemove.co.uk
Motor speed and servo controllers, etc

Hitec. www.hitecrd.com
RC systems, servos, etc

Instruments Direct. www.instrumentsdirect.co.uk
Importers and distributors of robot kits, etc

Jaycar Electronics. www.jaycarelectronics.co.uk
Motors, gear boxes, gears etc

Lego. <http://shop.lego.com>
The renowned construction system site

LeToy. www.letoy.co.uk
Robot kits, science and educational toys, etc

Lynxmotion. www.lynxmotion.com
Robot kits, components and boards, etc

Magenta Electronics Ltd. www.magenta2000.co.uk
Robot kits, motors, components, etc

Mark III Robot Store. www.junun.org
Autonomous robot components, sensors, wheels, motors, drivers, servos, etc

Mekatronix. www.mekatronix.com
Autonomous mobile robots and robot kits

Mike's Models. www.mikes-models.co.uk
RC systems, servos, components

Millford Instruments. www.milinst.com
Robot arms, animated heads, biped and six-legged walkers, motor driver boards, ultrasonic modules, etc

Mobile Robotics Research Group.
www.dal.ed.ac.uk/groups/mrg/MRG.html
A group of people who share a broad approach to AI and robotics

Mondo-tronics Robot Store. www.robotstore.com
Robot kits, circuits, motors, RC models, accessories, etc

Parallax Inc. www.parallax.com
Robot kits, components, servos, etc

Real Robots. www.realrobots.co.uk
Roboteers club, magazine, links, shop

Retrofire Rockets and Robots. www.retrofire.com
An interesting browsing site, with links

Ripmax Plc. www.ripmax.com
UK wholesale importers and distributors of RC models and systems, etc

Robot Store. www.robotstore.com
Robot kits, parts and ideas

Robotic Research Group. www.robots.ox.ac.uk
A group of like-minded engineers working in robotics research and AI

Rumble Robots UK. <http://rumblorobots.fateback.com/home.htm>
"The ultimate Rumble Robots Fansite!"

Squires Model & Craft Tools. www.squirestools.com
Motors, gears, pulleys, materials, tools, etc

SuperDroid Robots. www.superdroidrobots.com
Autonomous robot projects, sensors, etc

Team Delta. www.teamdelta.com
Motors, RC interfaces, controllers, bearings, etc, mainly for combat robots

Teaching Resources. www.mutr.co.uk
Motors, components, pneumatics, books, etc

Technobots Ltd. www.technobots.co.uk
Motors, speed controllers, RC systems, etc

Total Robots Ltd. www.totalrobots.com
Robot kits, components, etc

Victorian Robots. www.bigredhair.com/robots
Images and information on Victorian-era robots

W.Hobby Ltd. www.hobby.uk.com
Kits, tools, materials, books, etc

WCN Supplies. www.wcnsupplies.com
Stepper motors, components

4QD. www.4qd.co.uk
Speed controllers, joystick interfaces, RC interfaces, motors, etc

BIG-EARS BUGGY

Published in *EPE* August '02
By Thomas Scarborough

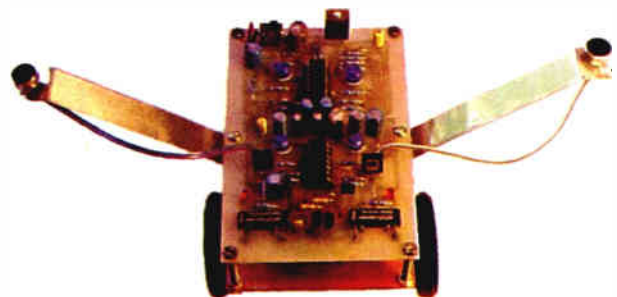

A mobile "pet" that follows your voice!

BOARD CONSTRUCTION

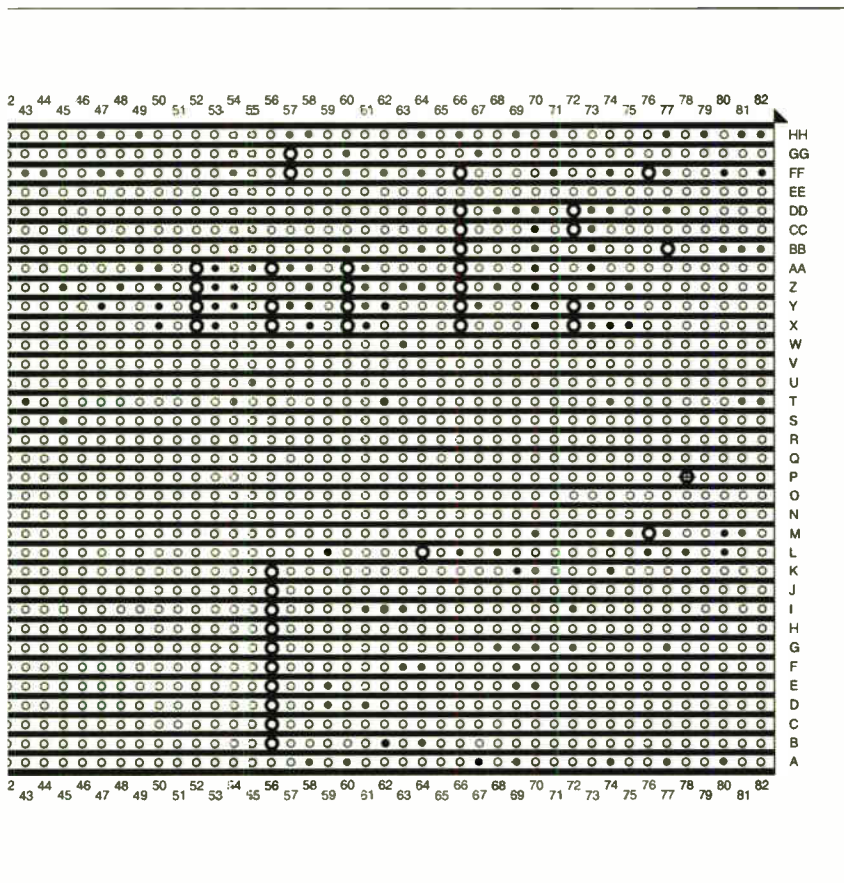
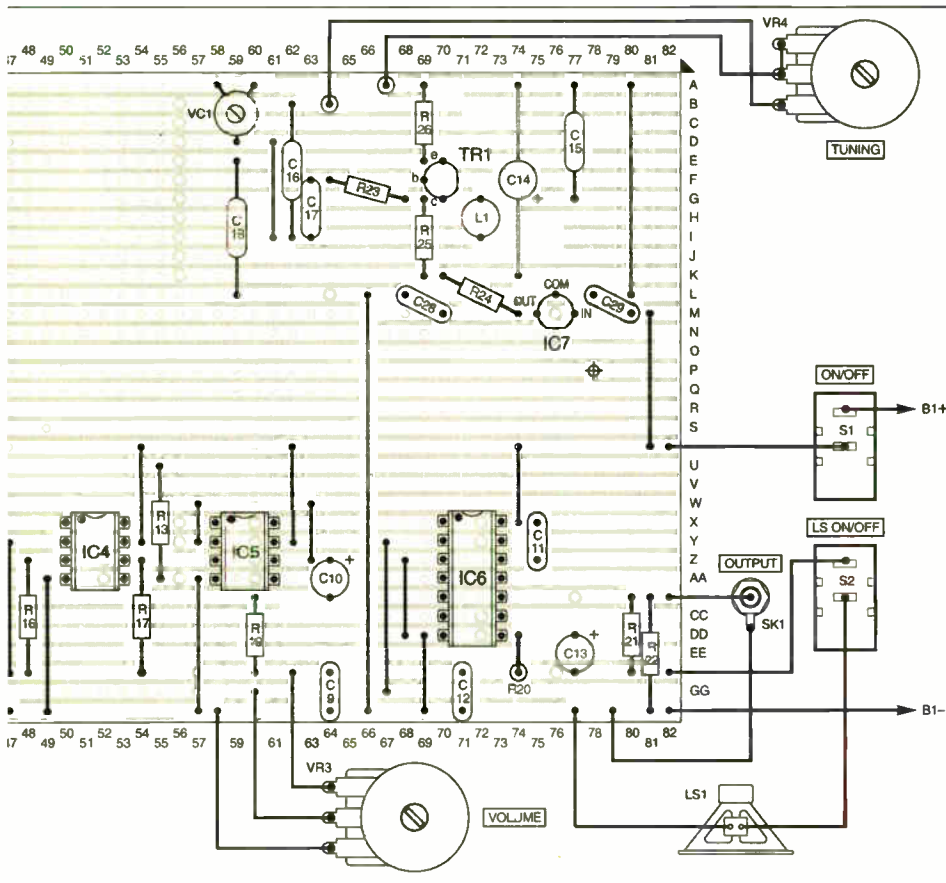

ward components and underside view showing the breaks required in all topside wire links before mounting any components.

Inevitably, a fair number of link wires are required, and due care has to be taken in order to avoid overlooking any. Some of the link wires are quite long. In order to avoid short circuits these links must either be very taut or insulated with pieces of plastic sleeving. Fit single-sided solder pins at the points where connections will eventually be made to the controls and other off-board components.

The two inductors used in the prototype are radial components, but the circuit should work just as well using axial ones mounted vertically. The trimmer capacitor specified for VC1 has a pin layout that matches up with holes in the board, but the three pins are too large to fit into the holes.

Rather than enlarge the holes and risk damaging the board it is better to fit single-sided pins and then solder the tags of the trimmer to these. This should be straightforward provided both sets of pins are fitted with solder first.

Any trimmer capacitor having a maximum value of around 40pF to 65pF is suitable electrically, but fitting alternatives into this layout could be awkward. Also, in order to fit into this layout easily the polyester capacitors should be printed circuit types having a pin spacing of 5mm (0.2in).

Only one static-sensitive device is used in this design, and it is the CA3140E MOSFET op.amp used for IC3. The normal anti-static handling precautions should be observed when dealing with this component, and the most important of these is for it to be mounted in a socket.

Diodes D1 and D2 are germanium diodes and they are consequently more vulnerable to heat damage than normal silicon

semiconductors. It is not essential to use a heat-shunt when connecting these two components, but each soldered joint must be completed reasonably quickly.

Casing -Up

Due to the size of the circuit board it is necessary to use a large case for this project, but this is essential anyway due to the need for a reasonable distance between the two aerials. The

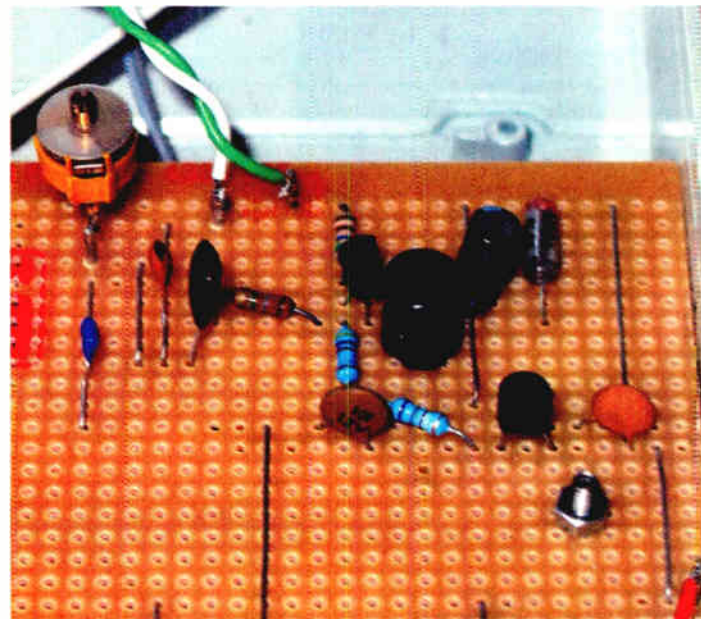

Top-right corner of the circuit board showing layout of components for the "tuneable" oscillator, including the miniature trimmer capacitor.

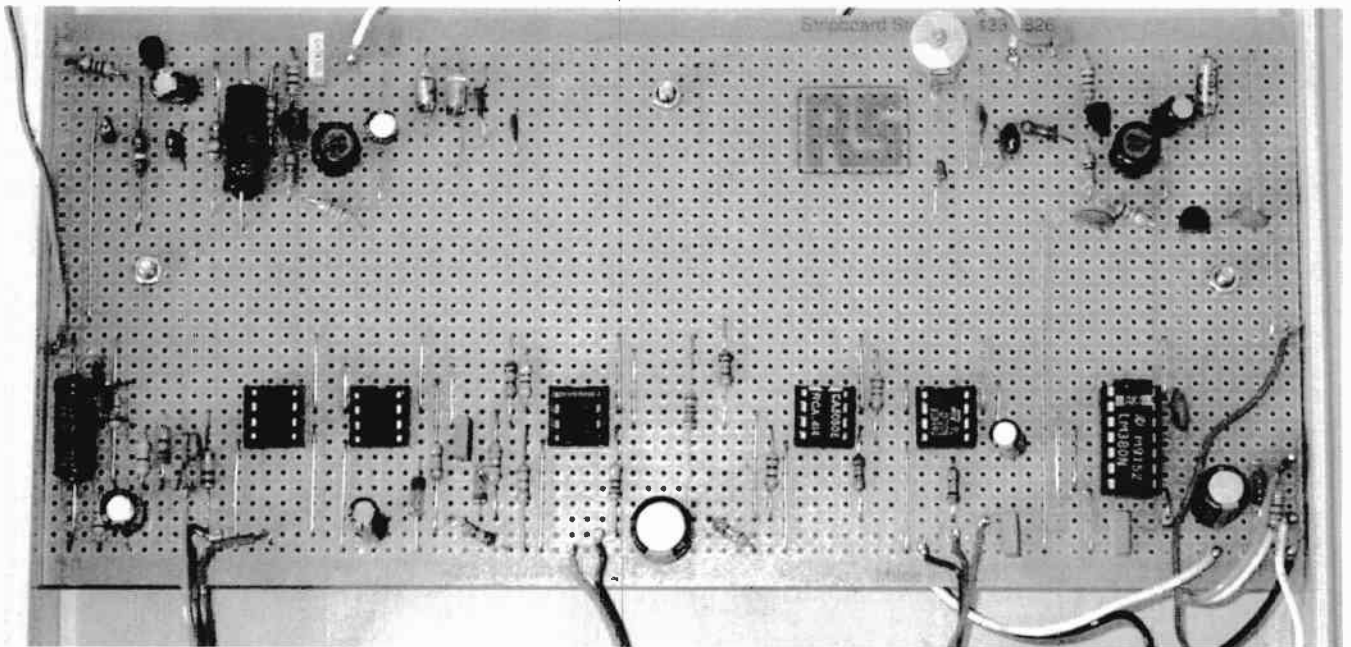

Component layout on the large circuit board. It is recommended that sockets be used for all the i.c.s.

aerials used on the prototype can be angled away from each other, which enables satisfactory results to be obtained with a relatively small gap between them. Normally a gap of at least 300mm is required, and it should preferably be nearer 500mm.

A telescopic aerial or a metal rod about 300mm long is probably the best choice for Tuning Aerial 2. In theory at any rate, a stout rod will give better operating range than a relatively thin telescopic aerial. In practice a telescopic aerial gives good results though. Bear in mind that having a large operating range for this aerial makes it necessary to have the other aerial mounted further away.

Although a second telescopic aerial was used for Volume Aerial 1, with hindsight a metal plate about 150mm square would have been a better choice. The operating range using any form of rod aerial is likely to be quite small, making the instrument relatively difficult to use. The plate can be a piece of aluminium with the connection made via a solder tag bolted to it.

Alternatively, a piece of copper laminate board as used for printed circuit boards will also work well. A connecting wire can, of course, be soldered direct to the copper side of this material.

It is possible to use a metal case, but construction is much easier using a case made of plastic or some other non-metallic material. If a metal case is used it is *essential* to insulate the aerials from the case.

This is not too difficult with the aid of a couple of grommets having the same inside diameter as the base section of the aerial. One grommet is fitted into the top panel of the case and the other is mounted just below it in an aluminium bracket.

Aerial Mounting

The aerials used on the prototype have a mounting bush at the base which makes it easy to mount them on a non-metallic case. It is just a matter of drilling a 10mm diameter mounting hole for each aerial and then securing them to the case with the supplied fixing nuts.

Again, things are more awkward if a

metal case is used. A large cutout would have to be made for each aerial, with a plate made from plastic or some other insulating material being mounted behind each cutout. The aerials would then be mounted on these plates.

If a metal plate is used for Aerial 1, it will not work properly if it is mounted behind a metal case. It would either have to be fitted externally or behind a cut-out in the top panel, taking care to ensure that it is properly insulated from the case. Using a non-metallic case is the easier and more practical approach.

With most large cases it will be possible to mount the controls, i.e.d. D3, socket SK1, and the loudspeaker (LS1) on the front panel. There was insufficient space to permit this with the low-profile case used for

the prototype, and the output socket SK1 was mounted on the rear panel together with tuning control VR4. The latter should need little readjustment once the unit has been set up correctly, so you may prefer to relegate it to the rear panel anyway.

Likewise, due to lack of space on the front panel the loudspeaker had to be mounted beneath the top panel, but this is probably the most effective position for it. Fitting miniature loudspeakers tends to be problematic due to their lack of built-in mounting brackets.

A speaker grille of some kind is also required. The simplest way of producing the grille is to drill a matrix of holes about four or five millimetres in diameter. It is difficult to make a really neat job of this, so try to drill the holes as accurately as

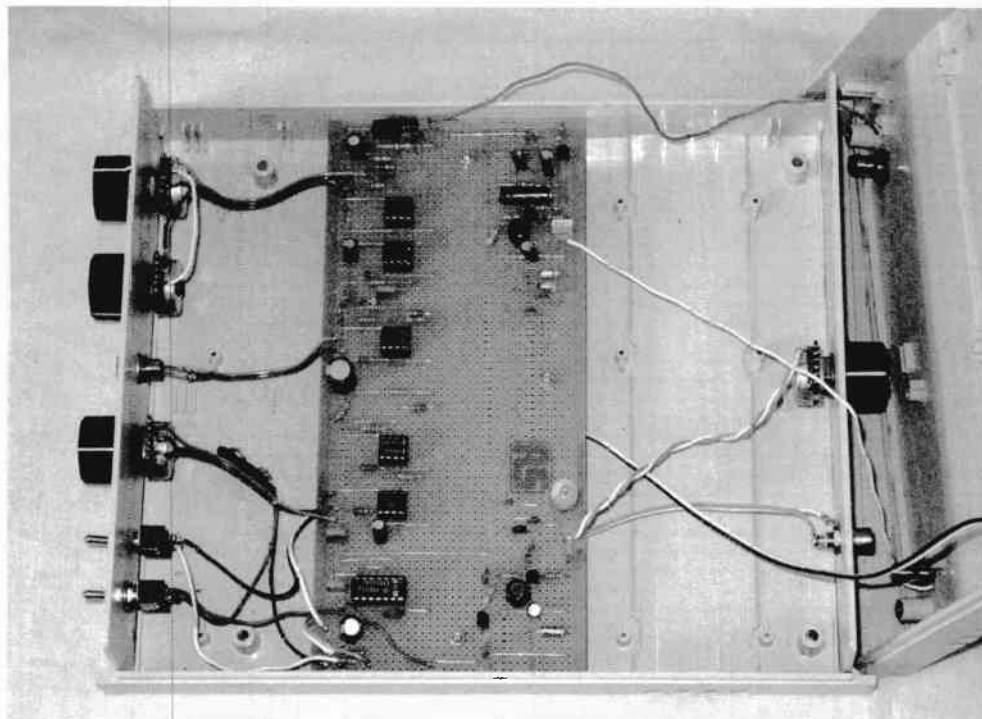

General layout of components and wiring inside the case. Allow plenty of room for the battery pack.

possible. It is probably best to drill small guide holes about one or two millimetres in diameter first, and then drill these out to the required final size.

With the grille completed, the loudspeaker is glued in place behind it using any general purpose adhesive or superglue. Try to avoid getting any adhesive onto the loudspeaker's diaphragm, which could seriously impair its performance.

Interwiring

With the circuit board mounted in the case the hard wiring can be added. This is shown in Fig.4, which should be used in conjunction with the accompanying photographs. The hard wiring is very straightforward, and there is no need to use any screened leads. Avoid having any of the wires longer than is really necessary.

The connections to the battery pack are made via an ordinary PP3 type battery clip. The cathode (k) lead of l.e.d. D3 will be shorter than the anode lead and (or) it will be indicated by a "flat" on that side of the encapsulation.

Tuning In

It is highly likely that the tuning will initially be so far out of adjustment that no audio tone will be produced. It is still possible to setup the volume control circuitry with the aid of l.e.d. indicator D3.

Start with feedback controls VR1 and VR2 adjusted well in a counter clockwise direction, which should result in l.e.d. D3 being switched off. Adjust the Coarse feedback control (VR2) in a clockwise direction until the l.e.d. switches on, and then back it off just far enough to switch it off again.

It is possible that the volume control circuit will then work quite well, but it is more likely that some fine adjustment using VR1 will be necessary. Adjust Fine Gain control VR1 in a counter clockwise direction to bring the circuit closer to the point of oscillation, or clockwise to reduce the sensitivity of the circuit.

Using high sensitivity gives a better operating range, but the circuit will probably show a reluctance to cease oscillating once it has started. VR1 must be fractionally backed off in order to correct this and give a more rapid response time.

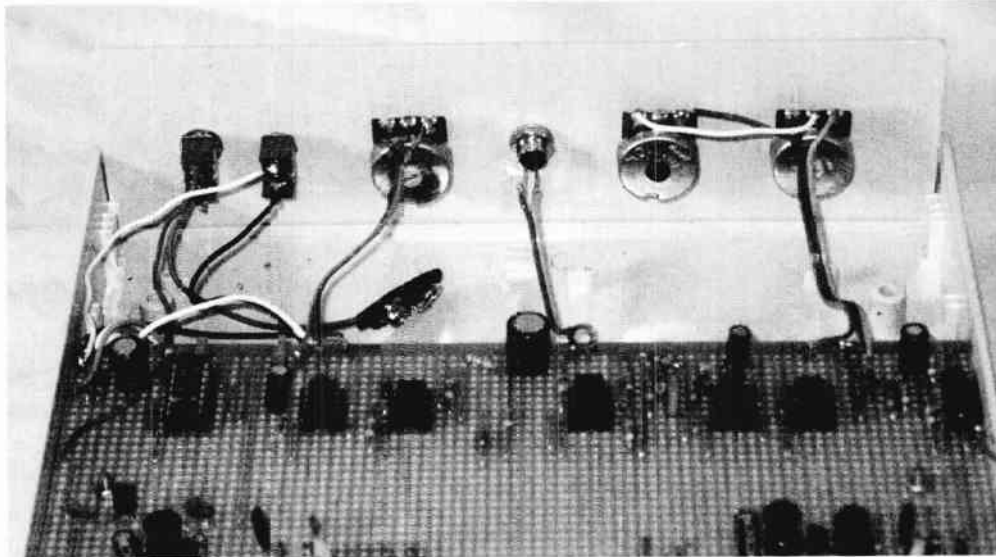

Wiring from the circuit board to the front panel mounted components.

Making a Pitch

When adjusting the pitch controls it is a good idea set VR2 so that l.e.d. D3 is switched on without having to place a hand close to the volume control aerial. The VCA will then let the output of the pitch generator pass straight through to the output stage.

With switch S2 closed and Volume Control VR3 well advanced in a clockwise direction, use a small screwdriver to adjust trimmer capacitor VC1. It should be possible to find a small range of settings where there is a central null, with a tone of increasing pitch being produced if VC1 is adjusted either side of that setting.

Slightly offset VC1 from that central setting so that a tone of low pitch is obtained. If this produces a reduction in tone when a hand is placed near the pitch aerial, adjust VC1 through the central null and out the other side so that a low frequency is again produced. Placing a hand near the aerial should then produce an *increase* in pitch.

As and when necessary, Tuning control VR4 can be used to adjust the basic tone produced by the instrument. Bear in mind that the tone set using VR4 is the lowest one that can be obtained when playing the instrument. If you would prefer to have the pitch reduce as a hand is placed nearer

the pitch aerial, adjust VC1 to the other side of the central null and then set it for the highest note that you will require.

There should be minimal interaction between the volume and pitch sections of the instrument. However, there will be a small but noticeable shift in pitch if Aerial 1 (Volume) is accidentally touched. If this should be a problem it is just a matter of adding some insulation over this aerial.

Making a Play

In some respects a Theremin is very simple to play. It is strictly monophonic for example, so there are no chords to worry about.

On the other hand, there is nothing to help you navigate from one note to another apart from the sound of the instrument. It has to be played "by ear", which is only a practical proposition for those possessing a reasonably good sense of pitch. As with any instrument, it is probably best to start with some scales and progress from there.

Some finger wiggling of the hands used to control the pitch and the volume will respectively introduce vibrato and tremolo effects. Vibrato is effective at giving practically any monophonic instrument a richer and more interesting sound, so it is worthwhile perfecting this technique. □



Rear view of the Theremin showing the phono output socket, tuning control (VR4) and sensor "aerials" mounting.

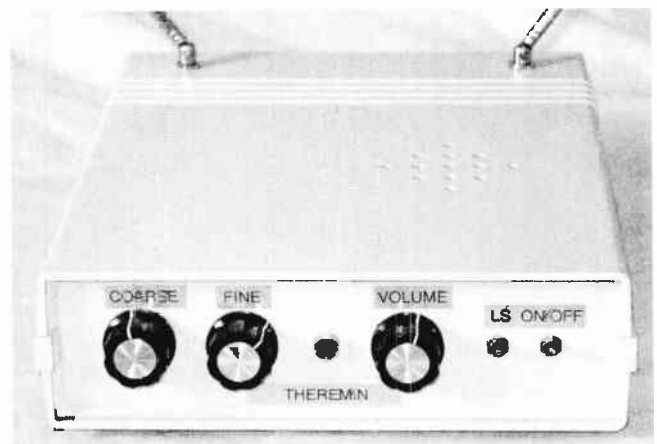

Front view showing layout of the most used controls. The loudspeaker is glued to the underside of the top panel.

New range of Hi Performance Electronic Kits for Cars – Exclusive to Jaycar Electronics Australia

We've sold kits for over 20 years and these are some of the best we've seen for automotive applications. With these kits you can finely tune your performance machine, or make your car become one. With 15 exceptional projects in all - check out our website, www.jaycarelectronics.co.uk or look at pages 12 & 13 in our catalogue for the full range. Don't have our UK pound catalogue? Log on to www.jaycarelectronics.co.uk/catalogue to receive your free 424 page copy!

A Cheap Nitrous Fuel Mixture Controller

KC-S382 £7.25. Due late September '04

Nitrous oxide systems can be expensive to set up, but now you can do it for much less. This project pulses a fuel injector at a preset rate, adding a fixed amount of nitrous fuel when you activate it. It will save you a bundle on dedicated fuel solenoids and jets. It can also be used to control electronic water pumps, cooling fans, and more. Kit supplied with PCB and all electronic components. *Please check local laws regarding the use of Nitrous Oxide systems in your vehicle.



Re-Map Your Fuel Curve After Upgrading Injectors!

KC-S385 £23.20. Due late September '04

A huge revolution in Do It Yourself automotive modifications has occurred. This project allows you to re-map your air/fuel ratio throughout the entire load range. One use for this is upgrading your fuel injectors, then re-mapping the fuel supply to eliminate the need for new engine or fuel management systems. It offers incredible mapping resolution, and features rival many commercially available units costing hundreds of dollars more! Kit supplied with PCB, machined case, and all electronic components. Programmed via Digital Hand Controller (KC-S386 shown below).



Keep an Eye on Your Car's Fuel Mixture and Performance

KC-S374 £8.15

It is quite common for the fuel mixture to become very lean in turbocharged and supercharged motors under high load conditions. This not only decreases potential power, but can also cause engine problems. This kit displays the fuel mixture on a series of LEDs, with an integrated buzzer that sounds when the mixture is critically low. Kit supplied with PCB and all electronic components. Requires engine to be fitted with an EGO (Exhaust Gas Oxygen) sensor.



LCD Digital Hand Controller

KC-S386 £17.40. Due late September '04

Not only can you re-map your injectors with the kit above, it also suits other projects we offer such as electronic boost controllers, additional injector controllers, and more! You can program the kit then remove it, or leave it connected for real time display. Kit supplied with PCB, silk screened and machined case, LCD, and all electronic components.



ORDER on-line: www.jaycarelectronics.co.uk

Check our website!

Information & easy, safe, fast ordering.

- Entire Jaycar 2004 Catalogue on-line - over 6,000 products.
- 128-bit secure on-line ordering - safe & secure.
- Search by category, keyword or catalogue number, & advanced search.
- Over 3,500 product datasheets & application notes available on-line.
- And we're from Australia so you can trust us!



More info?

www.jaycarelectronics.co.uk

New 2004 Catalogue - all 424 pages

The Wonder from Down Under

We have a brand new catalogue priced in UK Pounds crammed with over 6,000 exciting products. You can get one FREE by logging on to our website and filling out the catalogue request form at: www.jaycarelectronics.co.uk/catalogue



FREE
424 page
Catalogue



Log on to

www.jaycarelectronics.co.uk/catalogue

for your FREE catalogue!

TOLL FREE ORDERING 0800 032 7241

(We are open 11pm to 7:30am GMT, which equates to 9am to 5:30pm our time)

For those that want to write:

100 Silverwater Rd Silverwater NSW 2128 Sydney Australia

We Stock...

Electronic Components

Electronic Project Kits

Test & Measurement Equipment

Power Products & Accessories

Audio & Video Equipment & Accessories

Computer & Telecoms Accessories

Security & Surveillance Equipment



READOUT

Email: john.becker@wimborne.co.uk

John Becker addresses some of the general points readers have raised. Have you anything interesting to say? Drop us a line!

All letters quoted here have previously been replied to directly.

WIN AN ATLAS LCR ANALYSER WORTH £79

An Atlas LCR Passive Component Analyser, kindly donated by Peak Electronic Design Ltd., will be awarded to the author of the *Letter Of The Month* each month.

The Atlas LCR automatically measures inductance from 1 μ H to 10H, capacitance from 1pF to 10,000 μ F and resistance from 1 Ω to 2M Ω with a basic accuracy of 1%.



Design and Technology Resource

Dear EPE,

Reaching the end of another school year, I should like to pass on my thanks to *EPE* and its contributors for providing such an excellent resource for Design and Technology teachers.

Most of my GCSE Electronic Products students have used circuit ideas, articles and data from projects published in your magazine in their research this year. This year's cohort designed and made a range of imaginative projects such as an infra-red beam lap timer for Scalectrix; a decorator's measuring and calculation aid; a password-operated keypad lock and an ultrasonic "radar" attachment for a blind person's cane. A far cry from the days of "steady hand" games and fuse testers.

The PIC-based content has increased the knowledge and understanding of my A Level

students to the extent that they are producing coursework projects with genuine commercial potential.

Interest in electronics amongst pupils is at an all-time high at my school, and I suspect at many others. It is sad then to find out that Examination Boards are considering dropping courses through lack of uptake and schools are finding it difficult to recruit teachers to deliver those that remain. Any electronics professional tired of the rat-race and seeking real job satisfaction could do a lot worse than entering the teaching profession.

Bernard Grabowski, Aylesbury, Bucks

More power to you at your school Bernard. But I've been aware for over 15 years that many schools lack teachers trained to teach Design and Technology, with, in some cases, Art teachers fulfilling that role. The connection between art and technology in this context is hard to fathom.

SuperAb Farads?

Dear EPE,

Godfrey Manning's comment on the International Farad (Aug '04) appears to stem from improvements in measurement capability of the physical quantities involved, i.e. length, weight, time, temperature, etc. This has been an ongoing thing, and probably will still as measurements and technology improve but less frequently. In 1948 the "International" values gave way to "Absolute" units, a difference of 0.05% in which capacitance increased, while resistance and inductance were reduced. SI units appear to be based on this, refined to 0.04902%. (What next? SuperAbs? Ultimate?)

When I attended evening classes in winter 1934/35 we were taught two systems concurrently, c.g.s. and f.p.s., all very confusing. Later came M.K.S., the upgraded c.g.s. An incident at the time of the 1948 change was almost embarrassing. A batch of 0.1% resistors had been delivered from a reputable supplier for inclusion in equipment under construction and in order to check them at incoming goods stage I arranged with the Measurements Lab for an operator to use their precision bridge; they all passed.

When the next batch arrived, the same arrangement but with a different operator; several rejects. I was called and confirmed the findings, and cross-checked some of the original batch still in store; sure enough, some rejects. Calling in the first operator he said, "This is not the same bridge"! A word with the head of the Lab, "Oh yes! This has just been delivered, it's calibrated in Absolute Ohms. The old one was International Ohms". As were the resistors. (Unprintable expletives.)

The *Admiralty Handbook*, in use until well after the Second World War still rated capacitance in Jars. Presumably in deference to lower ratings' capacity of about six pints with a good head.

Des Mayes, Maidstone, Kent

Fascinating Des, and very confusing. Just as well, perhaps, that at the hobbyist level we don't need to concern ourselves too much with absolute values of components.

Batteries

Dear EPE,

Got a thing called Battery Genie G200 battery charger that is supposed to rejuvenate old 1.5V zinc batteries. Often you get a zinc or deac cell that shows an l.e.d. rapidly flashing which is supposed to denote a chuck-away situation. However if I pulse them rapidly about 10 times across a 12V motorbike battery, with a meter on the 10A range in series, they get about a 2A rapid pulse charge. Then this fancy magic genie computerised charger often accepts them as worth saving and usually, after about 10 hours, they are up to scratch. Any that refuse after a second dose of pulses or get a bit warm actually are for the scrapheap.

I wonder if anyone has experience of other dry battery chargers? There seems to be a complete lack of info in this area.

George Chatley, via email

Well, readers, what can you tell George?

★ LETTER OF THE MONTH ★

Underripe?

Dear EPE,

As a sort of follow-up to Dave Jones in September *Readout* (Overripe Student), I guess I am at the opposite end and just slightly younger . . . I have been interested in electrical fiddling all my life, with a spell of domestic wiring, and mostly running a motor repair business.

Apart from the very early battery, bell and bulb circuits, my first venture was trying to put together a valve amplifier from the then *Hobbies* magazine, using a smallish fire-heated soldering iron. I don't think it ever worked.

In 1952, my late father pointed out an advertisement in a national newspaper by the then *Practical Television* magazine saying "Build a Television for £20". So I bought the magazine and got stuck in, but with no previous experience and no idea of how a TV worked. However, a blueprint was supplied, and the building and fitting of components was really a matter of following this.

The TV consisted of five separate chassis that I cut, formed and drilled in my father's garage, and then bolted together. These were vision, sound, timebase, power supply and CRT unit. It had 21 valves and used a VCR97 ex-government radar tube six inches in diameter which produced a green and black picture size about 4.5 x 3.5 inches. The main transformer supplied 425V-0-425V at 200mA, the timebase transformer was 350V-0-350V at 150mA and a separate transformer supplied 2,500V for the tube (I still have these).

After the war there was a glut of radio and other military components, and the parts were obtained from various suppliers, but unfortunately, due to some faulty items and my own inexperience, it was some while before I got results, and in fact I rebuilt the vision section and obtained ready-wound coils as against my home-wound ones, and this did the trick. This was in fact our first home TV, and gave my family much enjoyment because TV sets were then

a minority, with only one channel and using a large H aerial.

Later in the fifties, *Practical Television* brought out further and larger tube television circuits for the home constructor. These early home built and commercial sets had numerous controls that it was usually necessary to keep twiddling with during an evening's viewing. It was common for the picture to roll or break sideways into lines and multiple pictures due to poor signal and components altering in value during use – these duties now being done automatically with chips. Youngsters of today have no idea how lucky they are just switching a set on and pushing a few buttons on the remote.

But my point in writing is that, whereas in the era above, TVs, radios and so on simply weren't available, or if they were, they were rather expensive and scarce. Therefore, there was a great demand and opportunity for various magazines to provide home built circuits and kits. A couple of friends built their own ham radio equipment and hand-wound all the coils etc. But in today's world, it would be totally uneconomic and pointless to build a TV etc, and in my opinion, this situation has killed much of the enjoyment for the self-build hobbyist, as there simply is no sensible economic sense in building almost anything unless it is unavailable on the market.

John Kendall, via email

Thank you John, I share your views, and my early history as an amateur partly shadowed yours, although it was mid-60s when I first became interested, getting my components from old TVs bought down the local street market. I too actually built a TV, using my home-built scope and some cannibalised sections from one of those scrap TVs – a nice green picture in the days of black and white!

These days we at EPE largely try to keep you all supplied with circuit designs for items which cannot be bought commercially.

SURFING THE INTERNET

NET WORK

ALAN WINSTANLEY

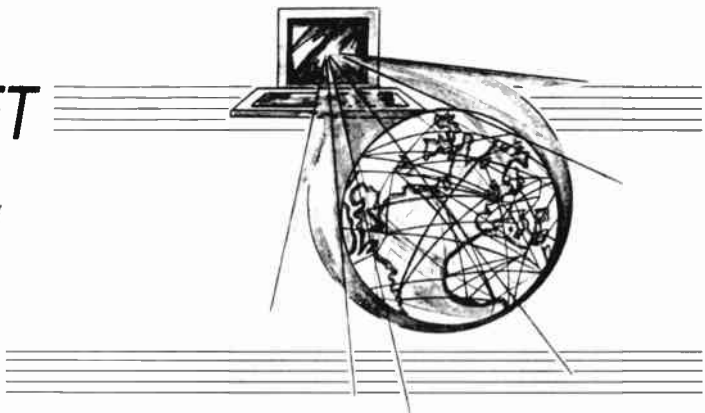

IN LAST month's *Net Work* the basic principles of Internet protocol (IP) addresses were outlined. The domain name system (DNS) translates human-readable domain names such as **epemag.co.uk** into a numerical IP address that identifies unique locations on a network, whether it's a web site, mail server or another type of network resource.

King of the Domains

Let's return to the topic of domain names themselves. In the UK, **.co.uk** domains are currently registered at a rate of approximately 90,000 per month (compared with just 3,000 per month in 1996). A **.uk** or a **.com** is known as a TLD or top level domain: they don't come any "higher" up in the pecking order of domain names. Below them are second-level domains (SLDs), such as the **.co** in **.co.uk** or the **.org** in **.org.uk**. And it's possible to split a domain down into sub-domains: the **epemag** in **epemag.wimborne.co.uk** is a sub-domain of the main **wimborne.co.uk** domain name.

The non-profit making body Nominet (**www.nominet.org.uk**) is responsible for managing the UK domain database. This is the definitive source for all UK domain name information, and you can search the database to check the ownership details of current domains, or search for the availability of a new domain.

Some users mistakenly search for evidence of a domain simply by looking for a web site associated with that domain. However, the fact that a web site is not launched in a browser does not necessarily mean that the domain has not been registered.

A search (often called a WHOIS lookup) at Nominet reveals basic details of domain name holders (where available) or *Registrants*. It should be mentioned that at no time is a Registrant the legal "owner" of a domain: being a Registrant merely entitles the holder to use the domain for as long as Nominet's fees continue to be met.

Rather than buy domains direct from Nominet, the cheapest way is for Registrants to pay their Internet Service Providers an annual fee, and the ISP will in turn settle Nominet's fees. Paying Nominet direct for a domain name is not only far more expensive but does not provide you with any web or email hosting service, for which you still need an ISP anyway.

Do-It-Yourself Domains

The remainder of this month's *Net Work* column is devoted to showing you how to buy a domain and set it up for your own use. We have chosen the popular UK domain seller **Easily.co.uk** because of the general ease of use of their system and the responsiveness of their technical support. Other domain name sellers include the mammoth German company Schlund/ I&I (**www.oneandone.co.uk**) but in the writer's view, the I&I online control panel is much less user friendly and seems to be less suited for general internet users or beginners.

To help you buy and set up your own domain name, an Easily Search box has been added to the Net Work A-Z page of the *EPE* web site (**www.epemag.wimborne.co.uk/netwkaz.html**), which also contains hundreds of useful web site links. Simply type a domain name (without any ending - no **.co.uk** or **.com** etc.) and Easily's web site will search for availability.

If you find a name, it is simple to buy online using a credit card or send a cheque in the post. Select the required number of years - a **.co.uk** domain costs £9.99 for two years - and create a username and password to set up your own account. It really is as simple as that! Confirmations are sent by email, and Easily will send you a healthy number of reminder emails before the domain name is due to expire.

Having bought a domain name, what to do with it? At the very least, use *email forwarding* and *web forwarding* in Easily's control

panel to point email to your regular email and web addresses. These handy features let you create up to 20 usernames in the format of <any username you like>@your new domain.co.uk and point them to any external email addresses. Web forwarding lets you point to your domain name to a regular web site, providing you with a web site address of **www.your new domain.co.uk**.

For more advanced users, you can buy a mailbox account from Easily and allocate it to your domain name, which then provides a fully-fledged POP3 password protected mailbox. Web hosting can also be purchased from Easily, if you are looking for somewhere to host your web site. Note that the above procedures also apply to the purchase of *dot-com* domain names, and although it is prudent to shop around for best prices, the Easily system is amongst the simplest to use. Other sources of domains to look at include **ukreg.com**, **www.GoDaddy.com** and **www.register.com** or search Google. Now you can register your own domain name using any of these online services.

You can email your comments to **alan@epemag.demon.co.uk**.



Type a name into the Easily domain name box to search for availability or to buy online.



The coloured buttons in Easily's control panel are the key to navigation.

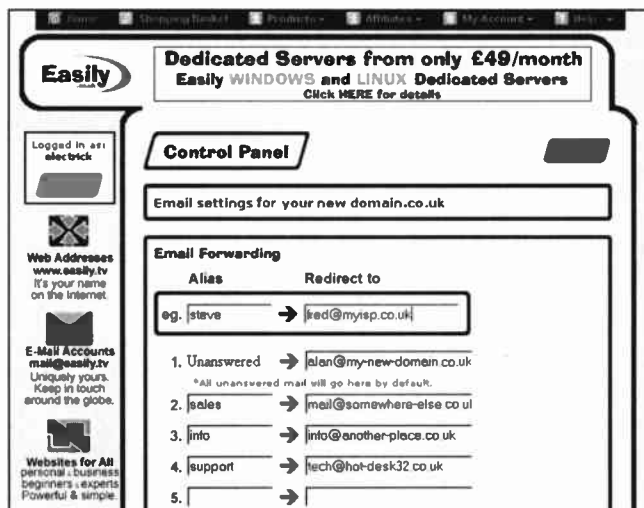

In the Control Panel, you can configure up to 20 email forwarding addresses for your new domain. Remember to "Save" the page before closing the window.

PIC N' MIX ANDREW JARVIS

Our periodic column for your PIC programming enlightenment

Hex Files Reopened: Record Viewer and Running Repairs

LAST month we saw that although hex files appear to look just like a bunch of numbers – they are actually structured into a series of discrete records. The records depend on the format of the hex file, which in turn is produced with knowledge of the intended target, and it is the job of the device programmer to interpret them and make something happen.

Import Duties

Device programmers almost always include some capacity for importing and viewing hex files. When you import the file you usually get to see and/or edit the content as disassembled code, or perhaps more likely hex opcodes, prior to programming the device – which can be useful if you are using a previously assembled project to which you don't have the source code.

Importing a hex file that contains configuration word and EEPROM data usually means that this information is set in the IDE also. *Toolkit TK3* doesn't go quite that far, but you can view the file as ASCII text with the View Hex button, and you can disassemble it too (Hex to MPASM).

There is no symbolic information stored in the hex file, so when a disassembler reconstructs the source code any CALL or GOTO statements will show the destination as absolute memory locations (or at least the lower eleven bits of them). Some software might assign an arbitrary label to this address to make reading the code less of a numbers game (*TK3* does this), but it's still not as clear as reading the original where, one hopes, the author has chosen something much more descriptive.

Exploring Alternatives

You almost never get to see the hex file in terms of its record structure, perhaps because it's not that useful unless you're actually interested in the mechanics of how the file is put together. So at the risk of producing something "not that useful", but nonetheless a bit different, the VB application that accompanies the column this month does just that.

The executable and full source code can be found in the usual place on the *EPE* website (access via www.epemag.wimborne.co.uk, and within the PIC n' Mix folder).

Actually, I originally wrote this as a C++ shell extension that integrated into Windows Explorer, thinking it would be nice to show the used memory as a proportion of the capacity of the device, much like Explorer shows how much disk capacity remains. But then I found that the source contained more code to enable Explorer behaviour than it did to parse and present the hex, so it was promptly dropped.

Problems like this are not trivial to track down without a little help, unless you have a good eye for numbers and too much spare time. A particular file runs to several hundred lines of hex digits that disassemble in *TK3* without any problems, and there's only so much staring at checksums you can do before everything starts to merge.

The screen dump in Fig.1 shows one such file opened in the hex file viewer, positioned to look at the end of the file. Using the application is simple enough, choose Open from the menu and select a hex file to view. The records within it are then parsed and each displayed as a single row of data,

split into columns that represent each field of the record. From the command line, you can issue "hexview [filename.hex]" to get the same result. Some of the columns implement "tooltips", which are the small pop-up windows with text offering additional information about a field over which the cursor is positioned. In screen order, the columns are:

Record: Useful indicator for showing the order of records as written to the file by the assembler or compiler.

Type: The record type, shown abbreviated. Tooltips give a full description.

Bytes: The number (in decimal) of bytes that appear in the data field.

Address: The load address of the data in hexadecimal. Tooltips show the same address in decimal in case you prefer things base 10.

To break the hex up a little, alternating colours are used to show where discontinuous data records appear. These give a feel for the memory organisation and show up instances where the author of the code has set the program origin to a new location, or where configuration word or EEPROM data has been embedded within the file.

Be aware that the programmer software decides how to fill memory locations on the device for which there is no object code. For some PICs it is recommended that a bulk erase be performed prior to programming, which will clear

Record	Type	Bytes	Address	Data	Checksum
522	Data	16	2ADD	2B343934263454346F3472346F346E34	✓ BA
523	Data	16	2AE0	74346F342D3435342634563461346E34	✓ BC
524	Data	16	2AF0	63346F3475347634653472342D343834	✓ BD
525	Data	16	2B00	26345634693465346E346E3461342B34	✓ BE
526	Data	16	2B10	3134263456346C346134643469347634	✓ BF
527	Data	16	2B20	6F34733474346F346B342B3431343034	✓ C0
528	Data	16	2B30	26345734613472347334613477342B34	✓ C1
529	Data	16	2B40	31342634573461347334683469346E34	✓ C2
530	Data	16	2B50	673474346F346E342D34353426345734	✓ C3
531	Data	16	2B60	65346C346C3469346E34673474346F34	✓ C4
532	Data	16	2B70	6E342B3431342634573469346E346E34	✓ C5
533	Data	16	2B80	69347034653467342D34363426345A34	✓ C6
534	Data	16	2B90	613467347234653462342B3431342634	✓ C7
535	Data	16	2BA0	5A34753472346934633468342B343134	✓ C8
536	Data	4	2B80	26342334	✗ 4B
537	Data	2	400E	313F	✓ 4D
538	End	0	0000		✓ 4E

Fig.1. EPE Hex File Viewer showing an example hex file with a checksum error on record 536

There was another reason too – as VB code it fits more with *EPE*'s preferred standard and in particular allows the possibility of integration with *TK3* or your own programs. A command line option is included to make this task easier. (John Becker tells me that he will be integrating this code with next version of *TK3*, to be released in the Autumn.)

Checksum Corruption

The creatively titled "EPE Hex File Viewer" suddenly becomes very useful indeed if a file is discovered to contain errors. In fact while I was testing it, I "accidentally" discovered that MPLAB does not accept some hex files generated by an early version of *TK3*.

program memory locations to 0x3FFF. Some programmers, like Microchip's PicStart Plus, erase and program every location in a given range regardless, while others like *TK3* program only the locations for which there is object code (which actually makes it faster by comparison).

Data: Data bytes for the record shown in hexadecimal character pairs. Tooltips show the same bytes as ASCII characters, if they are within the printable range. While this doesn't make a lot of sense for the majority of program memory (although you might be able to pick through tables that contain lots of `retlw` instructions, for instance, where the 8-bit literal is an ASCII character destined for an I.c.d. or similar), it is most useful for mining embedded EEPROM data. Bytes that are not printable are shown as space characters, " ".

Checksum: Shows a tick or a cross, depending on success or failure of the checksum calculation respectively, followed by the value. In failure cases, the repair menu function is enabled which allows you to save the file with the corrected checksum value. (If you use this you'll be prompted with the "Save As" dialog in case you don't want to overwrite the original file.)

As a nod to tradition, the tab strip at the bottom of the screen lets you choose to look at your hex file in the classic Notepad style with which you might be more comfortable.

The screen dump in Fig.1 shows that the problem with the example hex file is the checksum on record 536. A little further digging reveals that the problem originates from a checksum generation error from an early version of *TK3*. Checking the "updates history" file for the latest *TK3* showed that this problem was fixed in March '03.

This file error could be corrected either by re-assembling with the latest *TK3*, with the repair option from the file menu of the Hex File Viewer. Whichever way, the MPLAB IDE then import it.

It is possible that files from other sources might be reported by MPLAB as being corrupt for a variety of reasons, including general corruption of data on a disk. If so it is worth running the file through the Hex File Viewer.

Be aware, though, that if a checksum is shown to be incorrect, this may be because corruption exists in any one or more of the several other bytes in that line, not just in its original calculation. If this is the case, disassemble the hex file, through *TK3* for instance, or through other programmers which have a disassembly function, and examine the disassembled file's commands, looking for anything unusual.

SHOP TALK

with David Barrington

Moon and Tide Clock Calendar

Only the I.c.d. graphics display module should give rise for concern when shopping for parts for the *Moon and Tide Clock Calendar* project. The author used a Powertip PG12864-F monochrome Supertwist (STN) graphics display module, with an on-board Toshiba T6963-based controller chip.

As far as we are aware, this display module only appears on the **RS Components** listing, code 329-0329. It can be ordered direct (credit card only) from RS on ☎ 01536 444079 or web rswww.com. The last time we looked, the cost of the display module was around £37 plus a post and handling charge. It is most likely that some of our components advertisers will be able to offer a suitable display at a more reasonable price.

For those readers unable to program their own PICs, a preprogrammed PIC16F877 microcontroller can be purchased from **Magenta Electronics** (☎ 01283 565435 or www.magenta2000.co.uk) for the inclusive price of £10 each (overseas add £1 p&p). The software is available on a 3.5in. PC-compatible disk (Disk 7) from the *EPE Editorial Office* for the sum of £3 (UK), to cover admin costs (for overseas charges see page 744). It is also available for *Free* download from the click-link option on the *EPE* home page at www.epemag.wimborne.co.uk (take path **PICs/MoonTide**).

The printed circuit board is available from the *EPE PCB Service*, code 467 (see page 744).

Volts Checker

We do not expect any buying problems to be encountered when purchasing components for the *Volts Checker* project. The author makes the point that the Zetex ZTX458 transistor is best suited for this circuit and should *not* be substituted by other devices unless they can match or exceed its specification.

As mains voltages could be involved during voltage checks, it is *essential* that a plastic case is used to house the printed circuit board with nylon nuts and bolts used for the fixings. The small printed circuit board is available from the *EPE PCB Service*, code 468 (see page 744).

EPE Theremin

Most of the components needed to build the *EPE Theremin* project should be readily available from our components advertisers. The circuit board will need to be cut to size from a larger piece of stripboard. The most common large size appears to be 36 or 39 copper strips and it is probably not worth trimming off the redundant strips.

The 1mH miniature, general purpose, radial lead inductor should be easy to find. However, if you do have problems try **Squires** (☎ 01243 842424 or www.squirestools.com) or **Maplin** (☎ 0870 264 6000 or www.maplin.co.uk).

The telescopic aerials used for the "sensors" are usually sold as replacements for portable radios. They are certainly listed by **Squires** (see above). Finally, invest in as large as possible plastic case that your "pocket money" will allow to keep the Volume and Pitch sensors apart.

Smart Karts - 1

Apart from the "decks" material and choice of motors, the rest of the components required to construct the *Smart Kart* buggy should be available from readers' usual components suppliers.

We understand that the author obtained his p.v.c. material for the decks from a local signwriter as "off-cuts". You could also try your local craft shop or DIY store. Apart from some of the companies mentioned in this month's *Robots Special Supplement*, such as **Jaycar**, a good selection of low-voltage d.c. motors is listed by **Squires** (☎ 01243 842424 or www.squirestools.com).

For those readers unable to program their own PICs, a preprogrammed PIC16F84 microcontroller can be purchased from **Magenta Electronics** (☎ 01283 565435 or www.magenta2000.co.uk) for the inclusive price of £5.90 each (overseas add £1 p&p). The software is available on a 3.5in. PC-compatible disk (Disk 7) from the *EPE Editorial Office* for the sum of £3 (UK), to cover admin costs (for overseas charges see page 744). It is also available for *Free* download from the click-link on the *EPE* website at www.epemag.co.uk, follow path **PICs/SmartKart**).

PLEASE TAKE NOTE

Teach-In Part 10

(Aug '04)

Page 570, Fig.10.14. The top ends of VR2/R17 should be connected to the line above the one shown. Diode D5 should be labelled D6, and D6 should be labelled D7. The p.c.b. layout is correct.

Water Safety Interlock

(Sept '04 Ingenuity Unlimited)

Page 614, Fig.2. A link needs to be made between the transformer/relay RLB contact connection and the pump/switch connection.

SQUIRES

MODEL & CRAFT TOOLS

A COMPREHENSIVE RANGE OF MINIATURE HAND AND POWER TOOLS AND AN EXTENSIVE RANGE OF

ELECTRONIC COMPONENTS

FEATURED IN A FULLY ILLUSTRATED

656 PAGE MAIL ORDER CATALOGUE

2004 ISSUE

SAME DAY DESPATCH

FREE POST AND PACKAGING

Catalogues: FREE OF CHARGE to addresses in the UK.

Overseas: CATALOGUE FREE, postage at cost charged to credit card

SHOP EXTENSION NOW OPEN

**Squires, 100 London Road,
Bognor Regis, West Sussex, PO21 1DD**



TEL: 01243 842424

FAX: 01243 842525



AutotraxTM

Electronic Design Automation

autodesk[®]
authorised developer

Schematic Capture
SPICE Simulation
PCB Layout
Auto-Layout/Router
3D PCB Visualization
Database Support

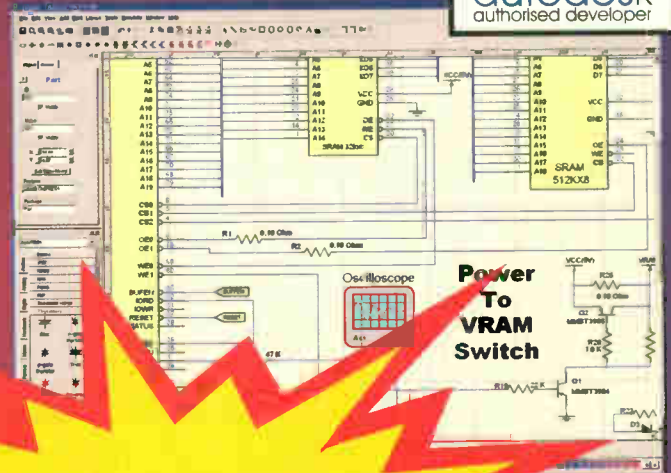

**Only £57
(\$95US)**

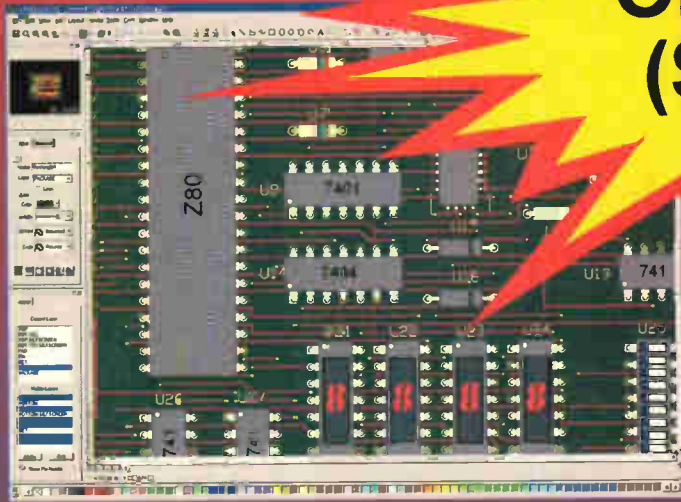

- Drag and drop parts onto your schematic. Connect them together.
- Add virtual instruments such as scopes and function generators.
- Use the PCB design wizard to create your PCB.
- Autolayout and autoroute the board.
- View the board in 3D.
- Output to Gerber and AutoCAD/Solidworks.

Over 35,000 users

To find out more go to
www.autotraxEDA.com

Free version available for small scale projects. (only pin limited)

3.0
It just gets
Better!

Why wait? Download AutoTRAX EDA NOW!

www.autoTRAX.com

EPE IS PLEASED TO BE ABLE TO OFFER YOU THESE ELECTRONICS CD-ROMS

ELECTRONICS PROJECTS

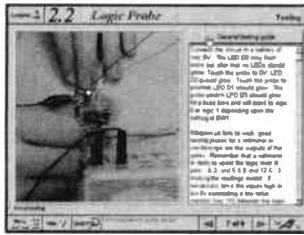

Logic Probe testing

Electronic Projects is split into two main sections: **Building Electronic Projects** contains comprehensive information about the components, tools and techniques used in developing projects from initial concept through to final circuit board production. Extensive use is made of video presentations showing soldering and construction techniques. The second section contains a set of ten projects for students to build, ranging from simple sensor circuits through to power amplifiers. A shareware version of Matrix's CADPACK **schematic capture, circuit simulation and p.c.b. design software** is included. The projects on the CD-ROM are: Logic Probe; Light, Heat and Moisture Sensor; NE555 Timer; Egg Timer; Dice Machine; Bike Alarm; Stereo Mixer; Power Amplifier; Sound Activated Switch; Reaction Tester. Full parts lists, schematics and p.c.b. layouts are included on the CD-ROM.

ELECTRONICS CAD PACK

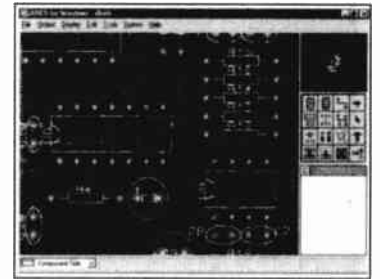

PCB Layout

Electronics CADPACK allows users to design complex circuit schematics, to view circuit animations using a unique SPICE-based simulation tool, and to design printed circuit boards. CADPACK is made up of three separate software modules. (These are restricted versions of the full Labcenter software.) **ISIS Lite** which provides full schematic drawing features including full control of drawing appearance, automatic wire routing, and over 6,000 parts. **PROSPICE Lite** (integrated into ISIS Lite) which uses unique animation to show the operation of any circuit with mouse-operated switches, pots, etc. The animation is compiled using a full mixed mode SPICE simulator. **ARES Lite** PCB layout software allows professional quality PCBs to be designed and includes advanced features such as 16-layer boards, SMT components, and an autorouter operating on user generated Net Lists.

ELECTRONIC CIRCUITS & COMPONENTS V2.0

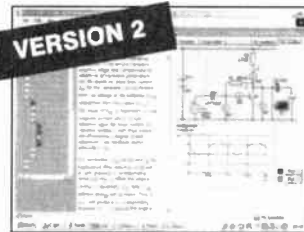

Circuit simulation screen

Provides an introduction to the principles and application of the most common types of electronic components and shows how they are used to form complete circuits. The virtual laboratories, worked examples and pre-designed circuits allow students to learn, experiment and check their understanding. Version 2 has been considerably expanded in almost every area following a review of major syllabuses (GCSE, GNVQ, A level and HNC). It also contains both European and American circuit symbols. Sections include: **Fundamentals:** units & multiples, electricity, electric circuits, alternating circuits. **Passive Components:** resistors, capacitors, inductors, transformers. **Semiconductors:** diodes, transistors, op.amps, logic gates. **Passive Circuits. Active Circuits. The Parts Gallery** will help students to recognise common electronic components and their corresponding symbols in circuit diagrams. Included in the Institutional Versions are multiple choice questions, exam style questions, fault finding virtual laboratories and investigations/worksheets.

ANALOGUE ELECTRONICS

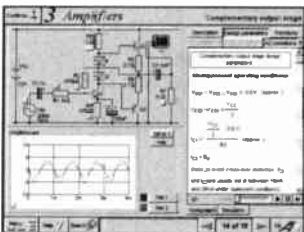

Complimentary output stage

Analogue Electronics is a complete learning resource for this most difficult branch of electronics. The CD-ROM includes a host of virtual laboratories, animations, diagrams, photographs and text as well as a SPICE electronic circuit simulator with over 50 pre-designed circuits. Sections on the CD-ROM include: **Fundamentals** – Analogue Signals (5 sections), Transistors (4 sections), Waveshaping Circuits (6 sections). **Op.Amps** – 17 sections covering everything from Symbols and Signal Connections to Differentiators. **Amplifiers** – Single Stage Amplifiers (8 sections), Multi-stage Amplifiers (3 sections). **Filters** – Passive Filters (10 sections), Phase Shifting Networks (4 sections), Active Filters (6 sections). **Oscillators** – 6 sections from Positive Feedback to Crystal Oscillators. **Systems** – 12 sections from Audio Pre-Amplifiers to 8-Bit ADC plus a gallery showing representative p.c.b. photos.

ROBOTICS & MECHATRONICS



Case study of the Milford Instruments Spider

Robotics and Mechatronics is designed to enable hobbyists/students with little previous experience of electronics to design and build electromechanical systems. The CD-ROM deals with all aspects of robotics from the control systems used, the transducers available, motors/actuators and the circuits to drive them. Case study material (including the NASA Mars Rover, the Milford Spider and the Furby) is used to show how practical robotic systems are designed. The result is a highly stimulating resource that will make learning, and building robotics and mechatronic systems easier. The Institutional versions have additional worksheets and multiple choice questions.

- Interactive Virtual Laboratories
- Little previous knowledge required
- Mathematics is kept to a minimum and all calculations are explained
- Clear circuit simulations

DIGITAL ELECTRONICS V2.0

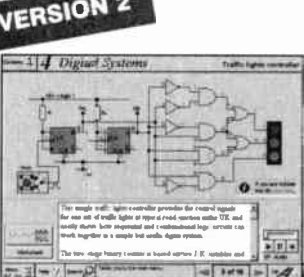

Virtual laboratory – Traffic Lights

Digital Electronics builds on the knowledge of logic gates covered in *Electronic Circuits & Components* (opposite), and takes users through the subject of digital electronics up to the operation and architecture of microprocessors. The virtual laboratories allow users to operate many circuits on screen. Covers binary and hexadecimal numbering systems, ASCII, basic logic gates, monostable action and circuits, and bistables – including JK and D-type flip-flops. Multiple gate circuits, equivalent logic functions and specialised logic functions. Introduces sequential logic including clocks and clock circuitry, counters, binary coded decimal and shift registers. A/D and D/A converters, traffic light controllers, memories and microprocessors – architecture, bus systems and their arithmetic logic units. Sections on Boolean Logic and Venn diagrams, displays and chip types have been expanded in Version 2 and new sections include shift registers, digital fault finding, programmable logic controllers, and microcontrollers and microprocessors. The Institutional versions now also include several types of assessment for supervisors, including worksheets, multiple choice tests, fault finding exercises and examination questions.

FILTERS

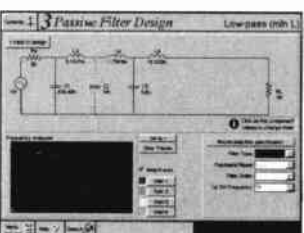

Filter synthesis

Filters is a complete course in designing active and passive filters that makes use of highly interactive virtual laboratories and simulations to explain how filters are designed. It is split into five chapters: **Revision** which provides underpinning knowledge required for those who need to design filters. **Filter Basics** which is a course in terminology and filter characterization, important classes of filter, filter order, filter impedance and impedance matching, and effects of different filter types. **Advanced Theory** which covers the use of filter tables, mathematics behind filter design, and an explanation of the design of active filters. **Passive Filter Design** which includes an expert system and filter synthesis tool for the design of low-pass, high-pass, band-pass, and band-stop Bessel, Butterworth and Chebyshev ladder filters. **Active Filter Design** which includes an expert system and filter synthesis tool for the design of low-pass, high-pass, band-pass, and band-stop Bessel, Butterworth and Chebyshev op.amp filters.

PRICES

Prices for each of the CD-ROMs above are:

(Order form on third page)

(UK and EU customers add VAT at 17.5% to "plus VAT" prices)

Hobbyist/Student	£45 inc VAT
Institutional (Schools/HE/FE/Industry)	£99 plus VAT
Institutional 10 user (Network Licence)	£199 plus VAT
Site Licence	£499 plus VAT

PICmicro TUTORIALS AND PROGRAMMING

HARDWARE

VERSION 2 PICmicro MCU DEVELOPMENT BOARD

Suitable for use with the three software packages listed below.

This flexible development board allows students to learn both how to program PICmicro microcontrollers as well as program a range of 8, 18, 28 and 40-pin devices. For experienced programmers all programming software is included in the PPP utility that comes with the development board. For those who want to learn, choose one or all of the packages below to use with the Development Board.

- Makes it easier to develop PICmicro projects
- Supports low cost Flash-programmable PICmicro devices
- Fully featured integrated displays – 13 individual l.e.d.s, quad 7-segment display and alphanumeric l.c.d. display
- Supports PICmicro microcontrollers with A/D converters
- Fully protected expansion bus for project work
- All inputs and outputs available on screw terminal connectors for easy connection

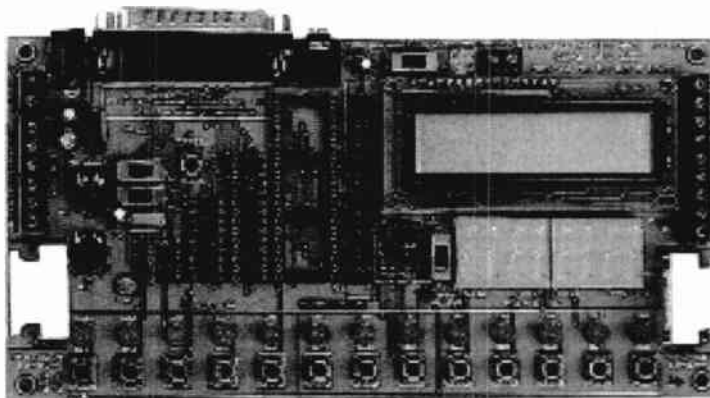

£145 including VAT and postage
12V 500mA plug-top PSU (UK plug) £7
25-way 'D' type connecting cable £5

SOFTWARE

Suitable for use with the Development Board shown above.

ASSEMBLY FOR PICmicro V2 (Formerly PICtutor)

Assembly for PICmicro microcontrollers V2.0 (previously known as PICtutor) by John Becker contains a complete course in programming the PIC16F84 PICmicro microcontroller from Arizona Microchip. It starts with fundamental concepts and extends up to complex programs including watchdog timers, interrupts and sleep modes. The CD makes use of the latest simulation techniques which provide a superb tool for learning: the Virtual PICmicro microcontroller. This is a simulation tool that allows users to write and execute MPASM assembler code for the PIC16F84 microcontroller on-screen. Using this you can actually see what happens inside the PICmicro MCU as each instruction is executed which enhances understanding.

- Comprehensive instruction through 39 tutorial sections
- Includes Vlab, a Virtual PICmicro microcontroller: a fully functioning simulator
- Tests, exercises and projects covering a wide range of PICmicro MCU applications
- Includes MPLAB assembler
- Visual representation of a PICmicro showing architecture and functions
- Expert system for code entry helps first time users
- Shows data flow and fetch execute cycle and has challenges (washing machine, lift, crossroads etc.)
- Imports MPASM files.

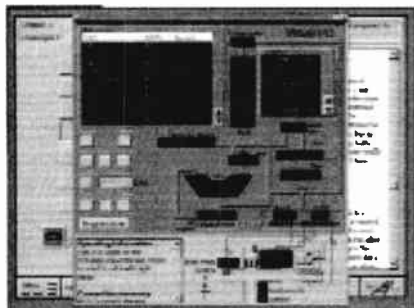

Virtual PICmicro

'C' FOR PICmicro VERSION 2

The C for PICmicro microcontrollers CD-ROM is designed for students and professionals who need to learn how to program embedded microcontrollers in C. The CD contains a course as well as all the software tools needed to create Hex code for a wide range of PICmicro devices – including a full C compiler for a wide range of PICmicro devices.

Although the course focuses on the use of the PICmicro microcontrollers, this CD-ROM will provide a good grounding in C programming for any microcontroller.

- Complete course in C as well as C programming for PICmicro microcontrollers
- Highly interactive course
- Virtual C PICmicro improves understanding
- Includes a C compiler for a wide range of PICmicro devices
- Includes full Integrated Development Environment
- Includes MPLAB software
- Compatible with most PICmicro programmers
- Includes a compiler for all the PICmicro devices.

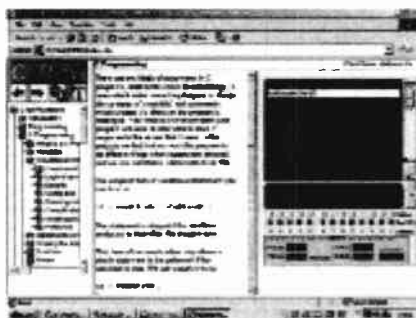

Minimum system requirements for these items: Pentium PC running Windows 98, NT, 2000, ME, XP; CD-ROM drive; 64MB RAM; 10MB hard disk space.

FLOWCODE FOR PICmicro

Flowcode is a very high level language programming system for PICmicro microcontrollers based on flowcharts. Flowcode allows you to design and simulate complex robotics and control systems in a matter of minutes.

Flowcode is a powerful language that uses macros to facilitate the control of complex devices like 7-segment displays, motor controllers and l.c.d. displays. The use of macros allows you to control these electronic devices without getting bogged down in understanding the programming involved.

Flowcode produces MPASM code which is compatible with virtually all PICmicro programmers. When used in conjunction with the Version 2 development board this provides a seamless solution that allows you to program chips in minutes.

- Requires no programming experience
- Allows complex PICmicro applications to be designed quickly
- Uses international standard flow chart symbols (ISO5807)
- Full on-screen simulation allows debugging and speeds up the development process
- Facilitates learning via a full suite of demonstration tutorials
- Produces ASM code for a range of 8, 18, 28 and 40-pin devices
- Institutional versions include virtual systems (burglar alarms, car parks etc.).

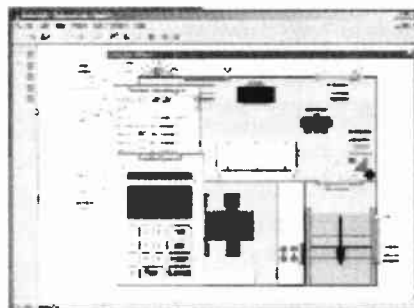

Burglar Alarm Simulation

PRICES

Prices for each of the CD-ROMs above are:

(Order form on next page)

(UK and EU customers add VAT at 17.5% to "plus VAT" prices)

Hobbyist/Student
 Institutional (Schools/HE/FE/Industry)
 Flowcode Institutional
 Institutional 10 user (Network Licence)
 Site Licence

£45 inc VAT
 £99 plus VAT
 £70 plus VAT
 £249 plus VAT
 £599 plus VAT

TEACH-IN 2000 – LEARN ELECTRONICS WITH EPE

EPE's own *Teach-In* CD-ROM, contains the full 12-part *Teach-In* series by John Becker in PDF form plus the *Teach-In* interactive software (Win 95, 98, ME and above) covering all aspects of the series. We have also added Alan Winstanley's highly acclaimed *Basic Soldering Guide* which is fully illustrated and which also includes *Desoldering*. The *Teach-In* series covers: Colour Codes and Resistors, Capacitors, Potentiometers, Sensor Resistors, Ohm's Law, Diodes and L.E.D.s, Waveforms, Frequency and Time, Logic Gates, Binary and Hex Logic, Op.amps, Comparators, Mixers, Audio and Sensor Amplifiers, Transistors, Transformers and Rectifiers, Voltage Regulation, Integration, Differentiation, 7-segment Displays, L.C.D.s, Digital-to-Analogue. Each part has an associated practical section and the series includes a simple PC interface (Win 95, 98, ME ONLY) so you can use your PC as a basic oscilloscope with the various circuits.

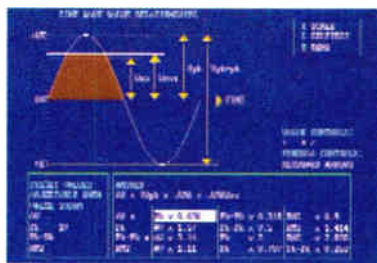

Sine wave relationship values

A hands-on approach to electronics with numerous breadboard circuits to try out.

£12.45 including VAT and postage. Requires Adobe Acrobat (available free from the Internet – www.adobe.com/acrobat).

FREE WITH EACH TEACH-IN CD-ROM – *Electronics Hobbyist Compendium* 80-page book by Robert Penfold. Covers Tools For The Job; Component Testing; Oscilloscope Basics.

FREE BOOK WITH TEACH-IN 2000 CD-ROM



DIGITAL WORKS 3.0

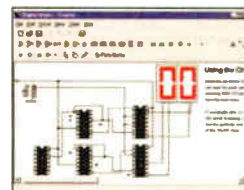

Counter project

Digital Works Version 3.0 is a graphical design tool that enables you to construct digital logic circuits and analyze their behaviour. It is so simple to use that it will take you less than 10 minutes to make your first digital design. It is so powerful that you will never outgrow its capability ● Software for simulating digital logic circuits ● Create your own macros – highly scalable ● Create your own circuits, components, and i.c.s ● Easy-to-use digital interface ● Animation brings circuits to life ● Vast library of logic macros and 74 series i.c.s with data sheets ● Powerful tool for designing and learning. **Hobbyist/Student £45 inc. VAT. Institutional £99 plus VAT. Individual 10 user £199 plus VAT. Site Licence £499 plus VAT.**

ELECTRONICS IN CONTROL

Two colourful animated courses for students on one CD-ROM. These cover Key Stage 3 and GCSE syllabuses. **Key Stage 3:** A pictorial look at the Electronics section featuring animations and video clips. Provides an ideal introduction or revision guide, including multi-choice questions with feedback. **GCSE:** Aimed at the Electronics in many Design & Technology courses, it covers many sections of GCSE Electronics. Provides an ideal revision guide with Homework Questions on each chapter. Worked answers with an access code are provided on a special website.

Single User £29 inc. VAT. Multiple User £39 plus VAT
Student copies (available only with a multiple user copy) £6 plus VAT
 (UK and EU customers add VAT at 17.5% to "plus VAT" prices)

MODULAR CIRCUIT DESIGN

Contains a range of tried and tested analogue and digital circuit modules, together with the knowledge to use and interface them. Thus allowing anyone with a basic understanding of circuit symbols to design and build their own projects. Version 3 includes data and circuit modules for a range of popular PICs; includes PICAXE circuits, the system which enables a PIC to be programmed without a programmer, and without removing it from the circuit. Shows where to obtain free software downloads to enable BASIC programming. Essential information for anyone undertaking GCSE or "A" level electronics or technology and for hobbyists who want to get to grips with project design. Over seventy different Input, Processor and Output modules are illustrated and fully described, together with detailed information on construction, fault finding and components. including circuit symbols, pinouts, power supplies, decoupling etc.

Single User £19.95 inc. VAT. Multiple User £34 plus VAT
 (UK and EU customers add VAT at 17.5% to "plus VAT" prices)

VERSION 3

ELECTRONIC COMPONENTS PHOTOS

A high quality selection of over 200 JPG images of electronic components. This selection of high resolution photos can be used to enhance projects and presentations or to help with training and educational material. They are royalty free for use in commercial or personal printed projects, and can also be used royalty free in books, catalogues, magazine articles as well as worldwide web pages (subject to restrictions – see licence for full details).

Also contains a **FREE 30-day evaluation** of Paint Shop Pro 6 – Paint Shop Pro image editing tips and on-line help included!

Price £19.95 inc. VAT



Minimum system requirements for these CD-ROMs: Pentium PC, CD-ROM drive, 32MB RAM, 10MB hard disk space. Windows 95/98/NT/2000/ME/XP, mouse, sound card, web browser.

Please send me:

CD-ROM ORDER FORM

- Electronic Projects
- Electronic Circuits & Components V2.0
- Analogue Electronics
- Digital Electronics V2.0
- Filters
- Electronics CAD Pack
- Robotics & Mechatronics
- Assembler for PICmicro
- 'C' for PICmicro
- Flowcode for PICmicro
- Digital Works 3.0

- Version required:
- Hobbyist/Student
 - Institutional
 - Institutional 10 user
 - Site licence



- PICmicro Development Board (hardware)
- Development Board UK plugtop power supply
- Development Board 25-way connecting lead

- Teach-In 2000 + FREE BOOK
- Electronic Components Photos
- Electronics In Control – Single User
- Electronics In Control – Multiple User
- Modular Circuit Design – Single User
- Modular Circuit Design – Multiple User

Note: The software on each version is the same, only the licence for use varies.

Full name:

Address:

..... Post code: Tel. No:

Signature:

I enclose cheque/PO in £ sterling payable to WIMBORNE PUBLISHING LTD for £

Please charge my Visa/Mastercard/Amex/Diners Club/Switch: £

Valid From: Card expiry date:

Card No: Switch Issue No.

Card Security Code (The last 3 digits on or just under the signature strip)

ORDERING ALL PRICES INCLUDE UK POSTAGE

Student/Single User/Standard Version price includes postage to most countries in the world
 EU residents outside the UK add £5 for airmail postage per order

Institutional, Multiple User and Deluxe Versions – overseas readers add £5 to the basic price of each order for airmail postage (do not add VAT unless you live in an EU (European Union) country, then add 17½% VAT or provide your official VAT registration number).

Send your order to:
 Direct Book Service
 Wimborne Publishing Ltd
 408 Wimborne Road East
 Ferndown, Dorset BH22 9ND

To order by phone ring
01202 873872. Fax: 01202 874562

Goods are normally sent within seven days

E-mail: orders@wimborne.co.uk

Online shop:
www.epemag.wimborne.co.uk/shopdoor.htm

For rapid development of electronic systems...



Eblocks

E-blocks are small circuit boards each of which contains a block of electronics typically found in an electronic system. E-blocks can be programmed in C. Assembly and are tightly integrated with Flowcode - which instantly converts flow charts into PIC-micro code

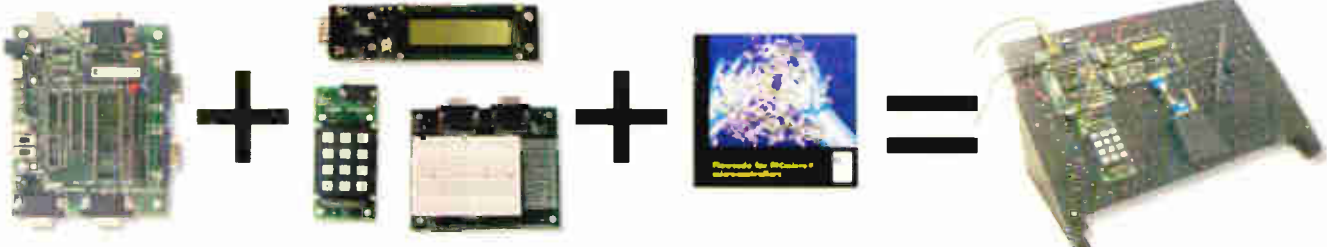

Low cost USB PIC programmers (Starting at £27, model shown £65)

...plus a wide range of add-on boards and accessories...

...plus incredibly easy to use software based on flow charts...

...equals extremely rapid system development: like this mobile text messaging system built from E-blocks.

...and solutions for learning and development...

Hands on training courses



training courses in PICmicro(R) programming, CPLD programming and ECAD

Resources for learning CPLD programming



Complete courses in electronics and programming



Equipment for datalogging, control and PC 'scopes



and more at:



...see www.matrixmultimedia.co.uk

Matrix Multimedia Limited
sales@matrixmultimedia.co.uk
t. 0870 700 1831 f. 0870 700 1832



A COMPLETE RANGE OF INVERTERS 150W TO 2500W - 12V & 24V

A Complete range of regulated inverters to power 220V and 240V AC equipment via a car, lorry or boat battery. Due to their high performance (>90%) the inverters generate very little heat. The high stability of the output frequency (+/-1%) makes them equally suitable to power sensitive devices.



These inverters generate a modified sine wave, which are considerably superior to the square waves which are produced by most other inverters. Due to this superior feature they are capable of powering electrical equipment such as TV,s, videos, desktop & notepad computers, microwave ovens, electrical lamps, pumps, battery chargers, etc.

Low Battery Alarm

The inverters give an audible warning signal when the battery voltage is lower than 10.5V (21V for the 24V version). The inverter automatically shuts off when the battery voltage drops below 10V (20V for the 24V version). Fuse protected input circuitry.

Order Code	Power	Voltage	Was	Price
651.581	150W Continuous	12V	£36.39	£29.72
651.578	150W Continuous	24V	£36.39	£29.72
651.582	300W Continuous	12V	£50.64	£41.93
651.585	300W Continuous	24V	£50.64	£41.93
651.583	600W Continuous	12V	£101.59	£83.76
651.593	600W Continuous	24V	£101.59	£83.76
651.587	1000W Continuous	12V	£177.18	£147.52
651.597	1000W Continuous	24V	£177.18	£147.52
651.602	1500W Continuous	12V	£314.52	£261.18
651.605	1500W Continuous	24V	£314.52	£261.18
651.589	2500W Continuous	12V	£490.54	£416.27
651.599	2500W Continuous	24V	£490.54	£416.27



All prices are inclusive of V.A.T. Delivery £100 Per Order

Many uses include:- . Fetes . Fairgrounds . Airshows . Picnics . Camping . Caravans . Boats . Carnivals . Field Research and . Amateur Radio field days * Powering Desktop & Notepad Computers.

DELIVERY CHARGES ARE £6.00 PER ORDER. OFFICIAL ORDERS FROM SCHOOLS, COLLEGES, GOVT. BODIES, PLC,S ETC. PRICES ARE INCLUSIVE OF V.A.T. SALES COUNTER. VISA AND ACCESS ACCEPTED BY POST, PHONE OR FAX, OR EMAIL US AT SALES@BKELEC.COM ALTERNATIVELY SEND CHEQUE OR POSTAL ORDERS MADE PAYABLE TO BK ELECTRONICS.



B.K. ELECTRONICS



UNIT 1, COMET WAY, SOUTHEND-ON-SEA, ESSEX. SS2 6TR
TEL.: +44(0)1702-527572 FAX: +44(0)1702-420243

For Full Specifications View our web site at:-
WWW.BKELEC.COM/INVERTERS.HTM

Circuit Surgery

Alan Winstanley and Ian Bell

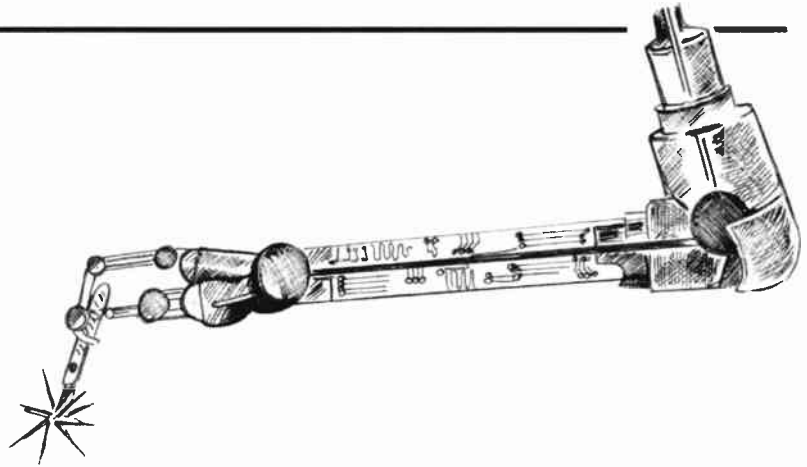

The identification of resistors and some essential safety advice are the topics of this month's column.

On Your marks

"I'm having difficulties with understanding resistors. Can you briefly explain the naming conventions to me? I've seen resistors that are called 100 ohm and 100R (which I assume are the same). I've also seen 1R2 and even 0R1.

I asked a supplier for some parts including a set of 5W 0R1 resistors, and the ones I received are marked as follows:

ERG 58 ER R10 J 8450

Can you help me unravel these markings? Thanks from John Neal, Southampton."

On your first question, it is simply a printer's convention that decimal points in resistor values are denoted using the multiplier letter instead. This helps ensure that resistor values won't be misread due to, for example, a decimal point not printing very clearly on the paper.

The capital letter "R" is used for resistors under 1 kilohm. So 0.1 ohms is indeed the same as 0R1 and 100 ohms can be listed as 100R (which means 100.0 ohms). Next up the scale, a lower-case letter "k" is used for denoting kilohms, so that 2k2 is shorthand for 2.2 kilohms or 2,200 ohms, and of course 680k is 680 kilohms. Lastly, the upper-case letter "M" relates to megohms (millions of ohms), so a 2M2 resistor is 2,200,000 ohms and 10M is 10 megohms.

Similar customs are used to describe capacitor markings, with letters representing the decimal point location. You may see 2u2 to describe a 2.2µF (microFarads) capacitor, and the lower-case letter "n" for nanoFarads, so 100n is 100 nanoFarads. The letter "p" relates to picoFarads, so 4p7 is 4.7 picoFarads and 22p is shorthand for 22 picoFarads.

On the second question of resistor markings, it can take quite some practical experience to decipher some of the very cryptic markings seen on electronic components. The fun usually starts when you open a bag of freshly-delivered parts and try to compare them against what you actually ordered!

ERG is a resistor manufacturer (which I only know due to my constant flicking

through countless catalogues). The only other marking I recognise is the R10, which it is safe to assume is a 0R10 resistor or 0.1 ohms. The leading zero in the value has not been printed on the resistor.

More by elimination than anything, the 58 ER can't be a resistor value because it's not a preferred value (see Table 1). I guess the 8450 is a batch number, possible week 50 of the year it was made, an Orwellian 1984.

Table 1: E12 (grey values only) and E24 preferred values used in resistor, potentiometer and capacitor manufacture.

1.0	2.2	4.7
1.1	2.4	5.1
1.2	2.7	5.6
1.3	3.0	6.2
1.5	3.3	6.8
1.6	3.6	7.5
1.8	3.9	8.2
2.0	4.3	9.1

Preferred Values

Manufacturers produce resistors, potentiometers (variable resistors) and capacitors in ranges of "Preferred values", see Table 1. The most basic range is the so-called E12 set that divides the range 1-10 into 12 roughly equal steps. The popular E24 range consists of 24 preferred values, whilst the E48 and E96 ranges are seldom seen in hobby electronics, but would be of interest to commercial manufacturers. For instance, 47 is an E12 value, but would you really be fussy whether your circuit used a 47.5 or 48.7 E96 value?

Smaller capacitors (especially ceramic ones) can be printed with mad numerical codes that can defeat the finest of electronics minds, forcing users to retreat to the data library to decrypt the capacitor's hieroglyphics. Don't worry, it all comes together with practice. A.R.W.

More on SuperGlue

Following on from our safety item on Super Glue (July 2004 issue), an email was received as follows:

"I just purchased the July 2004 EPE and was reading the article Super Glued. I noticed you did not mention anything about the potential "fire hazard" of super glues when they come into contact with a porous and flammable material like cotton (e.g. cotton balls, swabs, clothing etc).

Due to the nature of how these super glues set when spread out very thin, which happens when they come into contact with a porous material that soaks up and distributes the glue so fast that it sets almost instantly, the "heat" produced can (and has been proven by me) cause the material to burst into flames if the conditions of adequate oxygen or oxidising agent(s) are present.

Just one or two standard drops on a "dry" cotton ball in low humidity (20% or less) can easily start a fire – but more often than not there will just be a bit of gaseous fumes and/or smoke. Still, I've learned this from experience when I accidentally spilled two grams of superglue on my cotton trousers one horrible day.

It's strange that all the "Data Sheets" on various super glues that I've read fail to mention this potential deadly problem – especially in the electronics industry where flammable solvents are often stored near such glues.

Lastly, you also didn't mention the dangers about super glue in the mouth – alas, as many of us tend to use our teeth to open a frozen/glued cover." (Anon.)

Although I worked in manufacturing industry for a long period I didn't hear of any incidents of Super Glue causing fires, and I am not aware that it has any particular exothermic properties (emitting heat during curing). Valuing the integrity of my workshop I have not attempted to run any experiments and I strongly recommend that Super Glue is not played around with.

The previous article gave some common sense advice (and some less well known

information) about handling tubes of cyanoacrylate adhesive. As for superglue in the mouth, well, I used to compile instructions (in eleven languages!) for consumer products. During which time I learned that some consumers really do leave their brains in neutral gear at operating time.

Needless to say (or is it?), putting tubes of glue in the mouth or near the eyes is a **MUST NOT**. In today's blame culture I can understand why manufacturers protect themselves by printing disclaimers on their products, as I have been there myself. (E.g. "This pie may be hot after heating.") A.R.W.

A Shocking State

We will round off this month's article with some more timely reminders on First Aid, this time relating to the risks related to electric shock. This has been prompted by the near tragedy that befell a neighbour of the writer, who this week suffered an entirely avoidable electric shock with near-fatal results. Although this column does not really cover "electrical" issues, some common sense reminders on first aid and safety matters are never wasted.

A friend started to rewire some electric lighting but failed to isolate the mains electrical supply (an example of an unthinking consumer, see above). This is even more startling because he was formerly an electrician in the armed forces.

He started to strip the electric cables and his wire strippers bit into the live (hot) copper conductor. The resulting shock caused convulsions and he was unable to release his grip on the wire strippers. It is solely because his wife was nearby, and she quickly pulled the plug out of the mains outlet, that he managed to escape with his life. There are some lessons to be learned by everybody, and so this article is dedicated to Stuart the ex-electrician who is very lucky to be alive.

It stands to reason that all mains supplies must be fully isolated before working on them. Skilled and qualified electricians will work happily on live mains fuseboxes, but as for the rest of us, complete electrical isolation is the name of the game.

This does not necessarily just mean switching off, because parts of the circuit (e.g. up to and including the fuse) could still be live. The first point is that working on your own means that there would be no-one around to help you if anything went wrong, which is partly why in education it is forbidden to work with the mains supply by yourself if at all.

There are plenty of low cost voltage testers available that will warn you when supplies are live (such as Fluke's "Volt Alert" neon indicator from Maplin, code JJ18U, that doesn't even need to touch the mains wiring). These should be part of everyone's toolkit. Without fail, I use a mains-rated voltage probe to double check for live wires and I never, ever take anything for granted.

Deep Suspicion

If you want an example of why I view all mains wiring with deep suspicion, try this: after a major water leak and plumbing disaster in the author's kitchen, the whole lot had to be rebuilt from scratch. The "builders" also kindly reinstalled the

Table 2: Electric Shock Dangers

Current	Effect
1mA	Tingling sensation
9mA	Probably able to release the device
16mA	Borderline on ability to release the device
25mA	Probably unable to release the device
16-50mA	PAIN. Possible unconsciousness. Heart and respiratory functions probably continue.
> 100mA	Heart tremor (ventricular fibrillation). Respiratory paralysis. Asphyxia, suffocation. Severe shock and burns. Possible death.

dishwasher, which, one day, suddenly broke down. A piezo buzzer on the control panel warned of a fault condition. I turned off the wall switch but the buzzer kept on sounding; I removed the fuse to test it and, impossible to believe, the buzzer still kept bleeping.

Not relishing the idea of kneeling in a pool of water whilst tinkering with the electrical supply, it was then time to throw the master switch at the fuse board and isolate the whole building. It turned out that the "builders" had wired the dishwasher to the wrong terminals of the mains outlet, and had, in fact, wired it directly to the incoming ring mains terminals, thereby bypassing the fuse and switch altogether, so the whole appliance was still live even after I removed the fuse.

Nor do I trust the Live and Neutral wires to have been wired the correct way round either, ever since discovering a socket here in the Surgery that had a reverse polarity: it was permanently live. Simple neon testers are available that warn of mains socket wiring faults.

I too must admit to having had a near-miss of my own making, while stood knee deep in a garden pool clearing some lily roots and weeds, I held a very tough piece of blackened root between the blades of my garden snippers – and several "ohnoseconds" later realised that I was about to slice through the mains cable feeding the electric pump . . . *?!!

Out Of Control

Looking at the issues surrounding electric shock from the mains, the nature of alternating current means that you may lose control over the muscles. You may be unable to release your grip. The heart is also a muscle, and if this organ is in the path of the electric current then the heartbeat will be disrupted. Perversely, the heart is most susceptible to stimulation at a frequency of about 50Hz, which is the UK mains frequency. Furthermore, you may lose control over breathing functions and suffocate.

How much current flows through the body depends on a number of factors including skin surface moisture content, the route of the current through the body and what the victim was standing on (e.g. directly on earth or on a rubber mat); this latter point is why electrician's ladders are made of glass fibre. A smaller shock can still throw someone against a wall, causing an injury. Table 2 summarises the dangers of electric shock on human beings.

Additionally, burns may be caused that may run deeper in tissue than any visible outer burns might suggest, so this situation may be a medical emergency.

In the case of Stuart his wife had the presence of mind not to touch the victim or she

too would have received an electric shock. The correct action is to isolate the electrical supply, switch off or unplug, or use e.g. a dry wooden pole, wooden chair or other non-conductive material to reach over or push the victim clear of the live supply.

If the victim has stopped breathing, artificial respiration techniques should be used if you know how to apply the kiss of life. The latest advice on burns treatment is that pain and tissue damage can be reduced by cooling the area with plenty of clean water (apparently not using ice packs etc. which can damage nerves). Remove any item of a constrictive nature before swelling starts (e.g. watch straps, rings, boots etc.) and apply a sterile dressing.

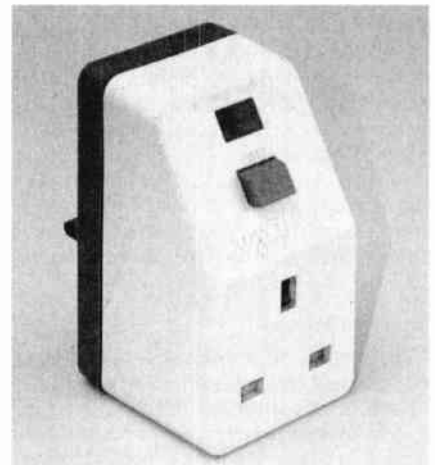

An example of a typical plug-in RCD, with test button and warning neon on the front. The reset button is on the back.

Safety First

A major improvement in safety will be derived from using Residual Current Devices (RCDs) formerly known as Earth Leakage Circuit Breakers (ELCBs), or Ground Fault Circuit Interruptors (GFCIs) in the USA. These detect any imbalance between current flowing in and current returning. Any discrepancy is due to earth leakage, e.g. faulty insulation or an electrical fault, and beyond a certain value (typically 30mA), the RCD will trip and completely isolate the appliance from the mains. My first kitchen rewiring job involved adding an RCD mains outlet for the dishwasher.

These should not be confused with an ordinary miniature circuit breaker (MCB), which is nothing more than a resettable thermal fuse. Enjoy your hobby, use your special knowledge to encourage safe practice amongst your family and friends and most of all, stay safe. A.R.W.

Smart Karts

Owen Bishop

Part 1 – Basic Construction

Get Smart! – Build a PIC-based mobile buggy that's expandable to meet your needs

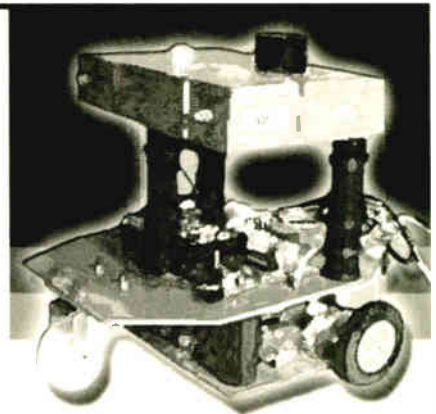

IN this short series of articles we describe the construction of a mobile hobby robot, Smart Kart, and then proceed to variously equip it with a collection of sensors and actuators, each capable of a variety of tasks, some serious and some amusing. There are also discussions about the controlling software and how you can modify it to suit your own needs.

The basic Smart Kart has a pair of infra-red sensors and a range of “bells and whistles” (actually, i.e.d.s and a bleeper) to give it character. They also indicate what it is going to do next.

Smart Kart comprises three decks (see photographs) joined vertically by spacer tubes. Construction is very simple, requiring few tools and does not involve high-precision engineering.

On the Move

The system of propulsion is a favourite one for small robots. The two drive wheels are separately driven by low-voltage d.c. electric motors. They each have a 1:288 gearbox to reduce the motor speed to a reasonable rate. The prototype has forward and reverse speeds of about 10cm/s, which is ideal for indoor operations. Balance is maintained by a castor at the rear of the vehicle.

In the basic Smart Kart, the motors are either switched off or run at full speed. Later in the series we introduce motor

speed control when it suits the application. The simple on-off control used in the first application gives nine possible actions, that are combinations of *off*, *forward* and *reverse* for each motor.

The motors are switched by an H-bridge of transistors, controlled by a PIC16F84 microcontroller. The battery for the motors is a pack of four AA-type rechargeable lithium metal hydride cells. Each cell delivers a nominal 1.2V, giving a total of 4.8V.

The control circuit, sensors, bleeper and i.e.d.s are powered by an identical but separate battery. This is to avoid power-line glitches from the motors getting on to the sensor circuits and possibly interfering with the action of the PIC.

Getting Started

Before discussing further what the Kart can do, and how it does it, we first describe the physical construction of its mobile platform. Although we start off with the hardware, the electronic circuits and their construction also play a part in the overall assembly, and both aspects must be considered jointly.

It is best to build the robot one deck at a time, completing each deck with the mounted items, including the electronic circuit boards, before working on the next deck. We begin by describing the lower deck.

Building the Lower Deck

For the prototype, 3mm expanded PVC board was used for the decking, but the Smart Kart could instead be built from plywood, hardboard, or many of the other plastic-based boards that are readily available. Expanded PVC board is one of the best of these. It is light, rigid and easily worked. It can be cut with a craft knife, using a steel rule. It can be glued using PVA clear-drying adhesive.

It is slightly resilient so it is unnecessary to use locking washers when bolting parts together. Unlike expanded polystyrene, it does not crumble and has a smooth “solid” surface. Finally, it is self-coloured (red, blue, yellow, green, black, white) so does not need painting. It is fairly expensive by the sheet, as used by signwriters, but off-cuts are usually available.

A cutting and drilling guide is given in Table 1 and Fig.1. Note that the exact number of holes and the positions for some of them depends on the sizes of items to be attached and what diameter bolts they require. Read each section's description thoroughly before marking out, cutting and drilling each board, as it may be necessary to modify the dimensions.

Avoid being tempted to make the overall size larger than shown – an over-large robot may be too heavy for the motors to drive and it may be difficult for the robot to manoeuvre in confined spaces (such as the average living-room or the average dining-room table).

The lower deck holds the motors with their gearboxes, the power switching board and the battery box that supplies the motors. The motors and/or the gearboxes will probably already have mounting holes drilled, usually for 2mm bolts. If not, springy clips are available for gripping small d.c. motors.

Mount the motors and gearboxes so that the axles are fairly close to the front edge of the deck. This helps to ensure that the sensors remain close to the path when the robot spins left or right.

Wheelies

A frequent problem is fixing the wheels securely to the axles, since very few wheels have grub-screws for this purpose. Plastic wheels were used in the prototype, 50mm

Smarty in line-follower mode. The robot pauses while deciding whether to turn left or right at a junction in the maze. This view shows the rear castor. The PIC is visible in the middle of the processor circuit board.

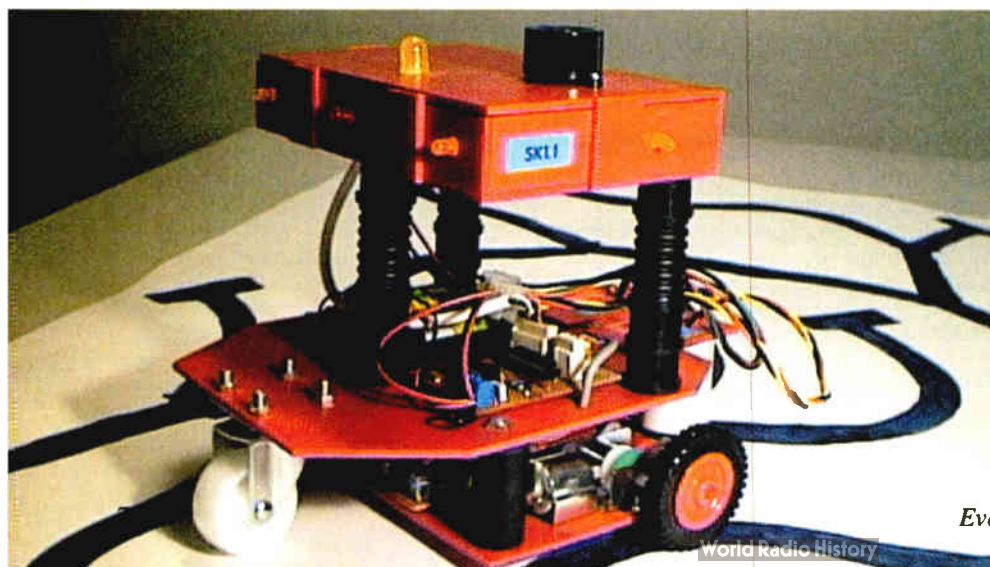

HARDWARE ... YOU WILL NEED

PVC board cut and drilled as in Table 1 and Fig.1.

Spacers cut from plastic tubing (usually ABS), see text for lengths (6 off)

Bolts for spacers, with nuts, preferably not more than 5mm diameter, see text for lengths (6 off)

Bolts and nuts for sensors, M3, 30mm long (2 off)

PVC water-pipe coupling 27mm internal diameter, 32mm external diameter, length 42mm (2 off)

Gearboxes, high reduction ratio, often integral with motors (see text) (2 off)

Drive wheels, 5cm diameter, preferably with rubber tyres (2 off)

Castor, small furniture type, preferably with ball-bearing swivel

Assorted M2, M3, and M4 bolts and nuts

Miniature stick-on cable clips, as required

Glue for upper deck panels

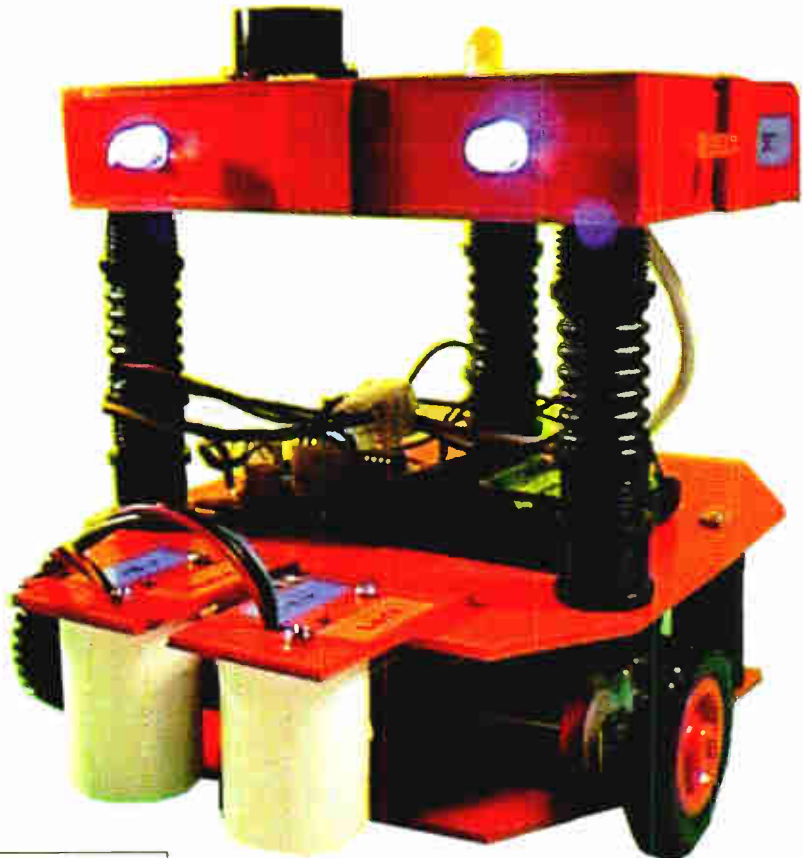

The Smart Kart, showing its three decks, large drive wheels and the pair of sensors.

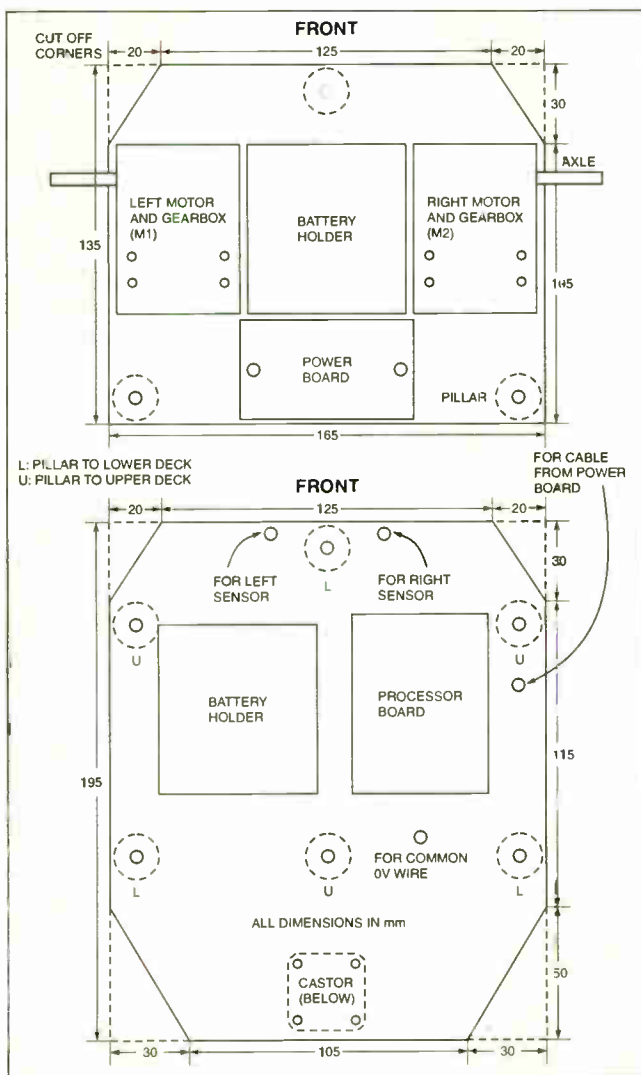
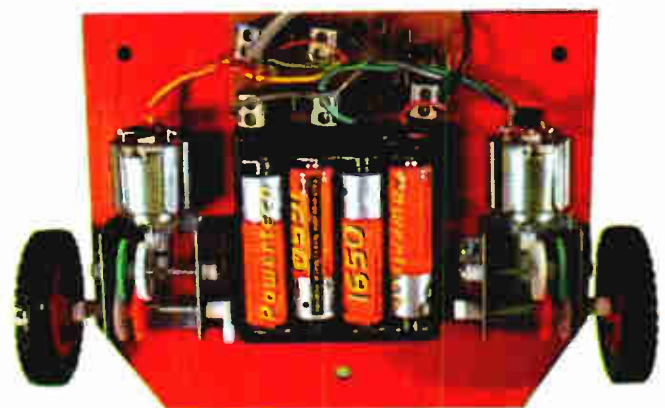

Fig. 1. Cutting and drilling guide for the boards. Exact positioning of holes depends on the sizes of the items to be mounted.



Early stage in construction of the prototype shows the motors and gearboxes, with the power switching board.

Table 1: Cutting and Drilling Guide.

Piece	Dim. (mm)	Holes for
Lower Deck	165 x 135 (see Fig.1)	separators (3), motors/gears, battery box, power board
Middle Deck	165 x 195 (see Fig.1)	separators (6), battery box, processor board, castor, sensors (2), cable, common 0V wire
Sensors	60 x 40 (2 off)	bolt, wires, screwdriver
Upper Deck - bottom	165 x 110	separators (3), slot for cable
Upper Deck - top	165 x 110	beacon i.e.d., bleeper (mounting and connector)
Upper Deck - front	165 x 25	headlight i.e.d.s (2)
Upper Deck - rear	165 x 25	reversing and indicator i.e.d.s (2)
Upper Deck - sides	104 x 25 (2 off)	indicator i.e.d.s (2)
Upper Deck - tabs	31 x 20 (5 off)	-

diameter, with 5mm diameter axle holes. Axles of small gearboxes are often 3mm in diameter. Cut a 10mm length of standard plastic aquarium aerator tubing to give a friction grip between axles and wheels.

First push the tubing on to the end of the axle; it should be a fairly tight fit. Then push the plastic-sheathed axle into the hole in the wheel. This too should be a tight fit. In many hours of testing, the wheels never came loose or dropped off. If you are not so lucky as to find compatible wheels, axles and tubing, you could try using lengths of PVC insulation stripped from mains cable.

One point to remember when mounting items on this deck is that bolts should generally be inserted in an upward direction, with their heads flush with the underside of the deck. This minimises the risk of bolts catching on the carpet or other soft surfaces as the robot moves along.

In the prototype, a battery box with a switch on its underside was used. Because of this, a slot had to be cut in the lower deck to allow access to the switch from below. However, if you are using a switchless box, you will need to drill a hole to mount a miniature low-voltage toggle switch. Probably this is best mounted toward the rear of the middle deck for easy access (see later).

Between Deck Spacers

A feature of this vehicle is that each deck is separated from adjacent decks by spacers, rather like those used for mounting circuit boards but considerably more robust. The boards are held together by long bolts which press the boards firmly against the ends of the spacers (see Fig.2).

The spacers used in the prototype are lengths of black ABS tubing 21mm in diameter with a 13mm bore. The tubing was cut from fittings used for garden/greenhouse reticulation (or irrigation) systems. These are cheap to buy and easy to cut with a junior hacksaw.

The length of the spacers between the lower and middle decks is determined by the dimensions of the castor (see photo below). It was felt preferable to use a really freely-turning castor that does not drag on the surface and divert the robot from its path. DIY stores stock a range of furniture castors with ball bearings and one of the smaller types was chosen. It functions perfectly.

First of all, work out the clearance between the underside of the lower deck and the running surface. This depends on the radius (r) of the drive wheels, the thickness of the board (t) and the height above the board of the axle centre (a):

$$\text{Clearance} = r - t - a$$

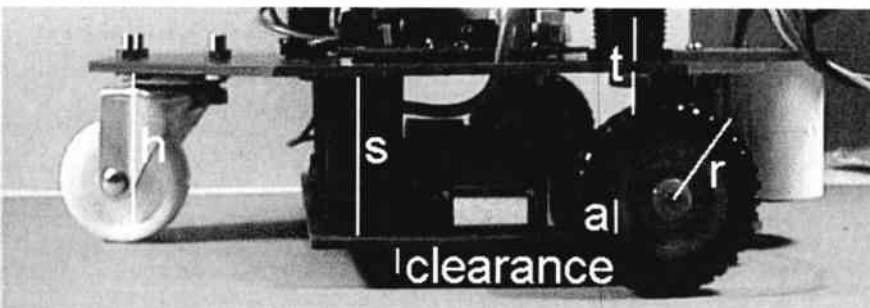

Showing how the dimensions of the castor determine the required length of the spacers between the lower and middle decks.

Allowing for protruding bolt-heads below the lower deck, it is advisable to have 10mm or more clearance for negotiating the edges of rugs and other hazards. Given the height (h) of the castor, the radius (r) of the drive wheel and the height of the axle (a), the required length (s) of each spacer is:

$$s = h - r + a$$

Before cutting the spacers, check that the distance between the decks is sufficient to allow you to insert and remove the cells of the motor power supply. If this is insufficient, consider mounting the castor on a block, or using a larger castor. It is important for the appearance and operation of the robot that the decks should be level.

Having determined the required length of the spacers, you need three long bolts with nuts (e.g. 50mm roofing bolts – DIY store again). Drill holes for the bolts at the centre front and the two rear corners. The distance from the edge and corners is a few millimetres greater than the external radius of the spacers. At the same time drill matching holes in the middle deck.

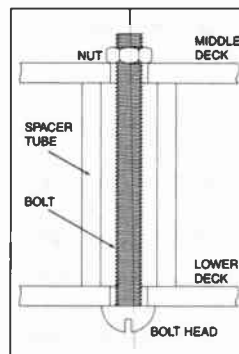
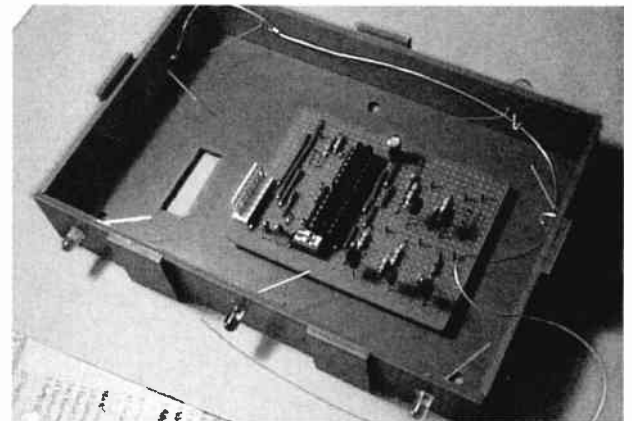

Fig.2. Connecting decks by spacers.



The upper deck at the stage when the l.e.d.s are being connected.

Building the Middle Deck

The middle deck carries the processor board, battery for the processor and its input and output circuits, the sensors (though these can be mounted elsewhere if you want to experiment), and the castor.

The castor is bolted at the rear end of the board. Although it normally trails behind as the vehicle moves forward, it must be free to turn to the opposite position when the vehicle is reversing. You may need to make the middle deck longer, to position the castor further back from the lower deck. The castor must turn freely through 360°.

If the processor battery holder has a built-in switch, you may need to cut a slot in the deck, as with the motor battery holder. Otherwise, mount a separate miniature switch on the deck, alongside the switch for the motor battery. Make sure that the bodies of the switches do not obstruct the turning of the castor.

Two holes are needed in the deck for wires (4-core cable and a common 0V line) to come from the lower deck. The two sensors are mounted at the front edge of the middle deck, directed downward. Two holes are needed for bolting the sensors to the deck.

The middle deck is supported above the lower deck by three separators. One is close to the centre of the front edge and the other two are at the rear corners of the deck. Leave room for these when planning the layout of the items on the deck, but you will not be able to fit them until later.

Building the Upper Deck

There is scope for inventiveness in designing and decorating the upper deck. For the prototype, a shallow box (see below) was made to house the Effects

circuit board, with the l.e.d.s and the bleeper mounted on the top and sides of the box. The box was made from rectangular panels of PVC board glued together by their edges. It consists of a shallow tray with a drop-on lid, held in place by five rectangular tabs projecting 3mm above the top of the box.

It is essential to drill the holes in the panels before gluing the panels together. The sides have pairs of 1mm holes through which the wires from the l.e.d.s pass. The bottom has three holes in it for the bolts of the separators. The bottom also has a slot cut in it to pass the 6-way socket from the Effects board out of the box, down to plug on to the processor board on the deck below.

The upper deck is mounted on three spacers, placed at the centre of the rear edge and near the front two corners. Leave room for these when planning the middle deck. Drill three holes for these bolts in the middle deck, and three matching holes in the board that will eventually form the bottom of the upper deck.

The spacers can be any reasonable length, the main point to consider is to have enough room between the middle and upper decks to allow the PIC to be removed easily from its socket for

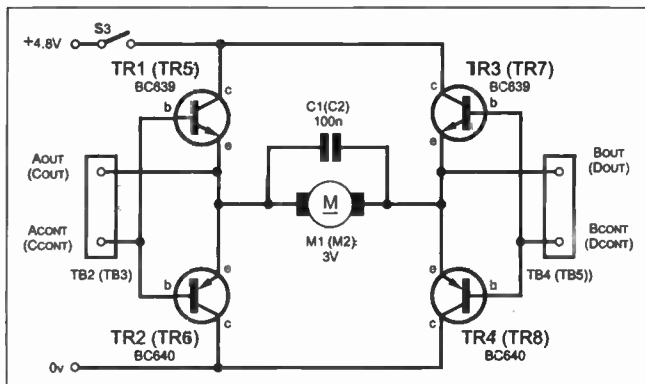

Fig.3. Schematic diagram of circuit for controlling one motor. A duplicate circuit is required for the other motor. Note capacitor C1 (C2) is connected directly across the motor M1 (M2).

programming, and then replaced. The battery cells must also be easily removable for charging.

However, the between-deck spacing may be limited by the length of bolts that you can buy. Long bolts are often quite hefty and add unwanted weight to the robot, so choose with care.

Power Switching Board

The first circuit to be built is a switching circuit to put the motors under the control of the PIC. The control circuit for each motor is a conventional H-bridge, in this case based on a four low power transistors, two *nnp*, two *pnnp*. The circuit diagram for this bridge is shown in Fig.3, and two copies of it are needed. This is reflected in its component numbering – those notations in brackets are for the second copy.

The circuit is operated by applying either a high voltage (4.8V) or a low voltage (0V) to terminals A and B. If A is made high and B is made low, TR1 and TR4 are switched on, while TR2 and TR3 are switched off. Current flows from the positive supply line, through TR1 (on), through the motor from left to right (in the figure) and through TR4 (on) to the 0V line.

If A is made low and B is made high, TR2 and TR3 are switched on, the other two transistors being turned off. Current flows through the motor from right to left (in Fig.3), so driving it in the opposite direction. If A and B are both high or both low, no current flows through the motor. The capacitor (C1) across the terminals of the motor filters out the worst spikes on the supply lines.

Construction

The stripboard component assembly layout for both copies of this circuit is shown in Fig.4. First cut out a rectangle of stripboard having the same number of strips and holes as indicated. Then cut the copper strips beneath the board where shown. Drill two 3mm mounting holes and drill matching holes in the lower deck.

Solder the wire links first, then the transistors and finally the 2-way terminal blocks. The +VE and 0V terminals are wired to the battery box (through a switch, either built-in or separate, as discussed earlier).

The terminals labelled A_OUT and B_OUT are connected to the left-hand motor, with A_OUT going to the brush on the left of the motor. Those labelled C_OUT and D_OUT are connected to the right-hand motor, with

C_OUT going to the brush on the left of the motor. Ensure that these connections are the right way round so that the motors will turn in the intended directions. (The connections can be changed later if necessary).

The other terminals, A_CONT, B_CONT, C_CONT and D_CONT are control inputs to the transistors. Eventually these will be connected to the PIC microcontroller. For the present, test the assembly by switching on the power, and using temporary leads to connect these terminals to the positive supply or to 0V for test purposes.

If the motors are wound with the same polarity as those used in the prototype and have the same gearbox, they will turn the drive wheels in the forward direction when A is made low and B high (or C low and D high). If the wheels turn in the reverse direction, swap the leads going from the terminal blocks to the motors.

When the power board has been tested, connect a 4-core light-weight cable to the control terminals. This should be about 20cm long to reach to the processor board, which will eventually be mounted on the middle deck. Note the colours of the wires to assist you when soldering their other ends to sockets later.

Connect the battery to the power terminals (+VE, 0V), carefully observing the correct polarity, inserting a switch in the +VE line if the battery box does not have one. The leads to the switch should be long enough to run to it when it is mounted on the middle deck. Finally, connect a wire to the 0V terminal to act as a common 0V line for the two power supplies. Another 0V connection will also run to the 0V terminal on the Processor board.

Make certain that the component wires are clipped short on the underside of the board. Secure the board to the lower deck, using 3mm nylon nuts and bolts. Use short spacers if you prefer, but remember that there is not much headroom between the lower and middle decks.

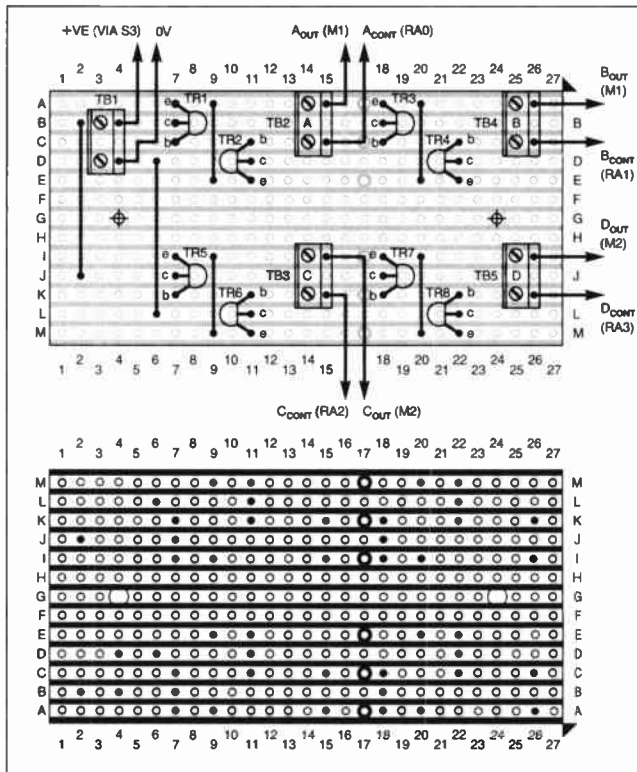
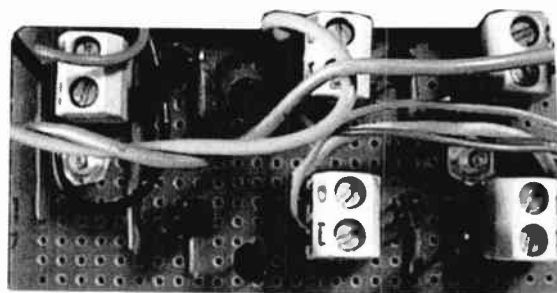

Fig.4. Stripboard layout of the Power Switching board.



Component layout on the completed Power Switching board.

COMPONENTS

POWER SWITCHING BOARD

Capacitors	C1, C2	100n polyester (2 off)	See SHOP TALK page
Semiconductors	TR1, TR3, TR5, TR7	BC639 <i>nnp</i> transistor (4 off)	
	TR2, TR4, TR6, TR8	BC640 <i>pnnp</i> transistor (4 off)	
Miscellaneous	M1, M2	3V d.c. motor, with reduction gearboxes (2 off)	
	S3	s.p.s.t. toggle switch (option – see text)	

Stripboard, size 13 strips x 27 holes; AA battery (4 off), plus holder; 2-way p.c.b. screw terminals (5 off); M3 nylon nut and bolt (2 off); wire for links and connections, solder, etc.

Approx. Cost
Guidance Only

£6

excl. batts & motors

Processor Circuit

The Processor circuit is the heart of the system, and its circuit diagram is shown in Fig.5.

The circuit is based around a PIC16F84 microcontroller, IC1. Its operational speed is set by the values of resistor R2 and capacitor C4. It is held in normal running mode by resistor R1, with switch S5 providing a Reset control if needed. Capacitor C3 provides a slight delay between the Reset pulse and the PIC entering normal running mode.

PIC pins RB0 to RB5 and RA0 to RA3 supply output control signals to other aspects of the whole system. Control signals from those aspects are input to the PIC via AND gates IC2a and IC2b, respectively into PIC pins RB6 and RB7.

The 4-8V power supply is switched to the circuit by S4, with capacitor C5 providing power line decoupling.

The stripboard layout for this circuit is shown in Fig.6. Again cut out a rectangle of stripboard to the size indicated, and cut the

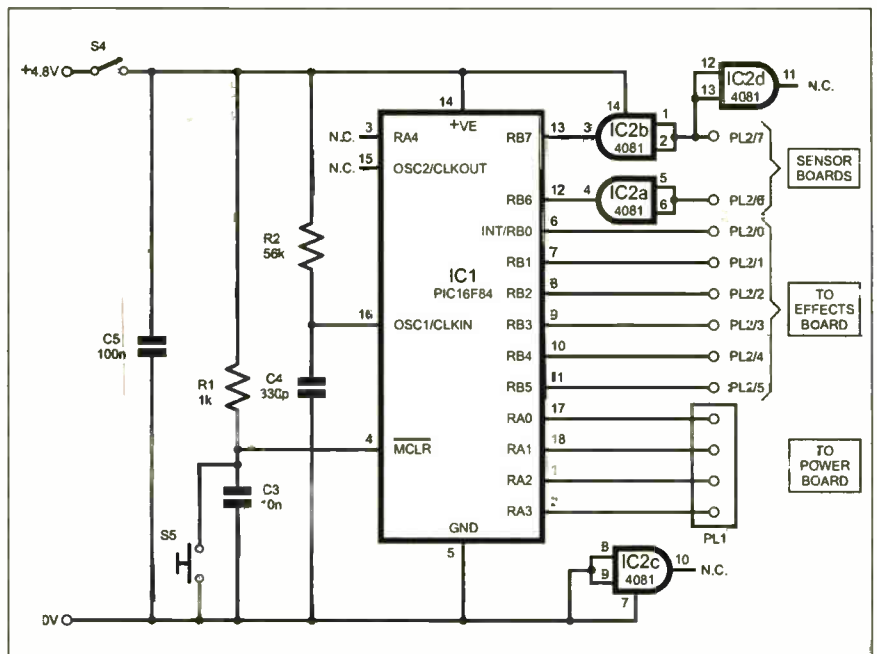
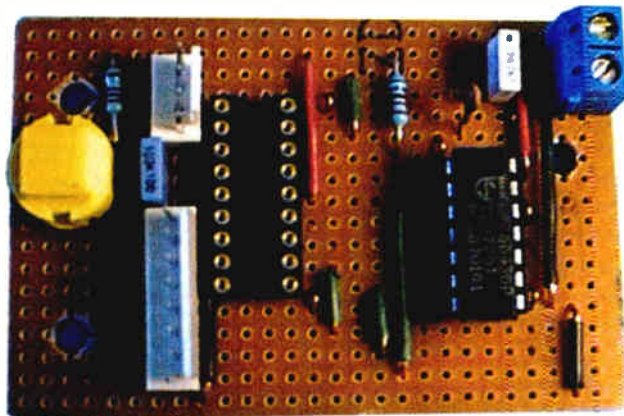

Fig.5. Circuit diagram for the PIC microcontroller Processor stage of Smart Kart.

copper strips beneath the board where shown. Drill the three 3mm mounting holes and drill matching holes in the middle deck.

Assemble the board in order of link wires, i.e. sockets, and then in ascending order of size. The 18-pin i.c. socket should be a turned-pin type for easy removal and replacement of the PIC. Do not insert the PIC into its socket at this stage. Wait until after all the connections have been tested. A completed assembly, but without the PIC, is shown in the photograph on the left.

The +VE and 0V terminals are wired to the battery box through a switch, either built-in or separate, as previously discussed.



The processor board, without the PIC but showing its turned-pin socket.

COMPONENTS

PROCESSOR BOARD

Resistors

R1	1k
R2	56k

Both 0.25W 5% tolerance or better.

Capacitors

C3	10n polyester, 5mm pitch
C4	330p ceramic, 5mm pitch
C5	100n polyester, 5mm pitch

Semiconductors

IC1	PIC16F84 microcontroller, pre-programmed (see text)
IC2	4081 quad 2-input AND gate

Miscellaneous

S4	s.p.s.t. min. toggle switch (option – see text)
S5	s.p.s.t. snap-action pushswitch, p.c.b. mounting
PL1	4-way locking and polarising header connector, with matching socket
PL2	8-way locking and polarising header connector, with 2-way and 6-way sockets

Stripboard 47mm x 73mm (18 strips x 28 holes); 2-way p.c.b. screw terminal; 14-pin d.i.l. socket; 18-pin d.i.l. socket; AA battery (4 off), plus holder; wire for links and connections; solder, etc.

Approx. Cost
Guidance Only

£9

excl. batts

See
SHOP
TALK
page

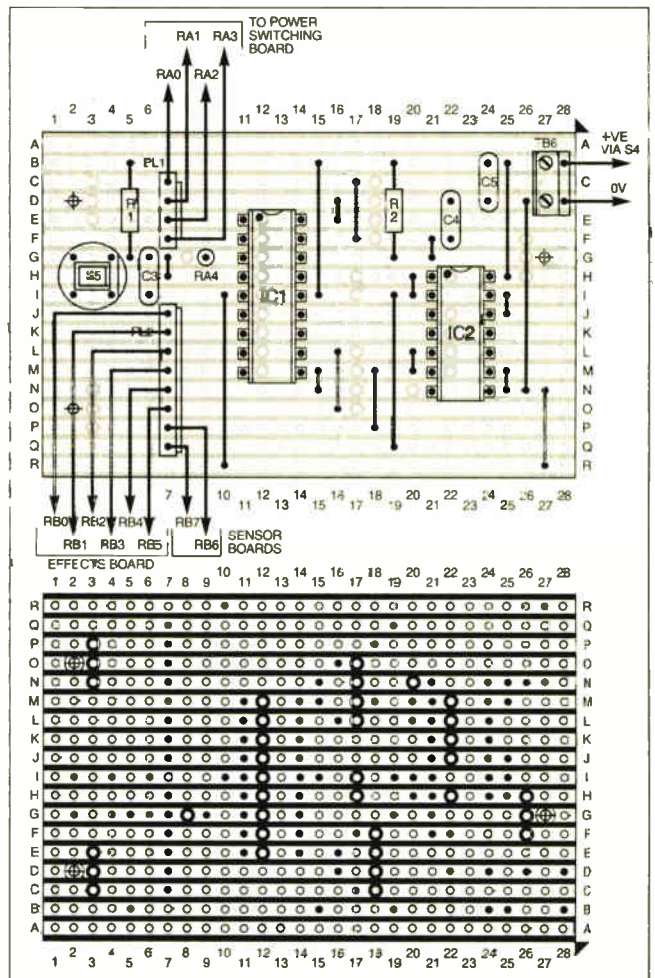

Fig.6. Stripboard layout of the processor board.

Table 2: Processor board connections, Plug PL1 (Port A)

Port name	Pin no	I/O	Connected to
RA0	17	Output	Power board, terminal A, left motor
RA1	18	Output	Power board, terminal B, left motor
RA2	1	Output	Power board, terminal C, right motor
RA3	2	Output	Power board, terminal D, right motor

Pin RA4 is not used, and is unconnected, so it is available for experimental use but can be left unused.

Table 3: Processor board connections, Plug PL2 (Port B)

Port name	Pin no.	I/O	Connected to
RB0	6	Output	Headlamp l.e.d.s
RB1	7	Output	Reversing l.e.d. and bleeper
RB2	8	Output	Left indicator l.e.d.
RB3	9	Output	Right indicator l.e.d.
RB4	10	Input	Behaviour mode select S1
RB5	11	Input	Behaviour mode select S2
RB6	12	Input	Infra-red sensor, right
RB7	13	Input	Infra-red sensor, left

Connections to the board are through 0.1in. (2.5mm) pitch pin-plugs and sockets, with a 2-way terminal block for the power supply. The board can be completely disconnected should you want to take it out and change its wiring.

Plug PL1 carries the wires from the power switching board to PIC Port A. Solder a 4-way socket to the 4-way cable and plug this on to PL1. Plug PL2 is an 8-way connector but there are two sockets mating with it. A 2-way and a 6-way socket will usually fit neatly onto PL2, but first you may need to pare away one of the polarity guides on each socket. Ignore PL2 until the sensors and effects boards have been built.

The plugs are connected as indicated in Table 2 and Table 3.

Sensors

There are two sensors, each comprising an infra-red (IR) l.e.d. and an infra-red photodiode. The l.e.d. is directed down onto the surface over which the vehicle is travelling. The photodiode receives the reflected radiation. The sensor gives a low logic output when the surface is black or dark-coloured, and a high output when the surface is white or light-coloured. The reason for using infra-red is to avoid interference from ambient light. No problems were found when operating in bright indoor daylight, or in low-level incandescent illumination.

The sensors are used to detect lines painted in black on a white background. Theoretically, it is possible to operate the sensors in the reverse direction, by changing the program so that they respond to white lines on a black background. This was the original intention, but an unexpected problem was encountered – some black cardboard is not black, or at least, it is not black in infra-red light.

Two different batches of black card were tried, purchased from the same stationers. They both looked equally black to the eye; one did not reflect IR, but the other reflected it very strongly. The robot was unable to detect a white strip on the reflecting black background. So it was decided to use white (or light-coloured) fluorescent or metallic card as the background and paint the paths

on it, using acrylic paint (black or Payne's Grey).

Sensor Circuit

The circuit diagram for one IR Sensor is shown in Fig.7 (the bracketed numbers refer to the second channel). IR l.e.d. D1 has series resistor R3 limiting the current to 40mA. This is near the maximum for the l.e.d., producing a high level of illumination. The radiation reflected back from the surface (Fig.8) is detected by IR photodiode D2. This is reverse-biased so only a weak leakage current flows.

The current passes through a high resistance (R4 plus preset potentiometer

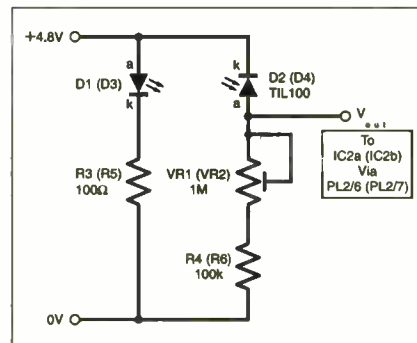

Fig.7. The circuit of one sensor.

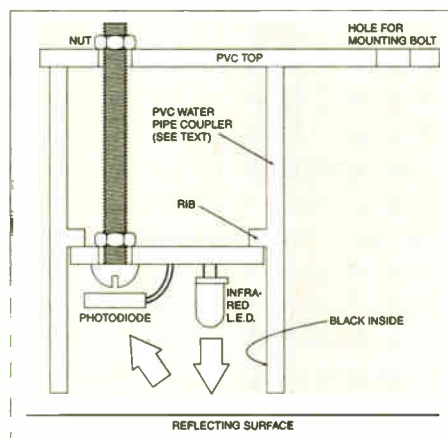

Fig.8. A sensor in vertical section.

VR1) generating a potential difference (p.d.) of a few volts. VR1 is adjusted so that the voltage at V_{out} is well above half-supply voltage (2.4V) when D2 is receiving IR reflected back from a light-coloured surface, but is well below half-supply voltage when reflection is from a dark surface.

To give a response which differentiates more strongly between light and dark, the voltage at V_{out} is fed to the PIC via one of the two CMOS AND gates (IC2a, IC2b) in Fig.5. The gate's output swings strongly between +VE and 0V, so presenting a more rapidly changing, clear-cut signal to the PIC.

Sensor Housing

Each sensor of the prototype is housed in a standard PVC waterpipe coupler, having an external diameter of 32mm (27mm internal). This has an internal rib half-way along it (Fig.8). The circuit board is made circular to fit the pipe, and is held (strip-side uppermost) pressed against the rib by a bolt that runs through the board and up through the plastic top of the sensor.

The top is a small rectangle of expanded PVC (as used for the decks). This has holes bored in it for the bolt, screwdriver access, the cable, and for bolting the sensor to the middle deck. If the pipe you are using has no rib, glue three small rectangles of PVC board inside the pipe at the right level.

COMPONENTS

SENSORS (Two required)

Resistors
R3, R5 100Ω (2 off)
R4, R6 100k (2 off)
All 0.25W 5% tolerance or better

See **SHOP TALK** page

Potentiometers
VR1, VR2 1M, min. preset, horiz (2 off)

Semiconductors
D1, D3 5mm infra-red l.e.d. (2 off)
D2, D4 TIL100 or similar photodiode (2 off)

Miscellaneous

Stripboard, circular 26.5 diameter (see text) (2 off); Wire for links and connections; solder etc.



Approx. Cost
Guidance Only

£4

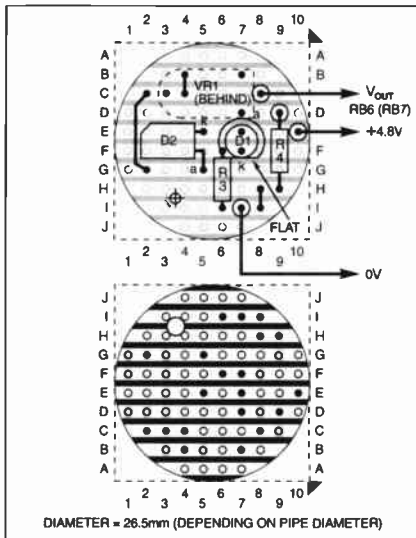

Fig.9. Stripboard layout of one of the sensors.

Sensor – Construction

The stripboard layout for the Sensor board is shown in Fig.9. You need to build two copies of it. For each copy, first cut a square of stripboard to the right size, and then very carefully, using a small hacksaw plus a file, trim it to a circular shape that will just fit inside the waterpipe coupler.

Drill a hole for the bolt, then assemble the board in order of component size. Note that preset VR1 should be mounted on the trackside of the board. Ensure that the diodes are correctly orientated. The leads on IR sensor D2 must be long enough to bend back, to make its sensitive side face away from the bolt (towards the floor when in use), see photograph.

Push the bolt up through the hole in the circuit board and secure it with a nut. Prepare the top PVC board (refer back to Table 1) with holes drilled to align with VR1 and the bolt, and for the three leads.

Thread the leads through the pipe from below and then through the hole in the top board. Press the board up against the internal rib, then push the end of the bolt through the hole in the top board and secure it with a nut. Before you tighten the nut, make sure that the screwdriver access hole is directly above VR1.

A slip of black card that shields D2 against direct light from D1 can be seen in the above photo. However, this has minimal effect and can be omitted, as the beam from D1 is fairly directional. The inside of the lower half of the pipe can be painted matt black, or lined with a collar of black paper to cut out reflection from the walls of the pipe. This is important to minimise interference from ambient light.

Testing

Test the sensors at this stage. Connect the power leads to a 4.8V supply and the output lead to a voltmeter. Hold the sensor with the tube vertical, pointing down on to a white surface about 15mm below the lower end of the pipe. Switch off any bench-lamps and nearby bright filament lamps. Adjust VR1 until the voltage swings high (nearly to 4.8V). Point the sensor at a black surface; the voltage should drop to a few hundred millivolts. Repeat until a clear response is obtained.

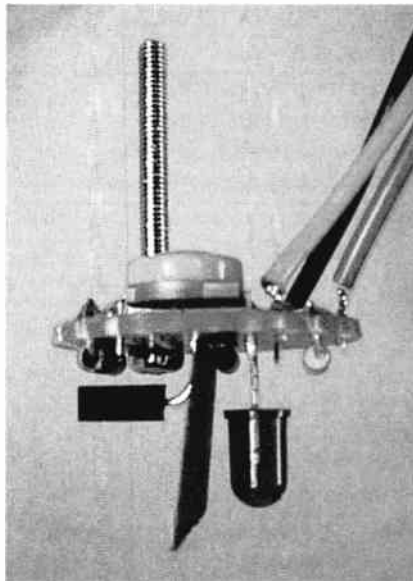

A sensor board, as seen from the side.

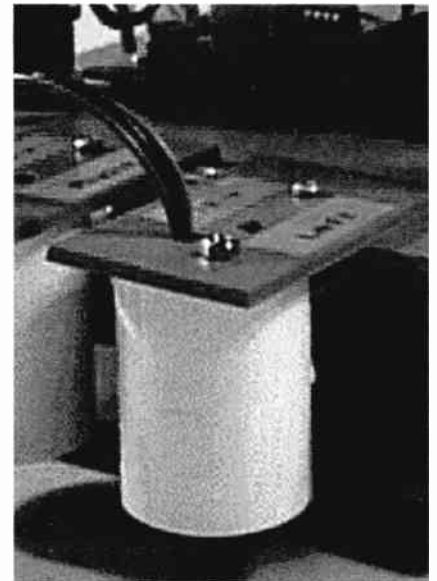

Plastic "shroud" around the sensor board.

If there are any particular surfaces on which you intend to run the Smart Kart, now is a good chance to test them for IR reflectivity. You will need a white or light background surface, producing a sensor output of 3V or more. You also need a dark surface (such as a wide, black strip painted on white card) for the guide-lines, producing an output of 1V or less.

The sensors are each connected to the processor board by three wires. Their +VE and 0V wires go to the screw terminals on the board. The output wires are fitted with a 2-way socket for plugging onto PL2 pins 6 and 7 (right and left respectively). In the prototype, these wires are about 30cm long to allow for the sensors to be mounted on other parts of the vehicle. You could make them shorter if you intend to mount them only at the front.

Effects Board

The Effects board holds the logic and switching circuits for the l.e.d.s and bleeper, whose circuit diagram is shown Fig.10. Switching is controlled by the PIC via a mixture of NAND gates and transistors.

The headlamps (l.e.d.s D5 and D6) are controlled by PIC pin RB0 via *npn* transistor TR9, a high level from RB0 turning them on. Resistor R7 limits the current flow through the l.e.d.s.

The yellow beacon l.e.d. (D12) on the lid is flashed on and off via transistor TR13, which is controlled by an astable based on NAND gates IC3a and IC3b. This l.e.d. flashes all the time, indicating that the power to the middle and upper decks is switched on.

PIC pins RB1 to RB3 are fed to NAND gates IC3c, IC4a and IC4b. These control transistors TR10 to TR12, which in turn control l.e.d.s D7 to D11 and bleeper WD1. The gates are also controlled by the astable, only allowing the PIC's control signal to pass through when the astable's output from IC3a pin 3 is high, with a resulting intermittent flashing of the selected l.e.d., or the sounding of the bleeper.

Switches S1 and S2 select the robot's behaviour mode, via PIC pins RB4 and RB5. These are used in input mode and are held normally-low by pull-down resistors R17 and R18, going high when the respective switch is on.

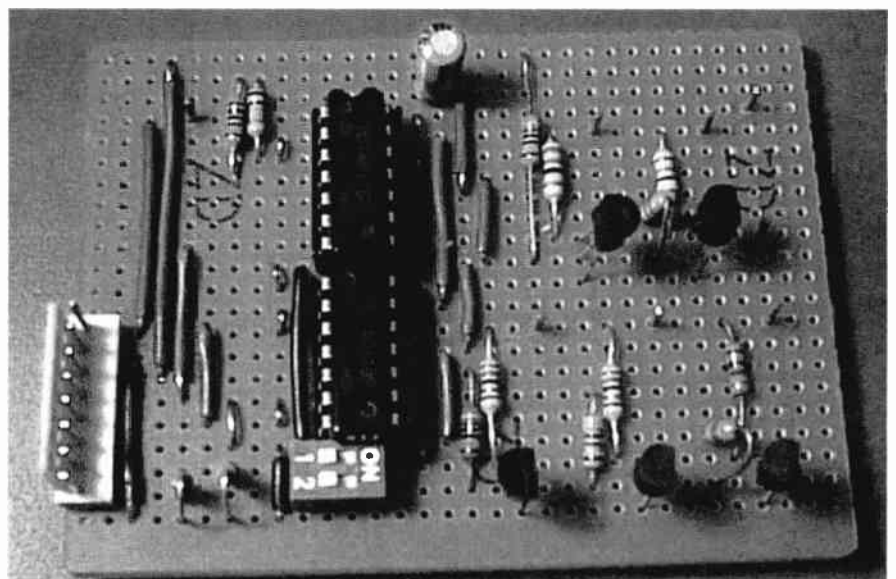

Completed Effects board showing component layout and the two d.i.l. switches S1 and S2.

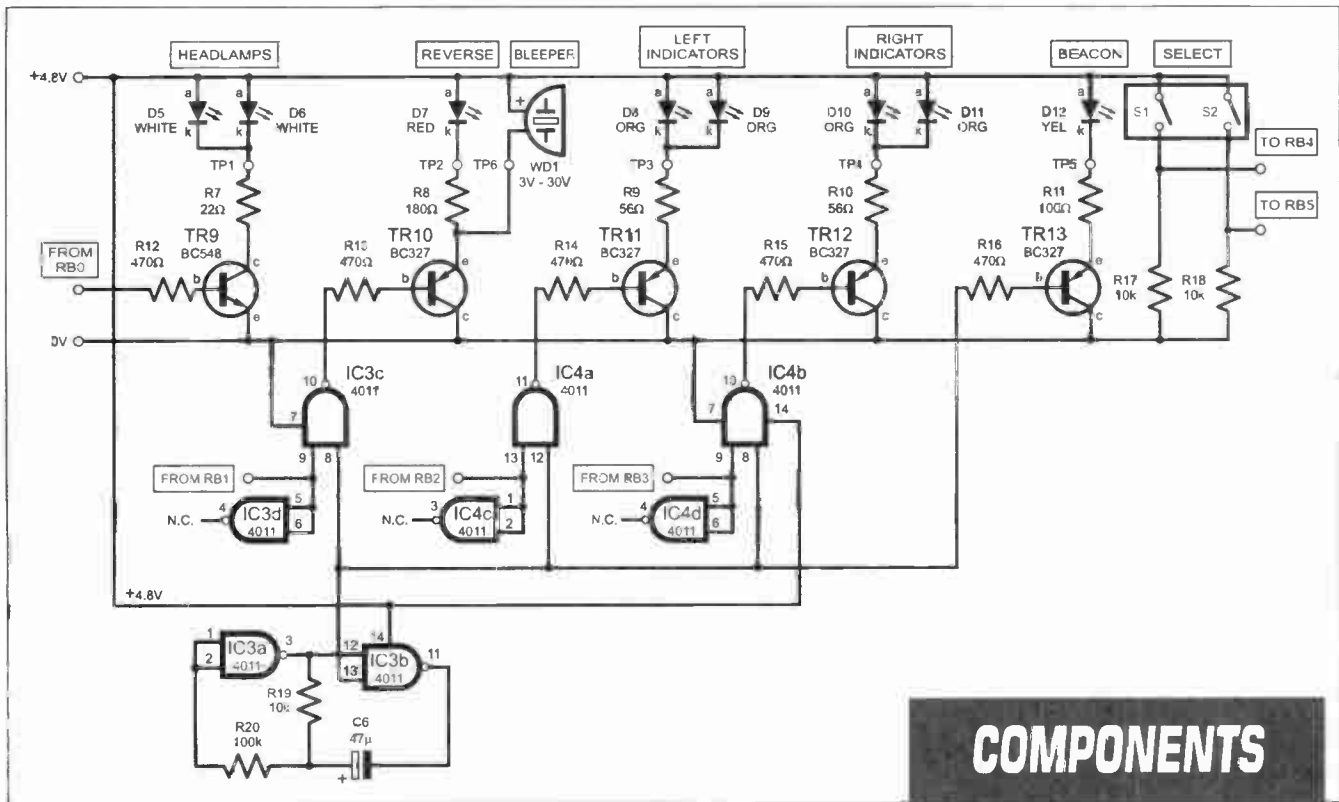

Fig.10. Circuit diagram for the Effects board.

COMPONENTS

EFFECTS BOARD

Resistors

R7	22Ω
R8	180Ω
R9, R10	56Ω (2 off)
R11	100Ω
R12 to R16	470Ω (5 off)
R17 to R19	10k (3 off)
R20	100k

All 0.25 W, 5% tolerance or better

Capacitor

C6	47μ radial elect. 10V
----	-----------------------

Semiconductors

D5, D6	white l.e.d., high brightness, 10mm (2 off)
D7	red l.e.d., standard brightness, 5mm
D8 to D11	orange l.e.d., standard brightness, 5mm (4 off)
D12	yellow l.e.d., standard brightness, 10mm
IC3, IC4	4011 quad 2-input NAND gate (2 off)
TR9	BC548 npn transistor
TR10 to TR13	BC327 pnp transistor (4 off)

Miscellaneous

S1, S2	dual d.i.l. switch (1 off)
PL3	8-way locking and polarising header connector, with matching socket, 0.1in (2.5mm) pitch
WD1	piezo-buzzer, miniature

Stripboard 56mm x 80mm (22 strips x 31 holes); 14-pin d.i.l. socket (2 off); 1mm terminal pins (7 off); wire for links and connections; solder etc.

Approx. Cost
Guidance Only

£8

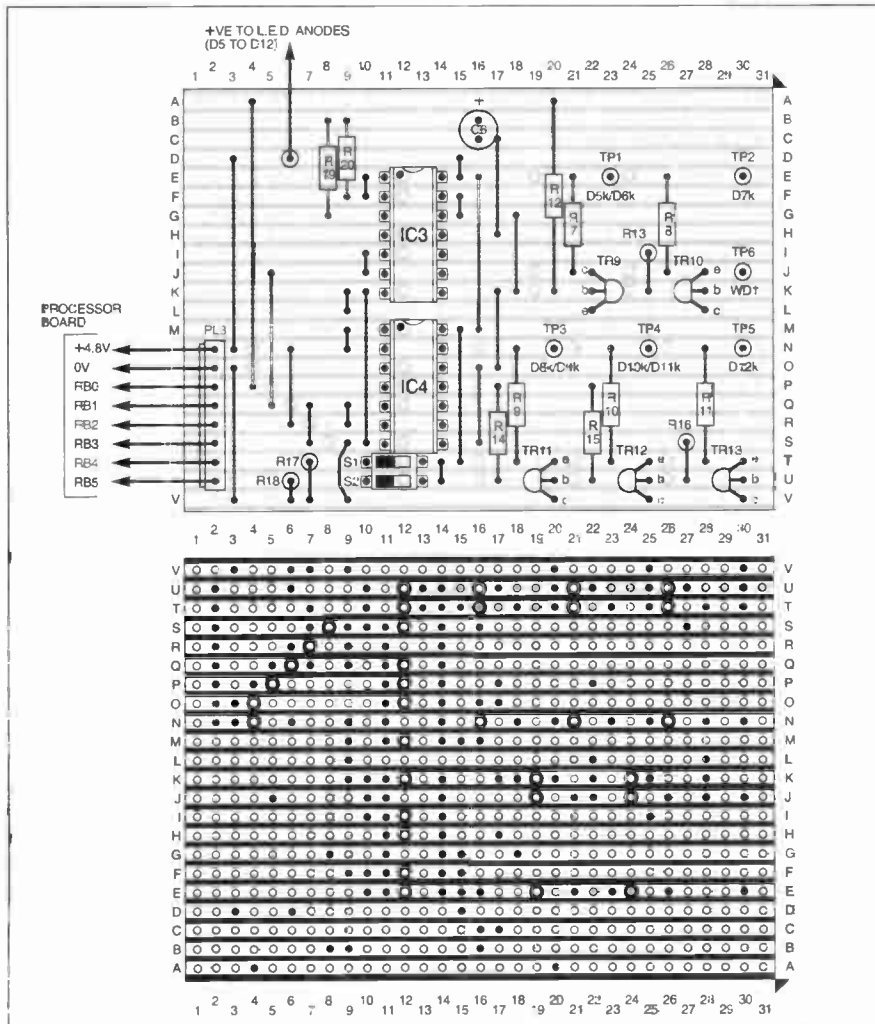

Fig.11. Stripboard layout of the Effects board.

Effects Board – Construction

The stripboard layout for the Effects board is shown in Fig.11. Cut the board to size and cut the strips where indicated. Assemble in the usual order, taking care to orientate the transistors correctly (note that the flat side of TR9 faces left, but the others face right). Connections from the board to PIC pins RB0 to RB5, and to the power supply, are made via connector PL3.

A 2-pole d.i.l. (dual-in-line) switch was used for S1 and S2 in the prototype. However, if you prefer, you could insert terminal pins at stripboard holes T10, U10, T13 and U13, and run wires from these to a pair of low-voltage toggle switches mounted on the side or top of the deck.

As shown in Fig.10, the anodes of the l.e.d.s and the positive terminal of the bleeper are all connected to the +VE supply line. In practice, you can run a bare wire around the inside of the deck, connecting all the anodes to it via flying leads, as can be seen in the accompanying photograph.



Running a common l.e.d. anode wire around the upper deck side panel.

The anode wire of an l.e.d. is cut short and bent around a bare wire before the joint is soldered. The bare wire is then connected to the board at D3. The cathode wires are connected individually to the terminal pins (TP1 to TP5) marked on Fig.11.

The two power lines to the board are soldered to PL3 as indicated in Fig.11, and pass down through the slot in the bottom of the box, to connect to the terminal block on the processor board. The 0V line completes the common connection between the 0V lines on all five circuit boards.

A 6-way cable about 20cm long, and with suitable sockets at each end, connects between plug PL3 and PL2 on the processor board, passing down through the allocated slot.

Once the board and its wiring have been completed and thoroughly checked, it can be fixed on the bottom of the box, using Blu-Tack.

Wiring Check

You should now check the Processor board, Effects boards and the sensors, but *without* the PIC or the logic gates in their sockets.

Interconnect the boards and sensors by their cables. Connect the negative probe of a testmeter to the 0V line at any convenient point. Switch the meter to its continuity checking function. With the power disconnected, touch the positive probe to as many as possible of the points that should normally be at 0V (refer to the appropriate figures), such as the 0V screw terminals on all boards, exposed wire links, pin 7 of each logic i.c. socket and pin 5 of the PIC's socket. There should be continuity throughout the circuits.

Connect the negative probe to the +VE line and check all points that are normally at a positive voltage, including pin 14 of each logic i.c. socket and pin 14 of the PIC's socket. There should be continuity throughout.

Reconnect the negative probe to the 0V line, switch on the processor board battery and use the positive probe to confirm that a voltage of 4.8V appears at all expected points.

Connect flying leads to the power lines and check the action of applying one or the other of these to the pins of the PIC's socket:

Pins 1, 2, 17, 18: Control the motors, as previously described (with motor power on)

Pin 6: Headlamp l.e.d.s come on when made high

Pin 7: Reverse l.e.d. flashes and bleeper sounds intermittently when made high

Pin 8: Left indicator l.e.d.s flash when made high

Pin 9: Right indicator l.e.d.s flash when made high

The beacon l.e.d. flashes all the time

With the meter probes to 0V and the positive probe to the following PIC socket pins, measure these voltages:

Pin 4: Normally high; goes low for as long as the Reset button is pressed

Pin 10: Low when S1 is off; high when it is on

Pin 11: Low when S2 is off; high when it is on

Pin 12: High when the right sensor points at white; low when it points at black

Pin 13: High when the left sensor points at white; low when it points at black

If you have a suitable meter or an oscilloscope, measure the signal frequency at pin 16 of the PIC socket. It should be in the region of 14kHz.

If the circuit passes all of the above checks, you are ready to insert a pre-programmed PIC and begin operating it in its four different modes. We shall look at this in Part 2 next month.

RESOURCES

Software, including source code files, for the Smart Kart Part 1 is available on 3.5-inch disk from the Editorial office (a small handling charge applies – see the *EPE PCB Service* page). It can also be downloaded free from the *EPE* Downloads page, accessible via the home page at www.epemag.wimborne.co.uk. It is held in the PICs folder, under SmartKart. Download all the files within that folder.

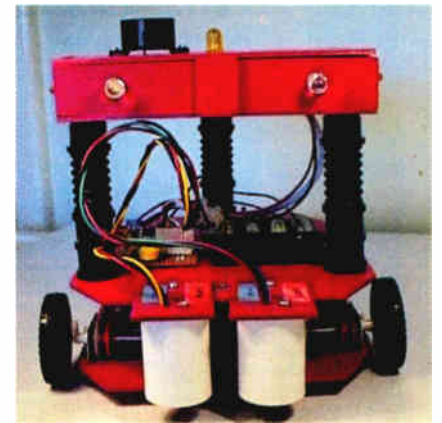

EVERYDAY
**PRACTICAL
ELECTRONICS**
INCORPORATING ELECTRONICS TODAY INTERNATIONAL

NEWSAGENTS ORDER FORM

Please reserve/deliver a copy of *Everyday Practical Electronics* for me each month

Signed

Name and Address

.....

..... Post Code

Everyday Practical Electronics is published on the second Thursday of each month and distributed S.O.R. by COMAG
Make sure of your copy of *EPE* each month – cut out or photostat this form, fill it in and hand it to your newsagent.

DrDAQ Data Logger



Output

Resistance

Voltage

Light level

Temperature

pH

Microphone

External sensors: Humidity

Temperature

O2 In Air

Reed Switch

- Low cost - under £60
- Built in sensors for light, temperature and sound (level and waveforms)
- Use DrDAQ to capture fast signals
- Outputs for control experiments
- Supplied with both PicoScope (oscilloscope) and PicoLog (data logging) software

For more information on DrDAQ, please visit:

www.picotech.com/drdaq105

PC Oscilloscopes

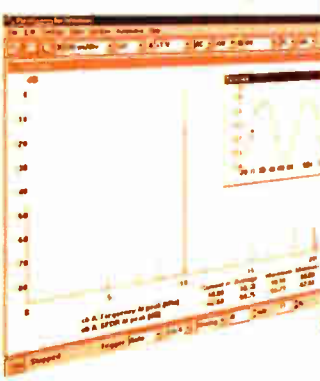
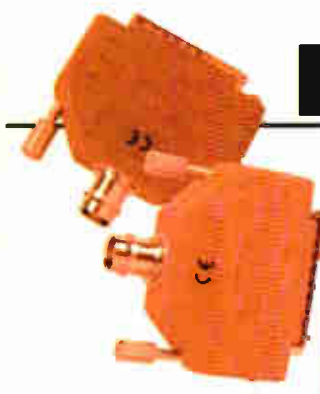

- Scope and spectrum analyser functions
- A fraction of the cost of benchtop scope
- Save multiple setups, for ease of use
- Save, print and e-mail your traces
- FREE technical support for life
- FREE software and upgrades
- Automated measurements

For more information on our scopes, please visit:

www.picotech.com/scope205

Tel: 01480 396395 Fax: 01480 396296 E-mail: sales@picotech.com

PICO
Technology Limited

Light Emitting Diodes – Operation and Applications

Anthony H. Smith, BSc. (Hons)

Part 2 – Biasing and Interfacing

IN Part One of this series, we examined the behaviour and characteristics of the l.e.d., and saw how simple resistor biasing circuits could be used to “drive” an l.e.d. at the proper forward current levels needed for adequate light output.

This month, we demonstrate the operation of other, more specialised, biasing circuits, looking at the best ways to interface l.e.d.s with different logic families, and showing how logic circuits can be developed both for flashing an l.e.d. and as an efficient way of varying the brightness.

Constant Current Biasing

We showed last month how a series resistor may be used as a simple means to set the forward current, I_F , through an l.e.d. Although effective, the technique depends on a stable voltage source; any changes in voltage will produce corresponding changes in I_F which can result in significant variations in light intensity.

Applications that suffer from wide changes in voltage, such as unregulated d.c. supplies and battery packs, usually require some kind of *constant current biasing* if the l.e.d.’s brightness is to remain fixed. A simple and yet remarkably effective technique is shown in Fig.1, where transistor TR1, an n-channel JFET (junction field effect transistor), maintains a constant current through the l.e.d.

To understand how the JFET regulates the current, consider the drain current equation for a JFET:

$$I_D = I_{DSS} \left(1 - \frac{V_{GS}}{V_p}\right)^2 \quad (A)$$

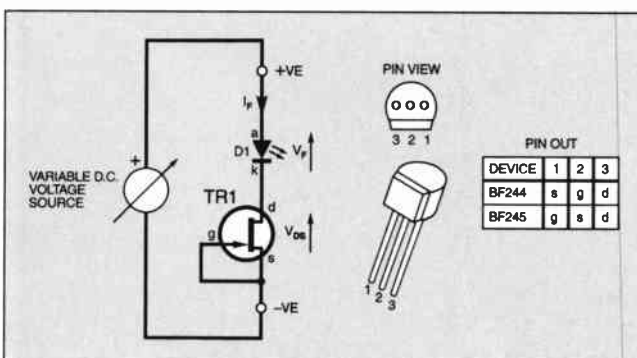

Fig.1. JFET constant current biasing.

where I_D is the drain current (= I_F in this case), I_{DSS} is the *drain source saturation current*, V_{GS} is the *gate-source voltage*, and V_p is the *pinch-off voltage*, also known as the *gate source cut-off voltage*. In this circuit, the gate is connected directly to the source such that $V_{GS} = 0$, and so the equation reduces to $I_D = I_{DSS}$. Since I_{DSS} is a constant for a given JFET, the drain current (the l.e.d.’s forward current) is also held constant.

A good choice for TR1 is a device from the BF244 or BF245 range of JFETs. These parts have essentially the same electrical characteristics but different pinouts, as also shown in Fig.1. They are grouped into different classes according to the spread in I_{DSS} : the BF244/5A has $I_{DSS} = 2$ to 6.5mA; the BF244/5B has $I_{DSS} = 6$ to 15mA; and the BF244/5C has $I_{DSS} = 12$ to 25mA.

Despite its obvious simplicity, the circuit can regulate the l.e.d. current to within about $\pm 10\%$ with supply variations of more than 20V. However, it is not without drawbacks. For example, the minimum working voltage is given by $V_F + V_{DS(min)}$, where V_F is the l.e.d.’s forward voltage and $V_{DS(min)}$ is the lowest value of drain-source voltage at which the JFET remains in its “active” region.

If V_{DS} falls too low, the device enters its “saturation” or “linear” region in which it can no longer maintain I_D equal to I_{DSS} . Typically, this means the supply voltage must be at least 6V, or so, in order to regulate the forward current in a red l.e.d.

The *maximum* working voltage depends not only on the JFET’s maximum drain-source voltage, $V_{DS(max)}$ (which is 30V for the BF244/5), but also on the maximum allowable power dissipation, $P_{D(max)}$. The BF244 and BF245 have $P_{D(max)} = 360mW$ at 25°C, and so if I_D is, say, 15mA, V_{DS} must not be allowed to exceed 24V.

Bipolar Alternative

A slightly more complex constant current circuit is shown in Fig.2, in which an

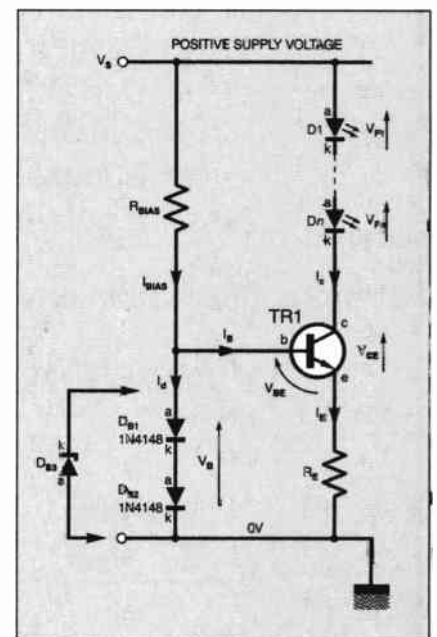
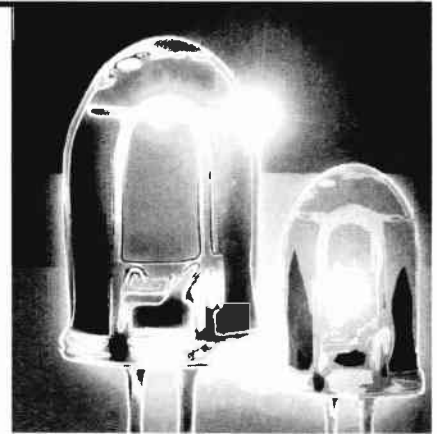

Fig.2. Bipolar transistor current sink capable of driving several l.e.d.s.

npn bipolar transistor, TR1, is used to regulate the l.e.d.s’ forward current. Forward-biased diodes D_{B1} and D_{B2} furnish a stable voltage, V_B , at the base of TR1, such that the voltage, V_E , across emitter resistor R_E is given by $V_E = V_B - V_{BE}$, where V_{BE} is TR1’s base-emitter voltage.

Provided TR1 has large current gain, we may ignore base current I_B and assume that collector current I_C equals emitter current I_E , which itself is given by $(V_B - V_{BE})/R_E$.

When examining a circuit, it’s often useful to make *reasonable* assumptions in order to simplify the analysis. In this case, since the 1N4148 signal diodes, D_{B1} and D_{B2} , are biased by the same current, I_D , we may assume that the voltage drop across each of them is the same, and denote the voltage V_D . Furthermore, since $V_B = 2V_D$, it follows that $I_C = (2V_D - V_{BE})/R_E$.

Now, provided the diodes are at the same temperature as TR1, it is also fair to assume that V_D is approximately (but not exactly) equal to V_{BE} . Therefore, the expression for the collector current simplifies to:

$$I_C = \text{l.e.d.s’ forward current} = V_D / R_E \quad (A)$$

For example, let's say we wish to drive the l.e.d.s at 15mA. At normal room temperature, V_D will be roughly 600mV, and so $R_E (= V_D / I_C) = 600\text{mV} / 15\text{mA} = 40\Omega$. We would make $R_E = 39\Omega$, this being the nearest preferred value. Provided V_D and V_{BE} remain constant, the current flowing through the l.e.d.s will also remain reasonably stable despite wide variations in supply voltage, V_S . If the supply voltage itself is large enough, the circuit can support a large number of series-connected l.e.d.s sharing the same forward current. The main requirement is that:

$$V_S > V_{F1} + V_{F2} + \dots + V_{Fn} + V_{CE} + V_E$$

where V_{F1} is the forward voltage of l.e.d. D1, V_{F2} is the forward voltage of l.e.d. D2, and so on. The transistor's collector-emitter voltage, V_{CE} , should be at least 1V to ensure the device does not saturate. If all the l.e.d.s are of the same type, we may assume they have the same forward voltage, V_F , such that $V_S > nV_F + V_{CE} + V_E$ where n is the number of l.e.d.s. Resistor R_{BIAS} establishes a current, I_{BIAS} , which supplies the diode current, I_D , and base current, I_B . The required resistor value is given by $R_{BIAS} = (V_{S(\text{min})} - 2V_D) / I_{BIAS}$, where $V_{S(\text{min})}$ is the lowest voltage to which V_S can fall.

Normally, a value of around 1mA will be suitable for I_{BIAS} , although lower values, say a few hundred microamperes, may be acceptable provided TR1 has high current gain (i.e., large β or h_{FE}). The circuit provides reasonable regulation of the l.e.d. current.

Test Example

For example, in a test circuit built with $R_{BIAS} = 3.6k\Omega$, $R_E = 39\Omega$, TR1 = BC550B, and with a single red l.e.d., the collector current was 12.9mA at $V_S = 5.0V$, rising to 17.0mA at $V_S = 15.0V$, equivalent to a 32% change in l.e.d. current with a 200% increase in supply voltage.

Current regulation is not as good as the JFET circuit in Fig.1, but the bipolar circuit has the advantage of allowing the nominal l.e.d. current to be set to any desired value by appropriate choice of R_E . Since V_E is of the same magnitude as V_{BE} , any changes in the latter (for example, caused by temperature variations or part to part differences) can have a marked effect on l.e.d. current. This drawback can be corrected to some extent by replacing the two diodes (D_{B1} and D_{B2}), with a single Zener diode, D_{B3} , such that:

$$I_C = (V_Z - V_{BE}) / R_E \text{ (A)}$$

Provided the Zener voltage, V_Z , is at least, say, 3.6V, any changes in V_{BE} will have negligible effect on the l.e.d. current. However, there is a price to be paid for this improvement. Since V_E , the voltage across R_E , is now much larger, $V_{S(\text{min})}$ must also be larger to support this voltage, and there is now more power wasted in R_E . Also, I_{BIAS} should be at least 5mA to ensure proper biasing of Zener diode D_{B3} , again wasting power.

We'll show in a later article how the addition of an extra l.e.d. can make a novel improvement to this circuit.

Two-Transistor Bias

By replacing the diodes with an extra npn transistor as shown in Fig.3, the

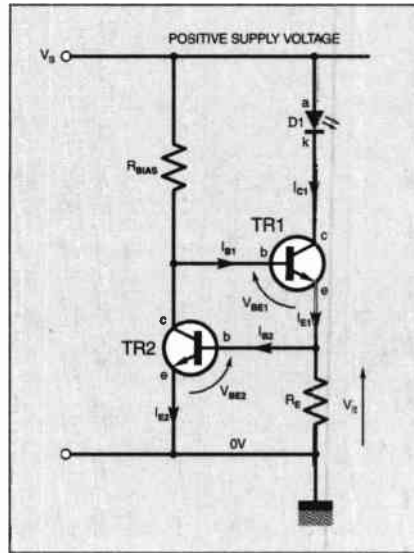

Fig.3. Two-transistor current sink.

circuit's regulation in response to supply voltage variations can be improved significantly.

The circuit is essentially a classical, two-transistor current sink, in which feedback around TR1 and TR2 ensures that the l.e.d. current remains fixed despite changes in V_S . Transistor TR1 and resistors R_{BIAS} and R_E play the same part as before. However, TR2's base-emitter voltage, V_{BE2} , now provides the reference voltage necessary to regulate the l.e.d. current.

A thorough analysis of the circuit is beyond the scope of this article, but to understand how it works, assume that an increase in supply voltage causes a momentary increase in TR1's collector current, I_{C1} . The corresponding increase in emitter current, I_{E1} , produces an increase in TR2's base current, I_{B2} . This, in turn, causes TR2's collector to sink more current through R_{BIAS} and also away from TR1's base.

The reduction in I_{B1} produces a proportionate decrease in I_{C1} , thereby mitigating the initial rise in collector current. This overall *negative feedback* around the two transistors acts to oppose any external effects which would otherwise tend to increase or decrease the l.e.d. current.

Provided TR1 has plenty of current gain (large h_{FE}), we may assume that $I_{C1} = I_{E1}$. Furthermore, if TR2 also has large h_{FE} , we may ignore the effects of I_{B2} and assume that $I_{E1} = V_E / R_E$. However, $V_E = V_{BE2}$ and so:

$$I_{C1} = \text{l.e.d.'s forward current} = V_{BE2} / R_E \text{ (A)}$$

Therefore, provided we can make a good estimate of V_{BE2} , we may set the l.e.d. current to any value we choose simply by selecting an appropriate value for R_E .

The value of bias resistor R_{BIAS} should be small enough to ensure adequate base drive for TR1 at minimum supply voltage. As a rule of thumb, the current through R_{BIAS} should be at least twice the maximum value of I_{B1} .

Worked Example

Let's say we require an l.e.d. current of 20mA at a minimum supply voltage of 5V, that is, $I_{C1} = 20\text{mA}$ and $V_{S(\text{min})} = 5V$. We'll use two BC108 transistors for TR1 and TR2; these are inexpensive and have a

minimum current gain of around 100, such that the *maximum* value of I_{B1} is: $20\text{mA}/100 = 200\mu\text{A}$. Thus, the current through R_{BIAS} should be at least $2 \times 200\mu\text{A} = 400\mu\text{A}$.

The voltage across resistor R_{BIAS} is simply $V_S - V_{BE1} - V_{BE2}$, and since both transistors are the same type it is fair to assume that $V_{BE1} = V_{BE2}$; therefore, the voltage across R_{BIAS} is $V_S - 2V_{BE}$. At room temperature, the typical value of V_{BE} for the BC108 is 600mV, so when $V_S = 5V$, the minimum voltage across R_{BIAS} is $5V - (2 \times 600\text{mV}) = 3.8V$. Therefore, the required value of R_{BIAS} is $3.8V/400\mu\text{A} = 9.5k\Omega$. The nearest lower preferred value is 9.1k Ω .

Rearranging the aforementioned equation for I_{C1} , we see that $R_E = V_{BE2} / I_{C1}$, and so in this example we require $R_E = 600\text{mV} / 20\text{mA} = 30\Omega$.

A breadboard circuit built using these component values produced impressive results. At the minimum supply voltage of 5V, the measured l.e.d. current was exactly 20mA. With V_S increased five-fold to 25V, the rise in collector current was just 1.7mA, that is a current increase of just 8.5% against a voltage increase of 200%!

Despite its splendid current regulation, the circuit provides only moderate thermal stability due to the dependence on V_{BE} as a reference voltage. Typically, the temperature coefficient of V_{BE} in a small-signal transistor is around $-2\text{mV}/^\circ\text{C}$. Therefore, if V_{BE} is 600mV at 25°C , a temperature change of, say, $\pm 20^\circ\text{C}$ will cause a change in V_{BE} , and hence in l.e.d. current, of around $\pm 7\%$.

Fortunately, this is unlikely to cause noticeable changes in l.e.d. intensity, so the circuit is usually a good choice for applications which must accommodate wide supply voltage changes and yet are not subject to extreme temperature variations.

One such application is the accompanying *EPE Voltage Checker*. This simple constructional project makes use of the circuit in Fig.3 to produce an inexpensive tester for "GO/NO GO" voltage checks.

From Logic to Light

In our examination of l.e.d. driver circuits thus far, we have dealt with purely *analogue* techniques for setting the current level and intensity. Many applications, however, require a *digital* interface between a logic circuit and one or more l.e.d.s. Depending on the type of logic device, it may be possible to drive the l.e.d. directly from one or more outputs using simple resistive current limiting. In other cases, a suitable driver circuit must be interposed between the digital output and the l.e.d.

As we shall see in a moment, different logic families have different drive capabilities, and their output characteristics – which can differ considerably from one family to another – will have a significant bearing on the kind of circuit required. The type and number of l.e.d.s that must be driven, along with the magnitude of the available supply voltage, will also influence the kind of circuit required.

CMOS 4000-Series

Due largely to its low quiescent supply current, high input impedance and relatively wide supply voltage range, the CMOS 4000-series logic family has been popular

Table 1: CD4049UB and CD4050B Output Current Vs Supply Voltage

Supply Voltage, V_{DD} (V)	Low-level (sink) Output Current, I_{OL} (mA)	High-level (source) Output Current, I_{OH} (mA)
5	5	1.6
10	12	3.6
15	40	12

for over quarter of a century. However, although a particular gate's output may be capable of driving the inputs of many other gates, it may be incapable of driving a single l.e.d.

In common with many other logic families, 4000-series outputs can sink and source current, that is, current can flow into a low-level output, or flow out of a high-level output. The actual output current available varies slightly with different devices and from one manufacturer to another. However, for a device such as the 4001B (quad 2-input NOR gate) or the 4011B (quad 2-input NAND gate), the output current is typically less than $\pm 1\text{mA}$ at a supply voltage, V_{DD} , of 5V, rising to around $\pm 8\text{mA}$ with V_{DD} increased to 15V.

For "light" loads, such as the inputs of other 4000-series gates, this is more than adequate. However, if a relatively "heavy" load is connected to the output, the output voltage tends to shift away from the nominal high or low logic level. In other words, the output does not behave as an ideal switch to V_{DD} or 0V, but instead appears resistive. For this reason, "standard" 4000-series gates often make poor l.e.d. drivers, except when *low current* l.e.d.s are used (more of this later).

Much better drive is available from "buffer" devices such as the 4049UB (hex, inverting) and 4050B (hex, non-inverting). Typical output current values at +25°C for the National Semiconductor CD4049UB and CD4050B are given in Table 1.

The buffer devices provide much greater output current than standard 4000-series gates. They are also clearly better at *sinking* current than sourcing it. For this reason, when driving an l.e.d. directly from a 4049UB or 4050B buffer output, it is best to refer the l.e.d. to V_{DD} as shown in Fig.4.

It would appear from Table 1 that the CD4049UB and CD4050B can happily sink up to 40mA when operating at 15V. However, careful examination of the data sheet's small print reveals otherwise. A footnote to the data states that:

"These are peak output current capabilities. Continuous output current is rated at 12mA maximum. The output current should not be allowed to exceed this value

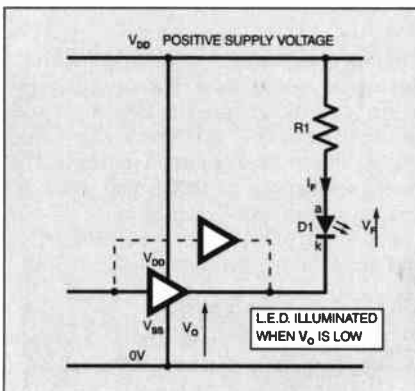

Fig.4. Logic buffer l.e.d. drive.

for extended periods of time."

When designing any l.e.d. drive circuit using logic gates, it is important to pay careful attention to the specifications for a particular device. We'll return to the subject of maximum ratings a little later in this article.

Boosted Output Drive

The output drive current can be increased by connecting two or more buffers of the same type in parallel, as shown by the dotted connections in Fig.4. The number of buffers and the resistor value required can be determined using the method demonstrated in the following worked example:

Let's say we wish to drive a forward current, I_F , of 15mA through a red l.e.d. with maximum forward voltage of 1.8V from a minimum supply voltage of $V_{DD} = 10\text{V}$. From Table 1, we see that I_{OL} for a single buffer is typically only 12mA at this voltage – not enough. However, connecting two buffers in parallel would provide a total sink current of 24mA – more than adequate. The value of current limiting resistor $R1$ is given by:

$$R1 = (V_{DD(\text{min})} - V_{F(\text{max})} - V_{OL(\text{max})}) / I_F (\Omega)$$

From the CD4049UB/CD4050B data sheet, the low level output voltage, V_{OL} , is found to be a maximum of 0.5V when the buffer is sinking 12mA. Although two buffers would each sink only 7.5mA, we can assume that $V_{OL(\text{max})} = 0.5\text{V}$, such that $R1 = (10\text{V} - 1.8\text{V} - 0.5\text{V}) / 15\text{mA} = 513\Omega$. The nearest preferred value is 510Ω.

74LS-Series

Like the original 74-series logic devices, the 74LS-series logic gates can sink much more current "into" their outputs than they can source out. A typical device like the 74LS02 (quad, 2-input NOR gate) operating on a 5V supply can sink up to 8mA, but can source only around 0.4mA. Therefore, with the l.e.d. referred to the positive supply, a single output may provide just enough current to illuminate an l.e.d. adequately, although two or more devices in parallel may be required to increase the brightness.

Like the 4000-series, the 74LS-series includes buffer devices which provide enhanced drive capability. For instance, the 74LS240 (octal buffer/line driver) can sink as much as 24mA into a single output.

74HC/HCT-series

Although the 74HC/HCT-series logic family uses CMOS technology like the 4000-series, its output drive capability is much better than 4000-series devices. Unlike the 74LS-series, its output drive is fairly symmetrical, in that the magnitude of the output sink and source currents are roughly equal. The 74HC parts have CMOS logic level compatibility, whereas the 74HCT parts are compatible with TTL voltage levels.

"Standard" devices such as the 74HC04 (hex inverter) and 74HC32 (quad, 2-input OR gate) operating on a 5V supply can sink

and source a *maximum* of 5mA with little shift in output voltage. "Buffer" devices like the 74HC365 (hex tri-state buffer) provide slightly more drive at around $\pm 7\text{mA}$ on a 5V supply.

Paralleling two standard outputs, for example, would provide around 10mA of drive current to an l.e.d. that could be referred either to the positive supply rail (l.e.d. illuminates when the outputs go low) or to the GND (0V) rail (l.e.d. illuminates when the outputs go high).

74AC/ACT-Series

Like the 4000-series and 74HC/HCT parts, the 74AC/ACT family uses CMOS technology and, likewise, benefits from low quiescent power consumption. However, this family also boasts remarkably good output current specifications.

Consider, for example, the 74AC/ACT04 (hex inverter). When powered by a 3V supply rail, each of the six inverters can source and sink up to 12mA. At 5V, the output drive doubles to $\pm 24\text{mA}$. These specifications mean that a single inverter could drive a low- V_F l.e.d. from a supply voltage as low as 3V. Most other devices in this family (gates, Schmitt triggers, flip-flops, and so on) provide the same degree of output drive.

Like most other 74-type logic families, the 74AC/ACT devices have a maximum operating voltage of around 6.0V. This is much lower than that of 4000-series parts which can operate at supply voltages as high as 15V. However, the 74AC devices are specified to operate down to just 2.0V, making them ideal for battery-powered applications.

For example, two series-connected Nickel Cadmium cells when fully charged will provide around 2.6V. Therefore, using a circuit similar to that in Fig.4, two parallel 74AC gates could easily drive around 15mA, or more, into a red l.e.d., and would continue to provide adequate brightness as the cells became discharged.

A Word of Caution

On several occasions, the author has seen circuits in which a logic gate output has been connected directly to an l.e.d., that is, *without* a series-connected, current limiting resistor. Except in very special circumstances, **this practice is inviting disaster!**

For example, let's consider the Philips HEF4000-series CMOS logic family. The *absolute maximum ratings* for these parts specify a maximum output current, $I_{O(\text{max})}$, of $\pm 10\text{mA}$ per output. Also, the maximum power dissipation, $P_{O(\text{max})}$, for each output is 100mW.

Tests on a single gate from an HEF4001B (quad 2-input NOR gate) produced interesting results. With the supply voltage, V_{DD} , set to 5V and the gate output set high, a red l.e.d. connected directly between the output and the V_{SS} (negative) supply rail drew just under 4mA from the output. With the output set low and the l.e.d. connected directly between the output and V_{DD} , the output current was 3.2mA.

In each case, the output current is below the maximum rating ($\pm 10\text{mA}$) and would do no damage to the l.e.d. itself. However, at a higher supply voltage, the results were drastically different. At $V_{DD} = 10\text{V}$, and with the gate output set high, the directly-connected l.e.d. drew 18.4mA from the

output and pulled down the high level output voltage (nominally 10V) to 2.3V. The corresponding power dissipation in the single gate was 142mW.

With the gate output set low, the i.e.d. current increased to 19.8mA and the low level output voltage (nominally 0V) was pulled up to 7.73V, corresponding to a gate power dissipation of 153mW!

In each case, the output current clearly exceeds the gate's maximum rating by a huge amount, and the gate's power dissipation is exceeded by around 50%! Furthermore, a forward current of 20mA, or so, could damage certain types of i.e.d., particularly the "low current" kind discussed later.

Obviously, in this example, increasing the supply voltage from 5V to 10V made an enormous difference to the current and power ratings. However, this does not necessarily imply that operation at low supply voltages is always safe.

As a second example, let's consider the National Semiconductor MM74HC02N, a quad 2-input NOR gate. The maximum operating voltage for this family of devices is 6V (although it's rare to see them operating at more than 5V) and the maximum output current per pin is $\pm 25\text{mA}$. Tests on a single gate from the 74HC02 produced sobering results. With the supply voltage set to 5V and the gate output set high, the red i.e.d. connected directly to the output drew almost 40mA from the output, some 15mA more than the maximum rated value!

With the output set low, the i.e.d. current was 37mA – again, dangerously high. Clearly, a series resistor should always be used when driving i.e.d.s from logic outputs. Not only does the resistor allow the forward current to be set to precisely the required value, but it can also be essential in protecting both the gate and the i.e.d.

Logic to L.E.D. Interfacing

Although we have seen that logic devices can drive i.e.d.s directly (via a suitable resistor), one often encounters applications where circumstances prevent a simple "direct drive" approach. For instance, although a 4000-series gate with a "weak" output could be boosted by several 4050B buffers, it may be inappropriate in terms of cost or board space to do this.

Similarly, it is often impossible for a logic output to drive a string of series-connected i.e.d.s, especially when the logic supply voltage is relatively low.

In these cases, some kind of interface circuit becomes necessary. One such approach is shown in Fig.5, where TR1, a *pnp* bipolar transistor, effectively provides current gain for a weak logic gate.

When the logic output, V_O , is high, TR1 and the i.e.d. are both "off". However, when V_O goes low (ideally to 0V), TR1 turns on and sinks current through R1 and the i.e.d. The transistor behaves as an emitter-follower in that it provides plenty of emitter current in return for very little base current supplied by the logic gate.

When V_O is low, the i.e.d.'s forward current is given by:

$$I_F = (V_{CC} - V_F - V_{BE} - V_O) / R1 \text{ (A)}$$

where V_{CC} is the logic supply voltage, and V_{BE} is TR1's base-emitter voltage drop. For most CMOS-type logic devices, the low-

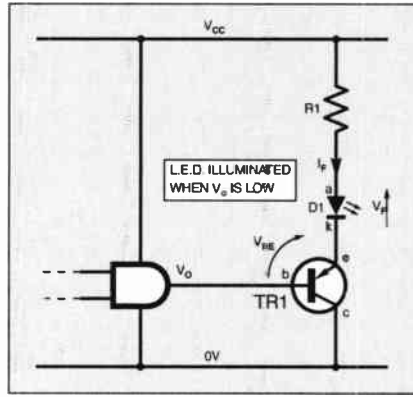

Fig.5. Active-low logic-i.e.d. interface circuit.

level output voltage is roughly zero when sinking little current, so it is reasonable to assume that $V_O = 0$. We can thus simplify and rearrange the equation to give an expression for the required value of series resistor:

$$R1 = (V_{CC} - V_F - V_{BE}) / I_F \text{ (}\Omega\text{)}$$

This circuit has the advantage of requiring very little current from the logic gate to drive the i.e.d. A forward current of, say, $I_F = 20\text{mA}$ would typically demand less than $100\mu\text{A}$ sink current from the gate output. A disadvantage, however, is the presence of TR1's V_{BE} drop which can limit the circuit's applicability when V_{CC} is low, or when two or more i.e.d.s must be driven in series.

Alternative Version

In Fig.6 is shown a variation on the theme in which either an *nnp* bipolar transistor (Fig.6a) or an *n*-channel MOSFET (Fig.6b) is used as the on-off "switch". In both circuits, the i.e.d. is illuminated when the logic output, V_O , goes high.

In Fig.6a, the high logic level sources base current to TR1, via current-limiting resistor R1, turning on both the transistor and the i.e.d. Provided R1 is chosen properly, TR1 will receive adequate base current from the logic output and will saturate, such that the i.e.d.'s forward current is:

$$I_F = (V_S - V_F - V_{CE(sat)}) / R2 \text{ (A)}$$

where V_S is the i.e.d. supply voltage and $V_{CE(sat)}$ is TR1's collector-emitter saturation voltage. In most cases, the magnitude of $V_{CE(sat)}$ will be negligibly small compared to

V_S and V_F , and so the equation simplifies to:

$$I_F = (V_S - V_F) / R2 \text{ (A)}$$

$$\text{or: } R2 = (V_S - V_F) / I_F \text{ (}\Omega\text{)}$$

making it a simple matter to select a suitable value for R2.

Base resistor R1 should be chosen to ensure TR1 turns on fully when V_O is high. The actual value required depends on the base current needed by TR1, and will therefore be influenced by the transistor type. A device like the BC546, for example, requires a base current of around $100\mu\text{A}$ to ensure $V_{CE(sat)}$ is less than 200mV when conducting a collector current of 20mA.

A higher collector current naturally requires a greater base current. Generally, for $V_{CC} = 5\text{V}$, a value of 2.2k Ω to 10k Ω should suffice for R1.

The circuit can be simplified by replacing the *nnp* transistor with an *n*-channel MOSFET as shown in Fig.6b. Again, the i.e.d. is turned on when V_O goes high. Provided the chosen MOSFET has low drain-source "on" resistance, $R_{DS(on)}$, the corresponding drain-source voltage, denoted $V_{DS(on)}$, will be small and negligible, such that the equation given above may be used to calculate R2.

Note, however, that achieving low $R_{DS(on)}$ isn't just a matter of choosing the right MOSFET – adequate gate voltage is also important. A device like the popular 2N7000, for example, will turn on with a typical gate-source voltage, V_{GS} , of just 2.3V, but at this level, $R_{DS(on)}$ could be more than 1k Ω !

With V_{GS} increased to 4.5V, however, $R_{DS(on)}$ is typically just 4.8 Ω ; at this value, the corresponding value of $V_{DS(on)}$ would be just 96mV with a forward i.e.d. current of 20mA.

With a logic supply voltage, V_{CC} , of 5V, the output of most CMOS gates will swing up to 5V, thus providing more than enough gate drive for TR1. However, a TTL device such as a 74LS gate might have an output high voltage of just 3.0V, or so, when operating at $V_{CC} = 5\text{V}$. In this case, pull-up resistor R1 can be employed to ensure the gate is pulled up to V_{CC} when V_O goes high. The pull-up resistor value can be fairly large (typically around 100k Ω), so little power is wasted in it when V_O is low.

In the circuits of Fig.6, the i.e.d. supply voltage, V_S , can be higher than V_{CC} . This is a distinct advantage when it is necessary to drive multiple series-connected i.e.d.s where the total forward voltage could

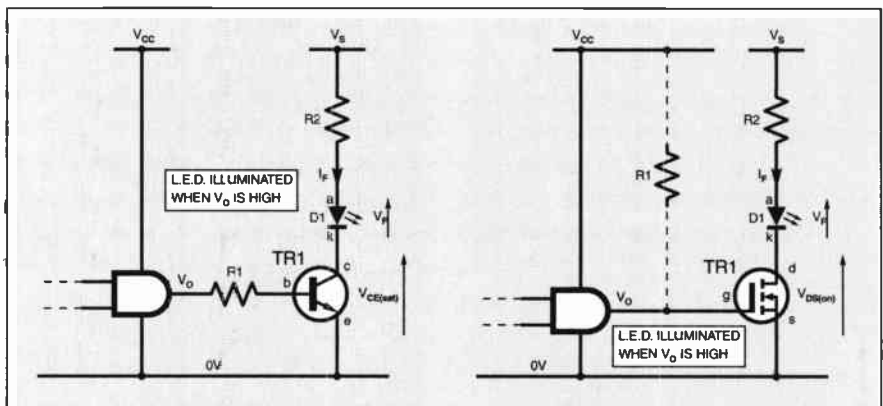

Fig.6. Active-high logic-i.e.d. interface circuits (a) bipolar, (b) MOSFET.

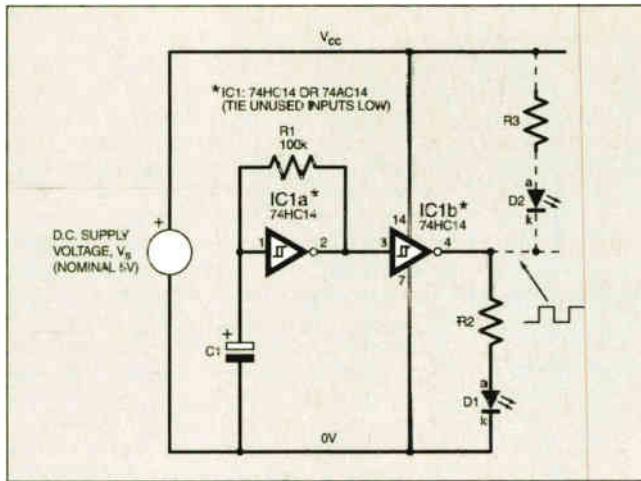

Fig.7. Astable l.e.d. flasher circuit.

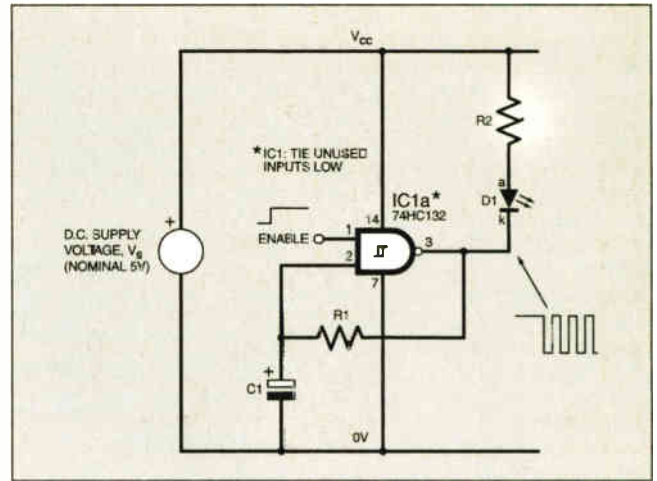

Fig.8. Gated l.e.d. flasher circuit.

easily exceed the available logic supply voltage. For example, driving five red l.e.d.s each having $V_f = 1.6V$ would require a supply voltage of at least 8V for proper operation.

Low Current L.E.D.s

Several manufacturers now supply a range of low current l.e.d.s which provide good light intensity at forward current levels that are a fraction of those needed by "standard" l.e.d.s. Take the HLMP-D155, for example, manufactured by Agilent (formerly Hewlett-Packard). This red l.e.d. has a typical luminous intensity of 10mcd (millicandela) when operated at a forward current of just 1mA. Compare this with a standard red l.e.d., such as the HLMP-3301, which has a typical luminous intensity of only 7mcd at 10mA.

Clearly, the standard l.e.d. has only 70% of the intensity of the low current lamp, even though it is operating at ten times the forward current!

The low current requirements of devices like the HLMP-D155 mean that relatively "weak" logic gates, such as standard 4000-series devices operating at low supply voltage, can drive the l.e.d. directly, i.e., without needing an interface circuit (but still needing a ballast resistor of course).

In addition to simplifying the drive circuit, low current l.e.d.s also provide significant power savings. The standard HLMP-3301, for example, operating at 10mA on a 5V supply consumes 50mW, whereas the low current HLMP-D155 operating at 1mA on the same supply voltage would require just 5mW – a power saving of 45mW. Such power savings are an obvious benefit for battery powered equipment where reduced power consumption equates to longer battery life.

The *EPE Volts Checker* project makes good use of a low current l.e.d. where a diminutive forward current of around 2mA is essential for high voltage operation.

On the Blink

A flashing l.e.d. is a highly effective visible signal, and can be used to warn of a fault condition, to provide a decorative display, or as a means of attracting attention such as an emergency beacon.

The circuit in Fig.7 is a simple and inexpensive l.e.d. "blinker", where IC1a forms an astable multivibrator and IC1b acts as a buffer. The second inverter is not essential,

but helps to minimise loading of IC1a which could otherwise affect the timing.

The l.e.d. may be connected to the negative supply rail (D1 with R2) or to the positive rail (D2 with R3). Connecting both l.e.d.s provides an alternating display. When experimenting with the circuit, choose l.e.d.s which give good brightness at a forward current of 10mA or less. The value of current limiting resistor R2 (and/or R3) should be around 270Ω to 1kΩ depending on the type and colour of l.e.d.(s) used.

Resistor R1 and capacitor C1 set the astable time constant, and hence the flash rate. A Schmitt trigger inverter such as the 74HC14 or 74AC14 is necessary for IC1a – a standard inverter will not work. Other Schmitt devices such as the 4093B (quad 2-input NAND gate) or 40106B (hex Schmitt inverter) could be substituted and would permit operation at supply voltages up to 15V, but suitable buffering may be required unless low current l.e.d.s are used.

The circuit is not a "precision" flasher because the flash rate depends heavily on the Schmitt trigger thresholds which vary on a part-to-part basis and with changes in supply voltage. Nevertheless, the circuit's simplicity makes it ideal for experimenting.

The value of resistor R1 should not be too small, otherwise a large value for capacitor C1 would be required to produce a low flash rate. On the other hand, R1 should not be too large, or leakage currents could affect the timing. A maximum value of 680kΩ should be acceptable.

With $R1 = 100k\Omega$, a capacitor value of $100\mu F$ will produce a typical flash frequency of around 0.15Hz, or roughly one flash every seven seconds. Reducing the value of C1 increases the flash rate. With $C1 = 1.0\mu F$, the l.e.d. blinks rapidly, at approximately 15 flashes per second.

Gated Flasher

The circuit in Fig.8 implements a "gated" flasher, where the flashing may be turned on and off by means of a logic level

Enable signal. The circuit is similar to that in Fig.7, but with the Schmitt inverter replaced by a single Schmitt NAND gate (one quarter of a 74HC132 quad Schmitt NAND gate).

When the Enable signal is low, the NAND output is continually high such that the l.e.d. is held off. Taking the Enable signal high "releases" the output, allowing the l.e.d. to flash. As before, the values of resistor R1 and capacitor C1 determine the flash rate; with $C1 = 10\mu F$ and $R1 = 100k\Omega$, the l.e.d. blinks roughly twice every second.

An interesting variation on this circuit is shown in Fig.9, where capacitor C1 and resistor R1 again determine the astable oscillation frequency. The addition of C2, R2, R3 and diode D2 forms another timing network which effectively causes the circuit to "gate itself". The result is a sequence of l.e.d. flashes, followed by a pause during which the l.e.d. is off, followed by another sequence of flashes, and so on.

On power up, both capacitors are initially discharged, such that pin 1 of IC1a is high and pin 2 is low causing the NAND output to be high. C1 now begins to charge via R1; during this time D2 is reverse biased and the l.e.d. is off. Eventually, the voltage on C1 crosses the Schmitt trigger's upper threshold, the gate output goes low, and the astable starts to oscillate and flashes the l.e.d. exactly as per the circuit in Fig.8.

However, every time the output pulses low and flashes the l.e.d., it also delivers a packet of charge into C2 via D2 and R2. As

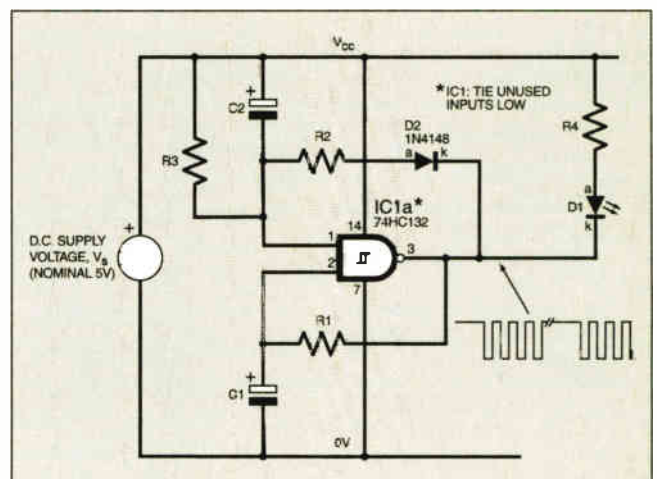

Fig.9. Self-gated l.e.d. flasher circuit.

a result, C2 slowly charges up causing the voltage at pin 1 to fall in a stepped fashion. Eventually, when this voltage crosses the Schmitt's lower threshold, the NAND output goes high and stays high irrespective of the voltage at pin 2.

The l.e.d. is now off and remains off while C2 begins to discharge via R3, causing the voltage at pin 1 to rise exponentially with a time constant determined by C2 and R3. When the voltage crosses the upper threshold, the gate is again Enabled, the astable starts to oscillate, and the process repeats.

Eye Catching

Although the circuit in Fig.9 is more complex than the simple flashers of Fig.7 and Fig.8, the visual effect is much more eye catching than an l.e.d. which simply flashes repeatedly.

The duration of each flash depends on the C1/R1 time constant. The number of flashes depends on the time taken to charge C2, and so depends on C1/R1, C2/R3, and R2. The "off" period depends on the time taken for C2 to discharge, which is determined only by the C2/R3 time constant.

For proper operation, the C1/R1 time constant should be much smaller than that of C2/R3. Also, R2 should be much smaller than R3, ideally by a factor ten or more, to ensure that the voltage at pin 1 can cross the Schmitt's lower threshold. Diode D2's voltage drop must also be taken into account here, especially if operating at supply voltages below 5V.

A test circuit built with R1 = 470kΩ, C1 = 1μF, R2 = 47kΩ, C2 = 33μF and R3 = 1MΩ produced a series of three flashes, followed by an "off" pause of around ten seconds. All timing parameters are affected by the Schmitt thresholds and by the supply voltage, so be prepared to experiment with component values to get the best effect.

From Flashers to Dimmers

Returning briefly to the circuit in Fig.7, and reducing the value of C1 to 100nF produces an interesting effect. The astable oscillates at around 150Hz, and although the l.e.d. actually flashes at this rate it appears to be continually on, *but at reduced brightness*. What is happening?

Put simply, the human eye cannot respond quickly enough to distinguish each individual flash, and so it effectively "integrates" the rapid pulsing to give the

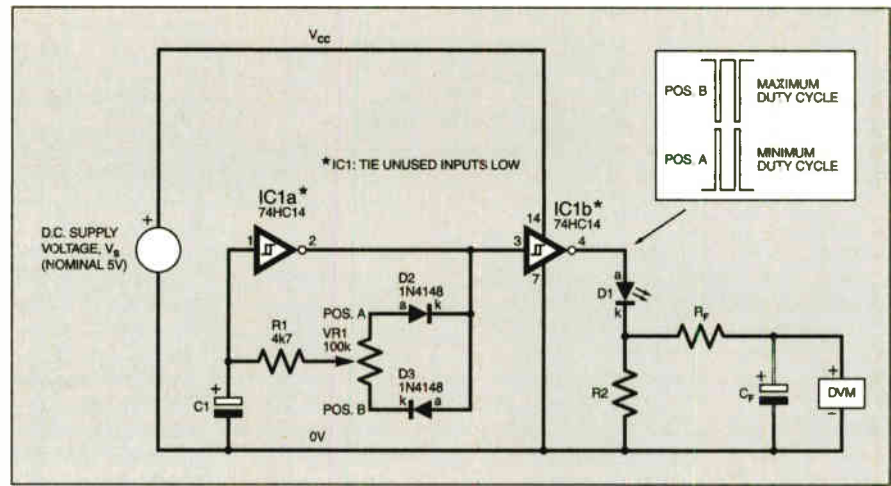

Fig. 10. PWM brightness control.

appearance of a dimmed l.e.d. This effect can be explored further using the circuit shown in Fig.10, where resistor R1 in Fig.7 has been replaced with the combination of R1, potentiometer VR1, and diodes D2, D3.

The presence of the potentiometer and two diodes allows the *duty cycle* of the flash pulses to be varied, where:

$$\text{Duty Cycle} = \frac{\text{On Time}}{\text{On Time} + \text{Off Time}} \quad (\%)$$

For example, with C1 = 10μF, the flash rate is typically around 2Hz and varies very little with changes in VR1's wiper position. However, the flash duration varies from a very brief flash with VR1's wiper at position A (corresponding to minimum duty cycle) to being on almost continually in position B (maximum duty cycle).

If C1 is now reduced to 10nF, the oscillation frequency is increased a thousand fold to around 2kHz, and although the l.e.d. is still being pulsed on and off, it appears to be on all the time. Adjusting the pot's wiper position changes the duty cycle and hence varies the average current through the l.e.d. Thus, with the wiper in position B, the l.e.d. is almost at full brightness, whereas in position A, it is very dim.

This circuit demonstrates an important technique known as *pulse width modulation*, or PWM, wherein the width of the pulse driving the l.e.d. is modulated to vary the brightness. Although the current

through the l.e.d. still consists of a series of variable width, constant amplitude pulses, the brightness is proportional to the average current. To measure the average current, the current limiting resistor R2 may be used as a convenient current sense resistor.

Additional components Cf and Rf (required only for measuring the average current) form a low-pass filter, such that the voltage across Cf is a d.c. level corresponding to the average voltage across R2. The voltage on Cf should be measured using a voltmeter with high input impedance, such as a 10MΩ digital voltmeter (DVM).

Dividing the measured voltage by the value of R2 gives the average current through the l.e.d. The values of Cf and Rf are not critical, but Cf should be large enough to minimise the ripple on the measured voltage. Values of Cf = 100μF and Rf = 22kΩ should give good results.

Digitally-Controlled Brightness

By replacing the manual potentiometer VR1 with a "digipot" (digitally controlled potentiometer), the circuit of Fig.10 can be adapted to provide fully digital control of the l.e.d.'s brightness. In the circuit of Fig.11, the digipot, IC2, takes the place of VR1 in Fig.10. The digital pot behaves in a similar manner to its manual counterpart, except that the wiper position and direction are controlled by digital signals at the CLK (clock) and U/D (up/down) inputs.

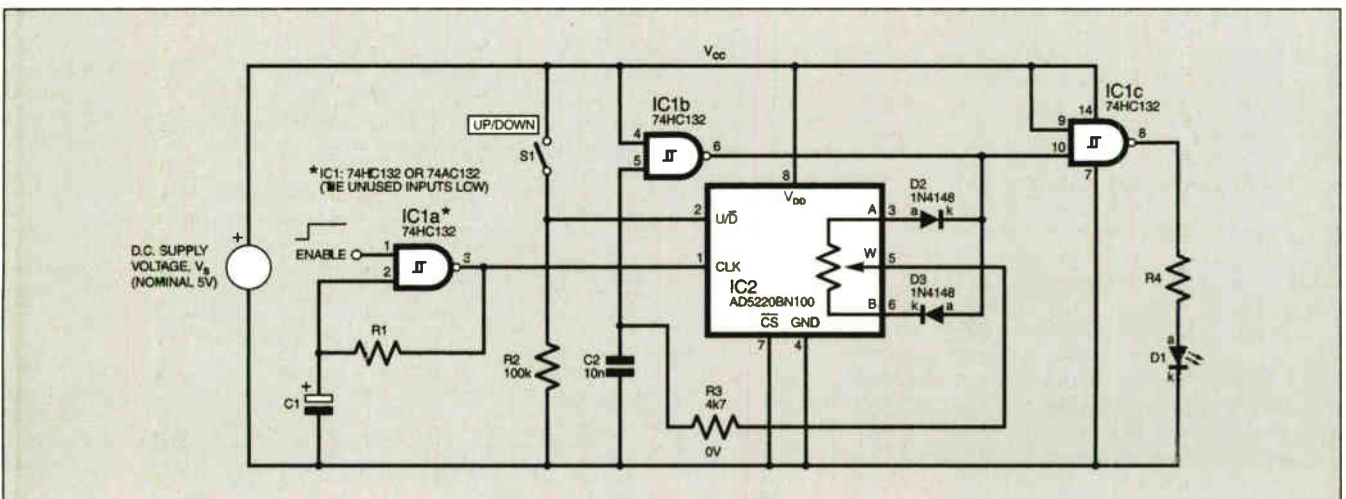

Fig. 11. Digitally controlled l.e.d. brightness.

Schmitt NAND gate IC1b, together with C2, R3 and the digipot, forms the astable multivibrator whose pulse width is modulated to vary the l.e.d. intensity. IC1c is not essential and simply acts as a buffer. IC1a, C1 and R1 form a gated astable similar to that in Fig.8; in this circuit, however, it provides a means of clocking the digital pot. With C1 = 1µF and R1 = 100kΩ, the clock frequency is around 15Hz.

Note that an astable clock source is not mandatory; a suitably "debounced" push-button switch could be used instead. The logic level at pin 2 of IC2 controls the direction of the pot wiper. Closing switch S1 puts a high level at this input, such that each clock pulse arriving at pin 1 causes the pot to increment, thereby moving the wiper "W" closer to terminal "A" at pin 3. This maximises the duty cycle at the output of IC1b, but the inversion by buffer IC1c minimises the duty cycle drive to the l.e.d., causing it to get dimmer.

With pin 2 low (switch S1 open), clocking IC2 causes the digipot to decrement,

such that the wiper moves in the opposite direction toward terminal "B" at pin 6. This maximises the duty cycle at the output of IC1c, thereby increasing the l.e.d.'s brightness!

When the Enable signal at pin 1 of IC1a is high, the astable "free runs", thus supplying continuous clock pulses for the digipot. By opening and closing switch S1, the l.e.d. ramps up to maximum brightness, or ramps down to minimum brightness, respectively. Taking the Enable signal low cuts off the clock pulses and holds the l.e.d. at its current level of intensity.

The circuit provides a completely solid-state way of varying the l.e.d.'s intensity – no moving parts are required. The PWM method is an efficient technique, often employed to vary the brightness of l.e.d.s used as backlights in items such as mobile phones and laptop computers. However, it is not restricted to l.e.d.s, and is widely used to control other loads, such as d.c. motors, heating elements, and so on.

When experimenting with the circuit, choose a fairly large value for resistor R4

so as to produce maximum contrast between the extremes of l.e.d. intensity. Also, note that IC2, a 128-position, 100kΩ digipot, is just one of many digital potentiometers on the market. Other types, manufactured by companies such as Maxim, Xicor and Catalyst Semiconductor, may be better suited to your application.

Next Month

In the next part of this series we look at other techniques for flashing an l.e.d., and we examine "booster" circuits capable of driving l.e.d.s from very low voltages. We'll also look at some of the convenient features of bicolour and tricolour l.e.d.s.

For now, we conclude this month's article with a conundrum: considering that a red l.e.d. can have a forward voltage of 1.6V or more, how is it possible to flash such an l.e.d. from a voltage of just 1.0V?

You can now move on to reading, and perhaps building, the accompanying *Volts Checker*.

Radio Bygones

The leading magazine
for vintage radio
enthusiasts

Now Also Available to
BUY ONLINE
www.radiobygones.com
Log on, pay by credit card
and download the magazine to
your PC
ONLY \$9.99 (US dollars)
FOR 6 ISSUES
A free issue is
available
online

ARTICLES on restoration and repair, history, circuit techniques, personalities, reminiscences and just plain nostalgia – you'll find them all. Plus features on museums and private collections and a full-colour photo-feature in every issue.

IT'S MOSTLY about valves, of course, but 'solid-state' – whether of the coherer and spark-gap variety or early transistors – also has a place.

FROM THE DAYS of Maxwell, Hertz, Lodge and Marconi to what was the state-of-the-art just a few short years ago ...

THERE IS ALSO a selection of free readers' For Sale and Wanted advertisements in every issue.

Radio Bygones covers it all!

THE MAGAZINE is published six times a year, and is only available by postal subscription. It is not available at newsagents.

TO TAKE OUT a subscription, or to request a sample copy, please complete the form below and return it to:
RADIO BYGONES, Wimborne Publishing Ltd, 408 Wimborne Road East, Ferndown, Dorset BH22 9ND.
Tel: 01202 873872. Fax: 01202 874562. Web sites: www.radiobygones.co.uk www.radiobygones.com



RADIO BYGONES ORDER FORM



A SAMPLE COPY of Radio Bygones£3.50
(Add 70p for overseas Airmail postage)

SUBSCRIPTIONS (post paid): 1 YEAR 2 YEAR

UNITED KINGDOM £19.75 £37.50

REST OF EUROPE (AIRMAIL) £22.00 £42.00

REST OF THE WORLD (AIRMAIL) £27.00 £52.00

Yes, I would like a sample copy for £3.50

Yes, I would like to take out a subscription for:

One year (6 issues) Two years (12 issues)

I enclose a cheque/Eurocheque/PO for £
payable to Wimborne Publishing Ltd

Please debit my Visa/Mastercard/Switch/Maestro card

My card number is:

.....
Please print clearly, and check that you have the number correct

Valid from: Expiry date

Switch/Maestro Issue No:

My name is

My address

Post Code/Zip Tel

Signed

If you do not wish to cut your issue, send a letter or a copy of this form.

FREE *Electronics Hobbyist Compendium* book with Teach-In 2000 CD-ROM



EPE TEACH-IN 2000 CD-ROM

The whole of the 12-part *Teach-In 2000* series by John Becker (published in *EPE* Nov '99 to Oct 2000) is now available on CD-ROM. Plus the *Teach-In 2000* interactive software (Win 95, 98, ME and above) covering all aspects of the series and Alan Winstanley's *Basic Soldering Guide* (including illustrations and Desoldering).

Teach-In 2000 covers all the basic principles of electronics from Ohm's Law to Displays, including Op.Amps, Logic Gates etc. Each part has its own section on the interactive software where you can also change component values in the various on-screen demonstration circuits.

The series gives a hands-on approach to electronics with numerous breadboard circuits to try out, plus a simple computer interface (Win 95, 98, ME only) which allows a PC to be used as a basic oscilloscope.

ONLY **£12.45** including VAT and p&p

Order code Teach-In CD-ROM

Robotics

INTRODUCING ROBOTICS WITH LEGO MINDSTORMS

Robert Penfold

Shows the reader how to build a variety of increasingly sophisticated computer controlled robots using the brilliant Lego Mindstorms Robotic Invention System (RIS). Initially covers fundamental building techniques and mechanics needed to construct strong and efficient robots using the various "click-together" components supplied in the basic RIS kit. Then explains in simple terms how the "brain" of the robot will be programmed on screen using a PC and "zapped" to the robot over an infra-red link. Also, shows how a more sophisticated Windows programming language such as Visual BASIC may be used to control the robots.

Details building and programming instructions provided, including numerous step-by-step photographs.

288 pages - large format Order code BP901 £14.99

MORE ADVANCED ROBOTICS WITH LEGO MINDSTORMS - Robert Penfold

Covers the Vision Command System

Shows the reader how to extend the capabilities of the brilliant Lego Mindstorms Robotic Invention System (RIS) by using Lego's own accessories and some simple home constructed units. You will be able to build robots that can provide you with 'waiter service' when you clap your hands, perform tricks, 'see' and avoid objects by using 'bats radar', or accurately follow a line marked on the floor. Learn to use additional types of sensors including rotation light, temperature, sound and ultrasonic and also explore the possibilities provided by using an additional (third) motor. For the less experienced, RCX code programs accompany most of the featured robots. However, the more adventurous reader is also shown how to write programs using Microsoft's VisualBASIC running with the ActiveX control (Spirit.OCX) that is provided with the RIS kit.

Detailed building instructions are provided for the featured robots, including numerous step-by-step photographs. The designs include rover vehicles, a virtual pet, a robot arm, an 'intelligent' sweet dispenser and a colour conscious robot that will try to grab objects of a specific colour.

298 pages Order code BP902 £14.99

ANDROIDS, ROBOTS AND ANIMATRONS - Second Edition - John Iovine

Build your own working robot or android using both off-the-shelf and workshop constructed materials and devices. Computer control gives these robots and androids two types of artificial intelligence (an expert system and a neural network). A lifelike android hand can be built and programmed to function doing repetitive tasks. A fully animated robot or android can also be built and programmed to perform a wide variety of functions.

The contents include an Overview of State-of-the-Art Robots; Robotic Locomotion; Motors and Power Controllers; All Types of Sensors; Tilt; Bump; Road and Wall Detection; Light; Speech and Sound Recognition; Robotic Intelligence (Expert Type) Using a Single-Board Computer Programmed in BASIC; Robotic Intelligence (Neural Type) Using Simple Neural Networks (Insect Intelligence); Making a Lifelike Android Hand; A Computer-Controlled Robotic Insect Programmed in BASIC; Telepresence Robots With Actual Arcade and Virtual Reality Applications; A Computer-Controlled Robotic Arm; Animated Robots and Androids; Real-World Robotic Applications.

224 pages Order code MGH1 £16.99

DIRECT BOOK SERVICE

NOTE: ALL PRICES INCLUDE UK POSTAGE

The books listed have been selected by *Everyday Practical Electronics* editorial staff as being of special interest to everyone involved in electronics and computing. They are supplied by mail order to your door. Full ordering details are given on the last book page.

For a further selection of books see the next two issues of *EPE*.

Radio

BASIC RADIO PRINCIPLES AND TECHNOLOGY

Ian Poole

Radio technology is becoming increasingly important in today's high technology society. There are the traditional uses of radio which include broadcasting and point to point radio as well as the new technologies of satellites and cellular phones. All of these developments mean there is a growing need for radio engineers at all levels.

Assuming a basic knowledge of electronics, this book provides an easy to understand grounding in the topic.

Chapters in the book: Radio Today, Yesterday, and Tomorrow; Radio Waves and Propagation; Capacitors, Inductors, and Filters; Modulation; Receivers; Transmitters; Antenna Systems; Broadcasting; Satellites; Personal Communications; Appendix - Basic Calculations.

263 pages Order code NE30 £18.99

PROJECTS FOR RADIO AMATEURS AND S.W.L.S.

R. A. Penfold

This book describes a number of electronic circuits, most of which are quite simple, which can be used to enhance the performance of most short wave radio systems.

The circuits covered include: An aerial tuning unit; A simple active aerial; An add-on b.f.o. for portable sets; A wavetramp to combat signals on spurious responses; An audio notch filter; A parametric equaliser; C.W. and S.S.B. audio filters; Simple noise limiters; A speech processor; A volt.me expander.

Other useful circuits include a crystal oscillator, and RTTY/C.W. tone decoder, and a RTTY serial to parallel converter. A full range of interesting and useful circuits for short wave enthusiasts.

92 pages Order code BP304 £4.45

AN INTRODUCTION TO AMATEUR RADIO

I. D. Poole

Amateur radio is a unique and fascinating hobby which has attracted thousands of people since it began at the turn of the century. This book gives the newcomer a comprehensive and easy to understand guide through the subject so that the reader can gain the most from the hobby. It then remains an essential reference volume to be used time and again. Topics covered include the basic aspects of the hobby, such as operating procedures, jargon and setting up a station. Technical topics covered include propagation, receivers, transmitters and aerials etc.

150 pages Order code BP257 £5.49

VALVE RADIO AND AUDIO REPAIR HANDBOOK

(Second Edition) Chas Miller

This book is not only an essential read for every professional working with antique radio and gramophone equipment, but also dealers, collectors and valve technology enthusiasts the world over. The emphasis is firmly on the practicalities of repairing and restoring, so technical content is kept to a minimum, and always explained in a way that can be followed by readers with no background in electronics. Those who have a good grounding in electronics, but wish to learn more about the practical aspects, will benefit from the emphasis given to hands-on repair work, covering mechanical as well as electrical aspects of servicing. Repair techniques are also illustrated throughout.

A large reference section provides a range of information compiled from many contemporary sources, and includes specialist dealers for valves, components and complete receivers.

270 pages Order code NE34 £23.99

Computers and Computing

THE INTERNET FOR THE OLDER GENERATION

Jim Gatenby

Especially written for the over 50s. Uses only clear and easy-to-understand language. Larger type size for easy reading. Provides basic knowledge to give you confidence to join the local computer club.

This book explains how to use your PC on the Internet and covers amongst other things: Choosing and setting up your computer for the Internet. Getting connected to the Internet. Sending and receiving emails, photographs, etc., so that you can keep in touch with family and friends all over the world. Searching for and saving information on any subject. On-line shopping and home banking. Setting up your own simple web site.

228 pages Order code BP500 £8.99

HOW TO BUILD YOUR OWN PC -

Third Edition

Morris Rosenthal

More and more people are building their own PCs. They get more value for their money, they create exactly the machine they want, and the work is highly satisfying and actually fun. That is, if they have a unique beginner's guide like this one, which visually demonstrates how to construct a state-of-the-art computer from start to finish.

Through 150 crisp photographs and clear but minimal text, readers will confidently absorb the concepts of computer building. The extra-big format makes it easy to see what's going on in the pictures. For non-specialists, there's even a graphical glossary that clearly illustrates technical terms. The author goes "under the hood" and shows step-by-step how to create a socket 7 (Pentium and non-intel chipsets) and a Slot 1 (Pentium II) computer, covering: What first-time builders need to know; How to select and purchase parts; How to assemble the PC; How to install Windows 98. The few existing books on this subject, although badly outdated, are in steady demand. This one delivers the expertise and new technology that fledgling computer builders are eagerly looking for.

224 pages - large format Order code MGH2 £20.99

PIC YOUR PERSONAL INTRODUCTORY COURSE

SECOND EDITION John Morton

Discover the potential of the PIC microcontroller through graded projects - this book could revolutionise your electronics construction work!

A uniquely concise and practical guide to getting up and running with the PIC Microcontroller. The PIC is one of the most popular of the microcontrollers that are transforming electronic project work and product design.

Assuming no prior knowledge of microcontrollers and introducing the PIC's capabilities through simple projects, this book is ideal for use in schools and colleges. It is the ideal introduction for students, teachers, technicians and electronics enthusiasts. The step-by-step explanations make it ideal for self-study too: this is not a reference book - you start work with the PIC straight away.

The revised second edition covers the popular reprogrammable EEPROM PICs: P16C84/16F84 as well as the P54 and P71 families.

270 pages Order code NE3E £15.99

UNDERSTANDING PC SPECIFICATIONS

R. A. Penfold (Revised Edition)

PCs range from simple systems of limited capabilities up to complex systems that can happily run applications that would have been considered beyond the abilities of a microcomputer not so long ago. It would be very easy to choose a PC system that is inadequate to run your applications efficiently, or one which goes beyond your needs and consequently represents poor value for money.

This book explains PC specifications in detail, and the subjects covered include the following: Differences between types of PC (XT, AT, 80386, etc); Maths coprocessors; Input devices (keyboards, mice, and digitisers); Memory, including both expanded (EMS) and extended RAM; RAM disks and disk caches; Floppy disk drive formats and compatibility; Hard disk drives (including interleave factors and access times); Display adaptors, including all standard PC types (CGA, Hercules, Super VGA, etc); Contains everything you need to know if you can't tell your EMS from your EGA!

128 pages Order code BP282 £5.45

Theory and Reference

BEBOP TO THE BOOLEAN BOOGIE Second Edition Clive (Max) Maxfield

**BOOK PLUS
CD-ROM**

This book gives the "big picture" of digital electronics. This in-depth, highly readable, up-to-the-minute guide shows you how electronic devices work and how they're made. You'll discover how transistors operate, how printed circuit boards are fabricated, and what the innards of memory ICs look like. You'll also gain a working knowledge of Boolean Algebra and Karnaugh Maps, and understand what Reed-Muller logic is and how it's used. And there's much, MUCH more. The author's tongue-in-cheek humour makes it a delight to read, but this is a REAL technical book, extremely detailed and accurate. Comes with a free CD-ROM which contains an eBook version with full text search plus bonus chapter - An Illustrated History of Electronics and Computing.

Contents: Fundamental concepts; Analog versus digital; Conductors and insulators; Voltage, current, resistance, capacitance and inductance; Semiconductors; Primitive logic functions; Binary arithmetic; Boolean algebra; Karnaugh maps; State diagrams, tables and machines; Analog-to-digital and digital-to-analog; Integrated circuits (ICs); Memory ICs; Programmable ICs; Application-specific integrated circuits (ASICs); Circuit boards (PWBs and DWBs); Hybrids; Multichip modules (MCMs); Alternative and future technologies.

500 pages **Order code BEB1** £27.50

BEBOP BYTES BACK (and the Bebop Computer Simulator) CD-ROM Clive (Max) Maxfield and Alvin Brown



This follow-on to *Bebop to the Boolean Boogie* is a multimedia extravaganza of information about how computers work. It picks up where "Bebop I" left off, guiding you through the fascinating world of computer design... and you'll have a few chuckles, if not belly laughs, along the way. In addition to over 200 megabytes of mega-cool multimedia, the CD-ROM contains a virtual microcomputer, simulating the motherboard and standard computer peripherals in an extremely realistic manner. In addition to a wealth of technical information, myriad nuggets of trivia, and hundreds of carefully drawn illustrations, the CD-ROM contains a set of lab experiments for the virtual microcomputer that let you recreate the experiences of early computer pioneers. If you're the slightest bit interested in the

inner workings of computers, then don't dare to miss this!

Over 800 pages in Adobe Acrobat format

CD-ROM **Order code BEB2 CD-ROM** £21.95

ELECTRONICS MADE SIMPLE

Ian Sinclair

Assuming no prior knowledge, *Electronics Made Simple* presents an outline of modern electronics with an emphasis on understanding how systems work rather than on details of circuit diagrams and calculations. It is ideal for students on a range of courses in electronics, including GCSE, C&G and GNVQ, and for students of other subjects who will be using electronic instruments and methods.

Contents: waves and pulses, passive components, active components and ICs, linear circuits, block and circuit diagrams, how radio works, disc and tape recording, elements of TV and radar, digital signals, gating and logic circuits, counting and correcting, microprocessors, calculators and computers, miscellaneous systems.

199 pages **Order code NE23** £13.99

SCROGGIE'S FOUNDATIONS OF WIRELESS AND ELECTRONICS - ELEVENTH EDITION

S. W. Amos and Roger Amos

Scroggie's Foundations is a classic text for anyone working with electronics, who needs to know the art and craft of the subject. It covers both the theory and practical aspects of a huge range of topics from valve and tube technology, and the application of cathode ray tubes to radar, to digital tape systems and optical recording techniques.

Since *Foundations of Wireless* was first published over 60 years ago, it has helped many thousands of readers to become familiar with the principles of radio and electronics. The original author Sowerby was succeeded by Scroggie in the 1940s, whose name became synonymous with this classic primer for practitioners and students alike. Stan Amos, one of the fathers of modern electronics and the author of many well-known books in the area, took over the revision of this book in the 1980s and it is he, with his son, who have produced this latest version.

400 pages **Order code NE27** £23.99

GETTING THE MOST FROM YOUR MULTIMETER

R. A. Penfold

This book is primarily aimed at beginners and those of limited experience of electronics. Chapter 1 covers the basics of analogue and digital multimeters, discussing the relative merits and the limitations of the two types. In Chapter 2 various methods of component checking are described, including tests for transistors, thyristors, resistors, capacitors and diodes. Circuit testing is covered in Chapter 3, with subjects such as voltage, current and continuity checks being discussed.

In the main little or no previous knowledge or experience is assumed. Using these simple component and circuit testing techniques the reader should be able to confidently tackle servicing of most electronic projects.

96 pages

Temporarily out of print

THE AMATEUR SCIENTIST CD-ROM

The complete collection of The Amateur Scientist articles from *Scientific American* magazine. Over 1,000 classic science projects from a renowned source of winning projects. All projects are rated for cost, difficulty and possible hazards.

Plus over 1,000 pages of helpful science techniques that never appeared in *Scientific American*. Exciting science projects in: Astronomy; Earth Science; Biology; Physics; Chemistry; Weather... and much more! The most complete resource ever assembled for hobbyists, and professionals looking for novel solutions to research problems.

Includes extensive Science Software Library with even more science tools.

Suitable for Mac, Windows, Linux or UNIX. 32MB RAM minimum, Netscape 4.0 or higher or Internet Explorer 4.0 or higher.

Over 1,000 projects

CD-ROM **Order code AS1 CD-ROM** £19.95



Music, Audio and Video

QUICK GUIDE TO ANALOGUE SYNTHESIS

Ian Waugh

Even though music production has moved into the digital domain, modern synthesizers invariably use analogue synthesis techniques. The reason is simple - analogue synthesis is flexible and versatile, and it's relatively easy for us to understand. The basics are the same for all analogue synths, and you'll quickly be able to adapt the principles to any instrument, to edit existing sounds and create exciting new ones. This book describes: How analogue synthesis works; The essential modules every synthesiser has; The three steps to synthesis; How to create phat bass sounds; How to generate filter sweeps; Advanced synth modules; How to create simple and complex synth patches; Where to find soft synths on the Web.

If you want to take your synthesiser - of the hardware or software variety - past the presets, and program your own sounds and effects, this practical and well-illustrated book tells you what you need to know.

60 pages **Order code PC118** £7.45

QUICK GUIDE TO MP3 AND DIGITAL MUSIC

Ian Waugh

MP3 files, the latest digital music format, have taken the music industry by storm. What are they? Where do you get them? How do you use them? Why have they thrown record companies into a panic? Will they make music easier to buy? And cheaper? Is this the future of music?

All these questions and more are answered in this concise and practical book which explains everything you need to know about MP3s in a simple and easy-to-understand manner. It explains:

How to play MP3s on your computer; How to use MP3s with handheld MP3 players; Where to find MP3s on the Web; How MP3s work; How to tune into Internet radio stations; How to create your own MP3s; How to record your own CDs from MP3 files; Other digital audio music formats.

Whether you want to stay bang up to date with the latest music or create your own MP3s and join the on-line digital music revolution, this book will show you how.

60 pages **Order code PC119** £7.45

ELECTRONIC MUSIC AND MIDI PROJECTS

R. A. Penfold

Whether you wish to save money, boldly go where no musician has gone before, rekindle the pioneering spirit, or simply have fun building some electronic music gadgets, the designs featured in this book should suit your needs. The projects are all easy to build, and some are so simple that even complete beginners at electronic project construction can tackle them with ease. Stripboard layouts are provided for every project, together with a wiring diagram. The

mechanical side of construction has largely been left to individual constructors to sort out, simply because the vast majority of project builders prefer to do their own thing in this respect.

None of the designs requires the use of any test equipment in order to get them set up properly. Where any setting up is required, the procedures are very straightforward, and they are described in detail.

Projects covered: Simple MIDI tester, Message grabber, Byte grabber, THRU box, MIDI auto switcher, Auto/manual switcher, Manual switcher, MIDI patchbay, MIDI controlled switcher, MIDI lead tester, Program change pedal, Improved program change pedal, Basic mixer, Stereo mixer, Electronic swell pedal, Metronome, Analogue echo unit.

124 pages **Order code PC116** ~~£10.95~~ £5.45

THE INVENTOR OF STEREO - THE LIFE AND WORKS OF ALAN DOWER BLUMLEIN

Robert Charles Alexander

This book is the definitive study of the life and works of one of Britain's most important inventors who, due to a cruel set of circumstances, has all but been overlooked by history.

Alan Dower Blumlein led an extraordinary life in which his inventive output rate easily surpassed that of Edison, but whose early death during the darkest days of World War Two led to a shroud of secrecy which has covered his life and achievements ever since.

His 1931 Patent for a Binaural Recording System was so revolutionary that most of his contemporaries regarded it as more than 20 years ahead of its time. Even years after his death, the full magnitude of its detail had not been fully utilized. Among his 128 patents are the principal electronic circuits critical to the development of the world's first electronic television system. During his short working life, Blumlein produced patent after patent breaking entirely new ground in electronic and audio engineering.

During the Second World War, Alan Blumlein was deeply engaged in the very secret work of radar development and contributed enormously to the system eventually to become 'H2S' - blind-bombing radar. Tragically, during an experimental H2S flight in June 1942, the Halifax bomber in which Blumlein and several colleagues were flying, crashed and all aboard were killed. He was just days short of his thirty-ninth birthday.

420 pages **Order code NE32** £17.99

VIDEO PROJECTS FOR THE ELECTRONICS CONSTRUCTOR

R. A. Penfold

Written by highly respected author R. A. Penfold, this book contains a collection of electronic projects specially

designed for video enthusiasts. All the projects can be simply constructed, and most are suitable for the newcomer to project construction, as they are assembled on stripboard.

There are faders, wipers and effects units which will add sparkle and originality to your video recordings, an audio mixer and noise reducer to enhance your soundtracks and a basic computer control interface. Also, there's a useful selection on basic video production techniques to get you started.

Complete with explanations of how the circuit works, shopping lists of components, advice on construction, and guidance on setting up and using the projects, this invaluable book will save you a small fortune.

Circuits include: video enhancer, improved video enhancer, video fader, horizontal wiper, improved video wiper, negative video unit, fade to grey unit, black and white keyer, vertical wiper, audio mixer, stereo headphone amplifier, dynamic noise reducer, automatic fader, push-button fader, computer control interface, 12 volt mains power supply.

124 pages **Order code PC115** ~~£10.95~~ £5.45

PC MUSIC - THE EASY GUIDE

Robin Vincent

How do I make music on my PC? Can I record music onto my PC? What's a sequencer? How can I get my PC to print a music score? What sort of a soundcard do I need? What hardware and software do I need? How do I connect a keyboard to my PC?

Just a few of the questions you've probably asked. Well, you'll find the answers to all these questions, and many more, in this book. It will show you what can be done, what it all means, and what you will need to start creating your own music on your PC. It's an easy read, it's fully illustrated and it will help you understand how a computer can be used as a creative music tool.

It covers soundcards, sequencers, hard disk digital audio recording and editing, plug-ins, printing scores with notation software, using your PC as a synthesiser, getting music onto and off the Internet, using Windows, sample PC music setups, FAQs, a glossary, advice on hardware and software, and a list of industry contacts.

116 pages **Order code PC117** £11.95

HIGH POWER AUDIO AMPLIFIER CONSTRUCTION

R. A. Penfold

Practical construction details of how to build a number of audio power amplifiers ranging from about 50 to 300/400 watts r.m.s. includes MOSFET and bipolar transistor designs.

96 pages

Temporarily out of print

Circuits, Data and Design

PRACTICAL ELECTRONIC FILTERS

Owen Bishop

This book deals with the subject in a non-mathematical way. It reviews the main types of filter, explaining in simple terms how each type works and how it is used.

The book also presents a dozen filter-based projects with applications in and around the home or in the constructor's workshop. These include a number of audio projects such as a rhythm sequencer and a multi-voiced electronic organ.

Concluding the book is a practical step-by-step guide to designing simple filters for a wide range of purposes, with circuit diagrams and worked examples.

88 pages **Order code BP299** £5.49

DIGITAL ELECTRONICS - A PRACTICAL APPROACH

With FREE Software: Number One
Systems - EASY-PC

**FREE
SOFTWARE**

Professional XM and Pulsar (Limited Functionality)
Richard Monk

Covers binary arithmetic, Boolean algebra and logic gates, combination logic, sequential logic including the design and construction of asynchronous and synchronous circuits and register circuits. Together with a considerable practical content plus the additional attraction of its close association with computer aided design including the FREE software.

There is a 'blow-by-blow' guide to the use of EASY-PC Professional XM (a schematic drawing and printed circuit board design computer package). The guide also conducts the reader through logic circuit simulation using Pulsar software. Chapters on p.c.b. physics and p.c.b. production techniques make the book unique, and with its host of project ideas make it an ideal companion for the integrative assignment and common skills components required by BTEC and the key skills demanded by GNVQ. The principal aim of the book is to provide a straightforward approach to the understanding of digital electronics.

Those who prefer the 'Teach-In' approach or would rather experiment with some simple circuits should find the book's final chapters on printed circuit board production and project ideas especially useful.

250 pages (large format) **Order code NE28** £21.99

A BEGINNER'S GUIDE TO TTL DIGITAL ICs

R. A. Penfold

This book first covers the basics of simple logic circuits in general, and then progresses to specific TTL logic integrated circuits. The devices covered include gates, oscillators, timers, flip/flops, dividers, and decoder circuits. Some practical circuits are used to illustrate the use of TTL devices in the "real world".

142 pages **Order code BP332** £5.45

DOMESTIC SECURITY SYSTEMS

A. L. Brown

This book shows you how, with common sense and basic do-it-yourself skills, you can protect your home. It also gives tips and ideas which will help you to maintain and improve your home security, even if you already have an alarm. Every circuit in this book is clearly described and illustrated, and contains components that are easy to source. Advice and guidance are based on the real experience of the author who is an alarm installer, and the designs themselves have been rigorously put to use on some of the most crime-ridden streets in the world.

The designs include all elements, including sensors, detectors, alarms, controls, lights, video and door entry systems. Chapters cover installation, testing, maintenance and upgrading.

192 pages **Order code NE25** £20.99

MICROCONTROLLER COOKBOOK

Mike James

The practical solutions to real problems shown in this cookbook provide the basis to make PIC and 8051 devices really work. Capabilities of the variants are examined, and ways to enhance these are shown. A survey of common interface devices, and a description of programming models, lead on to a section on development techniques. The cookbook offers an introduction that will allow any user, novice or experienced, to make the most of micro-controllers.

240 pages **Order code NE26** £23.99

For a further selection
of books see the next
two issues of *EPE*

Project Building & Testing

ELECTRONIC PROJECTS FOR EXPERIMENTERS

R. A. Penfold

Many electronic hobbyists who have been pursuing their hobby for a number of years seem to suffer from the dreaded "seen it all before" syndrome. This book is fairly and squarely aimed at sufferers of this complaint, plus any other electronics enthusiasts who yearn to try something a bit different. No doubt many of the projects featured here have practical applications, but they are all worth a try for their interest value alone.

The subjects covered include:- Magnetic field detector, Basic Hall effect compass, Hall effect audio isolator, Voice scrambler/descrambler, Bat detector, Bat style echo location, Noise cancelling, LED stroboscope, Infra-red "torch", Electronic breeze detector, Class D power amplifier, Strain gauge amplifier, Super hearing aid.

138 pages **Order code BP371** £5.45

FAULT-FINDING ELECTRONIC PROJECTS

R. A. Penfold

Starting with mechanical faults such as dry joints, short-circuits etc, coverage includes linear circuits, using a meter to make voltage checks, signal tracing techniques and fault finding on logic circuits. The final chapter covers ways of testing a wide range of electronic components, such as resistors, capacitors, operational amplifiers, diodes, transistors, SCRs and triacs, with the aid of only a limited amount of test equipment.

The construction and use of a Tristate Continuity Tester, a Signal Tracer, a Logic Probe and a CMOS Tester are also included.

136 pages **Order code BP391** £5.49

PRACTICAL FIBRE-OPTIC PROJECTS

R. A. Penfold

While fibre-optic cables may have potential advantages over ordinary electric cables, for the electronics enthusiast it is probably their novelty value that makes them worthy of exploration. Fibre-optic cables provide an innovative interesting alternative to electric cables, but in most cases they also represent a practical approach to the problem. This book provides a number of tried and tested circuits for projects that utilize fibre-optic cables.

The projects include:- Simple audio links, F.M. audio link, P.W.M. audio links, Simple d.c. links, P.W.M. d.c. link, P.W.M. motor speed control, RS232C data links, MIDI link, Loop alarms, R.P.M. meter.

All the components used in these designs are readily available, none of them require the constructor to take out a second mortgage.

132 pages **Order code BP374** £5.45

RADIO BYGONES

We also carry a selection of books aimed at readers of *EPE's* sister magazine on vintage radio *Radio Bygones*. These books include the *Comprehensive Radio Valve Guides* (five books with a Free copy of the Master Index) for just £15. Also Jonathan Hill's excellent *Radio Radio*, a comprehensive book with hundreds of photos depicting the development of the British wireless set up to the late 1960s.

The three volumes of our own *Wireless For the Warrior* by Louis Meulstee are also available. These are a technical history of radio communication equipment in the British Army from pre-war through to the 1960s.

For details see the shop on our UK web site at www.epemag.wimborne.co.uk or contact us for a list of *Radio Bygones* books.

BOOK ORDERING DETAILS

All prices include UK postage. For postage to Europe (air) and the rest of the world (surface) please add £2 per book. For the rest of the world airmail add £3 per book. CD-ROM prices include VAT and/or postage to anywhere in the world. Send a PO, cheque, international money order (£ sterling only) made payable to Direct Book Service or card details, Visa, Mastercard, Amex, Diners Club or Switch to:

**DIRECT BOOK SERVICE, WIMBORNE PUBLISHING LTD.,
408 WIMBORNE ROAD EAST, FERNDOWN, DORSET BH22 9ND.**

Orders are normally sent out within seven days of receipt, but please allow 28 days for delivery - more for overseas orders. Please check price and availability (see latest issue of *Everyday Practical Electronics*) before ordering from old lists.

For a further selection of books and CD-ROMs see the next two issues of *EPE*.

Tel 01202 873872 Fax 01202 874562. Email: dbs@epemag.wimborne.co.uk
Order from our online shop at: www.epemag.wimborne.co.uk/shopdoor.htm

BOOK/CD-ROM ORDER FORM

Full name:

Address:

.....

.....

..... Post code: Telephone No:

Signature:

I enclose cheque/PO payable to DIRECT BOOK SERVICE for £

Please charge my card £ Card expiry date.....

Card Number Switch Issue No.....

Card Security Code (The last 3 digits on or just below the signature strip)

Please send book/CD-ROM order codes:

.....

Please continue on separate sheet of paper if necessary
If you do not wish to cut your magazine, send a letter or copy of this form

PCB SERVICE

Printed circuit boards for most recent *EPE* constructional projects are available from the PCB Service, see list. These are fabricated in glass fibre, and are fully drilled and roller tinned. All prices include VAT and postage and packing. Add £1 per board for airmail outside of Europe. Remittances should be sent to **The PCB Service, Everyday Practical Electronics, Wimborne Publishing Ltd., 408 Wimborne Road East, Ferndown, Dorset BH22 9ND. Tel: 01202 873872; Fax 01202 874562; Email: orders@epemag.wimborne.co.uk. On-line Shop: www.epemag.wimborne.co.uk/shopdoor.htm.** Cheques should be crossed and made payable to *Everyday Practical Electronics (Payment in £ sterling only).*

NOTE: While 95% of our boards are held in stock and are dispatched within seven days of receipt of order, please allow a maximum of 28 days for delivery – overseas readers allow extra if ordered by surface mail. Back numbers or photostats of articles are available if required – see the *Back Issues* page for details. We do not supply kits or components for our projects.

Please check price and availability in the latest issue. A large number of older boards are listed on our website. Boards can only be supplied on a payment with order basis.

PROJECT TITLE	Order Code	Cost
★ PICAXE Projects-3: Chaser Lights 6-Channel Mains Interface	JAN '03 373 381	£3.00 £5.08
EPE Minder – Transmitter – Receiver	378 379	£4.75 £5.39
★ Wind Speed Monitor	380	£5.08
Tesla Transformer	FEB '03 382	£5.07
★ Brainbot Buggy	383	£3.00
★ Wind Tunnel	384	£6.02
200kHz Function Generator	MAR '03 385	£6.34
Wind-Up Torch Mk II	386	£4.75
★ Driver Alert	387	£6.35
★ Earth Resistivity Logger	388	£6.02
★ Intelligent Garden Lights Controller	389	£3.96
★ PIC Tutorial V2 – Software only	–	–
Door Chime	MAY '03 390	£5.07
Super Motion Sensor	391	£5.55
Radio Circuits-1 MK484 TRF Receiver	JUNE '03 392	£4.44
Headphone Amp.	393	£4.28
★ Fido Pedometer	394	£4.91
★ PICronos L.E.D. Wall Clock	395	£14.65
EPE Mini Metal Detector	JULY '03 396	£4.28
Radio Circuits – 2 Q-Multiplier	397	£4.28
MW Reflex Radio	398	£4.60
Wave Trap	399	£4.28
Speaker Amplifier	400	£4.44
Ohmmeter Adaptor MkII	401	£4.60
Ultimate Egg Timer (Top Tenner)	403	£4.91
★ EPE PIC Met Office	AUG '03 402	£10.46
Alarm System Fault Finder	404	£4.44
Radio Circuits-3 Regen. Radio	405	£5.07
Tuning Capacitor Board	406	£4.28
Master/Slave Intercom (Top Tenner)	407	£4.75
Two-Up (Top Tenner)	408	£4.91
Priority Referee (Top Tenner)	SEPT '03 410	£5.07
Vibration Alarm (Top Tenner)	411	£5.39
Radio Circuits-4 Varicap Tuner	412	£4.44
Coil Pack – General Coverage	413	£5.07
Coil Pack – Amateur Bands	414	£4.75
★ PIC-A-Colour – Software only	–	–
Spooky Bug (Top Tenner)	OCT '03 409	£5.07
Radio Circuits-5 Crystal Marker	415	£4.44
Super Regen. Receiver	419	£5.07
Buffer Amplifier	420	£4.44
★ Serial Interface for PICs and VB6	416	£5.23
★ PIC Breakpoint – Software only	–	–
Anyone At Home – Logic Board – Relay Board	NOV '03 421 422	£6.35 } Pair
Radio Circuits-6 Direct Conversion SW Receiver	423	£6.02
★ PIC Random L.E.D. Flasher	424	£4.60
★ PIC Virus Zapper Mk2	DEC '03 425	£5.72
Radio Circuits-7 SW Superhet Tuner/Mixer	426	£5.70
Christmas Cheeks (double-sided)	427	£4.44
★ PIC Nim Machine – Software only	–	–
Bedside Nightlight (Top Tenner)	JAN '04 417	£4.44
Sound Trigger	418	£4.60
Timing/Lamp	428	£5.71
Radio Circuits-8 Dual Conversion SW Rec. – I.F. Amp	429	£4.45
– Signal-Strength Meter	430	£4.75
– B.F.O./Prod. Detector	–	–
★ Car Computer (double-sided)	431	£7.61
★ PIC Watering Timer – Software only	–	–
★ GPS to PIC and PC Interface – Software only	–	–
Jazzy Necklace	FEB '04 432 pair	£5.40
Sonic Ice Warning	433	£5.39
★ LCF Meter	434	£5.00
★ PIC Tug-of-War	435	£5.00
Bat-Band Converter	MAR '04 436	£4.76
★ MIDI Health Check – Transmitter/Receiver	437 pair	£7.61
Emergency Stand-by Light	438	£5.55
★ PIC Mixer for RC Planes – Software only	–	–
★ Teach-In '04 Part 5 – Software only	–	–
Infra-Guard	APR '04 439	£5.07
★ Moon Clock	442	£5.71
★ Teach-In '04 Part 6 – Software only	–	–

PROJECT TITLE	Order Code	Cost
★ EPE Seismograph Logger	APR '04	
Control Board	440	} pair £6.50
Sensor Amp. Board	441	
In-Car Lap-Top PSU	MAY '04 443	£4.60
Beat Balance Metal Detector	444	£4.60
Teach-In '04 Part 7		
Transmitter	445	£4.91
Receiver	446	£4.75
Moisture	447	£4.44
★ PIC Quickstep	JUNE '04 448	£5.71
Body Detector MkII	449	£4.91
★ Teach-In '04 Part 8 – Software only	–	–
★ MIDI Synchronome – Software only	–	–
Hard Drive Warbler	JULY '04 450	£4.60
★ Bongo Box	451	£6.02
Portable Mini Alarm – Sensor	452	£5.23
– Counter	453	£5.07
★ Teach-In '04 Part 9		
PIC Combination Lock Alarm Monitor	454	£5.07
★ EPE Magnetometry Logger	455	£5.71
Keyring L.E.D. Torch	AUG '04 456	£4.12
★ Teach-In '04 Part 10 – PIC Curtain or Blind Winder	457	£5.39
Simple F.M. Radio – F.M. Tuner	458	£5.07
– Tone Control	459	£4.75
– Audio Power Amp (TDA2003)	347	£4.60
– Power Supply	460	£5.39
★ EPE Scorer – Control Board	461	£6.66
– Display Board	462	£7.93
– Slave Board	463	£5.55
★ PIC to Mouse/Keyboard – Software only	–	–
EPE Wart Zapper	SEPT '04 464	£4.60
★ Radio Control Failsafe	465	£4.76
★ AlphaMouse Game	466	£4.60
★ Rainbow Lighting Controller – Software only	–	–
★ Moon and Tide Clock Calendar	OCT '04 467	£5.55
Volts Checker	468	£4.20
★ Smart Karts – Software only	–	–

EPE SOFTWARE

Software programs for *EPE* projects marked with a single asterisk ★ are available on 3.5 inch PC-compatible disks or free from our Internet site. The following disks are available: *PIC Tutorial V2 (Apr-June '03)*; *EPE Disk 3 (2000)*; *EPE Disk 4 (2001 – excl. PIC Toolkit TK3)*; *EPE Disk 5 (2002)*; *EPE Disk 6 (2003 – excl. Earth Resistivity and Met Office)*; *EPE Disk 7 (Jan 2004 to current cover date)*; *EPE Earth Resistivity Logger (Apr-May '03)*; *EPE PIC Met Office (Aug-Sept '03)*; *EPE Seismograph (Apr-May '04)*; *EPE Magnetometry Logger (July-Aug '04)*; *EPE Teach-In 2000*; *EPE Spectrum*; *EPE Interface Disk 1 (October '00 issue to current cover date)*. *EPE Toolkit TK3* software is available on the *EPE PIC Resources CD-ROM*, £14.45. Its p.c.b. is order code 319, £8.24. ★★ The software for these projects is on its own CD-ROM. The 3.5 inch disks are £3.00 each (UK), the CD-ROMs are £6.95 (UK). Add 50p each for overseas surface mail, and £1 each for airmail. All are available from the *EPE PCB Service*. All files can be downloaded free from our Internet FTP site, accessible via our home page at: www.epemag.wimborne.co.uk.

EPE PRINTED CIRCUIT BOARD SERVICE

Order Code	Project	Quantity	Price
Name			
Address			
Tel. No.			
I enclose payment of £..... (cheque/PO in £ sterling only) to:			
 		Everyday Practical Electronics MasterCard, Amex, Diners Club, Visa or Switch/Maestro	
Card No.			
Valid From		Expiry Date	
Card Security Code		Switch/Maestro Issue No	
(The last 3 digits on or just under the signature strip)			
Signature			
NOTE: You can also order p.c.b.s by phone, Fax, Email or via our Internet site on a secure server:			
http://www.epemag.wimborne.co.uk/shopdoor.htm			

ELECTRONICS MANUALS ON CD-ROM £29.95 EACH

ELECTRONICS SERVICE MANUAL

THE MODERN ELECTRONICS MANUAL

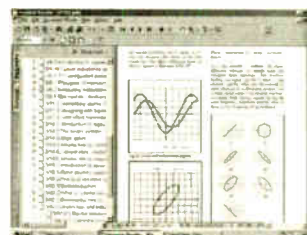
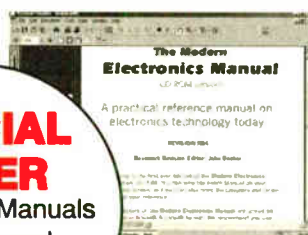
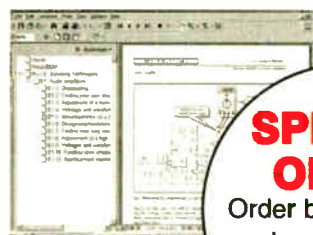

SPECIAL OFFER
Order both Manuals together and **SAVE £10**

Everything you need to know to get started in repairing electronic equipment

- Around 900 pages • Fundamental principles • Troubleshooting techniques • Servicing techniques • Choosing and using test equipment • Reference data • Manufacturers' web links
- Easy-to-use Adobe Acrobat format • Clear and simple layout
- Vital safety precautions • Professionally written • Supplements

SAFETY: Safety Regulations, Electrical Safety and First Aid.
UNDERPINNING KNOWLEDGE: Electrical and Electronic Principles, Active and Passive Components, Circuit Diagrams, Circuit Measurements, Radio, Computers, Valves and Manufacturers' Data, etc.
PRACTICAL SKILLS: Learn how to identify Electronic Components, Avoid Static Hazards, Carry Out Soldering and Wiring, Remove and Replace Components.
TEST EQUIPMENT: How to Choose and Use Test Equipment, Assemble a Toolkit, Set Up a Workshop, and Get the Most from Your Multimeter and Oscilloscope, etc.
SERVICING TECHNIQUES: The Manual includes vital guidelines on how to Service Audio Amplifiers. The Supplements include similar guidelines for Radio Receivers, TV Receivers, Cassette Recorders, Video Recorders, Personal Computers, etc.
TECHNICAL NOTES: Commencing with the IBM PC, this section and the Supplements deal with a very wide range of specific types of equipment – radios, TVs, cassette recorders, amplifiers, video recorders etc.
REFERENCE DATA: Diodes, Small-Signal Transistors, Power Transistors, Thyristors, Triacs and Field Effect Transistors. Supplements include Operational Amplifiers, Logic Circuits, Optoelectronic Devices, etc.

The essential reference work for everyone studying electronics

- Over 800 pages • In-depth theory • Projects to build
- Detailed assembly instructions • Full components checklists • Extensive data tables • Manufacturers' web links
- Easy-to-use Adobe Acrobat format • Clear and simple layout • Comprehensive subject range • Professionally written • Supplements

BASIC PRINCIPLES: Electronic Components and their Characteristics; Circuits Using Passive Components; Power Supplies; The Amateur Electronics Workshop; The Uses of Semiconductors; Digital Electronics; Operational Amplifiers; Introduction to Physics, including practical experiments; Semiconductors and Digital Instruments.

CIRCUITS TO BUILD: The Base Manual describes 12 projects including a Theremin and a Simple TENS Unit.

ESSENTIAL DATA: Extensive tables on diodes, transistors, thyristors and triacs, digital and linear i.c.s.
EXTENSIVE GLOSSARY: Should you come across a technical word, phrase or abbreviation you're not familiar with, simply look up the glossary and you'll find a comprehensive definition in plain English.
 The Manual also covers **Safety** and provides web links to component and equipment **Manufacturers and Suppliers**.

Full contents list available online at: www.epemag.wimborne.co.uk

Supplements: Additional CD-ROMs each containing approximately 500 pages of additional information on specific areas of electronics are available for £19.95 each. Information on the availability and content of each Supplement CD-ROM will be sent to you.

Presentation: CD-ROM suitable for any modern PC. Requires Adobe Acrobat Reader which is included on the CD-ROM.

Wimborne Publishing Ltd., Dept Y10, 408 Wimborne Road East, Ferndown, Dorset BH22 9ND. Tel: 01202 873872. Fax: 01202 874562.

PLEASE send me



THE MODERN ELECTRONICS MANUAL CD-ROM

ELECTRONICS SERVICE MANUAL CD-ROM

I enclose payment of £29.95 (for one Manual) or £49.90 for both Manuals (saving £10 by ordering both together).

FULL NAME
(PLEASE PRINT)

ADDRESS

.....

POSTCODE

SIGNATURE

I enclose cheque/PO in UK pounds payable to Wimborne Publishing Ltd.

Please charge my Visa/Mastercard/Amex/Diners Club/Switch/Maestro

Card No Switch/Maestro Issue No

Valid From Expiry Date

Card Security Code (The last 3 digits on or just under the signature strip)

ORDER FORM

Simply complete and return the order form with your payment to the following address:

Wimborne Publishing Ltd,
Dept. Y10,
408 Wimborne Road East, Ferndown,
Dorset BH22 9ND

Price includes postage to anywhere in the World

We will happily exchange any faulty CD-ROMs but since the content can be printed out we do not offer a refund on these items.

Your CD-ROM(s) will be posted to you by first class mail or airmail, normally within four working days of receipt of your order

PRACTICAL ELECTRONICS

Everyday Practical Electronics reaches twice as many UK readers as any other UK monthly hobby electronics magazine, our sales figures prove it. We have been the leading monthly magazine in this market for the last nineteen years.

If you want your advertisements to be seen by the largest readership at the most economical price our classified and semi-display pages offer the best value. The prepaid rate for semi-display space is £10 (+VAT) per single column centimetre (minimum 2.5cm). The prepaid rate for classified adverts is 40p (+VAT) per word (minimum 12 words).

All cheques, postal orders, etc., to be made payable to Everyday Practical Electronics. **VAT must be added.** Advertisements, together with remittance, should be sent to Everyday Practical Electronics Advertisements, Mill Lodge, Mill Lane, Thorpe-le-Soken, Essex CO16 0ED. Phone/Fax (01255) 861161.

For rates and information on display and classified advertising please contact our Advertisement Manager, Peter Mew as above.

VVT TRANSFORMERS

Transformers and Chokes for all types of circuits including specialist valve units
Custom design or standard range
High and low voltage

Variable Voltage Technology Ltd

Unit 3, Sheat Manor Farm, Chillerton,
Newport, Isle of Wight, PO30 3HP
Tel: 0870 243 0414 Fax: 01983 721572
email: sales@vvt-cowes.freemove.co.uk

www.vvttransformers.co.uk

X-10® Home Automation We put you in control™

Why tolerate when you can automate?

An extensive range of 230V X-10 products and starter kits available. Uses proven Power Line Carrier technology, no wires required.

Products Catalogue available Online.

Worldwide delivery.

Laser Business Systems Ltd.

E-Mail: info@laser.com

<http://www.laser.com>

Tel: (020) 8441 9788

Fax: (020) 8449 0430



BTEC ELECTRONICS TECHNICIAN TRAINING

VCE ADVANCED ENGINEERING
ELECTRONICS AND ICT
HNC AND HND ELECTRONICS
NVQ ENGINEERING AND IT
**PLEASE APPLY TO COLLEGE FOR
NEXT COURSE DATE
FULL PROSPECTUS FROM**

LONDON ELECTRONICS COLLEGE
(Dept EPE) 20 PENYWERN ROAD
EARLS COURT, LONDON SW5 9SU
TEL: (020) 7373 8721

The Versatile, Programmable On Screen Display System www.STV5730A.co.uk



- Fully programmable
- PIC 16F628 microcontroller
- Demo software code available
- OSD IC 28 by 11 screen
- I/O lines free to connect sensors or buttons
- Serial or PC keyboard interface versions

TEXT,
GPS or
DATA

TOTALROBOTS

ROBOTICS, CONTROL & ELECTRONICS TECHNOLOGY

High quality robot kits and components
UK distributor of the OOPic microcontroller

Secure on-line ordering

Rapid delivery

Highly competitive prices

Visit www.totalrobots.com

Tel: 0208 823 9220

BOWOOD ELECTRONICS LTD

Suppliers of Electronic Components

Place a secure order on our website or call our sales line
All major credit cards accepted

Web: www.bowood-electronics.co.uk

Unit 1, McGregor's Way, Turnoaks Business Park,
Chesterfield, S40 2WB. Sales: 01246 200222

Send 60p stamp for catalogue

Component Kits!

Brand new high quality
component kits
available from just

£4.99

www.fastcomponents.co.uk

Tel: 0870 750 4468 Fax: 0870 137 6005
Winchester House, Winchester Rd,
Walton-on-Thames, Surrey. KT12 2RH

SWAYSCIENCE

LOW TEMPERATURE DESOLDERING (60°C-80°C)

Remove electronic components without heat damage
to semiconductors or p.c.b.s.

★ Cost Effective ★ Free Details

★ Safer than most solder itself

★ Trade and Retail Enquiries Welcome

TEL: 0778 770 3785

PC Oscilloscope & Signal Generator



3-in-1 Digital Oscilloscope + Signal Generator + Spectrum
Analyser. Samples at 20 or 30 Msp. Programmable signal
generator with built in sine, triangular, saw and square waves
in normal & sweep modes. Plugs into printer port.

Prices from £119 - CL SYSTEM

Visit www.clysystem.co.uk or call 07986 860815

TRANSFORMERS

- Custom Wound
- 1 Phase to 50kVA
- 3 Phase to 100kVA
- A.C. and D.C. Chokes
- H.T. up to 5kV
- Transformer Kits
- Coils up to 1m Dia.
- Transformer Rectifiers
- Toroidals
- Motor Generators

Visit www.jemelec.com for details
or request our free leaflet

Jemelec, Unit 7, Shirebrook Business Park, Mansfield, NG20 8RN

Tel: 0870 787 1769

ELECTRONIC SURVEILLANCE

Phone tapping info and schematics (that work). Fully
explained (DIY). All methods covered. Series/Parallel/Manual
and Auto recording. Lots of practical info. Only £4.50 inc. p&p.

Cheques/P.O. to A. Spurr

47 Markeaton Street, Derby DE1 1DX

email: info@spytools.co.uk

Miscellaneous

**FREE! PROTOTYPE PRINTED CIRCUIT
BOARDS!** Free prototype p.c.b. with quantity
orders. Call Patrick on 028 9073 8897 for
details. Agar Circuits, Unit 5, East Belfast
Enterprise Park, 308 Alberbridge Road, Belfast
BT5 4GX.

**PRINTED CIRCUIT BOARDS - QUICK
SERVICE.** Prototype and production artwork
raised from magazines or draft designs at low
cost. PCBs designed from schematics.
Production assembly, wiring and software pro-
gramming. For details contact Patrick at Agar
Circuits, Unit 5, East Belfast Enterprise Park,
308 Alberbridge Road, Belfast, BT5 4GX.
Phone 028 9073 8897, Fax 028 9073 1802,
Email agar@argonet.co.uk.

**VALVES AND ALLIED COMPONENTS IN
STOCK.** Phone for free list. Valves, books and
magazines wanted. Geoff Davies (Radio), tel.
01788 574774.

KITS, TOOLS, COMPONENTS. S.a.e. cata-
logue: Sir-Kit Electronics, 52 Severn Road,
Clacton, CO15 3RB. [www.
geocities.com/sirkituk](http://www.geocities.com/sirkituk).

Computer Software

ELECTRONICS AND ELECTRICAL V8.2
colourful highly interactive software as used in
schools and colleges. Now downloadable for
just £4.95, normally £120. FREE trial download
www.eptsoft.com.

GCSE MATHS V8.2 colourful highly inter-
active software as used in schools and colleges.
Now downloadable for just £4.95, normally
£120. FREE trial download www.eptsoft.com.

We have moved to: 17A King Street, Mortimer, Nr. Reading RG7 3RS
Tel No: 0118 933 1111 Fax No: 0118 933 2375

MISCELLANEOUS CLEARANCE STOCK

OSCILLOSCOPES	POWER SUPPLY Model 12030 0-20V 0-30A - On Wheels £35
TEKTRONIX 4658 Dual Trace 100 MHz Delay fitted into 19in rack frame £125	HARMER SIMMONS 5025/110 Input 240V 10A Output 50V 25A £100
HP 1740A Dual Trace 100 MHz delay (no lock) £40	CENTRONIC M100 Regavolt Input 240V 25V VA Output 240V 1000VA £90
HP 1740A Dual Trace 100 MHz Delay £60	DRANETZ 606 Line Distribution Analyser £25
HP 1741 Dual Trace 100 MHz Analogue Storage £60	WAYNE KERR B601 Radio Frequency Bridge £25
HP 1744A Dual Trace 100 MHz Analogue Storage £60	FEDBACK TFA007 Transfer Function Analyser £25
PHILIPS PM2264 4 Ch. 100 MHz £125	WAVETEK 52 Delta Multimeter £90
GOULD O5300A Dual Trace 40 MHz £40	GOULD SG200 RF Signal Generator £10
TRO CS1040 Dual Trace 40 MHz £50	CHATILLON Force Meter £20
GOLDSTAR DS9020P Dual Trace 20 MHz £40	ALFRED 1E05 Variable Attenuator 4-9Ghz £20
IKATSU SS5702 Dual Trace 20 MHz £40	CAMMETRIC 6 Decade Resistance Box £15
IKKUSU COS9020 Dual Trace 20 MHz £40	SULLIVAN CS710 Precision 5 Decade Capacitor Box £20
POWER SUPPLIES	MARCONI 60382 Waveguide £30
FARNELL L308T 0-30V 0-1A Twice £40	MARCONI 2169 Pulse Modulator £30
FARNELL L30AT 0-50V 0-500MA Twice £30	MARCONI 2430A Frequency Meter 80MHz £30
FARNELL LT30-1 0-30V 0-1A Twice Scruffy £40	MARCONI 6950 RF Power Meter - No head £35
FARNELL L30-2 0-30V 0-2A Scruffy £30	MARCONI 6980 RF Power Meter - Digital £50
FARNELL L30-3 0-30V 0-1A Scruffy £20	HP 1332A Variable Attenuator Waveguide £20
FARNELL L308 0-30V 0-1A £25	HP 5316A Counter £20
FARNELL L30AT 0-50V 0-500MA £20	HP 8750A Storage Normalizer £20
FARNELL C1 0-50V 0-1A - 2 Meters £30	HP 907A Co-axial Sliding Load £20
Farnell TOP51 5V 1A x15V 200MA £35	PROGRAMMA TM2 Timer £20
COUTANT LB500 2 0-30V 0-5A - 2 Meters £45	RACAL 9009 Modulation Meter £40
COUTANT LA200 2 0-3V 0-2A - 2 Meters £35	RACAL 9009A Modulation Meter £50
COUTANT LQ7200 0-15V 0-2A - 2 Meters £30	TEXCAN SA50 102dB in 1dB steps £15
COUTANT LQ7100 0-30V 0-1A Twice £40	FLUKE 8502A Digital Multimeter £15
COUTANT LQ7500 0-50V 0-500MA £30	BIRD 8341-200 Coaxial Attenuator 20dB 40W 50ohm £25
WEIR 781 C-30V 2A or 0-15V 4A £30	BIRD 61 Wattmeter 6 & 30W 50ohm 30-50MHz £40
WEIR 782 C-30V 2A or 0-15V 4A £30	TELENIC TTP95-5-6EE Tunable Band Pass Filter £20
WEIR 4310 0-30V 1A - 5V 4A £20	RACAL 190-SEE Tunable Band Reject Filter 125-250 £15
WEIR 400 0-20V 0.3A - 10V 1A £20	TELENIC 95-6EZ Tunable Band Reject Filter 60-125 £15
WEIR 460 0-20V 0.3A - 20V 1A £20	HELPER INST CML 1 Snadder £30
HP 6256B 0-40V 0-5A 2 Meters £30	HELPER INST S103 Snadder 3 £30
HP 6256B 0-10V 0-20A 2 Meters £35	SXP100 Parallel to Serial Converter £10
HP 6111A 0-20V 0-1A £30	MICROMASTER LV £40
HP 6225A -6V 1A - 15V 200MA £25	DATAMAN S3 Programmer £50
KINGSNELL 30V20 0-36V 0-2A £30	RS 424-10 Logic Pulser £5
MARCONI TF2158 0-30V 0-2A Twice £30	GLOBAL S01 Shortcircuit £20
LAMBDA 422FM 0-40V 0-1A Twice 4 Meters £50	RS 180-7127 Conductivity Meter £35
LAMBDA LK345A FM 0-60V 0-11A 2 Meters £75	ENGLE DC30 Probe 30Ku DC £5
SYSTRON DOWNER SH94B-2 0-40V 0-2A - 2 Meters £25	AVO 100AMP Shunt for AVO 6 £5
SORENSEN SRL64 0-40V 0-4A £60	SOUTHERN CALIFORNIA BTRFM-5-10 2000.0 MHz £50
GRENSON BPU14 +5V 2.5A +/- 5V 0.5A £25	MOTOROLA R2001D Communication System Analyser £250
RS 813-801 2 x 5V 2.5A or 2 x 12V 1.5A or 2 x 5V 1A £40	WESTON 1149 Standard Cell 1.01859 ABS Volts at 20C £10
RS 200-187 Line Voltage Conditioner - Output 240V 0.65A £40	MURHEAD A-6-B Resistance Box £18
POWER CONVERSION PLC1000 Line Cond. 1000VA £30	RACAL 9917A UHF Frequency Meter 10Hz-560 MHz £45
HARLYN AUTOMATION PPS5000 System Power Supply £80	RACAL 9917 UHF Frequency Meter 10Hz-560 MHz £40
POWERLINE LAB807 0-300V AC 7.5A £40	RACAL 9915M UHF Frequency Meter 10Hz-520 MHz £30

RACAL 9901 Universal Counter Timer DC-50 MHz £15	RACAL 9900 Universal Counter Timer 30 MHz DC-30 MHz £15
WAVETEK 136 VCG/PCA Generator £20	HP 435A Power Meter - No lead no head £30
HP 4015A Pulse Generator £30	HP 8038 AC Voltmeter £15
DL-LOG PR415 Phase Rotation Indicator £10	MAYWOOD D2000 Digital Indicator £10
HP 1720A HP48 Extender £10	HATFIELD 2115 Attenuator 75ohm 100dB £10
HATFIELD 2118 Attenuator 75ohm 100dB £10	HATFIELD 2118 Attenuator 75ohm 100dB £10
HATFIELD 2135 Attenuator 600ohm 100dB £20	TEKTRONIX 1103 Teleglobe Power Supply £10
SYSTRON DOWNER 8243A Freq Counter 20Hz-1250 MHz £25	LEYELL TG301 Function Generator 1 MHz Sine/Sqr/Tri £30
SOLARTRON 7045 Digital Multimeter £30	HP 8404A Levelling Amplifier £15
HP 3455A Digital Voltmeter £50	FEDBACK FM610 Digital Frequency Meter £25
FARNELL T88 True RMS RF Millivoltmeter £40	THURLEY 1503 Digital Multimeter £15
SULLIVAN 6666 Millivoltmeter £15	K&L Tunable Bank Reject Filter £15
BARR & STROUD EP4-01 Bank Pass Filter 1Hz-100KHz £15	BARR & STROUD EP4-02 LPHPF Filter 1Hz-100KHz £15
FLUKE 8810A Digital Multimeter £30	FLUKE 8502A Digital Multimeter £25
ELECTRONIC VISUAL EV4040 TV Waveform Monitor £20	TRACER NORTHERN TM150 £30
RS 555-279 UV Exposure Unit £10	MICROPTIC CORP. Receiver £60
VARIAN V21-6941 F1 Travelling Wave Tube Amplifier £50	MOORE READ SFC5001 AUXR Static Frequency Converter 120 Volts 400 HZ £50
DRAGER 2131 Multi Gas Detector £10	PHILIPS PM2237B Multipoint Data Recorder £20
ENDUCEO 4417 Signal Conditioner X 2 £10	PULSATEK 132 DC Current Calibrator £30
PH1038-D14 Display with 1038-N10 Network Analyser No Heads £50	MEGGER MJ40M2 Wind Up 1000V MOhm £15
METROM 250V Pat Tester £10	SULLIVAN AC1012 4 Decade Resistance Box 0.05% £10
BULSSEK 132 DC Current Calibrator £30	50R08Z Output 115V 400HZ 20VA £40
NARDA 706 Attenuator £10	ANALOGUE ASSOCIATES X800 Audio Amplifier 800watt (400w per Channel no DC Protection) £60
W&G PC32 PCM Channel Generator £30	SIYERS LAB 19490 - 18000 MHz £10
SIYERS LAB 5212 2500 - 4000 MHz-C264 £10	CROPCO VS10 DC Standard 10V £30

EXTRA SPECIAL OFFERS

HP J. 8550A Spectrum Analyser, 50Hz-2.9GHz £3,250
HP 8596B Spectrum Analyser, 10MHz-2.2GHz £1,500
MARCONI 2382 Spectrum Analyser, 200Hz-400MHz £1,250
TEKTRONIX 2465A Oscilloscope, 4-ch, 350MHz £750
TEKTRONIX 2246 Oscilloscope, 4-ch, 100MHz £375
H.P. 8444A AM/FM Signal Gen, 500kHz-512MHz £175

SPECIAL OFFERS

OSCILLOSCOPES	LECRON 9400A dual trace 170MHz, 5GS £500
Lecky 9400 dual trace, 120kHz £400	TEKTRONIX 468 dual trace, 200MHz, digital storage £300
TEKTRONIX 475 dual trace, 200MHz, delay sweep £250	TEKTRONIX 465B dual trace, 130MHz, delay sweep £250
TEKTRONIX 465 dual trace, 40MHz, delay sweep £175	PHILIPS PM2217 dual trace, 50MHz, delay sweep £150
THURLEY PL2300MD 0-30V 0-2A twice digital PSU £160	H.P. 86312A 0-20V 0-2A Communications PSU £200
H.P. 8626A Precision High Resolution PSU, 4 outputs, 0-7V 0-15A or 0-50V 0-0.5A twice, 0-16V 0-0.2A or 0-54V 0-2A twice £500	CIRUIS CKL254 Sound Level Meter with calibrator £95
WAYNE KERR B424 Component Bridge £50	RACAL 9300 True RMS Voltmeter, 5Hz-20MHz usable to 60MHz, 10V-316V £50
RACAL 9300B True RMS Voltmeter, 5Hz-20MHz usable to 60MHz, 10V-316V £75	AVO DA116 Digital Acrometer with battery and leads £20
FARNELL LF3M Sine/Sq Oscillator, 10Hz-1MHz, low distortion TTL output amplitude meter £75	FARNELL J38 Sine/Sq Oscillator, 10Hz-100kHz, low dist. £80
HAME 1000 LCD Clamp Meter, 0-1000A, in carrying case £35	FLUKE 77 Multimeter 3 1/2 digit handheld with battery & leads £45
KENWOOD FT178 2-Channel Multimeter £50	KENWOOD FL140 Wow and Flutter Meter £75
KENWOOD FL180A Wow and Flutter Meter £75	KENWOOD FL180 Wow and Flutter Meter, unused £125
MARCONI 6960B Power Meter with 6820 head, 10MHz-20GHz £450	SOLARTRON 7150 DMW 6 1/2-digit True RMS IEEE £75
SOLARTRON 7150 Plus Ac 7150 - temp measurement £100	IEEE Cables £5
H.P. 3312A Function Gen, 0-1Hz-13MHz, AM/FM Sweep/Sqr/Tri/Burst etc £200	H.P. 3310A Function Gen, 0.005Hz-6MHz, Sine/Sqr/Tri Ramp/Pulse £80
RACAL 9008 Automatic Modulation Meter, 1-5MHz-2GHz £60	ISOLATING Transformer, input 250V, output 500VA, unused £325
RACAL 1792 Receiver £325	

STEWART of READING

17A King Street, Mortimer, Near Reading RG7 3RS
 Telephone: (0118) 933 1111. Fax: (0118) 933 2375
 www.stewart-of-reading.co.uk

Callers welcome 9am-5.30pm Monday to Friday (other times by arrangement)

Used Equipment - GUARANTEED. Manuals supplied
 This is a VERY SMALL SAMPLE of STOCK. SAE or Telephone for lists.
 Please check availability before ordering.
 CARRIAGE all units £16. VAT to be added to Total of Goods and Carriage



Get your magazine "instantly" anywhere in the world - buy from the web.

TAKE A LOOK, A FREE ISSUE IS AVAILABLE

A one year subscription (12 issues) costs just \$10.99 (US)
 www.epemag.com

N. R. BARDWELL LTD (Est. 1948)

100 Signal Diodes 1N4148 £1.00	80 Assid. capacitors 1Hf to 1uF £1.00
75 Rectifier Diodes 1N4001 £1.00	200 Assid. disc ceramic capacitors £1.00
50 Rectifier Diodes 1N4007 £1.00	Assid. Silicon Presets (cm, stand, cermet) £1.00
10 W01 Bridge Rectifiers £1.00	Assid. RF chokes (inductors) £1.00
10 555 Timer I.C.s £1.00	Assid. grommets £.60
4 741 Op Amps £1.00	8 Assid. di switches £1.00
50 Assorted Zener Diodes 400mW £1.00	8 Assid. push-button switches, multi-bank, multi-pole £1.00
12 Assorted 7-segment Displays £1.00	30 Assid. di sockets up to 40 way £1.00
Assorted I.e.d.s, v.c. shgcs, colours & sizes £1.00	10 TV coax plugs, plastic £1.00
5mm I.e.d.s, red or green or yellow £1.00	40 metres very thin connecting wire, red £1.80
5mm I.e.d.s, red or green or yellow £1.00	20 1in. glass reed switches £1.10
75 5mm I.e.d.s, green, 6-5mm legs £1.00	100 Any one value 1/4W 5% cf resistors range 1R to 10M £0.45
Assid. High Brightness .a.d.s, var coils £1.00	10 7812 Voltage Regulators £1.10
20 BC182 Transistors £1.00	300 Assid. resistors, 1/4W/1/2W, mostly on tapes £1.40
25 BC212 Transistors £1.00	
20 BC237 Transistors £1.00	
20 BC237 Transistors £1.00	
20 BC238 Transistors £1.00	
20 BC547 Transistors £1.00	
20 BC547B Transistor £1.00	
20 BC548 Transistors £1.00	
30 BC549 Transistors £1.00	
25 BC557 Transistors £1.00	
30 BC558 Transistors £1.00	
25 BC559 Transistors £1.00	
20 *N3904 Transistors £1.00	
100 1nf 50V w/g Anal. Capacitors £1.00	
80 Assid capacitors electrolytic £1.00	

288 Abbeydale Road, Sheffield S7 1FL
 Phone (local rate): 0845 166 2329
 Fax: 0114 255 5039
 e-mail: sales@bardwells.co.uk
 web: www.bardwells.co.uk
 Prices include VAT, Postage £1.85
 44p stamp for lists or disk
 P.O.s, Cheques and Credit Cards accepted
 SEE OUR WEB PAGES FOR MORE COMPONENTS AND SPECIAL OFFERS

FRUSTRATED!

Looking for ICs TRANSISTORS?
 A phone call to us could get a result. We offer an extensive range and with a world-wide database at our fingertips, we are able to source even more. We specialise in devices with the following prefix (to name but a few).



- 2N 2SA 25B 25C 25D 2P 2S1 25K 3N 35K 4N 6N 17 40 AD ADC AN AM AY BA BC BD BDT BDV BDW BDX BF BFR BFS BFT BFX BFY BLY BLX BS BR BRX BRY BS BSS BSV BSW BSX BT BTA BTB BRW BU BUK BUT BUV BUW BUX BUY BUZ CA CD CX CXA DAC DG DM DF DS DTA DTC GL GM HA HCF HD HEF ICL ICM IRF J KA KIA L LA LB LC LD LF LM M M5M MA MAB MAX MB MC MDJ MJE MJF MM MN MPS MP5A MP5H MP5U MRF NJM NE OM OP PA PAL PIC PN RC S SAA SAB SAD SAJ SAS SDA SG SI SL SN SO STA STK STR STRD STRM STRS SV1 T TA TAA TAG TBA TC TCA TDA TDB TEA TIC TIP TPL TE TL TLC TMP TMS TPU U UA UAA UC UDN ULN UM UPN UPC UPD VN X XR Z ZN ZTX + many others

PLEASE VISIT OUR WEB SITE AT
www.cricklewoodelectronics.com
 We Stock a Massive Range of Components

Mail, phone, Fax Credit Card orders and callers welcome



Cricklewood Electronics Ltd
 40-42 Cricklewood Broadway London NW2 3ET
 Tel: 020 8452 0161 Fax: 020 8208 1441

Watch Slides on TV.

Make videos of your slides. Digitise your slides (using a video capture card)
 "Liesgang diatv" automatic slide viewer with built in high quality colour TV camera. It has a composite video output to a phono plug (SCART & BNC adaptors are available). They are in very good condition with few signs of use. More details see www.diatv.co.uk.
 £91.91 + VAT = £108.00



Board cameras all with 512 x 582 pixels 8.5mm 1/3 inch sensor and composite video out. All need to be housed in your own enclosure and have fragile exposed surface mount parts. They all require a power supply of between 10V and 12V DC 150mA.
 47MIR size 60 x 36 x 27mm with 6 infra red LEDs (gives the same illumination as a small torch but is not visible to the human eye) £37.00 + VAT = £43.48
 30MP size 32 x 32 x 14mm spy camera with a fixed focus pin hole lens for hiding behind a very small hole £35.00 + VAT = £41.13
 40MC size 39 x 38 x 27mm camera for 'C' mount lens these give a much sharper image than with the smaller lenses £32.00 + VAT = £37.60
 Economy C mount lenses all fixed focus & fixed iris
 VSL1220F 12mm F1.6 12 x 15 degrees viewing angle £15.97 + VAT £18.76
 VSL4022F 4mm F1.22 63 x 47 degrees viewing angle £17.65 + VAT £20.74
 VSL6022F 6mm F1.22 42 x 32 degrees viewing angle £19.05 + VAT £22.38
 VSL8020F 8mm F1.22 32 x 24 degrees viewing angle £19.90 + VAT £23.38

Better quality C Mount lenses

VSL1614F 16mm F1.6 30 x 24 degrees viewing angle £26.43 + VAT £31.06
 VWL813M 8mm F1.3 with iris 56 x 42 degrees viewing angle £77.45 + VAT = £91.00
 1206 surface mount resistors E12 values 10 ohm to 1M ohm
 100 of 1 value £1.00 + VAT 1000 of 1 value £5.00 + VAT

866 battery pack originally intended to be used with an orbital mobile telephone it contains 10 1.6Ah sub C batteries (42 x 22 dia. the size usually used in cordless screwdrivers etc.) the pack is new and unused and can be broken open quite easily
 £7.46 + VAT = £8.77



Please add £1.66 + vat = £1.95 postage & packing per order

JPG Electronics

Shaws Row, Old Road, Chesterfield, S40 2RB.

Tel 01246 211202 Fax 01246 550959

Mastercard/Visa/Switch

Callers welcome 9.30 a.m. to 5.30 p.m. Monday to Saturday

ADVERTISERS INDEX

AUTOTRAX	717
N. R. BARDWELL	747
B.K. ELECTRONICS	Cover (iv)/721
BRUNNING SOFTWARE	675
BULL GROUP	Cover (ii)
CRICKLEWOOD ELECTRONICS	747
DISPLAY ELECTRONICS	670
ESR ELECTRONIC COMPONENTS	678
JAYCAR ELECTRONICS	712
JPG ELECTRONICS	748
LABCENTER	Cover (iii)
MAGENTA ELECTRONICS676/677
MATRIX MULTIMEDIA721
MICROCHIP697
MILFORD INSTRUMENTS693
PEAK ELECTRONIC DESIGN689
PICO TECHNOLOGY688/733
QUASAR ELECTRONICS672/673
SHERWOOD ELECTRONICS748
SQUIRES716
STEWART OF READING747

ADVERTISEMENT MANAGER: PETER J. MEW

ADVERTISEMENT OFFICES:

EVERYDAY PRACTICAL ELECTRONICS, ADVERTISEMENTS,
 MILL LODGE, MILL LANE, THORPE-LE-SOKEN,
 ESSEX CO16 0ED.

Phone/Fax: (01255) 861161

For Editorial address and phone numbers see page 679

SHERWOOD ELECTRONICS

FREE COMPONENTS

Buy 10 x £1 Special Packs and choose another one FREE

SP1 15 x 5mm Red LEDs	SP133 20 x 1N4004 diodes
SP2 12 x 5mm Green LEDs	SP134 15 x 1N4007 diodes
SP3 12 x 5mm Yellow LEDs	SP135 6 x Miniature slide switches
SP5 25 x 5mm 1 part LED clips	SP136 3 x BFY50 transistors
SP6 15 x 3mm Red LEDs	SP137 4 x W005 1.5A bridge rectifiers
SP7 12 x 3mm Green LEDs	SP138 20 x 2.2/63V radial elect. caps.
SP8 10 x 3mm Yellow LEDs	SP140 3 x W04 1.5A bridge rectifiers
SP9 25 x 3mm 1 part LED clips	SP142 2 x CMOS 4017
SP10 100 x 1N4148 diodes	SP143 5 Pairs min. crocodile clips (Red & Black)
SP11 30 x 1N4001 diodes	SP146 10 x 2N3704 transistors
SP12 30 x 1N4002 diodes	SP147 5 x Stripboard 9 strips x 25 holes
SP18 20 x BC182 transistors	SP151 4 x 8mm Red LEDs
SP20 20 x BC184 transistors	SP152 4 x 8mm Green LEDs
SP23 20 x BC549 transistors	SP153 4 x 8mm Yellow LEDs
SP24 4 x CMOS 4001	SP154 15 x BC548 transistors
SP25 4 x 555 timers	SP156 3 x Stripboard, 14 strips x 27 holes
SP26 4 x 741 Op.Amps	SP160 10 x 2N3904 transistors
SP28 4 x CMOS 4011	SP161 10 x 2N3906 transistors
SP29 3 x CMOS 4013	SP165 2 x LF351 Op.Amps
SP33 4 x CMOS 4081	SP166 20 x 1N4003 diodes
SP34 20 x 1N914 diodes	SP167 5 x BC107 transistors
SP36 25 x 10/25V radial elect. caps.	SP168 5 x BC108 transistors
SP37 12 x 100/35V radial elect. caps.	SP172 4 x Standard slide switches
SP39 10 x 470/16V radial elect. caps.	SP173 10 x 220/25V radial elect. caps.
SP40 15 x BC237 transistors	SP174 20 x 22/25V radial elect. caps.
SP41 20 x Mixed transistors	SP175 10 x 1A 20mm quick blow fuses
SP42 200 x Mixed 0.25W C.F. resistors	SP177 10 x 2A 20mm quick blow fuses
SP47 5 x Min. PB switches	SP181 5 x Phono plugs - asstd colours
SP49 4 x 5 metres stranded core wire	SP182 20 x 4.7/63V radial elect. caps.
SP102 20 x 8-pin DIL sockets	SP183 20 x BC547 transistors
SP103 15 x 14-pin DIL sockets	SP187 15 x BC239 transistors
SP104 15 x 16-pin DIL sockets	SP189 4 x 5 metres solid core wire
SP105 4 x 74LS00	SP192 3 x CMOS 4066
SP109 15 x BC557 transistors	SP195 3 x 10mm Yellow LEDs
SP112 4 x CMOS 4093	SP197 6 x 20 pin DIL sockets
SP115 3 x 10mm Red LEDs	SP198 5 x 24 pin DIL sockets
SP116 3 x 10mm Green LEDs	SP199 5 x 2.5mm mono jack plugs
SP118 2 x CMOS 4047	SP200 5 x 2.5mm mono jack sockets
SP124 20 x Assorted ceramic disc caps	
SP126 6 x Battery clips - 3 ea. PP3 + PP9	
SP130 100 x Mixed 0.5W C.F. resistors	
SP131 2 x TL071 Op.Amps	

RESISTOR PACKS - C.Film

RP3 5 each value - total 365 0.25W	£3.20
RP7 10 each value - total 730 0.25W	£4.45
RP10 1000 popular values 0.25W	£6.35
RP4 5 each value-total 345 0.5W	£4.10
RP8 10 each value-total 690 0.5W	£6.75
RP11 1000 popular values 0.5W	£8.60

2004 Catalogue now available £1 inc. P&P or FREE with first order.

P&P £1.50 per order. NO VAT

Cheques and Postal Orders to:

Sherwood Electronics,
 7 Williamson St., Mansfield,
 Notts. NG19 6TD.

EPE SUBSCRIPTIONS

Subscriptions for delivery direct to any address in the UK: 6 months £16.50, 12 months £31, two years £57; Overseas: 6 months £19.50 standard air service or £28.50 express airmail, 12 months £37 standard air service or £55 express airmail, 24 months £69 standard air service or £105 express airmail.

Cheques or bank drafts (in £ sterling only) payable to *Everyday Practical Electronics* and sent to *EPE* Subs. Dept., Wimborne Publishing Ltd., 408 Wimborne Road East, Ferndown, Dorset BH22 9ND. Tel: 01202 873872. Fax: 01202 874562. Email: subs@epemag.wimborne.co.uk. Also via the Web at <http://www.epemag.wimborne.co.uk>. Subscriptions start with the next available issue. We accept MasterCard, Amex, Diners Club, Switch or Visa. (For past issues see the Back Issues page.)

ONLINE SUBSCRIPTIONS

Online subscriptions, for downloading the magazine via the Internet, \$10.99US (approx. £7) for one year available from www.epemag.com.

USA/CANADA SUBSCRIPTIONS

To subscribe to *EPE* from the USA or Canada please telephone Express Mag toll free on 1877 363-1310 and have your credit card details ready. Or fax (514) 355 3332 or write to Express Mag, PO Box 2769, Plattsburgh, NY 12901-0239 or Express Mag, 8155 Larney Street, Anjou, Quebec, H1J 2L5.

Email address: expmag@expressmag.com.

Web site: www.expressmag.com.

USA price \$60(US) per annum, Canada price \$97(Can) per annum - 12 issues per year.

Everyday Practical Electronics, periodicals pending, ISSN 0262 3617 is published twelve times a year by Wimborne Publishing Ltd., USA agent USACAN at 1320 Route 9, Champlain, NY 12919. Subscription price in US \$60(US) per annum. Periodicals postage paid at Champlain NY and at additional mailing offices. POSTMASTER: Send USA and Canada address changes to *Everyday Practical Electronics*, c/o Express Mag., PO Box 2769, Plattsburgh, NY, USA 12901-0239.

PROTEUS

The Complete Electronics Design System

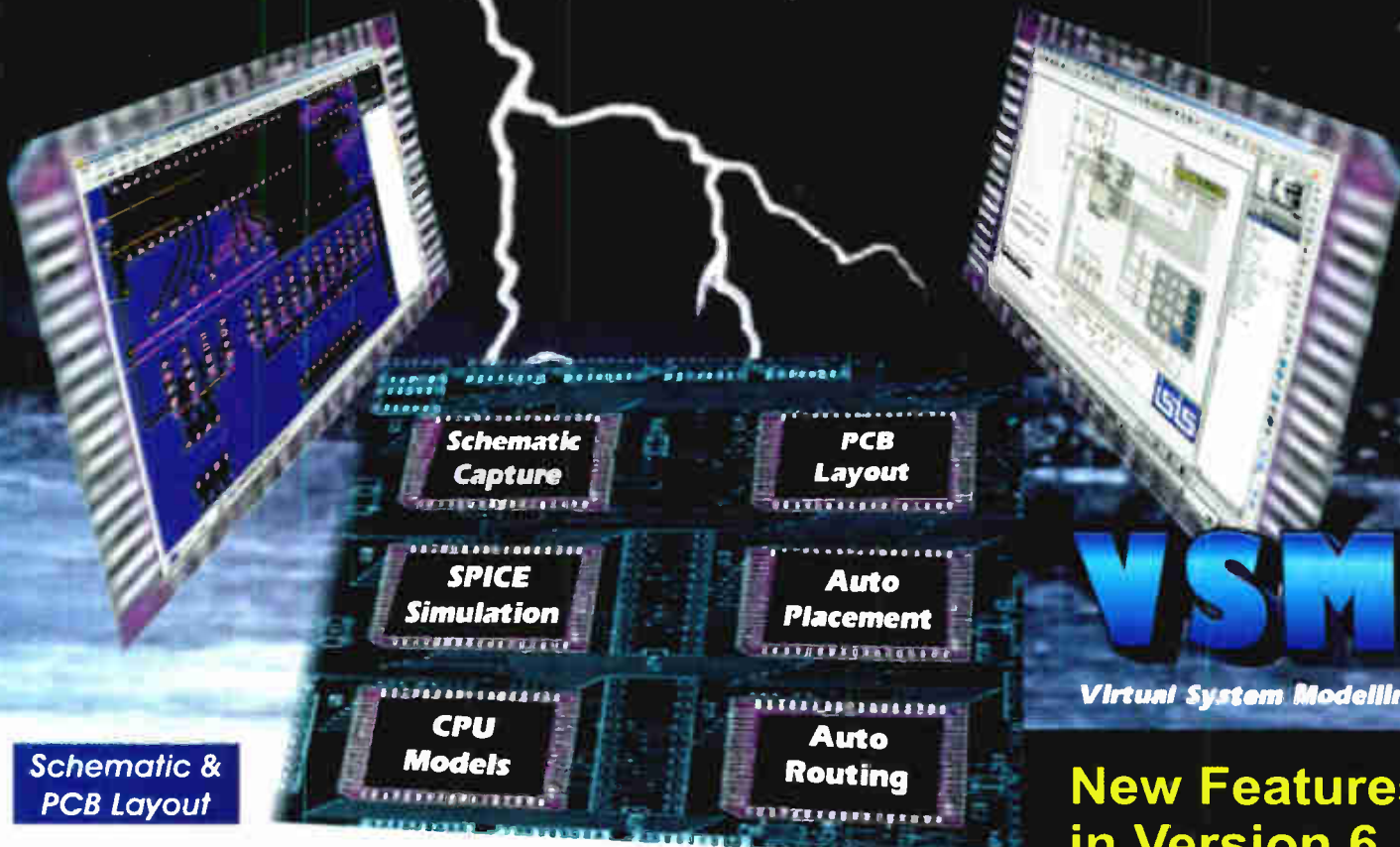

VSM

Virtual System Modelling

Schematic & PCB Layout

- Powerful & flexible schematic capture.
- Auto-component placement and rip-up/retry PCB routing.
- Polygonal gridless ground planes.
- Libraries of over 8000 schematic and 1000 PCB parts.
- Bill of materials, DRC reports and much more.

Mixed Mode SPICE Circuit Simulation

- Berkeley SPICE3F5 simulator with custom extensions for true mixed mode and interactive simulation.
- 6 virtual instruments and 14 graph based analysis types.
- 6000 models including TTL, CMOS and PLD digital parts.
- Fully compatible with manufacturers' SPICE models.

New Features in Version 6

- Drag and drop toolbars.
- Visual PCB packaging tool.
- Improved route editing.
- Point and click DRC report.
- Multiple design rules (per net).
- Multiple undo/redo.

Call Now for Upgrade Pricing

Proteus VSM - Co-simulation and debugging for popular Micro-controllers

- Supports PIC AVR 8051, HC11 and ARM micro-controllers
- Co-simulate target firmware with your hardware design.
- Includes interactive peripheral models for LED and LCD displays, switches, keypads, virtual terminal and much, much more.
- Provides source level debugging for popular compilers and assemblers from Crownhill, IAR, Keil, and others.



Labcenter

Electronics

53-55 Main Street, Grassington. BD23 5AA

Tel: 01756 753440
Fax: 01756 752857

Contact us for
Free Demo CD

www.labcenter.co.uk
info@labcenter.co.uk



POWER AMPLIFIER MODULES-LOUDSPEAKERS-MIXERS 19 INCH STEREO AMPLIFIERS-ACTIVE CROSS/OVERS.

* PRICES INCLUDE V.A.T.
* PROMPT DELIVERY

OMP MOS-FET POWER AMPLIFIERS HIGH POWER, TWO CHANNEL 19 INCH RACK

10,000's
SOLD
TO PRO
USERS



THE RENOWNED MXF SERIES OF POWER AMPLIFIERS

FOUR MODELS:- MXF200 (100W + 100W) MXF400 (200W + 200W)
MXF600 (300W + 300W) MXF900 (450W + 450W)

ALL POWER RATINGS ARE R.M.S. INTO 4 OHMS, WITH BOTH CHANNELS DRIVEN
FEATURES:- * Independent power supplies with two toroidal transformers
* Twin L.E.D. Vu Meters * Level controls * Illuminated on/off switch * Jack / XLR inputs
* Speakon Outputs * Standard 775mv inputs * Open and Short circuit proof * Latest Mos-Fets
for stress free delivery into virtually any load * High slew rate * Very low distortion * Aluminium
cases * MXF600 & MXF900 fan cooled with D.C. Loudspeaker and thermal protection.

USED THE WORLD OVER IN CLUBS, PUBS, CINEMAS, DISCOS ETC

SIZES:-

MXF200 W19" D11" H3 1/2" (2U)
MXF400 W19" D12" H5 1/4" (3U)
MXF600 W19" D13" H5 1/4" (3U)
MXF900 W19" D14" H5 1/4" (3U)

PRICES:- MXF200 £175.00 MXF400 £233.85
MXF600 £329.00 MXF900 £449.15
SPECIALIST CARRIER DEL £12.50 Each



ABSOLUTE HIGH END CLASS D AMPLIFIER

The OMP MFD600 can be used as a stand alone monoblock amplifier or fitted into existing loudspeakers to make them active

- Compact design due to switch mode P.S.U.
- 90% Efficient high switching frequency
- Small size, fits in a 110mm x 92mm opening
- Neutrik® Combi input balanced / unbalanced
- Output fully protected
- Status LEDs - Presence / Clip / Protect
- 600W / 2 Ohm - 500W / 4 Ohm - 300W / 8 Ohm
- All powers in R.M.S.
- Volume control. Input sensitivity 775mV
- Freq. Response 2Hz-20kHz
- Light weight 3kg

Stunning performance
Audiophile Quality

For further information please look at our website at www.bkelec.com and click on the modules and hybrids button

Special quantity pricing and customised artwork for OEM's.

Price £281.12 Inc Vat Each or £499.00 Per Pair when quoting this advert

Carriage UK Mainland Only £8.00

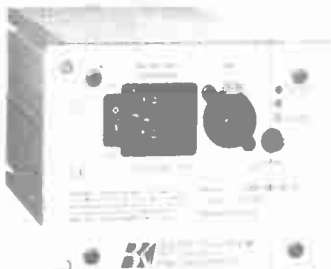

100 WATT ACTIVE SUB BASS AMPLIFIER PANEL



AN ACTIVE SUB BASS AMPLIFIER WITH A TRUE 100W RMS OUTPUT. SUPERB CONSTRUCTION WITH THE FACILITIES TO INTEGRATE SEAMLESSLY INTO MOST HI-FI OR HOME CINEMA SETUPS. USE THIS PANEL PLUS ONE OF OUR LOUDSPEAKERS TO MAKE YOUR OWN SUB WOOFER THAT WILL MATCH OR BEAT MOST COMMERCIALY AVAILABLE SUB WOOFERS.

FEATURES:- * 100W RMS INTO 8 OHMS * HIGH AND LOW LEVEL INPUTS * TOROIDAL TRANSFORMER * SHORT CIRCUIT PROTECTION * D.C. SPEAKER PROTECTION * FREQUENCY ROLL OFF, LOWER 10Hz, UPPER 60Hz TO 240Hz (FULLY ADJUSTABLE) * AC3 COMPATIBLE FILTER CAN BE BYPASSED FOR 5-1 FORMATS. * AIRTIGHT CONSTRUCTION * TENS OF THOUSANDS OF OUR PANELS ALREADY IN USE. * COMPLETE WITH LEADS

SPECIFICATIONS:- * POWER 100W RMS @ 8 OHMS * FREQ RESP. 10Hz 15KHz -3dB * DAMPING FACTOR >200 * DISTORTION 0.05% * S/N A WEIGHTED >100dB * SUPPLY 230V A.C. * WEIGHT 2.7Kg * SIZE H254 X W254 X D94mm

THERE ARE 2 VERSIONS OF THE ABOVE PANEL AVAILABLE :-BSB100/8 8 OHM VERSION BSB100/4 4 OHM VERSION BOTH PANELS ARE PRICED AT £117.44 + £5.00 P&P INCL. V.A.T. CHECK WEBSITE FOR PANELS UP TO 500W

ibf LIGHTCASED LOUDSPEAKERS

A new range of quality loudspeakers, designed to take advantage of latest loudspeaker technology and enclosure designs. All models utilise high quality studio cast aluminium loudspeakers with factory fitted grilles, wide dispersion constant directivity horns, extruded aluminium corner protection and steel ball corners, complimented with heavy duty black covering. The enclosures are fitted as standard with top hats for optional loudspeaker stands. The FC15-300 incorporates a large 16 X 6 inch horn. All cabinets are fitted with the latest Speakon connectors for your convenience and safety. Five models to choose from.

WEDGE MONITOR



PLEASE NOTE:- POWER RATINGS QUOTED ARE IN WATTS R.M.S. FOR EACH INDIVIDUAL CABINET ALL ENCLOSURES ARE 8 OHMS

15=15 inch speaker
12=12 inch speaker

- ibf FC15-300 WATTS Freq Range 35Hz-20kHz, Sens 101dB, Size H695 W502 D415mm Price:- £299.00 per pair
- ibf FC12-300 WATTS Freq Range 45Hz-20kHz, Sens 96dB, Size H600 W405 D300mm Price:- £249.00 per pair
- ibf FC12-200 WATTS Freq Range 40Hz-20kHz, Sens 97dB, Size H600 W405 D300mm Price:- £199.00 per pair
- ibf FC12-100 WATTS Freq Range 45Hz-20kHz, Sens 100dB, Size H546 W380 D300mm Price:- £179.00 per pair
- ibf WM12-200 WATTS Freq Range 40Hz-20kHz, Sens 97dB, Size H418 W600 D385mm

SPECIALIST CARRIER DEL:- £12.50 per pair, wedge monitor £7.00 each
Optional Metal Stands PRICE:- £49.00 per pair Delivery:- £6.00

OMP MOS-FET POWER AMPLIFIER MODULES

SUPPLIED BY BUILT AND TESTED

These modules now enjoy a world-wide reputation for quality, reliability and performance at a realistic price. Four models are available to suit the needs of the professional and hobby market. ie Industry, Leisure, Instrumental and Hi-Fi etc. When comparing prices, NOTE that all models include toroidal power supply, integral heatsink, glass fibre P.C.B. and drive circuits to power a compatible Vu meter. All models are open and short circuit proof

THOUSANDS OF MODULES PURCHASED BY PROFESSIONAL USERS



OMP/MF 100 Mos-Fet Output Power 100 watts R.M.S. into 4 ohms, frequency response 1Hz - 100kHz -3dB, Damping Factor >300, Slew Rate 45V/uS, T.H.D. typical 0.002%, Input Sensitivity 500mV, S.N.R. 110dB, Size 300 x 123 x 60mm. Price:- £43.85 + £4.00 P&P

OMP/MF 200 Mos-Fet Output Power 200 watts R.M.S. into 4 ohms, frequency response 1Hz - 100kHz -3dB, Damping Factor >300, Slew Rate 50V/uS, T.H.D. typical 0.001%, Input Sensitivity 500mV, S.N.R. 110dB, Size 300 x 155 x 100mm. Price:- £67.35 + £4.00 P&P

OMP/MF 300 Mos-Fet Output Power 300 watts R.M.S. into 4 ohms, frequency response 1Hz - 100kHz -3dB, Damping Factor >300, Slew Rate 60V/uS, T.H.D. typical 0.001%, Input Sensitivity 500mV, S.N.R. 110dB, Size 330 x 175 x 100mm. Price:- £84.75 + £5.00 P&P

OMP/MF 450 Mos-Fet Output Power 450 watts R.M.S. into 4 ohms, frequency response 1Hz - 100kHz -3dB, Damping Factor >300, Slew Rate 75V/uS, T.H.D. typical 0.001%, Input Sensitivity 500mV, S.N.R. 110dB, Fan Cooled, D.C. Loudspeaker Protection, 2 Second Anti Thump Delay, Size 385 x 210 x 105mm. Price:- £137.85 + £6.00 P&P

OMP/MF 1000 Mos-Fet Output Power 1000 watts R.M.S. into 2 ohms, frequency response 1Hz - 100kHz -3dB, Damping Factor >300, Slew Rate 75V/uS, T.H.D. typical 0.001%, Input Sensitivity 500mV, S.N.R. 110dB, Fan Cooled, D.C. Loudspeaker Protection, 2 Second Anti Thump Delay, Size 422 x 300 x 125mm. Price:- £209.00 + £12.00 P&P

NOTE: MOS-FET MODULES ARE AVAILABLE IN TWO VERSIONS: STANDARD - INPUT SENS 500mV BANDWIDTH 100kHz OR PEC (PROFESSIONAL EQUIPMENT COMPATIBLE) INPUT SENS 775mV BANDWIDTH 50kHz ORDER STANDARD OR PEC

WHARFEDALE - CHALLENGER COMPETITION SERIES CAR SUB WOOFERS



A superb range of car sub woofer loudspeakers manufactured by Wharfedale. Five models to choose from. All 4 Ohm

Challenger ProBass professional series sub woofers with cast aluminium chassis, heavy duty magnets and fitted with a steel protective grille (Not Shown)
PB-10 10 Inch 100W RMS 300W Max Price £29.97
PB-15 15 Inch 300W RMS 800W Max Price £45.82

Titan Competition series with pre-seed steel chassis (No Grille)
TC10-150 10 Inch 150W RMS 400W Max Price £28.20
TC12-200 12 Inch 200W RMS 600W Max Price £36.42
TC15-300 15 Inch 300W RMS 800W Max Price £43.47

Shown TC15-300

For more bargains go to www.bkelec.com and click on the bargain corner button

Carriage £8.00 any quantity

A punchy 10 Inch, a shockingly powerful 12 Inch and an awesome 15 Inch that will make your ears inform your eyes what they are missing out on! CAR HI-FI magazine had this to say about the 10 Inch 150W sub. "This debutante needs a good shove by a punchy amplifier before it stirs, but when it does, the lion roars. There's no doubting the authority it carries, and there's a highly prominent musical element - precise and snappy!" Please note we have tried these loudspeakers for PA use with great success with our MXF range of amplifier and OMP MF mosfet modules.

B.K. ELECTRONICS

REF D8

UNIT 1 COMET WAY, SOUTHEND-ON-SEA, ESSEX, SS2 6TR.
TEL.: 01702-527572 FAX.: 01702-420243
Web:- <http://www.bkelec.com> E-Mail sales@bkelec.com



DELIVERY CHARGES:- PLEASE INCLUDE AS ABOVE, TO A MAXIMUM AMOUNT £30.00. OFFICIAL ORDERS FROM SCHOOL COLLEGES, GOVT. PLC'S ETC PRICES INCLUSIVE OF V.A.T SALES COUNTER. CREDIT CARD ORDERS ACCEPTED BY POST PHONE OR FAX.

