

**TEACH-IN  
2004  
PART 1 INSIDE**

**THE No.1 MAGAZINE FOR ELECTRONICS TECHNOLOGY & COMPUTER PROJECTS**

**EVERYDAY**

**NOVEMBER 2003**

**PRACTICAL**

# **ELECTRONICS**

**NEW  
SERIES**

**£3.10**

## **TEACH-IN 2004**

### **A hands-on introduction to electronics**

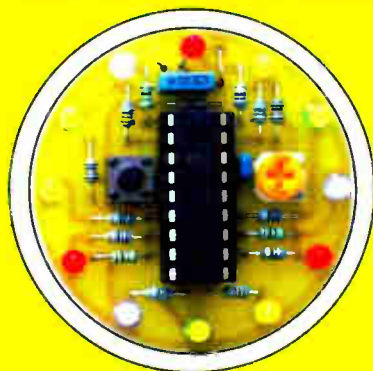

### **PIC RANDOM L.E.D. FLASHER**

#### **Christmas and party decoration**

### **CARDBOARD CLOCK**

#### **An inexpensive novel timepiece**

**PLUS**

### **PRACTICAL RADIO CIRCUITS - 6**



<http://www.epemag.wimborne.co.uk>

World Radio History



Colour CCTV camera, 8mm lens, 12V d.c. 200mA 582x628 Resolution 380 lines Automatic aperture lens Mirror function PAL Back Light Compensation MLR, 100x40x40mm. Ref EE2 £69

Built-in Audio. 15lux CCD camera 12V d.c. 200mA 480 lines s/n ratio >48db 1V P-P output 110mm x 60mm x 50mm. Ref EE1 £99



Metal CCTV camera housings for internal or external use. Made from aluminium and plastic they are suitable for mounting body cameras in. Available in two sizes 1 - 100 x 70 x 170mm and 2 - 100 x 70 x 280mm. Ref EE6 £22 EE7 £26 multi-position brackets. Ref EE8 £8

Excellent quality multi-purpose TV/TFT screen, works as just a LCD colour monitor with any of our CCTV cameras or as a conventional TV. Ideal for use in boats and caravans 49.7MHz-91.75MHz VHF channels 1-5.168-25MHz-222.75MHz VHF channels 6-12. 471.25MHz-869.75MHz. Cable channels 112.325MHz-166.75MHz Z1-Z7. Cable channels 224.25MHz-446.75MHz Z8-Z35 5" colour screen. Audio output 150mW. Connections, external aerial, earphone jack, audio/video input, 12V d.c. or mains. Accessories supplied Power supply, Remote control, Cigar lead power supply, Headphone Stand/bracket, 5" model £139 Ref EE9, 6" model £149 Ref EE10



Self-cocking pistol plier 002 crossbow with metal body. Self-cocking for precise string alignment. Aluminium alloy construction High rec fibre glass limbs Automatic safety catch Supplied with three bolts Track style for greater accuracy Adjustable rear sight 50lb drawweight 150ft/sec velocity Break action 17" string 30m range £21.65 Ref PLCR002

Fully cased IR light source suitable for CCTV applications. The unit measures 10 x 10 x 150mm, is mains operated and contains 54 infra-red LEDs. Designed to mount on a standard CCTV camera bracket. The unit also contains a daylight sensor that will only activate the infra-red lamp when the light level drops below a preset level. The infra-red lamp is suitable for indoor or exterior use, typical usage would be to provide additional IR illumination for CCTV cameras £49 Ref EE11



Mains operated and designed to be used with any CCTV camera causing it to scan. The clips can be moved to adjust the span angle, the motor reversing when it detects a clip. With the clips removed the scanner will rotate constantly at approx 2.3rpm. 75 x 75 x 80mm £23. Ref EE12



Colour CCTV Camera measures 60x45mm and has a built-in light level detector and 12 IR LEDs 0.2 lux 12 IR LEDs 12V d.c. Bracket Easy connect leads £69. Ref EE15



A high quality external colour CCTV camera with built-in infrared LEDs measuring 60 x 60 x 60mm Easy connect leads colour Waterproof PAL 1/4in. CCD 542 x 588 pixels 420 lines 0.05 lux 3.6mm F2.78 deg lens 12V d.c. 400mA Built-in light level sensor. £99. Ref EE13

Colour pinhole CCTV camera module with audio. Compact, just 20x20x20mm, built-in audio and easy connect leads PAL CMOS sensor 6.9V d.c. Effective Pixels 628x582 Illumination 2 lux Definition >240 Signal/noise ratio >40db Power consumption 200mW £35. Ref EE21



A small colour CCTV camera measuring just 35 x 28 x 30mm. Supplied complete with bracket, microphone and easy connect leads. Built-in audio. Colour 380 line resolution PAL 0.2 lux +18db sensitivity Effective pixels 628 x 582 Power source 6-12V d.c. Power consumption 200mW £36. Ref EE16

Complete wireless CCTV system with video. Kit comprises pinhole colour camera with simple battery connection and a receiver with video output, 380 lines colour 2.4GHz 3 lux 6-12V d.c. manual tuning Available in two versions, pinhole and standard. £79 (pinhole) Ref EE17, £79 (standard) Ref EE18



Small transmitter designed to transmit audio and video signals on 2.4GHz. Unit measures 45 x 35 x 10mm. Ideal for assembly into covert CCTV systems Easy connect leads Audio and video input 12V d.c. Complete with aerial Selectable channel switch £30. Ref EE19



2.4GHz wireless receiver Fully cased audio and video 2.4GHz wireless receiver 190x140x30mm, metal case, 4 channel, 12V d.c. Adjustable time delay. 4s, 8s, 12s, 16s. £45. Ref EE20

The smallest PMR446 radios currently available (54x87x37mm). These tiny handheld PMR radios not only look great, but they are user friendly & packed with features including VOX, Scan & Dual Watch. Priced at £59.99 PER PAIR they are excellent value for money. Our new favourite PMR radios! Standby - 35 hours Includes: - 2 x Radios, 2 x Belt Clips & 2 x Carry Strap £59.95 Ref ALAN1 Or supplied with 2 sets of rechargeable batteries and two mains chargers £84.99. Ref Alan2



Beltronics BEL550 Euro radar and GATSO detector Claimed Detection Range: GATSO up to 400m. Radar & Laser guns up to 3 miles. Detects GATSO speed cameras at least 200 metres away, plenty of time to adjust your speed £319. Ref BEL550

TheTENS mini Microprocessors offer six types of automatic programme for shoulder pain, back/neck pain, aching joints, Rheumatic pain, migraines headaches, sports injuries, period pain. In fact all over body treatment. Will not interfere with existing medication. Not suitable for anyone with a heart pacemaker. Batteries supplied. £19.95 Ref TEN327 Spare pack of electrodes £5.99. Ref TEN327X



Dummy CCTV cameras These motorised cameras will work either on 2 AA batteries or with a standard DC adapter (not supplied) They have a built-in movement detector that will activate the camera if movement is detected causing the camera to pan Good deterrent. Camera measures 20cm high, supplied with fixing screws. Camera also has a flashing red l.e.d. built in £9.95. Ref CAMERAB

INFRA-RED FILM 6" square piece of flexible infra-red film that will only allow IR light through. Perfect for converting ordinary torches, lights, headlights etc to infra-red output using standard light bulbs Easily cut to shape. 6" square £15. Ref IRF2 or a 12" sq for £29 IRF2A



**GASTON SEALED LEAD-ACID BATTERIES**



1.3AH 12V @ £5 REF GT1213  
3.4AH 12V @ £8 REF GT1234  
7AH 12V @ £8 REF FT127  
17AH 12V @ £18 REF GT1217

All new and boxed, bargain prices. Good quality sealed lead-acid batteries

SOLAR PANEL 10 watt silicon solar panel, at least 10 year life. 365 x 26mm, waterproof, ideal for fixing to caravans, boat, motorhomes etc. Nicely made unit with fixing holes for secure fittings. Complete with leads and connectors. Anodised frame. Supplied with two leads, one 3M lead is used for the o/p with two croc clips, the other lead is used to connect extra panels. Panels do NOT require a blocking diode, they can be left connected at all times without discharging the battery. £84.99. REF PAN  
8A solar regulator 12V, 96 watt, 150mm x 100mm x 25mm. £28. REF SOLREG2



High-power modules (80W+) using 125mm square multi-crystal silicon solar cells with bypass diode. Anti-reflection coating and BSF structure to improve cell conversion efficiency. 14%. Using white tempered glass, EVA resin, and a weatherproof film along with an aluminium frame for extended outdoor use, system Lead wire with waterproof connector. Four sizes, 80W 12V dc, 1200 x 530 x 35mm. £287. REF NE80, 123W 12V d.c., 1499 x 662 x 46mm, £439. REF NDL3, 125W 24V, 1190 x 792 x 46mm, £439. REF NEL5 and 165W 24V, 157 x 826 x 46mm, £593.

THE TIDE CLOCK These clocks indicate the state of the tide. Most areas in the world have two high tides and two low tides a day, so the tide clock has been specially designed to rotate twice each lunar day (every 12 hours and 25 minutes) giving you a quick and easy indication of high and low water. The Quartz tide clock will always stay calibrated to the moon. £21 REF TIDEC

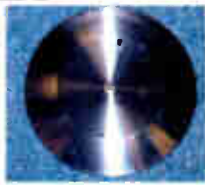

LINEAR ACTUATORS 12-36V D.C. BUILT-IN ADJUSTABLE LIMIT SWITCHES. POWER COATED 18in. THROW UP TO 1,000lb. THRUST (400lb RECOMMENDED LOAD) SUPPLIED WITH MOUNTING BRACKETS DESIGNED FOR OUTDOOR USE. These brackets originally made for moving very large satellite dishes are possibly more suitable for closing gates, mechanical machinery, robot wars etc. Our first sale was to a company building solar panels that track the sun! Two sizes available, 12in. and 18in. throw £29.95 REF ACT12. £34.95 REF ACT18.



POWERSAFE DEEP CYCLE BATTERIES 12V 51AH. NOW ONLY £29.95 EACH YUASA 6V 100AH NOW ONLY £19 EACH



BRAND NEW MILITARY ISSUE DOSE METERS (radiation detectors). Current NATO issue. Standard emergency services unit. Used by most of the world's military personnel New and boxed £69 REF SIEM69

NIGHT VISION SYSTEM. Superb hunting rifle sight to fit most rifles, grooved for a telescopic sight. Complete with infra-red illuminator. Magnification 2.7x Complete with rubber eye shield and case. Opens up a whole new world! Russian made. Can be used as a hand held or mounted on a rifle. £99 REF PN1



These Samarium magnets measure 57mm x 20mm and have a threaded hole (5/16th UNF) in the centre and magnetic strength of 2.2 gauss. We have tested these on a steel beam running through the offices and found that they will take more than 70lb (77kg) in weight before being pulled off. With keeper £19.95 REF MAG77.

Peltier Effect heat pump. Semiconductor thermoelectric device which works on the Peltier effect. When supplied with a suitable electric current, can either cool or heat. Also when subject to an externally applied temperature gradient can produce an electric current. Ideal for cooling or controlling the temperature of sub assemblies. Each module is supplied with a comprehensive 18-page Peltier design manual featuring circuit designs, design information etc. etc. The Peltier manual is also available separately. Maximum watts 56.2 40 x 40mm I<sub>max</sub> 5.5A V<sub>max</sub> 16.7 T<sub>max</sub> (c-dry N2). 72 £29.95 (inc. manual. REF PELT1. Just manual £4 REF PELT2.

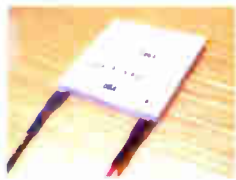

New transmitter, receiver and camera kit. £69. Kit contains four channel switchable camera with built-in audio, six IR l.e.d.s and transmitter, four channel switchable receiver, 2 power supplies, cables, connectors and mounting bracket £69. Wireless Transmitter Black and white camera (75 x 50 x 55mm) Built-in 4 channel transmitter (switchable) Audio built-in 6 IR l.e.d.s. Bracket/stand. Power supply 30m range Wireless Receiver 4 channel (switchable) Audio/video leads and scart adapter. Power supply and manual, £69. REF COP24

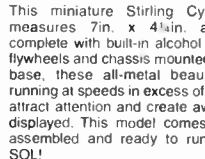

This miniature Stirling Cycle Engine measures 7in. x 4in. and comes complete with built-in alcohol burner. Ref flywheels and chassis mounted on a green base, these all-metal beauties silently running at speeds in excess of 1,000 r.p.m. attract attention and create awe wherever displayed. This model comes completely assembled and ready to run. £97 REF SOL!

**BULL GROUP LTD**  
UNIT D, HENFIELD BUSINESS PARK,  
HENFIELD, SUSSEX BN5 9SL  
TERMS: CASH, PO, CHEQUE PRICES + VAT  
WITH ORDER PLUS £5.50 P&P (UK) PLUS VAT.  
24 HOUR SERVICE £7.50 (UK) PLUS VAT.  
OVERSEAS ORDERS AT COST PLUS £3.50  
Tel: 0870 7707520 Fax 01273 491813  
Sales@bullnet.co.uk  
www.bullnet.co.uk

SHOP ONLINE  
WWW.BULLNET.CO.UK

ISSN 0262 3617  
PROJECTS ... THEORY ... NEWS ...  
COMMENTS ... POPULAR FEATURES ...

VOL. 32. No. 11 NOVEMBER 2003

Cover illustration by jgr22

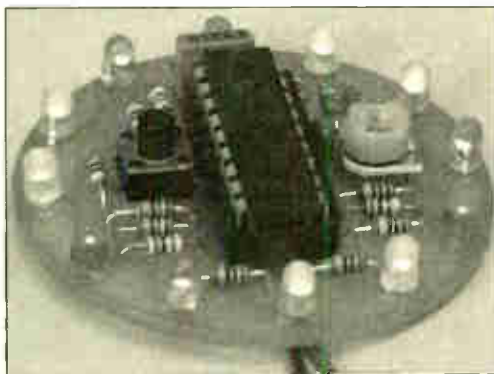
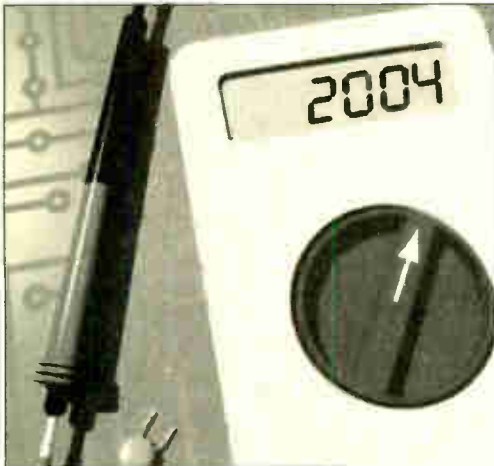

© Wimborne Publishing Ltd 2003. Copyright in all drawings, photographs and articles published in EVERYDAY PRACTICAL ELECTRONICS is fully protected, and reproduction or imitations in whole or in part are expressly forbidden.

# EVERYDAY PRACTICAL ELECTRONICS

INCORPORATING ELECTRONICS TODAY INTERNATIONAL

[www.epemag.wimborne.co.uk](http://www.epemag.wimborne.co.uk)

EPE Online: [www.epemag.com](http://www.epemag.com)

## Projects and Circuits

- PIC RANDOM L.E.D. FLASHER** by Andy Flind 740  
Enjoy the fun of an interesting and attractive pattern display
- INGENUITY UNLIMITED - Sharing your ideas with others** 746  
Three-Component Metal Detector; Emergency Light; Power Supply Tester
- ANYONE AT HOME?** by Owen Bishop 766  
Logically deter those shifty characters eyeing up your house!  
Another Top Tenner project
- CARDBOARD CLOCK** by Michael McLoughlin 778  
An intriguing and novel way in which you can tick-off time passing!
- PRACTICAL RADIO CIRCUITS - Part 6. Single-sideband and direct conversion** by Raymond Haigh 793  
Another superb receiving system for the set builder and experimenter

## Series and Features

- TECHNO TALK** by Andy Emmerson 748  
Why is lightning so potent, and can you protect your gizmos?
- TEACH-IN 2004 - 1. At the Beginning** by Max Horsey 750  
The first feature in our new 10-part tutorial and practical series -  
how to apply electronics meaningfully
- NEW TECHNOLOGY UPDATE** by Ian Poole 760  
Floating Gate Analogue technology improves voltage reference devices
- CIRCUIT SURGERY** by Alan Winstanley and Ian Bell 774  
Long delays; cooling fans; more on SPICE; op.amp enlightenment
- PRACTICALLY SPEAKING** by Robert Penfold 790  
A novice's guide to understanding semiconductor markings
- NET WORK - THE INTERNET PAGE** surfed by Alan Winstanley 802  
Oh for wireless webbing ... ! New EPE Downloads site

## Regulars and Services

- EDITORIAL** 739
- NEWS** - Barry Fox highlights technology's leading edge 744  
Plus everyday news from the world of electronics
- PIC RESOURCES CD-ROM** 762  
Invaluable to all PICkers!
- BACK ISSUES** Did you miss these? Many now on CD-ROM! 763
- READOUT** John Becker addresses general points arising 771
- SHOPTALK** with David Barrington 777  
The *essential* guide to component buying for EPE projects
- CD-ROMS FOR ELECTRONICS** 786  
A wide range of CD-ROMs for hobbyists, students and engineers
- DIRECT BOOK SERVICE** 800  
A wide range of technical books available by mail order, plus more CD-ROMs
- PRINTED CIRCUIT BOARD AND SOFTWARE SERVICE** 803  
PCBs for EPE projects. Plus EPE project software
- ELECTRONIC MANUALS** 804  
Essential reference works for hobbyists, students and service engineers
- ADVERTISERS INDEX** 808

Our December 2003 issue will be published on Thursday, 13 November 2003. See page 731 for details

Readers Services • Editorial and Advertisement Departments 739

Visit our website  
www.distel.co.uk

# THE ORIGINAL SURPLUS WONDERLAND!

THIS MONTH'S SELECTION FROM OUR VAST EVER CHANGING STOCKS

Surplus always  
wanted for cash!

## GIANT 10" 7-SEGMENT DISPLAYS

A bulk purchase enables us to bring to you these GIANT 7-segment digital displays at a now affordable price!! The 10" character size gives exceptional readability at long distances and enables a host of applications including, score boards, digital clocks, counters, event timers etc. As the units are a simple electro-mechanical device and operate from 12V DC, simple switching via switches, relays, PIC or PC may be used to control single or multiple digits. Units feature integral Zero Power memory which greatly simplifies design. For an excellent DIY practical article, see the May issue of 'Everyday Practical Electronics' magazine. Ideal School / College construction project. Supplied in good RFE condition, complete with data sheet.



Less than 30% of makers price  
Only £29.95(B) or 4 x £99.00(D)  
Order RW44 Order PH26

## THE AMAZING TELEBOX



TV SOUND & VIDEO TUNER  
CABLE COMPATIBLE

Converts your colour monitor into a QUALITY COLOUR TV!!

The TELEBOX is an attractive fully cased mains powered unit, containing all electronics ready to plug into a host of video monitors or AV equipment which are fitted with a composite video or SCART input. The composite video output will also plug directly into most video recorders, allowing reception of TV channels not normally receivable on most television receivers\* (TELEBOX MB). Push button controls on the front panel allow reception of 8 fully tuneable 'off air' UHF colour television channels. TELEBOX MB covers virtually all television frequencies VHF and UHF including the HYPERBAND as used by most cable TV operators. Ideal for desktop computer video systems & PIP (picture in picture) setups. For complete compatibility - even for monitors without sound - an integral 4 watt audio amplifier and low level Hi Fi audio output are provided as standard. Brand new - fully guaranteed.

TELEBOX ST for composite video input type monitors £36.95  
TELEBOX STL as ST but fitted with integral speaker £39.50  
TELEBOX MB Multiband VHF/UHF/Cable/Hyperband tuner £69.95  
For overseas PAL versions state 5.5 or 6 mHz sound specification.  
\*For cable / hyperband signal reception Telebox MB should be connected to a cable type service. Shipping on all Telebox's code (B)

**NEW** State of the art PAL (UK spec) UHF TV tuner module with composite 1V pp video & NICAM hi fi stereo sound outputs. Micro electronics all on one small PCB only 73 x 160 x 52 mm enable full tuning control via a simple 3 wire link to an IBM pc type computer. Supplied complete with simple working program and documentation. Requires +12V & +5V DC to operate. **BRAND NEW - Order as MY00. Only £39.95 code (B)**  
See www.distel.co.uk/data\_my00.htm for picture + full details

## HARD DISK DRIVES 2 1/2" - 14"

- 2 1/2" TOSHIBA MK1002MAV 1.1Gb laptop (12.5 mrr) H **New £59.95**
  - 2 1/2" TOSHIBA MK4313MAT 4.3Gb laptop (8.2 mm H) **New £105.00**
  - 2 1/2" TOSHIBA MK6409MAV 6.1Gb laptop (12.7 mm H) **New £98.00**
  - 2 1/2" TOSHIBA MK1614GAV 18 Gb laptop (12 mm H) **New £149.95**
  - 2 1/2" to 3 1/2" conversion kit for PCs, complete with connectors £15.95
  - 3 1/2" COMPAQ 313706-B21 (IBM) 9 gb ULT/SCSI3 **New £199.00**
  - 3 1/2" FUJITSU FK-309-25 20mb MFM I/F RFE **£59.95**
  - 3 1/2" CONNER CP3024 20 mb IDE I/F (or equiv.) RFE **£59.95**
  - 3 1/2" CONNER CP3044 40 mb IDE I/F (or equiv.) RFE **£69.00**
  - 3 1/2" QUANTUM 40S Prodriv 4e 42mb SCSI I/F **£49.00**
  - 5 1/4" MINISCRIBE 3425 20mb MFM I/F (or equiv.) RFE **£49.95**
  - 5 1/4" SEAGATE ST-238R 30 mb RLL I/F Refurb **£69.95**
  - 5 1/4" CDC 94205-51 40mb HHI MFM I/F RFE tested **£69.95**
  - 5 1/4" HP 97548 850 Mbit SCSI RFE tested **£99.00**
  - 5 1/4" HP C3010 2 Gbyte SCSI differential RFE tested **£195.00**
  - 8" NEC D2246 85 Mb SMD interface. **New £99.00**
  - 8" FUJITSU M2322K 160Mb SMD I/F RFE tested **£195.00**
  - 8" FUJITSU M2392K 2 Gb SMD I/F RFE tested **£345.00**
- Many other floppy & H drives, IDE, SCSI, ESDI etc from stock, see website for full stock list. Shipping on all drives is code

## IC's - TRANSISTORS - DIODES

OBSOLETE - SHORT SUPPLY - BULK  
10,000,000 items EX STOCK  
For MAJOR SAVINGS  
CALL or see web site www.distel.co.uk

## COMPUTER MONITOR SPECIALS

Legacy products  
High spec genuine multisync.  
CGA, EGA, VGA, SVGA

Mitsubishi FA3415ETKL 14" SVGA Multisync colour monitor with fine 0.28 dot pitch tube and resolution of 1024 x 768. A variety of inputs allows connection to a host of computers including IBM PCs in CGA, EGA, VGA & SVGA modes, BBC, COMMODORE (including Amiga 1200), ARCADE/MEDES and APPLE. Many features: Etched faceplate, text switching and LOW RADIATION MPR specification. Fully guaranteed, in EXCELLENT little used condition. Tilt & Swivel Base £4.75

VGA cable for IBM PC included. **Only £129 (E)** Order as CG73

External cables for other types of computers available - CALL

## Generic LOW COST SVGA Monitors

We choose the make, which includes Compaq, Mitsubishi, IBM, etc. Supplied ready to run with all cables, Standard RTB 90 day guarantee.

14"	15"	17"
£59.00	£69.00	£79.00

Supplied in good used condition. Shipping code (D)

## VIDEO MONITORS

PHILIPS HCS35 (same style as CM8833) attractively styled 14" colour monitor with both RGB and standard composite 15.625 KHz video inputs via SCART socket and separate phono jacks. Integral audio power amp and speaker for all audio visual uses. Will connect direct to Amiga and Atari BBC computers. Ideal for all video monitoring / security applications with direct connection to most colour cameras. High quality with many features such as front concealed flap controls, VCR correction button etc. Good used condition - fully tested - guaranteed  
Dimensions: W14" x H12 3/4" x 15 1/2" D. **Only £99.00 (E)**

PHILIPS HCS31 Ultra compact 9" colour video monitor with standard composite 15.625 KHz video input via SCART socket. Ideal for all monitoring / security applications. High quality, ex-equipment fully tested & guaranteed (possible minor screen bums). In attractive square black plastic case measuring W10" x H10" x 13 3/4" D. 240 V AC mains powered. **Only £79.00 (D)**

## INDUSTRIAL COMPUTERS

Tiny shoebox sized industrial 40 Mhz 386 PC system measuring only (mm) 266 x X 88 x H 272 d. Ideal for dedicated control applications running DOS, Linux or even Windows! Steel case contains 85 to 265 V AC 50 / 60 Hz 70 Watt PSU, a 3 slot ISA passive backplane and a Rocky 318 (PC104) standard, single board computer with 8 Mbyte NON VOLATILE solid state 'Disk On Chip' RAMDISK. System comprises: Rocky 318 (PC104) SBC ISA card with 40MHz ALI 386SX CPU, 72 pin SIMM slot with 16 Mbyte SIMM, AMI BIOS, battery backed up real time clock. 2 x 9 pin D 16550 serial ports. EPP/ECP printer port, mini DIN keyboard connector, floppy port, IDE port for hard drives up to 528 Mbyte capacity, watchdog timer and PC104 bus socket. The 8 Mbyte solid state 'disk on a chip' has its own BIOS, and can be fdisked, formatted & booted. Supplied BRAND NEW fully tested and guaranteed. For full data see featured item on website. Order as QG36 **Only £99.00 (D)**

100's of applications inc: firewall, routers, robotics etc

## 19" RACK CABINETS

Europe's Largest Stocks of quality rack cabinets, enclosures and accessories.  
Over 1000 Racks from stock

This month's special  
33 / 42 / 47 U - High Quality  
All steel Rack Cabinets

Made by Eurocraft Enclosures Ltd to the highest possible spec, rack features all steel construction with removable side, front and back doors. Front and back doors are hinged for easy access and all lockable with five secure 5 lever barrel locks. The front door is constructed of double walled steel with a 'designer style' smoked acrylic front panel to enable status indicators to be seen through the panel, yet remain unobtrusive. Internally the rack features fully slotted reinforced vertical fixing members to take the heaviest of 19" rack equipment. The two movable vertical fixing struts (extras available) are pre punched for standard 'cage nuts'. A mains distribution panel internally mounted to the bottom rear, provides 8 x IEC 3 pin Euro sockets and 1 x 13 amp 3 pin switched utility socket. Overall ventilation is provided by fully louvred back door and double skinned top section with top and side louvres. The top panel may be removed for fitting of integral fans to the sub plate etc. Other features include: fitted castors and floor levers, prepunched utility panel at lower rear for cable / connector access etc. Supplied in excellent, slightly used condition with keys. Colour Royal blue, some grey available - CALL - Can be supplied in many other configurations.



<b>33U</b> Order as BC44 External dimensions mm=1625H x 635D x 603 W. (64" H x 25" D x 23 3/4" W) <b>Only £245</b>	<b>42U</b> Order as DT20 External dimensions mm=2019H x 635D x 603 W. (79.5" H x 25" D x 23 3/4" W) <b>Only £345</b>	<b>47U</b> Order as RV36 External dimensions mm=2019H x 635D x 603 W. (88" H x 25" D x 23 3/4" W) <b>Only £410</b>
---	---	---

Call for shipping quotation

## COLOUR CCD CAMERAS

Undoubtedly a miracle of modern technology & our special buying power! A quality product featuring a fully cased COLOUR CCD camera at a give away price! Unit features full autolight sensing for use in low light & high light applications. A 10 mm fixed focus wide angle lens gives excellent focus and resolution from close up to long range. The composite video output will connect to any composite monitor or TV (via SCART socket) and most video recorders. Unit runs from 12V DC so ideal for security & portable applications where mains power not available. Overall dimensions mm=66mm wide x 117mm deep x 43mm high. Supplied BRAND NEW & fully guaranteed with user data, 100's of applications including Security, Home Video, Web TV, Web Cams etc, etc.

Order as LK33 **ONLY £79.00 or 2 for £149.00 (B)**

## SOFTWARE SPECIALS

- NT4 WorkStation, complete with service pack 3 and licence - OEM packaged. **ONLY £89.00 (B)**
- ENCARTA 95 - CDROM, Not the latest - but at this price! **£7.95**
- DOS 5.0 on 3 1/2" disks with concise books c/w QBasic. **£14.95**
- Windows for Workgroups 3.11+ Dos 6.22 on 3.5" disks **£55.00**
- Windows 95 CDROM Only - No Licence - **£19.95**

Wordperfect 6 for DOS supplied on 3 1/2" disks with manual **£24.95**

## SOLID STATE LASERS

Visible red, 670nm laser diode assembly. Unit runs from 5 V DC at approx 50 mA. Originally made for continuous use in industrial barcode scanners, the laser is mounted in a removable solid aluminium block, which functions as a heatsink and rigid optical mount. Dims of block are 50 x 50 x 15 mm. Integral features include over temperature shutdown, current control, laser OK output, and gated TTL ON / OFF. Many uses for experimental optics, comms & lightshows etc. Supplied complete with data sheet.  
Order as TD91 **ONLY £24.95 (A)**

## DC POWER SUPPLIES

Virtually every type of power supply you can imagine. Over 10,000 Power Supplies Ex Stock - Call or see our web site.

## RELAYS - 200,000 FROM STOCK

Save £££'s by choosing your next relay from our Massive Stocks covering types such as Military, Octal, Cradle, Hermetically Sealed, Continental, Contactors, Time Delay, Reed, Mercury Wetted, Solid State, Printed Circuit Mounting etc. CALL or see our web site www.distel.co.uk for more information. Many obsolete types from stock. Save £££'s

## TEST EQUIPMENT & SPECIAL INTEREST ITEMS

- MITSUBISHI FA3445ETKL 14" Ind. spec SVGA monitors £245
- FARNELL 0-60V DC @ 50 Amps bench Power Supplies £995
- FARNELL AP3080 0-30V DC @ 80 Amps, bench Supply £1850
- KINGSHILL CZ4031 0-50V @ DC 200 Amps - NEW £3950
- 1KW to 400 kW - 400 Hz 3 phase power sources - ex stock EPOA
- IBM 8230 Type 1, Token ring base unit driver £760
- Wayne Kerr RA200 Audio frequency response analyser £2500
- INFODEC 1U, 24 port, RJ45 network patch panels. #TH93 £49
- 3COM 16670 12 Port Ethernet hub - RJ45 connectors #LD97 £69
- 3COM 16671 24 Port Ethernet hub - RJ45 connectors £89
- 3COM 16700 8 Port Ethernet hub - RJ45 connectors NEW £39
- IBM 53F5501 Token Ring ICS 20 port lobe modules EPOA
- IBM MAU Token ring distribution panel 8228-23-5050N £45
- ALL 501 Low distortion Oscillator 9Hz to 330KHz, IEEE I/O £550
- ALMGON 8360, 11805-1880 MHz hybrid power combiners £250
- Trend DSA 274 Data Analyser with G703(2M) 64 i/o EPOA
- Marconi 6310 Programmable 2 to 22 GHz sweep generator £4500
- Marconi 2022C 10KHz-1 GHz RF signal generator £1550
- HP1650B Logic Analyser £3750
- HP3781A Pattern generator & HP3782A Error Detector EPOA
- HP8621A Dual Programmable GPIB PSU 0-7 V 160 watts £1800
- HP8624A Rack mount variable 0-20V @ 20A metered PSU £475
- HP54121A DC to 22 GHz four channel test set EPOA
- HP8130A opto 20 to 300 MHz pulse generator, GPIB etc £7900
- HP A1, A0 8 pen HPGL high speed drum plotters - from £550
- HP DRAFTMASTER 1 8 pen high speed plotter £1750
- EG+G Brookdeale 95035C Precision lock in amp £8000
- Keithley 590 CV capacitor / voltage analyser £3700
- Racal ICR40 dual 40 channel voice recorder system £4500
- Fiskers 45KV4 3 kV On Line UPS - New batteries £1499
- Emerson AP130 25kVA industrial spec UPS £2200
- Mann Tally MT645 High speed line printer £945
- Intel SBC 486/133SE Multibus 486 system. 8Mb Ram

## Unless marked NEW, items in this section are pre owned.

- HP6030A 0-200V DC @ 17 Amps bench power supply £1950
- Intel SBC 486/125C08 Enhanced Multibus (MSA) New £1150
- Nikon HFX-11 (Ephiphot) exposure control unit £1450
- PHILIPS PM5518 pro. TV signal generator £1250
- Motorola VME Bus Boards & Components List. SAE / CALL EPOA
- Triol 0-18 vdc linear, metered 30 amp bench PSU. New £550
- Fujitsu M3041R 600 LPM high speed band printer £1950
- Fujitsu M3041D 600 LPM printer with network interface £1250
- Siemens K4400 64Kb to 140Mb demux analyser £2950
- Perkin Elmer 299B Infrared spectrophotometer £500
- Perkin Elmer 597 Infrared spectrophotometer £3500
- VG Electronics 1035 TELETEXT Decoding Margin Meter £3250
- LightBand 60 output high spec 2u rack mount Video VDA's £495
- Sekonic SD 150H 18 channel digital hybrid chart recorder £1995
- B&K 2633 Microphone pre amp £300
- Taylor Hobson Talysurf amplifier / recorder £750
- ADC SS200 Carbon dioxide gas detector / monitor £1450
- BBC AM20/3 PPM Meter (Ernest Turner) + drive electronics £75
- ANRITSU 9654A Optical DC-2.5Gb/s waveform monitor £5650
- ANRITSU ML93A optical power meter £990
- ANRITSU Fibre optic characteristic test set EPOA
- R&S FT0Z Dual sound unit £650
- R&S SBUF-E1 Vision digitator £775
- WILTRON 6630B 12.4 / 20GHz RF sweep generator £5750
- TEK 2445 150 MHz 4 trace oscilloscope £1250
- TEK 2465 300 MHz 300 MHz oscilloscope rack mount £1955
- TEK TDS380 400MHz digital realtime + disk drive, FFT etc £2900
- TEK TDS524A 500MHz digital realtime + colour display etc £5100
- HP3585A Opt 907 20Hz to 40 Mhz spectrum analyser £3950
- PHILIPS PW1730/10 60KV XRAY generator & accessories EPOA
- VARIACS - Large range from stock - call or see our website
- CLAUDE LYONS 12A 240V single phase auto. volt. regs £325

Display Electronics - ELECTRONICS

ALL MAIL TO  
Dept PE, 29 / 35 Osborne Rd  
Thornton Heath  
Surrey CR7 8PD  
Open Mon - Fri 9.00 - 5:30

18 Million Items On Line Now!  
Secure ordering, Pictures, Information  
www.distel.co.uk  
email = admin@distel.co.uk

ALL ENQUIRIES  
0208 653 3333  
FAX 0208 653 8888

All prices for UK Mainland. UK customers add 17.5% VAT to TOTAL order amount. Minimum order £10. Bona Fide account orders accepted from Government, Schools, Universities and Local Authorities - minimum account order £50. Cheques over £100 are subject to 7 working days clearance. Carriage charges (A)=£3.50, (B)=£6.50, (C)=£10, (D)=£15.00, (E)=£18.00, (F)=CALL. Allow approx 3 days for shipping - faster CALL. All goods supplied to our Standard Conditions of Sale which can be viewed at our website and unless stated guaranteed for 90 days. All guarantees on a return to base basis. All rights reserved to change prices / specifications without prior notice. Orders subject to stock. Discounts for volume. Top CASH prices paid for surplus goods. All trademarks, tradenames etc acknowledged. © Display Electronics 2002. E & O. E.

# NEXT MONTH

## CHRISTMAS CHEEKS

A Christmas, disco or party project with a difference! Instead of enhancing your Christmas decorations, it is designed to enhance . . . you! With recent advances in semiconductor technology, the maximum luminous intensity of red I.e.d.s has increased to several candelas. Now consider that human flesh is translucent to red light. Combine these two facts, and we have the basis for this project. The average facial cheek has a thickness of between one and two centimetres, and this makes it possible to "backlight" a cheek from the gums with a high intensity I.e.d., causing it to glow in the subdued light of a Christmas party or disco etc. The slimline circuit featured in this article is slipped between the gums and cheek, and is activated by the presence of saliva. Just think of the attention you will attract with flashing cheeks!



## PIC NIM MACHINE

An ultra-modern version of the age-old game of NIM. There have been many electrical or electronic versions of NIM over the years since the Nimatron was demonstrated at the New York Trade Fair in 1940. This PIC-based project is simple to build, easy to play and has a switched range of difficulty levels from easy-to-beat to nigh-on-impossible-to-beat. It should keep everyone fascinated for hours at Christmas.

## VIRUS ZAPPER Mk2

Imagine, if you will, a simple battery-operated device capable of stopping the common cold and many other afflictions in their tracks. At the onset of a sore throat, say, the user would simply grasp a pair of electrodes, switch on, and in no time become perfectly well again. Sounds like an impossible pipedream, doesn't it. Yet this is the claim for the Clark Virus Zapper, versions of which are widely available from internet sources. Many enthusiasts swear by its effectiveness, so it's just possible it does work, at least for some users. The Virus Zapper is the invention of Dr. Hulda Regehr Clark, an American lady who claims it can destroy all manner of viruses, bacteria and parasites within the body. This project is an updated and improved development of the Virus Zapper we published in the March '02 issue which proved to be very popular with readers. Build it and judge the results for yourself.

**PLUS**

**TEACH-IN 2004 – PART 2**  
**RADIO CIRCUITS – PART 7: THE SUPERHET**

# NO ONE DOES IT BETTER

EVERYDAY  
**PRACTICAL**  
**ELECTRONICS**

**DON'T MISS AN  
ISSUE – PLACE YOUR  
ORDER NOW!**  
Demand is bound to be high

DECEMBER 2003 ISSUE ON SALE THURSDAY, NOVEMBER 13



**Quasar Electronics Limited**  
 PO Box 6935, Bishops Cleeve, Stortford,  
 CM23 4WP  
 Tel: 0870 246 1826  
 Fax: 0870 460 1045  
 E-mail: sales@quasarelectronics.com

Add £2.00 P&P to all UK orders. 1st Class Recorded - £4.  
 Next day (Insured £250) - £7. Europe - £5. Rest of World - £10.  
 We accept all major credit/debit cards. Make cheques/PO's  
 payable to Quasar Electronics Limited.  
 Prices include 17.5% VAT. MAIL ORDER ONLY.  
 Call now for our FREE CATALOGUE with details of over 300  
 high quality kits, projects, modules and publications.



**QUASAR 0871 CREDIT CARD SALES 717 7168**  
 electronics

Helping you make the right connections!

### PIC & ATMEL Programmers

We have a wide range of low cost PIC and ATMEL Programmers. Complete range and documentation available from our web site.

#### Programmer Accessories:

40-pin Wide ZIF socket (ZIF40W) £15.00  
 18VDC Power supply (PSU201) £5.95  
 Leads: Parallel (LEAD108) £4.95 / Serial (LEAD76) £4.95 / USB (LEADUAA) £2.95

#### NEW! USB 'All-Flash' PIC Programmer

USB PIC programmer for all 'Flash' devices. No external power supply making it truly portable. Supplied with box and Windows Software. ZIF Socket and USB Plug A-A lead not incl.  
 Kit Order Code: 3128KT - £29.95  
 Assembled Order Code: AS3128 - £39.95



#### Enhanced "PICALL" ISP PIC Programmer

Will program virtually ALL 8 to 40 pin PICs plus certain ATMEL AVR, SCENIX SX and EEPROM 24C devices. Also supports In System Programming (ISP) for PIC and ATMEL AVRs. Free software. Blank chip auto detect for super fast bulk programming. Requires a 40-pin wide ZIF socket (not included)  
 Kit Order Code: 3144KT - £54.95  
 Assembled Order Code: AS3144 - £59.95



#### ATMEL 89xxxx Programmer

Uses serial port and any standard terminal comms program. 4 LED's display the status. ZIF sockets not included. Supply: 16VDC.  
 Kit Order Code: 3123KT - £29.95  
 Assembled Order Code: AS3123 - £34.95



#### NEW! USB & Serial Port PIC Programmer

USB/Serial connection. Header cable for ICSP. Free Windows software. See website for PICs supported. ZIF Socket and USB Plug A-A lead extra. 18VDC.  
 Kit Order Code: 3149KT - £27.95  
 Assembled Order Code: AS3149 - £44.95



#### Introduction to PIC Programming

Go from a complete PIC beginner to burning your first PIC and writing your own code in no time! Includes a 49 page step-by-step Tutorial Manual, Programming Hardware (with LED bench testing section), Win 3.11—XP Programming Software (will Program, Read, Verify & Erase), and a rewritable PIC16F84A that you can use with different code (4 detailed examples provided for you to learn from). Connects to PC parallel port.  
 Kit Order Code: 3081KT - £14.95  
 Assembled Order Code: AS3081 - £24.95



#### ABC Mini Microcontroller Board

Currently learning about microcontrollers? Need to do more than flash a LED or sound a buzzer? The ABC Mini Starter Kit is based on ATMELs AVR 8535 RISC technology and will interest both the beginner and expert alike. Beginners will find that they can write and test a simple program, using the BASIC programming language, within an hour or two of connecting it up. Experts will like the power and flexibility of the ATMEL microcontroller, as well as the ease with which the board can be "designed-in" to a project. The ABC Mini STARTER PACK includes everything you need to get up and experimenting right away. On the hardware side, there's a pre-assembled ABC Mini Board with parallel and serial cables for connection to your PC. Windows software included on CD-ROM features an Assembler, BASIC compiler and in-system programmer.  
 Order Code ABCMINISP - £49.95  
 The ABC Mini boards only can also be purchased separately at £29.95 each.



ABC Mini Starter Pack

### Controllers & Loggers

Here are just a few of the controller and data acquisition and control units we have. See website for full details. Suitable PSU for all units: Order Code PSU203 £9.95

#### Rolling Code 4-Channel UHF Remote

State-of-the-Art. High security. 4 channels. Momentary or latching relay output. Range up to 40m. Up to 15 Tx's can be learnt by one Rx (kit includes one Tx but more available separately). 4 indicator LED's. Rx: PCB 77x85mm, 12VDC/6mA (standby). Two & Ten Channel versions also available.  
 Kit Order Code: 3180KT - £41.95  
 Assembled Order Code: AS3180 - £49.95



#### Computer Temperature Data Logger

Serial port 4-channel temperature logger. °C or °F. Continuously logs up to 4 separate sensors located 200m+ from board. Wide range of free software applications for storing/using data. PCB just 38x38mm. Powered by PC. Includes one DS1820 sensor and four header cables.  
 Kit Order Code: 3145KT - £22.95  
 Assembled Order Code: AS3145 - £29.95  
 Additional DS1820 Sensors - £3.95 each



Most items are available in kit form (KT suffix) or pre-assembled and ready for use (AS prefix).

#### NEW! DTMF Telephone Relay Switcher

Call your phone number using a DTMF phone from anywhere in the world and remotely turn on/off any of the 4 relays as desired. User settable Security Password, Anti-Tamper, Rings to Answer, Auto Hang-up and Lockout. Includes plastic case. 130 x 110 x 30mm. Power: 12VDC.  
 Kit Order Code: 3140KT - £39.95  
 Assembled Order Code: AS3140 - £59.95



#### Serial Port Isolated I/O Module

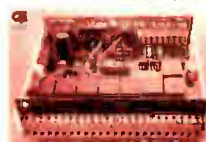

Computer controlled 8 channel relay board. 5A mains rated relay outputs and 4 opto-isolated digital inputs (for monitoring switch states, etc). Useful in a variety of control and sensing applications. Programmed via serial port (use our new Windows interface, terminal emulator or batch files). Serial cable can be up to 35m long. Once programmed, unit can operate without PC. Includes plastic case 130x100x30mm. Power: 12VDC/500mA.  
 Kit Order Code: 3108KT - £54.95  
 Assembled Order Code: AS3108 - £64.95

#### Infrared RC 12-Channel Relay Board



Control 12 onboard relays with included infrared remote control unit. Toggle or momentary. 15m+ range. 112 x 122mm. Supply: 12VDC/0.5A  
 Kit Order Code: 3142KT - £41.95  
 Assembled Order Code: AS3142 - £59.95

#### PC Data Acquisition & Control Unit

Monitor and log a mixture of analogue and digital inputs and control external devices via the analogue and digital outputs. Monitor pressure, temperature, light intensity, weight, switch state, movement, relays, etc. with the appropriate sensors (not supplied). Data can be processed, stored and the results used to control devices such as motors, sirens, relays, servo motors (up to 11) and two stepper motors.



#### Features

- 11 Analogue Inputs - 0-5V, 10 bit (5mV/step)
- 16 Digital Inputs - 20V max. Protection 1K in series, 5.1V Zener
- 1 Analogue Output - 0-2.5V or 0-10V. 8 bit (20mV/step)
- 8 digital Outputs - Open collector, 500mA, 33V max
- Custom box (140x110x35mm) with printed front & rear panels.
- Windows software utilities (3.1 to XP) and programming examples.
- Supply: 12V DC (Order Code PSU203).

Kit Order Code: 3093KT - £69.95  
 Assembled Order Code: AS3093 - £99.95

## Hot New Kits This Summer!

Here are a few of the most recent kits added to our range. See website or join our email Newsletter for all the latest news.

### NEW! EPE Ultrasonic Wind Speed Meter



Solid-state design wind speed meter (anemometer) that uses ultrasonic techniques and has no moving parts and

does not need calibrating. It is intended for sports-type activities, such as track events, sailing, hang-gliding, kites and model aircraft flying, to name but a few. It can even be used to monitor conditions in your garden. The probe is pointed in the direction from which the wind is blowing and the speed is displayed on an LCD display.

#### Specifications

- Units of display: metres per second, feet per second, kilometres per hour and miles per hour
- Resolution: Nearest tenth of a metre
- Range: Zero to 50mph approx.

Based on the project published in *Everyday Practical Electronics*, Jan 2003. We have made a few minor design changes (see website for full details). Power: 9VDC (PP3 battery or Order Code PSU203). Main PCB: 50x83mm.

Kit Order Code: 3168KT - £34.95

### NEW! Audio DTMF Decoder and Display

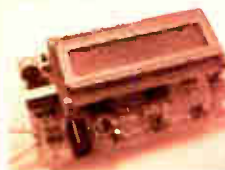

Detects DTMF tones via an on-board electret microphone or direct from the phone lines through an audio transformer. The

numbers are displayed on a 16 character, single line display as they are received. Up to 32 numbers can be displayed by scrolling the display left and right. There is also a serial output for sending the detected tones to a PC via the serial port. The unit will not detect numbers dialled using pulse dialling. Circuit is microcontroller based. Supply: 9-12V DC (Order Code PSU203). Main PCB: 55x95mm. Kit Order Code: 3153KT - £17.95  
Assembled Order Code: AS3153 - £29.95

### NEW! EPE PIC Controlled LED Flasher

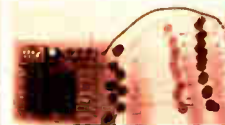

This versatile PIC based LED or filament bulb flasher can be used to flash from

1 to 160 LEDs. The user arranges the LEDs in any pattern they wish. The kit comes with 8 super bright red LEDs and 8 green LEDs. Based on the Versatile PIC Flasher by Steve Challinor, *EPE Magazine* Dec 02. See website for full details. Board Supply: 9-12VDC. LED supply: 9-45VDC (depending on number of LED used). PCB: 43x54mm. Kit Order Code: 3169KT - £10.95

Most items are available in kit form (KT suffix) or assembled and ready for use (AS prefix).

## FM Bugs & Transmitters

Our extensive range goes from discreet surveillance bugs to powerful FM broadcast transmitters. Here are a few examples. All can be received on a standard FM radio and have adjustable transmitting frequency.

### MMTX' Micro-Miniature 9V FM Room Bug



Our best selling bug! Good performance. Just 25x15mm. Sold to detective agencies worldwide. Small enough to hide just about anywhere. Operates at the 'less busy' top

end of the commercial FM waveband and also up into the more private Air band.

Range: 500m. Supply: PP3 battery.

Kit Order Code: 3051KT - £8.95

Assembled Order Code: AS3051 - £14.95

### HPTX' High Power FM Room Bug

Our most powerful room bug.



Very impressive performance. Clear and stable output signal thanks to the extra circuitry employed. Range: 1000m @ 9V. Supply: 6-12V DC (9V PP3 battery clip supplied). 70x15mm.

Kit Order Code: 3032KT - £9.95

Assembled Order Code: AS3032 - £17.95

### MTTX' Miniature Telephone Transmitter



Attach anywhere along phone line.

Tune a radio into the signal and hear exactly what both parties are saying. Transmits only when phone is used. Clear, stable signal. Powered from phone line so completely maintenance free once installed. Requires no aerial wire - uses phone line as antenna. Suitable for any phone system worldwide. Range: 300m. 20x45mm.

Kit Order Code: 3016KT - £7.95

Assembled Order Code: AS3016 - £13.95

### 4 Watt FM Transmitter



Small, powerful FM transmitter. Audio preamp stage and three RF stages deliver 4 watts of RF power. Can be used

with the electret microphone supplied or any line level audio source (e.g. CD or tape OUT, mixer, sound card, etc). Aerial can be an open dipole or Ground Plane. Ideal project for the novice wishing to get started in the fascinating world of FM broadcasting. 45x145mm. Kit Order Code: 1028KT - £22.95

Assembled Order Code: AS1028 - £34.95

### 25 Watt FM Transmitter

Four transistor based stages with a Philips BLY89 (or equivalent) in the final stage. Delivers a mighty 25 Watts of RF power. Accepts any line level audio source (input sensitivity is adjustable). Antenna can be an open dipole, ground plane, 5/8, J, or YAGI configuration. Supply 12-14V DC, 5A. Supplied fully assembled and aligned - just connect the aerial, power and audio input. 70x220mm.

Order Code: 1031M - £124.95



**QUASAR**  
electronics

Helping you make the right connections!

**CREDIT  
CARD  
SALES  
0871  
717  
7168**

## Electronic Project Labs

Great introduction to the world of electronics. Ideal gift for budding electronics expert!

### 500-in-1 Electronic Project Lab

This is the top of the range and is a complete electronics course taking you from beginner to A level standard and beyond! It contains all the parts and instructions to assemble 500 projects.



You get three comprehensive course books (total 368 pages) - *Hardware Entry Course*, *Hardware Advanced Course* and a micro-computer based *Software Programming Course*. Each book has individual circuit explanations, schematic and assembly diagrams. Suitable for age 12 and above. Order Code EPL500 - £149.95

**30, 130 - 200 and 300-in-1 project labs also available - see website for details.**

## Number 1 for Kits!

With over 300 projects in our range we are the UK's number 1 electronic kit specialist. Here are a few other kits from our range.

- 1046KT—25W Stereo Car Booster £26.95
- 3087KT—1W Stereo Amplifier £4.95
- 3105KT—18W BTL Mono Amplifier £9.95
- 3106KT—50W Mono Hi-fi Amplifier £19.95
- 3143KT—10W Stereo Amplifier £9.95
- 1011KT—Motorbike Alarm £11.95
- 1019KT—Car Alarm System £10.95
- 1048KT—Electronic Thermostat £9.95
- 1080KT—Liquid Level Sensor £5.95
- 3005KT—LED Dice with Box £7.95
- 3006KT—LED Roulette Wheel £8.95
- 3074KT—8-Ch PC Relay Board £29.95
- 3082KT—2-Ch UHF Relay £26.95
- 3126KT—Sound Activated Relay £7.95
- 3063KT—One Chip AM Radio £10.95
- 3102KT—4-Ch Servo Motor Driver £15.95
- 3160KT—PIC16F62x Experimenter £8.95
- 1096KT—3-30V, 5A Stabilised PSU £30.95
- 3029KT—Combination Lock £6.95
- 3049KT—Ultrasonic Detector £13.95
- 3130KT—Infrared Security Beam £12.95
- SG01MKT—Train Sounds £6.95
- SG10MKT—Animal Sounds £5.95
- 1131KT—Robot Voice Effect £8.95
- 3007KT—3V FM Room Bug £6.95
- 3028KT—Voice Activated FM Bug £12.95
- 3033KT—Telephone Recording Adpt £9.95
- 3112KT—PC Data Logger/sampler £18.95
- 3118KT—12-bit Data Acquisition Unit £52.95
- 3101KT—20MHz Function Generator £69.95

**No.1  
KITS**

[www.quasarelectronics.com](http://www.quasarelectronics.com)

Secure Online Ordering Facilities • Full Product Listing, Descriptions & Photos • Kit Documentation & Software Downloads

# Low cost USB I/O

For Datalogging & Control

**THE LABJACK U12 - ONLY £95**



- ♦ 8-Analogue in, 2-Analogue out, 20 digital I/O counter, watchdog
- ♦ USB plug-and-play - no PSU needed
- ♦ FREE 'scope and logger software
- ♦ Write data to disk, web page or email
- ♦ Temperature and Humidity Sensors connect directly

- ♦ Visual Basic, C++, Delphi, LabVIEW, Testpoint drivers
- ♦ Control pumps, lights, valves with Relay and opto-input expansion boards

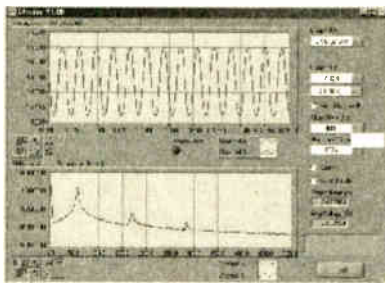

All prices exclude VAT and delivery. Order on-line: major credit/debit cards accepted.



**AUDON Electronics**

www.audon.co.uk +44 (0)115 925 8412 Fax (0)115 925 9757

# SQUIRES

## MODEL & CRAFT TOOLS

A COMPREHENSIVE RANGE OF MINIATURE HAND AND POWER TOOLS AND AN EXTENSIVE RANGE OF ELECTRONIC COMPONENTS

FEATURED IN A FULLY ILLUSTRATED 624 PAGE MAIL ORDER CATALOGUE

## 2004 ISSUE

**SAME DAY DESPATCH  
FREE POST AND PACKAGING**

Catalogues: FREE OF CHARGE to addresses in the UK. Overseas: CATALOGUE FREE, postage at cost charged to credit card

**SHOP EXTENSION NOW OPEN**

Squires, 100 London Road,  
Bognor Regis, West Sussex, PO21 1DD



TEL: 01243 842424  
FAX: 01243 842525



### SPECIAL OFFERS



**TEKTRONIX 2445A**  
4-ch 150MHz delay-cursors etc. Supplied with 2 Tektronix probes.  
**ONLY £425**

**TEKTRONIX 2232** Digital Storage Scope. Dual Trace, 100MHz, 100M/S with probes... £525  
**CIRRUS CRL254** Sound Level Meter with Calibrator 80-120dB, LEO... £95  
**BECKMAN HD110** Handheld 3 1/2 digit DMM, 28 ranges, with battery, leads and carrying case... £30  
**WAYNE KERR B424** Component Bridge... £50  
**RACAL 9300** True RMS Voltmeter, 5Hz-20MHz usable to 60MHz, 10V-316V... £50  
**RACAL 9300B**, as above... £75

**H.P. 3312A** Function Gen., 0-1Hz-13MHz, AM/FM Sweep/Tri/Gate/Burst etc... £300  
**FARNELL ANM255** Automatic Mo Meter, 1-5MHz-2GHz, unused... £300  
**FARNELL DSG3** Low Frequency Syn Sig. Gen., 0-001Hz-99.99kHz, low distortion, TTL Square/Pulse Outputs etc... £95  
**FLUKE 8060A** Handheld True RMS DMM, 4 1/2 digit... As new £150, used £95  
**H.P. 3310A** Function Gen., 0-005Hz-5MHz, Sine/Sqr/Tri/Ramp/Pulse... £125  
**FARNELL LFM4** Sine/Sq Oscillator, 10Hz-1MHz low distortion, TTL output, Amplitude Meter... £95  
**H.P. 545A** Logic Probe with 546A Logic Pulser and 547A Current Tracer... £95  
**FLUKE 77** Multimeter, 3 1/2 digit... £70  
**FLUKE 77 Series 11**... £70  
**HEME 1000** L.C.D. Clamp Meter... £60  
In carrying case... £60

**BLACK STAR ORION PAL/TV** Colour TV Generator... £50  
**THURBY/THANDER TG210** Function Generator, 0-002Hz-2MHz, TTL etc... £95  
**THURBY THANDER P.S.U. PL320OMD**, 0V-32V, 0A-2A (two late colours)... £200

**Datron 1061A**  
High Quality 5 1/2 digit Bench Multimeter  
**True RMS/4 wire/Current Converter**  
**£225**

**Racal Receiver RA1772**  
50kHz-30MHz  
**£250**

## STEWART of READING

110 WYKEHAM ROAD, READING, BERKS. RG6 1PL  
Telephone: (0118) 9268041. Fax: (0118) 9361696  
www.stewart-of-reading.co.uk

Callers welcome 9am-5.30pm Monday to Friday (other times by arrangement)

### JUST IN

**H.P. 8480A** Signal Generator, AM/FM, 500kHz-512MHz £250  
**KENWOOD CS4025** Oscilloscope, dual trace, 20MHz... £125  
**LEADER LB0523** Oscilloscope, dual trace, 35MHz... £140  
**GOULD OS300** Oscilloscope, dual trace, 20MHz... £95  
**NATIONAL PANASONIC VP7705A** Distortion Analyser... £125  
**KENWOOD VT176** Millivoltmeter 2-channel... £50  
**KENWOOD FL140** Wow & Flutter Meter... £50  
**KENWOOD FL180A** Wow & Flutter Meter... Used £75  
Unused £125  
**BIRD 43** Watt Meter... £75  
Elements for the above... £25

**MARCONI 893C** AF Power Meter, Sine Measurement... Unused £100, Used £80  
**MARCONI 893B**, No Sinead... £30  
**MARCONI 2610** True RMS Voltmeter, Autoranging, 5Hz-25MHz... £195

**GOULD J3B** Sine/Sq Occ., 10Hz-100kHz, low distortion... £75-£125  
**AVO 8 Mk. 6** in Every Ready case, with leads etc... £80  
Other AVOs from... £10  
**GOODWILL GVT427** Dual Ch AC Millivoltmeter, 10mV-300V in 12 ranges, Freq. 10Hz-1MHz... £12  
**SOLARTRON 7150** DMM, 4 1/2 digit, True RMS-IEEE... £95-£150  
**SOLARTRON 7150 Plus**... £200

**FARNELL RACAL RACAL COUNTER**... £95  
**95C Universal Trigger Counter**, 50MHz... £95  
**95C Counter**, 10Hz-50MHz, 9 digit... £50  
**WAYNE KERR B424** Component Bridge... £125  
**RACAL/AIM 9300** LCR Digital Automesurement... £200  
**FLUKE 77** TRACER... £75  
**FLUKE 77** Series 11... £75  
**FLUKE 77** Series 11... £75

**Portable Appliance Tester**  
Megger Pat... ONLY **£180**

**H.P. 4122A** Dist. 50V, 0-50A, 1000W... £1000  
**FARNELL H60/50** 1KW Autoranging... £1000  
**FARNELL H60/50** 0-60V 0-50A... £750  
**FARNELL H60/25** 0-60V 0-25A... £400  
**Power Supply HPS3010**, 0-30V, 0-10A... £140  
**FARNELL L30-2** 0-30V, 0-2A... £180  
**FARNELL L30-1** 0-30V, 0-1A... £80  
Many other Power Supplies available

**FARNELL DTV12-14 OSCILLOSCOPE.**  
Dual trace, 12MHz TV, coupling .ONLY **£75**

**FARNELL LF1 SINE/SQ OSCILLATOR.**  
10Hz-1MHz. ONLY **£75**

**OSCILLOSCOPES**  
**TELETRONIX TDS350** dual trace, 200MHz, 1GS... Unused £1500  
**TELETRONIX TDS320** dual trace, 200MHz, 500M/S... £1200  
**TELETRONIX TDS310** dual trace, 100MHz, 200M/S... £950  
**LECROY 9400A** dual trace, 175MHz, 5GS... £2800  
**HITACHI VC6523**, d/trace, 20MHz, 20M/S, delay etc... £1250  
**PHILIPS PM3082** 2+2-ch., 200MHz, delay etc... £950  
**PHILIPS PM3082** 2+2-ch., 200MHz, delay etc... £800  
**TELETRONIX T465B** dual trace, 100MHz, delay... £750  
**TELETRONIX T465B** dual trace, 100MHz, delay... £1500  
**TELETRONIX T465B** dual trace, 100MHz, delay... £900  
**TELETRONIX T465B** dual trace, 100MHz, delay... £1250  
**TELETRONIX T2215** dual trace, 100MHz, delay... £250  
**PHILIPS PM3082** 2+2-ch., 200MHz, delay... £950  
**PHILIPS PM3082** 2+2-ch., 200MHz, delay... £800  
**PHILIPS PM3082** 2+2-ch., 200MHz, delay... £1250  
**PHILIPS PM3082** 2+2-ch., 200MHz, delay... £1125  
**HALO HM3003.6** dual trace, 35MHz... £140  
**HALO HM3003.6** dual trace, 35MHz... £200  
Many other Oscilloscopes... £200

**MICRO 200** Synth AM/FM sig Gen... £525-£750  
**H.P. 4275A** Synth sig gen, 100Hz-1040MHz... £2000  
**H.P. 4275B** Synth sig gen, 100Hz-990MHz... £1350  
**H.P. 8656A** Synth sig gen, 100Hz-990MHz... £995  
**R&B APN82** Synth, 1Hz-260kHz sig. gen., balanced/unbalanced output, L.C.D. display... £425  
**PHILIPS PM3528** sig gen, 100kHz-180MHz with 20MHz, freq. counter, IEEE... £550  
**RACAL 9081** Synth AM/FM sig g en, 5MHz-520MHz... £250  
**H.P. 3325A** Synth function gen, 21MHz... £600  
**MARCONI 6500** Amplitude Analyser... £1500  
**H.P. 4192A** Impedance Analyser... £5000  
**H.P. 4275A** LCR Meter, 10kHz-10MHz... £2750  
**H.P. 8003A** Distortion Analyser... £1000  
**WAYNE KERR** 324S Inductance Analyser... £2000  
**H.P. 8112A** Pulse Generator, 50MHz... £1250  
**MARCONI 2440** Frequency Counter, 20GHz... £1000  
**H.P. 5350B** Frequency Counter, 20GHz... £2000  
**H.P. 5342A** 10kHz-18GHz Frequency Counter... £800  
**H.P. 1650B** Logic Analyser, 80-channel... £1000  
**MARCONI 2035** Mod Meter, 500kHz-2GHz... £750

**H.P. 6063B** DC Electronic Load, 3-240V/0-10A, 250W... POA  
**H.P. 6312A** PSU, 0-20V/0-2A... £400  
**H.P. 6311B** PSU, 0-15V/0-5A... £400  
**H.P. 6330B** PSU Dual, 0-15, 0-3A/0-12, 0-1.5A... £750  
**H.P. 6332B** PSU, 0-20V/0-5A... £500  
**H.P. 6623A** PSU, triple output ranging from 0-7V 0-5A to 0-20V 0-4A... £850  
**H.P./AGILENT 34461A** DMM 6 1/2 digit... £4000/£450  
**H.P. 3478A** DMM 5 1/2 digit... £275  
**FLUKE 45** DMM dual display... £400  
**KEITHLEY 2010** DMM 7 1/2 digit... £950  
**KEITHLEY 617** Programmable Electrometer... £1250  
**H.P. 4338B** Milliohmmeter... £1500  
**RACAL Counter type 1999** 2-6GHz... £500  
**H.P. 4338B** Counter type 53131A 3GHz... £250  
**H.P./AGILENT 33120A** Func. Gen./ARB, 100kHz-15MHz... £9000/£1000  
**SONY/TEKTRONIX AF322B** Arbitrary Func. Gen... £1250  
**H.P. 8004A** Syn. Function Gen, DC-800kHz... £1000/£1250  
**BLACK STAR JUPITOR 2010** Func. Gen, 0-2Hz-2MHz with frequency counter... £140  
**H.P. 1116A** Pulse Generator, 1mH-50MHz... £1950  
**H.P. 8657B** Syn Sig. Gen, 0-1-2000MHz... £2500  
**CO-AXIAL SWITCH**, 1.5GHz... £40  
**IEEE CABLES**... £10

### SPECTRUM ANALYSERS

**H.P. 8561B** 50Hz-6.5GHz... £5000  
**H.P. 8560A** 50Hz-2.9GHz synthesised... £5000  
**H.P. 8594E** 90Hz-2.9GHz... £4500  
**H.P. 8591E** 1MHz-1.9GHz, 75 Ohm... £2750  
**H.P. 8553A** with 8558A, 100kHz-21GHz... £1750  
**H.P. 8558B** with Main Frame, 100kHz-1500MHz... £750  
**H.P. 3858A** 20Hz-40MHz... £2500  
**H.P. 3590A** 5Hz-50kHz... £600  
**ADVANTEST RA131B** 100kHz-3.5GHz... £2750  
**EATON/WALTECH T57** 0-001-22GHz... £2500  
**MARCONI 2382** 100Hz-400MHz, high resolution... £2000  
**MARCONI 2370** 30Hz-110MHz... from £500  
**H.P. 182** with 8557, 10kHz-350MHz... £500  
**H.P. 141T** SVS7EM5  
**8553** 1Hz-110MHz... £500  
**8554** 500kHz-1250MHz... £750  
**8555** 10MHz-18GHz... £1000  
**H.P. 8443** Tracking Gen/Counter, 110MHz... £250  
**H.P. 8444** OPT 059... £750  
**B&K 2033R** Signal Analyser... £650  
**H.P. 8754A** Network Analyser, 4MHz-1300MHz... £1250  
**H.P. 8537A** Network Analyser, 5Hz-200MHz... £3000  
**H.P. 53310A** Mod Domain Analyser Opt 001/003... £5000  
**ONO SOKKI CF300** Portable FFT Analyser... £1500  
**H.P. 8720C** Microwave Network Analyser, 50MHz-20GHz... £12,500

### RADIO COMMUNICATIONS TEST SETS

**MARCONI 2955/2959R**... From £1000  
**RHODE & SCHWARZ CMT 0-1-100MHz**... £1500  
**SCHLUMBERGER 4040**... £750

**Used Equipment - GUARANTEED, Manuals supplied**  
This is a VERY SMALL SAMPLE OF STOCK, SAE or Telephone for lists.  
Please check availability before ordering.  
CARRIAGE all units £16. VAT to be added to Total of Goods and Carriage



# Learn About Microcontrollers

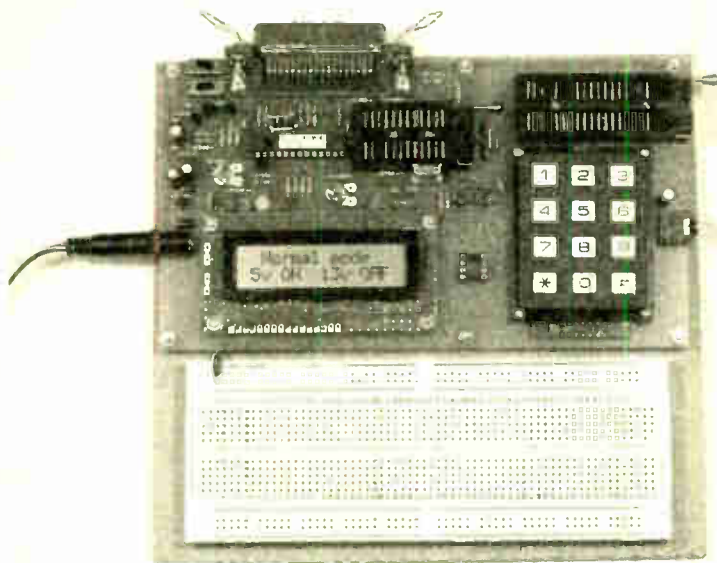

## PIC Training & Development System

The best place to start learning about microcontrollers is the PIC16F84. This is easy to understand and very popular with construction projects. Then continue on using the more sophisticated PIC16F877 family.

The heart of our system is a real book which lies open on your desk while you use your computer to type in the programme and control the hardware. Start with four very simple programmes. Run the simulator to see how they work. Test them with real hardware. Follow on with a little theory.....

Our complete PIC training and development system consists of our universal mid range PIC programmer, a 306 page book covering the PIC16F84, a 262 page book introducing the PIC16F877 family, and a suite of programmes to run on a PC. The module is an advanced design using a 28 pin PIC16F872 to handle the timing, programming and voltage switching requirements. The module has two ZIF sockets and an 8 pin socket which between them allow most mid range 8, 18, 28 and 40 pin PICs to be programmed. The plugboard is wired with a 5 volt supply. The software is an integrated system comprising a text editor, assembler disassembler, simulator and programming software. The programming is performed at normal 5 volts and then verified with plus and minus 10% applied to ensure that the device is programmed with a good margin and not poised on the edge of failure. DC version (shown) for UK, battery version for overseas. UK orders include a plugtop power supply.

- Universal mid range PIC programmer module
  - + Book Experimenting with PIC Microcontrollers
  - + Book Experimenting with the PIC16F877 (2nd edition)
  - + Universal mid range PIC software suite
  - + PIC16F84 and PIC16F872 test PICs. .... £139.00
- (Postage & insurance UK £9, Europe £14, Rest of world £24)

## Experimenting with PIC Microcontrollers

This book introduces the PIC16F84 and PIC16C711, and is the easy way to get started for anyone who is new to PIC programming. We begin with four simple experiments, the first of which is explained over ten and half a pages assuming no starting knowledge except the ability to operate a PC. Then having gained some practical experience we study the basic principles of PIC programming, learn about the 8 bit timer, how to drive the liquid crystal display, create a real time clock, experiment with the watchdog timer, sleep mode, beeps and music, including a rendition of Beethoven's *Für Elise*. Finally there are two projects to work through, using the PIC16F84 to create a sine wave generator and investigating the power taken by domestic appliances. In the space of 24 experiments, two projects and 56 exercises the book works through from absolute beginner to experienced engineer level.

## Hardware & Ordering Information

Our PIC software is supplied as a self installing programme which will operate on any modern PC whichever operating system is used. For full information click onto 'Using PIC Software' on our web site.

Telephone with Visa, Mastercard or Switch, or send cheque/PO for immediate despatch. All prices include VAT if applicable.

Web site:- [www.brunningssoftware.co.uk](http://www.brunningssoftware.co.uk)

## NEW 32 bit PC Assembler

*Experimenting with PC Computers* with its kit is the easiest way ever to learn assembly language programming. If you have enough intelligence to understand the English language and you can operate a PC computer then you have all the necessary background knowledge. Flashing LEDs, digital to analogue converters, simple oscilloscope, charging curves, temperature graphs and audio digitising.

Kit now supplied with our 32 bit assembler with 84 page supplement detailing the new features and including 7 experiments PC to PIC communication. Flashing LEDs, writing to LCD and two way data using 3 wires from PC's parallel port to PIC16F84.

- Book + made up kit 1a + software ..... £73.50
  - Book + unmade kit 1u + software ..... £66.50
- (PP UK £4, Europe £10, Rest of world £14)

## C & C++ for the PC

*Experimenting with C & C++ Programmes* teaches us to programme by using C to drive the simple hardware circuits built using the materials supplied in the kit. The circuits build up to a storage oscilloscope using relatively simple C techniques to construct a programme that is by no means simple. When approached in this way C is only marginally more difficult than BASIC and infinitely more powerful. C programmers are always in demand. Ideal for absolute beginners and experienced programmers.

- Book + made up kit 2a + software ..... £57.50
  - Book + unmade kit 2u + software ..... £51.50
  - Book + top up kit 2t + software ..... £37.98
- (PP UK £4, Europe £10, Rest of world £14)

## The Kits

The assembler and C & C++ kits contain the prototyping board, lead assemblies, components and programming software to do all the experiments. The 'made up' kits are supplied ready to start. The 'top up' kit is for readers who have already purchased kit 1a or 1u.

## Assembler and C & C++

Click on 'Special Offers' on our website for details of how to save by buying a combined kit for assembler and C & C++.

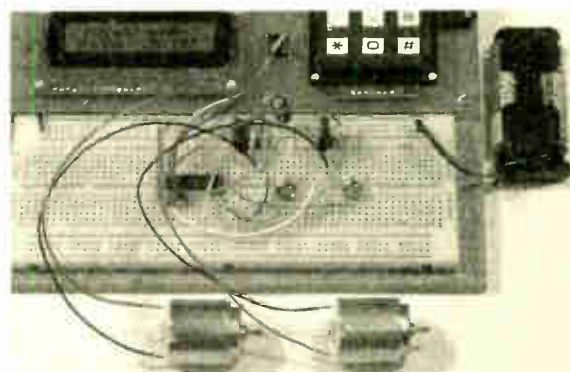

## Experimenting with the PIC16F877

The second PIC book starts with the simplest of experiments to give us a basic understanding of the PIC16F877 family. Then we look at the 16 bit timer, efficient storage and display of text messages, simple frequency counter, use a keypad for numbers, letters and security codes, and examine the 10 bit A/D converter.

The 2nd edition has two new chapters. The PIC16F627 is introduced as a low cost PIC16F84. We use the PIC16F627 as a step up switching regulator, and to control the speed of a DC motor with maximum torque still available. Then we study how to use a PIC to switch mains power using an optoisolated triac driving a high current triac.

Mail order address:

**Brunning Software** 138 The Street, Little Clacton, Clacton-on-sea, Essex, CO16 9LS. Tel 01255 862308

**MAIL ORDER ONLY • CALLERS BY APPOINTMENT**

### EPE PROJECT PICS

Programmed PICs for \*EPE Projects

12C508/9 - £3.90; 16F627/8 - £4.90

16C84/16F84/16C71 - £5.90

16F876/877 - £10.00

All inc. VAT and Postage

(\*Some projects are copyright)

### EPE MICROCONTROLLER P.I. TREASURE HUNTER

The latest MAGENTA DESIGN - highly stable & sensitive - with I.C. control of all timing functions and advanced pulse separation techniques.

- High stability drift cancelling
- Easy to build & use
- No ground effect, works in seawater



- Detects gold, silver, ferrous & non-ferrous metals

- Efficient quartz controlled microcontroller pulse generation.
- Full kit with headphones & all hardware

**KIT 847 ..... £63.95**

### 68000 DEVELOPMENT TRAINING KIT

- NEW PCB DESIGN
- 8MHz 68000 16-BIT BUS
- MANUAL AND SOFTWARE
- 2 SERIAL PORTS
- PIT AND I/O PORT OPTIONS
- 12C PORT OPTIONS



**KIT 621**

**£99.95**

- ON BOARD 5V REGULATOR
- PSU £6.99
- SERIAL LEAD £3.99

### Stepping Motors

MD100...Std 100 step...£9.99

MD200...200 step...£12.99

MD24...Large 200 step...£22.95



### PIC PIPE DESCALER

- SIMPLE TO BUILD
- HIGH POWER OUTPUT
- AUDIO & VISUAL MONITORING
- SWEPT FREQUENCY

An affordable circuit which sweeps the incoming water supply with variable frequency electromagnetic signals. May reduce scale formation, dissolve existing scale and improve lathering ability by altering the way salts in the water behave.

Kit includes case, P.C.B., coupling coil and all components. High coil current ensures maximum effect. L.E.D. monitor.



**KIT 868 ..... £22.95 POWER UNIT.....£3.99**

### MICRO PEST SCARER

Our latest design - The ultimate scarer for the garden. Uses special microchip to give random delay and pulse time. Easy to build reliable circuit. Keeps pets/pests away from newly sown areas, play areas, etc. uses power source from 9 to 24 volts.

- RANDOM PULSES
- HIGH POWER
- DUAL OPTION



Plug-in power supply £4.99

**KIT 867.....£19.99**

**KIT + SLAVE UNIT.....£32.50**

### WINDICATOR

A novel wind speed indicator with LED readout. Kit comes complete with sensor cups, and weatherproof sensing head. Mains power unit £5.99 extra.

**KIT 856.....£28.00**

## ★ TENS UNIT ★

### DUAL OUTPUT TENS UNIT

As featured in March '97 issue.

Magenta have prepared a FULL KIT for this excellent new project. All components, PCB, hardware and electrodes are included.

Designed for simple assembly and testing and providing high level dual output drive.

**KIT 866. . Full kit including four electrodes £32.90**

Set of 4 spare electrodes  
**£6.50**

### 1000V & 500V INSULATION TESTER



Superb new design. Regulated output, efficient circuit. Dual-scale meter, compact case. Reads up to 200 Megohms.

Kit includes wound coil, cut-out case, meter scale, PCB & ALL components.

**KIT 848..... £32.95**

## EPE TEACH-IN 2000

Full set of top quality NEW components for this educational series. All parts as specified by EPE. Kit includes breadboard, wire, croc clips, pins and all components for experiments, as listed in introduction to Part 1.

\*Batteries and tools not included.

**TEACH-IN 2000 -**

**KIT 879 £44.95**

**MULTIMETER £14.45**

### SPACEWRITER

An innovative and exciting project. Wave the wand through the air and your message appears. Programmable to hold any message up to 16 digits long. Comes pre-loaded with "MERRY XMAS". Kit includes PCB, all components & tube plus instructions for message loading.

**KIT 849 .....£16.99**

### 12V EPROM ERASER

A safe low cost eraser for up to 4 EPROMS at a time in less than 20 minutes. Operates from a 12V supply (400mA). Used extensively for mobile work - updating equipment in the field etc. Also in educational situations where mains supplies are not allowed. Safety interlock prevents contact with UV.

**KIT 790 ..... £29.90**

### SUPER BAT DETECTOR

1 WATT O/P, BUILT IN SPEAKER, COMPACT CASE 20kHz-140kHz NEW DESIGN WITH 40kHz MIC.

A new circuit using a 'full-bridge' audio amplifier i.c., internal speaker, and headphone/tape socket. The latest sensitive transducer, and 'double balanced mixer' give a stable, high performance superheterodyne design.



**KIT 861 .....£24.99**

ALSO AVAILABLE Built & Tested. . . £39.99

### MOSFET MKII VARIABLE BENCH POWER SUPPLY 0-25V 2.5A

Based on our Mk1 design and preserving all the features, but now with switching pre-regulator for much higher efficiency. Panel meters indicate Volts and Amps. Fully variable down to zero. Toroidal mains transformer. Kit includes punched and printed case and all parts. As featured in April 1994 EPE. An essential piece of equipment.



Kit No. 845 ..... £64.95

### ULTRASONIC PEST SCARER

Keep pets/pests away from newly sown areas, fruit, vegetable and flower beds, children's play areas, patios etc. This project produces intense pulses of ultrasound which deter visiting animals.

- KIT INCLUDES ALL COMPONENTS, PCB & CASE
- EFFICIENT 100V TRANSDUCER OUTPUT
- COMPLETELY INAUDIBLE TO HUMANS



- UP TO 4 METRES RANGE
- LOW CURRENT DRAIN

**KIT 812..... £15.00**

### SIMPLE PIC PROGRAMMER

**KIT 857... £12.99**

Includes PIC16F84 chip disk, lead, plug, p.c.b., all components and instructions

Extra 16F84 chips £3.84 Power Supply £3.99

## MAGENTA BRAINIBOT I & II

- Full kit with ALL hardware and electronics
- As featured in *EPE* Feb '03 – KIT 910
- Seeks light, beeps, avoids obstacles
- Spins and reverses when 'cornered'
- Uses 8-pin PIC
- ALSO KIT 911 – As 910
- PLUS programmable from PC serial port – leads and software CD provided

**NEW**



**KIT 910 £16.99    KIT 911 £24.99**

## PIC 16F84 MAINS POWER 4-CHANNEL CONTROLLER & LIGHT CHASER

- ZERO VOLT SWITCHING
- OPTO ISOLATED 5 Amp
- 12 KEYPAD CONTROL
- HARD-FIRED TRIACS
- WITH SOURCE CODE
- SPEED & DIMMING POT.
- EASILY PROGRAMMED

**Kit 855 £39.95**

## PIC 16F84 LCD DISPLAY DRIVER

INCLUDES 1-PIC16F84 WITH DEMO PROGRAM SOFTWARE DISK, PCB, INSTRUCTIONS AND 16-CHARACTER 2-LINE

LCD DISPLAY

**Kit 860 £19.99**

Power Supply £3.99

FULL PROGRAM SOURCE CODE SUPPLIED – DEVELOP YOUR OWN APPLICATION!

Another super PIC project from: Magenta. Supplied with PCB, industry standard 2 LINE x 16-character display, data, all components, and software to include in your own programs. Ideal development base for meters, terminals, calculators, counters, timers – Just waiting for your application!

## 8-CHANNEL DATA LOGGER

As featured in Aug/Sept. '99 *EPE*. Full kit with Magenta redesigned PCB. LCD fits directly on board. Use as Data Logger or as a test bed for many other 16F877 projects. Kit includes programmed chip, 8 EEPROMs, PCB, case and all components.

**KIT 877 £49.95 inc. 8 x 256K EEPROMS**

## ICEBREAKER

□□□□□□□□□□

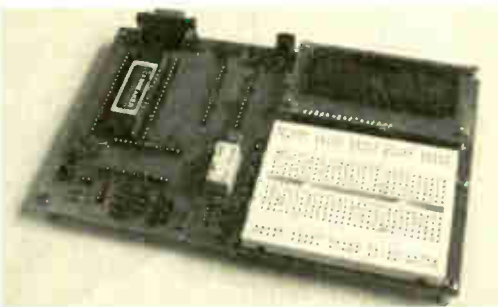

## PIC Real Time In-Circuit Emulator

- Icebreaker uses PIC16F877 in circuit debugger
- Links to Standard PC Serial Port (lead supplied)
- Windows™ (95+) Software included
- Works with MPASM and MPLAB Microchip software
- 16 x 2 L.C.D., Breadboard, Relay, I/O devices and patch leads supplied

As featured in March '00 *EPE*. Ideal for beginners AND advanced users. Programs can be written, assembled, downloaded into the microcontroller and run at full speed (up to 20MHz), or one step at a time.

Full emulation means that all I/O ports respond exactly and immediately, reading and driving external hardware.

Features include: Reset; Halt on external pulse; Set Breakpoint; Examine and Change registers, EEPROM and program memory; Load program, Single Step with display of Status, W register, Program counter, and user selected 'Watch Window' registers.

**KIT 900 ... £34.99**

POWER SUPPLY £3.99    STEPPING MOTOR 100 STEP £9.99

## EPE PIC TOOLKIT 3

**NEW**

- THE LATEST TOOLKIT BOARD – 8, 18, 28 AND 40-PIN CHIPS
- MAGENTA DESIGNED P.C.B. WITH COMPONENT LAYOUT AND EXTRAS
- L.C.D., BREADBOARD AND PIC CHIP INCLUDED
- ALL TOP QUALITY COMPONENTS AND SOFTWARE SUPPLIED

**KIT 880 ... £34.99 with 16F84 ... £39.99 with 16F877**

## PIC TOOLKIT V2

- SUPER UPGRADE FROM V1
- 18, 28 AND 40-PIN CHIPS
- READ, WRITE, ASSEMBLE & DISASSEMBLE PICS
- SIMPLE POWER SUPPLY OPTIONS 5V-20V
- ALL SWITCHING UNDER SOFTWARE CONTROL
- MAGENTA DESIGNED PCB HAS TERMINAL PINS AND OSCILLATOR CONNECTIONS FOR ALL CHIPS
- INCLUDES SOFTWARE AND PIC CHIP

**KIT 878 ... £22.99 with 16F84 ... £29.99 with 16F877**

## EPE PIC Tutorial

At last! A Real, Practical, Hands-On Series

- Learn Programming from scratch using PIC16F84
- Start by lighting I.e.d.s and do 30 tutorials to Sound Generation, Data Display, and a Security System.
- PIC TUTOR Board with Switches, I.e.d.s, and on board programmer

## PIC TUTOR BOARD KIT

Includes: PIC16F84 Chip, TOP Quality PCB printed with Component Layout and all components\* (\*not ZIF Socket or Displays). Included with the Magenta Kit is a disk with Test and Demonstration routines.

**KIT 870 .... £27.95, Built & Tested .... £42.95**

Optional: Power Supply – £3.99, ZIF Socket – £9.99

LCD Display ..... £7.99    LED Display ..... £6.99

Reprints Mar/Apr/May 98 – £3.00 set 3

## SUPER PIC PROGRAMMER

- READS PROGRAMS AND VERIFIES
- WINDOWS™ SOFTWARE
- PIC16C AND 16F – 6X, 7X, AND 8X
- USES ANY PC PARALLEL PORT
- USES STANDARD MICROCHIP
- HEX FILES
- OPTIONAL DISASSEMBLER SOFTWARE (EXTRA)
- PCB, LEAD, ALL COMPONENTS, TURNED-PIN SOCKETS FOR 18, 28, AND 40 PIN ICs

• SEND FOR DETAILED INFORMATION – A SUPERB PRODUCT AT AN UNBEATABLE LOW PRICE.

**Kit 862    £29.99**

Power Supply £3.99

**DISASSEMBLER SOFTWARE    £11.75**

## PIC STEPPING MOTOR DRIVER

INCLUDES PCB, PIC16F84 WITH DEMO PROGRAM, SOFTWARE DISC, INSTRUCTIONS AND MOTOR.

**Kit 863 £18.99**

FULL SOURCE CODE SUPPLIED ALSO USE FOR DRIVING OTHER POWER DEVICES e.g. SOLENOIDS

Another Magenta PIC project. Drives any 4-phase unipolar motor – up to 24V and 1A. Kit includes all components and 48 step motor. Chip is pre-programmed with demo software, then write your own, and re-program the same chip! Circuit accepts inputs from switches etc and drives motor in response. Also runs standard demo sequence from memory.

# MAGENTA

All prices include VAT. Add £3.00 p&p. Next day £6.99

Tel: 01283 565435    Fax: 01283 546932    E-mail: sales@magenta2000.co.uk

112003



Station Road, Cullercoats, Tyne & Wear, NE30 4PQ

Prices Exclude Vat @17%. UK Carriage £1.50 (less than 1kg) £3.50 greater than 1kg Cheques / Postal orders payable to ESR Electronic Components. PLEASE ADD CARRIAGE & VAT TO ALL ORDERS



See Next / Last Months Ad for COMPONENT ACCESSORIES

4000 Series

Table listing electronic components for the 4000 Series, including part numbers, descriptions, and prices.

74 Series

Table listing electronic components for the 74 Series, including part numbers, descriptions, and prices.

Linear ICs

Table listing linear integrated circuits, including part numbers, descriptions, and prices.

74LS Series

Table listing 74LS series components, including part numbers, descriptions, and prices.

74HC Series

Table listing 74HC series components, including part numbers, descriptions, and prices.

EPROM's

Table listing EPROM components, including part numbers, descriptions, and prices.

Large table listing various electronic components such as Bridge Rectifiers, A/D Converters, Voltage Regulators, Thyristors, Diodes, Transistors, and Capacitors, with columns for part numbers, descriptions, and prices.

We carry a large range of capacitors in stock, including: Ceramic, Mini Disc, Dipped Ceramic Multilayer, Dipped & Boxed Polyester, Mylar Film, Polystyrene, Plastic Film, MKT Polyester, Tantalum Bead, Sub-miniature Radial, 105°C Radial, Low Leakage Radial, Non Polarised Radial & Axial, PCB Cap Electrolytics, Polypropylene & Ceramic Trimmers and Tuning capacitors. Full technical details available.

Resistors - Please State Value Required: 1000's of one value only. 100's of one value only. 10's of one value only. 1's of one value only.

Preset Resistors - Please State Value Required: Enclosed, 10mm Square Horz / Vert. 100Ω - 1MΩ 0.15W. Skeleton, 10mm Dia. Horizontal. 100Ω - 1MΩ 0.1W.

Potentiometers - Please State Value Required: Single Gang 1/2" Shaft, 25mm Dia. 470Ω-2MΩ Linear. MultiTurn, 19mm Long End Adjust. 50Ω-500Ω-1MΩ 0.5W.

New Catalogue Out Now: Free with all orders or via the internet.

Tel: 0191 2514363 Fax: 0191 2522296 Email: sales@esr.co.uk http://www.esr.co.uk

# EVERYDAY PRACTICAL ELECTRONICS

THE No.1 MAGAZINE FOR ELECTRONICS TECHNOLOGY & COMPUTER PROJECTS

**VOL. 32 No. 11 NOVEMBER 2003**

**Editorial Offices:**  
EVERYDAY PRACTICAL ELECTRONICS EDITORIAL  
WIMBORNE PUBLISHING LTD., 408 WIMBORNE ROAD EAST,  
FERNDOWN, DORSET BH22 9ND  
Phone: (01202) 873872. Fax: (01202) 874562.

**Email:** enquiries@epemag.wimborne.co.uk  
**Web Site:** www.epemag.wimborne.co.uk  
**EPE Online** (downloadable version of EPE): www.epemag.com  
**EPE Online Shop:** www.epemag.wimborne.co.uk/shopdoor.htm  
See notes on **Readers' Technical Enquiries** below – we regret lengthy technical enquiries cannot be answered over the telephone.

**Advertisement Offices:**  
EVERYDAY PRACTICAL ELECTRONICS ADVERTISEMENTS  
MILL LODGE, MILL LANE,  
THORPE-LE-SOKEN, ESSEX CO16 0ED  
Phone/Fax: (01255) 861161 Email: epeads@aol.com

## COST

The Approximate Cost we give for projects is just that – approximate. We do not supply components for projects but we do make sure you can buy everything you need to build any of our projects – see *Shoptalk* for information on buying unusual items. However, the Approximate Cost we work out can vary over a very wide range. Take, for instance, the *PIC Random L.E.D. Flasher* by Andy Flind in this issue, if you buy the pre-programmed chip rather than programming it yourself and buy all the components from the most expensive supplier the cost could be as much a 50% more than we suggest. On the other hand if you program the PIC yourself, make your own p.c.b. using chemicals etc. you already have and buy the resistors and l.e.d.s in bulk then you could probably get the cost of the components down to about £7, or 65% of our Approximate Cost.

We tend to take the middle line and suggest what we feel is a reasonable price, including the cost of the p.c.b. from our *PCB Service*, but please don't take it as gospel and please be prepared to shop around for components. Also note that we do not include any minimum order charges or post and packing charges in any of our calculations.

## TEACH-IN

Sometimes pricing projects is difficult for various reasons and usually we will leave out the cost of the case because the price will vary so much with the style of case chosen. This month the price of components for the *Teach-In 2004* series has presented such a headache. The Components List shows what we expect to be the range of items needed but, because the designs of some of the later projects covered in the series are yet to be finalised, the list, particularly of Miscellaneous items, is still a little vague.

There is also the point that few readers will wish to build every project in the series and, even if they do, it is unlikely that they will want to complete them all in exactly the same way as we describe. After all, half the fun of project building is in tailoring the design to meet your own specific needs. With this in mind, we have priced the “regular” components for *Teach-In* (those that most readers will require) whilst leaving out the more specialised items under Miscellaneous which will be needed to build some of the later projects like the Electronic Lock or Automatic Curtain Winder. Thus the Approximate Cost that is shown will allow readers to follow the series but not to build some of the later projects.

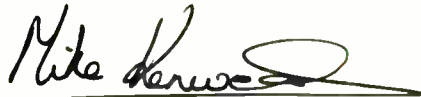

## AVAILABILITY

Copies of *EPE* are available on subscription anywhere in the world (see opposite), from all UK newsagents (distributed by COMAG) and from the following electronic component retailers: Omni Electronics and Yebo Electronics (S. Africa). *EPE* can also be purchased from retail magazine outlets around the world. An Internet on-line version can be purchased and downloaded for just \$10.99US (approx £7) per year available from [www.epemag.com](http://www.epemag.com)

## SUBSCRIPTIONS

Subscriptions for delivery direct to any address in the UK: 6 months £16.50, 12 months £31, two years £57; Overseas: 6 months £19.50 standard air service or £28.50 express airmail, 12 months £37 standard air service or £55 express airmail, 24 months £69 standard air service or £105 express airmail. To subscribe from the USA or Canada see the last magazine page.

Online subscriptions, for downloading the magazine via the Internet, \$10.99US (approx £7) for one year available from [www.epemag.com](http://www.epemag.com).

Cheques or bank drafts (in £ sterling only) payable to *Everyday Practical Electronics* and sent to EPE Subs. Dept., Wimborne Publishing Ltd. 408 Wimborne Road East, Ferndown, Dorset BH22 9ND. Tel: 01202 873872. Fax: 01202 874562. Email: subs@epemag.wimborne.co.uk. Also via the Web at: <http://www.epemag.wimborne.co.uk>. Subscriptions start with the next available issue. We accept MasterCard, Amex, Diners Club, Switch or Visa. (For past issues see the *Back Issues* page.)

## BINDERS

Binders to hold one volume (12 issues) are available from the above address. These are finished in blue p.v.c., printed with the magazine logo in gold on the spine. Price £6.95 plus £3.50 p&p (for overseas readers the postage is £6.00 to everywhere except Australia and Papua New Guinea which cost £10.50). Normally sent within seven days but please allow 28 days for delivery – more for overseas.

Payment in £ sterling only please. Visa, Amex, Diners Club, Switch and MasterCard accepted. Send, fax or phone your card number, card expiry date and card security code (the last 3 digits on or just under the signature strip), with your name, address etc. Or order on our secure server via our UK web site. Overseas customers – your credit card will be charged by the card provider in your local currency at the existing exchange rate.

**Editor:** MIKE KENWARD

**Deputy Editor:** DAVID BARRINGTON

**Technical Editor:** JOHN BECKER

**Business Manager:** DAVID J. LEAVER

**Subscriptions:** MARILYN GOLDBERG

**Administration:** FAY KENWARD

**Editorial/Admin:** (01202) 873872

**Advertisement Manager:**

PETER J. MEW, (01255) 861161

**Advertisement Copy Controller:**

PETER SHERIDAN, (01202) 873872

**On-Line Editor:** ALAN WINSTANLEY

**EPE Online** (Internet version) **Editors:**

CLIVE (MAX) MAXFIELD and ALVIN BROWN

## READERS' TECHNICAL ENQUIRIES

E-mail: techdept@epemag.wimborne.co.uk

We are unable to offer any advice on the use, purchase, repair or modification of commercial equipment or the incorporation or modification of designs published in the magazine. We regret that we cannot provide data or answer queries on articles or projects that are more than five years old. Letters requiring a personal reply *must* be accompanied by a **stamped self-addressed envelope or a self-addressed envelope and international reply coupons.**

## PROJECTS AND CIRCUITS

All reasonable precautions are taken to ensure that the advice and data given to readers is reliable. We cannot, however, guarantee it and we cannot accept legal responsibility for it. A number of projects and circuits published in *EPE* employ voltages than can be lethal. **You should not build, test, modify or renovate any item of mains powered equipment unless you fully understand the safety aspects involved and you use an RCD adaptor.**

## COMPONENT SUPPLIES

**We do not supply electronic components or kits for building the projects featured, these can be supplied by advertisers (see *Shoptalk*). We advise readers to check that all parts are still available before commencing any project in a back-dated issue.**

## ADVERTISEMENTS

Although the proprietors and staff of EVERYDAY PRACTICAL ELECTRONICS take reasonable precautions to protect the interests of readers by ensuring as far as practicable that advertisements are *bona fide*, the magazine and its Publishers cannot give any undertakings in respect of statements or claims made by advertisers, whether these advertisements are printed as part of the magazine, or in inserts.

The Publishers regret that under no circumstances will the magazine accept liability for non-receipt of goods ordered, or for late delivery, or for faults in manufacture.

## TRANSMITTERS/BUGS/TELEPHONE EQUIPMENT

We advise readers that certain items of radio transmitting and telephone equipment which may be advertised in our pages cannot be legally used in the UK. Readers should check the law before buying any transmitting or telephone equipment as a fine, confiscation of equipment and/or imprisonment can result from illegal use or ownership. The laws vary from country to country; readers should check local laws.



# PIC RANDOM L.E.D. FLASHER

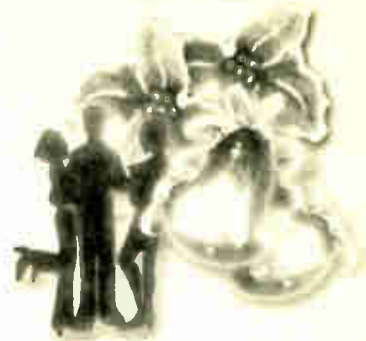

**ANDY FLIND**

*Enjoy the fun of an interesting and attractive pattern display*

**F**OR many years the author has wondered if a bunch of l.e.d.s flashing at apparently random intervals might produce an interesting and attractive display. Occasionally consideration was given to the construction of a suitable circuit, but the project always foundered because of the complexity of the electronics required.

As with so many other ideas, the PIC microcontroller has changed this since much of the complexity can now be achieved at virtually no cost (other than time!) through software. Since the PIC outputs can supply sufficient current to drive l.e.d.s directly, the hardware consists of just a PIC, some clock components and the l.e.d.s with their current limiting resistors.

## A RANDOM NUMBER

In addition, since the random pattern generating software takes up only part of the PIC's program memory, a conventional pattern sequence can be included with a pushbutton switch to make the selection.

Electronics is an exact science of course, and a truly random output is difficult to achieve. When Premium Bonds were introduced many years ago a large and costly computer system was developed to make the random winning selections. This was called *Emie*, an acronym for Electronic Random Number Indicating Engine, and was probably intended to impress the prospects.

Today's punters must be less easily impressed because the National Lottery has reverted to a sort of tombola machine in which the technology consists of numbered balls in a drum! Most "random" projects for home construction, such as electronic dice, rely on external factors such as tiny variations in the period for which the user presses a switch and do not actually generate a random output of their own.

## PRBS GENERATOR

A method of producing an apparently random stream of digital bits is to use a PRBS generator. The acronym stands for

Pseudo Random Bit Sequence and, as *pseudo* implies, the output is not truly random, it is a regularly repeating sequence. However, the sequence is so long that it seems to be random and PRBSs are increasingly being found in noise generation and other randomising circuits.

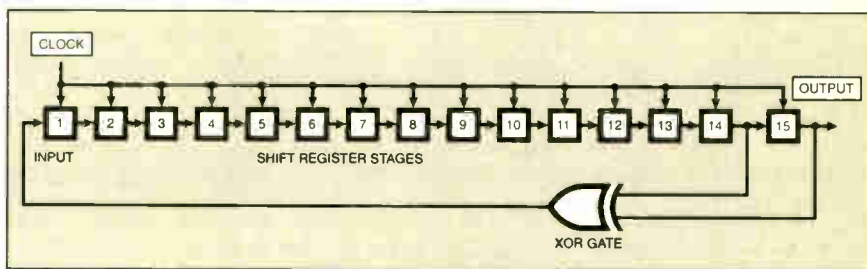

Fig. 1. Block schematic of the Pseudo Random Bit Sequence Generator.

A PRBS normally consists of a shift register with taps at one or more stages, the outputs of which are exclusive-ORed (XOR) with the output and fed back into the input. When the register is clocked, the resulting output is a stream of high and low bits with a fixed sequence, but the pattern of this sequence can be so long before it is repeated that for most purposes it appears to be random.

The actual length of the sequence depends on the number of shift register stages and the tapping points. For any given number of register stages there is an optimum tapping arrangement to obtain the longest sequence. The mathematics for finding this are complex, but fortunately the required factors are readily available from various books.

Two such sources are *The CMOS Cookbook* and *The Art of Electronics*.

though no doubt there are others. Digital audio "noise" generation usually requires a hardware circuit clocked at fairly high speed, but for randomly flashing some l.e.d.s the speed can be much lower and the PRBS itself can be implemented using software in a PIC.

## VIRTUAL RANDOMNESS

The PRBS in this design uses a "virtual" shift register with fifteen stages, tapped at stage fourteen, as shown in the block diagram of Fig. 1. This produces a sequence of over thirty two thousand steps, so there is little chance of a pattern being noticed in flashing l.e.d.s driven by it.

The way in which the PRBS is implemented in software is illustrated in the flow diagram of Fig. 2. Two 8-bit PIC registers, named in the software as SR1 and SR2, are used as the shift register. The last, or MSB (most significant bit), bit of SR2 is ignored as only fifteen bits are required.

A third register named EXOR is used for implementing the XOR function. To "step" the PRBS register, EXOR is initially cleared. Then the state of SR2 bit 5 (stage 14 of the shift register) is read and if it is high, EXOR is incremented. The same

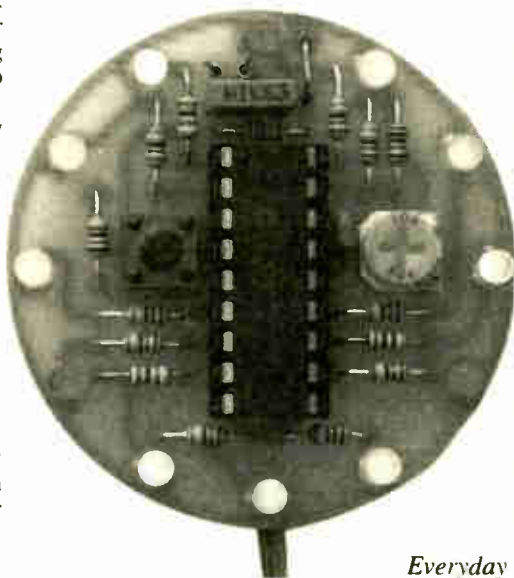

is done for SR2 bit 6 (stage 15, or the output).

If only one of these two bits is high, bit 0 (LSB - least significant bit) of EXOR will be high, but if neither or both are high it will be zero, so the state of this bit represents the XORed result of bits 5 and 6 of SR2, stages 14 and 15 of the shift register.

If EXOR is high, the STATUS CARRY bit is now set, if low, it is cleared. This becomes the input to the shift register when SR1 and SR2 are sequentially rotated left, the equivalent of clocking a hardware shift register. All of this requires just eleven lines of assembly code, including the RETURN statement since it is written as the subroutine, SHIFT. The statement CALL SHIFT is now all that is required to clock the virtual PRBS.

## ILLEGAL

A feature of PRBS generators is that there is usually an "illegal state" in which, depending on the design, all logic 0s or logic 1s are continuously circulating. Precautions must be taken to prevent this condition from occurring.

At the beginning of the random program a check is made for an "all zero" state in SR1 and SR2, and if this is detected SR1 is pre-loaded with a pattern. This is only done when such a state is detected as normally the random patterns found in these registers at power-up will contribute to the apparently random output from them.

## RANDOMISED FLASHING

Now that the PRBS has been implemented, the next step is to translate its output into randomly flashing l.e.d.s. The

method for this is shown in the flow diagrams of Fig.3 and Fig.4, which show the action for the first l.e.d.

The flow chart in Fig.3 illustrates the decision as to whether the first l.e.d. output should be updated. It starts by stepping the PRBS. Then it decrements register TM1, used as a counter. If this has reached zero the output subroutine for the first l.e.d. (LED1) is called, otherwise the program continues on to the next l.e.d.

Assuming the output subroutine of Fig.4 is called, firstly LED1 is turned on if the output of the PRBS is high, or off if it is low. Next the first three bits of register SR1 of the PRBS are taken and one is added to their value to give an apparently random factor between 1 and 8, which is placed into the counter TM1.

Program control then returns to the main loop where it continues by performing the same process for LED2 through LED12. The overall result is a random number of from one to eight complete loops between the updating of each l.e.d., and a random selection of whether each will be on or off after each update. Consequently, the effect is about as random as can be achieved with such a simple program.

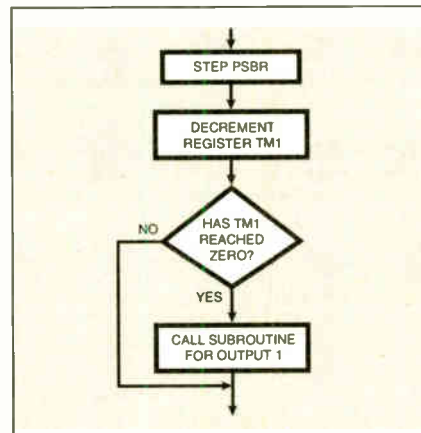

Fig.3. Output action decision making.

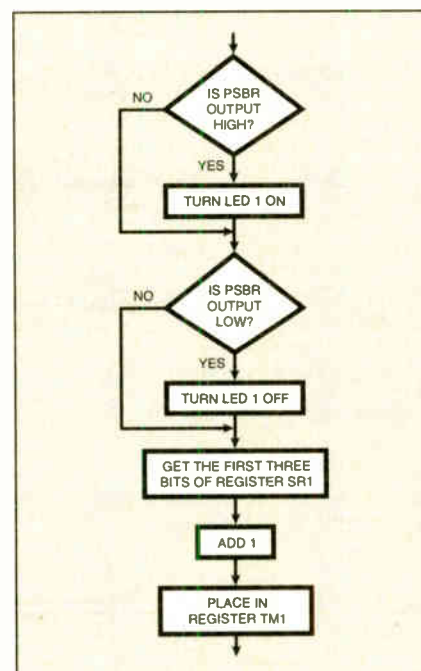

Fig.4. Flow diagram showing the output process.

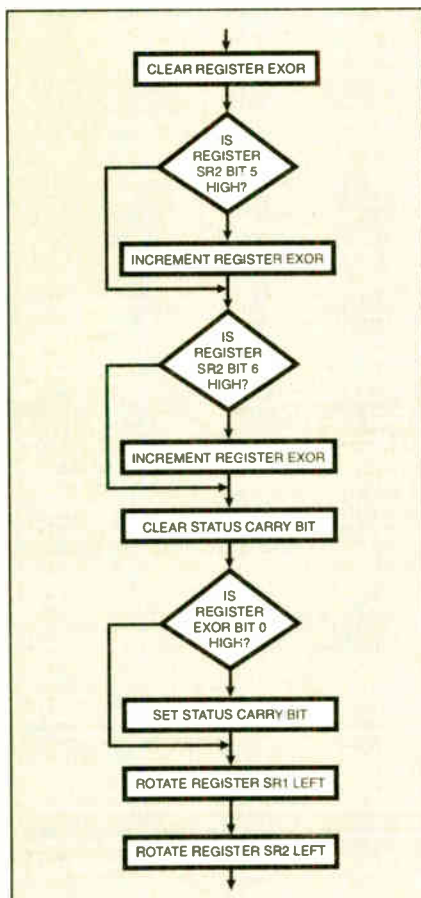

Fig.2. Pseudo random bit sequence generator in software.

## COMPONENTS

### Resistors

R1 R2 10k (2off)

R3 4k7

R4, R5, R7 to R9,

R11 to R13,

R15 390Ω (9 off)

R6, R10,

R14 100Ω (3 off)

All 0.25W 5% carbon film or better.

### Potentiometer

VR1 100k sub-min enclosed preset, 6mm, round

### Capacitors

C1 1n resin-dipped ceramic, 2.5mm pitch

C2 100n polyester layer or resin-dipped ceramic, 5mm pitch

### Semiconductors

D1, D5, D9 3mm yellow l.e.d., low-current, (3 off)

D2, D6, D10 3mm red l.e.d., low-current, (3 off)

D3, D7, D11 3mm blue l.e.d., hi-intensity, diffused, (3 off)

D4, D8, D12 3mm green l.e.d., low-current, (3 off)

IC1 PIC16F84 microcontroller, pre-programmed (see text)

### Miscellaneous

S1 push-to-make tactile switch, projected shaft, p.c.b. mounting

Printed circuit board, available from the EPE PCB Service, code 424; 18-pin d.i.l. socket; battery clip to hold 4 x AAA cells; solder etc.

Approx. Cost Guidance Only

**£11**  
excl. batts

The overall speed at which the program runs is determined by the system clock, which depends upon the values of a capacitor and a user-adjustable Speed control preset (VR1), wired as a variable resistor.

## SET PATTERN

The remaining program space in the PIC is used to implement a pattern sequence for the l.e.d.s as a change from the random effect, should this be desired. The patterns are all of the "turn it on, wait a bit, turn it off" variety, some using a couple of subroutines which rotate the whole pattern clockwise or anti-clockwise. A simple delay subroutine is used to achieve a suitable speed range from the clock used for the random pattern.

the clock speed between approximately 7.5kHz and 54kHz, internally divided by four by the PIC for its system clock.

Pin MCLR of the PIC, IC1, is normally connected to the positive supply by R3. The PIC is programmed to start the random sequence automatically at power-up but switch S1, in conjunction with pullup resistor R2, allows RA4 to be pulled low by the user to toggle between the output patterns.

The link shown on the circuit diagram can be replaced with a switch to enable in-circuit programming for constructors with programmers who would like to create new patterns of their own.

The patterns are very subjective in effect and it is hard to know whether one will

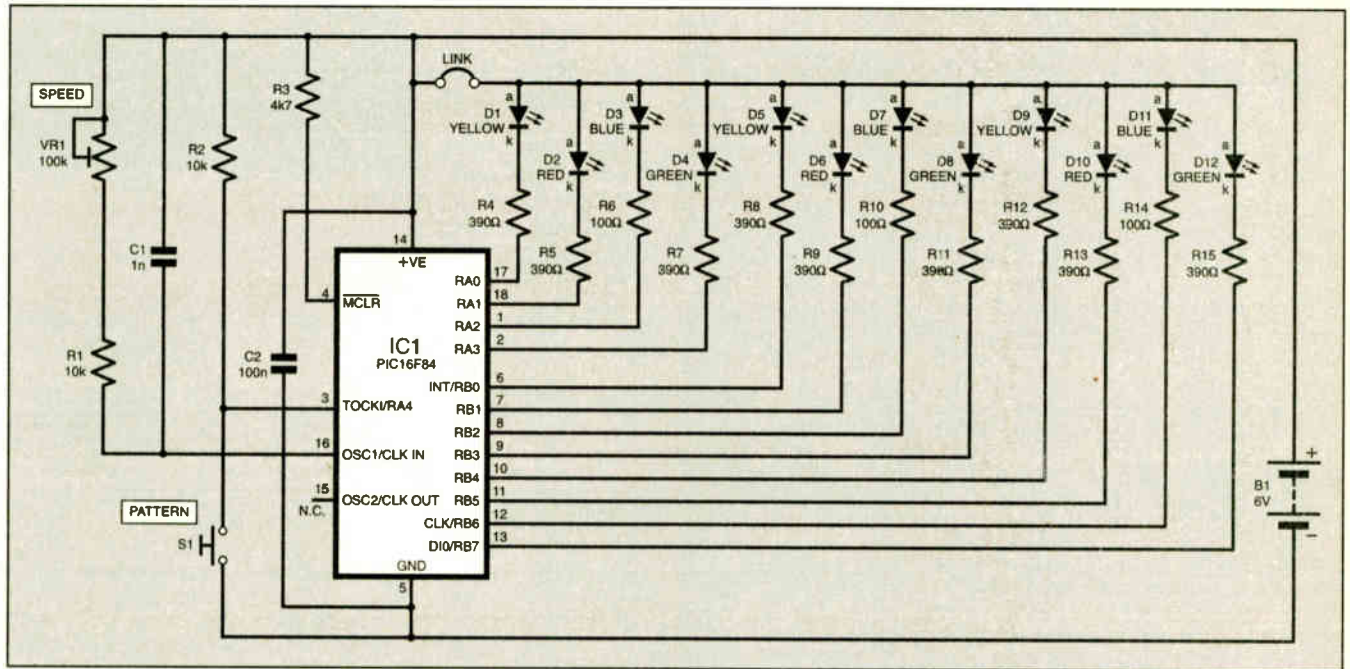
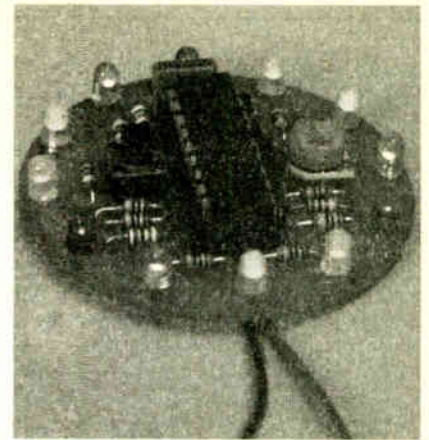

Fig.5. Complete circuit diagram for the PIC Random L.E.D. Flasher.

PIC output RA4 was not used for l.e.d. driving since its open-drain output can present difficulties. Thirteen l.e.d.s would be harder than twelve to combine into patterns, and some readers might consider thirteen unlucky!

This left RA4 available for use as an input to select the output pattern. Initially this was done by polling it, but polling often results in a short delay so an indication of some kind is needed to tell the user when the button press has been recognised. It is better to use an interrupt procedure, but RA4 cannot of itself be used to generate an interrupt.

However, it can be configured to increment the internal counter TMR0, which in turn can cause an interrupt. To do this, TMR0 is pre-loaded with 255 and enabled as an interrupt source, after which the first press of a pushswitch connected to RA4 will cause it to "roll over" and generate a jump to the interrupt routine. Here the usual switch debouncing is carried out, the output program is selected and the routine also provides a further output state where all twelve l.e.d.s are turned on simultaneously.

## FULL CIRCUIT

The full circuit diagram for the PIC Random L.E.D. Flasher shown in Fig.5 needs little explanation. Preset VR1 and resistor R1 together with capacitor C1 set

look pleasing or not until it is actually running, so a quick way of doing this is essential when programming. Resistors R4 to R15 limit the current through l.e.d.s D1 to D12. The red, yellow and green l.e.d.s are low-current types for which 390Ω resistors give about the right brilliance.

Three of the l.e.d.s used in the prototype are blue types, however. These have a higher forward voltage drop of about 3.6V so their resistors have the lower value of 100Ω. The use of blue l.e.d.s is not essential, but they do look spectacular and for decorative purposes are recommended.

No on-off switch is shown, because the prototype does not have one! Instead it is connected with a lead to a pack of four AAA cells giving 6V, and this is simply unclipped to switch the unit off.

## CONSTRUCTION

The project is built on a circular printed circuit board just 43mm in diameter, as shown in Fig.6. This board is available from the *EPE PCB Service*, code 424.

Little needs to be said regarding construction save that the easiest method is to fit the link and all the resistors, then a d.i.l. socket for IC1, followed by the capacitors, switch S1 and preset VR1, and finally the l.e.d.s, taking care with their polarity.

The tactile switch has four connections in the form of two pairs. Each pair is

connected together, so it may be necessary to check for correct orientation with a meter before fitting it. The power supply lead is soldered to the rear of the prototype board.

Testing consists of simply plugging in a programmed PIC and powering up with a supply of around 6V. when the random pattern should appear immediately. Preset VR1 can be used to adjust the overall speed to taste, and S1 should switch sequentially between random, patterns and "all on".

Since the design was initially intended to be used in the form of a badge, the solder side was filed very lightly to remove projecting bits and lower the profile. It may be attached to just about any type of badge with an insulating surface, using Blu-Tac or double-sided adhesive tape.

## IN-SITU PROGRAMMING

For in-situ programming the arrangement shown in Fig.7 can be used. With the prototype the unit was connected as shown to a version of John Becker's excellent *Toolkit TK3* board (Oct/Nov '01). It was powered by the 5V supply from this, giving it a common ground connection with *Toolkit*.

The link referred to in Fig.5 was replaced with a switch which, when open, prevents loading of the Clock and Data signals going to pins RB6 and RB7. The Vpp connection was made directly to MCLR,



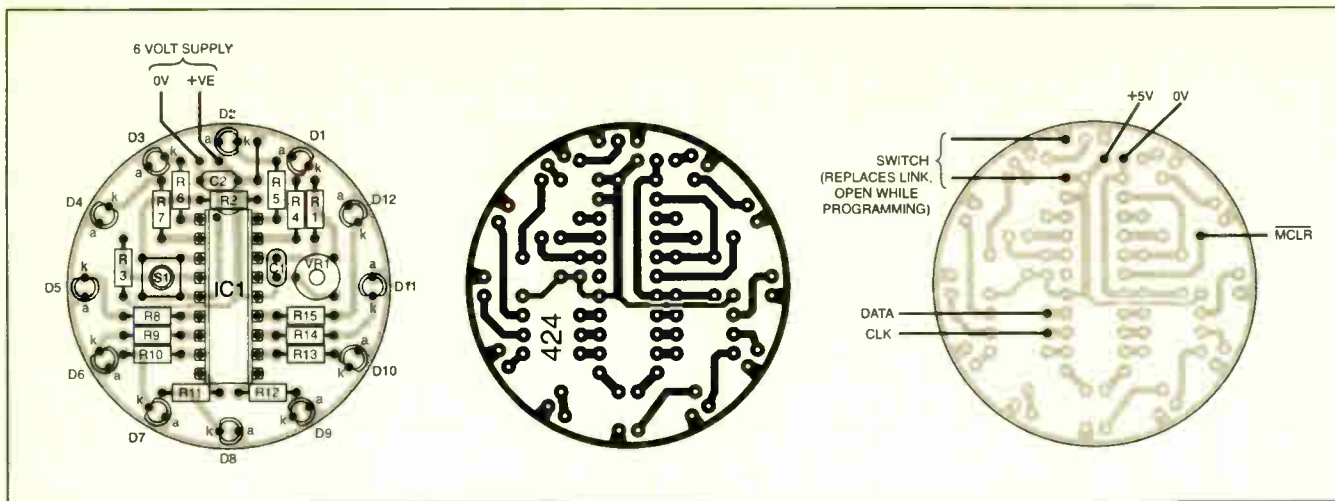

Fig.6. Printed circuit board component layout and full-size underside copper foil master.

Fig.7. Connection details for in-circuit programming of the PIC microcontroller – see text.

pin 4, and appears to override the voltage applied through resistor R3 without problems when programming.

Some care may be needed when using the original *TK3* design which has a 78L05 regulator, which may warm up a bit when loaded by the i.e.d.s. The author's version uses a 7805 on a small heatsink in place of this!

An alternative to this setup would be to arrange a bunch of low-current i.e.d.s in the intended pattern, perhaps a circle like that of this project, and connect them to the outputs of *TK3* with suitable series resistors, say 680Ω each. This would give enough output for them to be visible whilst avoiding any risk of overload, and the PIC could be simply inserted into the project when the programmer was happy with the results achieved.

### SOFTWARE

It should be noted that the ASM listing has been written in TASM and is not compatible with MPASM-type programmers without translation. *Toolkit TK3* can perform this translation.

The HEX file supplied is in MPASM format and can be used with any MPASM-type programmer without modification.

The software is available from the *EPE PCB Service* on 3.5in disk, for which a nominal handling charge applies. It is also available for free download from the *EPE Downloads* page, accessible via the home page at [www.epemag.wimbborne.co.uk](http://www.epemag.wimbborne.co.uk).

Pre-programmed PICs are available as stated on this month's *Shoptalk* page.

### EYE-CATCHING ALTERNATIVES

Although the i.e.d.s in this project are fitted directly to the board this is obviously not essential and many eye-catching alternative arrangements could be devised for this little project. It could be used for festive decorations, novelties or in an advertising display, or perhaps as a toy to keep children amused.

Several of them might make a really attractive Christmas tree decoration and the author is giving this serious thought for this year's festivities! Another suggestion is to place the unit behind a diffuser of some kind, even a sheet of white paper. This softens the light and hides the board, producing a really intriguing and attractive effect. □

**FREE Catalogue Available On Request**



WCN Supplies • Dept EPE • The Old Grain Store • Rear Of 62 Rumbridge Street • Totton • Southampton • SO40 9DS  
Telephone or Fax On Southampton 023 8066 0700 • Email: [info@wcnsupplies.fsnet.co.uk](mailto:info@wcnsupplies.fsnet.co.uk)

**Telephone, Fax Or Email For Your Free Catalogue**

## SINGLE-USE DIGITAL CAMERAS

Handy snapping takes another step forward – but who owns the technology's patent? asks Barry Fox

**S**INGLE-USE digital cameras are now going on sale in the US from Dakota Digital. The camera costs \$11 and the prints cost another \$11. Already two companies are claiming patent rights on the basic idea and more are likely to come out of the woodwork.

Pure Digital Technologies of San Francisco is hoping to win potentially very valuable worldwide rights with patents filed in September 2001 (WO 03/024083). Instead of film, the recyclable camera has a memory chip; instead of cracking open the camera to process the film, a lab sucks out the stored images and makes paper prints.

Pure Digital claims legal monopoly on "a limiting-use component" that "limits use to a single use cycle". To stop people re-using the camera and making their own prints with a home computer, the patented camera uses non-standard connections and digital coding. So, in theory at least, only an approved print centre can access the pictures, charge for prints and wipe the camera's memory clean for re-use.

Meanwhile DVC (Australia) of Auckland in New Zealand also has world filings on a similar theme, dated November 2001 (WO 03/047245). Encryption is used to lock the recording inside the camera.

### Cardboard Video

DVC is the same company, then called Disposable Video Camcorders, that was patenting (WO 98/26586) a throw-away video camcorder five years ago.

The idea then was to cut the cost by avoiding the need to lace the tape round the recording heads and rewind it. The DVC plan was to make the body from reinforced cardboard, with a simple recording mechanism and factory-loaded cassette tape. The lens and image sensor could either be cheap, with low resolution, or easily replaceable.

A tourist who had forgotten to bring a camcorder on holiday, would buy a disposable unit, shoot a video and then either throw it away or return it to a reconditioning centre for credit. To stop people trying to beat the system and re-loading their own tapes, the cardboard camcorder was to be sold with a seal which must be broken to remove the cassette. This shorts an electrical circuit to melt a plastic guide pin without which the tape cannot run. The cardboard camcorder did not need a battery. Instead it used a clockwork motor to drive the tape and power the video circuitry.

Cardboard clockwork cameras never caught on, but disposable digital

cameras might. If so there could be patent battles ahead, with lawyers trying to prove who did, said and wrote what first.

Intriguingly, Pentax and Sanyo announced plans in Japan in October 2001, between the filing dates of the two world patent applications. Very probably Pentax and Sanyo had by then filed their own patent applications.

### FML'S CAT

THE latest copy of FML Electronics' catalogue has been received, offering as usual the wide variety of electronic components that all enthusiasts need, including good ranges of semiconductors and passive devices. It's a useful cat to have on your workbench – 18 pages of A4 cram-packed with products. Tel: 01677 425840.

## CHALLENGE THE ROBOTS!

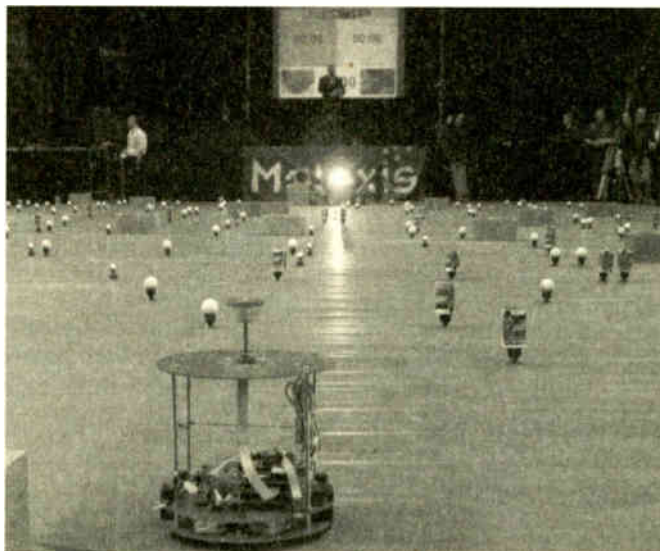

Can you build a robot car and enter a challenge? If you can then why not enter the Melexis Safety Trophy 2004! Belgian microelectronics Melexis company and the Flemish hands-on centre for science and technology Technopolis are organising the second edition of this international contest. The participants build a robot car that is able to negotiate an obstacle course as safely as possible by means of sensors and software.

The next Melexis Safety Trophy takes place on 24 and 25 April 2004 in the Brabant, close to Leuven, Belgium. In several heats the robots must attempt to negotiate a 20-metre by 10-metre route as quickly as possible. In this they will encounter obstacles placed through the route: bricks, warm and cold cans, as well as another robot. Colliding with warm cans (or with a bit of imagination, pedestrians!) and with the other robot yields penalty time. Knocking over cold cans on the other hand is rewarded with bonus time. In addition, road signs indicate where many cold and warm cans are located along the route.

Students and hobbyists may participate for free. Moreover, Melexis will provide them with sensors and test signs and on-line advice. Those who register before 31 October will receive a free pack of Melexis sensors. Participants may also use other sensors from any manufacturer. Not only will the three fastest robots win prizes, but the best looking, the most innovative, and the unluckiest robots, will also be rewarded.

The idea for this competition was inspired by the quick growth of active safety applications in cars, to practically acquaint creative students and hobbyists with this fascinating but complex issue. It might even yield usable ideas for real applications as the contest is just a simplified simulation of a real traffic situation.

More information on the competition, its prizes valued at 10,000 Euros, the previous edition, products etc. can be found at [www.melexis.com/trophy](http://www.melexis.com/trophy).

## TINY CCD CAMERA

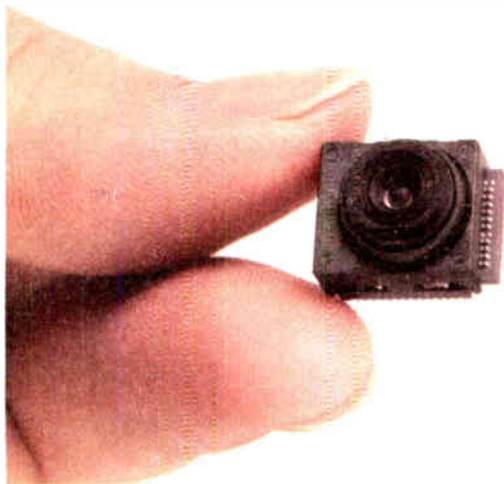

SHARP have developed a mega-pixel CCD camera module said to be the smallest (1.44cc) and thinnest (9.7mm) in the industry. This module makes it possible to incorporate mega-pixel class cameras into mobile phones with minimal changes to their current standard size and thickness.

The number of output pixels is 1144(H) x 880(V), the maximum frame rate is 7.5fps, power consumption 650mW, and the lens number F2.8.

For more information browse [www.sharpsme.com](http://www.sharpsme.com).

## OBSERVANT DATASTATION

OBSERVANT Electronics tell us that they have released a new development board for their range of DataStation products, making them even easier to use. The new board, which can be "piggy-backed" onto any standard DataStation module, gives the user full control of its analogue and digital I/Os while still allowing access to the screw terminals.

DataStation is a family of software-configurable, mixed signal I/O products that bring unique flexibility to control and data acquisition applications. By combining software-configurable channels with a compact instruction set, the DataStation family overcomes the two main problems of traditional serial I/O solutions: limited choice of channel configurations, and low sample rates.

Delivering a 12-bit sample rate of greater than 500 samples a second, DataStation is suitable for applications as diverse as machine control, industrial automation, environmental monitoring and robotics, making it possible for designers to meet the needs of virtually any application with just one software compatible family of products.

DataStation's 16 software-configurable channels can be configured to give any combination of up to six analogue inputs (with selectable 8-bit or 12-bit resolution), two PWM outputs, 16 digital inputs and 16 digital outputs, giving a total of 391 different I/O configurations from a single product.

DataStation can be purchased in one-off quantities online for £89.00 + VAT and £2.95 P&P (per order). The user manual and software development tools, templates and examples can be downloaded free of charge from Observant's website.

For more information contact Observant Electronics Ltd., Dept EPE, Unit F2B, Avonside Enterprise Park, Melksham SN12 8BS. Tel: 01225 704631. Web: [www.ObservantWorld.com](http://www.ObservantWorld.com).

## ROTO-VIEWING MOBILES

INNOVENTIONS, a Houston-based private company, has developed a new display "tilt-navigation" technology for PDAs, cell phones and other devices. With RotoView enabled, the user overcomes the display navigation challenge by simply changing the orientation at which the device is held.

It has been developed to answer the demand for cell phone manufacturers to pack more and more information into their tiny displays.

For more information browse [www.rotoview.com](http://www.rotoview.com).

# YOU WON'T GET YOUR FINGERS BURNT

It may surprise you but buying an Antex soldering iron costs less than you think in the long run. British made to exacting standards, they last significantly longer than imported brands. And with a wide range of thermally balanced soldering irons, you can pick up a "fixed temperature" or "in-handle" temperature model that will suit your needs perfectly.

None of which will burn a hole in your pocket.

If your hobby demands the best iron for the job but you don't want to get your fingers burnt by the cost, visit our website or your electronics retailer for the coolest models around.

Pick up an

**ANTEX**  
Not just any old iron.



[www.antex.co.uk](http://www.antex.co.uk)

2 Westbridge Industrial Estate Tavistock  
Devon PL19 8DE Tel 01822 613565

# INGENUITY UNLIMITED



Our regular round-up of readers' own circuits. We pay between £10 and £50 for all material published, depending on length and technical merit. We're looking for novel applications and circuit designs, not simply mechanical, electrical or software ideas. Ideas *must be the reader's own work and must not have been submitted for publication elsewhere*. The circuits shown have NOT been proven by us. *Ingenuity Unlimited* is open to ALL abilities, but items for consideration in this column should be typed or word-processed, with a brief circuit description (between 100 and 500 words maximum) and full circuit diagram showing all relevant component values. **Please draw all circuit schematics as clearly as possible.** Send your circuit ideas to: *Ingenuity Unlimited*, Wimborne Publishing Ltd., 408 Wimborne Road East, Ferndown Dorset BH22 9ND. (We do not accept submissions for *IU* via E-mail.) Your ideas could earn you some cash and a prize!

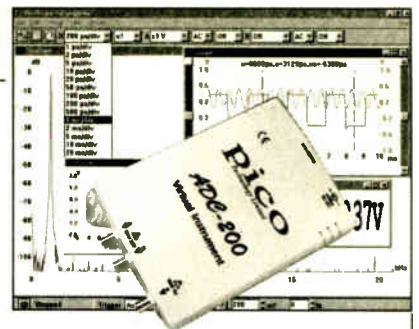

## WIN A PICO PC BASED OSCILLOSCOPE WORTH £586

- 100MS/s Dual Channel Storage Oscilloscope
- 50MHz Spectrum Analyser
- Multimeter • Frequency Meter
- Signal Generator

If you have a novel circuit idea which would be of use to other readers then a Pico Technology PC based oscilloscope could be yours. Every 12 months, Pico Technology will be awarding an ADC200-100 digital storage oscilloscope for the best IU submission. In addition, a DrDAQ Data Logger/Scope worth £69 will be presented to the runner up.

## THREE-COMPONENT METAL DETECTOR - TRI-UMPHAL TREASURE

THE circuit shown in Fig.1 must represent the limits of simplicity for a metal detector – yet the design works surprisingly well. It uses just one 40106 hex Schmitt inverter i.c., a capacitor, and a search coil – and of course the batteries. A lead from IC1b pin 4 needs to be attached to a medium wave (MW) radio aerial, or it should be wrapped around the radio.

As shown, the metal detector gives a respectable range for beat frequency operation (b.f.o.) – up to 90mm for a bottle-top. In fact, for the ultimate in simplicity, capacitor C1 may be omitted. In this way the author achieved an amazing 150mm range for the bottle-top. However, with the frequency then being raised to more than 4MHz, instability becomes a significant problem.

As shown, the circuit oscillates at around 230kHz. One may also experiment with the

frequency by changing the value of C1. A Faraday shield may be added to reduce ground effect and capacitive coupling, and this is wired to 0V.

Since an inductor resists rapid changes in voltage (called reactance), the charging of capacitor C1 is slightly delayed as the logic level at IC1a pin 2 changes. This sets up a rapid oscillation, which is picked up by a MW radio. Any changes in the inductance of the search coil (through the presence of metal) bring about a change to the oscillator frequency. Although 230kHz is out of range of the Medium Wave band, an MW radio will clearly pick up harmonics of this frequency. IC1b serves as a buffer.

The making of search coil L1 allows a lot of room for error, and is far from critical. The author used seventy turns of 30s.w.g. (0.315mm) enamelled copper wire on a 120mm diameter former.

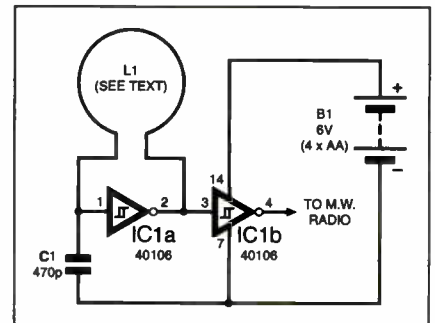

Fig.1. Three-component Metal Detector circuit.

The metal detector is set up by tuning the MW radio to pick up a whistle (a harmonic of 230kHz). Not every such harmonic works well, and the most suitable one needs to be found. The presence of metal will clearly change the tone of the whistle.

Thomas Scarborough, South Africa

## EMERGENCY LIGHT - BRIGHTENING AUNTY

THE idea for this circuit came when I was repairing my aunt's emergency light. Bulb-based emergency lighting has a low efficiency and ultrabright l.e.d.s provide greater efficiency and more illumination, with a much extended battery life. It was therefore decided to change from a 12V light bulb to a pack of l.e.d.s.

To get constant light, a constant voltage technique was adopted, using the circuit in Fig.2. For more power saving, step-down switching is used in preference to step-up. This function is provided by IC1 in conjunction with diode D3, inductor L1 and capacitors C3 and C4.

The resulting output is a stable 5V and powers the 12 ultrabright yellow l.e.d.s D4 to D15. The l.e.d.s are grouped in pairs, each pair buffered by a resistor, R4 to R9. Diode D3 is a high-efficiency type – do not change it to a 1N4000 series type as they are less efficient in this role.

The network consisting of R1 and D1 is a power-on indicator. The network around VR1, TR1, R2, R3 and D2 is a low-battery indicator. Preset VR1 should be adjusted until l.e.d. D2 turns on when the battery voltage is low.

Inductor L1 should be a toroid type in order to reduce radiated r.f. interference caused by the switching regulator IC1. It should be glued to the circuit board to prevent it from vibrating.

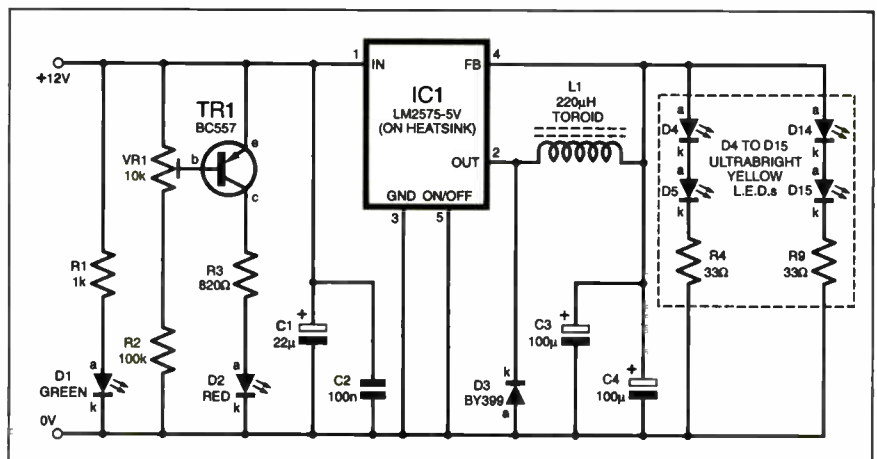

Fig.2. Circuit diagram for an Emergency L.E.D. Light.

A small heatsink should be fitted to IC1. The circuit efficiency was found to be around 80%, i.e. about 10% better than with the step-up switching technique. The circuit operates for about four times longer than the bulb-based one in respect of battery life.

Myo Min, Yangon, Myanmar

# Power Supply Tester – Taking the Strain

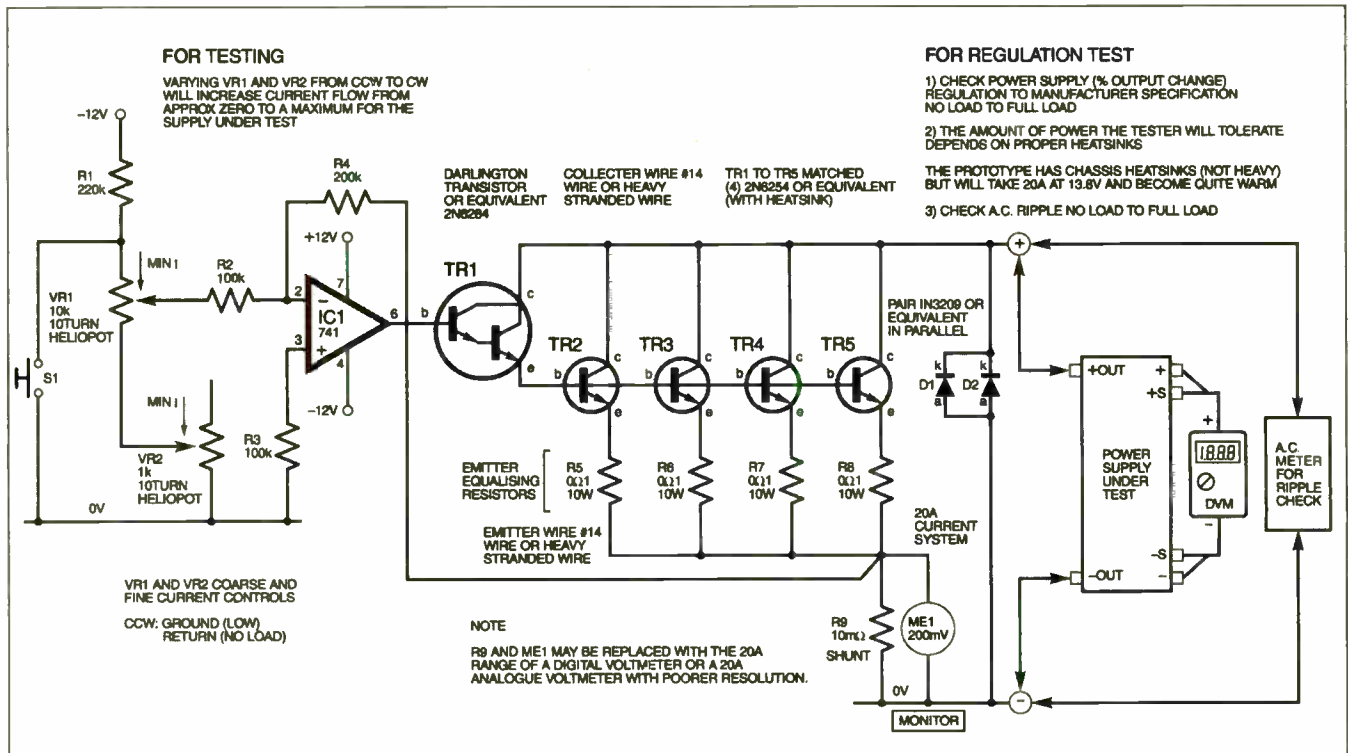

Fig.3. Circuit diagram for the Power Supply Load Tester.

As with many tinkerers and junk electronics collectors, a variety of “acquired” power supplies wind up on the author’s shelves to await attention. But are they worth keeping? Testing them with a resistive load is messy and difficult, and with high current supplies it is nearly impossible, unless you have a carbon pile!

The tester whose circuit diagram is shown in Fig.3 controls supply currents to 20A, and voltages from 1.7V to over 50V. Current control is so stable that once the current is set, a supply voltage can be varied across this range and the current will remain constant. Maximum power will depend upon how well the pass transistors utilise heatsinks.

## How It Works

The circuit operates as a loop. At the control end, a -12V regulated supply provides approximately 50µA to R1, VR1 and VR2. Resistor R2 sees this as a range of 0V to 5V, or 0µA to 5µA at pin 2 of IC1, the inverting input.

With no power supply connected to the test terminals, the output at IC1 pin 6 will be at -10V with the wipers of VR1 and VR2 at ground (0V). As their wipers are moved away from 0V, pin 6 of IC1 will change to 2.0V. When a power supply is connected for test and VR1 and VR2 are adjusted away from 0V, essentially the same thing will happen, except IC1 pin 6 will be at 1.2V as soon as the unit under test starts to draw current.

When the current controls are increased, say for a 20A supply, pin 6 of IC1 will rise to approximately 3V. The output of IC1 drives the Darlington transistor TR1, which has an  $H_{fe}$  (current gain) of 2500, and this turns on transistors TR2 to TR5, resulting in a current across shunt resistor R9. The resulting

voltage drop across R9 produces a current through R4 equal and opposite to the current through R2. This opposing action keeps pin 2 of IC1 at virtual ground and the loop is completed for feedback control.

Note that diode D1 (in parallel with D2) provides reverse voltage protection for the tester. Ensure that these diodes are connected the correct way round.

This circuit was designed around a 0.01Ω shunt and a DVM with 199.9mV full scale for R9 and ME1. For different shunt values, an op.amp can amplify the shunt voltage.

## Using the Tester

This tester can check to see how well the supply regulates to keep the voltage constant under load. When first using it, use a power supply with a known current limit, preferably one with meters that monitor both voltage and current. It is also a good idea to check the voltages quoted earlier, under no-load conditions.

First set the wipers of VR1 and VR2 to 0V, then connect the tester to the power supply to be tested and switch on its power. Monitor the output of the supply with a digital voltmeter (DVM). Increase the settings of VR1 and VR2 for a slight current increase, as shown by meter ME1. This meter can be another

DVM with full scale at 199.9mV (the equivalent to 20A).

Now increase VR1 and VR2 to the known current limit, noting the slight drop in the output voltage. Push on switch S1 to short the reference current to ground and note the change in the output. This test gives a *no load to full load* change. This should be done briefly, returning VR1 and VR2 wipers to ground after testing.

The power supply’s regulation can be calculated as:

$$\% \text{ regulation} = \frac{V_{NL} - V_{FL}}{V_{FL}} \times 100$$

where  $V_{NL}$  = voltage no load  
 $V_{FL}$  = voltage full load

## Caution

Testing a power supply for regulation at maximum ratings can be hazardous. The hazards can be minimized by being brief when at maximum current. Look for a slight drop in the supply output voltage when at maximum current, and immediately return the wipers of VR1 and VR2 to 0V if a drop is observed. A regulated supply can usually handle currents of 1A or greater.

Duane W. Clairmont,  
Conway, USA

## INGENUITY UNLIMITED

### BE INTERACTIVE

IU is *your* forum where you can offer other readers the benefit of your Ingenuity. Share those ideas, earn some cash and possibly a prize!



## Strike Force Nine

Why is lightning so potent, and can you protect your gizmos?  
Andy Emmerson offers some answers.

**C**HANCES are you've had at least one household appliance destroyed by lightning. It might be a video recorder or the modem in your computer. Chips designed for 5V or 3V operation are fried instantly by the monster voltage surges induced by lightning, which can also take out perhaps an entire PC, including the disk controller circuitry on a hard drive.

Apart from the pain of shelling out for new devices (assuming they're not covered by household insurance), there's more grief too if the strike destroys irreplaceable data (no – hang on, everyone makes backups now, don't they?). Perhaps you reckon manufacturers should put more protection into devices vulnerable to lightning damage, but if so, then you underestimate the destructive force of thunderbolts.

### HORROR STORY

Not convinced? Then just hear what a telephone engineer told me recently . . .

*"I spent the whole five days of last week clearing up after a lightning strike in a quiet residential area in south London. The bolt struck a tree that was a metre away from a telegraph pole and the damage was as follows:*

1. The entire pole top was a mass of melted plastic.

2. The 20-pair cable feeding the distributor at the top of the pole was completely fused into one mass of melted plastic and copper.

3. The joint at the base of the pole exploded.

4. Every one of the 18 customer drop-wires from this pole melted for approximately two metres away from the pole.

5. The 20-pair feeder cable (which was underground in a duct) feeding the base of the pole had the insulation of each individual pair melted within the cable.

6. The 100-pair joint that this cable fed (70 metres away on the other side of the road) was blackened inside and had melted pairs.

7. All 18 customers suffered their input terminal blocks explode inside their homes, with the lids being found the other side of the rooms.

8. All 18 main sockets inside the houses were destroyed internally (burnt out).

9. Ten of the homes required total internal rewire jobs.

10. Eleven modems, five complete computers, seven video recorders and eight cordless telephones were beyond repair.

11. One poor lady closest to the pole was hit in the back when the mains transformer of her cordless phone shot across her kitchen.

12. In the same household the power wiring melted and the mains sockets were blown out of their wallboxes.

13. No less than 14 similar faults were reported in homes not fed by this pole at distances up to 700 metres away along the road.

Not a happy story, but at least now you needn't feel so sore if your sole loss is a frazzled modem costing £30. And no, you cannot sue British Telecom or the electricity company for taking inadequate care, as this incident would be termed an "Act of God". In any case, phone companies do take precautions; every phone socket contains a so-called spark gap to minimise the effect of over-voltages and all lines in BT exchanges are protected by an argon-filled gas discharge tube that conducts down to earth at high voltages. But when the over-voltage is in the region of six kilovolts at 200kA (200 thousand amps!), there's little that any safety component can do. Your only hope then is to pray.

### ANY ANSWERS?

But what can you do? Certainly avoid using telephones and computers during thunderstorms and keep clear of video recording devices, TVs and mains radios. Tedious though it is, unplugging these devices may save you a lot of expense and inconvenience. It makes good sense to install surge-arresting plugs and telephone line filters too; the products made by a firm called Belkin ([www.belkin.com](http://www.belkin.com)) have a good reputation. Modern protection devices are remarkably sophisticated in fact and can work wonders. They don't guard against direct lightning hits, however, so don't be too judgmental if they fail to stop a 200 kilo-amp surge!

Of course, cheapskates always try to cut costs by assessing the likelihood of danger. For them saving £15 on surge arresters means far more than losing £1,000 on a multimedia computer system. They probably wouldn't take the same gamble with smoke detectors, yet the cost of surge protection is minimal by comparison with the benefits.

Lightning is not the only culprit, incidentally, and your equipment is at risk from less obvious hazards. Almost "invisible" spikes of very short duration but high voltage may lead to gradual deterioration or complete failure of the equipment. Repeated surges above normal line voltage but below the specified cut-off figure may also have a long-term effect of weakening components and lead to premature failure of semiconductor devices by altering their molecular structure.

### SOME MYTHS DISPELLED

*Lightning is not a problem round here...* don't bank on it. Every day Britain sees more than 150 lightning strikes to ground and on average the country sees six hits per square mile annually. No district is immune, either, although some hotspots do exist. In summer the lion's share of thunderstorms occurs in eastern England, whilst in winter the epicentre is Cornwall (information from the Met. Office)

*Our communications cables are all underground so they cannot be hit by lightning or contacts with power cables . . .* A common misconception but entirely false, for two reasons:

When lightning strikes the ground it takes the path of least resistance; an underground copper cable will do very nicely and the massive electrical forces involved are quite capable of bursting through plastic sheathing. Additionally, floods in roadside cable chambers are common occurrences when water mains burst, with potentially disastrous consequences.

*The insurance will pay out, so what the heck . . . ?* An "All Risks" insurance policy will cover the cost of replacing damaged equipment; a "Fire and Special Perils" policy will not. It's vitally important to check for exclusions.

For anyone who works from home, however, the cost of disruption and lost work is far more important than is the replacement cost of equipment. Anyone totally reliant on the telephone or their computers for their livelihood may not be able to survive the consequent loss of income; while you recover lost data and replace ruined equipment your customers will take their business elsewhere.

### NO FLASH IN THE PAN

Since 1989 the UK National Lightning Location Service has identified the position of lightning within the UK. This information is supplied to the insurance industry for evaluating actual lightning risk to property and has the possibility to validate insurance claims by referring to actual records of activity.

The service is provided by EA Technology Ltd ([www.eatechnology.com](http://www.eatechnology.com)), which has also developed a novel system that gives up to two hours prediction of the location of individual lightning strikes. This can locate strikes typically within 1km to a time accuracy of 0.01 seconds. Latest figures show that the number of lightning strikes that will affect an area can be predicted with an accuracy as high as a remarkable 85 per cent.

# PROTEUS

**The Complete Electronics Design System**

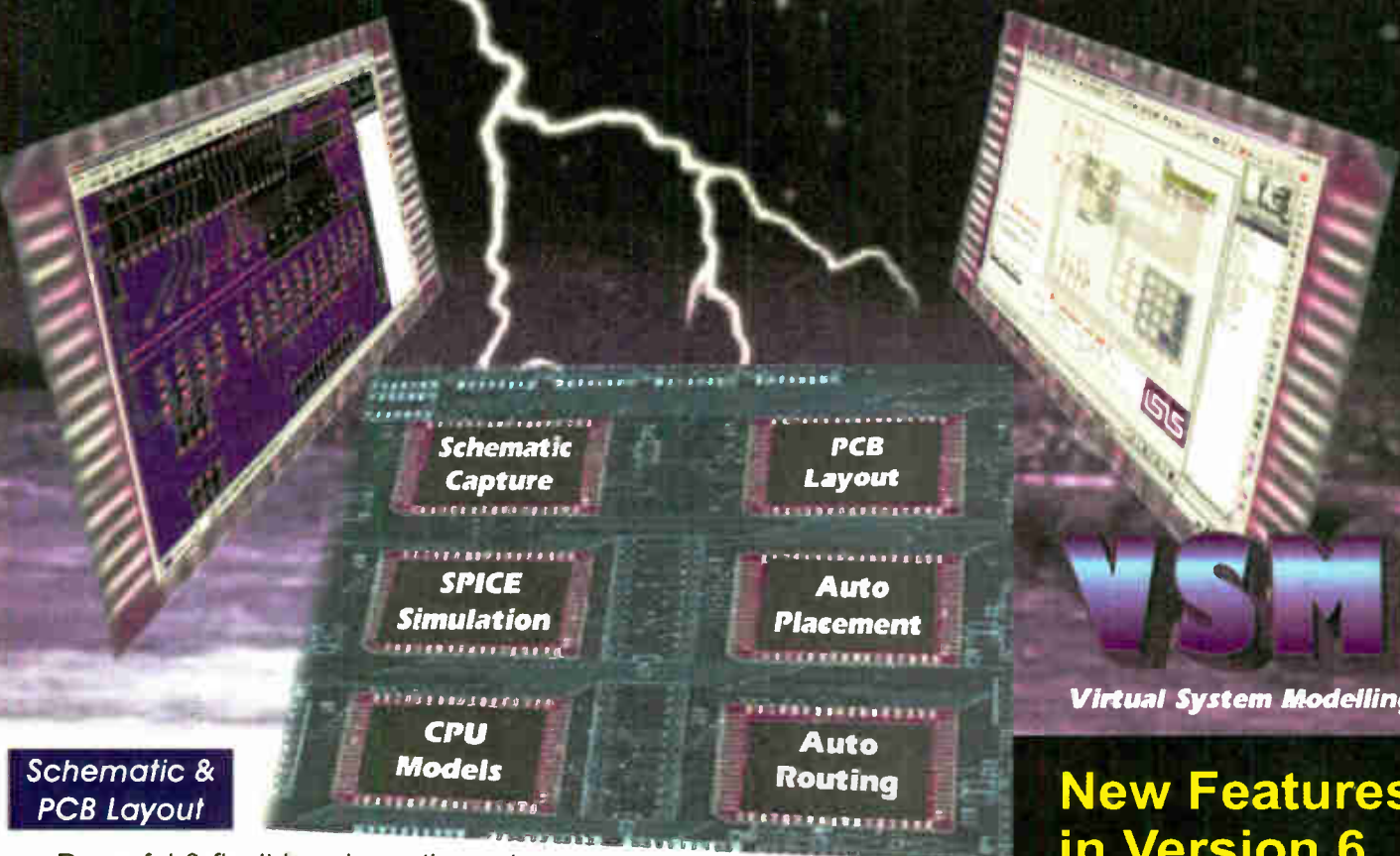

## Schematic & PCB Layout

- Powerful & flexible schematic capture.
- Auto-component placement and rip-up/retry PCB routing.
- Polygonal gridless ground planes.
- Libraries of over 8000 schematic and 1000 PCB parts.
- Bill of materials, DRC reports and much more.

## Mixed Mode SPICE Circuit Simulation

- Berkeley SPICE3F5 simulator with custom extensions for true mixed mode and interactive simulation.
- 6 virtual instruments and 14 graph based analysis types.
- 6000 models including TTL, CMOS and PLD digital parts.
- Fully compatible with manufacturers' SPICE models.

## Proteus VSM - Co-simulation and debugging for popular Micro-controllers

- Supports PIC, AVR, 8051, HC11 and ARM micro-controllers.
- Co-simulate target firmware with your hardware design.
- Includes interactive peripheral models for LED and LCD displays, switches, keypads, virtual terminal and much, much more.
- Provides source level debugging for popular compilers and assemblers from Crownhill, IAR, Keil, and others.

## New Features in Version 6

- Drag and drop toolbars.
- Visual PCB packaging tool.
- Improved route editing.
- Point and click DRC report.
- Multiple design rules (per net).
- Multiple undo/redo.

**Call Now for Upgrade Pricing**

Works with  
**PIC Basic Plus**  
from Crownhill  
Associates

**labcenter**  
Electronics  
53-55 Main Street, Grassington. BD23 5AA

Tel: 01756 753440  
Fax: 01756 752857  
Contact us for  
**Free Demo CD**

**www.labcenter.co.uk**  
**info@labcenter.co.uk**

# TEACH-IN 2004

## Part One – At the Beginning

**MAX HORSEY**



**How to apply electronics meaningfully – the aim of this 10-part series is to show, experimentally, how electronic components function as part of circuits and systems, demonstrating how each part of a circuit can be understood and tested, and offering advice about choosing components**

**A** FIRST glance at an electronic circuit can be very off-putting; there are no moving parts, and it is impossible to know what is happening without a sound knowledge of how the components function and interact.

Throughout this series we ignore what is happening inside a component since all that matters in a circuit is the effect the component has on the current flowing. In other words we use the systems approach and examine what components do, and how they interact with other components.

### MEASURING QUANTITIES

When you buy any item, its size or weight determines its suitability and cost. So you may buy 1kg of sugar, and 100m of string. Similarly, resistors are sold according to their resistance in ohms and their power in watts. Capacitors are measured in farads, and their working voltages in volts. We will discuss all these units in detail later, but since each unit has multiples, the chart shown in Table 1.1 may be helpful.

Note that micro ( $\mu$ ) is often written "u" if symbols are not supported by a printing system, and  $\Omega$  is often written as "R". For example, a 27 ohms resistor may be written 27 $\Omega$  or 27R. A 33,000 ohms resistor may be written 33k $\Omega$  or 33k.

(It used to be common to write 33k $\Omega$  as 33K. However, capital K has come to mean a kilobyte as used in computers, and this in turn means 1024 bytes – the nearest binary multiple of two.)

### PASSIVE COMPONENTS

When electricity flows through a resistance, electrical energy is converted into heat energy. This is how an electric fire works. The element of an electric fire is a resistor. Electronic circuits employ many resistors to reduce the flow of current and provide the range of voltages needed around the circuit – hopefully they do not become as hot as the electric fire element!

Electricity can produce several effects, including a "field effect". For example, when you rub a balloon on your sleeve the

**Table 1.1. Useful symbols and values**

V = volts  
A = amps  
 $\Omega$  = ohms  
F = farads

multiply by 1,000,000  $10^6$  M (mega) e.g. 1M $\Omega$   
multiply by 1,000  $10^3$  k (kilo) e.g. 1k $\Omega$   
multiply by 1 e.g. 1V  
divide by 1,000  $10^{-3}$  m (milli) e.g. 1mA  
divide by 1,000,000  $10^{-6}$   $\mu$  (micro) e.g. 1 $\mu$ F  
divide by 1,000,000,000  $10^{-9}$  n (nano)  
e.g. 1nF  
divide by 1,000,000,000,000  $10^{-12}$  p (pico)  
e.g. 1pF

balloon becomes charged with electricity and then attracts objects with a different charge. Hence the balloon will stick to a wall, which is neutral (which counts as a different charge to the balloon). The field effect is exploited in a capacitor, and in some types of semiconductor.

A flow of electricity produces a magnetic effect. When a wire is wound into a coil the magnetism is concentrated. A coil wound around a piece of soft iron is called an electromagnet; it can be turned on and off as required. A hollow coil is called a solenoid and can pull pieces of iron or steel into its centre. This mechanism is employed in electric locks.

In electronic circuits coils of wire are often known as inductors. In practice you will rarely, if ever, need an inductor (other than in radio circuits, or as an output device – like a solenoid), and so we will cover this area briefly.

The preceding components all lose energy – in other words they are *passive*. However, the invention of the thermionic valve – an *active* device – increased the potential of electronic circuits immensely and led to the "radio set" complete with "radio valves" and loudspeaker. For many years, electronics was essentially for radio; one of the most famous component suppliers, RS Components, was originally called Radio Spares.

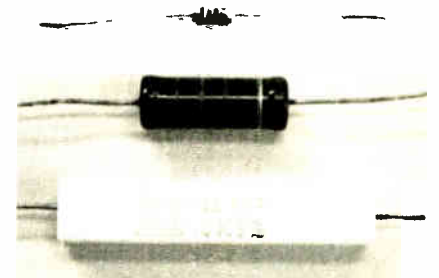

Photo 1.1. Examples of typical resistors. Top to bottom 0.25W, 2W, 11W.

### RESISTORS

Resistors are probably the most common component in electronic circuits. Three resistors are shown in Photo 1.1, the most common of which is the smallest. Resistors are designed to waste electrical energy, and in the process they convert it into heat. Hence they are employed to reduce the flow of current, and help create the correct voltage for a particular section of a circuit. A resistor obeys Ohm's Law, whereby:

$$\text{Resistance (in ohms)} = \text{Voltage/Current}$$

For example, we can calculate the current flowing in Fig.1.1 if we know the value of the resistor, and the voltage across the resistor – which in this case is the supply voltage. So, with 9V across the resistor, and a resistance value of 100 ohms, we can change round the formula, namely:

$$\text{Current} = \text{Voltage/Resistance}$$

hence:

$$\text{Current} = 9/100 = 0.09 \text{ amps} = 90\text{mA}$$

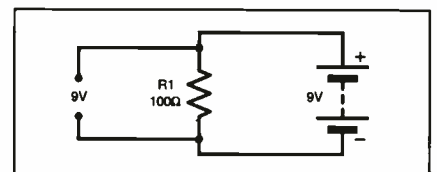

Fig.1.1. Current flow example.





Fig.1.2. A 4-band resistor.

## COLOUR CODES

The value of a resistor is indicated by means of a colour code. Consider a 4-band resistor as shown in Fig.1.2, where the last colour is gold.

Assuming that the last band is gold, the value should be read with the gold band on the right-hand side. The first band indicates the first digit, the second band indicates the second digit, and the third band indicates the "multiplier".

Table 1.2 illustrates this. Each colour represents a value, from lowest – black, to highest – white. The last band indicates the tolerance of the resistor, i.e. an indication of its accuracy. Gold means 5% tolerance (good enough for most purposes), red indicates 2% and brown indicates 1%. A 5% resistor whose colours indicate 100 ohms could have a value from 95 ohms to 105 ohms, i.e. 5% either way. For example:

red, red, red, gold = 2 2 00 ohms (2k2 ohms), 5% tolerance

brown, black, green, gold = 1 0 00000 ohms (1M ohms), 5%

brown, black, black, gold = 1 0 ohms (10 ohms), 5%

orange, orange, orange, gold = 3 3 000 ohms (33k ohms), 5%

Note how in the first instance the letter *k* is used in place of the decimal point.

## FIVE-BAND RESISTORS

Five-band resistors (see Table 1.3) simply contain an extra digit, but otherwise they are similar to the four-band types. The extra band allows a more accurate value to be indicated, and so five-band resistors will generally have a tolerance of 1%. This means that the fifth band is brown, making it much harder to know which way round the resistor is read.

Resistor values conform to a system, e.g. the E24 series, and so if the value you have read is not included in the series, you must have the resistor the wrong way round. If all else fails, use a multimeter to measure the resistance!

## POWER RATING

Resistors convert electrical energy into heat energy. In most circuits the current

## PANEL 1.1. SCHEDULE FOR THIS SERIES

### Part 1: At the Beginning

Revisiting passive components, and a few input/output devices.

### Part 2: Transistors

Bipolar and MOSFET transistors, with example circuits, including a voltage controller and a simple amplifier.

### Part 3: Operational Amplifiers

Useful op.amp circuit configurations, plus example circuits for an audio mixer and microphone amplifier.

### Part 4: Logic Gates

Basic logic gates and how to use them in practical applications, including a Quiz Game Controller.

### Part 5: Logic Gates as Switches

Logic gates as switches, with special reference to audio applications, and introducing PIC microcontrollers to reduce the chip count.

### Part 6: Sound Level Measurement

Sound level measurement, with example detection and display circuits using op.amps, I.e.d.s and bargraphs, and illus-

trating how data sheets can be turned into real circuits.

### Part 7: Moisture Detection and Radio Links

Methods for detecting moisture, and how data can be reliably transmitted via a variety of radio link modules.

### Part 8: Movement Detection

Exploring methods for detecting movement, with special regard to avoiding Deep Vein Thrombosis, associated with personal immobility on a coach or aircraft, concluding with a PIC-based "movement reminder".

### Part 9: Lock and Alarm Systems

Hard-wired and logic gate control of alarm and lock systems, including use of thyristors and matrixed keypads, and how to use PICs for decoding keypads.

### Part 10: Motor Control

Exploring reversible motor control, with the use of switches, light and current sensing to provide automatic "stop" constraint, concluding with an example of a PIC-based curtain winder.

flowing through each resistor is so small that the heat produced can be ignored. But low-value resistors can produce significant amounts of heat, as can higher value resistors operating at high voltage. The power formula is:

$$\text{Power} = \text{Voltage} \times \text{Current}$$

So if you know the current flowing through a resistor, and the voltage across it, the power (in watts) can be calculated.

The power rating of a typical resistor used in circuits is around 0.25W. Looking again at Photo 1.1 a resistor of this rating is shown at the top, together with a 2W resistor, and 11W resistor.

## VARIABLE RESISTORS (POTENTIOMETERS)

As the name suggests, a variable resistor is a resistor whose resistance can be varied from zero to the value stamped on its case. It is common practice to build variable resistors with connections at both ends, and a "wiper" in the centre. A symbol of this device is shown in Fig.1.3.

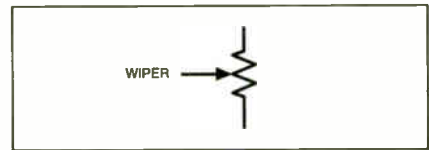

Fig.1.3. Basic symbol for a potentiometer.

If you use the wiper, and one end of the device, it behaves as a variable resistor. If you use all three connections, the device can be used as a potentiometer (often abbreviated to *pot*). The term potentiometer is that normally used irrespective of the application.

The pots shown in Photo 1.2 illustrate some examples, including the linear slider, popular in mixers and graphic equalisers. Photo 1.3 shows some miniature pots, known as presets. These are operated with a screwdriver, and are useful if their values are changed very infrequently. Note that some are designed for horizontal mounting on a circuit board, and others stand vertically. Dual-gang pots are available as shown in Photo 1.4, and are useful as the volume controls in stereo amplifiers.

Table 1.2. 4-band resistor colour coding

	1st digit	2nd digit	multiplier	tolerance
GOLD			divide by 10	5%
BLACK	0	0	none	
BROWN	1	1	× 10	1%
RED	2	2	× 100	2%
ORANGE	3	3	× 1000	
YELLOW	4	4	× 10000	
GREEN	5	5	× 100000	
BLUE	6	6	× 1000000	
VIOLET	7	7	× 10000000	
GREY	8	8	× 100000000	
WHITE	9	9	× 1000000000	

Table 1.3. 5-band resistor colour coding

	1st digit	2nd digit	3rd digit	multiplier	tolerance
GOLD				divide by 10	5%
BLACK	0	0	0	none	
BROWN	1	1	1	× 10	1%
RED	2	2	2	× 100	2%
ORANGE	3	3	3	× 1000	
YELLOW	4	4	4	× 10000	
GREEN	5	5	5	× 100000	
BLUE	6	6	6	× 1000000	
VIOLET	7	7	7	× 10000000	
GREY	8	8	8	× 100000000	
WHITE	9	9	9	× 1000000000	



Photo 1.2. Example of panel mounting single potentiometers.



Photo 1.3. Example of p.c.b. mounting preset potentiometers.



Photo 1.4. Example of panel mounting dual potentiometers.

## LINEAR OR LOG

Most potentiometer values are available as linear (lin) or logarithmic (log) types. For most purposes the linear type is best, since the resistance changes evenly as the control is rotated. Log pots are generally used as volume controls in amplifiers, where the sound level needs to rise in ever greater steps – in tune with the way in which humans hear sound.

## RHEOSTATS

A rheostat is a type of variable resistor, and will be looked at in more detail in Part 2, next month.

## CAPACITORS

A capacitor temporarily stores electricity. This should not be confused with the function of a battery, which chemically



Photo 1.5. A dramatic (but dangerous) illustration that a capacitor stores electrical charge (see text).

## PANEL 1.2. TOOLS AND EQUIPMENT

One of the advantages of experimental electronics is that it need cost very little. In fact, now that digital multimeters have fallen in price, the most expensive single item may well be a prototype board – a system which enables components to be plugged into it and connected together temporarily for testing and trialling. So a basic shopping list would be as follows:

- Prototype board (plug-in breadboard)
- Wire strippers/cutters
- Screwdrivers
- Small pliers
- Digital multimeter

A proposed list of the electronic components required for this series is shown

below. The quantities given assume that components are re-used between the different parts of the series. Be aware that there may be minor changes or additions to the list as the series progresses.

Throughout this series a 9V PP3 battery can power most of the circuits, even where 12V is suggested.

If serious experimental or faultfinding work is planned for the future, an oscilloscope will be useful, though this will cost far more than everything else put together! It is not necessary to the successful following of this series.

Anyone wishing to construct circuits permanently will need a few small stripboards, a small soldering iron and multi-core solder.

## COMPONENTS

Approx. Cost  
Guidance Only

**£27**  
excl. misc.

(Assumes that some components are re-used between different parts)

### Resistors

- 8Ω 2 3W
- 12Ω
- 100Ω
- 330Ω (7 off)
- 470Ω (2 off)
- 680Ω
- 1k (5 off)
- 2k2
- 4k7 (4 off)
- 10k (3 off)
- 22k (6 off)
- 47k (3 off)
- 51k
- 82k
- 100k (4 off)
- 680k (2 off)
- 1M (3 off)

All 0.25W 5% unless marked.

### Potentiometers

- 1k
- 10k (3 off)
- 22k
- 47k
- 100k
- 470k
- 1M

All preset or panel mounting rotary linear.

### Capacitors

- 100n disc or polylayer etc. (6 off)
- 470n disc or polylayer etc.
- 1μ polylayer (2 off)
- 1μ radial elect. 16V
- 2.2μ radial elect. 16V
- 4.7μ radial elect. 16V (2 off)
- 10μ radial elect. 16V (3 off)
- 100μ radial elect. 16V
- 220μ radial elect. 16V (2 off)
- 470μ radial elect. 16V
- 1000μ radial elect. 16V

All working voltages quoted are the minimum. Higher voltage ratings may be used.

### Semiconductors

- 1N4001 rectifier diode (4 off)
- 1N4148 signal diode (3 off)
- 3V9 Zener diode, e.g. BZYC3V9

See  
SHOP  
TALK  
page

- BC549 *n*pn transistor (or any high-gain *n*pn type, e.g. 2N3704) (3 off)
- BC214 *p*np transistor (or any high gain *p*np type, e.g. 2N3702)
- TIP122 (or TIP121) *n*pn Darlington transistor (3 off)
- TIP127 *p*np Darlington transistor
- TIP41A *n*pn power transistor (2 off)
- TIP42A *p*np power transistor (2 off)
- BUZ11A *n*-channel MOSFET
- 741 op.amp
- 4001B quad 2-input NOR gate
- 4011B quad 2-input NAND gate
- 4069UB hex inverter
- 4081B quad 2-input AND gate
- 4071B quad 2-input OR gate
- 4050B hex buffer
- 4052B dual 4-input analogue multiplexer
- PICAXE-18 or PIC16F627 microcontroller (see text Part 8)
- LB1412 VU i.c.
- HT12E encoder
- HT12F decoder
- 78L05 +5V 100mA voltage regulator
- ICL7660 voltage converter

### Miscellaneous

- AM-RT4-433 radio transmitter module
- AM-HRR3-433 radio receiver module
- d.p.d.t. toggle switch
- s.p. push-to-make switch (4 off)
- Microswitch (optional)
- Torch bulb (e.g. 3V) (2 off)
- Electret microphone insert
- Red l.e.d. (12 off)
- Green l.e.d. (2 off)
- Bi-colour l.e.d.
- Relay, 12V coil (optional)
- Shrouded 3-pin header (only required for PICAXE)
- Stripboard for moisture sensor (4cm x 3cm) (see text Part 4)
- Buzzer (solid state)
- Siren (loud buzzer), any 6V to 12V type
- Vibration switch, any type
- Matrix keypad, 12-key
- Solenoid lock (optional), any 12V type
- Thermal fuse 1A
- Motor and gearbox, e.g. Rapid 37-1238 or RS 336-337
- Miniature 12 l.d.r.
- Thermistor, n.t.c., 5kΩ at 25°C

generates electricity. A capacitor can be likened to the water storage tank in your loft; a battery is like the central heating pump pumping the water around the radiators.

You can conduct a very crude experiment to show that a capacitor stores electricity, as shown in Photo 1.5. Here we have taken a large electrolytic capacitor, and charged it from a power unit by connecting its terminals directly to the 12V supply from a power supply unit.

#### WARNINGS:

- This experiment may damage the capacitor, so use an old one!
- Always check that the capacitor is connected the correct way round i.e. positive of the capacitor to positive of the power supply, and check that the working voltage of the capacitor is higher than the voltage of the supply.

Now disconnect the capacitor from the supply, and place a screwdriver across its terminals. The large spark illustrates that it was charged. (NOTE: shorting a capacitor in this way may cause it damage).

Photo 1.6 shows a more elegant, if less dramatic illustration. A buzzer is connected to the capacitor and it will sound for some time, though the changing note from the buzzer indicates that the voltage is falling quite rapidly.



Photo 1.6. Audibly demonstrating that a capacitor stores electrical charge.

A battery of the same physical size as the capacitor would work the buzzer for very much longer. Hence capacitors are not very effective when used as rechargeable batteries. They can only be employed in this way for use in very low consumption circuits – such as keeping the clock going for an hour in your video recorder during a power cut!

The storage ability of a capacitor is measured in farads (in honour of Michael Faraday, one of Britain's greatest scientists). In practice we require smaller units such as microfarads ( $\mu\text{F}$ ), nanofarads (nF) and picofarads (pF):

$$1\text{F} = 1,000,000\mu\text{F}$$

$$1\text{F} = 1,000,000,000\text{nF}$$

$$1\text{F} = 1,000,000,000,000\text{pF}$$

or put another way:

$$1\mu\text{F} = 10^{-6}\text{F}$$

$$1\text{nF} = 10^{-9}\text{F}$$

$$1\text{pF} = 10^{-12}\text{F}$$

## USING CAPACITORS

Capacitors, like resistors, are so widely used that whole books are written about

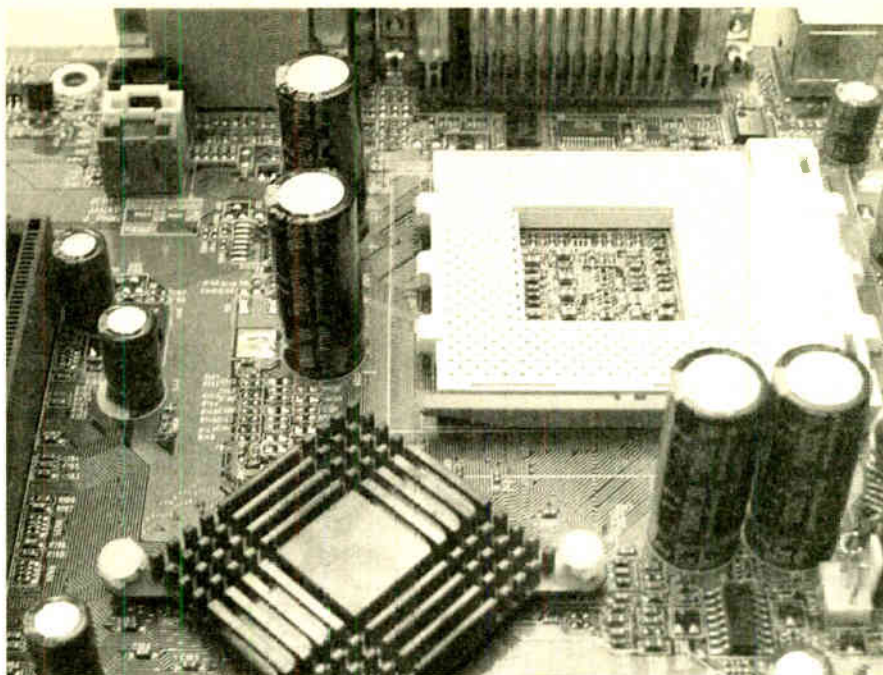

Photo 1.7. Electrolytic capacitors can dominate even the most sophisticated of circuit boards.

them. So we will just summarise some applications, and see them in action throughout this series. Capacitors are used for:

- storing small amounts of electrical energy
- smoothing (decoupling) power supplies
- removing voltage spikes from power supplies
- timing circuits
- oscillator circuits
- radio tuning
- tone control circuits
- blocking d.c. whilst coupling a.c.

## TYPES OF CAPACITORS

Capacitors tend to be rather bulky when compared with other components. The circuit board in Photo 1.7 shows part of a computer motherboard, where the black dots are tiny surface mount resistors, transistors and diodes. As the name suggests, these components are soldered on the upper surface of the p.c.b. and are ideal for mass production.

But standing like sky-scrapers are the capacitors (electrolytic in this instance), almost as if from another age. Some very small capacitors are capable of being surface mounted like resistors, but large value capacitors take up a large amount of space. Open up a hi-fi amplifier and you will find that nearly half the case is filled with the power transformer and capacitors.

The reason for an electrolytic capacitor's size is that it is comprised of two metal foil conductors, separated by an insulator. The whole thing can be rolled up like a Swiss roll, and although the conductors and insulator can be made very thin, there comes a point where the insulator is so thin that it breaks down when voltage is applied. So capacitors have a voltage rating known as a *working voltage*, above which you **should not** go!

Non-electrolytic (i.e. "normal") capacitors tend to have a reasonably high working voltage, typically 100V. The insulator may be made of polyester, polystyrene, mica, etc., and the size, shape, price and

effectiveness tend to depend on the type of insulation employed.

Rolled-up capacitors can have an inductive effect. This may be of no consequence in many circuits, but is best avoided where possible. So particular capacitors, such as "polylayer" types, are available which are not rolled-up and are useful in many circuits, including audio amplifiers and tone networks.

Using a non-electrolytic capacitor of a type different to that specified in a given component list is unlikely to prevent most circuits from working, providing the working voltage of the capacitor is sufficiently high, and it physically fits into the space provided on the circuit board. The price of "expensive" types of capacitor has fallen over recent years, and so there is often little point in the home-constructor using "cheaper" types.

## ELECTROLYTIC CAPACITORS

Electrolytic capacitors are polarised – in other words – they must be connected the correct way round with respect to positive and negative voltages. If you connect an electrolytic capacitor the wrong way round it is likely to explode. Photo 1.8 shows an

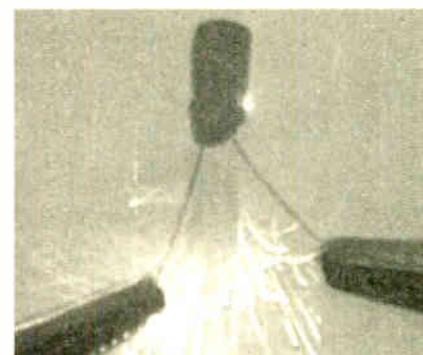

Photo 1.8. The dangerous effects of connecting an electrolytic capacitor to the wrong power supply polarity (photo created in a protected environment – see text).

experiment where a small electrolytic capacitor was connected with the wrong polarity to a 12V supply.

**WARNING: The experiment was conducted inside a sealed container, in a laboratory – do NOT try this at home!**

Electrolytic capacitors provide a large storage capacity in a reasonably compact case and at a reasonable cost, when compared with non-electrolytic capacitors. Their voltage ratings can be as low as 3V, so watch this when selecting your capacitor. In general, buy a capacitor with a voltage rating (i.e. working voltage) higher than the power supply voltage employed in your circuit.

There are two package types commonly employed – axial capacitors, and radial capacitors, as shown in Photo 1.9. An axial type (on the right-hand side) is designed to lie down like a resistor; a radial type has both its leads extending from the same end, and so stands upright and takes up less space on the circuit board. For this reason, radial capacitors are more commonly used.

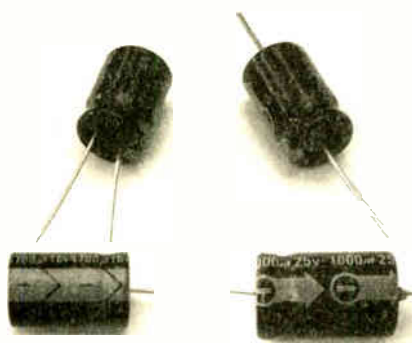

Photo 1.9. Examples of radial (left) and axial (right) electrolytic capacitors.

Notice that a band on the side of the body indicates the negative side of both types of capacitor. Additionally, in the case of a radial capacitor, positive is indicated by the longer lead

## TOLERANCE

No component can be manufactured perfectly, and all are made to a certain accuracy or tolerance. Electrolytic capacitors are notoriously imperfect and the actual value may be between half the stated value, or up to double the stated value. Fortunately, the actual value of an electrolytic capacitor is often not important, and circuit designers are used to making allowances for electrolytic capacitors!

## LEAKAGE

The plates of an electrolytic capacitor are not as well insulated as non-electrolytic types, and current can “leak” between the plates. This can adversely affect some circuits. For example, a popular timing circuit based on a chip known as a 555 timer measures the rising voltage on a capacitor, which is being charged via a resistor.

If times of several minutes are required, the resistor needs to restrict the flow of current so that the capacitor charges very slowly. You can use a larger capacitor to increase the timed period still further, but the size required to permit times of up to one hour, for instance, increases the risk of “leakage” which in turn affects the accuracy.

This can be very frustrating, when your calculations no longer work in practice!

## TANTALUM BEAD CAPACITORS

Tantalum bead capacitors are a form of electrolytic capacitor but have a better tolerance rating, and are generally smaller. They also have better leakage ratings (i.e. leak less), but – as you would expect – are more expensive.

## INDUCTORS

An inductor is a coil of wire either hollow, or wound around some ferrous (magnetic) material. When current flows through the coil a magnetic field is produced. When the current stops flowing the magnetic field collapses. If the coil is connected to a d.c. supply, a steady current will flow, and the opposition to the flow will be mainly due to the resistance of the wire used to make the coil.

However, at the moment when the current is switched on or switched off the rising or falling magnetic field also opposes the flow of current. This means that if an alternating supply is connected to the coil the opposition to the flow is greater than that due to the resistance alone.

The amount of opposition to a.c. depends upon the wire used, the number of turns, type of material inside the coil etc., and the effect is known as the inductance of the coil. Inductance is measured in henrys, and a small inductor may have a value of, say, 10mH.

There is also some capacitance associated with the coil, and this too affects the way it behaves with a.c. So the whole effect due to the resistance of the wire, the inductive effect and capacitive effect is summed up by referring to the impedance of the coil. Impedance is the total opposition to a.c. and will depend upon the a.c. frequency.

You will probably know that one of the important loudspeaker measurements is its impedance. If your amplifier has an output impedance of 8Ω, then you need a speaker of 8Ω impedance if you wish to extract the maximum power.

Inductors are often used to reduce voltage spikes in a circuit – in fact you often see ferrous material wrapped around mains leads or other leads associated with computers, video recorders etc. Inductors are also used in radio tuning, and combined with capacitors can form a “tuned circuit” i.e. one which resonates with a particular frequency – to tune in your favourite radio station for instance.

## TRANSFORMERS

A transformer normally consists of two or more coils of wire wound around a common core. Transformers which are designed to operate on 50Hz or 60Hz (the European/US mains frequencies) have cores made from laminated soft iron. The laminations (insulated sections) prevent the core acting like a coil of wire and conducting electricity.

When a.c. is applied to one coil known as the primary, a voltage of the same frequency is induced in the other coil known as the secondary. The voltage produced is in exact proportion to the ratio of turns. In other words:

$$\frac{\text{Output voltage}}{\text{Input voltage}} = \frac{\text{Secondary turns}}{\text{Primary turns}}$$

If the secondary coil has more turns than the primary, the transformer is known as a “step-up” type. However, the power output can never be greater than the power input (that’s a law of nature – you can’t get something for nothing!), and so the current available from the secondary coil is reduced by the same ratio.

The majority of electronics projects that require a transformer employ a “mains type”. These generally step down the voltage. For example, a mains transformer with a ratio of 20:1 will change an input of 230V a.c. down to 11.5V a.c.

Remember that transformers only work with a.c., and the current available from the secondary will be determined by the thickness of the wire used. If you require a large current, you need to obtain a larger, more expensive transformer.

A 20:1 ratio transformer which offers a current of, say, 1A from its secondary will consume 1/20A from the mains supply. These figures assume that the transformer is 100% efficient. In practice they are around 98% or worse.

Small mains transformers – the type often needed in projects – have quite poor “regulation”. This means that the output voltage claimed will only be correct when the current used from the secondary is near the maximum allowed. If less current is used, the output voltage will rise – by up to 25% or more. So a 12V transformer may supply a voltage of 15V or more when “off load”.

## DIODES

A diode allows current to flow in only one direction. Sounds easy – but whole books have been written on the development of the diode, including such classics as the thermionic radio valve and the “crystal and cats whisker”. Our present solid state diodes owe their existence to the latter device, although their development took a surprisingly long time.

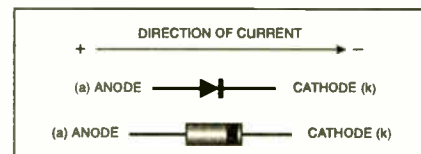

Fig. 1.4. Diode symbol and polarity markings.

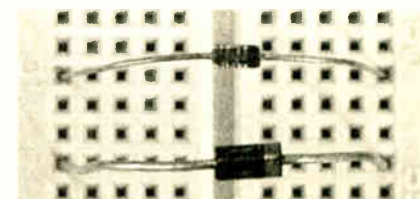

Photo 1.10. A 1N4148 (top) signal diode and a 1N4001 rectifier diode.

The symbol for a diode is shown in Fig. 1.4. Note the direction of the current through the diode. Fig. 1.4 also shows how the band around the real life diode corresponds with the cathode end of the symbol. Two common diodes are shown in Photo 1.10. The upper is a type 1N4148, and the lower is type 1N4001.

In all the following experiments, a type 1N4001 diode has been employed.

## USING DIODES

- Protecting against reverse polarity
- Steering applications
- Radio detection
- Rectification
- Protection from back e.m.f.

### Protecting against reverse polarity

Most electronic circuits will be damaged if you connect the power supply or battery the wrong way round. You can protect against this event by connecting a diode in series with the power supply as shown in Fig.1.5.

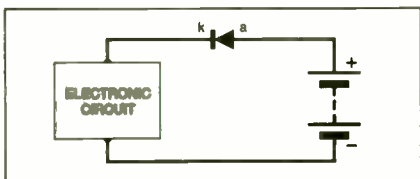

Fig.1.5. Common method of using a diode to protect a circuit against reverse power supply connection.

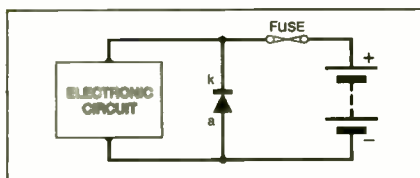

Fig.1.6. Another method of protecting a circuit, using a diode and a fuse.

If the battery is reversed, the diode will prevent any current flowing. The only problem with this arrangement is that the diode loses about 0.7V. So if you are using a 3V battery, the voltage applied to your circuit will be only 2.3V.

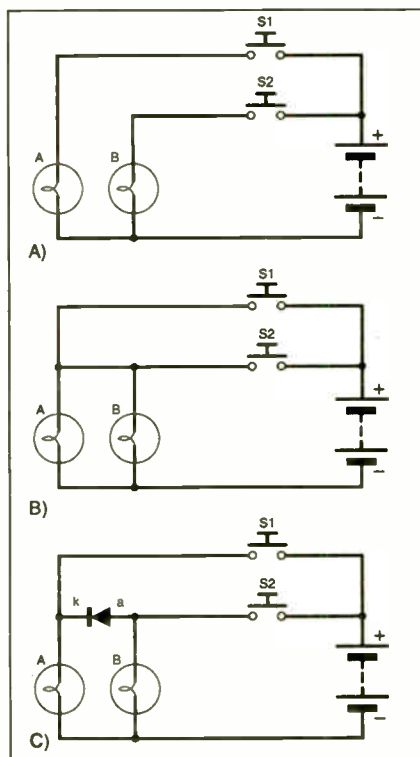

Fig.1.7. Using switches to control lamps, (a) individual switching, (b) dual-control of both lamps, (c) controlling lamp A by S1, but both lamps by S2, by using a steering diode.

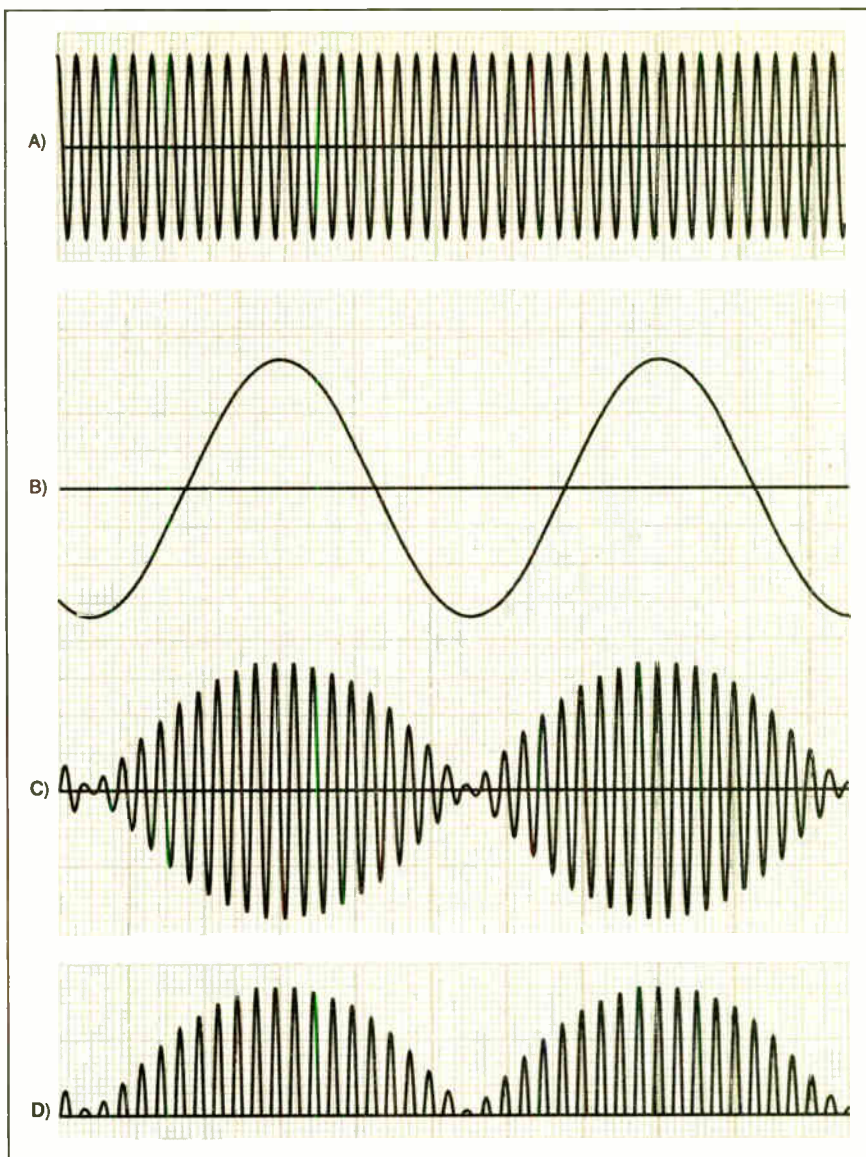

Fig.1.8. Principle of amplitude modulation (AM), (a) the carrier signal, (b) modulating signal, (c) the effect of modulating a by b, (d) half-wave rectification of c.

Hence the arrangement shown in Fig.1.6 is sometimes used. The diode will be "invisible" when the battery is connected correctly, but if the supply is reversed, the diode will short-circuit the current and the fuse will blow. A blown fuse is a much better option than a destroyed circuit.

### Steering

Steering applications probably account for the greatest use of diodes, particularly in logic circuits. An example will illustrate the point:

The circuit in Fig.1.7 show two lamps A and B controlled by means of two pushbutton switches, S1 and S2. We require button S1 to light lamp A, and button S2 to light both lamps. The wiring for dedicated lamp switching is shown in Fig.1.7a.

However, when S2 is connected to both lamps (Fig.1.7b), we find that S1 lights both lamps as well. The solution is shown in Fig.1.7c. A diode is used to steer the current so that S2 can light lamps A and B, but S1 can only light lamp A.

### Radio detection

A full description of radio is beyond the scope of this article, but the principle of Amplitude Modulation (AM) is easily explained.

A radio wave can carry audio information (e.g. speech or music) by superimposing or modulating the radio wave (known as the carrier) with the audio signal. The graphs in Fig.1.8 illustrate the point.

An example radio wave is shown in Fig.1.8a. This is simply a sine wave oscillating at high frequency. Fig.1.8b shows an audio signal – in this case a sine wave of much lower frequency than the radio wave. Fig.1.8c shows the radio wave modulated by the audio signal – its amplitude pulses up and down in synchronisation with the audio signal.

When the modulated radio wave is received by a radio set, the audio signal is recovered by removing all the waves below the centre line, i.e. removing the negative part of the signal. This is the part played by the diode in the "detection" circuit.

We now have the signal as shown in Fig.1.8d – which resembles quite closely the original audio signal. The high frequency radio signal is ignored by your headphones or loudspeaker, which responds to the "tops" of the signal. In practice, the high frequency radio signal can be removed by a capacitor, leaving the audio signal, which is similar to that shown in Fig.1.8b.

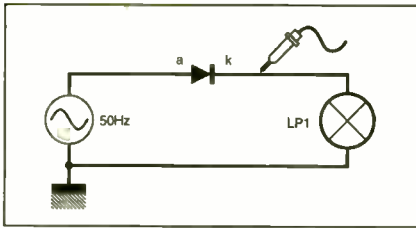

Fig.1.9. Experiment illustrating half-wave rectification.

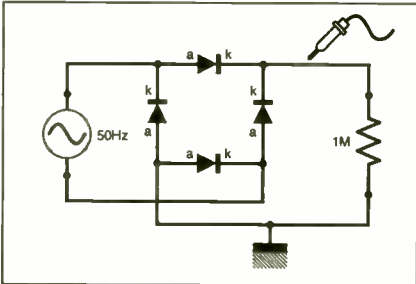

Fig.1.11. Experiment illustrating full-wave rectification.

### Rectification

In the previous example, the diode removes the negative parts of the radio signal. In other words we are changing the signal, which pulses above and below 0V, into a signal that pulses only above 0V. This is illustrated in Fig.1.9 and Fig.1.10.

In Fig.1.9 an a.c. generator is shown connected via a diode to a lamp. The upper graph in Fig.1.10 shows the a.c. waveform, and the lower graph shows the effect of the diode, which removes the negative parts of the waveform. Hence, we are left only with the positive part of the waveform i.e. a half-wave.

A single diode can therefore be used as a half-wave rectifier. Note that the half-wave is d.c., i.e. it always flows in the same direction, even though it is pulsing. This type of d.c. is inefficient, and full-wave rectified d.c. is generally preferred.

### Full-wave d.c.

There is more than one way of converting a.c. into full-wave d.c., but since diodes cost just a few pence, a useful method is by wiring the diodes into a "bridge" formation, hence the term *bridge rectifier*.

The four diodes are connected as shown in Fig.1.11, and the resulting graph is shown in Fig.1.12. Notice that unlike the previous graph, the gaps have been filled to

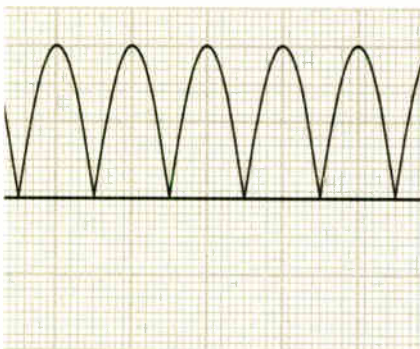

Fig.1.12. Full-wave rectification converts an a.c. signal into d.c. but retains the "ripples" of the a.c. waveform.

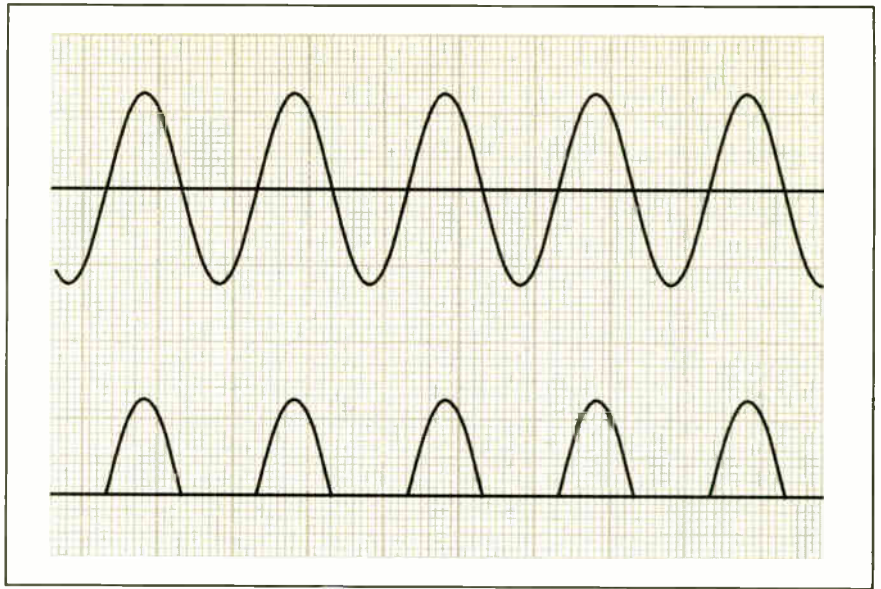

Fig.1.10. Sinewave before (top) and after half-wave rectification.

make full-wave d.c. Full-wave d.c. still wobbles up and down, but is much more efficient than half-wave d.c. Also, with smaller gaps, it is much easier to smooth into a steady flow of d.c.

**WARNING:** When experimenting with diodes, ensure that current is able to flow through the diodes by using a lamp (as in the half-wave circuit) or a resistor to provide a "load", as shown in Fig.1.11. Also, with the full-wave circuit, if you are using an oscilloscope (see Panel 1.3 later) to view the waveform, the oscilloscope ground (0V) must be connected only to the d.c. side of the bridge. You cannot, for example, use a double beam oscilloscope to monitor the a.c. and d.c. sides of the circuit at the same time.

The 4-diode bridge circuit is so often required that bridge rectifiers are available as single packages containing the four diodes, as shown in Photo 1.11. Notice that the positive and negative connections are marked on the top of each rectifier. The larger device can handle several amps, the smaller is rated at just over 1A.

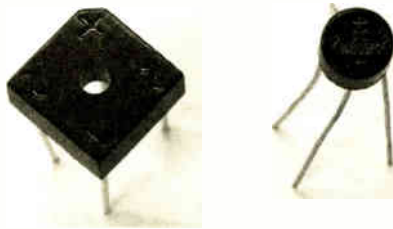

Photo 1.11. Examples of bridge rectifiers.

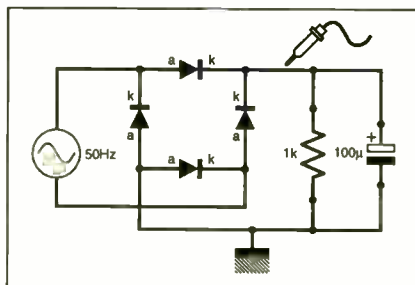

Fig.1.13. Smoothing a full-wave rectified signal.

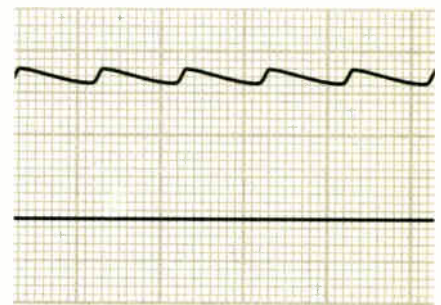

Fig.1.14. A ripple signal remains if inadequate smoothing is given to a full-wave rectified signal.

### Smoothing

Electronic circuits require a smooth d.c. supply – the type provided by a battery. With rectified d.c. this is achieved by means of a capacitor as shown in Fig.1.13.

If a capacitor value of 100µF is used and the load is 1MΩ, then the graph will be a perfectly straight line, since very little current flows through the 1MΩ resistor. However, if the resistor value is reduced to 1kΩ, then several milliamps flow through the resistor and noticeable ripple occurs. The difference is illustrated in Fig.1.14.

A larger capacitor value will reduce the ripple, but if the amount of current required by your circuit (as represented by the resistor) is 1A or more, then very large value capacitors are required. Hence the capacitors inside your hi-fi power amplifier will be very large indeed.

### Back-e.m.f. protection

Many output devices produce a high voltage spike when they switch off. This includes all magnetic devices such as

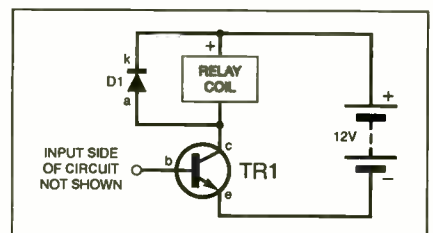

Fig.1.15. Using a diode to eliminate back-e.m.f.

motors, relays and solenoids. The high voltage spike, known as back-e.m.f. (e.m.f. = electromotive force), can damage sensitive components such as transistors and integrated circuits (i.c.s).

The circuit shown in Fig.1.15 illustrates the point. Here a transistor is used to switch a relay on and off. We won't worry about the input side of the circuit. When the transistor turns on, current flows through the relay coil. When the transistor turns off, the current through the relay coil stops, but the magnetism remains for a moment.

As the magnetic field collapses it is like pulling a magnet out of a coil at high speed – and this induces a voltage (e.m.f.) across the coil. Most transistors can only tolerate voltages of 30V or so but the e.m.f. (which is in the opposite direction to the normal supply voltage – hence “back-e.m.f.”) may be 50V or more, so the transistor is destroyed.

Diode D1 acts as a short-circuit to the back-e.m.f. and so removes the danger. However, the diode faces the wrong way for the normal supply voltage, and so does not affect the circuit in any other way.

It is possible to detect the high voltage produced when a relay switches off by placing your finger across the contacts connected to its coil. Connect one side of a power supply (e.g. 12V) to one side of the coil, connect a second lead to the other side of the power supply, and touch its end against the spare side of the relay coil.

Each time you brush the lead against the coil connection you should feel a small current. It helps if you use a large old-fashioned relay such as that shown in Photo 1.12.

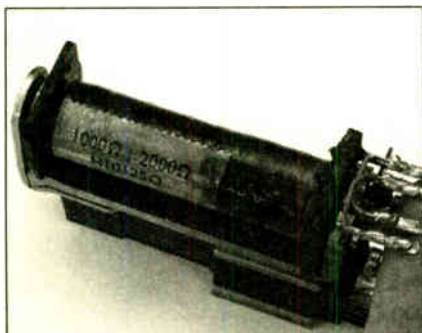

Photo 1.12. An old-fashioned relay, suitable for a back-e.m.f. experiment.

## SELECTING A DIODE

When selecting a diode the following considerations apply:

### Forward voltage drop ( $V_F$ )

When current flows through a diode, there is a voltage drop across it. In other words, some of the voltage is lost. The figure of 0.7V quoted earlier applies to silicon diodes. If this is too large a value, and you are dealing with small currents, you can employ a germanium diode such as type OA91, whose voltage drop is about 0.3V. Hence this type is more appropriate for simple radio receivers.

### Forward current ( $I_F$ )

Diodes are rated according to the current they can pass. For example, type 1N4001 can carry up to 1A. Type 1N4148 can carry 150mA.

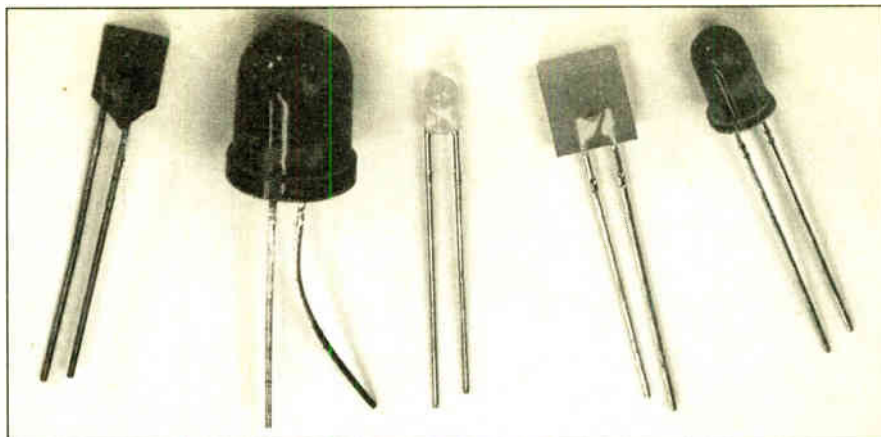

Photo 1.13. Examples of l.e.d. types.

### Peak Inverse Voltage (PIV)

The peak inverse voltage is the maximum voltage a diode can withstand in the reverse direction. For example, the 1N4001 diode can tolerate up to 50V. Type 1N4002 has a PIV of 100V, type 1N4003, 200V, and type 1N4004 has a PIV of 400V – making it useful for mains voltages. The popular 1N4148 has a PIV of 75V.

## LIGHT EMITTING DIODES

A light emitting diode (l.e.d.) is a special type of diode that emits light when current flows through it. L.E.D.s can be obtained in a range of colours and sizes, as illustrated in Photo 1.13. Note that the longer lead indicates the anode (positive) side of the l.e.d.

Most general purpose l.e.d.s require a current of around 10mA to 20mA, though special “low-current” l.e.d.s are available. The PIV is typically 5V (something to watch as it is much lower than an ordinary diode) and the forward voltage drop is around 1.7V for red l.e.d.s, 2.3V for yellow and green, and over 4V for blue.

A diode provides a low-resistance path in its forward direction. Hence if you connect a diode, including an l.e.d., across a power supply in the forward direction, a short-circuit current will flow, destroying the l.e.d. in the process. So a resistor is required as shown in Fig.1.16.

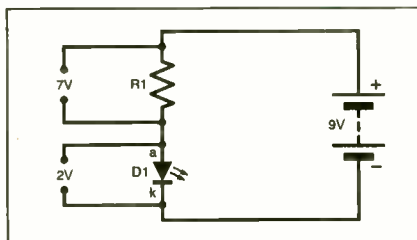

Fig.1.16. A resistor must be used in series with an l.e.d. to prevent excessive current flow.

### Calculating the resistor value

We calculate the resistor value by means of Ohm's Law, namely,

$$\text{Voltage} = \text{Current} \times \text{Resistance}$$

where Voltage is the voltage across the resistor, and Current is the current flowing through the resistor (and the l.e.d.).

A catalogue itemising the l.e.d. might tell us that the forward voltage drop across the l.e.d. is 2V (probably about 1.8V, but we will call it 2V). Assuming a 9V supply, this leaves 7V across the resistor.

We know from the catalogue that a suitable current through the l.e.d. is about 10mA. The same current flows through the resistor. So we have 7V across the resistor, and 10mA (i.e. 0.01A) flowing through it.

From Ohm's Law:

$$R = V/I, \text{ so } R = 7/0.01 = 700 \text{ ohms.}$$

The nearest conventional resistor value available is 680 ohms.

The calculation can be reduced to a single formula:

$$R = \frac{V_s - V_d}{I}$$

where

R = resistor value

$V_s$  = supply voltage

$V_d$  = l.e.d. voltage drop

I = current through l.e.d.

The assumption of 2V forward voltage drop is adequate for red, green and yellow l.e.d.s, but if you use white or blue the forward voltage is much higher.

Remember that the series resistor is required because the l.e.d. has little forward resistance. Virtually all other output devices such as buzzers, bulbs, motors etc., have their own resistance and do not require a series resistor.

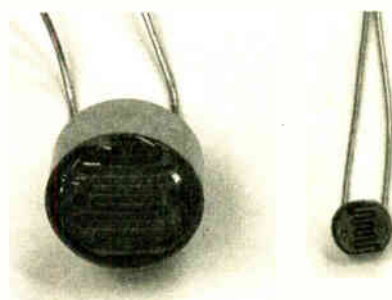

Photo 1.14. Examples of l.e.d.s, left a “standard” type, e.g. ORP12, and right a more responsive miniature version.

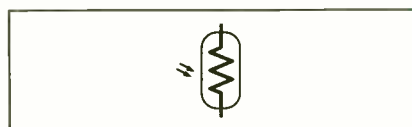

Fig.1.17. Symbol for an l.e.d.

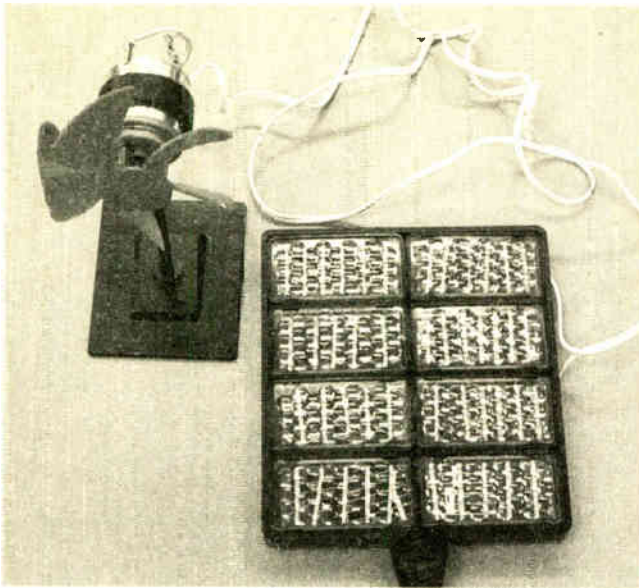

Photo 1.15 (above). A set of solar cells capable of powering a small fan.

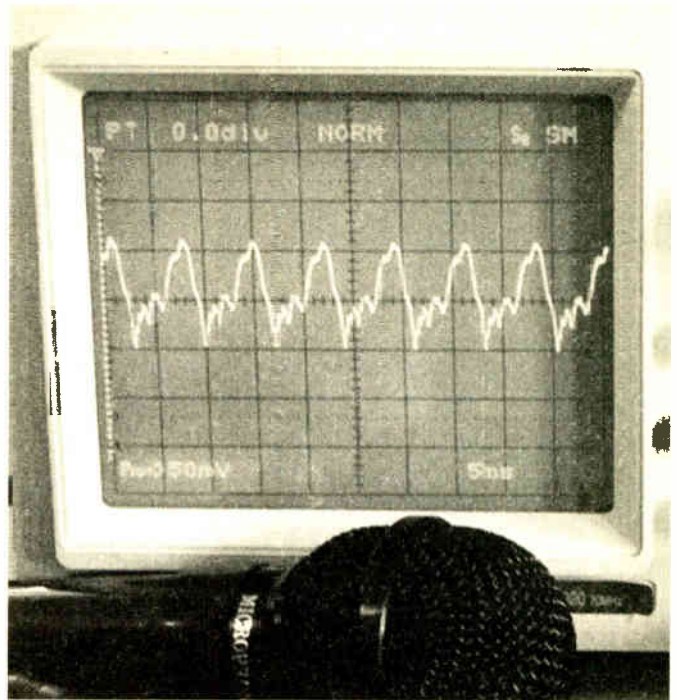

Photo 1.18 (right). Oscilloscope display of the signal output from a dynamic microphone.

## INPUT DEVICES

Input devices are often referred to as transducers or sensors. The flow of current through the transducer depends upon an external influence such as light or temperature. Some transducers are passive, i.e. they do not generate electricity; others are active, i.e. they *do* generate electricity. We will examine the most common examples.

### Light dependent resistor (passive)

A light dependent resistor (l.d.r.) is simply a variable resistor whose resistance changes according to the light intensity hitting its surface. Its resistance changes from about 200 ohms in bright sunlight, to over 1M ohms in total darkness. A "standard" l.d.r. is shown in Photo 1.14, together with a miniature type that is more responsive and cheaper. The schematic symbol is shown in Fig.1.17.

You can watch the resistance of an l.d.r. change if you connect it to a multimeter set to ohms (or k-ohms or M-ohms).

Note that an l.d.r. reacts quite slowly to a change of light; for example, it may take several seconds to fully change to its new value. This is of no consequence in automatic dusk triggered projects, since daylight changes very slowly anyway, but it can be a problem in some circuits, and so faster devices such as photo-diodes or photo-transistors should be considered.

### Solar cell (active)

A solar cell generates electricity when exposed to light. Its cost makes it less suitable as a sensor, but if you require power in remote locations a solar cell may provide an answer. The set of cells shown in Photo 1.15 generate enough electricity to power a very small motor when exposed to strong direct sunlight.

### Thermistor (passive)

A thermistor is a variable resistor whose resistance changes according to its temperature. The "-t" notation shown in Fig.1.18,



Fig.1.18. Symbol for an n.t.c. thermistor.

indicates a negative temperature coefficient (n.t.c.). In other words, as the temperature rises the resistance of the thermistor falls. The opposite is a positive temperature coefficient (p.t.c.) type.

Thermistors are generally given a resistance rating according to their resistance at about 25°C.

Try connecting a 5kΩ thermistor (n.t.c.) to a multimeter set to a range of 20k ohms. When you touch the thermistor, the warmth of your fingers will make its resistance fall a little.

When choosing a temperature sensor, also consider the range of "integrated circuit sensors" (i.e. complete circuits inside the sensor package) now available, which provide an exact voltage change per degree Celsius. These make accurate calibration of your circuit very easy.

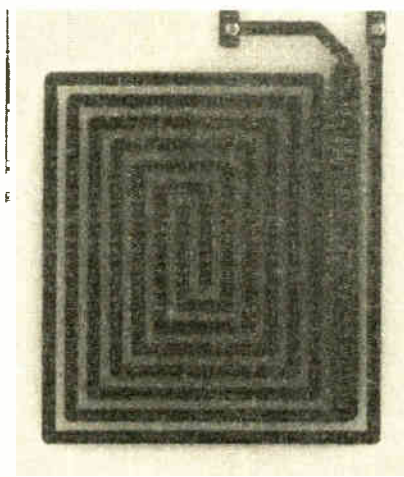

Photo 1.16. P.C.B. tracking used as a moisture sensor.



Photo 1.17. Commercial moisture sensor.

### Moisture sensor (passive)

A pair of bare wires, or the tracks of a piece of stripboard or p.c.b. can be used as an adequate moisture sensor. The p.c.b. shown in Photo 1.16 has a sensor made of two tracks close together but not touching each other. When you breathe on the sensor the moisture in your breath causes the resistance between the tracks to fall from over 10MΩ to less than 100kΩ. In a later part we will look at a transistor circuit that will cause a warning buzzer to sound with your breathe on a moisture sensor.

A more professional moisture sensor is shown Photo 1.17. It works the opposite way in that moisture causes the resistance between the wires to increase. This is useful in applications where the sensor is normally wet, since less current is wasted.

### Microphone (dynamic = active; electret = passive)

A dynamic microphone senses sound energy, and converts it into electrical energy. You can connect a high-impedance headphone to a microphone and receive sound without a battery or power unit.

The signal from a microphone is very small, and so an amplifier is generally required to boost the signal to an acceptable level. It is possible to connect a dynamic microphone directly to an oscilloscope to display your voice as shown in Photo 1.18.



Photo 1.19. Electret microphone handset.



## PANEL 1.3. OSCILLOSCOPE DISPLAYS

Throughout this series we use oscilloscope photographs to display the signals at the input and/or output of a circuit. An oscilloscope can show what is happening when a voltage is quickly rising or falling; it shows the voltage by means of a graph or trace on a screen. Some of the images used in this series are displayed on a "dual beam storage oscilloscope".

A dual beam oscilloscope has two channels, one for each trace. This allows you to compare waveforms. For example, you may wish to check that an amplifier does not distort your sound signal, and so

you could display the output signal below the input signal and check that their shapes are identical.

However, a cheaper single beam oscilloscope is almost as useful. The reason that the author used a storage oscilloscope is that photography was made much easier! Some of our displays are also produced by a computer simulation.

A digital multimeter is a much cheaper alternative to any oscilloscope and will cover many of the experiments in this series.

If an oscilloscope is not available, you can use a multimeter set to "a.c. voltage". This will provide a guide to the signal level being generated.

An electret microphone requires a power supply, and the microphone module houses a tiny amplifier. The microphone in Photo 1.19 contains a battery that supplies power to the amplifier module. Hence a signal is produced which is similar to the effect of using a dynamic microphone.

Expensive electret microphones do not contain a battery and so require "phantom power". This is (generally) a 48V supply that is fed down the microphone cable from the main microphone mixer/amplifier.

Dynamic microphones can be bought for as little as £5, though good quality dynamics costing around £100 are often used in stage shows. Electret microphones are often used in professional recording studios. They should be placed above the faces of the performers so that air is not puffed into the microphone, to avoid popping noises.

### Microphone Inserts

Dynamic and electret microphones are available as inserts, i.e. the microphone module without the housing. The one

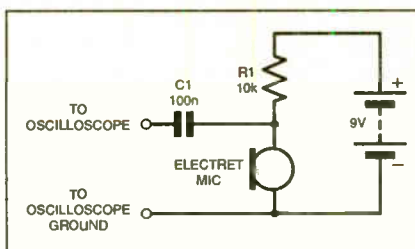

Fig.1.19. Experimental electret microphone circuit.

shown in Photo 1.20 is an electret type, available for about 50p and ideal for project work.

Try setting up the circuit in Fig.1.19 on a breadboard. Notice that resistor R1 is required in series with the microphone and the power supply. The signal from the microphone is normally connected to an amplifier circuit via a capacitor, C1. This blocks the d.c. supply, so leaving just the a.c. sound signal. The value of the capacitor is not critical and any value above 100nF should work.

If you use an electrolytic type then its positive connection should be nearer the

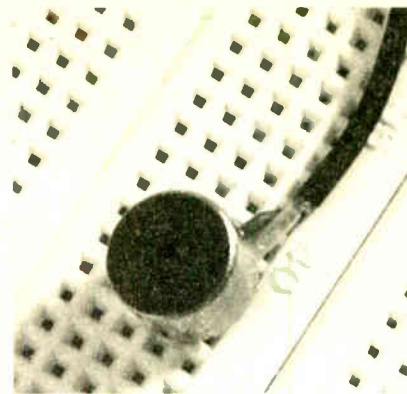

Photo 1.20. Electret microphone insert.

resistor. If you monitor the a.c. signal on an oscilloscope, you may also find that a "load resistor" is necessary – say 100kΩ – connected between the oscilloscope side of C1 and ground (0V). (Note that you can omit the capacitor and set the oscilloscope to "a.c. input".)

When you speak into the microphone you should see your voice on the oscilloscope screen, in the same way as illustrated in Photo 1.18.

## OUTPUT DEVICES

Output devices are best dealt with as their need arises, and we will examine many during this series. They include:

lamps, i.e.d.s, heaters, bells, buzzers, speakers, electromagnets, solenoids, relays and motors.

Many output devices require a significant current and you generally need to amplify the current available from a sensor before an output device will respond adequately.

## NEXT MONTH

Next month we will show how simple transistor circuits can provide the appropriate current and voltage for an output device.

IT'S FUN AND GAMES NEXT MONTH – SO ORDER YOUR COPY NOW

★ CHRISTMAS CHEEKS ★  
PIC NIM MACHINE

PLUS VIRUS ZAPPER Mk2  
TEACH-IN 2004 Pt 2

### Annual subscription rates:

6 Months: UK £16.50, Overseas £19.50 (standard air service),  
£28.50 (express airmail)  
1 Year: UK £31.00, Overseas £37.00 (standard air service),  
£55.00 (express airmail)  
2 Years: UK £57.00, Overseas £69.00 (standard air service),  
£105.00 (express airmail)

To: Everyday Practical Electronics,  
Wimborne Publishing Ltd., 408 Wimborne Road East, Ferndown, Dorset BH22 9ND  
Tel: 01202 873872 Fax: 01202 874562  
E-mail: subs@epemag.wimborne.co.uk  
Order from our online shop at:  
www.epemag.wimborne.co.uk/shopdoor.htm

EVERYDAY  
PRACTICAL  
ELECTRONICS

### SUBSCRIPTION ORDER FORM

To subscribe from the USA or Canada  
see the last magazine page

I enclose payment of £ .....  
(cheque/PO in £ sterling only),  
payable to Everyday Practical Electronics

My card number is: .....

Please print clearly, and check that you have the number correct

Signature .....

Card Security Code ..... (The last 3 digits on or just under  
the signature strip)

Card Ex. Date ..... Switch Issue No. ....

Subscriptions can only start with the next available issue.  
For back numbers see the Back Issues page.

Name .....

Address .....

Post code ..... Tel. ....

If you do not wish to cut your issue, send a letter or copy of this form.

# New Technology Update

*A new Floating Gate Analogue (FGA) technology is claimed to be setting the standards for accurate voltage references, reports Ian Poole.*

**D**EVELOPMENT of new chips to fill the ever-growing need for voltage references is always ongoing. In one advance, Xicor, an analogue and mixed signal i.c. manufacturer, has developed a novel technology that eliminates the need for laser trimming often used in the production of precision devices to enable them to meet their final required output voltage.

It is known as Floating Gate Analogue (FGA) technology and is an extension of the thick oxide Fowler-Nordheim Tunnelling technology that the company owns. This allows devices to retain a precision charge level on a floating gate within the device.

The company states that the advantages of the new technology enable the voltage reference to outperform other existing analogue technologies. By storing the voltage on the floating gate it is possible to produce a reference voltage that provides a very high level of initial accuracy, temperature stability and long term stability

## Basic Circuit

The basic circuit contained within the new voltage reference is quite standard, although the way in which the reference is derived and maintained is totally new. The circuit shown in Fig.1 uses two MOSFETS, TR1 and TR2, one employed as a current sink and the other as a current mirror. TR1 is a depletion mode device that is self-biased by the current from TR2. A two transistor current source, TR3 and TR4, also supplies a voltage to the gate of TR2 enabling it to conduct sufficiently to stabilise its gate drain voltage at its threshold.

As the source connections of TR1 and TR2 are connected together the voltage at gate/drain of TR2 is the sum of the two threshold voltages. The unadjusted voltage output is therefore dependent upon threshold implants and can vary by around  $\pm 15\%$ .

## Enhanced Circuit

To achieve the required performance, Xicor have taken the basic CMOS design and by replacing the usual depletion mode MOSFET with a floating gate version, they have enabled the output voltage to be trimmed to the required value. The circuit also exhibits far greater levels of temperature stability and long term

accuracy as a result of the new internal reference source.

The floating gate has an associated capacitance, C1. This stores the charge required to control the gate of the reference amplifier to produce the required output voltage.

The level of charge needs to be adjusted to enable control of the output voltage to be effected. This is achieved using tunnel diodes. There is an isolating area of oxide either side of the gate that forms the tunnel diodes. This requires around ten volts before the tunnelling mechanism allows conduction.

charge is effectively trapped on the floating gate and there is little change. Xicor state that the output voltage will remain intact for between 10 and 100 years.

## Internal Feedback

An internal feedback loop is also included in the design and this contains an operational amplifier that is activated during the voltage programming function. By using this approach the device is programmed such that the output accurately reflects the external reference voltage. Once the calibration is complete the operational amplifier is switched off to save power.

Although the calibration circuitry could have been left off the circuit and external reference circuitry used for calibration, it was decided to retain these components on the chip for the possible future developments of a programmable version of the chip.

## Slew Rate

The first of the devices to be launched has a very low power consumption. The device is able to provide its specified precision output with a power consumption of only 500nA. However, this also means that its transient response is not as good as devices consuming more power.

Applying a capacitor to the output makes a very large improvement, but where transient response is of particular importance, future devices that consume more power will be available with greatly improved performance. It is purely a matter of choosing what is required.

Using the new technology accuracies of around 250 microvolts and temperature coefficients as low as 1ppm/ $^{\circ}$ C can be achieved. As the device consumes a very low level of current it is ideal for many of today's portable applications where current drain is of great importance.

## First Offerings

Engineering samples of the X60008 became available during the early part of this year, and production volumes are just becoming available. Future devices in the family are also being developed and made ready for production.

More information about radio and electronics technology can be found at [www.radio-electronics.com](http://www.radio-electronics.com).

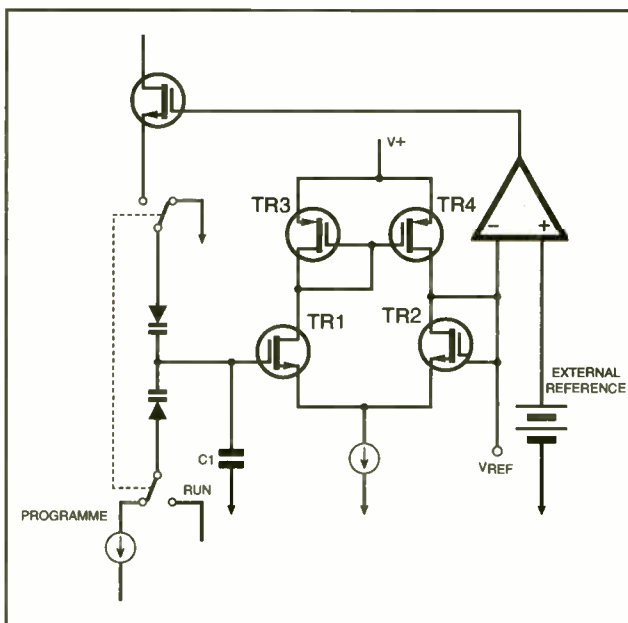

Fig. 1. Xicor voltage reference circuit.

## In Full Control

To allow full control of the gate charge voltage a current sink pulls charge out of the capacitor, whilst a variable voltage source feeds current in. By controlling the voltage source, it is possible to have complete control over the charge and hence the voltage on the gate capacitor, and the final output.

When the output voltage is set to the required value, the switches either side of the two tunnelling diodes are changed to completely isolate the diodes and the charge capacitor. Although it may appear that there may be some leakage of the charge on the capacitor and a resulting movement of the output voltage, the

# PAGM

The leaders in PIC development

**FROM**

**£99**

- ◆ All you need to get started with PIC
- ◆ Industry standard/quality board
- ◆ Open the box and get coding
- ◆ Available with C compiler or use our PicScript to write programs using simple commands...  
**NO ASSEMBLER,  
NO COMPILER,  
JUST WRITE AND RUN**



**EASE OF USE**

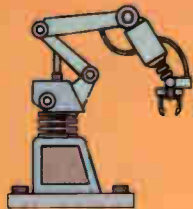

**AUTOMATION**

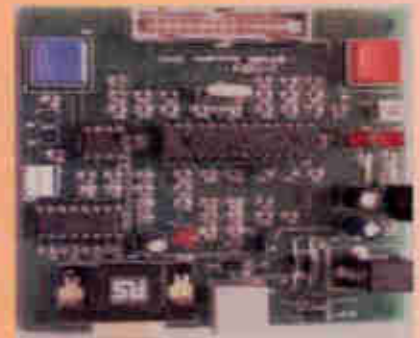

**SCRIPTABILITY**

PicDev Board with PicScript

**£99.00** (plus p+p)

This is a complete development suite for the novice or non programmer.

It is shipped with:

- PicDev Board
- PicShell and PicScript software
- Breakout board
- Cables
- Example scripts

PicDev Board with C Compiler

**£165.00** (plus p+p)

This is a complete development suite for the more advanced programmer.

It is shipped with:

- PicDev Board
- PicShell and PicScript software
- C compiler
- Breakout board
- Cables
- Example scripts
- ICD1

Both items require

- PC with serial port available
- Power supply adapter

**To order:**

[www.pagm.co.uk](http://www.pagm.co.uk)

[sales@pagm.co.uk](mailto:sales@pagm.co.uk)

Tel: +44 (0)1792 891927

# EPE PIC RESOURCES CD-ROM



**A companion to the EPE PIC Tutorial V2 series of Supplements (EPE April, May, June 2003)**

**ONLY £14.45 INCLUDING VAT and P&P**

**Contains the following Tutorial-related software and texts:**

- EPE PIC Tutorial V2 complete demonstration software, John Becker, April, May, June '03
- PIC Toolkit Mk3 (TK3 hardware construction details), John Becker, Oct '01
- PIC Toolkit TK3 for Windows (software details), John Becker, Nov '01

Plus these useful texts to help you get the most out of your PIC programming:

- How to Use Intelligent L.C.D.s, Julian Ilett, Feb/Mar '97
- PIC16F87x Microcontrollers (Review), John Becker, April '99
- PIC16F87x Mini Tutorial, John Becker, Oct '99
- Using PICs and Keypads, John Becker, Jan '01
- How to Use Graphics L.C.D.s with PICs, John Becker, Feb '01
- PIC16F87x Extended Memory (how to use it), John Becker, June '01
- PIC to Printer Interfacing (dot-matrix), John Becker, July '01
- PIC Magick Musick (use of 40kHz transducers), John Becker, Jan '02
- Programming PIC Interrupts, Malcolm Wiles, Mar/Apr '02
- Using the PIC's PCLATH Command, John Waller, July '02
- EPE StyloPIC (precision tuning musical notes), John Becker, July '02
- Using Square Roots with PICs, Peter Hemsley, Aug '02
- Using TK3 with Windows XP and 2000, Mark Jones, Oct '02
- PIC Macros and Computed GOTOs, Malcolm Wiles, Jan '03
- Asynchronous Serial Communications (RS-232), John Waller, unpublished
- Using I<sup>2</sup>C Facilities in the PIC16F877, John Waller, unpublished
- Using Serial EEPROMs, Gary Moulton, unpublished
- Additional text for EPE PIC Tutorial V2, John Becker, unpublished

NOTE: The PDF files on this CD-ROM are suitable to use on any PC with a CD-ROM drive. They require Adobe Acrobat Reader – included on the CD-ROM

**Order on-line from**  
[www.epemag.wimborne.co.uk/shopdoor.htm](http://www.epemag.wimborne.co.uk/shopdoor.htm)  
 or [www.epemag.com](http://www.epemag.com) (USA \$ prices)  
 or by Phone, Fax, Email or Post.

## EPE PIC RESOURCES CD-ROM ORDER FORM

Please send me ..... (quantity) EPE PIC RESOURCES CD-ROM

Price £14.45 each – includes postage to anywhere in the world.

Name .....

Address .....

.....

.....

..... Post Code .....

I enclose cheque/P.O./bank draft to the value of £ .....

Please charge my Visa/Mastercard/Amex/Diners Club/Switch

£ .....

Card No. ....

Card Security Code ..... (The last 3 digits on or just under the signature strip)

Expiry Date ..... Switch Issue No. ....

**SEND TO: Everyday Practical Electronics,  
 Wimborne Publishing Ltd.,  
 408 Wimborne Road East, Ferndown, Dorset BH22 9ND.  
 Tel: 01202 873872. Fax: 01202 874562.  
 Email: [orders@epemag.wimborne.co.uk](mailto:orders@epemag.wimborne.co.uk)**

Payments must be by card or in £ Sterling – cheque or bank draft drawn on a UK bank.

Normally supplied within seven days of receipt of order.

Send a copy of this form, or order by letter if you do not wish to cut your issue.

**BECOME A PIC WIZARD WITH THE HELP OF EPE!**

We can supply back issues of *EPE* by post, most issues from the past three years are available. An *EPE* index for the last five years is also available at [www.epemag.wimbome.co.uk](http://www.epemag.wimbome.co.uk) or see order form below. Alternatively, indexes are published in the December issue for that year. Where we are unable to provide a back issue a photocopy of any *one article* (or *one part* of a series) can be purchased for the same price. Issues from Nov. 96 are available on CD-ROM – see next page – and issues from the last six months are also available to download from [www.epemag.com](http://www.epemag.com). Please make sure all components are still available before commencing any project from a back-dated issue.

## DID YOU MISS THESE?

### JULY '02

**PROJECTS** • EPE StyloPIC • Infra-Red Autoswitch • Simple Audio Circuits – 3 • Rotary Combination Lock.

**FEATURES** • Teach-In 2002 – Part 9 • Practically Speaking • Using The PIC's PCLATH Command • Ingenuity Unlimited • Circuit Surgery • New Technology Update • Net Work – The Internet Page.

### AUG '02 Photocopies only

**PROJECTS** • PIC World Clock • Pickpocket Alarm • Big-Ears Buggy • Simple Audio Circuits – 4.

**FEATURES** • Teach-In 2002 – Part 10 • Using Square Roots with PICs • Ingenuity Unlimited • Evolutionary Electronics • Interface • Circuit Surgery • Net Work – The Internet Page.

### SEPT '02 Photocopies only

**PROJECTS** • Freebird Glider Control • Portable Telephone Tester • EPE Morse Code Reader • Vinyl to CD Preampifier.

**FEATURES** • Circuit Surgery • New Technology Update • Practically Speaking • Net Work • Flowcode for PICmicro • Logic Gate Inverter Oscillators • Net Work – The Internet Page.



### OCT '02 Photocopies only

**PROJECTS** • EPE Bounty Treasure Hunter • IC Tester • Headset Communicator • PIC-Pocket Battleships.

**FEATURES** • Circuit Surgery • New Technology Update • Logic Gate Inverter Oscillators – 2 • Interface • Network – The Internet Page • Using TK3 With Windows XP and 2000.

### NOV '02 Photocopies only

**PROJECTS** • EPE Hybrid Computer – 1 • Tuning Fork and Metronome • Transient Tracker • PICAXE Projects-1 (Egg Timer – Dice Machine – Quiz Game Monitor).

**FEATURES** • Practically Speaking • Ingenuity Unlimited • Circuit Surgery • New Technology Update • Net Work – The Internet Page.

### DEC '02

**PROJECTS** • Versatile PIC Flasher • EPE Hybrid Computer – 2 • Door Defender • PICAXE Projects – 2 (Temperature Sensor – Voltage Sensor – VU Indicator).

**FEATURES** • Electronic Paper • Alternative Uses for Transistors • Interface • Circuit Surgery • New Technology Update • Ingenuity Unlimited • Net Work – The Internet Page • 2002 Annual Index.

### JAN '03

**PROJECTS** • EPE Minder • FM. Frequency Surfer • Wind Speed Meter • PICAXE Projects-3 (Chaser Lights).

**FEATURES** • Who Really Invented The Transistor • TechnoTalk • Circuit Surgery • Practically Speaking • New Technology Update • Computer GOTOs • Ingenuity Unlimited • Net Work – The Internet Page.

### FEB '03

**PROJECTS** • Wind Tunnel • Brainbot Buggy • Back To Basics-1 (Hearing Aid, Audio Power Amplifier) • Tesla High Voltage Transformer.

**FEATURES** • In The Bag • Techno Talk • Circuit Surgery • New Technology Update • Interface • Ingenuity Unlimited • Net Work – The Internet Page.



### MAR '03

**PROJECTS** • Wind-Up Torch Mk II • 200kHz Function Generator • Driver Alert • Back-To-Basics-2 (Metal Detector, Simple Timer).

**FEATURES** • Ingenuity Unlimited • Practically Speaking • Techno Talk • New Technology Update • Circuit Surgery • Peak LCR Component Analyser Review • Net Work – The Internet Page.

### APR '03

**PROJECTS** • Atmospheric Monitor • Intelligent Garden Lights Controller • Back-To-Basics-3 (Touch Light, Plant Watering Reminder) • Earth Resistivity Logger-Part 1.

**FEATURES** • Ingenuity Unlimited • Techno Talk • New Technology Update • Circuit Surgery • Interface • Network – The Internet Page • **SPECIAL SUPPLEMENT** – EPE PIC Tutorial V2 – Part 1.

### MAY '03

**PROJECTS** • Super Motion Sensor • Earth Resistivity Logger – Part 2 • Door Chime • Back-To-Basics-4 (Live Wire Detector, Medium Wave Radio).

**FEATURES** • Ingenuity Unlimited • Techno Talk • Practically Speaking • Circuit Surgery • Net Work – The Internet Page • **SPECIAL SUPPLEMENT** – EPE PIC Tutorial V2 – Part 2.

### JUNE '03

**PROJECTS** • Fido Pedometer • PICronos L.E.D. Wall Clock-Part 1 • Back-To-Basics-5 (Mini Theremin, Twilight Switch) • Radio Circuits-1 (Crystal Set, MK484 TRF Receiver, Headphone Amplifier).

**FEATURES** • Ingenuity Unlimited • Techno Talk • Interface • Circuit Surgery • New Technology Update • Net Work – The Internet Page • **SPECIAL SUPPLEMENT** – EPE PIC Tutorial V2 – Part 3.

### JULY '03

**PROJECTS** • EPE Mini Metal Detector • Low Range Ohmmeter Adaptor Mk2 • Radio Circuits-2 (Q-Multiplier, MW Reflex Radio, Speaker Amplifier) • Ultimate Egg Timer • PICronos L.E.D. Wall Clock – Part 2.

**FEATURES** • Ingenuity Unlimited • Circuit Surgery • Techno Talk • Practically Speaking • Flowlog Lite Review • Net Work – The Internet Page.



### AUG '03

**PROJECTS** • EPE PIC Met Office-1 • Alarm System Fault Finder • Master/Slave Intercom • Electronic Two-Up • Radio Circuits-3 (Regenerative Receivers).

**FEATURES** • Digital Command Control for Model Trains • Ingenuity Unlimited • Circuit Surgery • Interface • Techno Talk • New Technology Update • Net Work – The Internet Page.

### SEPT '03

**PROJECTS** • PIC-A-Colour • Vibration Alarm • Priority Referee • EPE PIC Met Office-2 • Radio Circuits-4 (Tuning Systems).

**FEATURES** • Using the PIC's "High" Operator • Practically Speaking • Ingenuity Unlimited • Techno Talk • Circuit Surgery • Net Work – The Internet Page.

### OCT '03

**PROJECTS** • RC Car Wars • Serial Interface for PICs and VB6 • Practical Radio Circuits-5 (Super Regen. Receiver) • Spooky Bug.

**FEATURES** • PIC Breakpoint • Ingenuity Unlimited • Interface • Techno-Talk • New Technology Update • Net Work – The Internet Page.

## BACK ISSUES ONLY £3.50 each inc. UK p&p.

Overseas prices £4 each surface mail, £5.50 each airmail.

We can also supply issues from earlier years: 1998 (except Jan. to May, July, Sept., Nov., Dec.), 1999 (except Feb., May, Aug., Dec.), 2000 (except Feb.), 2001 (except May, Sept., Oct., Nov.), 2002 (except June, Aug. to Nov.) Where we do not have an issue a photocopy of any *one article* or *one part* of a series can be provided at the same price.

### ORDER FORM – BACK ISSUES – PHOTOCOPIES – INDEXES

- Send back issues dated .....
- Send photocopies of (article title and issue date) .....
- Send copies of last five years indexes (£3.50 for five inc. p&p – Overseas £4 surface, £5.50 airmail)

Name .....

Address .....

..... Tel: .....

- I enclose cheque/P.O./bank draft to the value of £ .....
- Please charge my Visa/Mastercard/Amex/Diners Club/Switch £ ..... Switch Issue No. ....

Card No. ....

Card Expiry Date ..... Card Security Code ..... (The last 3 digits on or just under the signature strip)

SEND TO: Everyday Practical Electronics, Wimborne Publishing Ltd., 406 Wimborne Road East, Ferndown, Dorset BH22 9ND.

Tel: 01202 873872. Fax: 01202 874562.

E-mail: [orders@epemag.wimbome.co.uk](mailto:orders@epemag.wimbome.co.uk) On-line Shop: [www.epemag.wimbome.co.uk/shopdoor.htm](http://www.epemag.wimbome.co.uk/shopdoor.htm)

Payments must be in £ sterling – cheque or bank draft drawn on a UK bank. Normally supplied within seven days of receipt of order.

Send a copy of this form, or order by letter if you do not wish to cut your issue.

M11703

# STORE YOUR BACK ISSUES ON MINI CD-ROMS



**VOL 8  
NOW AVAILABLE**

**ONLY  
£14.45 each**  
including VAT  
and p&p

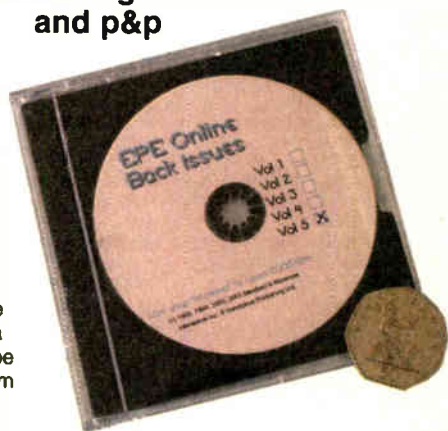

A great way to buy **EPE Back Issues** – our mini CD-ROMs contain back issues from our **EPE Online** website plus bonus articles, all the relevant PIC software and web links. Note: no free gifts are included. All this for just £14.45 each including postage and packing.

## **VOL 1 CONTENTS**

BACK ISSUES – November 1998 to June 1999

## **VOL 2 CONTENTS**

BACK ISSUES – July 1999 to December 1999

## **VOL 3 CONTENTS**

BACK ISSUES – January 2000 to June 2000

## **VOL 4 CONTENTS**

BACK ISSUES – July 2000 to Dec. 2000

## **VOL 5 CONTENTS**

BACK ISSUES – January 2001 to June 2001

## **VOL 6 CONTENTS**

BACK ISSUES – July 2001 to December 2001

## **VOL 7 CONTENTS**

BACK ISSUES – Jan 2002 to June 2002

## **VOL 8 CONTENTS**

BACK ISSUES – July 2002 to December 2002

## **WHAT IS INCLUDED**

All volumes include the full editorial content of every listed issue, plus all the available **PIC Project Codes** for the PIC projects published in those issues.

Note that no advertisements are included in Volumes 1 and 2; from Volume 5 onwards the available relevant software for *Interface* articles is also included.

## **EXTRA ARTICLES – ON ALL VOLUMES**

**BASIC SOLDERING GUIDE** – Alan Winstanley's internationally acclaimed fully illustrated guide. **UNDERSTANDING PASSIVE COMPONENTS** – Introduction to the basic principles of passive components. **HOW TO USE INTELLIGENT L.C.D.s**, by Julyan Ilett – An utterly practical guide to interfacing and programming intelligent liquid crystal display modules. **PhyzyyB COMPUTERS BONUS ARTICLE 1** – Signed and Unsigned Binary Numbers. By Clive "Max" Maxfield and Alvin Brown. **PhyzyyB COMPUTERS BONUS ARTICLE 2** – Creating an Event Counter. By Clive "Max" Maxfield and Alvin Brown. **INTERGRAPH COMPUTER SYSTEMS 3D GRAPHICS** – A chapter from Intergraph's book that explains computer graphics technology. **FROM RUSSIA WITH LOVE**, by Barry Fox – Russian rockets launching American Satellites. **PC ENGINES**, by Ernest Flint – The evolution of Intel's microprocessors. **THE END TO ALL DISEASE**, by Aubrey Scoon – The original work of Rife. **COLLECTING AND RESTORING VINTAGE RADIOS**, by Paul Stenning. **THE LIFE & WORKS OF KONRAD ZUSE** – a brilliant pioneer in the evolution of computers. A bonus article on his life and work written by his eldest son, including many previously unpublished photographs.

Note: Some of the **EXTRA ARTICLES** require WinZip to unzip them.

NOTE: These mini CD-ROMs are suitable for use on any PC with a CD-ROM drive. They require Adobe Acrobat Reader (available free from the Internet – [www.adobe.com/acrobat](http://www.adobe.com/acrobat))

## **Order on-line from**

[www.epemag.wimborne.co.uk/shopdoor.htm](http://www.epemag.wimborne.co.uk/shopdoor.htm)  
or [www.epemag.com](http://www.epemag.com) (USA \$ prices)  
or by phone, Fax, E-mail or Post

## **BACK ISSUES MINI CD-ROM ORDER FORM**

Please send me ..... (quantity) BACK ISSUES CD-ROM VOL 1  
Please send me ..... (quantity) BACK ISSUES CD-ROM VOL 2  
Please send me ..... (quantity) BACK ISSUES CD-ROM VOL 3  
Please send me ..... (quantity) BACK ISSUES CD-ROM VOL 4  
Please send me ..... (quantity) BACK ISSUES CD-ROM VOL 5  
Please send me ..... (quantity) BACK ISSUES CD-ROM VOL 6  
Please send me ..... (quantity) BACK ISSUES CD-ROM VOL 7  
Please send me ..... (quantity) BACK ISSUES CD-ROM VOL 8  
**Price £14.45 each** – includes postage to anywhere in the world.

Name .....

Address .....

.....

..... Post Code .....

I enclose cheque/P.O./bank draft to the value of £ .....

Please charge my Visa/Mastercard/Amex/Diners Club/Switch

£ .....

Card No. ....

Card Security Code ..... (The last 3 digits on or just under the signature strip)

Expiry Date ..... Switch Issue No. ....

**SEND TO: Everyday Practical Electronics,  
Wimborne Publishing Ltd.,**

**408 Wimborne Road East, Ferndown, Dorset BH22 9ND.**

Tel: 01202 873872. Fax: 01202 874562.

E-mail: [orders@epemag.wimborne.co.uk](mailto:orders@epemag.wimborne.co.uk)

Payments must be by card or in £ Sterling – cheque or bank draft drawn on a UK bank.

Normally supplied within seven days of receipt of order.

Send a copy of this form, or order by letter if you do not wish to cut your issue.

# Electronics, Mechanics and Computing Principles V8.1

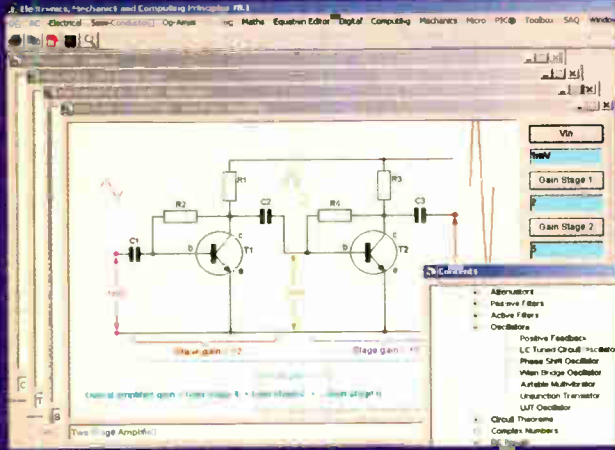

"First of all may I say what great software. Electronics, Mechanics & Computing Principles V8.1 really will keep me absorbed for months and it is so well presented. Well done."

**Now only  
£14.95**

Geoff Woolley. Head of Design Technology at Nottingham High School.

If you're looking for an easy and enjoyable way to learn electronics or just want to keep up-to-date, then this is the package for you! Also a valuable interactive reference tool for hobbyists and engineers, containing more than a thousand electronics, electrical, mechanics, maths, computing and PIC microcontroller topics. This highly acclaimed electronics software can also be found in hundreds of schools, colleges and universities to support GCSE, A-Level, City and Guilds, BTEC Nationals and many other courses up to degree level by students all over the world, yet still remains extremely easy to use.

There are more than a thousand electronics, electrical, mechanics, physics, maths, computing and PIC micro controller topics. See web site for full listing. EPV8.1 contains most of the content from the other two packages.

Still trying to get the hang of PIC micro controllers? This software contains an enormous amount of help to get you started, explaining how the PIC microcontroller works, where all the instructions can be interactively explored. Listed on the Microchip web site as a training tool for use in conjunction with their LATEST FREE downloadable MPLAB IDE programmer and simulator. Simply run the two packages together and you have all you need to begin programming.

## Mathematics and Computing Principles V8.1

Includes A-Level Computing, Computer Science and Information Technology.

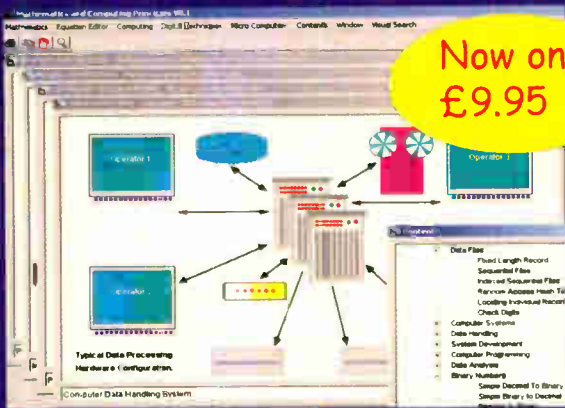

**Now on y  
£9.95**

Now combining mathematics along with a vast amount of interactive, computing and ICT material, much more than available from any other single source.

## GCSE Mathematics Principles V8.1

Struggling with GCSE Maths or just need those better grades, then try this to make it easier!

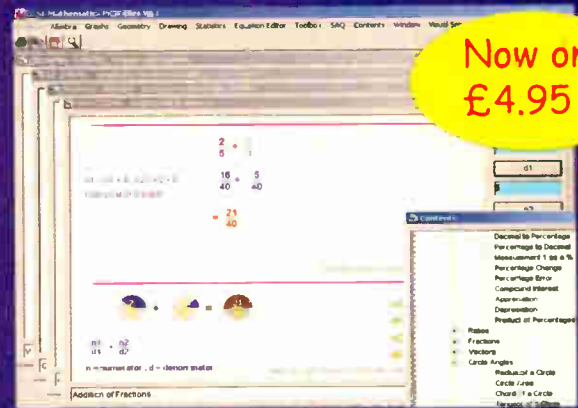

**Now only  
£4.95**

Studying with this dynamic software, you'll learn through doing and exploring mathematics! It's much more exciting than ploughing through a static textbook!

Includes the unique Equation and Graph Editors, plus full colour printing, white board technology and a host of other features.

[www.eptsoft.com](http://www.eptsoft.com) to download.



Certified software for Curriculum Online and eLearning credits.

SAVE more than £105 on the previous V8 price. FREE downloadable updates. FREE trial evaluation. NETWORK LICENCE see web site for details.

New Internet technology enables us to bring you our latest software at a fraction of the previous price.

eptsoft limited. Glebe House, School Lane, East Keal, Spilsby Lincolnshire UK PE23 4AU

Simple one-click to download and fully install to your hard drive with a backup copy, by visiting our web site.

info@eptsoft.com : Tel: 01790 754037 : Fax: 0870 0509660

World Radio History

# ANYONE AT HOME?



OWEN BISHOP

Logically deter those shifty characters eyeing up your house!

**T**HIS is a device to switch a mains-powered lamp on and off in a random way, to give a prospective intruder the impression that a house or room is occupied. Other lamps in the same room are switched on permanently, so that the house is never in darkness, but the frequent switching on and off of the controlled lamp will suggest that someone is there.

Constructors please note that part of this project is connected to the domestic MAINS supply and extreme caution must be exercised when building and running this project.

## SHIFTY LOGIC

The circuit is driven by a pseudo-random generator, based on an 8-bit shift register. Shift register outputs Q6 and Q7 are connected to a dual-input Exclusive-OR (XOR) gate, whose output is then fed back to the shift register's input. The output from the XOR gate is a long but repeating train of logic pulses.

Table 1 shows the principle in relation to the sequence generated by a 4-bit shift register, feeding back the XOR of its outputs Q3 and Q4. Remember that the logic of a dual-input XOR gate is that if both inputs have the same logic level on them the output is logic 0, whereas if the inputs are at opposite logic levels then the output is logic 1.

If this table is continued the register contents will eventually become 0010 again and then the sequence repeats. If you work it out correctly, you will find that the process takes 15 clock cycles.

The registers show all possible combinations of logic 0 and logic 1, except for

Table 1. Example 4-bit shift register sequence

Clock	Q1	Q2	Q3	Q4	XOR Q3/Q4
1	0	0	1	0	1
2	1	0	0	1	1
3	1	1	0	0	0
4	0	1	1	0	1

0000. Obviously this cannot be allowed to occur for it would result in the circuit being latched to produce an infinite series of zeroes.

However, this does not happen with a 4-bit register feeding back from registers 2 and 3 as in the Table. It *could* happen with the 8-bit shift register used in this project if at switch-on the register is randomly reset to all zeroes, although this is rare. If it does happen, switching off and on again should change the situation.

With the project circuit there are 127 states before the sequence repeats. Although the sequence is obviously not random, it is so long that it is almost impossible to detect the repeating pattern. It thus *appears* to be random, and for the purpose of deceiving an intruder, only the appearance matters.

If one clock cycle takes one minute, the sequence takes 127 minutes to repeat, which is over two hours. A prospective intruder is not likely to wait for two hours and so notice the repetition.

The generator may often produce runs of two, three or more logic 0s or logic 1s, so the lamp may be on or off for periods of as many minutes. You may feel that such frequent switching is not realistic, and may prefer to run the clock more slowly. In this case, increase the value of capacitor C1 to 220µF or more.

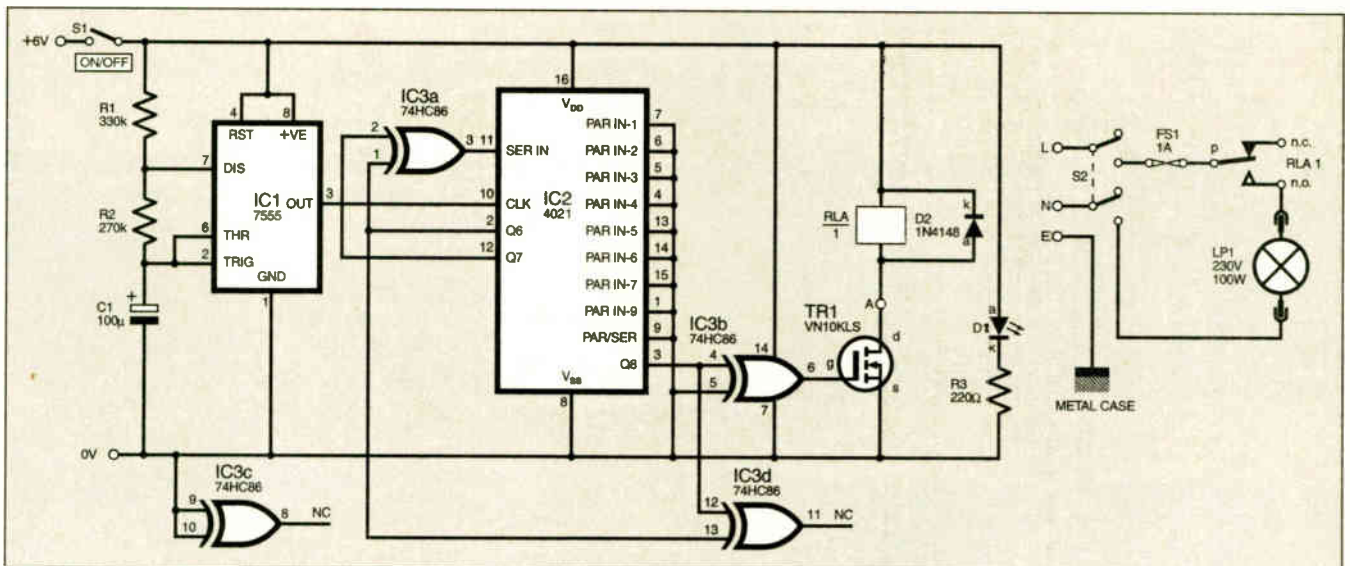

Fig.1. Full circuit diagram for the Anyone At Home?



## CIRCUIT DESCRIPTION

The complete circuit diagram for the Anyone at Home? project is shown in Fig.1. The clock generator is based on a CMOS 7555 timer, IC1. Its output cycle rate at pin 3 is set by the values of resistors R1 and R2, and capacitor C1. The rate is approximately one cycle per minute.

Negative-going output changes at pin 3 trigger the 8-stage shift register IC2, which shifts via its pin 11 the logic level from XOR gate IC3a pin 3. Simultaneously, all internal logic levels are shifted along by one stage. Outputs Q6 and Q7 are fed to the inputs of IC3a, whose output logic level changes as appropriate to their logic.

The final stage at Q8 is fed to one input of IC3b, with its other input held at 0V. This XOR gate simply acts as a non-inverting buffer. The other two gates (IC3c and IC3d) within the quad package are unused, their inputs being tied to the most convenient circuit points to prevent them from "floating".

The output from IC3b pin 6 controls MOSFET transistor TR1. When pin 6 is high, TR1 is turned on, activating relay RLA and so connecting lamp LP1 to the a.c. mains supply via fuse FS1 and switch S2 (if switched on). The specified relay can switch a mains-powered lamp rated at up to 200W.

To economise in cost, the logic circuits are powered by a battery, instead of a transformer/rectifier circuit. In the prototype four D-type cells in a battery box were used (supplying approximately 6V d.c.), but if the circuit is to be used only occasionally, it will run for many hours on C-type or even AA-type cells. A lot depends on the resis-

tance of the relay coil, so select one with high resistance (while still being rated for 6V d.c. across its coil).

## CONSTRUCTION

This project is connected to the mains and should only be constructed by those who are suitably experienced or supervised.

There are two printed circuit boards for this design, the Logic and Relay boards. These boards are available as a pair from the EPE PCB Service, codes 421 (Logic) and 422 (Relay).

Component layout, assembly and track details for the boards are shown in Fig.2 and Fig.3, respectively. Assemble the boards in ascending order of component

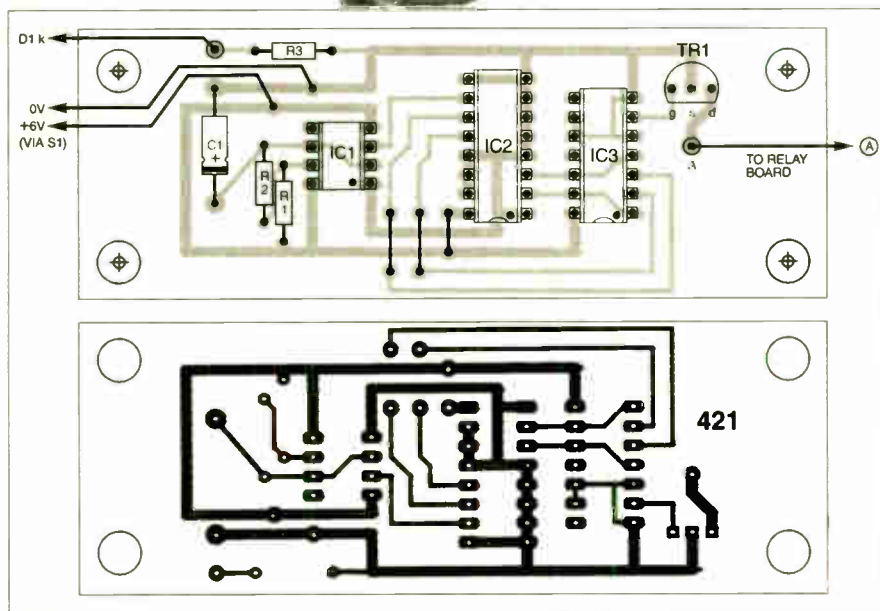
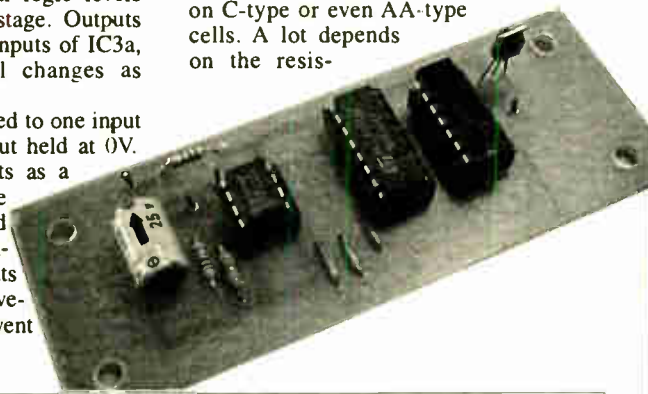

Fig.2. Logic p.c.b. component layout and full-size copper foil master.

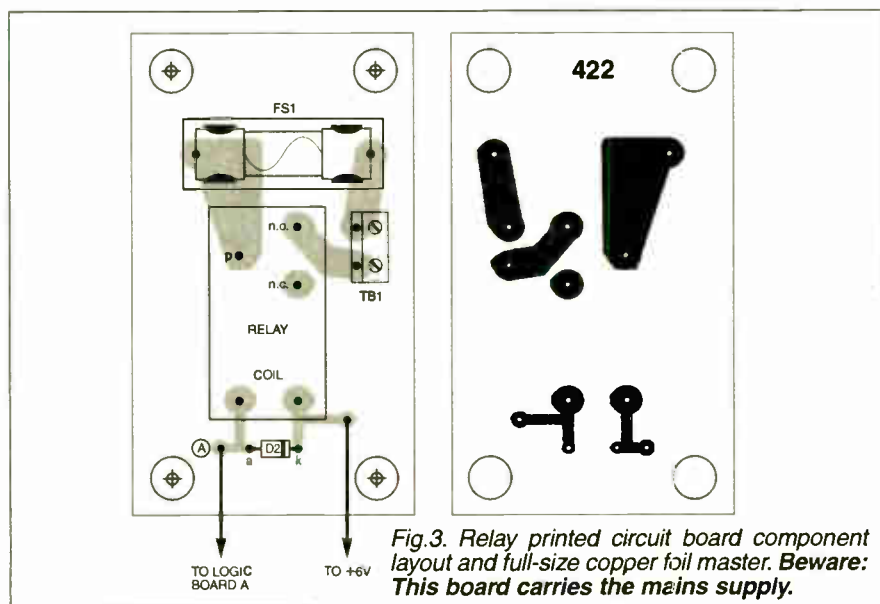

Fig.3. Relay printed circuit board component layout and full-size copper foil master. Beware: This board carries the mains supply.

## COMPONENTS

### Resistors

R1	330k
R2	270k
R3	220Ω

All 0.25W 5% carbon film or better

See  
**SHOP  
TALK**  
page

### Capacitor

C1	100μ axial elect. 25V
----	-----------------------

### Semiconductors

D1	red l.e.d., panel mounting
D2	1N4148 signal diode
IC1	7555 low-power CMOS timer
IC2	4021 CMOS 8-stage shift register
IC3	74HC86 quad XOR gate
TR1	VN10KLS low-power n-channel MOSFET, or similar

### Miscellaneous

RLA1	relay 6V d.c. coil, s.p.d.t. contacts, 3A, 230V a.c., p.c.b. mounting.
S1	s.p.s.t. min. toggle switch, panel mounting, low voltage
S2	d.p.d.t. toggle switch, mains rated
FS1	1A fuse plus fuseholder, p.c.b. mounting type

Printed circuit boards, available as a pair from the EPE PCB Service, codes 421 (logic), 422 (relay); metal case (205mm x 128mm x 65mm); 8-pin d.i.l. socket; 14-pin d.i.l. socket; 16-pin d.i.l. socket; 6V battery holder for four D-type cells; battery clip to suit; plastic p.c.b. spacers, screw-fix, 6.3mm (8 off); solder tag; nylon cable clamp, locking; nuts, bolts and washers for tag, cable clamp and mains socket; stick-on rubber feet (4 off); grommets, 7mm internal hole (2 off); 3-pin mains socket, surface mounting; mains plug; 1mm terminal pins (4 off); single-core insulated connecting wire; stranded light-duty connecting wire; 3-core mains cable (length as required); solder, etc.

Approx. Cost  
Guidance Only  
excl. case, batts & mains plug/socket

**£10**

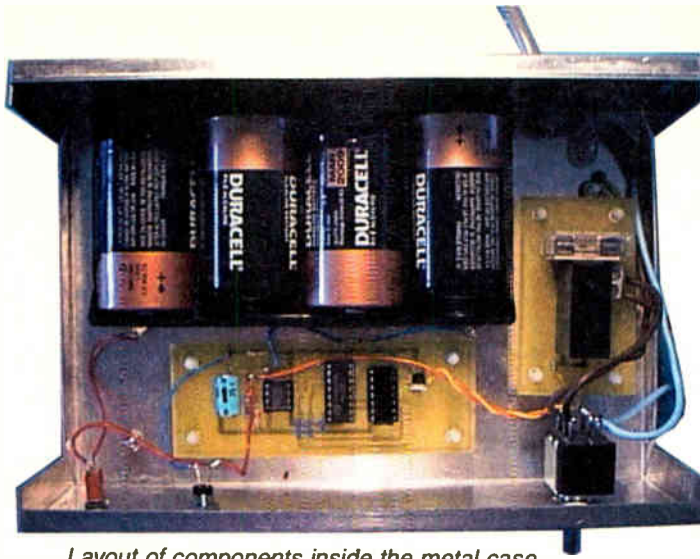

Layout of components inside the metal case. It is essential that the metal case is securely "earthed" by the mains lead, using a solder tag bolted to the case bottom.

As said earlier, it may happen that when switched on all register bits contain zero, the register producing a continuous low output. If this occurs, simply switch off, wait a second or two and then switch on again.

Connect the two boards and test the relay operation, using a multimeter set on the Ohms range to check the continuity across the relay's contacts (accessible via terminal block TB1) as they open and close.

If all is working correctly, replace the temporary 10 $\mu$ F capacitor C1 with the specified value of 100 $\mu$ F.

## ENCLOSURE

The case for this design *must* be all metal and firmly grounded to the Earth line of the a.c. mains, using a solder tag bolted to the floor of the case. The circuit boards have been designed so as to keep the low-voltage logic circuits well away from the relay and its mains connections.

For extra safety the mains switch is a double-pole toggle switch, controlling both the live and neutral lines, and rated at 10A.

It is not expected that the relay contacts will carry such heavy currents and the fuse is rated at 1A. This allows a filament lamp or lamps of up to 200W to be controlled by this project.

Drill the case to accept i.e.d. D1, switches, external mains cables, battery box and the mounting of the a.c. mains socket.

## INTERWIRING

The interwiring between the two circuit boards and case-mounted components is shown in Fig.4. Make sure you use suitably rated wires between the mains switch, the relay terminal block and to the lid-mounted mains output socket.

Wire in the mains supply to the enclosure, via a cable-clamping grommet. There must also be a grommet in the lid where the mains cable passes out to the lid-mounted mains output socket. Mount the circuit boards on well-secured spacers. Solder the other low voltage and mains voltage connections.

It is important that the connecting tags of the mains On/Off switch should be covered over with insulating sleeving, to protect against any possibility of touching the mains supply on them. The sleeving can be slipped over the wires before soldering them in position. The sleeves can then be pushed in place over the soldered joints.

Double-check all the wiring. Install the batteries into their box and insert a 1A fuse in the fuseholder. Place the lid on the enclosure and bolt it securely in place. Fit a plug to the mains lead.

Only after the lid has been secured in place should a mains test be carried out.

For the testing, plug a table-lamp into the mains socket on the lid. Plug the project into the mains. Switch on both power switches (d.c. and a.c. power). In a minute or so the table lamp should come on. If nothing happens (register contains all zeroes as discussed earlier) when five minutes have passed, switch the low-power switch off, then on.  $\square$

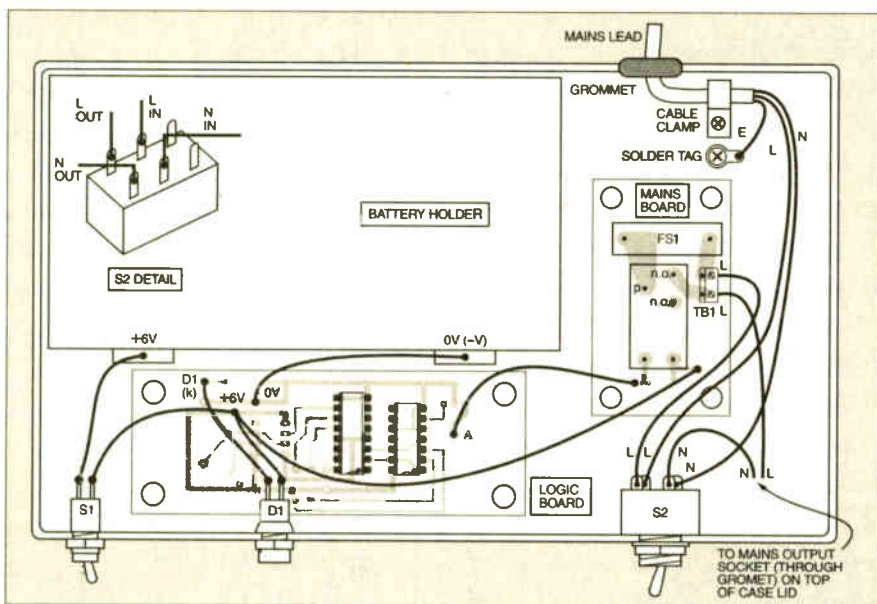

Fig.4. Details of the interwiring from the two circuit boards to the battery pack and off-board components. Wiring to the mains switch is shown inset.

size, observing the correct orientation of the semiconductors and electrolytic capacitor. Do not insert the i.c.s, or apply power until you have thoroughly checked the accuracy of your assembly and soldering.

## BOARD TESTING

Test the logic circuit by monitoring the output of IC1. It should change state (alternating between high and low) twice every

minute. Also monitor the voltage at the gate (g) terminal of TR1. This should change state periodically between high and low, but the rate of change will depend on the logic levels within the register, and so not be predictable.

To speed the checking operation you could temporarily use a 10 $\mu$ F electrolytic capacitor for C1. This gives a faster clocking rate than the specified 100 $\mu$ F.

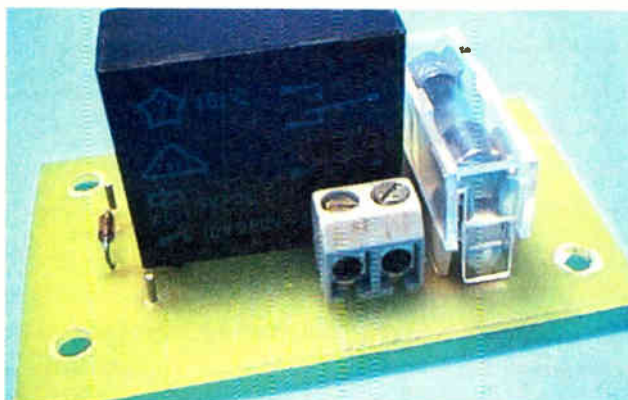

Components mounted on the Relay board.



# New Product

Atlas LCR Passive Component Analyser (Model LCR40)

**"No other LCR is as easy as this!"**

Just clip on the test leads and press test. The Atlas LCR will automatically identify the type of component, apply the appropriate test level and frequency, display the component's value and more!

Probes are detachable too, so you can use the optional SMT tweezers for your tiny unmarked passives - **fantastic**.

Inductance range: 1 $\mu$ H to 10H  
 Capacitance range: 1pF to 10,000 $\mu$ F  
 Resistance range: 1 $\Omega$  to 2M $\Omega$   
 Basic accuracy: 1%  
 Test signals: 1V, 3mA max



# £79

fully inclusive UK price



Lots of accessories available soon!

# atlas

semiconductor analyser

Check and identify your semi's

# £60

fully inclusive UK price

- Automatic component identification
- Pinout identification
- Transistor gain measurement
- MOSFET gate threshold measurement
- PN junction characteristics measurement
- Shorted Junction identification
- Transistor leakage measurement
- Just connect the part anyway round and press the button!
- Auto power on/off

### Supports:

- Bipolar transistors,
- Darlington transistors,
- Diode protected transistors,
- Resistor shunted transistors,
- Enhancement mode MOSFETs,
- Depletion mode MOSFETs,
- Junction FETs,
- Low power triacs and thyristors,
- Diodes and diode networks,
- LEDs (+bicolours)

IFN bipolar Darlington

Diode protection between C-E

Resistor shunt between B-E

Current gain Hfe=126

Enhancement mode N-Ch MOSFET

Gate Threshold Vgs=3.4V

RED SEMI BLUE Col Emit

50 Volt Vce=6.77V



**NOW MEASURES TRANSISTOR LEAKAGE**

enclosure colours may vary

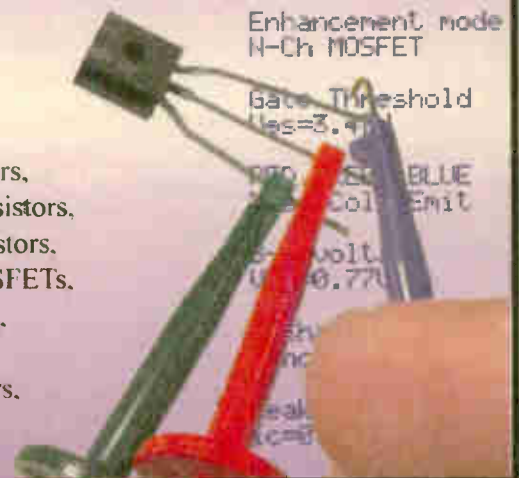

Visit [www.peakelec.co.uk](http://www.peakelec.co.uk) to download the data sheets, user guides and copies of independent reviews. You can pay using a cheque, postal order, credit or debit card and even pay securely online. Please contact us for your volume requirements.

Also available from: (prices vary)



**PEAK**  
 electronic design ltd

Atlas House, Kiln Lane  
 Harpur Ind. Est., Buxton  
 Derbyshire, SK17 9JL, UK

[www.peakelec.co.uk](http://www.peakelec.co.uk)  
[sales@peakelec.co.uk](mailto:sales@peakelec.co.uk)

Tel. 01298 70012 Fax. 01298 70046



## NEW FROM FED – FEDPIC Key - USB In Circuit Programmer / Debugger



FEDPIC Key – Ultra-Miniature USB In Circuit Serial Programmer and Debugger

Pricing £60.00

**Description :** Our new in-circuit programmer/debugger for PIC's operates on the PC USB port, requires no additional power supply and the programmer application runs under Windows '98, ME, 2000 or XP.

**Programs :** 12Cxxx, 12Fxxx, 16Fxxx, 18Cxxx and 18Fxxx devices and flash upgradeable for future devices.

**Operates** on a simple 6 pin SIL connector and includes the FED In Circuit Debugger. FEDPIC Key Debugger has the same functionality as our standard ICD described below, but runs 3 times faster !

## FED – PIC and AVR - ANSI C Compiler products



### Visual Development for the FED C Compilers WIZ-C for PIC, AVIDICY for AVR

- An application designer for the FED PIC or AVR C Compilers FULLY including the PIC or AVR C Compiler
- Drag a software component on to your design & set up the parameters using check boxes, drop down boxes and edit boxes (see shot below)
- Connect the component to the device pins using the mouse
- Select your own C functions to be triggered when events occur (e.g. Byte received, timer overflow etc.)
- Simulate, Trace at up to 10x the speed of other simulators
- Generate the base application automatically and then add your own functional code in C or assembler
- WIZ-C supports over 80 PICS - 16F87x, 16F627/8, 16C55x, 16C6x, 16F8x, 16C7xx 18Cxx, 18Fxxx, 12F629/676 etc.
- AVIDICY supports normal and Mega range devices
- Demonstration download available :

[www.fored.co.uk/CDemo.htm](http://www.fored.co.uk/CDemo.htm)

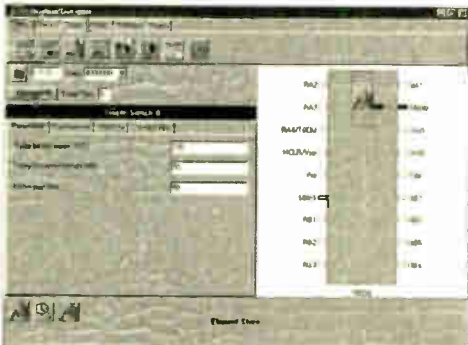

Screen shot (left) shows push button element connected to a PIC, Parameters may be set to control debounce and repeat. C function may be specified to call when the button is pressed

### FED ANSI C Compiler for PIC and AVR

- C Compiler designed to ANSI standards
- Supplied with library routines for C standard functions and many interface applications including I2C, LCD, LED's, timers, EEPROM, IRDA, Dallas 1 Wire, Hex Keypad, Maths, asynchronous serial interfacing, clocked data etc.
- With complete development/simulation environment including LCD/Keypad/LED/RS232 terminal
- View your simulation on a logic analyser application showing waveforms, timing or analogue results
- Profiler shows execution count, execution time and average time for functions and code blocks
- Smart linker – efficiently tiles routines throughout memory to minimise long jumps and page setting bits
- Supports the FEDPIC Key and FED In Circuit Debugger for PIC devices 16F87x and 18Fxx devices – See web site for more details.

### WIZ-C and C Compiler Pricing :

AVR or PIC C Compiler	£60.00
AVR or PIC C Compiler Professional	£90.00
AVIDICY or WIZ-C	£70.00
AVIDICY or WIZ-C Professional	£100.00

WIZ-C products are provided with introductory tutorial, full extensive manuals provided on CD.

All prices may be **reduced by £20.00** if the product is purchased at the same times as WIZ-ASM, serial or USB programmer, or our Development board.

## In Circuit Debugger board (or use the new FEDPIC Key)

Supports 16F87x and 18Fxxx

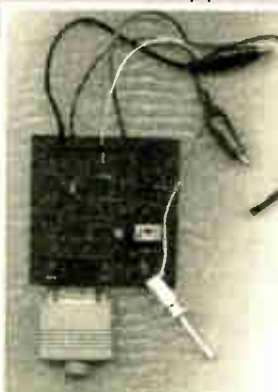

- ICD and FEDPIC Key, allow real hardware to be examined & programs to be debugged and to be run in real time on your application
- The FED ICD requires only one data I/O pin on the PIC which can be chosen from any of ports B, C or D.
- Can program and re-program applications in circuit
- Up to 13 breakpoints (18F version)
- Run, Animate, single step and step over, run to cursor line, set PC to any value in the program
- Trace execution in the original C or Assembler source files
- View and change values of PIC special function registers, W and the ports.
- Standard serial interface to PC

## Programmers and Development Board (See web pages)

**USB Programmer** - 40 pin multi-width ZIF socket. Same range of devices as our serial programmer (below).

**Price : £90/kit**

**PIC Programmer** - Handles serially programmed PIC devices in a 40 pin multi-width ZIF socket. 16C55X, 16C6X, 16C7X, 16C8x, 16F62x, 16F8X, 12C508, 12C509, 16C72XPIC 14000, 16F87X, 18Cxxx, 18Fxxx, 12F6xx etc.

Also In-Circuit programming.

Operates on PC serial port

**Price : £45/kit, £50/built & tested**

**Development Board** – For ALL 40 pin PICS from 16cxxx, 16Fxxx and 18C/Fxxx. Includes In-Circuit Programmer – NO separate programmer required. LCD interface, hex keypad, LED's and Driver, 32 I/O pins on header, I2C EEPROM, 2 Serial Interfaces, Will run FED PIC BASIC (supplied free on CD ROM) with, 1A 5V regulator etc.

The CD-ROM is supplied with FED PIC BASIC and Compiler

**Price : £35/kit, £45/built & tested, CD - £5.00.**

Manual on CD-ROM or download free from our web site

Forest Electronic Developments  
12 Buildowne Walk, Sway,  
LYMINGTON, Hampshire, SO41 6DU  
Email – [info@fored.co.uk](mailto:info@fored.co.uk)  
Web Site – <http://www.fored.co.uk>  
01590-631511 (Voice/Fax)



Prices : Please add £3.00 for P&P and handling to each order, and then EU residents add VAT at 17.5%. Cheques/POs payable to Forest Electronic Developments, phone with credit card details, or order using Credit card or Switch from our secure web site

# READOUT

Email: john.becker@wimborne.co.uk

**John Becker addresses some of the general points readers have raised. Have you anything interesting to say? Drop us a line!**

All letters quoted here have previously been replied to directly.

## WIN AN ATLAS LCR ANALYSER WORTH £79

An Atlas LCR Passive Component Analyser, kindly donated by Peak Electronic Design Ltd., will be awarded to the author of the *Letter Of The Month* each month.

The Atlas LCR automatically measures inductance from 1 $\mu$ H to 10H, capacitance from 1pF to 10,000 $\mu$ F and resistance from 1 $\Omega$  to 2M $\Omega$  with a basic accuracy of 1%.



## ★ LETTER OF THE MONTH ★

### CLEAR GOGGLES

I have discovered an improved means of preventing misting inside safety goggles. A PTFE spray is sold by Screwfix Direct (telephone 0500 414141) part no. D15152 (currently £3.10). A quick burst is applied to the inside lens of the goggles and wiped round with a soft tissue until the solvent dries to leave an undetectable film. Even in the hot weather goggles resist misting for much longer than without the PTFE treatment.

The spray did not harm the plastic materials of my goggles, but should first be tried on an unimportant area just in case. Although PTFE is extremely inert at room (or even body) temperatures, it would seem sensible not to adopt my suggestion in the unlikely case of someone with a known sensitivity or allergy to this spray.

The same supplier sells likely-looking solder safety goggles, part no. 12907 ("overspecs", currently £1.89) and for more adventurous work a brow guard, part no. 16142 (currently £7.59) offers full-face protection while allowing air-

flow and thus also helping to prevent misting.

No, I've no connection with this company (other than the fact that we enthusiasts shouldn't be without their latest, free, catalogue) but please note that small orders attract a delivery charge on top of the above-quoted (VAT inclusive) prices.

By chance, I have also discovered yet another means of preventing goggle misting and it might do for both terrestrial eye protection and also for use in scuba diving (where misting can be a problem). Speedo produce "lens cleaner anti-fog solution" which comes in 60ml spray canisters, about £5 from sports shops.

**Godfrey Manning, G4GLM, Edgware, Middx**

*Although there are "traditional" ("loutish"?) ways of keeping scuba and snorkeling masks and goggles free of condensation, they are not to be recommended for workshop goggles! Thank you Godfrey, and for the interesting private chats we've had on the subject!*

### DON'T BLAME BT

Dear EPE,

I feel you were unfair to British Telecom in your *Net Work* article of September 2003. The column used a disparaging and critical tone throughout, and your article seemed more like an irrational rant rather than a reasoned argument. That isn't good journalism, surely?

You are absolutely right that BT's business model is "hard-nosed" and quite rightly so. After all, BT is responsible to its shareholders for making a profit. In my view, the "needs of the nation" are as irrelevant to BT as they are to you. BT has not been a nationalised company for years!

In comparison, numerous rural villages in England have no gas supply. Do the villagers argue that the gas company is morally obliged to provide it because it would be of benefit to their community? No! They put up with it and make do with the alternatives, or they find the several tens of thousands of pounds the gas company charges to install a gas pipeline.

Why should BT provide ANY of its services at a loss? There would be only one reason to do so: if Ofcom made it a requirement in BT's licence. It does just this with its public payphone service, for instance. If BT installed ADSL equipment at exchanges where there is insufficient demand to pay for it, it would then be – in effect – cross-subsidising its own ISP division and it would doubtless be skating on very thin ice with the regulator.

Remember – no-one has the *right* to get a gas supply, and no-one has the *right* to a broadband connection. (Did you know that no-one has the *right* to a dial-up connection, even?)

Ah, I've enjoyed this rant! No hard feelings intended, just a vigorous difference of opinion!

(name and email address supplied.)

*Alan Winstanley, author of Net Work, replies:*

I do strive to offer a professional and balanced view on topical subjects, my recent analysis of Paypal being one example. Although it would not come across in the September column, I am not unrealistic or unsympathetic about the technical issues that face BT and cable companies. Besides, even if a local exchange has been upgraded for ADSL, if you are too far away or the line quality is too poor, then ADSL still cannot be used anyway.

However, I was really speaking up for all those frustrated users who are never likely to receive ADSL and who are therefore dependent on other more expensive broadband technologies being delivered some time in the future. What I think we are seeing is a land-grab for ADSL customers while the needs of the rest of us are being overlooked. It is only customer pressure that gave us, for example, the flat-rate Internet access that many of us enjoy today. Broadband is beyond reach of many users who could benefit the most from it, and even those without a gas supply have a choice of alternative "always on" energy sources. I do feel it is time that the focus switched to the plight of those who require high speed Internet access in areas where ADSL will never be available.

I recently attended a broadband launch where BT enabled ADSL in 18 exchanges at its own cost, and nearly £1.5 million of public money has also been made available for subsidising the delivery of broadband to 1,800 businesses. So they can do it when they want!

**Alan Winstanley, EPE On-Line Editor**

### CLOUD COVER

Dear EPE,

Congratulations John on yet another masterpiece – your *PIC Met Office* (Aug/Sep '03). I wondered whether you had considered a cloud cover (or sunshine) monitor. Pointing a light sensitive resistor and an infra-red detector diode to the north (northern hemisphere) provides a good indication of cloud cover. High IR indicating sunlight and low IR day/night/general illumination.

**Mike Halliday, via email**

*Thanks for your kind Met words Mike. But, no – dash it all (he exclaims in polite English)! – I didn't think of cloud cover, though daylight monitoring is included. Perhaps clouds for a Mk4? (the current being Mk3, over some 16 years or so). UV sensing I would have also liked to have included but I could not find any low cost sensors – does anyone know of a source?*

### PIC BREAKPOINT

Dear EPE,

I have found that the *PIC Breakpoint* (Oct '03) software won't work with a PIC16C84. I suspect this is because the "Include" file tries to use data locations 48 to 4F as indicated in the article on page 718. These locations don't exist in the C84 but there's a work around that may work for small programs – change the line LIST p = PIC16C84, r = dec to LIST p = PIC16F83, r = dec and then calibrate using an F84.

Although the differences between the i.c.s may introduce other problems, it works for the demo prog.

**Roger Warrington, via email**

*Thank you Roger. No attempt was made to suit Breakpoint for use with a C84 as this is an obsolete device. It's recognised that readers may still have stock of them, but neither I nor Richard Hinckley, Breakpoint's designer, can offer help on any problems that may arise with the C84.*

### AVR MIGRATION

Dear EPE,

Regarding your August 2003 *Readout* and the suggestion that *EPE* should come up with a toolkit for both programming and development for Atmel AVR microcontrollers. A few years ago I was given an AVR kit whereby you can program chips on a motherboard which plugs into the serial port of your computer.

My knowledge in electronics is growing steadily. I am currently doing an ICS City and Guilds electronic course and over the last few years have been taught bits and bobs by a uncle who served his time in the RAF working on computers and such like.

I feel I'm ready for the next step – programming and using microcontrollers. I've got a hunger for electronics, can you help feed that enthusiasm?

**Bob Norman, via email**

*Thanks for your comments Bob. Despite me recently raising AVRs in Readout you are only the 3rd person to respond, so I guess the majority still are not interested, meaning that we would not feel justified in pursuing them. Which I guess will be a disappointment to you, sorry! But PIC microcontrollers are easy to learn and use, so I recommend that you take that route instead.*

*Keep on enjoying electronics (and us)!*

### WITH HONOURS!

Dear EPE,

Thank you for your "well-wishes" in *Readout* July '03. I did indeed pass with Honours – a 2:1 Honours degree in fact. My electronics future looks bright!

**Jonathan Grainger, via email**

*That's great Jonathan – congrats and all best for your future career!*

## STORE WARS

The following thread from EPE contributor and reader Aubrey Scoon recently appeared on our Chat Zone, and deserves repeating here:

It's getting increasingly hard to find any electronics mags in WH Smiths, but often they do have them, but for some inexplicable reason, tend to hide them!

A few months ago I was in a Smith's (I forget which town) looking for EPE when suddenly I heard a commotion. A middle aged gentleman was complaining extremely loudly to a staff member that he couldn't find any electronics magazines. He was talking very loudly so everyone could hear but in a very educated and reasonably polite way. He was telling them that he believed there was a conspiracy amongst the staff to hide electronics magazines and was demanding an explanation. The staff were trying to reassure him that wasn't true, and even the manager was called.

EPE and EW were eventually located right at the back of the magazine stand, completely hidden between a magazine for showjumping and another for pig farming. When the gentleman complained that this was evidence that electronics was being deliberately hidden, the manager assured him this was not the case, and it was solely because electronics was not a popular subject.

Well, I couldn't resist it. I immediately waded in, loudly complaining that the manager was completely unjustified in making such a statement and that electronics was indeed very popular, and if anything, any fall in popularity was probably due to store managers hiding the magazines.

Between us, the gentleman and I were causing quite a fuss and we started to gather a large crowd of spectators. The manager kept trying to wriggle out of the situation but we were demanding an explanation. The best thing was that more

and more people started joining in on our side, complaining that they too could never find electronics magazines and demanding to know why the manager had such a prejudice against electronics hobbyists!

The poor manager, extremely embarrassed by all this attention, which by this time had brought virtually the whole store to a halt, eventually caved in and promised that the magazines would be placed in a prominent and consistent position in future, which raised a boisterous cheer from the assembled crowd.

Funny thing was, loads of people immediately snapped up the remaining copies, whereupon someone else started complaining that there were not enough copies to meet demand, leading to further concessions from the manager, who by that time clearly wished he'd stayed in bed that morning instead of going to work!

Anyway, the point is that it seems there are quite a few of us who suffer in silence and that it only takes a bit of consumer activism to bring out some support.

On that note, I strongly advise the proletariat to make their feelings known to WHS. I doubt if the store in question is still hiding the EPEs!

**Aubrey Scoon,**  
via the Chat Zone

*A splendid tale Aubrey! It's another very strong reason for taking out subs or buying online. Via the Chat Zone, On-Line Editor Alan commented to Aubrey:*

To clear up any confusion, AFAIK from previous discussions with Ed., each WHS store has a particular "level" or rating which determines the range of titles it will stock. You only have to look at the vast array of frivolous titles all competing for shelf space to know that each branch can't stock every title.

However, WHS should still be able to order it for you and put it away in the "Call Fors", a

personal folder reserved for a customer. If this is not the case I would very much like to know, if only because I used to work for WHS in Brigg as a lad... and doing the Call Fors formed part of my crashingly dull routine on a Saturday morning.

It's the same sort of thing in other retail sectors as well. My firm used to have to pay Halfords thousands in order to get our products included in their (compulsory) advertising, and profit was calculated per square inch of retail space.

It is getting more and more difficult for a manufacturer or publisher to get their product into the High Street.

**Alan Winstanley,** via the Chat Zone

## FLOW CHARTS

Dear EPE,

I must comment on what Jon Rigter writes in *Readout* August '03. I started with flow charts before I did any formal training in computers, and found them easy to use. Then I studied for an MS in computer science. There I was told flowcharts are out, with the same sort of reasoning Jon espouses. I tried the "more modern" methods, both during course projects and "real" projects. I never bought them.

Eventually, I started to learn about PICs. I read various magazine articles, and found myself floundering with them. Then I bought *PICtutor*, and all became very clear! I reverted to flow charts, and never looked back. In disagreeing with Jon I think it might just be a case of not everyone thinks the same way. But I should say a former work colleague, a relatively recent bachelor graduate, and much younger than me(!), definitely preferred flow charts.

**John Waller, USA,**  
via email

*Thank you John. As I've said before, I just don't get on with them and prefer to jump straight in to the assembly code stage.*

## FRUSTRATED!

### Looking for ICs TRANSISTORS?

A phone call to us could get a result. We offer an extensive range and with a worldwide database at our fingertips, we are able to source even more. We specialise in devices with the following prefix (to name but a few).



2N 2SA 2SB 2SC 2SD 2P 2SJ 2SK 3N 3SK 4N 6N 17 40 AD ADC AN AM AY BA BC BD BDT BDV BDW BDX BF BFR BFS BFT BFX BFY BLY BLX BS BR BRX BRY BS BSS BSV BSW BSX BT BTA BTB BRW BU BUK BUT BUW BUW BUX BUY BUZ CA CD CX CXA DAC DG DM DS DTA DTC GL GM HA HCF HD HEF ICL ICM IRF J KA KIA L LA LB LC LD LF LM M M5M MA MAB MAX MB MC MDAJ MJE MIF MM MN MPS MPSA MPSH MPSU MRF NJM NE OM OP PA PAL PIC PN RC S SAA SAB SAD SAJ SAS SDA SG SI SL SN SO STA STK STR STRD STRM STRS SV1 T TA TAA TAG TBA TC TCA TDA TDB TEA TIC TIP TIPL TEA TL TLC TMP TMS TPU U UA UAA UC UDN ULN UM UPA UPC UPD VN X XR Z ZN ZTX + many others

**PLEASE ASK FOR OUR FREE CD-ROM  
(In Excel) STOCK LIST**  
We Stock a Massive Range of Components

Mail, phone, Fax Credit Card orders and callers welcome



Connect

## Cricklewood Electronics Ltd

40-42 Cricklewood Broadway London NW2 3ET  
Tel: 020 8452 0161 Fax: 020 8208 1441

## Bring your Electronic Ideas to Life

Listen to your creations talk to you by incorporating Rykel's Voice Recording Module.

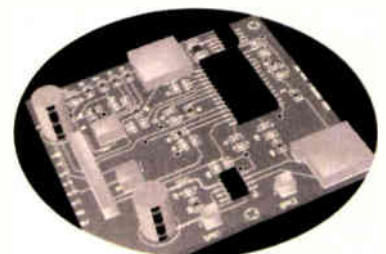

**Greet your visitors  
Warn your family of dangers  
Remind your workforce of procedures  
YOUR APPLICATIONS ARE LIMITLESS**

- Small enough to fit into or on to your project or product at 50mm x 50mm, this unique solid-state voice recorder and amplifier has all functions on board.
- Customisable to your needs using in-built microphone.
- Hi-fi Sound comparable to 20 seconds of broadcast audio.
- Re-recordable so you can change your message when you like up to 100 000 times with no loss of clarity.
- Non-Volatile RAM to retain message even without power.
- Low power consumption so ideal for battery operation.
- Simple to use for both record and playback.



Only £27.99 + VAT = £32.89 (+£2 P&P). Please visit our website for further details and purchasing info.

Rykel Ltd, Caldbeck Road, Croft Business Park, Bromborough, CH62 3PL. Tel: 0151 346 346 1166 Fax: 0151 334 7069  
E-mail: vrm@rykel.co.uk Web: [www.rykel.co.uk](http://www.rykel.co.uk)

# Autotrax<sup>TM</sup>

## Electronic Design Automation

autodesk<sup>®</sup>  
authorised developer

- Schematic Capture
- SPICE Simulation
- PCB Layout
- Auto-Layout/Router
- 3D PCB Visualization
- Database Support

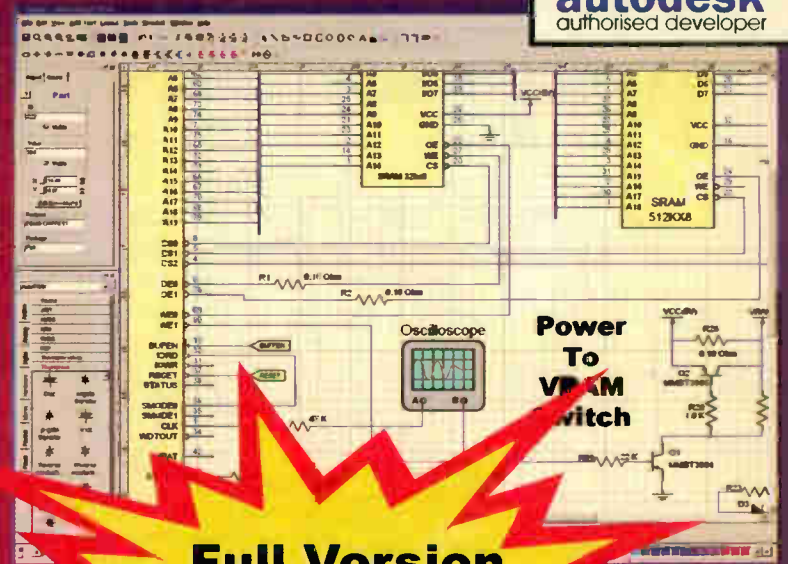

**Full Version  
Only £57(\$95)  
No Limits!**

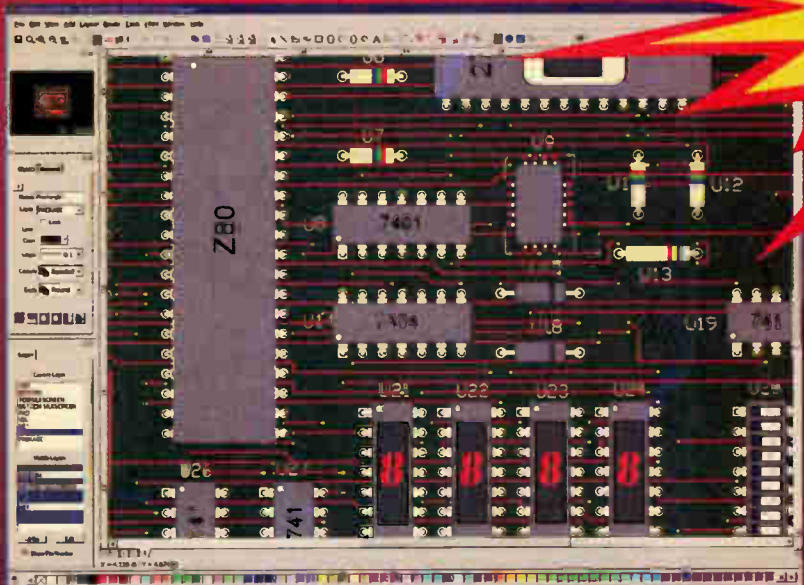

- Drag and drop parts onto your schematic.
- Connect them together.
- Add virtual instruments such as scopes and function generators.
- Use the PCB design wizard to create your PCB.
- Autolayout and autoroute the board.
- View the board in 3D.
- Output to Gerber and AutoCAD/Solidworks.

To find out more go to [www.autotraxEDA.com](http://www.autotraxEDA.com)

**Over 25,000 new users in the last 12 months**

Full version **FREE** to full time-students and schools/colleges (no limits)

Free version available for small scale projects. (pin limited)

**Why wait? Download AutoTRAX EDA NOW!**

**2.0**  
It just gets better

**[www.autotraxEDA.com](http://www.autotraxEDA.com)**

# CIRCUIT SURGERY

ALAN WINSTANLEY  
and IAN BELL

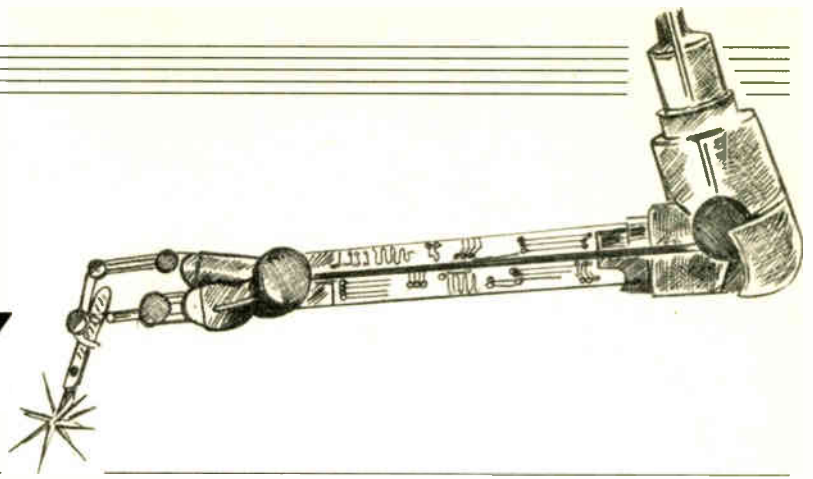

*Our surgeons offer advice on creating long delays with the 555, they give equipment cooling fans a whirl and introduce aspects of high-side current detection.*

## The Time is Nigh?

*I want to use a 7555 CMOS version of the 555 timer in monostable mode. Is it possible to obtain long output periods? What is the maximum value of timing resistor that can be used in the timing component? Should I use a high-value resistor and small capacitor, or vice versa? Thanks from Ivy Li in the EPE Chat Zone message board ([www.epemag.wimborne.co.uk](http://www.epemag.wimborne.co.uk)).*

In the mid 1980s the CMOS 7555 was introduced as a low power replacement for the universal bipolar 555, the world's most popular timer i.c. The CMOS type is usually a direct plug-in alternative, though it is worth remembering that there are differences in some areas – I resort to the bipolar 555 when I need higher output currents (say 100mA to 150mA), or some form of buffering, using say a MOSFET transistor, is useful at times.

However, the CMOS device tends not to cause spikes or “crowbar” the power supply when switching, and it has a much lower bias current (say 10 picoamps) than the bipolar type. A typical CMOS device is the Texas Instruments TLC555 and a data sheet can be downloaded by searching [www.ti.com](http://www.ti.com).

## A Long Delay

In order to generate large delays of, say, an hour or more, then obviously a high RC time constant is needed. Larger resistors can be used up to a point, but the need for larger capacitors as well implies that electrolytics must be used.

These can have a terrible leakage current characteristic, which affects the accuracy of the timer. I try to utilise tantalum bead types for longer delay periods. The CMOS version of the timer provides for higher resistance values, meaning smaller capacitors can be used.

The monostable time period is defined by  $t = 1.1 RC$  ( $t$  in seconds,  $R$  in ohms,  $C$  in farads). A high resistor coupled to a “leaky” timing capacitor will introduce serious timing errors because the charge leaks away to 0V, so the best approach is to use as large a resistance and as small a capacitance as possible.

In the past, some practical experiments produced reasonably consistent delays (>30 minutes) using say 100 $\mu$ F to 220 $\mu$ F maximum with up to 10M resistance or more. There seems to be no published figures for maximum RC values, because results would be highly variable between different RC components, especially due to the timing capacitor leakage and stability.

The main difficulty of using high RC combinations is the reproducibility of timing results. You can select values empirically in individual projects, but to create accurate, repeatable lengthy delays, a better technique is to use a digital method instead.

It is much better to use a 555 timer in astable mode to create a reasonably accurate clock signal, or quartz controlled oscillators can be built for higher accuracy. This clock can drive a digital counter circuit that can trigger after a preset number of pulses have been clocked; a variety of such circuits have appeared in *Ingenuity Unlimited* from time to time.

Some timer chips used these digital techniques including the interesting and long-lamented Ferranti ZN1034E that could time for up to a year! After scouring catalogues and the web, I could not find a readily-available long-range timer chip.

Today a microcontroller would be another way of generating accurate delays using a custom programmed chip. The Managing Director of Magenta Electronics Ltd. pointed out that a Microchip PIC microcontroller costs today only the same sort of price that a simple 555 cost in its heyday, which is a sign of what will probably happen in years to come. Is the end nigh for the 555? A.R.W.

## Let's Talk Hot Air

*When one decides to use forced air in cooling audio power amps, how does one go about choosing the efficiency of a cooling fan?*

*If you have a fan capable of “X” CFM (cubic feet per minute), is it more efficient to let it blow air over the*

*components i.e. heatsinks inside the equipment or let it remove the heat from inside the equipment? One is assuming the fan is operational from switch-on and does not operate on thermal conditions.*

*I have been a reader of your magazine for many years. The names may have changed, but the contents are as interesting as ever. Thanks from Bill McCleod, by email.*

The fan actually does both things – it blows (well, sucks) air over the components and it exhausts the hot air as well! The efficiency depends a lot on the internal layout of the equipment and what there is in terms of heatsinks, power components and ventilation inside. I would say the most efficient way would be to blow air out the rear of the equipment, and suck it in from the front, having constructed a suitable path for the cold air to be passed over power components.

The formula I have for reference is taken from that best-known of electronics textbooks, *The Art of Electronics* (Horowitz and Hill):

$$\text{air temp. rise } (^{\circ}\text{C}) = 1.6 \times \text{Power (W)} / \text{airflow (CFM)}$$

so you can work out the likely acceptable temperature rise.

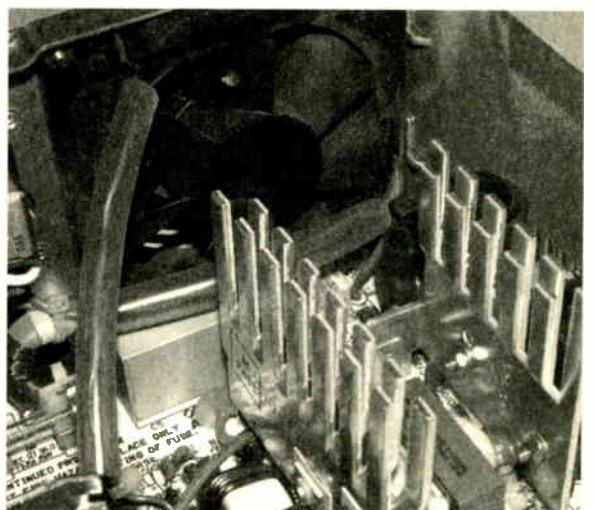

*Internal view of a power supply that uses fan cooling to draw cooler air over a heatsink.*



## Rule of Thumb

The rule of thumb quoted is that a 100 CFM fan will adequately cool instruments running 100 watts or more. The fan efficiency also depends on the back pressure that the fan will experience and other physical factors. Many catalogues don't quote the volumetric airflow, but an 80mm fan may be good for say 20-30 CFM roughly.

You will usually need a heatsink to enable power components to dissipate heat at maximum power without overheating, and it may be better to mount that on the rear of the cabinet; it is hard to give blanket recommendations. If you have large internal heatsinks then a fan may be best on an enclosed case. The idea is also to control the airflow by forcing air to be sucked in from e.g. the front and vented out of the rear, passing over hot components in the process.

Personal computers make very good case studies of how to control airflow properly. They usually have intake slots at the front (especially around hard drives, which get extremely hot), and one or more fans mounted at the back to blow exhaust air through the rear grilles. The processor and graphics card may have its own extractor fan as well.

Internally, round cables rather than ribbon cables are preferable for allowing cooling air to pass over hot, fast hard drives.

I was recently asked to fix a PC problem and discovered that whilst the fan blew dirt out of the rear, every ventilation hole was blocked and it had sucked dirt in from the front, eventually wrecking the CD-ROM and floppy drives by clogging them solidly as well. The use of an airduster aerosol at regular intervals is recommended to ensure efficiency is maintained, and to avoid more costly repairs later on. It is a simple task for any computer users to lift off the cover and dust out the vent holes with an aerosol. And you can now brighten up your projects using transparent fans that contain glowing l.e.d.s or cold cathode tubes! Glad to hear you enjoy the magazine. A.R.W.

## Another Flavour of Spice

Following our item on PSpice (September and October 2003), we were very pleased to receive feedback from Cadence themselves:

*I must congratulate you on the great mini-series on circuit design using the PSpice Student Download. As you know PSpice is a professional tool widely used throughout the electronics industry and last year won an Easit educational award.*

*You can find more information on PSpice and the OrCAD products on <http://orcad-pcb.com> and <http://orcad.com>. These websites contain a wealth of information as well as application papers and useful links to vendor model websites.*

*I would draw readers' attention to the article on the Hubble Space Telescope which uses PSpice to model and simulate the electrical power system for the telescope. Dennis Fitzpatrick, Lead Support Applications Engineer, Cadence Design Systems.*

Many thanks for the additional web links. We were pleased to major on PSpice Student Download, which we consider to be an excellent all-round circuit simulator. Products such as this used to

cost professionals tens of thousands of pounds and could only run on a main-frame computer, and were totally beyond the reach of the amateur user. We applaud the availability of the PSpice Student Download which we hope will encourage newcomers to try creating circuits in this environment for themselves.

Some users may struggle with such a large download though, and reader Nick de Smith reminded us about LTspice (also known as SwitcherCAD III) from Linear Technology. This is optimised for op.amps and switched-mode power supplies, but it does a fine job with ordinary Spice simulation tasks. Cadence's PSpice undoubtedly offers a far greater range of overall capabilities and functionality however.

LT produced the simulator because many other Spice simulators struggled with switch-mode circuits due to the complexity of waveforms involved. LTspice is also more efficient at dealing with parasitic components, such as the resistance of an inductor, than some other Spice versions. Parasitics are particularly important in switch mode circuit design.

For many readers one advantage of LTspice in that download size is reasonably small for a CAD tool, at around 5MB. It is available in its full form from the Linear Technology web site, [www.linear.com/software/](http://www.linear.com/software/). It comes with a set of models of LT devices, particularly op.amps (over 20 of them) and regulators, but other "standard" Spice models will work with it if you have them available. There are quite a few LT enthusiasts online in newsgroups, so you can find helpful discussions and information.

LTspice has an easy to use user interface and it is very straightforward to change something in a circuit and run the simulation again to see what difference it makes. LT's philosophy in designing the simulator was to allow a lot of flexibility; whilst providing sufficient warning messages if circuits are badly flawed.

The basic idea is very similar to using PSpice (and any other Spice software with schematic capture) so we will not describe step by step how to use LTspice. If you want to use it, read through last month's description with screenshots of using PSpice to get a general idea of what you should be doing, then have a look at the help file for LTspice and you should be able to work it out.

## Circuit Problem

Our thanks to R. D. Thompson who wrote to us about a problem with a circuit that detects failure of a vehicle light bulb. The bulb in question uses a 12V supply and draws 2A. The sensor is required to indicate when the bulb fails to draw any current. Mr. Thompson suggests a solution of using a small value sense resistor in series with the bulb, choosing 0.1 ohms, which will drop about 200mV (leaving 11.8V for the bulb) and consume only a few milliwatts.

We agree that this is a viable approach, and we also agree with the reader's suggestion that an op.amp can be used to process the small voltage drop across the sense resistor. We need a single supply op.amp, as the op.amp should be powered from the 12V supply, again Mr. Thompson had spotted this requirement.

Our reader tried the circuit shown in Fig. 1. The idea is that the op.amp, which has a very high gain (around 100,000), should amplify the voltage difference across the sense resistor. Thus the output should be around 12V when the bulb draws current, and zero otherwise. Unfortunately the suggested circuit failed to work!

There are a number of possible problems. First, if the op.amp has a gain of 100dB or  $\times 100,000$  then it only takes 120 microvolts across the sense resistor to switch the op.amp to positive saturation. It is not impossible that there would be leakage current or other noise of this magnitude present, particularly when the bulb is absent.

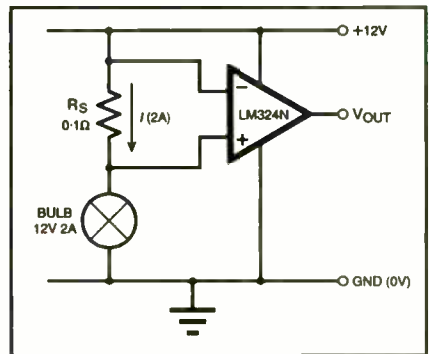

Fig.1. First circuit for a bulb failure monitor. As explained in the text, it may not work with the op.amp initially specified.

The op.amp gain is far higher than needed (200mV to 12V only requires a gain of 60). Opamps also have a widely varying open loop gain (the term used for an op.amp circuit when no feedback is applied), which makes it difficult to predict exactly what might happen with an individual device. Usually an op.amp amplifier uses **negative feedback** to set the gain of the circuit. This gain then depends mainly on the feedback components and not on the actual value of gain of the op.amp itself (which just has to be a very large value).

Potential open loop instability is not the only problem we face; a particular difficulty with this kind of circuit, which is known as a **high side current sensor**, is that the op.amp must have a **common mode input range** that includes the power supply. The common mode voltage is basically the average voltage at the two inputs. In effect what we have here is a  $\pm 100\text{mV}$  square wave (for bulb OK/not OK) with a common mode signal of 11.9V.

Unfortunately the common mode input range specified on the LM324's datasheet (from National Semiconductor, available on line at [www.national.com](http://www.national.com)) only goes to 1.5V below the positive supply. This circuit exceeds that requirement and therefore the LM324 is very unlikely to function correctly (although no damage should occur).

So the basic conclusion is that we should use a differential amplifier with negative feedback around the op.amp, setting a maximum gain of 60, and we must select a device with a common mode input range that includes the positive supply voltage. We will continue with this circuit next month and will hopefully simulate it in Spice as well. I.M.B.

# solutions for learning electronics

## PICmicro(R) microcontroller training days



We can help you learn PICmicro programming and also help you teach PICmicro programming to others. We provide a number of training days each term in:

**Introduction to PICmicro and flowchart programming**

**Programming PICmicros in Assembly**

**Programming PICmicros in C**

Each day includes 7 hands-on hours of training, and full support materials to allow you to continue learning at home.

## CPLD/FPGA training resources



**£99**  
+VAT

This low cost development board is suitable for both learning how to program CPLDs as well as for developing CPLD based projects.

**Suitable for programming and developing CPLD projects**

**Free development software from Altera\***

**Includes an Altera 7000 series device**

**Includes sample projects**

\*requires broadband internet connection

## FLOWLOG electronics workbench



**Multi-channel scope  
Power supply  
Proto board**

**£149**  
+VAT

Flowlog electronics workbench is the perfect platform to allow you to develop electronic projects and learn electronics. When connected to your PC it will provide you with:

**5V power supply (500mA)**

**2 channel analogue 'scope**

**4 channel digital 'scope**

**Software for datalogging and control**

**Prototype board and metal backplane**

please see our web site for full details of all products and training days and for free resources

**m|w** next time you are online take a quick look at:  
**www.matrixmultimedia.co.uk**

Matrix Multimedia Limited  
sales@matrixmultimedia.co.uk  
t. 0870 700 1831 f. 0870 700 1832



## A COMPLETE RANGE OF INVERTERS 150W TO 2500W - 12V & 24V

A Complete range of regulated inverters to power 220V and 240V AC equipment via a car, lorry or boat battery. Due to their high performance (>90%) the inverters generate very little heat. The high stability of the output frequency (+/-1%) makes them equally suitable to power sensitive devices.



These inverters generate a modified sine wave, which are considerably superior to the square waves which are produced by most other inverters. Due to this superior feature they are capable of powering electrical equipment such as TV's, videos, desktop & notepad computers, microwave ovens, electrical lamps, pumps, battery chargers, etc.

### Low Battery Alarm

The inverters give an audible warning signal when the battery voltage is lower than 10.5V (21V for the 24V version). The inverter automatically shuts off when the battery voltage drops below 10V (20V for the 24V version). Fuse protected input circuitry.

Order Code	Power	Voltage	Was	Price
651.581	150W Continuous	12V	<del>£36.39</del>	£29.72
651.578	150W Continuous	24V	<del>£36.39</del>	£29.72
651.582	300W Continuous	12V	<del>£50.64</del>	£41.93
651.585	300W Continuous	24V	<del>£50.64</del>	£41.93
651.583	600W Continuous	12V	<del>£101.59</del>	£83.76
651.593	600W Continuous	24V	<del>£101.59</del>	£83.76
651.587	1000W Continuous	12V	<del>£177.18</del>	£147.52
651.597	1000W Continuous	24V	<del>£177.18</del>	£147.52
651.602	1500W Continuous	12V	<del>£314.52</del>	£261.18
651.605	1500W Continuous	24V	<del>£314.52</del>	£261.18
651.589	2500W Continuous	12V	<del>£490.54</del>	£416.27
651.599	2500W Continuous	24V	<del>£490.54</del>	£416.27



REF D5

ILLUSTRATION SHOWN IS 651.581 600W VERSION

All prices are inclusive of V.A.T. Carriage £8.00 Per Order

Many uses include:- Fetes . Fairgrounds . Airshows . Picnics . Camping . Caravans . Boats . Carnivals . Field Research and . Amateur Radio field days \* Powering Desktop & Notepad Computers.



**B.K. ELECTRONICS**



UNIT 1, COMET WAY, SOUTHEND-ON-SEA, ESSEX. SS2 6TR  
TEL.: +44(0)1702-527572 FAX.: +44(0)1702-420243

DELIVERY CHARGES ARE £6.00 PER ORDER. OFFICIAL ORDERS FROM SCHOOLS, COLLEGES, GOVT. BODIES, PLC'S ETC. PRICES ARE INCLUSIVE OF V.A.T. SALES COUNTER. VISA AND ACCESS ACCEPTED BY POST, PHONE OR FAX, OR EMAIL US AT SALES@BKELEC.COM ALTERNATIVELY SEND CHEQUE OR POSTAL ORDERS MADE PAYABLE TO BK ELECTRONICS.

For Full Specifications View our web site at:-

**WWW.BKELEC.COM/INVERTERS.HTM**

# SHOP TALK

with David Barrington

## PIC Random L.E.D. Flasher

The only criterion to be taken into account when shopping for components for the *PIC Random L.E.D. Flasher* project is size, particularly if you wish to wear it as a "festive or disco badge".

The 3mm blue, high intensity, diffused l.e.d. was purchased from **Rapid Electronics** (☎ 01206 851166 or [www.rapidelectronics.co.uk](http://www.rapidelectronics.co.uk)), code 55-1460. Miniature 6mm square-shaped tactile switches should be fairly easy to locate and appear in most catalogues now. The one in the model also came from the above company (code 78-0605) and has an extended 5mm actuator (button). You may find that component suppliers only stock cermet type presets in the 6mm size specified. These are not too expensive and can, of course, be used in this circuit.

For those readers unable to program their own PICs, a ready-programmed PIC16F84 microcontroller can be purchased direct from the author for the sum of £6 (add £1 for overseas). Orders (mail only) should be sent to **Andy Flind, 22 Holway Hill, Taunton, Somerset, TA12HB**. Payments should be made out to *A. Flind*. The software is available on a 3.5in. PC-compatible disk (Disk 6) from the *EPE Editorial Office* for the sum of £3 each (UK), to cover admin costs (for overseas charges see page 803). It is also available for free download from the *EPE* ftp site, which is most easily accessed via the Downloads click-link option on the home page when you enter the main web site at [www.epemag.wimborne.co.uk](http://www.epemag.wimborne.co.uk), then enter the **PIC Microcontroller source codes** folder and select **PIC Random Flasher**.

The small circular printed circuit board is available from the *EPE PCB Service*, code 424 (see page 803).

## Practical Radio Circuits-7

Some readers may have problems finding the BF199 high frequency transistor called for in the *Direct Conversion Receiver*, this month's *Practical Radio Circuits* project. We understand that **Cricklewood Electronics** (☎ 0208 452 0161) have plenty in stock. The author indicates that most low power rectifier diodes can be pressed into service as a "varicap" diode for D1. Readers who prefer to use a true varicap could fit the BB105 from an earlier project in this series.

As previously, the Toko coils are available from **Sycom, Dept EPE, PO Box 148, Leatherhead, Surrey, KT33 9YW** (☎ 01372 372587 or [www.sycomcomp.co.uk](http://www.sycomcomp.co.uk)). They need to be ordered by quoting their type numbers as listed in the parts list and on the circuit diagrams.

The author says almost any polyvaricon (polythene dielectric) variable capacitor designed for a.m./f.m. portable radios will work in this circuit. They will normally be found listed as "transistor radio" types and consist of an antenna and oscillator section, plus trimmers. They are currently stocked by **ESR Components** (☎ 0191 251 4363 or [www.esr.co.uk](http://www.esr.co.uk)), code 896-110 and **Sherwood Electronics** (see page 808), code CT9. The one in the prototype was obtained from **Maplin** (☎ 0870 264 6000 or [www.maplin.co.uk](http://www.maplin.co.uk)), code AB11M.

The two printed circuit boards are available from the *EPE PCB Service*, codes 423 (Direct Con. Rec.) and 406 (T/Cap - optional), see page 803.

## Anyone At Home (Top Tenner)

Only two items used in the *Anyone At Home* project, this month's *Top Tenner* offering, could prove troublesome. The relay used in the prototype and shown in the photograph appears to be one with a low voltage d.c. coil and single-pole contacts rated at 10A 250V a.c. We do not have any source details for this particular relay, however, most components advertisers should be able to suggest a suitable one. It may mean "hard wiring" it to the p.c.b.

We have searched for the VN10KLS *n*-channel low power MOSFET device and, surprisingly, only **Sherwood Electronics** (see ad. on page 803) appear to carry it in their current listing, coded as the type number. No doubt other low power, general purpose *n*-channel MOSFETs will work in this simple circuit.

The two printed circuit boards are available as a pair from the *EPE PCB Service*, code 421 (Logic) and 422 (Relay), see page 803.

## Cardboard Clock

We do not expect any buying problems to arise when putting together parts for the *Cardboard Clock* project. The hardware bits and pieces, such as the obeche and balsa wood, should be obtainable from most good model craft shops.

The 15mm diameter disc magnets were purchased from **Maplin** (☎ 0870 264 6000 or [www.maplin.co.uk](http://www.maplin.co.uk)), code SF19V - two required. The 32s.w.g. (30a.w.g.) enamelled copper wire for the coil was obtained in a 50g (2oz) reel from **ESR Components** (☎ 0191 251 4363 or [www.esr.co.uk](http://www.esr.co.uk)).

## Teach-In 2004

Apart from a couple of semiconductor devices and some "Miscellaneous" items in the new *Teach-In 2004* tutorial series Components Box, most components should be readily available from advertisers. The "difficult" parts will be dealt with as and when they appear throughout the series.

The microcontroller chips will be offered by the author ready-programmed when they appear in the published instalment.

# Radio Bygones

The leading magazine for vintage radio enthusiasts

Now Also Available to BUY ONLINE [www.radiobygones.com](http://www.radiobygones.com) Log on, pay by credit card and download the magazine to your PC ONLY \$9.99 (US dollars) FOR 6 ISSUES A free issue is available

ARTICLES on restoration and repair, history, circuit techniques, personalities, reminiscences and just plain nostalgia - you'll find them all. Plus features on museums and private collections and a full-colour photo-feature in every issue.

IT'S MOSTLY about valves, of course, but 'solid-state' - whether of the coherer and spark-gap variety or early transistors - also has a place.

FROM THE DAYS of Maxwell, Hertz, Lodge and Marconi to what was the state-of-the-art just a few short years ago...

THERE IS ALSO a selection of free readers' For Sale and Wanted advertisements in every issue.

## Radio Bygones covers it all!

THE MAGAZINE is published six times a year, and is only available by postal subscription. It is not available at newsagents.

TO TAKE OUT a subscription, or to request a sample copy, please complete the form below and return it to:

**RADIO BYGONES, Wimborne Publishing Ltd, 408 Wimborne Road East, Ferndown, Dorset BH22 9ND.**

Tel: 01202 873872. Fax: 01202 874562. Web sites: [www.radiobygones.co.uk](http://www.radiobygones.co.uk) [www.radiobygones.com](http://www.radiobygones.com)



## RADIO BYGONES ORDER FORM



A SAMPLE COPY of Radio Bygones ..... £3.25  
(Add 70p for overseas Airmail postage)

SUBSCRIPTIONS (post paid):	1 YEAR	2 YEAR
UNITED KINGDOM	£18.50	£35.00
REST OF EUROPE (AIRMAIL)	£20.50	£39.00
REST OF THE WORLD (AIRMAIL)	£24.50	£47.00

Yes, I would like a sample copy of RADIO BYGONES

Yes, I would like to take out a subscription for:

One year (6 issues)  Two years (12 issues)

I enclose a cheque/PO/Bank Draft for £ ..... payable to Wimborne Publishing Ltd

Please debit my Visa/Mastercard/Switch/Amex/Diners card

My card number is:

.....  
Please print clearly, and check that you have the number correct

The card is valid from: ..... Switch Issue No: .....

My name is .....

My address .....

Post Code/Zip ..... Tel .....

Signed .....

If you do not wish to cut your issue, send a letter or a copy of this form.

## Constructional Project

# CARDBOARD CLOCK

MICHAEL McLOUGHLIN

*An intriguing way in which you can watch time passing!*

**T**HIS article describes how you can build an accurate low-cost electro-mechanical clock, using the minimum of component parts and normal household tools.

The Cardboard Clock uses a simple battery-powered circuit to control a pendulum and thus turn three gear wheels which double as "time dials". There are just five moving parts, including the cardboard gear wheels. The clock keeps time to within 15 seconds a day.

A normal pendulum clock that is accurate when fully wound will lose time towards the end of the week as the spring runs down and the error can reach about 30 seconds per day.

### COIL PARAMETERS

The author's intention was to build a pendulum clock with a magnetic drive. However, the conventional historic Kienzle circuit in Fig.1 was not felt to be suitable as it uses two coils of fine wire, with about 4500 turns altogether. Such a quantity and its required accuracy of winding, completely excludes amateur construction. In the design presented here, only one coil is used, having just 100 turns of 32s.w.g. wire, which is reasonably thick and easy to handle.

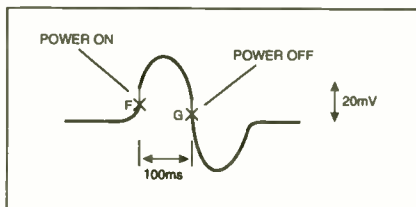

Fig.2. Trace of coil voltage as the magnet passes. It is roughly an induced sinusoid, with current/resistance jumps as the power switches on and off. Voltage measured at S in Fig.4.

Two disc magnets are used, each having a diameter of 15mm and thickness of 6mm, to form the bob of the pendulum. As the magnet passes over the coil, a voltage proportional to the rate of magnet movement is generated across the coil. The peak voltage is about 20mV and produced at intervals of 100 milliseconds, as illustrated in the waveform of Fig.2.

### DRIVER CIRCUITS

As so small a voltage is needed, the circuit can be powered by a single 1.5V cell, but the 20mV induced voltage must be current-amplified to produce a 2mA pulse. The 1.5V supply, though, rules out the use of op.amps as an amplifier. They have a

### ELECTRICAL TIME

In 1841 Alexander Bain took out the first patent for an electric clock. His pendulum worked a switch, which operated an electromagnet to pulse the pendulum. J. T. Gent of Leicester used the idea in his master clock, which could switch hundreds of slaves throughout a building.

In 1948 the transistor came along and the switch on the pendulum became replaced. The system was extended to drive balance wheels in watches. A circuit that was widely used is known as the Keinzle, Fig.1.

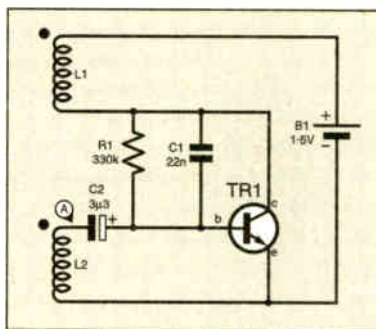

Fig.1. Keinzle clock circuit. The coils lie together, and the magnet travels past them.

Note the electrolytic capacitor, C2. For most of the cycle it charges gently, via resistor R1. On the balance wheel there is a magnet, and ten times a second it passes the coil assembly L2, inducing a voltage that raises point A upwards by about 500mV. This triggers transistor TR1 into conduction and the resulting magnetic field generated by inductor L1 gives the magnet a regenerative "push".

class B output stage which puts in series two base-emitter drops of 0.7V. As the output of a single cell falls to around 1.1V before it is considered to be exhausted it cannot drive such an arrangement.

Consequently we are forced back to circuits that use individual transistors. The classical monostable is a good starting point, as shown in Fig.3a. When a magnet passes coil L1 a voltage is produced. If this is in the direction of the arrow, the voltage at H will fall. The resulting negative-going pulse through capacitor C1 causes transistor TR1 to turn off and TR2 to turn on, triggering an even larger pulse through the coil.

The classical circuit meets a difficulty, though. We need to trigger the current early in the induced pulse, perhaps at point F in Fig.2, when the induced voltage might be around 5mV. Transistor TR1 must be given twice the base current needed to saturate it, but its current gain may turn out to be five times its quoted minimum and so could be saturated tenfold. The magnetically induced negative-going pulse at H then needed to bring TR1 out of saturation and trigger the circuit could be as much as 60mV, whereas the available voltage at point F is only 5mV.

### MILLIVOLT DRIVER

The millivolt monostable circuit shown in Fig.3b can handle this problem. Here the stable state relies on the comparative values of resistors R1 and R2. Resistor R1 is only about five times larger than R2, but it carries less than one hundredth of the current. Thus the voltage across R1 is small, and the voltage at point K is clamped very near to that at point J, at around 0.6V.

A voltage of about 1.0V is dropped across R2, resulting in a further drop of about 0.25V across R3. The resulting voltage at L holds transistor TR2 turned off, and so the state is stable.

In this circuit TR1 does not become saturated, and it will amplify any pulses applied at J, according to the "four percent" rule. This states that a 1mV drop at the base cuts the collector current by four percent. Thus, when the activated coil reduces the voltage at J by 5mV, TR1's collector current will fall by 20%, raising the voltage at point L enough for TR2 to conduct and trigger pulse regeneration.

With this circuit the sensitivity is much greater, and is independent of transistor gain.

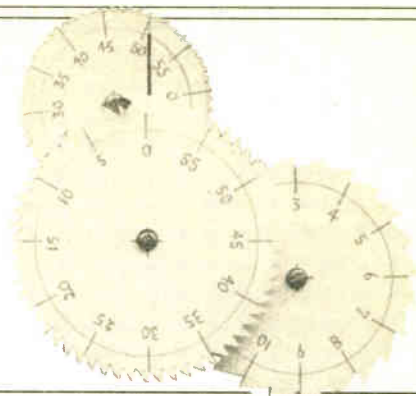

## SCHMITT TRIGGER

The millivolt circuit in Fig.3b drives the clock well. But as the battery gets older its internal resistance exceeds that of the coil, causing an additional voltage drop at *J* during the induced "power stroke". Consequently, the circuit can fail to return reliably to a stable state.

As we are only interested in feeding a.c. signals to the base of TR1, though, the circuit can be reconfigured as shown in Fig.3c, in which it behaves as a Schmitt trigger.

When the magnet induces a positive voltage at *S*, current through TR1 is reduced, switching on TR2, which further raises *S* to cause the required regeneration. Here TR2 is controlled by TR1, which is controlled by its base-coil-emitter loop. The troublesome battery resistance is now outside this loop. The circuit works as before, and battery life is extended.

Capacitor C2 in Fig.3b and Fig.3c is effectively connected across the coil and is there to inhibit resonance. Without it the circuit would oscillate in the 250kHz region. In all three circuits potentiometer VR1 is used to adjust the sensitivity.

## CLOCK CIRCUIT

In the circuit of Fig.3c, TR2 passes 2mA or so, but only for one-fifth of the time, giving an average consumption of 0.4mA. But resistor R2 takes that much current on a continuous basis. If the current through R2 could be abolished, battery life would be doubled.

It is tempting to increase the value of R2, but then it will not provide enough current to drive TR2 into regeneration when the battery is low. A better solution is to operate the circuit at much higher impedance, and follow with a *pn-p* transistor, as shown in Fig.4. It is this circuit that is used in the Cardboard Clock.

Notice in Fig.4 that the coil connections have been reversed, compared to Fig.3c, producing the waveform shown at the top. Also, the value of capacitor C1 has been much reduced. The first half cycle now



Fig.4. Cardboard Clock three-transistor switch circuit diagram. Average current consumption is 0.5mA.

## MECHANICAL CLOCKS

No one knows for sure who invented mechanical clocks, although it is believed that the Chinese did. They began to appear in Europe from about 1310 onwards.

At first they had no hands and just struck a bell on the hour. They were fearsome objects, made by blacksmiths, and driven by a weight whose descent was controlled by an escapement. This was based on a vertical T-piece, made of iron and about the size of an average table. One arm spun the T-piece around its vertical axis by 30° one way, and then another arm returned it. This was a cycle and the cycles were "counted" by gears. The working clock made about as much noise as the blacksmith!

The accuracy was poor, however, and a clock set correctly at sunrise might be half an hour out at sunset. Nevertheless, such a clock was a great asset to any town.

In 1494 Leonardo da Vinci made a drawing of a clock with a pendulum and in 1581 Galileo observed that a pendulum of a given length seemed to move through its cycle in a given amount of time. However, it was Galileo's son Vincenzo who first made a working model of a pendulum clock, in 1649, although he never completed it.

It was not until 1656, though, that Christian Huygens actually made the pendulum clock practical. After a few improvements, it turned out to be about a thousand times more accurate than its medieval predecessors.

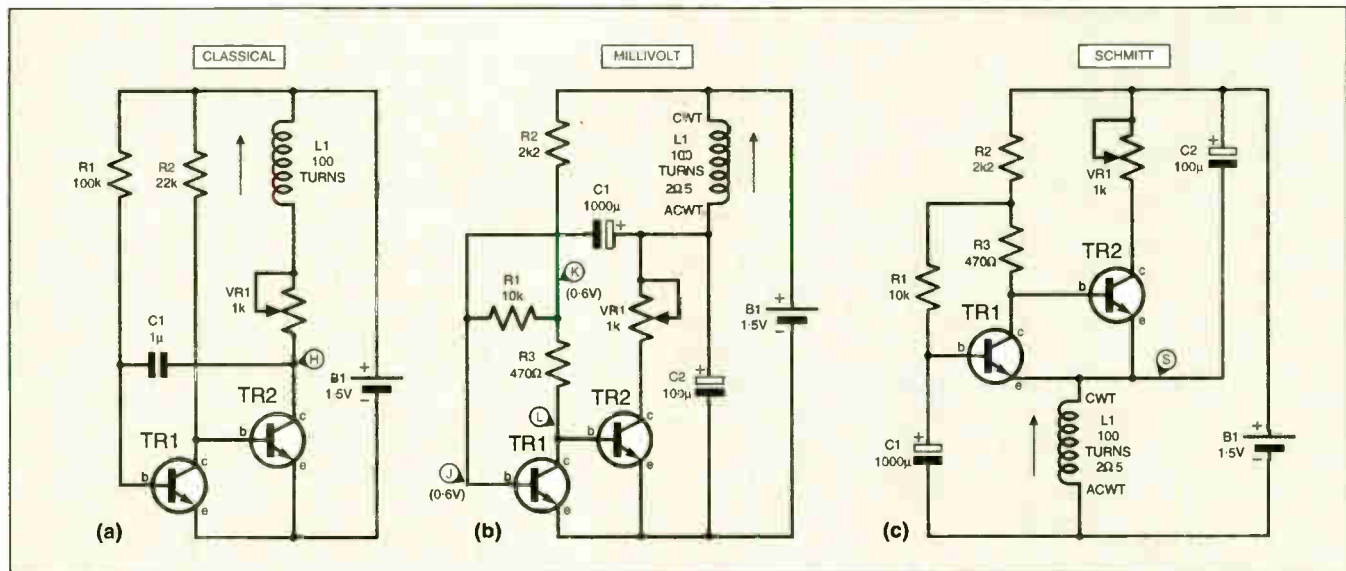
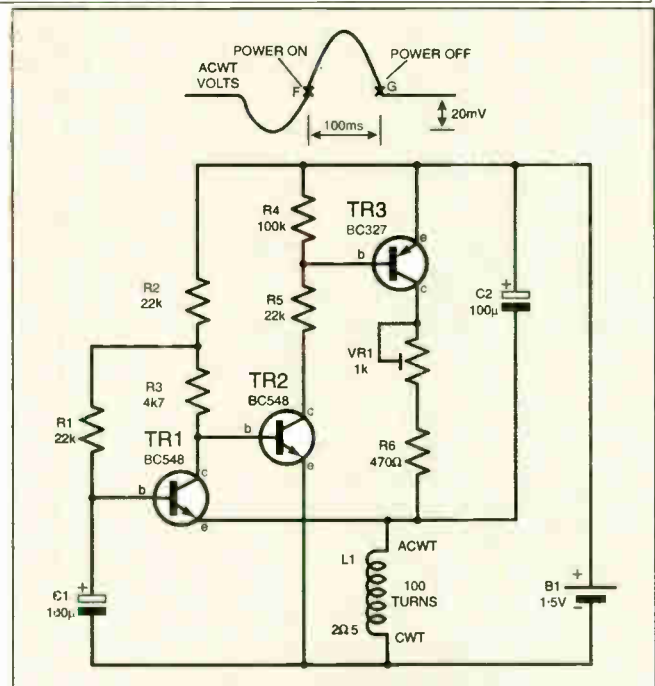

Fig.3. Three monostables. CWT is the clockwise tail of the coil, when viewed from above, and ACWT is anticlockwise.

# COMPONENTS

## Resistors

R1, R2,	
R5	22k (3 off)
R3	4k7
R4	100k
R6	470Ω

All 0.25W 5% carbon film or better.

## Potentiometer

VR1	1k min. preset, side adjustment, p.c.b. mounting
-----	--

## Capacitors

C1, C2	100μ radial elect. 6V (2 off)
--------	-------------------------------

## Semiconductors

TR1, TR2	BC548 <i>n</i> p <i>n</i> transistor (2 off)
TR3	BC327 <i>p</i> n <p>n</p> transistor

## Miscellaneous

Stripboard, 14 holes x 11 strips; disc magnet 15mm diameter, pre-drilled and counter sunk (2 off); AA size battery and holder; 16 s.w.g. enamelled copper wire; 32 s.w.g. enamelled copper wire; M3 25mm bolts, nuts and washers (25 each); robust white card; Blu-tack; balsa wood sheet, 5mm x 75mm x 1 metre; obeche strut, 10mm x 13mm x 1 metre; balsa cement; solid insulated connecting wire; solder, etc.

See **SHOP TALK** page

Approx. Cost  
Guidance Only

**£15**  
excl. battery

discharges C1 a little via resistor R1, so that point F on the waveform is now nearer to 0V. This tunes the circuit to favour the waveform shown and helps at low battery voltages.

The battery can now fall to about 1.1V before the clock fails, and average consumption is reduced to 0.5mA. An AA size cell when new produces about 1.6V, and if it is an alkaline type will give about 2100mA-hours before it falls to 1.1V. Hence, it will drive the clock for 4200 hours, or about six months.

## CONSTRUCTION

The clock circuit of Fig.4 is built on a piece of stripboard measuring 14 rows by 11 holes, as shown in Fig.5. Drill a 3mm diameter hole at position H6, through which a mounting bolt will be inserted later.

Ensure that the transistors and electrolytic capacitors are inserted the correct way round, and that the four link wires are inserted. After soldering is completed, scrape firmly past each side of each joint with a small screwdriver, to test for solder bridges.

## COIL ASSEMBLY

The coil's optimum size and position were found by computer simulation, a discussion

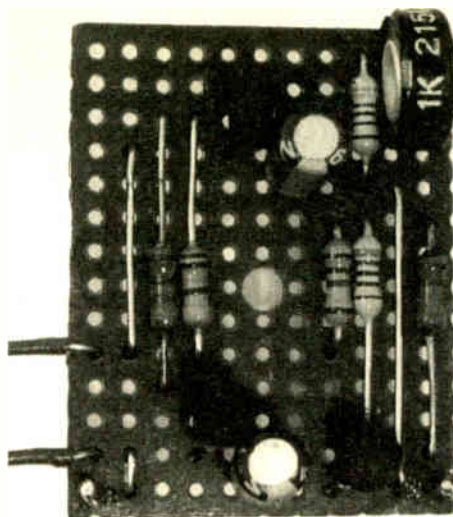
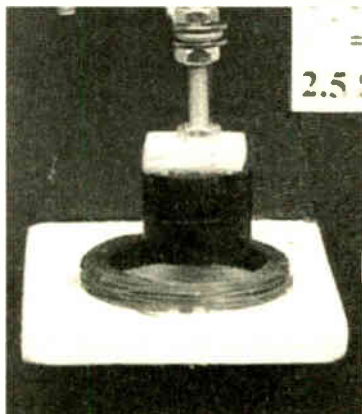

Completed circuit board.

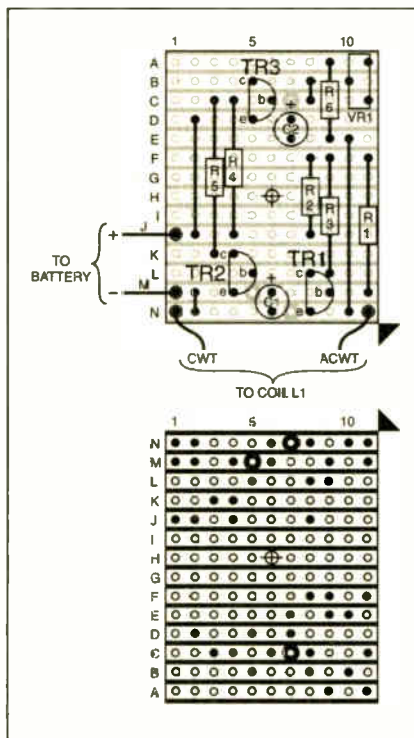

Fig.5. Stripboard layout and track breaks for the three-transistor circuit. There should be no substantial border adjacent to row N. Drill out H6 to 3mm diameter.

of which is outside the scope of this article. Its constructional method is outlined in Fig.6.

Carefully cut a sheet of 5mm thick balsa wood to a size of 45mm x 55mm and drill a 3mm diameter hole at point X, 10mm

from the edge of the shorter side. This is the "coil table".

Mark out on white card a circle of 32mm diameter, and cut it out with care. Knead well some Blu-tack, and form eight spheres of about 1mm diameter. Place them symmetrically around a £1 coin (or other object having a diameter of 22mm), about 1mm from its edge. Turn the coin over and press it very firmly onto the centre of the card. If any trace of Blu-tack shows, remove it with a pin.

Form a neat Blu-tack sphere of 5mm diameter, and locate it centrally on the coin. Turn the whole structure over, and press it very firmly onto the coil table. The coin (not the card) should be just clear of hole X. There must be no gap between coin and table. If there is, rotate the coin under slight pressure, or use less Blu-tack.

## COIL WINDING

The coil requires 100 turns of 32s.w.g. insulated copper wire. Take care to avoid tangles or kinks in it. Pass the first 60cm of this wire down through hole X, and fix it below with Blu-tack.

Going slowly, wind 100 turns of the wire onto the coil former. Winding may be in either direction. Keep one eye in the plane of the coil table and make a serious attempt to wind parallel to this plane, but move laterally when necessary, to keep roughly even depth, neglecting neither front nor rear of the coil.

Check regularly that the coil is winding evenly on its hidden side. Wind with minimum tension, or the wire may pull the coin away from the table. If these precautions are observed, the winding is neither a critical nor a lengthy operation.

If you do create a kink, do not attempt to pull it out, but unwind it carefully backwards.

After 100 turns trap the wire at the coil with Blu-tack, and cut it 60cm further on. Drill hole Y well clear of the coil, and pass the wire tail through this hole.

Prepare four "straps" of Blu-tack as long as a matchstick, but twice as thick. Peel the cardboard disc back gently from the coil to its halfway point. Run two of the straps radially across the coil, and pin it down securely. Remove the cardboard completely, and use the remaining two straps to pin down the remainder of the coil. Check that it really is fully pinned down.

Drizzle some balsa cement on the top of the coil, and down its outside, being sure to deliver a good blob to the balsa table. Check that there is a visible flow of cement down the side of the coil, and onto the table. Without delay apply a piece of paper

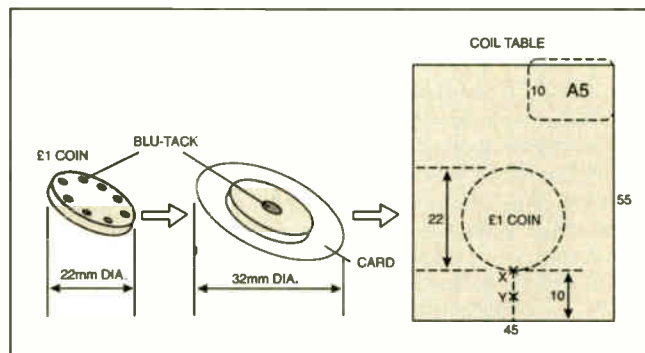

Fig.6. Making the coil former. For the dotted piece A5 see the text. The completed coil is shown in the photograph.

to smooth away the cement lying on top of the coil, so that it will not project. Repeat the procedure at three other points, and allow to dry for an hour.

Once the cement has dried, carefully remove the coin and the Blu-tack, then drizzle more cement down the inside of the coil.

## HARDWARE

Details of the wood and metalwork assembly are shown in Fig.7 and Fig.8. They should be used in conjunction with the photographs.

The strut in Fig.7a is made from obeche wood, just slightly harder than balsa but

still easy to work. Drill 3mm holes in the strut at points B, C and E, and cut the five sections, A1 to A5.

Cement section A5 below the coil table, but 1mm proud, as shown in Fig.6.

The backboard in Fig.7b is made from balsa wood. Carefully drill 3mm holes at G, H and I, and then drill out hole G to

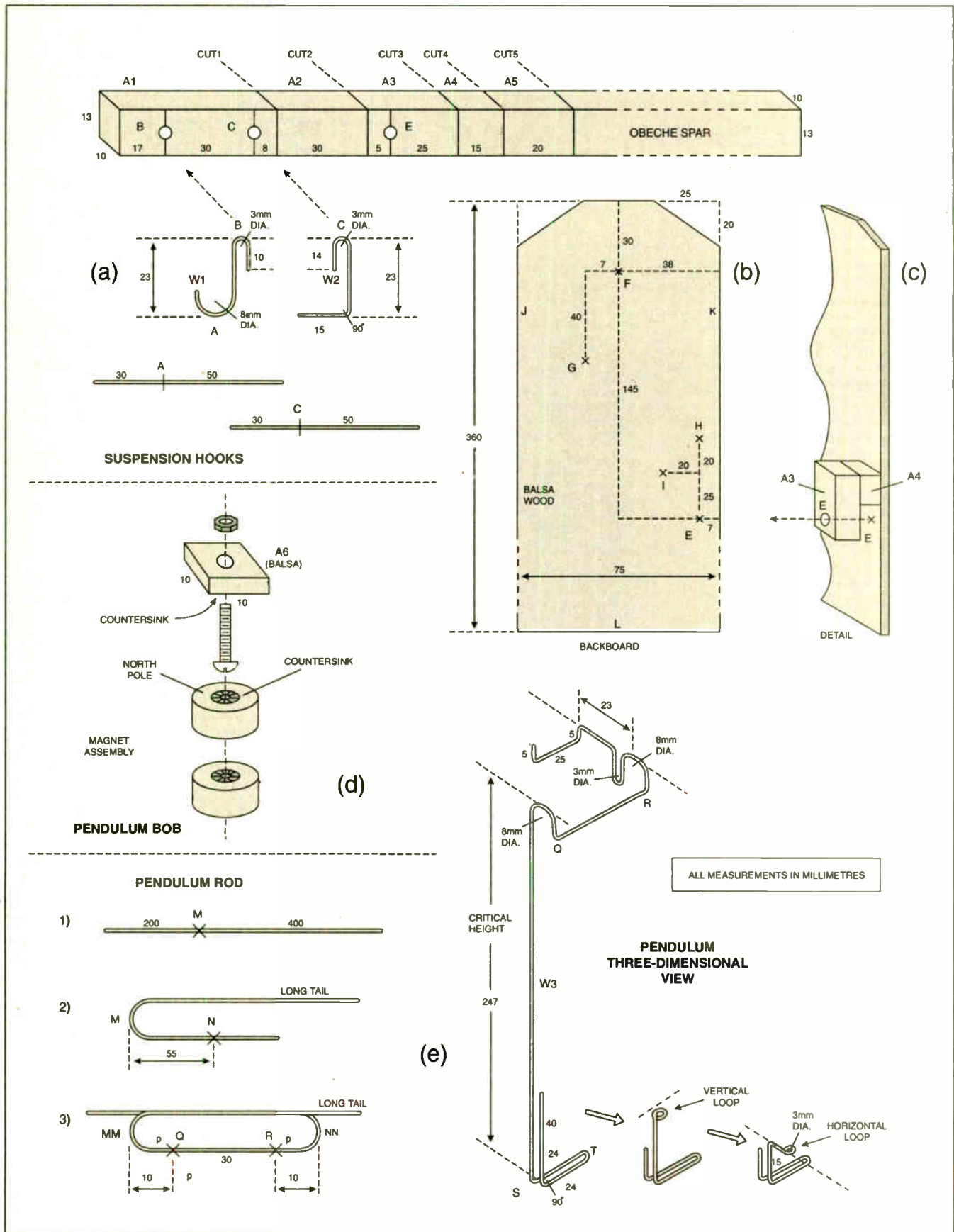

Fig.7. Backboard and pendulum construction details (not to scale).

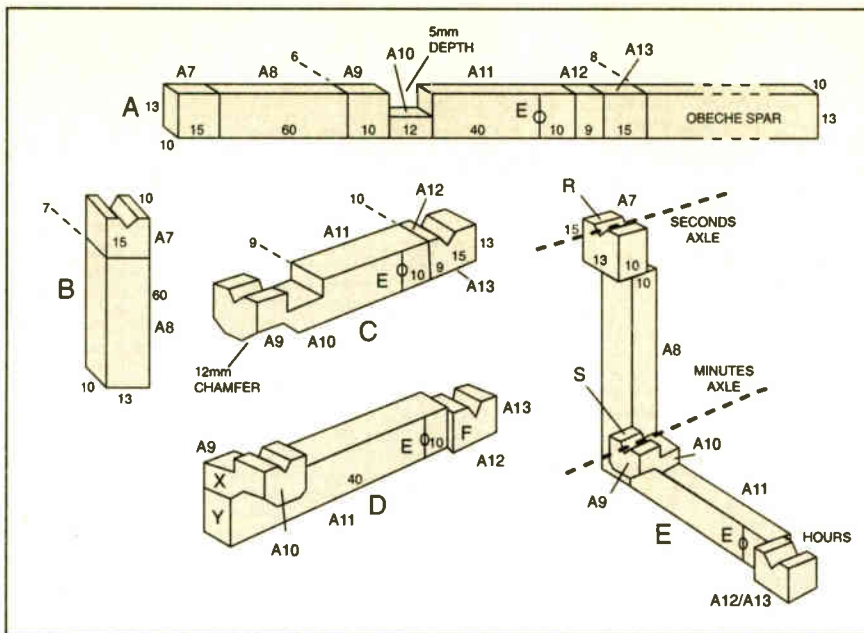
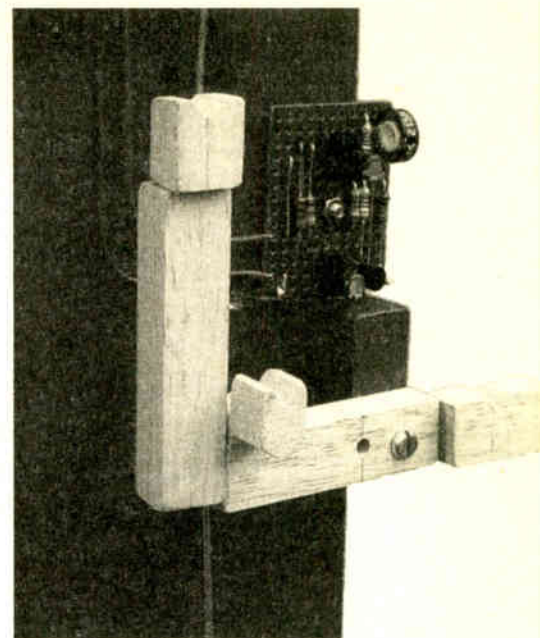

Fig. 8. Wheel bearings (not to scale).



Time wheels axle bearing assembly mounted on the backboard.

10mm. Fix the battery holder as shown in the photograph. Cut a matchstick into three parts and cement the pieces behind the board at J, K and L, with each piece parallel to the nearby edge.

Cement sections A3 and A4 as shown in Fig. 7c. Point E on the board should be visible through hole E in section A3. Cement section A1 end on centrally at point F, and then cement section A2 to its right as a support, as in the photograph.

Suspension hooks W1 and W2 (Fig. 7a) are bent from 80mm lengths of 16s.w.g. enamelled copper wire. Pendulum rod W3, Fig. 7e, is formed from a 600mm length. The bends can be formed around screwdrivers having shafts of about 3mm and 8mm diameter as appropriate.

Note that the pendulum rod requires a loop to be formed at its lower end. First form it while the end is in a vertical position, and then bend the last 15mm sideways. This will be used for timing adjustment, as described later.

*Pendulum bob suspended above the coil.*

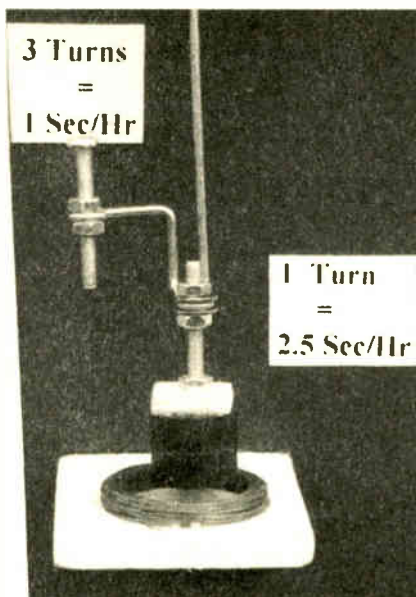

Pendulum suspension hooks and wooden support bar.

## ASSEMBLY

Starting from behind the backboard, pass a bolt through hole H, and through hole H6 in the electronics stripboard assembly. Secure the stripboard to the backboard and run its power supply connections over the front of the board to connect to the battery holder, using solid-core insulated connecting wire.

From the rear of pendulum post A1, insert bolts through holes B and C. Mount suspension hooks W1 and W2 onto these bolts, using washers under the nuts. Hold the backboard vertical and adjust the hooks carefully so that the 15mm length at W2 point D is horizontal and tangential to W1 bend A.

From the 5mm thick balsa cut a 10mm x 10mm square, section A6 in Fig. 7d. Drill a central hole, countersink it slightly and attach a bolt and nut. Cement together the magnets, which are supplied with countersunk holes, and the board as shown to form the pendulum bob. The magnets should have their North poles facing uppermost.

The clock should hang on a wall where it is unlikely to be jolted. To obtain proper balance insert the battery/holder and secure the backboard via 10mm hole G.

Use nuts and washers to suspend the bob from bend T on the pendulum (W3), with

equal amounts of thread showing on the suspension screw above and below its fixing point. Hang the pendulum on its W1 and W2 hooks. It has two large (8mm diameter) bends from which it hangs. Check that the planes of these bends are parallel, and perpendicular to their axis of rotation.

Select a suitable rubber band and pass it around the backboard and section A5 on the coil table, as a temporary fixing.

Bend the pendulum rod and adjust the position of the coil table so that when the magnet is at rest it sits squarely over the coil, and when it moves it must clear the coil by one millimetre. A smaller gap is not advisable because air resistance increases sharply. Note that the coil table will not be central. Mark its position.

Looking down on the coil and going around it clockwise leads to the clockwise tail, CWT – make a mark on it for identification. Drill a hole in the backboard 5mm below the coil table and take both coil wires through it to the back. Then pass them both through hole I, pull them tight, and cut to about 15cm.

Clean the enamel from the ends of the wires, then tin and solder them to the allocated pins on the stripboard. Draw all surplus wire back through hole I, and trap it behind the backboard with adhesive tape.

## WHEEL BEARINGS

The axle for each toothed wheel is a 3M bolt 25mm long. Each bearing is a V-shaped groove, so that there are two points of contact with the bolt. This eliminates any tendency for the wheel to roll backwards. Drill, cut and assemble the obeche sections as in Fig. 8. The cuts are indicated by the numbered dotted lines, 6 to 10.

Mount section A12/A13 3mm forward as in Fig. 8d, and ensure that there is no step between surfaces X and Y of A9/A10 and A11.

Cement the sections as shown in Fig. 8e. Before the cement dries lay the structure on its back, and adjust the vertical post (A7/A8), to produce exactly 52mm centre to centre between the axles of the seconds and minutes wheels. This measurement is



critical. It is best taken between the nearby edges marked R and S.

When dry, push a bolt through holes E in Fig.8e and Fig.7c and tighten a nut on it, with the seconds wheel support span (A7/A8) vertical.

### MARKING TIME

Maximum accuracy is needed for all wheels. A geometry compass, protractor and sharp HB pencil are needed. In place of the protractor, the template shown in Fig.9 could be used. The 60 dots at the perimeter are  $6^\circ$  apart.

First cut out from card three circles having a 20mm radius, for use as backing plates for the time wheels.

For the hours wheel draw two concentric circles of radius 40mm and 45mm, and cut out round the outer circle. Using the protractor or template as a guide, draw radial lines at  $15^\circ$  intervals from the centre to the edge of the disc.

All pencil lines should be drawn on the side that will be hidden when the wheels are assembled. Take this into account when making the "teeth" cuts, so that they face in the correct direction, as shown in the photographs.

Cut in along each of the radials as far as the 40mm circle. Then cut the teeth at an angle between the outer rim and this circle.

For the minutes wheel draw circles of radius 45mm and 50mm, and then repeat as for the Hours wheel, only this time at  $6^\circ$  intervals.

The seconds wheel requires maximum accuracy. Draw circles of radius 33mm and

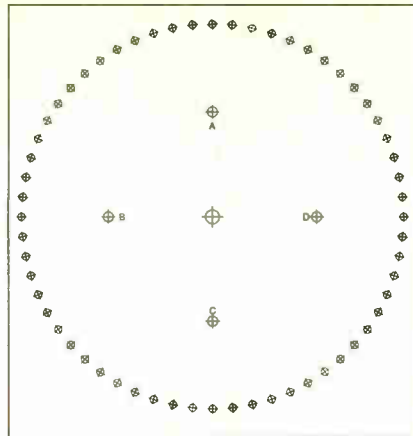

Fig.9. Template (half-size) for the clock wheels.

35mm, and radial lines again at  $6^\circ$  intervals. Cut out the circle and teeth. Beware that one badly placed cut is enough to compromise the wheel.

Note the front of the discs with their time-indicating lines and numerals.

With each toothed wheel, use a pencil to enlarge its central hole and that of a backing plate to accept a bolt. Lay down a thin continuous track of balsa cement inside the circumference of a backing disc.

Load the wheel and backing disc onto a bolt and press them together. Remove the bolt, ensure that the wheel is lying quite flat, and allow the cement to dry. Then fit the bolt again, using a washer on either side (two washers for the front of the

seconds and minutes wheels), and secure the bolt with a nut. Add a further four nuts at the end of the bolt, place the wheel on its bearing and adjust these nuts to give 0.5mm of play. With the seconds wheel the nuts also act as a counter weight.

### SECONDS OUT

The seconds actuators are made from solid connecting wire, shaped as shown in Fig.10.

Hang the ratchet, Fig.10a, from its drawbar. Place the seconds wheel on its bearing, adjusting its counterweight nuts to allow 0.5mm play. Rotate the axle support system at its fixing bolt, so that the seconds wheel teeth at their extremities just touch the ratchet.

Connect the battery to the circuit board, set the wiper of preset VR1 to midway and swing the pendulum to start the clock.

Having observed the pendulum for while, if necessary stop it swinging and then slightly reduce the  $30^\circ$  angle on the ratchet, so that it tilts towards the wheel to drive it correctly.

When satisfied, adjust VR1 so that the ratchet swings back and forth over a distance of (ideally!) 1.7 teeth, so optimising the circuit's efficiency.

Disconnect the battery before progressing with the next stage.

### WHEEL ASSEMBLY

The minutes wheel is driven by a spike on the front of the seconds wheel. This is made from solid connecting wire, as shown in Fig.10b.

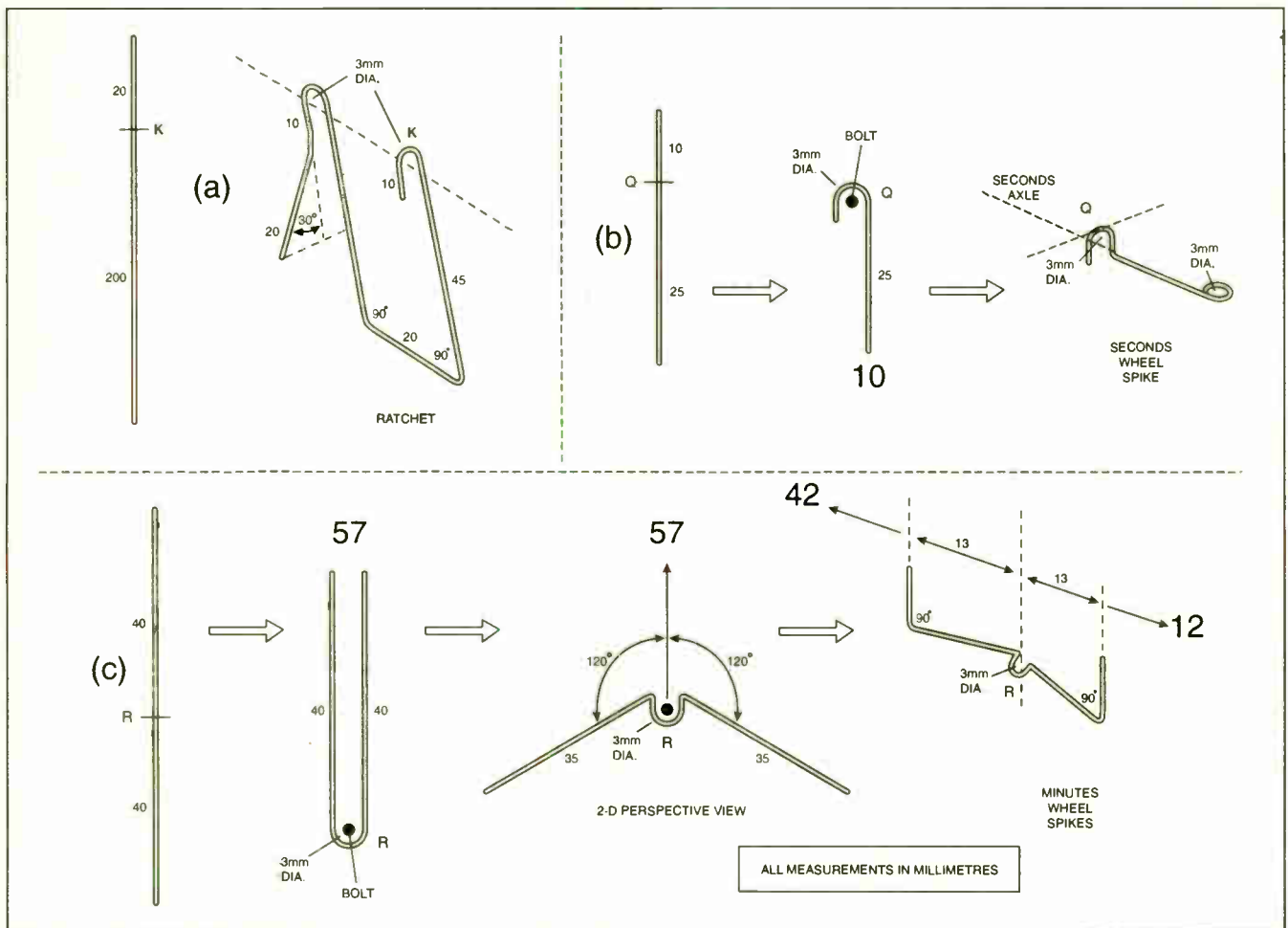
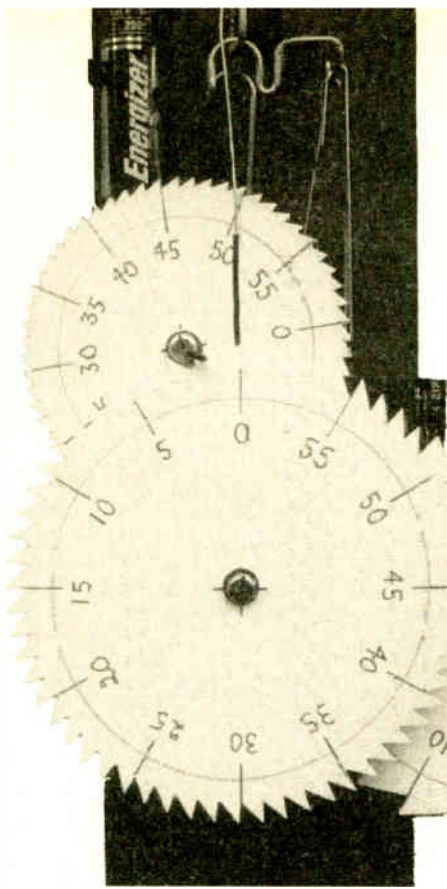

Fig.10. Three actuators, made from connecting wire. The large numerals indicate direction of installation, by referring to teeth numbers on the wheels.



Timewheels assembly.

Mount it between the two washers in front of the seconds wheel, so that it points towards numeral 10. Bend the spike forward where it leaves the washers so that it runs parallel to the axle, and form a small vertical loop at the end. Adjust the spike so that its loop enters three-quarters of the way into the minutes wheel teeth. Check its action at different positions.

The hours wheel is driven by a double spike (Fig. 10c) behind the minutes wheel. Fix it between the two washers immediately behind the minutes wheel, so that both arms point to numeral 57.

Bend the spike arms back by 120° where they leave the washers, and form a 90° bend on each at exactly 13mm from the centre of the bolt, to form the "working" arms.

View the arms in line with the axle, and adjust them to align with wheel numerals 12 and 42. Place the wheel on its bearing and trim the working arm lengths so that they clear the horizontal spar by 2mm. Check that the arms do not foul the seconds wheel.

Place the hours wheel on its bearing, and rotate the minutes wheel clockwise, to check for proper operation. If more friction is needed on the minutes wheel, make its V bearing steeper, or balance it better by adding a small piece of card.

### KEEPING TIME

Seconds are read at the ratchet, minutes and hours at the top of their wheels.

Hang a piece of insulated wire from the front screw on the pendulum post to act as a pointer to the minutes.

Run a nut halfway up a 25mm bolt and rest this assembly in the last loop on the pendulum wire (W3, Fig. 7a). Fix the nut to the wire with two spots of cement, but avoid fouling the thread. This screw is the fine adjuster.

The main adjuster is that provided by the bolt on the magnet assembly (see Pendulum Bob photograph). Lowering this assembly by one turn of its supporting bolt will slow the clock by 2.5 seconds per hour.

To make adjustments, loosen the upper bolt (at the end of the pendulum) and hold the lower one (on the magnet bolt) while rotating the magnet. Then readjust the coil table, using the bolt through hole E in section A3 (Fig. 7c).

Using this method, bring the clock error within  $\pm 2$  seconds per hour. Then apply cement to section A6 under the coil table, and press it onto the backboard in the correct position. The rubber band (see earlier) must continue to press it firmly home while the cement dries, or the necessary right angle can be compromised. From now on the suspension hooks should not be undone.

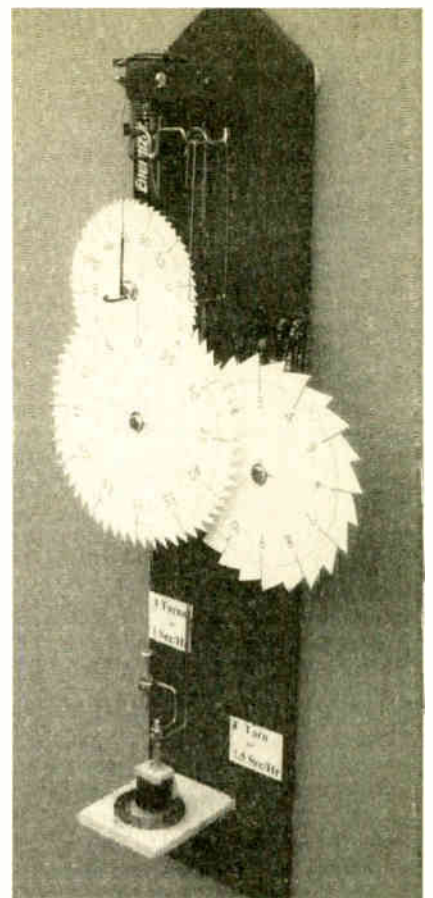

To check that all is well, allow the clock to run while the cement dries.

Clock error should now be within the range of the fine adjuster on the pendulum assembly. Lowering that bolt by three complete turns slows the clock by one second per hour, but only if the pendulum is handled gently!

Timing depends slightly on the rolling point of the pendulum, and this depends slightly on how it is started. To minimise surprises, follow a standard starting drill. Use a pencil to move the pendulum almost as far as it will go to the right, and release. Set the time after the swing has stabilised.

Do not allow anything magnetic to come near the coil or the timekeeping property of the pendulum will be severely affected.

You may find it difficult not to clock-watch!

## EVERYDAY PRACTICAL ELECTRONICS

THE No. 1 MAGAZINE FOR ELECTRONICS TECHNOLOGY & COMPUTER PROJECTS

### NEWSAGENTS ORDER FORM

Please reserve/deliver a copy of *Everyday Practical Electronics* for me each month

Signed .....

Name and Address .....

.....

..... Post Code .....

*Everyday Practical Electronics* is published on the second Thursday of each month and distributed S.O.R. by COMAG. Make sure of your copy of *EPE* each month – cut out or photostat this form, fill it in and hand it to your newsagent.



BS2-IC



BS2-SX

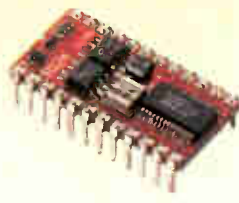

BS2E-IC

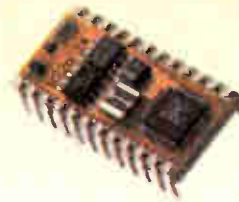

BS2P/24



BS2P/40

**Parallax BASIC Stamps - still the easy way to get your project up and running!**

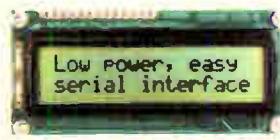
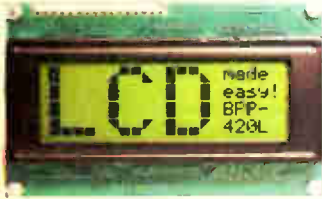

**Serial Alphanumeric and Graphic Displays, Mini-Terminals and Bezel kits**

# www.milinst.com



Animated Head



3-Axis Machine



Six-Legged Walkers



Robotic Arms



Bipeds

**Robotic models for both the beginner and the advanced hobbyist**



Servo Drivers

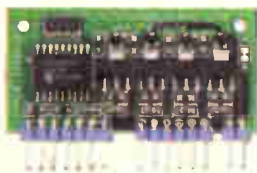

Motor Drivers



On-Screen Displays



DMX Protocol

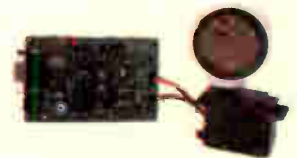

U/Sound Ranging

**Animatronics and Specialist Interface-Control Modules**



Quadravox MP3 & Speech Systems



SensoryInc Voice Recognition



Parallax Ubicom Tool Kits



Tech-Tools PIC & Rom Emulators



BASICMicro PIC BASIC Compilers

**Development Tools**

Milford Instruments Limited Tel 01977 683665, Fax 01977 681465, sales@milinst.com

# EPE IS PLEASED TO BE ABLE TO OFFER YOU THESE ELECTRONICS CD-ROMS

## ELECTRONICS PROJECTS



Logic Probe testing

*Electronic Projects* is split into two main sections: **Building Electronic Projects** contains comprehensive information about the components, tools and techniques used in developing projects from initial concept through to final circuit board production. Extensive use is made of video presentations showing soldering and construction techniques. The second section contains a set of ten projects for students to build, ranging from simple sensor circuits through to power amplifiers. A shareware version of Matrix's CADPACK schematic capture, circuit simulation and p.c.b. design software is included. The projects on the CD-ROM are: Logic Probe; Light, Heat and Moisture Sensor; NE555 Timer; Egg Timer; Dice Machine; Bike Alarm; Stereo Mixer; Power Amplifier; Sound Activated Switch; Reaction Tester. Full parts lists, schematics and p.c.b. layouts are included on the CD-ROM.

## ELECTRONICS CAD PACK

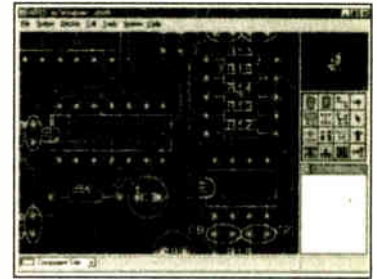

PCB Layout

Electronics CADPACK allows users to design complex circuit schematics, to view circuit animations using a unique SPICE-based simulation tool, and to design printed circuit boards. CADPACK is made up of three separate software modules. (These are restricted versions of the full Labcenter software.) **ISIS Lite** which provides full schematic drawing features including full control of drawing appearance, automatic wire routing, and over 6,000 parts. **PROSPICE Lite** (integrated into ISIS Lite) which uses unique animation to show the operation of any circuit with mouse-operated switches, pots, etc. The animation is compiled using a full mixed mode SPICE simulator. **ARES Lite** PCB layout software allows professional quality PCBs to be designed and includes advanced features such as 16-layer boards, SMT components, and an autorouter operating on user generated Net Lists.

## ELECTRONIC CIRCUITS & COMPONENTS V2.0

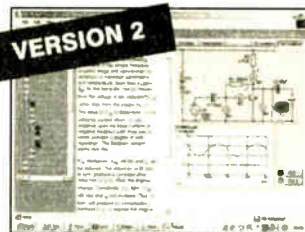

Circuit simulation screen

Provides an introduction to the principles and application of the most common types of electronic components and shows how they are used to form complete circuits. The virtual laboratories, worked examples and pre-designed circuits allow students to learn, experiment and check their understanding. Version 2 has been considerably expanded in almost every area following a review of major syllabuses (GCSE, GNVQ, A level and HNC). It also contains both European and American circuit symbols. Sections include: **Fundamentals**: units & multiples, electricity, electric circuits, alternating circuits. **Passive Components**: resistors, capacitors, inductors, transformers. **Semiconductors**: diodes, transistors, op.amps, logic gates. **Passive Circuits**. **Active Circuits**. **The Parts Gallery** will help students to recognise common electronic components and their corresponding symbols in circuit diagrams. Included in the Institutional Versions are multiple choice questions, exam style questions, fault finding virtual laboratories and investigations/worksheets.

## ANALOGUE ELECTRONICS

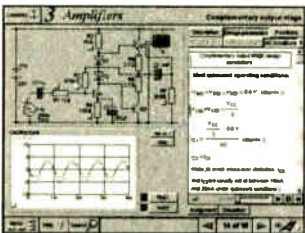

Complimentary output stage

*Analogue Electronics* is a complete learning resource for this most difficult branch of electronics. The CD-ROM includes a host of virtual laboratories, animations, diagrams, photographs and text as well as a SPICE electronic circuit simulator with over 50 pre-designed circuits.

Sections on the CD-ROM include: **Fundamentals** – Analogue Signals (5 sections), Transistors (4 sections), Waveshaping Circuits (6 sections). **Op.Amps** – 17 sections covering everything from Symbols and Signal Connections to Differentiators. **Amplifiers** – Single Stage Amplifiers (8 sections), Multi-stage Amplifiers (3 sections). **Filters** – Passive Filters (10 sections), Phase Shifting Networks (4 sections), Active Filters (6 sections). **Oscillators** – 6 sections from Positive Feedback to Crystal Oscillators. **Systems** – 12 sections from Audio Pre-Amplifiers to 8-Bit ADC plus a gallery showing representative p.c.b. photos.

## ROBOTICS & MECHATRONICS



Case study of the Milford Instruments Spider

Robotics and Mechatronics is designed to enable hobbyists/students with little previous experience of electronics to design and build electromechanical systems. The CD-ROM deals with all aspects of robotics from the control systems used, the transducers available, motors/actuators and the circuits to drive them. Case study material (including the NASA Mars Rover, the Milford Spider and the Furby) is used to show how practical robotic systems are designed. The result is a highly stimulating resource that will make learning, and building robotics and mechatronic systems easier. The Institutional versions have additional worksheets and multiple choice questions.

- Interactive Virtual Laboratories
- Little previous knowledge required
- Mathematics is kept to a minimum and all calculations are explained
- Clear circuit simulations

## DIGITAL ELECTRONICS V2.0

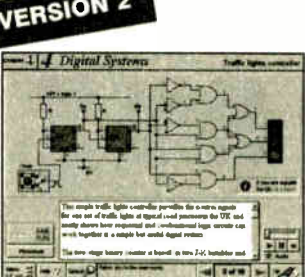

Virtual laboratory – Traffic Lights

*Digital Electronics* builds on the knowledge of logic gates covered in *Electronic Circuits & Components* (opposite), and takes users through the subject of digital electronics up to the operation and architecture of microprocessors. The virtual laboratories allow users to operate many circuits on screen. Covers binary and hexadecimal numbering systems, ASCII, basic logic gates, monostable action and circuits, and bistables – including JK and D-type flip-flops. Multiple gate circuits, equivalent logic functions and specialised logic functions. Introduces sequential logic including clocks and clock circuitry, counters, binary coded decimal and shift registers. A/D and D/A converters, traffic light controllers, memories and microprocessors – architecture, bus systems and their arithmetic logic units. Sections on Boolean Logic and Venn diagrams, displays and chip types have been expanded in Version 2 and new sections include shift registers, digital fault finding, programmable logic controllers, and microcontrollers and microprocessors. The Institutional versions now also include several types of assessment for supervisors, including worksheets, multiple choice tests, fault finding exercises and examination questions.

## FILTERS

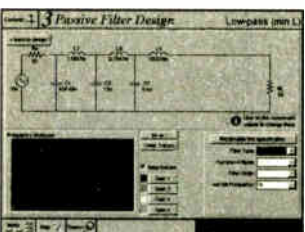

Filter synthesis

*Filters* is a complete course in designing active and passive filters that makes use of highly interactive virtual laboratories and simulations to explain how filters are designed. It is split into five chapters: **Revision** which provides underpinning knowledge required for those who need to design filters. **Filter Basics** which is a course in terminology and filter characterization, important classes of filter, filter order, filter impedance and impedance matching, and effects of different filter types. **Advanced Theory** which covers the use of filter tables, mathematics behind filter design, and an explanation of the design of active filters. **Passive Filter Design** which includes an expert system and filter synthesis tool for the design of low-pass, high-pass, band-pass, and band-stop Bessel, Butterworth and Chebyshev ladder filters. **Active Filter Design** which includes an expert system and filter synthesis tool for the design of low-pass, high-pass, band-pass, and band-stop Bessel, Butterworth and Chebyshev op.amp filters.

## PRICES

Prices for each of the CD-ROMs above are:

(Order form on third page)

(UK and EU customers add VAT at 17.5% to "plus VAT" prices)

Hobbyist/Student .....£45 inc VAT  
 Institutional (Schools/HE/FE/Industry).....£99 plus VAT  
 Institutional 10 user (Network Licence) .....£199 plus VAT  
 Site Licence.....£499 plus VAT

# PICmicro TUTORIALS AND PROGRAMMING

## HARDWARE

### VERSION 2 PICmicro MCU DEVELOPMENT BOARD

*Suitable for use with the three software packages listed below.*

This flexible development board allows students to learn both how to program PICmicro microcontrollers as well as program a range of 8, 18, 28 and 40-pin devices. For experienced programmers all programming software is included in the PPP utility that comes with the development board. For those who want to learn, choose one or all of the packages below to use with the Development Board.

- Makes it easier to develop PICmicro projects
- Supports low cost Flash-programmable PICmicro devices
- Fully featured integrated displays – 13 individual I.e.d.s, quad 7-segment display and alphanumeric I.c.d. display
- Supports PICmicro microcontrollers with A/D converters
- Fully protected expansion bus for project work
- All inputs and outputs available on screw terminal connectors for easy connection

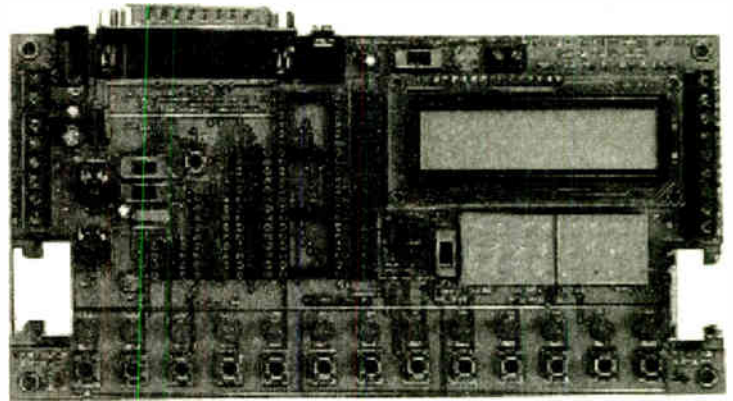

**£145 including VAT and postage**

**12V 500mA plug-top PSU (UK plug) £7**

**25-way 'D' type connecting cable £5**

## SOFTWARE

*Suitable for use with the Development Board shown above.*

### ASSEMBLY FOR PICmicro V2 (Formerly PICtutor)

Assembly for PICmicro microcontrollers V2.0 (previously known as PICtutor) by John Becker contains a complete course in programming the PIC16F84 PICmicro microcontroller from Arizona Microchip. It starts with fundamental concepts and extends up to complex programs including watchdog timers, interrupts and sleep modes. The CD makes use of the latest simulation techniques which provide a superb tool for learning: the Virtual PICmicro microcontroller. This is a simulation tool that allows users to write and execute MPASM assembler code for the PIC16F84 microcontroller on-screen. Using this you can actually see what happens inside the PICmicro MCU as each instruction is executed which enhances understanding.

- Comprehensive instruction through 39 tutorial sections
- Includes Vlab, a Virtual PICmicro microcontroller: a fully functioning simulator
- Tests, exercises and projects covering a wide range of PICmicro MCU applications
- Includes MPLAB assembler
- Visual representation of a PICmicro showing architecture and functions
- Expert system for code entry helps first time users
- Shows data flow and fetch execute cycle and has challenges (washing machine, lift, crossroads etc.)
- Imports MPASM files.

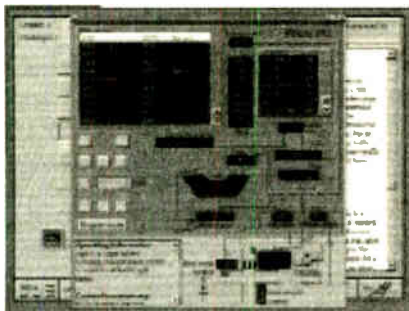

Virtual PICmicro

### 'C' FOR PICmicro VERSION 2

The C for PICmicro microcontrollers CD-ROM is designed for students and professionals who need to learn how to program embedded microcontrollers in C. The CD contains a course as well as all the software tools needed to create Hex code for a wide range of PICmicro devices – including a full C compiler for a wide range of PICmicro devices.

Although the course focuses on the use of the PICmicro microcontrollers, this CD-ROM will provide a good grounding in C programming for any microcontroller.

- Complete course in C as well as C programming for PICmicro microcontrollers
- Highly interactive course
- Virtual C PICmicro improves understanding
- Includes a C compiler for a wide range of PICmicro devices
- Includes full Integrated Development Environment
- Includes MPLAB software
- Compatible with most PICmicro programmers
- Includes a compiler for all the PICmicro devices.

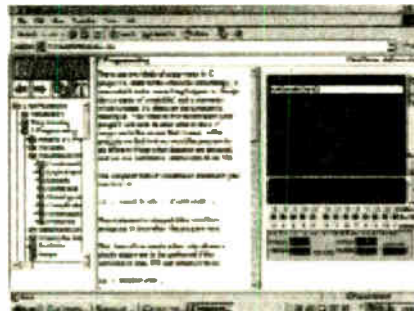

Minimum system requirements for these items: Pentium PC running Windows 98, NT, 2000, ME, XP; CD-ROM drive; 64MB RAM; 10MB hard disk space.

### FLOWCODE FOR PICmicro

Flowcode is a very high level language programming system for PICmicro microcontrollers based on flowcharts. Flowcode allows you to design and simulate complex robotics and control systems in a matter of minutes.

Flowcode is a powerful language that uses macros to facilitate the control of complex devices like 7-segment displays, motor controllers and I.c.d. displays. The use of macros allows you to control these electronic devices without getting bogged down in understanding the programming involved.

Flowcode produces MPASM code which is compatible with virtually all PICmicro programmers. When used in conjunction with the Version 2 development board this provides a seamless solution that allows you to program chips in minutes.

- Requires no programming experience
- Allows complex PICmicro applications to be designed quickly
- Uses international standard flow chart symbols (ISO5807)
- Full on-screen simulation allows debugging and speeds up the development process
- Facilitates learning via a full suite of demonstration tutorials
- Produces ASM code for a range of 8, 18, 28 and 40-pin devices
- Institutional versions include virtual systems (burglar alarms, car parks etc.).

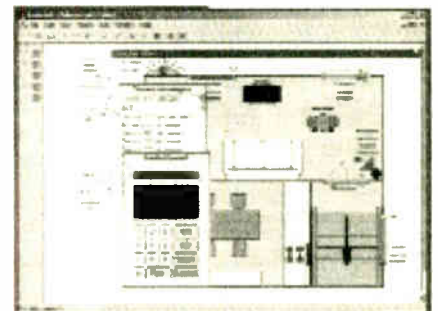

Burglar Alarm Simulation

## PRICES

Prices for each of the CD-ROMs above are:

*(Order form on next page)*

*(UK and EU customers add VAT at 17.5% to "plus VAT" prices)*

Hobbyist/Student  
Institutional (Schools/HE/FE/Industry)  
Flowcode Institutional  
Institutional 10 user (Network Licence)  
Site Licence

£45 inc VAT  
£99 plus VAT  
£70 plus VAT  
£249 plus VAT  
£599 plus VAT

# TEACH-IN 2000 – LEARN ELECTRONICS WITH EPE

EPE's own *Teach-In* CD-ROM, contains the full 12-part *Teach-In* series by John Becker in PDF form plus the *Teach-In* interactive software covering all aspects of the series. We have also added Alan Winstanley's highly acclaimed *Basic Soldering Guide* which is fully illustrated and which also includes *Desoldering*. The *Teach-In* series covers: Colour Codes and Resistors, Capacitors, Potentiometers, Sensor Resistors, Ohm's Law, Diodes and L.E.D.s, Waveforms, Frequency and Time, Logic Gates, Binary and Hex Logic, Op.amps, Comparators, Mixers, Audio and Sensor Amplifiers, Transistors, Transformers and Rectifiers, Voltage Regulation, Integration, Differentiation, 7-segment Displays, L.C.D.s, Digital-to-Analogue.

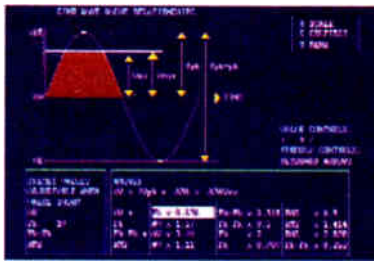

Sine wave relationship values

Each part has an associated practical section and the series includes a simple PC interface so you can use your PC as a basic oscilloscope with the various circuits.

**A hands-on approach to electronics with numerous breadboard circuits to try out.**

**£12.45** including VAT and postage. Requires Adobe Acrobat (available free from the Internet – [www.adobe.com/acrobat](http://www.adobe.com/acrobat)).

**FREE WITH EACH TEACH-IN CD-ROM** – *Electronics Hobbyist Compendium* 80-page book by Robert Penfold. Covers Tools For The Job; Component Testing; Oscilloscope Basics.

**FREE BOOK WITH TEACH-IN 2000 CD-ROM**



# DIGITAL WORKS 3.0



Counter project

*Digital Works Version 3.0* is a graphical design tool that enables you to construct digital logic circuits and analyze their behaviour. It is so simple to use that it will take you less than 10 minutes to make your first digital design. It is so powerful that you will never outgrow its capability ● Software for simulating digital logic circuits ● Create your own macros – highly scalable ● Create your own circuits, components, and i.c.s ● Easy-to-use digital interface ● Animation brings circuits to life ● Vast library of logic macros and 74 series i.c.s with data sheets ● Powerful tool for designing and learning. **Hobbyist/Student £45 inc. VAT. Institutional £99 plus VAT. Institutional 10 user £199 plus VAT. Site Licence £499 plus VAT.**

## ELECTRONICS IN CONTROL

Two colourful animated courses for students on one CD-ROM. These cover Key Stage 3 and GCSE syllabuses. **Key Stage 3:** A pictorial look at the Electronics section featuring animations and video clips. Provides an ideal introduction or revision guide, including multi-choice questions with feedback. **GCSE:** Aimed at the Electronics in many Design & Technology courses, it covers many sections of GCSE Electronics. Provides an ideal revision guide with Homework Questions on each chapter. Worked answers with an access code are provided on a special website.

**Single User £29 inc. VAT. Multiple User £39 plus VAT**  
**Student copies (available only with a multiple user copy) £6 plus VAT**  
 (UK and EU customers add VAT at 17.5% to "plus VAT" prices)

## MODULAR CIRCUIT DESIGN

**VERSION 3**

Contains a range of tried and tested analogue and digital circuit modules, together with the knowledge to use and interface them. Thus allowing anyone with a basic understanding of circuit symbols to design and build their own projects. Version 3 includes data and circuit modules for a range of popular PICs; includes PICAXE circuits, the system which enables a PIC to be programmed without a programmer, and without removing it from the circuit. Shows where to obtain free software downloads to enable BASIC programming. Essential information for anyone undertaking GCSE or "A" level electronics or technology and for hobbyists who want to get to grips with project design. Over seventy different Input, Processor and Output modules are illustrated and fully described, together with detailed information on construction, fault finding and components, including circuit symbols, pinouts, power supplies, decoupling etc.

**Single User £19.95 inc. VAT. Multiple User £34 plus VAT**  
 (UK and EU customers add VAT at 17.5% to "plus VAT" prices)

Minimum system requirements for these CD-ROMs: Pentium PC, CD-ROM drive, 32MB RAM, 10MB hard disk space. Windows 95/98/NT/2000/ME/XP, mouse, sound card, web browser.

Please send me:

## CD-ROM ORDER FORM

- Electronic Projects
- Electronic Circuits & Components V2.0
- Analogue Electronics
- Digital Electronics V2.0
- Filters
- Electronics CAD Pack
- Robotics & Mechatronics
- Assembler for PICmicro
- 'C' for PICmicro
- Flowcode for PICmicro
- Digital Works 3.0

- Version required:
- Hobbyist/Student
  - Institutional
  - Institutional 10 user
  - Site licence



- PICmicro Development Board (hardware)
- Development Board UK plugtop power supply
- Development Board 25-way connecting lead

- Teach-In 2000 + FREE BOOK
- Electronic Components Photos
- Electronics In Control – Single User
- Electronics In Control – Multiple User
- Modular Circuit Design – Single User
- Modular Circuit Design – Multiple User

Note: The software on each version is the same, only the licence for use varies.

Full name: .....

Address: .....

.....Post code: .....Tel. No: .....

Signature: .....

I enclose cheque/PO in £ sterling payable to WIMBORNE PUBLISHING LTD for £ .....

Please charge my Visa/Mastercard/Amex/Diners Club/Switch: £ .....Card expiry date: .....

Card No: .....Switch Issue No. ....

Card Security Code ..... (The last 3 digits on or just under the signature strip)

## ORDERING ALL PRICES INCLUDE UK POSTAGE

Student/Single User/Standard Version price includes postage to most countries in the world  
 EU residents outside the UK add £5 for airmail postage per order

Institutional, Multiple User and Deluxe Versions – overseas readers add £5 to the basic price of each order for airmail postage (do not add VAT unless you live in an EU (European Union) country, then add 17½% VAT or provide your official VAT registration number).

Send your order to:  
**Direct Book Service**  
**Wimborne Publishing Ltd**  
**408 Wimborne Road East**  
**Ferndown, Dorset BH22 9ND**

To order by phone ring  
**01202 873872. Fax: 01202 874562**

Goods are normally sent within seven days

E-mail: [orders@wimborne.co.uk](mailto:orders@wimborne.co.uk)

Online shop:  
[www.epemag.wimborne.co.uk/shopdoor.htm](http://www.epemag.wimborne.co.uk/shopdoor.htm)

# B<sup>2</sup> Spice Pro v4.2

Watch your designs come alive

Reader Offer  
Save 15%  
Quote discount code  
**EPE79315**  
when ordering on  
the telephone, fax  
or web site.

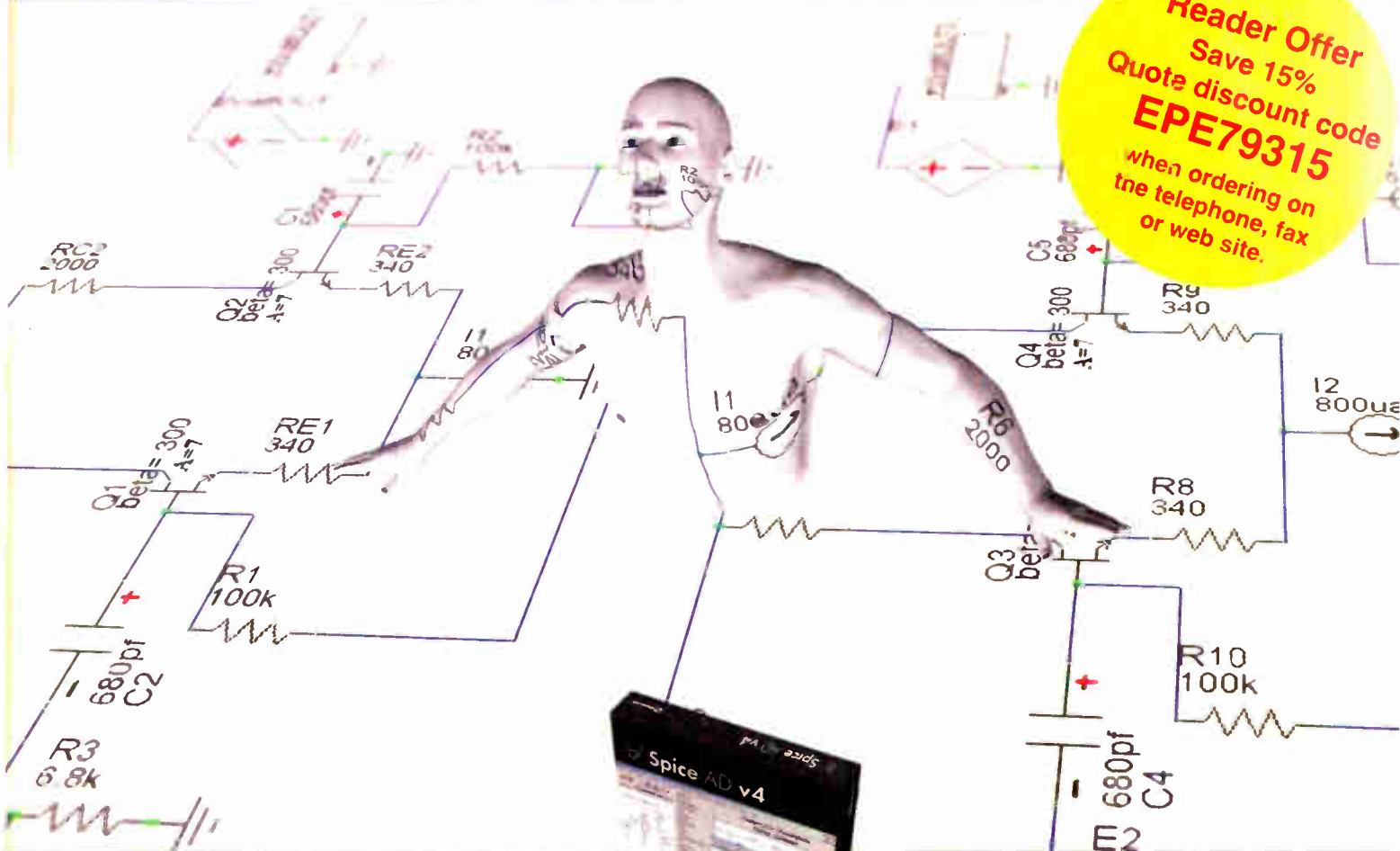

## Setting new standards in price & performance for SPICE

See what's really going on with powerful new Dynamic Schematics.

Make changes to designs during simulation and watch the effects in real time.

More simulation options than ever before.

A massive parts database as standard.

Free telephone and on-line technical support.

Outstanding value

*'We are so confident that B2 Spice Pro will impress you that we offer an unconditional 30-day evaluation of the full boxed version, complete with printed user manual. If you don't like it, then simply return it.'*

**Call 01603 872331**

order on-line [www.spice-software.com](http://www.spice-software.com)



**30 day no quibble  
money back  
guarantee**

## Just some of what's available

A whole range of new features not found in packages costing under £1000.

- Advanced animated schematics.
- Realtime 'live' simulation adjustments.
- 16 simulation options from Monte Carlo to RF.
- Improved PCB export and bill of materials.
- Detailed schematics with DIN and ANSI symbols.
- RF simulations and network analysis.
- Schematic borders and titles for professional output.
- Smith and polar plots.
- A massive 25,000 parts database as standard.
- Powerful new graphing and plotting - display & switch between multiple graphs easily.
- New "workspace" window to manage your projects.
- New "parts chooser" window to easily pick and place.
- Combined digital and analogue graphs.
- Even faster simulations.
- Unlimited undo / redo.
- Many new simulation models.
- Create new parts.
- Create and edit symbols.
- Create new PCB layout parts.
- New fully featured schematic editor.

**Professional version £239 ex VAT**

**Standard version £139 ex VAT**

**Upgrade from earlier versions £119 ex VAT**

Postage & packing £5.00.

Education discounts and site licences available.



Research House, Norwich Road, Eastgate  
Norwich. NR10 4HA. Fax: 01603 879010  
Email [info@looking.co.uk](mailto:info@looking.co.uk)



# PRACTICALLY SPEAKING

*Robert Penfold looks at the Techniques of Actually Doing It!*

**U**NLESS you are into building valve equipment, at least one semiconductor will feature in every project that you build. It is too soon to write-off discrete transistors and diodes, but they are used relatively little in modern designs.

These days most projects are based on integrated circuits (i.c.s). Locating the correct integrated circuit in component catalogues tends to be problematic for beginners, and can occasionally give problems to "old hands".

Integrated circuits tend to be divided into various categories in catalogues, so you have to look in the right category in order to stand any chance of finding a given device. There might be a complete list of all the semiconductors on offer, but locating a device in a list having many thousands of entries could be difficult and quite time consuming.

## In There Somewhere

Beginners tend to be nonplussed by the markings on many integrated circuits, and also those on some other components. The problem is the "extras" that seem to be included on every device (see Fig.1).

There will usually be a manufacturer's logo, and the country of manufacture might also be included. Anything else is unlikely to be of any significance.

Typically there is a batch number or the date of manufacture in some cryptic form such as the number of days since the factory was opened. It can be confusing at first, but you soon get used to picking out the type number from the extraneous characters.

Locating the right device is much easier if you understand the fundamentals of integrated circuit type numbers. No doubt there are exceptions, but virtually all integrated circuits type numbers consist of three sections. The first part of the type number indicates the manufacturer, and it usually consists of two or three letters. Matters are complicated by the fact that a manufacturer may use more than one set of identification letters. The prefix for linear devices could be different to the prefix for logic types for example.

A further complication is that integrated circuits are often second-sourced. Industrial customers prefer not to be tied to a single source of supply, so integrated circuits are often produced under license by a second or even a third manufacturer. In some cases the second-source components retain the original type

number, but the prefix is often changed to that of the second-source manufacturer.

What this means in practice is that there is no need to panic if the first two or three letters in the type number of a device you obtain are not what you were expecting. If you require an MC1458CP but are supplied with a CA1458E they will actually be the same device from different manufacturers. They are manufactured by Motorola and RCA respectively.

The most popular devices are actually manufactured by several companies, and can be obtained with a range of prefixes in the type number. While this state of affairs is far from ideal, and it does leave room for errors, you soon get used to it.

With some European devices the first three letters of the type number indicate the kind of integrated circuit rather than the manufacturer. These are the devices that have prefixes such as TBA, TCA, TDA, TEA, etc. Clearly with these it is essential to obtain a device that has the right prefix, and a (say) TDA820 is definitely not the same as a TBA820.

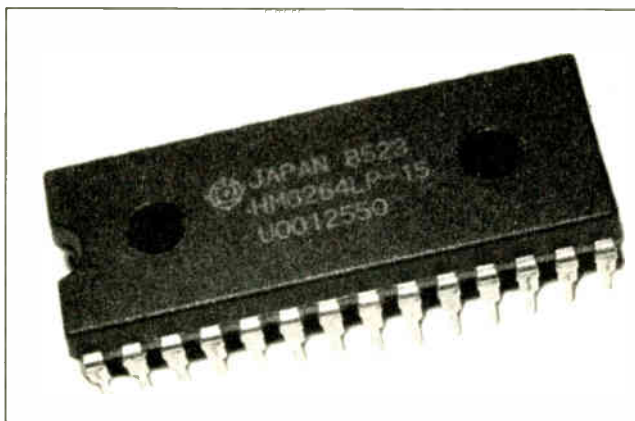

*Fig.1. This is a 6264 memory chip. Unusually, there is a suffix to the suffix (-15) that indicates the chip's speed.*

The middle part of a type number is what you have to regard as the real type number. It is usually from three to five digits in length, and consists entirely of numeric characters. It is highly unlikely that you would encounter a semiconductor that has the type number you require but is actually the wrong device.

However, there is no harm in looking at the description of a device to check that it ties in correctly with the required device. If the specified device is a PIC microcontroller but the device in the catalogue is an operational amplifier, you have obviously not found the right component. A further search through the catalogue should soon locate the correct device.

## Tail Piece

The final part of a type number is important, and potentially confusing. It indicates the package type, and usually consists of one or two letters. A wide range of package types are used in the electronics industry, but the integrated circuits used in designs for the home constructor are almost invariably housed in d.i.l. (dual in-line) plastic encapsulations. Dual in-line just means that the device has two lines of pins, one along each side of the body.

Unhelpfully, a given package often has several different suffix letters, with each manufacturer tending to do "its own thing". In the previous example the suffix letters were "CP" and "E". The CP suffix is quite common, with the "C" and "P" respectively indicating a dual in-line package and plastic construction. In the second example the single letter E means exactly the same thing. Devices having "CN", "C", "N", "CS", "P", and "G" suffixes all have a plastic d.i.l. encapsulation, and no doubt there are many more alternatives.

The suffix used to be of little importance, because the devices available to amateur users always had plastic d.i.l. encapsulations. In some catalogues you will probably still find that few devices, if any, are offered in an alternative type of case.

However, it is becoming increasingly common for surface-mount versions to be included, so more care is needed when ordering devices that are listed in two versions. The component catalogue should make it perfectly clear which device is which.

You also need to take care when ordering integrated circuits from a company that is primarily supplying components to industry (RS and Premier Farnell for instance).

Popular devices are often available from these sources in a range of case styles. The catalogue or web site usually indicates the case style of each version, so there should be no problems provided you check this point prior to ordering.

The range of integrated circuits on offer from the main suppliers is so vast that they are categorised. This makes it easier to find a given device, but only if you understand the way devices are categorised.

There are usually two main categories of logic device, which are the 4000 series CMOS integrated circuits and the 74 series TTL chips. The CMOS chips have basic type numbers starting at 4000. The "A" suffix chips are



now long obsolete so you should only be offered the current "B" series devices. Provided the basic type number is right, you should be supplied with the correct chip.

### Family Differences

Matters are more convoluted with TTL integrated circuits. The original range is now largely obsolete, as are many of the "turbo charged" ranges. A few of the improved ranges are still in common use though.

The main type number of the original devices has "74" as the first two digits, followed by a two or three digit serial number. Essentially the same method is retained in the current devices, but two or three letters are added between the "74" and the serial number. These letters denote which family of "super" devices the chip comes from.

Some of the letters are: "LS" for low-power Schottky; "HC" for high-speed CMOS and "HCT" for the high-speed CMOS devices that operate at normal TTL voltage levels. The original 7432 is therefore available as the 74LS32, the 74HC32, and the 74HCT32.

While there is not a total lack of compatibility between the various TTL families, it is definitely in short supply. Consequently, it is very important to ensure that you always obtain the correct version.

There are many digital chips that are not 4000 or 7400 series. These include such things as microcontrollers, and interfacing chips. These are usually listed in two or three subcategories, so there should be no difficulties provided you have some idea of the chip's purpose.

The non-logic devices tend to be lumped together in the general category of "linear" integrated circuits. The range of devices covered is pretty huge, and includes audio and other low frequency chips, radio and communications chips, timers and oscillators, special purpose devices, etc.

There will usually be a few devices that are not, strictly speaking, linear type, but do not really fit properly into any of the main categories. If you are looking for a chip that is not a standard logic device or computing chip, it will probably be listed in the linear devices.

### Voltage Regulators

Voltage regulators might appear in the linear section, but this ever growing range of devices usually has a category of its own. The popular voltage regulators are produced by a large number of manufacturers, so they are usually referred to by their basic type numbers with no prefixes or suffixes included. Actually, in some cases the type numbers might be abandoned altogether. In both component lists and catalogues the voltage and current ratings are sometimes used instead.

Matters are much easier if you understand the way in which the type numbering operates for the standard regulator chips. Devices for operation with positive supplies have type numbers

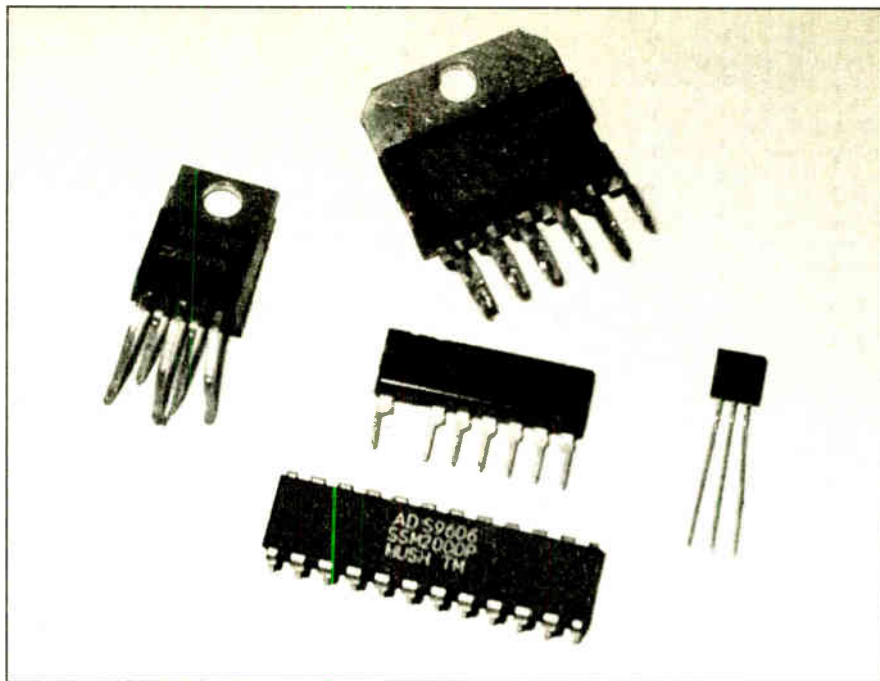

Fig.2. Integrated circuits come in a variety of shapes and sizes. The d.i.l. devices are by far the most common though.

that begin with "78", and those for operation with negative supplies have type numbers that start with "79".

The normal regulators operate at a current of up to one amp, and with these the next part of the type number is two digits that indicate the output voltage. A 7805 is therefore a 5-volt positive regulator, and a 7912 is a 12-volt negative type. There are about half a dozen standard output voltages from five to 30 volts.

Chips with other maximum operating currents are available, and a letter inserted in the middle of the number indicates the current rating. An "L" is used for 0.1A (100mA) chips, an "M" for 0.5A types, and an "S" for 2A chips. A device marked 78L15 is therefore a 15V, 100mA positive voltage regulator, and one having 79M05 as the type number is a 5V 0.5A (500mA) negative regulator.

These days there are a number of improved voltage regulators that use very low supply currents or will operate with the input voltage very close to the output potential. Where a project requires a "special" of some kind, the exact requirements should be made clear in the article concerned.

With many projects now based on a special chip of some description, it is always advisable to check the article and components list for any helpful information. Do not overlook the *Shoptalk* feature when building *EPE* projects. This will always give a source of supply for any awkward or unusual components, including semiconductors.

### Getting Physical

As d.i.l. integrated circuits are symmetrical it is possible to fit them the wrong way round. Doing so is likely to have dire consequences for the chip, and possibly for other components as well.

The supply pins are usually at opposite corners, so getting a device fitted the wrong way around results in it being fed with a supply of the wrong polarity. Although this is unlikely to "zap" a modern device, it is likely to cause a very high supply current to flow. Unless you switch off the project fairly quickly the device will probably overheat. Toasted semiconductors often explode with a loud "crack".

The orientation of d.i.l. i.c.s is usually indicated by a notch in what is normally considered to be the top edge of the component and (or) a dimple next to pin one (see Fig.1). There is an alternative method that is becoming increasingly common, and this is to have a white bar marked across the top end of the case. This method is particularly common amongst logic integrated circuits. Some devices take the "belt and braces approach", with all three types of marking used.

Do not be misled by moulding marks, manufacturer's logos, and other irrelevant markings on the case. Mostly these are easily distinguished from the "real thing", but some devices appear to have notches at both ends of the case! Close inspection should reveal that one notch is just a moulding mark. The real notch is usually much smaller and deeper than the moulding mark.

By no means all integrated circuits have d.i.l. encapsulations (see Fig.2). Small voltage regulators look like ordinary transistors, and the larger types have the same appearance as power transistors. Most audio power amplifier devices look like large power transistors with more leadout wires. A few devices have s.i.l. (single in-line) encapsulations. When an unusual device is used, the article concerned should always have diagrams that make the correct orientation of the component perfectly clear.

# DrDAQ Data Logger



External sensors: Humidity  
Temperature  
O2 In Air  
Reed Switch

- Low cost - under £60
- Built in sensors for light, temperature and sound (level and waveforms)
- Use DrDAQ to capture fast signals
- Outputs for control experiments
- Supplied with both PicoScope (oscilloscope) and PicoLog (data logging) software

For more information on DrDAQ, please visit:

[www.picotech.com/drdaq72](http://www.picotech.com/drdaq72)

# PC Oscilloscopes

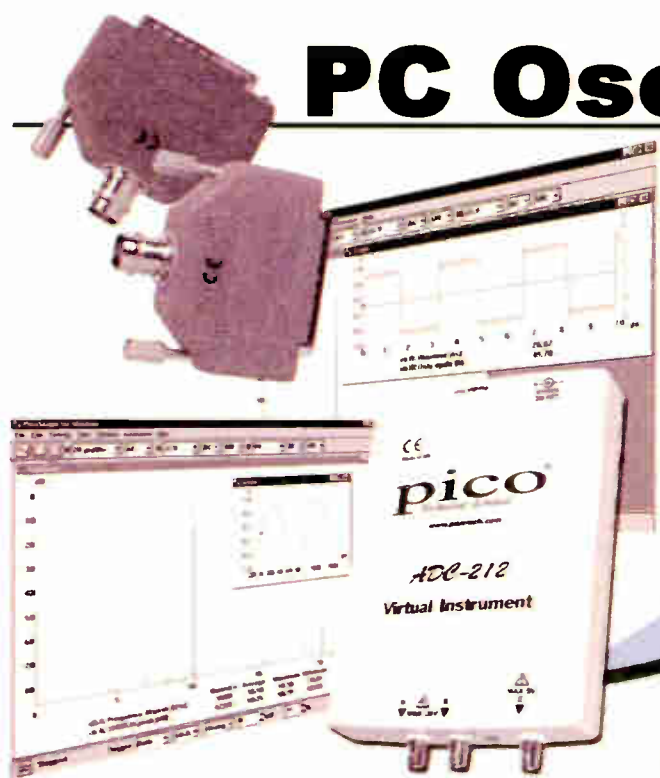

- Scope and spectrum analyser functions
- A fraction of the cost of benchtop scope
- Save multiple setups, for ease of use
- Save, print and e-mail your traces
- FREE technical support for life
- FREE software and upgrades
- Automated measurements

For more information on our scopes, please visit:

[www.picotech.com/scope128](http://www.picotech.com/scope128)

Tel: 01480 396395 Fax: 01480 396296 E-mail: [sales@picotech.com](mailto:sales@picotech.com)

**PICO**  
Technology Limited

# PRACTICAL RADIO CIRCUITS

## RAYMOND HAIGH



### Part 6: Single-sideband and direct conversion.

*Circuits for the set builder and experimenter*

**S**UPPRESSED carrier single-sideband (s.s.b.), a highly efficient method of transmitting speech by radio, will be considered this month. A popular and simple technique for receiving these signals is known as direct conversion, and a circuit is included.

#### CARRIERS

Radio frequency transmissions cannot, by themselves, convey information. They are no more than *carriers*, and the speech or music has to be impressed upon them by a process known as *modulation*.

The amplitude of a carrier can be varied in sympathy with a speech signal, and the process is known as *amplitude modulation*. This is the oldest and still the widest used method of transmitting speech and music by radio. It was described in Part One of the series.

If a 1000kHz carrier is amplitude modulated by a 3kHz signal, two sidebands, each 3kHz wide, are produced. The radio transmission then occupies a bandwidth of 6kHz, extending from 997kHz to 1003kHz.

Assuming a reasonable depth of modulation, some 50% of the total power supplied by the transmitter is expended on the carrier and 25% on each of the sidebands. Just one sideband is carrying all of the information in the signal. The other sideband is, in

effect, a mirror image of reverse polarity removed by the rectifying action of the detector in the receiver. With conventional amplitude modulation, around 75% of the transmitter power is, therefore, wasted. By suppressing the carrier and one of its side bands, transmitter efficiency is greatly increased and bandwidth halved.

#### RECEPTION

Equipment for the reception of single-sideband transmissions must include an oscillator to replace the missing carrier. When the carrier has been restored, a diode or some other non-linear detector can make the signal intelligible in the usual way.

Simple regenerative receivers are capable of resolving single-sideband transmissions if the Q-Multiplier is made to oscillate and restore the missing carrier. An Amateur Bands Regenerative Receiver was described in Parts Three and Four.

Better performance can be obtained from a mixing circuit that combines the signal and local oscillation and, at the same time, recovers the wanted audio. Circuits of this kind are known as *product detectors*. They function in the same way as mixers in superhet receivers, but the output is at audio rather than at radio frequencies.

A simple technique adopted by radio amateurs involves feeding signals picked up by the aerial straight into a product detector and amplifying the audio frequency output. Sometimes the signals are amplified before being passed to the detector, but the crucial feature of the technique is the direct conversion of the radio frequency transmissions to an audio frequency signal, hence the term *direct conversion*.

#### PASSIVE DETECTOR

Passive product detectors use an arrangement of between one and four diodes to combine the two radio frequency inputs and produce an audio output. A typical circuit diagram is given in Fig.6.2. Its operation will be described later, but the important features are simplicity, low cost, and immunity to overloading by strong signals. On the down side, the circuit attenuates the signal by about 6dB.

The simplest receivers place a passive detector of this kind immediately after the aerial tuned circuit. There is no amplification at radio frequencies, and a very high gain audio amplifier is needed to overcome detector losses and make the signals audible.

#### HISTORY

Single-sideband transmission was invented by John R. Carson, an American engineer. Initially, the technique was used to conserve channel space in carrier-current telephone systems, but, by the late 1920s, it was being deployed at low (60kHz) radio frequencies for the transatlantic telephone service.

During the Second World War, single-sideband transmitters were used, by the American forces, for long distance radio communication. The British avoided the technique, claiming it was technically too demanding for a battlefield environment, but they adopted it after the war.

American amateurs began to test the system in the 1940s, and it was taken up, by amateurs, world-wide, during the sixties. At the present time it is the standard mode of speech transmission on all of the high-frequency amateur bands.

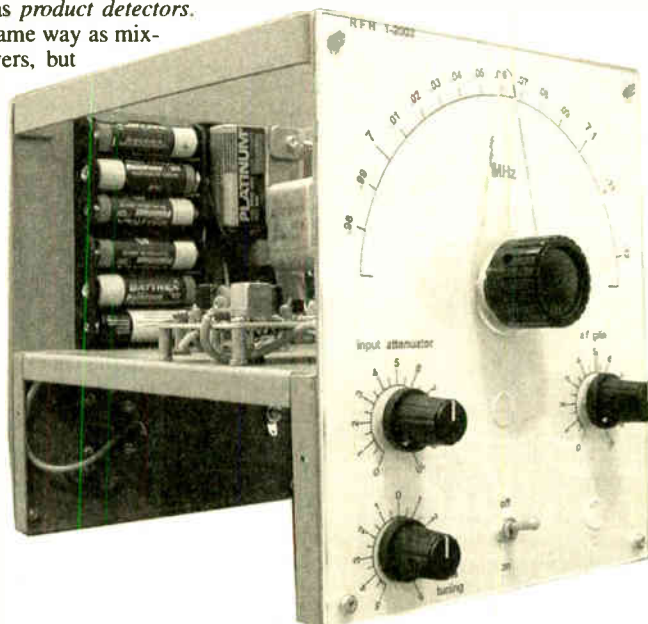

Even when an efficient aerial is available to deliver the strongest possible signals to the receiver, results are likely to be disappointing. Moreover, the high levels of audio frequency amplification are usually accompanied by hum pick-up and microphony problems.

The microphony arises because the receiver components and wiring act as a microphone, picking up vibrations. This manifests itself as clanging and ringing sounds when the receiver is touched or adjusted, the sounds growing into howls as feedback from the loudspeaker takes over.

The situation can be improved by preceding the passive detector with a stage of radio frequency amplification. The improved gain distribution does a great deal to overcome the problems outlined above, but receivers of this kind still require high levels of audio amplification.

### **ACTIVE DETECTOR**

An active product detector, which gives signal amplification rather than attenuation, will usually transform the performance of these simple receivers. A drawback with this arrangement is the

possibility of cross modulation being caused by overloading.

When this occurs, weak signals are modulated by strong ones within the product detector and the strong signals seem to spread across the entire band. Careful use of the receiver's input attenuator will do much to prevent this.

Unwanted envelope detection, or rectification, of powerful, amplitude modulated transmissions is a more prevalent cause of breakthrough with simple active or passive product detectors. Again, the strong signals spread across the band and cannot be tuned out.

---

---

## **DIRECT CONVERSION RECEIVER**

---

---

*A sensitive, single-sideband, amateur band set*

The full circuit diagram for an amateur bands Direct Conversion Receiver is shown in Fig.6.1. A radio frequency amplifier, consisting of TR1 and TR2, precedes the product detector, TR3. The carrier replacement oscillator is TR5, its output being buffered and amplified by TR4. Audio amplification is provided by TR6 and TR7.

### **R.F. STAGE**

Field-effect transistors, TR1 and TR2 form a cascode where TR1 is configured in the common source and TR2 in the grounded gate mode. This combination gives about 20dB of gain. Input and output impedances are high and damping on the tuned circuits, L1/C4 and L2/C5, is minimal.

Source bias to TR1 is provided by resistor R3 which is bypassed by capacitor C6. The gate (g) of TR2 is held at half the supply voltage by resistors R1 and R2, and grounded at radio frequencies by capacitor C3. The stage is decoupled from the supply rail by resistor R4 and capacitor C2.

All of the windings of coil L1 are connected in series to provide an appropriate tapping ratio for Input Attenuator potentiometer VR1. This helps to maintain the Q factor and selectivity of the tuned circuit. The aerial is connected to the circuit via capacitor C1, which is included to protect any preamplifiers or converters against shorting by VR1.

The tuned circuit formed by coil L2 and capacitor C5 acts as the drain (d) load for TR2, and the output is coupled to the gate (g) of TR3, the product detector, by capacitor C7.

Despite the isolation between the input and output ports afforded by grounding the base of TR2, the cascode r.f. stage is not unconditionally stable. Indeed, because of the light loading on both tuned circuits, the stage will come close to oscillation when they are precisely aligned to the same frequency.

Accordingly, resistor R5 is connected across the coupling winding L3 to provide additional damping. This increases the stability margin and the problems are avoided. When the alternative passive detector circuit (described later), given in Fig.6.2, is used, the damping imposed by the diodes and balance potentiometer serves the same purpose.

### **PRODUCT DETECTOR**

Field-effect transistor TR3 is configured as a product detector. Signal input is to the gate, oscillator input to the source through capacitor C11, and the audio frequency output is taken from the drain.

The drain load resistor is R8 and R7, C8 and C9 decouple the stage from the supply rail at audio and radio frequencies. Source bias for TR3 is provided by resistor R9, and the d.c. potential on the gate is held at 0V by R6.

### **OSCILLATOR**

A Colpitts oscillator, TR5, replaces the carrier suppressed at the transmitter. The capacitance tap across tuning coil L4 is formed by capacitors C20 and C21, and feedback is developed across emitter resistor R17. The stage is biased by resistors R18 and R19, and heavily decoupled by R15, R16, C14 and C15.

All sections and windings of oscillator coil L4 are connected in series to obtain the required inductance, and it is brought to resonance within the 7MHz amateur band by capacitor C22. Main tuning is by VC1, one of the 5pF to 25pF f.m. gangs of a polyvaricon tuning capacitor, and capacitor C23 reduces its swing to restrict coverage to the 7MHz amateur band.

Without some means of fine tuning, the single-sideband signals will be difficult to clarify. A shift of one or two picofarads is all that is required, and the varactor properties of an ordinary power rectifier diode, D1, can provide this.

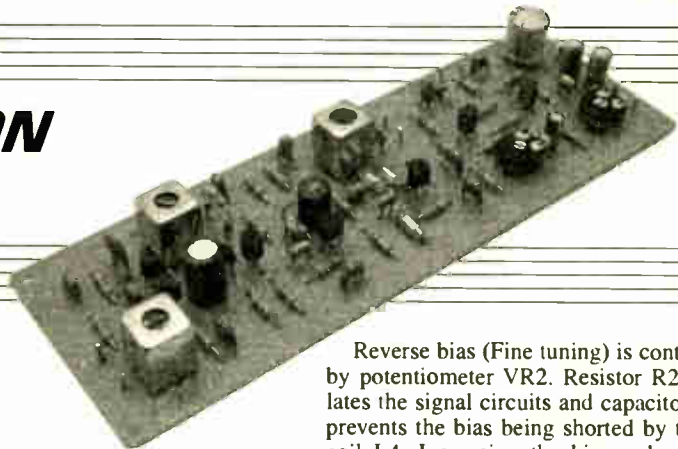

Reverse bias (Fine tuning) is controlled by potentiometer VR2. Resistor R20 isolates the signal circuits and capacitor C24 prevents the bias being shorted by tuning coil L4. Increasing the bias reduces the capacitance across the semiconductor junction of D1.

### **BUFFER STAGE**

The output from oscillator TR5 has to be amplified to ensure the correct operation of either the transistor or the alternative diode mixer. The oscillator also needs isolating in the interests of frequency stability.

Buffer transistor TR4 performs these functions. Oscillations are applied to its base by capacitor C16, and the stage is biased by resistors R13, R14 and R12. The output is developed across collector load resistor R11; and R10 and C10 decouple the stage from the supply rail.

### **AUDIO PREAMPLIFIER**

The directly coupled preamplifier formed by transistors TR6 and TR7 is an adaptation of the front-end circuitry found in most high-fidelity amplifiers.

Current through TR6 is kept below 100µA by high-value collector load resistor R22 and d.c. feedback resistor R21. The low collector current reduces the noise introduced by the stage.

Preset VR3 sets the gain of the two transistor combination. The calculated value with VR3 at maximum is approximately 200, and 2000 with it turned to zero resistance.

The biasing of transistor TR7 is determined by resistors R21 and R26. The amplifier's output, developed across collector load resistor R25, is coupled to the signal feedback loop by capacitor C29, and to the Volume control potentiometer VR5 by C30. Supply line decoupling is provided by R24 and C31 and, in view of the high level of gain, is generous.

### **AUDIO RESPONSE**

Signal-to-noise ratios are improved, and clarity increased, if the frequency response of a speech communication system is rolled off below 300Hz and above 3000Hz.

The low values of capacitors C17 and C30, and bypass capacitor C27, reduce response to the lower audio frequencies (gain reducing negative feedback, which increases as frequency lowers, is introduced because of the low value of C27). Bypass capacitor, C12, C18, and C28 curtail the high frequency response.

Signal feedback preset VR4 can be progressively shunted by capacitor C26. This increases negative feedback, and reduces gain, at the upper audio frequencies and enables the response of the amplifier to be tailored to suit individual preferences.

### ON BALANCE

The active product detector depicted in the circuit of Fig.6.1 is not balanced and this makes the receiver more vulnerable to breakthrough from powerful broadcast transmissions.

An alternative, balanced arrangement is shown in Fig.6.2, where signal diodes D2 and D3 are switched in and out of conduction, by the oscillator voltage, in order to produce the desired mixing action.

To avoid confusion, it should be stressed that the silicon diodes are used here as switches and their poor performance as rectifiers of weak signals is not relevant. The oscillator must, however, be vigorous enough drive the diodes into conduction, and buffer stage TR4 ensures the delivery of sufficient power.

Balancing potentiometer VR6 optimizes immunity to the envelope detection of the signal, and amplitude modulated signals. Some

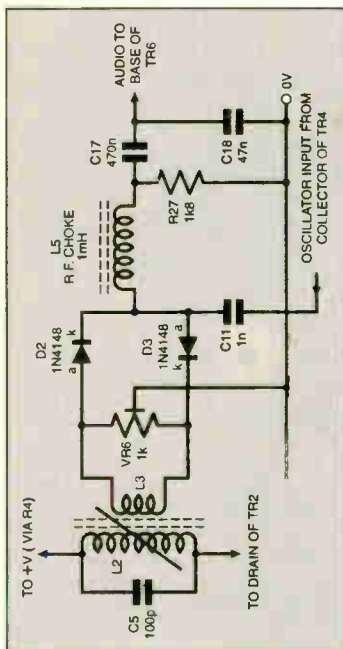

Fig.6.2. Alternative passive balanced product detector. This circuit can be substituted for TR3, the active detector, see text.

advocates of the circuit bring the potentiometer out as a panel control so that it can be adjusted to reduce break-through under varying reception conditions.

The balanced diode arrangement shown in Fig.6.2 attenuates signals by about 6dB. The active product detector included in Fig.6.1 gives about 6dB of gain. The 12dB difference is very noticeable, but readers may wish to try the balanced alternative and the increased protection against breakthrough that it offers.

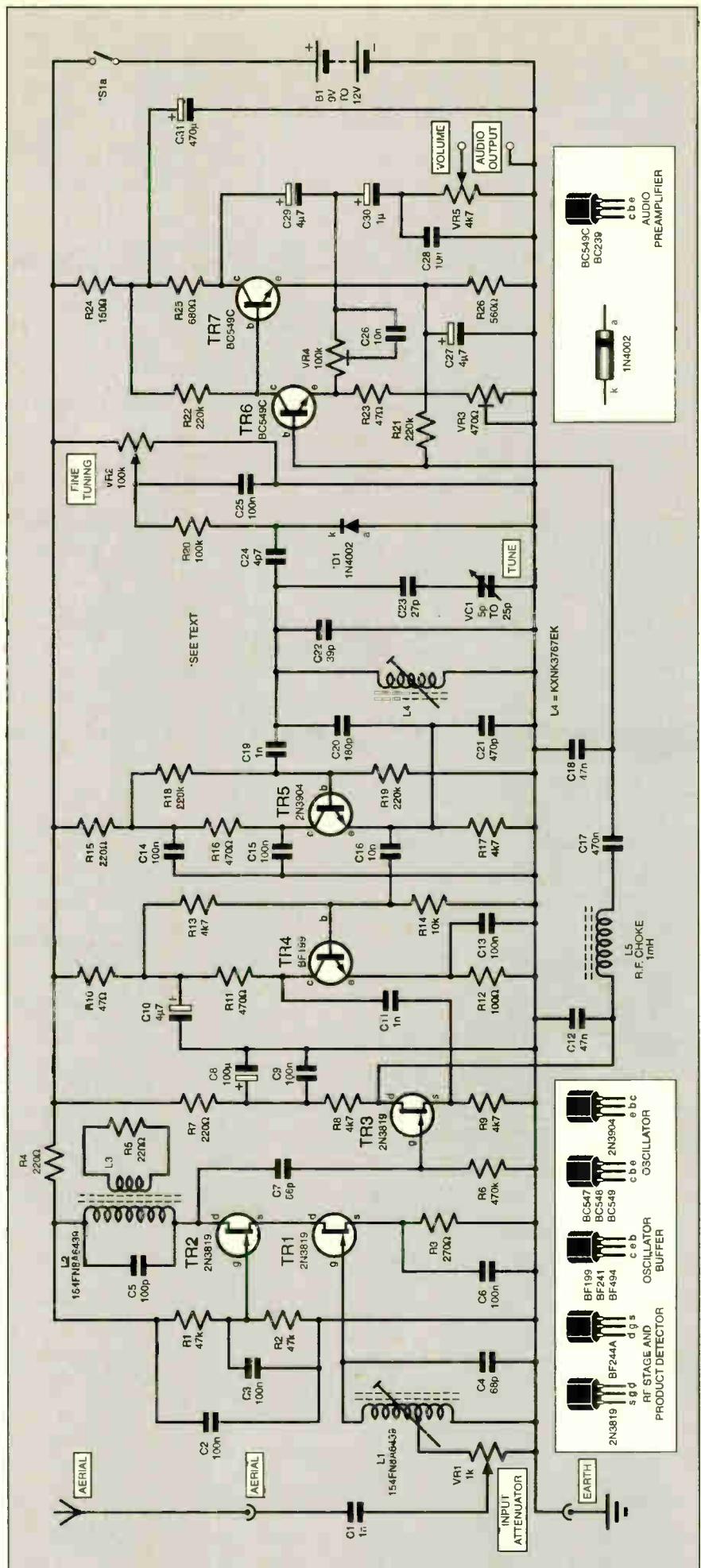

Fig.6.1. Circuit diagram for the Direct Conversion Receiver for the 7MHz (40m) amateur bands.

## POWER SUPPLIES

Even small audio power amplifiers impose voltage swings on the supply rails, especially when batteries are ageing. These signal induced fluctuations can cause low frequency instability, and the receiver and power amplifier must have *separate* batteries. This is particularly important when electronic tuning bias is derived directly from the receiver battery.

Switch S1a controls the supply to the Receiver; S1b (the other half of the switch) is used to switch the amplifier battery.

## COMPONENTS

Transistor types are not critical and base connections for alternative devices are shown inset in Fig.6.1. In the interests of stability, the r.f. stage field-effect transistors

should have the same lead out sequence as the specified 2N3819. Buffer stage transistor TR4 must be a small-signal r.f. type with an  $f_T$  of at least 200MHz.

Almost any small-signal *npn* transistor in the BC107, BC108 and BC109 families, or their plastic-cased variants, should work in the oscillator and audio preamplifier stages. For best performance, TR6 should be a high-gain, low-noise device such as the BC549C.

The forward resistance of the diodes used in the alternative product detector (Fig.6.2) should, preferably, be matched with a test meter, and it will be easier and cheaper to produce a matched pair if silicon types are used. Most small power rectifier diodes can be pressed into service as a "varactor" diode for D1. Readers who prefer to use a true varactor diode should fit a BB105.

Any miniature 1mH r.f. choke will be suitable for L5. If a wire-ended component is substituted for the bobbin wound choke, mount it vertically and as close as possible to the printed circuit board.

## CONSTRUCTION

Most of the components for the Direct Conversion Receiver are assembled on a single printed circuit board (p.c.b.). The tuning capacitor (VC1) has its own small p.c.b. for ease of assembly and mounting. These boards are available from the *EPE PCB Service*, codes 423 (Dir. Conv. Rec.) and 406 (T/Cap).

The Receiver topside p.c.b. component layout, together with the underside copper foil master and interwiring to off-board components, is illustrated in Fig.6.3. Solder pins, located at the lead-out points,

## COMPONENTS

Approx. Cost  
Guidance Only  
£25  
excl. case, slow-motion drive, batt. & optional items

### DIRECT CONVERSION RECEIVER

#### Resistors

R1, R2	47k (2 off)
R3	270Ω
R4, R5, R7, R15	220Ω (4 off)
R6	470k
R8, R9, R13, R17	4k7 (4 off)
R10, R23	47Ω (2 off)
R11, R16	470Ω (2 off)
R12	100Ω
R14	10k
R18, R19, R21, R22	220k (4 off)
R20	100k
R24	150Ω
R25	680Ω
R26	560Ω
R27	1k8 (optional – see Fig.6.2 and text)

All 0.25W 5% carbon film or better

#### Potentiometers

VR1	1k rotary carbon, lin.
VR2	100k rotary carbon, lin.
VR3	470Ω enclosed carbon preset
VR4	100k enclosed carbon preset
VR5	4k7 rotary carbon, log.
VR6	1k enclosed carbon preset (optional – see Fig.6.2 and text)

#### Capacitors

C1, C11, C19	1n ceramic (3 off)
C2, C3, C6, C9, C13 to C15, C25	100n ceramic (8 off)
C4	68p ceramic "low k" or polystyrene
C5	100p ceramic "low k" or polystyrene
C7	56p ceramic "low k"
C8	100μ radial elect. 25V
C10	4μ7 tantalum bead 35V
C12, C18	47n ceramic (2 off)
C16	10p ceramic
C17	470n ceramic
C20	180p polystyrene or ceramic "low k"
C21	470p polystyrene or ceramic "low k"
C22	39p polystyrene or ceramic "low k"
C23	27p polystyrene or ceramic "low k"
C24	4p7 ceramic "low k"
C26, C28	10n ceramic (2 off)
C27, C29	4μ7 radial elect. 25V (2 off)
C30	1μ radial elect. 25V
C31	470μ radial elect. 25V
VC1	5p to 25p one f.m. gang of a polythene dielectric variable capacitor (see text)

#### Semiconductors

D1	1N4002 rectifier diode (see text)
----	-----------------------------------

See  
SHOP  
TALK  
page

D2, D3	1N4148 signal diode (2 off) (optional – see Fig.6.2 and text)
TR1, TR2, TR3	2N3819 <i>n</i> -channel field effect transistor (3 off)
TR4	BF199 <i>npn</i> high frequency transistor or similar (see text)
TR5	2N3904 <i>npn</i> low power, small signal, transistor
TR6, TR7	BC549C <i>npn</i> small signal transistor

#### Miscellaneous

L1, L2/L3	154FN8A6439 Toko screened (metal can) coil (2 off)
L4	KXNK3767EK Toko screened (metal can) coil
L5	1mH r.f. choke (see text)
S1	d.p.s.t. toggle switch

Printed circuit boards available from the *EPE PCB Service*, codes 423 (Dir. Con. Rec.) and 406 (T/Cap); screw terminal for aerial and earth (2 off); slow-motion drive (optional); one large and three small plastic control knobs; audio type screened cable; multistrand connecting wire; p.c.b. stand-off pillars; front panel card and protective 2mm thick Perspex sheet; battery holder and connector; solder pins; solder etc.

Note: Case is Regenerative Radio from Part 3.

### SWITCHED 3-BAND VERSION

(Component changes and additions – see Fig.6.4 and Table 6.1)

#### Capacitors

C20 (14MHz Band)	82p polystyrene or ceramic "low k"
C21 (14MHz Band)	180p polystyrene or ceramic "low k"
C22 (3.5MHz Band) (14MHz Band)	82p polystyrene or ceramic "low k" not required – see text
C23 (3.5MHz Band) (14MHz Band)	200p polystyrene or ceramic "low k"
VC1 (3.5MHz Band) (14MHz Band)	15p polystyrene or ceramic "low k" 5p to 130p polythene dielectric variable capacitor (one a.m. gang of specified cap.) 5p to 25p polythene dielectric variable capacitor (one f.m. gang of specified cap.)

#### Miscellaneous

L1, L2/3 (3.5MHz Band) (14MHz Band)	154AN7A6440 (2 off) KXNK376EK (2 off)
L4 (3.5MHz Band) (14MHz Band)	154FN8A6439 KXNK3767EK
S2	4-pole 3-way rotary switch

Note: The main circuit (Fig.6.1) and components list covers the 7MHz Band.

Also, you will need two additional main p.c.b.s (code 423) if you go for the switched-band option; but you only build the front end up to, and including, r.f. choke L5 and resistor R20.

will simplify off-board wiring, and they should be inserted first. Follow these with the tuning coils.

Next, solder in place the resistors, then the capacitors, smallest first, and, finally, the diodes and all the transistors. Semiconductor leads should be just long enough to permit the use of a miniature crocodile clip as a heatsink during soldering.

If the alternative product detector (Fig.6.2) is used, mount preset VR6 and diodes D2 and D3 on the p.c.b. solder pins connected to coil L3. Resistors R5 to R9, together with capacitors C7, C8, C9 and C12, and transistor TR3, must be removed from the board.

Failure to remove capacitor C12 will result in the oscillator output being shorted to the 0V rail. Use wire links to connect the buffer stage, TR4, to the diodes via capacitor C11, and the output from the diodes to r.f. choke L5.

## SETTING UP

The printed circuit board can be tested before being mounted on a chassis or in an enclosure. First, check the placement of all of the components and examine the printed circuit board for poor soldered joints and bridged tracks.

Use the leads of capacitor C23 to make the "hot" connection to tuning capacitor

VC1 and wire up the three off-board potentiometers. Connect the audio output to the Speaker Amplifier described in Part Two with *screened* cable. Receiver current consumption should be approximately 13mA with a 9V supply.

Set the cores of all of the coils about two turns down from the tops of the cans. The core of L4 is particularly brittle and a plastic trimming tool should be used for the adjustments.

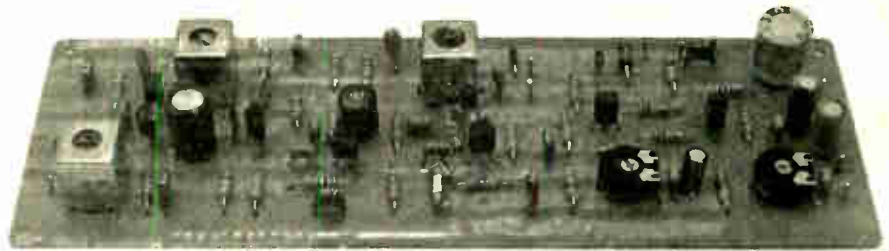

Completed circuit board for the Direct Conversion Receiver.

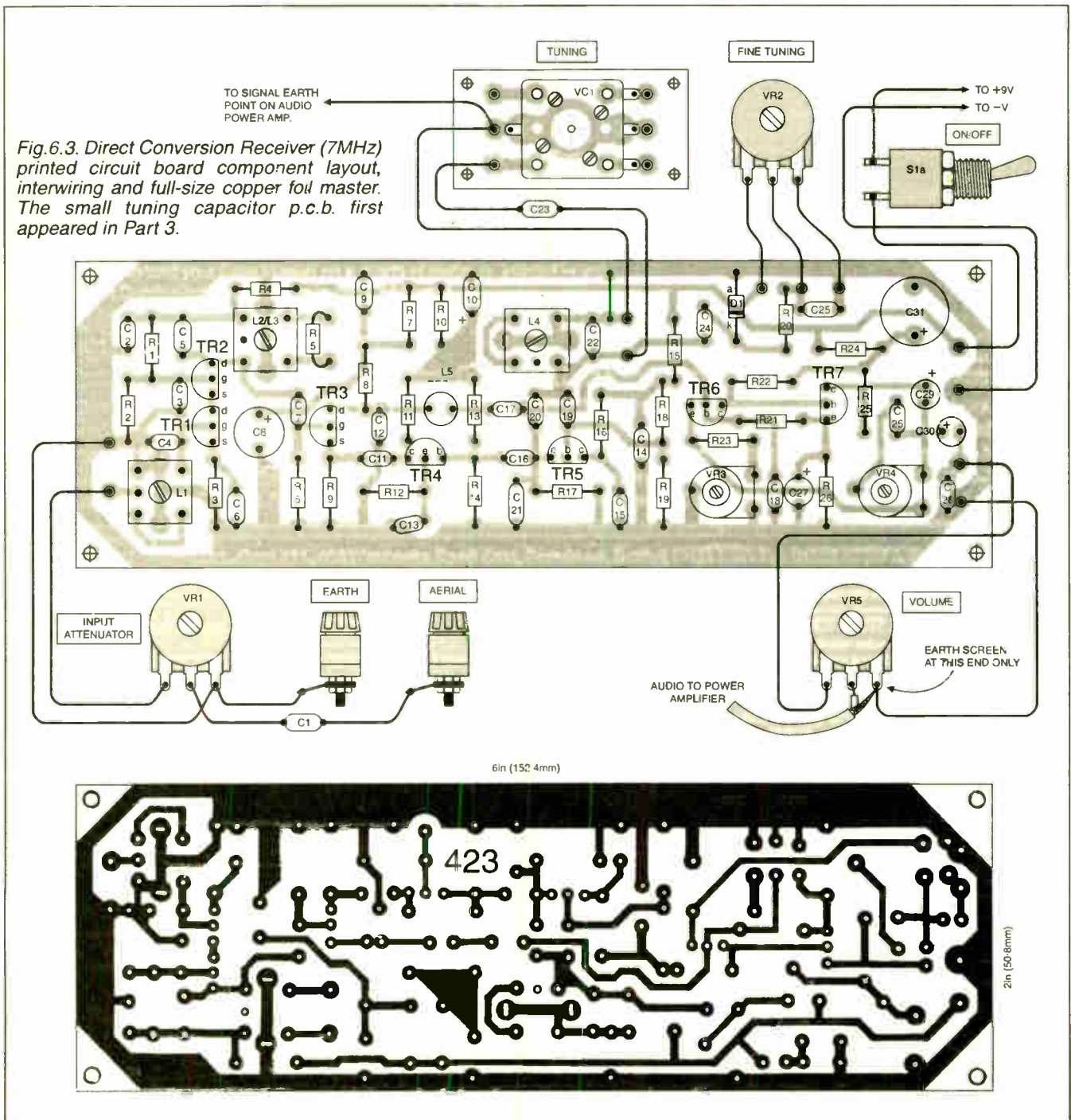

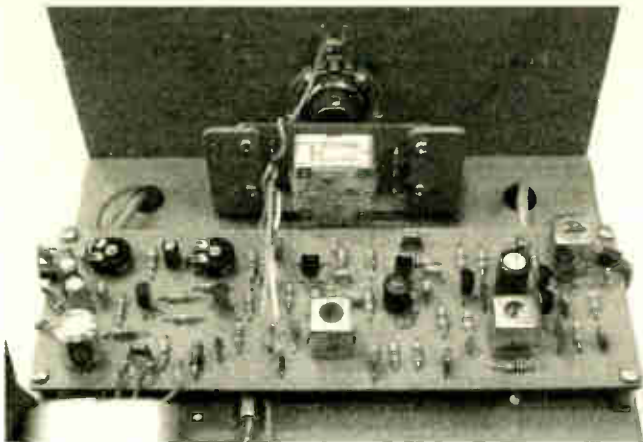

Receiver p.c.b. mounted on the metal chassis and wired to the tuning capacitor board.

Fig.6.4 (right). Block diagram showing switching of three p.c.b. "front-ends" to give coverage of the 80 (3.5MHz), 40 (7MHz) and 20 (14MHz) metre amateur bands. VC1 is a 4-gang a.m./f.m. variable capacitor, one gang permanently connected to each board. One a.m. gang is not connected.

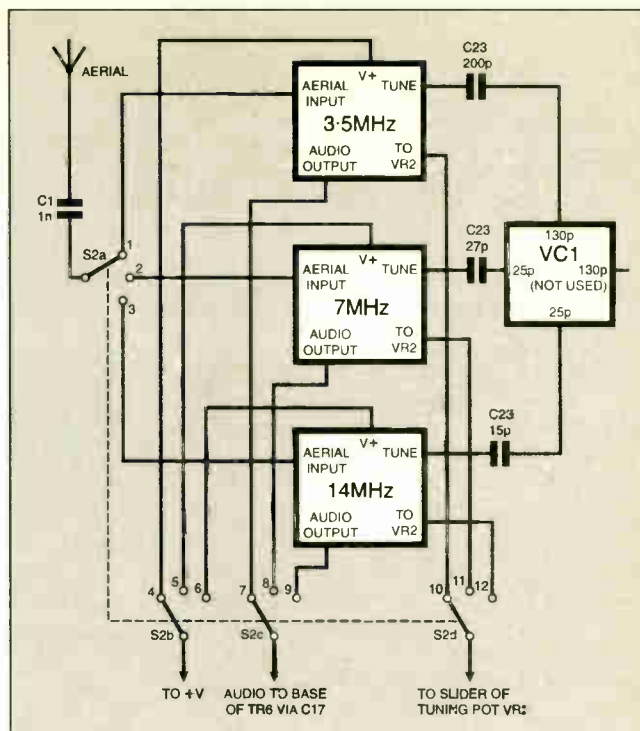

Connect an aerial (at least 10 metres or 30ft of wire located as high as possible). Set input Attenuation control VR1 for maximum input and turn up Volume control VR5. There should be a faint hissing in the loudspeaker and signals should be heard if Tuning capacitor VC1 is slowly rotated and/or the core of L4 is adjusted.

## ALIGNMENT WITH A RECEIVER

If you have access to a Communications Receiver, connect a short aerial wire to it and lay the wire near to the Direct Conversion set. Switch on the communications receiver's b.f.o. (beat frequency oscillator) and tune it to 7MHz.

Turn Tuning capacitor VC1 to maximum capacitance, and slowly adjust the core of L4 until a tone is heard in the speaker of the communications receiver. This receiver is, of course, picking up the signal radiated by the oscillator in the direct conversion set.

With input and volume controls turned up, rotate VC1 towards minimum capacitance. Even if tuning coils L1 and L2 are badly out of alignment, the direct conversion set should pick up some signals.

When a single-sideband transmission has been tuned in, adjust the cores of L1 and L2/L3 for maximum output. It will be necessary to turn back the Input Attenuator and the Volume control as the circuits are brought into alignment.

## ALIGNMENT WITH A CRYSTAL MARKER

If a communications receiver is not available, use the simple Crystal Marker described in Part Five. Placing this unit close to the input of the direct conversion receiver will inject a 7.16MHz signal. This is just above the UK upper band limit of 7.1MHz (at the centre of the USA 7MHz to 7.3MHz allocation).

Readers in the UK should set VC1 close to minimum capacitance before adjusting the core of oscillator coil L4 until a tone is heard in the speaker. If necessary, switch the marker on and off to make sure that the correct signal has been identified. Adjust the cores of L1 and L2/3 to peak the response.

Connect the long aerial wire to the receiver. slowly turn VC1 towards maximum capacitance and tune in a single-sideband signal. Adjust the cores of L1 and L2/L3 for maximum output.

## ENCLOSURE

The printed circuit board and tuning capacitor must be rigidly mounted, preferably in a diecast or aluminium box. At the very least an aluminium chassis and front panel should be provided.

The accompanying photographs show the board mounted on the chassis and front panel assembly used for the evaluation of most of the receivers in the series. This arrangement works well and microphony (feedback via the speaker) is not a problem at normal volume levels.

Keep the tuning capacitor, VC1, very close to the connecting pins on the receiver printed circuit board. Because of the provision of a fine tuning system, it is not absolutely essential to fit a slow motion drive to VC1. It will, however, make the receiver more pleasant to operate.

## MULTIBAND OPERATION

Some readers may wish to extend coverage to the 3.5MHz and 14MHz amateur bands. Attempts to switch the tuning and oscillator coils are likely to result in unstable and erratic operation. A better solution is to construct three separate front-end boards. (Components up to, and including, r.f. choke L5 and resistor R20 are required.)

A block diagram of the arrangement is given in Fig.6.4, where a four-pole, three-way, rotary switch S2 connects the three boards into circuit. The aerial is switched from board-to-board by section S2a, the battery power supply by S2b, the audio output from the product detector by S2c, and the fine tuning voltage from the slider of VR2, by S2d.

The polythene dielectric tuning capacitors used in a.m./f.m. receivers have two

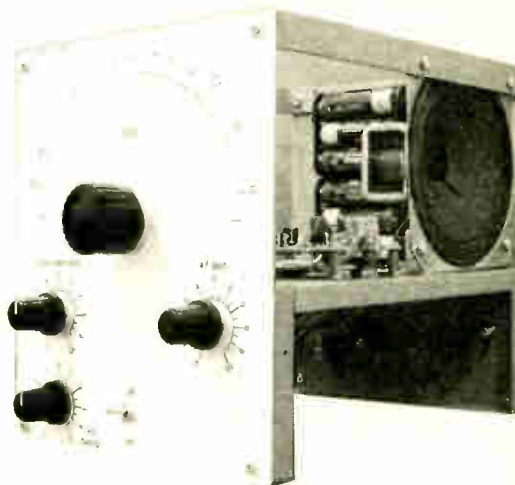

Completed 7MHz version of the Direct Conversion Receiver. If a 3-Band version is to be built, the band change rotary switch is mounted in the blanked-out hole just below the tuning knob.

25pF and two 130pF (or thereabouts) gangs. One of the 25pF f.m. gangs is connected to the 7MHz board, the other to the 14MHz board. The 3.5MHz front-end is tuned by one of the 130pF a.m. gangs.

Providing each board with its own variable capacitor avoids the problems associated with switching high impedance r.f. circuits. Only one r.f. lead, the aerial, is switched. This is at low impedance and can be screened without causing problems.

Connections between the tuning capacitor gangs and the three front-ends must be as short as possible. This calls for a compact arrangement of the boards around the tuning capacitor.

Aerial and audio links between the boards and switch S2 must be screened. Earth the screen at one end only: do not use it to carry the negative supply rail to the board.

Align the additional boards in one of the ways described earlier. Details of amateur



**Table 6.1: Toko Coils and Tuning Capacitor Values for three popular Amateur Bands (80, 40 and 20 metre)**

Band	L1	C4 (pF)	L2/L3	C5 (pF)	L4	C22 (pF)	C23 (pF)	VC1 (pF)	C20 (pF)	C21 (pF)
3.5MHz (80)	154AN7 A6440	33	154AN7 A6440	47	154FN8 A6439	82	200	130	180	470
7MHz (40)	154FN8 A6439	68	154FN8 A6439	100	KXNK 3767EK	39	27	25	180	470
14MHz (20)	KXNK 3767EK	47	KXNK 3767EK	82	KXNK 3767EK	-	15	25	82	180

**Notes.**

- (1) Fixed capacitors must be polystyrene or low-k ceramic types.
- (2) 3.5MHz band: the values quoted here will give coverage of the wider USA allocation.
- (3) 7MHz band: the C23 value given here restricts coverage to the UK's 7.1MHz band limit. For the wider 7.1MHz to 7.3MHz allocation, connect VC1 directly across L4.
- (4) The quoted tuning capacitor values are nominal. Measured values for the component used in the prototype receivers are: f.m. gangs, 4pF to 22.5pF; a.m. gangs, 4pF to 127pF.

A small signal r.f. transistor must be used for TR5 on the 14MHz board to maintain oscillator output at the higher frequency. Any of the r.f. types listed in Fig.6.1, together with the 2N2369, should prove suitable.

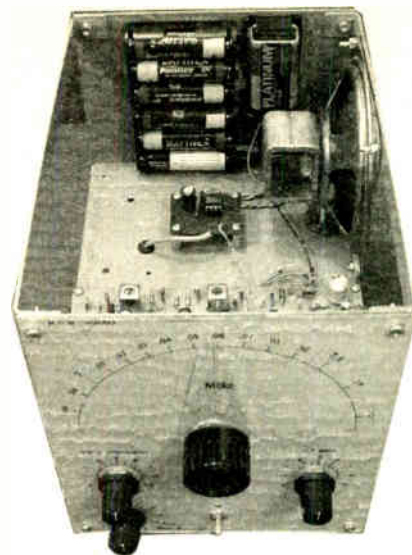

The two separate power supply battery "packs", one for the receiver and the other for the amplifier, located on the rear panel.

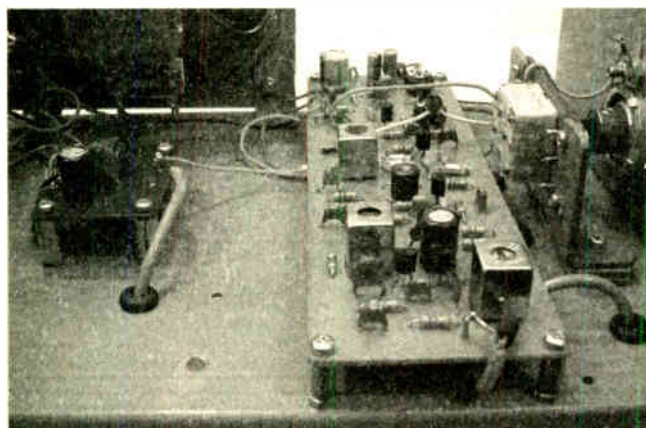

The Receiver board wired to the Speaker Amplifier (Part 2) using screened cable. These boards must have separate battery supplies.

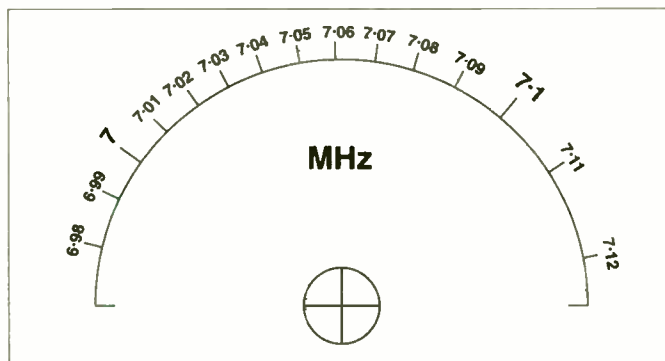

Calibrated tuning dial (half-size approx.) for the 7MHz version of the Direct Conversion Receiver.

band allocations were given in Part Four. Toko coil numbers and tuning and swing-reducing capacitor values for the 3.5MHz and 14MHz bands are given in Table 6.1.

**OPERATION**

Tuning has to be very carefully adjusted to transform the garbled sounds into clear speech. Fine tuning potentiometer VR2 shifts the tuning across just one or two amateur transmissions and is very useful for clarifying signals. Reception may also be improved by an earth connection.

Activity on the amateur bands varies. The 7MHz allocation was chosen for the receiver described here because plenty of signals can usually be heard during the day. When setting up the tuning on 3.5MHz or 7MHz, listen in around 10a.m., when these bands are busy. Activity on 14MHz is more variable, but the early afternoon will usually produce some signals.

Readers who have access to a frequency counter can use it to obtain a digital display of operating frequency. A buffer circuit was described last month. It should be connected, by very short leads, to the emitter of oscillator transistor TR5.

**PERFORMANCE**

The version with an active product detector is sensitive. Using ten yards of flex as an aerial, quite weak signals can be brought up to a good loudspeaker volume when the sim-

ple power amplifier described in Part Two is used. Gain preset VR3 will probably have to be turned well down. If the passive product detector is used, sensitivity should be adequate if VR3 is set for maximum gain.

Signals are reproduced with great clarity, and the receiver is not fatiguing to listen to. After a five-minute warm-up period, frequency drift is minimal.

Unlike diodes and other devices that demodulate by a rectifying action, the heterodyning product detector will continue to function down to the lowest signal levels. In theory, therefore, the ultimate sensitivity of receivers with product detectors should be greater. In practice, received and internally generated noise are limiting factors.

The receiver cannot match the selectivity of a superhet. Its performance in this respect is similar to the Regenerative Receiver described in Part Four. When the bands are busy, the severe crowding of transmissions results in a faint background of unintelligible chattering. However, only the wanted signal is clarified, and this makes the interference less distracting.

There are no discernible overloading or cross-modulation problems with either product detector. Indeed, the feature which separates this receiver from the regenerative set is its ability to cope with strong signals without the need for adjustment of the input attenuator.

Breakthrough from powerful broadcast transmitters can be a problem after dark, particularly on the 7MHz band. Careful adjustment of the cores of L1 and L2/L3 will usually clear up the problem, and refinements of this kind should be carried out during the setting up process. Keeping the signal input low will also minimize interference of this kind.

**Next Month: The Superhet**

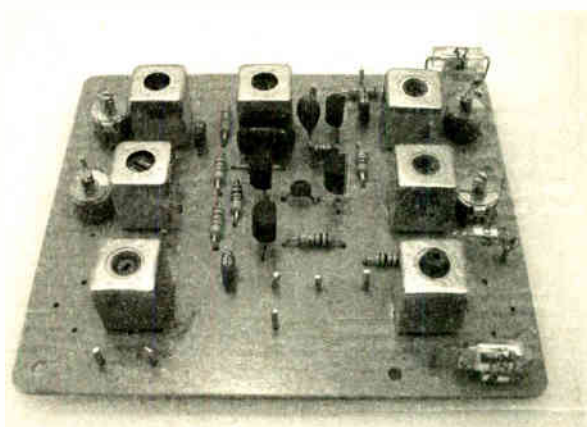

FREE *Electronics Hobbyist Compendium*  
book with Teach-In 2000 CD-ROM



## EPE TEACH-IN 2000 CD-ROM

The whole of the 12-part *Teach-In 2000* series by John Becker (published in *EPE* Nov '99 to Oct 2000) is now available on CD-ROM in PDF form. Plus the *Teach-In 2000* interactive software covering all aspects of the series and Alan Winstanley's *Basic Soldering Guide* (including illustrations and Desoldering).

*Teach-In 2000* covers all the basic principles of electronics from Ohm's Law to Displays, including Op.Amps, Logic Gates etc. Each part has its own section on the interactive software where you can also change component values in the various on-screen demonstration circuits.

The series gives a hands-on approach to electronics with numerous breadboard circuits to try out, plus a simple computer interface which allows a PC to be used as a basic oscilloscope.

ONLY **£12.45** including VAT and p&p

Order code Teach-In CD-ROM

## PROJECT CONSTRUCTION

### IC 555 PROJECTS E. A. Parr

Every so often a device appears that is so useful that one wonders how life went on before without it. The 555 timer is such a device. Included in this book are over 70 circuit diagrams and descriptions covering basic and general circuits, motor car and model railway circuits, alarms and noise makers as well as a section on 556, 558 and 559 timers. (Note. No construction details are given.) A reference book of invaluable use to all those who have any interest in electronics, be they professional engineers or designers, students or hobbyists.

167 pages Order code BP44 £4.99

### POWER SUPPLY PROJECTS R. A. Penfold

This book offers a number of power supply designs, including simple unregulated types, and variable voltage regulated designs, the latter being primarily intended for use as bench power supplies for the electronics workshop. The designs provided are all low voltage types for semiconductor circuits. The information in this book should also help the reader to design his own power supplies. Includes cassette PSU, Ni-Cad charger, voltage step-up circuit and a simple inverter.

91 pages Order code BP76 £4.99

### HOW TO USE OSCILLOSCOPES AND OTHER TEST EQUIPMENT R. A. Penfold

This book explains the basic function of an oscilloscope, gives a detailed explanation of all the standard controls, and provides advice on buying. A separate chapter deals with using an oscilloscope for fault finding on linear and logic circuits, plenty of example waveforms help to illustrate the control functions and the effects of various fault conditions. The function and use of various other pieces of test equipment are also covered, including signal generators, logic probes, logic pulser and crystal calibrators.

104 pages Order code BP267 £4.99

### PRACTICAL REMOTE CONTROL PROJECTS Owen Bishop

Provides a wealth of circuits and circuit modules for use in remote control systems of all kinds; ultrasonic, infra-red, optical fibre, cable and radio. There are instructions for building fourteen novel and practical remote control projects. But this is not all, as each of these projects provides a model for building dozens of other related circuits by simply modifying parts of the design slightly to suit your own requirements. This book tells you how.

Also included are techniques for connecting a PC to a remote control system, the use of a microcontroller in remote control, as exemplified by the BASIC Stamp, and the application of ready-made type-approved 418MHz radio transmitter and receiver modules to remote control systems.

160 pages Temporarily out of print

# DIRECT BOOK SERVICE

The books listed have been selected by *Everyday Practical Electronics* editorial staff as being of special interest to everyone involved in electronics and computing. They are supplied by mail order direct to your door. Full ordering details are given on the last book page.

FOR A FURTHER SELECTION OF BOOKS  
SEE THE NEXT TWO ISSUES OF EPE.

All prices include UK postage

### ELECTRONIC PROJECT BUILDING FOR BEGINNERS

R. A. Penfold

This book is for complete beginners to electronic project building. It provides a complete introduction to the practical side of this fascinating hobby, including the following topics:

Component identification, and buying the right parts; resistor colour codes, capacitor value markings, etc; advice on buying the right tools for the job; soldering; making easy work of the hard wiring; construction methods, including stripboard, custom printed circuit boards, plain matrix boards, surface mount boards and wire-wrapping; finishing off, and adding panel labels; getting "problem" projects to work, including simple methods of fault-finding.

In fact everything you need to know in order to get started in this absorbing and creative hobby.

135 pages Order code BP392 £5.49

### A PRACTICAL INTRODUCTION TO SURFACE MOUNT DEVICES

Bill Mooney

This book takes you from the simplest possible starting point to a high level of competence in handworking with surface mount devices (SMD's). The wider subject of SM technology is also introduced, so giving a feeling for its depth and fascination.

Subjects such as p.c.b. design, chip control, soldering techniques and specialist tools for SM are fully explained and developed as the book progresses. Some useful constructional projects are also included.

Whilst the book is mainly intended as an introduction it is also an invaluable reference book, and the browser should find it engrossing.

120 pages Order code BP411 £5.49

### TEST EQUIPMENT CONSTRUCTION

R. A. Penfold

This book describes in detail how to construct some simple and inexpensive but extremely useful, pieces of test equipment. Stripboard layouts are provided for all designs, together with wiring diagrams where appropriate, plus notes on construction and use.

The following designs are included:-

AF Generator, Capacitance Meter, Test Bench Amplifier, AF Frequency Meter, Audio Multivoltmeter, Analogue Probe, High Resistance Voltmeter, CMOS Probe, Transistor Tester, TTL Probe. The designs are suitable for both newcomers and more experienced hobbyists.

104 pages Order code BP248 £4.49

## COMPUTING

### COMPUTING FOR THE OLDER GENERATION

Jim Gatenby

Especially written for the over 50s, using plain English and avoiding technical jargon. Large clear type for easy reading.

Among the many practical and useful ideas for using your PC that are covered in this book are: Choosing, setting up and understanding your computer and its main components. Writing letters, leaflets, invitations, etc., and other word processing jobs. Keeping track of your finances using a spreadsheet. Recording details of holidays and other ideas using a database. Using the Internet to find useful information, and email to keep in touch with family and friends. Making "back-up" copies of your work and checking for viruses. How to use Windows XP to help people with impaired vision, hearing or mobility.

Provides the basic knowledge so you can gain enough confidence to join the local computer class.

308 pages Order code BP601 £8.99

### THE INTERNET FOR THE OLDER GENERATION

Jim Gatenby

Especially written for the over 50s. Uses only clear and easy-to-understand language. Larger type size for easy reading. Provides basic knowledge to give you confidence to join the local computer class.

This book explains how to use your PC on the Internet and covers amongst other things: Choosing and setting up your computer for the Internet. Getting connected to the Internet. Sending and receiving emails, photographs, etc., so that you can keep in touch with family and friends all over the world. Searching for and saving information on any subject. On-line shopping and home banking. Setting up your own simple web site.

228 pages Order code BP600 £8.99

## RADIO

### SETTING UP AN AMATEUR RADIO STATION

I. D. Poole

The aim of this book is to give guidance on the decisions which have to be made when setting up any amateur radio or short wave listening station. Often the experience which is needed is learned by one's mistakes, however, this can be expensive. To help overcome this, guidance is given on many aspects of setting up and running an efficient station. It then proceeds to the steps that need to be taken in gaining a full transmitting licence.

Topics covered include: The equipment that is needed; Setting up the shack; Which aerials to use; Methods of construction; Preparing for the licence.

An essential addition to the library of all those taking their first steps in amateur radio.

86 pages Order code BP300 £4.45

### EXPERIMENTAL ANTENNA TOPICS

H. C. Wright

Although nearly a century has passed since Marconi's first demonstration of radio communication, there is still research and experiment to be carried out in the field of antenna design and behaviour.

The aim of the experimenter will be to make a measurement or confirm a principle, and this can be done with relatively fragile, short-life apparatus. Because of this, devices described in this book make liberal use of cardboard, cooking foil, plastic bottles, cat food tins, etc. These materials are, in general, cheap to obtain and easily worked with simple tools, encouraging the trial-and-error philosophy which leads to innovation and discovery.

Although primarily a practical book with text closely supported by diagrams, some formulae which can be used by straightforward substitution and some simple graphs have also been included.

72 pages Order code BP278 £4.00

### 25 SIMPLE INDOOR AND WINDOW AERIALS

E. M. Noll

Many people live in flats and apartments or other types of accommodation where outdoor aerials are prohibited, or a lack of garden space etc. prevents aerials from being erected. This does not mean you have to forgo shortwave-listening, for even a 20-foot length of wire stretched out along the skirting board of a room can produce acceptable results. However, with some additional effort and experimentation one may well be able to improve performance further.

This concise book tells the story, and shows the reader how to construct and use 25 indoor and window aerials that the author has proven to be sure performers. Much information is also given on shortwave bands, aerial directivity, time zones, dimensions etc.

50 pages Order code BP136 £2.25

# CIRCUITS AND DESIGN

## AN INTRODUCTION TO PIC MICROCONTROLLERS

Robert Penfold

Designing your own PIC based projects may seem a daunting task, but it is really not too difficult providing you have some previous experience of electronics.

The PIC processors have plenty of useful features, but they are still reasonably simple and straightforward to use. This book should contain everything you need to know.

Topics covered include: the PIC register set; numbering systems; bitwise operations and rotation; the PIC instruction set; using interrupts; using the analogue to digital converter; clock circuits; using the real time clock counter (RTCC); using subroutines; driving seven segment displays.

166 pages **Order code BP394** £6.49

## PRACTICAL OSCILLATOR CIRCUITS

A. Filind

Extensive coverage is given to circuits using capacitors and resistors to control frequency. Designs using CMOS, timer i.c.s and op.amps are all described in detail, with a special chapter on "waveform generator" i.c.s. Reliable "white" and "pink" noise generator circuits are also included.

Various circuits using inductors and capacitors are covered, with emphasis on stable low frequency generation. Some of these are amazingly simple, but are still very useful signal sources.

Crystal oscillators have their own chapter. Many of the circuits shown are readily available special i.c.s for simplicity and reliability, and offer several output frequencies. Finally, complete constructional details are given for an audio sine wave generator.

133 pages **Order code BP393** £5.49

## PRACTICAL ELECTRONICS HANDBOOK –

Fifth Edition. Ian Sinclair

Contains all of the everyday information that anyone working in electronics will need.

It provides a practical and comprehensive collection of circuits, rules of thumb and design data for professional engineers, students and enthusiasts, and therefore enough background to allow the understanding and development of a range of basic circuits.

Contents: Passive components. Active discrete components. Circuits. Linear I.C.s. Energy conversion components. Digital I.C.s. Microprocessors and microprocessor systems. Transferring digital data. Digital-analogue conversions. Computer aids in electronics. Hardware components and practical work. Micro-controllers and PLCs. Digital broadcasting. Electronic security.

440 pages **Order code NE21** £17.99

## COIL DESIGN AND CONSTRUCTIONAL MANUAL

B. B. Babani

A complete book for the home constructor on "how to make" RF, IF, audio and power coils, chokes and transformers. Practically every possible type is discussed and calculations necessary are given and explained in detail. Although this book is now twenty years old, with the exception of toroids and pulse transformers little has changed in coil design since it was written.

96 pages **Order code BP160** £4.49

## OPTOELECTRONICS CIRCUITS MANUAL

R. M. Marston

A useful single-volume guide to the optoelectronics device user, specifically aimed at the practical design engineer, technician, and the experimenter, as well as the electronics student and amateur. It deals with the subject in an easy-to-read, down-to-earth, and non-mathematical yet comprehensive manner, explaining the basic principles and characteristics of the best known devices, and presenting the reader with many practical applications and over 200 circuits. Most of the i.c.s and other devices used are inexpensive and readily available types, with universally recognised type numbers.

182 pages **Order code NE14** £20.99

## OPERATIONAL AMPLIFIER USER'S HANDBOOK

R. A. Penfold

The first part of this book covers standard operational amplifier based "building blocks" (integrator, precision

rectifier, function generator, amplifiers, etc), and considers the ways in which modern devices can be used to give superior performance in each one. The second part describes a number of practical circuits that exploit modern operational amplifiers, such as high slew-rate, ultra low noise, and low input offset devices. The projects include: Low noise tape preamplifier, low noise RIAA pre-amplifier, audio power amplifiers, d.c. power controllers, opto-isolator audio link, audio millivolt meter, temperature monitor, low distortion audio signal generator, simple video fader, and many more.

120 pages **Order code BP335** £5.45

## A BEGINNERS GUIDE TO CMOS DIGITAL ICs

R. A. Penfold

Getting started with logic circuits can be difficult, since many of the fundamental concepts of digital design tend to seem rather abstract, and remote from obviously useful applications. This book covers the basic theory of digital electronics and the use of CMOS integrated circuits, but does not lose sight of the fact that digital electronics has numerous "real world" applications.

The topics covered in this book include: the basic concepts of logic circuits; the functions of gates, inverters and other logic "building blocks"; CMOS logic i.c. characteristics, and their advantages in practical circuit design; oscillators and monostables (timers); flip/flops, binary dividers and binary counters; decade counters and display drivers.

119 pages **Order code BP333** £5.45

# AUDIO AND MUSIC



## VALVE & TRANSISTOR AUDIO AMPLIFIERS

John Linsley Hood

This is John Linsley Hood's greatest work yet, describing the milestones that have marked the development of audio amplifiers since the earliest days to the latest

systems. Including classic amps with valves at their heart and exciting new designs using the latest components, this book is the complete world guide to audio amp design.

Contents: Active components; Valves or vacuum tubes; Solid-state devices; Passive components; Inductors and transformers; Capacitors, Resistors, Switches and electrical contacts; Voltage amplifier stages using valves; Valve audio amplifier layouts; Negative feedback; Valve operated power amplifiers; Solid state voltage amplifiers; Early solid-state audio amplifiers; Contemporary power amplifier designs; Preamplifiers; Power supplies (PSUs); Index.

250 pages **Order code NE24** £21.99

## AUDIO AMPLIFIER PROJECTS

R. A. Penfold

A wide range of useful audio amplifier projects, each project features a circuit diagram, an explanation of the circuit operation and a stripboard layout diagram. All constructional details are provided along with a shopping list of components, and none of the designs requires the use of any test equipment in order to set up properly. All the projects are designed for straightforward assembly on simple circuit boards.

Circuits include: High impedance mic preamp. Low impedance mic preamp, Crystal mic preamp, Guitar and GP preamplifier. Scratch and rumble filter, RIAA preamplifier, Tape preamplifier, Audio limiter, Bass and treble tone controls, Loudness filter, Loudness control, Simple graphic equaliser, Basic audio mixer, Small (300mW) audio power amp, 6 watt audio power amp, 20/32 watt power amp and power supply, Dynamic noise limiter.

A must for audio enthusiasts with more sense than money!

116 pages **Order code PC113** £18.95 £5.45

## VALVE AMPLIFIERS

Second Edition. Morgan Jones

This book allows those with a limited knowledge of the field to understand both the theory and practice of valve audio amplifier design, such that they can analyse and modify circuits, and build or restore an amplifier. Design principles and construction techniques are provided so readers can devise and build from scratch, designs that actually work.

The second edition of this popular book builds on its main strength – exploring and illustrating theory with practical applications. Numerous new sections include: output transformer problems; heater regulators; phase splitter analysis; and component technology. In addition to the numerous amplifier and preamplifier circuits, three major new designs are included: a low-noise single-ended LP stage, and a pair of high voltage amplifiers for driving electrostatic transducers directly – one for headphones, one for loudspeakers.

288 pages **Order code NE33** £29.95

## LOUDSPEAKERS FOR MUSICIANS

Vivan Capel

This book contains all that a working musician needs to know about loudspeakers; the different types, how they work, the most suitable for different instruments, for cabaret work, and for vocals. It gives tips on constructing cabinets, wiring up, when and where to use wadding, and when not to, what fittings are available, finishing, how to ensure they travel well, how to connect multi-speaker arrays and much more.

Ten practical enclosure designs with plans and comments are given in the last chapter, but by the time you've read that far you should be able to design your own!

164 pages **Order code BP297** £5.49

## BOOK ORDERING DETAILS

All prices include UK postage. For postage to Europe (air) and the rest of the world (surface) please add £2 per book. For the rest of the world airmail add £3 per book. CD-ROM prices include VAT and/or postage to anywhere in the world. Send a PO, cheque, international money order (£ sterling only) made payable to **DIRECT BOOK SERVICE** or card details. Visa, Mastercard, Amex, Diners Club or Switch to: **DIRECT BOOK SERVICE, WIMBORNE PUBLISHING LIMITED, 408 WIMBORNE ROAD EAST, FERNDOWN, DORSET BH22 9ND.**

Books are normally sent within seven days of receipt of order, but please allow 28 days for delivery – more for overseas orders. Please check price and availability (see latest issue of Everyday Practical Electronics) before ordering from old lists.

For a further selection of books see the next two issues of EPE.

Tel 01202 873872 Fax 01202 874562. E-mail: [dbs@epemag.wimborne.co.uk](mailto:dbs@epemag.wimborne.co.uk)  
Order from our online shop at: [www.epemag.wimborne.co.uk/shopdoor.htm](http://www.epemag.wimborne.co.uk/shopdoor.htm)

## BOOK ORDER FORM

Full name: .....

Address: .....

.....

..... Post code: ..... Telephone No: .....

Signature: .....

I enclose cheque/PO payable to DIRECT BOOK SERVICE for £ .....

Please charge my card £ ..... Card expiry date.....

Card Number ..... Switch Issue No.....

Card Security Code ..... (the last three digits on or just below the signature strip)

Please send book order codes: .....

.....

Please continue on separate sheet of paper if necessary

# SURFING THE INTERNET

# NET WORK

## ALAN WINSTANLEY

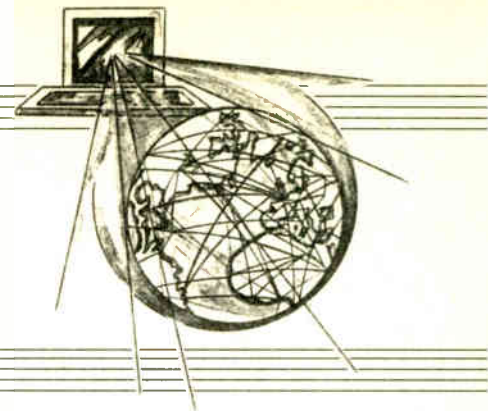

### If Only I Could...

IT'S a lovely evening, and here I am, sitting in a sun lounge overlooking my quintessential English garden in the Autumnal sun, whilst typing this column into a laptop. Now, if I had broadband Internet, I could readily use the latest 802.11g wireless standards to check my email through a wireless-G router; I could browse the web through my laptop, wirelessly and with ease, ten times faster than 56K dialup, and I could search for data sheets or look through component web sites whilst online.

I could even fetch the screenshot I need for this article in a trice, and copy my text to another machine. At other times I could use a handheld computer such as an iPAQ to record some part numbers when thumbing through printed catalogues, or I could quickly hook into the vendor's online shopping cart to buy online. A simple wireless home network would allow me to fetch documents or files from the other networked computers that I use.

My thanks to Jon Rigger in Canberra, Australia, who emailed to say that "For some businesses, not being net connected and not having a web presence is suicide. We are connected to broadband here and my wife (not a techno addict) has taken to it like crazy. To the extent that we booked our Christmas (summer in Oz) holiday totally over the net. If the accommodation or attraction wasn't on the net we did not even see it no matter how nice it may have been. Any that said "We are great, please phone ..." were skipped over. In one place where we recently stayed (booked over the net) the proprietor said that at least 80% of their bookings are over the net and they do not have any other contact (i.e. phone or fax) until the guests arrive."

If the advantages of broadband sound idyllic, that's because for many they are, at least for now. The phone exchanges that have been ADSL-enabled are pretty much known to their subscribers by now, and BT will probably only fill in the odd remaining gap in their network: the rest of us are on our own.

### Land Grab

A huge land grab is under way amongst ISPs such as AOL, Tiscali, BT and Freeserve to sign up or switch ADSL (asymmetric digital subscriber line) users, while the rest of us have no choice but to sit it out and struggle on with dial-up Internet access. At least we are not alone in this predicament. One American correspondent in Silicon Valley talks of having similar problems with the frustrating lack of broadband, thanks mainly to the non-dynamic approach of private phone companies.

In the UK at any rate, what I feel is likely to happen in the next two to three years is this: with a huge gap in the market and BT cherry-picking ADSL customers all the time, there are a number of suppliers wanting to deliver alternative solutions such as 54Mbps wireless 802.11g (one such company - WRBB - was described last month). I would like to think that some ISPs would provide broadband Internet access for philanthropic reasons, but it is debatable whether any broadband ISP would roll out a service in the hope of eventually gaining sufficient subscribers to make it viable.

Whilst some ISPs may emphasise a commitment to delivering wireless broadband "up front" regardless of initial demand, nevertheless, commercial pressures mean that there must be a certain threshold of firm demand before the service could be considered feasible to begin with. So we get back to those "pre-registration" or "expressions of firm interest" figures again.

The factor that will unlock broadband Internet access for the rest of us in the UK will be the uptake of broadband services by the public sector, including village schools and libraries etc., encouraged by Government and supported by local authorities, allied to demands from local businesses. This will form the stimulus for ISPs to develop a broadband service, probably delivered wirelessly using mesh radio or perhaps by satellite.

The market is still volatile and has yet to settle down: with satellite access for example, word from the trade is that a number of customers have thrown out satellite because it is too unreliable, but for other commercial users it may be a lifeline. If you want broadband Internet access in the regions, unless you can spare an arm or a leg for satellite services, the only solution will be to wait and see what happens. Or move to e.g. Hull.

### EPE Web Site Downloads

Regular users of the EPE web site ([www.epemag.wimborne.co.uk](http://www.epemag.wimborne.co.uk)) will have noticed the latest addition to our online services in the form of the new Downloads page. This is accessible using the Downloads link on the home page (half way down the left-hand side) and elsewhere. A new GUI (graphical user interface) "tree" is displayed that offers a web front-end to our traditional FTP site, where our PIC source codes are stored.

This new web page works best in Microsoft Internet Explorer 6.0. It is impossible to fully replicate in a web page the functionality of Windows Explorer that runs on a powerful PC, but the new Downloads page comes close enough and enables you to quickly navigate to the appropriate folder to fetch your source code. By clicking once on the desired sub folder, the available files are displayed. If you have the relevant applications installed (e.g. Winzip) then familiar Windows icons are displayed on our GUI page as well.

Our "tree" GUI has a trick up its sleeve: using MSIE 6, you can left-mouse-click and "drag" around the files to highlight them all; then right-click and a new option opens that may be unfamiliar to most MSIE users: simply choose "Copy to Folder..." and *all the selected files will be saved to your hard disk in one slick batch operation.*

The page was also tested with a number of other systems and browsers including Netscape and Opera, but the Copy to Folder... option will not be available, so files should be saved individually. A link is also provided that offers a "classic" browser view of our FTP site, should the GUI not work for you. Alternatively, you can use FTP software such as WS\_FTP ([www.ipswitch.com](http://www.ipswitch.com)) and fetch the files by anonymous FTP instead. A number of other web pages and changes are in the pipeline, including a shopping cart upgrade. You can email comments to [alan@epemag.demon.co.uk](mailto:alan@epemag.demon.co.uk).

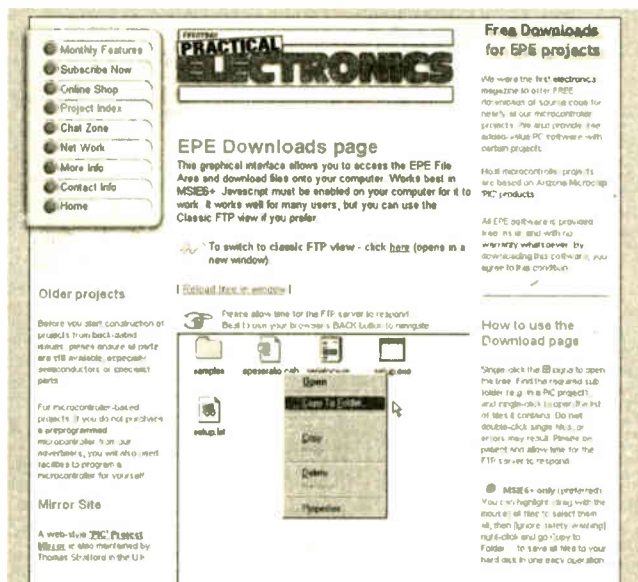

The new Downloads page, opened at the Serial Interface project source code. In MSIE6, select all files, then right-click and Copy to Folder to save to your disk.

# PCB SERVICE

Printed circuit boards for most recent *EPE* constructional projects are available from the PCB Service, see list. These are fabricated in glass fibre, and are fully drilled and roller tinned. All prices include VAT and postage and packing. Add £1 per board for airmail outside of Europe. Remittances should be sent to **The PCB Service, Everyday Practical Electronics, Wimborne Publishing Ltd., 408 Wimborne Road East, Ferndown, Dorset BH22 9ND. Tel: 01202 873872; Fax 01202 874562; Email: orders@epemag.wimborne.co.uk. On-Line Shop: www.epemag.wimborne.co.uk/shopdoor.htm.** Cheques should be crossed and made payable to *Everyday Practical Electronics* (Payment in £ sterling only). **NOTE: While 95% of our boards are held in stock and are dispatched within seven days of receipt of order, please allow a maximum of 28 days for delivery – overseas readers allow extra if ordered by surface mail. Back numbers or photostats of articles are available if required – see the Back Issues page for details. We do not supply kits or components for our projects.**

**Please check price and availability in the latest issue.**  
**A number of older boards are listed on our website.**  
**Boards can only be supplied on a payment with order basis.**

PROJECT TITLE	Order Code	Cost
PIC Toolkit MK3	OCT '01	318 £8.24
★PIC Toolkit TK3 – Software only	NOV '01	–
4-Channel Twinkling Lights	DEC '01	325 £6.82
Ghost Buster – Mic	326	} Set £5.78
– Main	327	
★PIC Polywhatsit – Digital	328	
– Analogue	329	} Set £7.61
Forever Flasher	JAN '02	330 £4.44
Time Delay Touch Switch	331	£4.60
★PIC Magick Musick	332	£5.87
Versatile Bench Power Supply	333	£5.71
★PIC Spectrum Analyser	FEB '02	334 £7.13
Versatile Current Monitor	335	£4.75
Guitar Practice Amp	336	£5.39
★PIC Virus Zapper	MAR '02	337 £4.75
RH Meter	338	£4.28
★PIC Mini-Enigma – Software only	–	–
★Programming PIC Interrupts – Software only	–	–
★PIC Controlled Intruder Alarm	APR '02	339 £6.50
★PIC Big Digit Display	MAY '02	341 £6.02
Washing Ready Indicator	342	£4.75
Audio Circuits–1 – LM386N-1	343	£4.28
– TDA7052	344	£4.12
– TBA820M	345	£4.44
– LM380N	346	£4.44
– TDA2003	347	£4.60
– Twin TDA2003	348	£4.75
World Lamp	JUNE '02	340 £5.71
Simple Audio Circuits–2 – Low, Med and High	349	£4.60
Input Impedance Preampifiers (Single Trans.)	350	£4.75
Low-Noise Preampifier (Dual Trans.)	351	£4.60
Tone Control	352	£4.75
Bandpass Filter	353	£4.12
Frequency Standard Generator – Receiver	354	£6.82
– Digital	355	£5.71
★Biopic Heartbeat Monitor	–	–
Simple Audio Circuits – 3	JULY '02	356 £4.60
– Dual Output Power Supply	357	£4.44
– Crossover/Audio Filter	358	£4.91
Infra-Red Autoswitch	359	£6.50
★EPE StyloPIC	360	£5.39
Rotary Combination Lock – Main Board	361	£4.91
– Interface Board	–	–
★Using the PIC's PCLATH Command – Software only	–	–
Big-Ears Buggy	AUG '02	362 £5.71
★PIC World Clock	363	£5.39
Simple Audio Circuits–4 – Low Freq. Oscillator	364	£4.44
– Resonance Detector	365	£4.28
Vinyl-To-CD Preampifier	SEPT '02	366 £5.71
★Freebird Glider Control	367	£4.91
★Morse Code Reader	368	£5.23
Headset Communicator	OCT '02	369 £4.75
EPE Bounty Treasure Hunter	370	£4.77
★Digital I.C. Tester	371	£7.14
★PIC-Pocket Battleships – Software only	–	–
Transient Tracker	NOV '02	372 £4.75
★PICAXE Projects–1: Egg Timer; Dice Machine;	373	£3.00
Quiz Game Monitor (Multiboard)	374	£5.39
★Tuning Fork & Metronome	375	£18.87
★★EPE Hybrid Computer – Main Board	} double-sided	376 £11.57
– Atom Board		
★PICAXE Projects–2: Temperature Sensor;	DEC '02	373 £3.00
Voltage Sensor; VJ Indicator (Multiboard)	377	£5.07
★Versatile PIC Flasher	378	£4.75
★PICAXE Projects–3: Chaser Lights	JAN '03	373 £3.00
6-Channel Mains Interface	381	£5.08
EPE Minder – Transmitter	378	£4.75
– Receiver	379	£5.39
★Wind Speed Monitor	380	£5.08
Tesla Transformer	FEB '03	382 £5.07
★Brainbot Buggy	383	£3.00
★Wind Tunnel	384	£6.02
200kHz Function Generator	MAR '03	385 £6.34
Wind-Up Torch Mk II	386	£4.75
★Driver Alert	387	£6.35

PROJECT TITLE	Order Code	Cost
★Earth Resistivity Logger	APR '03	388 £6.02
★Intelligent Garden Lights Controller	389	£3.96
★PIC Tutorial V2 – Software only	–	–
Door Chime	MAY '03	390 £5.07
Super Motion Sensor	391	£5.55
Radio Circuits–1 MK484 TRF Receiver	JUNE '03	392 £4.44
Headphone Amp.	393	£4.28
★Fido Pedometer	394	£4.91
★PICronos L.E.D. Wall Clock	395	£14.65
EPE Mini Metal Detector	JULY '03	396 £4.28
Radio Circuits – 2 Q-Multiplier	397	£4.28
MW Reflex Radio	398	£4.60
Wave Trap	399	£4.28
Speaker Amplifier	400	£4.44
Ohmmeter Adaptor MkII	401	£4.60
Ultimate Egg Timer (Top Tenner)	403	£4.91
★EPE PIC Met Office	AUG '03	402 £10.46
Alarm System Fault Finder	404	£4.44
Radio Circuits–3 Regen. Radio	405	£5.07
Tuning Capacitor Board	406	£4.28
Master/Slave Intercom (Top Tenner)	407	£4.75
Two-Up (Top Tenner)	408	£4.91
Priority Referee (Top Tenner)	SEPT '03	410 £5.07
Vibration Alarm (Top Tenner)	411	£5.39
Radio Circuits–4 Varicap Tuner	412	£4.44
Coil Pack – General Coverage	413	£5.07
Coil Pack – Amateur Bands	414	£4.75
★PIC-A-Colour – Software only	–	–
Spooky Bug (Top Tenner)	OCT '03	409 £5.07
Radio Circuits–5 Crystal Marker	415	£4.44
Super Regen. Receiver	419	£5.07
Buffer Amplifier	420	£4.44
★Serial Interface for PICs and VB6	416	£5.23
★PIC Breakpoint – Software only	–	–
Anyone At Home – Logic Board	NOV '03	421 } Pair £6.35
– Relay Board	422	
Radio Circuits–6 Direct Conversion Receiver	423	£6.02
★PIC Random L.E.D. Flasher	424	£4.60

## EPE SOFTWARE

Software programs for *EPE* projects marked with a single asterisk ★ are available on 3.5 inch PC-compatible disks or free from our Internet site. The following disks are available: **PIC Tutorial V2** (Apr-June '03); **EPE Disk 1** (Apr '95-Dec '98); **EPE Disk 2** (1999); **EPE Disk 3** (2000); **EPE Disk 4** (2001); **EPE Disk 5** (2002); **EPE Disk 6** (Jan 2003 issue to current cover date) – excl. Earth Resistivity); **EPE Earth Resistivity Logger** (Apr-May '03); **EPE PIC Met Office** (Aug-Sept '03); **EPE Teach-In 2000**; **EPE Spectrum**; **EPE Interface Disk 1** (October '00 issue to current cover date). ★★The software for these projects is on its own CD-ROM. The 3.5 inch disks are £3.00 each (UK), the CD-ROMs are £6.95 (UK). Add 50p each for overseas surface mail, and £1 each for airmail. All are available from the *EPE PCB Service*. All files can be downloaded free from our Internet FTP site, accessible via our home page at: [www.epemag.wimborne.co.uk](http://www.epemag.wimborne.co.uk).

## EPE PRINTED CIRCUIT BOARD SERVICE

Order Code      Project      Quantity      Price

Name .....

Address .....

Tel. No. ....

I enclose payment of £..... (cheque/PO in £ sterling only) to:



**Everyday Practical Electronics**

**MasterCard, Amex, Diners Club, Visa or Switch**



Card No. ....

Card Exp. Date ..... Switch Issue No .....

Card Security Code .....  
 (The last 3 digits on or just under the signature strip)

Signature .....

NOTE: You can also order p.c.b.s by phone, Fax, Email or via our Internet site on a secure server:

<http://www.epemag.wimborne.co.uk/shopdoor.htm>

**WHETHER ELECTRONICS IS YOUR HOBBY  
OR YOUR LIVELIHOOD . . .**

**YOU NEED THE MODERN ELECTRONICS MANUAL  
and the ELECTRONICS SERVICE MANUAL**

## **THE MODERN ELECTRONICS MANUAL (CD-ROM VERSION ONLY)**

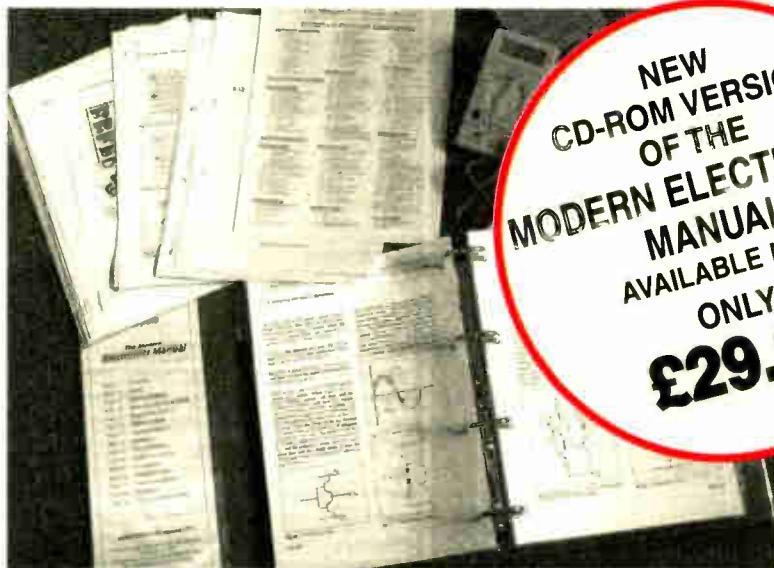

**NEW  
CD-ROM VERSION  
OF THE  
MODERN ELECTRONICS  
MANUAL  
AVAILABLE NOW  
ONLY  
£29.95**

**The essential reference  
work for everyone  
studying electronics**

- Over 800 pages
- In-depth theory
- Projects to build
- Detailed assembly instructions
- Full components checklists
- Extensive data tables
- Manufacturers' web links
- Easy-to-use Adobe Acrobat format
- Clear and simple layout
- Comprehensive subject range
- Professionally written
- Regular Supplements

## **EVERYTHING YOU NEED TO GET STARTED AND GO FURTHER IN ELECTRONICS!**

The revised CD-ROM edition of the Modern Electronics Base Manual (MEM) contains practical, easy-to-follow information on the following subjects:

**BASIC PRINCIPLES:** Electronic Components and their Characteristics (16 sections from Resistors and Potentiometers to Crystals, Crystal Modules and Resonators); Circuits Using Passive Components (10 sections); Power Supplies: The Amateur Electronics Workshop; The Uses of Semiconductors: Digital Electronics (6 sections); Operational Amplifiers; Introduction to Physics, including practical experiments; Semiconductors (5 sections) and Digital Instruments (3 sections).

**CIRCUITS TO BUILD:** There's nothing to beat the satisfaction of creating your own projects. From basic principles, like soldering and making printed circuit boards, to the tools needed for circuit-building, the Modern Electronics Manual and its Supplements describe clearly, with appropriate diagrams, how to assemble a radio, loudspeaker circuits, amplifiers, car projects,

a computer interface, measuring instruments, workshop equipment, security systems, medical and musical circuits, etc. The Base Manual describes 12 projects including a Theremin and a Simple TENS Unit.

**ESSENTIAL DATA:** Extensive tables on diodes, transistors, thyristors and triacs, digital and linear i.c.s.

**EXTENSIVE GLOSSARY:** Should you come across a technical word, phrase or abbreviation you're not familiar with, simply look up the glossary included in the Manual and you'll find a comprehensive definition in plain English.

The Manual also covers **Safety** and provides web links to component and equipment **Manufacturers and Suppliers**. The most comprehensive reference work ever produced at a price you can afford, the CD-ROM edition of **THE MODERN ELECTRONICS MANUAL** provides you with all the **essential** information you need.

## **THE MODERN ELECTRONICS MANUAL (MEM – CD-ROM version only)**

**Revised CD-ROM Edition of Basic Work:** Contains over 800 pages of information in Adobe Acrobat format. Edited by John Becker.

**Regular Supplements:** Additional CD-ROMs each containing approximately 500 pages of additional information on specific areas of electronics are available for £19.95 each. Information on the availability and content of each Supplement CD-ROM will be sent to you.

**Presentation:** CD-ROM suitable for any modern PC. Requires Adobe Acrobat Reader which is included on the MEM CD-ROM.

**Price of the Basic Work: £29.95 POST FREE.**

## **ORDER BOTH MANUALS TOGETHER AND SAVE £20**

**A mass of well-organised and clearly explained information is brought to you by expert editorial teams whose combined experience ensures the widest coverage**  
**Regular Supplements to these unique publications, keep you abreast of the latest technology and techniques if required**

# ELECTRONICS SERVICE MANUAL

(PRINTED VERSION ONLY)

## EVERYTHING YOU NEED TO KNOW TO GET STARTED IN REPAIRING AND SERVICING ELECTRONIC EQUIPMENT

**SAFETY:** Be knowledgeable about Safety Regulations, Electrical Safety and First Aid.

**UNDERPINNING KNOWLEDGE:** Specific sections enable you to Understand Electrical and Electronic Principles, Active and Passive Components, Circuit Diagrams, Circuit Measurements, Radic, Computers, Valves and Manufacturers' Data, etc.

**PRACTICAL SKILLS:** Learn how to identify Electronic Components, Avoid Static Hazards, Carry Out Soldering and Wiring, Remove and Replace Components.

**TEST EQUIPMENT:** How to Choose and Use Test Equipment, Assemble a Toolkit, Set Up a Workshop, and Get the Most from Your Multimeter and Oscilloscope, etc.

**SERVICING TECHNIQUES:** The regular Supplements include vital guidelines on how to Service Audio Amplifiers, Radio Receivers, TV Receivers, Cassette Recorders, Video Recorders, Personal Computers, etc.

**TECHNICAL NOTES:** Commencing with the IBM PC, this section and the regular Supplements deal with a very wide range of specific types of equipment -- radios, TVs, cassette recorders, amplifiers, video recorders etc..

**REFERENCE DATA:** Detailing vital parameters for Diodes, Small-Signal Transistors, Power Transistors, Thyristors, Triacs and Field Effect Transistors. Supplements include Operational Amplifiers, Logic Circuits, Optoelectronic Devices, etc.

## The essential work for servicing and repairing electronic equipment

- Around 900 pages
- Fundamental principles
- Troubleshooting techniques
- Servicing techniques
- Choosing and using test equipment
- Reference data
- Easy-to-use format
- Clear and simple layout
- Vital safety precautions
- Professionally written
- Regular Supplements
- Sturdy gold blocked ring-binder

## ELECTRONICS SERVICE MANUAL (ESM - Printed version only)

**Basic Work:** Contains around 900 pages of information. Edited by Mike Tooley BA  
**Regular Supplements:** Unlike a book or encyclopedia, this Manual is a living work -- continuously extended with new material. If requested, Supplements are sent to you on approval approximately every three months. Each Supplement contains around 160 pages -- all for only £23.50+£2.50 p&p. You can, of course, return any Supplement (within ten days) which you feel is superfluous to your needs. You can also purchase a range of past Supplements to extend your Base Manual on subjects of particular interest to you.

**Presentation:** Durable looseleaf system in large A4 format

**Price of the Basic Work: £29.95**  
 (to include a recent Supplement FREE).



### Guarantee

Our 30 day money back guarantee gives you complete peace of mind. If you are not entirely happy with the *Electronics Service Manual*, for whatever reason, simply return it to us in good condition within 30 days and we will make a full refund of your payment -- no small print and no questions asked. All we ask is that you pay the return postage. (Overseas buyers also have to pay our overseas postage charge). Sorry, but we can only make exchanges on the *Modern Electronics Manual* (CD-ROM version) if the CD-ROM is faulty, we cannot offer a money back guarantee on this product as the content can be printed out.

Wimborne Publishing Ltd., Dept Y11, 408 Wimborne Road East, Ferndown, Dorset BH22 9ND. Tel: 01202 873872. Fax: 01202 874562.  
 Online shop: [www.epemag.wimborne.co.uk/shopdoor.htm](http://www.epemag.wimborne.co.uk/shopdoor.htm)

**PLEASE** send me



- THE MODERN ELECTRONICS MANUAL (CD-ROM version only)
- ELECTRONICS SERVICE MANUAL plus a FREE SUPPLEMENT (Printed version only)
- I enclose payment of £29.95 (for one Manual) or £39.90 for both Manuals (saving £20 by ordering both together) plus postage if applicable.
- I also require the appropriate ESM Supplements four times a year. These are billed separately and can be discontinued at any time. (Please delete if not required.)

FULL NAME .....  
 (PLEASE PRINT)

ADDRESS .....

.....POSTCODE .....

SIGNATURE .....

I enclose cheque/PO in UK pounds payable to Wimborne Publishing Ltd.

Please charge my Visa/Mastercard/Amex/Diners Club/Switch Switch Issue No .....

Card No .....

Card Exp. Date ..... Card Security Code .....

(The last 3 digits on or just under the signature strip)

### ORDER FORM

Simply complete and return the order form with your payment to the following address:

Wimborne Publishing Ltd, Dept. Y11, 408 Wimborne Road East, Ferndown, Dorset BH22 9ND

We offer a 30 day MONEY BACK GUARANTEE on ESM -- see the panel above for details.

### POSTAGE CHARGES FOR ESM

MEM CD-ROM POST FREE TO ALL COUNTRIES  
 (Note we use the VAT portion of the MEM CD-ROM payment to pay for overseas postage)

Postal Region	Price PER ESM PRINTED MANUAL	
	Surface	Air
Mainland UK	FREE	-
Scottish Highlands, UK Islands & Eire	£7 each	-
Europe (EU)	-	£23 each
Europe (Non-EU)	£23 each	£30 each
USA & Canada	£28 each	£39 each
Far East & Australasia	£35 each	£43 each
Rest of World	£28 each	£52 each

Please allow four working days for UK delivery.

NOTE: Surface mail can take over 10 weeks to some parts of the world. Each ESM weighs about 4kg when packed.

mem-cd

Everyday Practical Electronics reaches twice as many UK readers as any other UK monthly hobby electronics magazine, our sales figures prove it. We have been the leading monthly magazine in this market for the last eighteen years.

If you want your advertisements to be seen by the largest readership at the most economical price our classified and semi-display pages offer the best value. The prepaid rate for semi-display space is £8 (+VAT) per single column centimetre (minimum 2.5cm). The prepaid rate for classified adverts is 30p (+VAT) per word (minimum 12 words).

All cheques, postal orders, etc., to be made payable to Everyday Practical Electronics. VAT must be added. Advertisements, together with remittance, should be sent to Everyday Practical Electronics Advertisements, Mill Lodge, Mill Lane, Thorpe-le-Soken, Essex CO16 0ED. Phone/Fax (01255) 861161.

For rates and information on display and classified advertising please contact our Advertisement Manager, Peter Mew as above.

## VVT TRANSFORMERS

Transformers and Chokes for all types of circuits including specialist valve units  
Custom design or standard range  
High and low voltage

### Variable Voltage Technology Ltd

Unit 3, Sheat Manor Farm, Chillerton,  
Newport, Isle of Wight, PO30 3HP  
Tel: 0870 243 0414 Fax: 01983 721572  
email: sales@vvt-cowes.freeserve.co.uk

[www.vvttransformers.co.uk](http://www.vvttransformers.co.uk)

## BTEC ELECTRONICS TECHNICIAN TRAINING

VCE ADVANCED ENGINEERING  
ELECTRONICS AND ICT  
HNC AND HND ELECTRONICS  
NVQ ENGINEERING AND IT  
**PLEASE APPLY TO COLLEGE FOR  
NEXT COURSE DATE**  
FULL PROSPECTUS FROM

**LONDON ELECTRONICS COLLEGE**  
(Dept EPE) 20 PENYVERN ROAD  
EARLS COURT, LONDON SW5 9SU  
TEL: (020) 7373 8721

## BOWOOD ELECTRONICS LTD

Suppliers of Electronic Components

Place a secure order on our website or call our sales line  
All major credit cards accepted

Web: [www.bowood-electronics.co.uk](http://www.bowood-electronics.co.uk)

7 Bakewell Road, Baslow, Derbyshire DE45 1RE

Sales: 01246 583777

Send 42p stamp for catalogue

## X-10® Home Automation We put you in control™

### Why tolerate when you can automate?

An extensive range of 230V X-10 products and starter kits available. Uses proven Power Line Carrier technology, no wires required.

Products Catalogue available Online.

Worldwide delivery.

### Laser Business Systems Ltd.

E-Mail: [info@laser.com](mailto:info@laser.com)

<http://www.laser.com>

Tel: (020) 8441 9788

Fax: (020) 8449 0430



## TRANSFORMERS

- Custom Wound
- 1 Phase to 50kVA
- 3 Phase to 100kVA
- A.C. and D.C. Chokes
- H.T. up to 5kV
- Transformer Kits
- Coils up to 1m Dia.
- Transformer Rectifiers
- Toroidals
- Motor Generators

Visit [www.jemelec.com](http://www.jemelec.com) for details  
or request our free leaflet

Jemelec, Unit 7, Shirebrook Business Park, Mansfield, NG20 8RN

Tel: 0870 787 1769

## PC Oscilloscope & Signal Generator



3-in-1 Digital Oscilloscope + Signal Generator + Spectrum  
Analyser Samples at 20 or 30 Mps Programmable signal  
generator with built in sine, triangular, saw and square waves  
in normal & sweep modes. Plugs into printer port.

Prices from £139 - CL SYSTEM

Visit [www.clsystem.co.uk](http://www.clsystem.co.uk) or call 07906 860815

## EPE NET ADDRESSES

EPE FTP site: <ftp://ftp.epemag.wimborne.co.uk>

Access the FTP site by typing the above into your web browser, or by setting up an FTP session using appropriate FTP software, then go into quoted sub-directories:

PIC-project source code files: /pub/PICS

PIC projects each have their own folder; navigate to the correct folder and open it, then fetch all the files contained within. Do not try to download the folder itself!

EPE text files: /pub/docs

Basic Soldering Guide: solder.txt

Ingenuity Unlimited submission guidance: lng\_unlit.txt

New readers and subscribers info: epem\_info.txt

Newsgroups or Usenet users advice: usenet.txt

Ni-Cad discussion: nlcadfaq.zip and nlcad2.zip

Writing for EPE advice: write4us.txt

You can also enter the FTP site via the link at the top of the main page of our home site at:

<http://www.epemag.wimborne.co.uk>

Shop now on-line:

[www.epemag.wimborne.co.uk/shopdoor.htm](http://www.epemag.wimborne.co.uk/shopdoor.htm)

Ensure you set your FTP software to ASCII transfer when fetching text files, or they may be unreadable.

Note that any file which ends in .zip needs unzipping before use. Unzip utilities can be downloaded from:

<http://www.winzip.com>

Ensure you use the latest version

## TOTALROBOTS

### ROBOTICS, CONTROL & ELECTRONICS TECHNOLOGY

High quality robot kits and components  
UK distributor of the OOPic microcontroller

Secure on-line ordering

Rapid delivery

Highly competitive prices

Visit [www.totalrobots.com](http://www.totalrobots.com)

Tel: 0208 823 9220

## SWAYSCIENCE

### LOW TEMPERATURE DESOLDERING (60°C-80°C)

Remove electronic components without heat damage to semiconductors or p.c.b.s.

★ New Product ★ Cost Effective

★ Free Details

★ Safer than most solder itself

★ Trade and Retail Enquiries Welcome

Tel: 0778 770 3785

## Miscellaneous

**FREE PROTOTYPE PRINTED CIRCUIT BOARDS!** Free prototype p.c.b. with quantity orders. Call Patrick on 028 9073 8897 for details. Agar Circuits, Unit 5, East Belfast Enterprise Park, 308 Alberbridge Road, Belfast BT5 4GX.

**PRINTED CIRCUIT BOARDS - QUICK SERVICE.** Prototype and production artwork raised from magazines or draft designs at low cost. PCBs designed from schematics. Production assembly, wiring and software programming. For details contact Patrick at Agar Circuits, Unit 5, East Belfast Enterprise Park, 308 Alberbridge Road, Belfast, BT5 4GX. Phone 028 9073 8897, Fax 028 9073 1802, Email [agar@argonet.co.uk](mailto:agar@argonet.co.uk).

**G.C.S.E. ELECTRONICS KITS, TOOLS,** pocket money prices. S.A.E. for free catalogue. SIR-KIT Electronics, 52 Severn Road, Clacton, CO15 3RB. [www.geocities.com/sirkituk](http://www.geocities.com/sirkituk).

**VALVES AND ALLIED COMPONENTS IN STOCK.** Phone for free list. Valves, books and magazines wanted. Geoff Davies (Radio), tel. 01788 574774.

**SOMETHING DIFFERENT.** Forbidden knowledge, plans and experiments. More information: [info@dacdirect.co.uk](mailto:info@dacdirect.co.uk). Unit 2, 105 London Street, Reading, RG1 4QA.

**B.S.R. TAPE DECK,** 240V, 3-speed, three heads, £9.95. CD player plus remote, 240V, £9.95. K.I.A., 1 Regent Road, Ilkley LS29.

**COMPONENT KITS for Everyday Practical Electronics projects plus other products.** Visit [www.metastable.electronics.btinternet.co.uk](http://www.metastable.electronics.btinternet.co.uk).

**GRIMSBY ELECTRONICS,** Lambert Road, Grimsby: Components, accessories, unusual items. S.a.e. enquiries, tel. 01472 697414.

**P.C.B.s MADE, ONE OR MANY.** Low prices, any country. Sesame Electronics, [http://sesame\\_elec.tripod.com](http://sesame_elec.tripod.com).



## IMPROVE YOUR SKILLS WITH A HOME STUDY COURSE

Make a real success of yourself by gaining the vital skills and qualifications you need with an ICS home study course. You learn in your own time, at your own pace and from the comfort of your home. And with over 13 million successful students, you'll be joining the most experienced home study school in the world. You can do it with ICS! So why not improve your prospects today by calling us now or returning the coupon below.

- Electrical Contracting & Installation
- Electrical Engineering
- C&G Basic Electronic Engineering
- C&G Basic Mechanical Engineering
- TV & Video Servicing
- Radio & Hi-Fi Servicing
- Refrigerator, Heating & Air Conditioning
- Motorcycle Maintenance

**FREEPHONE 0800 056 6137** Extn 1091 Mon-Fri 8.30 am - 4 pm

Or write to: ICS, FREEPOST 882, Glasgow, G3 8BR. Tel: 01800 620 490

Please send me my Free Information on your Technical Courses.

Mr/Ms/Ms/Ms  
 (BLOCK CAPITAL PLEASE)

Date of Birth: / /

Address

Postcode

Tel No:

Dept ZEEVT113 [www.icslearn.co.uk](http://www.icslearn.co.uk)

**ICS THE WORLD'S NO.1 IN HOME LEARNING** From time to time we permit other carefully screened organisations to contact you about products and services. If you prefer not to hear from such organisations please tick box

Autonomous Programmable Robot Kits  
Accessories - Sensors - Controller Boards

**competition-robotics.com**

Secure on-line ordering. Fast, friendly service.



Web: [www.competition-robotics.com](http://www.competition-robotics.com) Tel: 01793 636119 Fax: 01793 705772 e-Mail: [sales@competition-robotics.com](mailto:sales@competition-robotics.com)

## N. R. BARDWELL LTD (Est. 1948)

100	Sigfig Diodes 1N4148	£1.00	200	Asstd capacitors 1nF to 1uF	£1.00
75	Rectifier Diodes 1N4001	£1.00	50	Asstd disc ceramic capacitors	£1.00
50	Rectifier Diodes 1N4007	£1.00	50	Asstd Skel Presets (sm, stand cermet)	£1.00
10	W01 Bridge Rectifiers	£1.00	50	Asstd RF chokes (inductors)	£1.00
10	555 Timer ICs	£1.00	50	Asstd grommets	£1.00
4	741 Op Amps	£1.00	10	Asstd crystals - plug in	£1.00
10	Assorted Zener Diodes 400mW	£1.00	8	Asstd di switches	£1.00
52	Assorted 7-segment Displays	£1.00	8	Asstd push-button switches, multi-bank, multi-pole	£1.00
35	Assorted I.e.d.s, var shapes, colours & sizes	£1.00	30	Asstd di sockets up to 40 way	£1.00
25	5mm I.e.d.s, red or green or yellow	£1.00	10	TV coax plugs, plastic	£1.00
25	3mm I.e.d.s, red or green or yellow	£1.00	40	metres very thin connecting wire, red	£1.00
75	5mm I.e.d.s, green, 6.5mm legs	£1.00	20	1m, glass reed switches	£1.00
50	Avail I.e.d.s, 2mm red Diode Package	£1.00	100	Any one value 1/4W 5% CI resistors range 1R to 10M	£0.45
25	Asstd High Brightness I.e.d.s, var cols	£1.00	10	7812 Voltage Regulators	£1.00
20	BC182L Transistors	£1.00	300	Asstd resistors, 1/4W 5%, mostly on tapes	£1.00
25	BC212L Transistors	£1.00			
30	BC237 Transistors	£1.00			
30	BC237 Transistors	£1.00			
30	BC328 Transistors	£1.00			
20	BC547 Transistors	£1.00			
20	BC547B Transistor	£1.00			
30	BC548 Transistors	£1.00			
30	BC549 Transistors	£1.00			
25	BC557 Transistors	£1.00			
30	BC558 Transistors	£1.00			
30	BC559 Transistors	£1.00			
20	2N3904 Transistors	£1.00			
100	1nf 50V wkg Axial Capacitors	£1.00			
100	4n7 50V wkg Axial Capacitors	£1.00			
80	Asstd capacitors electrolytic	£1.00			

288 Abbeydale Road, Sheffield S7 1FL  
Phone (local rate): 0845 166 2329  
Fax: 0114 255 5039

e-mail: [sales@bardwells.co.uk](mailto:sales@bardwells.co.uk)  
web: [www.bardwells.co.uk](http://www.bardwells.co.uk)  
Prices include VAT. Postage £1.65  
44p stamp for lists or disk  
POs, Cheques and Credit Cards accepted  
SEE OUR WEB PAGES FOR MORE  
COMPONENTS AND SPECIAL OFFERS



Get your magazine "instantly" anywhere in the world - buy from the web.

TAKE A LOOK, A FREE ISSUE IS AVAILABLE

A one year subscription (12 issues) costs just \$10.99 (US)

[www.epemag.com](http://www.epemag.com)



National College of Technology

## DISTANCE LEARNING COURSES

The following courses are available:

- Electronic Circuits
- Digital Circuits
- Fibre-Optics
- Mathematics
- Electronic Testing & Fault Finding
- Programmable Logic Controllers
- Mechanics & Mechanisms

These courses lead to a BTEC QUALIFICATION and are suitable for beginners and those with more experience, needing to update their skills.

Tutor support is available to help you succeed.

Register for any of these courses NOW and learn at your own pace.

[www.oakcad.co.uk/nct.aspx](http://www.oakcad.co.uk/nct.aspx)

or telephone: 08456 345 445



OakCAD Training is now running the National College of Technology and will endeavour to provide the same high level of service and support.

## EPE BINDERS KEEP YOUR MAGAZINES SAFE - RING US NOW!

This ring binder uses a special system to allow the issues to be easily removed and re-inserted without any damage. A nylon strip slips over each issue and this passes over the four rings in the binder, thus holding the magazine in place.

The binders are finished in hard-wearing royal blue p.v.c. with the magazine logo in gold on the spine. They will keep your issues neat and tidy but allow you to remove them for use easily.

The price is £6.95 plus £3.50 post and packing. If you order more than one binder add £1 postage for each binder after the initial £3.50 postage charge (overseas readers the postage is £6.00 each to everywhere except Australia and Papua New Guinea which costs £10.50 each).

Send your payment in £'s sterling cheque or PO (Overseas readers send £ sterling bank draft, or cheque drawn on a UK bank or pay by card), to Everyday Practical Electronics, Wimborne Publishing Ltd, 408 Wimborne Road East, Ferndown, Dorset BH22 9ND. Tel: 01202 873872.

Fax: 01202 874562.

E-mail: [editorial@epemag.wimborne.co.uk](mailto:editorial@epemag.wimborne.co.uk)

Web site: <http://www.epemag.wimborne.co.uk>

Order on-line from [www.epemag.wimborne.co.uk/shopdoor.htm](http://www.epemag.wimborne.co.uk/shopdoor.htm)

We also accept card payments. Mastercard, Visa, Amex, Diners Club or Switch. Send your card number and card expiry date plus Switch Issue No. with your order.



## Watch Slides on TV.

Make videos of your slides. Digitise your slides (using a video capture card)

"Liesgang diatv" automatic slide viewer with built in high quality colour TV camera. It has a composite video output to a phono plug (SCART & BNC adaptors are available). They are in very good condition with few signs of use. More details see [www.diatv.co.uk](http://www.diatv.co.uk).  
£91.91 + VAT = £108.00



Board cameras all with 512 x 582 pixels 8.5mm 1/3 inch sensor and composite video out. All need to be housed in your own enclosure and have fragile exposed surface mount parts. They all require a power supply of between 10V and 12V DC 150mA.  
47MIR size 60 x 36 x 27mm with 6 infra red LEDs (gives the same illumination as a small torch but is not visible to the human eye) £37.00 + VAT = £43.48  
30MP size 32 x 32 x 14mm spy camera with a fixed focus pin hole lens for hiding behind a very small hole £35.00 + VAT = £41.13  
40MC size 39 x 38 x 27mm camera for 'C' mount lens these give a much sharper image than with the smaller lenses £32.00 + VAT = £37.60  
Economy C mount lenses all fixed focus & fixed iris  
VSL1202F 12mm F1.6 12 x 15 degrees viewing angle £15.97 + VAT £18.76  
VSL4022F 4mm F1.22 63 x 47 degrees viewing angle £17.65 + VAT £20.74  
VSL6022F 6mm F1.22 42 x 32 degrees viewing angle £19.05 + VAT £22.38  
VSL8020F 8mm F1.22 32 x 24 degrees viewing angle £19.90 + VAT £23.38

## Better quality C Mount lenses

VSL1614F 16mm F1.6 30 x 24 degrees viewing angle £26.43 + VAT £31.06  
VWL813M 8mm F1.3 with iris 56 x 42 degrees viewing angle £77.45 + VAT = £91.00  
1206 surface mount resistors E12 values 10 ohm to 1M ohm  
100 of 1 value £1.00 + VAT 1000 of 1 value £5.00 + VAT

866 battery pack originally intended to be used with an orbitel mobile telephone it contains 10 1.6Ah sub C batteries (42 x 22 dia. the size usually used in cordless screw-drivers etc.) the pack is new and unused and can be broken open quite easily  
£7.46 + VAT = £8.77



Please add £1.66 + vat = £1.95 postage & packing per order

## JPG Electronics

Shaws Row, Old Road, Chesterfield, S40 2RB.

Tel 01246 211202 Fax 01246 550959

Mastercard/Visa/Switch

Callers welcome 9.30 a.m. to 5.30 p.m. Monday to Saturday

# ADVERTISERS INDEX

ANTEX	745
AUDON ELECTRONICS	734
AUTOTRAX	773
N. R. BARDWELL	807
B.K. ELECTRONICS	Cover (iv)/776
BRUNNING SOFTWARE	735
BULL GROUP	Cover (ii)
CRICKLEWOOD ELECTRONICS	772
CROWNHILL ASSOCIATES	Cover (iii)
DISPLAY ELECTRONICS	730
ENERGISE TECHNOLOGY	807
EPT SOFTWARE	765
ESR ELECTRONIC COMPONENTS	738
FOREST ELECTRONIC DEVELOPMENTS	770
ICS	807
JPG ELECTRONICS	808
LABCENTER	749
MAGENTA ELECTRONICS	736/737
MATRIX MULTIMEDIA	776
MILFORD INSTRUMENTS	785
NATIONAL COLLEGE OF TECHNOLOGY	807
PAGM	761
PEAK ELECTRONIC DESIGN	769
PICO TECHNOLOGY	792
QUASAR ELECTRONICS	732/733
RD RESEARCH	789
RYKEL TECHNOLOGIES	772
SHERWOOD ELECTRONICS	808
SQUIRES	734
STEWART OF READING	734
WCN SUPPLIES	743

ADVERTISEMENT MANAGER: PETER J. MEW

ADVERTISEMENT OFFICES:

EVERYDAY PRACTICAL ELECTRONICS, ADVERTISEMENTS, MILL LODGE, MILL LANE, THORPE-LE-SOKEN, ESSEX CO16 0ED.

Phone/Fax: (01255) 861161

For Editorial address and phone numbers see page 739

# SHERWOOD ELECTRONICS

## FREE COMPONENTS

Buy 10 x £1 Special Packs and choose another one FREE

SP1	15 x 5mm Red LEDs	SP134	15 x 1N4007 diodes
SP2	12 x 5mm Green LEDs	SP135	6 x Miniature slide switches
SP3	12 x 5mm Yellow LEDs	SP136	3 x BFY50 transistors
SP6	15 x 3mm Red LEDs	SP137	4 x W005 1-5A bridge rectifiers
SP7	12 x 3mm Green LEDs	SP138	20 x 2/263V radial elect. caps.
SP8	10 x 3mm Yellow LEDs	SP140	3 x W04 1-5A bridge rectifiers
SP10	100 x 1N4148 diodes	SP142	2 x CMOS 4017
SP11	30 x 1N4001 diodes	SP143	5 Pairs min. crocodile clips (Red & Black)
SP12	30 x 1N4002 diodes	SP145	6 x ZTX300 transistors
SP18	20 x BC182 transistors	SP146	10 x 2N3704 transistors
SP20	20 x BC184 transistors	SP147	5 x Stripboard 9 strips x 25 holes
SP21	20 x BC212 transistors	SP151	4 x 8mm Red LEDs
SP23	20 x BC549 transistors	SP152	4 x 8mm Green LEDs
SP24	4 x CMOS 4001	SP153	4 x 8mm Yellow LEDs
SP25	4 x 555 timers	SP154	15 x BC548 transistors
SP26	4 x 741 Op.Amps	SP156	3 x Stripboard, 14 strips x 27 holes
SP28	4 x CMOS 4011	SP160	10 x 2N3904 transistors
SP29	3 x CMOS 4013	SP161	10 x 2N3906 transistors
SP34	20 x 1N914 diodes	SP165	2 x LF351 Op.Amps
SP36	25 x 10/25V radial elect. caps.	SP166	20 x 1N4003 diodes
SP37	12 x 100/35V radial elect. caps.	SP167	5 x BC107 transistors
SP39	10 x 470/16V radial elect. caps.	SP168	5 x BC108 transistors
SP40	15 x BC237 transistors	SP172	4 x Standard slide switches
SP41	20 x Mixed transistors	SP174	20 x 22/25V radial elect. caps
SP42	200 x Mixed 0-25W C.F. resistors	SP175	20 x 1/63V radial elect. caps.
SP47	5 x Min. PB switches	SP177	10 x 1A 20mm quick blow fuses
SP49	4 x 5 metres stranded core wire	SP182	20 x 4-7/63V radial elect. caps.
SP102	20 x 8-pin DIL sockets	SP183	20 x BC547 transistors
SP103	15 x 14-pin DIL sockets	SP187	15 x BC239 transistors
SP104	15 x 16-pin DIL sockets	SP189	4 x 5 metres solid core wire
SP105	4 x 74LS00	SP192	3 x CMOS 4066
SP109	15 x BC557 transistors	SP195	3 x 10mm Yellow LEDs
SP112	4 x CMOS 4093	SP197	6 x 20 pin DIL sockets
SP115	3 x 10mm Red LEDs	SP198	5 x 24 pin DIL sockets
SP116	3 x 10mm Green LEDs	SP199	5 x 2-5mm mono jack plugs
SP124	20 x Assorted ceramic disc caps	SP200	5 x 2-5mm mono jack sockets
SP126	6 x Battery clips - 3 ea. PP3 + PP9		
SP130	100 x Mixed 0-5W C.F. resistors		
SP131	2 x TL071 Op.Amp.		
SP133	20 x 1N4004 diodes		

### RESISTOR PACKS - C.Film

RP3	5 each value - total 365 0.25W	£3.10
RP7	10 each value - total 730 0.25W	£4.35
RP10	1000 popular values 0.25W	£6.25
RP4	5 each value-total 345 0.5W	£4.00
RP8	10 each value-total 690 0.5W	£6.65
RP11	1000 popular values 0.5W	£8.50

2003 Catalogue now available £1 inc. P&P or FREE with first order. P&P £1.50 per order. NO VAT

Orders to:  
**Sherwood Electronics,**  
7 Williamson St., Mansfield,  
Notts. NG19 6TD.

## EPE SUBSCRIPTIONS

Subscriptions for delivery direct to any address in the UK: 6 months £16.50, 12 months £31, two years £57; Overseas: 6 months £19.50 standard air service or £28.50 express airmail, 12 months £37 standard air service or £55 express airmail, 24 months £69 standard air service or £105 express airmail.

Cheques or bank drafts (in £ sterling only) payable to *Everyday Practical Electronics* and sent to *EPE* Subs. Dept., Wimborne Publishing Ltd., 408 Wimborne Road East, Ferndown, Dorset BH22 9ND. Tel: 01202 873872. Fax: 01202 874562. Email: [subs@epemag.wimborne.co.uk](mailto:subs@epemag.wimborne.co.uk). Also via the **Web** at <http://www.epemag.wimborne.co.uk>. Subscriptions start with the next available issue. We accept MasterCard, Amex, Diners Club, Switch or Visa. (For past issues see the Back Issues page.)

## ONLINE SUBSCRIPTIONS

Online subscriptions, for downloading the magazine via the Internet, \$10.99US (approx. £7) for one year available from [www.epemag.com](http://www.epemag.com).

## USA/CANADA SUBSCRIPTIONS

To subscribe to *EPE* from the USA or Canada please telephone Express Mag toll free on 1877 363-1310 and have your credit card details ready. Or fax (514) 355 3332 or write to Express Mag, PO Box 2769, Plattsburgh, NY 12901-0239 or Express Mag, 8155 Larney Street, Anjou, Quebec, H1J 2L5.

Email address: [expsmag@expressmag.com](mailto:expsmag@expressmag.com).

Web site: [www.expressmag.com](http://www.expressmag.com).

USA price \$60(US) per annum, Canada price \$88(Can) per annum - 12 issues per year.

*Everyday Practical Electronics*, periodicals pending, ISSN 0262 3617 is published twelve times a year by Wimborne Publishing Ltd., USA agent USACAN at 1320 Route 9, Champlain, NY 12919. Subscription price in US \$60(US) per annum. Periodicals postage paid at Champlain NY and at additional mailing offices. POSTMASTER: Send USA and Canada address changes to *Everyday Practical Electronics*, c/o Express Mag., PO Box 2769, Plattsburgh, NY, USA 12901-0239.

Published on approximately the second Thursday of each month by Wimborne Publishing Ltd., 408 Wimborne Road East, Ferndown, Dorset BH22 9ND. Printed in England by Apple Web Offset Ltd., Warrington, WA1 4RW. Distributed by COMAG Magazine Marketing, Tavistock Rd., West Drayton, UB7 7QE. Subscriptions INLAND: £16.50 (6 months); £31 (12 months); £57 (2 years). OVERSEAS: Standard air service, £19.50 (6 months); £37 (12 months); £69 (2 years). Express airmail, £28.50 (6 months); £55 (12 months); £105 (2 years). Payments payable to "Everyday Practical Electronics". Subs Dept, Wimborne Publishing Ltd. Email: [subs@epemag.wimborne.co.uk](mailto:subs@epemag.wimborne.co.uk). EVERYDAY PRACTICAL ELECTRONICS is sold subject to the following conditions, namely that it shall not, without the written consent of the Publishers first having been given, be lent, resold, hired out or otherwise disposed of by way of Trade at more than the recommended selling price shown on the cover, and that it shall not be lent, resold, hired out or otherwise disposed of in a mutilated condition or in any unauthorised cover by way of Trade or affixed to or as part of any publication or advertising, literary or pictorial matter whatsoever.

# PIC BASIC

Crownhill Associates

smart electronic solutions

The most cost effective solution to PIC programming and development - Ever!!

## Proton <sup>New Improved</sup> LET PIC BASIC

- ReWritten from the ground up
- Best Value For Money
- Most powerful entry level compiler
- 100% MPASM™ compatibility
- Windows™ 98, ME, 2000, NT & XP compliant
- Real-Time Syntax checking
- Integrated PIC Programmer driver
- Program with one keystroke
- View BASIC and the resulting Assembly
- Supplied with book "LET PIC BASIC Unleashed" by Les Johnson

Free Evaluation copy from:  
[www.picbasic.org](http://www.picbasic.org)

LET PIC BASIC £65.00

## Proton <sup>SMART</sup> ACCESS THE WORLD OF SMART CARDS

### PIC BASIC Smart Card Development system

Another First from Crownhill, access the world of SMART CARDS using PIC BASIC. This versatile development system provides a platform for the development of applications using SMART memory cards and SECURE memory cards. Detailed documentation describes all aspects of development using the sample cards supplied, source code and circuit diagrams are included.

- Includes card Reader Writer hardware and circuit
- Integrated Boot Loader - No programmer required
- Sample cards, Documentation
- Fully commented LICENSE FREE Source code

Proton Smart from £79.95

6 smart cards in stock over 20 types and 40,000 smart cards in stock over 20 types



2 x16 serial LCD display, supplied as a kit or ready assembled. PCB, PICmicro, LCD display, Circuit, LICENSE FREE commented source code

Proton LCD £16.95

## Proton <sup>PIC BASIC Plus</sup> v2

- Windows™ Integrated Development Environment
- Integrated serial bootloader software "program without a programmer!"
- Support for 12/14/18bit series devices
- Handles 32bit signed and unsigned variables (numbers up to ± 2147483647)
- Specific commands for on-chip peripherals
- Comprehensive command set
  - Tighter code generation than MBASIC
  - More functionality than MELABS PICBASIC Pro
  - More flexible than all BASIC Stamps
- Integrates directly into Proteus VSM - allows you to build a virtual circuit and see your BASIC code run in real-time - see [www.labcenter.co.uk](http://www.labcenter.co.uk)
- Easy macro Integration (includes Floating pointmath example)
- Aimed at graduates, and professionals, all code produced is LICENCE FREE

Free Evaluation copy from:  
[www.picbasic.org](http://www.picbasic.org)

Crownhill PIC BASICv2 £125.00

## Proton <sup>NET</sup> PIC BASIC / InterNet Development System

The worlds First PIC BASIC InterNet development system allowing PIC BASIC projects to communicate across the WORLD via the InterNet. Development board includes RS232, Ethernet Interface and dedicated controller, LCD, Prototype area, Power supply and full documentation.

Proton Net £169.95

Visit [www.picbasic.org](http://www.picbasic.org) for comprehensive details of these and other PIC BASIC products, including:



Full range of DEVELOPMENT boards, incl Graphics LCD's and Audio



[www.labcenter.co.uk](http://www.labcenter.co.uk)  
Proteus VSM Fully supported by PICBASIC Plus



Infra RED TX and Rx development system, with experiments and source code

All prices subject to Postage Packing and VAT

All major credit cards accepted, telephone, web or mail order.

www.picbasic.org  
Old Station Yard, Station Road, Wilburton, Cambs. CB6 3PZ, UK Tel: +44 (0) 1353 749990 Fax: +44 (0) 1353 749991



**POWER AMPLIFIER MODULES-LOUDSPEAKERS-MIXERS  
19 INCH STEREO AMPLIFIERS-ACTIVE CROSS/OVERS.**

\* PRICES INCLUDE V.A.T.  
\* PROMPT DELIVERY

**OMP MOS-FET POWER AMPLIFIERS  
HIGH POWER, TWO CHANNEL 19 INCH RACK**

10,000's  
SOLD  
TO PRO  
USERS



**THE RENOWNED MXF SERIES OF POWER AMPLIFIERS**

FOUR MODELS:- MXF200 (100W + 100W) MXF400 (200W + 200W)  
MXF600 (300W + 300W) MXF900 (450W + 450W)

ALL POWER RATINGS ARE R.M.S. INTO 4 OHMS, WITH BOTH CHANNELS DRIVEN  
FEATURES:- \* Independent power supplies with two toroidal transformers.  
\* Twin L.E.D. Vu Meters \* Level controls \* Illuminated on/off switch \* Jack / XLR inputs.  
Speaker Outputs \* Standard 775mv inputs \* Open and Short circuit proof \* Latest Mos-Fets  
for stress free delivery into virtually any load \* High slew rate \* Very low distortion \* Aluminium  
cases \* MXF600 & MXF900 fan cooled with D.C. Loudspeaker and thermal protection.

USED THE WORLD OVER IN CLUBS, PUBS, CINEMAS, DISCOS ETC

SIZES:-	MXF200 W19"	D11"	H3 1/2"	(2U)
	MXF400 W19"	D12"	H5 1/4"	(3U)
	MXF600 W19"	D13"	H5 1/4"	(3U)
	MXF900 W19"	D14"	H5 1/4"	(3U)

PRICES:- MXF200 £175.00 MXF400 £233.85  
MXF600 £329.00 MXF900 £449.15  
SPECIALIST CARRIER DEL £12.50 Each



**FLIGHTCASED  
LOUDSPEAKERS**

A new range of quality loudspeakers, designed to take advantage of latest loudspeaker technology and enclosure designs. All models utilise high quality studio cast aluminium loudspeakers with factory fitted grilles, wide dispersion constant directivity horns, extruded aluminium corner protection and steel ball corners, complimented with heavy duty black covering. The enclosures are fitted as standard with top hats for optional loudspeaker stands. The FC15-300 incorporates a large 16 X 6 inch horn. All cabinets are fitted with the latest Speakon connectors for your convenience and safety. Five models to choose from.

WEDGE MONITOR



PLEASE NOTE:- POWER RATINGS  
QUOTED ARE IN WATTS R.M.S. FOR  
EACH INDIVIDUAL CABINET ALL  
ENCLOSURES ARE 8 OHMS

15=15 Inch speaker  
12=12 Inch speaker

- ibl FC15-300 WATTS Freq Range 35Hz-20kHz, Sens 101dB, Size H695 W502 D415mm Price:- £299.00 per pair
- ibl FC12-300 WATTS Freq Range 45Hz-20kHz, Sens 96dB, Size H600 W405 D300mm Price:- £249.00 per pair
- ibl FC12-200 WATTS Freq Range 40Hz-20kHz, Sens 97dB, Size H600 W405 D300mm Price:- £199.00 per pair
- ibl FC12-100 WATTS Freq Range 45Hz-20kHz, Sens 100dB, Size H546 W380 D300mm Price:- £179.00 per pair
- ibl WM12-200 WATTS Freq Range 40Hz-20kHz, Sens 97dB, Size H418 W600 D385mm Price:- £125.00 Each

SPECIALIST CARRIER DEL:- £12.50 per pair, wedge monitor £7.00 each  
Optional Metal Stands PRICE:- £49.00 per pair Delivery:- £6.00

**OMP X03-S STEREO 3 WAY ACTIVE CROSSOVER**

SWITCHABLE 2-WAY



**FEATURES:-**  
Advanced 3-Way Stereo Active Cross-Over (Switchable two way), housed in a 19" x 1U case. Each channel has three level controls: Bass, Mid & Top. The removable front fascia allows access to the programmable DIL switches to adjust the cross-over frequency. There are two versions available: X03-S Bass-Mid 125/250/500Hz, Mid-Top 1.8/3/5kHz, all at 24 dB per octave. X03 Bass-Mid 250/500/800Hz, Mid-Top 1.8/3/5kHz, all at 24 dB per Octave. Please make sure you ask for the correct model when ordering. The 2/3 way selector switches are also accessed by removing the front fascia. Each stereo channel can be configured separately. Bass Invert Switches are incorporated on each channel. Nominal 775mV input/output. Fully compatible with the OMP Rack Amplifier and Modules.

BOTH MODELS PRICED AT :- £117.44 + £5.00 P&P

**OMP MOS-FET POWER AMPLIFIER MODULE**

SUPPLY RACK  
BUILT AND TESTED

These modules now enjoy a world-wide reputation for quality, reliability and performance at a realistic price. Four models are available to suit the needs of the professional and hobby market i.e. Industry, Leisure, Instrumental and Hi-Fi etc. When comparing prices, NOTE that all models include toroidal power supply, integral heatsink, glass fibre P.C.B. and drive circuits to power a compatible Vu meter. All models are open and short circuit proof.

**THOUSANDS OF MODULES PURCHASED BY PROFESSIONAL USERS**

- OMP/MF 100 Mos-Fet Output Power 110 watts R.M.S. into 4 ohms, frequency response 1Hz - 100kHz -3dB, Damping Factor >300, Slew Rate 45V/uS, T.H.D. typical 0.002%, Input Sensitivity 500mV, S.N.R. 110dB. Size 300 x 123 x 60mm. Price:- £42.85 + £4.00 P&P
- OMP/MF 200 Mos-Fet Output Power 200 watts R.M.S. into 4 ohms, frequency response 1Hz - 100kHz -3dB, Damping Factor >300, Slew Rate 50V/uS, T.H.D. typical 0.001%, Input Sensitivity 500mV, S.N.R. 110dB. Size 300 x 155 x 100mm. Price:- £66.35 + £4.00 P&P
- OMP/MF 300 Mos-Fet Output Power 300 watts R.M.S. into 4 ohms, frequency response 1Hz - 100kHz -3dB, Damping Factor >300, Slew Rate 60V/uS, T.H.D. typical 0.001%, Input Sensitivity 500mV, S.N.R. 110dB. Size 330 x 175 x 100mm. Price:- £83.75 + £5.00 P&P
- OMP/MF 450 Mos-Fet Output Power 450 watts R.M.S. into 4 ohms, frequency response 1Hz - 100kHz -3dB, Damping Factor >300, Slew Rate 75V/uS, T.H.D. typical 0.001%, Input Sensitivity 500mV, S.N.R. 110dB. Fan Cooled, D.C. Loudspeaker Protection, 2 Second Anti Thump Delay. Size 385 x 210 x 105mm. Price:- £135.85 + £6.00 P&P
- OMP/MF 1000 Mos-Fet Output Power 1000 watts R.M.S. into 2 ohms, frequency response 1Hz - 100kHz -3dB, Damping Factor >300, Slew Rate 75V/uS, T.H.D. typical 0.001%, Input Sensitivity 500mV, S.N.R. 110dB. Fan Cooled, D.C. Loudspeaker Protection, 2 Second Anti Thump Delay. Size 422 x 300 x 125mm. Price:- £261.00 + £12.00 P&P

NOTE: MOS-FET MODULES ARE AVAILABLE IN TWO VERSIONS:  
STANDARD - INPUT SENS 500mV/BANDWIDTH 100kHz OR PEC  
(PROFESSIONAL EQUIPMENT COMPATIBLE) - INPUT SENS  
775mV, BANDWIDTH 50kHz ORDER STANDARD OR PEC

**CATALOGUE 2001-2002**

Robots  
Test Tools  
Electronic Kits  
The Sky's The Limit  
Catalogue  
Communication  
Security  
Accessories

**B.K. Electronics**  
Unit 1, Comet Way, Southend-on-Sea, Essex, SS2 6TR  
Tel:- 01702-527572 Fax:- 01702-420243  
Email:- sales@bkelec.com  
Web Site:- www.bkelec.com

FREE Over Sky  
over 3000 items  
The catalogue is free with every order, or you can order a copy with  
and to personal orders of £10.00 to cover P&P if ordered by post.  
This is a fully refundable gift, your choice of any item in the catalogue.

**100 WATT ACTIVE SUB BASS AMPLIFIER PANEL**



AN ACTIVE SUB BASS AMPLIFIER WITH A TRUE 100W RMS OUTPUT. SUPERB CONSTRUCTION WITH THE FACILITIES TO INTEGRATE SEAMLESSLY INTO MOST HI-FI OR HOME CINEMA SETUPS. USE THIS PANEL PLUS ONE OF OUR LOUDSPEAKERS TO MAKE YOUR OWN SUB WOOFER THAT WILL MATCH OR BEAT MOST COMMERCIALY AVAILABLE SUB WOOFERS.

FEATURES:- \* 100W RMS INTO 8 OHMS \* HIGH AND LOW LEVEL INPUTS \* TOROIDAL TRANSFORMER \* SHORT CIRCUIT PROTECTION \* D.C. SPEAKER PROTECTION \* FREQUENCY ROLL OFF, LOWER 10Hz, UPPER 60Hz TO 240Hz (FULLY ADJUSTABLE) \* AC3 COMPATIBLE FILTER CAN BE BYPASSED FOR 5-1 FORMATS. \* AIRTIGHT CONSTRUCTION \* TENS OF THOUSANDS OF OUR PANELS ALREADY IN USE. \* COMPLETE WITH LEADS

SPECIFICATIONS:- \* POWER 100W RMS @ 8 OHMS \* FREQ RESP. 10Hz 15kHz -3dB \* DAMPING FACTOR >200 \* DISTORTION 0.05% \* S/N A WEIGHTED >100dB \* SUPPLY 230V A.C. \* WEIGHT 2.7Kg \* SIZE H254 X W254 X D94mm

THERE ARE 2 VERSIONS OF THE ABOVE PANEL AVAILABLE :-BSB100/8 8 OHM VERSION BSB100/4 4 OHM VERSION BOTH PANELS ARE PRICED AT £117.44 + £5.00 P&P INCL. V.A.T. CHECK WEBSITE FOR PANELS UP TO 500W

DELIVERY CHARGES:- PLEASE INCLUDE AS ABOVE, TO A MAXIMUM AMOUNT £30.00. OFFICIAL ORDERS FROM SCHOOL, COLLEGES, GOVT. PLCs ETC. PRICES INCLUSIVE OF V.A.T. SALES COUNTER, CREDIT CARD ORDERS ACCEPTED BY POST PHONE OR FAX.



**B.K. ELECTRONICS**

REF D5

UNIT 1 COMET WAY, SOUTHEND-ON-SEA, ESSEX. SS2 6TR.  
TEL:- 01702-527572 FAX:- 01702-420243  
Web:- <http://www.bkelec.com> E-Mail sales@bkelec.com