

THE No.1 MAGAZINE FOR ELECTRONICS TECHNOLOGY & COMPUTER PROJECTS

EVERYDAY

SEPTEMBER 2003

PRACTICAL

ELECTRONICS

£3.10

PIC-A-COLOUR

Pit your wits against a mastermind



VIBRATION ALARM

**Versatile
inexpensive
project**

PRIORITY REFEREE

Who was first?

PLUS

USING THE PIC's "HIGH" OPERATOR

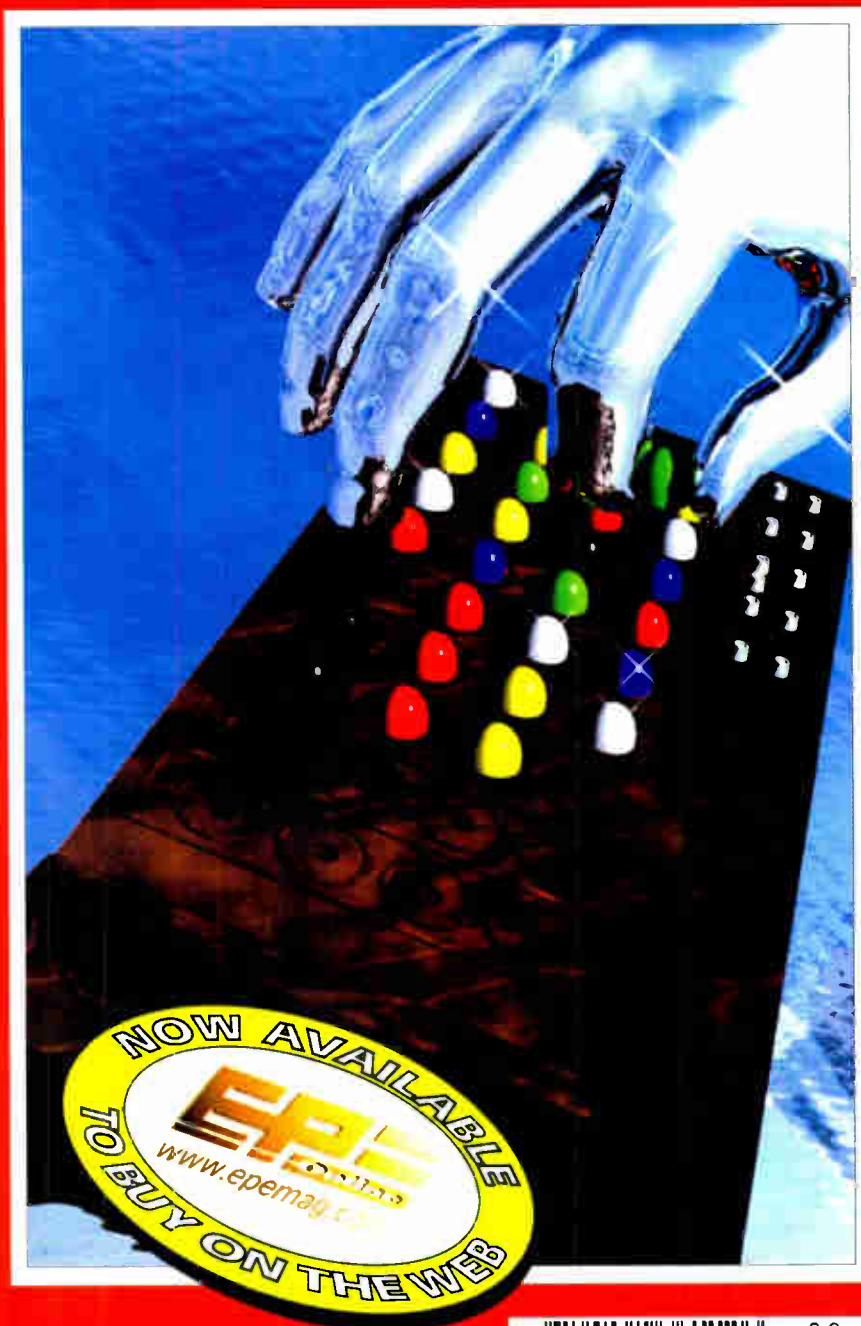

<http://www.epemag.wimborne.co.uk>

World Radio History

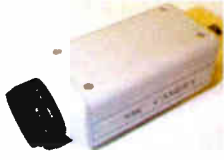

Colour CCTV camera, 8mm lens, 12V d.c. 200mA 582x628 Resolution 380 lines Automatic aperture lens Mirror function PAL Back Light Compensation MLR. 100x40x40mm. Ref EE2 £69

Built-in Audio .15lux CCD camera 12V d.c. 200mA 480 lines s/n ratio >48db 1V P-P output 110mm x 60mm x 50mm. Ref EE1 £99



Metal CCTV camera housings for internal or external use. Made from aluminium and plastic they are suitable for mounting body cameras in. Available in two sizes 1 - 100 x 70 x 170mm and 2 - 100 x 70 x 280mm. Ref EE6 £22 EE7 £26 multi-position brackets. Ref EE8 £8



Excellent quality multi-purpose TV/TFT screen, works as just a LCD colour monitor with any of our CCTV cameras or as a conventional TV. Ideal for use in boats and caravans 49-7MHz-91-75MHz VHF channels 1-5, 168-25MHz-222.75MHz VHF channels 6-12, 471.25MHz-869-75MHz, Cable channels 112-325MHz-166-75MHz Z1-Z7, Cable channels 224-25MHz-446-75MHz Z8-Z35 5" colour screen. Audio output 150mW. Connections, external aerial, earphone jack, audio/video input, 12V d.c. or mains. Accessories supplied Power supply, Remote control, Cigar lead power supply, Headphone Stand/bracket. 5" model £139 Ref EE9, 6" model £149. Ref EE10



Fully cased IR light source suitable for CCTV applications. The unit measures 10 x 10 x 150mm, is mains operated and contains 54 infra-red LEDs. Designed to mount on a standard CCTV camera bracket. The unit also contains a daylight sensor that will only activate the infra-red lamp when the light level drops below a preset level. The infra-red lamp is suitable for indoor or exterior use, typical useage would be to provide additional IR illumination for CCTV cameras. £49. Ref EE11



Self-cocking pistol pcr002 crossbow with metal body. Self-cocking for precise string alignment Aluminium alloy construction High tec fibre glass limbs Automatic safety catch Supplied with three bolts Track style for greater accuracy. Adjustable rear sight 50lb drawweight 150ft sec velocity Break action 17" string 30m range £21.65 Ref PLCR002



Mains operated and designed to be used with any CCTV camera causing it to scan. The clips can be moved to adjust the span angle, the motor reversing when it detects a clip. With the clips removed the scanner will rotate constantly at approx 2.3rpm. 75 x 75 x 80mm £23. Ref EE12

Colour CCTV Camera measures 60x45mm and has a built-in light level detector and 12 IR LEDs 0.2 lux 12 IR LEDs 12V d.c. Bracket Easy connect leads £69. Ref EE15



A high quality external colour CCTV camera with built-in infra-red LEDs measuring 60 x 60 x 60mm Easy connect leads colour Waterproof PAL 1/4in. CCD 542 x 588 pixels 420 lines 0.05 lux 3.6mm F2.8 deg lens 12V d.c. 400mA Built-in light level sensor. £99. Ref EE13

Colour pinhole CCTV camera module with audio. Compact, just 20x20x20mm, built-in audio and easy connect leads PAL CMOS sensor 6-9V d.c. Effective Pixels 628x582 Illumination 2 lux Definition >240 Signal/noise ratio >40db Power consumption 200mW £35. Ref EE15



A small colour CCTV camera measuring just 35 x 28 x 30mm. Supplied complete with bracket, microphone and easy connect leads. Built-in audio. Colour 380 line resolution PAL 0.2 lux +18db sensitivity. Effective pixels 628 x 582 Power source 6-12V d.c. Power consumption 200mW £36. Ref EE16

Complete wireless CCTV system with video. Kit comprises pinhole colour camera with simple battery connection and a receiver with video output, 380 lines colour 2.4GHz 3 lux 6-12V d.c. manual tuning Available in two versions, pinhole and standard. £79 (pinhole) Ref EE17, £79 (standard). Ref EE18



Small transmitter designed to transmit audio and video signals on 2.4GHz. Unit measures 45 x 35 x 10mm. Ideal for assembly into covert CCTV systems Easy connect leads Audio and video input 12V d.c. Complete with aerial Selectable channel switch £30. Ref EE19



2.4GHz wireless receiver Fully cased audio and video 2.4GHz wireless receiver 190x140x30mm, metal case, 4 channel, 12V d.c. Adjustable time delay. 4s, 8s, 12s, 16s. £45. Ref EE20

The smallest PMR446 radios currently available (54x87x37mm). These tiny handheld PMR radios not only look great, but they are user friendly & packed with features including VOX, Scan & Dual Watch. Priced at £59.99 PER PAIR they are excellent value for money. Our new favourite PMR radios! Standby: - 35 hours Includes: - 2 x Radios, 2 x Belt Clips & 2 x Carry Strap £59.95 Ref ALAN1 Or supplied with 2 sets of rechargeable batteries and two mains chargers £84.99. Ref Alan2



Beltronics BEL550 Euro radar and GATSO detector Claired Detection Range: GATSO up to 400m. Radar & Laser guns up to 3 miles. Detects GATSO speed cameras at least 200 metres away, plenty of time to adjust your speed £319. Ref BEL550

The TENS mini Microprocessors offer six types of automatic programme for shoulder pain, back/neck pain, aching joints, Rheumatic pain, migraines headaches, sports injuries, period pain. In fact all over body treatment. Will not interfere with existing medication. Not suitable for anyone with a heart pacemaker. Batteries supplied. £19.95 Ref TEN327 Spare pack of electrodes £5.99. Ref TEN327X



Dummy CCTV cameras These motorised cameras will work either on 2 AA batteries or with a standard DC adapter (not supplied) They have a built-in movement detector that will activate the camera if movement is detected causing the camera to 'pan' Good deterrent. Camera measures 20cm high, supplied with fixing screws. Camera also has a flashing red l.e.d. built in. £9.95. Ref CAMERAB

INFRA-RED FILM 6" square piece of flexible infra-red film that will only allow IR light through. Perfect for converting ordinary torches, lights, headlights etc to infra-red output using standard light bulbs Easily cut to shape. 6" square £15. Ref IRF2 or a 12" sq for £29 IRF2A



GASTON SEALED LEAD-ACID BATTERIES
1-3AH 12V @ £5 REF GT1213
3-4AH 12V @ £8 REF GT1234
7AH 12V @ £8 REG FT127
17AH 12V @ £18 REF GT1217

All new and boxed, bargain prices. Good quality sealed lead-acid batteries

SOLAR PANEL 10 watt silicon solar panel, at least 10 year life, 365 x 26mm, waterproof, ideal for fixing to caravans, boat, motorhomes etc. Nicely made unit with fixing holes for secure fittings. Complete with leads and connectors. Anodised frame. Supplied with two leads, one 3M lead is used for the o/p with two croc clips, the other lead is used to connect extra panels. Panels do NOT require a blocking diode, they can be left connected at all times without discharging the battery. £84.99 REF PAN
8A solar regulator 12V, 96 watt, 150mm x 100mm x 25mm. £28. REF SOLREG2



High-power modules (80W+) using 125mm square multi-crystal silicon solar cells with bypass diode. Anti-reflection coating and BSF structure to improve cell conversion efficiency; 14%. Using white tempered glass, EVA resin, and a weatherproof film along with an aluminium frame for extended outdoor use, system Lead wire with waterproof connector. Four sizes, 80W 12V dc, 1200 x 530 x 35mm, £287. REF NE80, 123W 12V d.c., 1499 x 662 x 46mm, £439. REF NDL3, 125W 24V, 1190 x 792 x 46mm, £439. REF NEL5 and 165W 24V, 157 x 826 x 46mm, £593.

THE TIDE CLOCK. These clocks indicate the state of the tide. Most areas in the world have two high tides and two low tides a day, so the tide clock has been specially designed to rotate twice each lunar day (every 12 hours and 25 minutes) giving you a quick and easy indication of high and low water. The Quartz tide clock will always stay calibrated to the moon. £21 REF TIDEC



LINEAR ACTUATORS 12-36V D.C. BUILT-IN ADJUSTABLE LIMIT SWITCHES. POWER COATED 18in THROW UP TO 1,000lb. THRUST (400lb. RECOMMENDED LOAD). SUPPLIED WITH MOUNTING BRACKETS DESIGNED FOR OUTDOOR USE. These brackets originally made for moving very large satellite dishes are possibly more suitable for closing gates, mechanical machinery, robot wars etc. Our first sale was to a company building solar panels that track the sun! Two sizes available, 12in. and 18in. throw. £29.95. REF ACT12, £34.95 REF ACT18.



POWERSAFE DEEP CYCLE BATTERIES
12V 51AH. NOW ONLY £29.95 EACH
YUASA 6V 100AH NOW ONLY £19 EACH



BRAND NEW MILITARY ISSUE DOSE METERS (radiation detectors). Current NATO issue. Standard emergency services unit. Used by most of the world's military personnel. New and boxed. £69. REF SIEM69

NIGHT VISION SYSTEM. Superb hunting rifle sight to fit most rifles, grooved for a telescopic sight. Complete with infra-red illuminator. Magnification 2-7x. Complete with rubber eye shield and case. Opens up a whole new world! Russian made. Can be used as a hand held or mounted on a rifle. £99. REF PN1



These Samarium magnets measure 57mm x 20mm and have a threaded hole (5/16th UNF) in the centre and magnetic strength of 2-2 gauss. We have tested these on a steel beam running through the offices and found that they will take more than 170lb. (77kg) in weight before being pulled off. With keeper. £19.95. REF MAG77.

Peltier Effect heat pump. Semiconductor thermo-electric device which works on the Peltier effect. When supplied with a suitable electric current, can either cool or heat. Also when subject to an externally applied temperature gradient can produce an electric current. Ideal for cooling or controlling the temperature of sub assemblies. Each module is supplied with a comprehensive 18-page Peltier design manual featuring circuit designs, design information etc., etc. The Peltier manual is also available separately. Maximum watts 56-2 40 x 40mm lmax, 5.5A Vmax, 16.7 Tmax (c-dry N2), 72. £29.95 (inc manual. REF PELT1. Just manual £4 REF PELT2.



New transmitter, receiver and camera kit. £69. Kit contains four channel switchable camera with built-in audio, six IR l.e.d.s and transmitter, four channel switchable receiver, 2 power supplies, cables, connectors and mounting bracket. £69. Wireless Transmitter, Black and white camera (75 x 50 x 55mm). Built-in 4 channel transmitter (switchable). Audio built-in

6 IR l.e.d.s. Bracket/stand. Power supply 30m range Wireless Receiver 4 channel (switchable). Audio/video leads and scart adapter. Power supply and manual, £69. REF COP24

This miniature Stirling Cycle Engine measures 7in. x 4in. and comes complete with built-in alcohol burner. Red flywheels and chassis mounted on a green base, these all-metal beauties silently running at speeds in excess of 1,000 r.p.m. attract attention and create awe wherever displayed. This model comes completely assembled and ready to run. £97. REF SOL!

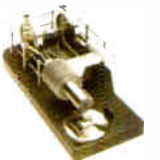

BULL GROUP LTD
UNIT D, HENFIELD BUSINESS PARK,
HENFIELD, SUSSEX BN9 9SL
TERMS: CASH, PO, CHEQUE PRICES + VAT
WITH ORDER PLUS £5.50 P&P (UK) PLUS VAT.
24 HOUR SERVICE £7.50 (UK) PLUS VAT.
OVERSEAS ORDERS AT COST PLUS £3.50
Tel: 0870 7707520 Fax 01273 491813
Sales@bullnet.co.uk
www.bullnet.co.uk

SHOP ONLINE
WWW.BULLNET.CO.UK

ISSN 0262 3617

PROJECTS ... THEORY ... NEWS ...
COMMENTS ... POPULAR FEATURES ...

VOL. 32. No. 9 SEPTEMBER 2003

Cover illustration by jgr22

EVERYDAY PRACTICAL ELECTRONICS

INCORPORATING ELECTRONICS TODAY INTERNATIONAL

www.epemag.wimborne.co.uk

EPE Online: www.epemag.com

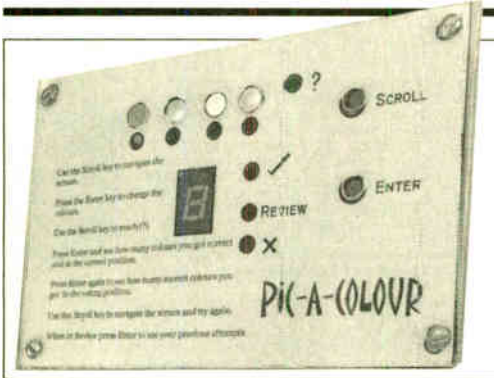

Projects and Circuits

- PIC-A-COLOUR** by Nick Dossis 596
PIC your wits against a colourful code-setting master mind!
- INGENUITY UNLIMITED - Sharing your Ideas with others** 606
Thermal Charge Monitor; Infra-red Body Detector; Divider Feedback
- VIBRATION ALARM** by Owen Bishop 609
Guards your property by sounding an alarm if moved - another in our occasional Top Terner series of simple low-cost circuits.
- PRIORITY REFEREE** by Owen Bishop 614
Fair play is ensured with this novel quiz monitor - another simple Top Terner circuit
- EPE PIC MET OFFICE - Part 2** by John Becker 625
Concluding our totally solid-state alternative to sea-weed and proverbs!
- PRACTICAL RADIO CIRCUITS - Part 4. Tuning systems, coils and coil packs for general coverage and the amateur bands** 640
by Raymond Haigh
More practical circuits for the set builder and experimenter

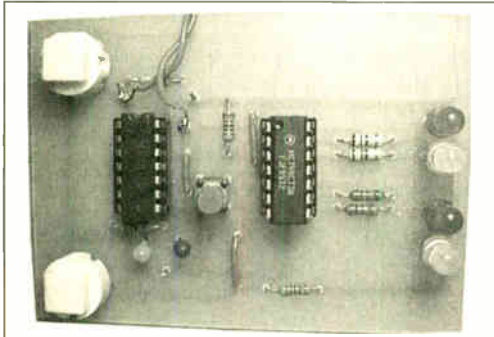

Series and Features

- TECHNO TALK** by Andy Emmerson 602
More Connected homes - the brass tacks about networked domestic automation and entertainment
- NEW TECHNOLOGY UPDATE** by Ian Poole 618
A new hypersonic sound system is set to revolutionise the audio industry
- CIRCUIT SURGERY** by Alan Winstanley and Ian Bell 622
Continuing our introduction to SPICE simulation software
- USING THE PIC'S "HIGH" OPERATOR** by Malcolm Wiles 634
Simpler programming for segmented PIC architectures
- PRACTICALLY SPEAKING** by Robert Penfold 648
A novice's guide to the tools needed for electronics construction
- NET WORK - THE INTERNET PAGE** surfed by Alan Winstanley 650
Broadband - will BT's coverage ever be universal?



Regulars and Services

- EDITORIAL** 595
- NEWS** - Barry Fox highlights technology's leading edge 604
Plus everyday news from the world of electronics
- SHOPTALK** with David Barrington 612
The *essential* guide to component buying for EPE projects
- BACK ISSUES** Did you miss these? Many now on CD-ROM! 616
- READOUT** John Becker addresses general points arising 620
- CD-ROMS FOR ELECTRONICS** 636
A wide range of CD-ROMs for hobbyists, students and engineers
- PRINTED CIRCUIT BOARD AND SOFTWARE SERVICE** 651
PCBs for EPE projects. Plus EPE project software
- DIRECT BOOK SERVICE** 652
A wide range of technical books available by mail order, plus more CD-ROMs
- ADVERTISERS INDEX** 656

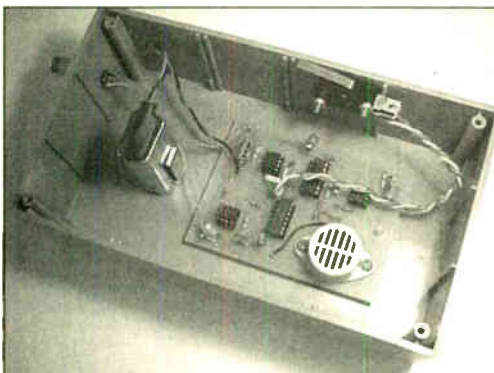

© Wimborne Publishing Ltd 2003. Copyright in all drawings, photographs and articles published in EVERYDAY PRACTICAL ELECTRONICS is fully protected, and reproduction or imitations in whole or in part are expressly forbidden.

Our October 2003 issue will be published on Thursday, 11 September 2003. See page 587 for details

Readers Services • Editorial and Advertisement Departments 595

Visit our website
www.distel.co.uk

THE ORIGINAL SURPLUS WONDERLAND!

THIS MONTH'S SELECTION FROM OUR VAST EVER CHANGING STOCKS

Surplus always
wanted for cash!

GIANT 10" 7-SEGMENT DISPLAYS

A bulk purchase enables us to bring to you these GIANT 7-segment digital displays at a now affordable price! The 10" character size gives exceptional readability at long distances and enables a host of applications including, score boards, digital clocks, counters, event timers etc. As the units are a simple electro-mechanical device and operate from 12V DC, simple switching via switches, relays, PIC or PC may be used to control single or multiple digits. Units feature integral Zero Power memory which greatly simplifies design. For an excellent DIY practical article, see the May issue of 'Everyday Practical Electronics' magazine. Ideal School / College construction project. Supplied in good RFE condition, complete with data sheet.



Less than 30%
of makers price
Only £29.95(B) or 4 / £99.00(D)
Order RW44 Order PH26

THE AMAZING TELEBOX



TV SOUND &
VIDEO TUNER
CABLE COMPATIBLE

Converts your colour monitor into a QUALITY COLOUR TV!!

The TELEBOX is an attractive fully cased mains powered unit, containing all electronics ready to plug into a host of video monitors or AV equipment which are fitted with a composite video or SCART input. The composite video output will also plug directly into most video recorders, allowing reception of TV channels not normally available on most television receivers* (TELEBOX MB). Push button controls on the front panel allow reception of 8 fully tuneable off air UHF colour television channels. TELEBOX MB covers virtually all television frequencies VHF and UHF including the HYPERBAND as used by most cable TV operators. Ideal for desktop computer video systems & PIP (picture in picture) setups. For complete compatibility - even for monitors without sound - an integral 4 watt audio amplifier and low level Hi Fi audio output are provided as standard. Brand new - fully guaranteed.

TELEBOX ST for composite video input type monitors £36.95
TELEBOX STL as ST but fitted with integral speaker £39.50
TELEBOX MB Multiband VHF/UHF/Cable/Hyperband tuner £69.95
For overseas PAL versions state 5.5 or 6 mhz sound specification.
*For cable / hyperband signal reception Telebox MB should be connected to a cable type service. Shipping on all Teleboxes, code (B)

NEW State of the art PAL (UK spec) UHF TV tuner module with composite 1V pp video & NICAM hi fi stereo sound outputs. Micro electronics all on one small PCB only 73 x 160 x 52 mm enable full tuning control via a simple 3 wire link to an IBM pc type computer. Supplied complete with simple wiring program and documentation. Requires +12V & +5V DC to operate.
BRAND NEW - Order as MY00. Only £39.95 code (B)
See www.distel.co.uk/data_my00.htm for picture & full details

HARD DISK DRIVES 2 1/2" - 14"

2 1/2" TOSHIBA MK1002MAV 1.1Gb laptop (12.5 mm H) New £59.95
2 1/2" TOSHIBA MK4313MAT 4.3Gb laptop (8.2 mm H) New £105.00
2 1/2" TOSHIBA MK6409MAV 6.1Gb laptop (12.7 mm H) New £98.00
2 1/2" TOSHIBA MK1614GAV 18 Gb laptop (12 mm H) New £149.95
2 1/2" to 3 1/2" conversion kit for PCs, complete with connectors £15.95
3 1/2" FUJII FK-309-26 20mb MFH V/F RFE £59.95
3 1/2" CONNER CP3024 20 mb IDE I/F (or equiv.) RFE £59.95
3 1/2" CONNER CP3044 40 mb IDE I/F (or equiv.) RFE £69.00
3 1/2" QUANTUM 40S Prodril v 42mb SCSI I/F, New RFE £49.00
5 1/4" MINISCRIBE 3425 20mb MFH V/F (or equiv.) RFE £49.95
5 1/4" SEAGATE ST-238R 30 mb RLL V/F Refurb £69.95
5 1/4" CDC 94205-51 40mb HH MFH V/F RFE tested £69.95
5 1/4" HP 97548 850 Mb SCSI RFE tested £99.00
5 1/4" HP C3010 2 Gbyte SCSI differential RFE tested £195.00
8" NEC D2246 85 Mb SMD interface. New £99.00
8" FUJITSU M2322K 160Mb SMD V/F RFE tested £195.00
8" FUJITSU M2392K 2 Gb SMD V/F RFE tested £345.00
Many other floppy & H drives, IDE, SCSI, ESDI etc from stock, see website for full stock list. Shipping on all drives is code

TEST EQUIPMENT & SPECIAL INTEREST ITEMS

MITSUBISHI FA3445ETKL 14" Ind. spec SVGA monitors £245
FARNELL 0-60V DC @ 50 Amps, bench Power Supplies £995
FARNELL AP3080 0-30V DC @ 80 Amps, bench Supply £1850
KINGSHILL CZ403/1 0-50V @ DC 200 Amps - NEW £3950
1KW to 400 kW - 400 Hz 3 phase power sources - ex stock £POA
IBM 8230 Type 1, Token ring base unit driver £760
Wayne Kerr RA200 Audio frequency response analyser £2500
INFODISC I.U., 24 port, RJ45 network patchpanels. #TH93 £49
3COM 16670 12 Port Ethernet hub - RJ45 connectors #LD97 £59
3COM 16671 24 Port Ethernet hub - RJ45 connectors £99
3COM 16700 8 Port Ethernet hub - RJ45 connectors NEW £39
IBM 53F5501 Token Ring ICS 20 port toke module £POA
IBM MAU Token ring distribution panel 8228-23-5050N £45
AIM 501 Low distortion Oscillator 9Hz to 330KHz, IEEE I/O £550
ALLGON 8360.11805-1880 MHz hybrid power combiners £250
Trend DSA 274 Data Analyser with G703(2M) 64 i/o £POA
Marconi 6310 Programmable 2 to 22 GHz sweep generator £4500
Marconi 2022C 10KHz-1GHz RF signal generator £1550
HP1650B Logic Analyser £3750
HP3781A Pattern generator & HP3782A Error Detector £POA
HP6621A Dual Programmable GPIB PSU 0-7 V 160 watts £1800
HP6264 Rack mount variable 0-20V @ 20A metered PSU £475
HP54112A DC to 22 GHz four channel test set £POA
HP18130A opt 0 to 200 MHz pulse generator, GPIB etc £7900
HP A1, A0 8 pen HPGL High speed drum plotters - from HP DRAFTMASTER 18 pen high speed plotter £550
EG-G Brookdale 95035C Precision logic in amp £1800
Keithley 590 CV capacitor / voltage analyser £POA
Recal ICR40 dual 40 channel video recorder system £3750
Fliskers 45KVA 3 ph On Line UPS - New batteries £4500
Emerson AP130 2.5KVA industrial spec.UPS £1499
Mann Tally MT645 High speed line printer £2200
Intel SBC 486/133SE Multibus 486 system, 8Mb Ram £945

IC's - TRANSISTORS - DIODES

OBSOLETE - SHORT SUPPLY - BULK
10,000,000 items EX STOCK
For MAJOR SAVINGS
CALL or see web site www.distel.co.uk

COMPUTER MONITOR SPECIALS

Legacy products
High spec genuine multisync.
CGA, EGA, VGA, SVGA

Mitsubishi FA3415ETKL 14" SVGA Multisync colour monitor with fine 0.28 dot pitch tube and resolution of 1024 x 768. A variety of inputs allows connection to a host of computers including IBM PC's in CGA, EGA, VGA & SVGA modes, BBC, COMMODORE (including Amiga 1200), ARCHIMEDES and APPLE. Many features: Etched faceplate, text switching and LOW RADIATION MPP specification. Fully guaranteed, in EXCELLENT little used condition. Tilt & Swivel Base £4.75

VGA cable for IBM PC included. Order as CG73
Only £129 (E)

General cables for other types of computers available - CALL

Generic LOW COST SVGA Monitors

We choose the make, which includes Compaq, Mitsubishi, IBM, etc. Supplied ready to run with all cables, Standard RTB 90 day guarantee.

14"	15"	17"
£59.00	£69.00	£79.00

Supplied in good used condition. Shipping code (D)

VIDEO MONITORS

PHILIPS HCS35 (same style as CM8833) attractively styled 14" colour monitor with both RGB and standard composite 15.625 KHz video inputs via SCART socket and separate phono jacks. Integral audio power amp and speaker for all audio visual uses. Will connect direct to Amiga and Atari BBC computers. Ideal for all video monitoring / security applications with direct connection to most colour cameras. High quality with many features such as front concealed flap controls, VCR correction button etc. Good used condition - fully tested - guaranteed
Dimensions: W14" x H12 3/4" x 15 1/2" D. Only £99.00 (E)

PHILIPS HCS31 Ultra compact 9" colour video monitor with standard composite 15.625 KHz video input via SCART socket. Ideal for all monitoring / security applications. High quality, ex-equipment fully tested & guaranteed (possible minor screen burns). In attractive square black plastic case measuring W10" x H10" x 13 1/2" D. 240 V AC mains powered.
Only £79.00 (D)

INDUSTRIAL COMPUTERS

Tiny shoebox sized industrial 40 Mhz 386 PC system measuring only (mm) 266 w x 88 h x 272 d. Ideal for dedicated control applications running DOS, Linux or even Windows / Steel case contains 85 to 265 V AC 50 / 60 Hz 70 Watt PSU, a 3 slot ISA passive backplane and a Rocky 318 (PC104) standard, single board computer with 8 MByte NON VOLATILE solid state 'Disk On Chip' RAMDISK. System comprises: Rocky 318 (PC104) SBC ISA card with 40MHz ALI 386SX CPU, 72 pin SIMM slot with 16 MByte SIMM, AMI BIOS, battery backed up real time clock, 2 x 9 pin D 16550 serial ports, EPP/ECP printer port, mini DIN key board connector, floppy port, IDE port for hard drives up to 528 MByte capacity, watchdog timer and PC/104 bus socket. The 8 MByte solid state 'disk on a chip' has its own BIOS, and can be fished, formatted & booted. Supplied BRAND NEW fully tested and guaranteed. For full data see featured item on website. Order as CG28

100's of applications inc:
firewall, routers, robotics etc
Only £99.00 (D)

Unless marked NEW, items in this section are pre owned.

HP6030A 0-200V DC @ 17 Amps bench power supply £1950
Intel SBC 486/1250C Enhanced Multibus (MSA) New £1150
Nikon HF-X11 (Ephiphot) exposure control unit £1450
PHILIPS PM5518 pro. tv signal generator £1250
Motorola VME Bus Boards & Components List. SAE / CALL £POA
EPOA
Trilo 0-18 vdc linear, metered 30 amp bench PSU. New £550
Fujitsu M3041R 600 LPM high speed band printer £1950
Fujitsu M3041D 600 LPM printer with network interface £1250
Siemens K4400 64Kb to 140Kb demux analyser £2950
Perkin Elmer 299B Infrared spectrophotometer £500
Perkin Elmer 597 Infrared spectrophotometer £3500
VG Electronics 1035 TELETEXT Decoding Margin Meter £3250
LightBand 60 output high spec 2u rack mount Video VDA's £495
Sekonik SD 150H 18 channel digital Hybrid chart recorder £1995
B&K 2633 Microphone pre amp £300
Taylor Hobson Tallysur amplifier / recorder £750
ADC SS200 Carbon dioxide gas detector / monitor £1450
BBC AM203 PPM Meter (Ernest Turner) + drive electronics £75
ANRITSU 9654A Optical DC-2.5Gb waveform monitor £5650
ANRITSU ML93A optical power meter £990
ANRITSU Fibre optic characteristic test set £POA
R&S FTDZ Dual sound unit £650
R&S SBUF-E1 Vision monitor £775
WILTRON 6630B 12.4 / 20GHz RF sweep generator £5750
TEK 2445 150 MHz 4 trace oscilloscope £1250
TEK 2465 300 MHz 300 MHz oscilloscope rack mount £1955
TEK TD5380 400MHz digital realtime + disk drive, FFT etc £2900
TEK TDS524A 500MHz digital realtime + colour display etc £5100
HP3585A Opt 907 20Hz to 40 MHz spectrum analyser £3950
PHILIPS PW1730/10 60KV XRAY generator & accessories £POA
VARIACS - Large range from stock - call or see our website
CLAIRE CLYONS 12A 240V single phase auto. volt. regs £325

19" RACK CABINETS

Europe's Largest Stocks of
quality rack cabinets,
enclosures and accessories.
Over 1000 Racks from stock

This month's special
33 / 42 / 47 U - High Quality
All steel Rack Cabinets



Made by Eurocraft Enclosures Ltd to the highest possible spec, rack features all steel construction with removable side, front and back doors. Front and back doors are hinged for easy access and all lockable with five secure 5 lever barrel locks. The front door is constructed of double walled steel with a designer style smoked acrylic front panel to enable status indicators to be seen through the panel, yet remain unobtrusive. Internally the rack features fully slotted reinforced vertical fixing members to take the heaviest of 19" rack equipment. The two movable vertical fixing struts (extras available) are pre punched for standard 'cage nuts'. A mains distribution panel internally mounted to the bottom rear, provides 8 x IEC 3 pin Euro sockets and 1 x 13 amp 3 pin switched utility socket. Overall ventilation is provided by fully louvered back door and double skinned top section with top and side louvers. The top panel may be removed for fitting of integral fans to the sub plate etc. Other features include: fitted castors and floor levelers, pre-punched utility panel at lower rear for cable / connector access etc. Supplied in excellent, slightly used condition with keys. Colour Royal blue. some grey available - CALL - Can be supplied in many other configurations.

33U Order as BC44 External dimensions mm=1625H x 635D x 603 W. (64" H x 25" D x 23 3/4" W) Only £245	42U Order as DT20 External dimensions mm=2019H x 635D x 603 W. (79.5" H x 25" D x 23 3/4" W) Only £345	47U Order as RV36 External dimensions mm=2019H x 635D x 603 W. (89" H x 25" D x 23 3/4" W) Only £410
---	---	---

Call for shipping quotation

COLOUR CCD CAMERAS

Undoubtedly a miracle of modern technology & our special buying power! A quality product featuring a fully cased COLOUR CCD camera at a give away price! Unit features full autolight sensing for use in low light & high light applications.



A 10 mm fixed focus wide angle lens gives excellent focus and resolution from close up to long range. The composite video output will connect to any composite monitor or TV (via SCART socket) and most video recorders. Unit runs from 12V DC so ideal for security & portable applications where mains power not available. Overall dimensions 66 mm wide x 117 deep x 43 high. Supplied BRAND NEW & fully guaranteed with user data, 100's of applications including Security, Home Video, Web TV, Web Cams etc, etc.

Order as LK33 ONLY £79.00 or 2 for £149.00 (B)

SOFTWARE SPECIALS

NT4 WorkStation, complete with service pack 3 and licence - OEM packaged. ONLY £89.00 (B)
ENCARTA 95 - CDROM, Not the latest - but at this price! £7.95
DOS 5.0 on 3 1/2" disks with concise books & QBASIC £14.95
Windows for Workgroups 3.11 + Dos 6.22 on 3.5" disks £55.00
Windows 95 CDROM Only - No Licence - £19.95

Wordperfect 6 for DOS supplied on 3 1/2" disks with manual £24.95

SOLID STATE LASERS

Visible red, 670nm laser diode assembly. Unit runs from 5 V DC at approx 50 mA. Originally made for continuous use in industrial barcode scanners, the laser is mounted in a removable solid aluminium block, which functions as a heatsink and rigid optical mount. Dims of block are 50 w x 50 d x 15 h mm. Integral features include over temperature shutdown, current control, laser OK output, and gated TTL ON / OFF. Many uses for experimental optics, comms & lightshows etc. Supplied complete with data sheet.

Order as TD91 ONLY £24.95 (A)

DC POWER SUPPLIES

Virtually every type of power supply you can imagine. Over 10,000 Power Supplies Ex Stock - Call or see our web site.

RELAYS - 200,000 FROM STOCK

Save £££'s by choosing your next relay from our Massive Stocks covering types such as Military, Octal, Cradle, Hermetically Sealed, Continental, Contactors, Time Delay, Reed, Mercury Wetted, Solid State, Printed Circuit Mounting etc., CALL or see our web site www.distel.co.uk for more information. Many obsolete types from stock. Save £££'s



ALL MAIL TO
Dept PE, 29 / 35 Osborne Rd
Thornton Heath
Surrey CR7 8PD
Open Mon - Fri 9.00 - 5.30

18 Million Items On Line Now!
Secure ordering, Pictures, Information
www.distel.co.uk
email = admin@distel.co.uk

ALL ENQUIRIES
0208 653 3333
FAX 0208 653 8888

All prices for UK Mainland. UK customers add 17.5% VAT to TOTAL order amount. Minimum order £10. Bona Fide account orders accepted from Government, Schools, Universities and Local Authorities - minimum account order £50. Cheques over £100 are subject to 7 working days clearance. Carriage charges (A)=£3.50, (B)=£6.50, (C)=£10, (D)=£15.00, (E)=£18.00, (F)=CALL. Allow approx 3 days for shipping - faster CALL. All goods supplied to our Standard Conditions of Sale which can be viewed at our website and unless stated guaranteed for 90 days. All guarantees on a return to base basis. All rights reserved to change prices / specifications without prior notice. Orders subject to stock. Discounts for volume. Top CASH prices paid for surplus goods. All trademarks, tradenames etc acknowledged. © Display Electronics 2002. E & O E..

NEXT MONTH

CAR WARS

Take a few switches and l.e.d.s. a couple of logic i.c.s and a handful of other components plus two inexpensive radio controlled cars and you have yourself Car Wars. It's a bit like Robot Wars without the expense or the destruction.

Two competitors each control a car with three lives, if you can hit the pushswitch on the side of your opponent's car three times with your car, then their car "dies". Of course, they will be trying to do the same to you.

Once a competitor has "killed" the opponent, just press the reset switch on the top of each car to start again. It's addictive and great fun. We show you how next month.



SERIAL INTERFACE FOR PICS AND VB6

Many PIC project developers would like to be able to interface their designs with Visual Basic via the PC's serial port, but encounter several difficulties. The principal one is that not all versions of VB allow access to the MSCOMM Active-X serial communications control function.

The other problem is that serial port voltages can vary considerably from PC to PC, and these voltages need to be converted to standard TTL voltage levels to enable connection to a PIC.

This project provides a two-fold solution to the problems. Firstly, a small circuit board is described that allows safe interfacing between a PC and a PIC, or other digital design. Secondly, and importantly, a freeware Active-X (OCX control) software component suitable for use with all versions of Visual Basic 6 is provided and its use described. This software allows the developer complete access to the serial port and its pins and is compatible with all current versions of Microsoft Windows, namely 95, 98, ME, NT4, 2000 and XP. It can be used with other designs without the interface board.

SPOOKY BUG

This is one of those novelty projects that leave the constructor with full scope to use their imagination and skill. The essential idea is that the circuit is made to look like a fearsome (or perhaps foolish) bug. In the light, the bug just stands there looking fearsome (or foolish). As soon as the light level falls below the preset level, the eyes of the bug start to glow and it emits a weird wailing sound. This continues until the light is switched on again. This is only one of several possible applications for this circuit, some bug-related, some not – you could even spook up that Halloween pumpkin!

PIC BREAKPOINT

A PIC program debugging tool that allows your PC to display all PIC register contents at as many selected stages of a program's development as required. The software has been written specifically for use with EPE PIC Toolkit TK3, which has been upgraded to include it as a standard facility from version V1.5.

PLUS PRACTICAL RADIO CIRCUITS – PART 5

NO ONE DOES IT BETTER

EVERYDAY
PRACTICAL
ELECTRONICS

**DON'T MISS AN
ISSUE – PLACE YOUR
ORDER NOW!**
Demand is bound to be high

ON SALE THURSDAY, SEPTEMBER 11



Quasar Electronics Limited
PO Box 6935, Bishops Cleeve, Nottingham
CM23 4WP
Tel: 0870 246 1826
Fax: 0870 460 1045
E-mail: sales@quasarelectronics.com

Add £2.00 P&P to all UK orders. 1st Class Recorded - £4.
Next day (insured £250) - £7. Europe - £5. Rest of World - £10.
We accept all major credit/debit cards. Make cheques/PO's
payable to Quasar Electronics Limited.
Prices include 17.5% VAT. MAIL ORDER ONLY.
Call now for our FREE CATALOGUE with details of over 300
high quality kits, projects, modules and publications.

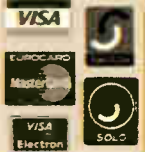

QUASAR 0871 CREDIT CARD SALES 717 7168
electronics
Helping you make the right connections!

PIC & ATMEL Programmers

We have a wide range of low cost PIC and ATMEL Programmers. Complete range and documentation available from our web site.

Programmer Accessories:

40-pin Wide ZIF socket (ZIF40W) £15.00
18VDC Power supply (PSU201) £5.95
Leads: Parallel (LEAD108) £4.95 / Serial (LEAD76) £4.95 / USB (LEADUAA) £4.95

NEW! USB 'All-Flash' PIC Programmer

USB PIC programmer for all 'Flash' devices. No external power supply making it truly portable. Supplied complete with 40-pin wide-slot ZIF socket, box and Windows Software.
Kit Order Code: 3128KT - £49.95
Assembled Order Code: AS3128 - £54.95



Enhanced "PICALL" ISP PIC Programmer

Will program virtually ALL 8 to 40 pin PICs plus certain ATMEL AVR, SCENIX SX and EEPROM 24C devices. Also supports In System Programming (ISP) for PIC and ATMEL AVRs. Free software. Blank chip auto detect for super fast bulk programming. Requires a 40-pin wide ZIF socket (not included)
Kit Order Code: 3144KT - £54.95
Assembled Order Code: AS3144 - £59.95



ATMEL 89xxxx Programmer

Uses serial port and any standard terminal comms program. 4 LED's display the status. ZIF sockets not included. Supply: 16VDC.
Kit Order Code: 3123KT - £29.95
Assembled Order Code: AS3123 - £34.95



NEW! USB & Serial Port PIC Programmer

USB/Serial connection. Ideal for field use. Header cable for ICSP. Free Windows software. Call or see website for PICs supported. ZIF socket not incl. 18VDC.
Kit Order Code: 3149KT - £29.95
Assembled Order Code: AS3149 - £44.95

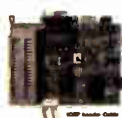

Introduction to PIC Programming

Go from a complete PIC beginner to burning your first PIC and writing your own code in no time! Includes a 49 page step-by-step Tutorial Manual, Programming Hardware (with LED bench testing section), Win 3.11-XP Programming Software (will Program, Read, Verify & Erase), and a rewritable PIC16F84A that you can use with different code (4 detailed examples provided for you to learn from). Connects to PC parallel port.
Kit Order Code: 3081KT - £14.95
Assembled Order Code: AS3081 - £24.95



ABC Mini Microcontroller Board

Currently learning about microcontrollers? Need to do more than flash a LED or sound a buzzer? The ABC Mini Starter Kit is based on ATMELs AVR 8535 RISC technology and will interest both the beginner and expert alike. Beginners will find that they can write and test a simple program, using the BASIC programming language, within an hour or two of connecting it up. Experts will like the power and flexibility of the ATMEL microcontroller, as well as the ease with which the board can be "designed-in" to a project. The ABC Mini STARTER PACK includes everything you need to get up and experimenting right away. On the hardware side, there's a pre-assembled ABC Mini Board with parallel and serial cables for connection to your PC. Windows software included on CD-ROM features an Assembler, BASIC compiler and in-system programmer.
Order Code ABCMINISP - £54.95
The ABC Mini boards only can also be purchased separately at £34.95 each.



ABC Mini Starter Pack

Controllers & Loggers

Here are just a few of the controller and data acquisition and control units we have. See website for full details. Suitable PSU for all units: Order Code PSU203 £9.95

Rolling Code 4-Channel UHF Remote

State-of-the-Art. High security. 4 channels. Momentary or latching relay output. Range up to 40m. Up to 15 Tx's can be learnt by one Rx (kit includes one Tx but more available separately). 4 indicator LED's. Rx: PCB 77x85mm, 12VDC/6mA (standby). Two & Ten Channel versions also available.
Kit Order Code: 3180KT - £41.95
Assembled Order Code: AS3180 - £49.95



Computer Temperature Data Logger

Serial port 4-channel temperature logger. °C or °F. Continuously logs up to 4 separate sensors located 200m+ from board. Wide range of free software applications for storing/using data. PCB just 38x38mm. Powered by PC. Includes one DS1820 sensor and four header cables.
Kit Order Code: 3145KT - £22.95
Assembled Order Code: AS3145 - £29.95
Additional DS1820 Sensors - £3.95 each



NEW! DTMF Telephone Relay Switcher

Call your phone number using a DTMF phone from anywhere in the world and remotely turn on/off any of the 4 relays as desired. User settable Security Password, Anti-Tamper, Rings to Answer, Auto Hang-up and Lockout. Includes plastic case. 130 x 110 x 30mm. Power: 12VDC.
Kit Order Code: 3140KT - £39.95
Assembled Order Code: AS3140 - £59.95



Serial Port Isolated I/O Module

Computer controlled 8 channel relay board. 5A mains rated relay outputs and 4 opto-isolated digital inputs (for monitoring switch states, etc). Useful in a variety of control and sensing applications. Programmed via serial port (use our new Windows interface, terminal emulator or batch files). Serial cable can be up to 35m long. Once programmed, unit can operate without PC. Includes plastic case 130x100x30mm. Power: 12VDC/500mA.
Kit Order Code: 3108KT - £54.95
Assembled Order Code: AS3108 - £64.95



Infrared RC 12-Channel Relay Board

Control 12 onboard relays with included infrared remote control unit. Toggle or momentary. 15m+ range. 112 x 122mm. Supply: 12VDC/0.5A
Kit Order Code: 3142KT - £41.95
Assembled Order Code: AS3142 - £59.95



PC Data Acquisition & Control Unit

Monitor and log a mixture of analogue and digital inputs and control external devices via the analogue and digital outputs. Monitor pressure, temperature, light intensity, weight, switch state, movement, relays, etc. with the appropriate sensors (not supplied). Data can be processed, stored and the results used to control devices such as motors, sirens, relays, servo motors (up to 11) and two stepper motors.



Features

- 11 Analogue Inputs - 0-5V, 10 bit (5mV/step)
- 16 Digital Inputs - 20V max. Protection 1K in series, 5.1V Zener
- 1 Analogue Output - 0-2.5V or 0-10V. 8 bit (20mV/step)
- 8 digital Outputs - Open collector, 500mA. 33V max
- Custom box (140x110x35mm) with printed front & rear panels.
- Windows software utilities (3.1 to XP) and programming examples.
- Supply: 12V DC (Order Code PSU203).

Kit Order Code: 3093KT - £69.95
Assembled Order Code: AS3093 - £99.95

Most items are available in kit form (KT suffix) or pre-assembled and ready for use (AS prefix).

Hot New Kits This Summer!

Here are a few of the most recent kits added to our range. See website or join our email Newsletter for all the latest news.

NEW! EPE Ultrasonic Wind Speed Meter



Solid-state design wind speed meter (anemometer) that uses ultrasonic techniques and has no moving parts and

does not need calibrating. It is intended for sports-type activities, such as track events, sailing, hang-gliding, kites and model aircraft flying, to name but a few. It can even be used to monitor conditions in your garden. The probe is pointed in the direction from which the wind is blowing and the speed is displayed on an LCD display.

Specifications

- Units of display: metres per second, feet per second, kilometres per hour and miles per hour
- Resolution: Nearest tenth of a metre
- Range: Zero to 50mph approx.

Based on the project published in *Everyday Practical Electronics*, Jan 2003. We have made a few minor design changes (see website for full details). Power: 9VDC (PP3 battery or Order Code **PSU203**). Main PCB: 50x83mm.

Kit Order Code: 3168KT - £34.95

NEW! Audio DTMF Decoder and Display



Detects DTMF tones via an on-board electret microphone or direct from the phone lines through an audio transformer. The

numbers are displayed on a 16 character, single line display as they are received. Up to 32 numbers can be displayed by scrolling the display left and right. There is also a serial output for sending the detected tones to a PC via the serial port. The unit will not detect numbers dialled using pulse dialling. Circuit is microcontroller based. Supply: 9-12V DC (Order Code **PSU203**). Main PCB: 55x95mm. Kit Order Code: 3153KT - £17.95
Assembled Order Code: AS3153 - £29.95

NEW! EPE PIC Controlled LED Flasher



This versatile PIC based LED or filament bulb flasher can be used to flash from

1 to 160 LEDs. The user arranges the LEDs in any pattern they wish. The kit comes with 8 super bright red LEDs and 8 green LEDs. Based on the *Versatile PIC Flasher* by Steve Challinor, *EPE Magazine* Dec 02. See website for full details. Board Supply: 9-12VDC. LED supply: 9-45VDC (depending on number of LED used). PCB: 43x54mm. Kit Order Code: 3169KT - £10.95

Most items are available in kit form (KT suffix) or assembled and ready for use (AS prefix).

FM Bugs & Transmitters

Our extensive range goes from discreet surveillance bugs to powerful FM broadcast transmitters. Here are a few examples. All can be received on a standard FM radio and have adjustable transmitting frequency.

MMTX' Micro-Miniature 9V FM Room Bug



Our best selling bug! Good performance. Just 25x15mm. Sold to detective agencies worldwide. Small enough to hide just about anywhere.

Operates at the 'less busy' top end of the commercial FM waveband and also up into the more private Air band. Range: 500m. Supply: PP3 battery. Kit Order Code: 3051KT - £8.95
Assembled Order Code: AS3051 - £14.95

HPTX' High Power FM Room Bug

Our most powerful room bug.



Very impressive performance. Clear and stable output signal thanks to the extra circuitry employed. Range: 1000m @ 9V. Supply: 6-12V DC (9V PP3 battery clip supplied). 70x15mm. Kit Order Code: 3032KT - £9.95
Assembled Order Code: AS3032 - £17.95

MTTX' Miniature Telephone Transmitter



Attach anywhere along phone line. Tune a radio into the signal and hear exactly what both parties are saying. Transmits only when phone is used. Clear, stable signal. Powered from phone line so completely maintenance free once installed. Requires no aerial wire - uses phone line as antenna. Suitable for any phone system worldwide. Range: 300m. 20x45mm. Kit Order Code: 3016KT - £7.95
Assembled Order Code: AS3016 - £13.95

4 Watt FM Transmitter



Small, powerful FM transmitter. Audio preamp stage and three RF stages deliver 4 watts of RF power. Can be used

with the electret microphone supplied or any line level audio source (e.g. CD or tape OUT, mixer, sound card, etc). Aerial can be an open dipole or Ground Plane. Ideal project for the novice wishing to get started in the fascinating world of FM broadcasting. 45x145mm. Kit Order Code: 1028KT - £22.95
Assembled Order Code: AS1028 - £34.95

25 Watt FM Transmitter

Four transistor based stages with a Philips BLY89 (or equivalent) in the final stage. Delivers a mighty 25 Watts of RF power. Accepts any line level audio source (input sensitivity is adjustable). Antenna can be an open dipole, ground plane, 5/8, J, or YAGI configuration. Supply 12-14V DC, 5A. Supplied fully assembled and aligned - just connect the aerial, power and audio input. 70x220mm. Order Code: 1031M - £124.95



QUASAR
electronics

Helping you make the right connections!

**CREDIT
CARD
SALES**
0871
717
7168

Electronic Project Labs

Great introduction to the world of electronics. Ideal gift for budding electronics expert!

500-in-1 Electronic Project Lab

This is the top of the range and is a complete electronics course taking you from beginner to A level standard and beyond! It contains all the parts and instructions to assemble 500 projects. You get three comprehensive course books (total 368 pages) - *Hardware Entry Course*, *Hardware Advanced Course* and a micro-computer based *Software Programming Course*. Each book has individual circuit explanations, schematic and assembly diagrams. Suitable for age 12 and above. Order Code EPL500 - £149.95



30, 130 - 200 and 300-in-1 project labs also available - see website for details.

Number 1 for Kits!

With over 300 projects in our range we are the UK's number 1 electronic kit specialist. Here are a few other kits from our range.

- 1046KT—25W Stereo Car Booster £26.95
- 3087KT—1W Stereo Amplifier £4.95
- 3105KT—18W BTL Mono Amplifier £9.95
- 3106KT—50W Mono Hi-fi Amplifier £19.95
- 3143KT—10W Stereo Amplifier £9.95
- 1011KT—Motorbike Alarm £11.95
- 1019KT—Car Alarm System £10.95
- 1048KT—Electronic Thermostat £9.95
- 1080KT—Liquid Level Sensor £5.95
- 3005KT—LED Dice with Box £7.95
- 3006KT—LED Roulette Wheel £8.95
- 3074KT—8-Ch PC Relay Board £29.95
- 3082KT—2-Ch UHF Relay £26.95
- 3126KT—Sound Activated Relay £7.95
- 3063KT—One Chip AM Radio £10.95
- 3102KT—4-Ch Servo Motor Driver £15.95
- 3160KT—PIC16F62x Experimenter £8.95
- 1096KT—3-30V, 5A Stabilised PSU £30.95
- 3029KT—Combination Lock £6.95
- 3049KT—Ultrasonic Detector £13.95
- 3130KT—Infrared Security Beam £12.95
- SG01MKT—Train Sounds £6.95
- SG10MKT—Animal Sounds £5.95
- 1131KT—Robot Voice Effect £8.95
- 3007KT—3V FM Room Bug £6.95
- 3028KT—Voice Activated FM Bug £12.95
- 3033KT—Telephone Recording Adpt £9.95
- 3112KT—PC Data Logger/sampler £18.95
- 3118KT—12-bit Data Acquisition Unit £52.95
- 3101KT—20MHz Function Generator £69.95

www.quasarelectronics.com

Secure Online Ordering Facilities • Full Product Listing, Descriptions & Photos • Kit Documentation & Software Downloads



EPE PIC RESOURCES CD-ROM



A companion to the EPE PIC Tutorial V2 series of Supplements (EPE April, May, June 2003)

ONLY £14.45

INCLUDING VAT and P&P

Contains the following Tutorial-related software and texts:

- EPE PIC Tutorial V2 complete demonstration software, John Becker, April, May, June '03
- PIC Toolkit Mk3 (TK3 hardware construction details), John Becker, Oct '01
- PIC Toolkit TK3 for Windows (software details), John Becker, Nov '01

Plus these useful texts to help you get the most out of your PIC programming:

- How to Use Intelligent L.C.D.s, Julyan Ilett, Feb/Mar '97
- PIC16F87x Microcontrollers (Review), John Becker, April '99
- PIC16F87x Mini Tutorial, John Becker, Oct '99
- Using PICs and Keypads, John Becker, Jan '01
- How to Use Graphics L.C.D.s with PICs, John Becker, Feb '01
- PIC16F87x Extended Memory (how to use it), John Becker, June '01
- PIC to Printer Interfacing (dot-matrix), John Becker, July '01
- PIC Magick Musick (use of 40kHz transducers), John Becker, Jan '02
- Programming PIC Interrupts, Malcolm Wiles, Mar/Apr '02
- Using the PIC's PCLATH Command, John Waller, July '02
- EPE StyloPIC (precision tuning musical notes), John Becker, July '02
- Using Square Roots with PICs, Peter Hemsley, Aug '02
- Using TK3 with Windows XP and 2000, Mark Jones, Oct '02
- PIC Macros and Computed GOTOs, Malcolm Wiles, Jan '03
- Asynchronous Serial Communications (RS-232), John Waller, unpublished
- Using I²C Facilities in the PIC16F877, John Waller, unpublished
- Using Serial EEPROMs, Gary Moulton, unpublished
- Additional text for EPE PIC Tutorial V2, John Becker, unpublished

NOTE: The PDF files on this CD-ROM are suitable to use on any PC with a CD-ROM drive. They require Adobe Acrobat Reader – included on the CD-ROM

Order on-line from
www.epemag.wimborne.co.uk/shopdoor.htm
 or www.epemag.com (USA \$ prices)
 or by Phone, Fax, Email or Post.

EPE PIC RESOURCES CD-ROM ORDER FORM

Please send me (quantity) EPE PIC RESOURCES CD-ROM

Price £14.45 each – includes postage to anywhere in the world.

Name

Address

.....

.....

..... Post Code

I enclose cheque/P.O./bank draft to the value of £

Please charge my Visa/Mastercard/Amex/Diners Club/Switch

£

Card No.

Card Security Code (The last 3 digits on or just under the signature strip)

Expiry Date Switch Issue No.

**SEND TO: Everyday Practical Electronics,
 Wimborne Publishing Ltd.,
 408 Wimborne Road East, Ferndown, Dorset BH22 9ND.
 Tel: 01202 873872. Fax: 01202 874562.
 Email: orders@epemag.wimborne.co.uk**

Payments must be by card or in £ Sterling – cheque or bank draft drawn on a UK bank.

Normally supplied within seven days of receipt of order.

Send a copy of this form, or order by letter if you do not wish to cut your issue.

BECOME A PIC WIZARD WITH THE HELP OF EPE!

Learn to Program in C with FED !

Free book provides complete introduction to C programming for the PIC

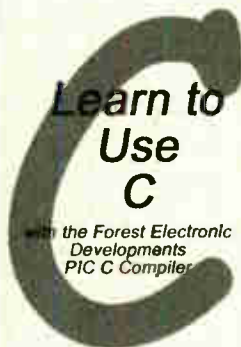

Our free book will take you through the process of learning C from variables through constants to pointers and then structures and unions. Most of the examples are standalone and are as small as possible to enable the purpose and effect to be easily understood. Nearly all can be run on our PIC C Compiler simulator so you can experiment quickly - but code can also be run on practically any C Compiler.

- Start to use C for the PIC – standard portable code with a standard syntax designed to be “close” to the processor for efficiency in size and speed
- Suitable for beginners or BASIC programmers
- Covers Comments and Statements, Variables and Constants, Expressions, Functions, Program Control, Pointers, Structures & Unions, and the Pre-processor.
- The final example is a comprehensive real time programming application showing the simultaneous use of LCD, keypads, timers, clocks and ports
- Examples will run on our development board
- Soft copy of examples provided - ready to run on the PIC C Compiler
- Examples will run on other C Compilers

Download Free of Charge – www.fored.co.uk/ccomp.htm (follow the link “Learn C with FED”)

FED – PIC C Compiler products

WIZ – C Visual Development for the FED PIC C Compiler

- An application designer for the FED PIC C Compiler FULLY including the PIC C Compiler
- Drag a software component on to your design & set up the parameters using check boxes, drop down boxes and edit boxes (see shot below)
- Connect the component to the PIC pins using the mouse
- Select your own C functions to be triggered when events occur (e.g. Byte received, timer overflow etc.)
- Simulate, Trace at up to 10x the speed of MPLAB
- Generate the base application automatically and then add your own functional code in C or assembler
- Supports over 80 PICS - 16F87x, 16F627/8, 16C55x, 16C6x, 16F8x, 16C7xx 18Cxx, 18Fxxx, 12F629/675 etc.
- Demonstration download available :

www.fored.co.uk/CDemo.htm

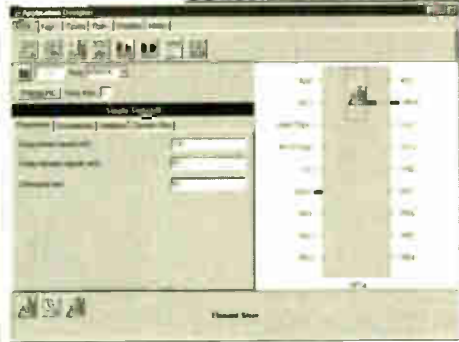

Screen shot (left) shows push button element connected to the PIC. Parameters may be set to control debounce and repeat. C function may be specified to call when the button is pressed

FED PIC C Compiler

- C Compiler designed to ANSI standards
- Supplied with library routines for C standard functions and many interface applications including I2C, LCD, LED's, timers, EEPROM, IRDA, Dallas 1 Wire, Hex Keypad, Maths, asynchronous serial interfacing, clocked data etc.
- With complete development/simulation environment including LCD/Keypad/LED/RS232 terminal
- View your simulation on a logic analyser application showing waveforms, timing or analogue results
- Profiler shows execution count, execution time and average time for functions and code blocks
- Smart linker – efficiently tiles routines throughout memory to minimise long jumps and page setting bits
- Supports the FED In Circuit Debugger for 16F87x and 18Fxx devices

WIZ-C and C Compiler Pricing :

PIC C Compiler	£60.00
PIC C Compiler Professional	£90.00
WIZ-C	£70.00
WIZ-C Professional	£100.00

WIZ-C products are provided with introductory tutorial. full extensive manuals provided on CD.

All prices may be reduced by £20.00 if the product is purchased at the same times as WIZ-ASM, or serial programmer, or our Development board.

In Circuit Debugger

Supports 16F87x and 18Fxxx



- Allows real hardware to be examined & programs to be debugged and to be run in real time on your application
- The FED ICD requires only one data I/O pin on the PIC which can be chosen from any of ports B, C or D.
- Can program and re-program applications in circuit
- Up to 13 breakpoints (18F version)
- Run, Animate, single step and step over, run to cursor line, set PC to any value in the program
- Trace execution in the original C or Assembler source files
- View and change values of PIC special function registers, W and the ports.
- Standard serial interface to PC

Programmers and Development Board

(See web pages)

PIC Programmer - Handles serially programmed PIC devices in a 40 pin multi-width ZIF socket. 16C55X, 16C6X, 16C7X, 16C8x, 16F62x, 16F8X, 12C508, 12C509, 16C72XPIC 14000, 16F87X, 18Cxxx, 18Fxxx, 12F6xx etc.

Also In-Circuit programming. Operates on PC serial port

Price : £45/kit, £50/built & tested

Development Board – For ALL 40 pin PICS from 16cxxx, 16Fxxx and 18C/Fxxx. Includes In-Circuit Programmer – NO separate programmer required. LCD interface, hex keypad, LED's and Driver, 32 I/O pins on header, I2C EEPROM, 2 Serial Interfaces, Will run FED PIC BASIC (supplied free on CD ROM), 1A 5V regulator etc.

The CD-ROM is supplied with FED PIC BASIC and Compiler

Price : £45/kit, £50/built & tested, CD - £5.00. Manual on CD-ROM or download free from our web site

Forest Electronic Developments
12 Buldowne Walk, Sway,
LYMINGTON, Hampshire. SO41 6DU
Email – info@fored.co.uk
Web Site – <http://www.fored.co.uk>
01590-681511 (Voice/Fax)



Prices : Please add £3.00 for P&P and handling to each order, and then EU residents add VAT at 17.5%. Cheques/POs payable to Forest Electronic Developments, phone with credit card details, or order from our secure web site

MAIL ORDER ONLY • CALLERS BY APPOINTMENT

EPE PROJECT PICS

Programmed PICs for *EPE Projects

12C508/9 - £3.90; 16F627/8 - £4.90

16C84/16F84/16C71 - £5.90

16F876/877 - £10.00

All inc. VAT and Postage

(*Some projects are copyright)

EPE MICROCONTROLLER P.I. TREASURE HUNTER

The latest MAGENTA DESIGN - highly stable & sensitive - with I.C. control of all timing functions and advanced pulse separation techniques.

- High stability drift cancelling
- Easy to build & use
- No ground effect, works in seawater



- Detects gold, silver, ferrous & non-ferrous metals

- Efficient quartz controlled microcontroller pulse generation.
- Full kit with headphones & all hardware

KIT 847£63.95

PIC PIPE DESCALER

- SIMPLE TO BUILD
- HIGH POWER OUTPUT
- AUDIO & VISUAL MONITORING
- SWEPT FREQUENCY

An affordable circuit which sweeps the incoming water supply with variable frequency electromagnetic signals. May reduce scale formation, dissolve existing scale and improve lathering ability by altering the way salts in the water behave.

Kit includes case, P.C.B., coupling coil and all components. High coil current ensures maximum effect. L.E.D. monitor.



KIT 868 £22.95 POWER UNIT.....£3.99

MICRO PEST SCARER

Our latest design - The ultimate scarer for the garden. Uses special microchip to give random delay and pulse time. Easy to build reliable circuit. Keeps pets/pests away from newly sown areas, play areas, etc. uses power source from 9 to 24 volts.

- RANDOM PULSES
- HIGH POWER
- DUAL OPTION



Plug-in power supply £4.99

KIT 867.....£19.99

KIT + SLAVE UNIT.....£32.50

WINDICATOR

A novel wind speed indicator with LED readout. Kit comes complete with sensor cups, and weatherproof sensing head. Mains power unit £5.99 extra.

KIT 856.....£28.00

★ TENS UNIT ★

DUAL OUTPUT TENS UNIT

As featured in March '97 issue.

Magenta have prepared a FULL KIT for this excellent new project. All components, PCB, hardware and electrodes are included. Designed for simple assembly and testing and providing high level dual output drive.

KIT 866. Full kit including four electrodes £32.90

Set of 4 spare electrodes £6.50

68000 DEVELOPMENT TRAINING KIT

- NEW PCB DESIGN
- 8MHz 68000 16-BIT BUS
- MANUAL AND SOFTWARE
- 2 SERIAL PORTS
- PIT AND I/O PORT OPTIONS
- 12C PORT OPTIONS

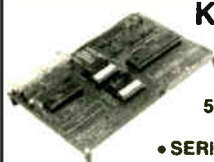

KIT 621 £99.95

- ON BOARD 5V REGULATOR
- PSU £6.99
- SERIAL LEAD £3.99

Stepping Motors

MD100...Std 100 step...£9.99

MD200...200 step...£12.99

MD24...Large 200 step...£22.95



1000V & 500V INSULATION TESTER

Superb new design. Regulated output, efficient circuit. Dual-scale meter, compact case. Reads up to 200 Megohms.

Kit includes wound coil, cut-out case, meter scale, PCB & ALL components.

KIT 848.....£32.95

EPE TEACH-IN 2000

Full set of top quality NEW components for this educational series. All parts as specified by EPE. Kit includes breadboard, wire, croc clips, pins and all components for experiments, as listed in introduction to Part 1.

*Batteries and tools not included.

TEACH-IN 2000 -

KIT 879 £44.95

MULTIMETER £14.45

SPACEWRITER

An innovative and exciting project. Wave the wand through the air and your message appears. Programmable to hold any message up to 16 digits long. Comes pre-loaded with "MERRY XMAS". Kit includes PCB, all components & tube plus instructions for message loading.

KIT 849.....£16.99

12V EPROM ERASER

A safe low cost eraser for up to 4 EPROMS at a time in less than 20 minutes. Operates from a 12V supply (400mA). Used extensively for mobile work - updating equipment in the field etc. Also in educational situations where mains supplies are not allowed. Safety interlock prevents contact with UV.

KIT 790.....£29.90

SUPER BAT DETECTOR

1 WATT O/P, BUILT IN SPEAKER, COMPACT CASE 20KHz-140kHz NEW DESIGN WITH 40kHz MIC.

A new circuit using a 'full-bridge' audio amplifier i.c., internal speaker, and headphone/tape socket. The latest sensitive transducer, and 'double balanced mixer' give a stable, high performance superheterodyne design.



KIT 861.....£24.99

ALSO AVAILABLE Built & Tested...£39.99

MOSFET MKII VARIABLE BENCH POWER SUPPLY 0-25V 2.5A

Based on our Mk1 design and preserving all the features, but now with switching pre-regulator for much higher efficiency. Panel meters indicate Volts and Amps. Fully variable down to zero. Toroidal mains transformer. Kit includes punched and printed case and all parts. As featured in April 1994 EPE. An essential piece of equipment.



Kit No. 845£64.95

ULTRASONIC PEST SCARER

Keep pets/pests away from newly sown areas, fruit, vegetable and flower beds, children's play areas, patios etc. This project produces intense pulses of ultrasound which deter visiting animals.

- KIT INCLUDES ALL COMPONENTS, PCB & CASE
- EFFICIENT 100V TRANSDUCER OUTPUT
- COMPLETELY INAUDIBLE TO HUMANS



- UP TO 4 METRES RANGE
- LOW CURRENT DRAIN

KIT 812.....£15.00

SIMPLE PIC PROGRAMMER

KIT 857... £12.99

Includes PIC16F84 chip disk, lead, plug, p.c.b., all components and instructions

Extra 16F84 chips £3.84 Power Supply £3.99

MAGENTA BRAINBOT I & II

- Full kit with ALL hardware and electronics
- As featured in *EPE* Feb '03 – KIT 910
- Seeks light, beeps, avoids obstacles
- Spins and reverses when 'cornered'
- Uses 8-pin PIC
- ALSO KIT 911 – As 910 PLUS programmable from PC serial port – leads and software CD provided

NEW



KIT 910 £16.99 KIT 911 £24.99

PIC 16F84 MAINS POWER 4-CHANNEL CONTROLLER & LIGHT CHASER

- ZERO VOLT SWITCHING
- OPTO ISOLATED 5 Amp
- 12 KEYPAD CONTROL
- HARD-FIRED TRIACS
- WITH SOURCE CODE
- SPEED & DIMMING POT.
- EASILY PROGRAMMED

Kit 855 £39.95

PIC 16F84 LCD DISPLAY DRIVER

INCLUDES 1-PIC16F84 WITH DEMO PROGRAM SOFTWARE DISK, PCB, INSTRUCTIONS AND 16-CHARACTER 2-LINE

LCD DISPLAY

Kit 860 £19.99

Power Supply £3.99

FULL PROGRAM SOURCE CODE SUPPLIED – DEVELOP YOUR OWN APPLICATION!

Another super PIC project from Magenta. Supplied with PCB, industry standard 2-LINE x 16-character display, data, all components, and software to include in your own programs. Ideal development base for meters, terminals, calculators, counters, timers – Just waiting for your application!

8-CHANNEL DATA LOGGER

As featured in Aug./Sept. '99 *EPE*. Full kit with Magenta redesigned PCB – LCD fits directly on board. Use as Data Logger or as a test bed for many other 16F877 projects. Kit includes programmed chip, 8 EEPROMs, PCB, case and all components.

KIT 877 £49.95 inc. 8 x 256K EEPROMS

ICEBREAKER

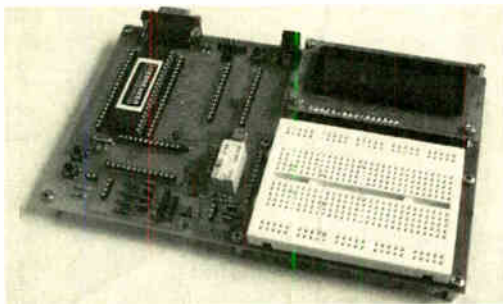

PIC Real Time In-Circuit Emulator

- Icebreaker uses PIC16F877 in circuit debugger
- Links to Standard PC Serial Port (lead supplied)
- Windows™ (95+) Software included
- Works with MPASM and MPLAB Microchip software
- 16 x 2 L.C.D., Breadboard, Relay, I/O devices and patch leads supplied

As featured in March '00 *EPE*. Ideal for beginners AND advanced users. Programs can be written, assembled, downloaded into the microcontroller and run at full speed (up to 20MHz), or one step at a time.

Full emulation means that all I/O ports respond exactly and immediately, reading and driving external hardware.

Features include: Reset; Halt on external pulse; Set Breakpoint; Examine and Change registers, EEPROM and program memory; Load program, Single Step with display of Status, W register, Program counter, and user selected 'Watch Window' registers.

KIT 900 ... £34.99

POWER SUPPLY £3.99 STEPPING MOTOR 100 STEP £9.99

EPE PIC TOOLKIT 3

NEW

- THE LATEST TOOLKIT BOARD – 8, 18, 28 AND 40-PIN CHIPS
- MAGENTA DESIGNED P.C.B. WITH COMPONENT LAYOUT AND EXTRAS
- L.C.D., BREADBOARD AND PIC CHIP INCLUDED
- ALL TOP QUALITY COMPONENTS AND SOFTWARE SUPPLIED

KIT 880 ... £34.99 with 16F84 ... £39.99 with 16F877

PIC TOOLKIT V2

- SUPER UPGRADE FROM V1 • 18, 28 AND 40-PIN CHIPS
- READ, WRITE, ASSEMBLE & DISASSEMBLE PICS
- SIMPLE POWER SUPPLY OPTIONS 5V-20V
- ALL SWITCHING UNDER SOFTWARE CONTROL
- MAGENTA DESIGNED PCB HAS TERMINAL PINS AND OSCILLATOR CONNECTIONS FOR ALL CHIPS
- INCLUDES SOFTWARE AND PIC CHIP

KIT 878 ... £22.99 with 16F84 ... £29.99 with 16F877

EPE PIC Tutorial

At last! A Real, Practical, Hands-On Series

- Learn Programming from scratch using PIC16F84
- Start by lighting I.e.d.s and do 30 tutorials to Sound Generation, Data Display, and a Security System.
- PIC TUTOR Board with Switches, I.e.d.s, and on board programmer

PIC TUTOR BOARD KIT

Includes: PIC16F84 Chip, TOP Quality PCB printed with Component Layout and all components* (*not ZIF Socket or Displays). Included with the Magenta Kit is a disk with Test and Demonstration routines.

KIT 870 £27.95, Built & Tested £42.95

Optional: Power Supply – £3.99, ZIF Socket – £9.99

LCD Display £7.99 LED Display £6.99

Reprints Mar/Apr/May 98 – £3.00 set 3

SUPER PIC PROGRAMMER

- READS, PROGRAMS, AND VERIFIES
- WINDOWS® SOFTWARE
- PIC16C AND 16F – 6X, 7X, AND 8X
- USES ANY PC PARALLEL PORT
- USES STANDARD MICROCHIP • HEX FILES
- OPTIONAL DISASSEMBLER SOFTWARE (EXTRA)
- PCB, LEAD, ALL COMPONENTS, TURNED-PIN SOCKETS FOR 18, 28, AND 40 PIN ICs

• SEND FOR DETAILED INFORMATION – A SUPERB PRODUCT AT AN UNBEATABLE LOW PRICE.

Kit 862 £29.99

Power Supply £3.99

DISASSEMBLER SOFTWARE £11.75

PIC STEPPING MOTOR DRIVER

INCLUDES PCB, PIC16F84 WITH DEMO PROGRAM, SOFTWARE DISC, INSTRUCTIONS AND MOTOR.

Kit 863 £18.99

FULL SOURCE CODE SUPPLIED ALSO USE FOR DRIVING OTHER POWER DEVICES e.g. SOLENOIDS

Another Magenta PIC project. Drives any 4-phase unipolar motor – up to 24V and 1A. Kit includes all components and 48 step motor. Chip is pre-programmed with demo software, then write your own, and re-program the same chip! Circuit accepts inputs from switches etc and drives motor in response. Also runs standard demo sequence from memory.

MAGENTA

All prices include VAT. Add £3.00 p&p. Next day £6.99

Tel: 01283 565435 Fax: 01283 546932 E-mail: sales@magenta2000.co.uk

092003



Station Road, Cullercoats, Tyne & Wear, NE30 4PQ

Prices Exclude Vat @17.5%. UK Carriage £1.50 (less than 1kg) £3.50 greater than 1kg

Cheques / Postal orders payable to ESR Electronic Components. PLEASE ADD CARRIAGE & VAT TO ALL ORDERS



See Next / Last Months Ad. for COMPONENT ACCESSORIES

4000 Series

Table listing electronic components for the 4000 Series, including part numbers, descriptions, and prices.

74LS Series

Table listing electronic components for the 74LS Series, including part numbers, descriptions, and prices.

74 Series

Table listing electronic components for the 74 Series, including part numbers, descriptions, and prices.

Linear ICs

Table listing linear integrated circuit components, including part numbers, descriptions, and prices.

74LS Series

Table listing electronic components for the 74LS Series, including part numbers, descriptions, and prices.

74LS Series

Table listing electronic components for the 74LS Series, including part numbers, descriptions, and prices.

Main table listing various electronic components such as RAM, A/D Converters, Voltage Regulators, Diodes, and Transistors, with columns for part numbers, descriptions, and prices.

Table listing Bridge Rectifiers, Thyristors, Triacs, and Diacs, with columns for part numbers, descriptions, and prices.

Table listing various electronic components including resistors, capacitors, and other parts, with columns for part numbers, descriptions, and prices.

Quality Components. No surplus or redundant stock. All from leading manufactures.

Quality Service. Sameday despatch on all stock items. Friendly helpful staff.

Fast Delivery. Nextday service for all small (<1kg) orders at no extra charge. 3 day service for orders >1kg

No Minimum Order. Order what you need, no pack quantities or min order value.

Quantity Discounts Available. We offer discounts for all items subject to quantity required, phone, fax or email for a quote.

We carry a large range of capacitors in stock, including: Ceramic Mini Disc, Dipped Ceramic Multilayer, Dipped & Boxed Polyester, Mylar Film, Polyester, Film, MKT Polyester, Tantalum Bead, Sub-miniature Radial, 105°C Radial, Low Leakage Rectifier, Non-Polarised Radial & Axial, PCB Can Electrolytics, Polypropylene & Ceramic Trimmers and Tuning capacitors. Full technical details available.

Resistors - Please State Value Required. 100 of one value only. 1/2W Carbon Film 5%, 12 Series 10Ω-1M0, £0.02 Each, £0.80 per 100. 1/4W Carbon Film 5%, 12 Series 10Ω-1M0, £0.02 Each, £0.60 per 100. 1/2W Metal Film 1%, 24 Series 10Ω-1M, £0.04 Each, £1.72 per 100. 1/4W Carbon Film 5%, 12 Series 10Ω-1M0, £0.02 Each, £0.95 per 100. 2.5W Wirewound 5%, 12 Series 0Ω1-220Ω, £0.23 Each.

Preset Resistors - Please State Value Required. Enclosed, 10mm Square Horiz / Vert. 100Ω-1M0 0.15W, £0.12 Each. Ceramic, 10mm Dia, Horizontal. 100Ω-1M0 0.1W, £0.09 Each. Sub-min, 6mm Dia, Horizontal. 100Ω-1M0 0.1W, £0.12 Each. Multiturn, 10mm Square, Top Adjust. £3 100Ω-1M0 0.5W, £0.81 Each. Multiturn, 19mm Long, End Adjust. £3 500Ω-1M0 0.5W, £0.59 Each.

Potentiometers - Please State Value Required. Single Gang 1/2" Shaft, 25mm Dia. 470Ω-2M2 Linear, £0.56 Each. Single Gang 1/4" Shaft, 25mm Dia. 4k7,10k,47k,100k,1M,2M2 Log, £0.56 Each. Dual Gang 1/2" Shaft, 20mm Dia. 1kΩ-2M2 Linear, £1.54 Each. Dual Gang 1/4" Shaft, 20mm Dia. 1kΩ-470k Logarithmic, £1.54 Each. Switched 1/2" Shaft, 20mm Dia. 1kΩ-2M2 Linear, £1.92 Each. Switched 1/4" Shaft, 20mm Dia. 4k7-2M2 Logarithmic, £1.92 Each. PCB Mount, Splined Shaft, 16mm Dia. 470Ω-1M0 Linear, £0.48 Each. PCB Mount, Splined Shaft, 16mm Dia. 470Ω,4k7,100k,1M0 Log, £0.48 Each. Dual PCB, Splined Shaft, 16mm Dia. 10k,50k,100k,500k Log, £0.84 Each. Dual PCB, Splined Shaft, 16mm Dia. 10k,50k,100k,500k Log, £0.84 Each.

Tel: 0191 2514363 Fax: 0191 252296 Email: sales@esr.co.uk http://www.esr.co.uk

EVERYDAY PRACTICAL ELECTRONICS

THE No.1 MAGAZINE FOR ELECTRONICS TECHNOLOGY & COMPUTER PROJECTS

VOL. 32 No. 9 SEPTEMBER 2003

INGENIOUS

Quite often these days we publish some ingenious projects, usually worked out by dedicated hobbyists. Projects like the *EPE PIC Met Office* (Aug '03) with its all solid state design, the *EPE Mini Metal Detector* (July '03) which can be worn on the wrist, *PICronos L.E.D. Wall Clock* (June and July '03) with its solid state analogue/digital display or the *Super Motion Sensor* (May '03) which can detect a single finger moving at five metres (to mention just a few from recent issues). Some of these are quite complex while others are reasonably simple, but each represents an ingenious application of electronics.

Next month we present a simple project with equally simple electronics but with an ingenious application that might well be copied by toy makers around the world. The application of some switches, i.e.d.s and a couple of chips allows inexpensive radio-controlled model cars to "fight" each other to the "death" without destruction. A kind of humane "Robot Wars".

With inexpensive RC cars now readily available on most high streets, this project enhances the excitement once the initial enjoyment of racing round the living room or patio has waned. Our contributor has come up with an excellent use of simple electronics that enhances a "standard" product and turns its use into an exciting, addictive game.

CARS v. ROBOTS

If you can't afford to get involved in robot wars and if you would hate to see your pride and joy destroyed, then *RC Car Wars* is for you. We actually think it is more fun than Robot Wars because once you have pressed a reset button to give your car three more "lives" you are ready to "fight" again. Good, clean, relatively inexpensive fun for everyone.

Don't miss the project in next month's issue.

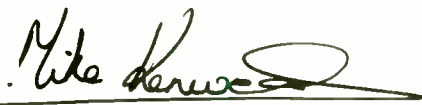

AVAILABILITY

Copies of *EPE* are available on subscription anywhere in the world (see opposite), from all UK newsagents (distributed by COMAG) and from the following electronic component retailers: Omni Electronics and Yebo Electronics (S. Africa). *EPE* can also be purchased from retail magazine outlets around the world. An Internet on-line version can be purchased and downloaded for just \$10.99US (approx £7) per year available from www.epemag.com

SUBSCRIPTIONS

Subscriptions for delivery direct to any address in the UK: 6 months £16.50, 12 months £31, two years £57; Overseas: 6 months £19.50 standard air service or £28.50 express airmail, 12 months £37 standard air service or £55 express airmail, 24 months £69 standard air service or £105 express airmail. To subscribe from the USA or Canada see the last magazine page. Online subscriptions, for downloading the magazine via the Internet, \$10.99US (approx £7) for one year available from www.epemag.com.

Cheques or bank drafts (in £ sterling only) payable to *Everyday Practical Electronics* and sent to EPE Subs. Dept., Wimborne Publishing Ltd, 408 Wimborne Road East, Ferndown, Dorset BH22 9ND. Tel: 01202 873872. Fax: 01202 874562. Email: subs@epemag.wimborne.co.uk. Also via the Web at: <http://www.epemag.wimborne.co.uk>. Subscriptions start with the next available issue. We accept MasterCard, Amex, Diners Club, Switch or Visa. (For past issues see the *Back Issues* page.)

BINDERS

Binders to hold one volume (12 issues) are available from the above address. These are finished in blue p.v.c., printed with the magazine logo in gold on the spine. Price £6.95 plus £3.50 p&p (for overseas readers the postage is £6.00 to everywhere except Australia and Papua New Guinea which cost £10.50). Normally sent within seven days but please allow 28 days for delivery - more for overseas.

Payment in £ sterling only please. Visa, Amex, Diners Club, Switch and MasterCard accepted. Send, fax or phone your card number, card expiry date and card security code (the last 3 digits on or just under the signature strip), with your name, address etc. Or order on our secure server via our UK web site. Overseas customers - your credit card will be charged by the card provider in your local currency at the existing exchange rate.



Editorial Offices:

EVERYDAY PRACTICAL ELECTRONICS EDITORIAL
WIMBORNE PUBLISHING LTD., 408 WIMBORNE ROAD EAST,
FERNDOWN, DORSET BH22 9ND
Phone: (01202) 873872. Fax: (01202) 874562.

Email: enquiries@epemag.wimborne.co.uk

Web Site: www.epemag.wimborne.co.uk

EPE Online (downloadable version of EPE): www.epemag.com

EPE Online Shop: www.epemag.wimborne.co.uk/shopdoor.htm

See notes on Readers' Technical Enquiries below - we regret lengthy technical enquiries cannot be answered over the telephone.

Advertisement Offices:

EVERYDAY PRACTICAL ELECTRONICS ADVERTISEMENTS
MILL LODGE, MILL LANE,
THORPE-LE-SOKEN, ESSEX CO16 0ED
Phone/Fax: (01255) 861161 Email: epeads@aol.com

Editor: MIKE KENWARD

Deputy Editor: DAVID BARRINGTON

Technical Editor: JOHN BECKER

Business Manager: DAVID J. LEAVER

Subscriptions: MARILYN GOLDBERG

Administration: FAY KENWARD

Editorial/Admin: (01202) 873872

Advertisement Manager:

PETER J. MEW, (01255) 861161

Advertisement Copy Controller:

PETER SHERIDAN, (01202) 873872

On-Line Editor: ALAN WINSTANLEY

EPE Online (Internet version) Editors:

CLIVE (MAX) MAXFIELD and ALVIN BROWN

READERS' TECHNICAL ENQUIRIES

E-mail: techdept@epemag.wimborne.co.uk

We are unable to offer any advice on the use, purchase, repair or modification of commercial equipment or the incorporation or modification of designs published in the magazine. We regret that we cannot provide data or answer queries on articles or projects that are more than five years old. Letters requiring a personal reply *must* be accompanied by a stamped self-addressed envelope or a self-addressed envelope and international reply coupons.

PROJECTS AND CIRCUITS

All reasonable precautions are taken to ensure that the advice and data given to readers is reliable. We cannot, however, guarantee it and we cannot accept legal responsibility for it.

A number of projects and circuits published in *EPE* employ voltages that can be lethal. You should not build, test, modify or renovate any item of mains powered equipment unless you fully understand the safety aspects involved and you use an RCD adaptor.

COMPONENT SUPPLIES

We do not supply electronic components or kits for building the projects featured, these can be supplied by advertisers (see *Shoptalk*). We advise readers to check that all parts are still available before commencing any project in a back-dated issue.

ADVERTISEMENTS

Although the proprietors and staff of EVERYDAY PRACTICAL ELECTRONICS take reasonable precautions to protect the interests of readers by ensuring as far as practicable that advertisements are *bona fide*, the magazine and its Publishers cannot give any undertakings in respect of statements or claims made by advertisers, whether these advertisements are printed as part of the magazine, or in inserts.

The Publishers regret that under no circumstances will the magazine accept liability for non-receipt of goods ordered, or for late delivery, or for faults in manufacture.

TRANSMITTERS/BUGS/TELEPHONE EQUIPMENT

We advise readers that certain items of radio transmitting and telephone equipment which may be advertised in our pages cannot be legally used in the UK. Readers should check the law before buying any transmitting or telephone equipment as a fine, confiscation of equipment and/or imprisonment can result from illegal use or ownership. The laws vary from country to country; readers should check local laws.

Constructional Project

PIC-A-COLOUR GAME



NICK DOSSIS

PIC your wits against a colourful code-setting master mind!

READERS may remember some years ago there was a popular board game called *Mastermind*. It was a two-player game and the object was for one person to secretly create a colour code using four coloured pegs, the other person then had to try and guess the colours by putting four coloured pegs into a board full of holes.

The code-maker then gave the other person clues as to how close they had come to breaking the secret code. This was in the form of white or black pegs. The number of black pegs denoted the number of correct colours in the correct order. The number of white pegs denoted the number of correct colours in the wrong order.

This process of guessing the code continued until the player correctly established the four colours in the correct order, or until all of the player's ten guesses were up, in which case the code-maker had won the game.

AIM OF THE GAME

The original board game is still marketed today and there have been various commercial electronic versions of the game available over the years. PIC-A-Colour is an attempt to emulate the principle of the original game using a PIC microcontroller. In this version the player pits their wits against the PIC, which creates a secret random colour code, the player then has ten attempts to try and guess the code. After each guess the PIC gives the player clues as to how close they are to cracking the code, using a 7-segment display.

The electronic version described here utilises four tri-colour l.e.d.s, which act as the coloured pegs. There are four colours available for each l.e.d., these are red, green, yellow and white (off), this gives a total number of 256 combinations.

The original *Mastermind* board game had six coloured pegs available to the players, giving just over 1000 different combinations for the player to try and guess. The fact that PIC-A-Colour has fewer combinations does not, in practice, seem to reduce the difficulty of the game. The game is still quite addictive, and there is plenty of scope

for the constructor to modify the program to increase the difficulty levels of the game if they so require. Some ideas for doing this are discussed later in this article.

DESIGN CRITERIA

The main criteria for the game were that it should be a small hand-held unit, which had low power consumption, and all components mounted on a single piece of stripboard, including switches, and l.e.d. displays.

Initially when thinking about the concept for the game, the intention was to use three chips in the design. A PIC (the heart of the unit and to drive the tri-colour l.e.d.s), a 4017 decade counter (for the red indicator l.e.d.s), and a 4026 7-segment driver (to show the user the relevant numerical values on a 7-segment display).

The original design, however, was considered to be too complicated to fit on a single piece of stripboard, and the current consumption was deemed to be too high. This gave rise to thoughts about using a PIC on its own to drive all three types of

display using a multiplexing technique. The circuit diagram for the final result is shown in Fig.1.

CIRCUIT DESCRIPTION

Referring to the complete circuit diagram in Fig.1, the design is based around a PIC16F84, which is powered by four 1.5V AA batteries via diode D13. The purpose of the diode is to prevent damage to the components in the event of the batteries being connected the wrong way around. Note that the PIC's maximum operating voltage is 6V and supplies greater than this must not be used.

There is no mechanical on/off switch in this unit and a mercury-free tilt switch, S1, is used instead. The unit is switched on if it is in the upright position, turning it upside down disconnects the power.

All eight pins of the PIC's Port B are configured as outputs and these are connected, via ballast resistors R4 to R11, to the three different types of display, which are wired in parallel:

1. Four tri-colour l.e.d.s – these simulate the coloured pegs of both the player and the PIC.
2. Eight single-colour l.e.d.s – these are used to navigate the screen and access the Guess and Review functions.

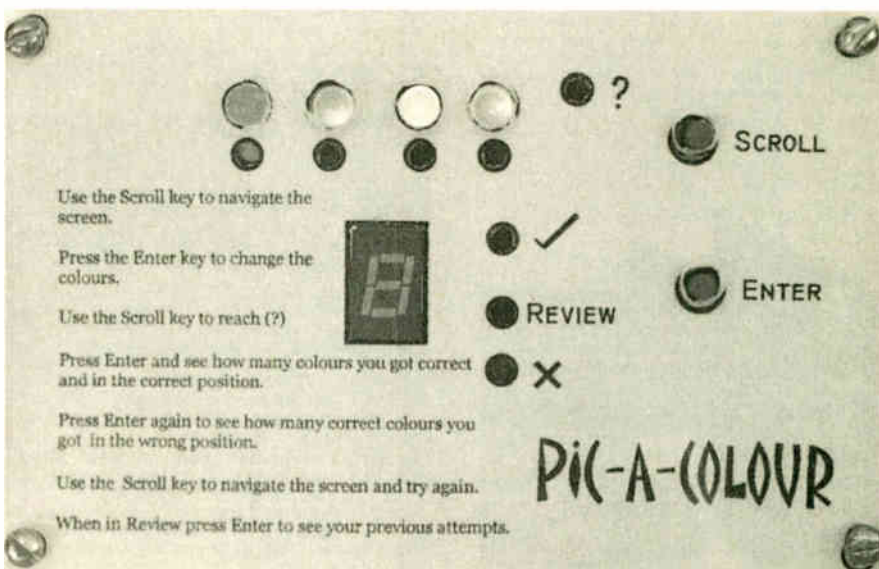

Front panel layout of the PIC-A-Colour Game.

3. 7-segment display – this gives the user information such as the number of guesses and the number of correct/incorrect colours matched.

ON DISPLAY

Selection of which display block is selected by the multiplexing technique is performed by transistors TR1 to TR3, which are under the control of the PIC's Port A pins RA0 to RA2 used in output mode. Each time one of these outputs is taken high it switches the corresponding transistor on, via its base ballast resistor (R1 to R3), allowing current to flow from the I.e.d.s, which are in common-cathode configuration.

Only one transistor is on at any one time and the program activates the transistors in sequence. The PIC is operated in RC mode and when adjusted correctly via preset control VR1 it runs fast enough to flash the displays at a speed which fools the eye into thinking that all three displays are continuously lit. Port B uses all 8 bits to drive the values of the three display blocks – more on this later.

The basic program for multiplexing the three displays is as follows:

1. All ports are switched off
2. Switch on Port A, bit X – to activate its transistor

3. Get the value of the relevant display's memory register
4. Move the register value to Port B
5. Delay (see text)
6. Switch off Port A, bit X
7. Clear port B
8. Repeat for the next type of display

The above procedure is repeated three times in a never-ending loop in the following order, red I.e.d.s, tri-colour I.e.d.s, seven-segment display.

The unit also has two pushbutton switches, these being a Scroll (S2) and Enter (S3), which allow the user to navigate the display and perform functions such as altering the tri-colour I.e.d. colours, having a guess and reviewing previous attempts. These switches are connected to Port A pins RA3 and RA4, which are biased normally-low by resistors R13 and R14.

Tables 1 and 2 show the assignment for each of the PIC's ports and their relationship to the display layout.

Table 1. Port A functions

RA0	Output	red I.e.d. driver
RA1	Output	tri-colour I.e.d. driver
RA2	Output	7-segment display driver
RA3	Input	Scroll via S2
RA4	Input	Enter via S3

TRI-COLOUR DISPLAY

The tri-colour I.e.d.s used have two different coloured I.e.d.s in the same package, one red and one green. These can be either switched on individually, or switched on together to produce a yellow display.

Table 2. Port B functions, all outputs

	B7	B6	B5	B4	B3	B2	B1	B0
D5 to D12	D12	D11	D10	D9	D8	D7	D6	D5
D1 to D4	D4-G	D4-R	D3-G	D3-R	D2-G	D2-R	D1-G	D1-R
7-Segment	A	C	DP	E	D	G	F	B
0 display	1	1	0	1	1	0	1	1
1 display	0	1	0	0	0	0	0	1
2 display	1	0	0	1	1	1	0	1
3 display	1	1	0	0	1	1	0	1
4 display	0	1	0	0	0	1	1	1
5 display	1	1	0	0	1	1	1	0
6 display	1	1	0	1	1	1	1	0
7 display	1	1	0	0	0	0	0	1
8 display	1	1	0	1	1	1	1	1
9 display	1	1	0	0	0	1	1	1

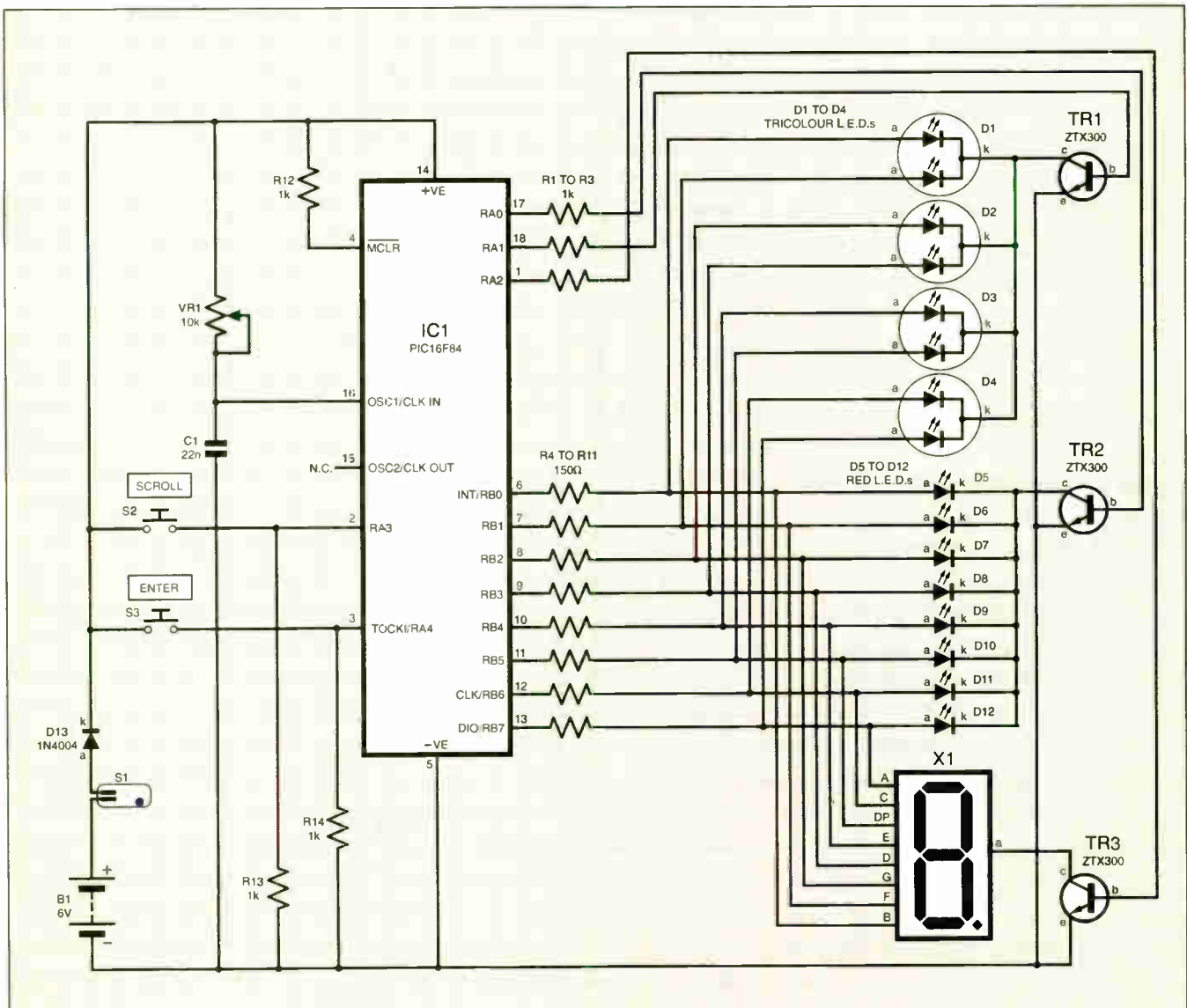

Fig. 1. Complete circuit diagram for the PIC-A-Colour Game.

As explained earlier, these l.e.d.s simulate the coloured pegs in the original game. It can be seen from the Table 2 that each l.e.d. is driven by two output bits of Port B.

The different colours are created by configuring each of the two ports in the following manner:

Code	Colour
00	white (both red and green l.e.d.s off)
01	red l.e.d. on
10	green l.e.d. on
11	yellow (both red and green l.e.d.s on)

For example, if the Port B output is given a binary value of 10101000 then the screen will show four tri-colour l.e.d.s in the order:

Green Green Green White

When the game is being played the player is able to alter the colour l.e.d.s by using the Enter key. All that is happening is that the PIC program increments the two relevant bits to create the colour change when the Enter switch is pressed.

When the unit is first switched on the unit shows a lamp test sequence, this is to help diagnose any damaged or incorrectly inserted l.e.d.s, and is also quite pleasing to the eye!

The random colour code is generated until the user exits the lamp test by pressing either switch and then the value at that time is selected as the PIC's colour code.

While the game is being played a new random number is being generated for the next game. This detail is shown in the code and is actually used to delay the multiplex display slightly. The purpose of this delay is to make the screen l.e.d.s stay on slightly longer before switching to the next display. This has the effect of making the screen l.e.d.s seem brighter to the player.

The PIC source code contains comments which should hopefully help the constructor to understand how the unit works. However, it is worth while explaining how the PIC establishes how many correct and incorrect colours have been guessed.

HOW CORRECT?

The player's binary guess value and the PIC's binary value are compared in the following way (spaces are included in the binary codes for clarity):

Let's assume that the PIC has created a random colour code of:

Colour Code	Red	Red	Yellow	Green
	01	01	11	10

and the player guesses that the code is:

Colour Code	Red	Green	Green	Yellow
	01	10	10	11

By visually comparing the two codes we can see that if we were playing the role of codemaker we would inform the player that they had correctly guessed one colour in the correct order (red), and two correct colours in the wrong order (yellow and green).

The PIC's program has a routine that compares the two values as follows:

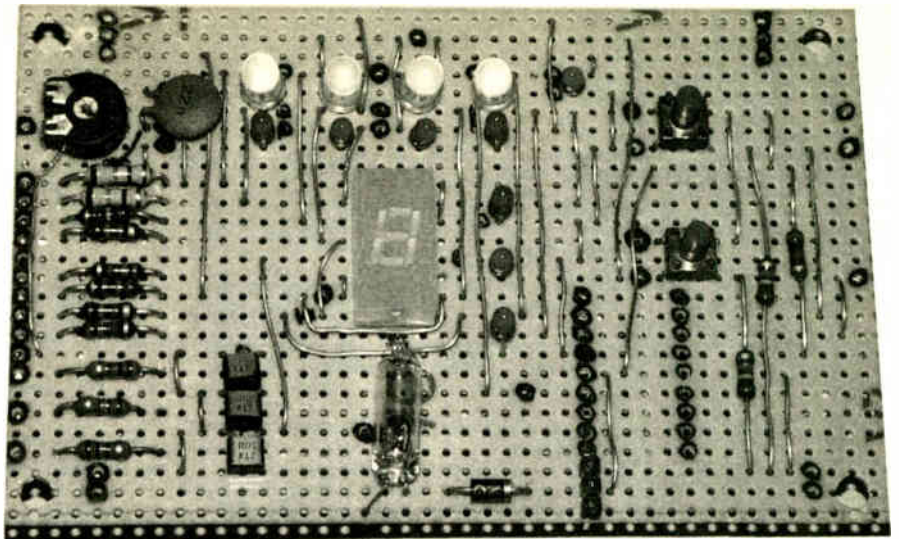

PIC-A-Colour prototype stripboard component layout. The PIC microcontroller is mounted on the underside.

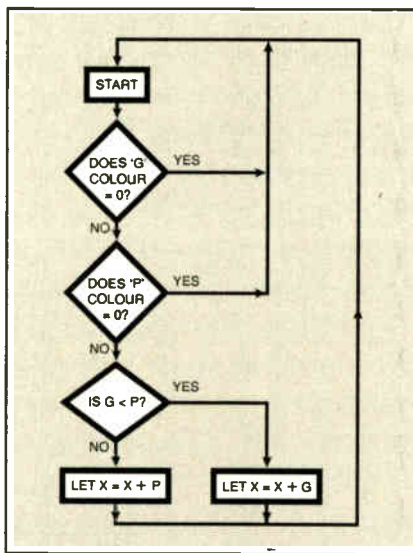

Fig.2. Colour check flow diagram.

A binary "mask" of zeros and ones is ANDed to both codes to remove six unwanted bits and leave the two bits to be examined:

PIC value	01011110
AND	11000000
result	01000000
Guess value	01101011
AND	11000000
result	01000000

The two results are then compared to see if they are equal, if they are then the "Correct" register is incremented.

The "mask" procedure is repeated four times to cover all four twin bits (colours).

1. Values equate – red is in the correct order

PIC	01 00 00 00
Guess	01 00 00 00

2. Values do not equate

PIC	00 01 00 00
Guess	00 10 00 00

3. Values do not equate

PIC	00 00 11 00
Guess	00 00 10 00

4. Values do not equate

PIC	00 00 00 10
Guess	00 00 00 11

CORRECT COLOURS, WRONG ORDER

After the previous checks have been carried out the two codes are compared again. This check is a little more complex than the last one.

To begin with both the guess value and the PIC's value are split down into four individual 2-bit components (colours) and the quantity of each colour in each of the two codes is counted, but ignoring the values which we already know are in the correct order:

PIC	01 01 11 10
Guess	01 10 10 11

this equates to:

PIC	red = 1	yellow = 1	green = 1	white = 0
Guess	red = 0	yellow = 1	green = 2	white = 0

Once the quantity of colours has been established, the quantity of each of the colours is compared in turn to calculate the number of correct colours in the wrong order. There are four comparisons in total and the procedure for incrementing the Wrong register (X) uses an algorithm that is shown in the flow diagram in Fig.2.

CONSTRUCTION

The components for PIC-A-Colour are mounted on stripboard, whose component positioning (a), track cut details (b) and PIC wiring (c) are shown in Fig.3.

Cut the stripboard to size, cut the tracks, and drill holes at the corners suitable for 6BA screws.

Solder the components onto the stripboard in the order of wire links (but not the PIC's interconnecting wires yet), resistors, capacitors, transistors, switches (but see later), and d.i.l. socket for the PIC.

Note that the d.i.l. socket is soldered to the *trackside* of the stripboard. To achieve this, bend the pins of the socket outwards so that the socket is able to sit flat on the stripboard (turned-pin sockets are *not* suitable for this method).

Make sure that the nine tracks are cut on the stripboard where the socket is going to be positioned before soldering takes place.

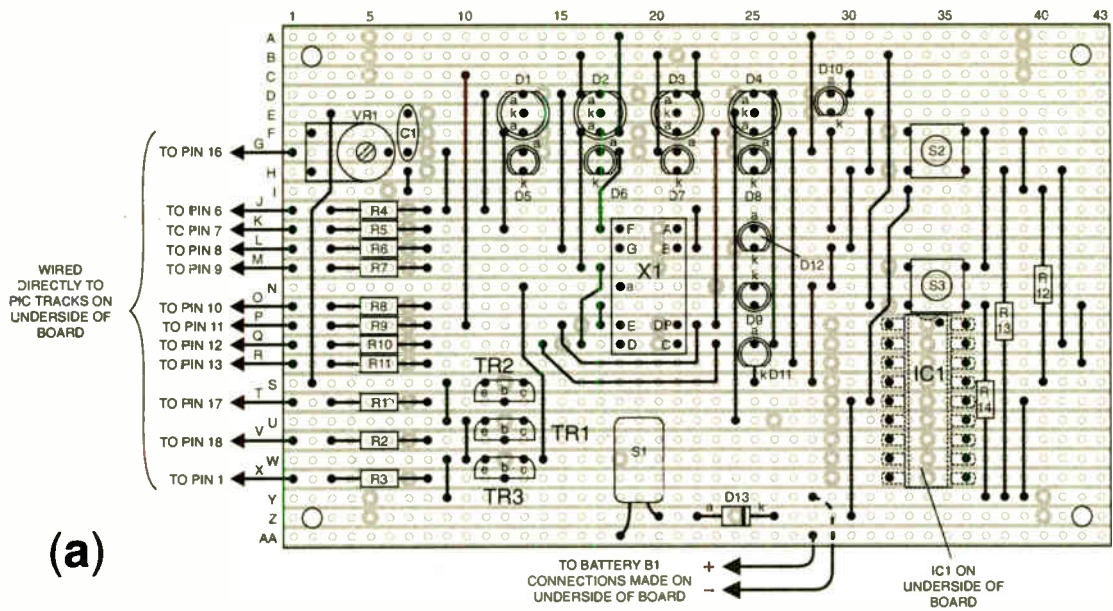

(a)

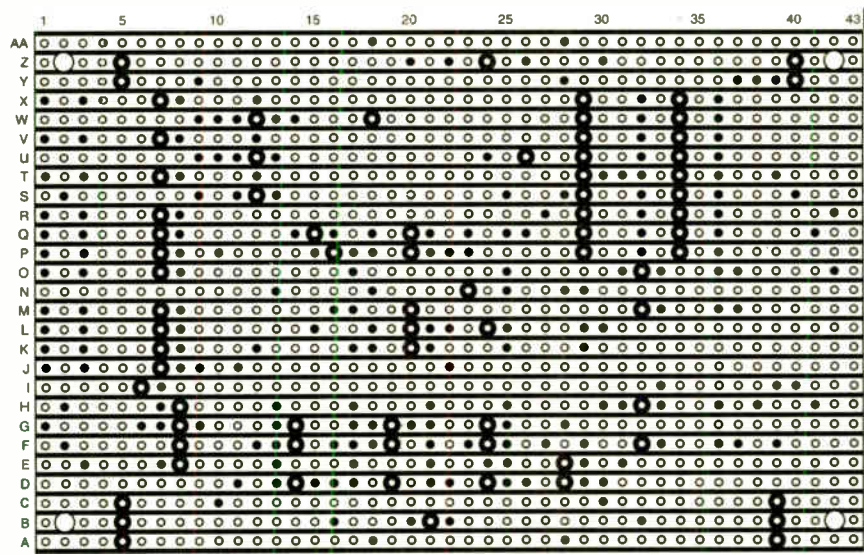

(b)

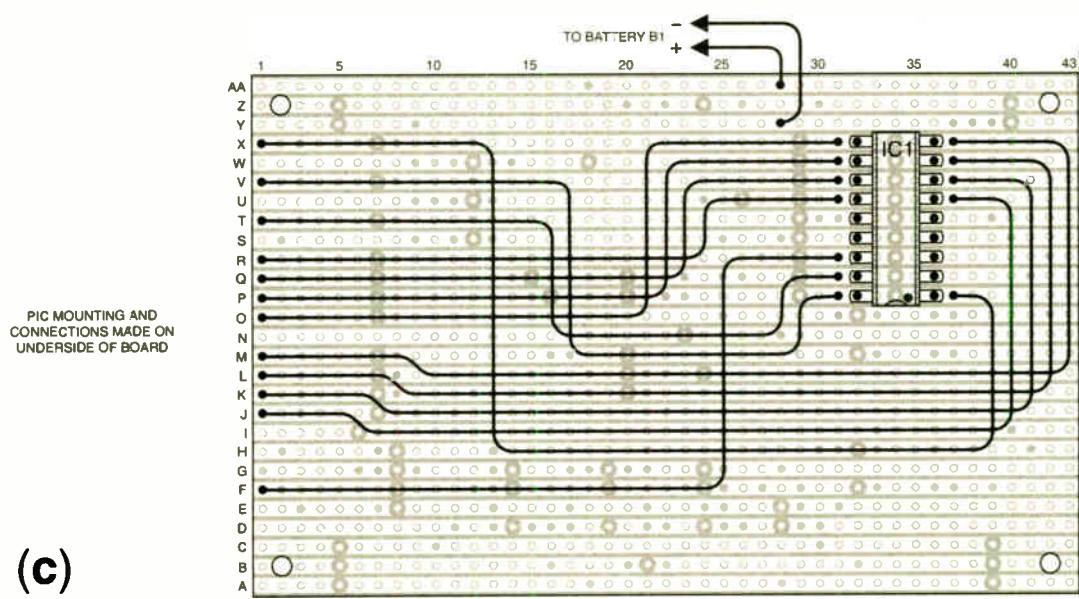

(c)

Fig.3. Stripboard component layout and details of breaks required in the underside copper tracks. The PIC d.i.l. socket is soldered on the trackside and the interconnecting wiring is shown in diagram (c).

Mark out the position of the socket using a pen and then remove it. Tin the areas of the strips where the pen marks have been drawn and then position the socket over the solder points.

Carefully press the soldering iron on each of the pins in turn so that the solder melts underneath the pins and bonds it to the stripboard. Once finished the socket should sit flat on the stripboard in a similar manner to a surface mount device.

Be careful when performing this task and wear protective goggles. If you are not careful the flat pins of the socket can sometimes flex when being soldered and splash a little bit of solder onto the stripboard.

Solder the 12 wires to the appropriate pins of the socket as shown in Fig.3c, using thin insulated solid copper wire. Note that the cables are soldered and positioned on the trackside of the board.

Next solder the 3-pin battery connector onto the stripboard making sure that the pins protrude through the trackside. These act as the battery connectors.

Check the component layout and make sure that all solder joints are sound and that the l.e.d.s have been fitted the correct way around. Adjust preset VR1's wiper to about mid-position.

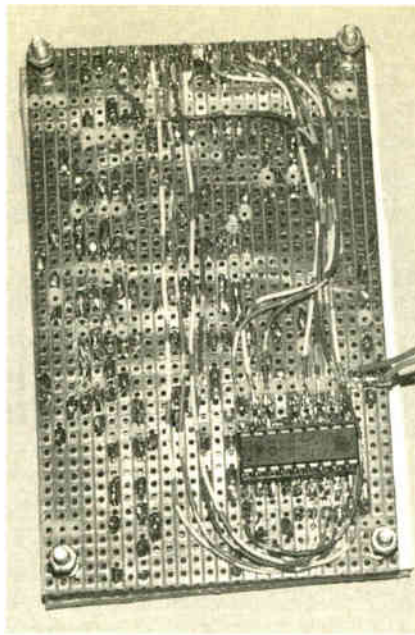

Underside of prototype board showing the PIC (IC1).

FIRST CHECKS

Before inserting the preprogrammed PIC, apply power to the stripboard and check the following voltage points on its socket: pin 5 = 0V, pin 14 = +5V. Check that the PIC socket pins 2 and 3 are normally low, and that pressing the appropriate switch will make the relevant pin go high (S2 = pin 2, S3 = pin 3).

If the voltage checks are not correct then re-check the component positions and solder joints, and restart the checks again.

Insert the preprogrammed PIC into its socket, ensuring it is the correct way round. Plug the battery lead strip into the 3-pin connector on the stripboard and turn the board the correct way up so that the tilt switch activates the board. The lamp test start-up display should appear. If it does not then disconnect the battery and immediately restart the component and solder checks.

Pressing either of the switches during the lamp test will make the tri-colour l.e.d.s

switch off. Diode D5 (the 3mm l.e.d. underneath the first tri-colour l.e.d., D1) should be lit and the 7-segment display should show a 0. Fine-tune the clock rate potentiometer VR1 until the display looks steady and has no flicker.

ENCLOSURE

Pic-A-Colour is not intended for mounting in a conventional ABS box, but uses a technique that's a little more creative.

The unit's enclosure is made from 2mm thick acrylic sheet. Readers may use an alternative technique if preferred, in which case the switches need not be mounted on the stripboard, but could be mounted in the lid of standard plastic case, using interconnecting wires.

The other unusual feature is the use of a tilt switch to turn the power supply on and off. This may be replaced by a more conventional slide or toggle switch if required.

Cut the two pieces of clear acrylic to size and drill the acrylic to suit the four holes in the stripboard. Prepare a paper label (see Fig.4) to sit underneath the front acrylic. Cut out holes in the paper for the l.e.d.s, switches, 7-segment display and four screws using a scalpel.

The original label was designed using Microsoft Publisher. The label includes some basic operating instructions in addition to the l.e.d. and switch descriptions. The image was printed onto a sheet of plain white paper using a standard inkjet printer.

Next line up the four stripboard holes to four holes on the front piece of acrylic and mark out the positions of the two switches and tri-colour l.e.d.s D1 to D4. Drill holes in the acrylic large enough for these l.e.d.s and switches to protrude through. Holes are not required in the acrylic for the other l.e.d.s or the 7-segment display. These have a low profile and can be viewed through the acrylic without the need for holes in it.

Position the AA battery holder on the rear piece of acrylic and mark out the positions of the battery tags. Drill two small holes in the acrylic to allow the AA battery holder tags to protrude through. Secure the battery holder onto the acrylic using double-sided adhesive strips. Solder two wires

COMPONENTS

Resistors

R1 to R3, R12 to R14 1k (6 off)
R4 to R11 150Ω (8 off)
All 0.25W 5% carbon film or better

See
SHOP
TALK
page

Potentiometer

VR1 10k enclosed carbon preset, horizontal

Capacitor

C1 22n ceramic disc

Semiconductors

D1 to D4 tri-colour l.e.d., 5mm (4 off)
D5 to D12 red l.e.d. 3mm (8 off)
D13 1N4004 rectifier diode
TR1 to TR3 ZTX300 npn transistor (3 off)
IC1 PIC16F84 microcontroller, preprogrammed (see text)

Miscellaneous

S1 tilt switch, non-mercury type
S2, S3 min. s.p. push-to-make switch, p.c.b. mounting, 6mm shaft (2 off)
X1 7-segment l.e.d. display, common cathode

Stripboard, 27 strips x 43 holes; AA-type batteries (4 off); AA-size battery box; 18-pin d.i.l. socket; 2mm acrylic sheet (see text); 25mm 6BA bolts (4 off); 6BA nuts (20 off); 3-pin terminal strip plus connector, 2.54mm pitch; insulated solid connecting wire; solder, etc.

Approx. Cost
Guidance Only

£16

excl. case & batts.

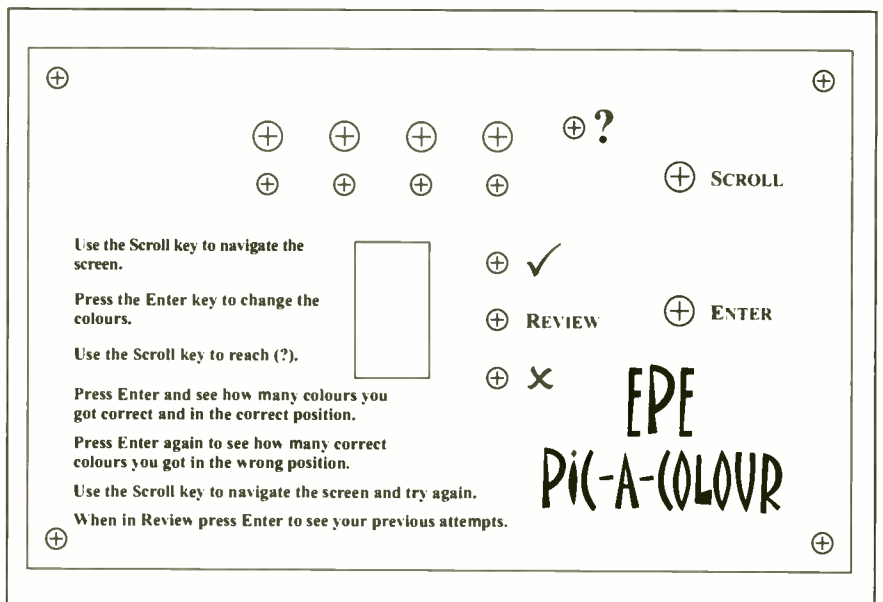

Fig.4. Front panel template and drilling guide.

to the AA battery tags and solder the 3-pin socket to the other end of the wires.

Complete the assembly of the unit by making a sandwich comprising the strip-board, paper label and clear acrylic pieces using the 6BA screws and nuts, see Fig.5.

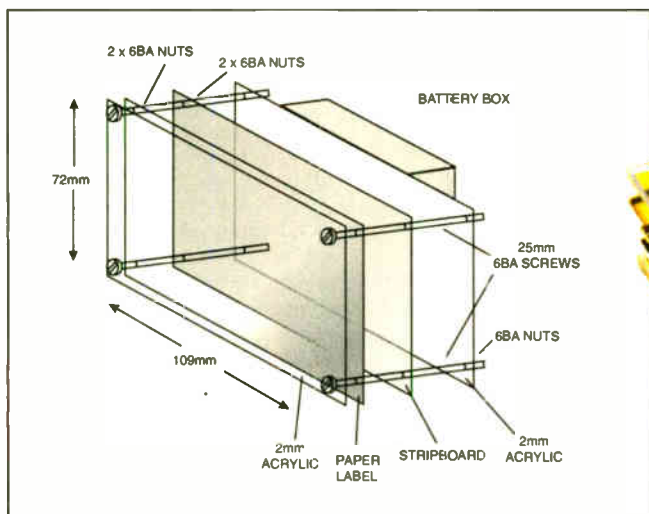

Fig.5. "Sandwich" construction and photograph (right) of the completed PIC-A-Colour.

GAME PLAY

Once the unit has been constructed and all of the checks have been completed, PIC-A-Colour is ready to play.

To switch the unit on, turn it the correct way up so that the tilt switch activates the power.

The game begins by showing the flashing Start-Up display, which also acts as a lamp test. The details are:

- Tri-colour l.e.d.s – all four change in colour, yellow, green, red then white.
- Red l.e.d.s – each switches on in turn.
- 7-segment display – each individual segment switches on in turn, followed by the top four segments, then the bottom four segments and finally all segments on together.

Pressing any key takes the unit into the start of the game, all four tri-colour l.e.d.s will be off (four white pegs), the red l.e.d. (D5) under the first tri-colour l.e.d. (D1) will be lit, and the 7-segment display will read 0 (to denote the number of attempts so far). The player is able to navigate the screen using the "Scroll" button; this moves the "on" red l.e.d. position in the following manner:

Scroll press	"on" r.e.d. l.e.d. position
1	D5 – under first tri-colour l.e.d. (D1)
2	D6 – under second tri-colour l.e.d. (D2)
3	D7 – under third tri-colour l.e.d. (D3)
4	D8 – under fourth tri-colour l.e.d. (D4)
5	D9 – Review
6	D10 – Guess (?)
7	above sequence starts again

If a red led is illuminated underneath one of the tri-colour l.e.d.s, then pressing the 'Enter' key will change the colour of the selected l.e.d. This will allow the player to

alter each l.e.d. from white, to red, to green, to yellow.

If Scroll is pressed until the red l.e.d. is illuminated underneath Guess, then by pressing Enter the unit will compare the players guess against the PIC's secret code.

The unit then instantly informs the player

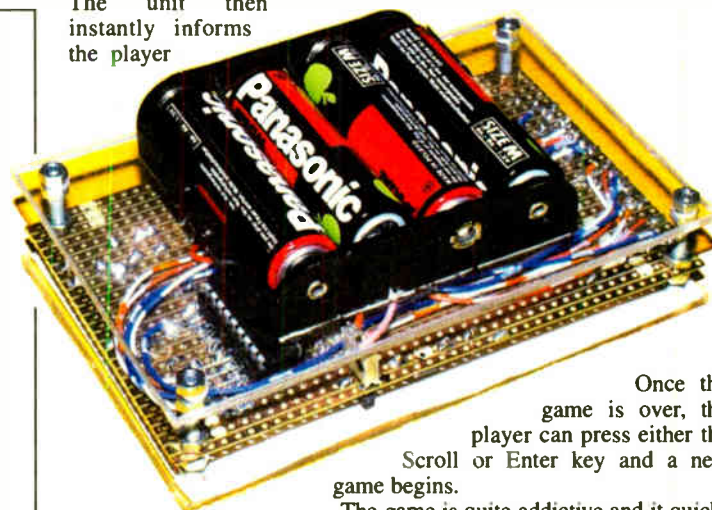

Once the game is over, the player can press either the

Scroll or Enter key and a new game begins.

The game is quite addictive and it quickly becomes a challenge to try and guess the secret code using as few guesses as possible.

To switch the unit off, turn it upside down and place it on a flat surface. If the battery holder has been fitted in the correct position on the rear piece of acrylic then the unit will free-stand at a slight angle.

PROGRAM MODIFICATIONS

There is scope for PIC-knowledgeable constructors to modify the code to make the game more difficult to play. Here are a few ideas:

- Reduce the maximum number of guesses allowed before the game is over. There was once a Mini-Mastermind game that allowed a maximum of six guesses rather than 10. This may be applied to this game.
- Make the PIC reduce the amount of guesses allowed for each successive game if the player wins. e.g. Game 1 – allow the player 10 guesses, Game 2 – allow the player nine guesses, and so on.
- Allow the user a maximum period of time to take a guess. If the time expires then a guess is lost.
- At the end of the game indicate to the player the amount of time taken for the game to be won – this may be indicated using the red l.e.d.s. For example, each l.e.d. that is lit at the end of the game may indicate a 10-second period, or a method may be found to display this information on the 7-segment display.

The scope for modification is only limited by the readers imagination and by the practical constraints of the display.

RESOURCES

The PIC software for PIC-A-Colour is available from the EPE Editorial office on 3.5in disk, for which a nominal charge applies – see the PCB Service page. It is also available for free download from the EPE ftp site, access to which can be gained via the EPE home page at www.epemag.wimborne.co.uk.

For information about purchasing components for PIC-A-Colour read the *Shoptalk* column elsewhere in this issue. □

of the number of correct colours in the correct order, this will be shown on the seven-segment display and the correct (✓) l.e.d. (D12) will be illuminated.

By pressing Enter, the wrong (X) l.e.d. (D11) will illuminate and the 7-segment display will show the number of correct colours in the wrong order. Keep pressing Enter and the 7-segment value alternates between the correct and wrong values. Pressing Scroll moves the red l.e.d. back under the first tri-colour l.e.d. (D1) for the player to have another try. The 7-segment display will now show the amount of tries that the user has had so far.

The game continues in the same manner, where the player alters the tri-colour l.e.d.s through the four-colour sequence (the fourth colour being white – l.e.d. not illuminated) and tries to deduce the secret code by using the clues given by the PIC.

After a number of guesses the player may wish to refresh their memory on some of their previous attempts. This can be achieved by pressing the Scroll button until the red l.e.d. underneath Review is illuminated. By pressing Enter the 7-segment display will show the guess number and the four tri-colour l.e.d.s will show the colours guessed on that attempt. Keep pressing Enter and the complete history of the attempts made by the player can be reviewed.

Pressing Scroll at any time will escape the Review menu and move the red l.e.d. to the first tri-colour l.e.d.

The game is over in either of the following circumstances:

1. The player correctly guesses all four colours in the correct order – in this case all eight red l.e.d.s illuminate, the four tri-colour l.e.d.s show the correct answer and the 7-segment display informs the player of how many guesses it took to deduce the answer.
2. The player has taken 10 attempts to guess the code and is still unable to get the answer. In this case all eight l.e.d.s

More Connected Homes

Andy Emmerson resumes his look at the networked home of the future, this time talking brass tacks.

LAST month we looked at some rather optimistic and futuristic views of automated and networked homes of the future. Tipping our cap to the word "Practical" in this magazine's title, this time we examine ways of making it work and look for evidence of good intent.

As the train approached Waterloo when I commuted into London 35 years ago (yes, I'll get to the point in a moment), a sign announced a large building belonged to the New Century Cleaning Company. The firm is still there and now called OCS and whilst the old styling might sound quite appropriate now, it illustrated in the 1960s how rapidly once-trendy names could become desperately unfashionable. For that reason I rather pity the residents of the Greenwich Millennium Village, who must feel tainted by the aura surrounding the Millennium Dome disaster. Or perhaps they don't.

Be that as it may, the development was one of the first large housing developments to offer a fully networked solution to residents. It's not only bright colours and gardens, eco-friendly materials and a fresh approach overall that distinguish the Greenwich Millennium Village. The practical attitudes run deeper, with a future-proof cable network for home automation, infotainment and telematics.

SHOWCASE SITE

The Village (www.greenwich-village.co.uk) is a showcase for the work of some of the world's most forward thinking developers, architects, designers and engineers, incorporating the most advanced technologies, research and practices, yet at the same time sympathetic to the development's landscape and ecology, to achieve a high standard of environmentally sustainable development. A target to reduce primary energy consumption by 80% is being achieved through a combination of local electrical and heat generation, improved insulation and energy efficient devices for the home.

Pioneer residents of these "intelligent homes" at Greenwich enjoy ingenious energy-reduction systems plus a comprehensive communications infrastructure installed by BT that provides all voice and data (ADSL) communications, security television (CCTV), and systems for access control and reception. The overriding concept to "future-proof" the communications infrastructure of the Village, is to obviate the need to dig up and renew the cables and so on, every time an enhancement is needed. It also means that the new homes are "wired" from the outset for the wide variety of home networking applications that are now emerging

and that discerning homebuyers are demanding increasingly.

GENUINE FIRST

Three years ago Laing Homes hit the headlines as the first UK and European housebuilder to build an "Internet home", setting new standards in the use of artificial intelligence in housebuilding. Category 5e cabling (suitable for all domestic and home office voice and data applications) concealed in the walls provided the necessary connectivity, with network equipment supplied by Cisco. The Internet House later won the Gold award in the 2000 *What House?* "Best Future Home" category.

Several housebuilder companies, including Laing, Charles Church and Rice Homes, are now building homes with integral network cabling. Similar systems are increasingly in demand for upgrading existing properties as well.

Initially the thrust of network installations is going into the upper end of the housing market, where discerning buyers are in no doubt of the value of these systems. As wired homes move towards becoming a mass-market commodity, astute designers and builders will be considering the inclusion of home networking as an essential feature in other levels of the housing market.

Soon the networked house, with hidden wiring replacing today's jumble of spaghetti cables, will become the new middle-class must-have too. The reason lies in people's growing familiarity with (and endearment to) the Internet and all things digital, along with aspirations to a better quality of life. Falling prices and a rising standard of living complete the formula.

HOME SURVEY

A new survey published by respected research consultancy Datamonitor indicates that no less than 20% of all European households will have a home network by 2005. The continued launch of new technologies and adoption of new services by consumers will further the move towards the networked digital home, with 76% having two or more digital devices by 2004.

"The home networking market in Europe is set to explode over the next five years," says Doug Wilson, Director at Datamonitor. "Enabled by rapidly advancing consumer technology but driven by an increasing demand for interactive content and services, home networking will develop from a niche technophile application to mass-market status."

According to Datamonitor, the home network will develop in households with

multiple PCs, with homes looking increasingly to network other interactive devices such as set-top boxes with PCs. Shared broadband Internet access between multiple PCs and other access devices will figure significantly, as will other digital home devices such as fridges and security systems, whilst new interfaces in the digital home will emerge from the development of the PC and TV as access devices.

NERVE CENTRE

In all cases the "nerve centre" or hub of these domestic networks is a Home Distribution Unit or HDU, from which wiring branches out to outlets in each room. Telephone lines, either ordinary analogue, with or without ADSL or ISDN, enter the compact HDU, which can be sited in the hall, garage or under the stairs.

Within the home the networking uses the same "structured" cabling technology that's standard in offices now, with cables from the sockets throughout the house running back to the HDU. A simple connector terminated to the end of the cable completes the link to the incoming service via a module housed within the HDU. When users need to move a computer or fax machine to a different location they simply open the HDU and move the internal connecting links to reassign the cable.

LIGHT RELIEF?

As a concept, the idea of smart homes has been around for more than 60 years. Excerpts from *Plenty of Time for Play*, an advertising film made in 1934 by the Electrical Development Association, have been seen on television several times. It shows a vision of life 20 years hence from 1934, including household robots and an intriguing simulation of large-screen television.

Documentaries and *Ideal Home Exhibition* demonstrations portraying the home of the future that never quite seemed to materialise are also familiar, whilst manic robot vacuum cleaners and other gadgets with a mind of their own have been a source of merriment in countless cartoons and comedies since.

For real amusement (or amazement), however, you need look back only to the early-1990s, when a British company issued a fabulous catalogue of "domestic light and magic", with *Butler In The Box* - the world's first environmental control system that responds to voice commands", at the trifling cost of £2,050. Even a basic system controlling two appliances and a lamp cost £762 so it's little wonder that intelligent homes and domestic automation did not become a mass market back then.

FREE Catalogue Available On Request



WCN Supplies • Dept EPE • The Old Grain Store • Rear Of 62 Rumbridge Street • Totton • Southampton • SO40 9DS
Telephone or Fax On Southampton 023 8066 0700 • Email: info@wcnsupplies.fsnet.co.uk

Telephone, Fax Or Email For Your Free Catalogue

SPECIAL OFFERS

TEKTRONIX 2445A
4-ch 150MHz delay, cursors etc. Supplied with 2 Tektronix probes.
ONLY **£425**

TEKTRONIX 2232 Digital Storage Scope, Dual trace, 100MHz, 100MS with probes... £25

CIRRUS CRL284 Sound Level Meter with Calibrator 10-120dB, LEO... £95

BECKMAN HD110 Handheld 3 1/2 digit DMM, 28 ranges with battery, leads and carrying case... £30

WAYNE KERR B424 Component Bridge... £50

RACAL 9300 True RMS Voltmeter, 5Hz-20MHz usable to 60MHz, 10V-316V... £50

RACAL 9306B as above... £75

JUST IN

H.P. 8460A Signal Generator, AM/FM, 500kHz-51.3MHz £250

KENWOOD CS4025 Oscilloscope, dual trace, 20MHz £125

LEADER LBS523 Oscilloscope, dual trace, 35MHz £140

GOULD OS300 Oscilloscope, dual trace, 20MHz £95

NATIONAL PANASONIC VP7705A Distortion Analyser £125

KENWOOD VT175 Millivoltmeter 2-channel... £50

KENWOOD FL140 Wow & Flutter Meter... £50

KENWOOD FL180A Wow & Flutter Meter... Used £75

BIRD 43 Watt Meter... £75

MARCONI H938 AF Power Meter, Sinad Measurement... Unused £100, Used £60

MARCONI H938B, No Sinad... £30

MARCONI 2610 True RMS Voltmeter, Autoranging, 5Hz-25MHz... £195

GOULD J38 Sine/Sq Osc., 10Hz-100kHz, low distortion... £75-£125

AVO 8 Mk. II In Every Ready case, with leads etc... £80

Other AVOs from... £50

GOODWILL GVT427 Dual Ch AC Millivoltmeter, 10mV-300V in 12 ranges, Freq 10Hz-1MHz... £100-£125

SOLARTRON 7150 DMM 6 1/2 digit Tru RMS, IEEE... £95-£150

SOLARTRON 7150 Plus... £240

FARNELL DTV12-14 OSCILLOSCOPE

Dual trace, 12MHz TV, coupling, ONLY **£75**

FARNELL LF1 SINE/SQ OSCILLATOR.

ONLY **£75**

OSCILLOSCOPES

TEKTRONIX TD5350 dual trace 200MHz 1G/S Unused £1500

TEKTRONIX TD5320 dual trace 100MHz 500MS £3200

TEKTRONIX TD5310 dual trace 50MHz 200MS £950

LECROY 9400A dual trace, 175MHz, 5G/S £750

HITACHI VC6523, 4 trace, 20MHz, 20MS, delay etc. Unused £500

PHILIPS PM3092 2+2-ch, 20MHz, delay etc. £800 all new £950

PHILIPS PM3082 2+2-ch, 10MHz, delay etc. £700 all new £800

TEKTRONIX TA5465 dual trace 100MHz delay etc. £750

TEKTRONIX 2465B 4-ch, 40MHz, delay cursors etc. £1500

TEKTRONIX 2465 4-ch, 40MHz, delay cursors etc. £900

TEKTRONIX 468 Dig Storage, dual trace 100MHz delay £450

TEKTRONIX 466 Analogue Storage dual trace, 100MHz £250

TEKTRONIX 485 dual trace 45MHz, delay sweep £550

TEKTRONIX 475 dual trace 20MHz, delay sweep £350

TEKTRONIX 465B dual trace, 60MHz, delay sweep £250

PHILIPS PM3065 2+1-ch, 100MHz, dual TB delay out/ret. £375

PHILIPS PM3055 2+1-ch, 100MHz, dual TB delay out/ret. £275

PHILIPS PM3217 dual trace, 50MHz delay £200-£250

GOULD OS1100 dual trace, 30MHz delay £125

HAMEG HM303 6 dual trace, 30MHz component tester as new £240

HAMEG HM303 dual trace 30MHz component tester. Many other Oscilloscopes available £200

H.P. 8063B DC Electronic Load, 3-240V/0-10A 250W POA

H.P. 86312A PSU, 0-20V/0-2A £400

H.P. 86311B PSU, 0-15V/0-3A £400

H.P. 86309D PSU Dual 0-15, 0-3A/12, 0-1-5A £750

H.P. 8632B PSU, 0-20V/0-5A £500

H.P. 8629A PSU, triple output ranging from 0-7V-0-5A to 0-20V-1-4A £950

H.P. JAGLENT 34401A OMM 8 1/2 digit £400/£450

H.P. 3478A DMM 5 1/2 digit £275

FLUKE 15 DMM dual display £420

KEITHLEY 2010 DMM 7 1/2 digit £950

KEITHLEY 617 Programmable Electrometer £1250

H.P. 4338B Milliohmmeter... £1500

RACAL Counter type 1999 2 6GHz... £500

H.P. Counter type 53731A 3GHz... £350

H.P. JAGLENT 33120A Func. Gen/ARB. 100Hz-15MHz £900/£1000

SONY/TEKTRONIX AF320 Arbitrary Func. Gen. £1250

H.P. 8904A Sin. Function Gen., DC-400kHz £1000/£1250

BLACK STAR JUPITER 2010 Func. Gen., 0.2Hz-2MHz with frequency counter... £140

H.P. 8116A Pulse Generator, 1mH-50MHz... £1950

H.P. 8657B Sin. Sig. Gen., 0.1-2080kHz... £50

CO-AXIAL SWITCH, 1.5GHz £40

IEEE CABLES £10

H.P. 3312A Function Gen., 0.1Hz-13MHz, AM/FM Sweep/Tri/Gate/Burst etc. £300

FARNELL AMM255 Automatic Mo Meter, 1.5MHz-2GHz, unused £300

FARNELL DSG1 Low Frequency Syn Sig. Gen., 0-001Hz-99.99kHz, low distortion, TTL Square/Pulse Outputs etc. £125

FLUKE 8060A Handheld True RMS, DMM, 4 1/2 digit, as new £150, used £95

H.P. 3310A Function Gen., 1Hz-50MHz-5MHz, Sine/Sq/Tri/Ramp/Pulse £125

FARNELL LFM4 Sine/Sq Oscillator 10Hz-1MHz, low distortion, TTL output, Amplitude Meter £125

H.P. 545A Logic Probe with 546A Logic Pulsar and 547A Current Tracer... £90

FLUKE 77 Multimeter, 3 1/2 digit, handheld £70

FLUKE 77 Series 11 £60

HEINE 1000 L.C.D. Clamp Meter, 0D 1000A, in carrying case... £60

BLACK STAR ORION PAL-TV Colour Pattern Generator... Iron £75-£125

THURLBY/THANDER TG210 Function Generator, 0-002Hz-2MHz, TTL etc... £60-£95

THURLBY THANDER P.S.U. P.320CMD, 0V-32V, 0A-2A Twice (late colours)... £200

HIGH QUALITY RACAL COUNTERS

9904 Universal Timer Counter, 50MHz... £50

9916 Counter, 10Hz-520MHz... £75

9918 Counter, 10Hz-560MHz, 9-digit... £50

WAYNE KERR B424 Component Bridge £125

RACAL/AIM 9343M LCR Databridge, Digital Auto-measurement of R, C, L, Q, D £200

HUNTRON TRACKER Model 1000... £125

FLUKE 8060A 4.5 Digit 2A True RMS £75

FLUKE 8C10A 3.5 Digit 10A £50

FLUKE 8C12A 3.5 Digit 2A £40

Portable Appliance Tester £180

Megger P142

H.P. 8012B DC PSU 0-60V, 0-50A, 1000W £1000

FARNELL AP60/50 1KW Autoranging... £1000

FARNELL B60/50 0-60V, 0-50A... £750

FARNELL R60/25 0-60V, 0-25A... £400

Power Supply HPS3010, C-30V, 0-10A £140

FARNELL Dual PSU XA35-2T, 0-35V, 0-2A Twice OMD I.c.d. Display... £190

FARNELL L30-2 0-30V, 0-2A... £30

FARNELL L30-1 0-30V, 0-1A... £50

Many other Power Supplies available

MARCONI 2022E Synth AM/FM Sin. Gen 1MHz-101GHz I.c.d. display etc £525-£750

H.P. 8657A Synth sig gen, 100kHz-1040MHz £2000

H.P. 8656B Synth sig gen, 100kHz-990MHz £1350

H.P. 8658A Synth sig gen, 100kHz-990MHz £995

R&S APMS2 Synth, 1Hz-2600Hz sig gen, balanced/unbalanced output, c.d. display £425

PHILIPS PM5328 sig gen, 100Hz-180MHz with 200MHz freq. counter, IEEE £550

RACAL 9081 Synth AM/FM sig gen, 5MHz-520MHz £250

H.P. 3325A Synth function gen, 2MHz £600

MARCONI 6500 Impedance Analyser £1500

H.P. 4192A Impedance Analyser £2750

H.P. 4275A LCR Meter, 10Hz-10MHz £1000

H.P. 1903A Distortion Analyser £2000

WAYNE KERR 3245 Inductance Analyser £1250

H.P. 8112A Pulse Generator, 5MHz £1000

MARCONI 2440 Frequency Counter, 20GHz £2000

H.P. 1350B Frequency Counter, 20GHz £800

H.P. 1342A 10Hz-8GHz Frequency Counter £1000

H.P. 1650B Logic Analyser, 8 channel £750

MARCONI 2035 Mod Meter, 540kHz-2GHz £750

SPECTRUM ANALYSERS

H.P. 85E1B 5MHz-6.5GHz £5000

H.P. 85E0A 5MHz-6.5GHz synthesised £5000

H.P. 8594E 9kHz-2.9GHz £4500

H.P. 8591E 1MHz-1.6GHz, 75 Ohm £2770

H.P. 853A with 8559A 100kHz-21GHz £1750

H.P. 8558B with Main Frame, 100kHz-1500MHz £750

H.P. 3585A 20Hz-40MHz £2500

H.P. 3580A 5Hz-50MHz £600

ADVANTEK RA131B 10kHz-0.5GHz £2750

EATON/AILTECH 757 0.001-2GHz £750

MARCONI 2282 100Hz-400MHz, high resolution £2800

MARCONI 2270 30Hz-110MHz from £500

H.P. 182 with 8557 10kHz-35MHz £500

H.P. 141T SYSTEMS 8553 1MHz-10MHz £500

8554 50kHz-1250MHz £750

8555 1MHz-180MHz £1000

H.P. 8443 Tracking Gen/Counter, 110MHz £225

H.P. 8444 OPT 059 £760

B&K 2033R Signal Analyser £5000

H.P. 8754A Network Analyser, 4MHz-1300MHz £1250

H.P. 3557A Network Analyser, 5Hz-30MHz £3000

H.P. 53810A Mod Domain Analyser Opt 001/0C/D £5000

ONO SDK30 C9000 Portable FFT Analyser £1920

H.P. 8720C Mod Network Analyser 50MHz-20GHz £12,500

RADIO COMMUNICATIONS TEST SETS

MARCONI 2955/2958 From £1600

ROWDE & SCHWARZ CMT 11-10MHz £1500

SCHLUMBERGER 4440 £750

STEWART of READING

110 WYKEHAM ROAD, READING, BERKS. RG6 1PL
Telephone: (0118) 9268041. Fax: (0118) 9351696
www.stewart-of-reading.co.uk
Callers welcome 9am-5.30pm Monday to Friday (other times by arrangement)

Used Equipment - GUARANTEED. Manuals supplied
This is a VERY SMALL SAMPLE OF STOCK. SAE or Telephone for lists.
Please check availability before ordering.
CARRIAGE all units £16. VAT to be added to Total of Goods and Carriage

PATENTLY UNFRIENDLY

Access to patent documentation is available to all, but the Net databases are not user-friendly, as Barry Fox has discovered.

THE purpose of a patent is that it lays open full technical details of a new idea, in return for the chance of winning a limited period of legal monopoly. Laying open the details gives others the chance to challenge the inventor if the idea is not as new as claimed. The British Library is now running free clinics to help non-experts use the online databases which are now available to anyone with Internet access (<http://www.bl.uk/services/information/patents/clinic.html>).

The courses will be invaluable to anyone trying to navigate the European and world PCT sites:

http://ep.espacenet.com/espacenet/ep/e_net.htm

<http://ipdl.wipo.int/en/search/pct/browse.html>

<http://ipdl.wipo.int/en/search/pct/search3.html>

<http://ipdl.wipo.int/en/search/full/search3.html>

All these search sites are user-unfriendly, and all have different obstacles for the unwary, with no consistent policy on search commands.

The PCT sites need free registration, whereas the EPO site does not. When the EPO's site Espacenet is searched, patent numbers must be entered as a continuous string without spaces. So **WO 03/051033** must be entered as **wo03051033**. The leading zero is essential; entering **wo0351033** gets no result and can lock up the system.

Perversely, the PCT Database Browse search page finds nothing when **wo03051033** is entered. It needs a completely different entry format, **wo/03/051033**. And again the leading zero is essential. So **wo/03/51033** finds nothing. The PCT Full Text Database search page (prototype) also needs the number format **wo/03/051033** – but the leading zero can be dropped. So **wo/03/51033** works.

As a hidden pitfall the PCT Full Text Database defaults to searching only the current week's patents, and must be reset to All Date for a full search by patent number. The EPO site has no such default. The mouse scroll wheel works when a PCT patent is displayed as plain text; and keeping the cursor arrow key pressed scrolls down the page. But when a pdf "Image" of the printed patent is downloaded from the EPO site (either by direct access to the EPO site or via hyperlinks from the PCT sites) the mouse scroll wheel does not work. The cursor arrow

key has to be repeatedly pressed because keeping it pressed does not scroll down the page. This is not a good way to avoid RSI.

Each page of the pdf must be downloaded separately, which makes page-turning painfully slow, even with a broadband line. Speed reading is impossible. Each page must be printed separately, too. There is no option to download the whole specification for rapid reading or one-command printing.

Third-party software can fool the EPO site into downloading whole documents, but it is expensive. The existence of this software suggests that the EPO site could be modified at source to allow what every patent searcher wants – easy access to complete documents.

HILLS CAT

MASSIVE – over 660 pages of products to interest you all! That's the simple description of the latest catalogue from Hills Components. Printed in full colour, A4-sized, it covers a very wide range of products, far too large to itemise, but it's worth highlighting that computing, motoring, electrical, musical, servicing, tools and test equipment are included. On the cover of this 30th anniversary edition of the catalogue, Hills simply say Computer Accessories & Electronics. If that's what it says on the label, that's what's covered!

For your copy contact Hills Components Ltd, Dept EPE, Valley Park, Olds Approach, Watford WD18 9TL. Tel: 01923 424344. Fax: 01923 421421.

Email: sales@hillsonline.co.uk
Web: www.hillsonline.com

N.V.C.F. FAIR

THE National Vintage Communications Fair takes place on Sunday 28 September 2003. This specialist Antiques and Collectors' Fair will have thousands of vintage radio sets, crystal sets, valve amps, classic hi-fi, horn speakers, gramophones, records, transistors, valves, spares, scientific instruments, early TVs and telephones, plus mechanical and electrical antiques and collectables for sale.

This year sees the N.V.C.F. celebrating its 11th successful year. Since its inception in 1992, it has been recognised as the UK's leading vintage communications fair

aimed specifically at collectors of equipment from a bygone era.

The fair is held twice a year at the NEC, and is supported by over 300 stallholders from all over Britain and as far afield as Europe, America and the Far East, who may be anything from full time specialist dealers, to people selling surplus items from their collections.

Venue: Hall 11, National Exhibition Centre, Birmingham. Doors open 10.30am to 4pm. Admission £5 (under 14s free).

Web: www.bvws.org.uk

Email: info@nvcf.org.uk

SONICEYE



"IN my studio I use it all the time", Pete Townsend is reported as saying in the press release we have received about the Soniceye instrument level checker.

The Soniceye is a simple, affordable minitool that provides both musicians and studio users with what is said to be the fastest and most effective way of checking if anything is present at an audio system's output sockets. This is particularly important in setups where musical instrument signals may pass through many effects boxes, sound modifiers and cables on their way from the musician to the loudspeaker.

Soniceye can test electric guitars and basses, FX pedals, synthesizers, keyboards and electric organs, rack effects, sound modules, drum machines, samplers, recording console outputs and PC soundcards, etc. With appropriate adaptor leads it can also be used to test Walkmans, CD and cassette players, studio wall boxes and other audio gear. It costs around £24.67/\$36 US.

For more information browse www.soniceye.co.uk

PROTEUS

The Complete Electronics Design System

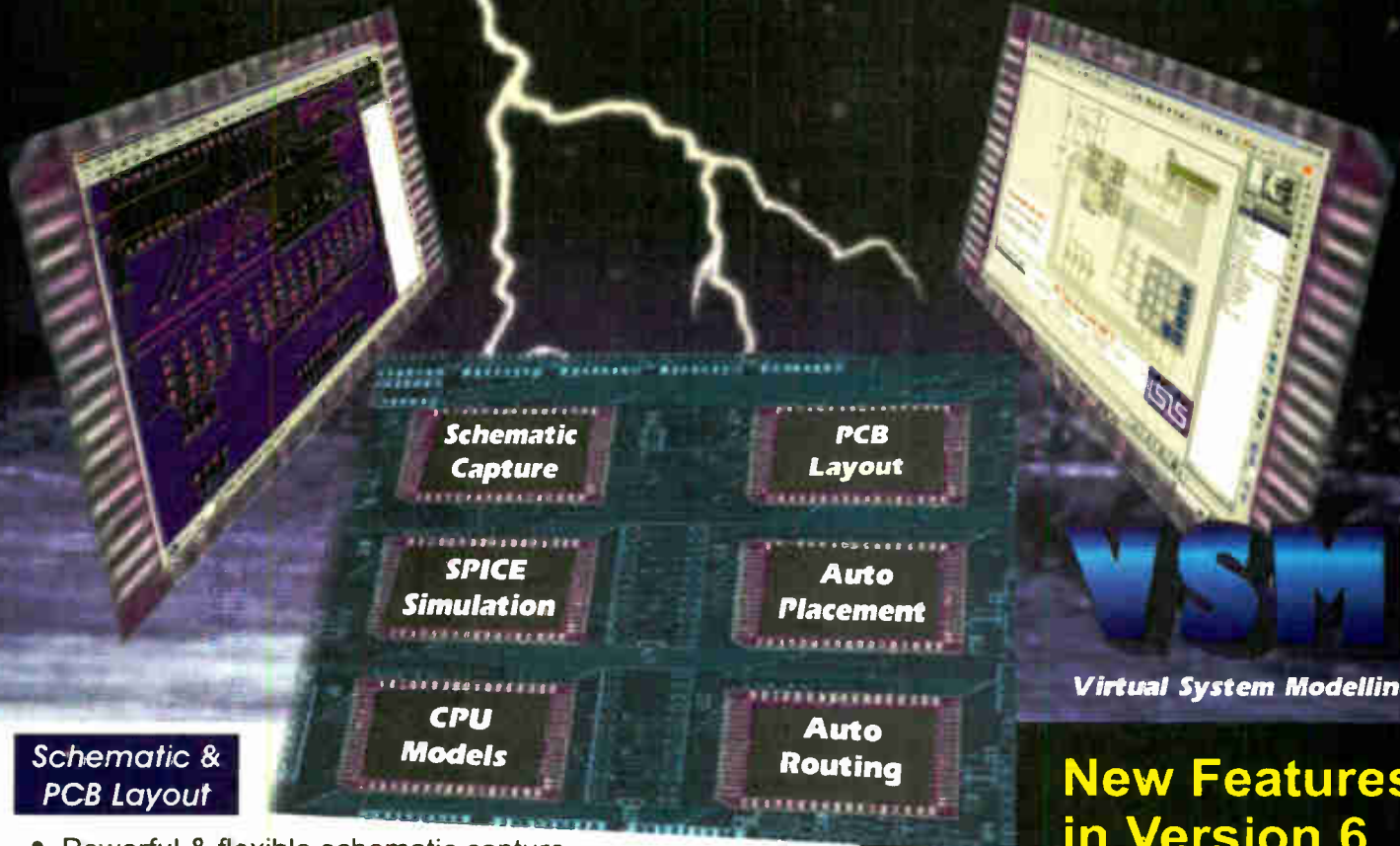

Schematic & PCB Layout

- Powerful & flexible schematic capture.
- Auto-component placement and rip-up/retry PCB routing.
- Polygonal gridless ground planes.
- Libraries of over 8000 schematic and 1000 PCB parts.
- Bill of materials, DRC reports and much more.

Mixed Mode SPICE Circuit Simulation

- Berkeley SPICE3F5 simulator with custom extensions for true mixed mode and interactive simulation.
- 6 virtual instruments and 14 graph based analysis types.
- 6000 models including TTL, CMOS and PLD digital parts.
- Fully compatible with manufacturers' SPICE models.

Proteus VSM - Co-simulation and debugging for popular Micro-controllers

- Supports PIC, AVR, 8051, HC11 and ARM micro-controllers.
- Co-simulate target firmware with your hardware design.
- Includes interactive peripheral models for LED and LCD displays, switches, keypads, virtual terminal and much, much more.
- Provides source level debugging for popular compilers and assemblers from Crownhill, IAR, Keil, and others.

Virtual System Modelling

New Features in Version 6

- Drag and drop toolbars.
- Visual PCB packaging tool.
- Improved route editing.
- Point and click DRC report.
- Multiple design rules (per net).
- Multiple undo/redo.

Call Now for Upgrade Pricing

Works with
PIC Basic Plus
from Crownhill
Associates

labcenter

Electronics
53-55 Main Street, Grassington. BD23 5AA

Tel: 01756 753440
Fax: 01756 752857

Contact us for
Free Demo CD

www.labcenter.co.uk
info@labcenter.co.uk

INGENUITY UNLIMITED



Our regular round-up of readers' own circuits. We pay between £10 and £50 for all material published, depending on length and technical merit. We're looking for novel applications and circuit designs, not simply mechanical, electrical or software ideas. Ideas *must be the reader's own work* and **must not have been submitted for publication elsewhere**. The circuits shown have NOT been proven by us. *Ingenuity Unlimited* is open to ALL abilities, but items for consideration in this column should be typed or word-processed, with a brief circuit description (between 100 and 500 words maximum) and full circuit diagram showing all relevant component values. **Please draw all circuit schematics as clearly as possible.** Send your circuit ideas to: *Ingenuity Unlimited*, Wimborne Publishing Ltd., 408 Wimborne Road East, Ferndown Dorset BH22 9ND. (We do not accept submissions for *IU* via E-mail.) Your ideas could earn you some cash and a prize!

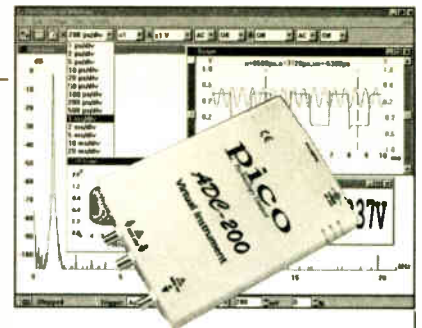

WIN A PICO PC BASED OSCILLOSCOPE WORTH £586

- 100MS/s Dual Channel Storage Oscilloscope
- 50MHz Spectrum Analyser
- Multimeter • Frequency Meter
- Signal Generator

If you have a novel circuit idea which would be of use to other readers then a Pico Technology PC based oscilloscope could be yours. Every 12 months, Pico Technology will be awarding an ADC200-100 digital storage oscilloscope for the best *IU* submission. In addition, a DrDAQ Data Logger/Scope worth £69 will be presented to the runner up.

THERMAL CHARGE MONITOR – HOTLY SWITCHED

MANY simple constant-current chargers for NiCd and NiMH batteries do not adapt to state-of-charge, so continue to deliver current, even to fully-charged batteries, until manually switched off. Depending on the current, such overcharging can damage batteries through excessive heating. The circuit diagram shown in Fig.1 when connected between such a charger and battery, will automatically switch off the charge current when the temperature rise of the battery indicates that full-charge has been reached.

MOSFET switch TR2 is connected in series with the positive lead between a charger (up to several amps) and the charge battery using terminals SK1 and SK2.

Silicon diodes D2 and D3 form a differential temperature transducer, measuring the difference in temperature between the battery (D2) and the ambient temperature (D3). Diode D2, on extension wires and encased in heat-shrink tubing, is placed in thermal contact with the battery.

Potentiometer VR1 is preset (once only), to compensate for forward-bias mismatch

between D2 and D3 and to establish the temperature threshold for charge termination, as follows:

Pushbutton switch S2 is pressed to bias transistor TR1 "on" and thereby connect the 6V internal battery supply to the circuit. With the target battery (and hence D2) at ambient temperature, VR1 is then adjusted until the voltage at test-point TP1 is about 25mV higher than that at TP2.

Voltage comparator IC1 responds to the 25mV offset between TP1 and TP2 by setting output pin 7 low, so turning on transistor TR1. Switch S2 can now be released. The 6V supply now conducted by TR1 turns on MOSFET TR2, enabling charge current to flow from the charger to the On-charge battery. Light emitting diode D1 indicates this "charging" condition.

When the battery reaches full-charge its temperature begins to rise, reducing the forward-bias voltage across diode D2 by about 2.5mV/°C. When the battery temperature reaches about 10°C above ambient, the voltage at TP1 falls below that at TP2, causing

comparator IC1 to switch off (aided by positive feedback through capacitor C3), so switching off transistor TR1 and disconnecting the 6V supply from the circuit.

Simultaneously, TR2 also switches off, isolating the charged battery from the charger. The circuit will not switch itself on again when the battery cools – this can only be done manually by pressing switch S2. Pushswitch S1 provides a "manual override" function for switching the circuit off, terminating the charging.

The 10°C temperature threshold is a suggested starting value and is easily changed, using VR1, for other applications.

Metallised polyester (or polyester film) capacitors were used throughout the circuit. Their values have been chosen to provide noise filtering and to facilitate switch-on and switch-off actions.

The circuit draws about 10mA from the 6V internal battery supply when on, and less than 100nA when off, ensuring long battery life.

Nigel E. Stone,
Fulham, S. Australia.

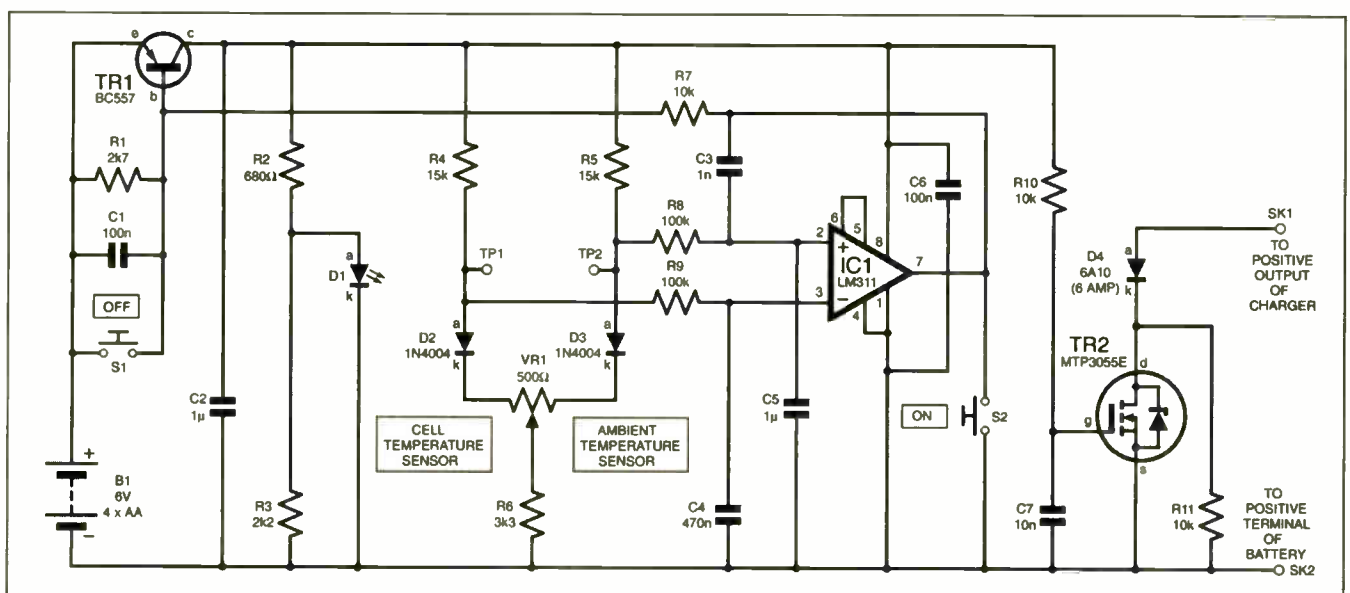

Fig.1. Circuit diagram for a Thermal Charge Monitor.

INFRA-RED BODY DETECTOR – HOT SPOTTED

THE circuit in Fig.2 can detect any large object which appears in front of the sensor, IC1. This device is an infra-red remote control receiver and a variety of types can be used, including the readily available IS1U60.

The heart of the circuit is the NE567, IC2, a tone decoder which produces a logic 1 output at pin 8 when the frequency at its input pin 3 is equal to that produced by its internal oscillator. The oscillator's frequency is set by resistor R2 and capacitor C5. It is output from pin 5 and fed via resistor R3 to one input of NAND gate IC3a, pin 12.

NAND gates IC3a and IC3b are configured as an oscillator whose output at IC3b pin 4 controls the other input of IC3c, pin 13. The modulated output from IC3c pin 11 is fed to transistor TR1 via buffer resistor R8. This causes the two infra-red l.e.d.s D3 and D4 to turn on and off in response to the modulated signal. Their output intensity is adjustable by preset VR1. Components R9 and C8 filter ripple voltages produced across the l.e.d.s and also increase the peak current flow through them.

Preset VR1 is used to set the desired detection range. With its resistance set at 10Ω if a

large object, such as a human body, approaches the circuit within two metres, IC2 pin 8 will go high. The output is fed to the network D1, R4, R6 and C7, which filters the signal to ensure that random noise does not affect the circuit. The network feeds into IC3d whose output when high turns on l.e.d. D2 via buffer resistor R7.

You can also use IC2 output pin 8 to control other circuits, as part of a thief alarm or automatic door-opener, for example.

Hein Myo Latt,
Yangon, Myanmar

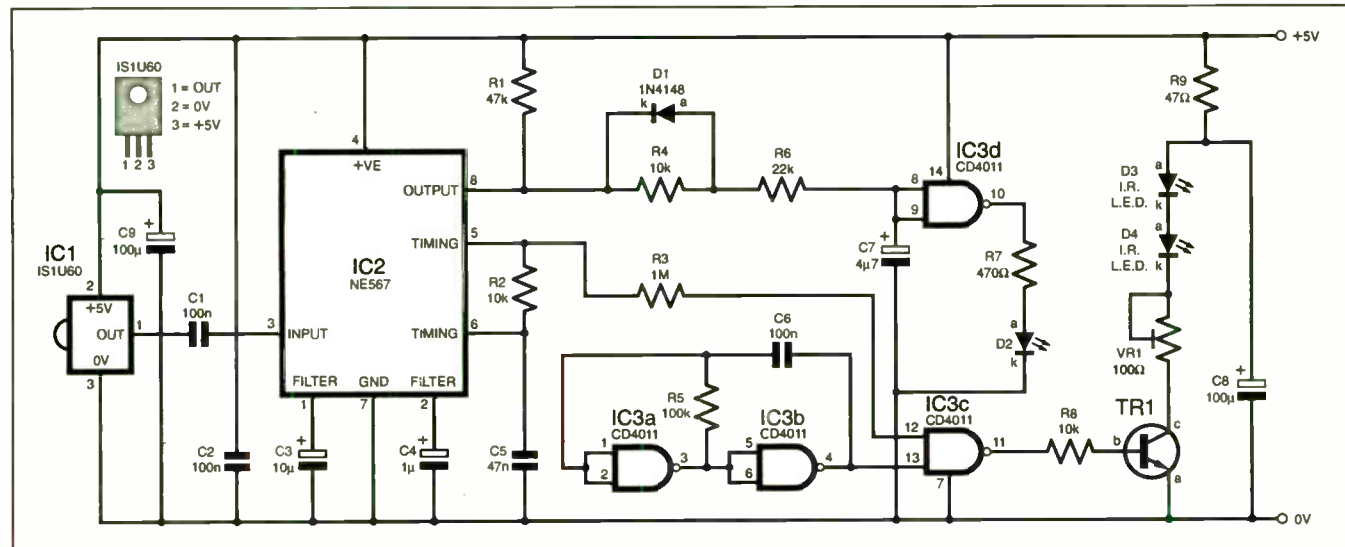

Fig.2. Circuit diagram for a novel Infra-Red Body Detector.

DIVIDER FEEDBACK – SQUARING THE ODDS

WHEN a square-wave is required from a divider, a separate toggle stage is normally required to follow the divider's output. This can be inconvenient and, if the divisor cannot be halved, requires doubling the source frequency.

Type 74161 and 74163 synchronous dividers add further complications. They require external logic and the output pin must be carefully selected: pin 15 (Terminal Count) should not drive edge-triggered logic. Correct selection depends on the value loaded, which also changes the output mark-space ratio. Loading all-highs may stop operation.

The circuit given in Fig.3 avoids all these problems by integrating the load control logic and the toggle stage. Square waves are ensured for any input value, n , by executing two loops of lower six bits per output period, yielding divisor $D = 2n + 4$. Binary inputs a to f are active-low (n for negative logic). All-highs render division by four. Grounding all inputs ($n = 63$) gives a maximum divisor of 130.

The penultimate counter input must be tied high in order to render control bit Qc inactive, enabling incrementing until 6-bit overflow sends Qc low and output Qd high (counter state = 128). Control output Qc initiates reload at the next clock-edge, the new output state being preserved by local feedback to pin 6. The next loop ("mark") finishes with both Qc and Qd toggling low, as the counter chain overflows to zero.

Feeding Q back to input a will cause the value loaded when Q is high to be one step

nearer overflow. The mark period thus gets truncated by one clock period, creating an odd divisor with pseudo-square output. The average value loaded into a is $1/2$. The maximum divisor is now 129 ($n = 62\frac{1}{2}$, inputs b to f grounded).

Only half of odd divisors within range can be implemented this way (see Table 1), because "weight = 1" is now missing. The others need multiple-bit change during alternate loads (e.g. 001111 to 010000 for +99), necessitating feedback of both Q and its inversion. This is inconvenient, but does permit any mark-space ratio to be selected at will. However, if Q is fed back to both a and b , half of these "missing" divisors can be recovered without extra logic (see Table 1), with a mark-space imbalance of three.

Trevor Skeggs, Beccles, Suffolk

D	f	e	d	c	b	a	Ratio
127†	L	L	L	L	H	Q	62:65
126	L	L	L	L	H	L	63:63
125*	L	L	L	L	H	Q	62:63
124	L	L	L	L	H	H	62:62
123‡	L	L	L	Q	Q	Q	58:65
122	L	L	L	H	L	L	61:61
121*	L	L	L	H	L	Q	60:61
119†	L	L	L	H	Q	Q	58:61
117*	L	L	L	H	H	Q	58:59
115	L	L	Q	Q	Q	Q	50:65
100	L	L	H	H	H	H	50:50
50	H	L	H	L	L	L	25:25

* $(D - 5)/4$ = integer i
 f, e, d, c, b = NOT $(2i)_2$
 † $(D - 7)/8$ = integer i
 f, e, d, c = NOT $(4i)_2$
 ‡ $(D - 11)/16$ = integer i
 f, e, d = NOT $(8i)_2$

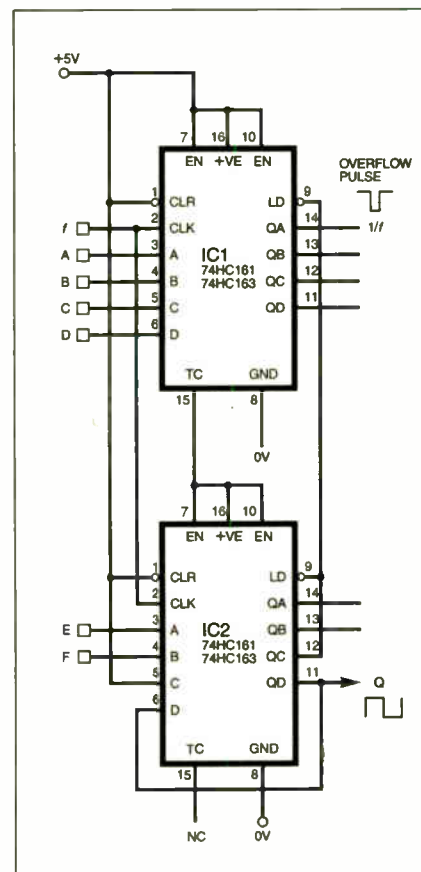
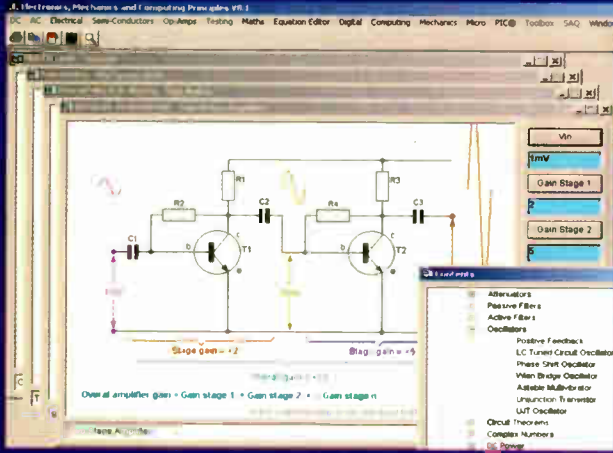

Fig.3. Divider Feedback circuit.

Electronics, Mechanics and Computing Principles V8.1



"First of all may I say what great software. Electronics, Mechanics & Computing Principles V8.1 really will keep me absorbed for months and it is so well presented. Well done."

£14.95

Geoff Woolley. Head of Design Technology at Nottingham High School.

A valuable interactive reference tool for hobbyists and engineers, this highly acclaimed electronics package can also be found in hundreds of schools, colleges and universities to support GCSE, A-Level, City and Guilds, BTEC Nationals and many other courses up to degree level by students all over the world, yet still remains extremely easy to use.

There are more than a thousand electronics, electrical, mechanics, physics, maths, computing and PIC micro controller topics. See web site for full listing. EPV8.1 contains most of the content from the other two packages.

Still trying to get the hang of PIC micro controllers? This software contains an enormous amount of information to get you started, explaining how the PIC microcontroller works, where all the instructions can be interactively explored. Listed on the Microchip web site as a training tool for use in conjunction with their LATEST FREE downloadable MPLAB IDE programmer and simulator. Simply run the two packages together and you have all you need to begin programming.

Mathematics and Computing Principles V8.1

Includes A-Level Computing, Computer Science and Information Technology.

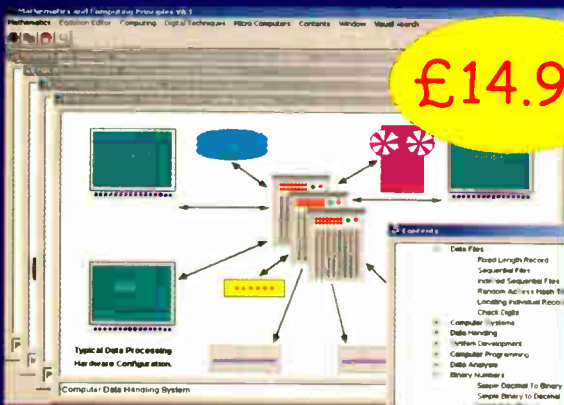

£14.95

Now combining mathematics along with a vast amount of interactive, computing and ICT material, much more than available from any other single source.

Includes the unique Equation and Graph Editors, plus full colour printing, white board technology and a host of other features.



Certified software for Curriculum Online and eLearning credits.

GCSE Mathematics Principles V8.1

Struggling with GCSE Maths or just want to get better grades then this is the software for you!

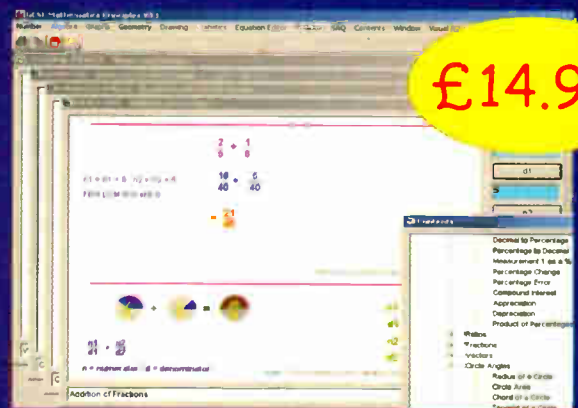

£14.95

Studying with this dynamic software, you'll learn through doing and exploring mathematics! It's much more exciting than ploughing through a static textbook!

www.eptsoft.com to download.

SAVE £105 on the previous V8 price.

FREE downloadable updates.

FREE trial evaluation.

NETWORK LICENCE see web site for details.

New Internet technology enables us to bring you our latest software at a fraction of the previous price.

Simple one-click to download and fully install to your hard drive with a backup copy, by visiting our web site.

eptsoft limited, Glebe House, School Lane, East Keal, Spilsby
Lincolnshire UK PE23 4AU

info@eptsoft.com : Tel: 01790 754037 : Fax: 0870 0509660

VIBRATION ALARM

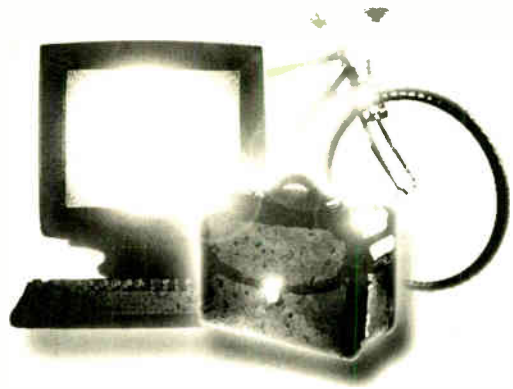

OWEN BISHOP

This short collection of projects, some useful, some instructive and some amusing, can be made for around the ten pounds mark. The estimated cost does not include an enclosure. All of the projects are battery powered, so are safe to build. In a few cases where the project is to be run for long periods, power may be provided by an inexpensive mains adaptor.

THIS versatile and portable project guards your property by sounding an alarm whenever it is disturbed. Place it on top of your TV set and the alarm will go off if anyone tries to remove either the TV set or the detector. Put it in the saddlebag of your bicycle and it will warn others if any attempt is made to move the bike.

Place it on the floor inside a closed door and the alarm will sound if anyone opens the door and disturbs it. There are very many ways to use this electronic Vibration Alarm guard-dog.

HOW IT WORKS

The block diagram in Fig.1 shows the seven main parts of the system, and the full circuit diagram is shown in Fig.2.

Disturbances are detected by a mercury-free tilt switch, S1. This is normally closed, but contact is broken when it is disturbed, allowing the pull-up resistor, R1, to pull up inputs 1, 2 and 5 of the pulse generator formed around NAND gates IC1a

and IC1b. This causes a brief low-going output pulse at IC1b pin 4, with a period set by resistor R2 and capacitor C1.

There is a microswitch (S2) in series with the tilt switch. This is mounted so that it is held on (closed) when the lid of the enclosure is in place. If anyone loosens the lid, with the idea of disabling the alarm, the microswitch opens and this too triggers the pulse generator.

The low-going pulse from the pulse generator triggers timer IC2 to produce a high output at pin 3 for about 11 seconds, a timing set by components R3 and C2. This output level is inverted by NOR gate IC3a, whose low-going output at pin 6 feeds to input pin 2 of NOR gate IC3b. If input pins 1 and 8 of IC3b are already held low, the resulting high-going pulse at IC3b pin 9 turns on MOSFET TR1, which in turn activates the sounder or siren, WD1.

After the 11 seconds timed period, the siren is silenced, but will start again if there is any further disturbance.

KEY CONNECTION

The device is disarmed by inserting a "key" in a socket. This is an electronic "key", consisting of a mono jack plug (PL1) containing a resistor, R6. When this is inserted in its socket R6 acts with R7 to form a potential divider. With a 9V supply and the resistor values $R6 = 3.9k\Omega$ and $R7 = 820\Omega$, the voltage at point B (and at pins 2 and 5 of op.amps IC5a and IC5b) is 1.56V.

The voltage must lie within the window of the discriminator formed by the configuration of the circuit around IC5a and IC5b. That is to say, it must be between the voltages at pin 3 and pin 6. These are set by the values chosen for R8, R9 and R10. If $R8 = 8.2k\Omega$, $R9 = 470\Omega$ and $R10 = 1.6k\Omega$, the resulting voltages are 1.4V at pin 6 and 1.8V at pin 3, so the voltage at pins 2 and 5 comes near the middle of this window.

As an aside, when choosing resistor values for a discriminator window, a small value should be chosen for R9 so that the window is reasonably narrow. This makes it less likely for anyone to produce a key that will put pins 2 and 5 within the range of the window.

As long as the correct "key" is in the socket, pin 5 of IC5 is higher than pin 6, and pin 2 is lower than pin 3, so pins 1 and 7, which are "open-collector", are pulled up to 9V by resistor R11. These outputs are coupled to input pin 8 of IC3b. When this pin is held high, i.e. the "key" is inserted, the NOR gate cannot be affected by pulses arriving at its pin 2. In other words the circuit is "disarmed".

If the key is removed, or a key with an incorrect value for R6 is inserted, it is likely that the voltage at pins 2 and 5 will be outside the window, either too high or too low, and one of the outputs remains at 0V. The resulting output of the discriminator is

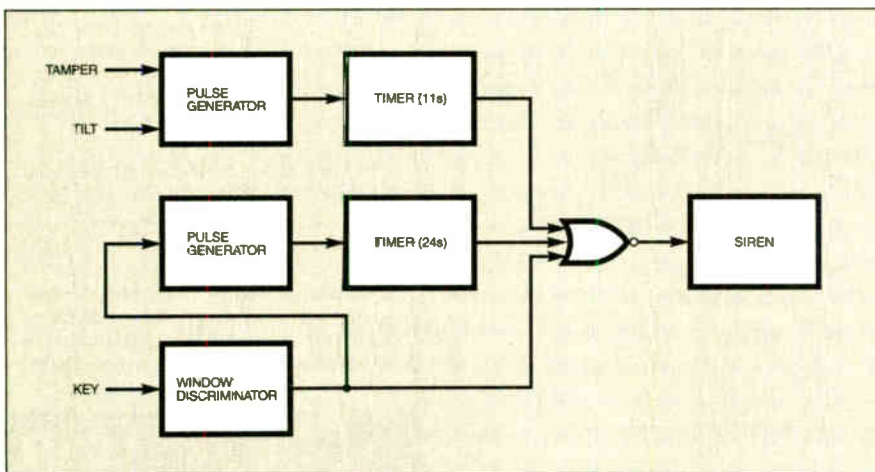

Fig.1. Block schematic diagram for the Vibration Alarm.

0V and the device is "armed", and the alarm will sound if tilt switch S1 is disturbed.

Arming the circuit by removing the key causes IC3b pin 8 to go low. It also triggers the pulse generator formed around IC1c and IC1d, to produce a brief low output pulse at IC1d pin 11. This triggers timer IC4 to produce a high output pulse at pin 3 for about 24 seconds. The result is that during this period the output of IC3b is held low, so the alarm cannot sound. This gives time for residual vibrations of the tilt switch to settle.

For the siren to sound, all three inputs to IC3b must be low. This situation occurs when the key is not in its socket AND it is more than 24 seconds since the device was armed AND the tilt switch is shaken or someone is tampering with the case.

Then the siren sounds for 11 seconds, but can be silenced by inserting the key.

OTHER KEYS

For resistors R6 to R10 you can use the values specified, or alternatively select your own "key voltage" (the voltage at IC5 pins 2 and 5) and calculate suitable values for R6 and R7. Assuming a 9V supply, calculation is as follows:

$$\text{Key voltage} = 9V \times (R7 / (R6 + R7))$$

Then, assuming that R9 is 470Ω, choose values for R8 and R10 so that the upper and lower window thresholds are

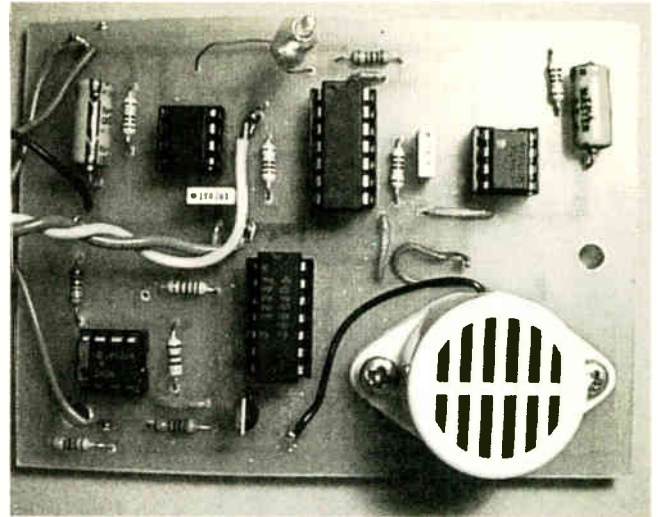

Completed circuit board, with a small siren bolted to it.

about 0.2V above and below the key voltage. i.e.:

$$\text{Upper threshold} = 9V \times (R10 + 470) / (R8 + 470 + R10)$$

$$\text{Lower threshold} = 9V \times R10 / (R8 + 470 + R10)$$

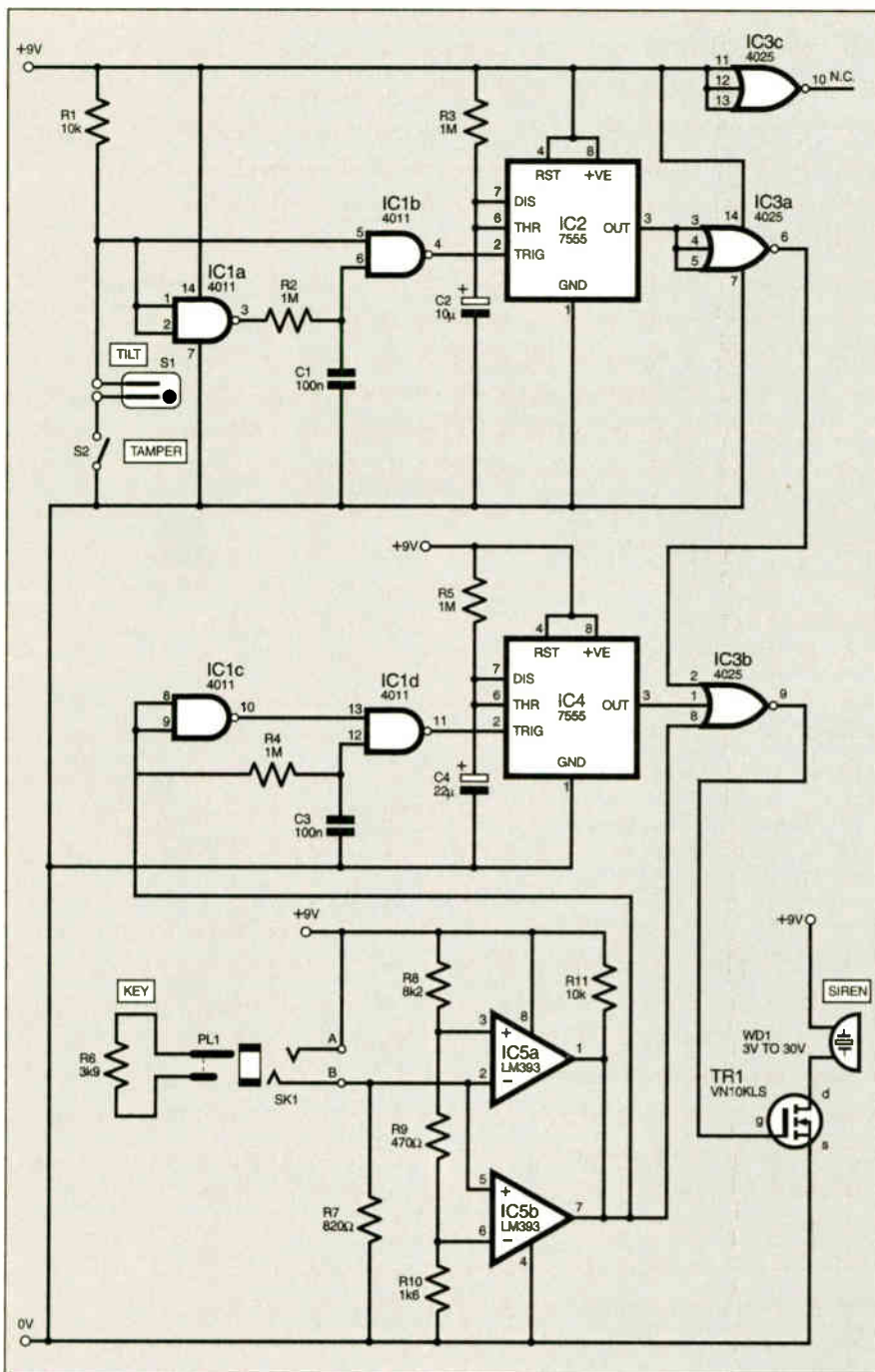

Fig.2. Complete circuit diagram for the Vibration Alarm. The "key" resistor is mounted inside a miniature jack plug.

COMPONENTS

Resistors

R1, R11 10k (2 off)
R2 to R5 1M (4 off)
R6 to R10 (see text)
All 0.25W 5% carbon film or better.

See
SHOP
TALK
page

Capacitors

C1, C3 100n metallised polyester film (2 off)
C2 10μ axial elect. 16V
C4 22μ axial elect. 16V

Semiconductors

TR1 VN10KLS *n*-channel low power MOSFET
IC1 4011 quad 2-input NAND gate
IC2, IC4 7555 timer (2 off)
IC3 4025 triple 3-input NOR gate
IC5 LM393 dual comparator

Miscellaneous

S1 tilt switch, non-mercury type
S2 microswitch, with lever actuator
PL1 3.5mm mono jack plug
SK1 3.5mm mono jack socket
WD1 audible warning device, e.g. siren, 12V

Printed circuit board, available from the *EPE PCB Service*, code 411; 8-pin d.i.l. socket (3 off), 14-pin d.i.l. socket (2 off), 1mm terminal pins (9 off); PP3 battery plus clip or holder (see text); nuts and bolts; plastic or metal case to suit; double-sided adhesive pads for fixing p.c.b. and battery holder; stick-on feet (4 off, optional); connecting wire; solder, etc.

Approx. Cost
Guidance Only

£10
excl. case & batt.

You may need a few trials to find values that are obtainable in the E24 series. It is worth while to set up the resistor networks on a breadboard and check that the values you have calculated actually do produce the intended voltages.

POWER SUPPLY

The circuit can be powered by a 9V PP3 battery. The current drawn is about 3mA when quiescent, so a typical alkaline battery will last for around 180 hours. However, if longer continuous running time is required, the circuit can operate on 6V, obtained from four AA cells, or even D-type cells. With the latter, it should run for about six months.

CONSTRUCTION

Printed circuit board component layout and tracking details are shown in Fig.3. This board is available from the *EPE PCB Service*, code 411.

As the logic is slightly complicated and involves delays, it is best to adopt the following build-and-test procedure. This avoids sounding the alarm until the circuit is known to be working properly.

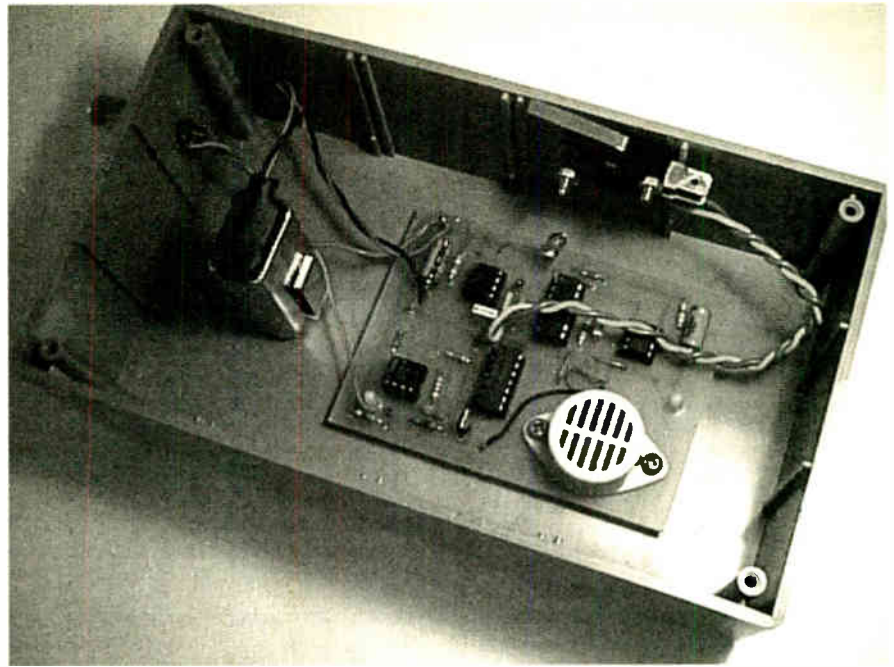

Layout of components inside the plastic box. Note the Tamper switch positioning. The key is in its socket on the left.

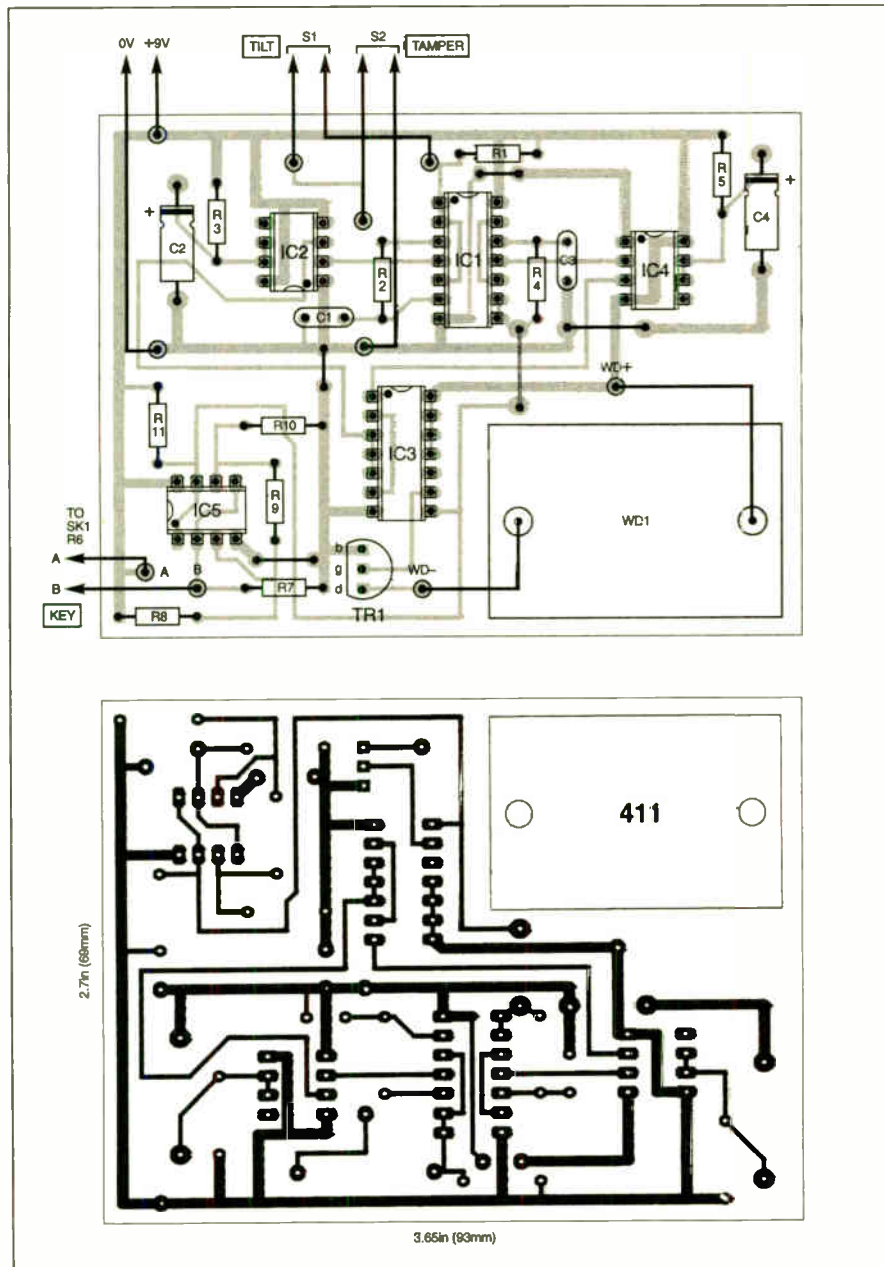

First, mount all the components except for transistor TR1, correctly observing the polarities of the electrolytic capacitors. Do not insert the i.c.s into their sockets or apply power until you have fully checked the correctness of your assembly. Observe normal anti-static precautions before handling the i.c.s, by touching a grounded (earthed) item of equipment to discharge static electricity from your body.

TILT SWITCH

Connect tilt switch S1 and position it so that its contacts are closed. Ensure that the microswitch (S2) contacts are closed. Insert IC1 and IC2, noting that IC2 is inverted with respect to IC1. Switch on the power and measure the output from IC2 pin 3. This should be high (9V) for an initial period of 11 seconds, and then go low (0V).

Now set tilt switch S1 so that its contacts are open. The output from IC2 should go high for 11 seconds. Close S1 and open S2; the same high output should be produced. If there is no high output, check the output at IC1 pin 4 and try to detect a brief low-going pulse.

Insert IC4, ensuring that it is the right way up. With IC5 still omitted, temporarily connect pins 8 and 9 of IC1 to +9V. Measure the output at pin 3 of IC4. It should be low after an initially high period of 24 seconds. Now connect IC1 pins 8 and 9 to 0V; the output should go high for 24 seconds.

Insert IC5 and the "key" (R6). Measure the voltages at the junction of R8/R9 and at R9/R10. These define the window. The voltage at point B when measured should be within this window. Measure the voltage at pins 1 and 7 of IC5; this should be 9V with the key in and 0V with the key out.

Insert IC3 and measure the output at pin 9. A high level is equivalent to "siren on". Check what happens when the tamper switch S2 is opened, or the tilt switch

disturbed with the key in and with the key out. The circuit should behave as described earlier. Finally mount TR1 and run through the final test again, with the siren sounding on the correct occasions.

At this stage you may need to adjust the angle of the tilt switch so that contact is broken when the alarm is disturbed.

COMPLETION

For full security, the circuit, siren and battery are housed in a plastic or metal box.

There are many different types of solid-state siren that are suitable for operation on 9V. Some emit a single tone, but a dual-tone siren is generally more effective. Space is left on the circuit board for a small siren. This can be bolted in place, in which case drill holes in the board in suitable positions. Alternatively it can be fixed to the board with double-sided adhesive pads.

Leads from the siren are soldered to the two terminal pins marked WD+ and WD-. Also drill a cluster of small holes in the box

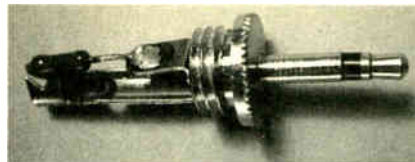

Assembling the Key from a 3.5mm jack plug and 1/8W resistor.

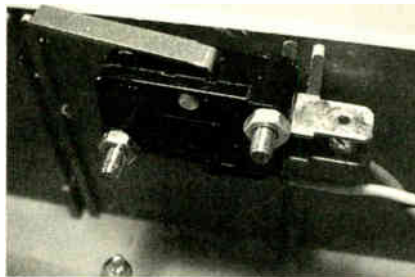

Mounting the Tamper microswitch on the case sidewall. The operating lever must project just above the edge of the box.

to allow the siren to be heard more clearly. The siren shown in the photograph is a relatively small one, producing a sound pressure level of 80dB to 90dB. However, there is room in the case for a more powerful siren. Transistor TR1 is rated at 300mA, so it can drive medium-power sirens with sound pressure levels of 106dB or more.

The way to fix tamper switch S2 depends on the shape and size of the switch and of the lid of the box. The aim is to mount the switch so that its operating lever projects slightly above, the rim of the box when the lid is off. The switch may be glued or bolted in place or mounted on a scrap of circuit board resting in internal slots.

When the lid is bolted on, it presses the lever down, causing the switch to change state. Microswitches usually have changeover contacts, so check which pair are closed when the lid is on and connect this pair into the circuit. □

SHOP TALK

with David Barrington

PIC-A-Colour Game

The author used an old spare part for the tilt switch, loaded with mercury, in the *PIC-A-Colour Game* project. As mercury is such a highly toxic and dangerous substance to handle, readers should *NOT* use a glass-encased mercury tilt switch. We recommend they purchase one of the hermetically sealed *non-mercury* types and a suitable switch is currently listed by **Maplin** (☎ 0870 264 6000 or www.maplin.co.uk), code DP50E.

The 7-segment, common cathode, display used in the model has its pins running alongside the segments, similar to a dual-in-line i.c. Some devices have their pins along the top and bottom of the package, so check the pinouts when ordering. The display used in the prototype came from **ESR Components** (☎ 0191 251 4363 or www.esr.co.uk), code 716-002.

The p.c.b.-mounting pushswitches used in this project are usually referred to by suppliers as miniature "tactile switches" and should be widely available. However, you need a switch with a "button" height of at least 6mm minimum, and this should be verified when purchasing. Unless, of course, you use a different case arrangement to the author and use standard pushbutton switches mounted on the lid of the case. We see that **Rapid Electronics** (☎ 01206 751166 or www.rapidelectronics.co.uk) currently list a tactile switch with a 9mm operating stem, code 78-0610.

For those readers unable to program their own PICs, a ready-programmed PIC16F84 microcontroller can be purchased from **Magenta Electronics** (☎ 01283 565435 or www.magenta2000.co.uk) for the inclusive price of £5.90 each (overseas add £1 p&p). The software is available on a 3.5in. PC-compatible disk (Disk 6) from the *EPE Editorial Office* for the sum of £3 each (UK), to cover admin costs (for overseas charges see page 651). It is also available for free download from the *EPE* ftp site, which is most easily accessed via the click-link option on the home page when you enter the main web site at www.epemag.wimborne.co.uk. On entry to the ftp site take the path **pub/PICS/PICAColour**.

Readers should have no problems with the tri-colour i.e.d.s and strip-board. The latter will need to be cut from a larger piece.

Practical Radio Circuits-4

We understand that the two types of varicap diode called for in this month's part of the *Practical Radio Circuits* series were obtained (mail order only) from **JAB Electronic Components** (☎ 0121 682 7045 or www.jabdog.com). They also supplied the slow-motion drives and the enamelled copper wire (in 50g reels) for the hand-wound coils.

As previously mentioned, the Toko coils are available from **Sycom**, Dept EPE, PO Box 148, Leatherhead, Surrey, KT33 9YW (☎ 01372 372587 or www.sycomcomp.co.uk). They need to be ordered by quoting their type numbers as listed in the parts list and on the circuit diagrams.

The author claims almost any polyvaricon (polythene dielectric) variable capacitor designed for a.m./f.m. portable radios will work in these circuits. They will normally be found listed as "transistor radio" types and consist of an antenna and oscillator section, plus trimmers. They are currently stocked by **ESR Components** (☎ 0191 251 4363 or www.esr.co.uk), code 896-110 and **Sherwood Electronics** (see page 656), code CT9.

The a.m./f.m. varicon capacitor used in the prototype models was obtained from **Maplin** (☎ 0870 264 6000 or www.maplin.co.uk), code

AB11M. For the General Receiver both a.m. gangs are paralleled together to form VC1 and only one f.m. section used for VC2. For the Amateur Receiver, only one f.m. gang is used.

The printed circuit boards are available from the *EPE PCB Service*: codes 412 (Varicap); 413 (Gen Coil pack) plus two 406 (T/Cap) and 414 (Amateur Coil pack) with 406 (T/Cap). The tuning capacitor p.c.b. is optional, but makes for easier wiring.

Vibration Alarm (Top Tenner)

Once again we have the situation where the photographs of the *Vibration Alarm*, one of this month's *Top Tenners* projects, shows a glass-encapsulated mercury switch. We reiterate that, glass being easily fractured and mercury highly dangerous, readers should *not* use this switch and should obtain a *non-mercury* type, such as the one stocked by **Maplin** (☎ 0870 264 6000 or www.maplin.co.uk), code DP50E.

We have searched for the VN10KLS *n*-channel low power MOSFET device and, surprisingly, only **Sherwood Electronics** (see ad. on page 656) appear to carry it in their current listing, coded as the type number. No doubt other low power, general purpose MOSFETs will work in this simple circuit. The rest of the semiconductor devices should be widely available.

The alarm printed circuit board is available from the *EPE PCB Service*, code 411 (see page 651).

Priority Referee (Top Tenner)

All components required to build the *Priority Referee*, the second of this month's *Top Tenners* projects, should not prove too hard to find. The 74HC series of i.c.s are now stocked by most of our components advertisers. One point, do not exceed the 6V supply as the HC series would definitely *not* like it!

The miniature pushswitches are normally found listed as "p.c.b. key-board switches". Note they have strapped terminals (i.e. each contact is connected to two pins) and they need to be placed on the p.c.b. the correct way.

The printed circuit board is available from the *EPE PCB Service*, code 410 (see page 651).

EPE PIC Met Office

After prolonged "environmental field trials", it has been confirmed that it is essential to protect the electronics by spraying the p.c.b. and its components (first protecting/covering the humidity sensor and i.d.r.) with an anti-condensation spray to prevent rain/mist, fog and general condensation affecting the *EPE PIC Met Office's* performance. This conformal coating, as it is called, comes in 100ml and 200ml cans. Readers might like to contact **ESR Components** (☎ 0191 251 4363 or www.esr.co.uk), code 251-950 and **Rapid Electronics** (☎ 01206 751166 or www.rapidelectronics.co.uk), code 87-1210 (used on prototype).

The 40kHz ultrasonic transducers must be the moisture proof, "sealed for external use", types. These were purchased as pairs from **Rapid** (see above), codes 35-0182 (Tx) and 35-0184 (Rx). They also supplied the capacitive type humidity sensor, code 61-0960.

For those readers unable to program their own PICs, a ready-programmed PIC16F877-20 (20MHz) microcontroller can be purchased from **Magenta Electronics** (☎ 01283 565435 or www.magenta2000.co.uk) for the inclusive price of £10 each (overseas add £1 p&p). The software is available on a 3.5in. PC-compatible disk (PIC Met Office) from the *EPE Editorial Office* for the sum of £3 each (UK), to cover admin costs (for overseas charges see page 651). It is also available for free download from the *EPE* ftp site, which is most easily accessed via the click-link option when you enter the main web site at www.epemag.wimborne.co.uk. On entry to the ftp site take the path **pub/PICS/PICMetOffice**, downloading all files within the latter folder.

The large printed circuit board is available from the *EPE PCB Service*, code 402 (see page 651).

New Product

Atlas LCR Passive Component Analyser (Model LCR40)

"No other LCR is as easy as this!"

Just clip on the test leads and press test. The Atlas LCR will automatically identify the type of component, apply the appropriate test level and frequency, display the component's value and more!

Probes are detachable too, so you can use the optional SMT tweezers for your tiny unmarked passives - fantastic.

Inductance range: 1 μ H to 10H
 Capacitance range: 1pF to 10,000 μ F
 Resistance range: 1 Ω to 2M Ω
 Basic accuracy: 1%
 Test signals: 1V, 3mA max

£79

fully inclusive UK price



Lots of accessories available soon!

atlas

semiconductor analyser

Check and identify your semi's

£60

fully inclusive UK price



NOW MEASURES TRANSISTOR LEAKAGE!

enclosure colours may vary

- Automatic component identification
- Pinout identification
- Transistor gain measurement
- MOSFET gate threshold measurement
- PN junction characteristics measurement
- Shorted Junction identification
- Transistor leakage measurement
- Just connect the part anyway round and press the button!
- Auto power on/off

Supports:

- Bipolar transistors,
- Darlington transistors,
- Diode protected transistors,
- Resistor shunted transistors,
- Enhancement mode MOSFETs,
- Depletion mode MOSFETs,
- Junction FETs,
- Low power triacs and thyristors,
- Diodes and diode networks,
- LEDs (+bicolours)

NPN bipolar Darlington

Diode protection between C-E

Resistor shunt between B-E

Current gain Hfe=126

Enhancement mode N-Ch MOSFET

Gate Threshold Vgs=3.4V

BLUE Emit

Volt Vce=6.77V

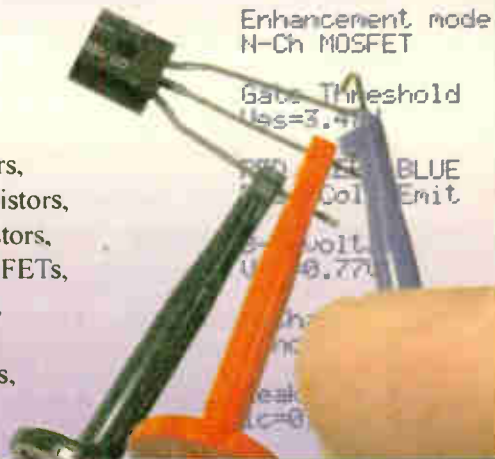

Visit www.peakelec.co.uk to download the data sheets, user guides and copies of independent reviews. You can pay using a cheque, postal order, credit or debit card and even pay securely online. Please contact us for your volume requirements.

Also available from: (prices vary)

Fa n e l l

MAPLIN

PEAK
 electronic design ltd

Atlas House, Kiln Lane
 Harpur Ind. Est., Buxton
 Derbyshire, SK17 9JL, UK

Tel. 01298 70012

www.peakelec.co.uk
sales@peakelec.co.uk

Fax. 01298 70046



PRIORITY REFEREE



OWEN BISHOP

Fair play is ensured with this novel quiz monitor

IN so many competitive games, such as Snap and various quizzes, the winner is the person who is the first to respond. Too often, this turns out to be the person who shouts the loudest! This is clearly unfair and the aim of this circuit is to decide which of two players was really the first.

Each player has a switch which they press when they think they have a Snap pair or know the answer, depending on the game. Each player has a pair of l.e.d.s, one red and one yellow or green. When the circuit is reset ready for play, the yellow l.e.d.s are turned on. As soon as one player presses their button, their yellow l.e.d. goes out and their red l.e.d. comes on.

However, once a player has pressed their button, their opponent's button is automatically locked out and their l.e.d. stays yellow, even when they press their button.

Many *Who Was First?* circuits have been published before, but this is believed to be the first one to allow one of the players to be handicapped. This prevents Mum from always being the winner!

After the Handicap button is pressed, there is a delay of one second or so before the red l.e.d. comes on. During this delay it is still possible for the opponent to press their button and score. The length of delay can be adjusted to vary the handicap time.

HOW IT WORKS

The complete circuit diagram for the Priority Referee is shown in Fig.1. The l.e.d.s are controlled by a dual J-K flip-flop, IC2. The \bar{Q} outputs of each flip-flop are always the opposite of that at output Q. The flip-flops are triggered by a falling edge on their clock (CLK) inputs.

What happens when a J-K flip-flop is triggered depends on the states of inputs J and K at that instant. Table 1 lists the four logical possibilities.

The Reset inputs are normally held high. A low reset input (produced by pressing switch S3) instantly makes both pairs of Q and \bar{Q} low and high respectively, with the yellow l.e.d.s, D1 and D3, turned on. This is the state in which the circuit is ready to act as *priority referee*.

The flip-flops are wired so that the J input of each is receiving the \bar{Q} output of the other player, which is high in the reset state. The K input of each flip-flop receives its own Q output.

Consider what happens if Player 2 presses their switch (S2) first. This triggers the clock input of their flip-flop, IC2b. The fourth line of Table 1 shows that with J = 1 and K = 1, a falling edge at the clock input triggers the flip-flop to make Q high and \bar{Q}

low. In other words, the flip-flop changes state, yellow l.e.d. D3 goes out and red l.e.d. D4 comes on. Player 2 has won!

What is the effect of this on the flip-flop of Player 1? Their K input is still high, but the J input has now changed to low. In this condition, as shown in Table 1 line 2, the outputs can only remain in their reset state.

HANDICAP

Player 1 has a time handicap, causing the clock input to flip-flop IC2a to go low about one second after pressing switch S1. This is achieved by using two pulse generators in series, each built from a pair of NAND gates, within IC1.

The first pulse generator normally has a high output, at IC1b pin 11, but this produces a low pulse on a falling edge; that is,

Table 1: J-K Flip-flop Logic when Clocked

J	K	Effect
0	0	No change
0	1	Q = 0, \bar{Q} = 1
1	0	Q = 1, \bar{Q} = 0
1	1	Changes to opposite state

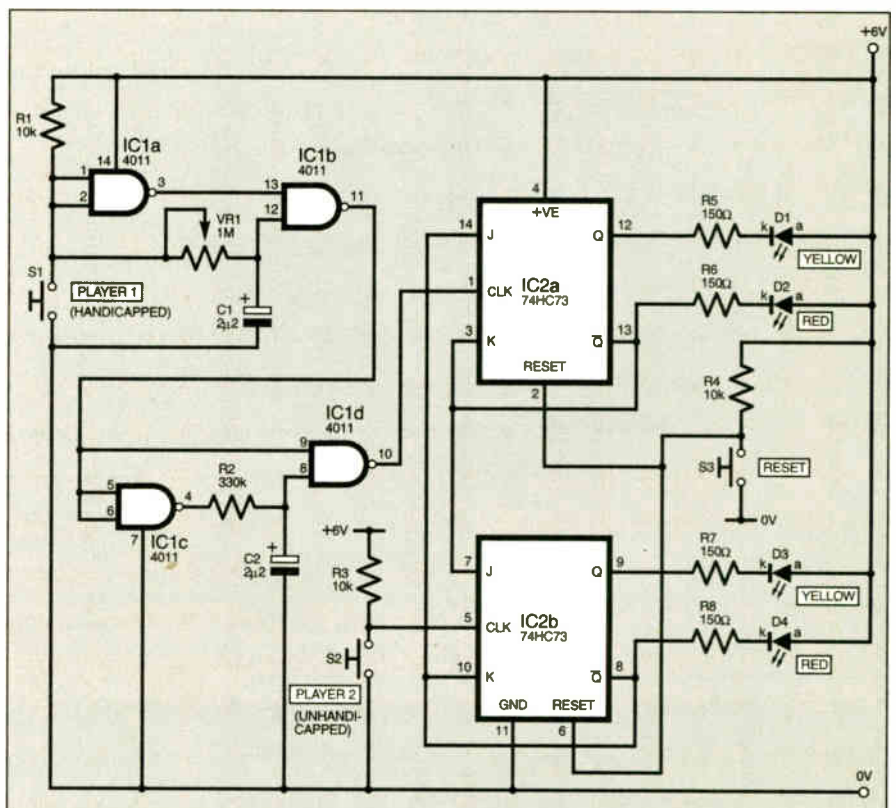

Fig. 1. Full circuit diagram for the Priority Referee. Do not exceed the 6V supply.

when switch S1 is pressed and the inputs to IC1a pins 1 and 2 change from high to low. The length of the pulse is determined by the values of potentiometer VR1 and capacitor C1. In this circuit, with VR1 set to 1M Ω and C1 being 2.2 μ F, the maximum delay is about 1.5 seconds. For a longer delay, fit a capacitor of larger value. With VR1 set to a resistance of zero, there is no delay.

When switch S1 is pressed the output at IC1b pin 11 falls and stays low for up to 1.5 seconds. When it goes high again it triggers the next pulse generator, around IC1c and IC1d, which produces a low pulse on a rising edge. So its output at IC1d pin 10 immediately goes low and triggers the flip-flop of Player 1. A very short low pulse is sufficient.

CONSTRUCTION

The component positioning and track layout details for the Priority Referee are shown in Fig.2. This board is available from the *EPE PCB Service*, code 410.

Assemble the board in order of ascending component size, and use sockets for IC1 and IC2. The link wires can be made from resistor lead offcuts. Ensure that the l.e.d.s are the correct way round, as must be the i.c.s. Do not insert the i.c.s until after the board has been fully checked.

The circuit operates on a 6V d.c. supply, which can be provided by four 1.5V dry

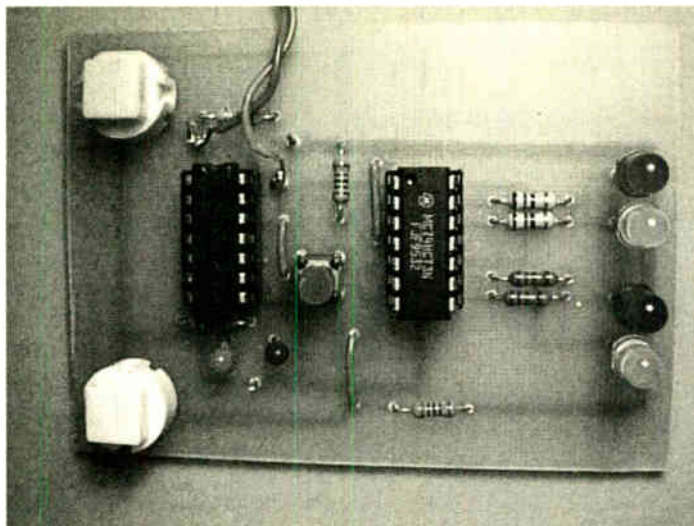

cells in a battery box, or a 6V regulated plug-in power supply unit. Note that a supply in excess of 6V *must not* be used with this circuit.

For compactness, the prototype has all the components on the board. However,

you may prefer to give each player a separate pushbutton unit. One or both of the switches, S1 and S2, can be mounted separately on a small rectangle of stripboard or the lid of a small box. Leads are then taken to the switches from the pads on the p.c.b.

The pads are intended to fit miniature click-effect switches. These usually have four pins, internally connected in pairs. Note that S2 is mounted with its orientation different from S1 and S3. Any other type of pushswitch can be used if mounted off-board.

After assembly and thorough checking, connect the power supply. Normally, the

two yellow l.e.d.s light first. If not, press Reset switch S3 and they should then both light. Check the effects of pressing S1 and S2, one after the other. Press them both at the same time – Player 2 (S2) should always win. □

COMPONENTS

Resistors

R1, R3, R4 10k (3 off)
R2 330k
R5 to R8 150 Ω (4 off)
All 0.25W 5% carbon film or better.

See
**SHOP
TALK**
page

Potentiometer

VR1 1M rotary carbon, lin.

Capacitors

C1, C2 2 μ 2 tantalum bead, 10V (2 off)

Semiconductors

D1, D3 yellow l.e.d. (or green) (2 off)
D2, D4 red l.e.d. (2 off)
IC1 4011 quad 2-input NAND gate
IC2 74HC73 dual J-K flip-flop

Miscellaneous

S1 to S3 push-to-make switch, p.c.b. mounting (see text) (3 off)

Printed circuit board, available from the *EPE PCB Service*, code 410; 14-pin d.i.l. socket (2 off); knob for potentiometer; 1mm terminal pins; connecting wire; solder, etc.

Approx. Cost
Guidance Only

£9
excl. case

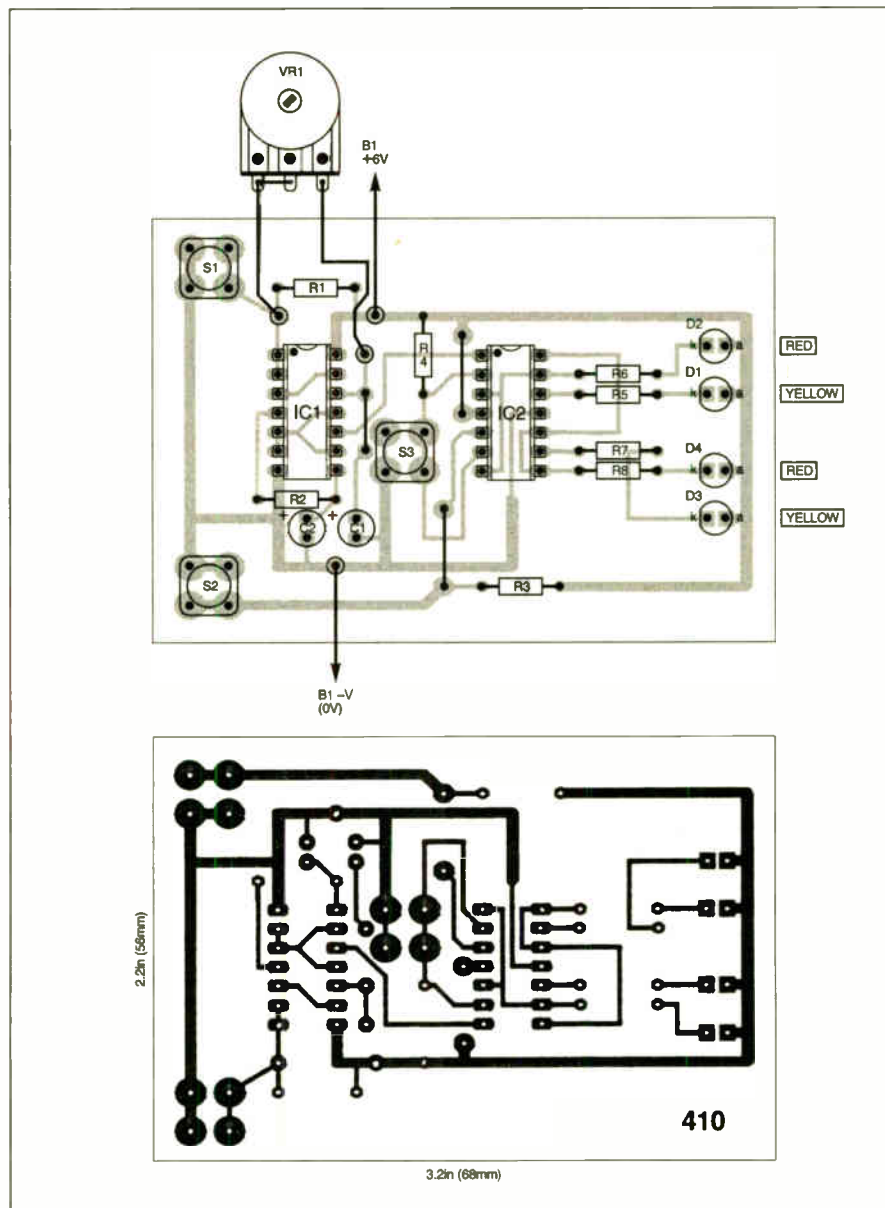

Fig.2. Priority Referee printed circuit board component layout, wiring and full-size copper foil master.

We can supply back issues of *EPE* by post, most issues from the past three years are available. An *EPE* index for the last five years is also available at www.epemag.wimborne.co.uk or see order form below. Alternatively, indexes are published in the December issue for that year. Where we are unable to provide a back issue a photocopy of any *one article* (or *one part* of a series) can be purchased for the same price. Issues from Nov. 98 are available on CD-ROM – see next page – and issues from the last six months are also available to download from www.epemag.com.

DID YOU MISS THESE?

MAY '02

PROJECTS • PIC Big-Digit Display • Simple Audio Circuits – 1 • Freezer Alarm • Washing Ready Indicator.
FEATURES • Teach-In 2002 – Part 7 • Ingenuity Unlimited • Practically Speaking • New Technology Update • Circuit Surgery • Net Work – The Internet Page.

JUNE '02

PROJECTS • Biopic Heartbeat Monitor • Frequency Standard Generator • Simple Audio Circuits – 2 • World Lamp.
FEATURES • Teach-In 2002 – Part 8 • Interface • New Technology Update • Circuit Surgery • Ingenuity Unlimited • Net Work – The Internet Page.

JULY '02

PROJECTS • EPE StyloPIC • Infra-Red Autoswitch • Simple Audio Circuits – 3 • Rotary Combination Lock.
FEATURES • Teach-In 2002 – Part 9 • Practically Speaking • Using The PIC's PCLATH Command • Ingenuity Unlimited • Circuit Surgery • New Technology Update • Net Work – The Internet Page.

AUG '02 Photocopies only

PROJECTS • PIC World Clock • Pickpocket Alarm • Big-Ears Buggy • Simple Audio Circuits – 4.
FEATURES • Teach-In 2002 – Part 10 • Using Square Roots with PICs • Ingenuity Unlimited • Evolutionary Electronics • Interface • Circuit Surgery • Net Work – The Internet Page.

SEPT '02 Photocopies only

PROJECTS • Freebird Glider Control • Portable Telephone Tester • EPE Morse Code Reader • Vinyl to CD Preamp.
FEATURES • Circuit Surgery • New Technology Update • Practically Speaking • Net Work • Flowcode for PICmicro • Logic Gate Inverter Oscillators • Net Work – The Internet Page.

OCT '02 Photocopies only

PROJECTS • EPE Bounty Treasure Hunter • IC Tester • Headset Communicator • PIC-Pocket Battleships.
FEATURES • Circuit Surgery • New Technology Update • Logic Gate Inverter Oscillators – 2 • Interface • Network – The Internet Page • Using TK3 With Windows XP and 2000.

NOV '02 Photocopies only

PROJECTS • EPE Hybrid Computer – 1 • Tuning Fork and Metronome • Transient Tracker • PICAXE Projects–1 (Egg Timer – Dice Machine – Quiz Game Monitor).
FEATURES • Practically Speaking • Ingenuity Unlimited • Circuit Surgery • New Technology Update • Net Work – The Internet Page.

DEC '02

PROJECTS • Versatile PIC Flasher • EPE Hybrid Computer – 2 • Door Defender • PICAXE Projects – 2 (Temperature Sensor – Voltage Sensor – VU Indicator).
FEATURES • Electronic Paper • Alternative Uses for Transistors • Interface • Circuit Surgery • New Technology Update • Ingenuity Unlimited • Net Work – The Internet Page • 2002 Annual Index.

JAN '03

PROJECTS • EPE Minder • F.M. Frequency Surfer • Wind Speed Meter • PICAXE Projects–3 (Chaser Lights).
FEATURES • Who Really Invented The Transistor • TechnoTalk • Circuit Surgery • Practically Speaking • New Technology Update • Computer GOTOs • Ingenuity Unlimited • Net Work – The Internet Page.



FEB '03

PROJECTS • Wind Tunnel • Brainbot Buggy • Back To Basics–1 (Hearing Aid, Audio Power Amplifier) • Tesla High Voltage Transformer.
FEATURES • In The Bag • Techno Talk • Circuit Surgery • New Technology Update • Interface • Ingenuity Unlimited • Net Work – The Internet Page.

MAR '03

PROJECTS • Wind-Up Torch Mk II • 200kHz Function Generator • Driver Alert • Back-To-Basics–2 (Metal Detector, Simple Timer).
FEATURES • Ingenuity Unlimited • Practically Speaking • Techno Talk • New Technology Update • Circuit Surgery • Peak LCR Component Analyser Review • Net Work – The Internet Page.

APR '03

PROJECTS • Atmospheric Monitor • Intelligent Garden Lights Controller • Back-To-Basics–3 (Touch Light, Plant Watering Reminder) • Earth Resistivity Logger–Part 1.
FEATURES • Ingenuity Unlimited • Techno Talk • New Technology Update • Circuit Surgery • Interface • Network – The Internet Page • **SPECIAL SUPPLEMENT** – EPE PIC Tutorial V2–Part 1.

MAY '03

PROJECTS • Super Motion Sensor • Earth Resistivity Logger – Part 2 • Door Chime • Back-To-Basics–4 (Live Wire Detector, Medium Wave Radio).
FEATURES • Ingenuity Unlimited • Techno Talk • Practically Speaking • Circuit Surgery • Net Work – The Internet Page • **SPECIAL SUPPLEMENT** – EPE PIC Tutorial V2 – Part 2.

JUNE '03

PROJECTS • Fido Pedometer • PICronos L.E.D. Wall Clock–Part 1 • Back-To-Basics–5 (Mini Theremin, Twilight Switch) • Radio Circuits–1 (Crystal Set, MK484 TRF Receiver, Headphone Amplifier).
FEATURES • Ingenuity Unlimited • Techno Talk • Interface • Circuit Surgery • New Technology Update • Net Work – The Internet Page • **SPECIAL SUPPLEMENT** – EPE PIC Tutorial V2 – Part 3.



JULY '03

PROJECTS • EPE Mini Metal Detector • Low Range Ohmmeter Adaptor Mk2 • Radio Circuits–2 (Q-Multiplier, MW Reflex Radio, Speaker Amplifier) • Ultimate Egg Timer • PICronos L.E.D. Wall Clock – Part 2.
FEATURES • Ingenuity Unlimited • Circuit Surgery • Techno Talk • Practically Speaking • Flowlog Lite Review • Net Work – The Internet Page.

Aug '03

PROJECTS • EPE PIC Met Office–1 • Alarm System Fault Finder • Master/Slave Intercom • Electronic Two-Up • Radio Circuits–3 (Regenerative Receivers).
FEATURES • Digital Command Control for Model Trains • Ingenuity Unlimited • Circuit Surgery • Interface • Techno Talk • New Technology Update • Net Work – The Internet Page.

BACK ISSUES ONLY £3.50 each inc. UK p&p.

Overseas prices £4 each surface mail, £5.50 each airmail.

We can also supply issues from earlier years: 1998 (except Jan. to May, July, Sept., Nov., Dec.), 1999 (except May, Aug., Dec.), 2000 (except Feb.), 2001 (except May, Sept., Oct.), 2002 (except Aug. to Nov.) Where we do not have an issue a photocopy of any *one article* or *one part* of a series can be provided at the same price.

ORDER FORM – BACK ISSUES – PHOTOCOPIES– INDEXES

- Send back issues dated
- Send photocopies of (article title and issue date)
- Send copies of last five years indexes (£3.50 for five inc. p&p – Overseas £4 surface, £5.50 airmail)

Name

Address

..... Tel:

I enclose cheque/P.O./bank draft to the value of £

Please charge my Visa/Mastercard/Amex/Diners Club/Switch £ Switch Issue No.

Card No.

Card Expiry Date Card Security Code (The last 3 digits on or just under the signature strip)

SEND TO: Everyday Practical Electronics, Wimborne Publishing Ltd., 408 Wimborne Road East, Ferndown, Dorset BH22 9ND.

Tel: 01202 873872. Fax: 01202 874562.

E-mail: orders@epemag.wimborne.co.uk On-line Shop: www.epemag.wimborne.co.uk/shopdoor.htm

Payments must be in £ sterling – cheque or bank draft drawn on a UK bank. Normally supplied within seven days of receipt of order.

Send a copy of this form, or order by letter if you do not wish to cut your issue.

M09/03

STORE YOUR BACK ISSUES ON MINI CD-ROMS



A great way to buy *EPE* Back Issues – our mini CD-ROMs contain back issues from our *EPE Online* website plus bonus articles, all the relevant PIC software and web links. Note: no free gifts are included. All this for just £14.45 each including postage and packing.

VOL 1 CONTENTS

BACK ISSUES – November 1998 to June 1999

VOL 2 CONTENTS

BACK ISSUES – July 1999 to December 1999

VOL 3 CONTENTS

BACK ISSUES – January 2000 to June 2000

VOL 4 CONTENTS

BACK ISSUES – July 2000 to Dec. 2000

VOL 5 CONTENTS

BACK ISSUES – January 2001 to June 2001

VOL 6 CONTENTS

BACK ISSUES – July 2001 to December 2001

VOL 7 CONTENTS

BACK ISSUES – Jan 2002 to June 2002

VOL 8 CONTENTS

BACK ISSUES – July 2002 to December 2002

WHAT IS INCLUDED

All volumes include the full editorial content of every listed issue, plus all the available PIC Project Codes for the PIC projects published in those issues.

Note that no advertisements are included in Volumes 1 and 2; from Volume 5 onwards the available relevant software for *Interface* articles is also included.

EXTRA ARTICLES – ON ALL VOLUMES

BASIC SOLDERING GUIDE – Alan Winstanley's internationally acclaimed fully illustrated guide. **UNDERSTANDING PASSIVE COMPONENTS** – Introduction to the basic principles of passive components. **HOW TO USE INTELLIGENT L.C.D.s**, by Julyan Ilett – An utterly practical guide to interfacing and programming intelligent liquid crystal display modules. **PhyzyzB COMPUTERS BONUS ARTICLE 1** – Signed and Unsigned Binary Numbers. By Clive "Max" Maxfield and Alvin Brown. **PhyzyzB COMPUTERS BONUS ARTICLE 2** – Creating an Event Counter. By Clive "Max" Maxfield and Alvin Brown. **INTERGRAPH COMPUTER SYSTEMS 3D GRAPHICS** – A chapter from Intergraph's book that explains computer graphics technology. **FROM RUSSIA WITH LOVE**, by Barry Fox – Russian rockets launching American Satellites. **PC ENGINES**, by Ernest Flint – The evolution of Intel's microprocessors. **THE END TO ALL DISEASE**, by Aubrey Scoon – The original work of Rife. **COLLECTING AND RESTORING VINTAGE RADIOS**, by Paul Stenning. **THE LIFE & WORKS OF KONRAD ZUSE** – a brilliant pioneer in the evolution of computers. A bonus article on his life and work written by his eldest son, including many previously unpublished photographs.

Note: Some of the EXTRA ARTICLES require WinZip to unzip them.

NOTE: These mini CD-ROMs are suitable for use on any PC with a CD-ROM drive. They require Adobe Acrobat Reader (available free from the Internet –

www.adobe.com/acrobat)

**VOL 8
NOW AVAILABLE**

**ONLY
£14.45** each
including VAT
and p&p



Order on-line from

www.epemag.wimborne.co.uk/shopdoor.htm
or www.epemag.com (USA \$ prices)
or by phone, Fax, E-mail or Post

BACK ISSUES MINI CD-ROM ORDER FORM

Please send me (quantity) BACK ISSUES CD-ROM VOL 1
Please send me (quantity) BACK ISSUES CD-ROM VOL 2
Please send me (quantity) BACK ISSUES CD-ROM VOL 3
Please send me (quantity) BACK ISSUES CD-ROM VOL 4
Please send me (quantity) BACK ISSUES CD-ROM VOL 5
Please send me (quantity) BACK ISSUES CD-ROM VOL 6
Please send me (quantity) BACK ISSUES CD-ROM VOL 7
Please send me (quantity) BACK ISSUES CD-ROM VOL 8
Price £14.45 each – includes postage to anywhere in the world.

Name

Address

Post Code

I enclose cheque/P.O./bank draft to the value of £

Please charge my Visa/Mastercard/Amex/Diners Club/Switch

£

Card No.

Card Security Code (The last 3 digits on or just under the signature strip)

Expiry Date Switch Issue No.

SEND TO: **Everyday Practical Electronics,
Wimborne Publishing Ltd.,**

408 Wimborne Road East, Ferndown, Dorset BH22 9ND.

Tel: 01202 873872. Fax: 01202 874562.

E-mail: orders@epemag.wimborne.co.uk

Payments must be by card or in £ Sterling – cheque or bank draft drawn on a UK bank.

Normally supplied within seven days of receipt of order.

Send a copy of this form, or order by letter if you do not wish to cut your issue.

New Technology Update

A new HyperSonic sound is set to revolutionise the audio industry, reports Ian Poole.

NEW sound technology does not hit the headlines very often. However, a totally new development known as HyperSonic Sound (HSS) from a company in the USA called the American Technology Corporation (ATC) provides some revolutionary new features. It is claimed to focus sound in a way that has not been possible before.

In large international conferences it will be possible to project audio in different languages to different seats so that people can hear the relayed speech in their own language. For paging systems it will be possible to direct messages to a specific area, or it would be possible to provide targeted advertising directly at the point of purchase in a shop or supermarket.

Basic Principles

The new technology uses a little known property that occurs in air. It is found that a pressure wave such as a sound waveform causes the pressure to move up and down. The non-linear nature of the air causes the soundwave to be changed or distorted slightly, see Fig.1. This "distortion" is the classic requirement for a non-linear mixer where two frequencies are mixed or multiplied and new signals at the sum and difference frequencies are generated. It is not at all difficult to be able to predict or calculate the new frequencies that will be generated by this process.

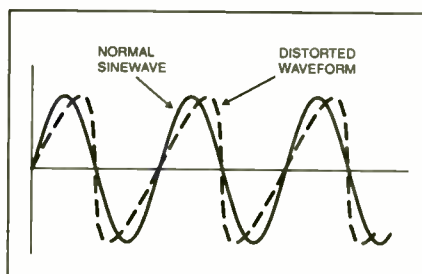

Fig.1. Distortion of a sound waveform caused by the non-linear effect of the air

The HSS system uses ultrasonic sound. This is highly directional and obviously being above the range of human hearing it cannot be heard. However, if several ultrasonic sounds are sent together, and they are of sufficient intensity to cause the non-linear mixing effect, then it is possible to generate audible sounds.

It is possible to calculate what ultrasonic sounds are needed to create the required audible sounds. In this way the full range can be synthesised; speech, music or any form of sound can all be created.

How It Works

A HyperSonic Sound system consists of an audio source which may be a CD player, microphone, tape player, etc.. Added to this there is an HSS signal processor, an ultrasonic amplifier and finally an ultrasonic emitter (transducer).

The audio from the source is passed into the signal processor. This analyses the signal and calculates the required ultrasonic frequencies required for the original audio to be recreated by the mixing action in the air. This ultrasonic signal is then amplified and passed to the ultrasonic emitter where it is converted into sound waves.

As the signal from the ultrasonic emitter is very directional it creates a column of sound directly in front of the transducer. Interestingly, the sound does not spread in the same way that sound does from a conventional loudspeaker, even when it has been mixed down to audio frequencies.

The listener must be within the column of the ultrasonic signal to be able to hear the sound. Outside this column it is virtually inaudible.

Modulation

In order that the sound can be carried at an ultrasonic frequency, techniques very similar to those used in radio transmitters are employed. Instead of using a radio frequency electromagnetic wave, an ultrasonic carrier is used. The most straightforward technique is to amplitude modulate the ultrasonic carrier. Here the amplitude of the ultrasonic signal is varied in line with the instantaneous amplitude of the audio waveform.

A balance has to be struck with the level of modulation that is used. To achieve low distortion, the level of modulation needs to be kept reasonably low. As the level of modulation increases then so does the distortion. Accordingly, it is necessary to determine an acceptable level of modulation consistent with the efficiency that is required.

A form of modulation known as single sideband gives significant advantages in terms of lower distortion levels and narrower bandwidth. This latter point is of particular significance for the transducer.

Transducer Technology

The design and performance of the transducer is of particular importance. The ideal performance is to have a flat frequency response extending from about 30kHz upwards to infinity. In reality this is clearly not possible and a more realistic aim is to have a useable frequency response of around 20kHz that falls with increasing frequency. This can then be equalised by having an inverse response in the amplifier.

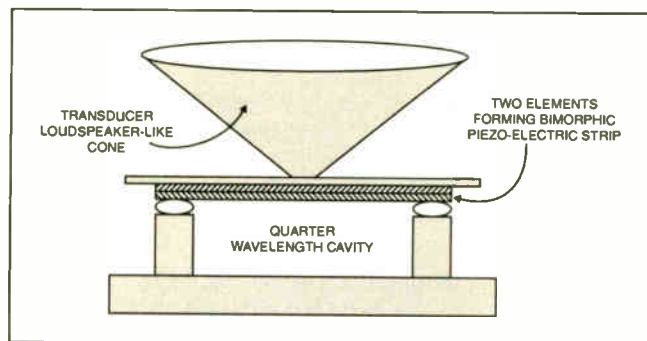

Fig.2. The new piezo-electric ultrasonic transducer

To achieve this a considerable amount of development of the transducer emitter has been undertaken. A technology known as PZT bimorph has been adopted and meets the overall requirements. Using this technology a piezo-electric material called plumbum zirconate titanate (PZT) is coupled to a lightweight cone. To enhance the output the PZT is mounted a quarter of a wavelength above the rigid mounting assembly, see Fig.2.

Current Exploitation

There are many possibilities for this new development and interest is being shown by some large organisations. In May this year ATC announced a sales agreement to supply HSS units and technology to Sony Business Europe. Under the agreement the HSS technology will be used to provide hyper-directional audio solutions for Sony Business' European customers.

Simon Beesley, Sony Business Europe's product manager for HSS said, "One of the first applications of HSS will be in our plasma screen digital signage business to provide hyper-directional audio in many of our business systems applications."

It certainly appears to be a new form of technology that will be adopted in a large way before too long. It will be interesting to report the feedback of people who hear this form of highly directional sound for the first time.

SPECIAL EPE READER OFFER L.E.T. PIC BASIC PRO COMPILER

HIGH PERFORMANCE LOW COST COMPILER FOR PIC MICROCONTROLLERS

L.E.T. PIC BASIC has been updated by Crownhill Associates and we are therefore able to offer readers the original version at the fantastic price of just **£22.50** including VAT and UK postage. It was previously advertised at **£58.69** plus postage.

Windows 95/98/ME/2000 compatible

L.E.T. PIC BASIC produces tight concise code from your program written in the easy to learn yet powerful BASIC language. No machine code to learn in order to use the popular PIC microcontrollers. The compiler will produce code for both the 12-bit and 14-bit micros, therefore it can be used to produce code for many of the popular PIC devices including the 12C508 and 12C509 and the 16F84 and 16F877 and other popular Flash devices.

The pack includes:

- L.E.T. PIC BASIC Pro Compiler on CD-ROM
- L.E.T. PIC BASIC User Guide on CD-ROM
- Data Sheets and support documents on CD-ROM
- StampPlot Lite Trial
- Printed User Guide
- *L.E.T. PIC BASIC Unleashed* book by Les Johnson covering the following subjects:

Interfacing to L.C.D. and L.E.D. Displays; Interfacing to Keypads; Infra-red Remote Control; Using the 433MHz Transmitter/Receiver modules; Interfacing to Serial Devices; Temperature Measurement; Downloading the Computer's Time; Using the On-board A to D Converter; Advanced Programming Techniques; RS232 Serial Communications Demystified; Implementing Interrupts in BASIC; Temperature Data Logging Project.

Offer available while stocks last



PRICES – UK £22.50 including VAT and p&p
Other EU Countries **£28.50** including VAT
and p&p
Rest of the World **£26.50** including postage
Please allow 7 working days for delivery – more for
overseas orders

SPECIAL EPE OFFER L.E.T. PIC BASIC PRO COMPILER

Please send me (quantity) sets of L.E.T. PIC BASIC PRO Compiler

Name

Address

..... Post Code

I enclose cheque/P.O./bank draft to the value of £ Payable to Everyday Practical Electronics

Please charge my Visa/Mastercard/Amex/Diners Club/Switch

£

Card No.

Card Security Code (The last 3 digits on or just under the signature strip)

Expiry Date Switch Issue No.

**SEND TO: Everyday Practical Electronics,
Wimborne Publishing Ltd.,
408 Wimborne Road East, Ferndown, Dorset BH22 9ND.
Tel: 01202 873872. Fax: 01202 874562.
E-mail: orders@epemag.wimborne.co.uk**

Payments must be by card or in £ Sterling – cheque or bank draft drawn on a UK bank.

Normally supplied within seven working days of receipt of order.
Send a copy of this form, or order by letter if you do not wish to cut your issue.

READOUT

WIN AN ATLAS LCR ANALYSER WORTH £79

Email: john.becker@wimborne.co.uk
John Becker addresses some of the general points readers have raised. Have you anything interesting to say? Drop us a line!

All letters quoted here have previously been replied to directly.

An Atlas LCR Passive Component Analyser, kindly donated by Peak Electronic Design Ltd., will be awarded to the author of the *Letter Of The Month* each month.

The Atlas LCR automatically measures inductance from 1 μ H to 10H, capacitance from 1pF to 10,000 μ F and resistance from 1 Ω to 2M Ω with a basic accuracy of 1%.



★ LETTER OF THE MONTH ★

PIC ZERO FLAG

Dear EPE,
I have been going through your *PIC Tutorial V2* (May-July '03) trying to remind myself about PICs after a break of three years. I think I've come across a minor error that you may not be aware of.

On the last page of the first part of the Supplement, page 16, column 3 at the top you say that if the result of DECFSZ or INCFSZ is zero then the zero flag is automatically set. Logically I would expect this to be true, but in the command table (Table 1) on page 4 it states that these two commands do not affect the Zero flag and this is repeated on the Microchip data sheets. So I wrote the following to check:

BEGIN	CLRF COUNT	: Set Count to zero
	INCF COUNT,F	: Set Count to one and Clear Zero flag.
	DECFSZ COUNT,F	: Make zero BUT has it set the Zero Flag?
	GOTO ERROR	: Should never come here
	BTFSS STATUS,Z	: Test the Zero Flag
	GOTO NONZERO	: It's not set
ZEROSET	MOVLW H'F0'	: Output H'F0' as marker
	MOVWF PORTB	
	GOTO BEGIN	
NONZERO	MOVLW H'0F'	: Output H'0F' as marker

MOVWF PORTB		
GOTO BEGIN		
ERROR	MOVLW H'55'	: Output H'55' as marker
MOVWF PORTB		
GOTO BEGIN		

Initially, I started with a MOVLW 1 and a MOVWF COUNT until I realized that neither of these affects the Zero Flag so I used the INCF on the second line to ensure that the Zero flag was not set at that point. Clearly the DECFSZ that follows will skip but apparently without actually setting the flag because the BTFSS STATUS,Z doesn't skip and I get H'0F' output on Port B.

In fact I can insert a line just between the INCF and the DECFSZ which is either BSF STATUS,Z or BCF STATUS,Z. The result is dependent on this line and *not* the DECFSZ going to zero.

Have I done something wrong? If so what, and why do the command tables say Zero flag not affected??

Hope I haven't wasted your time but this does appear to be an odd quirk which I haven't seen mentioned in print anywhere so I thought you might be interested if you didn't already know.

Roger Warrington,
via email

That's an interesting situation you highlight Roger and you seem to be right! The immediate effect, or course, is as though the flag is affected even though it isn't. Indeed it's obviously a situation that could be exploited if the Z flag status acquired in a previous routine needs to be preserved. So thanks for spotting it!

PIC FAN CLUB

Dear EPE,

I enjoyed reading August's *PIC Met Office* part one by my hero John Becker. The reason I was so interested in this project was that I have just finished my final year HND project which was a PC-controlled greenhouse environment controller. Although it doesn't by a long shot meet the spec or depth of the *Met Office* it used similar principles. I used a PIC at the heart of the design and measured temperature, humidity and moisture level as well as controlling a fan, heater and sprinkler system to maintain user defined ambient conditions.

The PC program was written in VB6 but I used MSCOMM as the input and output control as discussed by Robert Penfold in several of his *Interface* articles, whom I would like to thank for very interesting and informative articles which helped me complete the interface very quickly.

It was interesting to see how John tackled the sensing problems by pulsing the sensors. When I tried to build my moisture sensor I had to end up making it only tell if the moisture level was low, medium or high because of the polarising effects John discussed when using a d.c. current.

If only the *Met Office* had been released last year I could have used John's method.

I was forced to use a PIC16C55 in my design because of the primitive equipment and software in my college. This meant I had to use a separate ADC rather than being able to use those available on the PIC16F877. I also had to program the PIC in a mix of assembly and C so as to avoid the need for a separate UART chip.

Since completing the project I have purchased the *EPE PIC Toolkit TK3* from Magenta in order to get experience of more modern PICs and try to join the PIC fan club.

Anthony Devine, via email

Thanks for your kind comments, Anthony. I've been called many things in my time (usually spelt with asterisks!) but it's the first time for "hero"! Congrats on what you have achieved too, despite limited resources.

I'm pleased you can now become more fully involved in the PIC fan club!

What made Met Office so complex was the writing and integrating of both PIC and VB software for what in effect were several separate projects, but I am extremely pleased with the final result.

TK3 WITH XP – NEW DLL

Via our Chat Zone, Ian Stedman recently reported that:

I have TK3 running on Windows XP/2000 with no patches! Go to www.logix4u.net/inpout32.htm, download the new *inpout32.dll* package, unzip the archive, go into the *binaries\dll* directory and copy *inpout32.dll* to your TK3 folder (it must be in the same directory as *tk3prog.exe*), then run TK3 as usual. That's it!

Chris Shucksmith followed up with:

This is a great find! It does exactly what it claims, and it's so easy to patch up old Visual Basic programs that used to work under '98. I can now ditch my '98 partition for programming! The author of this new updated DLL assures us on his website of back-support for Windows 98, ME etc that work with the old *inpout32.dll*. As a result it is possible to replace the DLL regardless of your operating system, so a request John – could all future TK3 releases be produced using this file?

I have since spoken to Logix4U about using his work and being able to distribute it with a project of mine, and with TK3. He replied:

"I hereby give permission to use *Inpout32.dll* for win9x/NT/2000/XP in any manner you want, either with freeware or commercial software. I expect credits, but you may choose what text to add and where to add. Being interested in microcontroller programming, I would be happy if you give me the details of the programmer, and if you can make a write up on this, I can put it in my website. Logix4u."

Thanks Ian and Chris, and Logix4u, that's very much appreciated! I've also confirmed that it does work on the older platforms of W95/98/ME. It's great that this new DLL has been found.

*I've also told Robert Penfold, who made us aware of the original DLL in about 1999. He has downloaded it and had a play and says he will be covering it in depth in *Interface* sometime, as he did with the original. It makes life far less complicated than using *AllowIO*, although this did/does help many readers and we're grateful to Mark Jones who discovered that solution.*

TK3 will include the new DLL following release of V1.5 when Richard Hinckley's forthcoming PIC Breakpoint debugging aid has been published in the October issue (his code is being put into TK3 as a standard facility).

VISUAL BASIC SOURCE

Dear EPE,

There has been a bit of talk in recent issues about where to get Visual Basic 6. Readers might be interested to know that the SAMS book *Teach Yourself Basic* in 24 hours comes with a CD containing (amongst other things) a copy of VB6, Working Model – and it works very well.

I got my copy from PC World.

John Boyes, Liverpool, via email

That's very interesting news, John, thank you. I understand, though, that this VB version does not allow programs to be compiled to an EXE, which may be a drawback to some people.



BS2-IC

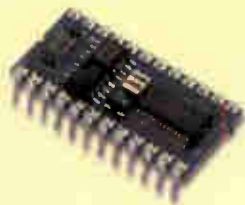

BS2-SX

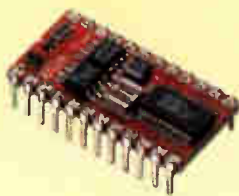

BS2E-IC



BS2P/24

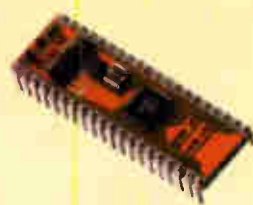

BS2P/40

Parallax BASIC Stamps - still the easy way to get your project up and running!



**Serial Alphanumeric and Graphic Displays,
Mini-Terminals and Bezel kits**

www.milinst.com



Animated Head



3-Axis Machine



Six-Legged Walkers



Robotic Arms



Bipeds

Robotic models for both the beginner and the advanced hobbyist

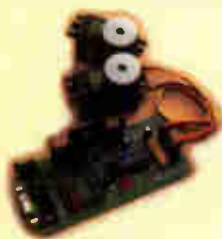

Servo Drivers

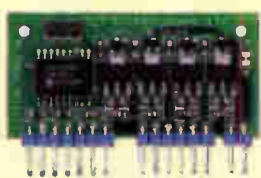

Motor Drivers



On-Screen Displays



DMX Protocol



U/Sound Ranging

Animatronics and Specialist Interface-Control Modules



Quadravox
MP3 & Speech Systems



SensoryInc
Voice Recognition



Parallax
Ubicom Tool Kits



Tech-Tools
PIC & Rom Emulators



BASICMicro
PIC BASIC Compilers

Development Tools

Milford Instruments Limited Tel 01977 683665, Fax 01977 681465, sales@milinst.com

CIRCUIT SURGERY

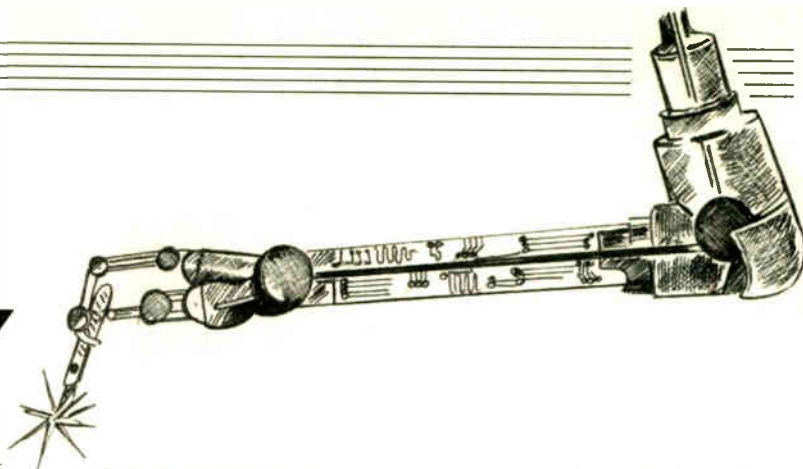

ALAN WINSTANLEY
and IAN BELL

We continue with our introduction to SPICE simulation software, with a step-by-step guide to downloading the free student version.

IN last month's *Circuit Surgery*, we discussed a way in which circuit diagrams can be described in a universal text language used by the SPICE circuit simulator. We introduced the fairly standard syntax for describing a circuit in the text format used by most variants of SPICE; this is also a useful way of communicating circuit diagrams by email, especially if scanned drawings or computer-drawn schematics are not available. There is much more to SPICE than this, so this month we delve into SPICE in more detail, using the freeware student version that you can download from the web.

Tasty Spice

SPICE is an acronym for Simulation Program with Integrated Circuit Emphasis. It was originally developed in the early 1970's at the University of California, Berkeley. SPICE is now a de-facto industrial standard for computer aided electronic circuit analysis. It was developed because i.c.s required complex fabrication processes and could not be changed significantly once they were made - you could not mess around with the circuit on a lab bench like you could with discrete devices! Using a simulator to analyse the circuit

greatly increased the chance that a fabricated i.c. would work correctly.

The textual descriptions of circuits are known as *netlists* (see last month). Of course, modern simulation software often allows you to draw circuit schematics in a process known as schematic capture, as well as typing in netlists. If required, the software will usually generate the text format of the schematic you draw (known as *netlisting*).

Originally an analogue circuit simulator, modern versions of SPICE allow logic gates, and more complex digital functions to be included, allowing digital and mixed-signal (analogue and digital) circuits to be simulated. However, it would not normally be used for large fully digital circuits.

Not only does SPICE simulate the behaviour of electronic circuits, but it also emulates, via a number of *analysis* options, the measurement instruments found in the electronics laboratory, for example:

- Multimeters
- Spectrum Analysers
- Oscilloscopes
- Curve Tracers

The analyses performed are determined by commands placed in the netlist file, or via commands and set-up windows in the software's user interface.

Analysis Options

A basic selection of analysis options typically provided by SPICE simulators is given below. All simulations are performed at a specified temperature, and the effects of temperature variation can also be analysed.

D.C. Analysis: Calculates the behaviour of the circuit with only quiescent d.c. voltages and currents applied. This is usually performed (automatically) prior to other forms of analysis to determine bias conditions and operating points, but may also be run separately.

D.C. Sweep: Calculates the behaviour of the circuit for a range of d.c. voltages (also known as the large signal response, or d.c. transfer function). To do this manually on a real circuit you would set a d.c. voltage at an input, measure the point of interest with a meter, change the input voltage, measure again, and repeat.

Transient Analysis: Voltages and currents in the circuit are calculated as a function of time. Time-varying input signals must be applied to the circuit, and the results are displayed as waveforms, as you might see on an oscilloscope

A.C. Analysis: Also called small signal analysis. This calculates the behaviour of the circuit as a function of frequency. This is achieved by determining the d.c. operating point, and then analysing the network elements under these conditions, as a function of frequency. This could be used, for example, to determine the frequency response of an amplifier.

D.C. Sensitivity Analysis: Computes changes in the d.c. operating point due to component value variations.

Monte Carlo Analysis: Performs multiple analysis runs using statistical component value variations. If you are designing a circuit for mass production, this will give you some idea of how much variation in circuit performance there will be between individual units.

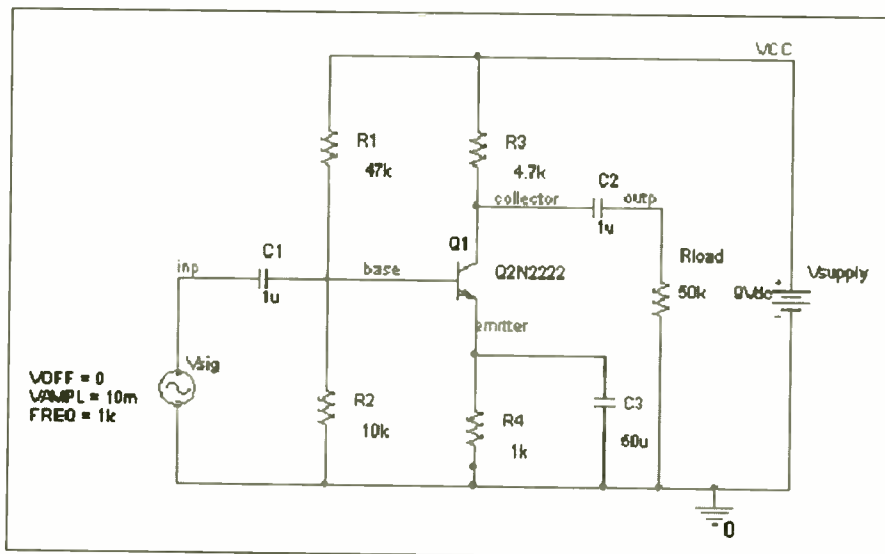

Fig. 1. PSpice schematic diagram of example circuit. (More on this next month).

Circuit Models

Nodes are the "wires" or the electrical contacts between elements. They are given names or numbers and may be named automatically by a schematic capture system if you decide not to name them yourself. Importantly, node zero is a special case – it's the ground node to which *all* other circuit node voltages are referenced.

Each node must have a d.c. path to ground in order for the SPICE analysis to run. Two capacitors in series break this rule and will cause an error. The problem can usually be overcome by using a very large value resistor (e.g. 1G ohm) in parallel with one capacitor to provide the d.c. path. Also disallowed are loops (i.e. direct parallel connection) of inductors and/or voltage sources, and series connection of current sources and/or capacitors.

In order to accurately simulate a device such as a transistor, the simulator needs to know a lot of information about the characteristics of that device. This information is held in *models* that are provided with the software or can be purchased separately. The models consist of a set of equations and associated data (*model parameters*) that may be used during the simulation to calculate the response of the device to the applied voltages and currents. In some cases a number of different models are available for the same type of device.

A detailed knowledge of the physics of these devices is required to fully understand these models, but this is unnecessary if the models are provided for you – all you have to do is select one from a list. The models used by the simulator are often much more complex and accurate than anything used by designers doing "hand

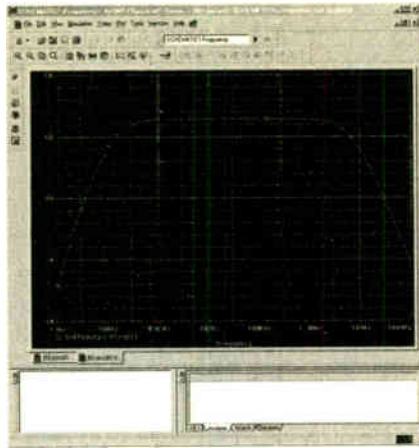

The "idealised" frequency response of the circuit has been simulated by PSpice.

calculations" – this allows highly accurate results to be obtained.

Software

There are a number of commercial software versions of SPICE available on a variety of computing platforms. The most popular Windows package is probably PSpice. Cadence Design Systems Inc., a world leader in the provision of electronic design software and services, owns PSpice. Cadence obtained PSpice from OrCAD when it acquired OrCAD in 1999. OrCAD in turn had acquired PSpice from MicroSim Corp in 1998. MicroSim first developed PSpice in 1985.

A demo ("student") version of PSpice 9.1 is available as a free download (28Mbytes for the software and 13Mbytes for the documentation). For dialup users, this may be somewhat of a challenge.

Although the software is described as a student edition, it is reasonable to point out that no formal confirmation of student status is required, and it would also be true to say that many *EPE* readers are students of electronics anyway, even if they are not registered on a course!

Key limitations of the PSpice demo version are listed below (the Release Note gives you a lot more detail).

- 64 nodes
- 10 transistors
- 65 digital primitive devices
- The sample library includes 39 analogue and 134 digital parts.
- You can place a maximum of 50 parts on a schematic design.

Downloading and Installing

If you are using a multi-user Operating system, log on as Administrator. Go to <http://www.cadencepcb.com/products/downloads/PSpicestudent/>, click on the link to download the installation file. You should also download the documentation. You need to disable virus checkers before installation as these may cause conflicts.

The software download file is a self-extracting executable. Run it, making sure you take note of, or specifically set, the location where the files will be extracted. Then go to that directory and run the *setup.exe* programme to install the software, following the on-screen instructions. Read the release notes as well.

Next Month: we run the program, look at aspects of netlisting and show how to run the circuit simulation in Pspice. *IMB*.

IT'S JUST THE TRICK AND TREAT FOR YOU NEXT MONTH – SO ORDER YOUR COPY NOW

★ RC CAR WARS ★

PLUS

SPOOKY BUG SERIAL INTERFACE PIC BREAKPOINT

Annual subscription rates:

- 6 Months: UK £16.50, Overseas £19.50 (standard air service),
£28.50 (express airmail)
1 Year: UK £31.00, Overseas £37.00 (standard air service)
£55.00 (express airmail)
2 Years: UK £57.00, Overseas £69.00 (standard air service)
£105.00 (express airmail)

To: Everyday Practical Electronics,
Wimborne Publishing Ltd., 408 Wimborne Road East, Ferndown,
Dorset BH22 9ND

Tel: 01202 873872 Fax: 01202 874562

E-mail: subs@epemag.wimborne.co.uk

Order from our online shop at:
www.epemag.wimborne.co.uk/shopdoor.htm

Name

Address

Post code Tel.

EVERYDAY PRACTICAL ELECTRONICS



SUBSCRIPTION ORDER FORM

To subscribe from the USA or Canada
see the last magazine page



I enclose payment of £
(cheque/PO in £ sterling only),

payable to Everyday Practical Electronics



My card number is:

Please print clearly, and check that you have the number correct

Signature

Card Security Code (The last 3 digits on or just under
the signature strip)

Card Ex. Date Switch Issue No.

Subscriptions can only start with the next available issue.
For back numbers see the *Back Issues* page.

If you do not wish to cut your issue, send a letter or copy of this form.

DrDAQ Data Logger

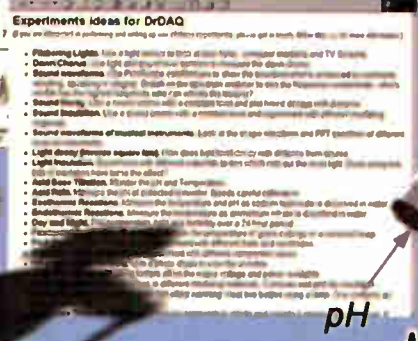
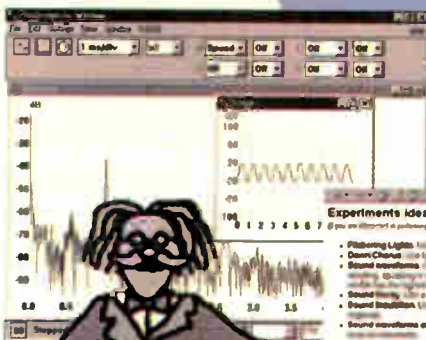

- Output
- Resistance
- Voltage
- Light level
- Temperature

pH
Microphone

External sensors: Humidity
Temperature
O2 In Air
Reed Switch

- Low cost - under £60
- Built in sensors for light, temperature and sound (level and waveforms)
- Use DrDAQ to capture fast signals
- Outputs for control experiments
- Supplied with both PicoScope (oscilloscope) and PicoLog (data logging) software

For more information on DrDAQ, please visit:

www.picotech.com/drdaq65

PC Oscilloscopes



- Scope and spectrum analyser functions
- A fraction of the cost of benchtop scope
- Save multiple setups, for ease of use
- Save, print and e-mail your traces
- FREE technical support for life
- FREE software and upgrades
- Automated measurements

PICO
Technology Limited

For more information on our scopes, please visit:

www.picotech.com/scope113

Tel: 01480 396395 Fax: 01480 396296 E-mail: sales@picotech.com

EPE PIC MET OFFICE



JOHN BECKER

Part Two

Forget the seaweed and proverbs, let technology cater for your insatiable interest in the weather!

LAST month the electronic circuits were discussed, construction of the p.c.b. described and some preliminary tests outlined. We now conclude the tests, describe the enclosure and then the final alignment of the software.

RAIN TEST

Testing the rain sensor is perhaps the easiest test of all, and can be done in domestic safety without the need for the bathroom shower!

Again the multimeter leads can be used. Clip them to the designated points on the board. Hold the probes side-by-side in your hand and repeatedly dip them in and out of a container of tap water.

Rain water and tap water are sufficiently electrically conductive so that the controlling pulse train is conducted from one probe to the other, so being recognised by the PIC as a variation in input logic level as the probes are repeatedly dipped.

Note that there is a time lag in the PIC's response to the probes, caused by capacitor C20 and resistor R6.

The construction of simple equivalent probing for outdoor use is described presently.

No setting-up is required for rain sensing, other than making sure the probing is adequately positioned.

WATER TEST

The water barrel's content level circuit can also be tested indoors without recourse to the bathroom!

Place the assembly for transducers RX3 and TX3 on the bench, pointing towards the ceiling. Measure the distance between the transducers and the ceiling and observe the displayed screen reading. Using something such as a tea tray as a sound reflector, position it at varying heights between the transducers and the ceiling. The displayed values should change accordingly.



Example of water sensor l.c.d. screen.

It will be necessary to adjust preset VR2 until the response becomes obvious.

Establish the minimum distance at which the echo signals cause a response from the display. This is the minimum height at which the transducers can be placed above a full water barrel.

WIND TEST

Wind sensor testing cannot be done until the unit's enclosure has been made and the four wind transducers mounted on it.

ENCLOSURE

Much thought was given to how the EPE PIC Met Office electronics should be housed outdoors. The requirements were for:

- light sensor to be exposed to sunlight
- temperature sensor not to be affected by direct sunlight, or the "greenhouse effect" of the enclosure's interior warming up in sunlight

- barometric pressure sensor not being subjected to variations in surrounding wind pressure changes

- overall electronics to be maintained in a dry condition, while allowing access to switches and l.c.d. panel viewing

These criteria ruled out any conventional form of casing.

Consideration was given to building a slatted enclosure, such as used for those local weather monitoring points seen along roadsides, perhaps even with a door. This was rejected because not all readers have the necessary tools and skills for such a construction.

For some time when on visits to garden centres, various forms of bird box were considered, but eventually rejected on the grounds of cost and unlikely widespread availability of similar types.

Then there was the question about how the wind transducers should be mounted. The ideal would have been that used on the

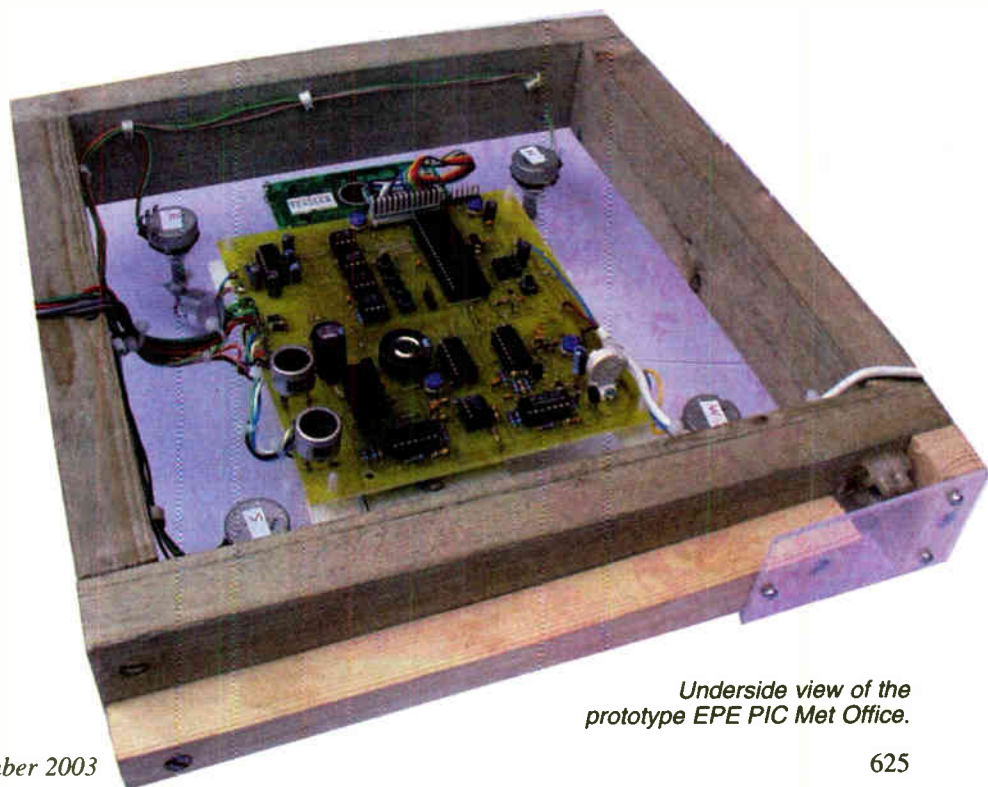

Underside view of the prototype EPE PIC Met Office.

commercial unit shown in the CAT1/2 photograph. Various methods of constructing something similar were considered, but no satisfactory conclusion could be reached.

The answer that eventually came to mind was sparked by remembrance of an offcut of clear acrylic sheet left over from the author's *Wind Tunnel* (Feb '03). This could form the top of an enclosure with the l.c.d. and light sensor mounted beneath it. Using a large enough piece, the wind transducers could be mounted on vertical shafts secured to its outer surface by some means. A solar panel could also be placed underneath the acrylic.

All that was needed then was a rigid open-based framework on which to mount the acrylic assembly, with enough depth to allow ventilation and switch access but prevent rain from driving into the electronics. The resulting assembly is shown in the photograph on the previous page and in Part One.

YOUR CHOICE

Feel free to use a different housing technique if preferred. Within the fore-going criteria, there is nothing special that you need to consider, other than what you would like to achieve.

You might also prefer to mount some of the sensors away from the main assembly, connecting them back to the board by cables. The l.c.d. could also be mounted remotely, via inexpensive ribbon cable, right back to the house. Although the author has not tried these options, it seems that cable lengths of several tens of metres could be used for the l.c.d. and those sensors that are pulsed at logic levels.

However, the barometric and temperature sensors, which generate analogue voltages, are probably best left on the p.c.b.

ACRYLIC COVER

From the acrylic sheet a square was cut measuring approximately 30cm x 30cm. This was accomplished by scoring across either side of the sheet with a Stanley knife (a blade type 5194 is recommended), using a metal straightedge to guide the blade.

Resting the sheet over the edge of the workbench allowed it to be cleanly snapped along the scored line.

The acrylic was drilled to allow three round-headed screws on each side to secure it to the timber frame. Holes to allow the l.c.d. to be mounted were also drilled, initially marking their position by taping a sheet of paper to the acrylic, holding the l.c.d. against the sheet and using a pencil.

It had been decided that potentiometers with long plastic shafts would make ideal vertical supports on which to mount the transducers, their mounting bushes perfectly suited to securing through the acrylic. Feeder holes were drilled near each corner of the acrylic sheet so that their centres were diagonally spaced apart by 25.5cm.

The actual spacing is not absolutely critical, although it should be close to it to allow the timing of the sound pulse transition between the transducers to be applied meaningfully to the wind speed calculations.

Holes to suit the bushes of the pots were then drilled at the feeder hole positions. Four small holes to allow two connecting wires to be passed through were drilled "behind" the pots towards the corners,

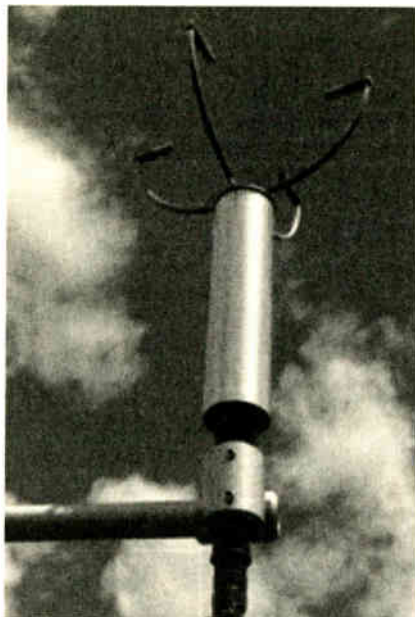

CAT1/2 solid-state ultrasonic wind speed and direction sensor. Photo Courtesy www.apptech.com/cat12.htm, Applied Technologies, inc.

allowing clearance for the body dimensions of the pots.

It was not felt necessary to make these holes watertight following electrical connection as any water leaking through would be routed along the plastic covering of the wires, to drip off harmlessly through the open base of the enclosure.

The pots used had a flat side on their plastic shafts (specify this when ordering them) that would allow the rear of the transducers to sit flatly on them. Towards the end of each shaft two holes were drilled to match the pins of the transducers.

Note that if shafts longer than those used by the pots are preferred, shaft extension bushes (spindle couplers) are available so that another length can be attached.

The pots were secured into their holes and the transducer pins pushed into the shaft holes, TX1 (north) opposite RX1 (south), TX2 (west) opposite RX2 (east) according to normal compass notation.

The pots and their shafts were rotated so that the transducer faces were aligned. A dab of holt-melt glue can prevent the shafts from rotating out of alignment.

WOODEN FRAME

A length of weather-treated rough-sawn timber was purchased from a d.i.y. store. This measured 2m x 20mm x 52mm. Two lengths were then cut to 30cm each.

The first two pieces of timber were secured to opposite sides of the acrylic. A further two pieces of timber were cut to fit snugly into the space left on the other two sides. Four wood screws were used to firmly secure the "outer" battens to the inner two, having drilled feeder holes for them first. A waterproof sealant (bath tub caulk) should be spread along the timber before screwing down the acrylic.

The "rustic" nature of the assembly, without planing or painting, was felt to be in keeping with its garden role.

RAIN SENSOR

In the earlier test for rain sensing, two meter probes were used side-by-side, with

the water container simulating a drop of rain electrically bridging the two probes together. It was considered undesirable to fit similar probes to the PIC Met Office's enclosure, there being the danger of someone injuring themselves on the exposed points. Consequently, an alternative technique is used.

A length of wood, measuring approximately 25cm x 20mm x 20mm was screwed to the front of the frame (with the l.c.d. position at the rear). It was angled downwards towards the left to form a ramp down which rain-water could run, for detection by the sensor. A length of 4mm dowel was glued to the upper surface of the ramp to channel the water.

The idea is that the whole framework should be mounted so as to slope downwards slightly at the front, allowing rain falling on the acrylic sheet to run down to the ramp and on to the sensor. A short length of the 20mm x 20mm wood was screwed to the lefthand end of the front of the frame. After this, a section of acrylic was cut to form a cover across the sensor position, secured using three screws.

The sensor was made by screwing a 2-way terminal block to the frame, into which two rigid 18s.w.g. lengths of tinned copper wire were inserted at one side, with connecting cables inserted in the other, and fed through a hole in the framework and to the p.c.b.

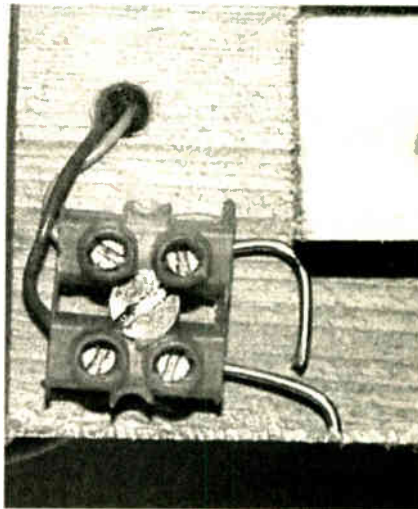

Rain sensor assembly.

The two rigid wires are positioned and bent so that rain falling from the ramp drips/flows across the wires to make electrical contact. The lower wire is angled so that water drips run to the end of the wire and drip off.

The software simply detects whether or not a shorting water drop is bridging the wires, and displays an asterisk on each l.c.d. screen display.

An alternative technique for rain sensing would be to mount probes inside the down-pipe that feeds into the water barrel.

FITTING OUT

Having completed the framework assembly, self-adhesive p.c.b. supports, having pillars to hold the p.c.b. about 10mm above the acrylic, were pushed into the corner holes of the p.c.b. This was carefully positioned as felt appropriate between the pots and the l.c.d. position, and the

supports allowed to adhere. (Beware that once the adhesive surface has contacted the sheet, it is very difficult to remove.)

The p.c.b. was then removed from the supports and the solar panel secured between the supports using Selotape Fixer Strip, a double-sided self-adhesive foam strip; stationers sell it.

The position was chosen to suit the length of the wires on the solar panel, allowing them to be soldered to their p.c.b. pins without having to extend them.

Replacing the p.c.b. on its supports, pairs of wires were soldered to the ultrasonic transducers, using sufficient solder to prevent the transducer pins pulling out through the pot shaft holes. The wires were colour coded to assist identification at the p.c.b. end.

Cable ties were used to neatly hold the wires against the shaft. Internally the wires were secured to the sides of the frame using small U-shaped clips having pins that were lightly hammered into the wood. They are electrical accessories obtainable from d.i.y. stores.

The trailing ends of the wires were grouped into a harness using cable ties, cut to length and soldered to their allocated p.c.b. pins.

The l.c.d. should be pre-wired with ribbon cable, preferably colour-coded, and the wires connected to their designated p.c.b. pins. An in-line connector with 1mm socket holes was used with the author's l.c.d., allowing it to be plugged onto a pin header.

It is advisable not to bolt the l.c.d. to the acrylic until final setting-up has been done, since some aspects are best done while looking at the p.c.b. component side.

SOIL PROBES

The only criteria that the soil probes should meet is that they are made of a non-corrosive material and can be readily inserted into the soil at a known distance apart.

For the prototype, stainless steel kitchen skewers having a length of about 15cm were used. Connections to them were via crocodile-clipped leads. In use, the probes can be inserted into the soil to a depth and distance apart of about 10cm.

For comparative readings to be consistently taken if a "roving" pair of probes is needed, the probes could be passed through holes drilled in a robust wooden batten (short section of a broken handle of a rake for instance – at last a use for them!). The holes should be drilled so that friction holds the probes in place, and two metal clips screwed down on them to provide a degree of stability.

The use of crocodile clips here would allow several sets of probes to be scattered around the garden and leads temporarily clipped to them while taking readings.

Alternatively, for a single probe pair, wired connection could be via tagged eyelets held by the screws.

This is an area where personal creativity can be used to provide a workable solution based on materials to hand. In other words, use your ingenuity!

OFF-BOARD CONNECTIONS

Connection of the soil probes and water barrel sensors can be made by directly soldering their wires to the p.c.b., or by the

use of, say, 3.5mm jack plugs and sockets. The sockets could be mounted on a right-angled bracket screwed to the internal side of the wooden frame.

The serial connector could be similarly mounted on a bracket secured to the frame, allowing the computer connecting lead to be inserted and removed as desired. With the prototype, twin-screened stereo cable of around 70 metres was used successfully, and it is likely that even greater lengths could be used.

It might also be worth replacing the p.c.b. mounted switches by panel mounting types on another bracket. It is admitted that accessing the switches in their present position is not ideal, although once setting-up is complete they rarely need to be used.

SETTING-UP PIC SOFTWARE

The PIC software must be set up to suit the range factors obtained during the earlier sensor tests.

With power applied, press Reset switch S5 and hold it pressed. Now press switch S1 and hold it pressed. Release S5 but keep S1 pressed for a second or so after S5 has been released, then release it as well. The PIC now enters its correction mode in which the upper and lower ranges for each sensor are set using switches S2 and S3.

On release of switch S1, the display top line shows the statement HUMID MAX at the left and a 4-digit hexadecimal number at the right. Below the hex value's lefthand digit will be seen an asterisk. This indicates that the digit above it can be changed. On line 2 is also shown the decimal conversion of the hex value.



Example of the first humidity correction screen.

By pressing switch S2, the digit value is incremented at approximately half-second intervals. The cycle is from 0 to 9 followed by A to F, rolling over to 0 and continuing again. Pressing S3 decrements the value.

The digits to either side are unaffected by the rollover in either direction. Set the corresponding digit value you noted earlier for the maximum value (in hex) when using two capacitors to obtain the range, and release the switch.

Press S1 to shift the asterisk below the second digit. Adjust this as required using S2 or S3. The next press of S1 selects digit 3 for adjustment, and the fourth press selects digit 4.

The next press of S1 causes the word SAVED to be shown briefly if the value has been changed, indicating that the new value you have just entered has been stored to the PIC's data EEPROM for future recall.

The screen now changes to show HUMID MIN and a hex value at the right. Adjust this value in the same way as above, this time for the minimum range value you noted earlier.

After the asterisk has reached the final digit, the next mode change screen is displayed, with the caption SOIL MAX. Adjust this similarly.

Work through all the mode options, filling in values as you can. If you cannot change a value, or prefer not to, just keep pressing S1 or S4 until the next mode appears. The amendment process can be performed whenever you want.

SETTING TEMPERATURE RANGE

When you get to temperature, the requirement is different to the above. The relative values of TEMP MAX and TEMP MIN form a span setting control, rather like changing the gain of an op.amp using a preset control in the negative feedback path.

The value produced by the PIC's ADC is multiplied by the TEMP MAX value and then divided by the TEMP MIN value. Thus to increase the ADC value by a factor of two, MAX would be set to 0002 and MIN to 0001. For a value reduction by, say, 0.4, MAX would be set to 0004 and MIN to 00A0 (decimal 10).

However, assuming the gain provided by the Temperature circuit is accurate, the MAX and MIN values should be left at the author's default setting of 0001 and 0002, respectively, i.e. multiplying by 0.5 (halving the value).

At this time, bypass both TEMP MAX and TEMP MIN, either using S1 to step through the consecutive digit positions, or using S4 to step directly from one mode to the next.

Later on in the correction sequence you can correct the temperature value upwards or downwards, as you would in an op.amp circuit using a bias level adjustment preset.

SETTING BAROMETER RANGE

The method for setting the barometer range uses values you obtain either in relation to weather forecasts or an existing domestic barometer, or to changes in pressure between known heights.

Using the weather forecasts, and while the unit is under normal running, note the l.c.d.'s hex value in relation to forecasted pressure values in millibars (mb – the standard barometric pressure unit used by the UK's Met Office) on two occasions, when the forecast values are fairly widely apart.

Suppose that the first forecast value is for 990mb and that the l.c.d. hex value shows 0201 (decimal 513). Suppose then that the other forecast value is 1010mb and the l.c.d. shows hex 020E (decimal 526). The difference in the forecast values is 20 (hex 0014), and that for the l.c.d. values is decimal 13 (hex 000D).

To bring the l.c.d. span (pressure sensor's processed ADC span values) into range with the forecast values, it has to be multiplied by 20 (hex 14) and divided by 13 (hex 0D). Thus BAROM MAX is set for 0014 and BAROM MIN is set for 000D.

Although you cannot set decimal values directly into the hex value position on line 1, you can refer to the decimal conversion value on line 2 while you are setting the hex value. (The PC software also includes a binary-hex-decimal facility which converts values, in any direction, that you key in from the keyboard – its use is self-explanatory.)

Note that if you were to set the hex value as 0020 rather than 0014, it would be interpreted by the PIC as a value of 32 (16 × 2).

As with Temperature, the up/down value adjustment is performed later.

Using height as the scaling method rather than weather forecasts or domestic barometers, select two locations at different heights from a large-scale Ordnance Survey map, say 1:25,000, and note the l.c.d.'s millibar value at each location.

The author chose two locations that his OS map said were at 64 metres and 144 metres above sea-level, 80 metres apart. The relationship of altitude to barometric pressure is 10 metres = 1 millibar. Therefore an altitude change of 80m represents a barometric pressure change of 8mb.

The height technique is potentially more accurate than the forecast method, being related to your local conditions rather than an averaged value for a wide area.

Note, though, that the temperature of the pressure sensor must be allowed to stabilise before taking the first reading (i.e. if taking the assembly out of the house into the car, wait several minutes to allow the assembly to adjust to the outdoor temperature. Furthermore, do not delay moving from one location to the other, to avoid natural changes in ambient barometric pressure.

ULTRASONIC CORRECTION

Following barometer range setting, the next four l.c.d. screen modes can be ignored. There were for the author's use during program development. They are WATER PULSE, WATER MASK, WIND PULSE and WIND MASK.

The PULSE values refer to the number of ultrasonic pulses that the ultrasonic transmitters generate on each sampling. The MASK values control the "masking delay" between the end of each transmission and the point at which the PIC starts to "listen" for the reception signal.

Do not change these values.

However, if inquisitive readers want to investigate their effect and have a good dual-trace oscilloscope with external sync, the following points will be of interest.

The scope's external sync input should be connected and synchronised (positive-going edge) to the transmission pin of the transducer being investigated. Channel 1 can then monitor test point TP5 at the output of op.amp IC5b. Channel 2 can monitor TP6 at the collector of transistor TR1. This allows the amplified reception signal and the resulting transistor pulse to be observed in relation to the setting of preset VR2.

The scope's external sync probe could also monitor IC4 pin 3 (the connection from PIC pin RE2).

Another option is to monitor PIC pin RA5. This reflects the status of the "mask". The pin goes high at the end of the masking period and then low when the signal is captured or the time-out occurs, allowing the relationship between the mask and the received pulse to be observed.

It is stressed that if you do not understand the purpose of the above you should not attempt to make use of it.

ADJUSTING WIND VALUES

Wind scale adjustment should be done indoors, without drafts!

Before you make corrections, it is worth pressing switch S2 to hold the l.c.d. screen display showing the four wind value counts. These values can indicate whether or not transmission signals are being received, as will be apparent when you adjust preset VR2 for the best reception response.

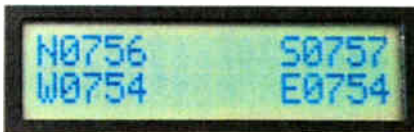

Wind values l.c.d. running screen.

If the signal is not being captured and the time-out occurs, a hex value of 00FF will be shown. Adjust preset VR2 until the values are consistent. Note that lines 1 and 2 on the l.c.d. will likely show different values due to the exact position of the transducers.

Incidentally, one transducer in the batch bought by the author turned out to be faulty, a fact that the four-wind screen confirmed by displaying erratic values. Also note that it is preferable that all transducers should be purchased from the same manufacturing batch, if your supplier keeps track of such detail.

North/south (N ADJUST) and west/east (W ADJUST) are corrected on separate screens. Previously, while in normal running mode, note the values on the top line of the wind screen. Ideally they should show as zero, i.e. the top line should display WIND N00 W00. The values represent the difference between the transmission/reception timings for the N/S and W/E transducers. (Incidentally, you will hear the transducers "clicking" as they are pulsed.)



Example of the wind sensor l.c.d. screen while actively monitoring wind.



Example of one of the wind sensor adjustment screens.

Taking the N ADJUST screen first, if the N value does not show as N00, the correction screen must be set for a value which when added to the N value will result in zero. For example, if the value is N01, then set the N ADJUST value to -1, using switch S2 or S3 as before.

Similarly, if the W value does not show as W00, the W ADJUST screen value should be adjusted accordingly.

The PIC software uses the corrected incoming transducer data and relates it to the geometry of right-angled triangles. The N/S axis is the vertical side, and W/E is the horizontal. Knowing these two values, the angle at which the wind is travelling can be calculated, as can the length of the effective hypotenuse joining those two sides.

From this last result, and knowing the speed at which sound travels (in still air) directly across the known distance between two opposite transducers, wind speed at that angle can also be calculated by the PIC.

The quadrant into which the result falls is determined by the signs of the values (plus or minus), and so compass bearing can thus be allocated, using N, NE, E, SE, S, SE, W, NW notations. If wind direction is uncertain (e.g. no wind blowing), a question mark (?) is shown.

SAMPLE PERIOD

As previously said, the PIC constantly records incoming data to the on-board EEPROM chips (if installed). The rate at which it does so is set via the SAMPLE PRD screen that follows W ADJUST.

There are 128 periods from which to select, from approximately once per minute (range 1) to once per 128 minutes (range 128). The timing is not absolutely precise as there are too many factors in the software that are impossible to predict for exact timing, but the accuracy is fairly close.

Using switch S2 or S3, select the period you require. The range cycles upwards from 1 to 128 and then rolls over to 1 again, etc.

TEMPERATURE SHIFT

Following sample rate selection, the TEMP+- screen is shown. This allows the temperature value to be shifted upwards or downwards (the previous adjustment simply sets the "span" range adjustment).

Only one asterisk position is used in this mode, below the righthand hex digit (LSN - least significant nibble). Using switch S2 or S3 affects the whole value, i.e. using S2 to increment, rolling over from 000F causes the next value to be 0010. Using S3 to decrement, causes 0010 to rollover to 000F. Decrementing from 0000 the next hex value becomes FFFF.



Temperature adjustment screens.

For hex values commencing with F the decimal value becomes a negative number, i.e. FFFF becomes 00001- (the negative sign following the number).

Prior to using this screen you should have noted the ambient temperature as shown by a good thermometer (placed close to the sensor). Then adjust the TEMP+- screen decimal value to correct for any difference. For example, if the thermometer shows 20.5°C whereas the running screen shows 23.9°C, an adjustment of -3.4 is needed. However, decimal points are not used in the correction value and just 00034- would be the decimal needed in this instance.

BAROMETER SHIFT

The barometer display reading is adjusted up and down in a similar way to temperature. Note the current weather forecast or domestic barometer value and set an adjustment value that causes the l.c.d.

running screen to show the same millibar reading.

When the barometer correction has been set, the next press of switch S1 or S4 causes the PIC to return to normal running.

ON-BOARD DATA LOGGING

The software assesses for itself how many serial chips are installed, including none. The assessment is made when the unit's power is switched on, and when Reset switch S5 is pressed. The rate at which sampling occurs can be set as described earlier.

During each l.c.d. running cycle, the CHAN/SAMPLE screen shows the channel (serial chip) to which data is being stored, and the total number of sample groups so far stored to that channel.

The serial chips can have their contents reset to zero when required. There is a safety procedure to prevent unwanted erasure. It is similar to that used for entering the change settings mode.

With power applied, press Reset switch S5 and hold it pressed. Now press switch S4 and hold it pressed. Release S5 but keep S4 pressed for a second or so after S5 has been released, then release it as well. The PIC now enters its EEPROM erasure mode, stating so via the l.c.d.

The process is lengthy, about two minutes 20 seconds per chip, due to the required timing delays within the EEPROM writing routine. A progress count is shown on screen, in kilobyte blocks per channel (32K).

On completion, the software goes into normal running mode.

PC SOFTWARE

The PIC Met Office's PC software was written in Visual Basic 6 (VB6) and has been proved under Windows 95, 98 and ME. It has not been proved with Windows NT, XP or 2000 as the author does not have these systems. However, the serial communications software used is believed to be compatible with all six Windows varieties.

Before running the software, the PIC Met Office board must be powered up and connected via the serial socket to the PC at one of its COM port sockets. The software allows selection of which one is to be used.

It is best, but not essential, to disable the PC's Screen Saver if long term display monitoring is required.

To run the PC software, open its folder and double-click on the Weather.exe icon (a "sunshine" symbol). Having done so, the program loads and displays the main screen, as in the adjacent photograph, but without bargraph detail.

First, click on the Start Record button at the bottom right. A sub-screen will be displayed superimposed on the main screen and offering two button choices. The choices are to download data from the PIC unit (the data that has been recorded to the serial EEPROM chips) or to record the data to disk at a pre-selected rate, as discussed presently.

At this time click YES to select full download (even though download is not required at this time). The screen shown in the above-right photo will be displayed, with two button options, to start the download (Start) or to return to the main screen (Main). Ignore both. At the top of the screen are two "radio"

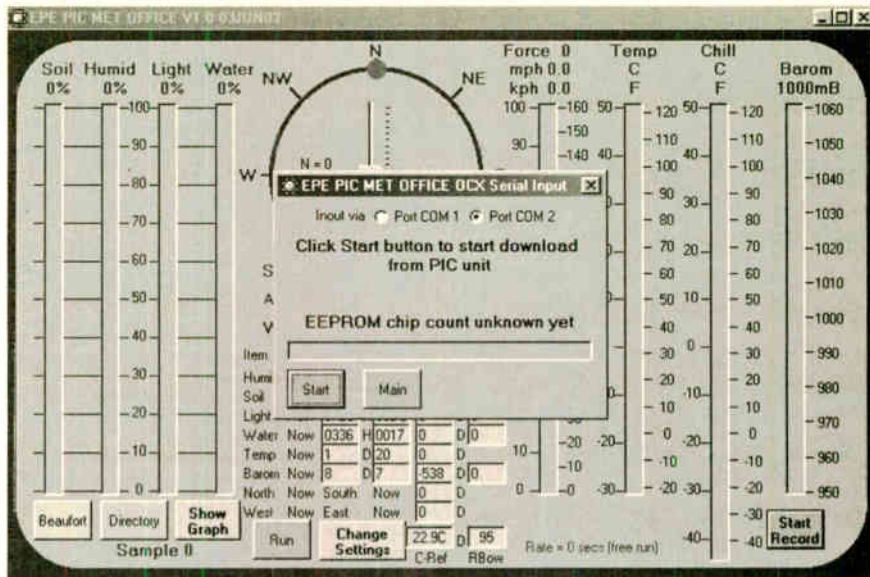

Example of superimposed sub-screen through which various serial data input functions are performed.

buttons through which the required serial COM port is selected, COM 1 or COM 2. If the one you want is not highlighted (black dot in centre), click on the other.

Then click on Main to return to the main screen. This action causes the selected COM port address to be stored to disk, in the WeatherSettings.txt file.

MAIN SCREEN DISPLAY

Having set the COM port address and returned to the main screen, click the RUN button.

In Run mode the PC inputs at 9600 Baud each new batch of sensor data as it is monitored, then formats and outputs it to the screen. It is not recorded to disk unless you have requested that mode (see later).

Most data is displayed in bargraph format, as shown below. The main exception is that the wind direction is displayed in a compass format, with relative N/S wind speed indicated on a vertical slider, and W/E wind speed on a horizontal slider. The wind direction is also shown numerically in degrees, relative to north.

Additionally, the relative wind speed values detected by the transducer pairs are also shown in text, as for example, North = 3, West = 1. This means the wind has been monitored as coming mainly from the north, at 3 mph, and partly from the west, at 1 mph. In this instance, the compass would show that wind was coming from roughly NNW. Had the wind been shown with values of north = -3, west = -1, the compass direction would have been SSE.

To the right of the compass the first bargraph shows the wind speed graphically in both mph and kph. The values are also stated numerically above it, together with the Beaufort scale wind force value.

The next bargraph shows temperature, in degrees Celsius and Fahrenheit, and the next shows the relative wind chill factor (more on this presently). The rightmost bargraph shows barometric pressure in millibars.

The lefthand bargraphs show soil moisture, humidity, light level and the fullness of the water barrel, all as relative percentage values.

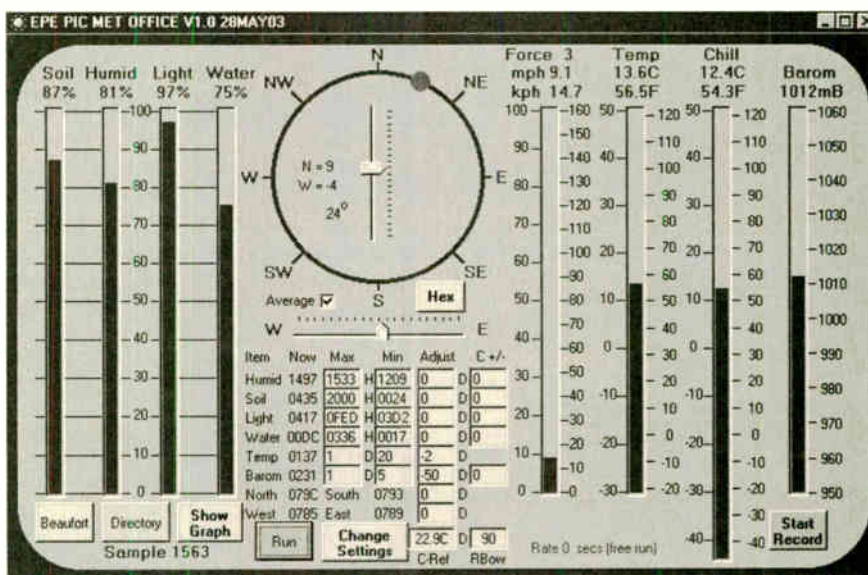

Typical example of the main PC display screen.

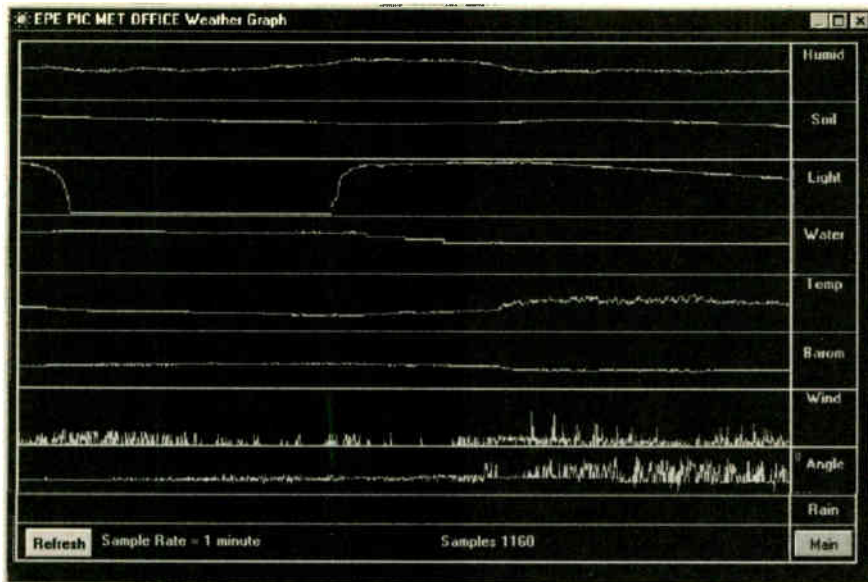

Example of screen for displaying current or recorded weather values. This display shows data recorded over a rain-free period of about 19 hours, commencing late afternoon.

At this time the displays are unlikely to be valid as PC correction factors have yet to be set. (Note that "raw" data is output from the PIC, i.e. it has not been processed.)

Rain, when detected, is indicated by a graphical rain cloud symbol within the wind compass circle (see next page). The symbol is displayed for as long as water bridges the sensor probes.

GRAPH DISPLAY

Clicking the Graph button displays the graph screen in which the values are seen being displayed as "waveforms" commencing at the left and moving to the right, in oscilloscope fashion (see above photo). The active graph screen width is 9855 pixels, each pixel representing one sample.

The running mode sampling rate is related to the rate at which the PIC sends each sample block, about 60 per minute. It thus takes about two hours 44 minutes for the graph width to be covered. You are unlikely to see any meaningful waveforms for the first 30 seconds or so.

There are ten waveforms drawn on the graph, whose function is stated to their right, in order of humidity, soil, light, water depth, temperature, barometer and wind speed, wind angle and rain.

The number of samples that have been taken so far is stated at the bottom of the screen.

When the graph lines reach the far right of the screen area, they recommence from the left, clearing previous data as they are plotted.

To return to the main screen, click the button marked Main. The next time you call up the graph, it will redraw and resume from where it left off (but is reset to zero if the program is exited or recorded data loaded from disk file).

SETTINGS BOXES

On the main screen, below the wind compass are several text and value boxes. The sensor referred to is listed under Item. The values under Now are those that are the latest values to have been received from the PIC, in hex. The values under Max and Min have the same function as those you

have previously set in the PIC software for Humidity, Soil, Light, Water, Temperature and Barometer.

The Adjust boxes allow the displayed values to be raised or lowered by the stated amount (as with the TEMP+/- and BAROM+/- correction on the PIC). Unlike the PIC software, the PC software allows all values to be shifted up or down.

The C+/- boxes are those in which you can set values to compensate for temperature drift should you find that to be necessary (the PIC unit does not offer this option). The values may be set as positive or negative values per degree Celsius change from a preset reference value. They are added or subtracted from the incoming values as appropriate.

The temperature at which Max, Min, Adjust and C+/- are set should also be set when changes are made, via the box (C-Ref) to the right of the Change Settings button.

CHANGING SETTINGS

Ignore the actual settings values shown in these photographs - you are required to set your own, as follows:

To change the PC's display settings, click on the Change Settings button. Sampling is automatically stopped and additional information is displayed, including a message about what to do now! (See photo below.)

A drop down list also appears across the wind compass. It is through this that the sampling rate used when performing live recording can be changed. The range is from Free Run (sampling as fast as the PIC sends the data, through one sample every five seconds to one sample per hour.

The sampling rate does not affect the updating of the bargraphs or wind compass, which continue displaying at the normal rate. It is the recording to disk that is affected by the sampling rate.

To select the sampling rate, click on the required line in the list. You may also add your own rate by first clicking on the top line in the list. This calls in and displays a text file, WeatherSettings.txt.

All the PIC Met Office's PC settings are stored here and recalled each time the program is run. Any of the timing values at the bottom of the file may be changed or added to, but ensure that you do not change their relative positions and do not change the earlier lines.

If you do make a mistake, you can recreate the file by first deleting it. This will make the program believe when next you run it that it has not been run on your PC before, and so create its own settings file.

To add your own timing rate, insert it in correct numerical order into the existing text list. Then save the file and close it in the normal Windows fashion.

ADJUSTMENT

When the Change Settings button is clicked, those Max/Min etc. boxes which are coloured blue are changed to white, and any of the values within them can now be changed. So too can the Adjust and C+/- values, but set them to 0 if compensation is not needed. The name of the Change Settings button is also changed when clicked, to Save New Settings.

The Now box values are in hexadecimal, as are the Min/Max values for Humidity, Soil, Light and Water (as indicated by the letter H). Other values are in decimal (as

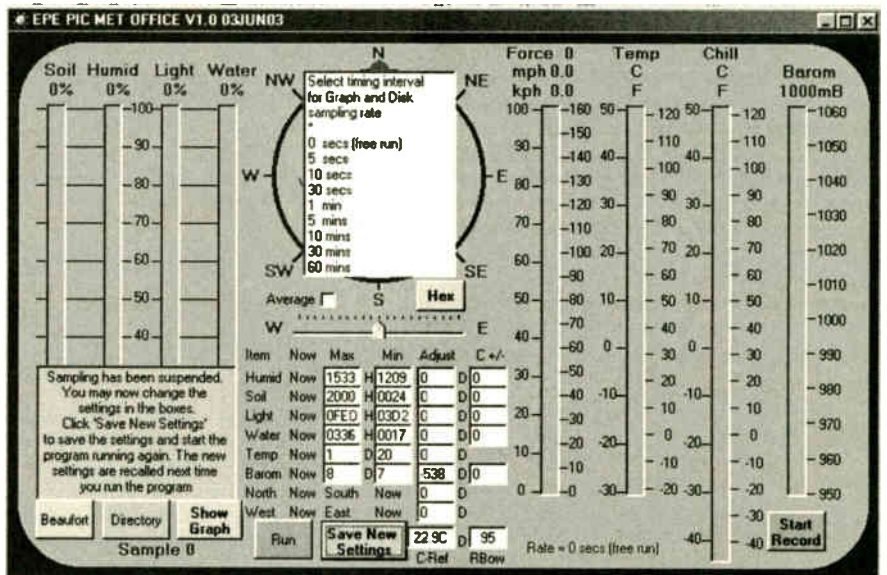

Display mode through which various settings can be changed.

indicated by the letter D). To change a value click on its box and amend it. The hex values should be the same as those set into the PIC, although it may sometimes be beneficial to change them slightly as the PC program does its calculation using fractions, whereas the PIC works only in integers (whole numbers).

Note that the barometer up/down correction value needed is different as the PIC and PC use slightly different calculation procedures.

There is another value that can be changed as well, notated RBoW. This controls the light level percentage value at which the Rainbow display is activated if rain has been detected. The best setting must be judged from experience (wait till you see a rainbow, note the light value at that time, and adjust accordingly!).

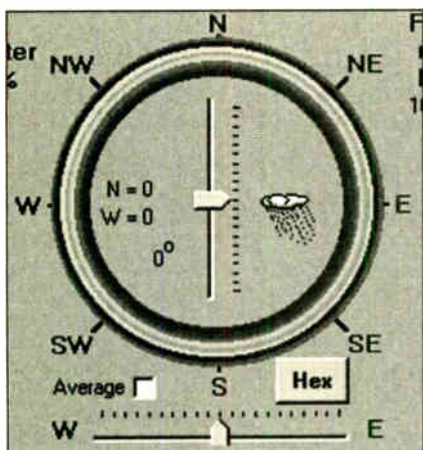

Typical example of the novelty "Rainbow Alert" display. Note the "rain" symbol.

Having changed all the values required, click on the Save New Settings button. This causes all the values to be stored to the **WeatherSettings.txt** file. Note that if this file has been accessed in relation to timing rates, the button will be renamed Reload Timings. Click the button to reload the timing rates. It then returns to being named Save New Settings. Click it to store the settings to disk and to replace the previous settings in the program's memory. Then click Run to restart the sampling.

There is one other control on the main screen, a tick box that controls an averaging process. When ticked, the software takes the average of the last 16 samples and it is that average which is displayed. The box may be used at anytime.

RECORDING TO DISK

Live recording to disk can only be started when the settings are not being changed. Conversely, settings cannot be changed when recording is in progress.

Recording is started by clicking on Start Record (as you did earlier to set the COM port address). This time accept the "live" option. The sub-window closes, the Start Record caption changes to End Record, and live recording commences.

The data is recorded to disk in the same folder that the PIC Met Office software is held in. The file is given a unique time and date title, prefixed by "WeatherLD" (LD for Live Data). The rate at which data is recorded is that previously set via Change Settings. Each recorded data block is

suffixed by the date and time at which it was recorded. Recording continues until the End Record button is clicked, which closes the file. Closing the file then starts another routine in which the recorded data is re-input and processed for output to another file, prefixed "WeatherLP" (LP for Live Processed).

The file data is principally intended for viewing and graphing via Microsoft's Excel. Many PCs are likely to have this, or a variant. However, the option to view the first 10,000 samples of a recorded file via the PIC Met Office's graphing facility is provided. This will be discussed in a moment.

BLOCK DOWNLOAD

The data stored to the serial EEPROM chips on the p.c.b. can be downloaded via the Start Record button. Click it and this time accept the Download option, to reveal the screen through which you set the COM port address.

To start the downloading, click on START. This sends a handshake value to the PIC, which having received it first stores the current EEPROM write address values and then acknowledges the handshake by sending an ID code, the number of chips installed and the current write address. It then starts sending serial EEPROM data in sequence in blocks of 256 bytes, with handshakes exchanged between blocks.

The data blocks are stored to disk as binary values in a general file named **STORE1.txt** (but which cannot be read via a text editor), held in the same folder as the other PIC Met Office files.

The download continues until the PIC has sent data from all the serial EEPROM chips installed. When the PC recognises that a timeout has occurred following the PIC sending all the data, it closes the file and resumes normal sampling. Once started, the download cannot be stopped.

The download rate is set at 9600 Baud, the same conditions as used during normal sampling. Baud rate is fixed but the COM address can be changed via the download sub-screen, as described earlier.

Once the download has been completed, **STORE1.txt** is reopened and two other files created for values expressed in ASCII, and which can be read via a text editor. The files are given a timed and dated file name, prefixed by WeatherED and WeatherEP, respectively.

The downloaded data is sent as two bytes per sample, MSB and LSB. The WeatherED (ED for EEPROM Data) files hold the download data formatted as decimal values created from the two-byte data and separated by TAB commands (ASCII 9, to suit Windows Excel), and set

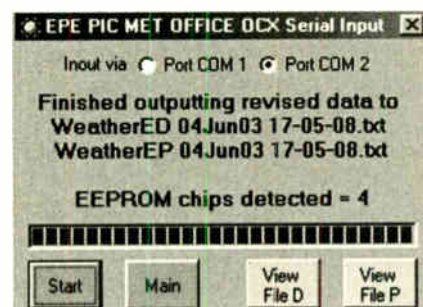

Download screen following transfer completion.

into text lines representing each batch of recorded values.

When viewed via a text editor, the values are displayed in columns headed by the sensor name to which they relate.

The second file is named WeatherEP (EP for EEPROM Processed), again with a dated and timed ID. In this file the downloaded data values are processed in relation to the on-screen correction values, identically to the bargraph values.

Data values are again separated by TABs and the columns provided with headings. The file can be viewed via the PIC Met Office's graph screen and also further processed by Excel (like the WeatherLP file).

VIEWING RECORDED FILES

To view a recorded file, click on the Directory button. Through the sub-screen displayed (see next page) folder paths can be set and recorded files selected. It is a modified version of the Directory screen first used with the author's *Toolkit TK3* (Nov '01) software.

It will not be described in detail here as it has its own text file that is readable via an on-screen NOTES button.

There are, though, four radio buttons that are specific to the PIC Met Office. They allow selective display of the ED, EP, LD and LP letters that follow the prefix Weather in the file names. The default is LP and all files with the prefix WeatherLP within the selected folder are listed.

Single clicking on a file name allows it to be viewed as a text file (through Windows Notepad) via the VIEW button. The author would have preferred to use Windows Wordpad but the correct VB commands to access it could not be established (reader feedback on this would be appreciated!). If the file is too long for Notepad to handle, the PC automatically offers the choice of using Wordpad instead – accept it.

Double-clicking on a file name (EP and LP only, not ED or LD), causes it to be loaded into the program and displayed via the PIC Met Office graph. Irrespective of the file length, the data is formatted to extend fully across the graph area (up to 10,000 samples). The sample counter is reset by doing so.

The graph itself is only rudimentary in terms of data analysis, just showing the relative amplitude of values. For more detailed analysis, in relation to specific periods of time for example, Windows Excel should be used.

BEAUFORT SCALE

The final option provide by the PIC Met Office is a text file that gives the comparison between wind speed and the Beaufort scale. It is Beaufort's wind force scale that is referred to when weather forecasters say, for example, "gale force eight".

Admiral Sir Francis Beaufort (1774-1857) developed the scale in 1805 to help sailors estimate wind speeds using visual observations. The speeds are measured at a height of 10 metres.

His scale can be read by clicking on the main screen's Beaufort button.

POLAR CONDITIONS

No recommendation is offered for mounting the finished PIC Met Office

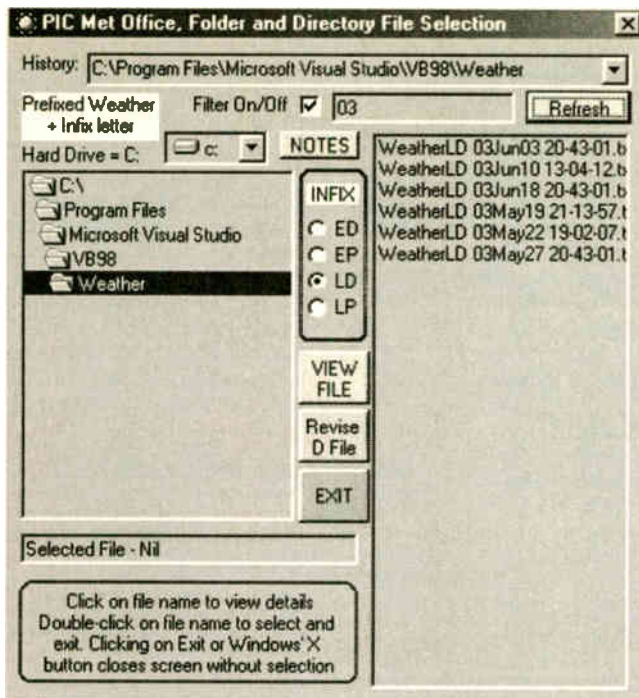

Example of the directory screen, used to select recorded file data for viewing.

assembly. The prototype sat on the author's garden table, with a 12V car battery below it, during extended proving tests. However, it would be easy to mount two cross struts below the enclosure and secure the assembly to a suitably sturdy pole.

Although wind speeds are typically quoted in relation to a height of several metres above ground level, practicalities in the garden rule this out as an option.

In the garden, what you are likely to be most interested in, is the speed of the hurricane that's blowing you out of your deckchair, or the temperature that you're sweltering under or freezing in.

A modest construction using a short pole is probably better suited to domestic needs, and one that is at a readily readable and usable height.

WIND CHILL

Wind chill factors are often quoted on winter weather forecasts. We all know we get cooler when the wind blows, but by what relationship remained a mystery to the author until Googling the web in search of enlightenment.

The National Weather Service of America provided the answer and a formula for calculating it. Their website, www.nsw.noaa.gov, has much that makes it worth browsing generally, but their Wind Chill Glossary is particularly informative, saying that the condition is based on the rate of heat loss from exposed skin caused by wind and cold. As the wind increases, it draws heat from the body, driving down skin temperature and eventually internal body temperature. Therefore the wind makes it feel much colder.

On 1 November 2001, NWS implemented a new Wind Chill Temperature (WCT) index based on a revised formula that uses advances in science, technology and computer modelling to provide a more accurate and useful formula for calculating the dangers from wind chill temperatures. It is shown above.

WIND CHILL FORMULA

$$WCT (^\circ F) = 35.74 + 0.6215T - 35.75(V^{0.16}) + 0.4275T(V^{0.16})$$

where T = air temperature (°F) and V = wind speed (mph)

This formula is used by the PIC Met Office's PC software to display the wind chill bargraph values. (The PIC software does not have this function.)

On the NWS web site, a Wind Chill Chart is displayed, plotting not only wind speed against temperature, but also indicating frost bite times. For example, at a temperature of +10°F (-12°C) and a wind speed of 60m.p.h., WCT is -19°F (-28°C), and frost bite can occur in 30 minutes.

Note that the formula cannot be applied if wind speed is below 1m.p.h.

function in freezing conditions. Snow, too, will cover the ultrasonic transducers, l.d.r. and solar panel.

But might the l.c.d., for instance, object to winter coldness, or to high level summer temperatures? How much will torrential rain affect the ultrasonic signal transmission? Will really high winds do so too?

Will birds consider the acrylic sheet to be a splendid landing platform, or the transducers as convenient perches, and will they "bomb" the acrylic at the l.d.r. and solar panel positions?

To the latter questions, the answer is yes, but birds haven't actually nested on the prototype, yet!

To the former, the answers are unknown. Perhaps you would be good enough to tell the author should you find out. You know how to contact him, at EPE of course – techdept@epemag.wimborne.co.uk.

LIGHT BUG FIX

Data from the serial chips has been found to be prone to spikes occurring just after dusk and just prior to dawn. This can be cured by restricting the range of the l.d.r. by connecting a 22kΩ resistor across it. If the problem persists, reduce the resistor's value.

SOME RELATED SITES

UK Met Office: www.metoffice.gov.uk/
 US Met Office: www.nws.noaa.gov/
 Hurricane Watch: www.nhc.noaa.gov/
 Aurora Watch: www.dcs.lancs.ac.uk/iono/aurorawatch/
 Australian Met Office: www.bom.gov.au/

Links to national meteorological offices: http://badc.nerc.ac.uk/community/highlighted_sites/nat_met_offices.html

ACKNOWLEDGEMENT

The author gratefully thanks Peter Hemsley for his excellent maths routines which have been used extensively in the PIC software for this project. □

PROTECTION

It is essential that you protect the electronics by spraying the p.c.b. and its components liberally with an anti-condensation spray to prevent fog, mist and general condensation adversely affecting operation. Obviously, though, you must protect the humidity sensor while spraying otherwise it will cease to function. Suitable spray is available from many electronic component suppliers, it is commonly known as "conformal" spray, and sources were quoted in last month's *Shoptalk* column.

It has not been feasible to test the PIC Met Office through all the rigours of varying weather conditions and a number of matters are unproved. For example, although the temperature sensor is capable of outputting voltages relative to sub-zero temperatures, can the rest of the electronics cope with such outdoor winter conditions?

It will be obvious, of course, that the soil, humidity and rain sensors cannot

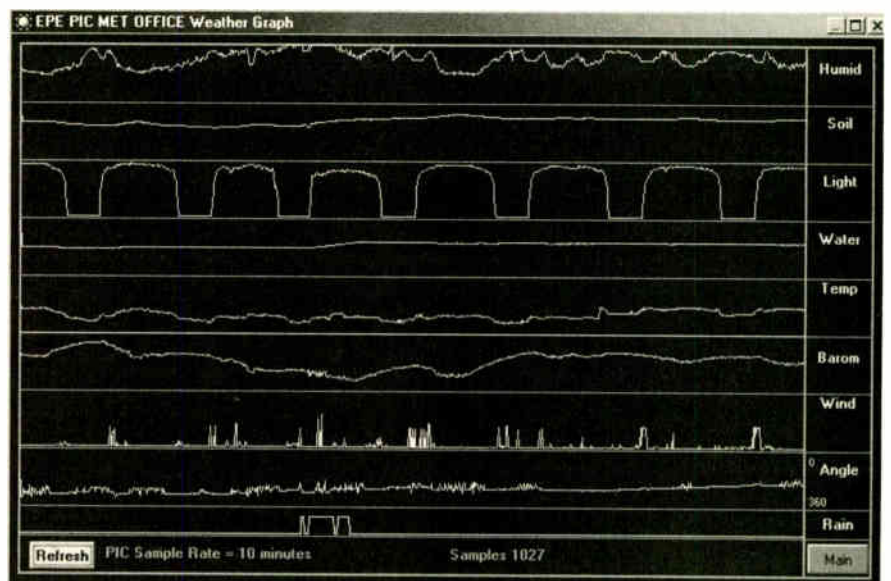

Seven days of weather.

FLOWLOG

datalogging • control • electrical measurement

A NEW, LOW COST OSCILLOSCOPE, DATALOGGER AND CONTROL UNIT

£99
+VAT

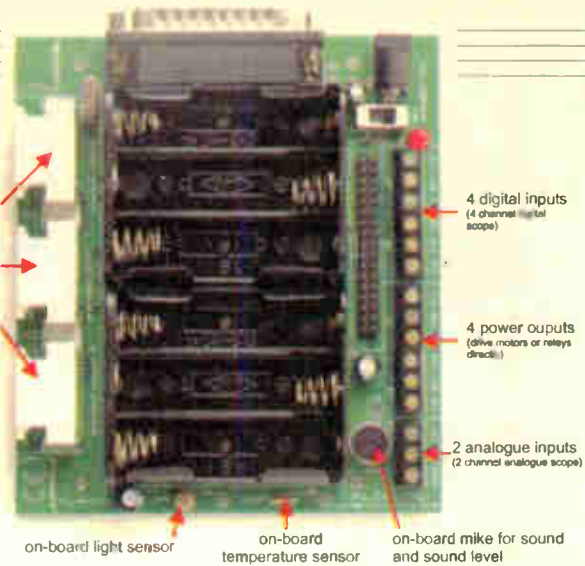

FREE SOFTWARE APPLICATIONS INCLUDE:

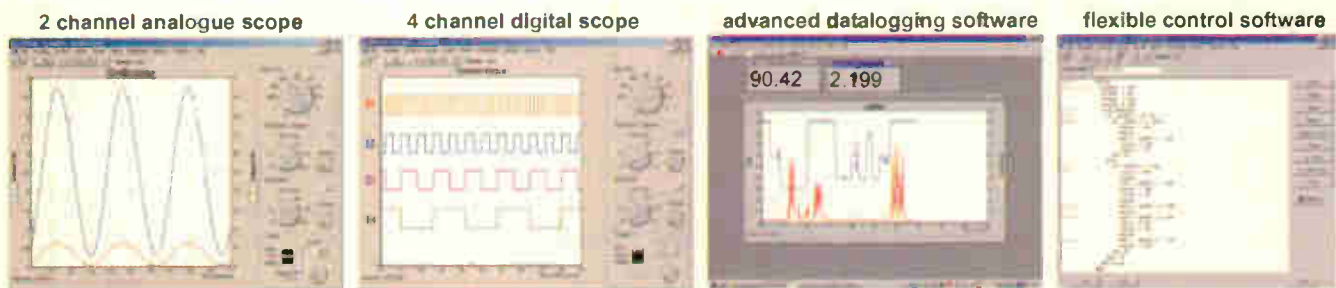

Flowlog is a new computer interface that provides datalogging, control and electrical measurement functions for use in science and electronics. Flowlog provides unrivalled value for money and performance. Please log onto our web site for full specification and description.

www.matrixmultimedia.co.uk
sales@matrixmultimedia.co.uk
 t. 0870 700 1831 f. 0870 700 1832



A COMPLETE RANGE OF INVERTERS 150W TO 2500W - 12V & 24V

A Complete range of regulated inverters to power 220V and 240V AC equipment via a car, lorry or boat battery. Due to their high performance (>90%) the inverters generate very little heat. The high stability of the output frequency (+/-1%) makes them equally suitable to power sensitive devices.



These inverters generate a modified sine wave, which are considerably superior to the square waves which are produced by most other inverters. Due to this superior feature they are capable of powering electrical equipment such as TV,s, videos, desktop & notepad computers, microwave ovens, electrical lamps, pumps, battery chargers, etc.

Low Battery Alarm

The inverters give an audible warning signal when the battery voltage is lower than 10.5V (21V for the 24V version). The inverter automatically shuts off when the battery voltage drops below 10V (20V for the 24V version). Fuse protected input circuitry.

Order Code	Power	Voltage	Was	Price
651.581	150W Continuous	12V	£36.39	£29.72
651.578	150W Continuous	24V	£36.39	£29.72
651.582	300W Continuous	12V	£50.64	£41.93
651.585	300W Continuous	24V	£50.64	£41.93
651.583	600W Continuous	12V	£101.59	£83.76
651.593	600W Continuous	24V	£101.59	£83.76
651.587	1000W Continuous	12V	£177.18	£147.52
651.597	1000W Continuous	24V	£177.18	£147.52
651.602	1500W Continuous	12V	£314.52	£261.18
651.605	1500W Continuous	24V	£314.52	£261.18
651.589	2500W Continuous	12V	£490.54	£416.27
651.599	2500W Continuous	24V	£490.54	£416.27



All prices are inclusive of V.A.T. Carriage £8.00 Per Order

Many uses include - * Fetes * Fairgrounds * Airshows * Picnics * Caravan * Caravans * Boats * Carnivals * Field Research and * Amateur Radio field days * Powering Desktop & Notepad Computers.

DELIVERY CHARGES ARE £6.00 PER ORDER. OFFICIAL ORDERS FROM SCHOOLS, COLLEGES, GOVT. BODIES, PLC,S ETC. PRICES ARE INCLUSIVE OF V.A.T. SALES COUNTER. VISA AND ACCESS ACCEPTED BY POST, PHONE OR FAX, OR EMAIL US AT SALES@BKELEC.COM ALTERNATIVELY SEND CHEQUE OF POSTAL ORDERS MADE PAYABLE TO BK ELECTRONICS.

B.K. ELECTRONICS
 UNIT 1, COMET WAY, SOUTHEND-ON-SEA, ESSEX, SS2 6TR
 TEL: +44(0)1702-527572 FAX: +44(0)1702-420243

For Full Specifications View our web site at:
WWW.BKELEC.COM/INVERTERS.HTM

USING THE PIC'S "HIGH" OPERATOR

MALCOLM WILES

Simpler programming for segmented PIC architectures

DESIGN is often a matter of making trade-offs between various desirable but competing factors. When computer processors are designed, one design issue is how much memory should the processor support?

Computer memory is made up of individual binary digits, or "bits". These bits are usually structured into groups; groupings of 8 bits (the *byte*), and 16 or 32 bits (often called a *word*) are common. Such groupings form the basic memory access unit. In this article, *word* is used generically to refer to any such grouping of bits, independent of how many bits it comprises.

To be accessible, memory has to be addressed. Each word of memory is assigned a unique number, usually starting with zero and followed by the contiguous positive integers 1, 2, 3 . . . etc. This number is called an address. Then any memory location (word) can be identified by specifying its address.

When we program, we write statements either in assembly language, or in a high level language such as Basic or C. These statements are then translated by an assembler or compiler into machine code instructions, which are actually read and executed by the computer processor. As programmers, it's not often necessary for us to be concerned with the details of these machine code instructions, but for our present purposes we can note that, suitably encoded, they need to contain (amongst other things):

- the operation to be performed – add, compare, branch etc.
- the operands on which the specified operation is to be performed, either "literally" or as the address of the memory word holding the operand.

This is where one of the design trade-offs comes in. The more memory that we want to be able to support, then the larger the memory addresses will be, and the longer the machine instructions must be in order to be able to hold these addresses. This will tend to drive up the cost and/or complexity of the processor, and

lower its speed, all of which are clearly undesirable.

SEGMENTED ARCHITECTURES

One solution to this design problem is a segmented architecture. Memory is divided up into several segments of typically a few hundred or thousand words each. A segment register in the processor is used to hold the address of the segment containing the word which it is wished to address. The computer instruction itself then holds just the address (or offset) of the relevant memory word within the segment.

This is shorter than the full address of the word. Thus all computer instructions can be kept short and cheap, at the cost of implementing just one additional segment register. The general principle is illustrated in Fig.1, which shows a physical memory of 8K words divided into four segments of 2K words each. In this example, the machine instructions only address up to 2K words.

Usually segments are addressed as 0, 1, 2 . . . and so on. In this case the segment register can be thought of as holding the most significant part of a memory address, and the program instruction the least significant part. A full memory address can be obtained by prefixing the computer

instruction address with the address held in the segment register.

Some of the most successful computer designs of all time have used segmented architectures. The IBM 360/370 series of mainframes, which dominated the data processing scene during the 1960s to 1980s, employed a segmented design. The Intel 8086/8 and 80186 processors which were the basis of the first IBM PCs also had a segmented architecture.

Even the very latest Pentium processors can be (and in fact are) still run in an 8086-compatible mode (real mode), even though their normal operating mode when running Windows-style operating systems is the non-segmented protected mode. And on the Microchip PIC series of microcontrollers, both program memory and data memory are segmented.

PROGRAMMING IMPLICATIONS

Although segmented architectures are a successful solution to a design problem from a hardware designer's point of view, from a software engineer's point of view they are less satisfactory. A segmented architecture means that, while the total amount of memory that can be addressed can be quite large, not all of it is "visible" at any one time. Only the segment that is currently addressed by the segment register can be accessed by machine code instructions.

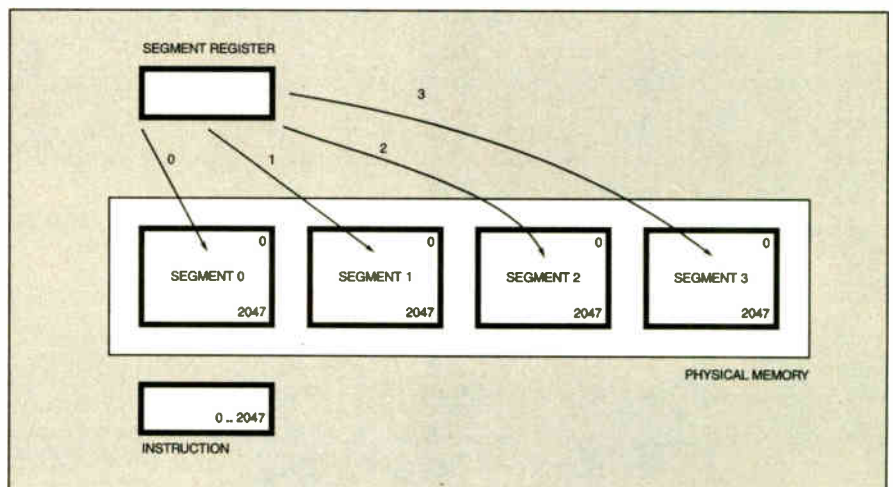

Fig.1. PIC memory comprising four segments.

The segment register has to be continually manipulated by software in order to make the correct memory segments visible for the operation being done at the time. This is an overhead; it is at best a chore, and at worst a fruitful source of programming errors.

The software structure may have to be artificially contrived so that closely related parts of a program fit into the same segment. Worst of all, segmented architectures are a maintenance headache. If a program has to be modified some time after it was first written, the chances are that some of the subtleties of what was placed close to what in order to be in the same segment will have been forgotten. Additional code (maintenance always involves adding more code!) may push something over a segment boundary, causing it no longer to be accessible from locations that it was previously.

From a software engineer's point of view, a "flat" memory architecture where all of the memory is simultaneously visible and accessible is much easier to work with, and much to be preferred.

SEGMENTS AND PICS

As previously indicated, on the PIC16F series both program memory and data memory are segmented. Microchip documentation refers to program memory segments as "pages", and data memory segments as "banks". To avoid confusion it is helpful to use this terminology consistently. Program memory is divided into four pages of 2K (14-bit) words each, and data memory into four banks of up to 128 8-bit bytes each.

On the PIC, the program memory segment register comprises bits 3 and 4 of the register PCLATH. The data memory segment register is not a physically separate register, but comprises bits 5 and 6 of the STATUS register.

The ways in which PCLATH is used to form addresses in various cases were covered by John Waller in *Using the PIC's PCLATH Command* (July '02), and John Becker described memory bank and block use in *PIC16F87x Extended Memory Use* (June '01), so these details have not been repeated here. Readers wanting more information should refer to these two articles, and to Microchip's data sheets for the relevant PIC microcontrollers.

On the smaller members of the PIC16F family, such as the PIC16F84, only two banks and one page are physically implemented, and general purpose data registers are in bank 0 only (bank 1 general purpose registers map to bank 0). On these processors, bit 7 (IRP) and bit 6 (RP1) of the STATUS register are ignored by the processor and should not be programmed by software.

For completeness the following two points are noted. First, when using indirect addressing via the INDF and FSR registers, data memory may be considered to be segmented into two parts, sometimes called block 0 and block 1. The segment register in this case is the IRP bit, bit 7 of the STATUS register. Interested readers can find more details in John Becker's article referenced above.

Second, the remaining three bits (2 to 0) of PCLATH are used to complete addresses in conjunction with any instruction that has PCL as a destination. This includes the

"computed GOTO" instruction used to implement data tables held in program memory. In these cases, program memory is effectively segmented into "sub-pages" of only 256 bytes each, so beware – it is very easy to overflow a sub-page boundary!

The HIGH operator, to be described in the next section, can be used to set PCLATH for PCL-referencing instructions too. Examples and more details may be found in the author's article *PIC Macros and Computed Gotos* (Jan '03). That article also gives examples of using LCALL and LGOTO pseudo-instructions, as supported by MPASM, which provide an alternative to the explicit use of the HIGH operator. Neither of these two points is discussed further now.

In the author's opinion, data memory segments (banks) are less of a programming problem than program memory segments (pages). This is because assignment of data memory locations is usually done consciously by the programmer. In other words, when you write a PIC program, you usually explicitly choose where in bank 0 to bank 3 your various variables will be assigned.

Thus, as a programmer, you are generally aware of how data memory is structured. The chances are reasonable, therefore, that when you write code to access some variable, you will remember which bank it is in and remember to set the bank register correctly first.

This is not true of program memory. As programmers, we write a sequence of assembly or high level language instructions. We generally don't know, or care, where in memory the machine code corresponding to these instructions will end up. That's a detail we (rightly) leave to the assembler or compiler to sort out for us. So when manipulation of PCLATH becomes necessary, probably in a program that has grown beyond 2K words in length, the chances are that we will be much less aware of the fact, and so much more prone to make errors.

In compensation, however, both MPASM and the *Toolkit TK3* (V1.4 onwards) program software (Nov '01) provide a feature that greatly simplifies the task of programming PCLATH – the HIGH operator.

USING HIGH

Even though machine code can only hold part of a memory address, the assembler knows the full address of each memory location, and where each assembled statement will be placed. For those statements that have been assigned a label in a program, the operator HIGH can be used in conjunction with this label to cause the assembler to return the most significant part (bits 12 to 8) of the address of the memory location corresponding to the label (which will contain

LISTING 1

```

LOOP:  movlw HIGH SUB1    ; load most significant part of
                                ; SUB1 address
        movwf PCLATH      ; and store in PCLATH for call
        call SUB1         ; call SUB1
        movlw HIGH LOOP   ; now set PCLATH for the next
                                ; GOTO
        movwf PCLATH
        goto LOOP         ; and repeat loop
; subroutine 1 – can be located anywhere in 8K program memory
SUB1:  (subroutine code goes here)
        return           ; call stack pushes 13-bit
                                ; address, so no need to adjust
                                ; PCLATH here

```

the assembled machine code instruction generated from the labelled statement). This can then be used to set PCLATH, as the program fragment in Listing 1 illustrates.

What's happening here is that the assembler is effectively being made to do the chore of programming PCLATH instead of the programmer having to do it. As a programmer, using this approach you do not have to mess about with ORG directives to try to place sections of your program in sensible places. You don't have to keep inspecting assembler .LST files to try to work out whether things have crossed page boundaries yet. You don't have to program PCLATH explicitly with literals which are subject to change. The assembler now sorts all this out for you.

If the "movlw HIGH destination, movwf PCLATH" sequence is used routinely before every CALL or GOTO instruction in a program, then it becomes as if the programmer had a flat memory space to work in. CALLs and GOTOs may be made without restriction from anywhere in the 8K memory space to anywhere else in the 8K memory space. Even if a program is longer than 2K words, the programmer doesn't need to know or worry where in memory all the various bits and subroutines of the program end up.

Best of all, each time the program is modified by adding or removing code, and so potentially things get moved around across page boundaries, then the assembler redoes all the page fix-ups automatically each time it reassembles. The maintenance problem goes away completely.

The author strongly recommends this technique wherever possible in any program that could ever conceivably grow to more than 2K program words long. Of course there's no such thing as a completely free lunch, and the two "movlw HIGH destination, movwf PCLATH" instructions do represent a small overhead that might be unacceptable if just blindly used everywhere in an extremely time-critical program.

But in almost all cases the overhead will prove to be well worth while when weighed against the simplification of the programming task and the elimination of a source of hard-to-find bugs.

ACKNOWLEDGEMENTS

The author gratefully acknowledges helpful comments from John Becker, Richard Hinkley, Andrew Jarvis and John Waller during the preparation of this article. □

EPE IS PLEASED TO BE ABLE TO OFFER YOU THESE ELECTRONICS CD-ROMS

ELECTRONICS PROJECTS



Logic Probe testing

Electronic Projects is split into two main sections: **Building Electronic Projects** contains comprehensive information about the components, tools and techniques used in developing projects from initial concept through to final circuit board production. Extensive use is made of video presentations showing soldering and construction techniques. The second section contains a set of ten projects for students to build, ranging from simple sensor circuits through to power amplifiers. A shareware version of Matrix's CADPACK schematic capture, circuit simulation and p.c.b. design software is included. The projects on the CD-ROM are: Logic Probe; Light, Heat and Moisture Sensor; NE555 Timer; Egg Timer; Dice Machine; Bike Alarm; Stereo Mixer; Power Amplifier; Sound Activated Switch; Reaction Tester. Full parts lists, schematics and p.c.b. layouts are included on the CD-ROM.

ELECTRONICS CAD PACK

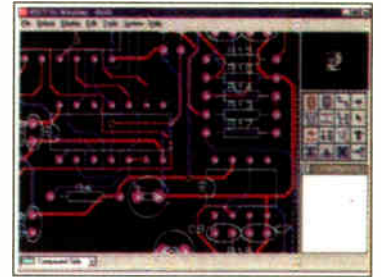

PCB Layout

Electronics CADPACK allows users to design complex circuit schematics, to view circuit animations using a unique SPICE-based simulation tool, and to design printed circuit boards. CADPACK is made up of three separate software modules. (These are restricted versions of the full Labcenter software.) **ISIS Lite** which provides full schematic drawing features including full control of drawing appearance, automatic wire routing, and over 6,000 parts. **PROSPICE Lite** (integrated into ISIS Lite) which uses unique animation to show the operation of any circuit with mouse-operated switches, pots, etc. The animation is compiled using a full mixed mode SPICE simulator. **ARES Lite** PCB layout software allows professional quality PCBs to be designed and includes advanced features such as 16-layer boards, SMT components, and an autorouter operating on user generated Net Lists.

ELECTRONIC CIRCUITS & COMPONENTS V2.0

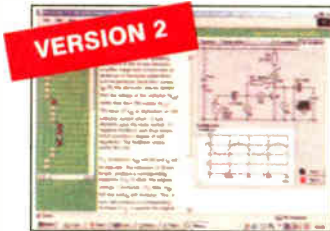

Circuit simulation screen

Provides an introduction to the principles and application of the most common types of electronic components and shows how they are used to form complete circuits. The virtual laboratories, worked examples and pre-designed circuits allow students to learn, experiment and check their understanding. Version 2 has been considerably expanded in almost every area following a review of major syllabuses (GCSE, GNVQ, A level and HNC). It also contains both European and American circuit symbols. Sections include: **Fundamentals**: units & multiples, electricity, electric circuits, alternating circuits. **Passive Components**: resistors, capacitors, inductors, transformers. **Semiconductors**: diodes, transistors, op.amps, logic gates. **Passive Circuits**. **Active Circuits**. The **Parts Gallery** will help students to recognise common electronic components and their corresponding symbols in circuit diagrams. Included in the Institutional Versions are multiple choice questions, exam style questions, fault finding virtual laboratories and investigations/worksheets.

ANALOGUE ELECTRONICS

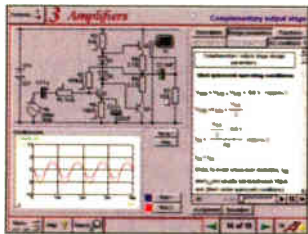

Complimentary output stage

Analogue Electronics is a complete learning resource for this most difficult branch of electronics. The CD-ROM includes a host of virtual laboratories, animations, diagrams, photographs and text as well as a SPICE electronic circuit simulator with over 50 pre-designed circuits.

Sections on the CD-ROM include: **Fundamentals** – Analogue Signals (5 sections), Transistors (4 sections), Waveshaping Circuits (6 sections), **Op.Amps** – 17 sections covering everything from Symbols and Signal Connections to Differentiators. **Amplifiers** – Single Stage Amplifiers (8 sections), Multi-stage Amplifiers (3 sections). **Filters** – Passive Filters (10 sections), Phase Shifting Networks (4 sections), Active Filters (6 sections). **Oscillators** – 6 sections from Positive Feedback to Crystal Oscillators. **Systems** – 12 sections from Audio Pre-Amplifiers to 8-Bit ADC plus a gallery showing representative p.c.b. photos.

ROBOTICS & MECHATRONICS



Case study of the Milford Instruments Spider

Robotics and Mechatronics is designed to enable hobbyists/students with little previous experience of electronics to design and build electromechanical systems. The CD-ROM deals with all aspects of robotics from the control systems used, the transducers available, motors/actuators and the circuits to drive them. Case study material (including the NASA Mars Rover, the Milford Spider and the Furby) is used to show how practical robotic systems are designed. The result is a highly stimulating resource that will make learning, and building robotics and mechatronic systems easier. The Institutional versions have additional worksheets and multiple choice questions.

- Interactive Virtual Laboratories
- Little previous knowledge required
- Mathematics is kept to a minimum and all calculations are explained
- Clear circuit simulations

DIGITAL ELECTRONICS V2.0

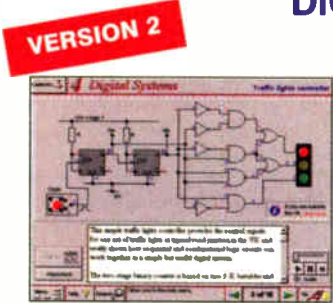

Virtual laboratory – Traffic Lights

Digital Electronics builds on the knowledge of logic gates covered in *Electronic Circuits & Components* (opposite), and takes users through the subject of digital electronics up to the operation and architecture of microprocessors. The virtual laboratories allow users to operate many circuits on screen. Covers binary and hexadecimal numbering systems, ASCII, basic logic gates, monostable action and circuits, and bistables – including JK and D-type flip-flops. Multiple gate circuits, equivalent logic functions and specialised logic functions. Introduces sequential logic including clocks and clock circuitry, counters, binary coded decimal and shift registers. A/D and D/A converters, traffic light controllers, memories and microprocessors – architecture, bus systems and their arithmetic logic units. Sections on Boolean Logic and Venn diagrams, displays and chip types have been expanded in Version 2 and new sections include shift registers, digital fault finding, programmable logic controllers, and microcontrollers and microprocessors. The Institutional versions now also include several types of assessment for supervisors, including worksheets, multiple choice tests, fault finding exercises and examination questions.

FILTERS

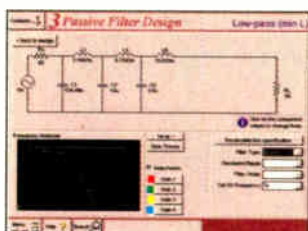

Filter synthesis

Filters is a complete course in designing active and passive filters that makes use of highly interactive virtual laboratories and simulations to explain how filters are designed. It is split into five chapters: **Revision** which provides underpinning knowledge required for those who need to design filters. **Filter Basics** which is a course in terminology and filter characterization, important classes of filter, filter order, filter impedance and impedance matching, and effects of different filter types. **Advanced Theory** which covers the use of filter tables, mathematics behind filter design, and an explanation of the design of active filters. **Passive Filter Design** which includes an expert system and filter synthesis tool for the design of low-pass, high-pass, band-pass, and band-stop Bessel, Butterworth and Chebyshev ladder filters. **Active Filter Design** which includes an expert system and filter synthesis tool for the design of low-pass, high-pass, band-pass, and band-stop Bessel, Butterworth and Chebyshev op.amp filters.

PRICES

Prices for each of the CD-ROMs above are:

(Order form on third page)

(UK and EU customers add VAT at 17.5% to "plus VAT" prices)

Hobbyist/Student£45 inc VAT
 Institutional (Schools/HE/FE/Industry).....£99 plus VAT
 Institutional 10 user (Network Licence).....£199 plus VAT
 Site Licence.....£499 plus VAT

PICmicro TUTORIALS AND PROGRAMMING

HARDWARE

VERSION 2 PICmicro MCU DEVELOPMENT BOARD

Suitable for use with the three software packages listed below.

This flexible development board allows students to learn both how to program PICmicro microcontrollers as well as program a range of 8, 18, 28 and 40-pin devices. For experienced programmers all programming software is included in the PPP utility that comes with the development board. For those who want to learn, choose one or all of the packages below to use with the Development Board.

- Makes it easier to develop PICmicro projects
- Supports low cost Flash-programmable PICmicro devices
- Fully featured integrated displays – 13 individual I.e.d.s, quad 7-segment display and alphanumeric I.c.d. display
- Supports PICmicro microcontrollers with A/D converters
- Fully protected expansion bus for project work
- All inputs and outputs available on screw terminal connectors for easy connection

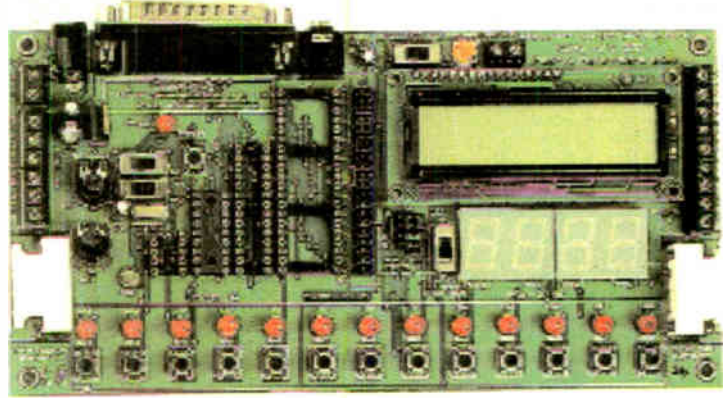

£145 including VAT and postage
12V 500mA plug-top PSU (UK plug) £7
25-way 'D' type connecting cable £5

SOFTWARE

Suitable for use with the Development Board shown above.

ASSEMBLY FOR PICmicro V2 (Formerly PICtutor)

Assembly for PICmicro microcontrollers V2.0 (previously known as PICtutor) by John Becker contains a complete course in programming the PIC16F84 PICmicro microcontroller from Arizona Microchip. It starts with fundamental concepts and extends up to complex programs including watchdog timers, interrupts and sleep modes. The CD makes use of the latest simulation techniques which provide a superb tool for learning: the Virtual PICmicro microcontroller. This is a simulation tool that allows users to write and execute MPASM assembler code for the PIC16F84 microcontroller on-screen. Using this you can actually see what happens inside the PICmicro MCU as each instruction is executed which enhances understanding.

- Comprehensive instruction through 39 tutorial sections
- Includes Vlab, a Virtual PICmicro microcontroller: a fully functioning simulator
- Tests, exercises and projects covering a wide range of PICmicro MCU applications
- Includes MPLAB assembler
- Visual representation of a PICmicro showing architecture and functions
- Expert system for code entry helps first time users
- Shows data flow and fetch execute cycle and has challenges (washing machine, lift, crossroads etc.)
- Imports MPASM files.



Virtual PICmicro

'C' FOR PICmicro VERSION 2

The C for PICmicro microcontrollers CD-ROM is designed for students and professionals who need to learn how to program embedded microcontrollers in C. The CD contains a course as well as all the software tools needed to create Hex code for a wide range of PICmicro devices – including a full C compiler for a wide range of PICmicro devices.

Although the course focuses on the use of the PICmicro microcontrollers, this CD-ROM will provide a good grounding in C programming for any microcontroller.

- Complete course in C as well as C programming for PICmicro microcontrollers
- Highly interactive course
- Virtual C PICmicro improves understanding
- Includes a C compiler for a wide range of PICmicro devices
- Includes full Integrated Development Environment
- Includes MPLAB software
- Compatible with most PICmicro programmers
- Includes a compiler for all the PICmicro devices.

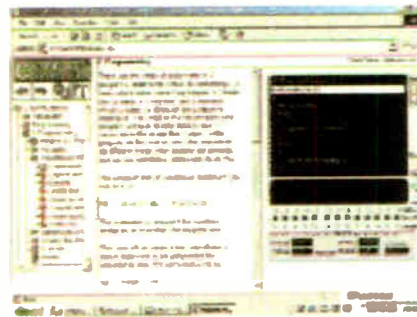

Minimum system requirements for these items: Pentium PC running Windows 98, NT, 2000, ME, XP; CD-ROM drive; 64MB RAM; 10MB hard disk space.

FLOWCODE FOR PICmicro

Flowcode is a very high level language programming system for PICmicro microcontrollers based on flowcharts. Flowcode allows you to design and simulate complex robotics and control systems in a matter of minutes.

Flowcode is a powerful language that uses macros to facilitate the control of complex devices like 7-segment displays, motor controllers and I.c.d. displays. The use of macros allows you to control these electronic devices without getting bogged down in understanding the programming involved.

Flowcode produces MPASM code which is compatible with virtually all PICmicro programmers. When used in conjunction with the Version 2 development board this provides a seamless solution that allows you to program chips in minutes.

- Requires no programming experience
- Allows complex PICmicro applications to be designed quickly
- Uses international standard flow chart symbols (ISO5807)
- Full on-screen simulation allows debugging and speeds up the development process
- Facilitates learning via a full suite of demonstration tutorials
- Produces ASM code for a range of 8, 18, 28 and 40-pin devices
- Institutional versions include virtual systems (burglar alarms, car parks etc.).



Burglar Alarm Simulation

PRICES

Prices for each of the CD-ROMs above are:

(Order form on next page)

(UK and EU customers add VAT at 17.5% to "plus VAT" prices)

Hobbyist/Student
Institutional (Schools/HE/FE/Industry)
Flowcode Institutional
Institutional 10 user (Network Licence)
Site Licence

£45 inc VAT
£99 plus VAT
£70 plus VAT
£249 plus VAT
£599 plus VAT

TEACH-IN 2000 – LEARN ELECTRONICS WITH EPE

EPE's own *Teach-In* CD-ROM, contains the full 12-part *Teach-In* series by John Becker in PDF form plus the *Teach-In* interactive software covering all aspects of the series. We have also added Alan Winstanley's highly acclaimed *Basic Soldering Guide* which is fully illustrated and which also includes *Desoldering*. The *Teach-In* series covers: Colour Codes and Resistors, Capacitors, Potentiometers, Sensor Resistors, Ohm's Law, Diodes and L.E.D.s, Waveforms, Frequency and Time, Logic Gates, Binary and Hex Logic, Op.amps, Comparators, Mixers, Audio and Sensor Amplifiers, Transistors, Transformers and Rectifiers, Voltage Regulation, Integration, Differentiation, 7-segment Displays, L.C.D.s, Digital-to-Analogue.

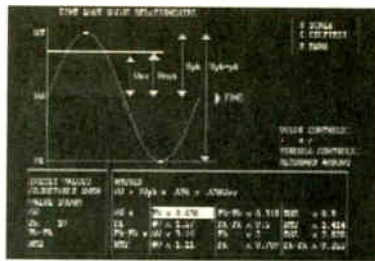

Sine wave relationship values

Each part has an associated practical section and the series includes a simple PC interface so you can use your PC as a basic oscilloscope with the various circuits.

A hands-on approach to electronics with numerous breadboard circuits to try out.

£12.45 including VAT and postage. Requires Adobe Acrobat (available free from the Internet – www.adobe.com/acrobat).

FREE WITH EACH TEACH-IN CD-ROM – *Electronics Hobbyist Compendium* 80-page book by Robert Penfold. Covers Tools For The Job; Component Testing; Oscilloscope Basics.

FREE BOOK WITH TEACH-IN 2000 CD-ROM

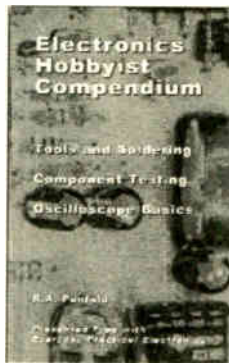

DIGITAL WORKS 3.0

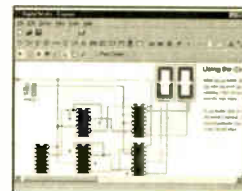

Counter project

Digital Works Version 3.0 is a graphical design tool that enables you to construct digital logic circuits and analyze their behaviour. It is so simple to use that it will take you less than 10 minutes to make your first digital design. It is so powerful that you will never outgrow its capability ● Software for simulating digital logic circuits ● Create your own macros – highly scalable ● Create your own circuits, components, and i.c.s ● Easy-to-use digital interface ● Animation brings circuits to life ● Vast library of logic macros and 74 series i.c.s with data sheets ● Powerful tool for designing and learning. **Hobbyist/Student £45 inc. VAT. Institutional £99 plus VAT. 10 user £199 plus VAT. Site Licence £499 plus VAT.**

ELECTRONICS IN CONTROL

Two colourful animated courses for students on one CD-ROM. These cover Key Stage 3 and GCSE syllabuses. **Key Stage 3:** A pictorial look at the Electronics section featuring animations and video clips. Provides an ideal introduction or revision guide, including multi-choice questions with feedback. **GCSE:** Aimed at the Electronics in many Design & Technology courses, it covers many sections of GCSE Electronics. Provides an ideal revision guide with Homework Questions on each chapter. Worked answers with an access code are provided on a special website.

Single User £29 inc. VAT. Multiple User £39 plus VAT
Student copies (available only with a multiple user copy) £6 plus VAT
 (UK and EU customers add VAT at 17.5% to "plus VAT" prices)

MODULAR CIRCUIT DESIGN

VERSION 3

Contains a range of tried and tested analogue and digital circuit modules, together with the knowledge to use and interface them. Thus allowing anyone with a basic understanding of circuit symbols to design and build their own projects. Version 3 includes data and circuit modules for a range of popular PICs; includes PICAXE circuits, the system which enables a PIC to be programmed without a programmer, and without removing it from the circuit. Shows where to obtain free software downloads to enable BASIC programming. Essential information for anyone undertaking GCSE or "A" level electronics or technology and for hobbyists who want to get to grips with project design. Over seventy different Input, Processor and Output modules are illustrated and fully described, together with detailed information on construction, fault finding and components, including circuit symbols, pinouts, power supplies, decoupling etc.

Single User £19.95 inc. VAT. Multiple User £34 plus VAT
 (UK and EU customers add VAT at 17.5% to "plus VAT" prices)



A high quality selection of over 200 JPG images of electronic components. This selection of high resolution photos can be used to enhance projects and presentations or to help with training and educational material. They are royalty free for use in commercial or personal printed projects, and can also be used royalty free in books, catalogues, magazine articles as well as worldwide web pages (subject to restrictions – see licence for full details). Also contains a **FREE** 30-day evaluation of Paint Shop Pro 6 – Paint Shop Pro image editing tips and on-line help included!

Price £19.95 inc. VAT

Minimum system requirements for these CD-ROMs: Pentium PC, CD-ROM drive, 32MB RAM, 10MB hard disk space. Windows 95/98/NT/2000/ME/XP, mouse, sound card, web browser.

Please send me:

CD-ROM ORDER FORM

- Electronic Projects
- Electronic Circuits & Components V2.0
- Analogue Electronics
- Digital Electronics V2.0
- Filters
- Electronics CAD Pack
- Robotics & Mechatronics
- Assembler for PICmicro
- 'C' for PICmicro
- Flowcode for PICmicro
- Digital Works 3.0

Version required:

- Hobbyist/Student
- Institutional
- Institutional 10 user
- Site licence



- PICmicro Development Board (hardware)
- Development Board UK plugtop power supply
- Development Board 25-way connecting lead

- Teach-In 2000 + FREE BOOK
- Electronic Components Photos
- Electronics In Control – Single User
- Electronics In Control – Multiple User
- Modular Circuit Design – Single User
- Modular Circuit Design – Multiple User

Note: The software on each version is the same, only the licence for use varies.

Full name:

Address:

..... Post code: Tel. No:

Signature:

I enclose cheque/PO in £ sterling payable to WIMBORNE PUBLISHING LTD for £

Please charge my Visa/Mastercard/Amex/Diners Club/Switch: £ Card expiry date:

Card No: Switch Issue No.

Card Security Code (The last 3 digits on or just under the signature strip)

ORDERING

ALL PRICES INCLUDE UK POSTAGE

Student/Single User/Standard Version price includes postage to most countries in the world
 EU residents outside the UK add £5 for airmail postage per order

Institutional, Multiple User and Deluxe Versions – overseas readers add £5 to the basic price of each order for airmail postage (do not add VAT unless you live in an EU (European Union) country, then add 17½% VAT or provide your official VAT registration number).

Send your order to:

**Direct Book Service
 Wimborne Publishing Ltd
 408 Wimborne Road East
 Ferndown, Dorset BH22 9ND**

To order by phone ring

01202 873872. Fax: 01202 874562

Goods are normally sent within seven days

E-mail: orders@wimborne.co.uk

Online shop:

www.epemag.wimborne.co.uk/shopdoor.htm

Learn About Microcontrollers

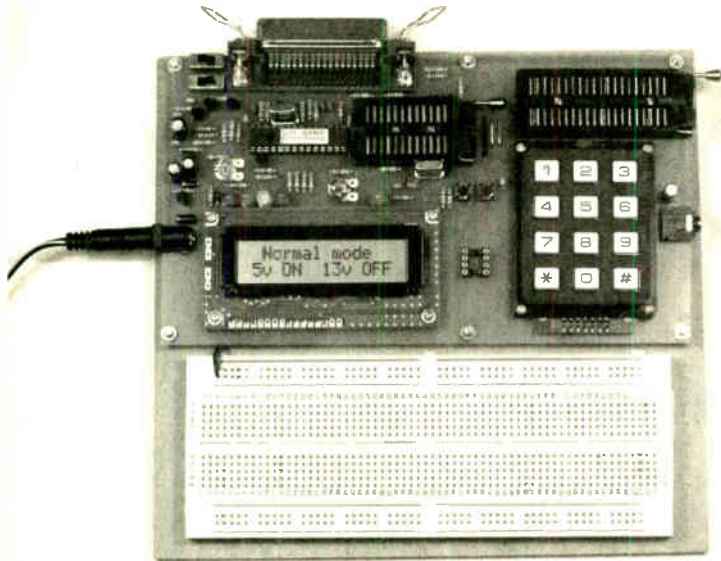

PIC Training & Development System

The best place to start learning about microcontrollers is the PIC16F84. This is easy to understand and very popular with construction projects. Then continue on using the more sophisticated PIC16F877 family.

The heart of our system is a real book which lies open on your desk while you use your computer to type in the programme and control the hardware. Start with four very simple programmes. Run the simulator to see how they work. Test them with real hardware. Follow on with a little theory....

Our complete PIC training and development system consists of our universal mid range PIC programmer, a 306 page book covering the PIC16F84, a 262 page book introducing the PIC16F877 family, and a suite of programmes to run on a PC. The module is an advanced design using a 28 pin PIC16F872 to handle the timing, programming and voltage switching requirements. The module has two ZIF sockets and an 8 pin socket which between them allow most mid range 8, 18, 28 and 40 pin PICs to be programmed. The plugboard is wired with a 5 volt supply. The software is an integrated system comprising a text editor, assembler disassembler, simulator and programming software. The programming is performed at normal 5 volts and then verified with plus and minus 10% applied to ensure that the device is programmed with a good margin and not poised on the edge of failure. DC version (shown) for UK, battery version for overseas. UK orders include a plugtop power supply.

- Universal mid range PIC programmer module
 - + Book *Experimenting with PIC Microcontrollers*
 - + Book *Experimenting with the PIC16F877 (2nd edition)*
 - + Universal mid range PIC software suite
 - + PIC16F84 and PIC16F872 test PICs. £125.00
- (Postage & insurance UK £9, Europe £14, Rest of world £24)

Experimenting with PIC Microcontrollers

This book introduces the PIC16F84 and PIC16C711, and is the easy way to get started for anyone who is new to PIC programming. We begin with four simple experiments, the first of which is explained over ten and half a pages assuming no starting knowledge except the ability to operate a PC. Then having gained some practical experience we study the basic principles of PIC programming, learn about the 8 bit timer, how to drive the liquid crystal display, create a real time clock, experiment with the watchdog timer, sleep mode, beeps and music, including a rendition of Beethoven's *Für Elise*. Finally there are two projects to work through, using the PIC16F84 to create a sinewave generator and investigating the power taken by domestic appliances. In the space of 24 experiments, two projects and 56 exercises the book works through from absolute beginner to experienced engineer level.

Hardware & Ordering Information

Our PIC software is supplied as a self installing programme which will operate on any modern PC whichever operating system is used. For full information click onto 'Using PIC Software' on our web site.

Telephone with Visa, Mastercard or Switch, or send cheque/PO for immediate despatch. All prices include VAT if applicable.

Web site:- www.brunningsoftware.co.uk

NEW 32 bit PC Assembler

Experimenting with PC Computers with its kit is the easiest way ever to learn assembly language programming. If you have enough intelligence to understand the English language and you can operate a PC computer then you have all the necessary background knowledge. Flashing LEDs, digital to analogue converters, simple oscilloscope, charging curves, temperature graphs and audio digitising.

Kit now supplied with our 32 bit assembler with 84 page supplement detailing the new features and including 7 experiments PC to PIC communication. Flashing LEDs, writing to LCD and two way data using 3 wires from PC's parallel port to PIC16F84.

- Book + made up kit 1a + software..... £73.50
 - Book + unmade kit 1u + software..... £66.50
- (PP UK £4, Europe £10, Rest of world £14)

C & C++ for the PC

Experimenting with C & C++ Programmes teaches us to programme by using C to drive the simple hardware circuits built using the materials supplied in the kit. The circuits build up to a storage oscilloscope using relatively simple C techniques to construct a programme that is by no means simple. When approached in this way C is only marginally more difficult than BASIC and infinitely more powerful. C programmers are always in demand. Ideal for absolute beginners and experienced programmers.

- Book + made up kit 2a + software £57.50
 - Book + unmade kit 2u + software £51.50
 - Book + top up kit 2t + software £37.98
- (PP UK £4, Europe £10, Rest of world £14)

The Kits

The assembler and C & C++ kits contain the prototyping board, lead assemblies, components and programming software to do all the experiments. The 'made up' kits are supplied ready to start. The 'top up' kit is for readers who have already purchased kit 1a or 1u.

Assembler and C & C++

Click on 'Special Offers' on our website for details of how to save by buying a combined kit for assembler and C & C++.

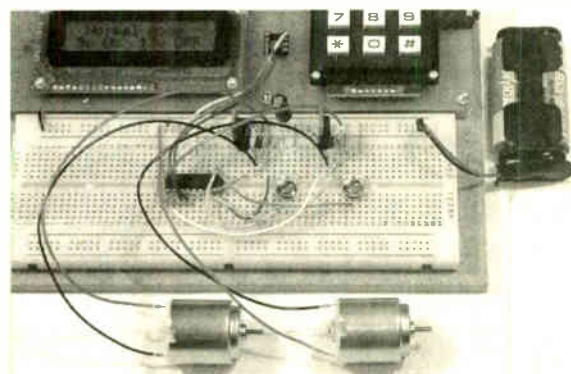

Experimenting with the PIC16F877

The second PIC book starts with the simplest of experiments to give us a basic understanding of the PIC16F877 family. Then we look at the 16 bit timer, efficient storage and display of text messages, simple frequency counter, use a keypad for numbers, letters and security codes, and examine the 10 bit A/D converter.

The 2nd edition has two new chapters. The PIC16F627 is introduced as a low cost PIC16F84. We use the PIC16F627 as a step up switching regulator, and to control the speed of a DC motor with maximum torque still available. Then we study how to use a PIC to switch mains power using an optoisolated triac driving a high current triac.

Mail order address:

Brunning Software 138 The Street, Little Clacton, Clacton-on-sea, Essex, CO16 9LS. Tel 01255 862308

PRACTICAL RADIO CIRCUITS

RAYMOND HAIGH



Part 4: Tuning systems, coils and coil packs for general coverage and the amateur bands.

Circuits for the set builder and experimenter

IN Part Three the basic requirements of a regenerative receiver for serious listening on the long, medium and shortwave bands were listed and a simple but effective practical circuit described.

This month, we explore the merits of tuning systems and give details of add-on coil packs to extend the coverage of last month's High Performance Regenerative Radio into the amateur bands.

TUNING SYSTEMS

Ease of tuning is crucial in a receiver to be used for searching for weak signals. Large movements of the control knob should produce only a small change in frequency and the drive must be free from backlash. For these requirements to be met components must be of good quality and set construction rigid and strong.

The Regenerative Radio design described last month incorporated the simplest possible tuning arrangements. Alternative and more refined systems will now be described.

VARIABLE CAPACITORS

Charles S. Franklin, an engineer who spent most of his career in the service of Marconi, invented the variable capacitor in 1902. Receivers began to have more than

one tuned circuit, and Franklin introduced capacitor ganging in 1907.

Air-spaced variables with ceramic insulation are the components of choice for traditional tuning systems. They are more stable and have a higher Q factor (the greater the Q the more selective the tuning circuit) than solid dielectric capacitors. Unfortunately, the increasing use of electronic tuning is making them something of an expensive rarity.

A selection of the kind of air-spaced units still manufactured in the UK and the USA is shown in the photographs. Values range from 5pF to 365pF or more; and one, two, and three-gang versions can be obtained – at a price!

Variable capacitors with a polythene dielectric are the standard tuning component in inexpensive domestic receivers. They were discussed and illustrated in Part One. The solid dielectric results in smaller size and makes them less prone to microphony (electro-mechanical feedback via the capacitor vanes). Minimum capacitance is lower (5pF instead of 10pF per gang).

Because of their low cost, ready availability and versatility, polyvaricons have been chosen for the receivers described in this series of articles. Constructors wishing to get the most out of these comparatively

simple circuits should substitute air-spaced variables. Remember that moving vanes are connected to the "ground" or 0V rail: fixed vanes are connected to the "hot" end of the tuning coil.

CAPACITOR SWING

The Q of a tuned circuit reduces as tuning capacitance increases. With regenerative receivers, positive feedback must, therefore, be gradually increased in order to keep the receiver in a sensitive condition. Setting up the circuit to ensure sufficient feedback at maximum capacitance can make regeneration fierce when the tuning capacitor is turned low, and smooth control can only be secured over a limited capacitor swing.

For long and medium wave coils, the maximum capacitance should be no greater than 400pF. On the highest shortwave range (up to 30MHz), smooth regeneration will be difficult to achieve if the maximum capacitance exceeds 100pF, and a 50pF component is to be preferred.

A reasonable compromise for general coverage regenerative receivers spanning 150kHz to 30MHz is a 200pF tuning capacitor, and provision for reducing the swing to around 100pF on the highest frequency shortwave range is most desirable. Receivers covering the narrow amateur bands are best tuned with a 25pF variable capacitor.

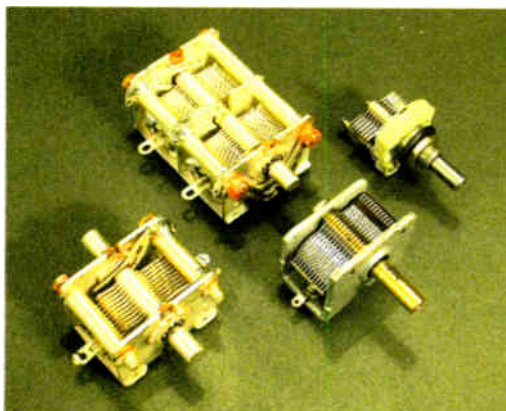

Group of air-spaced variable capacitors.



Slow-motion drives.



Spindle couplers.



Tuning "drums", spindle, springs and cord.

SWING LOW

Fixed capacitors can be connected in series with tuning capacitors in order to reduce their swing. This technique, adopted in the circuits illustrated in Fig.4.3 and Fig.4.4, eases regeneration problems and reduces the tuning rate.

A 1000pF fixed capacitor will reduce the swing of a 260pF variable to 206pF. A 470pF fixed capacitor will reduce the swing of a 365pF variable to 205pF.

Always use polystyrene or low K ceramic components for this purpose. Medium and high K ceramic capacitors (usually values above 200pF or so) have a lower Q factor and this will impair the efficiency of the circuit.

TUNING RATE

The sought after standard when communications receivers were tuned by variable capacitors was a frequency change of 5kHz for each full turn of the tuning control. This was seldom achieved with basic superhet designs, especially on the high frequency bands.

Tuning has to be set to within 25Hz or so of the signal frequency in order to clarify a single-sideband transmission. Doing this at 28MHz calls for a very slow tuning rate and a receiver of robust and rigid construction.

The tuning rate can be reduced by mechanical or electrical means, or a combination of both. The first method involves gears, pulleys or epicyclic ball drives: the second a low value fine tuning or vernier capacitor wired in parallel with

the main tuning component.

Both methods have the same drawback: an arrangement which produces an acceptable tuning rate at 2MHz is still much too fast at 20MHz. (Constant tuning rates can only be achieved with superhets of complex design; e.g., sets with tunable intermediate frequency (i.f.) amplifiers or synthesized oscillators).

The only mechanical reduction system currently available to home constructors is the epicyclic ball drive. A pointer mounting flange is sometimes fitted and the drives usually offer a 6:1 reduction. They can be coupled in tandem to give ratios of 36:1 and, if three are used, almost 220:1. Standard and miniature versions are depicted in the photographs.

A drum or large pulley driven by a cord wrapped around a 6mm (1/4in.) spindle forms an effective slow motion drive, and the component parts are shown in the photographs. The cord is secured to the drum and tensioned by a spring. Although still fitted in most capacitor-tuned portable radios, the parts are no longer retailed.

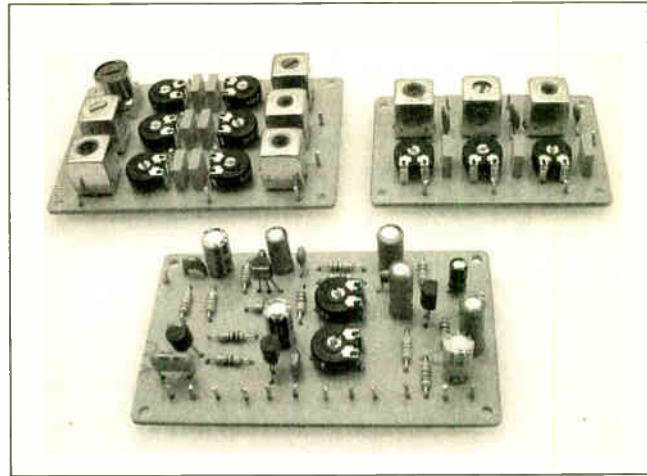

General Coverage and Amateur Bands coil pack p.c.b.s together with the Regen. Radio board (last month).

Some constructors will, however, be able to salvage them from discarded receivers, and the drums will usually fit directly onto the stubby spindles of polyvaricon capacitors. Combining a large (say 100mm or 4in.) drum with an epicyclic drive gives a worthwhile reduction of around 120:1.

A fine tuning, or vernier, capacitor value of 10pF is a good compromise for a general coverage receiver. The main tuning component is called the Bandset, and the fine tuner the Bandsread, control. If both are fitted with 6:1 reduction drives the arrangement represents a very acceptable tuning system for simple receivers.

VARICAP TUNER

Easy-tune using a varicap diode

Electronic tuning systems exploit the way the capacitance across a semiconductor diode junction can be varied by applying a reverse bias. Special diodes, known as "varicaps" or "varactors", with swings of up to 500pF, are produced for this purpose.

Capacitance change is reasonably linear over the mid-range of reverse bias. At low bias levels, when capacitance is approaching maximum, the tuning rate is higher. At high bias levels the rate of change is much lower.

Varicaps are comparatively inexpensive and very convenient to use. The potentiometer Tuning control can be mounted remotely from the diode and this greatly simplifies receiver layout. Bandspreading involves no more than the addition of a second potentiometer.

DRAWBACKS

There are disadvantages. They have a comparatively low Q, especially when the capacitance is approaching maximum.

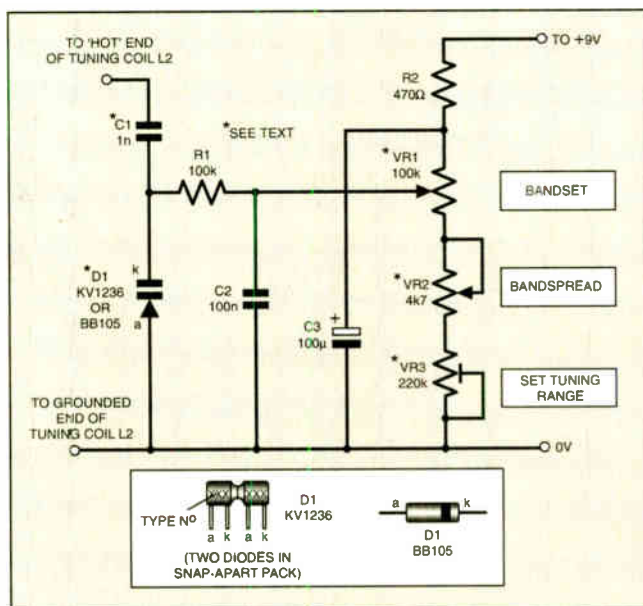
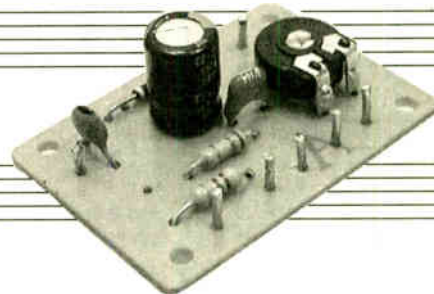

Fig.4.1. Circuit diagram for a simple Varicap Tuner. For Bandset and Bandsread tuning, use half of a twin KV1236 varicap. For Bandsread tuning only, use a BB105 varicap diode and a 22pF capacitor for C1. Also, omit VR2 and connect VR1 to VR3.



Moreover, high value types have a high minimum capacitance, and thermal drift can be greater than with conventional variable capacitors. The drawbacks become more evident when high capacitance diodes are used above 10MHz or so, but low capacitance types are satisfactory for fine tuning throughout the shortwave spectrum.

VARICAP TUNER

A typical Varicap Tuner circuit is given in Fig.4.1, where D1 is the varicap diode and VR1 the potentiometer (Bandset) that sets the reverse bias. Signal frequencies are isolated from the bias network by resistor R1 (the diode passes no current so the resistor does not reduce the voltage). Capacitor C2 eliminates potentiometer noise and C1 prevents the bias being shorted to the 0V rail through the tuning coil.

Potentiometer VR2 produces a small change in the bias and acts as a fine tuning or Bandsread control. Potentiometer VR3

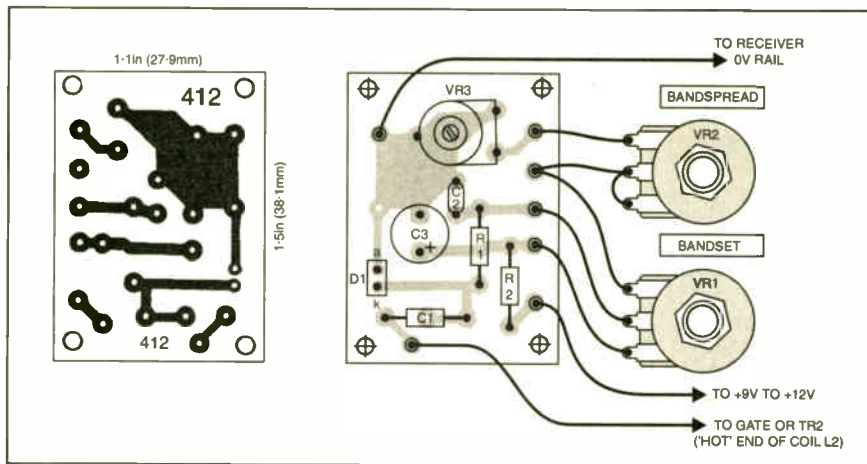

Fig.4.2. Printed circuit board component layout, wiring details and full-size underside copper foil master for the Varicap Tuner. Clockwise rotation of the pots. reduces the capacitance and increases frequency. The lead-off wires go to last month's Regenerative Radio.

determines the minimum bias voltage thereby fixing the varicap's swing.

In mains powered equipment, the bias supply must be well smoothed and regulated. With battery equipment, regulation is still essential if the tuning potentiometer has a calibrated dial. If the varicap acts only as a low value fine tuning capacitor, regulation, although still desirable, can be dispensed with, but supply-line fluctuations must not be imposed by other circuits (e.g., audio power amplifiers).

CONSTRUCTION

The "electronic tuning" Varicap Tuner is assembled on a small printed circuit board that must be mounted close (within 50mm or 2in.) to the coil or coils and wavechange



switch. Tuning potentiometers can be located in any convenient position.

Details of the printed circuit board (p.c.b.) topside component layout, full-size copper foil master and the off-board wiring details are shown in Fig.4.2. This board is available from the EPE PCB Service, code 412. Full tuning and just vernier tuning alternatives were given earlier. General guidance on construction is given later.

COMPONENTS

VARICAP TUNER

Resistors

R1 100k
R2 470Ω
All 0.25W 5% carbon film

See
SHOP
TALK
page

Potentiometers

VR1 100k rotary carbon, lin.
VR2 4k7 rotary carbon, lin. (see text)
VR3 220k enclosed carbon preset

Capacitors

C1 1n polyester or polystyrene (full tuning) or 22p ceramic "low k" (bandspread only) – see text

Semiconductors

D1 KV1236 varicap diode (full tuning) or BB105 varicap diode (bandspread only) – see text

Miscellaneous

Printed circuit board available from the EPE PCB Service, code 412 (Varicap); multistrand connecting wire; insulated p.c.b. mounting stand-off pillar (4 off); solder pins; solder etc.

Approx. Cost
Guidance Only

£9
excl.

GENERAL COVERAGE AND AMATEUR BANDS RECEIVERS

Upgrading the Regen. Radio (Part 3) to receive LW, MW, SW or Amateur Bands signals

It is our understanding that the only commercial coils available to home constructors in the UK are those produced by the Japanese manufacturer Toko. These miniature coils, with their ferrite cup or slug tuned cores and bright plated brass cans, are ubiquitous.

Any reader who has removed the back of a transistor radio will have seen them or an imitation. The adjustable cores permit wide variation of the inductance.

GENERAL COVERAGE RECEIVER

The circuit diagram for a switched coil-pack, General Coverage Receiver incorporating Toko inductors is shown in Fig.4.3. Coils L2a to L2f are tuned by the Bandset or Tune capacitor VC1, formed by connecting both a.m. gangs of a polyvaricon (polythene dielectric capacitor) in

parallel. The tuning sweep being reduced to around 200pF by series capacitor C19.

Fine or Bandspread tuning is carried out with VC2, one of the f.m. gangs of a second polyvaricon. The swing of this component is reduced to around 10pF by capacitor C20.

Readers using the receiver primarily for long and medium wave listening should delete capacitor C20 and leave VC2 at its full value. Where shortwave coverage is the area of interest, readers may prefer to reduce capacitor C20 to, say, 6.8pF in order to produce a slower tuning rate.

The inductors (L2a to L2f) are switched by S2a, and the TR2 source bias presets (VR2a to VR2f) by S2b. The circuit details around TR2 were given last month, see Fig.3.4.

Connections to the coil windings vary in order to increase inductance and/or to

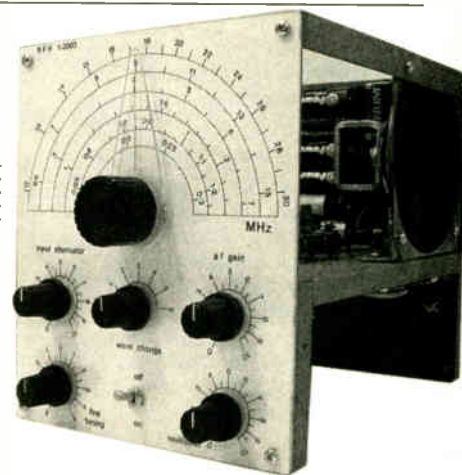

General Coverage Receiver.

improve the feedback tapping ratio. Details of the base connections are also given so that constructors wishing to use the coils individually, without the switching, can easily do so.

AMATEUR BANDS

Amateur transmissions occupy narrow segments of the high frequency spectrum and the actual band allocations are listed in Table 4.1. Speech signals are in a mode known as single-sideband (s.s.b.), and tun-

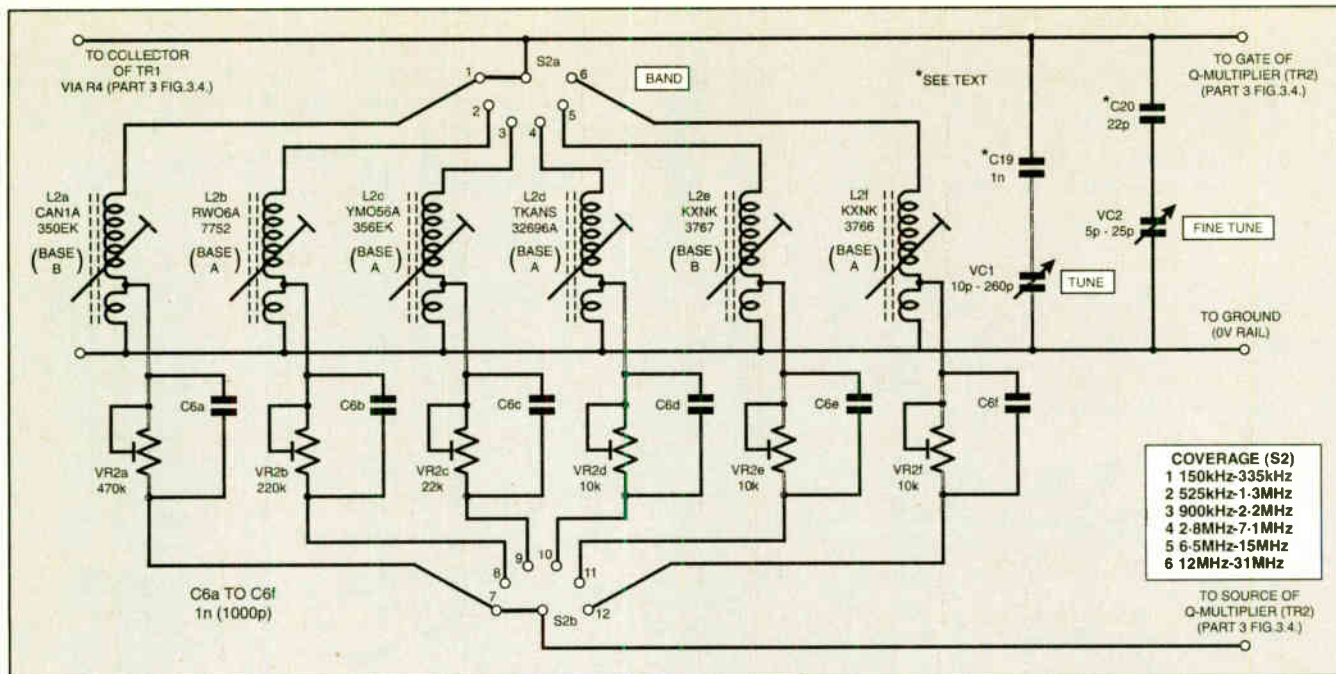

Fig.4.3. Coil pack circuit diagram for providing a switched 6-band General Coverage version of last month's Regen. Radio (see Fig.3.4). Maximum capacitance for VC1 (Tune) is set to 200pF approx. by series capacitor C19 and for VC2 (Fine) to 10pF approx. by C20.

Table 4.1: Amateur Band Allocations and Marker Frequencies

Band Metres	Frequency Allocation MHz	Marker Frequency MHz	Crystal Harmonic
80	3.5 to 4 (3.5 to 3.8 in UK)	3.58	Fundamental
40	7 to 7.3 (7 to 7.1 in UK)	7.16	Second
30	10.1 to 10.15	10.74	Third
20	14 to 14.35	14.32	Fourth
15	21 to 21.45	21.48	Sixth
12	24.89 to 24.99	25.06	Seventh
10	28 to 29.7	28.64	Eighth

The crystal frequency has been rounded up to 3.58MHz.

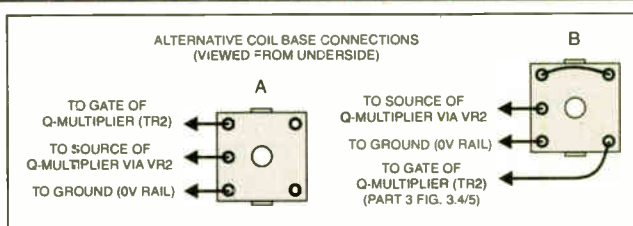
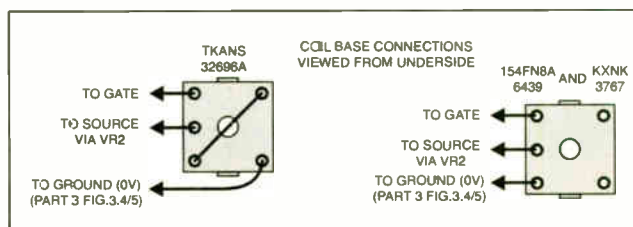

Fig.4.3a (above) and Fig.4.4a (below). Base connections for those wishing to "plug-in" individual coils, without any switching, into the General Coverage and Amateur Bands receivers.



ing has to be very precise to make them intelligible. Because of the narrow bands and need for critical tuning, improved results will be obtained with the coil and capacitor combinations illustrated in Fig.4.4.

The circuit arrangement shown covers the three most popular allocations: 80, 40, and 20 metre bands. Coils L2a, L2b and L2c are switched by S2a, and brought to resonance within the band by fixed capacitors C19, C20 and C21.

Tuning is by one of the 5pF to 25pF f.m. gangs of a polyvaricon. Even this swing is excessive for the 40m and 20m bands and switch S2c connects series capacitors C22 and C23 into circuit in order to reduce it.

Source bias presets VR2a to VR2c, together with their bypass capacitors C6a to C6c, are switched by S2b. Again, coil base connections are given for readers who wish to use crocodile clips to connect coils into circuit. (The coil can/screen must be securely held in place or vibrations will affect tuning).

COIL PACK CONSTRUCTION

Coils, presets and capacitors are assembled on printed circuit boards. These boards

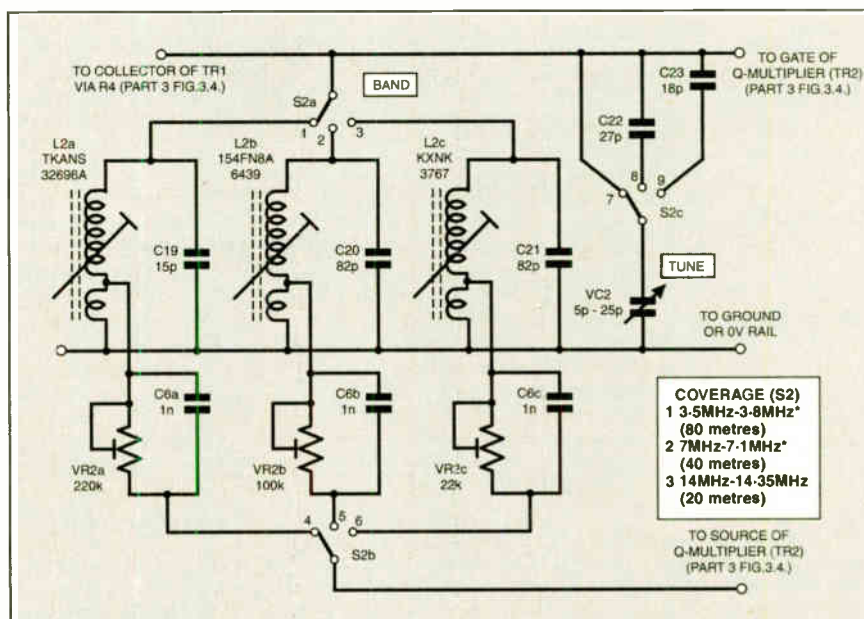
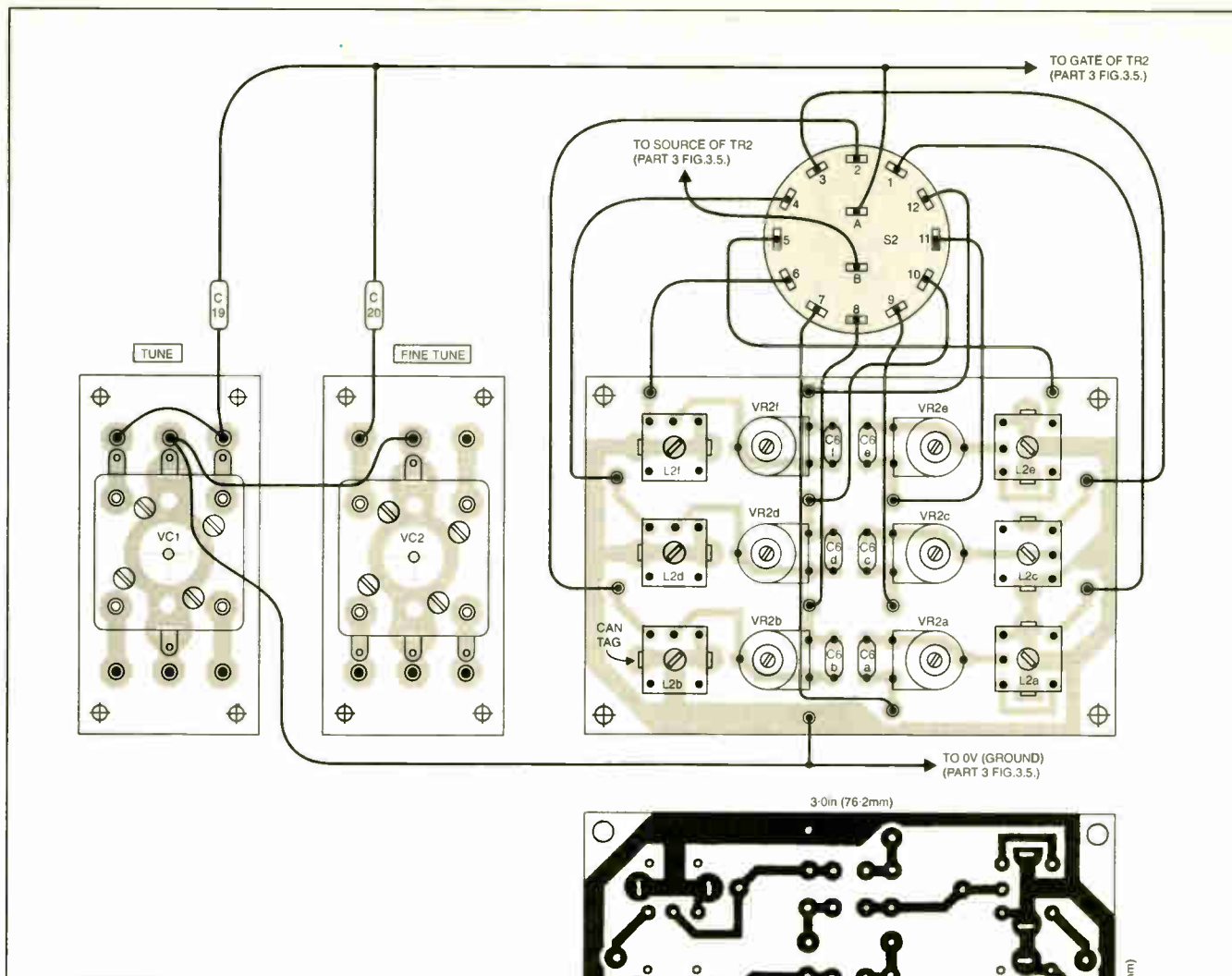

Fig.4.4. Circuit diagram for a 3-band Amateur Band version of last month's Regen. Radio (see Fig.3.4). Bands shown with an asterisk (*) are wider in the USA: 3.5MHz-4MHz and 7MHz-7.3MHz. The coil and capacitor combinations will give full USA coverage.



COMPONENTS

GENERAL COVERAGE REC. (Coil Pack)

Potentiometers

VR2a	470k enclosed carbon preset
VR2b	220k enclosed carbon preset
VR2c	22k enclosed carbon preset
VR2d to VR2f	10k enclosed carbon preset (3 off)

Capacitors

C6a to C6f	1n polycarbonate (6 off)
C19	1n polystyrene
C20	22p polystyrene or ceramic "low k"
VC1	10p to 260p polythene dielectric variable capacitor (see text)
VC2	5p to 25p polythene dielectric variable capacitor (see text)

Miscellaneous

L2a	CAN1A350EK Toko screened (metal can) coil
L2b	RWO6A7752 Toko screened (metal can) coil
L2c	YMOS6A356EK Toko screened coil
L2d	TKANS32696A Toko screened coil
L2e	KXNK3767 Toko screened coil
L2f	KXNK3766 Toko screened coil
S2	2-pole 6-way rotary switch

Printed circuit boards available from the *EPE PCB Service*, code 413 (Coil Gen. Cover) and code 406 (T/Cap - two required); slow-motion drive (2 off); spindle extenders and/or couplers (see text); front panel card and protective 2mm thick Perspex sheet; p.c.b. stand-off pillars; connecting wire; solder pins; solder etc.

Note: Case is the Regenerative Radio in Part 3.

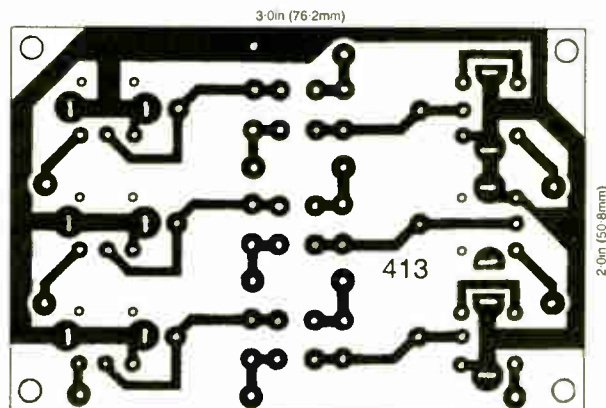

Fig. 4.5 General Coverage Receiver coil pack printed circuit board component layout, full-size underside copper foil master and interwiring details to band selection switch S2, two varicon (polythene) variable capacitor p.c.b.s and lead-off wires to last month's Regen. Radio (see Fig.3.5). Wiring to actual unit must be kept as short as possible and direct.

See
**SHOP
TALK**
page

HAND-WOUND COILS (General Coverage Rec.)

Potentiometers

VR2	100k enclosed carbon preset (4 off)
(Ranges 1 to 4)	
VR2 (Range 5)	22k enclosed carbon preset
VR2 (Range 6)	10k enclosed carbon preset

Capacitors

C6 (Ranges 1 to 6) 1n polyester (6 off)

Coils (see Table 4.2 and Fig.4.7)

Enamelled copper wire for coils, 50g (20z) reels, sizes: 36s.w.g. (32a.w.g.), 32s.w.g. (30a.w.g.), 24s.w.g. (23a.w.g.), 18s.w.g. (16a.w.g.); plastic tube, 20mm (3/4in.) outside diameter (o/d) for coil former; thin card for coil bobbins; adhesive; clear cellulose; nuts; bolts, washers and solder tags.

Approx. Cost
Guidance Only

£27

excl. slow-motion drives & case

available from the *EPE PCB Service*, codes 413 (Gen.) and 414 (Amateur).

Details of the component side of the general coverage coil pack board, full-size copper foil track master and the wiring to the wavechange switch and tuning capacitors are given in Fig.4.5.

The component side of the amateur bands board, p.c.b. foil master together with the wiring to the wavechange switch and tuning capacitor are shown in Fig.4.6. Swing reducing capacitors, C22 and C23, are mounted on the tags of switch S2c: provision is not made for these components on the printed circuit board.

Note that the wiring to the variable capacitor is correct for the component suggested in the Components List. Alternatives should have their values and connections checked.

Coil pack, capacitors and wavechange switch S2 must be mounted very close to one another and all wiring kept as short as possible and direct. These components must also be very close to the terminal pin side of the Regen. Radio printed circuit board. Lead lengths should certainly be no more than 75mm (3in.). Guidance notes on construction are given later.

HAND-WOUND COILS

With a little care and patience, efficient coils can be wound by hand on the plastic tubing manufactured for plumbing services and electrical conduits.

With the Regen. Radio circuit given in Part Three, the "feedback" tapping should be about 5% of the total number of turns for the longwave coil, and 10% of the total on all other ranges. The highest shortwave range; i.e., up to 30MHz, may require a

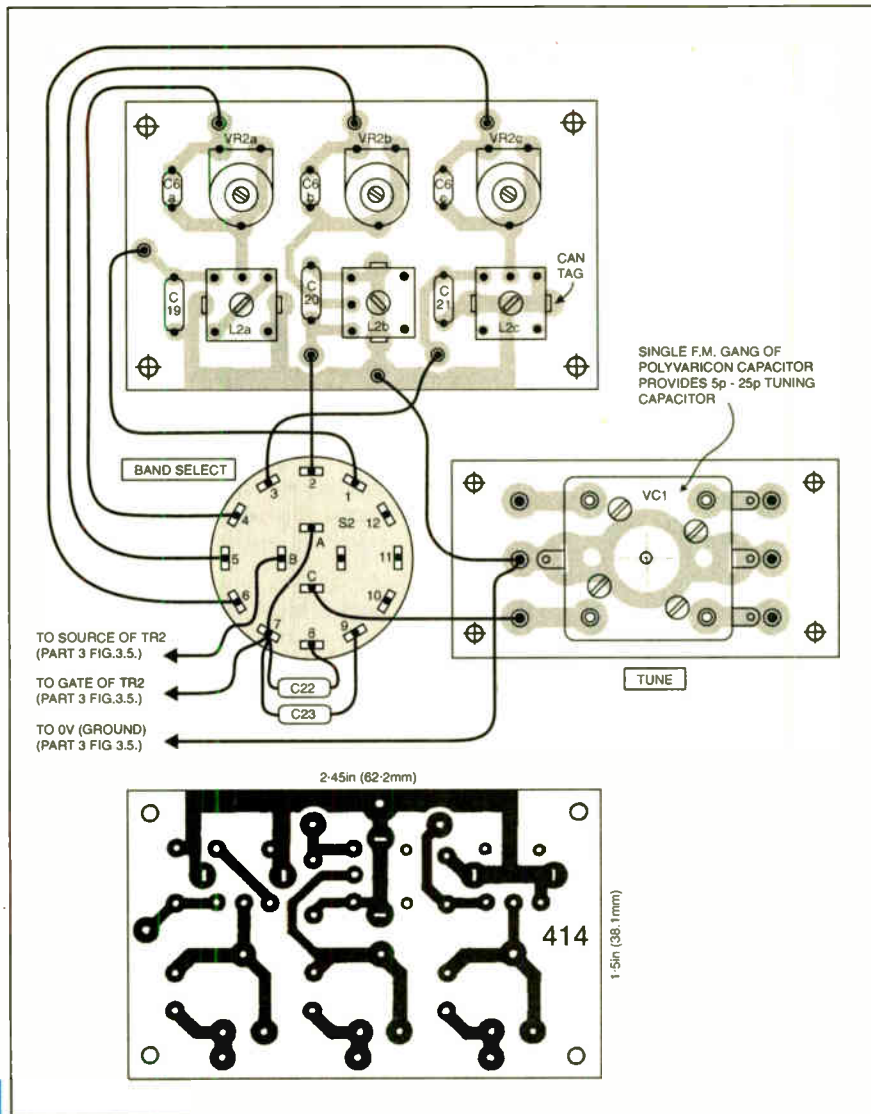
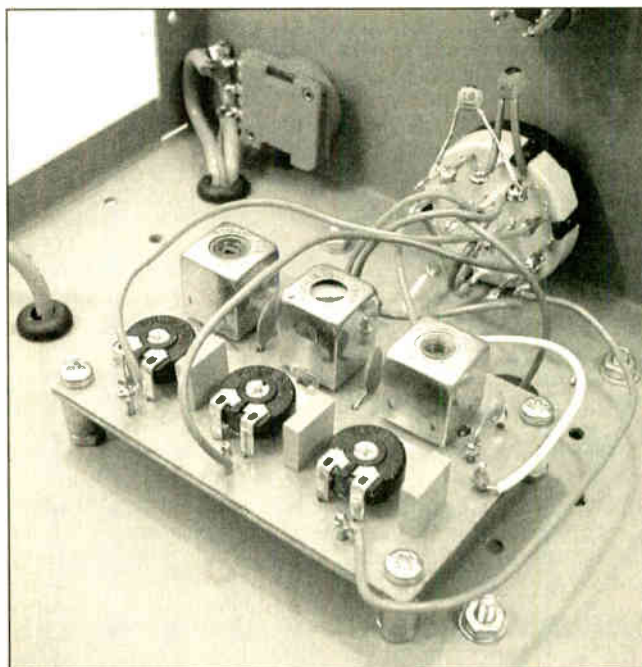

Fig.4.6. Amateur Bands coil pack printed circuit board component layout, full-size copper foil master and interwiring to range switch, tuning capacitor p.c.b. and lead-off wires to last month's Regen. Radio (see Fig.3.5). All wiring should be kept short and direct.



Completed Amateur Bands coil pack p.c.b. wired to the wavechange switch.

COMPONENTS

AMATEUR BANDS (Coil Pack)

Potentiometers

VR2a	220k enclosed carbon preset
VR2b	100k enclosed carbon preset
VR2c	22k enclosed carbon preset

Capacitors

C6a to C6c	1n polyester (3 off)
C19	15p polystyrene or ceramic "low k"
C20, C21	82p polystyrene or ceramic "low k" (2 off)
C22	27p polystyrene or ceramic "low k"
C23	18p polystyrene or ceramic "low k"
VC1	5p to 25p polythene dielectric variable capacitor (see text)

Miscellaneous

L2a	TKANS32696A Toko screened (metal can) coil
L2b	154FN8A6439 Toko screened (metal can) coil
L2c	KXNK3767 Toko screened (metal can) coil
S2	4-pole 3-way rotary switch

Printed circuit boards available from the *EPE PCB Service*, code 414 (Amateur) and code 406 (T/Cap); slow-motion drive (see text); spindle extender/coupler (see text); front panel card and protective 2mm thick Perspex sheet; p.c.b. stand-off pillars; connecting wire; solder pins; solder etc.

Note: Case is the Regenerative Radio in Part 3.

Approx. Cost
Guidance Only

£15

excl. slow-motion drive & case

See
**SHOP
TALK**
page

15% tapping if the value of the tuning capacitor exceeds 100pF.

Winding details for a range of coils for a general coverage receiver are given in Table 4.2. The specified coverage is based on a tuning capacitor with minimum capacitance of 10pF and a swing of 200pF; i.e. both gangs of a polyvaricon with the swing limited by C19. (On the highest shortwave range, just one gang should be switched into circuit to give a swing of around 115pF.)

The higher inductance long and medium wave coils must be sectionalized to reduce self-capacitance and maintain an acceptable tuning range. This is done by winding the coils in a series of "pies" (the traditional term) or piles, held in place by card bobbins. Full details are given in Fig.4.7.

Thin card (postcard) glued with Durofix, or a similar quick setting adhesive, is ideal for the coil bobbins. It is a good idea to dip the bobbins in cellulose paint, in order to stiffen them, allowing the paint to harden before sliding them onto the plastic tubing.

CLOSE CALL

When producing close-wound coils (turns touching), wind the turns on tightly and slightly spaced, and keep pushing them together with the thumb of the hand holding and rotating the former, as the winding proceeds. For space-wound coils, just concentrate on winding on the correct number of turns as tightly as possible, then carefully even out the spacing with the tip of a screwdriver (avoid damaging the enamel coating) when the ends of the coil have been anchored.

A coat of clear cellulose can be applied to hold the turns in place. Coils wound on bobbins can be protected by strips of masking or insulating tape but they must not be impregnated.

Solder tags are a convenient means of anchoring the ends of the windings. Wire gauges are not especially critical, but thicker material may not be accommodated in the bobbins or on the formers.

COIL CHANGING

The coils can be connected into circuit by short (no more than 75mm or 3in.) flying leads terminated with miniature crocodile clips. Source bias preset VR2 and capacitor C6 can be mounted on solder tags at the end of the coil former (see Fig.3.6, last month) when this connection method is adopted.

If hand-wound coils are arranged in a coil pack with wavechange switching, provision must be made to short out the coil next higher in inductance to the one in use. If this is not done it will be tuned by its self-capacitance to resonate within the tuning range of the coil in circuit and draw energy from it. This will cause a regeneration dead-spot.

Switches can be obtained which short all unused windings. They are much to be preferred for packs of *unscreened* coils.

Screening afforded by the metal cans and cup cores makes shorting arrangements unnecessary with Toko coils.

CALIBRATION

An accurately calibrated dial adds greatly to the enjoyment of using a receiver and the following guidance is offered to readers who do not have access to a signal

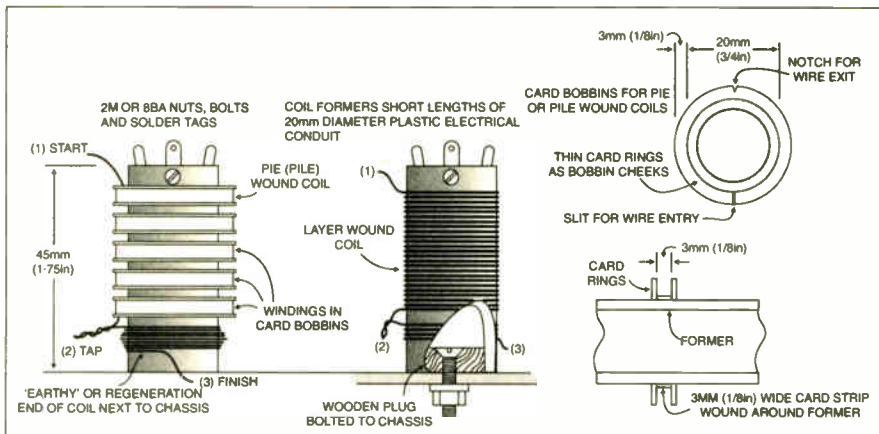

- 1 - START of winding (to TR2 gate of Q-multiplier, see Fig.3.5 Part 3)
- 2 - TAPPING (to TR2 source of Q-multiplier, see Fig.3.5 Part 3)
- 3 - FINISH of winding (to 0V rail or ground, see Fig.3.5 Part 3)

Fig.4.7. Construction details for producing hand-wound coils for the General Coverage Receiver. see Table 4.2 for winding details and bands covered. A collection of completed hand-wound coils is shown below.

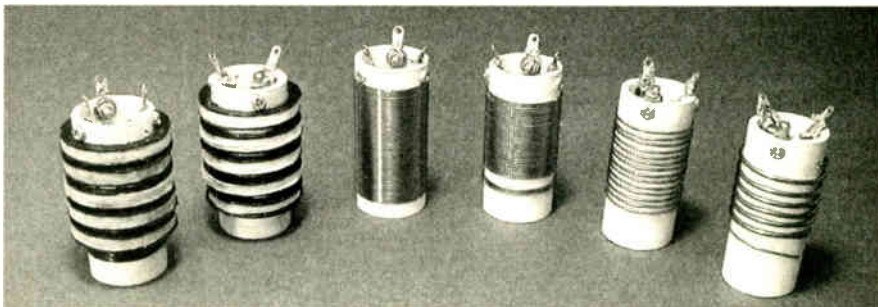

Table 4.2: Details of Hand-Wound Coils

No. (S2)	Wave Band	Turns 1-2	Turns 2-3	S.W.G.	A.W.G.	Type of Winding	Range	VR2
1	LW	600	20	36	32	5 bobbins of 120 plus pile of 20	141kHz-345kHz	100k
2	MW1	160	16	32	30	4 bobbins of 40 plus bobbin of 16	520kHz-1.28MHz	100k
3	MW2	100	10	32	30	Close wound	1MHz-2.6MHz	100k
4	SW1	35	3	24	23	Close wound	2.6MHz-6.7MHz	100k
5	SW2	12	2	24	23	Spaced	6.4MHz-16.8MHz	22k
6	SW3	6	1	18	16	Spaced	13.5MHz-33.8MHz	10k

NOTES:

- (1) Enamelled copper wire used throughout.
- (2) Tuning capacitor for Ranges 1 to 5: 10pF min. to 210pF max.
- (3) Tuning capacitor for Range 6: 5pF min. to 120pF max.
- (4) The Range 6 shortwave coil (SW3) has a separate 24s.w.g. feedback winding located at the "earthy" end of the tuned winding. Finish of both windings connected to the 0V rail and all turns wound in the same direction.

generator, crystal calibrator or frequency counter.

On medium waves, careful listening, during daylight hours, aided by a copy of the local and regional transmitter schedules (e.g., the *Radio Times*), should enable stations and frequencies to be identified and the receiver dial calibrated.

This procedure would be impossibly tedious on shortwaves. Here the simplest calibration method is to keep the Regen. receiver's tuning in step with the tuning of another receiver with an accurate, preferably digital, dial.

If the calibrating receiver has a beat frequency oscillator (b.f.o.), switch it on and

place its aerial lead close to the regenerative receiver's p.c.b. Advance the regeneration control until the Q-multiplier is oscillating. When both sets are tuned to the same frequency the calibrating receiver will pick up the signal radiated by the Q-multiplier circuitry and reproduce it as a tone.

Adjust the regenerative receiver's tuning to make the tone lower in pitch until it is an almost inaudible fluttering. This is the zero beat position and the tuning of the two receivers is then very precisely matched. By setting the calibrating receiver to precise spot frequencies, the regenerative receiver's dial can be marked out.

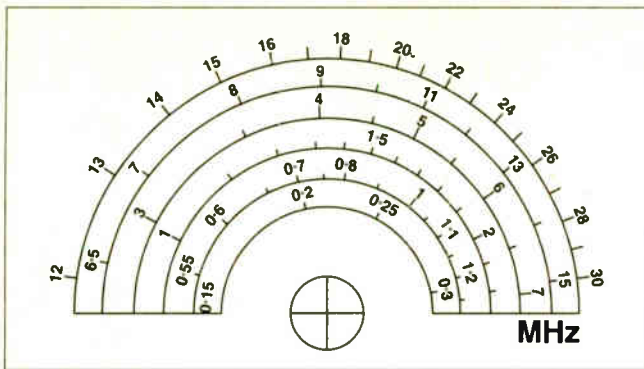

Fig.4.8. General Coverage Receiver dial, approx. half-size. Receivers will vary, but it gives a good idea of coverage to be expected.

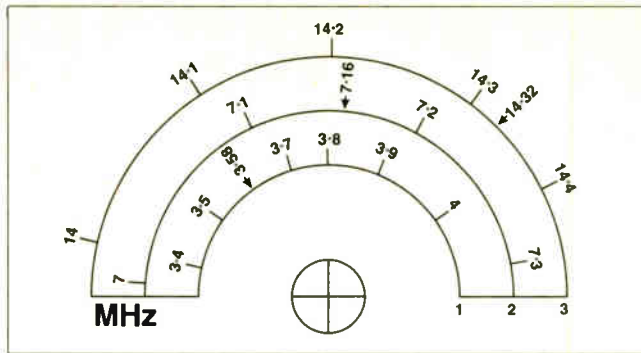

Fig.4.9. Calibrated dial (half-size approx.) for the Amateur Bands Receiver. Typical frequency "markers" are indicated by the arrowhead pointers.

CONSTRUCTION NOTES

Solder pins at the lead-out points ease the task of off-board wiring. They should be located in the printed circuit boards first. Follow these with the resistors; then the capacitors, smallest first; and, finally, the semiconductors.

Take care to insert the coils in the correct positions on the printed circuit board. Identification lettering on the cans is quickly erased by handling. Readers wishing to preserve it should apply a piece of clear sticky tape. Stressing the coil pins can result in open-circuit windings, and they should be treated with great care.

Some variable capacitors are secured by screws driven into their front plates. Check the length of the screws to ensure that they do not project too far and foul the capacitor vanes.

Wiring between the printed circuit boards making up the receivers should be short and direct. *The ground plane on the coil pack p.c.b.s must be connected directly to the ground or 0V pin on the Regenerative Radio board. The Regeneration control may function erratically if there is a separate return via the case metal chassis.*

FINAL CHECKS

On completion the printed circuit boards should be checked for poor soldered joints and bridged tracks. Check the orientation of semiconductors and electrolytic capacitors, the positioning of Toko coils, and the inter-board wiring.

The electronic tuning printed circuit board should be wired to the potentiometers, on the workbench, and tested before being mounted

in the receiver. Coil packs can be tested by applying flying leads, terminated with crocodile clips, to the receiver solder pins.

BOXING UP

Receiver printed circuit boards, wavechange switch and tuning capacitor must be assembled on or in an aluminium chassis or box. An aluminium front panel is most desirable.

The arrangement used for assessing the prototype circuits is shown in the various photographs and itemized in the Components List. Whilst it proved to be sufficiently rigid it should be regarded as no more than adequate: diecast boxes and air-spaced tuning capacitors are much to be preferred.

SETTING UP

Detailed guidance on setting up was given last month. Because of the General Coverage Receiver's tuning capacitor swing, presets VR3 and VR5 have to be turned close to minimum resistance in order to give Regeneration control VR4 a wide enough range of control.

On the highest shortwave range, bias preset, VR2, should be optimized at the frequency overlap point rather than at tuning capacitor maximum. Coil cores should be adjusted to give continuous coverage, but note the gaps between 335kHz and 525kHz, and 2.2MHz and 2.8MHz. A half-size (approx.) calibrated dial is shown in Fig.4.8.

Coil core adjustments with the Amateur Bands Receiver are very critical. The dial of the prototype receiver is reproduced, half-size (approx.), in Fig.4.9, and this should give some idea of the tuning capacitor position at the various marker frequencies.

With this version of the Regen. receiver, presets VR2a to VR2c should be adjusted so that the *Q*-multiplier begins to oscillate when Regeneration control VR4 just moves away from the zero position. Presets, VR3 and VR5, should be set as close to maximum resistance as possible.

PERFORMANCE

Correctly operated, the General Coverage Receiver is sensitive and selective. It is capable of receiving transmissions from all over the world.

The Regeneration control is completely free from backlash but, on the shortwave bands, when tuning capacitance is low, the transition into oscillation is very abrupt. (For the reasons given earlier, this is a common problem with regenerative receivers). Fitting a ten-turn potentiometer in the VR4

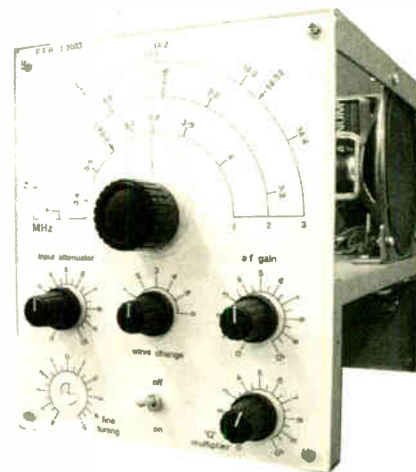

position will overcome this difficulty and make the control of regeneration extremely smooth.

Adjusting the input attenuator, VR1, changes, very slightly, the damping on the tuned circuit (L2/VC1). This potentiometer can, therefore, be used as an alternative means of gently controlling regeneration at the threshold on the higher shortwave bands.

The Amateur Bands receiver's low value tuning capacitor makes tuning much easier. Increasing the *Q*-multiplier's (TR2) drain voltage causes a slight reduction in its gate to source capacitance, thereby increasing the frequency of oscillation. Regeneration potentiometer, VR4, can, therefore, be used as a very fine tuning control, and single-sideband (s.s.b.) signals are easy to clarify. Breakthrough from powerful broadcast transmitters can usually be eliminated by turning down the input attenuator, VR1.

Amateur signals are very closely spaced and the selectivity of the receiver is inevitably inferior to that of a superhet with narrow i.f. filters. However, only the tuned signal is clarified and interfering stations on adjacent channels are high-pitched, unintelligible and not too distracting. Speech reproduction is clear and distinct.

Activity on the amateur bands, especially 20 metres, varies, and 80 metres can be noisy. Begin by listening on 80 and 40 metres on Sunday mornings.

Next month we embark on the construction of a Super Regeneration Receiver, claimed to be the most sensitive of single-device receiving systems, and a simple crystal calibration aid.

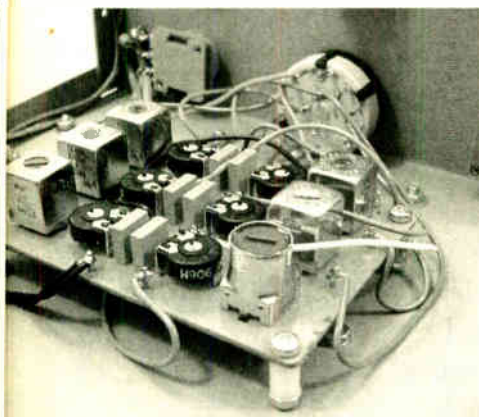

General Coverage coil pack p.c.b. wired to the wavechange switch.

PRACTICALLY SPEAKING

Robert Penfold looks at the Techniques of Actually Doing It!

THIS piece is being written on a baking hot day in July, but this issue of *EPE* will still be on the bookstalls as summer fades and we move into autumn. This is traditionally the time that electronic project builders dust off their soldering irons and start building again after a lull in activity during the summer.

It is also a time when many newcomers to the hobby start to think seriously about building their first project. One problem for those building their first project is that they will probably need to buy some new tools as well as the components for their first project.

It is understandable that most people starting a new hobby wish to keep the initial cost to a minimum. That way little is wasted if they decide that the hobby simply is not for them. It would be possible to spend hundreds or even thousands of pounds getting equipped with all sorts of tools and test equipment, but you can actually get started for quite a small outlay.

Rather than buying a variety of tools in case they are needed, it makes sense to buy things as and when you need them. This will avoid wasting money on likely looking tools that you never use in earnest.

Starters

It is tempting to dive straight in with a "mega" project, but it is more sensible to start with something that is reasonably simple and straightforward. Plenty of beginners' projects are published in *EPE*, so it should not be difficult to find something simple but useful to build as a first project. (*Better still – You could sign-up to take on the NEW Teach-In '04 series starting in the Nov '03 issue. Plenty of "beginners" projects will be covered. Ed.*)

It is probably best to avoid anything that is mechanically complex or awkward. Something more straightforward will enable you to concentrate on the electronics where there will be new skills to learn. It will also minimise expenditure on new tools.

Many of the tools used in electronic project construction are actually the type of thing that can be found in the toolbox of an average household. Things like pliers, a hacksaw or a junior hacksaw, a centre punch, a small hammer, a drill and some bits, and screwdrivers are commonly used in project construction. They are also the type of thing most budding project builders will already own.

The screwdrivers in many toolkits are large types, but miniature screwdrivers are

more useful in the current context (see Fig.1). Fortunately, small and medium size electrician's screwdrivers will cost very little. A couple of cross-point screwdrivers will be more than a little useful and should also cost little.

Getting Physical

The mechanical side of construction is often dominated by drilling holes, but it is not necessary to have the ultimate in power drills. Most project cases are made from aluminium or plastic, both of which are relatively soft. A good hand-drill is perfectly adequate for drilling these materials.

When using a power drill it should preferably be a type that has at least one slow speed. With soft materials the drilling process is usually more controllable if a slow speed is used.

It is not a good idea to use high drilling speeds with plastic cases. Some of these cases are quite brittle and the "bull in a china shop" approach risks cracking the case. Also, the heat generated tends to melt the plastic. This can give some very rough looking holes and the solidified plastic can occasionally be difficult to remove from the drill bit.

Large power drills can be a bit unwieldy when used for drilling small holes in soft materials. They are much easier to use for precision work when mounted in a stand.

A small cordless, low power, "mini" drill is the most suitable type of power drill. A drill of this type would struggle when drilling into masonry, but it is just about perfect for project building.

Drilling the larger holes into soft materials can be troublesome, with the drill bit corkscrewing into the case rather than producing a neat round hole. Experience has shown that a hand-drill or even a brace are the best tools for tackling this type of thing.

Normally it is advisable to buy the best quality tools that you can afford. The cheaper types are often short-lived and provide poor value for money in the longer term. The expense of top quality drill bits is probably not justified for project building, where the softness of the materials being worked means that cheaper drills will last a long time.

It is probably best to avoid ultra-cheap drill bits as many of these have a tendency to snap. A set of mid-priced drills should last years when used with plastics and aluminium.

Hole Truth

In the past it was possible to get by using a few drill bits, but things have changed over the years. Metrication introduced new sizes but did not immediately do away with the old ones. New ranges of small switches, potentiometers, etc., have been introduced, but the old sizes are still in use.

Also, there are simply more types of component available than there were previously. If you do not have a set of drill bits running from about 2mm to 10mm, it will have to be placed high on the tools shopping list.

For holes of more than about 10mm in diameter there are various options. The preferred choice used to be chassis punches, which produce wonderfully "clean" results. They tend to be quite expensive though, and are relatively difficult to obtain these days. Your local DIY superstore should have some inexpensive tools that will cut large holes in soft materials such as plastic or aluminium.

Probably the best low cost option is a needle file such as an "Abrafile". With one of these you drill a small starter hole and then use the file to cut along the outline of the required cut-out. This method is relatively slow, but it can handle cut-outs of any size or shape, and costs very little.

If you have one of the popular mini-drills plus a set of tools it is quite likely that there will be at least one tool that can be used to cut through soft materials such as aluminium and plastic. These work like a rotary version of a needle file and permit accurate results to be produced quite easily. There is usually a deburring tool that is useful for tidying holes where the drill has left rough edges.

Note, though, that the high speeds of these drills can give the melting problem when they are used with some plastics. The bit becomes coated with solidified plastic and becomes totally ineffective (see Fig.2). A similar problem can occur



Fig.1. The large screwdriver on the left is the type found in most toolkits. The three smaller screwdrivers are what you need for project building.

when using fretsaws and coping saws. A needle file is the best method with awkward plastics.

A Soft Touch

A set of needle files of various shapes is useful for tidying up holes and cut-outs, elongating small holes that just missed the target, and this sort of thing. Probably the most useful type of full-size file is the half round variety. The flat side is good for general filing work and the round side can be used to tidy large round cut-outs.

As one would probably expect, electricians pliers are the most useful for project building. Practically any type of pliers should do initially, but it is worthwhile investing in a good pair of electricians pliers before too long.

A small adjustable spanner is also useful, but when project building it is best not to tighten everything as hard as you can. The screw threads are often made from relatively soft metals or even from plastics. Tighten things firmly, but particularly when using a spanner do not use brute force.

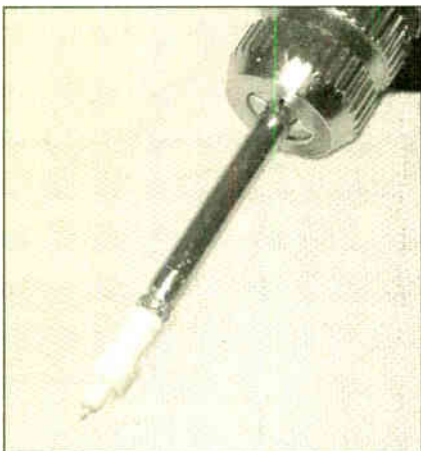

Fig.2. High drill speeds and most plastics do not go well together.

Hot Stuff

Most of the tools mentioned so far are the type of thing that you may already have, but the soldering equipment does not really fall into this category. A small electric soldering iron is included with some of the household toolkits that are available from the DIY stores, but many of these irons are a bit large for modern electronic work.

Also, they often lack the quality needed for regular electronic work. They are only designed to handle the odd electrical soldering job here and there.

It is advisable to buy a good quality electric soldering iron at the outset. Soldering can be a bit tricky initially, but it will be much easier if you use the right tools and equipment. A good basic iron does not actually cost very much these days and should last many years even with heavy use.

There is no need to bother with expensive temperature controlled irons. An iron having a rating of about 15 to 25 watts is ideal for project construction. The excellent Antex irons are the most widely available and their model CS 18-watt iron is well suited to project work.

A soldering iron stand is an extra that is certainly not optional. It provides somewhere safe to keep the iron between soldering operations, and it also helps to prevent the iron from getting excessively hot during longer lulls in soldering activity. A matching stand for your selected soldering iron should cost no more than a few pounds, so it is not worthwhile compromising safety and performance by improvising something.



Soldering On

It is advisable to always have a good supply of electrical solder in the toolkit. Running out of solder just as a project nears completion is extremely frustrating, especially if the shops have just shut. Initially a small reel will do, but it is advisable to buy a large (500g) reel before too long. Apart from not having to worry about running out of solder at an inopportune time, in the long term a large reel should be much cheaper.

The type to use for electronic work is a 60 percent tin and 40 percent lead solder containing a non-corrosive flux, or a lead-free equivalent if you are prepared to pay extra for "greener" solder. Most component catalogues offer solder in two thicknesses. The thinner (22s.w.g.) type is the best one to use for circuit boards and most other joints. It can be useful to have a small amount of the thicker (18s.w.g.) type for larger joints such as the connections to large switches and transformers. The thicker solder is not essential though and it is probably not worthwhile buying any at first.

It is possible to obtain soldering kits that contain an electric iron, a matching stand, some solder, and an instruction booklet that includes useful soldering hints. These offer good value for money and are ideal for beginners.

Cut Above

Do not be tempted to save money by using scissors or a penknife to cut and strip insulated wires. This is definitely a false economy since improvised methods will provide poor results. Even small scissors are far too large and clumsy to be used effectively as wire cutters when building circuit boards.

Cutting wire will seriously damage the blades of knives and scissors, and

there is a strong risk of cutting yourself. Improvised methods of stripping insulation usually nick the wire which seriously weakens it.

A pair of combination wire cutters and strippers is the cheapest solution, and should cost just a few pounds. For wire stripping these actually work better than many of the fancy tools designed specifically for stripping wires. Provided they are adjusted correctly the insulation will be stripped away without damaging the wires at all.

In due course it would be advisable to buy a pair of wire cutters of the "side cutter" variety. These usually give greater precision than combination cutters and strippers, and should work well for many years.

Useful Additions

There are various other tools that can be very useful. Electronic components seem to get smaller and

smaller, making many of them difficult to pick up. A pair of tweezers should provide a solution if you have difficulty picking up pieces of wire, resistors, and other small components.

Some sort of vice is extremely useful when trimming spindles to length and for similar tasks. A small "hobby" vice is adequate for this sort of thing. A desoldering tool is useful for removing components fitted in error, clearing the solder from bad joints so that a new joint can be made, and for cleaning away excess solder on circuit boards. A desolder pump is the best low cost option.

A printed circuit work frame is very helpful when making circuit boards. All the components are fitted to the board and then clamped in place by the frame while they are soldered to the copper pads. These frames are quite expensive but are worthwhile if, as is very likely, you end up building lots of projects.

In the meantime, it is worth buying some Bostik Blu-Tack, which is very useful for holding components in position while they are soldered in place. In fact it is useful for securing all sorts of things that have a tendency to "walk" while you are trying to work on them.

Summing-Up

Electronics has been accused of being an expensive hobby, but it would be possible to buy all the necessary components and tools and still build a beginners project for about 50 pounds or so. At a guess, most people could build their first project for no more than half that by, as far as possible, utilizing the tools they already own.

It is doubtful if there are many other hobbies where it is possible to get started for such a modest outlay.

SURFING THE INTERNET

NET WORK

ALAN WINSTANLEY

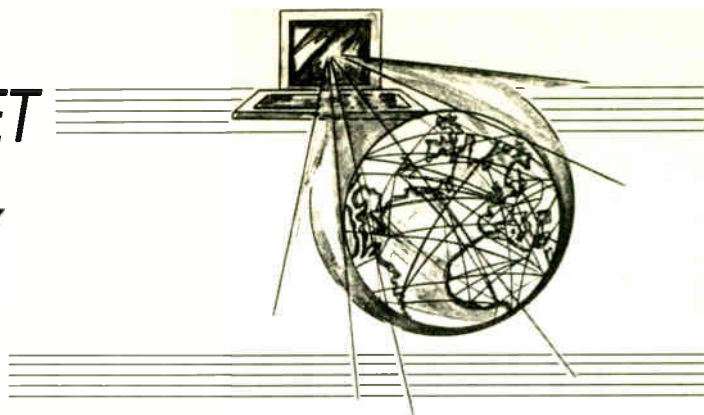

Shock Course

ATTENDING a recent web design course, the writer found himself grappling with an appealing Apple computer instead of his more mundane PC that he keeps tethered to a phone socket. The Apple was an enlightening experience, but what came as a serious shock was the rapidity with which web sites loaded into the Apple's web browser. Of course, it was because the Apple was hooked into the college network: no waiting for dialup access here!

As a regular dialup user, after a couple of days I came away from the course shocked at what I was missing. Web pages that take half a minute to load were there instantly. There was much sympathy from other delegates who could never imagine life without having always-on, high speed broadband Internet at their disposal.

For regular users it is now a source of immense frustration to be stuck with narrowband dialup Internet access. If you are anything like the writer, you live and work in a broadband blackspot and you are probably heartily sick of the advertising that offers broadband at under £20 per month (www.tiscali.co.uk), which rubs salt into one's wounds. Imagine making a call on a cellphone, and waiting one minute just for a dial tone: after that, you can only talk at one-tenth of your normal speed because that's all the technology will allow. Such is today's 56K dialup experience.

A year ago I wrote about BT's rollout of broadband ADSL, and also complained about the ludicrous lottery of "trigger levels" that had been introduced. BT's business model is nothing if not hard-nosed as usual, and it appears to put profits (theirs) first before the needs of the nation. Broadband is rapidly becoming an essential tool, but the way in which BT as well as cable companies are delivering it is becoming a complete travesty.

Long before affordable broadband ever arrives in non-urban regions, many areas will find themselves half a decade behind the rest of the country in terms of Internet connectivity. BT's press releases about "how they could cover 90% of the country subject to demand" are particularly galling at this time.

Surf or Crawl?

The lack of broadband access is starting to have a profound effect on small businesses as well as the ordinary home user. Whether at work or at home, one's time is irreplaceable and it is now incredibly wasteful to have to wait for a dialup connection, and then to communicate, undertake research or do any number of tasks on the Internet using 56K dialup.

If a small company or consultant charges just £30 per hour then the lack of always-on broadband is typically costing them £1,500 per year in time wasted just in dialling up. If they spend just one hour a working day on the Internet (e.g. surfing or handling email), then that is another £7,500 per year of labour spent struggling to achieve just 10% of the efficiency that could be obtained using broadband instead.

There are plenty of ways in which a broadband enabled society can immediately benefit. Imagine how the UK farming community might have coped better with the catastrophic foot and mouth epidemic (caused by imported infected meat), if there had been a far greater exchange of high quality information constantly available online and accessible by all through a computer. Even shopping for groceries: the Tesco Online delivery van is often seen delivering groceries to neighbours who shop online: far more efficient than driving to a Tesco supermarket and wasting hours shopping.

Perversely, those who would benefit the most from broadband Internet access – i.e. those in non-urban areas who face chronic travel and transport problems – are cruelly starved of the right to enjoy always-on high speed access. But even town dwellers with larger telephone exchanges face the same deep frustrations, caused

by the haphazard way in which broadband has been rolled out by British Telecom and cable companies in recent years.

For many of us without broadband access, what is happening now is that the whole Internet scene is turning into an unrewarding and pretty boring chore, a grind that is filled with the frustrations of slow speed, delays, waiting for downloads, thumb-twiddling and timeouts. Web sites are skipped over because banner ads slow the initial download to a crawl.

Paradoxically, many ordinary users can't see any of the huge benefits that broadband would bring, and don't know that there is indeed a better way, so their expectations of service remain quite low. Thus, the demand by mainstream users for broadband is slowly being strangled at birth. In turn, "lack of demand" is a major excuse given by BT for not ADSL-enabling more telephone exchanges.

A Hard Sell

Who better to stimulate demand, and also do a good job selling on behalf of BT at the same time, than to enlist a local Internet enthusiast or group who realises broadband's benefits and is eager to "sell" the idea to others in their region? Then they can "get the numbers up". BT now actively offers help to groups who want to campaign for broadband in their community. Since broadband can be considered proportionately more critical to smaller communities, village groups etc. as well as rural businesses, it would be good to see some sort of acknowledgement of the urgent needs of non-urban users, businesses and groups, but BT merely presents a black and white case based on trigger levels, which in turn relate to how feasible (costly) it would be for BT to ADSL-enable an exchange.

In fact, BT recently released a raft of new trigger levels; one local village in the writer's vicinity has a figure of 400, which is virtually unattainable, yet another nearby town has hit an altogether lower target and will receive ADSL. There are huge anomalies with BT's registration scheme when a village requires an impossible 400, a nearby small town requires an insurmountable 500, but a larger town 20 miles away only needs 250 registrations before BT will install ADSL.

As reported by BT, only 11 per cent of market towns and 6 per cent of rural villages enjoy broadband services, compared to 90 per cent of urban centres and 52 per cent of suburban areas. By the time you read this, BT will have launched ADSL Exchange Activate – described as "a solution for very small local exchanges where there is specific demand and a sponsor body interested in bringing broadband to the area for developmental, commercial or social reasons."

Meantime, newly launched BT Midband is a less than inspirational ISDN-based temporary solution but it costs £35 per month and offers no more than 150 hours a month at 64K or 75 hours at 128K. You do gain the ability to use an analogue phone at the same time (as you would, with ISDN) but, true to form, BT ties you into a 12 month contract. Midband is up to eight times slower than 512K ADSL but nearly twice the price.

BT's programme of ADSL delivery has, however, left an enormous vacuum, one waiting to be filled by suppliers of alternative technologies. Imagine an Internet company that deliberately avoids towns or cities, and whose sworn policy is to give priority to rural-based users instead, without the need for telephone lines or close proximity to a telephone exchange. The speed is also typically five to ten times faster than 512K ADSL. The answer lies in 802.11g wireless broadband (wideband).

Next month I will outline some of the very latest offerings becoming available to those disenchanting users who are no longer prepared to wait for BT. You can email comments to alan@epemag.demon.co.uk.

PCB SERVICE

Printed circuit boards for most recent *EPE* constructional projects are available from the PCB Service, see list. These are fabricated in glass fibre, and are fully drilled and roller tinned. All prices include VAT and postage and packing. Add £1 per board for airmail outside of Europe. Remittances should be sent to **The PCB Service, Everyday Practical Electronics, Wimborne Publishing Ltd., 408 Wimborne Road East, Ferndown, Dorset BH22 9ND. Tel: 01202 873872; Fax 01202 874562; Email: orders@epemag.wimborne.co.uk. On-line Shop: www.epemag.wimborne.co.uk/shopdoor.htm.** Cheques should be crossed and made payable to *Everyday Practical Electronics* (Payment in £ sterling only).

NOTE: While 95% of our boards are held in stock and are dispatched within seven days of receipt of order, please allow a maximum of 28 days for delivery – overseas readers allow extra if ordered by surface mail. Back numbers or photostats of articles are available if required – see the Back Issues page for details. We do not supply kits or components for our projects.

Please check price and availability in the latest issue. A number of older boards are listed on our website.

Boards can only be supplied on a payment with order basis.

PROJECT TITLE	Order Code	Cost
L.E.D. Super Torches – Red Main	SEPT '01 313	} Set £6.10
– Display Red	314	
– White L.E.D.	315	
★ Water Monitor	317	
Camcorder Power Supply	OCT '01 318	£5.94
PIC Toolkit Mk3	319	£8.24
Perpetual Projects Uniboard-4. Gate Sentinel, Solar-powered Bird Scarer and Solar-Powered Register	305	£3.00
Teach-In 2002 Power Supply	NOV '01 320	£4.28
Lights Needed Alert	321	£5.39
Pitch Switch	322	£5.87
★ PIC Toolkit TK3 – Software only	–	–
4-Channel Twinkling Lights	DEC '01 325	£6.82
Ghost Buster – Mic	326	} Set £5.78
– Main	327	
★ PIC Polywhatsit – Digital	328	
– Analogue	329	} Set £7.61
Forever Flasher	JAN '02 330	
Time Delay Touch Switch	331	£4.60
★ PIC Magick Musick	332	£5.87
Versatile Bench Power Supply	333	£5.71
★ PIC Spectrum Analyser	FEB '02 334	£7.13
Versatile Current Monitor	335	£4.75
Guitar Practice Amp	336	£5.39
★ PIC Virus Zapper	MAR '02 337	£4.75
RH Meter	338	£4.28
★ PIC Mini-Enigma – Software only	–	–
★ Programming PIC Interrupts – Software only	–	–
★ PIC Controlled Intruder Alarm	APR '02 339	£6.50
★ PIC Big Digit Display	MAY '02 341	£6.02
Washing Ready Indicator	342	£4.75
Audio Circuits-1 – LM386N-1	343	£4.28
– TDA7052	344	£4.12
– TBA820M	345	£4.44
– LM380N	346	£4.44
– TDA2003	347	£4.60
– Twin TDA2003	348	£4.75
World Lamp	JUNE '02 340	£5.71
Simple Audio Circuits-2 – Low, Med and High Input Impedance Preamplifiers (Single Trans.)	349	£4.60
Low-Noise Preamplifier (Dual Trans.)	350	£4.75
Tone Control	351	£4.60
Bandpass Filter	352	£4.75
Frequency Standard Generator – Receiver	353	£4.12
– Digital	354	£6.82
★ Biopic Heartbeat Monitor	355	£5.71
Simple Audio Circuits – 3	JULY '02 356	£4.60
– Dual Output Power Supply	357	£4.44
– Crossover/Audio Filter	358	£4.91
Infra-Red Autoswitch	359	£6.50
★ EPE StyloPIC	360	£5.39
Rotary Combination Lock – Main Board	361	£4.91
– Interface Board	–	–
★ Using the PIC's PCLATH Command – Software only	–	–
Big-Ears Buggy	AUG '02 362	£5.71
★ PIC World Clock	363	£5.39
Simple Audio Circuits-4 – Low Freq. Oscillator	364	£4.44
– Resonance Detector	365	£4.28
Vinyl-To-CD Preamplifier	SEPT '02 366	£5.71
★ Freebird Glider Control	367	£4.91
★ Morse Code Reader	368	£5.23
Headset Communicator	OCT '02 369	£4.75
EPE Bounty Treasure Hunter	370	£4.77
★ Digital I.C. Tester	371	£7.14
★ PIC-Pocket Battleships – Software only	–	–
Transient Tracker	NOV '02 372	£4.75
★ PICAXE Projects-1: Egg Timer; Dice Machine; Quiz Game Monitor (Multiboard)	373	£3.00
★ Tuning Fork & Metronome	374	£5.39
★ ★ EPE Hybrid Computer – Main Board	375	£18.87
– Atom Board	376	£11.57
★ PICAXE Projects-2: Temperature Sensor; Voltage Sensor; VU Indicator (Multiboard)	DEC '02 373	£3.00
★ Versatile PIC Flasher	377	£5.07

PROJECT TITLE	Order Code	Cost
★ PICAXE Projects-3: Chaser Lights	JAN '03 373	£3.00
– 6-Channel Mains Interface	381	£5.08
EPE Minder – Transmitter	378	£4.75
– Receiver	379	£5.39
★ Wind Speed Monitor	380	£5.08
Tesla Transformer	FEB '03 382	£5.07
★ Brain bot Buggy	383	£3.00
★ Wind Tunnel	384	£6.02
200kHz Function Generator	MAR '03 385	£6.34
Wind-Up Torch Mk II	386	£4.75
★ Driver Alert	387	£6.35
★ Earth Resistivity Logger	APR '03 388	£6.02
★ Intelligent Garden Lights Controller	389	£3.96
★ PIC Tutorial V2 – Software only	–	–
Door Chime	MAY '03 390	£5.07
Super Motion Sensor	391	£5.55
Radio Circuits-1 MK484 TRF Receiver	JUNE '03 392	£4.44
Headphone Amp	393	£4.28
★ Fido Pedometer	394	£4.91
★ PICronos L.E.D. Wall Clock	395	£14.65
EPE Mini Metal Detector	JULY '03 396	£4.28
Radio Circuits – 2 Q-Multiplier	397	£4.28
MW Reflex Radio	398	£4.60
Wave Trap	399	£4.28
Speaker Amplifier	400	£4.44
Ohmmeter Adaptor MkII	401	£4.60
Ultimate Egg Timer (Top Tenner)	403	£4.91
★ EPE PIC Met Office	AUG '03 402	£10.46
Alarm System Fault Finder	404	£4.44
Radio Circuits-3 Regen. Radio	405	£5.07
Tuning Capacitor Board	406	£4.28
Master/Slave Intercom (Top Tenner)	407	£4.75
Two-Up (Top Tenner)	408	£4.91
Priority Referee (Top Tenner)	SEPT '03 410	£5.07
Vibration Alarm (Top Tenner)	411	£5.39
Radio Circuits-4 Varicap Tuner	412	£4.44
Coil Pack – General Coverage	413	£5.07
Coil Pack – Amateur Bands	414	£4.75
★ PIC-A-Colour – Software only	–	–

EPE SOFTWARE

Software programs for *EPE* projects marked with a single asterisk ★ are available on 3.5 inch PC-compatible disks or free from our Internet site. The following disks are available: **PIC Tutorial V2** (Apr-June '03); **EPE Disk 1** (Apr '95-Dec '98); **EPE Disk 2** (1999); **EPE Disk 3** (2000); **EPE Disk 4** (2001); **EPE Disk 5** (2002); **EPE Disk 6** (Jan 2003 issue to current cover date – excl. Earth Resistivity); **EPE Earth Resistivity Logger** (Apr-May '03); **EPE PIC Met Office** (Aug-Sept '03); **EPE Teach-In 2000**; **EPE Spectrum**; **EPE Interface Disk 1** (October '00 issue to current cover date). ★ ★ The software for these projects is on its own CD-ROM. The 3.5 inch disks are £3.00 each (UK), the CD-ROMs are £6.95 (UK). Add 50p each for overseas surface mail, and £1 each for airmail. All are available from the *EPE PCB Service*. All files can be downloaded free from our Internet FTP site, accessible via our home page at: www.epemag.wimborne.co.uk.

EPE PRINTED CIRCUIT BOARD SERVICE

Order Code	Project	Quantity	Price
Name			
Address			
Tel. No.			
I enclose payment of £..... (cheque/PO in £ sterling only) to:			
   			
Everyday Practical Electronics MasterCard, Amex, Diners Club, Visa or Switch			
Card No.			
Card Exp. Date Switch Issue No			
Card Security Code			
(The last 3 digits on or just under the signature strip)			
Signature			
NOTE: You can also order p.c.b.s by phone, Fax, Email or via our Internet site on a secure server: http://www.epemag.wimborne.co.uk/shopdoor.htm			

DIRECT BOOK SERVICE

NOTE: ALL PRICES INCLUDE UK POSTAGE

FREE *Electronics Hobbyist Compendium* book with Teach-In 2000 CD-ROM



EPE TEACH-IN 2000 CD-ROM

The whole of the 12-part *Teach-In 2000* series by John Becker (published in *EPE* Nov '99 to Oct 2000) is now available on CD-ROM. Plus the *Teach-In 2000* interactive software covering all aspects of the series and Alan Winstanley's *Basic Soldering Guide* (including illustrations and Desoldering).

Teach-In 2000 covers all the basic principles of electronics from Ohm's Law to Displays, including Op.Amps, Logic Gates etc. Each part has its own section on the interactive software where you can also change component values in the various on-screen demonstration circuits.

The series gives a hands-on approach to electronics with numerous breadboard circuits to try out, plus a simple computer interface which allows a PC to be used as a basic oscilloscope.

ONLY **£12.45** including VAT and p&p

Order code Teach-In CD-ROM

Circuits and Design

Practical Remote Control Projects

Owen Bishop

Provides a wealth of circuits and circuit modules for use in remote control systems of all kinds; ultrasonic, infra-red, optical fibre, cable and radio. There are instructions for building fourteen novel and practical remote control projects. But this is not all, as each of these projects provides a model for building dozens of other related circuits by simply modifying parts of the design slightly to suit your own requirements. This book tells you how.

Also included are techniques for connecting a PC to a remote control system, the use of a microcontroller in remote control, as exemplified by the BASIC Stamp, and the application of ready-made type-approved 418MHz radio transmitter and receiver modules to remote control systems.

160 pages

Temporarily out of print

Discovering Electronic Clocks

W. D. Phillips

This is a whole book about designing and making electronic clocks. You start by connecting HIGH and LOW logic signals to logic gates. You find out about and then build and test bistables, crystal-controlled astables, counters, decoders and displays. All of these subsystems are carefully explained, with practical work supported by easy to follow prototype board layouts.

Full constructional details, including circuit diagrams and a printed circuit board pattern, are given for a digital electronic clock. The circuit for the First Clock is modified and developed to produce additional designs which include a Big Digit Clock, Binary Clock, Linear Clock, Andrew's Clock (with a semi-analogue display), and a Circles Clock. All of these designs are unusual and distinctive.

This is an ideal resource for project work in GCSE *Design and Technology: Electronics Product*, and for

project work in AS-Level and A-Level *Electronics and Technology*.

194 pages, A4 spiral bound Order code DEP1 £17.50

Domestic Security Systems

A. L. Brown

This book shows you how, with common sense and basic do-it-yourself skills, you can protect your home. It also gives tips and ideas which will help you to maintain and improve your home security, even if you already have an alarm. Every circuit in this book is clearly described and illustrated, and contains components that are easy to source. Advice and guidance are based on the real experience of the author who is an alarm installer, and the designs themselves have been rigorously put to use on some of the most crime-ridden streets in the world.

The designs include all elements, including sensors, detectors, alarms, controls, lights, video and door entry systems. Chapters cover installation, testing, maintenance and upgrading.

192 pages

Temporarily out of print

Microcontroller Cookbook

Mike James

The practical solutions to real problems shown in this cookbook provide the basis to make PIC and 8051 devices really work. Capabilities of the variants are examined, and ways to enhance these are shown. A survey of common interface devices, and a description of programming models, lead on to a section on development techniques. The cookbook offers an introduction that will allow any user, novice or experienced, to make the most of microcontrollers.

240 pages

Order code NE26

£21.99

A Beginner's Guide to TTL Digital ICs

R. A. Penfold

This book first covers the basics of simple logic circuits in general, and then progresses to specific TTL logic integrated circuits. The devices covered include gates, oscillators, timers, flip/flops, dividers, and decoder circuits. Some practical circuits are used to illustrate the use of TTL devices in the "real world".

142 pages

Order code BP332

£5.45

Practical Electronics Calculations and Formulae

F. A. Wilson, C.G.J.A., C.Eng., F.I.E.E., F.I.E.R.E., F.B.I.M.

Bridges the gap between complicated technical theory, and "cut-and-try" methods which may bring success in design but leave the experimenter unfulfilled. A strong practical bias - tedious and higher mathematics have been avoided where possible and many tables have been included.

The book is divided into six basic sections: Units and Constants, Direct-Current Circuits, Passive Components, Alternating-Current Circuits, Networks and Theorems, Measurements.

256 pages

Order code BP53

£5.49

Computing & Robotics

Windows XP Explained

N. Kantaris and P. R. M. Oliver

If you want to know what to do next when confronted with Microsoft's Windows XP screen, then this book is for you. It applies to both the Professional and Home editions.

The book was written with the non-expert, busy person in mind. It explains what hardware requirements you need in order to run Windows XP successfully, and gives an overview of the Windows XP environment.

The book explains: How to manipulate Windows, and how to use the Control Panel to add or change your printer, and control your display; How to control information using WordPad, Notepad and Paint, and how to use the Clipboard facility to transfer information between Windows applications; How to be in control of your filing system using Windows Explorer and My Computer; How to control printers, fonts, characters, multimedia and images, and how to add hardware and software to your system; How to configure your system to communicate with the outside world, and use Outlook Express for all your email requirements; How to use the Windows Media Player 8 to play your CDs, burn CDs with your favourite tracks, use the Radio Tuner, transfer your videos to your PC, and how to use the Sound Recorder and Movie Maker; How to use the System Tools to restore your system to a previously working state, using Microsoft's Website to update your Windows set-up, how to clean up, defragment and scan your hard disk, and how to backup and restore your data; How to successfully transfer text from those old but cherished MS-DOS programs.

268 pages

Order code BP514

£7.99

Introducing Robotics with LEGO Mindstorms

Robert Penfold

Shows the reader how to build a variety of increasingly sophisticated computer controlled robots using the brilliant Lego Mindstorms Robotic Invention System (RIS). Initially covers fundamental building techniques and mechanics needed to construct strong and efficient robots using the various "click-together" components supplied in the basic RIS kit. Explains in simple terms how the "brain" of the robot may be programmed on screen using a PC and "zapped" to the robot over an infra-red link. Also, shows how a more sophisticated Windows programming language such as Visual BASIC may be used to control the robots.

Detailed building and programming instructions provided, including numerous step-by-step photographs.

288 pages - large format

Order code BP901

£14.99

More Advanced Robotics with LEGO Mindstorms - Robert Penfold

Covers the Vision Command System

Shows the reader how to extend the capabilities of the brilliant Lego Mindstorms Robotic Invention System (RIS) by using Lego's own accessories and some simple home constructed units. You will be able to build robots that can provide you with 'waiter service' when you clap your hands, perform tricks, 'see' and avoid objects by using 'bats radar', or accurately follow a line marked on

the floor. Learn to use additional types of sensors including rotation, light, temperature, sound and ultrasonic and also explore the possibilities provided by using an additional (third) motor. For the less experienced, RCX code programs accompany most of the featured robots. However, the more adventurous reader is also shown how to write programs using Microsoft's VisualBASIC running with the ActiveX control (Spirit.OCX) that is provided with the RIS kit.

Detailed building instructions are provided for the featured robots, including numerous step-by-step photographs. The designs include rover vehicles, a virtual pet, a robot arm, an 'intelligent' sweet dispenser and a colour conscious robot that will try to grab objects of a specific colour.

298 pages

Order code BP902

£14.99

PIC Your Personal Introductory Course

SECOND EDITION John Morton

Discover the potential of the PIC microcontroller through graded projects - this book could revolutionise your electronics construction work!

A uniquely concise and practical guide to getting up and running with the PIC Microcontroller. The PIC is one of the most popular of the microcontrollers that are transforming electronic project work and product design.

Assuming no prior knowledge of microcontrollers and introducing the PICs capabilities through simple projects, this book is ideal for use in schools and colleges. It is the ideal introduction for students, teachers, technicians and electronics enthusiasts. The step-by-step explanations make it ideal for self-study too: this is not a reference book - you start work with the PIC straight away.

The revised second edition covers the popular reprogrammable EEPROM PICs: P16C84/16F84 as well as the P54 and P71 families.

270 pages

Order code NE36

£13.99

Introduction to Microprocessors

John Crisp

If you are, or soon will be, involved in the use of microprocessors, this practical introduction is essential reading. This book provides a thoroughly readable introduction to microprocessors, assuming no previous knowledge of the subject, nor a technical or mathematical background. It is suitable for students, technicians, engineers and hobbyists, and covers the full range of modern microprocessors.

After a thorough introduction to the subject, ideas are developed progressively in a well-structured format. All technical terms are carefully introduced and subjects which have proved difficult, for example 2's complement, are clearly explained. John Crisp covers the complete range of microprocessors from the popular 4-bit and 8-bit designs to today's super-fast 32-bit and 64-bit versions that power PCs and engine management systems etc.

222 pages

Order code NE31

£18.99

The books listed have been selected by *Everyday Practical Electronics* editorial staff as being of special interest to everyone involved in electronics and computing. They are supplied by mail order direct to your door. Full ordering details are given on the last book page.

FOR A FURTHER SELECTION OF BOOKS SEE THE NEXT TWO ISSUES OF *EPE*

All prices include UK postage

Theory and Reference

ELECTRONICS MADE SIMPLE

Ian Sinclair
Assuming no prior knowledge, *Electronics Made Simple* presents an outline of modern electronics with an emphasis on understanding how systems work rather than on details of circuit diagrams and calculations. It is ideal for students on a range of courses in electronics, including GCSE, C&G and GNVO, and for students of other subjects who will be using electronic instruments and methods.

Contents: waves and pulses, passive components, active components and ICs, linear circuits, block and circuit diagrams, how radio works, disc and tape recording, elements of TV and radar, digital signals, gating and logic circuits, counting and correcting, microprocessors, calculators and computers, miscellaneous systems.

199 pages **Order code NE23** £13.99

SCROGGIE'S FOUNDATIONS OF WIRELESS AND ELECTRONICS - ELEVENTH EDITION

S. W. Amos and Roger Amos
Scroggie's Foundations is a classic text for anyone working with electronics, who needs to know the art and craft of the subject. It covers both the theory and practical aspects of a huge range of topics from valve and tube technology, and the application of cathode ray tubes to radar, to digital tape systems and optical recording techniques.

Since *Foundations of Wireless* was first published over 60 years ago, it has helped many thousands of readers to become familiar with the principles of radio and electronics. The original author Sowerby was succeeded by Scroggie in the 1940s, whose name became synonymous with this classic primer for practitioners and students alike. Stan Amos, one of the fathers of modern electronics and the author of many well-known books in the area, took over the revision of this book in the 1980s and it is he, with his son, who have produced this latest version.

400 pages **Order code NE27** £21.99

GETTING THE MOST FROM YOUR MULTIMETER

R. A. Penfold
This book is primarily aimed at beginners and those of limited experience of electronics. Chapter 1 covers the basics of analogue and digital multimeters, discussing the relative merits and the limitations of the two types. In Chapter 2 various methods of component checking are described, including tests for transistors, thyristors, resistors, capacitors and diodes. Circuit testing is covered in Chapter 3, with subjects such as voltage, current and continuity checks being discussed.

In the main little or no previous knowledge or experience is assumed. Using these simple component and circuit testing techniques the reader should be able to confidently tackle servicing of most electronic projects.

96 pages **Temporarily out of print**

PRACTICAL ELECTRONIC FILTERS

Owen Bishop
This book deals with the subject in a non-mathematical way. It reviews the main types of filter, explaining in simple terms how each type works and how it is used.

The book also presents a dozen filter-based projects with applications in and around the home or in the constructor's workshop. These include a number of audio projects such as a rhythm sequencer and a multi-voiced electronic organ.

Concluding the book is a practical step-by-step guide to designing simple filters for a wide range of purposes, with circuit diagrams and worked examples.

188 pages **Order code BP299** £5.49

PREAMPLIFIER AND FILTER CIRCUITS

R. A. Penfold
This book provides circuits and background information for a range of preamplifiers, plus tone controls, filters, mixers, etc. The use of modern low noise operational amplifiers and a specialist high performance audio preamplifier i.c. results in circuits that have excellent performance, but which are still quite simple. All the circuits featured can be built at quite low cost (just a few pounds in most cases). The preamplifier circuits featured include: Microphone preamplifiers (low impedance, high impedance, and crystal). Magnetic cartridge pick-up preamplifiers with R.I.A.A. equalisation. Crystal/ceramic pick-up preamplifier. Guitar pick-up preamplifier. Tape head preamplifier (for use with compact cassette systems).

Other circuits include: Audio limiter to prevent overloading of power amplifiers. Passive tone controls. Active tone controls. PA filters (highpass and lowpass) Scratch and rumble filters. Loudness filter. Mixers. Volume and balance controls.

92 pages **Order code BP309** £4.49

Project Building

ELECTRONIC PROJECTS FOR EXPERIMENTERS

R. A. Penfold
Many electronic hobbyists who have been pursuing their hobby for a number of years seem to suffer from the dreaded "seen it all before" syndrome. This book is fairly and squarely aimed at sufferers of this complaint, plus any other electronics enthusiasts who yearn to try something a bit different.

The subjects covered include:- Magnetic field detector, Basic Hall effect compass, Hall effect audio isolator, Voice scrambler/descrambler, Bat detector, Bat style echo location, Noise cancelling, LED stroboscope. Infra-red "torch", Electronic breeze detector, Class D power amplifier, Strain gauge amplifier, Super hearing aid.

138 pages **Order code BP371** £5.45

PRACTICAL FIBRE-OPTIC PROJECTS

R. A. Penfold
While fibre-optic cables may have potential advantages over ordinary electric cables, for the electronics enthusiast it is probably their novelty value that makes them worthy of exploration. Fibre-optic cables provide an innovative interesting alternative to electric cables, but in most cases they also represent a practical approach to the problem. This book provides a number of tried and tested circuits for projects that utilize fibre-optic cables.

The projects include:- Simple audio links, F.M. audio link, P.W.M. audio links, Simple d.c. links, P.W.M. d.c. link, P.W.M. motor speed control, RS232C data links, MIDI link, Loop alarms, R.P.M. meter.

All the components used in these designs are readily available, none of them require the constructor to take out a second mortgage.

132 pages **Order code BP374** £5.45

ELECTRONIC MUSIC AND MIDI PROJECTS

R. A. Penfold
Whether you wish to save money, boldly go where no musician has gone before, rekindle the pioneering spirit,

or simply have fun building some electronic music gadgets, the designs featured in this book should suit your needs. The projects are all easy to build, and some are so simple that even complete beginners at electronic project construction can tackle them with ease. Stripboard layouts are provided for every project, together with a wiring diagram. The mechanical side of construction has largely been left to the individual constructors to sort out, simply because the vast majority of project builders prefer to do their own thing.

None of the designs requires the use of any test equipment in order to get them set up properly. Where any setting up is required, the procedures are very straightforward, and they are described in detail.

Projects covered: Simple MIDI tester, Message grabber, Byte grabber, THRU box, MIDI auto switcher, Auto/manual switcher, Manual switcher, MIDI patchbay, MIDI controlled switcher, MIDI lead tester, Program change pedal, Improved program change pedal, Basic mixer, Stereo mixer, Electronic swell pedal, Metronome, Analogue echo unit.

138 pages **Order code PC116** £4.95

VIDEO PROJECTS FOR THE ELECTRONICS CONSTRUCTOR

R. A. Penfold
Written by highly respected author R. A. Penfold, this book contains a collection of electronic projects specially designed for video enthusiasts. All the projects can be simply constructed, and most are suitable for the newcomer to project construction, as they are assembled on stripboard.

There are faders, wipers and effects units which will add sparkle and originality to your video recordings, an audio mixer and noise reducer to enhance your soundtracks and a basic computer control interface. Also, there's a useful selection on basic video production techniques to get you started.

Circuits include: video enhancer, improved video enhancer, video fader, horizontal wiper, improved video wiper, negative video unit, fade to grey unit, black and white keyer, vertical wiper, audio mixer, stereo headphone amplifier, dynamic noise reducer, automatic fader, pushbutton fader, computer control interface, 12 volt mains power supply.

124 pages **Order code PC115** £4.95

BOOK ORDERING DETAILS

All prices include UK postage. For postage to Europe (air) and the rest of the world (surface) please add £2 per book. For the rest of the world airmail add £3 per book. CD-ROM prices include VAT and/or postage to anywhere in the world. Send a PO, cheque, international money order (£ sterling only) made payable to **Direct Book Service** or card details, Visa, Mastercard, Amex, Diners Club or Switch to:

**DIRECT BOOK SERVICE, WIMBORNE PUBLISHING LTD.,
408 WIMBORNE ROAD EAST, FERNDOWN, DORSET BH22 9ND.**

Books are normally sent within seven days of receipt of order, but please allow 28 days for delivery - more for overseas orders. *Please check price and availability (see latest issue of Everyday Practical Electronics) before ordering from old lists.*

For a further selection of books see the next two issues of *EPE*.
Tel 01202 873872 Fax 01202 874562. Email: dbs@epemag.wimborne.co.uk

Order from our online shop at: www.epemag.wimborne.co.uk/shopdoor.htm

BOOK ORDER FORM

Full name:

Address:

..... Post code: Telephone No:

Signature:

I enclose cheque/PO payable to DIRECT BOOK SERVICE for £

Please charge my card £ Card expiry date.....

Card Number Switch Issue No.....

Card Security Code (the last three digits on or just under the signature strip)

Please send book order codes:

Please continue on separate sheet of paper if necessary
If you do not wish to cut your magazine, send a letter or copy of this form

Everyday Practical Electronics reaches twice as many UK readers as any other UK monthly hobby electronics magazine, our sales figures prove it. We have been the leading monthly magazine in this market for the last eighteen years.

If you want your advertisements to be seen by the largest readership at the most economical price our classified and semi-display pages offer the best value. The prepaid rate for semi-display space is £8 (+VAT) per single column centimetre (minimum 2.5cm). The prepaid rate for classified adverts is 30p (+VAT) per word (minimum 12 words).

All cheques, postal orders, etc., to be made payable to Everyday Practical Electronics. VAT must be added. Advertisements, together with remittance, should be sent to Everyday Practical Electronics Advertisements, Mill Lodge, Mill Lane, Thorpe-le-Soken, Essex CO16 0ED. Phone/Fax (01255) 861161.

For rates and information on display and classified advertising please contact our Advertisement Manager, Peter Mew as above.

X-10® Home Automation
We put you in control™

Why tolerate when you can automate?

An extensive range of 230V X-10 products and starter kits available. Uses proven Power Line Carrier technology, no wires required.

Products Catalogue available Online.

Worldwide delivery.

Laser Business Systems Ltd.



E-Mail: info@laser.com

http://www.laser.com

Tel: (020) 8441 9788

Fax: (020) 8449 0430



TRANSFORMERS

- Custom Wound
- 1 Phase to 50kVA
- 3 Phase to 100kVA
- A.C. and D.C. Chokes
- H.T. up to 5kV
- Transformer Kits
- Coils up to 1m Dia.
- Transformer Rectifiers
- Toroidals
- Motor Generators

Visit www.jemelec.com for details or request our free leaflet

Jemelec, Unit 7, Shirebrook Business Park, Mansfield, NG20 8RN

Tel: 0870 787 1769

GREENWELD
Mail Order Specialists

ELECTRICAL & ELECTRONIC COMPONENTS & KITS, TOOLS, MATERIALS & HARDWARE

Greenweld Limited
Unit 14 Homdon Industrial Park
West Homdon • Brentwood • Essex • CM13 3XD
Tel: 01277 811042 • Fax: 01277 812419
Email: batgains@greenweld.co.uk

Visit our website: www.greenweld.co.uk

Ask now for our FREE catalogue with the latest special offers

BOWOOD ELECTRONICS LTD

Suppliers of Electronic Components

Place a secure order on our website or call our sales line

All major credit cards accepted

Web: www.bowood-electronics.co.uk

7 Bakewell Road, Baslow, Derbyshire DE45 1RE

Sales: 01246 583777

Send 42p stamp for catalogue

VVT TRANSFORMERS

Transformers and Chokes for all types of circuits including specialist valve units

Custom design or standard range

High and low voltage

Variable Voltage Technology Ltd

Unit 3, Sheat Manor Farm, Chillerton,

Newport, Isle of Wight, PO30 3HP

Tel: 0870 243 0414 Fax: 01983 721572

email: sales@vvt-cowes.freemove.co.uk

www.vvttransformers.co.uk

TOTALROBOTS

ROBOTICS, CONTROL & ELECTRONICS TECHNOLOGY

High quality robot kits and components
UK distributor of the OOPic microcontroller

Secure on-line ordering

Rapid delivery

Highly competitive prices

Visit www.totalrobots.com

Tel: 0208 823 9220

BTEC ELECTRONICS TECHNICIAN TRAINING

VCE ADVANCED ENGINEERING

ELECTRONICS AND ICT

HNC AND HND ELECTRONICS

NVQ ENGINEERING AND IT

PLEASE APPLY TO COLLEGE FOR NEXT COURSE DATE

FULL PROSPECTUS FROM

LONDON ELECTRONICS COLLEGE
(Dept EPE) 20 PENYWERN ROAD
EARLS COURT, LONDON SW5 9SU
TEL: (020) 7373 8721

EPE NET ADDRESSES

EPE FTP site: <ftp://ftp.epemag.wimborne.co.uk>

Access the FTP site by typing the above into your web browser, or by setting up an FTP session using appropriate FTP software, then go into quoted sub-directories:

PIC-project source code files: [/pub/PICS](#)

PIC projects each have their own folder; navigate to the correct folder and open it, then fetch all the files contained within. *Do not try to download the folder itself!*

EPE text files: [/pub/docs](#)

Basic Soldering Guide: [solder.txt](#)

Ingenuity Unlimited submission guidance: [ing_unlit.txt](#)

New readers and subscribers info: [epe_info.txt](#)

Newsgroups or Usenet users advice: [usenet.txt](#)

Ni-Cad discussion: [nicadfaq.zip](#) and [nicad2.zip](#)

Writing for EPE advice: [write4us.txt](#)

You can also enter the FTP site via the link at the top of the main page of our home site at:

<http://www.epemag.wimborne.co.uk>

Shop now on-line:

www.epemag.wimborne.co.uk/shopdoor.htm

Ensure you set your FTP software to ASCII transfer when fetching text files, or they may be unreadable.

Note that any file which ends in .zip needs unzipping before use. Unzip utilities can be downloaded from:

<http://www.winzip.com>

Ensure you use the latest version

PC Oscilloscope & Signal Generator

3-in-1 Digital Oscilloscope + Signal Generator + Spectrum Analyser. Samples at 20 or 30 Msps. Programmable signal generator with built in sine, triangular, saw and square waves in normal & sweep modes. Plugs into printer port

Prices from £139 - CL SYSTEM

Visit www.clystem.co.uk or call 07986 860815

Miscellaneous

FREE PROTOTYPE PRINTED CIRCUIT BOARDS! Free prototype p.c.b. with quantity orders. Call Patrick on 028 9073 8897 for details. Agar Circuits, Unit 5, East Belfast Enterprise Park, 308 Albertbridge Road, Belfast BT5 4GX.

PRINTED CIRCUIT BOARDS - QUICK SERVICE. Prototype and production artwork raised from magazines or draft designs at low cost. PCBs designed from schematics. Production assembly, wiring and software programming. For details contact Patrick at Agar Circuits, Unit 5, East Belfast Enterprise Park, 308 Albertbridge Road, Belfast, BT5 4GX. Phone 028 9073 8897, Fax 028 9073 1802, Email agar@argonet.co.uk.

G.C.S.E. ELECTRONICS KITS, TOOLS, pocket money prices. S.A.E. for free catalogue. SIR-KIT Electronics, 52 Severn Road, Clacton, CO15 3RB. www.geocities.com/sirkituk. www.luv-it.electronics.co.uk. Quality components at lowest ever price. Mail order only. See web or phone 01843 570905.

VALVES AND ALLIED COMPONENTS IN STOCK. Phone for free list. Valves, books and magazines wanted. Geoff Davies (Radio), tel. 01788 574774.

TUNGSTEN CARBIDE P.C.B. DRILLS: A collection of drills from a liquidation sellout from a large p.c.b. manufacturer, 0.25mm-6.35mm available. I've put together a number of drill sets at a good price. Also a collection of high quality copper laminate materials. See www.st-anna-data.se.
FOR SALE: Double-beam oscilloscope and micro-voltmeter, v.g.c., £150. Owner retired. 01489 786938.

N. R. BARDWELL LTD (Est. 1948)

100	Signal Diodes 1N4148	£1.00	80	Asstd. capacitors 1nF to 1µF	£1.00
75	Rectifier Diodes 1N4001	£1.00	200	Asstd. disc ceramic capacitors	£1.00
50	Rectifier Diodes 1N4007	£1.00	50	Asstd. Steel Presets (sm, stand, ceramic)	£1.00
10	W01 Bridge Rectifiers	£1.00	50	Asstd. RF chokes (inductors)	£1.00
10	555 Timer I.C.s	£1.00	50	Asstd. grommets	£1.00
4	741 Op Amps	£1.00	10	Asstd. crystals - plug in	£1.00
50	Assorted Zener Diodes 400mW	£1.00	8	Asstd. di! switches	£1.00
12	Assorted 7-segment Displays	£1.00	8	Asstd. push-button switches, multi-bank, multi-pole	£1.00
35	Assorted I.e.d.s, var. shapes, colours & sizes	£1.00	30	Asstd. di! sockets up to 40 way	£1.00
25	5mm I.e.d.s, red or green or yellow	£1.00	10	TV coax plugs, plastic	£1.00
25	3mm I.e.d.s, red or green or yellow	£1.00	40	metres very thin connecting wire, red	£1.00
75	5mm I.e.d.s, green, 5.5mm legs	£1.00	10	1in. glass reed switches	£1.00
50	Axial I.e.d.s, 2mcd red Diode Package	£1.00	100	Any one value 1/4W 5% of resistors range 1R to 10M	£0.45
25	Asstd. High Brightness I.e.d.s, var. cols	£1.00	10	7812 Voltage Regulators	£1.00
20	BC182L Transistors	£1.00	300	Asstd. resistors, 1/4W/1/2W, mostly on tapes	£1.00
25	BC212L Transistors	£1.00			
30	BC237 Transistors	£1.00			
30	BC327 Transistors	£1.00			
30	BC328 Transistors	£1.00			
30	BC347 Transistors	£1.00			
30	BC547B Transistor	£1.00			
30	BC548 Transistors	£1.00			
30	BC549 Transistors	£1.00			
25	BC557 Transistors	£1.00			
30	BC558 Transistors	£1.00			
30	BC559 Transistors	£1.00			
20	2N3904 Transistors	£1.00			
100	1nF 50V wkg Axial Capacitors	£1.00			
100	4N7 50V wkg Axial Capacitors	£1.00			
80	Asstd capacitors electrolytic	£1.00			

288 Abbeydale Road, Sheffield S7 1FL
 Phone (local rate): 0845 166 2329
 Fax: 0114 255 5039
 e-mail: sales@bardwells.co.uk
 web: www.bardwells.co.uk
 Prices include VAT, Postage £1.65
 44p stamp for lists or disk
 POs, Cheques and Credit Cards accepted
 SEE OUR WEB PAGES FOR MORE
 COMPONENTS AND SPECIAL OFFERS

Autonomous Programmable Robot Kits Accessories - Sensors - Controller Boards

competition-robotics.com

Secure on-line ordering. Fast, friendly service.



Web: www.competition-robotics.com

Tel: 01793 636119 Fax: 01793 705772
 e-Mail: sales@competition-robotics.com

FRUSTRATED!

Looking for ICs TRANSISTORS?

A phone call to us could get a result. We offer an extensive range and with a world-wide database at our fingertips, we are able to source even more. We specialise in devices with the following prefix (to name but a few).



2N 2SA 2SB 2SC 2SD 2P 2SJ 2SK 3N 3SK 4N 6N 17 40 AD ADC AN AM AY BA BC BD BDT BDV BDW BDX BF BFR BFS BFT BFX BFY BLY BLX BS BR BRX BRY BS BSS BSV BSW BSX BT BTA BTB BRW BU BUK BUT BUY BUW BUX BUY BUZ CA CD CX CXA DAC DG DM DS DTA DTC GL GM HA HCF HD HEF ICL ICM IRF J KA KIA L LA LB LC LD LF LM M MSM MA MAB MAX MB MC MDAJ MJE MUF MM MN MPS MPMA MPMS MRF NJM NE OM OP PA PAL PIC PN RC S SAA SAB SAD SAJ SAS SDA SG SI SL SN SO STA STK STR STRD STRM STRS SVI T TA TAA TAG TBA TC TCA TDA TDB TEA TIC TIP TIPL TEA TL TLC TMP TMS TPU U UA UAA UC UDN ULN UM UPA UPC UPD VN X XR Z ZN ZTX + many others

**PLEASE ASK FOR OUR FREE CD-ROM
 (In Excel) STOCK LIST**
 We Stock a Massive Range of Components

Mail, phone, Fax Credit Card orders and callers welcome



Connect

Cricklewood Electronics Ltd

40-42 Cricklewood Broadway London NW2 3ET
 Tel: 020 8452 0161 Fax: 020 8208 1441

Low cost USB I/O

For Datalogging & Control

THE LABJACK U12 - ONLY £95



- ◆ 8-Analogue in, 2-Analogue out, 20 digital I/O counter, watchdog
- ◆ USB plug-and-play - no PSU needed
- ◆ FREE 'scope and logger software
- ◆ Write data to disk, web page or email
- ◆ Temperature and Humidity Sensors connect directly
- ◆ Visual Basic, C++, Delphi, LabVIEW, Testpoint drivers
- ◆ Control pumps, lights, valves with Relay and opto-input expansion boards

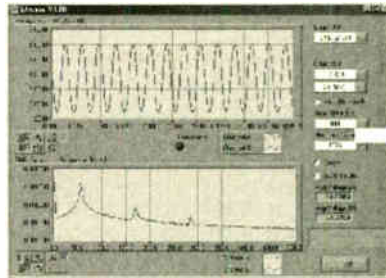

All prices exclude VAT and delivery. Order on-line: major credit/debit cards accepted.



audon Electronics

www.audon.co.uk +44 (0)115 925 8412 Fax (0)115 925 9757

SQUIRES

MODEL & CRAFT TOOLS

A COMPREHENSIVE RANGE OF MINIATURE HAND AND POWER TOOLS AND AN EXTENSIVE RANGE OF

ELECTRONIC COMPONENTS

FEATURED IN A FULLY ILLUSTRATED

624 PAGE MAIL ORDER CATALOGUE

2003 ISSUE

SAME DAY DESPATCH

FREE POST AND PACKAGING

Catalogues: **FREE OF CHARGE** to addresses in the UK.
 Overseas: CATALOGUE FREE, postage at cost charged to credit card

SHOP EXTENSION NOW OPEN

Squires, 100 London Road,
 Bognor Regis, West Sussex, PO21 1DD

TEL: 01243 842424

FAX: 01243 842525



Watch Slides on TV.

Make videos of your slides. Digitise your slides (using a video capture card) "Liesgang diatv" automatic slide viewer with built in high quality colour TV camera. It has a composite video output to a phono plug (SCART & BNC adaptors are available). They are in very good condition with few signs of use. More details see www.diatv.co.uk.
£91.91 + VAT = £108.00



Board cameras all with 512 x 582 pixels 8.5mm 1/3 inch sensor and composite video out. All need to be housed in your own enclosure and have fragile exposed surface mount parts. They all require a power supply of between 10V and 12V DC 150mA.
47MIR size 60 x 36 x 27mm with 6 infra red LEDs (gives the same illumination as a small torch but is not visible to the human eye) £37.00 + VAT = £43.48
30MP size 32 x 32 x 14mm spy camera with a fixed focus pin hole lens for hiding behind a very small hole £35.00 + VAT = £41.13
40MC size 39 x 38 x 27mm camera for 'C' mount lens these give a much sharper image than with the smaller lenses £32.00 + VAT = £37.60
Economy C mount lenses all fixed focus & fixed iris
VSL1220F 12mm F1.6 12 x 15 degrees viewing angle £15.97 + VAT £18.76
VSL4022F 4mm F1.22 63 x 47 degrees viewing angle £17.65 + VAT £20.74
VSL6022F 6mm F1.22 42 x 32 degrees viewing angle £19.05 + VAT £22.38
VSL8020F 8mm F1.22 32 x 24 degrees viewing angle £19.90 + VAT £23.38

Better quality C Mount lenses

VSL1614F 16mm F1.6 30 x 24 degrees viewing angle £26.43 + VAT £31.06
VWL813M 8mm F1.3 with iris 56 x 42 degrees viewing angle £77.45 + VAT = £91.00
1206 surface mount resistors E12 values 10 ohm to 1M ohm
100 of 1 value £1.00 + VAT 1000 of 1 value £5.00 + VAT

866 battery pack originally intended to be used with an orbital mobile telephone it contains 10 1-6Ah sub C batteries (42 x 22 dia. the size usually used in cordless screw-drivers etc.) the pack is new and unused and can be broken open quite easily
£7.46 + VAT = £8.77



Please add £1.66 + vat = £1.95 postage & packing per order

JPG Electronics

Shaws Row, Old Road, Chesterfield, S40 2RB.

Tel 01246 211202 Fax 01246 550959

Mastercard/Visa/Switch

Callers welcome 9.30 a.m. to 5.30 p.m. Monday to Saturday

SHERWOOD ELECTRONICS

FREE COMPONENTS

Buy 10 x £1 Special Packs and choose another one FREE

SP1	15 x 5mm Red LEDs	SP134	15 x 1N4007 diodes
SP2	12 x 5mm Green LEDs	SP135	6 x Miniature slide switches
SP3	12 x 5mm Yellow LEDs	SP136	3 x BFY50 transistors
SP6	15 x 3mm Red LEDs	SP137	4 x W005 1.5A bridge rectifiers
SP7	12 x 3mm Green LEDs	SP138	20 x 2-2/63V radial elect. caps.
SP8	10 x 3mm Yellow LEDs	SP140	3 x W04 1.5A bridge rectifiers
SP10	100 x 1N4148 diodes	SP142	2 x CMOS 4017
SP11	30 x 1N4001 diodes	SP143	5 Pairs min. crocodile clips (Red & Black)
SP12	30 x 1N4002 diodes	SP145	6 x ZTX300 transistors
SP18	20 x BC182 transistors	SP146	10 x 2N3704 transistors
SP20	20 x BC184 transistors	SP147	5 x Stripboard 9 strips x 25 holes
SP21	20 x BC212 transistors	SP151	4 x 8mm Red LEDs
SP23	20 x BC549 transistors	SP152	4 x 8mm Green LEDs
SP24	4 x CMOS 4001	SP153	4 x 8mm Yellow LEDs
SP25	4 x 555 timers	SP154	15 x BC548 transistors
SP26	4 x 741 Op.Amps	SP156	3 x Stripboard, 14 strips x 27 holes
SP28	4 x CMOS 4011	SP160	10 x 2N3904 transistors
SP29	3 x CMOS 4013	SP161	10 x 2N3906 transistors
SP34	20 x 1N914 diodes	SP165	2 x LF351 Op.Amps
SP36	25 x 10/25V radial elect. caps.	SP166	20 x 1N4003 diodes
SP37	12 x 100/35V radial elect. caps.	SP167	5 x BC107 transistors
SP39	10 x 470/16V radial elect. caps.	SP168	5 x BC108 transistors
SP40	15 x BC237 transistors	SP172	4 x Standard slide switches
SP41	20 x Mixed transistors	SP174	20 x 22/25V radial elect. caps.
SP42	200 x Mixed 0.25W C.F. resistors	SP175	20 x 1/63V radial elect. caps.
SP47	5 x Min. PB switches	SP177	10 x 1A 20mm quick blow fuses
SP49	4 x 5 metres stranded core wire	SP182	20 x 4-7/63V radial elect. caps.
SP102	20 x 8-pin DIL sockets	SP183	20 x BC547 transistors
SP103	15 x 14-pin DIL sockets	SP187	15 x BC239 transistors
SP104	15 x 16-pin DIL sockets	SP189	4 x 5 metres solid core wire
SP105	4 x 74LS00	SP192	3 x CMOS 4066
SP109	15 x BC557 transistors	SP195	3 x 10mm Yellow LEDs
SP112	4 x CMOS 4093	SP197	6 x 20 pin DIL sockets
SP115	3 x 10mm Red LEDs	SP198	5 x 24 pin DIL sockets
SP116	3 x 10mm Green LEDs	SP199	5 x 2.5mm mono jack plugs
SP124	20 x Assorted ceramic disc caps	SP200	5 x 2.5mm mono jack sockets
SP126	6 x Battery clips - 3 ea. PP3 + PP9		
SP130	100 x Mixed 0.5W C.F. resistors		
SP131	2 x TL071 Op.Amps		
SP133	20 x 1N4004 diodes		

RESISTOR PACKS - C.Film

RP3	5 each value - total 365 0.25W	£3.10
RP7	10 each value - total 730 0.25W	£4.35
RP10	1000 popular values 0.25W	£6.25
RP4	5 each value-total 345 0.5W	£4.00
RP8	10 each value-total 690 0.5W	£6.65
RP11	1000 popular values 0.5W	£8.50

2003 Catalogue now available £1 inc. P&P or FREE with first order.

P&P £1.50 per order. NO VAT

Orders to:

Sherwood Electronics,
7 Williamson St., Mansfield,
Notts. NG19 6TD.

ADVERTISERS INDEX

AUDON ELECTRONICS	655
N. R. BARDWELL	655
B.K. ELECTRONICS	Cover (iv)/633
BRUNNING SOFTWARE	639
BULL GROUP	Cover (ii)
CRICKLEWOOD ELECTRONICS	655
CROWNHILL ASSOCIATES	Cover (iii)
DISPLAY ELECTRONICS	586
ENERGISE TECHNOLOGY	655
EPT SOFTWARE	608
ESR ELECTRONIC COMPONENTS	594
FOREST ELECTRONIC DEVELOPMENTS	591
JPG ELECTRONICS	656
LABCENTER	605
MAGENTA ELECTRONICS	592/593
MATRIX MULTIMEDIA	633
MILFORD INSTRUMENTS	621
PEAK ELECTRONIC DESIGN	613
PICO TECHNOLOGY	624
QUASAR ELECTRONICS	588/589
SHERWOOD ELECTRONICS	656
SQUIRES	655
STEWART OF READING	603
WCN SUPPLIES	603

ADVERTISEMENT MANAGER: PETER J. MEW

ADVERTISEMENT OFFICES:

EVERYDAY PRACTICAL ELECTRONICS, ADVERTISEMENTS,
MILL LODGE, MILL LANE, THORPE-LE-SOKEN,
ESSEX CO16 0ED.

Phone/Fax: (01255) 861161

For Editorial address and phone numbers see page 595

EPE SUBSCRIPTIONS

Subscriptions for delivery direct to any address in the UK: 6 months £16.50, 12 months £31, two years £57; Overseas: 6 months £19.50 standard air service or £28.50 express airmail, 12 months £37 standard air service or £55 express airmail, 24 months £69 standard air service or £105 express airmail.

Online subscriptions, for downloading the magazine via the Internet, \$10.99US (approx. £7) for one year available from www.epemag.com.

Cheques or bank drafts (in £ sterling only) payable to *Everyday Practical Electronics* and sent to EPE Subs. Dept., Wimborne Publishing Ltd., 408 Wimborne Road East, Ferndown, Dorset BH22 9ND. Tel: 01202 873872. Fax: 01202 874562. Email: subs@epemag.wimborne.co.uk. Also via the Web at <http://www.epemag.wimborne.co.uk>. Subscriptions start with the next available issue. We accept MasterCard, Amex, Diners Club, Switch or Visa. (For past issues see the Back Issues page.)

USA/CANADA SUBSCRIPTIONS

To subscribe to EPE from the USA or Canada please telephone Express Mag toll free on 1877 363-1310 and have your credit card details ready. Or fax (514) 355 3332 or write to Express Mag, PO Box 2769, Plattsburgh, NY 12901-0239 or Express Mag, 8155 Larney Street, Anjou, Quebec, H1J 2L5.

Email address: expsmag@expressmag.com.

USA price \$59.40(US) per annum, Canada price \$83.88(Can) per annum - 12 issues per year.

Online subscriptions, for downloading the magazine via the Internet, \$10.99US for one year available from www.epemag.com.

Everyday Practical Electronics, periodicals pending, ISSN 0262 3617 is published twelve times a year by Wimborne Publishing Ltd., USA agent USACAN at 1320 Route 9, Champlain, NY 12919. Subscription price in US \$59.40 per annum. Periodicals postage paid at Champlain NY and at additional mailing offices. POSTMASTER: Send address changes to *Everyday Practical Electronics*, c/o Express Mag., PO Box 2769, Plattsburgh, NY, USA 12901-0239.

PIC BASIC

The most cost effective solution to PIC programming and development - Ever!!

Crownhill Associates
smart electronic solutions



New Improved
LET PIC BASIC

- ReWritten from the ground up
- Best Value For Money
- Most powerful entry level compiler
- 100% MPASM™ compatibility
- Windows™ 98,ME,2000,NT & XP compliant
- Real-Time Syntax checking
- Integrated PIC Programmer driver
- Program with one keystroke
- View BASIC and the resulting Assembly
- Supplied with book "LET PIC BASIC Unleashed" by Les Johnson

Free Evaluation copy from:
www.picbasic.org

LET PIC BASIC £65.00



ACCESS THE WORLD OF
SMART SMART CARDS

PIC BASIC Smart Card Development system

Another First from Crownhill, access the world of SMART CARDS using PIC BASIC. This versatile development system provides a platform for the development of applications using SMART memory cards and SECURE memory cards. Detailed documentation describes all aspects of development using the sample cards supplied, source code and circuit diagrams are included.

- Includes card Reader Writer hardware and circuit
- Integrated Boot Loader - No programmer required
- Sample cards, Documentation
- Fully commented LICENSE FREE Source code

Proton Smart from £79.95

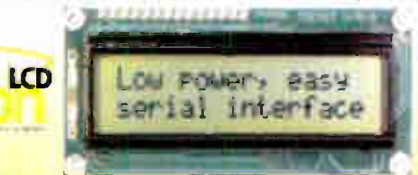

2 x16 serial LCD display, supplied as a kit or ready assembled. PCB, PICmicro, LCD display, Circuit, LICENSE FREE commented source code

Proton LCD £16.95



PIC BASIC Plus v2

- Windows™ Integrated Development Environment
- Integrated serial bootloader software "program without a programmer!"
- Support for 12/14/18bit series devices
- Handles 32bit signed and unsigned variables (numbers up to ± 2147483647)
- Specific commands for on-chip peripherals
- Comprehensive command set
 - Tighter code generation than MBASIC
 - More functionality than MELABS PICBASIC Pro
 - More flexible than all BASIC Stamps
- Integrates directly into Proteus VSM - allows you to build a virtual circuit and see your BASIC code run in real-time - see www.labcenter.co.uk
- Easy macro Integration (includes Floating pointmath example)
- Aimed at graduates, and professionals, all code produced is LICENCE FREE

Free Evaluation copy from:
www.picbasic.org

Crownhill PIC BASICv2 £125.00



PIC BASIC / InterNet Development System

The worlds First PIC BASIC InterNet development system allowing PIC BASIC projects to communicate across the WORLD via the InterNet. Development board includes RS232, Ethernet Interface and dedicated controller, LCD, Prototype area, Power supply and full documentation.

Proton Net £169.95



VSM

Full range of DEVELOPMENT boards, incl Graphics LCD's and Audio



DEV

www.labcenter.co.uk
Proteus VSM Fully supported by PICBASIC Plus



DEV-IR

Infra RED TX and Rx development system, with experiments and source code

Visit www.picbasic.org for comprehensive details of these and other PIC BASIC products, including:

All prices subject to Postage Packing and VAT

All major credit cards accepted, telephone, web or mail order.



**POWER AMPLIFIER MODULES-LOUDSPEAKERS-MIXERS
19 INCH STEREO AMPLIFIERS-ACTIVE CROSS/OVERS.**

* PRICES INCLUDE V.A.T.
* PROMPT DELIVERY

**OMP MOS-FET POWER AMPLIFIERS
HIGH POWER, TWO CHANNEL 19 INCH RACK**

10,000's
SOLD
TO PRO
USERS

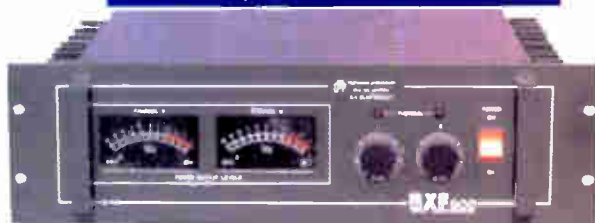

THE RENOWNED MXF SERIES OF POWER AMPLIFIERS

FOUR MODELS:- MXF200 (100W + 100W) MXF400 (200W + 200W)
MXF600 (300W + 300W) MXF900 (450W + 450W)

ALL POWER RATINGS ARE R.M.S. INTO 4 OHMS, WITH BOTH CHANNELS DRIVEN
FEATURES:- * Independent power supplies with two toroidal transformers
* Twin L.E.D. Vu Meters * Level controls * Illuminated on/off switch * Jack / XLR inputs
* Speakon Outputs * Standard 775mv input * Open and Short circuit proof * Latest Mos-Fets
for stress free delivery into virtually any load * High slew rate * Very low distortion * Aluminium cases * MXF600 & MXF900 fan cooled with D.C. Loudspeaker and thermal protection.

USED THE WORLD OVER IN CLUBS, PUBS, CINEMAS, DISCOS ETC

SIZES:-
MXF200 W19" D11" H3 1/2" (2U)
MXF400 W19" D12" H5 1/2" (3U)
MXF600 W19" D13" H5 1/2" (3U)
MXF900 W19" D14" H5 1/2" (3U)

PRICES:- MXF200 £175.00 MXF400 £233.85
MXF600 £329.00 MXF900 £449.15
SPECIALIST CARRIER DEL £12.50 Each



**FLIGHTCASED
LOUDSPEAKERS**

A new range of quality loudspeakers, designed to take advantage of latest loudspeaker technology and enclosure designs. All models utilise high quality studio cast aluminium loudspeakers with factory fitted grilles, wide dispersion constant directivity horns, extruded aluminium corner protection and steel ball corners, complimented with heavy duty black covering. The enclosures are fitted as standard with top hats for optional loudspeaker stands. The FC15-300 incorporates a large 16 X 6 inch horn. All cabinets are fitted with the latest Speakon connectors for your convenience and safety. Five models to choose from.

MONITOR



PLEASE NOTE:- POWER RATINGS QUOTED ARE IN WATTS R.M.S. FOR EACH INDIVIDUAL CABINET ALL ENCLOSURES ARE 8 OHMS

15=15 Inch speaker
12=12 Inch speaker

- ibl FC15-300 WATTS Freq Range 35Hz-20kHz, Sens 101dB, Size H695 W502 D415mm
Price:- £299.00 per pair
 - ibl FC12-300 WATTS Freq Range 45Hz-20kHz, Sens 96dB, Size H600 W405 D300mm
Price:- £249.00 per pair
 - ibl FC12-200 WATTS Freq Range 40Hz-20kHz, Sens 97dB, Size H600 W405 D300mm
Price:- £199.00 per pair
 - ibl FC12-100 WATTS Freq Range 45Hz-20kHz, Sens 100dB, Size H546 W380 D300mm
Price:- £179.00 per pair
 - ibl WM12-200 WATTS Freq Range 40Hz-20kHz, Sens 97dB, Size H418 W600 D385mm
Price:- £125.00 Each
- SPECIALIST CARRIER DEL:- £12.50 per pair, wedge monitor £7.00 each
Optional Metal Stands PRICE:- £49.00 per pair Delivery:- £6.00

CATALOGUE 2001-2002

Test & Tools Robots Electronic Kits

The Sky's The Limit Catalogue

Communication Security Accessories

B.K. Electronics

Unit 1, Comet Way, Southend-on-Sea, Essex, SS2 6TR
Tel: 01702-527572 Fax: 01702-420243
E-mail: sales@bkelec.com
Web Site: www.bkelec.com

FREE Our Sky's The Limit Catalogue with your order over 3000 items. The catalogue is free with any item ordered from this advertisement and to personal callers or £4.00 to cover P&P if ordered separately. This is fully refundable with your first order.

100 WATT ACTIVE SUB BASS AMPLIFIER PANEL



AN ACTIVE SUB BASS AMPLIFIER WITH A TRUE 100W RMS OUTPUT. SUPERB CONSTRUCTION WITH THE FACILITIES TO INTEGRATE SEAMLESSLY INTO MOST HI-FI OR HOME CINEMA SETUPS. USE THIS PANEL PLUS ONE OF OUR LOUDSPEAKERS TO MAKE YOUR OWN SUB WOOFER THAT WILL MATCH OR BEAT MOST COMMERCIALLY AVAILABLE SUB WOOFERS.

FEATURES:- * 100W RMS INTO 8 OHMS * HIGH AND LOW LEVEL INPUTS * TOROIDAL TRANSFORMER * SHORT CIRCUIT PROTECTION * D.C. SPEAKER PROTECTION * FREQUENCY ROLL OFF, LOWER 10Hz, UPPER 60Hz TO 240Hz (FULLY ADJUSTABLE) * AC3 COMPATIBLE FILTER CAN BE BYPASSED FOR 5-1 FORMATS. * AIRTIGHT CONSTRUCTION * TENS OF THOUSANDS OF OUR PANELS ALREADY IN USE. * COMPLETE WITH LEADS

SPECIFICATIONS:- POWER 100W RMS @ 8 OHMS * FREQ RESP. 10Hz 15KHz -3dB * DAMPING FACTOR >200 * DISTORTION 0.05% * S/N A WEIGHTED >100dB * SUPPLY 230V A.C. * WEIGHT 2.7Kg * SIZE H254 X W254 X D94mm

THERE ARE 2 VERSIONS OF THE ABOVE PANEL AVAILABLE :- **BSB100/8 8 OHM VERSION** **BSB100/4 4 OHM VERSION** BOTH PANELS ARE PRICED AT £117.44 + £5.00 P&P INCL. V.A.T. CHECK WEBSITE FOR PANELS UP TO 500W

OMP X03-S STEREO 3 WAY ACTIVE CROSSOVER SWITCHABLE 2-WAY



FEATURES:-
Advanced 3-Way Stereo Active Cross-Over (Switchable two way), housed in a 19" x 1U case. Each channel has three level controls: Bass, Mid & Top. The removable front fascia allows access to the programmable DIL switches to adjust the cross-over frequency. There are two versions available:- X03-S Bass-Mid 125/250/500Hz, Mid-Top 1.8/3/5kHz, all at 24 dB per octave. X03 Base-Mid 250/500/800Hz, Mid-Top 1.8/3/5kHz, all at 24 dB per Octave. Please make sure you ask for the correct model when ordering. The 2/3 way selector switches are also accessed by removing the front fascia. Each stereo channel can be configured separately. Bass Invert Switches are incorporated on each channel. Nominal 775mV input/output. Fully compatible with the OMP Rack Amplifier and Modules.

BOTH MODELS PRICED AT :- £117.44 + £5.00 P&P

OMP MOS-FET POWER AMPLIFIER MODULES SUPPLIES BUILT AND TESTED

These modules now enjoy a world-wide reputation for quality, reliability and performance at a realistic price. Four models are available to suit the needs of the professional and hobby market i.e. Industry, Leisure, Instrumental and Hi-Fi etc. When comparing prices, NOTE that all models include toroidal power supply, integral heat sink glass fibre P.C.B. and drive circuits to power a compatible Vu meter. All models are open and short circuit proof.

THOUSANDS OF MODULES PURCHASED BY PROFESSIONAL USERS

- OMP/MF 100 Mos-Fet Output Power 110 watts R.M.S. into 4 ohms, frequency response 1Hz - 100kHz -3dB, Damping Factor >300, Slew Rate 45V/uS, T.H.D. typical 0.002%, Input Sensitivity 500mV, S.N.R. 110dB, Size 300 x 123 x 60mm. Price:- £42.85 + £4.00 P&P
- OMP/MF 200 Mos-Fet Output Power 200 watts R.M.S. into 4 ohms, frequency response 1Hz - 100kHz -3dB, Damping Factor >300, Slew Rate 50V/uS, T.H.D. typical 0.001%, Input Sensitivity 500mV, S.N.R. 110dB, Size 300 x 155 x 100mm. Price:- £66.35 + £4.00 P&P
- OMP/MF 300 Mos-Fet Output Power 300 watts R.M.S. into 4 ohms, frequency response 1Hz - 100kHz -3dB, Damping Factor >300, Slew Rate 60V/uS, T.H.D. typical 0.001%, Input Sensitivity 500mV, S.N.R. 110dB, Size 330 x 175 x 100mm. Price:- £83.75 + £5.00 P&P
- OMP/MF 450 Mos-Fet Output Power 450 watts R.M.S. into 4 ohms, frequency response 1Hz - 100kHz -3dB, Damping Factor >300, Slew Rate 75V/uS, T.H.D. typical 0.001%, Input Sensitivity 500mV, S.N.R. 110dB, Fan Cooled, D.C. Loudspeaker Protection, 2 Second Anti Thump Delay, Size 385 x 210 x 105mm. Price:- £135.85 + £6.00 P&P
- OMP/MF 1000 Mos-Fet Output Power 1000 watts R.M.S. into 2 ohms, frequency response 1Hz - 100kHz -3dB, Damping Factor >300, Slew Rate 75V/uS, T.H.D. typical 0.001%, Input Sensitivity 500mV, S.N.R. 110dB, Fan Cooled, D.C. Loudspeaker Protection, 2 Second Anti Thump Delay, Size 422 x 300 x 125mm. Price:- £261.00 + £12.00 P&P

NOTE: MOS-FET MODULES ARE AVAILABLE IN TWO VERSIONS:- STANDARD - INPUT SENS 500mV/BANDWIDTH 100kHz, OR PEC (PROFESSIONAL EQUIPMENT COMPATIBLE) - INPUT SENS 775mV, BANDWIDTH 50kHz ORDER STANDARD OR PEC

DELIVERY CHARGES:- PLEASE INCLUDE AS ABOVE, TO A MAXIMUM AMOUNT £30.00. OFFICIAL ORDERS FROM SCHOOL, COLLEGES, GOVT. PLCs ETC. PRICES INCLUSIVE OF V.A.T. SALES COUNTER, CREDIT CARD ORDERS ACCEPTED BY POST PHONE OR FAX.

B.K. ELECTRONICS REF D5
UNIT 1 COMET WAY, SOUTHEND-ON-SEA, ESSEX, SS2 6TR.
TEL.: 01702-527572 FAX.: 01702-420243
Web:- <http://www.bkelec.com> E-Mail sales@bkelec.com