

**2 FREE CD-ROMS**

THE No.1 MAGAZINE FOR ELECTRONICS TECHNOLOGY & COMPUTER PROJECTS

EVERYDAY

OCTOBER 2001

**PRACTICAL**

# ELECTRONICS

£2.85

**2 FREE CD-ROMS**  
FULL MICROCHIP 2001  
TECHNICAL LIBRARY  
CD-ROMS

**PIC TOOLKIT Mk3**  
The Ideal PIC programming aid

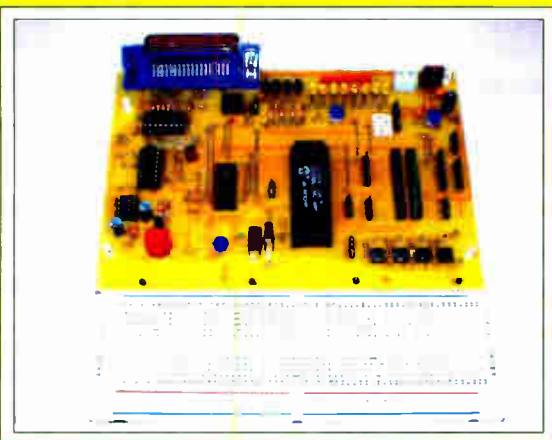

**TWO-VALVE SW RECEIVER**  
Battery powered retro project



NOW AVAILABLE TO BUY ON THE WEB  
**EPE** electronics  
www.epemag.co.uk

**SPECIAL FEATURE**

## TRAFFIC CONTROL



<http://www.epemag.wimborne.co.uk>

**PIR OPERATED WATER VALVES.** These brand new units consist of a control box with integral PIR and a water valve fitted with 15mm compression fittings. The valve is 6V d.c. operation and latches, e.g. 6V pulse will open it, 6V negative pulse will release it. Originally made to control urinals (flush when someone comes in) they have many other uses in cast scrothers, automatic watering systems etc. They have built-in adjustable time delays and settings and run quite happily for months on just a 9V battery. The valve alone could have many uses in garden features, solar systems, etc. Current retail price for the complete unit is £120, we can offer them at just £19.95 while stocks last! Ref PIRVAL2.

**EMMINENCE LOUDSPEAKERS.** 12in. diameter, 50 watts nominal, 100 watts peak, 16 ohm Imp. Pack of 4 just £39.95. Ref SPEAK39.

**PIR SECURITY SWITCHES.** These brand new swivel mounting PIR units will switch up to 2 kilowatts. Adjustable sensitivity, light level and time delay (9 seconds to 10 minutes), 15m detection range, mains operated, waterproof. £5.95. Ref PIR1PACK or a pack of 5 for £22.95. Ref PIR5PACK or 10 for £39.95 Ref PIR10PACK

**12V 18Ah SEALED LEAD-ACID BATTERIES, new and boxed, unused, pack of 4 £44.95, Ref CYC7 or £15.95 each, Ref CYC6.**

**12V 6.5Ah SEALED LEAD ACID BATTERIES, new and boxed, pack of 5 £34.95, Ref CYC65A, or individually at £8.99, Ref CYC65B.**

## A new range of 12V to 240V INVERTERS

**IV400S (400 watt) £89**  
**IV800S (800 watt) £159**  
**IV1200S (1200 watt) £219**

**SODIUM LAMP SYSTEMS, £75.70.** Complete system with 250W or 400W SON-T Agro bulb, reflector with bulbholder and remote ballast and starter (uncased), all you need is wire. 250W system Ref SLS1, 400W system SLS2.

**HYDROPONICS - DO YOU GROW YOUR OWN?** Check our web site at [www.bullnet.co.uk](http://www.bullnet.co.uk)

**PC COMBINED UPS AND PSU.** The unit has a total power of 292 watts, standard motherboard connectors and 12 peripheral power leads for drives etc. Inside are three 12V 7.2Ah sealed lead-acid batteries. Backup time is 8 mins at full load or 30 mins at half load. Made in the UK by Magnum, 110V or 240V a.c. input, +5V at 35A, -5V at 0.5A, +12V at 9A, -12V at 0.5A outputs. 170mm x 260mm x 220mm, new and boxed. £29.95. Ref PCUPS2.

**AERIAL PHOTOGRAPHY KIT.** This rocket comes with a built-in camera, it flies up to 500 feet (150m), turns over, and takes an aerial photograph of the ground below. The rocket then returns, with its film, via its parachute. Takes 110 film. Supplied complete with everything, including a launch pad and three motors (no film). £29.98. Ref ASTRO.

**3HP MAINS MOTORS.** Single-phase 240V, brand new, 2-pole, 340mm x 180mm, 2,850 rpm, built-in automatic reset overload protector, keyed shaft (40mm x 16mm). Made by Leeson. £99 each. Ref LEE1.

**BUILD YOUR OWN WINDFARM FROM SCRAP.** New publication gives step-by-step guide to building wind generators and propellers. Armed with this publication and a good local scrapyard could make you self-sufficient in electricity! £12 Ref LOT81.

**MAGNETIC CREDIT CARD READERS AND ENCODING MANUAL,** £9.95. Cased with fly-leads, designed to read standard credit cards! Complete with control electronics p.c.b. and manual covering everything you could want to know about what's hidden in that magnetic strip on your card! Just £9.95. Ref BAR31.

**SOLAR POWER LAB SPECIAL.** 2in. x 6in. x 6in., 6V 130mA cells, 4 l.e.d.s, wire, buzzer, switch plus relay or motor. £7.99. Ref SA27.

**SOLAR NICAD CHARGERS.** 4 x AA-size, £9.99. Ref 6P476, 2 x C-size, £9.99. Ref 6P477.

**LOCKPICKS.** We sell a full range of lockpicks and lockpicking books on our website: [www.lockpicks.co.uk](http://www.lockpicks.co.uk)

**SHUT THE BOX.** Check out [www.bullybeef.co.uk](http://www.bullybeef.co.uk) for a range of pub games and magic tricks.

**AIR RIFLES FROM LESS THAN £40, CROSSBOWS, WIDE RANGE OF BB GUNS, AMMO, TARGETS, PISTOLS, REPLICA GUNS, UZI MACHINE GUN REPLICAS (BB), REPEATERS, LASER SIGHTS, ELECTRIC BB, GAS BB**  
**[www.airpistol.co.uk](http://www.airpistol.co.uk)**

**INKJET CARTRIDGES FROM JUST £3 AT**  
**[www.officebits.co.uk](http://www.officebits.co.uk)**

## GIANT WEATHER BALLOONS

NEW, BOXED, NATO, TOTEX 7 FOOT DIAMETER, £13.99

## ONE MILLION HITS A MONTH

**[WWW.BULLNET.CO.UK](http://WWW.BULLNET.CO.UK)**

Hydrogen fuel cells. Our new Hydrogen fuel cells are 1V at up to 1A output. Hydrogen Input, easily driven from a small electrolosis assembly or from a hydrogen source, our demo model uses a solar panel with the output leads in a glass of salt water to produce the hydrogen! Each cell is designed to be completely taken apart, put back together and expanded to whatever capacity you like (up to 10 watts and 12V per assembly). Cells cost £49. Ref HFC11.

**PHILIPS VP406 LASER DISC PLAYERS, SALE PRICE JUST £9.95. SCART OUTPUT, JUST PUT YOUR VIDEO DISC IN AND PRESS PLAY. STANDARD AUDIO AND VIDEO OUTPUTS. £9.95. REF VP406.**

**SMOKE ALARMS.** Mains powered, made by the famous Gent company, easy fit next to light fittings, power point. Pack of 5 £15. Ref SS23. Pack of 12 £24. Ref SS24.

**SENDER KIT.** Contains all components to build a AV transmitter complete with case, £35. Ref VSXX2.

**CCTV CAMERAS FROM £22.** Check out our web site at [www.cctvstuff.co.uk](http://www.cctvstuff.co.uk)

**MAMOD STEAM ENGINES AND A FULL RANGE OF SPARE PARTS.**

CHECK OUT [www.mamodspares.co.uk](http://www.mamodspares.co.uk).

**14 WATT SOLAR PANEL.** Amorphous silicon panel fitted in an anodised aluminium frame. Panel measures 3ft. by 1ft. with screw terminals for easy connection. 3ft. x 1ft. solar panel £69. Ref MAG45. Unframed 4 pack (3ft. x 1ft.) £69. Ref SOLX.

**12V SOLAR POWERED WATER PUMP.** Perfect for many 12V d.c. uses, from solar fountains to hydroponics! Small and compact, yet powerful, works direct from our 10 watt solar panel in bright sun. Max hd: 17ft., max flow = 8l.p.m., 1.5A. Ref AC8. £18.99

**SOLAR MOTORS.** Tiny motors which run quite happily on voltages from 3V to 12V d.c. Works on our 6V amorphous 6in. panels, and you can run them from the sun! 32mm dia., 20mm thick. £1.50 each.

**WALKIE TALKIES. 1 MILE RANGE, £37/PAIR. REF MAG30.**

**LIQUID CRYSTAL DISPLAY.** Bargain prices, 40-character 1-line 154mm x 16mm, £6.00. Ref SMC4011A.

**YOUR HOME COULD BE SELF-SUFFICIENT IN ELECTRICITY.** Comprehensive plans with loads of info on designing systems, panels, control electronics, etc. £7. Ref PV1.

**SOLAR POWER LAB SPECIAL.** 2in. x 6in. x 6in., 6V 130mA cells, 4 l.e.d.s, wire, buzzer, switch plus relay or motor. £7.99. Ref SA27.

**SOLAR NICAD CHARGERS.** 4 x AA-size, £9.99. Ref 6P476, 2 x C-size, £9.99. Ref 6P477.

**BRAND NEW NATO ISSUE RADIATION DETECTORS, SALE PRICE JUST £99.95.** Current NATO issue standard emergency services unit used by most of the world's military personnel. New and boxed. Normal retail price £400, BULL'S bargain price just £99. Ref PDRM.

**PC COMBINED UPS AND PSU.** The unit has a total power of 292 watts, standard motherboard connectors and 12 peripheral power leads for drives etc. Inside are 3 12V 7.2Ah sealed lead-acid batteries. Backup time is 8 mins at full load or 30 mins at half load. Made in the UK by Magnum, 110V or 240V a.c. input, +5 at 35A, -5V at 0.5A, +12V at 9A, -12V at 0.5A outputs. 170mm x 260mm x 220mm, new and boxed. £29.95. Ref PCUPS2.

**BASIC GUIDE TO BIO DIESEL. HOW TO MAKE DIESEL FUEL FROM USED KITCHEN OIL, £6. REF BIOF.**

**SPECIAL OFFER! SAVE ££££££££, RCB UNITS.** In-line IEC lead with fitted RC breaker. Installed in seconds. Fit to any computer, monitor, office equipment and make it safe! Pack of 10 just £9.98. Ref LOT5B.

**INFRA-RED REMOTE CONTROL WATCHES, £16.99;** vibrating watches, vibrate when your phone rings, £16.99; pulse watches, display your pulse, £16.99.

**ALTERNATIVE ENERGY CD,** packed with hundreds of alternative energy related articles, plans and information etc. £14.50. Ref CD56.

**BULL ELECTRICAL**  
UNIT D, HENFIELD BUSINESS PARK,  
SHOREHAM ROAD, HENFIELD, SUSSEX  
BN5 9SL (ESTABLISHED 50 YEARS)  
MAIL ORDER TERMS: CASH, PO  
OR CHEQUE WITH ORDER  
PLUS £5.00 P&P PLUS VAT  
24 HOUR SERVICE £7.50 PLUS VAT  
OVERSEAS ORDERS AT COST PLUS £3.50  
(ACCESS, VISA, SWITCH, AMERICAN EXPRESS)  
'phone orders: 0871 871 1300  
FAX 0871 871 1301  
Sales@bull-electrical.com

**BASIC GUIDE TO LOCKPICKING.** New publication gives you an insight! £6. Ref LPK.

**30 WATTS OF SOLAR POWER** for just £69. 4 panels, each one 3ft. x 1ft. and producing 8W, 13V. Pack of four £69. Ref SOLX.

**200 WATT INVERTERS,** plugs straight into your car cigarette lighter socket and is fitted with a 13A socket so you can run your mains-operated devices from your car battery. £49.95. Ref SS66.

**THE TRUTH MACHINE.** Tells if someone is lying by micro tremors in their voice, battery operated, works in general conversation and on the phone and TV as well! £42.49. Ref TD3.

**INFRA-RED FILM.** 6in. square piece of flexible infra-red film that will only allow IR light through. Perfect for converting ordinary torches, lights, headlights etc. to infra-red output only using standard light bulbs. Easily cut to shape. 6in. square. £15. Ref IRF2.

**33 KILO LIFT MAGNET.** Neodymium, 32mm diameter with a fixing bolt on the back for easy mounting. Each magnet will lift 33 kilos, 4 magnets bolted to a plate will lift an incredible 132 kilos! £15. Ref MAG33. Pack of 4 just £39. Ref MAG33AA.

**77 KILO LIFT MAGNET.** These Samarium magnets measure 57mm x 20mm and have a threaded hole (5/16th UNF) in the centre and a magnetic strength of 2.2 gauss. We have tested these on a steel beam running through the offices and found that they will take more than 77kg (170lb) in weight before being pulled off. Supplied with keeper. £19.95 each. Ref MAG77.

**HYDROGEN FUEL CELL PLANS.** Loads of information on hydrogen storage and production. Practical plans to build a hydrogen fuel cell (good workshop facilities required). £8 set. Ref FCP1.

**STIRLING ENGINE PLANS.** Interesting information pack covering all aspects of Stirling engines, pictures of home made engines made from an aerosol can running on a candle! £12. Ref STIR2.

**ENERGY SAVER PLUGS.** Saves up to 15% electricity when used with fridges, motors up to 2A, light bulbs, soldering irons etc. £9 each. Ref LOT71, 10 pack. £69. Ref LOT72.

**12V OPERATED SMOKE BOMBS.** Type 3 is a 12V trigger and three smoke cannisters, each cannister will fill a room in a very short space of time! £14.99. Ref SB3. Type 2 is 20 smaller cannisters (suitable for mock equipment fires etc.) and one trigger module for £29. Ref SB2. Type 1 is a 12V trigger and 20 large cannisters. £49. Ref SB1.

**HI-POWER ZENON VARIABLE STROBES.** Useful 12V p.c.b. fitted with hi-power strobe tube and control electronics and speed control potentiometer. Perfect for interesting projects etc. 70mm x 55mm 12V d.c. operation. £6 each. Ref FLS1. Pack of 10 £49. Ref FLS2.

**HOW TO PRODUCE 35 BOTTLES OF WHISKY FROM A SACK OF POTATOES.** Comprehensive 270 page book covers all aspects of spirit production from everyday materials. Includes construction details of simple stills. £12. Ref MS3.

**NEW HIGH POWER MINI BUG.** With a range of up to 800 metres and 3 days use from a PP3 battery this is our top selling bug! Less than 1in. square and a 10m voice pick-up range. £28. Ref LOT102.

**IR LAMP KIT.** Suitable for CCTV cameras, enables the camera to be used in total darkness! £6. Ref EF138.

**INFRA-RED POWER BEAM.** Handheld battery powered lamp, 4 inch reflector, gives out powerful pure infra-red light! Perfect for CCTV use, night sights etc. £29. Ref PB1.

**SUPER WIDEBAND RADAR DETECTOR.** Whistler 1630. Detects both radar and laser, XK and KA bands, speed cameras, and all known speed detection systems. 360 degree coverage, front and rear waveguides. 1.1in. x 2.7in. x 4.6in., fits on visor or dash. New low price £99. Ref WH1630. Other models available at [www.redergun.co.uk](http://www.redergun.co.uk).

**LOPTX.** Made by Samsung for colour TV. £3 each. Ref SS52.

**WANT TO MAKE SOME MONEY? STUCK FOR AN IDEA?** We have collated 140 business manuals that give you information on setting up different businesses, you peruse these at your leisure using the text editor on your PC. Also included is the certificate enabling you to reproduce (and sell) the manuals as much as you like! £14. Ref EP74.

**ELECTRONIC SPEED CONTROLLER KIT.** For the above motor is £19. Ref MAG17. Save £5 if you buy them both together, one motor plus speed controller rp is £41. Offer price £36. Ref MOT5A.

**INFRA-RED REMOTE CONTROLS.** Made for TVs but may have other uses. Pack of 100 £39. Ref IREM.

**RCB UNITS.** In-line IEC lead with fitted RC breaker. Installed in seconds. Pack of 3 £9.98. Ref LOT5A.

**STEPPER MOTORS.** Brand new stepper motors, 4mm fixing holes with 47-14mm fixing centres, 20mm shaft, 6-35mm diameter, 5V/phase, 0.7A/phase, 1.8 deg. step (200 step), body 56mm x 36mm. £14.99 each. Ref STEP6. Pack of 4 for £49.95.

## On our web sites you can:

1. Order online.
2. Check your premium bonds.
3. Enter our auction or build your own.
4. Add E-commerce to your own site.
5. Discover our software site, optical site, hydroponics site, holiday home exchange site, inkjet site, radar detectors, hotels site.

**<http://www.bullnet.co.uk>**

ISSN 0262 3617  
PROJECTS ... THEORY ... NEWS ...  
COMMENTS ... POPULAR FEATURES ...

VOL. 30. No. 10 OCTOBER 2001  
Cover illustration by Jonathan Robertson

EVERYDAY  
**PRACTICAL**  
**ELECTRONICS**  
INCORPORATING **ELECTRONICS TODAY INTERNATIONAL**

[www.epemag.wimborne.co.uk](http://www.epemag.wimborne.co.uk)  
*EPE Online: [www.epemag.com](http://www.epemag.com)*



## Projects and Circuits

- CAMCORDER POWER SUPPLY** by Terry de Vaux-Balbirnie **688**  
Battery replacement with a lot more bottle!
- PIC TOOLKIT Mk3** by John Becker **700**  
An enhanced PIC microcontroller programming development board, and prelude to next month's exciting new Windows-based TK3 software!
- 2-VALVE SW RECEIVER** by Robert Penfold **714**  
A nostalgic and simple design for valve radio enthusiasts
- INGENUITY UNLIMITED** hosted by Alan Winstanley **730**  
Three-way Lighting
- PERPETUAL PROJECTS - 4** by Thomas Scarborough **732**  
Three more solar powered projects to complete the series - Gate Sentinel; Bird Scarer; In-Out Register

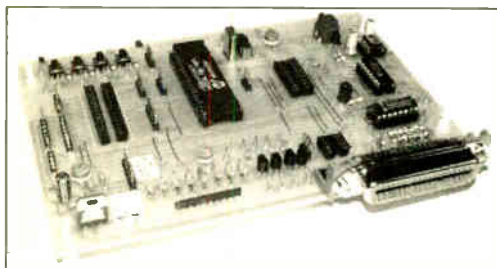

## Series and Features

- CIRCUIT SURGERY** by Alan Winstanley and Ian Bell **698**  
Heatsink calculations
- NEW TECHNOLOGY UPDATE** by Ian Poole **706**  
Thermocouple-based accelerometers dispense with moving parts
- TRAFFIC CONTROL** by Owen Bishop **710**  
SCOOT systems speed the flow of road traffic and pedestrians
- NET WORK - THE INTERNET PAGE** surfed by Alan Winstanley **726**  
Sircam and other worms and viruses
- INTERFACE** by Robert Penfold **738**  
Single-chip 32-bit output port



## Regulars and Services

- EDITORIAL** **687**
- NEWS** - Barry Fox highlights technology's leading edge **695**  
Plus everyday news from the world of electronics
- BACK ISSUES** Did you miss these? Many now on CD-ROM! **707**
- READOUT** John Becker addresses general points arising **721**
- ELECTRONICS VIDEOS** Our range of educational videos **724**
- SHOPTALK** with David Barrington **727**  
The *essential* guide to component buying for *EPE* projects
- CD-ROMS FOR ELECTRONICS** **728**  
A wide range of CD-ROMs for hobbyists, students and engineers
- ELECTRONICS MANUALS** **740**  
Essential reference works for hobbyists, students and service engineers
- DIRECT BOOK SERVICE** **742**  
A wide range of technical books available by mail order
- PRINTED CIRCUIT BOARD AND SOFTWARE SERVICE** **745**  
PCBs for *EPE* projects. Plus *EPE* software
- ADVERTISERS INDEX** **748**

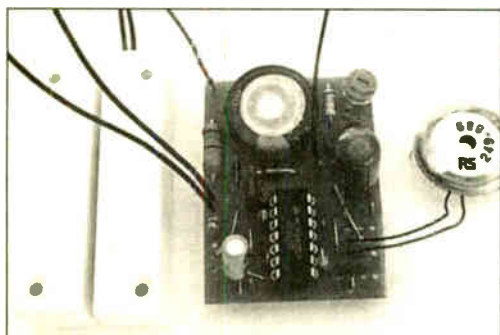

© Wimborne Publishing Ltd 2001. Copyright in all drawings, photographs and articles published in **EVERYDAY PRACTICAL ELECTRONICS** is fully protected, and reproduction or imitations in whole or in part are expressly forbidden.

Our November 2001 issue will be published on Thursday, 11 October 2001. See page 679 for details

**Readers Services • Editorial and Advertisement Departments 687**

Visit our website  
www.distel.co.uk

# THE ORIGINAL SURPLUS WONDERLAND!

THIS MONTH'S SELECTION FROM OUR VAST EVER CHANGING STOCKS

Surplus always  
wanted for cash!

## THE AMAZING TELEBOX

Converts your colour monitor into a QUALITY COLOUR TV!!



TV SOUND &  
VIDEO TUNER  
CABLE COMPATIBLE

The TELEBOX is an attractive fully caset mains powered unit, containing all electronics ready to plug into a host of video monitors or AV equipment which are fitted with a composite video or SCART input. The composite video output will also plug directly into most video recorders, allowing reception of TV channels not normally receivable on most television receivers\* (TELEBOX MF). Push button controls on the front panel allow reception of 8 fully tuneable 'off air' UHF colour television channels. TELEBOX MB covers virtually all television frequencies VHF and UHF including the HYPERBAND as used by most cable TV operators. Ideal for desktop computer video systems & PIP (picture in picture) setups. For complete compatibility - even for monitors without sound - an integral 4 watt audio amplifier and low level Hi Fi audio output are provided as standard. Brand new - fully guaranteed.

TELEBOX ST for composite video input type monitors £36.95  
TELEBOX STL as ST but fitted with integral speaker £39.50  
TELEBOX MB Multiband VHF/UHF/Cable/Hyperband tuner £69.95  
For overseas PAL versions state 5.5 or 6 mHz sound specification.  
\*For cable / hyperband signal reception a Telebox MB should be connected to a cable type service. Shipping on all Teleboxes, code (B)

**NEW** State of the art PAL (UK spec) UHF TV tuner module with composite 1V pp video & NICAM hi fi stereo sound outputs. Micro electronics all on one small PCB only 73 x 160 x 52 mm enable full tuning control via a simple 3 wire link to an IBM pc type computer. Supplied complete with simple working program and documentation. Requires +12V & +5V DC to operate. **BRAND NEW - Order as MY00. Only £49.95 code (B)**  
See [www.distel.co.uk/data\\_my00.htm](http://www.distel.co.uk/data_my00.htm) for picture + full details

## FLOPPY DISK DRIVES 2 1/2" - 8"

All units (unless stated) are **BRAND NEW** or removed from often brand new equipment and are fully tested, aligned and shipped to you with a full 90 day guarantee. Call or see our web site [www.distel.co.uk](http://www.distel.co.uk) for over 2000 unlisted drives for spares or repair.

- 3 1/2" Mitsubishi MF355C-L 1.4 Meg Laptops only £25.95(B)
- 3 1/2" Mitsubishi MF355C-D 1.4 Meg. Non laptop £18.95(B)
- 5 1/4" Teac FD-55GHR 1.2 Meg (for IBM pc's) RFE £18.95(B)
- 5 1/4" Teac FD-55F-03-U 720K 40/80 (for BBC's etc) RFE £29.95(B)
- 5 1/4" BRAND NEW Mitsubishi MF501B 360K £22.95(B)
- Table top case with integral PSU for HH 5 1/4" Floppy / HD £29.95(B)
- 8" Shugart 800/801 8" SS refurbished & tested £210.00(E)
- 8" Shugart 810 8" SS HH Brand New £195.00(E)
- 8" Shugart 851 8" double sided refurbished & tested £260.00(L)
- 8" Mitsubishi M2894-63 double sided NEW £295.00(E)
- 8" Mitsubishi M2896-63-02U DS slimline NEW £295.00(E)
- Dual 8" cased drives with integral power supply 2 Mb £499.00(E)

## HARD DISK DRIVES 2 1/2" - 14"

- 2 1/2" TOSHIBA MK1002MAV 1.1Gb laptop(12.5 mm H) New £79.95
  - 2 1/2" TOSHIBA MK2101MAN 2.16 Gb laptop (19 mm H) New £89.50
  - 2 1/2" TOSHIBA MK4309MAT 4.3Gb laptop (8.2 mm H) New £105.00
  - 2 1/2" TOSHIBA MK6409MAV 6.1Gb laptop (12.7 mm H) New £190.00
  - 2 1/2" to 3 1/2" conversion kit for PC's, complete with connectors £14.95
  - 3 1/2" FUJI FK-309-26 20mb MFM I/F RFE £59.95
  - 3 1/2" CONNER CP3024 20 mb IDE I/F (or equiv.) RFE £59.95
  - 3 1/2" CONNER CP3044 40 mb IDE I/F (or equiv.) RFE £69.00
  - 3 1/2" QUANTUM 40S Prodril v 42mb SCSI I/F, New RFE £49.00
  - 5 1/4" MINISCRIBE 3425 20mb MFM I/F (or equiv.) RFE £49.95
  - 5 1/4" SEAGATE ST-238R 30 mb RLL I/F Refurb £69.95
  - 5 1/4" CDC 94205-51 40mb HH MFM I/F RFE tested £69.95
  - 5 1/4" HP 97548 850 Mb SCSI RFE tested £39.00
  - 5 1/4" HP C3010 2 Gbyte SCSI differential RFE tested £195.00
  - 8" NEC D2246 85 Mb SMD interface. New £199.00
  - 8" FUJITSU M2322K 160Mb SMD I/F RFE tested £195.00
  - 8" FUJITSU M2392K 2 Gb SMD I/F RFE tested £345.00
- Many other drives in stock - Shipping on all drives is code (C1)

## TEST EQUIPMENT & SPECIAL INTEREST ITEMS

- MTS, FA3445ETK L47 Industrial spec SVGA monitors £245
- FARNELL 0-60V DC @ 50 Amps, bench Power Supplies £995
- FARNELL AP080 0-30V DC @ 80 Amps, bench Supply £1850
- 1kW to 400 kW - 400 Hz 3 phase power sources - ex stock EPOA
- IBM 8230 Type 1, Token ring base unit driver £760
- Wayne Kerr RA200 Audio frequency response analyser £2500
- IBM 53F501 Token Ring ICS 20 port lobe modules £750
- IBM MAU Token ring distribution panel B228-23-5050N £95
- AIM 501 Low distortion Oscillator 9Hz to 330KHz, IEEE £550
- ALLGON 8360, 11805-1880 MHz hybrid power combiners £250
- Trend DSA 274 Data Analyser with G703(2M) 64 v0 EPOA
- Marconi 6310 Programmable 2 to 22 GHz sweep generator £6500
- Marconi 2022C 10KHz-1GHz RF signal generator £15500
- Marconi 2030 opt 03 10KHz-1.3 GHz signal generator, New £4995
- HP1650B Logic Analyser £3750
- HP3781A Pattern generator & HP3782A Error Detector EPOA
- HP6621A Dual Programmable GPIB PSU 0-7 V 160 watts £1800
- HP6264 Rack mount variable 0-20V @ 20A metered PSU £675
- HP54120A DC to 22 GHz four channel test set EPOA
- HP8130A opt 020 300 MHz pulse generator, GPIB etc £7900
- HP A1, A0 8 pen HPGL high speed drum plotters from HP DRAFTMASTER 1 8 pen high speed plotter £7500
- EG+G Brookdeal 95035C Precision lock in amp £1800
- View Eng. Mod 1200 compensated inspection system EPOA
- Sony DXC-3000A High quality CCD colour TV camera £995
- Keithley 590 CV capacitor / voltage analyser EPOA
- Racal ICR40 dual 40 channel voice recorder system £3750
- Fiskers 45KVA 3 ph On Line UPS - Now batteries £9500
- Emerson AP130 2 SKVA industrial spec UPS £2100
- Mann Tally MT645 High speed line printer £2200
- Intel SBC 486/133SE Multibus 486 system 8Mb Ram £945
- Siemens K4400 64Kb to 140Mb demux analyser £2950

## IC's - TRANSISTORS - DIODES

OBSOLETE - SHORT SUPPLY - BULK  
10,000,000 items EX STOCK  
For MAJOR SAVINGS

CALL OR SEE OUR WEBSITE [www.distel.co.uk](http://www.distel.co.uk)  
**VIDEO MONITOR SPECIALS**

One of the highest specification  
monitors you will ever see -  
At this price - Don't miss it!!

Mitsubishi FA3415ETK L47 SVGA Multisync colour monitor with fine 0.28 dot pitch tube and resolution of 1024 x 768. A variety of inputs allows connection to a host of computers including IBM PC's in CGA, EGA, VGA & SVGA modes, BBC, COMMODORE (including Amiga 1200), ARCHIMEDES and APPLE. Many features: Etched faceplate, test switching and LOW RADIATION MPR specification. Fully guaranteed, in EXCELLENT little used condition.

Tilt & Swivel Base £4.75  
VGA cable for IBM PC included.  
External cables for other types of computers available - CALL

Only £119 (C) Order as MITS-SVGA

Ex demo 17" 0.28 SVGA Mitsubishi Diamond Pro monitors, Full multisync etc.  
Full 90 day guarantee. Only £199.00 (E)

Just In - Microvitec 20" VGA (800 x 600 res.) colour monitors. Good SH condition - from £299 - CALL for Info

PHILIPS HCS35 (same style as CM8833) attractively styled 14" colour monitor with RGB and standard composite 15.625 KHz video inputs via SCART socket and separate phono jacks. Integral audio power amp and speaker for all audio visual uses. Will connect direct to Amiga and Atari BBC computers. Ideal for all video monitoring / security applications with direct connection to most colour cameras. High quality with many features such as front concealed flap controls, VCR correction button etc. Good used condition - fully tested - guaranteed.  
Dimensions: W14" x H12 1/4" x 15 1/2" D. Only £99.00 (E)

PHILIPS HCS31 Ultra compact 9" colour video monitor with standard composite 15.625 KHz video input via SCART socket. Ideal for all monitoring / security applications. High quality, ex-equipment fully tested & guaranteed (possible minor screen bums). In attractive square black plastic case measuring W10" x H10" x 1 3/8" D. 24V AC mains powered. Only £79.00 (D)

KME 10" 15M10009 high definition colour monitors with 0.28" dot pitch. Superb clarity and modern styling. Operates from any 15.625 khz sync RGB video source, with RGB analog and composite sync such as Atari, Commodore Amiga, Acorn Archimedes & BBC. Measures only 13 1/2" x 12" x 1 1/2". Good used condition. Only £125 (E)

## 20" 22" and 26" AV SPECIALS

Superbly made UK manufacture. PIL all solid state colour monitors, complete with composite video & optional sound input. Attractive test style case. Perfect for Schools, Shops, Disco, Clubs, etc. In EXCELLENT little used condition with full 90 day guarantee.

20"....£135 22"....£155 26"....£185 (F)

We probably have the largest range of video monitors in Europe. All sizes and types from 4" to 42" call for info.

## DC POWER SUPPLIES

Virtually every type of power supply you can imagine. Over 10,000 Power Supplies Ex Stock. Call or see our web site.

- HP6030A 0-200V DC @ 17 Amps bench power supply £1950
- Intel SBC 486/125C08 Enhanced Multibus (MSA) New £1150
- Nikon HF-X11 (Ephiphot) exposure control unit £1450
- PHILIPS PM5518 pro. TV signal generator £1250
- Motorola VME Bus Boards & Components List. SAE / CALL EPOA
- Trio 0-18 vdc linear metered 30 amp bench PSU. New £550
- Fujitsu M3041R 600 LPM high speed band printer £1950
- Fujitsu M3041D 600 LPM printer with network interface £1250
- Perkin Elmer 299B Infrared spectrophotometer £500
- Perkin Elmer 597 Infrared spectrophotometer £3500
- VG Electronics 1035 TELETEXT Decoding Margin Meter £3250
- LightBand 60 output high spec 2u rack mount Video VDA's £495
- Sikson SD 150H 18 channel digital Hybrid chart recorder £1995
- B&K 2633 Microphone pre amp £300
- Taylor Hobson Tallysurf amplifier / recorder £750
- ADC S5200 Carbon dioxide gas detector / monitor £1450
- BBC AM203 PPM Meter (Ernest Turner) + drive electronics £75
- ANRITSU 9654A Optical DC-2.5Gb waveform monitor £5650
- ANRITSU MS9001B1 0.6-1.7 uM optical spectrum analyser EPOA
- ANRITSU ML93A optical power meter £990
- ANRITSU Fibre optic characteristic test set EPOA
- R&S FTDZ Dual sound unit £650
- R&S SBUFE-1 Vision modulator £775
- WILTRON 6630B 12 / 4 / 20GHz RF sweep generator £5750
- TEK 2445 150 MHz 4 trace oscilloscope £1250
- TEK 2465 300 MHz 300 MHz oscilloscope rack mount £1955
- TEK TD5308 400MHz digital real-time + disk drive, FFT etc £2900
- TEK TD5524A 500MHz digital real-time + colour display etc £1950
- HP3585A Opt 907 20Hz to 40 MHz spectrum analyser £5100
- PHILIPS PW1730/10 60KV XRAY generator & accessories EPOA
- CLAUDE LYONS 12A 740V single phase auto volt regs £325
- CLAUDE LYONS 100A 240/415V 3 phase auto volt regs £2900

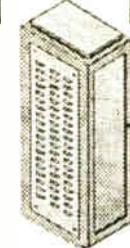

## 19" RACK CABINETS

Superb quality 6 foot 40U  
Virtually New, Ultra Smart  
Less than Half Price!

Top quality 19" rack cabinets made in UK by Optima Enclosures Ltd. Units feature designer, smoked acrylic lockable front door, full height lockable half louvered back door and louvered removable side panels. Fully adjustable internal fixing struts, ready punched for any configuration of equipment mounting, plus ready mounted integral 12 way 13 amp socket switched mains distribution strip make these racks some of the most versatile we have ever sold. Racks may be stacked side by side and therefore require only two side panels to stand singly or in multiple bays. Overall dimensions are 77 1/2" H x 32 1/2" D x 22" W. Order as: OPT Rack 1 Complete with removable side panels. £345.00 (G)  
OPT Rack 2 Rack, Less side panels. £245.00 (G)

Over 1000 racks, shelves, accessories  
19" 22" & 24" wide 3 to 46 U high.  
Available from stock !!

## 32U - High Quality - All steel RakCab

Made by Eurocraft Enclosures Ltd to the highest possible spec, rack features all steel construction with removable side, front and back doors. Front and back doors are hinged for easy access and all are lockable with five secure 5 lever barrel locks. The front door is constructed of double walled steel with a 'designer style' smoked acrylic front panel. Panel enable status indicators to be seen through the panel, yet remain unobtrusive. Internally the rack features fully slotted reinforced vertical fixing members to take the heaviest of 19" rack equipment. The two movable vertical fixing struts (extras available) are pre punched for standard 'cage nuts'. A mains distribution panel internally mounted to the bottom rear, provides 8 x IEC 3 pin Euro sockets and 1 x 13 amp 3 pin switched utility socket. Overall ventilation is provided by fully louvered back door and double slatted top section with top and side louvers. The top panel may be removed for fitting of integral fans to the sub plate etc. Other features include: fitted castors and floor levelers, pruned utility panel at lower rear for cable / connector access etc. Supplied in excellent, slightly used condition with keys. Colour Royal blue. External dimensions mm=1625H x 635D x 603 W (64" H x 25" D x 23 3/4" W)



Sold at LESS than a third of makers price !!  
A superb buy at only £245.00 (G)  
42U version of the above only £345 - CALL

## 12V BATTERY SCOOP - 60% off !!

A special bulk purchase from a cancelled export order brings you the most amazing savings on these ultra high spec 12v DC 1Ah rechargeable batteries. Made by Hawker Energy Ltd, type SBS15 featuring pure lead plates which offer a far superior shell & guaranteed 15 year service life. Fully BT & BS6290 approved. Supplied BRAND NEW and boxed. Dimensions 200 wide, 137 high, 77 deep. M6 bolt terminals. Fully guaranteed. Current makers price over £70 each. **Our Price £35 each (C) or 4 for £99 (E)**

## RELAYS - 200,000 FROM STOCK

Save ££££'s by choosing your next relay from our Massive Stocks covering types such as Military, Octal, Cradle, Hermetically Sealed, Continental, Contactors, Time Delay, Reed, Mercury Wetted, Solid State, Printed Circuit Mounting etc. CALL or see our web site [www.distel.co.uk](http://www.distel.co.uk) for more information. Many obsolete types from stock. Save ££££'s

## COLOUR CCD CAMERAS

Undoubtedly a miracle of modern technology & our special buying power! A quality product featuring a fully cased COLOUR CCD camera at a give away price! Unit features full auto light sensing for use in low light & high light applications. A 10 mm fixed focus wide angle lens gives excellent focus and resolution from close up to long range. The composite video output will connect to any composite monitor or TV (via SCART) and most video recorders. Unit runs from 12V DC so ideal for security & portable applications where mains power not available.

Overall dimensions 66 mm wide x 117 deep x 43 high. Supplied BRAND NEW & fully guaranteed with user data, 100's of applications including Security, Home Video, Web TV, Web Cams etc. etc.  
Web ref = LK33 **ONLY £99.00 or 2 for £180.00 (E)**

## SOFTWARE SPECIALS

NT4 WorkStation, complete with service pack 3 and licence - OEM packaged. **ONLY £89.00 (E)**  
ENCARTA 95 - CDROM, Not the latest - but at this price! £7.95  
DOS 5.0 on 3 1/2" disks with concise books c/w OBasic £14.95  
Windows for Workgroups 3.11 + Dos 6.22 on 3 1/2" disks £55.00  
Wordperfect 6 for DOS supplied on 3 1/2" disks with manual £24.95  
shipping charges for software is code B

**DISTEL on the web !! - Over 16,000,000 items from stock - www.distel.co.uk**

**Display Electronics**  
-ELECTRONICS-

**ALL MAIL TO**  
Dept PE, 29/35 Osborne Rd  
Thornton Heath  
Surrey CR7 8PD  
Open Mon - Fri 9.00 - 5:30

**LONDON SHOP**  
Open Mon - Sat 9.00 - 5.30  
215 Whitehorse Lane  
South Norwood  
On 68A Bus Route  
N.Thornton Heath &  
Selhurst Park SR Rail Stations

**DISTEL**  
Visit our web site  
[www.distel.co.uk](http://www.distel.co.uk)  
email = admin@distel.co.uk

**ALL ENQUIRIES**  
**0208 653 3333**  
FAX 0208 653 8888

# NEXT MONTH

FREE  
16-PAGE  
SUPPLEMENT

## SPECIAL SUPPLEMENT PIC TOOLKIT TK3 FOR WINDOWS

The long-awaited sequel to Toolkit Mk2, crafted for PIC programming enthusiasts by a PIC programming addict. PIC Toolkit TK3 for Windows is the most sophisticated EPE PIC microcontroller code assembler and programmer ever published.

Designed explicitly for running in the "desk-top PC" environments of Windows 95 and 98, TK3 is intuitively easy to use, fast in operation, has many extra features that are probably not found elsewhere, and is the ideal programming aid for all who love to play with reprogrammable PICs.

The PIC families catered for are principally the PIC16x84 and PIC16F87x EEPROM-based series, whose members include C84, F84, F873, F874, F876 and F877. It is likely that TK3 can be used with other PICs that also have 14-bit program codes, including F83, F84A and no doubt some other devices.

Written in Visual Basic 6, TK3 is run as a fully stand-alone program, and can be used with the new Toolkit Mk3 programming board published in this current issue, or with the well-established Toolkit Mk2 board of May-June '99.

## TEACH-IN 2002

Our new 10-part educational series Teach-In 2002: Making Sense of the Real World, gives you an insight into the world of sensors. More than ever before, sensors are being deployed to measure environmental parameters, so Teach-In 2002 demonstrates what sensors are all about and how to use them effectively.

Also described are some of the key circuits generally involved in sensing and measuring, including amplifiers, filters, comparators and analogue-to-digital converters (ADCs), as well as specific circuits for various sensor applications.

We aim to give Teach-In 2002 a broad appeal, so that every reader will gain something from the series in one way or another. We know that the theory will be highly relevant to schools and university students.

Each part includes practical "Lab Work" based on the sensors, circuits and concepts discussed within it. The experiments can be monitored by a multimeter, or more fully demonstrated via the recommended Picoscope ADC40 PC-based oscilloscope which will be offered to readers at a special price. These labs help reinforce practical principles that you can then incorporate into your own future project designs.



## CAPACITANCE METER

Although some modern multimeters have capacitance-measuring capability, this is often limited to a maximum of around 10 microfarads and is often inaccurate at both ends of the scale.

The circuit described next month allows all types of capacitor, including non-polarised, electrolytic and tantalum, to be measured accurately and over a wide range. It measures capacitance from a few picofarads to 10,000 microfarads in three sub-scales (10nF, 10 $\mu$ F, and 10,000 $\mu$ F) and is accurate across the whole range.

**PLUS ALL THE REGULAR FEATURES**

**NO ONE DOES IT BETTER**

EVERYDAY  
**PRACTICAL**  
**ELECTRONICS**  
INCORPORATING **ELECTRONICS TODAY INTERNATIONAL**

**DON'T MISS AN  
ISSUE - PLACE YOUR  
ORDER NOW!**  
Demand is bound to be high

**NOVEMBER 2001 ISSUE ON SALE THURSDAY, OCTOBER 11**

# QUASAR ELECTRONICS LIMITED

Unit 14 Sunningdale, BISHOPS STORTFORD, Herts. CM23 2PA

TEL: 01279 467799 FAX: 07092 203496

A/D 2000...  
 (United Kingdom) £7, Europe £5.00, Rest of World £10.00. We accept all major credit cards. Make cheques/POs payable to Quasar Electronics.  
 Prices include 17.5% VAT, MAIL ORDER ONLY.  
 FREE CATALOGUE with order or send 2 x 1st class stamps (refundable) for details of over 150 kits & publications.



## PROJECT KITS

Our electronic kits are supplied complete with all components, high quality PCBs (NOT cheap Tripad strip board) and detailed assembly/operating instructions

- **2 x 25W CAR BOOSTER AMPLIFIER** Connects to the output of an existing car stereo cassette player, CD player or radio. Heatsinks provided. PCB 76x75mm. 1046KT £24.95
- **3-CHANNEL WIRELESS LIGHT MODULATOR** No electrical connection with amplifier. Light modulation achieved via a sensitive electret microphone. Separate sensitivity control per channel. Power handling 400W/channel. PCB 54x112mm. Mains powered. Box provided. 6014KT £24.95
- **12 RUNNING LIGHT EFFECT** Exciting 12 LED light effect ideal for parties, discos, shop-windows & eye-catching signs. PCB design allows replacement of LEDs with 220V bulbs by inserting 3 TRIACs. Adjustable rotation speed & direction. PCB 54x112mm. 1026KT £15.95; BOX (for mains operation) 2026BX £9.00
- **DISCO STROBE LIGHT** Probably the most exciting of all light effects. Very bright strobe tube. Adjustable strobe frequency: 1-60Hz. Mains powered. PCB: 60x68mm. Box provided. 6037KT £28.95
- **ANIMAL SOUNDS** Cat, dog, chicken & cow. Ideal for kids farmyard toys & schools. SG10M £5.95
- **3 1/2 DIGIT LED PANEL METER** Use for basic voltage/current displays or customise to measure temperature, light, weight, movement, sound levels, etc. with appropriate sensors (not supplied). Various input circuit designs provided. 3061KT £13.95
- **IR REMOTE TOGGLE SWITCH** Use any TV/VCR remote control unit to switch onboard 12V/1A relay on/off. 3058KT £10.95
- **SPEED CONTROLLER** for any common DC motor up to 100W/5A. Pulse width modulation gives maximum torque at all speeds. 5-15VDC. Box provided. 3067KT £12.95
- **3 x 8 CHANNEL IR RELAY BOARD** Control eight 12V/1A relays by Infra Red (IR) remote control over a 20m range in sunlight. 6 relays turn on only, the other 2 toggle on/off. 3 operation ranges determined by jumpers. Transmitter case & all components provided. Receiver PCB 76x89mm. 3072KT £52.95

## PRODUCT FEATURE

**COMPUTER TEMPERATURE DATA LOGGER**  
 PC serial port controlled 4-channel temperature meter (either deg C or F). Requires no external power. Allows continuous temperature data logging of up to four temperature sensors located 200m+ from motherboard/PC. Ideal use for old 386/486 computers. Users can tailor input data stream to suit their purpose (dump it to a spreadsheet or write your own BASIC programs using the INPUT command to grab the readings). PCB just 38mm x 38mm. Sensors connect via four 3-pin headers, 4 header cables supplied but only one DS18S20 sensor.  
 Kit software available free from our website.  
**ORDERING:** 3145KT £23.95 (kit form); AS3145 £29.95 (assembled); Additional DS18S20 sensors £4.95 each

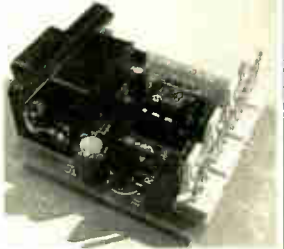

- **SOUND EFFECTS GENERATOR** Easy to build. Create an almost infinite variety of interesting/unusual sound effects from birds chirping to sirens. 9VDC. PCB 54x65mm. 1045KT £8.95
- **ROBOT VOICE EFFECT** Make your voice sound similar to a robot or Darteek. Great fun for discos, school plays, theatre productions, radio stations & playing jokes on your friends when answering the phone! PCB 42x71mm. 1131KT £8.95
- **AUDIO TO LIGHT MODULATOR** Controls intensity of one or more lights in response to an audio input. Sale, modern opto-coupler design. Mains voltage experience required. 3012KT £8.95
- **MUSIC BOX** Activated by light. Plays 8 Christmas songs and 5 other tunes. 3104KT £7.95
- **20 SECOND VOICE RECORDER** Uses non-volatile memory - no battery backup needed. Record/relay messages over & over. Playback as required to greet customers etc. Volume control & built-in mic. 6VDC PCB 50x73mm. 3131KT £12.95
- **TRAIN SOUNDS** 4 selectable sounds: whistle blowing, level crossing bell, 'clickey-clack' & 4 in sequence. SG01M £8.95
- **PC CONTROLLED RELAY BOARD** Convert any 286 upward PC into a dedicated automatic controller to independently turn on/off up to eight lights, motors & other devices around the home, office, laboratory or factory using 8 240VAC/12A onboard relays. DOS utilities, sample test program, full-featured Windows utility & all components (except cable) provided. 12VDC. PCB 70x200mm. 3074KT £31.95
- **2 CHANNEL UHF RELAY SWITCH** Contains the same transmitter/receiver pair as 30A15 below plus the components and PCB to control two 240VAC/10A relays (also supplied). Ultra bright LEDs used to indicate relay status. 3082KT £27.95
- **TRANSMITTER RECEIVER PAIR** 2-button keyboard style 300-375MHz Tx with 30m range. Receiver encoder module with matched decoder IC. Components must be built into a circuit like kit 3082 above. 30A15 £14.95
- **PIC 16C71 4DUR SERVO MOTOR DRIVER** Simultaneously control up to 4 servo motors. Software & all components (except servos/control pots) supplied. 5VDC PCB 50x70mm. 3102KT £15.95
- **UNIPOLAR STEPPER MOTOR DRIVER** for any 5/6/8 lead motor. Fast/slow & single step rates. Direction control & on/off switch. Wave, 2-phase & half-wave step modes. 4 LED indicators. PCB 50x65mm. 3109KT £14.95
- **PC CONTROLLED STEPPER MOTOR DRIVER** Control two unipolar stepper motors (3A max. each) via PC printer port. Wave, 2-phase & half-wave step modes. Software accepts 4 digital inputs from external switches & will single step motors. PCB fits in D-shell case provided. 3113KT £17.95
- **12-BIT PC DATA ACQUISITION/CONTROL UNIT** Similar to kit 3093 above but uses a 12 bit Analogue-to-Digital Converter (ADC) with internal analogue multiplexer. Reads 8 single ended channels or 4 differential inputs or a mixture of both. Analogue inputs read 0-4V. Four TTL/CMOS compatible digital input/outputs. ADC conversion time <10µs. Software (C, QB & Win), extended D shell case & all components (except sensors & cable) provided. 3118KT £52.95
- **LIQUID LEVEL SENSOR/RAIN ALARM** Will indicate fluid levels or simply the presence of fluid. Relay output to control a pump to add/remove water when it reaches a certain level. 1080KT £5.95
- **AM RADIO KIT 1 Tuned Radio Frequency** front-end, single chip AM radio IC & 2 stages of audio amplification. All components inc. speaker provided. PCB 32x102mm. 3063KT £10.95
- **DRILL SPEED CONTROLLER** Adjust the speed of your electric drill according to the job at hand. Suitable for 240V AC mains powered drills up to

## X FACTOR PUBLICATIONS

THE EXPERTS IN RARE & UNUSUAL INFORMATION!

Full details of all X-FACTOR PUBLICATIONS can be found in our catalogue. N.B. Minimum order charge for reports and plans is £5.00 PLUS normal P&P.

- **SUPER-EAR LISTENING DEVICE** Complete plans to build your own parabolic dish microphone. Listen to distant voices and sounds through open windows and even walls! Made from readily available parts. R002 £3.50
- **LOCKS** - How they work and how to pick them. This fact filled report will teach you more about locks and the art of lock picking than many books we have seen at 4 times the price. Packed with information and illustrations. R008 £3.50
- **RADIO & TV JOKER PLANS** We show you how to build three different circuits for disrupting TV picture and sound plus FM radio! May upset your neighbours & the authorities!! DISCRETION REQUIRED. R017 £3.50
- **INFINITY TRANSMITTER PLANS** Complete plans for building the famous Infinity Transmitter. Once installed on the target phone, device acts like a room bug. Just call the target phone & activate the unit to hear all room sounds. Great for home office security! R019 £3.50
- **THE ETHER BOX CALL INTERCEPTOR PLANS** Grabs telephone calls out of thin air! No need to wire-in a phone bug. Simply place the device near the phone lines to hear the conversations taking place! R025 £3.00
- **CASH CREATOR BUSINESS REPORTS** Need ideas for making some cash? Well this could be just what you need! You get 40 reports (approx. 800 pages) on floppy disk that give you information on setting up different businesses. You also get valuable reproduction and duplication rights so that you can sell the manuals as you like. R030 £7.50

# SURVEILLANCE

High performance surveillance bugs. Room transmitters supplied with sensitive electret microphone & battery holder/clip. All transmitters can be received on an ordinary VHF/FM radio between 88-108MHz. Available in Kit Form (KT) or Assembled & Tested (AS).

## ROOM SURVEILLANCE

- **MTX - MINIATURE 3V TRANSMITTER** Easy to build & guaranteed to transmit 300m @ 3V. Long battery life. 3-5V operation. Only 45x18mm. B. 3007KT £8.95 AS3007 £11.95
- **MFTX - MINIATURE 9V TRANSMITTER** Our best selling bug. Super sensitive, high power - 500m range @ 9V (over 1km with 18V supply and better aerial). 45x19mm. 3018KT £7.95 AS3018 £12.95
- **HPTX - HIGH POWER TRANSMITTER** High performance. 2 stage transmitter gives greater stability & higher quality reception. 1000m range @ 12V DC operation. Size 70x15mm. 3032KT £9.95 AS3032 £18.95
- **MMTX - MICRO-MINIATURE 9V TRANSMITTER** The ultimate bug for its size, performance and price. Just 15x25mm. 500m range @ 9V. Good stability 6-18V operation. 3051KT £8.95 AS3051 £14.95
- **VTX - VOLTAGE ACTIVATED TRANSMITTER** Operates only when sounds detected. Low standby current. Variable trigger sensitivity. 500m range. Peaking circuit supplied for maximum RF output. On/off switch. 6V operation. Only 63x38mm. 3028KT £12.95 AS3028 £19.95
- **HARD-WIRED BUG/TWO STATION INTERCOM** Each station has its own amplifier, speaker and mic. Can be set up as either a hard-wired bug or two-station intercom. 10m x 2-core cable supplied. 9V operation. 3021KT £15.95 (kit form only)
- **TRVS - TAPE RECORDER VOX SWITCH** Used to automatically operate a tape recorder (not supplied) via its REMOTE socket when sounds are detected. All conversations recorded. Adjustable sensitivity & turn-off delay. 115x19mm. 3013KT £9.95 AS3013 £21.95



## TELEPHONE SURVEILLANCE

- **MTTX - MINIATURE TELEPHONE TRANSMITTER** Attaches anywhere to phone line. Transmits only when phone is used! Tune-in your radio and hear both parties. 300m range. Uses line as aerial & power source. 20x45mm. 3016KT £8.95 AS3016 £14.95
- **TRI - TELEPHONE RECORDING INTERFACE** Automatically record all conversations. Connects between phone line & tape recorder (not supplied). Operates recorders with 1.5-12V battery systems. Powered from line. 50x33mm. 3033KT £8.95 AS3033 £18.95
- **TPA - TELEPHONE PICK-UP AMPLIFIER/WIRELESS PHONE BUG** Place pick-up coil on the phone line or near phone earpiece and hear both sides of the conversation. 3055KT £11.95 AS3055 £20.95

## HIGH POWER TRANSMITTERS

- **1 WATT FM TRANSMITTER** Easy to construct. Delivers a crisp, clear signal. Two-stage circuit. Kit includes microphone and requires a simple open dipole aerial. 8-30VDC. PCB 42x45mm. 1009KT £14.95
- **4 WATT FM TRANSMITTER** Comprises three RF stages and an audio preamplifier stage. Piezoelectric microphone supplied or you can use a separate preamplifier circuit. Antenna can be an open dipole or Ground Plane. Ideal project for those who wish to get started in the fascinating world of FM broadcasting and want a good basic circuit to experiment with. 12-18VDC. PCB 44x146mm. 1028KT £22.95 AS1028 £34.95
- **15 WATT FM TRANSMITTER (PRE-ASSEMBLED & TESTED)** Four transistor based stages with Philips BLY 88 in final stage. 15 Watts RF power on the air. 88-108MHz. Accepts open dipole, Ground Plane, 5/8, J, or Yagi antennas. 12-18VDC. PCB 70x220mm. SWS meter needed for alignment. 1021KT £99.95
- **SIMILAR TO ABOVE BUT 25W** Output. 1031KT £109.95

700W power. PCB: 48mm x 65mm. Box provided. 6074KT £17.95

- **3 INPUT MONO MIXER** Independent level control for each input and separate bass/treble controls. Input sensitivity: 240mV. 18V DC. PCB: 60mm x 185mm. 1052KT £16.95
- **NEGATIVE/POSITIVE ION GENERATOR** Standard Cockcroft-Walton multiplier circuit. Mains voltage experience required. 3057KT £10.95
- **LED DICE** Classic intro to electronics & circuit analysis. 7 LEDs simulate dice roll, slow down & land on a number at random. 555 IC circuit. 3003KT £9.95
- **STAIRWAY TO HEAVEN** Tests hand-eye co-ordination. Press switch when green segment of LED lights to climb the stairway - miss & start again! Good intro to several basic circuits. 3005KT £9.95
- **ROULETTE LED 'Ball'** spins round the wheel, slows down & drops into a slot. 10 LEDs. Good intro to CMOS decade counters & Op-Amps. 3006KT £10.95
- **9V XENON TUBE FLASHER** Transformer circuit steps up 9V battery to flash a 25mm Xenon tube. Adjustable flash rate (0.25-2 Sec's). 3022KT £11.95
- **LED FLASHER 1** 5 ultra bright red LEDs flash in 7 selectable patterns. 3037MKT £5.95
- **LED FLASHER 2** Similar to above but flash in sequence or randomly. Ideal for model railways. 3052MKT £5.95
- **INTRODUCTION TO PIC PROGRAMMING.** Learn programming from scratch. Programming hardware, a P16F84 chip and a two-part, practical, hands-on tutorial series are provided. 3081KT £22.95
- **SERIAL PIC PROGRAMMER** for all 818/28/40 pin DIP serial programmed PICs. Shareware software supplied limited to programming 256 bytes (registration costs £14.95). 3096KT £13.95
- **ATMEL 89C051 PROGRAMMER** Simple-to-use yet powerful programmer for the Atmel 89C1051, 89C2051 & 89C4051 uC's. Programmer does NOT require special software other than a terminal emulator program (built into Windows). Can be used with ANY computer/operating system. 3121KT £24.95
- **3V/1.5V TO 9V BATTERY CONVERTER** Replace expensive 9V batteries with economic 1.5V batteries. IC based circuit steps up 1 or 2 'AA' batteries to give 9V/18mA. 3035KT £5.95
- **STABILISED POWER SUPPLY 3-30V/2.5A** Ideal for hobbyist & professional laboratory. Very reliable & versatile design at an extremely reasonable price. Short circuit protection. Variable DC voltages (3-30V). Rated output 2.5 Amps. Large heatsink supplied. You just supply a 24VAC/3A transformer. PCB 55x112mm. Mains operation. 1007KT £16.95.
- **STABILISED POWER SUPPLY 2-30V/5A** As kit 1007 above but rated at 5Amp. Requires a 24VAC/5A transformer. 1096KT £27.95.
- **MOTORBIKE ALARM** Uses a reliable vibration sensor (adjustable sensitivity) to detect movement of the bike to trigger the alarm & switch the output relay to which a siren, bikes horn, indicators or other warning device can be attached. Auto-reset. 6-12VDC. PCB 57x64mm. 1011KT £11.95 Box 2011BX £7.00
- **CAR ALARM SYSTEM** Protect your car from theft. Features vibration sensor, courtesy/boot light voltage drop sensor and bonnet/boot earth switch sensor. Entry/exit delays, auto-reset and adjustable alarm duration. 6-12V DC. PCB: 47mm x 55mm. 1019KT £11.95 Box 2019BX £8.00
- **PIEZO SCREAMER** 1100dB of ear piercing noise. Fits in box with 2 x 35mm piezo elements built into their own resonant cavity. Use as an alarm siren or just for fun! 6-9VDC. 3015KT £10.95
- **COMBINATION LOCK** Versatile electronic lock comprising main circuit & separate keypad for remote opening of lock. Relay supplied. 3029KT £10.95
- **ULTRASONIC MOVEMENT DETECTOR** Crystal locked detector frequency for stability & reliability. PCB 75x40mm houses all components. 4-7m range. Adjustable sensitivity. Output will drive external relay/circuits. 9VDC. 3049KT £13.95
- **PIR DETECTOR MODULE** 3-lead assembled unit just 25x35mm as used in commercial burglar alarm systems. 3076KT £8.95
- **INFRARED SECURITY BEAM** When the invisible IR beam is broken a relay is tripped that can be used to sound a bell or alarm. 25 metre range. Mains rated relays provided. 12VDC operation. 3130KT £12.95
- **SQUARE WAVE OSCILLATOR** Generates square waves at 6 preset frequencies in factors of 10 from 1Hz-100KHz. Visual output indicator. 5-18VDC. Box provided. 3111KT £8.95
- **PC DRIVEN POCKET SAMPLER/DATA LOGGER** Analogue voltage sampler records voltages up to 2V or 20V over periods from milli-seconds to months. Can also be used as a simple digital scope to examine audio & other signals up to about 5KHz. Software & D-shell case provided. 3112KT £18.95
- **20 MHz FUNCTION GENERATOR** Square, triangular and sine waveform up to 20MHz over 3 ranges using 'coarse' and 'fine' frequency adjustment controls. Adjustable output from 0.2V p-p. A TTL output is also provided for connection to a frequency meter. Uses MAX038 IC. Plastic case with printed front/rear panels & all components provided. 7-12VAC. 3101KT £69.95

BARGAIN BUY!

## 30-In-ONE Electronic Projects Lab

Great introduction to electronics. Ideal for the budding electronics expert! Build a radio, burglar alarm, water detector, Morse code practice circuit, simple computer circuits, and much more! NO soldering, tools or previous electronics knowledge required. Circuits can be built and unassembled repeatedly. Comprehensive 68-page manual with explanations, schematics and assembly diagrams. Suitable for age 10+. Excellent for schools. Requires 2 x AA batteries. ONLY £14.95 (phone for bulk discounts).



Secure Online Ordering Facilities  
 Full Kit Listing, Descriptions & Photos  
 Kit Documentation & Software Downloads

WEB: <http://www.QuasarElectronics.com>  
 email: [epesales@QuasarElectronics.com](mailto:epesales@QuasarElectronics.com)

www.QuasarElectronics.com

Credit Card Sales: 01279 306504

## 'PICALL' PIC Programmer

Kit will program ALL 8\*, 18\*, 28 and 40 pin serial AND parallel programmed PIC micro controllers. Connects to PC parallel port. Supplied with fully functional pre-registered PICALL DOS and WINDOWS AVR software packages, all components and high quality DSPTH PCB. Also programs certain ATMEL AVR, serial EPROM 24C and SCENIX SX devices. New PIC's can be added to the software as they are released. Software shows you where to place your PIC chip on the board for programming. Now has blank chip auto sensing feature for super-fast bulk programming. \*A 40 pin wide ZIF socket is required to program 8 & 18 pin devices (available at £15.95).



3117KT	'PICALL' PIC Programmer Kit	£59.95
AS3117	Assembled 'PICALL' PIC Programmer	£69.95
AS3117ZIF	Assembled 'PICALL' PIC Programmer c/w ZIF socket	£84.95

## ATMEL AVR Programmer

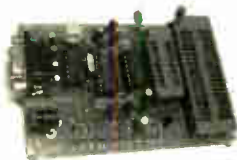

Powerful programmer for Atmel AT90Sxxx (AVR) micro controller family. All fuse and lock bits are programmable. Connects to serial port. Can be used with ANY computer and operating system. Two LEDs to indicate programming status. Supports 20-pin DIP AT90S1200 & AT90S2313 and 40-pin

DIP AT90S4414 & AT90S8515 devices. NO special software required - uses any terminal emulator program (built into Windows). The programmer is supported by BASCOM-AVR Basic Compiler software (see website for details).

NB ZIF sockets not included.

3122KT	ATMEL AVR Programmer	£24.95
AS3122	Assembled 3122	£39.95

Atmel 89Cx051 and 89xxx programmers also available.

## PC Data Acquisition & Control Unit

With this kit you can use a PC parallel port as a real world interface. Unit can be connected to a mixture of analogue and digital inputs from pressure, temperature, movement, sound, light intensity, weight sensors, etc. (not supplied) to sensing switch and relay states. It can then process the input data and use the information to control up to 11 physical devices such as motors, sirens, other relays, servo motors & two-stepper motors.



### FEATURES:

- 8 Digital Outputs: Open collector, 500mA, 33V max.
- 16 Digital Inputs: 20V max. Protection 1K in series, 5-1V Zener to ground.
- 11 Analogue Inputs: 0-5V, 10 bit (5mV/step.)
- 1 Analogue Output: 0-2.5V or 0-10V. 8 bit (20mV/step.)

All components provided including a plastic case (140mm x 110mm x 35mm) with pre-punched and silk screened front/rear panels to give a professional and attractive finish (see photo) with screen printed front & rear panels supplied. Software utilities & programming examples supplied.

3093KT	PC Data Acquisition & Control Unit	£99.95
AS3093	Assembled 3093	£124.95

See opposite page for ordering information on these kits

## ABC Mini 'Hotchip' Board



Currently learning about microcontrollers? Need to do something more than flash a LED or sound a buzzer? The ABC Mini 'Hotchip' Board is based on Atmel's AVR 8535 RISC technology and will interest both the beginner and expert alike. Beginners will find that they can write and test a simple program, using the BASIC programming language, within an hour or two of connecting it up.

Experts will like the power and flexibility of the ATMEL microcontroller, as well as the ease with which the little Hot Chip board can be "designed-in" to a project. The ABC Mini Board 'Starter Pack' includes just about everything you need to get up and experimenting right away. On the hardware side, there's a pre-assembled micro controller PC board with both parallel and serial cables for connection to your PC. Windows software included on CD-ROM features an Assembler, BASIC compiler and in-system programmer. The pre-assembled boards only are also available separately.

ABCMINISP	ABC MINI Starter Pack	£64.95
ABCMINIB	ABC MINI Board Only	£39.95

## Advanced Schematic Capture and Simulation Software

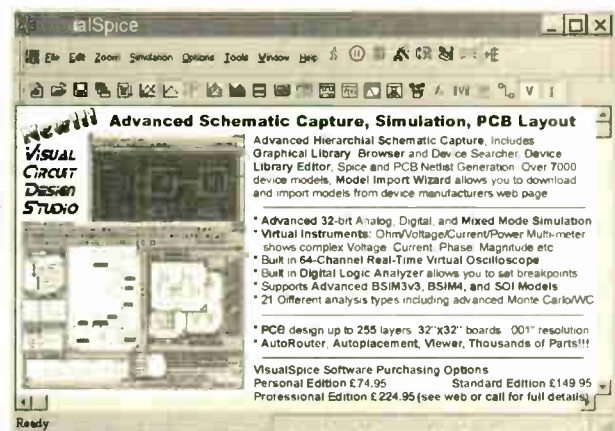

**Advanced Schematic Capture, Simulation, PCB Layout**

Advanced Hierarchical Schematic Capture, includes Graphical Library, Browser and Device Searcher, Device Library Editor, Spice and PCB Netlist Generation. Over 7000 device models. Model Import Wizard allows you to download and import models from device manufacturers web page

- Advanced 32-bit Analog, Digital, and Mixed Mode Simulation
- Virtual Instruments: Ohm/Voltage/Current/Power Multi-meter shows complex Voltage, Current, Phase, Magnitude etc
- Built in 64-Channel Real-Time Virtual Oscilloscope
- Built in Digital Logic Analyzer allows you to set breakpoints
- Supports Advanced BSM3v3, BSM4, and SOI Models
- 21 Different analysis types including advanced Monte Carlo/WC

• PCB design up to 255 layers, 32"x32" boards, .001" resolution  
• AutoRouter, AutoPlacement, Viewer, Thousands of Parts!!!

VisualSpice Software Purchasing Options  
Personal Edition £74.95      Standard Edition £149.95  
Professional Edition £224.95 (see web or call for full details)

## Serial Port Isolated I/O Controller

Kit provides eight 240VAC/12A (110VAC/15A) rated relay outputs and four optically isolated inputs. Can be used in a variety of control and sensing applications including load switching, external switch input sensing, contact closure and external voltage sensing. Programmed via a computer serial port, it is compatible with ANY computer & operating system. After programming, PC can be disconnected. Serial cable can be up to 35m long, allowing 'remote' control. User can easily write batch file programs to control the kit using simple text commands. NO special software required - uses any terminal emulator program (built into Windows). All components provided including a plastic case with pre-punched and silk screened front/rear panels to give a professional and attractive finish (see photo).



3108KT	Serial Port Isolated I/O Controller Kit	£54.95
AS3108	Assembled Serial Port Isolated I/O Controller	£69.95

## Watch Slides on TV.

Make videos of your slides. Digitise your slides (using a video capture card) "Liesgang diatv" automatic slide viewer with built in high quality colour TV camera. It has a composite video output to a phono plug (SCART & BNC adaptors are available). They are in very good condition with few signs of use. More details see [www.diatv.co.uk](http://www.diatv.co.uk)  
£91.91 + VAT = £108.00



Board cameras all with 512 x 582 pixels 8.5mm 1/3 inch sensor and composite video out. All need to be housed in your own enclosure and have fragile exposed surface mount parts. They all require a power supply of between 10V and 12V DC 150mA.  
47MIR size 60 x 36 x 27mm with 6 infra red LEDs (gives the same illumination as a small torch but is not visible to the human eye) £37.00 + VAT = £43.48  
30MP size 32 x 32 x 14mm spy camera with a fixed focus pin hole lens for hiding behind a very small hole £35.00 + VAT = £41.13  
40MC size 39 x 38 x 27mm camera for 'C' mount lens these give a much sharper image than with the smaller lenses £32.00 + VAT = £37.60  
Economy C mount lenses all fixed focus & fixed iris  
VSL1220F 12mm F1.6 12 x 15 degrees viewing angle £15.97 + VAT £18.76  
VSL4022F 4mm F1-22 63 x 47 degrees viewing angle £17.65 + VAT £20.74  
VSL6022F 6mm F1-22 42 x 32 degrees viewing angle £19.05 + VAT £22.38  
VSL8020F 8mm F1-22 32 x 24 degrees viewing angle £19.90 + VAT £23.38

## Better quality C Mount lenses

VSL1614F 16mm F1-6 30 x 24 degrees viewing angle £26.43 + VAT £31.06  
VWL13M 8mm F1.3 with iris 56 x 42 degrees viewing angle £77.45 + VAT = £91.00  
1206 surface mount resistors E12 values 10 ohm to 1M ohm  
100 of 1 value £1.00 + VAT 1000 of 1 value £5.00 + VAT

866 battery pack originally intended to be used with an orbital mobile telephone it contains 10 1.6Ah sub C batteries (42 x 22 dia. the size usually used in cordless screwdrivers etc.) the pack is new and unused and can be broken open quite easily  
£7.46 + VAT = £8.77



Please add £1.66 + vat = £1.95 postage & packing per order

## JPG Electronics

Shaws Row, Old Road, Chesterfield, S40 2RB.

Tel 01246 211202 Fax 01246 550959

Mastercard/Visa/Switch

Callers welcome 9.30 a.m. to 5.30 p.m. Monday to Saturday

## FRUSTRATED!

### Looking for ICs TRANSISTORS?

A phone call to us could get a result. We offer an extensive range and with a world-wide database at our fingertips, we are able to source even more. We specialise in devices with the following prefix (to name but a few).



2N 2SA 2SB 2SC 2SD 2P 2SJ 2SK 3N 3SK 4N 6N 17 40 AD  
ADC AN AM AY BA BC BD BDT BDV BDW BDX BF  
BFR BFS BFT BFX BFY BLY BLX BS BR BRX BRY BS  
BSS BSV BSW BSX BT BTA BTB BRW BU BUK BUT BUY  
BUW BUX BUY BUZ CA CD CX CXA DAC DG DM DS  
DTA DTC GL GM HA HCF HD HEF ICL ICM IRF J KA  
KIA L LA LB LC LD LF LM M M5M MA MAB MAX MB  
MC MDAJ MJE MJF MM MN MPS MPA MPAH MPSU  
MRF NJM NE OM OP PA PAL PIC PN RC S SAA SAB  
SAD SAJ SAS SDA SG SI SL SN SO STA STK STR STRD  
STRM STRS SV1 T TA TAA TAG TBA TC TCA TDA TDB  
TEA TIC TIP TIPL TEA TL TLC TMP TMS TPU U UA  
UAA UC UDN ULN UM UPA UPC UPD VN X XR Z ZN  
ZTS + many others

We can also offer equivalents (at customers' risk)

We also stock a full range of other electronic components  
Mail, phone, Fax Credit Card orders and callers welcome



Connect

## Cricklewood Electronics Ltd

40-42 Cricklewood Broadway London NW2 3ET  
Tel: 020 8452 0161 Fax: 020 8208 1441

## VARIABLE VOLTAGE TRANSFORMERS

INPUT 220V/240V AC 50/60Hz OUTPUT 0V-260V

PANEL MOUNTING

Price	P&P
0-5KVA 2.5 amp max £33.00	£6.00
1KVA 5 amp max £45.25	(£45.84 inc VAT)
	£7.00
	(£61.39 inc VAT)

### SHROUDED

0-5KVA 2.5 amp max £34.00	£6.00
1KVA 5 amp max £46.25	£7.00
	(£47.00 inc VAT)
2KVA 10 amp max £65.00	£8.50
	(£62.57 inc VAT)
3KVA 15 amp max £86.50	£8.50
	(£111.63 inc VAT)

5KVA 25 amp max £150.00 (+ Carriage & VAT)  
Buy direct from the Importers. Keenest prices in the country.

### 500VA ISOLATION TRANSFORMER

Input lead 240V AC. Output via 3-pin 13A socket. 240V AC continuously rated. Mounted in fibreglass case with handle. Internally fused. Price £35.00 carriage paid + VAT (£41.13)

### TOROIDAL L.T. TRANSFORMER

Primary 0-240V AC. Secondary 0-30V + 0-30V 600VA. Fixing bolt supplied.  
Price £25.00 carriage paid + VAT (£29.38)

### COMPREHENSIVE RANGE OF TRANSFORMERS - LT-ISOLATION & AUTO

110V-240V Auto transfer either cased with American socket and mains lead or open frame type. Available for immediate delivery.

### ULTRA VIOLET BLACK LIGHT BLUE FLUORESCENT TUBES

4ft 40 watt £14.00 (callers only)	(£16.45 inc VAT)
2ft 20 watt £9.00 (callers only)	(£10.58 inc VAT)
12in 8 watt £4.90 + 75p p&p	(£6.52 inc VAT)
9in 6 watt £3.96 + 50p p&p	(£5.24 inc VAT)
6in 4 watt £3.96 + 50p p&p	(£5.24 inc VAT)

### 230V AC BALLAST KIT

For either 6in, 9in or 12in tubes £6.06-£11.40 p&p (£8.75 inc VAT)  
The above Tubes are 3500/4000 angstrom (350-400nm) ideal for detecting security markings, effects lighting & Chemical applications.  
Other Wavelengths of UV TUBE available for Germedal & Photo Sensitive applications. Please telephone your enquiries.

### 400 WATT BLACK LIGHT BLUE UV LAMP

GES Mercury Vapour lamp suitable for use with a 400W P.F. Ballast.  
Only £39.95 incl. p&p & VAT



### 5 KVA ISOLATION TRANSFORMER

As New. Ex-Equipment, fully shrouded. Line Noise Suppression, Ultra Isolation Transformer with terminal covers and knock-out cable entries. Primary 120V/240V, Secondary 120V/240V, 50/60Hz, 0-005pF Capacitance. Size, L 37cm x W 19cm x H 16cm. Weight 42 kilos. Price £120 + VAT. Ex-warehouse. Carriage on request.

### 24V DC SIEMENS CONTACTOR

Type 3TH8022-0B 2 x NO and 2 x NC 230V AC 10A. Contacts. Screw or Din Rail fixing. Size H 120mm x W 45mm x D 75mm. Brand New Price £7.63 incl. p&p and VAT.

### 240V AC WESTOOL SOLENOIDS

Model TT2 Max. 6mm. 15lb. pull. Base mounting. Rating 1. Model TT6 Max. stroke 25mm, 15lb. pull. Base mounting. Rating 1. Series 400 Max. stroke 28mm, 15lb. pull. Front mounting. Rating 2. Prices inc. p&p & VAT: TT2 £5.88, TT6 £8.81, Series 400 £8.84.

### AXIAL COOLING FAN

230V AC 120mm square x 38mm 3 blade 10 watt Low Noise fan. Price £7.29 incl. p&p & VAT.  
Other voltages and sizes available from stock. Please telephone your enquiries.

### INSTRUMENT CASE

Brand new. Manufactured by Imhof. L 31cm x H 18cm x 19cm Deep. Removable front and rear panel for easy assembly of your components. Grey textured finish, complete with case feet. Price £16.45 incl. p&p and VAT. 2 off £28.20 inclusive.

### DIECAST ALUMINIUM BOX

with internal PCB guides. Internal size 265mm x 165mm x 50mm deep. Price £9.93 incl. p&p & VAT. 2 off £17.80 incl.

### 230V AC SYNCHRONOUS GEARED MOTORS

Brand new. Ovoid Gearbox. Crouzet type motors. H 65mm x W 55mm x D 35mm, 4mm dia. shaft x 10mm long. 6 RPM anti cw. £9.99 incl. p&p & VAT.  
20 RPM anti cw. Depth 40mm. £11.18 incl. p&p & VAT.

### 16 RPM REVERSIBLE Crouzet 220V/230V

50Hz geared motor with ovoid gear box. 4mm dia. shaft. New manu. surplus. Sold complete with reversing capacitor, connecting block and circ. Overall size: h 68mm x w 52mm x d 43mm deep

PRICE incl. P&P & VAT £9.99

### EPROM ERASURE KIT

Build your own EPROM ERASURE for a fraction of the price of a made-up unit. Kit of parts less case includes 12in. 8watt 2537 Angstrom Tube Ballast unit, pair of bi-pin leads, neon indicator, on/off switch, safety microswitch and circuit £15.00+£2.00 p&p. (£19.90 inc VAT)

### WASHING MACHINE WATER PUMP

Brand new 240V AC fan cooled. Can be used for a variety of purposes. Inlet 1 1/2 in., outlet 1 in. dia. Price includes p&p & VAT. £11.20 each or 2 for £20.50 inclusive.

## ELECTRONICS SURPLUS CLEARANCE SALE

### SCOOP PURCHASE:

### FLUKE HAND HELD DIGITAL MULTIMETER, MODEL 8024B

Cancelled export order 750V AC/DC 2 amp AC/DC Resistance 20Megohm plus Siemens range. Also measures temperature -20°C to +1265°C. Temp. probe not included. Calibrated for K-type thermocouple. Peak hold facility. Supplied brand new and boxed but with original purchasing organisation's small identifying mark on case. Test leads and handbook included.

Offered at a fraction of original price: £47.50, p&p £6.50

A DIGITAL HANDHELD LCR METER. Measuring inductance, capacitance and resistance. 3-5 digit, 1999 count, l.c.d. display, inductance range 2MH to 20H, capacitance range 2000pF to 200µF, resistance range 200Ω to 20 megohms. Brand new and boxed with test alligator-clip leads and user manual. £44 + £3 p&p.

VARIABLE 0-15V D.C. OUTPUT, 3 amp continuous, ±1% stability. Digital readout. Attractive cabinet 29 x 126 x 164mm. £39.50. Carriage £6.50.

MAGNETIC CREDIT CARD READER. Keyboard and laptop display system. Point of sale unit. Cost over £150, our price £12.50, carriage £6.50. Two units for £35 including carriage. To be used for experimental purposes only. No info.



OC42 VINTAGE TRANSISTORS. Individually wrapped, military spec. 10 for £2.50 including post.

HEAVY DUTY 80 WATT SOLDERING IRONS. Extra long life. Mains input. Bargain price £11.95. P&P £4.

### BOOKS:

ELECTRIC UFOs by Albert Budden. A chilling exposure of electromagnetic pollution and its effects on the environment and health including fireballs, UFOs and abnormal states. Many case studies and field investigations and experiments. 286 pages, photos. £7.50, p&p £2.50.

THE ELECTRONICS SURPLUS TRADER - This is a listing of new first class components, books and electronic items at below trade prices. Includes manufacturers' surplus and overstocks. Also obsolete semiconductors, valves and high voltage caps and components, audio components and accessories.

Send two first class stamps for large catalogue.

## (Dept E) CHEVET SUPPLIES LTD

157 Dickson Road, BLACKPOOL FY1 2EU

Tel: (01253) 751858. Fax: (01253) 302979

E-mail: [chevet@globalnet.co.uk](mailto:chevet@globalnet.co.uk) Telephone Orders Accepted

Callers welcome Tues, Thurs, Fri and Sat.



## SERVICE TRADING CO

57 BRIDGMAN ROAD, CHISWICK, LONDON W4 5BB

Tel: 020 8995 1560

FAX: 020 8995 0549



Ample Parking Space



# Learn The Easy Way!

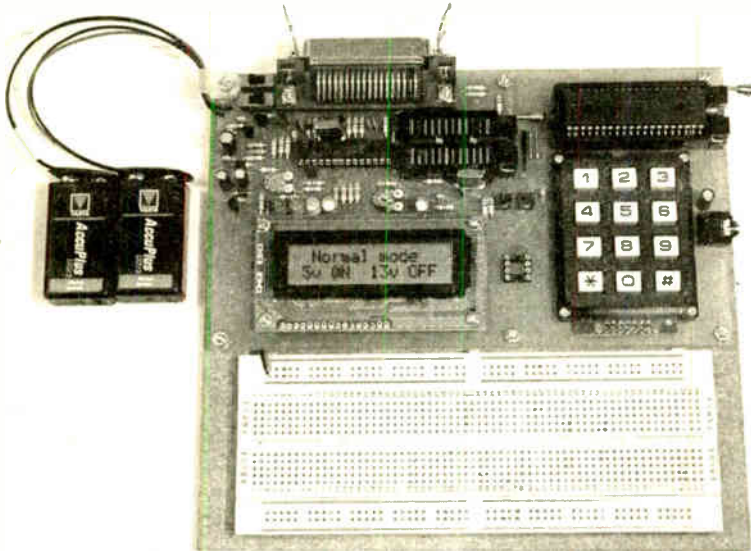

## PIC Training & Development System

The heart of our system is a real book which lies open on your desk while you use your computer to type in the programme and control the hardware. Start with four very simple programmes. Run the simulator to see how they work. Test them with real hardware. Follow on with a little theory....

The best place to start learning about microcontrollers is the PIC16F84. This is easy to understand and very popular with construction projects. Then continue on using the more sophisticated PIC16F877 family.

Our complete PIC training and development system consists of our universal mid range PIC programmer, a 306 page book covering the PIC16F84, a 212 page book introducing the PIC16F877 family, and a suite of programmes to run on a PC. The module is an advanced design using a 28 pin PIC16F872 to handle the timing, programming and voltage switching requirements. The module has two ZIF sockets and an 8 pin socket which between them allow most mid range 8, 18, 28 and 40 pin PICs to be programmed. The plugboard is wired with a 5 volt supply. The software is an integrated system comprising a text editor, assembler disassembler, simulator and programming software. The programming is performed at normal 5 volts and then verified with plus and minus 10% applied to ensure that the device is programmed with a good margin and not poised on the edge of failure. Requires two PP3 batteries which are not supplied.

- Universal mid range PIC programmer module
- + Book Experimenting with PIC Microcontrollers
- + Book Experimenting with the PIC16F877
- + Universal mid range PIC software suite
- + PIC16F84 and PIC16F872 test PICs ..... £157.41
- UK Postage and insurance ..... £ 7.50
- (Europe postage & insurance ..... £13.00. Rest of world ..... £22.00)

## Experimenting with PIC Microcontrollers

This book introduces the PIC16F84 and PIC16C711, and is the easy way to get started for anyone who is new to PIC programming. We begin with four simple experiments, then having gained some practical experience we study the basic principles of PIC programming, learn about the 8 bit timer, how to drive the liquid crystal display, create a real time clock, experiment with the watchdog timer, sleep mode, beeps and music, including a rendition of Beethoven's *Für Elise*. Finally there are two projects to work through, using the PIC16F84 to create a sawwave generator and investigating the power taken by domestic appliances.

## Experimenting with the PIC16F877

We start with the simplest of experiments to get a basic understanding of the PIC16F877 family. Then we look at the 16 bit timer, efficient storage and display of text messages, simple frequency counter, use a keypad for numbers, letters and security codes, and examine the 10 bit A/D converter.

## Ordering Information

Telephone with Visa, Mastercard or Switch, or send cheque/PO for immediate despatch. All prices include VAT if applicable. Postage must be added to all orders. UK postage £2.50 per book, £1.00 per kit, maximum £7.50. Europe postage £3.50 per book, £1.50 per kit. Rest of World £6.50 per book, £2.50 per kit.  
Web site:- [www.brunningssoftware.co.uk](http://www.brunningssoftware.co.uk)

## NEW 32 bit PC Assembler

*Experimenting with PC Computers* with its kit is the easiest way ever to learn assembly language programming. If you have enough intelligence to understand the English language and you can operate a PC computer then you have all the necessary background knowledge. Flashing LEDs, digital to analogue converters, simple oscilloscope, charging curves, temperature graphs and audio digitising. Kit now supplied with our 32 bit assembler with 84 page supplement detailing the new features and including 7 experiments PC to PIC communication. Flashing LEDs, writing to LCD and two way data using 3 wires from PC's parallel port to PIC16F84.

- Book *Experimenting with PCs* ..... £21.50
- Kit 1a 'made up' with software ..... £52.00
- Kit 1u 'unmade' with software ..... £45.00

## C & C++ for the PC

*Experimenting with C & C++ Programmes* teaches us to programme by using C to drive the simple hardware circuits built using the materials supplied in the kit. The circuits build up to a storage oscilloscope using relatively simple C techniques to construct a programme that is by no means simple. When approached in this way C is only marginally more difficult than BASIC and infinitely more powerful. C programmers are always in demand. Ideal for absolute beginners and experienced programmers.

- Book *Experimenting with C & C++* ..... £24.99
- Kit CP2a 'made up' with software ..... £32.51
- Kit CP2u 'unmade' with software ..... £26.51
- Kit CP2t 'top up' with software ..... £12.99

## The Kits

The assembler and C & C++ kits contain the prototyping board, lead assemblies, components and programming software to do all the experiments. The 'made up' kits are supplied ready to start. The 'top up' kit is for readers who have already purchased kit 1a or 1u. The kits do not include the book.

## Hardware required

All systems in this advertisement assume you have a PC (386 or better) and a printer lead. The experiments require no soldering.

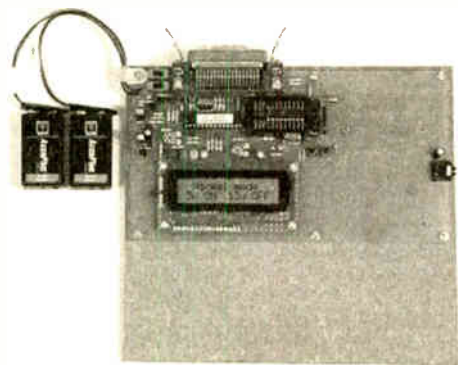

## Part built PIC Training System

This has the same specification as the complete system but is supplied without the keypad, 40 pin ZIF socket and plugboard, with just one book *Experimenting with PIC Microcontrollers*, and with software to programme the PIC16F84 & PIC16C711. Can be upgraded later to the full specification.

- Part built universal PIC programmer module
- +Book: *Experimenting with PIC Microcontrollers*
- +84/711 software suite and PIC16F84 ..... £92.50
- UK postage and packing ..... £ 5.00
- (Europe postage .... £7.50. Rest of World .... £13.00)

Mail order address:

**Brunning Software** 138 The Street, Little Clacton, Clacton-on-sea, Essex, CO16 9LS. Tel 01255 862308



**MAIL ORDER ONLY • CALLERS BY APPOINTMENT**

**EPE MICROCONTROLLER  
P.I. TREASURE HUNTER**

The latest MAGENTA DESIGN – highly stable & sensitive – with I.C. control of all timing functions and advanced pulse separation techniques.

- High stability drift cancelling
- Easy to build & use
- No ground effect, works in seawater



- Detects gold, silver, ferrous & non-ferrous metals

- Efficient quartz controlled microcontroller pulse generation.
- Full kit with headphones & all hardware

**KIT 847 .....£63.95**

**PORTABLE ULTRASONIC  
PEsT SCARER**

A powerful 23kHz ultrasound generator in a compact hand-held case. MOSFET output drives a special sealed transducer with intense pulses via a special tuned transformer. Sweeping frequency output is designed to give maximum output without any special setting up.

**KIT 842.....£22.56**

**68000 DEVELOPMENT  
TRAINING KIT**

- NEW PCB DESIGN
- 8MHz 68000 16-BIT BUS
- MANUAL AND SOFTWARE
- 2 SERIAL PORTS
- PIT AND I/O PORT OPTIONS
- 12C PORT OPTIONS

**KIT 621**

**£99.95**

- ON BOARD 5V REGULATOR
- PSU £6.99
- SERIAL LEAD £3.99

**Stepping Motors**

- MD38...Mini 48 step...£8.65
- MD35...Std 48 step...£9.99
- MD200...200 step...£12.99
- MD24...Large 200 step...£22.95



**PIC PIPE DESCALER**

- SIMPLE TO BUILD
- HIGH POWER OUTPUT
- AUDIO & VISUAL MONITORING
- SWEPT FREQUENCY

An affordable circuit which sweeps the incoming water supply with variable frequency electromagnetic signals. May reduce scale formation, dissolve existing scale and improve lathering ability by altering the way salts in the water behave. Kit includes case, P.C.B., coupling coil and all components. High coil current ensures maximum effect. L.E.D. monitor.



**KIT 868 ..... £22.95 POWER UNIT.....£3.99**

**MICRO PEsT  
SCARER**

Our latest design – The ultimate scarer for the garden. Uses special microchip to give random delay and pulse time. Easy to build reliable circuit. Keeps pets/pests away from newly sown areas, play areas, etc. uses power source from 9 to 24 volts.

- RANDOM PULSES
- HIGH POWER
- DUAL OPTION



Plug-in power supply £4.99

**KIT 867.....£19.99**

**KIT + SLAVE UNIT.....£32.50**

**WINDICATOR**

A novel wind speed indicator with LED readout. Kit comes complete with sensor cups, and weatherproof sensing head. Mains power unit £5.99 extra.

**KIT 856.....£28.00**

**★ TENS UNIT ★**

**DUAL OUTPUT TENS UNIT**  
As featured in March '97 issue.

Magenta have prepared a FULL KIT for this, excellent new project. All components, PCB, hardware and electrodes are included. Designed for simple assembly and testing and providing high level dual output drive.

Set of 4 spare electrodes £6.50

**KIT 866. . Full kit including four electrodes £32.90**

**1000V & 500V INSULATION  
TESTER**



Superb new design. Regulated output, efficient circuit. Dual-scale meter, compact case. Reads up to 200 Megohms. Kit includes wound coil, cut-out case, meter scale, PCB & ALL components.

**KIT 848. .... £32.95**

**EPE  
TEACH-IN  
2000**

Full set of top quality NEW components for this educational series. All parts as specified by EPE. Kit includes breadboard, wire, croc clips, pins and all components for experiments, as listed in introduction to Part 1.

\*Batteries and tools not included.

**TEACH-IN 2000 -**

**KIT 879 £44.95  
MULTIMETER £14.45**

**SPACEWRITER**

An innovative and exciting project. Wave the wand through the air and your message appears. Programmable to hold any message up to 16 digits long. Comes pre-loaded with "MERRY XMAS". Kit includes PCB, all components & tube plus instructions for message loading.

**KIT 849 .....£16.99**

**12V EPROM ERASER**

A safe low cost eraser for up to 4 EPROMs at a time in less than 20 minutes. Operates from a 12V supply (400mA). Used extensively for mobile work - updating equipment in the field etc. Also in educational situations where mains supplies are not allowed. Safety interlock prevents contact with UV.

**KIT 790 .....£29.90**

**SUPER BAT  
DETECTOR**

1 WATT O/P, BUILT IN  
SPEAKER, COMPACT CASE  
20kHz-140kHz  
NEW DESIGN WITH 40kHz MIC.

A new circuit using a 'full-bridge' audio amplifier i.c., internal speaker, and headphone/tape socket. The latest sensitive transducer, and 'double balanced mixer' give a stable, high performance superheterodyne design.



**KIT 861 .....£24.99**

ALSO AVAILABLE Built & Tested. . . £39.99

**MOSFET MkII VARIABLE BENCH  
POWER SUPPLY 0-25V 2-5A**

Based on our Mk1 design and preserving all the features, but now with switching pre-regulator for much higher efficiency. Panel meters indicate Volts and Amps. Fully variable down to zero. Toroidal mains transformer. Kit includes punched and printed case and all parts. As featured in April 1994 EPE. An essential piece of equipment.



Kit No. 845 .....£64.95

**EPE  
PROJECT  
PICS**

Programmed PICs for all\* EPE Projects  
16C84/18F84/16C71  
All **£5.90 each**  
PIC16F877 now in stock  
**£10 inc. VAT & postage**  
(\*some projects are copyright)

**ULTRASONIC PEsT SCARER**

Keep pets/pests away from newly sown areas, fruit, vegetable and flower beds, children's play areas, patios etc. This project produces intense pulses of ultrasound which deter visiting animals.

- KIT INCLUDES ALL COMPONENTS, PCB & CASE
- EFFICIENT 100V TRANSDUCER OUTPUT
- COMPLETELY INAUDIBLE TO HUMANS



- UP TO 4 METRES RANGE
- LOW CURRENT DRAIN

**KIT 812.....£15.00**

## SIMPLE PIC PROGRAMMER

INCREDIBLE LOW PRICE! Kit 857 **£12.99**

INCLUDES 1-PIC16F84 CHIP  
SOFTWARE DISK, LEAD  
CONNECTOR, PROFESSIONAL  
PC BOARD & INSTRUCTIONS

Power Supply £3.99

EXTRA CHIPS:

PIC 16F84 £4.84

Based on February '96 EPE. Magenta designed PCB and kit. PCB with 'Reset' switch, Program switch, 5V regulator and test L.E.D.s, and connection points for access to all A and B port pins.

## PIC 16C84 DISPLAY DRIVER

INCLUDES 1-PIC16F84 WITH  
DEMO PROGRAM SOFTWARE  
DISK, PCB, INSTRUCTIONS  
AND 16-CHARACTER 2-LINE  
LCD DISPLAY

Kit 860 **£19.99**

Power Supply £3.99

FULL PROGRAM SOURCE  
CODE SUPPLIED - DEVELOP  
YOUR OWN APPLICATION!

Another super PIC project from Magenta. Supplied with PCB, industry standard 2-LINE x 16-character display, data, all components, and software to include in your own programs. Ideal development base for meters, terminals, calculators, counters, timers - Just waiting for your application!

## PIC 16F84 MAINS POWER 4-CHANNEL CONTROLLER & LIGHT CHASER

- WITH PROGRAMMED 16F84 AND DISK WITH SOURCE CODE IN MPASM
- ZERO VOLT SWITCHING
- MULTIPLE CHASE PATTERNS
- OPTO ISOLATED
- 5 AMP OUTPUTS
- 12 KEYPAD CONTROL
- SPEED/DIMMING POT.
- HARD-FIRED TRIACS

Kit 855 **£39.95**

LOTS OF OTHER APPLICATIONS

Now features full 4-channel chaser software on DISK and pre-programmed PIC16F84 chip. Easily re-programmed for your own applications. Software source code is fully 'commented' so that it can be followed easily.

## ICEBREAKER

□□□□□□□□□□

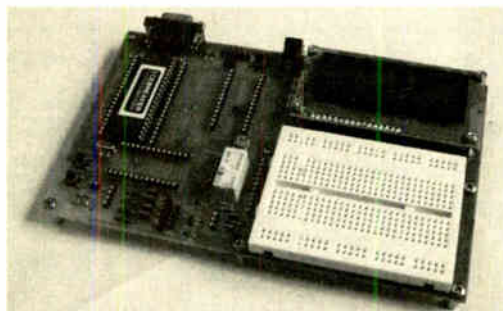

## PIC Real Time In-Circuit Emulator

- Icebreaker uses PIC16F877 in circuit debugger
- Links to Standard PC Serial Port (lead supplied)
- Windows™ (95+) Software included
- Works with MPASM and MPLAB Microchip software
- 16 x 2 L.C.D., Breadboard, Relay, I/O devices and patch leads supplied

As featured in March '00 EPE. Ideal for beginners AND advanced users. Programs can be written, assembled, downloaded into the microcontroller and run at full speed (up to 20MHz), or one step at a time.

Full emulation means that all I/O ports respond exactly and immediately, reading and driving external hardware.

Features include: Reset; Halt on external pulse; Set Breakpoint; Examine and Change registers, EEPROM and program memory; Load program, Single Step with display of Status, W register, Program counter, and user selected 'Watch Window' registers.

**KIT 900 . . . £34.99**

POWER SUPPLY £3.99 STEPPING MOTOR £5.99

## EPE PIC Tutorial

At last! A Real, Practical, Hands-On Series

- Learn Programming from scratch using PIC16F84
- Start by lighting I.e.d.s and do 30 tutorials to Sound Generation, Data Display, and a Security System.
- PIC TUTOR Board with Switches, I.e.d.s, and on board programmer

### PIC TUTOR BOARD KIT

Includes: PIC16F84 Chip, TOP Quality PCB printed with Component Layout and all components\* (\*not ZIF Socket or Displays). Included with the Magenta Kit is a disk with Test and Demonstration routines.

**KIT 870 .... £27.95, Built & Tested .... £42.95**

Optional: Power Supply - £3.99, ZIF Socket - £9.99

LCD Display ..... £7.99 LED Display ..... £6.99

Reprints Mar/Apr/May 98 - £3.00 set 3

## PIC TOOLKIT V2

- SUPER UPGRADE FROM V1 • 18, 28 AND 40-PIN CHIPS
- READ, WRITE, ASSEMBLE & DISASSEMBLE PICS
- SIMPLE POWER SUPPLY OPTIONS 5V-20V
- ALL SWITCHING UNDER SOFTWARE CONTROL
- MAGENTA DESIGNED PCB HAS TERMINAL PINS AND OSCILLATOR CONNECTIONS FOR ALL CHIPS
- INCLUDES SOFTWARE AND PIC CHIP

**KIT 878 . . . £22.99 with 16F84 . . . £29.99 with 16F877**

## SUPER PIC PROGRAMMER

- READS, PROGRAMS, AND VERIFIES
- WINDOWS™ SOFTWARE
- PIC16C6X, 7X, AND 8X
- USES ANY PC PARALLEL PORT
- USES STANDARD MICROCHIP • HEX FILES
- OPTIONAL DISASSEMBLER SOFTWARE (EXTRA)
- PCB, LEAD, ALL COMPONENTS, TURNED-PIN SOCKETS FOR 18, 28, AND 40 PIN ICs

- SEND FOR DETAILED INFORMATION - A SUPERB PRODUCT AT AN UNBEATABLE LOW PRICE.

**Kit 862 £29.99**

Power Supply £3.99

DISASSEMBLER  
SOFTWARE **£11.75**

## PIC STEPPING MOTOR DRIVER

INCLUDES PCB,  
PIC16F84 WITH  
DEMO PROGRAM,  
SOFTWARE DISC,  
INSTRUCTIONS  
AND MOTOR.

**Kit 863 £18.99**

FULL SOURCE CODE SUPPLIED  
ALSO USE FOR DRIVING OTHER  
POWER DEVICES e.g. SOLENOIDS

Another NEW Magenta PIC project. Drives any 4-phase unipolar motor - up to 24V and 1A. Kit includes all components and 48 step motor. Chip is pre-programmed with demo software, then write your own, and re-program the same chip! Circuit accepts inputs from switches etc and drives motor in response. Also runs standard demo sequence from memory.

## 8-CHANNEL DATA LOGGER

As featured in Aug./Sept. '99 EPE. Full kit with Magenta redesigned PCB - LCD fits directly on board. Use as Data Logger or as a test bed for many other 16F877 projects. Kit includes programmed chip, 8 EEPROMs, PCB, case and all components.

**KIT 877 £49.95 inc. 8 x 256K EEPROMS**

# MAGENTA

All prices include VAT. Add £3.00 p&p. Next day £6.99

Tel: 01283 565435 Fax: 01283 546932 E-mail: sales@magenta2000.co.uk

102001



Station Road, Cullercoats, Tyne & Wear, NE30 4PQ

Prices Exclude Vat @17.5%. UK Carriage £1.50 (less than 1kg) £3.50 greater than 1kg

See Next / Last Months Ad. for COMPONENT ACCESSORIES

Table listing electronic components such as 4000 Series, 74HC Series, and 74 Series with their respective part numbers and prices.

Main table listing various electronic components including RAM, A/D Converters, Voltage Regulators, Thyristors, Diodes, and Resistors, with columns for part number, price, and description.

# EVERYDAY PRACTICAL ELECTRONICS

INCORPORATING ELECTRONICS TODAY INTERNATIONAL

THE No.1 MAGAZINE FOR ELECTRONICS TECHNOLOGY & COMPUTER PROJECTS

## VOL. 30 No. 10 OCTOBER 2001

### 2002

Two thousand and two is upon us – well our *Teach-In 2002* will be next month. It hardly seems any time at all since we were all worrying about how to celebrate the new millennium and now the numbers have moved on by two. Of course, regular readers will know that every other year we publish a *Teach-In* series with the intention of providing a wide range of educational material on electronics. *TI 2002* will be all about interfacing to the outside world and will look in some depth at sensors, how they work, how to use them and the data they can supply.

This new series is being produced by a team of writers co-ordinated by Alan Winstanley and drawing from the vast range of knowledge of the electronics department at Hull University. Some months have been spent planning the content and working on demonstration projects for readers to build and test. The course will employ a Pico Technology PC-based oscilloscope to provide PC displays of the various parameters to be measured. The scope will be available to readers at a Special Offer price.

### SUBJECTS

The course is planned to cover the following areas: Temperature; Light and Colour; Sound and Ultrasonics; Time; Humidity; Gases, Smoke and pH; Electric and Magnetic Fields, Radiation; Movement, Acceleration, Strain and Vibration; Optical/Digital Presence, Distance and Position; Weather. It will look at a range of circuit topics from Basic Principles through Op.Amps, Instrumentation Amplifiers, Filters, Comparators, ADC, Data Logging etc. Each part will have associated labs and projects.

The new series will assume some basic knowledge of electronics, so if you want to start right at the very beginning with a series that requires no previous knowledge, you will need to look at the previous *Teach-In*, which is available on CD-ROM (*Teach-In 2000*) – see page 731 for details.

### FREE PIC'INGS

Thanks to John Becker we are now on version three of his highly acclaimed *PIC Toolkit* (see page 700), we know readers will find this totally new design very useful and next month we will publish a free 16-page supplement describing the new Toolkit TK3 for Windows software. We also believe the two free CD-ROMs from Microchip given away with this issue will be invaluable to anyone using PICs.

Don't miss next month's issue, place an order with your newsagent or take out a subscription now!

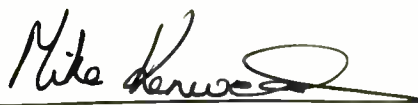

### AVAILABILITY

Copies of *EPE* are available on subscription anywhere in the world (see below), from all UK newsagents (distributed by COMAG) and from the following electronic component retailers: Omni Electronics and Yebo Electronics (S. Africa). *EPE* can also be purchased from retail magazine outlets around the world. An internet on-line version can be purchased and downloaded for just \$9.99/US – approx £7.70 per year available from [www.epemag.com](http://www.epemag.com)

### SUBSCRIPTIONS

Subscriptions for delivery direct to any address in the

UK: 6 months £15, 12 months £28.50, two years £52; Overseas: 6 months £18 standard air service or £27 express airmail, 12 months £34.50 standard air service or £52 express airmail, 24 months £64 standard air service or £99 express airmail.

Online subscriptions, for downloading the magazine via the Internet, \$9.99/US – approx £7.70 for one year available from [www.epemag.com](http://www.epemag.com).

Cheques or bank drafts (in £ sterling only) payable to *Everyday Practical Electronics* and sent to EPE Subs. Dept., Wimborne Publishing Ltd. 408 Wimborne Road East, Ferndown, Dorset BH22 9ND. Tel: 01202 873872. Fax: 01202 874562. E-mail: [subs@epemag.wimborne.co.uk](mailto:subs@epemag.wimborne.co.uk). Also via the Web at: <http://www.epemag.wimborne.co.uk>. Subscriptions start with the next available issue. We accept MasterCard, Amex, Diners Club, Switch or Visa. (For past issues see the *Back Issues* page.)

### BINDERS

Binders to hold one volume (12 issues) are available from the above address. These are finished in blue p.v.c., printed with the magazine logo in gold on the spine. Price £5.95 plus £3.50 p&p (for overseas readers the postage is £6.00 to everywhere except Australia and Papua New Guinea which cost £10.50). *Normally sent within seven days but please allow 28 days for delivery – more for overseas.*

*Payment in £ sterling only please. Visa, Amex, Diners Club, Switch and MasterCard accepted, minimum card order £5. Send, fax or phone your card number and card expiry date with your name, address etc. Or order on our secure server via our UK web site. Overseas customers – your credit card will be charged by the card provider in your local currency at the existing exchange rate.*

### Editorial Offices:

EVERYDAY PRACTICAL ELECTRONICS EDITORIAL  
WIMBORNE PUBLISHING LTD., 408 WIMBORNE ROAD EAST,  
FERNDOWN, DORSET BH22 9ND

Phone: (01202) 873872. Fax: (01202) 874562.

E-mail: [editorial@epemag.wimborne.co.uk](mailto:editorial@epemag.wimborne.co.uk)

Web Site: <http://www.epemag.wimborne.co.uk>

EPE Online [www.epemag.com](http://www.epemag.com)

EPE Online Shop: [www.epemag.wimborne.co.uk/shopdoor.htm](http://www.epemag.wimborne.co.uk/shopdoor.htm)

See notes on *Readers' Enquiries* below – we regret lengthy technical enquiries cannot be answered over the telephone.

### Advertisement Offices:

EVERYDAY PRACTICAL ELECTRONICS ADVERTISEMENTS

MILL LODGE, MILL LANE

THORPE-LE-SOKEN, ESSEX CO16 0ED

Phone/Fax: (01255) 861161

E-mail: [epeads@aol.com](mailto:epeads@aol.com)

Editor: MIKE KENWARD

Deputy Editor: DAVID BARRINGTON

Technical Editor: JOHN BECKER

Business Manager: DAVID J. LEAVER

Subscriptions: MARILYN GOLDBERG

Administration: FAY KENWARD

Editorial/Admin: (01202) 873872

Advertisement Manager:

PETER J. MEW, Frinton (01255) 861161

Advertisement Copy Controller:

PETER SHERIDAN, (01202) 873872

On-Line Editor: ALAN WINSTANLEY

EPE Online (Internet version) Editors:

CLIVE (MAX) MAXFIELD and ALVIN BROWN

### READERS' ENQUIRIES

E-mail: [techdept@epemag.wimborne.co.uk](mailto:techdept@epemag.wimborne.co.uk)

We are unable to offer any advice on the use, purchase, repair or modification of commercial equipment or the incorporation or modification of designs published in the magazine. We regret that we cannot provide data or answer queries on articles or projects that are more than five years old. Letters requiring a personal reply *must* be accompanied by a **stamped self-addressed envelope or a self-addressed envelope and international reply coupons**. All reasonable precautions are taken to ensure that the advice and data given to readers is reliable. We cannot, however, guarantee it and we cannot accept legal responsibility for it.

### COMPONENT SUPPLIES

**We do not supply electronic components or kits for building the projects featured, these can be supplied by advertisers (see *Shoptalk*). We advise readers to check that all parts are still available before commencing any project in a back-dated issue.**

### ADVERTISEMENTS

Although the proprietors and staff of EVERYDAY PRACTICAL ELECTRONICS take reasonable precautions to protect the interests of readers by ensuring as far as practicable that advertisements are *bona fide*, the magazine and its Publishers cannot give any undertakings in respect of statements or claims made by advertisers, whether these advertisements are printed as part of the magazine, or in inserts.

The Publishers regret that under no circumstances will the magazine accept liability for non-receipt of goods ordered, or for late delivery, or for faults in manufacture.

### TRANSMITTERS/BUGS/TELEPHONE EQUIPMENT

We advise readers that certain items of radio transmitting and telephone equipment which may be advertised in our pages cannot be legally used in the UK. Readers should check the law before buying any transmitting or telephone equipment as a fine, confiscation of equipment and/or imprisonment can result from illegal use or ownership. The laws vary from country to country; readers should check local laws.



## Constructional Project

# CAMCORDER POWER SUPPLY

TERRY de VAUX-BALBIRNIE

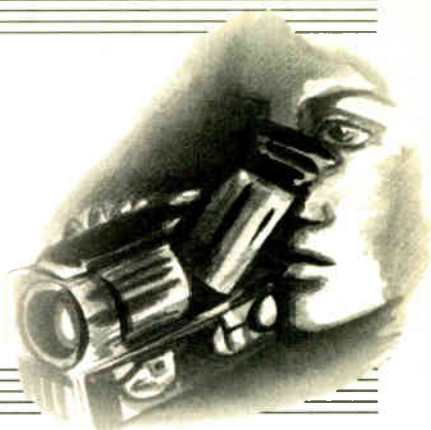

### Battery replacement with a lot more bottle!

**M**ANY camcorder users manage perfectly well with the battery supplied with their machine. If they need to extend the operating time, they simply buy another battery and carry them both around.

A typical camcorder battery provides an operating time of 45 minutes, including using the zoom lens and rewinding the tape every so often to review the results. Two batteries would still only give 90 minutes of operation.

However, "serious" users often need much more than this between charges, possibly even up to 12 hours. Although high-capacity batteries are available, they are an expensive option.

### CIRCUIT OVERVIEW

The circuit described here is a high-capacity supply with integral charger. With the author's camcorder it provides over 11 hours of operation. Charging may be effected either from the mains or a 12V d.c. source, such as plugging it into the car cigar lighter socket, and takes around 15 to 20 hours to recharge.

The author's unit is housed in a camera bag, large enough to accommodate the connecting leads and various pieces of camcorder equipment.

On the front panel there are mains and 12V d.c. input plugs, output socket and mode switch. This latter toggles between charging (CH/OFF) and camera operation (CAM)

While charging, one of a pair of light-emitting diodes (l.e.d.s) indicates whether a mains or 12V supply is connected. In camera mode, a further l.e.d. operates to confirm the output. In addition, three "charge level" l.e.d.s provide an indication of the state of charge of the battery pack, green for high, yellow for medium and red for low.

The unit may be used to power camcorders having an operating voltage between 6V and 9.6V d.c. If you measure it, the voltage will be somewhat higher than the stated nominal value when the battery is fully charged. Note that a 9.6V output may not be available when the battery pack is in a poor state of charge.

### CURRENT SITUATION

The maximum current which may be drawn from the unit is 2.5A. However, for the sake of battery life, this should be regarded as a peak figure. A better practical limit is 1.5A. The author's camcorder never requires more than 900mA and it seems unlikely that any amateur equipment would need 1.5A.

If the power (in watts) is stated in the user's manual, divide this by the nominal battery voltage to arrive at the average current. Another method would be to work from the battery's stated amp-hour (Ah) capacity, dividing this by the known operating time in hours. Multiply the average current by 1.5 to give a safety margin and to take account of instantaneous demands.

It is not advisable to measure the current directly unless you are certain of being able to maintain the correct polarity and avoid short-circuiting the battery.

### BATTERY CHOICE

Lead-acid batteries have been chosen for this circuit because they provide a high capacity for a relatively small cost. Two 6V batteries are used rather than a single 12V one because these may be charged simultaneously from a 12V car supply. A single 12V battery would *not* be satisfactory because, when the battery was well-charged, there would be no voltage difference to drive the current through.

The specified batteries have a capacity of 7Ah but others could be used with a proportional change in operating and charging time. However, do not use a capacity less than 4Ah. Note that a pair of 7Ah units provides the equivalent of about 10Ah for a 6V camcorder because the circuit delivers around 80 per cent of the total energy to the load.

The disadvantage of lead-acid batteries is that they can be damaged if allowed to discharge below their "low point" (say, 5V for a nominal 6V unit) and especially if left like that for a prolonged period. The "charge level" l.e.d.s should therefore be checked from time to time to make sure the batteries have sufficient charge.

Unlike nickel-cadmium cells, lead-acid batteries may be "topped-up" with charge as the opportunity arises because they do not suffer from the memory effect. In fact, doing this extends their service life. Lead-acid batteries also hold their charge much better than the nickel-cadmium type. If



lead-acid batteries are left charged, they will not self-discharge significantly over a period of several months.

## CIRCUIT DESCRIPTION

The complete circuit for the Camcorder Power Supply is shown in Fig.1.

The mains supply is connected via transformer T1. The 12V a.c. secondary voltage is rectified by bridge rectifier REC1. With mode switch S1 set to "CH/OFF", current flows via diode D4 to smoothing capacitor C1.

The capacitor charges to the transformer's peak output voltage less the forward voltage drop of the bridge rectifier diodes and D4. With the specified transformer this gives about 15V d.c. under full load.

When a 12V d.c. supply is connected instead of the mains, current flows into C1 via diode D3, which gives reverse-polarity protection to the 12V input. Diodes D3 and D4 also provide isolation between the two input sources so that current from one cannot possibly drain into the other.

Light-emitting diodes D1 (Mains) and D2 (12V) draw current direct from their

respective supply, with current-limiting effected by resistors R1 and R2.

## CHARGING VOLTAGE

The rectified voltage at C1 is fed to the input (pin 1) of voltage and current regulator IC1. This is configured to provide the correct output voltage to charge the battery pack.

A voltage higher than that required appears at the output, pin 5. Current then flows through three resistors (all labelled R3) connected in parallel and the excess voltage is developed across them. This forms the current-limiting aspect of the regulator. If the current tends to rise, the voltage across resistors R3 will increase. Pin 2 senses this change and "turns down" IC1 to reduce it.

With a battery in a poor state of charge, the difference between its own voltage and that of the charger output is significant and this drives current through the battery. Without current-limiting, the current would be quite high due to the very small resistances involved, and could be destructive to circuit components or to the batteries themselves.

The "as required" voltage is obtained at the junction of R3/R5 and is determined by the voltage difference between IC1's limit and reference pins (2 and 4). This is set at 7.7V by the potential divider formed by R4, R5 and preset VR1.

Three resistors are used for R3 rather than a single unit because they are easily-obtainable values and also allow for some "trimming" of the limiting current during setting up. With the values specified, the theoretical limit is approximately 1A. However, taking into account "stray" resistance (that of connecting copper tracks, soldered joints and so on), it is likely to be in the region of 900mA.

The 7.7V regulator output is applied to the pair of Schottky diodes, D5 and D6. These route current to the individual 6V batteries, B1 and B2, at a maximum of about 450mA each.

Schottky diodes are used as these have a smaller forward voltage drop than "ordinary" silicon diodes. This varies to some extent with the load but will be typically 0.4V rather than 0.7V. Thus, the voltage appearing across B1 and B2 will be about 7.3V. The diodes also prevent the batteries

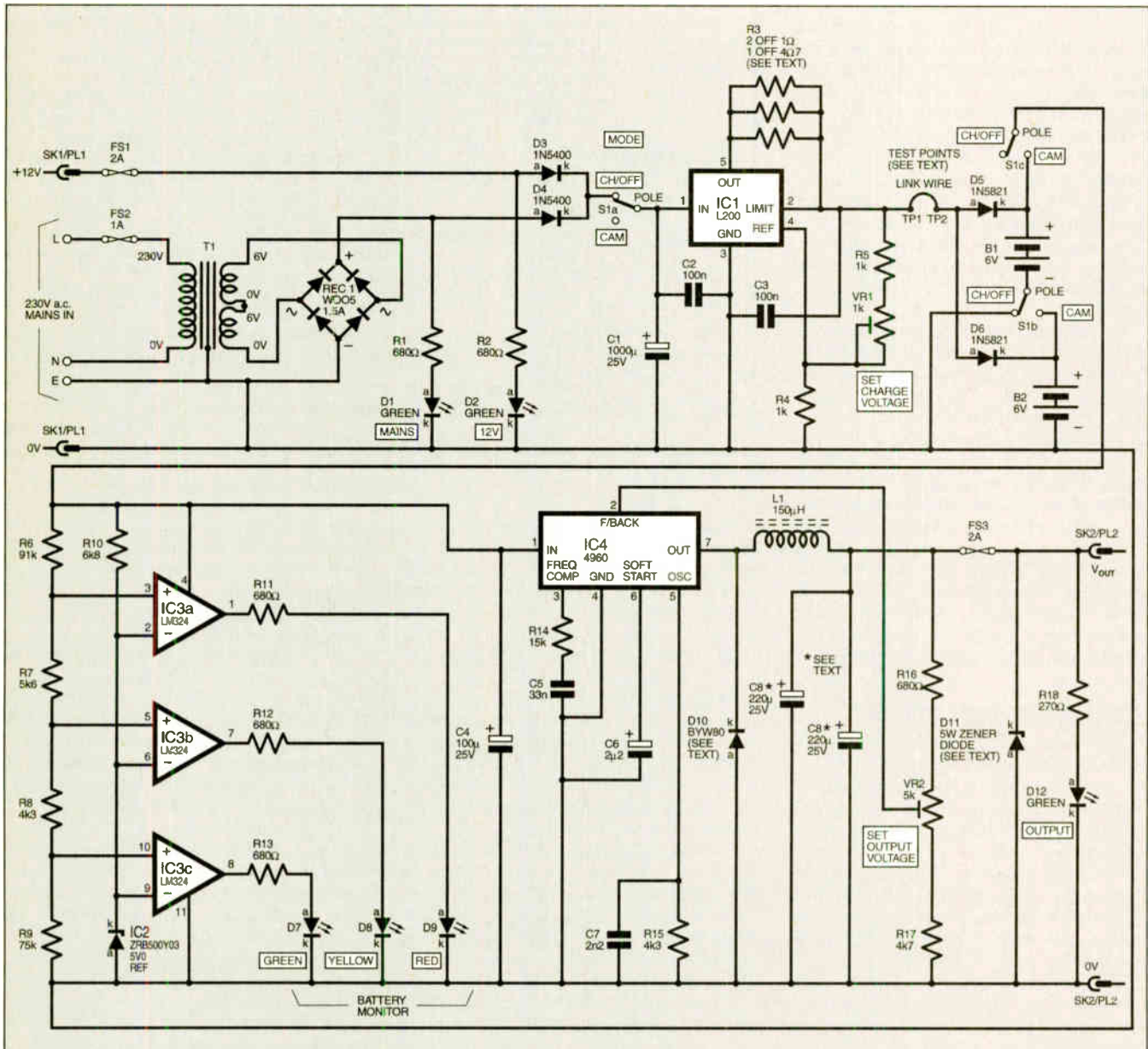

Fig.1. Complete circuit diagram for the Camcorder Power Supply/Charger.

from discharging back into IC1 when the supply is switched off.

As charging progresses, the current flowing into the batteries reduces, to about 50mA when the charging is nearly complete. Some 90 per cent of the required charge is delivered before the current reduces significantly. With the specified batteries, this takes 15 to 20 hours approximately and in most cases the batteries will then be regarded as fully charged.

While charging, switch S1c disconnects the subsequent circuit so current does not drain into this unnecessarily.

## ON CAMERA

Camcorder operation is selected by moving switch S1 to "CAM". Switch S1a now disconnects the charging supply if it has been left switched on. Switch S1b connects the two 6V batteries in series so that nominally 12V appears across them, which S1c then connects to the following part of the circuit.

As the batteries discharge, their combined terminal voltage falls slightly. At 10V, they may be regarded as dangerously "flat". The voltage (and hence charge) is monitored by three sections of quad op.amp IC3, configured as comparators.

All three inverting inputs (pins 2, 6 and 9) are connected together and are set at 5V by voltage reference IC2. Resistor R10 limits the current flow through IC2 to ensure its correct operation.

The non-inverting inputs (pins 3, 5 and 10) are connected to points along the potential divider chain which comprises resistors R6 to R9 joined in series across the supply. When the voltage at any of these inputs is higher than the reference voltage, the comparator's output will be high, and its associated l.e.d. (D7 to D9) turned on.

Respectively, the "turn on" voltages for IC3a to IC3c (and their l.e.d.s) are 10.4V, 11.0V and 11.7V. The l.e.d.s represent the charge states: high (D7 - green), medium (D8 - yellow) and low (D9 - red).

As the battery voltage falls, so does the voltage at each comparator's non-inverting input. When the voltage falls below each threshold the relevant output goes low and its associated l.e.d. is turned off.

If all three l.e.d.s are off, the voltage is below 10.4V and the batteries *must* be charged as soon as possible. In use, it will be found that high and medium charge are shown for a relatively long time but low charge is shown for only a short period.

## CAMERA VOLTAGE

The correct camcorder operating voltage is obtained from the battery supply using switching regulator IC4. Compared with the linear regulator used for charging the batteries, the switching type is much more efficient, by around 80 per cent or more. This allows as much useful energy as possible to be "squeezed" from the batteries and so maximise the camcorder operating time. At the same time, less waste heat is produced.

The regulator contains an on-chip oscillator which produces a stream of pulses. Their frequency is determined by the value of resistor R15 and capacitor C7 connected in parallel to pin 5 (oscillator). With the values specified it is about 100kHz.

# COMPONENTS

Approx. Cost  
Guidance Only

**£35**  
excluding batts. & case

## Resistors

R1, R2, R11 to R13, R16	680Ω (6 off)
R3	1Ω (2 off) plus 4Ω7 (see text)
R4, R5	1k (2 off)
R6	91k
R7	5k6
R8, R15	4k3 (2 off)
R9	75k
R10	6k8
R14	15k
R17	4k7
R18	270Ω

All 0.6W 1% carbon film.

## Potentiometers

VR1	1k min. multiturn preset, top adjust
VR2	5k min. multiturn preset, top adjust

## Capacitors

C1	1000μ radial elect. 25V
C2, C3	100n ceramic (2 off)
C4	100μ radial elect. 25V
C5	33n ceramic (see text)
C6	2μ2 radial elect. 16V
C7	2n2 polystyrene
C8	220μ YXF series elect. 50V, 0.12Ω at 100kHz (2 off) (see text)

## Semiconductors

REC1	W005 1.5A bridge rectifier
D1, D2, D7, D12	3mm green l.e.d. (4 off)
D3, D4	1N5400 3A rectifier diode (2 off)
D5, D6	1N5821 3A Schottky diode (2 off)
D8	3mm yellow l.e.d.
D9	3mm red l.e.d.
D10	BYW80 fast recovery diode (see text)
D11	5W Zener diode (see text)
IC1	L200CV voltage and current regulator

See  
**SHOP**  
**TALK**  
page

IC2	ZRB500Y03 +5V voltage reference
IC3	LM324 quad op.amp
IC4	L4960 2.5A switching regulator

## Miscellaneous

L1	150μH inductor, 3A rating minimum
FS1, FS3	20mm 2A quick-blow fuse (2 off)
FS2	20mm 1A ceramic fuse, mains rated
B1, B2	6V 7Ah sealed lead acid battery (2 off) (see text)
S1	3-pole 2-way toggle switch, 3A
TB1	5-way p.c.b. screw terminal block, 5mm pitch
TB2	4-way p.c.b. screw terminal block, 5mm pitch
TB3	2-way p.c.b. screw terminal block, 5mm pitch
PL1/SK1	chassis plug and line socket (for 12V input) (see text)
PL2/SK2	chassis socket and line plug (for output) (see text)
PL3	IEC mains connector, male, chassis mounting
T1	230V mains transformer, twin 6V secondary windings, each 20VA min.

Printed circuit board, available from the *EPE PCB Service*, code 318; aluminium case, 102mm x 76mm x 38mm; 14-pin d.i.l. socket; fuseholder, 20mm, p.c.b. mounting (2 off); fuseholder, 20mm, panel mounting; l.e.d. clip, panel mounting (5 off); sheet aluminium, 15mm x 40mm (see text), transformer primary insulating shield; insulating boots for mains input plug and fuse FS2; mains lead; p.c.b. supports, plastic (4 off); test bulb and holder (see text); solder tags (2 off); battery spade connectors (2 pairs); materials for battery bracket; 3A mains rated wire; connecting wire; 4.7 ohm 3W test resistor (optional - see text); solder, etc.

The output appears at pin 7 and is smoothed by inductor L1 in conjunction with twin capacitors (both labelled C8) connected in parallel. During each pulse, current rises relatively slowly in L1 (as energy is "soaked up" to create the magnetic field) and charge flows into the capacitors and load.

During this time, diode D10 is reverse-biased and has no effect. When the output pulse falls, the resulting negative-going current is conducted through diode D10 rather than from the inductor and the load current is maintained from the stored energy. The process then repeats.

The specification of D10 and capacitor(s) C8 is especially important. Due to the rapid switching involved, the diode must be capable of switching on and off at high speed. It must therefore be of the fast recovery type and have a generous current rating (8A minimum).

Capacitor(s) C8 must have a low impedance at 100kHz and a working voltage of 50V d.c. minimum. Two capacitors in parallel are regarded as better than a single unit of double the value because this also

reduces the impedance. These facts must be remembered if different components to those specified are used.

## VOLTAGE STABILISATION

The output voltage is connected across the potential divider consisting of fixed resistors R16 and R17 and preset potentiometer VR2. The voltage appearing at the wiper of VR2 is connected to IC4's feedback input, pin 2. This is one input of an on-chip comparator (the error amplifier). Its other input is internally connected to a 5.1V reference source.

The difference between the two voltages is the "error" and this controls the mark/space ratio of the oscillator's output, the regulator varying its operation to reduce the error to zero.

Preset VR2 is adjusted so that the output voltage is at the required value. If it rises, the voltage at the wiper will exceed the reference value and the oscillator "on" times will be reduced in relation to the "off" periods. If the output voltage falls, the "on" times will be increased. The regulator has





This board is available from the *EPE PCB Service*, code 318.

Assemble the board in order of component size, observing the correct orientation of polarity-conscious components.

Note that the 4.7 ohm (4Ω7) resistor in the R3 group may need to be changed in value after the unit has been tested (to adjust the limiting current). To enable this to be done more easily, it could be soldered between a pair of solder pins or short wire "stalks". It would then be a simple matter of de-soldering it and replacing it with one of a different value.

The value of capacitor C5 (33n) may not be readily available. Provision has therefore been made to solder two capacitors in parallel, 10n and 22n, to give nearly the same value.

There are different manufactured styles for voltage reference device IC2. Some have three leads instead of two, in which case refer to the pin-out of the particular device (which your component supplier should have available) and cut off the unwanted lead.

Note that IC1, IC2 and IC3 are static-sensitive, so touch something which is earthed (such as a metal water tap) before handling their pins.

Leave the test point, TP1/TP2, link unmade at this time.

The l.e.d.s can be mounted directly to the p.c.b. with their leads bent at right angles to line up with holes in the case front panel. If the leads are too short, extension leads can be added, as was the case with the prototype.

A heatsink is needed for diode D10 (but not shown in the photograph) and this may be a piece of sheet aluminium having minimum dimensions of 15mm by 40mm bent through right angles and attached so as to maintain a clear gap with all internal parts. The diode's integral tab **must not make metallic contact with anything else** so, as a precaution, fit a mounting kit so that the tab is electrically isolated from the heatsink.

Solder 15cm pieces of stranded connecting wire of 3A rating minimum to switch S1 pads. Use different colours to avoid errors later.

### BOXING UP

**This circuit must be mounted in an Earthed metal box.** Note that the metal-work is used as a heatsink for the regulators so these must be placed flat against

the box. **It is very important that no part of the circuit makes contact with the case.**

The 12V input and output connectors may be of any polarised type but must be sufficiently rated for the expected load. The 12V and camcorder connectors must be of a different pattern so that the cables cannot be interchanged.

Mount the p.c.b. vertically on plastic stand-off insulators as shown in the photographs.

Using a suitable mounting bracket, attach the batteries securely in position. Make sure there is a clear space between the terminals and everything else. Partially discharged batteries should be used initially to allow correct testing of the charging circuit.

Refer to Fig.3 and complete the wiring, using stranded mains-type wire of 3A rating minimum. Insulate all mains connections so that they cannot be touched.

Make up a lead (or use a ready-made one) to connect the car cigar lighter socket to the 12V input observing the correct polarity. **It is essential for an in-line fuse-holder and 3A fuse to be included in this lead.**

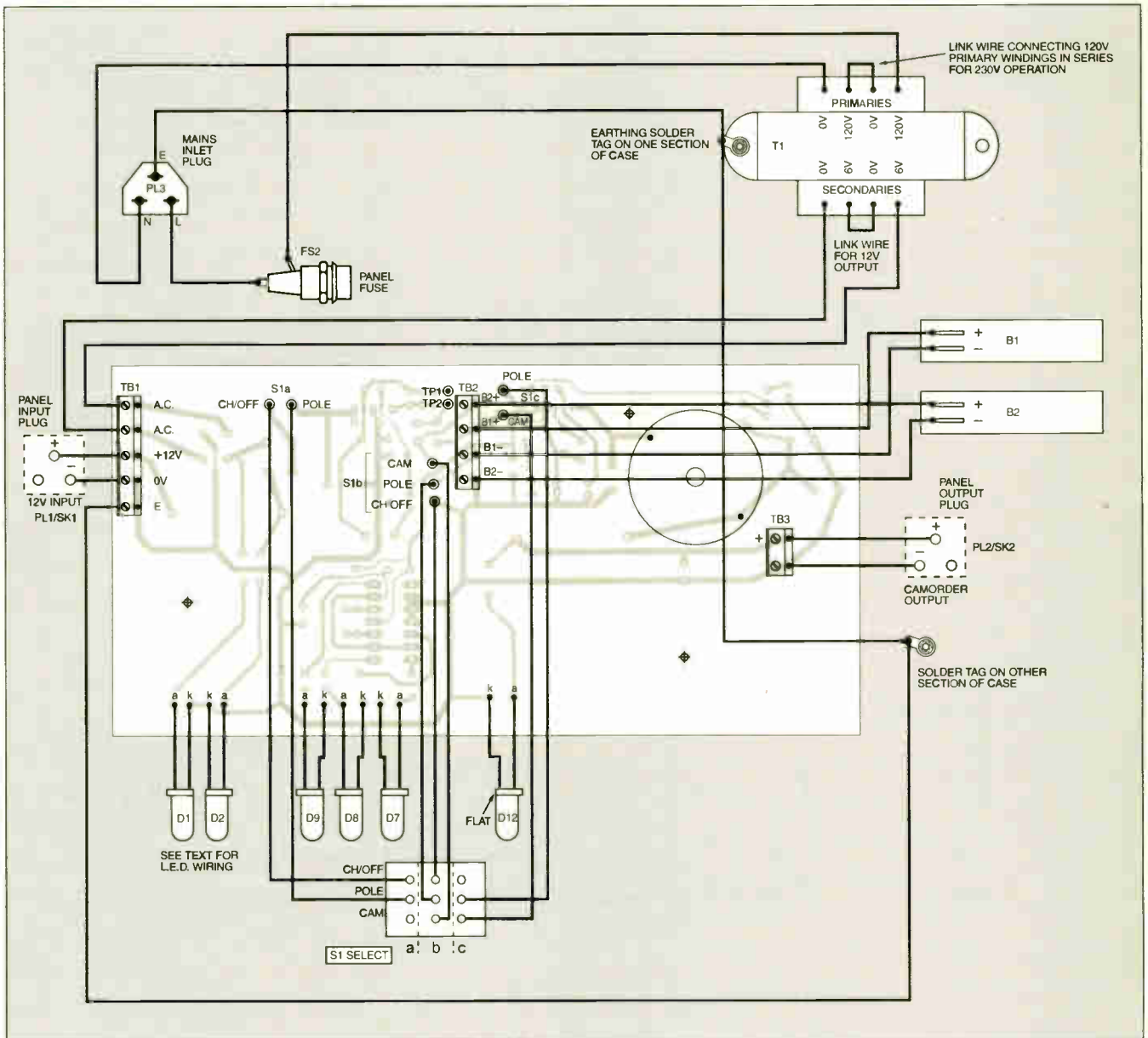

Fig.3. Interwiring between circuit board and off-board components. Use stranded mains-type wire of 3A rating minimum.

## ADJUSTMENTS

Initial testing should be made using a 12V car battery or bench power supply.

Whenever a mains supply is plugged in, the case must be fully enclosed so that there is no access to internal parts.

Switch S1 to "CH/OFF" and connect the supply. The "12V" l.e.d. should operate. Adjust VR1 to give a voltage at test point TP1 of 7.7V.

Connect an ammeter between test points TP1 and TP2 and switch to "CH/OFF". If the ammeter reads less than 950mA, no action is needed. If it is too high, experiment by increasing the value of the 4Ω resistor in the R3 group until a satisfactory reading is achieved.

With the current limit set, permanently link TP1 to TP2.

Once the batteries have reached a reasonable charge level, set switch S1 to "CAM". Adjust preset VR2 until the correct voltage is obtained across the output terminals (SK2). If fuse FS3 blows, or regulator IC4 becomes hot, switch off immediately. Investigate and correct the fault before proceeding.

Note that the presence of Zener diode D11 will limit the maximum output voltage. It will also increase the current flow if IC4 tries to raise the voltage above the Zener threshold.

Make checks on the circuit using a filament bulb (6V rating for up to 7.2V and 12V for more than this) and run the battery pack down to "low". Check all aspects of operation and make certain the unit and camcorder operate correctly.

Disconnect the 12V test supply and plug

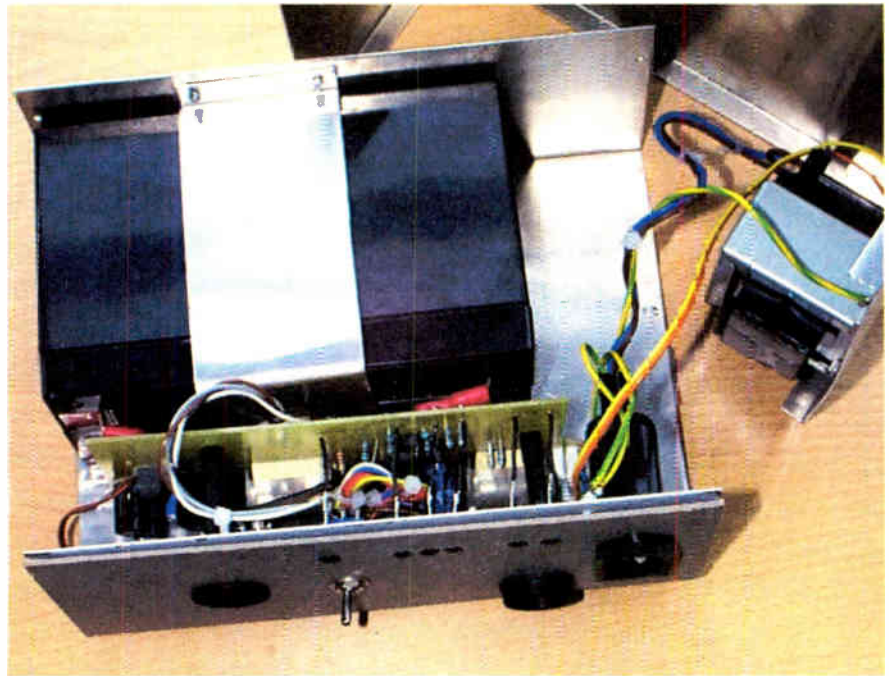

Internal view showing the p.c.b. bolted to the front panel and battery bracket.

into the mains. Check that the output voltage at SK2 is still the same.

Now fully charge the batteries using the mains supply. After 30 minutes, then at hourly intervals, unplug the supply, remove the lid and check that nothing is excessively hot. If necessary, drill ventilation holes in the case but make sure they are small enough so that nothing conductive could be pushed through and touch a mains connection.

## FINALLY

When the unit is not in use, remember to return the mode switch to "CH/OFF". When in use, the batteries need recharging when only the red l.e.d. remains on (or when all l.e.d.s. are off!).

The unit should be removed from the camera bag while charging. This is because the bag would insulate the case and could cause the unit to overheat.

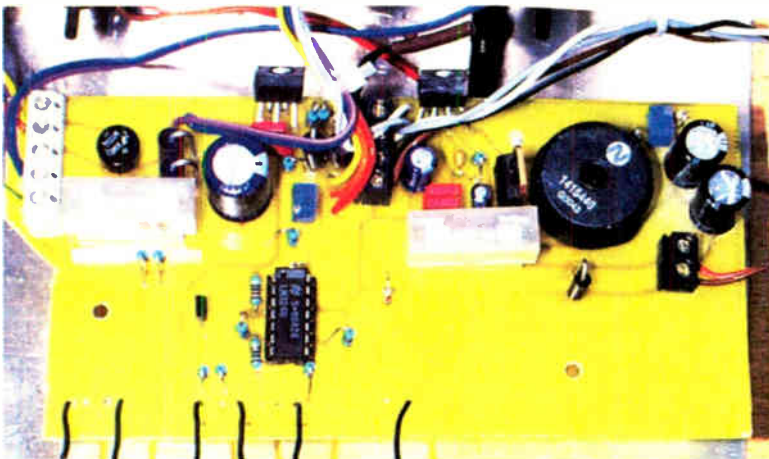

Completed circuit board. Note the l.e.d. extension wires at the front.



Front panel component positioning.

## EPE BINDERS

**KEEP YOUR MAGAZINES SAFE – RING US NOW!**

This ring binder uses a special system to allow the issues to be easily removed and re-inserted without any damage. A nylon strip slips over each issue and this passes over the four rings in the binder, thus holding the magazine in place.

The binders are finished in hard-wearing royal blue p.v.c. with the magazine logo in gold on the spine. They will keep your issues neat and tidy but allow you to remove them for use easily.

The price is £5.95 plus £3.50 post and packing. If you order more than one binder add £1 postage for each binder after the initial £3.50 postage charge (overseas readers the postage is £6.00 each to everywhere except Australia and Papua New Guinea which costs £10.50 each).

Send your payment in £'s sterling cheque or PO (Overseas readers send £ sterling bank draft, or cheque drawn on a UK bank or pay by card), to **Everyday Practical Electronics, Wimborne Publishing Ltd, 408 Wimborne Road East, Ferndown, Dorset BH22 9ND. Tel: 01202 873872. Fax: 01202 874562.**

E-mail: [editorial@epemag.wimborne.co.uk](mailto:editorial@epemag.wimborne.co.uk) Web site: <http://www.epemag.wimborne.co.uk>

Order on-line from [www.epemag.wimborne.co.uk/shopdoor.htm](http://www.epemag.wimborne.co.uk/shopdoor.htm)

We also accept card payments. Mastercard, Visa, Amex, Diners Club or Switch (minimum card order £5). Send your card number and card expiry date plus Switch Issue No. with your order.



Diners Club  
International



## £1 BARGAIN PACKS Selected Items

**PIEZO ELECTRIC SOUNDER**, also operates efficiently as a microphone. Approximately 30mm diameter, easily mountable, 2 for £1. Order Ref: 1084.

**LIQUID CRYSTAL DISPLAY** on p.c.b. with i.c.s etc. to drive it to give 2 rows of 8 figures or letters with data. Order Ref: 1085.

**30A PANEL MOUNTING TOGGLE SWITCH**. Double-pole. Order Ref: 166.

**SUB MIN TOGGLE SWITCHES**. Pack of 3. Order Ref: 214.

**HIGH POWER 3in. SPEAKER** (11W 8ohm). Order Ref: 246.

**MEDIUM WAVE PERMEABILITY TUNER**. It's almost a complete radio with circuit. Order Ref: 247.

**HEATING ELEMENT**, mains voltage 100W, brass encased. Order Ref: 8.

**MAINS MOTOR** with gearbox giving 1 rev per 24 hours. Order Ref: 89.

**ROUND POINTER KNOBS** for flatted ¼in. spindles. Pack of 10. Order Ref: 295.

**CERAMIC WAVE-CHANGE SWITCH**. 12-pole, 3-way with ¼in. spindle. Order Ref: 303.

**REVERSING SWITCH**. 20A double-pole or 40A single pole. Order Ref: 343.

**LUMINOUS PUSH-ON PUSH-OFF SWITCHES**. Pack of 3. Order Ref: 373.

**SLIDE SWITCHES**. Single pole changeover. Pack of 10. Order Ref: 1053.

**PAXOLIN PANEL**. Approximately 12in. x 12in. Order Ref: 1033.

**CLOCKWORK MOTOR**. Suitable for up to 6 hours. Order Ref: 1038.

**TRANSISTOR DRIVER TRANSFORMER**. Maker's ref. no. LT44, impedance ratio 20k ohm to 1k ohm; centre tapped, 50p. Order Ref: 1/23R4.

**HIGH CURRENT RELAY**, 12V d.c. or 24V a.c., operates changeover contacts. Order Ref: 1026.

**3-CONTACT MICROSWITCHES**, operated with slightest touch, pack of 2. Order Ref: 861.

**HIVAC NUMICATOR TUBE**, Hivac ref XN3. Order Ref: 865 or XN11 Order Ref: 866.

**2IN. ROUND LOUDSPEAKERS**. 50Ω coil. Pack of 2. Order Ref: 908.

**5K POT**, standard size with DP switch, good length ¼in. spindle, pack of 2. Order Ref: 11R24.

**13A PLUG**, fully legal with insulated legs, pack of 3. Order Ref: GR19.

**OPTO-SWITCH** on p.c.b., size 2in. x 1in., pack of 2. Order Ref: GR21.

**COMPONENT MOUNTING PANEL**, heavy paxolin 10in. x 2in., 32 pairs of brass pillars for soldering binding components. Order Ref: 7RC26.

**HIGH AMP THYRISTOR**, normal 2 contacts from top, heavy threaded fixing underneath, think amperage to be at least 25A, pack of 2. Order Ref: 7FC43.

**BRIDGE RECTIFIER**, ideal for 12V to 24V charger at 5A, pack of 2. Order Ref: 1070.

**TEST PRODS FOR MULTIMETER** with 4mm sockets. Good length flexible lead. Order Ref: D86.

**LUMINOUS ROCKER SWITCH**, approximately 30mm square, pack of 2. Order Ref: D64.

**MES LAMP HOLDERS** slide on to ¼in. tag, pack of 10. Order Ref: 1054.

**HALL EFFECT DEVICES**, mounted on small heatsink, pack of 2. Order Ref: 1022.

**12V POLARISED RELAY**, 2 changeover contacts. Order Ref: 1032.

**PROJECT CASE**, 95mm x 66mm x 23mm with removable lid held by 4 screws, pack of 2. Order Ref: 876.

**LARGE MICROSWITCHES**, 20mm x 6mm x 10mm, changeover contacts, pack of 2. Order Ref: 826.

**MAINS RELAY** with 15A changeover contacts. Order Ref: 965.

**COPPER CLAD PANELS**, size 7in. x 4in., pack of 2. Order Ref: 973.

**100M COIL OF CONNECTING WIRE**. Order Ref: 685.

**WHITE PROJECT BOX**, 78mm x 115mm x 35mm. Order Ref: 106.

**LEVER-OPERATED MICROSWITCHES**, ex-equipment, batch tested, any faulty would be replaced, pack of 10. Order Ref: 755.

**MAINS TRANSFORMER**, 12V-0V-12V, 6W. Order Ref: 811.

## THIS MONTH'S SPECIAL

**IT IS A DIGITAL MULTITESTER**, complete with backrest to stand it and hands-free test prod holder. This tester measures d.c. volts up to 1,000 and a.c. volts up to 750; d.c. current up to 10A and resistance up to 2 megs. Also tests transistors and diodes and has an internal buzzer for continuity tests. Comes complete with test prods, battery and instructions. Price £6.99. Order Ref: 7P29.



**1mA PANEL METER**. Approximately 80mm x 55mm, front engraved 0-100. Price £1.50 each. Order Ref: 1/16R2.

**VERY THIN DRILLS**. 12 assorted sizes vary between 0.6mm and 1.6mm. Price £1. Order Ref: 128.

**EVEN THINNER DRILLS**. 12 that vary between 0.1mm and 0.5mm. Price £1. Order Ref: 129.

**BT PLUG WITH TWIN SOCKET**. Enables you to plug 2 telephones into the one socket for all normal BT plugs. Price £1.50. Order Ref: 1.5P50.

**D.C. MOTOR WITH GEARBOX**. Size 60mm long, 30mm diameter. Very powerful, operates off any voltage between 6V and 24V D.C. Speed at 6V is 200 rpm, speed controller available. Special price £3 each. Order Ref: 3P108.

**FLASHING BEACON**. Ideal for putting on a van, a tractor or any vehicle that should always be seen. Uses a Xenon tube and has an amber coloured dome. Separate fixing base is included so unit can be put away if desirable. Price £5. Order Ref: 5P267.

**MOST USEFUL POWER SUPPLY**. Rated at 9V 1A, this plugs into a 13A socket, is really nicely boxed. £2. Order Ref: 2P733.

**MOTOR SPEED CONTROLLER**. These are suitable for D.C. motors for voltages up to 12V and any power up to 1/6hp. They reduce the speed by intermittent full voltage pulses so there should be no loss of power. In kit form these are £12. Order Ref: 12P34. Or made up and tested, £20. Order Ref: 20P39.

**BT TELEPHONE EXTENSION WIRE**. This is proper heavy duty cable for running around the skirting board when you want to make a permanent extension. 4 cores properly colour coded, 25m length. Only £1. Order Ref: 1067.

**LARGE TYPE MICROSWITCH** with 2in. lever, changeover contacts rated at 15A at 250V, 2 for £1. Order Ref: 1/2R7.

**BALANCE ASSEMBLY KITS**. Japanese made, when assembled ideal for chemical experiments, complete with tweezers and 6 weights 0.5 to 5 grams. Price £2. Order Ref: 2P44.

**CYCLE LAMP BARGAIN**. You can have 100 6V 0.5A MES bulbs for just £2.50 or 1,000 for £20. They are beautifully made, slightly larger than the standard 6.3V pilot bulb so they would be ideal for making displays for night lights and similar applications.

**DOORBELL PSU**. This has AC voltage output so is ideal for operating most doorbells. The unit is totally enclosed so perfectly safe and it plugs into a 13A socket. Price only £1. Order Ref: 1/30R1.

**INSULATION TESTER WITH MULTIMETER**. Internally generates voltages which enable you to read insulation directly in megohms. The multi-meter has four ranges: AC/DC volts, 3 ranges DC milliamps, 3 ranges resistance and 5 amp range. These instruments are ex-British Telecom but in very good condition, tested and guaranteed OK, probably cost at least £50 each, yours for only £7.50 with leads, carrying case £2 extra. Order Ref: 7.5P4.

**REPAIRABLE METERS**. We have some of the above testers but slightly faulty, not working on all ranges, should be repairable, we supply diagram, £3. Order Ref: 3P176.

### TWO MORE POST OFFICE INSTRUMENTS

Both instruments contain lots of useful parts, including sub-min toggle switch sold by many at £1 each. They are both in extremely nice cases, with battery compartment and flexible carrying handles, so if you don't need the instruments themselves, the case may be just right for a project you have in mind.

The first is **Oscillator 87F**. This has an output, continuous or interrupted, of 1kHz. It is in a plastic box size 115mm wide, 145mm high and 50mm deep. Price only £1. Order Ref: 7R1.

The other is **Amplifier Ref. No. 109G**. This is in a case size 80mm wide, 130mm high and 35mm deep. Price £1. Order Ref: 7R2.

### HEAVY DUTY POT

Rated at 25W, this is 20 ohm resistance so it could be just right for speed controlling a d.c. motor or device or to control the output of a high current amplifier. Price £1. Order Ref: 1/33L1.

### STEPPER MOTOR

Made by Philips as specified for the wind-up torch in the Oct '00 Practical Electronics is still available, price £2. Order Ref: 2P457.

**SOLDERING IRON**, super mains powered with long-life ceramic element, heavy duty 40W for the extra special job, complete with plated wire stand and 245mm lead, £3. Order Ref: 3P221.

## RELAYS

We have thousands of relays of various sorts in stock, so if you need anything special give us a ring. A few new ones that have just arrived are special in that they are plug-in and come complete with a special base which enables you to check voltages of connections of it without having to go underneath. We have 6 different types with varying coil voltages and contact arrangements. All contacts are rated at 10A 250V AC.



Coil Voltage	Contacts	Price	Order Ref:
12V DC	4-pole changeover	£2.00	FR10
24V DC	2-pole changeover	£1.50	FR12
24V DC	4-pole changeover	£2.00	FR13
240V AC	1-pole changeover	£1.50	FR14
240V AC	4-pole changeover	£2.00	FR15

Prices include base

### MINI POWER RELAYS

For p.c.b. mounting, size 28mm x 25mm x 12mm, all have 16A changeover contacts for up to 250V. Four versions available, they all look the same but have different coils:

6V Order Ref: FR17

12V Order Ref: FR18

24V Order Ref: FR19

48V Order Ref: FR20

Price £1 each less 10% if ordered in quantities of 10, same or mixed values.

**NOT MUCH BIGGER THAN AN OXO CUBE**. Another relay just arrived is extra small with a 12V coil and 6A changeover contacts. It is sealed so it can be mounted in any position or on a p.c.b. Price 75p each, 10 for £6 or 100 for £50. Order Ref: FR16.

**RECHARGEABLE NICAD BATTERIES**. AA size, 25p each, which is a real bargain considering many firms charge as much as £2 each. These are in packs of 10, coupled together with an output lead so are a 12V unit but easily divideable into 2 x 6V or 10 x 1.2V. £2.50 per pack, 10 packs for £25 including carriage. Order Ref: 2.5P34.

**FOR QUICK HOOK-UPS**. You can't beat leads with a croc clip each end. You can have a set of 10 leads, 2 each of 5 assorted colours with insulated crocodile clips on each end. Lead length 36cm, £2 per set. Order Ref: 2P459.



**BIG 12V TRANSFORMER**. It is 55VA so that is over 4A which is normal working, intermittently it would be a much higher amperage. Beautiful transformer, well made and very well insulated, terminals are in a plastic frame so can't be accidentally touched. Price £3.50. Order Ref: 3.5P20.

## BUY ONE GET ONE FREE

**ULTRASONIC MOVEMENT DETECTOR**. Nicely cased, free standing, has internal alarm which can be silenced. Also has connections for external speaker or light. Price £10. Order Ref: 10P154.

**CASED POWER SUPPLIES** which, with a few small extra components and a bit of modifying, would give 12V at 10A. Originally £9.50 each, now 2 for £9.50. Order Ref: 9.5P4.

**3-OCTAVE KEYBOARDS** with piano size keys, brand new, previous price £9.50, now 2 for the price of one. Order Ref: 9.5P5.

### 1.5V-6V MOTOR WITH GEARBOX

Motor is mounted on the gearbox which has interchangeable gears giving a range of speeds and motor torques. Comes with full instructions for changing gears and calculating speeds, £7. Order Ref: 7P26.

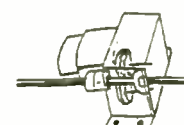

**MINI BLOWER HEATER**. 1kW, ideal for under desk or airing cupboard, etc., needs only a simple mounting frame, price £5. Order Ref: 5P23.

### TERMS

Send cash, PO, cheque or quote credit card number - orders under £25 add £4.50 service charge.

## J & N FACTORS

**Pilgrim Works (Dept.E.E.)**  
**Stairbridge Lane, Bolney**  
**Sussex RH17 5PA**  
**Telephone: 01444 881965**  
**E-mail: jnfactors@aol.com**

### COMMSIM FOR EWB

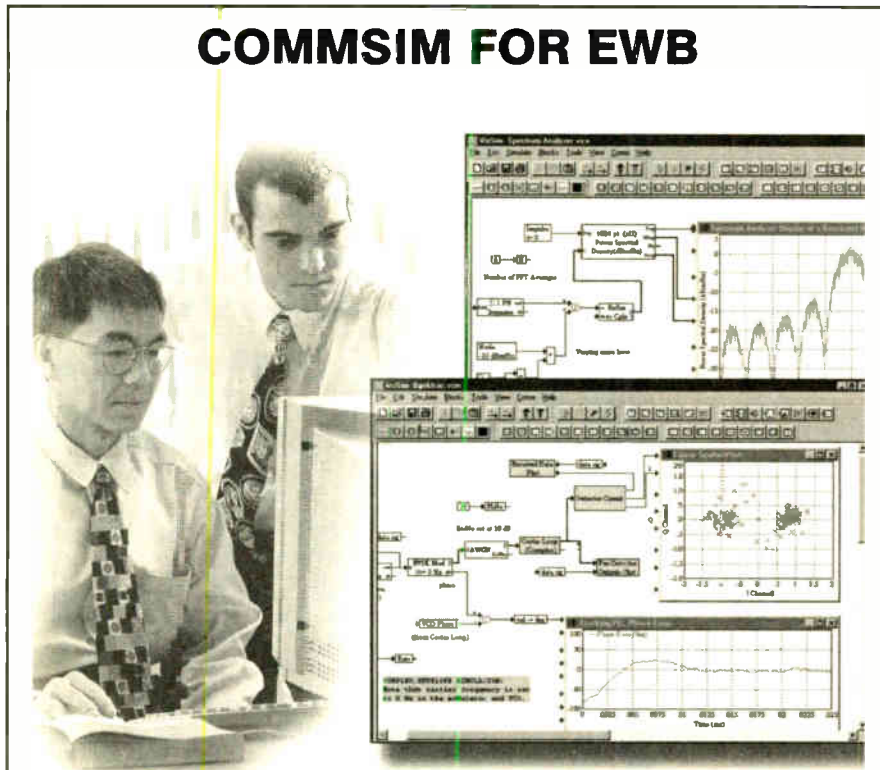

**A**DEPT Scientific has announced the introduction of Commsim, a new product from Electronics Workbench. Commsim is a powerful and easy to use Windows-based simulation environment for modelling analogue, digital or mixed-signal networks.

Commsim offers hundreds of communication and maths blocks for powerful yet intuitive design, so modelling and simulation can be performed, say Adept, without having to write a single line of code. The product reflects the new system level approach currently being taught in colleges and universities throughout the world to introduce electronics and its real world applications to engineering students.

Consistent with the approach taken by other renowned Electronics Workbench products, Commsim offers both hierarchical modelling and embedded compound blocks, facilitating rapid prototyping. Once designed the system can be simulated to determine its performance under a variety of operating conditions.

For more information contact Anna Moorhouse, Dept. EPE, Adept Scientific plc, Amor Way, Letchworth, Herts SG6 1ZA. Tel: 01462 480055. Fax: 01462 480213.

E-mail [ewb@adeptsience.co.uk](mailto:ewb@adeptsience.co.uk). Web: [www.adeptsience.co.uk](http://www.adeptsience.co.uk).

### LEICESTER SHOW

The 30th Leicester Amateur Radio Show (LARS) will be held at Donington Park, on 21 and 22 September 2001.

LARS is claimed to be the UK's largest amateur radio, computing and electronics event. For further information contact LARS committee member G. W. Dover G4AFJ, 31 Newbold Road, Kirkby Mallory, Leics LE9 7QG.

Tel: 01455 823344. Fax: 01455 828273.

E-mail: [g4afj@argonet.co.uk](mailto:g4afj@argonet.co.uk).

Web: [www.lars.org.uk](http://www.lars.org.uk).

Please mention *EPE* when contacting.

### ENERGY FACTS

The Department of Trade and Industry has recently sent information on Energy Statistics for period February to April 2001.

It is interesting to note that the production of primary fuels such as coal and other solid fuels, petrol, gas and electricity, is actually down by 6.9 per cent compared to the same period last year. As to quite how this squares with the 3.9 per cent rise in consumption of the same fuels in that period is unclear, presumably it means we are importing more.

For more information, browse [www.dti.gov.uk/energy/energystats/energystats.htm](http://www.dti.gov.uk/energy/energystats/energystats.htm).

### V92 MODEMS

By Barry Fox

**I**F you are buying a new modem, be sure it carries the telltale mark "V92 Ready". Otherwise you will miss out on the chance to access the Internet more quickly, and do so with a single conventional phone line without blocking speech calls.

A V92 modem with Quick Connect can halve tiresome logon times. Modem on Hold pauses the PC while it is Internet surfing, to let the user take an incoming speech call on the same phone line. When the talking stops, the PC clicks back to the Internet without the need to redial.

The International Telecommunications Union sets the V standards which ensure that modems round the world talk to each other. V90, as now widely used, pushes the data capacity of phone lines to their practical limit, by receiving at up to 56Kbps and sending at up to 33.6Kbps.

Because reliable working speed varies with line quality, existing V90 modems waste up to a minute each time a connection is made by "handshaking" with line test signals. If the phone line has a call-waiting service, which sends bleep tones down the line to warn that someone is trying to make a voice call while the line is engaged, existing modems often mistake call-waiting for a disconnect tone and hang up on the Internet, without giving the surfer any choices.

A V92 modem solves both these problems with non-volatile memory which builds a library of previous settings. When the modem dials an Internet service with matching software they quickly recognise a known situation and skip the rest of the handshake.

The V92 modem also recognises a call-waiting tone for what it is, puts the Internet connection on hold and then uses the stored settings to reconnect quickly when the speech caller hangs up.

Connexant, the spin-off from modem chip maker Rockwell which has driven V92, expects ISPs to offer the services by the end of this year. Some modems already promise V92 in the small print. Clearer publicity might spoil V90 sales.

### ELECTROMAIL CEASES MAIL ORDER

Electromail (a division of RS Components) have confirmed that they have ceased to provide a mail order service. However, it is still possible to purchase RS goods on credit card (only), either via the web site <http://rswww.com> or via telephone to 01536 444079.

## MUSICAL DRIVE-BY

Barry Fox

If you are driving along and your car suddenly starts singing, you can probably thank Gert van der Merwe of South Africa. His international patent filing WO 01/32989 tells how it's done.

A series of small metal ridges is built into the road, like miniature sleeping policeman speed humps. The ridges are around 15mm apart and in a pattern that matches the peaks of a musical waveform. So the car vibrates to play a tune. If slightly different sets of ridges are formed, to the left and right of the road, the car vibrates in stereo sympathy. The ridges can be temporary, on a mat laid on the road alongside an advertising sign, to play a matching jingle.

## NRPB VIDEO

"Mobile Telephony and Health" is the title of a 30-minute VHS video produced by NPRP (National Radiological Protection Board). It provides a timely, digestible review of the current state of knowledge about possible health effects of mobile phone handsets and the associated mobile transmission masts.

There are documentary style interviews with leading scientists in the field, and members of the Independent Expert Group on Mobile Phones whose report was published last year.

The video has been produced professionally and contains graphics and other material to illustrate points made. For example, there are useful graphic sequences showing how mobile phones work, what the possible heating effects could be in the head and how people are exposed to transmissions from masts.

NRPB felt there was a need for a video giving straightforward, factual information about mobile phones and health issues. There is a charge of £6.00 and copies can be obtained from Information Services, NRPB, Chilton, Didcot, Oxon OX11 0RQ, or by telephoning Jane True/Jill Cook on 01235 822742 to order by major credit cards.

The NRPB's web site is at [www.nrpb.org.uk](http://www.nrpb.org.uk).

## SONY'S TECHNOLOOK

Sony has announced the development of a comprehensive range of TechnoLook products, following the successful introduction of its first video microscope last year. The expanded TechnoLook range includes higher magnification and semi-digital models, taking the first step towards a fully digital microscope.

Rudy Cosjins, Sony General Manager for Visual Solutions Marketing Europe, comments, "Sony tackled a number of major issues faced by users of traditional microscopes with the introduction of the TechnoLook. Our aim was to create an easy to use product that could be connected to a PC, eliminate eyestrain and reduce neck and back problems."

For more information contact Sony United Kingdom, Pippa Copeman-Hill, Corporate Communications. Tel: 01932 816488. Fax: 01932 817029. E-mail: [pippa.copeman-hill@eu.sony.com](mailto:pippa.copeman-hill@eu.sony.com). Web: [www.sony.com](http://www.sony.com).

## TETRA AND HEALTH

In the National news recently, concerns have been raised about possible health effects of exposure to radio frequency (r.f.) radiation via TETRA (Terrestrial Trunked Radio) cables. TETRA is the new digital radio system for use by commercial organisations and the emergency services. Its operation results in pulse modulation of the r.f. signal at a low frequency (17.6Hz).

The National Radiological Protection Board (NRPB) has sent us the following statement on behalf of AGNIR, the NRPB Advisory Group on Non-ionising Radiation:

"Agnir has reviewed the features of operation of the TETRA system, the likely levels of exposure of people, and studies relevant to the assessment of any biological effects. It has noted that the signals from base stations are not pulsed whereas those from hand portables and from terminals built into vehicles are.

"Agnir has concluded that although areas of uncertainty remain about the biological effects of low-level r.f. radiation in general, including modulated signals, current evidence suggests that it is unlikely that the special features of signals from TETRA hand portables and terminals mounted in vehicles pose a hazard to health."

For more information contact NRPB, Chilton, Didcot, Oxon, OX11 0RQ. Tel: 01235 822744. Fax: 01235 822746. Web: [www.nrpb.org.uk](http://www.nrpb.org.uk).

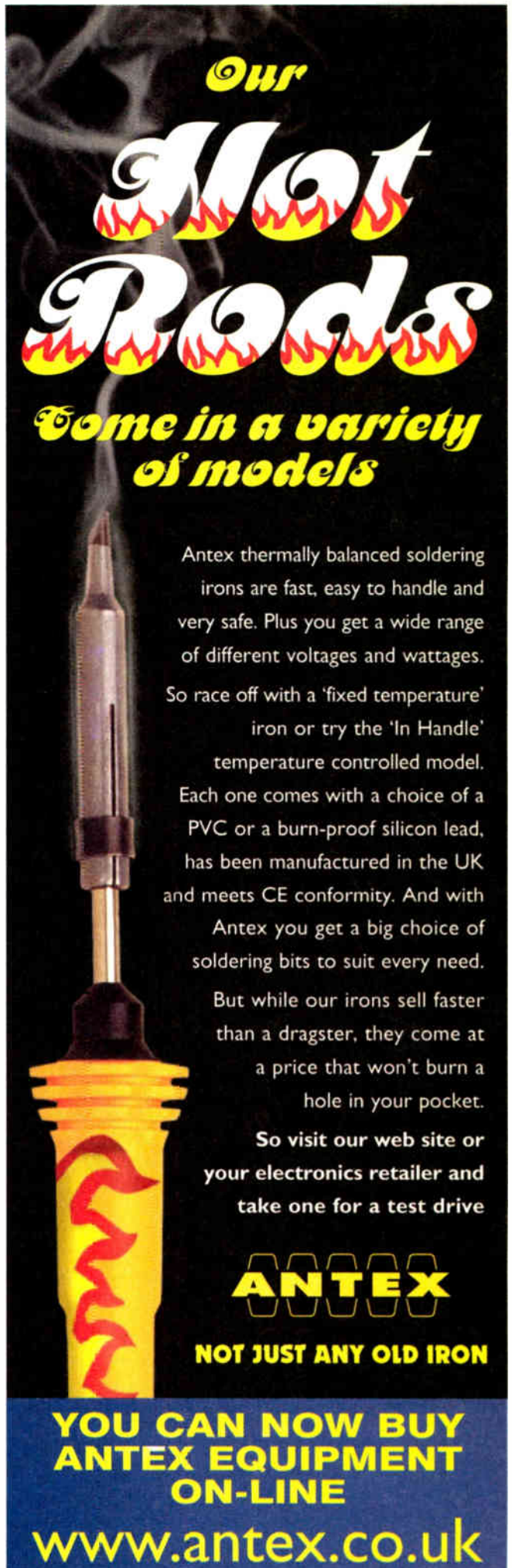

**Our**  
**Hot**  
**Pods**

**Come in a variety of models**

Antex thermally balanced soldering irons are fast, easy to handle and very safe. Plus you get a wide range of different voltages and wattages. So race off with a 'fixed temperature' iron or try the 'In Handle' temperature controlled model. Each one comes with a choice of a PVC or a burn-proof silicon lead, has been manufactured in the UK and meets CE conformity. And with Antex you get a big choice of soldering bits to suit every need. But while our irons sell faster than a dragster, they come at a price that won't burn a hole in your pocket.

So visit our web site or your electronics retailer and take one for a test drive

**ANTEX**

**NOT JUST ANY OLD IRON**

**YOU CAN NOW BUY ANTEX EQUIPMENT ON-LINE**

**[www.antex.co.uk](http://www.antex.co.uk)**

**SPECIAL  
READER  
OFFER -  
SEE WEBSITE  
FOR DETAILS**

# PROTEUS

## VSM

Virtual System Modelling

Build It In Cyberspace

[www.labcenter.co.uk](http://www.labcenter.co.uk)

**Develop and test complete micro-controller designs without building a physical prototype. PROTEUS VSM simulates the CPU and any additional electronics used in your designs. And it does so in real time. \***

- CPU models for PIC and 8051 and series micro-controllers available now. 68HC11 coming soon. More CPU models under development. See website for latest info.
- Interactive device models include LCD displays, RS232 terminal, universal keypad plus a range of switches, buttons, pots, LEDs, 7 segment displays and much more.
- Extensive debugging facilities including register and memory contents, breakpoints and single step modes.
- Source level debugging supported for selected development tools.
- Integrated 'make' utility - compile and simulate with one keystroke.
- Over 4000 standard SPICE models included. Fully compatible with manufacturers' SPICE models.
- DLL interfaces provided for application specific models.
- Based on SPICE3F5 mixed mode circuit simulator.
- CPU and interactive device models are sold separately - build up your VSM system in affordable stages.
- ARES Lite PCB Layout also available.

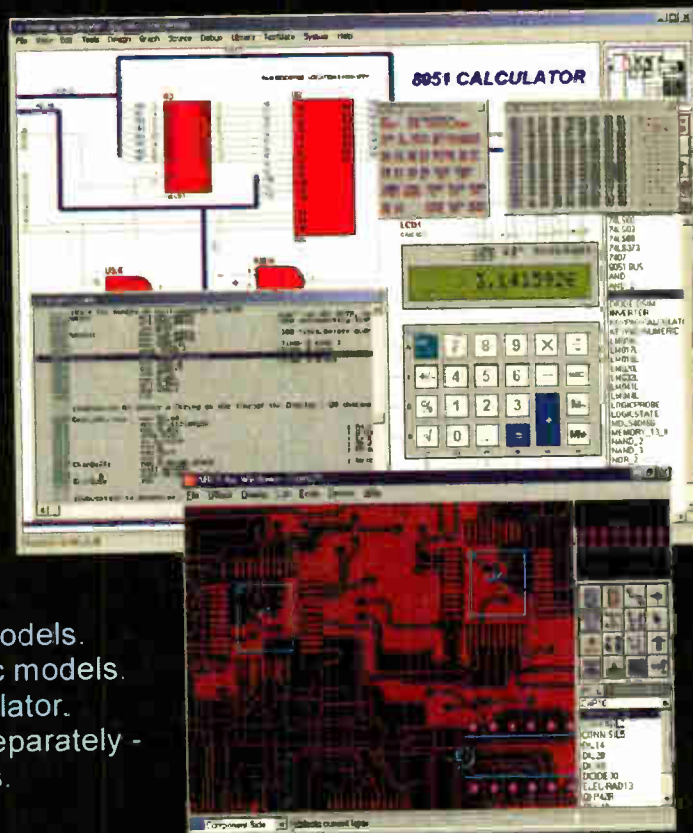

**labcenter**  
Electronics

\*E.g. PROTEUS VSM can simulate an 8051 clocked at 12MHz on a 300MHz Pentium II.

Write, phone or fax for your free demo CD - or email [info@labcenter.co.uk](mailto:info@labcenter.co.uk).  
Tel: 01756 753440. Fax: 01756 752857. 53-55 Main St, Grassington. BD23 5AA.

# CIRCUIT SURGERY

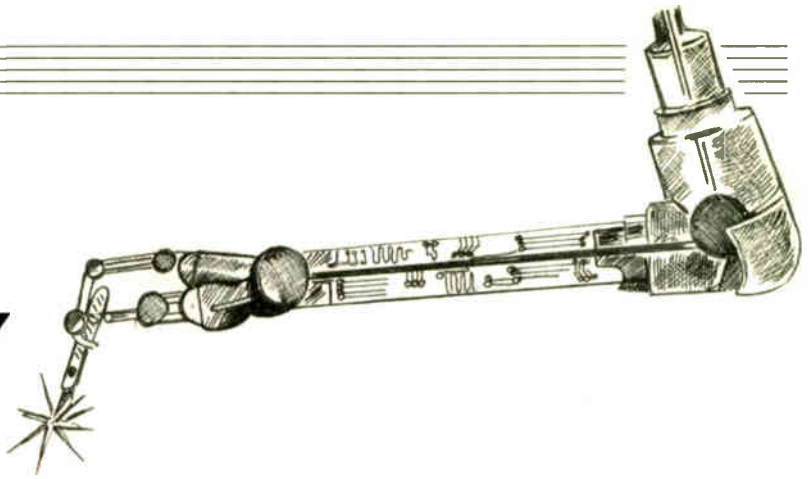

**ALAN WINSTANLEY  
and IAN BELL**

*Out consultant troubleshooters take a look at basic heatsink calculations this month*

**L**AST month we outlined some of the basic considerations related to the power and heat dissipated by components. Without doubt some parts (e.g. mains transformers) can become very hot indeed even in normal operation, especially if they are mounted on plastic cases which don't dissipate heat very well at all. Hopefully, adequate ventilation will be available to help with the throughflow of air. Obviously, bolting such parts to a steel or aluminium chassis will help dissipate heat.

The point was made last month that heatsinks are often necessary on certain devices – regulator chips or power transistors for example – but if the heatsinks become very hot it's usually just a sign that the heatsink is doing its job of conveying heat from the regulator. If the heatsink system has been correctly designed, it will prevent the semiconductor junction from exceeding the manufacturer's maximum temperature rating.

Although a wide variety of parts (e.g. 3-pin regulators) have built-in thermal overload protection, relying on this feature is not a good way of compensating for the use of inadequate heatsinking; thermal cycling between extremes of temperature may ultimately "stress" the device leading to premature failure over time.

## Thermal Resistance

In this month's *Circuit Surgery* we describe the basic procedure for selecting the correct heatsink for a device. The idea is to carry heat away from the part that matters most – the semiconductor junction or i.c. die. Just as electric current flows through a conductor, heat flows from a semiconductor chip to the outside ambient air also through a path of "conductors" – air, metals and alloys which carry the heat away through a *thermal conduction* action. Hence, anything getting in the way of this path adds to the system's overall *thermal resistance*, preventing the heat from being conveyed so efficiently.

Thermal resistance is measured in °C/Watt – it indicates how much the temperature will increase across a "thermal resistor" for a given power dissipation. A large, expensive heatsink rated at 1°C/W increases temperature by only one degree per watt of power dissipated, and is far more efficient (because it has a much lower thermal resistance) than a small heatsink of, say, 25°C/W.

A typical heatsink system contains the elements described in the photo. This could represent any power transistor containing a junction, or say a voltage regulator chip such as a the TO-3 type opened up

for the photograph. The requirement is to ensure that the semiconductor junction temperature (symbol  $T_j$ ) does not exceed a figure of 125°C usually, a typical value specified by data sheets.

The junction is at the heart of the package, but unfortunately for us, various elements of the system hinder the passage of heat and have to be accounted for. Everything possesses a thermal resistance, symbol  $\theta$  (theta), which can be sub-defined as follows:

$\theta_{JC}$  – thermal resistance between junction and the case;

$\theta_{CS}$  – thermal resistance between the case and heatsink;

$\theta_{SA}$  – thermal resistance between heatsink and ambient.

The electronics designer will hopefully see a number of "thermal resistors" in series: each resistor prevents heat from flowing to ambient, so heatsink design implies calculating to ensure that the overall thermal resistance of the system is not so large as to prevent heat flowing away efficiently, or this will result in the semiconductor junction producing more heat than can be carried away effectively.

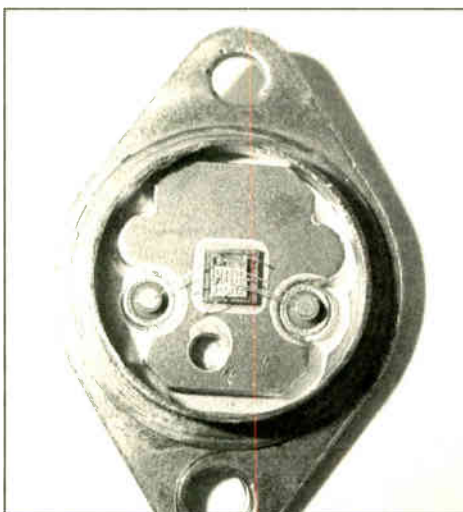

A TO-3 can style regulator sawn off to reveal the i.c. chip inside.

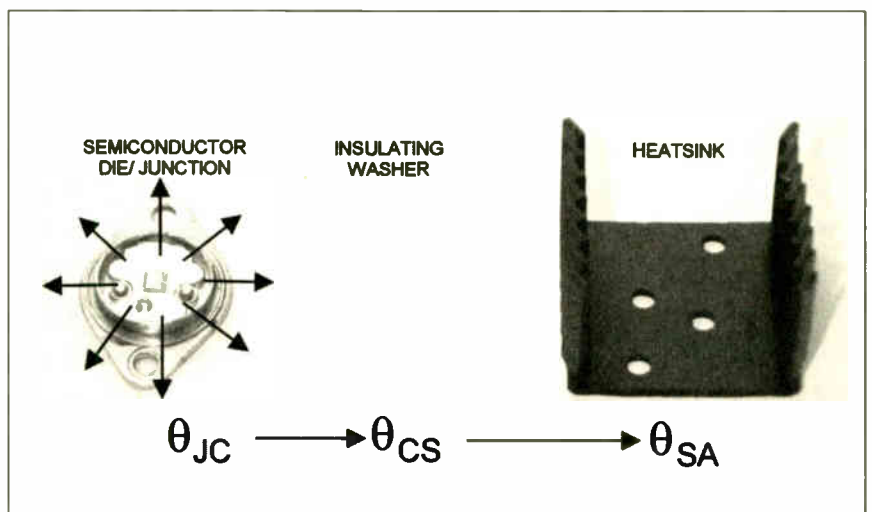

A typical assembly showing how the thermal resistance is divided between the device and heatsink.



## On the Case

The first item  $\theta_{JC}$  corresponds to the material between the junction and the case wall. The junction of a TO-3 device will be fixed to a steel base, but the case might also be packed with thermal conductive grease to help improve (reduce) the thermal resistance; it is usually just full of fresh air though.

A junction mounted in a TO-202 or TO-220 device will be embedded in a plastic resin, not known for its heat conducting properties but the metal tab is there to help with heatsinking.

Manufacturers' data sheets give the values for the thermal resistances of different case types. For comparison National Semiconductor quotes  $\theta_{JC}$  of  $3^{\circ}\text{C}/\text{W}$  for a TO-3 LM320 regulator,  $4^{\circ}\text{C}/\text{W}$  for the TO-220 and  $12^{\circ}\text{C}/\text{W}$  for the TO-202 version. The differences in thermal efficiencies are obvious.

The next parameter  $\theta_{CS}$  relates to the thermal resistance between the case and sink (heatsink). This means an insulating washer as shown in the photo, perhaps with a smear of thermal conductive grease. You might want to allow say  $0.5^{\circ}\text{C}/\text{W}$  for this.

Lastly  $\theta_{SA}$  – the thermal resistance between the heatsink and ambient temperature which is actually the thermal resistance of the heatsink itself. In some catalogues, it is shown as  $R_{th}$ . Some typical heatsinks are shown in the photo, including types intended for integrated circuits.

## Choose a Heatsink

Let's now look at a typical design example. A semiconductor is calculated to be dissipating 10 watts (some quick  $V \times I$  calculations told us that). The first question is, what is the device's ambient temperature ( $T_A$ ) likely to be? This directly affects our calculation and it depends on ventilation and the proximity of any other hot devices.

For now let us say that it is  $40^{\circ}\text{C}$ . Therefore, if the maximum junction temperature permitted is  $125^{\circ}\text{C}$ , the total permissible thermal resistance from end to end is  $(125 - 40)/10 \text{ Watts} = 8.5^{\circ}\text{C}/\text{W}$ . Suddenly, those heatsink ratings need scrutinising carefully!

Breaking it down further, we would firstly pick a semiconductor package with an appropriate thermal resistance  $\theta_{JC}$ . If we were using an LM320 regulator we could rule out the TO-202 package, a  $12^{\circ}\text{C}/\text{W}$  device. Choosing a TO-3 package, that accounts for  $3^{\circ}\text{C}/\text{W}$  already of our total permitted thermal resistance.

You might also add in say  $0.5^{\circ}\text{C}/\text{W}$  for silicon grease and a washer ( $\theta_{CS}$ ) leaving us with a value of  $5^{\circ}\text{C}/\text{W}$  remaining for the heatsink. If this value is exceeded then heat may not be dissipated efficiently enough to prevent the junction overheating.

## Stay Cool

Clearly the likely ambient temperature surrounding the assembly directly affects the heatsink specification. This factor relates to ventilation and cabinet or circuit board layout. A cooler ambient figure of  $25^{\circ}\text{C}$  makes life easier for the semiconductor, it means the overall thermal resistance allowed can be raised to  $10^{\circ}\text{C}/\text{W}$ . A higher ambient –  $65^{\circ}\text{C}$  say – and you are left with a total value of  $6^{\circ}\text{C}/\text{W}$ , implying a heftier heatsink rating of  $2.5^{\circ}\text{C}/\text{W}$ . What effect would using the smaller TO-220 package have instead? The higher thermal resistance means that a better heatsink would be required.

There is often the need to compromise somewhere along the line. Larger heatsinks are costlier and take up more space, implying a larger and more expensive cabinet. Looking at it another way, if a TO-3 device is used on a  $2.5^{\circ}\text{C}/\text{W}$  heatsink with silicon grease, then the maximum permissible ambient temperature allowed is  $65^{\circ}$ . Heatsinks might be mounted on the outside of a box with a lower ambient temperature, rather than being fixed within, at a much

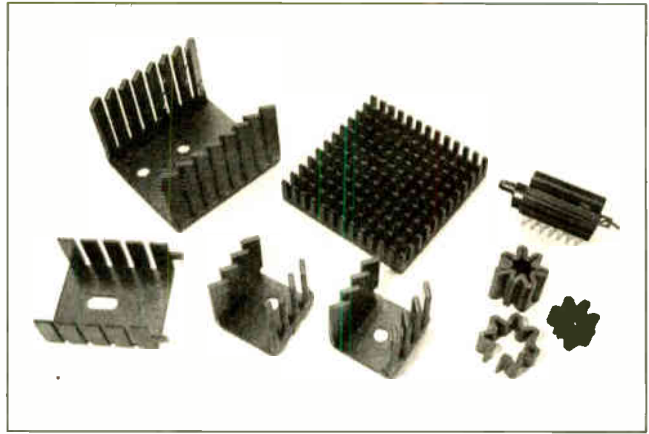

A selection of heatsinks including types to fit integrated circuits.

higher temperature. All these aspects should be borne in mind by the budding designer.

Some really purposeful-looking heatsinks are available which include 10in. diameter fan-assisted cooling to lower their thermal resistance to a staggering  $0.03^{\circ}\text{C}/\text{Watt}$ : unfortunately they cost nearly £250 (\$350) without the fan! Computer enthusiasts will be well aware of the need to fan-cool processor and video chips and a wide variety of very impressive-looking processor fans with heatsinks are now available.

AW

## CIRCUIT THERAPY

*Circuit Surgery* is your column. If you have any queries or comments, please write to: Alan Winstanley, *Circuit Surgery*, Wimborne Publishing Ltd., 408 Wimborne Road East, Ferndown, Dorset, BH22 9ND. E-mail (no attachments) [alan@epemag.co.uk](mailto:alan@epemag.co.uk). Please indicate if your query is not for publication. A personal reply cannot be guaranteed but we will try to publish representative answers in this column.



## ORDER YOUR COPY NOW!

NEXT MONTH: ★ FREE 16-page Supplement – PIC TOOLKIT TK3 for WINDOWS  
★PLUS – EPE TEACH-IN 2002 Part One

EVERYDAY  
**PRACTICAL  
ELECTRONICS**

Signed.....

Name and Address.....

.....

.....

Post Code.....

## NEWSAGENTS ORDER FORM

Please reserve/deliver a copy of *Everyday Practical Electronics* for me each month

*Everyday Practical Electronics* is published on the second Thursday of each month and distributed S.O.R. by COMAG. Make sure of your copy of *EPE* each month – cut out or photostat this form, fill it in and hand it to your newsagent.

# PIC TOOLKIT Mk3

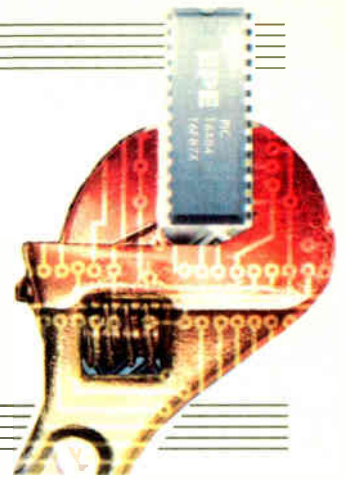

## JOHN BECKER

*By popular demand – an enhanced PIC microcontroller programming development board.*

**T**HIS PIC-programming printed circuit board has been designed for use with the software for the new Windows-based *Toolkit TK3*, to be described next month, and the DOS-based *Toolkit V2.4*, originally released in May/June '99.

The board has been introduced following readership suggestions about how the original Mk2 board could be beneficially extended to allow its greater use as a PIC design development facility.

The Mk2 board was principally designed as a platform on which various PIC types could be programmed via the accompanying software. Whilst it provided limited access to the pins of an on-board PIC16x84 microcontroller, allowing it to be used *in situ* as the rudimentary heart of a developing hardware circuit, it did not offer direct access to all pins of the larger PIC16F87x family that could be programmed on it.

This new board design is intended to rectify this situation, allowing the four PIC sizes that it can accept to be hard-wired not only to additional on-board hardware, but also external components in conjunction

with an optional plug-in breadboard. In this context, it is not only a programmer, but its options are also closely allied to the facilities available on the highly successful *EPE PIC Tutorial* board of Mar-May '98.

Direct connection of the programming lines can be made to external PIC-controlled circuits under development or final completion (such as published *EPE* PIC-based designs).

The notable difference between the *PIC Tutorial* board and that of *Toolkit Mk3* is that the latter, like its Mk2 predecessor, is under complete programming control by the connected PC-compatible computer. The *Tutorial* board, you may recall, had to be manually switched at different stages of the programming procedure.

### TOOLKIT Mk3 CIRCUIT

The main circuit diagram for the PIC Toolkit Mk3 board is shown in Fig.1.

Electronically, the circuit is essentially the same as that for the Mk2 board. Connections between the PC-compatible computer and the board are made via the parallel printer port and a standard

connector cable. The connections are buffered by IC2a to IC2e, ensuring that the input and output signals are maintained at optimum logic levels.

The input signals also have ballast and pull-down resistors, R1 to R8. The ballast resistors protect the connected computer output lines when the board is unpowered. The pull-down resistors provide a 0V bias to the buffer inputs when the computer is unpowered, or the port connector is unplugged.

Data and clock signals are brought in via printer port lines DA0 and DA1. Reset control of the PIC is via port line DA3, and programming mode control via DA4.

A fifth port line connection, ACK, sends signals back to the computer during PIC data reading, such as is required in code verification and disassembly modes.

A new sixth connection has been added, between IC2 pin 2 and the  $\overline{\text{BUSY}}$  line at connector pin 11. This allows the software to check that the printer port cable is connected and the p.c.b. power is switched on.

### MULTIPLEXER

Multiplexer IC3 is a 3-channel 2-way "changeover switch" and routes the PIC's data and clock connections according to the programming or non-programming mode, which is controlled by port line DA4. The logic is illustrated in the block diagram in Fig.2.

During programming, the PIC's data and clock lines are connected to the Port's DA0 and DA1 lines. At other times they are disconnected from the port and routed as PIC data lines to any development circuit connected to them. This prevents the two PIC lines, and the computer, from being adversely affected by external circuit loads during programming.

The third 2-way path in IC3 controls the on-board voltage converter IC1, via its SHDN (shutdown) pin. When this pin is held low, during non-programming mode, IC1 outputs +5V via its  $V_{\text{out}}$  pin to the MCLR pins of the PIC(s), allowing the PIC to run its loaded program.

During programming mode, the SHDN pin is held at +5V and IC1 generates a  $V_{\text{out}}$  voltage of +12V, as required by the PIC at this time. Visual advice that the PIC is in programming mode is provided by l.e.d. D8, being turned on during programming and data read back.

When the PIC needs to be reset, port line DA3 is set high and turns on npn transistor TR1. This pulls the PIC MCLR pin

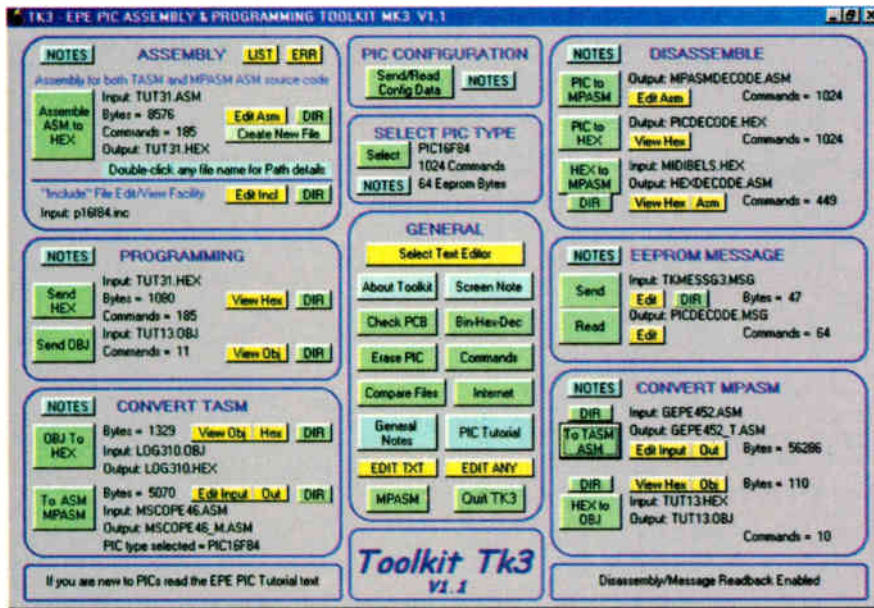

Typical main screen display of the controlling software described in the 16-page Free supplement to be published next month.



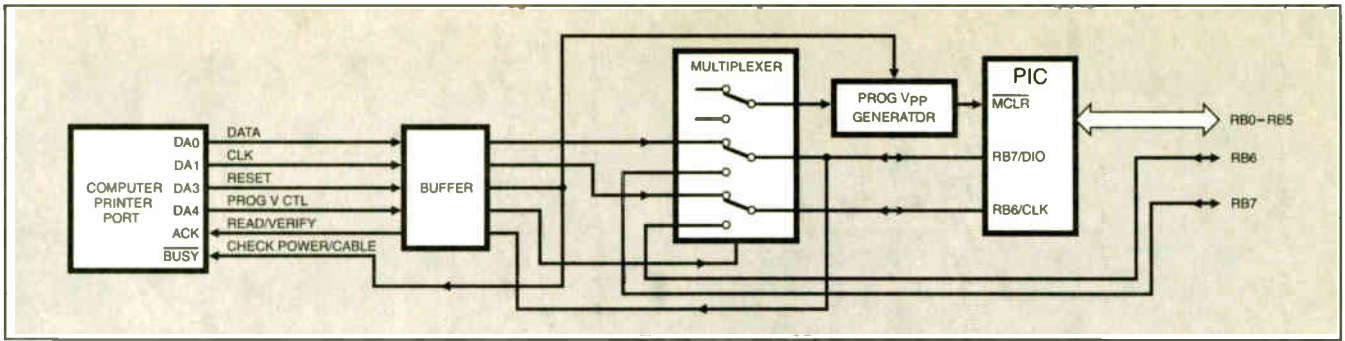

Fig.2. Block diagram illustrating the signal connection logic.

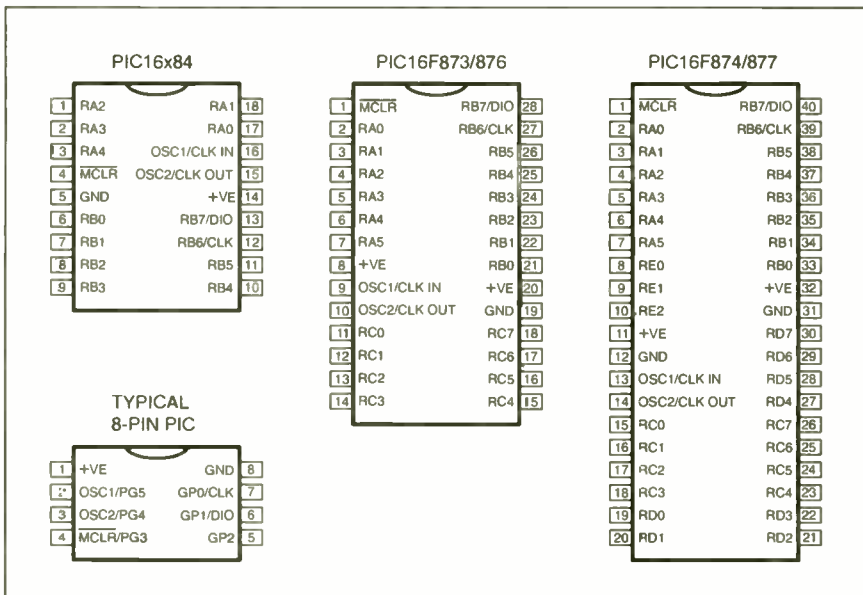

Fig.3. Pin-out identities for the PIC sockets on the p.c.b.

low, which is held in reset mode until DA3 goes low again. Ballast resistor R12 prevents IC1  $V_{out}$  from being shorted to 0V during reset.

The PIC may also be reset manually by pushbutton switch S1. This facility is useful during code development, allowing the PIC to be repeatedly reset in order that some programmed actions can be observed from the beginning.

### CONNECTION POINTS

The board has four PIC-insertion sockets, catering for 8-pin, 18-pin, 28-pin and 40-pin PICs (see Fig.3). The PICs are notated as IC5 to IC8 and their data input/output pins are variously combined onto five bus lines, as shown in Fig.1. The bus lines are terminated at pin header strips or terminal pins to which external circuit components can be connected.

The three larger sockets are intended for use with PIC16x84 and 'F87x devices, although it is likely that some other PIC types can also be programmed via them. The 8-pin socket has been included at reader suggestion. There are several small PICs that are likely to be suitable for programming via this socket, although none have been tested. Consult data sheets for PIC types not specifically mentioned here by name.

It is recommended that ZIF sockets are installed in any PIC position which is likely to be regularly used (but they are not made in 8-pin size so far as is known).

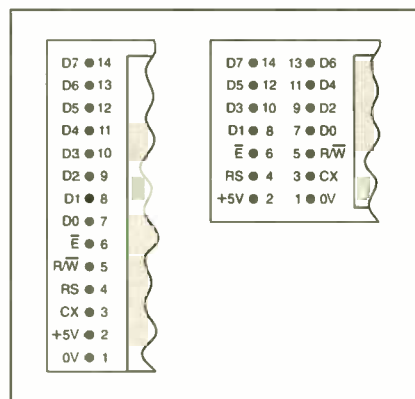

Fig.4. The two "standard" l.c.d. module pinout arrangements.

### L.C.D. CONNECTION

An additional pin-header strip is connected to PIC port pins RB0 to RB5, which is intended for the plugged connection of an optional alphanumeric liquid crystal display (l.c.d.), whose typical pinouts are shown in Fig.4.

Also connected to this pin header are VR2, the l.c.d. contrast setting preset, and the +5V and 0V connections as required. All connections at this header are the same as specified in all the author's recent (since 1998) alphanumeric l.c.d. based PIC designs.

Magenta Electronics supply 2-line x 16-character (per line) l.c.d.s which have pre-connected sockets intended for plugging

## COMPONENTS

### Resistors

R1 to R4, 1k (6 off)  
 R5 to R8, 100k (4 off)  
 R9, R13 to R20, 10k (9 off)  
 R12, 470Ω  
 RM1, 470Ω commoned 8-resistor module

See **SHOP TALK** page

### Potentiometers

VR1, 500k cermet preset, round  
 VR2, VR3, 10k cermet preset, round (2 off)

### Capacitors

C1, C2, 220n ceramic disc (2 off)  
 C3, C6, 4μ7 radial elect. 16V (2 off)  
 C4, C5, 100n ceramic disc (2 off)  
 C7, see text  
 C8, C9, 10p ceramic disc (2 off)

### Semiconductors

D0 to D8, red l.e.d. (9 off)  
 TR1 to TR5, BC549 or similar npn transistor  
 IC1, MAX662A 12V 30mA Flash memory programming supply  
 IC2, 4050 non-inverting hex buffer  
 IC3, 4053 triple 2-channel analogue multiplexer  
 IC4, 7805 +5V 1A voltage regulator  
 IC5 to IC8, PIC microcontroller (see text)

### Miscellaneous

S1, S3 to S6, min. s.p. push-to-make switch  
 S2, s.p.d.t. slide switch, p.c.b. mounting  
 SK1, 36-way Centronics female parallel printer connector, p.c.b. mounting  
 X1, crystal (see text)

Printed circuit board, available from the EPE PCB Service, code 319; alphanumeric l.c.d. (see text); 8-pin d.i.l. socket (2 off); 16-pin d.i.l. socket (2 off); 18-pin d.i.l. or ZIF socket; 28-pin d.i.l. or ZIF socket; 40-pin d.i.l. or ZIF socket; 1mm pin header strips; 2-pin socket (2 off) (for crystal and C1, see text); solder, etc.

Approx. Cost Guidance Only

**£25** excluding PICs

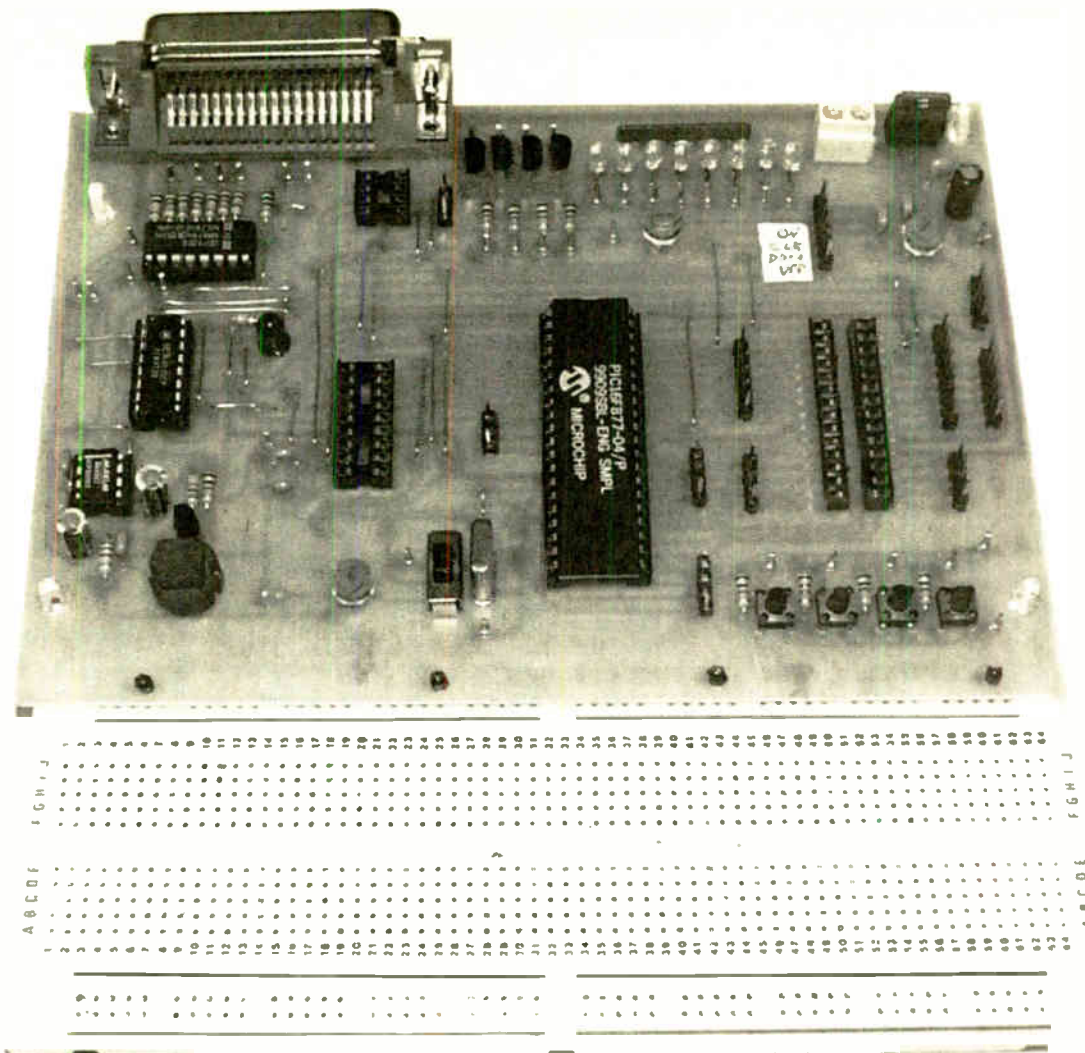

onto this header. It is the same I.C.D. as supplied with the p.c.b. for *PICtutor*, the CD-ROM based *PIC Tutorial* and development kit.

If ordering this I.C.D. from Magenta, you MUST specify that it is this I.C.D. version required (you will otherwise be supplied with a connector-less I.C.D.).

### OSCILLATOR COMPONENTS

The Mk3 board includes facilities for crystal and RC (resistor-capacitor) oscillator components. Crystal X1 is used in conjunction with capacitors C8 and C9. It is recommended that a crystal socket is used on the p.c.b. so that a crystal of any required frequency may be inserted.

The RC oscillator generation is controlled by capacitor C7 and the total resistance across R11 and preset VR1. It is also recommended that a p.c.b. socket is used for C7 so that its value can be readily changed as needed.

Switch S2 allows crystal or RC oscillation mode to be selected. It should be noted that the PIC requires its Configuration bits set to different logic values in relation to the oscillator type used.

### UNCOMMITTED OPTIONS

Several "uncommitted" components can be included on the p.c.b. The components are shown in Fig.5. They comprise four npn transistors (TR2 to TR5) with 10kΩ ballast resistors (R13 to R16) on their bases (Fig.5a).

Their emitters are grounded and you may connect their open-collectors to other circuits that require currents greater than the PIC can provide (about 100mA maximum per transistor, compared to about 25mA per PIC pin – see PIC data sheets for more information on the currents permitted).

The bases can be connected to any PIC pin as required, via the ballast resistors provided.

Eight uncommitted I.C.D.s (Fig.5b) can be included, D7 to D0 (numbered in this way to simplify PIC connection numbering when all are connected to the same port). They all have 470Ω ballast resistors (module RM1) in series, providing enough current for adequate brilliance without overloading the PIC.

Referring to Fig.5c, four uncommitted parallel switches (S3 to S6) can also be added. They are normally-open pushbuttons, with 10kΩ resistors (R17 to R20) in series. Their commoned outer

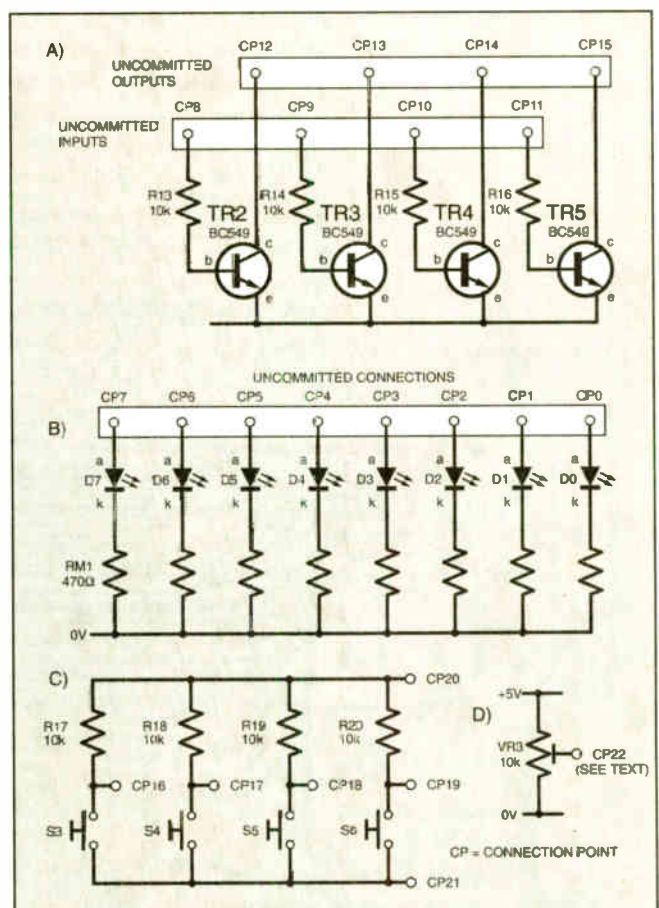

Fig.5. The "uncommitted" component options.

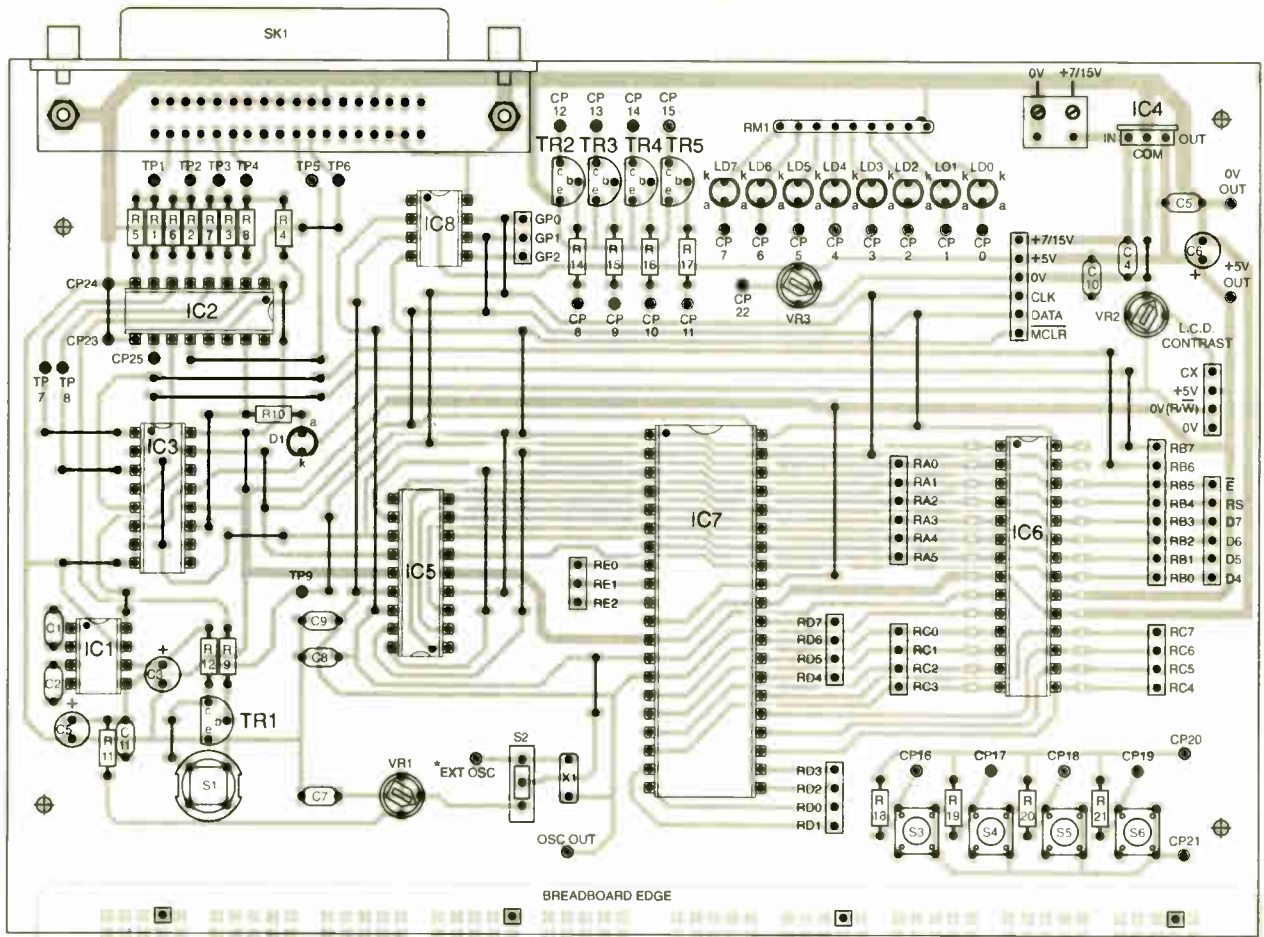
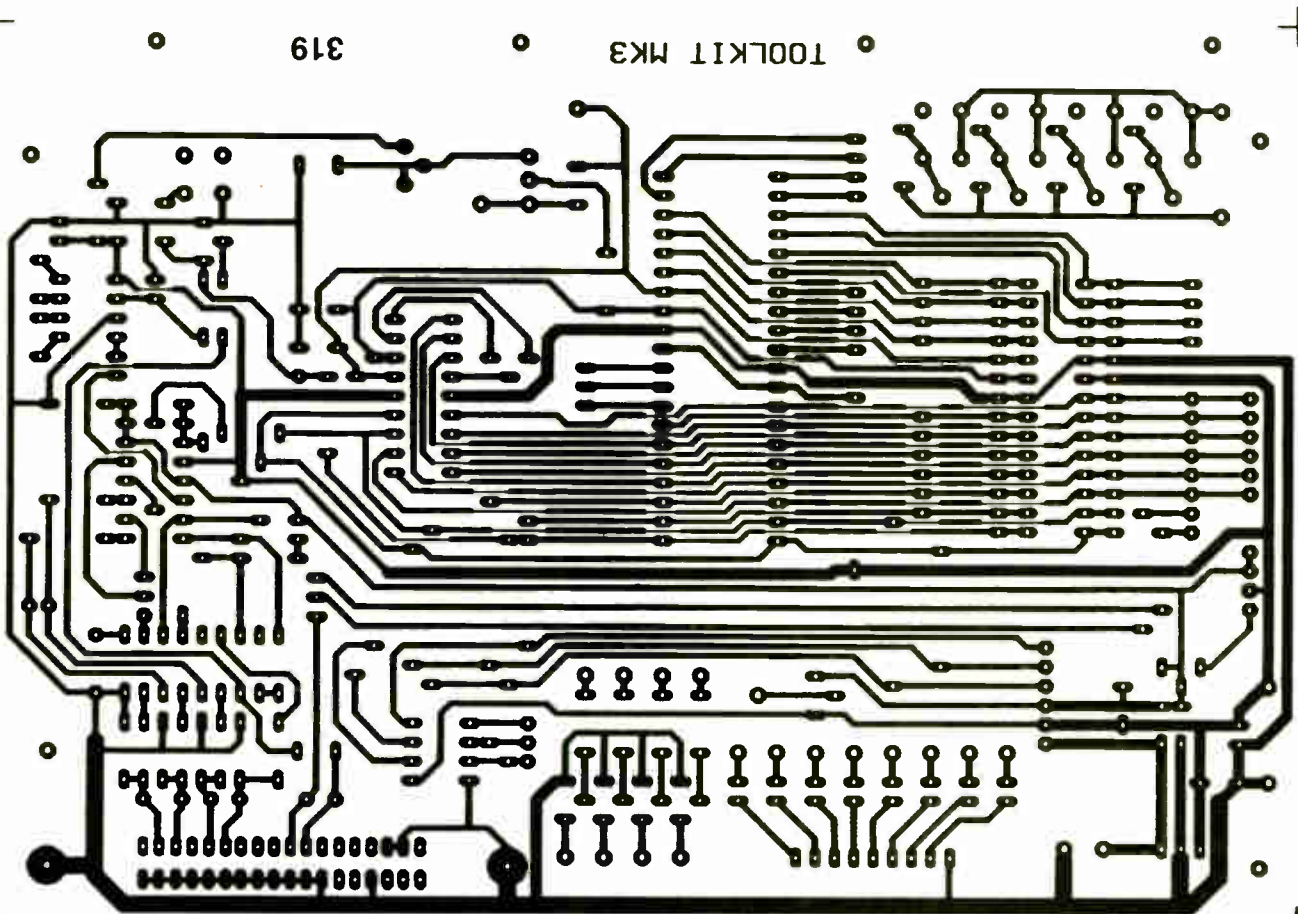

Fig.6. Printed circuit board component layout and full size master track pattern for PIC Toolkit Mk3, showing positioning of optional breadboard.



terminations can be connected to the 0V/5V power lines, with the polarity order as required. The "active" switch pins can be connected to any PIC data pin.

Lastly (Fig.5d), a 10kΩ preset (VR3) is provided, with its outer connections across the 0V/5V power lines. Its wiper can be used to provide a reference voltage to an A-to-D (analogue-to-digital) pin of any PIC that provides A-to-D conversion (the PIC16F87x family, for instance).

## EXTERNAL BREADBOARD

There are terminal pin connections (not electrically connected to anything) which allow the p.c.b. to be mounted firmly onto a prototyping breadboard (of the same type, for example, as used in the *EPE Teach-In 2000* series of Nov '99 to Oct '00). This allows additional components to be breadboarded alongside the Toolkit Mk3 board for extended circuit development use.

Connections between the two boards can be made via solid-core connecting wires, soldered or "pinned" as required.

## POWER SUPPLY

The Toolkit Mk3 board can be powered by any d.c. supply of between about +7V and +12V. IC4 in Fig.1 regulates this supply down to +5V. A 7805 1A device (IC4) is recommended to provide enough current to power the board and other development circuits connected to it.

The external power supply should be chosen so that it can satisfactorily handle

the power required of it. Also note that regulator IC4 may require a heatsink at high input voltages and output currents.

## CONSTRUCTION

Printed circuit connection and tracking details are shown in Fig.6. This board is available from the *EPE PCB Service*, code 319.

It is suggested that you assemble the board in order of wire links (don't forget the one underneath IC3), i.e. sockets, and the other components in order of size or convenience.

Thoroughly check the board for assembly errors before inserting the d.i.l. devices and applying power. Next check the powered board with only regulator IC4 in circuit, then check the power line voltages with voltage

converter IC1 inserted as well. From then, fully populate with the other i.c.s, and a chosen PIC type (a PIC16F84 is suggested at this time). *Only one PIC should be inserted at any one time.*

The rest is up to you and your computer, either using your existing DOS-based Toolkit V2.4 software, or migrating to the exciting new Toolkit TK3 for Windows software described next month's Supplement. May your programming dreams be fulfilled!

## ACKNOWLEDGEMENT

The author thanks Andy Flind for suggestions regarding some of the p.c.b. facilities included with Toolkit Mk3.

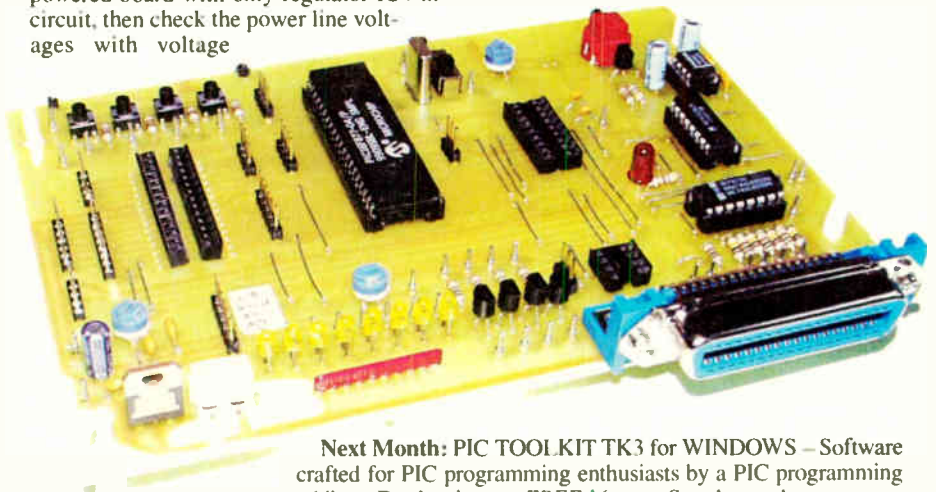

Next Month: PIC TOOLKIT TK3 for WINDOWS – Software crafted for PIC programming enthusiasts by a PIC programming addict – Don't miss our FREE 16-page Supplement!



## A COMPLETE RANGE OF INVERTERS

150W TO 2500W - 12V & 24V

A Complete range of regulated inverters to power 220V and 240V AC equipment via a car, lorry or boat battery. Due to their high performance (>90%) the inverters generate very little heat. The high stability of the output frequency (+/-1%) makes them equally suitable to power sensitive devices.

These inverters generate a modified sine wave, which are considerably superior to the square waves which are produced by most other inverters. Due to this superior feature they are capable of powering electrical equipment such as TV.s, videos, desktop & notepad computers, microwave ovens, electrical lamps, pumps, battery chargers, etc.

### Low Battery Alarm

The inverters give an audible warning signal when the battery voltage is lower than 10.5V (21V for the 24V version). The inverter automatically shuts off when the battery voltage drops below 10V (20V for the 24V version). Fuse protected input circuitry.

Order Code	Power	Voltage	Price
651.581	150W Continuous	12V	£36.39
651.578	150W Continuous	24V	£36.39
651.582	300W Continuous	12V	£50.64
651.585	300W Continuous	24V	£50.64
651.583	600W Continuous	12V	£101.59
651.593	600W Continuous	24V	£101.59
651.587	1000W Continuous	12V	£177.18
651.597	1000W Continuous	24V	£177.18
651.602	1500W Continuous	12V	£314.52
651.605	1500W Continuous	24V	£314.52
651.589	2500W Continuous	12V	£490.54
651.599	2500W Continuous	24V	£490.54

All prices are inclusive of V.A.T. Carriage £6.00 Per Order

Many uses include:- Fetes · Fairgrounds · Airshows · Picnics · Camping · Caravans · Boats · Carnivals · Field Research and · Amateur Radio field days \* Powering Desktop & Notepad Computers.



ILLUSTRATION SHOWN IS 651.583 600W VERSION.

DELIVERY CHARGES ARE £6-00 PER ORDER. OFFICIAL ORDERS FROM SCHOOLS, COLLEGES, GOVT. BODIES, PLC.S ETC. PRICES ARE INCLUSIVE OF V.A.T. SALES COUNTER. VISA AND ACCESS ACCEPTED BY POST, PHONE OR FAX, OR EMAIL US AT SALES@BKELEC.COM ALTERNATIVELY SEND CHEQUE OR POSTAL ORDERS MADE PAYABLE TO BK ELECTRONICS.

For Full Specifications View our web site at:-

[WWW.BKELEC.COM/INVERTERS.HTM](http://WWW.BKELEC.COM/INVERTERS.HTM)



**B.K. ELECTRONICS**



UNIT 1, COMET WAY, SOUTHEND-ON-SEA, ESSEX. SS2 6TR  
TEL.: +44(0)1702-527572 FAX.: +44(0)1702-420243

# New Technology Update

*The latest accelerometer technology promises to speed up their introduction into many areas, reports Ian Poole.*

**A**CELEROMETERS are used in many areas of testing. Usually their operation depends on a solid mass that is allowed to move under the differing conditions of acceleration and its position monitored to give an indication of the acceleration.

These devices have a number of disadvantages including the difficulty of manufacturing them and using integrated circuit technology. Although in recent years new micro-machining techniques have been introduced that allow for accelerometers to be manufactured as integrated items.

However, these processes involve many masks and etching steps in the manufacturing process. Not only is this complicated but it is also very expensive.

## New Development

In a new development organised by the American National Institute of Standards and Technology in Gaithersburg in Maryland, USA, researchers have overcome the problems of incorporating an accelerometer into an integrated circuit. The idea is based around a concept that has recently been proposed using the effect of acceleration on natural heat convection. The device uses heat generated from conductors that is transferred into the gas surrounding the device. It is hermetically sealed to ensure that it is not influenced by external pressure or airflow.

The new implementation of this idea uses standard CMOS circuitry and micro-machined thermopile or thermistor sensors for temperature sensing. In view of this it is possible to have a completely integrated sensor on a single chip including all the sensing and drive circuitry.

This can give significant cost advantages over existing sensors. Not only this but the sensors show significant performance advantages over other types.

These manifest themselves in terms of much lower power consumption and a higher frequency response, extending up to figures of a few hundreds of Hertz rather than a few tens of Hertz when compared to other convective sensors.

## Construction

The basic device consists of a suspended polysilicon micro-heater, see Fig.1. When a current is passed through this heated element the thermal difference between the element and the surrounding gas generates a convective flow of gas.

When the device experiences some acceleration the change in the convection flow of the gas causes a temperature difference between the sides of the heated element. Temperature sensors placed on either side of the heater element then detect a temperature

difference. The acceleration is proportional to that applied to the device.

The temperature sensors can be either thermocouples or thermistors. Both types are equally compatible with CMOS fabrication technology and the interfacing requirements for both types can be accommodated equally as well. However, there are a few differences in the actual construction of the devices.

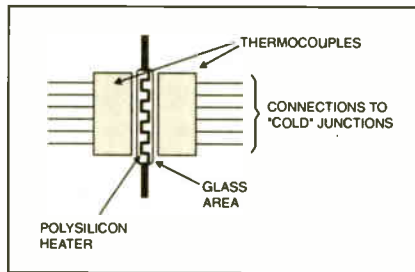

Fig.1. Thermocouple-based accelerometer.

In the device using thermocouples a polysilicon heater encapsulated in a glass passivation is suspended in air. The thermocouple junctions are then located either side and close to the heater. A thermocouple requires a second junction at a different temperature and this "cold" junction is located above the base silicon material.

Whilst it would be possible to use a single pair of junctions either side of the heater, greater sensitivity can be achieved by using several thermocouples in series. In the development examples twelve thermocouples were used in series on either side of the heater, giving far greater level of output and hence sensitivity.

A different configuration was used for the thermistor-based devices, see Fig.2. Here two parallel polysilicon resistors were suspended but with an air gap between them. These were connected in a Wheatstone bridge circuit with two reference or "cold" resistors that were not suspended.

Two heaters then heated the suspended resistors. These heaters were micro-machined to give exactly the required conditions. When the circuit experienced acceleration the convection pattern was

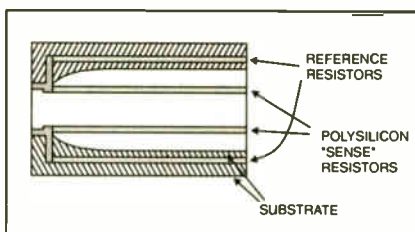

Fig.2. Concept of thermistor-based accelerometer.

disrupted such that the bridge conditions were altered.

## Test Conditions

The accelerometers were tested under a variety of conditions. One crucial test was that of investigating how the devices operated when they were inclined to the horizontal. Their operation was tested between plus and minus 90 degrees and for accelerations between zero and 7g.

They were also tested over a range of vibration frequencies from 30Hz to 3kHz.

## Results

The accelerometers showed very good levels of linearity. Errors of less than 0.5% were achieved under tilt conditions of up to  $\pm 90$  degrees, and less than two per cent for accelerations of less than 7g. The sensitivity was also good and was found to be almost a linear function of the heater power.

Using a heater running at 100mW, sensitivity levels of just over  $100\mu\text{V}$  per g were achieved for the thermocouple devices. Values of  $25\mu\text{V}$  per g were obtained for thermistor devices.

Sensitivity is of considerable importance. If values fall too low then the output voltage can become lost in the noise. A typical thermocouple device with a resistance of 64 kilohms produced a noise voltage of  $32\text{nV}/\text{Hz}^{1/2}$  (32 nanovolts per square root Hertz) and for a thermistor device with a resistance of 4 kilohms the value was about a quarter of this.

It was also found that the thermistor device had a higher frequency response than the thermocouple. This is thought to result from the significantly smaller spacing between the sensing devices.

## Summary

In manufacture these devices only use one additional mask post-processing step. This makes them ideal for easy introduction into production. This will also result in their cost not being significantly above many other specialist devices, and considerably cheaper than other accelerometers.

A further advantage is their robustness as they have no mechanically moving parts.

Further development work is still required. The devices can be further optimised and their performance needs to be characterised using different gases, pressures and temperatures. Other geometries internal to the device also need to be investigated.

This new technology shows a significant amount of promise and should enable accelerometers to become cheaper, smaller and more flexible in their use.



We can supply back issues of *EPE* by post, most issues from the past three years are available. An *EPE* index for the last five years is also available – see order form. Alternatively, indexes are published in the December issue for that year. Where we are unable to provide a back issue a photostat of any *one article* (or *one part* of a series) can be purchased for the same price. Issues from Jan. 2001 onwards are also available to download from [www.epemag.com](http://www.epemag.com).

## DID YOU MISS THESE?

### JUNE '00

**PROJECTS** • Atmospheric Electricity Detector-1 • Canute Tide Predictor • Multi-Channel Transmission System-2 • Automatic Nightlight.  
**FEATURES** • Teach-In 2000 – Part 8 • Technology Timelines-5 • Circuit Surgery • Interface • New Technology Update • Ingenuity Unlimited • Net Work – The Internet.

### JULY '00

**PROJECTS** • Q-Meter • Camera Shutter Timer PIC-Gen Frequency Generator/Counter • Atmospheric Electricity Detector-2.  
**FEATURES** • Teach-In 2000-Part 9 • Practically Speaking • Ingenuity Unlimited • Circuit Surgery • PIC DrDAQ Reviewed • Net Work – The Internet.

### AUG '00

**PROJECTS** • Handy-Amp • EPE Moodloop • Quiz Game Indicator • Door Protector  
**FEATURES** • Teach-In 2000-Part 10 • Cave Electronics • Ingenuity Unlimited • Circuit Surgery • Interface • New Technology Update • Net Work – The Internet.



### SEPT '00

**PROJECTS** • Active Ferrite Loop Aerial • Steeplechase Game • Remote Control IR Decoder • EPE Moodloop Power Supply.  
**FEATURES** • Teach-In 2000-Part 11 • New Technology Update • Circuit Surgery • Ingenuity Unlimited • Practically Speaking • Net Work – The Internet Page.

### OCT '00

**PROJECTS** • Wind-Up Torch • PIC Dual-Chan Virtual Scope • Fridge/Freezer Alarm • EPE Moodloop Field Strength Indicator.  
**FEATURES** • Teach-In 2000-Part 12 • Interface • Ingenuity Unlimited • New Technology Update • Circuit Surgery • Peak Atlas Component Analyser Review • Net Work – The Internet Page.

### NOV '00

**PROJECTS** • PIC Pulsometer • Opto-Alarm System • Sample-and-Hold • Handclap Switch.  
**FEATURES** • The Schmitt Trigger-Part 1 • Ingenuity Unlimited • PIC Toolkit Mk2 Update V2.4 • Circuit Surgery • New Technology Update • Net Work – The Internet • FREE Transistor Data Chart.

### DEC '00

**PROJECTS** • PIC-Monitored Dual PSU-Part1 • Static Field Detector • Motorists' Buzz-Box • Twinkling Star • Christmas Bubble • Festive Fader • PICtogram.  
**FEATURES** • The Schmitt Trigger-Part 2 • Ingenuity Unlimited • Interface • Circuit Surgery • New Technology Update • Quasar Kits Review • Net Work – The Internet • 2000 Annual Index.

### JAN '01

**PROJECTS** • Versatile Optical Trigger • UFO Detector and Event Recorder • Two-Way Intercom • PIC-Monitored Dual PSU-Part 2.  
**FEATURES** • Using PICs and Keypads • The Schmitt Trigger-Part 3 • New Technology Update • Circuit Surgery • Practically Speaking • Ingenuity Unlimited • CIRSIM Shareware Review • Net Work – The Internet.

### FEB '01

**PROJECTS** • Ice Alert • Using LM3914-6 Bargraph Drivers • Simple Metronome • PC Audio Power Meter.  
**FEATURES** • The Schmitt Trigger-Part 4 • Ingenuity Unlimited • Circuit Surgery • New Technology Update • Net Work – The Internet • Free 16-page supplement – How To Use Graphics L.C.D.s With PICs.



### MAR '01

**PROJECTS** • Doorbell Extender • Body Detector • DIY Tesla Lightning • Circuit Tester  
**FEATURES** • Understanding Inductors • The Schmitt Trigger-Part 5 • Circuit Surgery • Interface • New Technology Update • Net Work – The Internet Page.

### APRIL '01

**PROJECTS** • Wave Sound Effect • Intruder Alarm Control Panel-Part 1 • Sound Trigger • EPE Snug-Bug Pet Heating Control Centre.  
**FEATURES** • The Schmitt Trigger-Part 6 • Practically Speaking • Ingenuity Unlimited • Circuit Surgery • Net Work – The Internet Page • FREE supplement – An End To All Disease.

### MAY '01

**PROJECTS** • Camcorder Mixer • PIC Graphics L.C.D. Scope • D.C. Motor Controller • Intruder Alarm Control Panel-Part 2.  
**FEATURES** • The Schmitt Trigger-Part 7 • Interface • Circuit Surgery • Ingenuity Unlimited • New Technology Update • Net Work – The Internet Page.

### JUNE '01

**PROJECTS** • Hosepipe Controller • In-Circuit Ohmmeter • Dummy PIR Detector • Magfield Monitor.  
**FEATURES** • Controlling Jodrell Bank • PIC1687x Extended Memory Use • Practically Speaking • Ingenuity Unlimited • New Technology Update • Circuit Surgery • Net Work – The Internet Page.

### JULY '01

**PROJECTS** • Stereo/Surround Sound Amplifier • PIC to Printer Interface • Perpetual Projects 1- Solar-Powered Power Supply and Voltage Regulator • MSF Signal Repeater and Indicator.  
**FEATURES** • The World of PLCs • Ingenuity Unlimited • Circuit Surgery • New Technology Update • Net Work – The Internet Page.



### AUG '01

**PROJECTS** • Digitimer • Lead-Acid Battery Charger • Compact Shortwave Loop Aerial • Perpetual Projects 2 – L.E.D. Flasher – Double Door-Buzzer.  
**FEATURES** • Controlling Power Generation • Ingenuity Unlimited • Interface • Circuit Surgery • New Technology Update • Net Work – The Internet Page.

### SEPT '01

**PROJECTS** • Water Monitor • L.E.D. Super Torch • Synchronous Clock Driver • Perpetual Projects 3 – Loop Burglar Alarm – Touch-Switch Door-Light – Solar-Powered Rain Alarm.  
**FEATURES** • Controlling Flight • Ingenuity Unlimited • Practically Speaking • Circuit Surgery • New Technology Update • Net Work – The Internet Page.

**BACK ISSUES ONLY £3.30 each inc. UK p&p.**

Overseas prices £3.80 each surface mail, £5.25 each airmail.

We can also supply issues from earlier years: 1998 (except Jan. to May, July, Nov., Dec.), 1999, 2000 (except Feb.). Where we do not have an issue a photostat of any *one article* or *one part* of a series can be provided at the same price.

### ORDER FORM – BACK ISSUES – PHOTOSTATS– INDEXES

Send back issues dates .....

Send photostats of (article title and issues date) .....

Send copies of last five years indexes (£3.30 for five inc. p&p – Overseas £3.80 surface, £5.25 airmail)

Name .....

Address .....

.....Tel: .....

I enclose cheque/P.O./bank draft to the value of £ .....

Please charge my Visa/Mastercard/Amex/Diners Club/Switch £ ..... Switch Issue No. ....

Card No. .... Card Expiry Date .....

Note: Minimum order for credit cards £5.

SEND TO: Everyday Practical Electronics, Wimborne Publishing Ltd., 406 Wimborne Road East, Ferndown, Dorset BH22 9ND.

Tel: 01202 873872. Fax: 01202 874562.

E-mail: [orders@epemag.wimborne.co.uk](mailto:orders@epemag.wimborne.co.uk) On-line Shop: [www.epemag.wimborne.co.uk/shopdoor.htm](http://www.epemag.wimborne.co.uk/shopdoor.htm)

Payments must be in £ sterling – cheque or bank draft drawn on a UK bank. Normally supplied within seven days of receipt of order.

Send a copy of this form, or order by letter if you do not wish to cut your issue.

M10/01

# STORE YOUR BACK ISSUES IN YOUR WALLET!



**VOL 4  
NOW AVAILABLE**

**ONLY  
£12.45** each  
including VAT  
and p&p

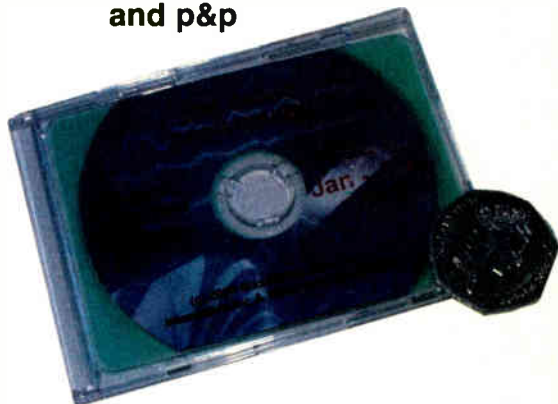

A great way to buy *EPE* Back Issues – our wallet-sized CD-ROMs contain back issues from our *EPE Online* website plus bonus articles, all the relevant PIC software and web links. All this for just £12.45 each including postage and packing.

## VOL 1 CONTENTS

**BACK ISSUES** – November 1998 to June 1999 (all the projects, features, news, IUs etc. from all eight issues). Note: No advertisements or Free Gifts are included.

**PIC PROJECT CODES** – All the available codes for the PIC based projects published in issues from November 1998 to June 1999.

## VOL 2 CONTENTS

**BACK ISSUES** – July 1999 to December 1999 (all the projects, features, news, IUs, etc. from all six issues). Note: No advertisements or Free Gifts are included.

**PIC PROJECT CODES** – All the available codes for the PIC-based projects published in issues from July to December 1999.

## VOL 3 CONTENTS

**BACK ISSUES** – January 2000 to June 2000 (all the projects, features, news, IUs, etc. from all six issues). Note: No advertisements or Free Gifts are included.

**PIC PROJECT CODES** – All the available codes for the PIC-based projects published in issues from January to June 2000.

## VOL 4 CONTENTS

**BACK ISSUES** – July 2000 to Dec. 2000 (all the projects, features, news, IUs etc. from all six issues). Note: No Free Gifts are included.

**PROJECT CODES** – All the available codes for the programmable projects from July to Dec. 2000.

## EXTRA ARTICLES – ON ALL VOLUMES

**BASIC SOLDERING GUIDE** – Alan Winstanley's internationally acclaimed fully illustrated guide.

**UNDERSTANDING PASSIVE COMPONENTS** – Introduction to the basic principles of passive components.

**HOW TO USE INTELLIGENT L.C.D.s**, By Julian Hett – An utterly practical guide to interfacing and programming intelligent liquid crystal display modules.

**PhyzyB COMPUTERS BONUS ARTICLE 1** – Signed and Unsigned Binary Numbers. By Clive "Max" Maxfield and Alvin Brown.

**PhyzyB COMPUTERS BONUS ARTICLE 2** – Creating an Event Counter. By Clive "Max" Maxfield and Alvin Brown.

**INTERGRAPH COMPUTER SYSTEMS 3D GRAPHICS** – A chapter from Intergraph's book that explains computer graphics technology in an interesting and understandable way with full colour graphics.

## EXTRA ARTICLE ON VOL 1 & 2

**THE LIFE & WORKS OF KONRAD ZUSE** – a brilliant pioneer in the evolution of computers. A bonus article on his life and work written by his eldest son, including many previously unpublished photographs.

**NOTE:** This mini CD-ROM is suitable for use on any PC with a CD-ROM drive. It requires Adobe Acrobat Reader (available free from the Internet – [www.adobe.com/acrobat](http://www.adobe.com/acrobat))

Order on-line from

[www.epemag.wimborne.co.uk/shopdoor.htm](http://www.epemag.wimborne.co.uk/shopdoor.htm)

or [www.epemag.com](http://www.epemag.com) (USA \$ prices)

or by phone, Fax, E-mail or Post

### BACK ISSUES CD-ROM ORDER FORM

Please send me ..... (quantity) BACK ISSUES CD-ROM VOL 1

Please send me ..... (quantity) BACK ISSUES CD-ROM VOL 2

Please send me ..... (quantity) BACK ISSUES CD-ROM VOL 3

Please send me ..... (quantity) BACK ISSUES CD-ROM VOL 4

Price £12.45 each – includes postage to anywhere in the world.

Name .....

Address .....

.....

..... Post Code .....

I enclose cheque/P.O./bank draft to the value of £ .....

Please charge my Visa/Mastercard/Amex/

Diners Club/Switch

£ .....

Card No. ....

Expiry Date ..... Switch Issue No. ....

SEND TO: **Everyday Practical Electronics,**  
Wimborne Publishing Ltd.,

408 Wimborne Road East, Ferndown, Dorset BH22 9ND.

Tel: 01202 873872. Fax: 01202 874562.

E-mail: [orders@epemag.wimborne.co.uk](mailto:orders@epemag.wimborne.co.uk)

Payments must be by card or in £ Sterling – cheque or bank draft drawn on a UK bank.

Normally supplied within seven days of receipt of order.

Send a copy of this form, or order by letter if you do not wish to cut your issue.

# L.E.T PIC BASIC PRO COMPILER

The Fast and Easy way to Program the PIC Microcontroller

Write and Compile your first Program in under 5 minutes  
Distribute your applications ROYALTY FREE  
Technical Support direct from the authors  
Dedicated user group mailing list  
Easy to navigate Windows (GUI)  
CDROM Includes software and example programs  
Book Includes worked examples and Projects  
Supports the popular PIC micro's including Flash devices

## INCLUDES:

- LET PIC BASIC Pro Compiler on CD-ROM
- LET PIC BASIC User Guide on CD-ROM
- Data Sheets and support documents on CD-ROM
- Adobe Acrobat reader on CD-ROM
- StampPlot Lite
- LET PIC BASIC Unleashed Book
- Printed User Guide

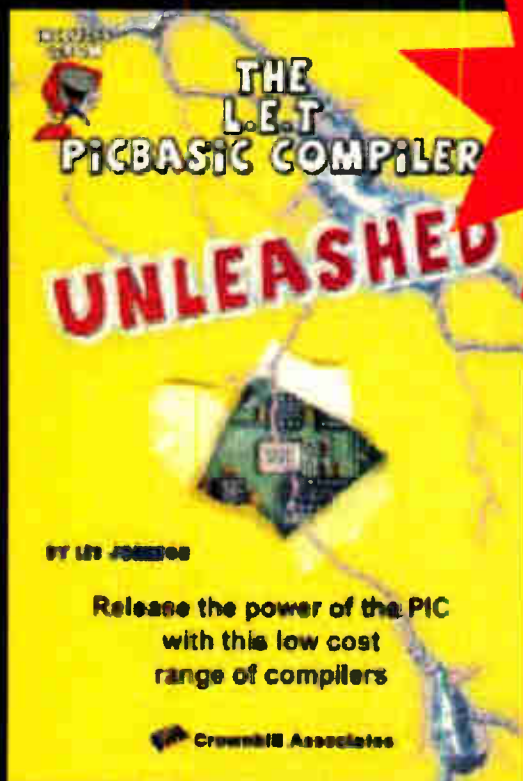

LET PIC BASIC Unleashed by Les Johnson

Covering the following subjects:  
Interfacing to LCD and LED Displays  
Interfacing to Keypads  
Infrared Remote Control  
Using the 433Mhz Transmitter/Receiver Modules  
Interfacing to Serial Devices  
Temperature Measurement  
Downloading the computer's time  
Using the on board A to D Converter  
Advanced Programming Techniques  
RS232 serial communications demystified  
Implementing interrupts in BASIC  
Temperature data Logging Project

**LE.T. PIC  
BASIC PLUS  
NOW AVAILABLE**  
**£99.95**  
+ £5.50 p-p  
+VAT



Includes  
CD-ROM

Download StampPlot

Free at [www.letbasic.com](http://www.letbasic.com)

LET PICBASIC produces tight concise code from your program written in the easy to learn yet powerful BASIC language. You no longer have to struggle to learn machine code to use the popular PIC Microcontrollers, the compiler will produce code for both the 12 bit and 14 bit micros, therefore it can be used to produce code for any of the popular PIC devices including the 12C508 and 12C509 and the 16F84 and 16F877 and other popular Flash Devices.

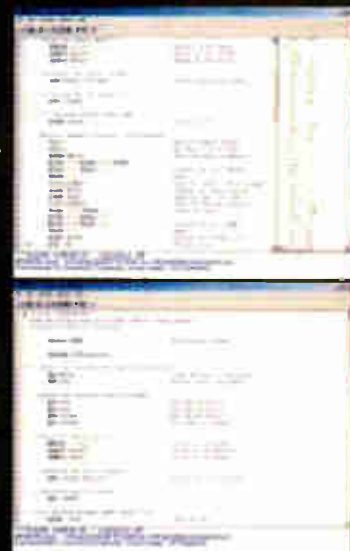

**FREE Download**  
**L.E.T PIC BASIC LITE**  
[www.letbasic.com](http://www.letbasic.com)

**Crownhill Associates Limited**

32 Broad Street Ely Cambridge CB7 4AH  
Tel: 01353 665700 Fax: 01353 665710



ORDER ONLINE [www.crownhill.co.uk](http://www.crownhill.co.uk)

All prices are subject to a delivery charge + VAT@17.5%

# TRAFFIC CONTROL

OWEN BISHOP



*SCOOT systems speed the flow of road traffic and pedestrians.*

**W**hear much about air traffic controllers, but more important to our daily lives are those relatively inconspicuous systems and people who control the flow of traffic in our busy cities. This article describes how electronics and computers are used to make their work possible.

## INCONSPICUOUS CONTROL

Anyone standing on the pavement outside the Norfolk County Council Urban Traffic Control Centre in Norwich would probably not notice the inconspicuous semi-basement entrance. Yet behind this door lies the UTCC, under the control of a DEC ALPHAstation 255 computer, running at 300MHz.

This computer keeps the traffic flowing (or at least minimises the delays) not only for Norwich city but also for the whole of the county of Norfolk. It keeps the pedestrians flowing too, out of the 256 signals linked to the system, about 50 per cent are pedestrian crossings.

The control centre is manned during the day but the computer is able to function unassisted during the evenings and night. Fortunately for the motorists, the computer can call on an engineer to handle emergencies out of hours. Fortunately for the engineer, this can be done through a remote link to a PC in the engineer's own home.

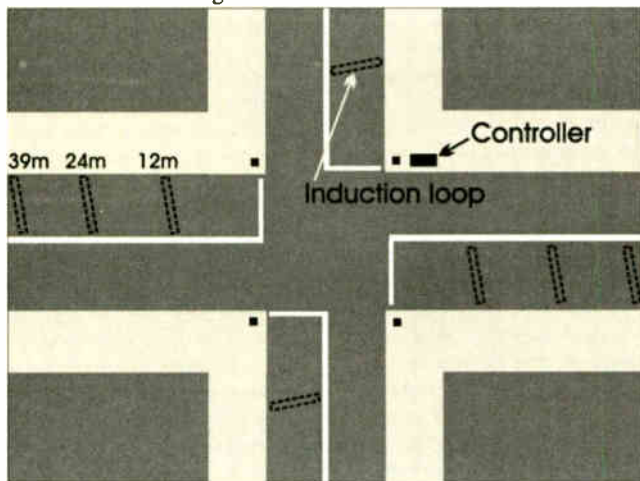

Fig.1. At an independently controlled road junction, each approach lane has three inductive loops.

## INDEPENDENT LIGHTS

It makes sense for the signal lights situated in the more remote parts of Norfolk (happily, there are still a few such parts!) to be independently controlled. A single road junction might have the layout shown in Fig.1.

Vehicles approaching the junction are detected by inductive loops. Essentially, an inductive loop is a loop of cable embedded just beneath the road surface. The loop is connected into an a.c. bridge circuit set up to measure the self-inductance of the loop. This changes when a massive ferromagnetic object such as a vehicle is situated above the loop.

Changes in inductance change the input to the control computer that is located beside the road junction. Information from the inductive loops can tell the computer the length of the traffic queue at the lights and also the speed and approximate size of vehicles approaching the lights. The computer is programmed to read this data and to use it to decide which lights are to be switched to GO and which to STOP and for how long.

In the centre of a small town there may be two sets of lights with a link road joining them. Each junction has its own independent set of inductive loops, traffic lights and computer. However, their programs are designed so that the action of the two computers is coordinated. They are linked by a data cable and they both run according to clocks driven by the mains frequency. Thus their action is synchronised and takes into account the time delay of traffic leaving one junction and proceeding along the link road to the other junction.

Although their local computers independently control these single and double junctions, their action is monitored remotely by dedicated BT telephone line to the

UTCC. Here the operator can call up the data for any particular junction.

The monitor screen displays a plan of the junction or junctions and pedestrian crossing too. The plan shows the state of the inductive loops, the state of the lights and the state of the pedestrians' pushbutton on the crossing. Sitting in the UTCC in Norwich, an operator can check that all of the signals systems in Norfolk are operating correctly.

## SCOOT

In a larger town, where there are more than two junctions close together, the junction computers are connected to and controlled by the central computer at the UTCC. Connection is through an Outstation Transmission Unit (OTU) which comprises a modem wired to BT telephone lines. The kerbside computer controls the lights at the junction but is under the supervision of the control computer in the UTCC.

The main computer runs traffic control software known as SCOOT. This program is written in C and its name is short for Split Cycle and Offset Optimisation Technique. The difference between SCOOT and an ordinary pre-planned light sequencing controller is that the SCOOT computer responds instantly to current traffic demands.

SCOOT also depends on sensing traffic by means of inductive loops. These are additional loops on the exits from junctions, where traffic leaves the junction to pass along a stretch of roadway to the next junction. In some places there may be two loops close together to allow the speed of the vehicles to be measured.

Other kinds of sensor are used where appropriate. On the faster roads there may be Doppler-effect microwave sensors to detect the presence and speed of vehicles. These register vehicles at a distance of about 50 metres.

Doppler-effect sensors are also used on pedestrian crossings to detect the presence of people waiting to cross or actually crossing. Active infrared detectors are also used on pedestrian crossings, as well as sensor mats on the waiting area on the pavement.

## ENGINEERING DATA

Data collected by the control computer is available to the engineers in several ways. As mentioned earlier, the controller can call up a display to check the operation

Fr 09:32:01	D01217	DEREHAM/LKMAN O	[OPE]	Congestion formed
Fr 09:33:16	X41160	LITLPORT/HIGHGT	[0511]	TX fault
Fr 09:34:17	X41160	LITLPORT/HIGHGT	[0511]	TX replies restored
Fr 09:35:00	D01217	DEREHAM/LKMAN O	[OPE]	Congestion cleared
Fr 09:35:00	D04317	BSHPG/BSHPGT S	[OPE]	Congestion cleared
Fr 09:38:00	D04317	BSHPG/BSHPGT S	[OPE]	Congestion formed
Fr 09:40:36	Z05329	SVD Chartwell		Bus arrival
Fr 09:40:40	Z05329	SVD Chartwell		Bus departed
Fr 09:41:01	D04317	BSHPG/BSHPGT S	[OPE]	Congestion cleared

Fig.2. The traffic log records all events on the system immediately they occur.

of lights at all road junctions. This information is also presented for all the junctions in an area in tabular form. The computer also displays a running log of events on the system. Fig.2 shows a typical abstract from this and illustrates the kinds of event reported just after 9.32, one Friday morning in September.

A few minutes after the last entry in the figure, the log reported the failure of a Wait lamp at the junction of High Street and Baker Street in Gorleston. The maintenance contractor was automatically alerted to the failure. The log went on to show that the lamp was replaced nine minutes and 33 seconds later. The data is used only for monitoring and is not stored.

In addition to monitoring the system, the controller can call up visuals from a number of remotely controlled video cameras mounted at strategic points in the Norfolk road system. These cameras have full aiming and zooming features. This allows the operator to sort out any serious problems such as might arise from a traffic accident or football crowd.

For an overall view of the situation, the controller watches the map that covers one entire wall of the control room (Fig.3). Lamps on this map indicate the status of the lights at each junction. On the same wall are subsidiary maps for the two large towns, Great Yarmouth and King's Lynn.

## AUTOMATIC CONTROL

Each junction in the system has a basic plan for the sequencing and timing of the lights. Because that sequencing is done by software, rather than by mechanical means or logic circuits, it opens up all kinds of possibilities.

SCOOT allows for a large number of different plans to be available for each junction and to switch from one plan to the other as the situation demands. The selected plan at each junction may change automatically at different times of day to cope with daily variations in traffic flow. However, under SCOOT, the plan may be changed or modified automatically second by second.

For instance, if signals from the inductive loops show that a vehicle (perhaps an HGV) is moving slowly toward a junction, SCOOT can extend the green period to allow the vehicle to clear the junction. On the other hand, if further data input shows that the vehicle is speeding up, the extension of green time can be automatically cancelled.

In the longer term, SCOOT also accumulates traffic data at a given junction over a period of time and then amends the green times on different branches so as to minimise waiting times. Changes of the current sequencing plan at each junction are noted on the log as they come into effect.

## DIRECTION SENSING

In the narrower streets of this ancient city, cars may find their way blocked by vehicles parked on the left at the kerbside. They are then obliged to cross into the other traffic lane in order to pass the obstruction. While doing this, they might well pass over an inductive sensor, which would then indicate a vehicle apparently travelling in the opposite direction. SCOOT software is able to recognise such a situation and ignores the misleading data.

The flexibility of the system is such that it can receive input from the emergency services. A signal from the Fire Station for example can bring about a "green wave". Along a number of selected routes, the "green wave" puts the lights at green in an expanding zone centred on the Fire Station. The emergency vehicles are thus given priority on their way to the fire.

Pedestrians too benefit from the flexibility and intelligence of SCOOT. If the crossing detector shows that a person is a slow walker, the green time on the crossing is automatically extended.

Motorists at crossings benefit too. One is only too familiar with the exasperating situation of being stopped at a pedestrian crossing when there is no one wanting to cross. The pedestrian had pressed the crossing button and subsequently decided not to cross, or managed to cross during a lucky break in the traffic. With SCOOT, the sensors detect that the person is no longer waiting and the call is cancelled.

## BY THE ROADSIDE

The photograph shows the inside of one of those boxes that stand on the pavement at traffic junctions. The box has been opened (which fact will have been noted in the log) so that we can see (1) the SCOOT detector. This one reads data from four inductive loops placed in the road at the four exits from the junction.

At (2) there are the circuits for the inductive loops on the approaches to the junction. Data from (1) and (2) are relayed to the control room through the OTU, which is item (3) in the photograph. Below, at (4) is the rack holding the processor cards of the local junction computer. Its power supply is to the right of this.

Below the computer and out of sight in the photograph is the power supply for the signal lamps. These are 24V lamps and receive their supply from a transformer working on the 230V a.c. mains.

The system incorporates a photosensor that detects low ambient light levels, such as occur at night and during overcast weather. Under such conditions the supply to the transformer is automatically reduced to 160V. The lamps receive only 16V but they are still bright enough for signalling under low light conditions and the low voltage prolongs their life.

## OPTIMISING

The software has three optimisation procedures. The first is the Split Optimiser, which analyses the current red and green timings. It determines whether the change times should be advanced, retarded or remain the same. It increments or decrements the timings by one to four seconds at each analysis.

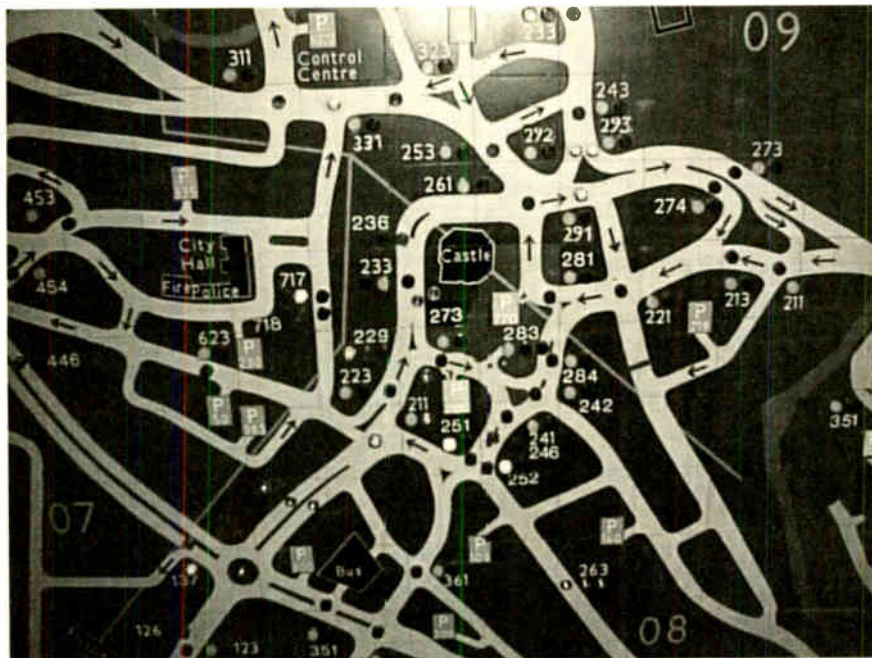

Fig.3. The control room of the Norfolk UTCC has a large-scale map showing the current state of all the traffic lights in Norwich, including pedestrian crossings.

The Offset Optimiser delays or advances the whole red-green timing in units of four seconds during each cycle, so as to optimise traffic flow.

Finally, the Cycle Time Organiser operates once every five minutes (or every two and a half minutes when necessary). It identifies the most critical road junction in a region and attempts to adjust the cycle time of the lights to reduce congestion. Cycle time can be increased or decreased by amounts of four, eight or 16 seconds.

By this combination of relatively small changes in the timings, SCOOT is able to respond rapidly to the current demands of traffic.

### BENEFITS

The benefits of using a computer-controlled system based on electronic sensors have been demonstrated by surveys in several urban areas, including Worcester, Southampton, Glasgow and Coventry. SCOOT systems have always improved journey times when compared with fixed-time systems. On average it has been estimated that using SCOOT reduces traffic delays by 20 per cent.

It takes months of work to collect the data and produce the plan for a fixed-time system. The SCOOT system continuously updates itself to take account of present and future changes in traffic conditions.

### ACKNOWLEDGEMENT

Thanks are due to Peter Lock of the NCCUTCC for demonstrating and explaining the system to the author.



The contents of this kerbside traffic control box are described in the text.

### READ MORE ABOUT IT

Owen Bishop continues the theme of electronic control in his book *Understand Electronic Control Systems*, ISBN 0-7506-4601-2, which is available through our *Direct Book Service*. Order code NE35 price £17.99 including UK p&p. See page 744 for ordering details.

# Video Surveillance

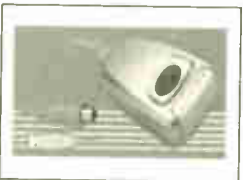

- C-MOS B/W Camera 15mm/15mm £29.00
- C-MOS Colour Camera 15mm/15mm £65.00
- PCB B/W Camera 32mm/32mm £24.00
- PCB Colour Camera w/Audio 32mm/32mm £65.00
- 23cm (1.3GHz) Video/Audio Transmitter £35.00
- 13cm (2.4GHz) Video/Audio Transmitter £35.00
- 1.2 Watt 2.4GHz Video/Audio Transmitter £120.00
- 4" TFT Boxed Colour Monitor w/Audio £110.00
- Video to VGA Converter £65.00
- VGA to Video Converter £90.00
- External USB Video Capture Box £55.00



All prices exclude VAT.

Many more products on our website:

[WWW.BITZTECHNOLOGY.COM](http://WWW.BITZTECHNOLOGY.COM)

Tel: 01753 522 902 Fax: 01753 571 657

# CONTROL & ROBOTICS

Milford Instruments

## BASIC Stamp Microcontrollers

Still the simplest and easiest way to get your project or development work done. BASIC Stamps are small computers that run BASIC programmes. With either 8 or 16 Input-Output pins they may be connected directly to push-buttons, LEDs, speakers, potentiometers and integrated circuits such as digital thermometers, real-time clocks and analog-digital converters. BASIC Stamps are programmed using an ordinary PC running DOS or Windows. The language has familiar, easy-to-read instructions such as FOR...NEXT, IF...THEN and GOTO. Built-in syntax make it easy to measure and generate pulses, read push-buttons, send/receive serial data etc. Stamps from £25 (single quantities), Full development kits from £79

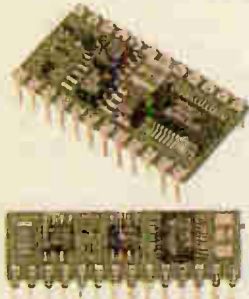

Full information on using BASIC Stamps plus lots of worked projects and practical electronics help. CD-ROM also includes 30+ past magazine articles and Stamp software. £29.95



New to PICs or just wanting to learn more tricks? We stock the excellent PIC primer books from David Benson - suitable for the complete beginner to the advanced user.



### SERIAL LCDs

Banish the hassle of interfacing to LCD displays. We stock a comprehensive range of alphanumeric and Graphic LCDs - all with an easy-to-use standard RS232 serial Interface. Sizes from 2x16 to 4x40 plus 128x64 graphic panels. Prices start at £25 (single quantity)



**Stamp2 based 3-axis machine**  
Stepper drive to X, Y and Z axes with 0.1mm (4thou) resolution. Kit contains pre-machined frame components. Complete with Windows software for drilling pcbs. Full kit at £249, Part kit at £189

### StampBug

Stamp1 based walking insect. Forwards, backwards and left/right turn when feelers detect object in path. Up to 2 hours raving from 4xAA Nicads. Chips pre-programmed but programme may be changed (software supplied). Body parts pre-cut. Full kit £68



### TecArm4

New range of robotic arms for educational and hobbyist use with super powerful servos. Controlled from PC (Windows freeware provided) or from optional keypad. Stands about 450mm high when fully extended. Kit includes all pre-cut body parts, servo controller board, servos and software. Requires 9v Dc. Kits start at £189

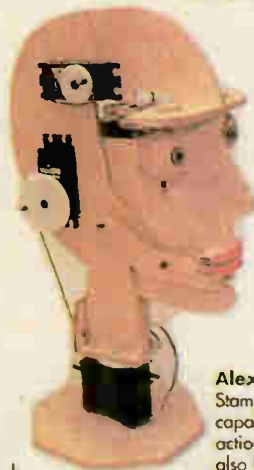

### Alex- Animated Head

Stamp2 based controller with voice record-playback capability, PIR input and/or random playback. 4-servo actions are recorded/edited one track at a time. May also be controlled from PC. Head kits start at £29. Controllers from £29

### BigFoot

Stamp1 based walking humanoid. Walks forwards/backwards with left and right turn when detects obstacles. Electronics pcb pre-built and tested. Programme pre-loaded but may be changed with supplied software. Full kit £68



**On Screen Display**  
Superimpose text onto standard CCTV from simple RS232 serial line. Ready built/tested at £59

### IR Decoder Board

Control your project using a standard domestic IR remote. 7 Output lines (5v @ 20mA) may be set to momentary or toggle action. Simple teaching routine. Requires 9-12vDC. Supplied built and tested. £29 single quantity



### Servo Driver Board

Control up to 8 standard hobby servos from an RS232 serial data line using this controller board. Simple command structure holds servos in position until update is received. Fully built and tested- requires 9vDC and servos. Supplied with Windows freeware. £29 single quantity. Optional keypad available.



## Milford Instruments

120 High Street, South Milford, LEEDS LS25 5AQ  
Tel: 01977 683665 Fax: 01977 681465

All prices exclude VAT and shipping.

**BASIC Stamp** is the registered trademark of Parallax Inc. For further details on the above and other interesting products, please see our web site [www.milinst.demon.co.uk](http://www.milinst.demon.co.uk)

# Constructional Project

# 2-VALVE SW RECEIVER

ROBERT PENFOLD

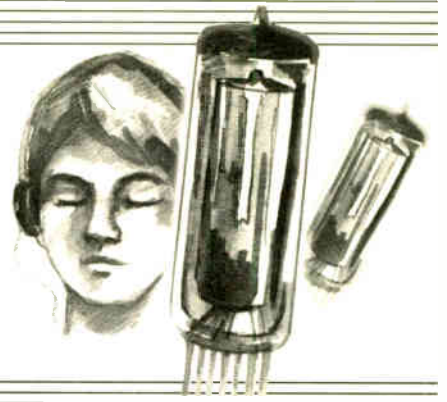

*Designed for valve radio enthusiasts, or anyone who would like to try the nostalgic approach to shortwave listening.*

**D**ESPITE continuing advances in semiconductor technology the humble valve refuses to totally stand aside in favour of modern technology. Audio equipment having the true "valve sound" has a strong following, as do *olde worlde* electronic music equipment and radios.

I wish I could say that I do not remember the days when this type of receiver was the normal introduction to the shortwave bands, but it is very much the type of set that I built as a lad in the 1960s. I still remember the HAC two-valve set with its pre-war valves the size of 100W light bulbs, and the RCS "Telstar" with its miniature "acorn" valves that really were more or less acorn shaped.

## BATTERY POWER

The design featured here follows along the same general lines as these sets, with its simple chassis and front panel method of construction and regenerative detector. It covers an approximate tuning range of 5MHz to 13MHz using a simple home constructed tuning coil. This provides coverage of several popular shortwave broadcast bands.

Sets of this type were almost invariably powered from batteries, and required about 90 volts for the main supply and around 1.5 to 6 volts for the heaters. These were respectively the HT (high tension) and LT (low-tension) supplies.

Suitable HT batteries are no longer produced, but the design featured here will work well using three or four "bog standard" PP3 size 9V batteries wired in series. A single 1.5V cell is needed to power the heaters. By the standards of battery powered valve sets the unit is quite economic to run. When HT batteries were available they were far from cheap.

In the "old days" the normal aerial for a set of this type

was the longest piece of wire that your garden could accommodate. Band conditions have changed somewhat over the years, and there are now many more stations on air. Also, they are using higher output powers and more efficient aerials than in the past.

Going for the strongest possible aerial signal these days tends to overload a

simple receiver and give poor results. A short indoor antenna consisting of about one to five metres of wire is perfectly adequate for use with this receiver. The output will drive practically any type of headphones at good volume.

## BIASED VIEW

Valve circuits are substantially different to those using bipolar transistors, but have strong similarities to field effect transistor (f.e.t.) circuits. A typical f.e.t. amplifier has the configuration shown in Fig.1a.

Unlike a bipolar transistor, which requires a forward bias for linear amplification, a f.e.t. normally conducts strongly between its drain (d) and source (s) terminals. A small reverse bias must be applied to its gate (g) in order to make it conduct less heavily so that it can provide linear amplification.

This bias is provided by resistor R1, which ties the gate to the 0V rail, in conjunction with the positive bias provided to the source (s) by resistor R2. The gate is therefore negative of the source, and the required reverse bias is obtained. Capacitor C1 removes the negative feedback that would otherwise be introduced by R2.

The valve equivalent, shown in Fig.1b, operates in the same manner. Resistor R1 biases the control grid (g) to the 0V rail. With f.e.t.s and valves there is very little current flow at the input. Consequently, in both cases resistor R1 can have a high value and the circuit as a whole can have a high input impedance. Also as before, resistor R2 provides

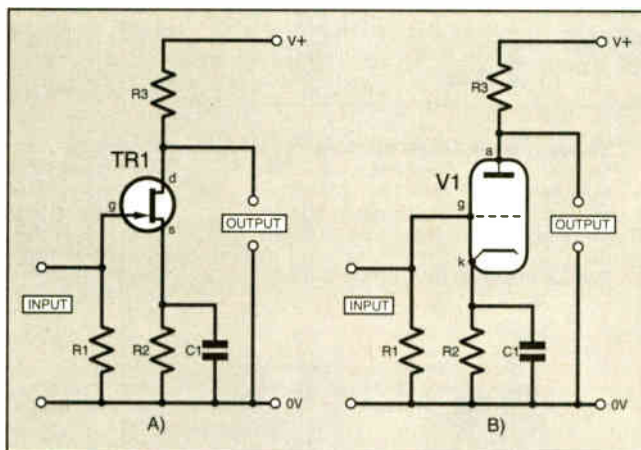
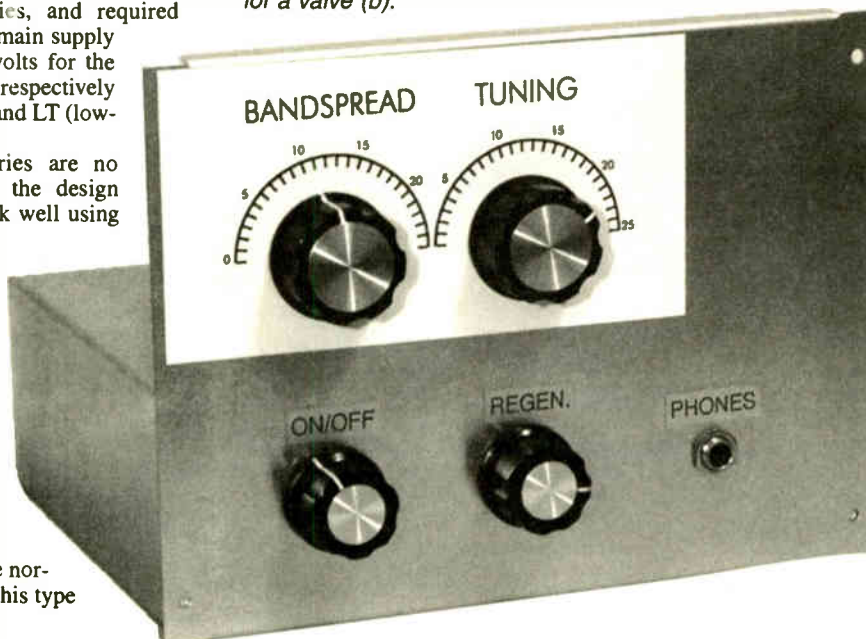

Fig.1. Biasing for a f.e.t. (a) is essentially the same as that for a valve (b).





a positive bias, but this time to the cathode (k). The output signal is developed across anode (a) load resistor R3.

## CIRCUIT OPERATION

The full circuit diagram for the 2-Valve SW Receiver is shown in Fig.2. Valve V1 is used in the regenerative detector and V2 operates as an audio amplifier. A valve type DF91 is used for both stages, and these are pentodes that are specifically designed for battery operation.

Inductor coil L2, tuning capacitor VC1, and bandspread capacitor VC2 form the tuned circuit. Bandspread capacitor VC2 has a low value so that it covers only a limited range of frequencies, facilitating easier fine-tuning. Because the input impedance at the control grid of V1 (pin 6) is very high it is acceptable to couple the tuned circuit directly to the grid.

Coil L2 effectively provides the grid bias resistance for V1. The aerial is normally coupled to a low impedance tap on L2, but SK2 provides a more direct coupling for use with very short aerials.

not be possible. For reasons that will be explained shortly, optimum results are produced with the amount of feedback just below the point at which oscillation occurs.

The audio load for valve V1 is resistor R1 or inductor L4. Both components are shown in the circuit diagram of Fig.2, but only one or the other is actually needed. Using a resistor saves money and significantly reduces the cost of the receiver, but it also reduces the efficiency of the circuit very noticeably. It is certainly worthwhile using an inductor if available funds permit.

## SOUND REGENERATION

On the face of it there will be no audio output from the detector. Capacitor C3 provides smoothing of the r.f. signal so that the audio output signal is equal to the average voltage in the r.f. signal. With no rectification the positive and negative half cycles should cancel out one another to produce zero output.

centre of the receiver's passband where the gain is already higher, and less towards the edges where the gain is lower. As the regeneration is increased, the selectivity of the set is therefore greatly improved. Instead of receiving two stations on adjacent channels simultaneously, with the enhanced selectivity the tuning controls can be used to pick out one station or the other.

This factor is very important with the plethora of stations that are often to be found on the shortwave broadcast bands. High sensitivity alone is not sufficient to guarantee good results.

It is clearly essential to have some means of accurately adjusting the level of feedback so that it can be set just below the point of oscillation, where optimum results are obtained. Trimmer capacitor VC3 is used to provide a preset amount of feedback, but potentiometer VR1 is the Regeneration control. This component provides a variable bias voltage to the screen grid of V1 (pin 3).

The gain obtained at the control grid depends on the bias voltage at the screen

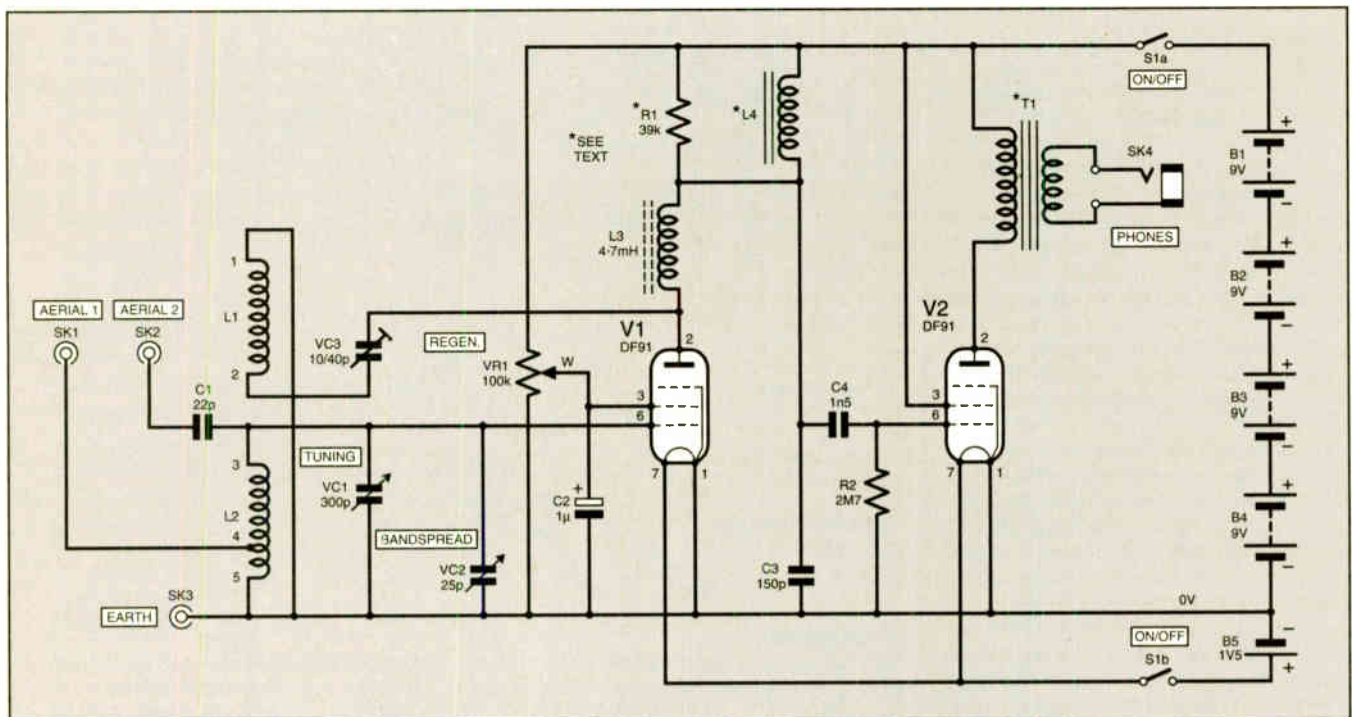

Fig.2. Complete circuit diagram for the 2-Valve SW Receiver. Note only L4 or R1 is required, not both – see text.

Because the DF91 valve is intended for battery operation it does not use a separate cathode and heater. The heating filament is also the cathode. On the face of it there is no reverse bias to the control grid since one side of the heater/cathode connects direct to the 0V rail. However, the other connection to the heater/cathode is taken about 1.5 volts positive by the LT battery, B5, so there is actually a small reverse bias on the control grid.

Valve V1 provides radio frequency (r.f.) amplification with r.f. choke L3 acting as the anode load. Some of the output signal at the anode is fed back to the aerial coil, via trimmer capacitor VC3 and coupling winding L1. There is an inversion of the signal through V1, but the phasing of L1 is such that positive feedback (regeneration) is applied.

If too much feedback is applied the circuit will oscillate and proper reception will

In practice there is less than perfect linearity through a valve or any other amplifying device, and one set of half cycles receives more amplification than the other set. This gives a very inefficient form of rectification, but does provide some audio output from an a.m. (amplitude modulation) broadcast signal.

Negative feedback is often used to reduce distortion, and the positive feedback utilized here has the opposite effect. As the amount of regeneration is increased, the gain of the circuit is boosted, but the increase is much larger on the set of half cycles that originally received only slightly higher gain. Advancing the Regeneration control VR1 therefore produces a much higher output level, with both the gain and detection efficiency being boosted.

Another advantage of the regeneration is that it provides a greater boost in gain at the

grid, with higher voltage giving increased gain. Control VR1 therefore controls the regeneration by altering the gain of V1 rather than adjusting the amount of feedback. This method gives very precise control and avoids problems with tuning shifts that can occur with other systems.

## AUDIO STAGE

Valve V2 is used in a straightforward audio amplifier set up. Resistor R2 is the grid bias resistor and capacitor C4 couples the output of the detector to the input of the amplifier.

The original sets of this type were mainly used with high impedance (about 2kΩ to 4kΩ) headphones, but these have not been produced for many years. A genuine valve output transformer might still be available from a specialist supplier of valve components, but the simpler and cheaper alternative is to use a small mains

transformer for T1. Either way, the receiver can then be used with ordinary 8 ohm impedance headphones.

Although the valves are designed to operate from 90 volts, they will actually work very well on much lower supply potentials. Four 9V batteries, B1 to B4, connected in series to give a nominal 36V supply are shown in the circuit diagram Fig.2. This is obviously well short of the designed operating voltage of the valves, but it actually gives very good results.

In fact, adding a fifth battery to take the supply to 45V did not bring any obvious increase in performance. It was found that the circuit will actually work reasonably well from three batteries giving a nominal 27V supply.

The HT supply current is only about 2.5mA to 3mA, so there is no need to use any form of "high power" battery. Ordinary zinc chloride PP3 batteries can be obtained for less than a pound each and are perfectly adequate. A single 1.5V cell powers the heaters, and it is advisable to use a high capacity type such as a D-size cell as the current consumption is around 100mA.

## COMPONENTS

In a retro design such as this it is inevitable that some of the components require further explanation. The DF91 valves are available from any specialist valve supplier, as are B7G chassis mounting valveholders. An equivalent valve for the DF91 is the 1T4 and is also suitable for this circuit. Inductor L3 is a Maplin r.f. choke (see *Shoptalk*), but any inductor of about this value and for high frequency use should work just as well.

An audio frequency inductor having a value of a few Henries is required for L4. If a suitable component can be found it is likely to be very expensive. The cheaper alternative is to use the primary winding of a small mains transformer. Several types were tried and there was no obvious difference in performance between them. The secondary voltage is irrelevant since it is unused, so simply use the cheapest mains transformer you can find.

A small mains transformer is also used for T1, but in this case the secondary voltage is very important. A very high step-down ratio is needed in order to give good performance, and a 3V-0V-3V type was found to give the best results. The full secondary winding is used to drive the headphones with the centre-tap being left unused.

## VARIABLE CAPACITORS

Ideally the tuning and bandspread capacitors would be high quality air-spaced types, but these are now very expensive. If you can, salvage suitable components from the spares box or obtain surplus components. Any value from about 200pF to 400pF should be all right for VC1, and a value of around 10pF to 30pF will suffice for VC2.

The alternative is to use modern miniature components having a solid dielectric. For VC1 the two a.m. gangs are wired in parallel and should provide a maximum value of 250pF or more. The component used for VC2 must be a type that includes low value sections (about 20pF) intended for use in a f.m. receiver. Either of these

# COMPONENTS

Approx. Cost  
Guidance Only  
excluding batts. & headphones

£39



### Resistors

R1 39k (see text)  
R2 2M7  
All 0.25W 5% carbon film  
(see text)

### Potentiometer

VR1 100k rotary  
carbon,  
linear

### Capacitors

C1 22p ceramic plate or  
polystyrene  
C2 1 $\mu$  radial elect. 100V  
C3 150p ceramic plate or  
polystyrene  
C4 1n5 polystyrene  
VC1 300p air-spaced variable  
(see text)  
VC2 25p air-spaced variable  
(see text)  
VC3 10p to 40p ceramic or  
5.5p to 65p foil trimmer

### Valves

V1, V2 DF91 or 1T4 pentode (2 off)

### Miscellaneous

B1 to B4 9V battery, PP3 size  
(4 off)  
B5 1.5V, D-size battery  
L1, L2 see text  
L3 4.7mH r.f. choke  
L4 small mains transformer  
(see text)  
T1 230V mains primary,  
3V-0V-3V secondary  
S1 d.p.s.t. rotary or toggle  
switch  
SK1, SK2 4mm socket, red (2 off)  
SK3 4mm socket, black  
SK4 6.35mm standard mono  
jack socket

See  
SHOP  
TALK  
page

Aluminium chassis, with base/front panel, size 203mm x 63mm x 152mm approx.; B7G valveholder (2 off); battery holder for B5; PP3 battery clip (4 off); 32mm tube and 0.56mm enamelled copper wire for L1/L2 (see text); control knob (4 off); five-way tagstrip; 8 ohm headphones; aerial wire; M3 spacers; multi-strand connecting wire; solder tags (3 off); solder; fixings, etc.

sections can be used for VC2 and the other three sections of the component are left unused.

Trimmer capacitor VC3 can be any type having a maximum value of around 40pF to 65pF. A 10/40pF ceramic component is used on the prototype but a 5.5/65pF foil type was found to work just as well.

## COIL DETAILS

Plug-in coils are no longer made, and those coils that are still available are not

well suited for use with valves. Coil formers and ferrite cores would seem to be unobtainable these days. The most practical solution is to use a simple home-made coil of the air-cored variety. These were often used with valve receivers and give surprisingly good results.

The coil used in this set is wound on a 32mm diameter plastic former about 65mm long. The former is actually cut from a "32mm Trap-Inlet Height Adjuster", which should be available from

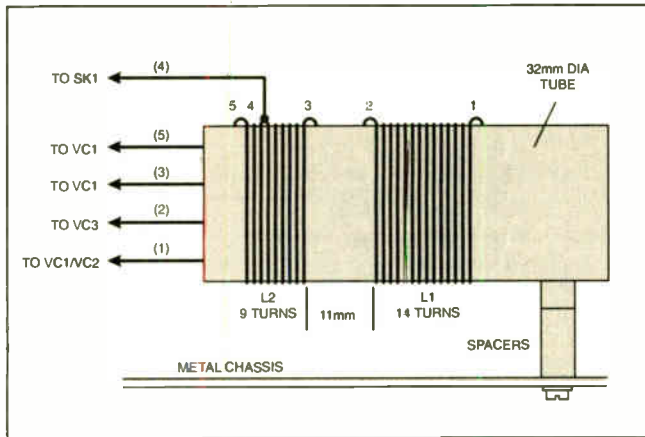
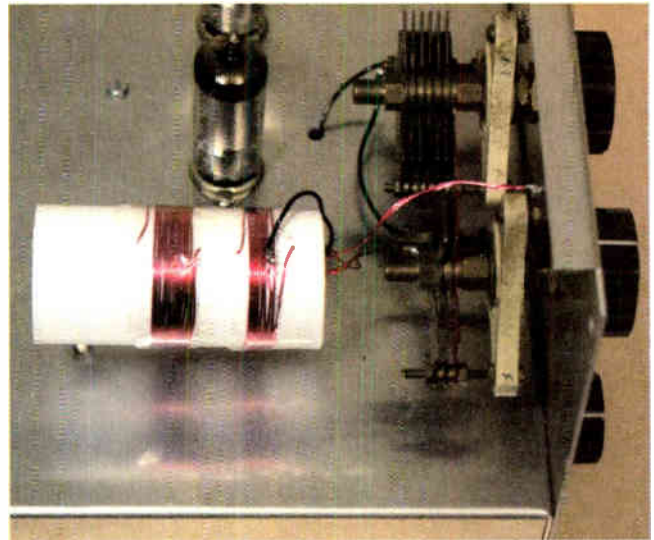

Fig.3. Details of the home-made tuning coil. The plastic coil former measures 32mm diameter by about 65mm length. Strips of tape can be used to stop the windings unravelling – see photograph right.



the plumbing department of your local DIY superstore. However, any rigid plastic tube of about the right size will suffice.

Details of the coil are provided in Fig.3. Both windings are made using 24s.w.g. (0.56mm) enamelled copper wire. The windings will tend to unwind and spring apart, and the simplest method of resisting this is to drill holes of about 1mm in diameter to take the leads from the coil. This provides a simple but effective means of holding the ends of each winding in place.

Tuned winding L2 starts about 10mm or so from one end of the former. Start by threading the free end of the wire through the appropriate hole (5) in the former to leave a lead about 250mm in length. Then wind two turns around the former and produce a small loop (4) in the wire. This will act as a connection point for the tapping on coil L2.

To complete the winding add a further seven turns of wire, cut the wire to leave a lead about 250mm long, and then thread the lead through the appropriate hole (3) in the former.

Try to keep the wire taut with the turns of wire closely bunched together. Even with the ends of the winding held in place it is likely that the turns will tend to spring apart slightly, but some pieces of tape can be used to hold them in place. Use the blade of a penknife or a miniature file to scrape the insulation from the small loop of wire and then tin (coat) it with solder.

### FEEDBACK WINDING

The feedback winding L1 is made in the same way, but it has 14 turns and no tapping. The feedback winding will look rather large if you are used to semiconductor radio circuits, but valves generally have much higher output impedances than semiconductor equivalents. Hence the feedback winding is much larger than it would be for a regenerative set based on transistors.

The completed coil can be mounted on the chassis vertically or horizontally, and the simplest method is to bolt it in place in a horizontal position, see photographs. However, a small gap is needed between the metal chassis and the coil, so some spacers must be used between the chassis and the coil former. A gap of around 15mm to 20mm is more than adequate.

### CONSTRUCTION – CHASSIS DETAILS

Sets of this type traditionally use an open aluminium chassis construction, but an outer casing is easily added if preferred. A chassis measuring approximately 203mm x 63mm x 152mm will comfortably accommodate everything. What is intended to be the base plate is used here as the front panel.

The general layout of the receiver can be seen from the photographs, and the exact positioning of the main components is not critical. Switch S1, potentiometer VR1, and 'phone jack socket SK4 are effectively used to bolt the front panel to the chassis.

Tuning capacitor VC1 and bandsread capacitor VC2 are mounted on the front panel above the chassis. Some variable capacitors have ordinary 10mm mounting bushes, but most types use two or three mounting bolts. If mounting bolts are used it is essential that they do not penetrate more than about three or four millimetres into the capacitor. With greater penetration there is a real risk that the bolts will foul the plates and ruin the component.

The valveholders require main mounting holes about 16mm in diameter. The holders themselves can be used as templates when marking the positions of the smaller mounting holes. These take either metric M3 or 6BA mounting bolts. Solder-tags are mounted on three of these bolts on the underside of the chassis to provide chassis connection points.

Hard wired construction is used throughout, and this requires some additional anchor points for the components. These points are provided by a five-way tagstrip mounted on the underside of the chassis just to the rear of the two valveholders. Note that the centre tag connects to the chassis via the tagstrip's mounting bracket, and that it can only be used as a chassis (Earth/0V) connection point.

Sockets SK1 to SK3 are mounted on the rear panel of the chassis, as is L4 if it is used. Transformer T1 is mounted on the right-hand side panel, and the plastic holder for B5 is glued or bolted to the left-hand side panel. A couple of holes about 3mm or 4mm in diameter are drilled in the top panel of the chassis, just in front of the valveholder for V2. These enable the components above the chassis to be wired to the main assembly on the underside.



Front panel is held in position by the mounting bolts of the switch, potentiometer and headphones socket.

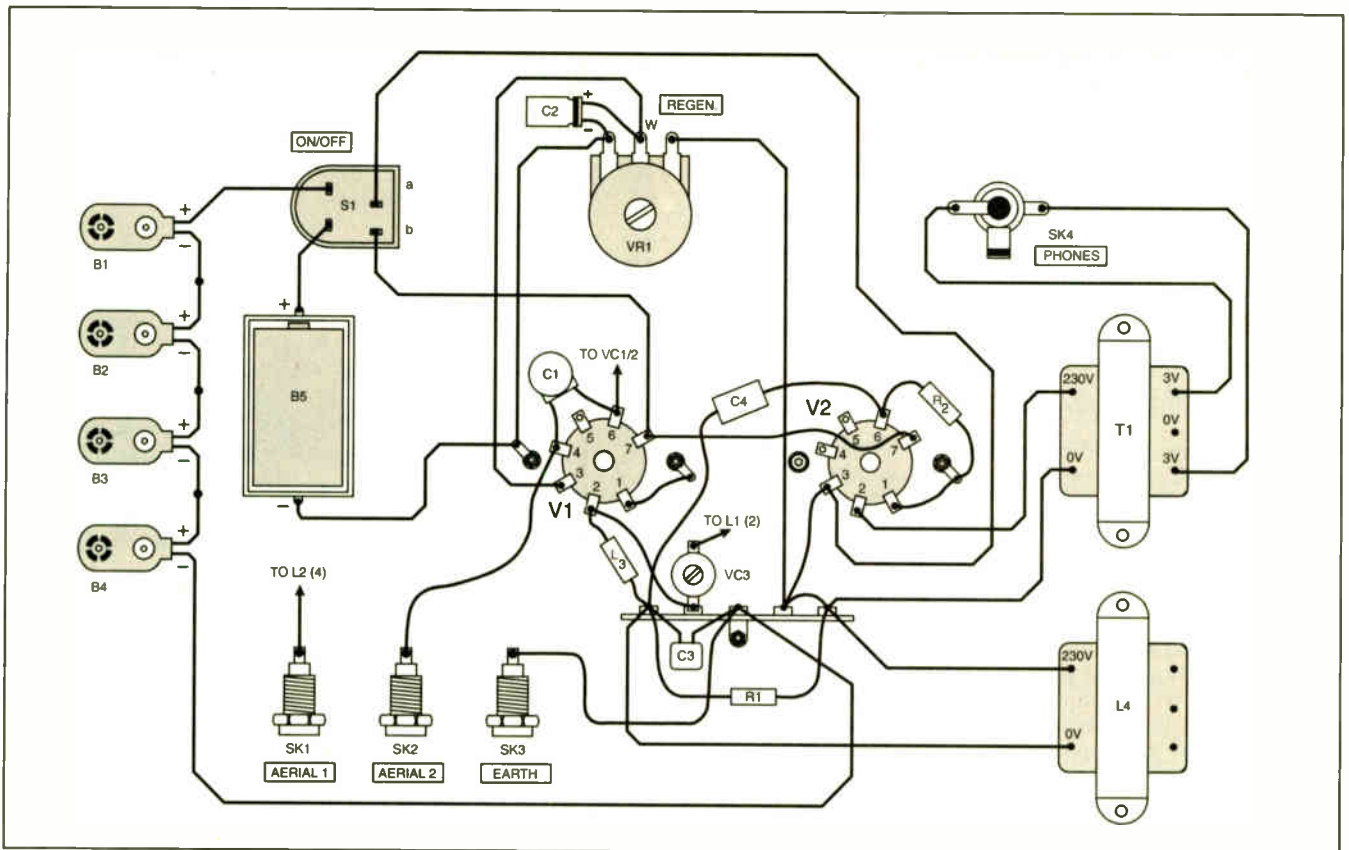

Fig. 4. Interwiring details between the valve bases and underside components. The metal chassis forms the common "earth/0V" connection via the solder tags and centre mounting tag of the 5-way tagstrip. Pin 4 of valveholder V1 is used as an anchor point for C1 and socket SK2.

## WIRING-UP

All the interwiring on the underside of the chassis is shown in Fig. 4, which should be used in conjunction with Fig. 3 and Fig. 5. The latter shows the connections to VC1 and VC2, and is correct for most miniature solid dielectric components. With other types, or different styles of solid dielectric capacitor it may be necessary to experiment a little to find the correct method of connection. One side of a variable capacitor connects internally to the chassis, so getting the connections around the wrong way will place a short circuit across coil L2 and prevent the circuit from working.

Getting all the wiring installed is not too difficult. As with any "hard wiring", strong joints are more or less guaranteed if the tags and ends of the leadout wires are solder-tinned prior to making a connection.

Pin 4 of valve V1 is used as a convenient anchor point for one lead of capacitor C1. Do not use pin 5 as this does have an internal connection to the valve.

There are three connections between the 9V batteries, and these must all be insulated with tape or sleeving to make sure that they cannot accidentally come into electrical contact with each other or other parts of the circuit. The batteries can be fixed to the right-hand side panel of the chassis using adhesive pads. The unused leads of T1 and L4 should be cut short, and any exposed wire must be insulated to ensure that no unwanted connections occur.

## HEADPHONES

Low impedance mono headphones can be used with a standard jack socket used for SK4. Stereo headphones will also work, but only one phone will be driven. For operation with stereo headphones it is

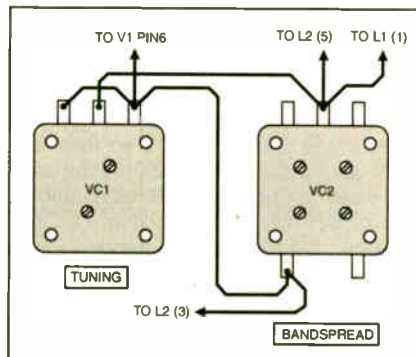
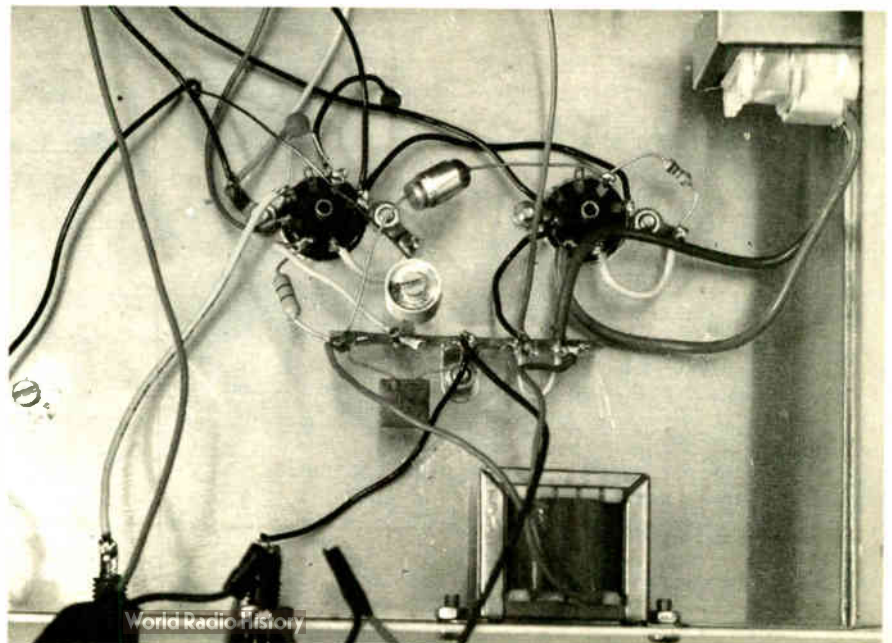

Fig. 5. Wiring to variable capacitors VC1 and VC2 (solid dielectric type).

Components soldered directly to the valveholder pins and wiring to the 5-way tagstrip. Note the "earthing" solder tags secured to the chassis by the mounting bolts of the valve bases.



preferable to use a stereo jack socket, and it does not seem to make much difference whether the phones are driven in series or parallel.

The circuit will also work quite well with medium impedance headphones of the type sold as replacements for personal stereo units. Socket SK4 should then be a 3.5mm jack type and results are best with the phones driven in parallel.

## TESTING AND USE

Give the wiring a thorough check before testing the finished receiver. In particular, make sure that the HT and LT supplies have not been accidentally swapped over at the On/Off switch S1.

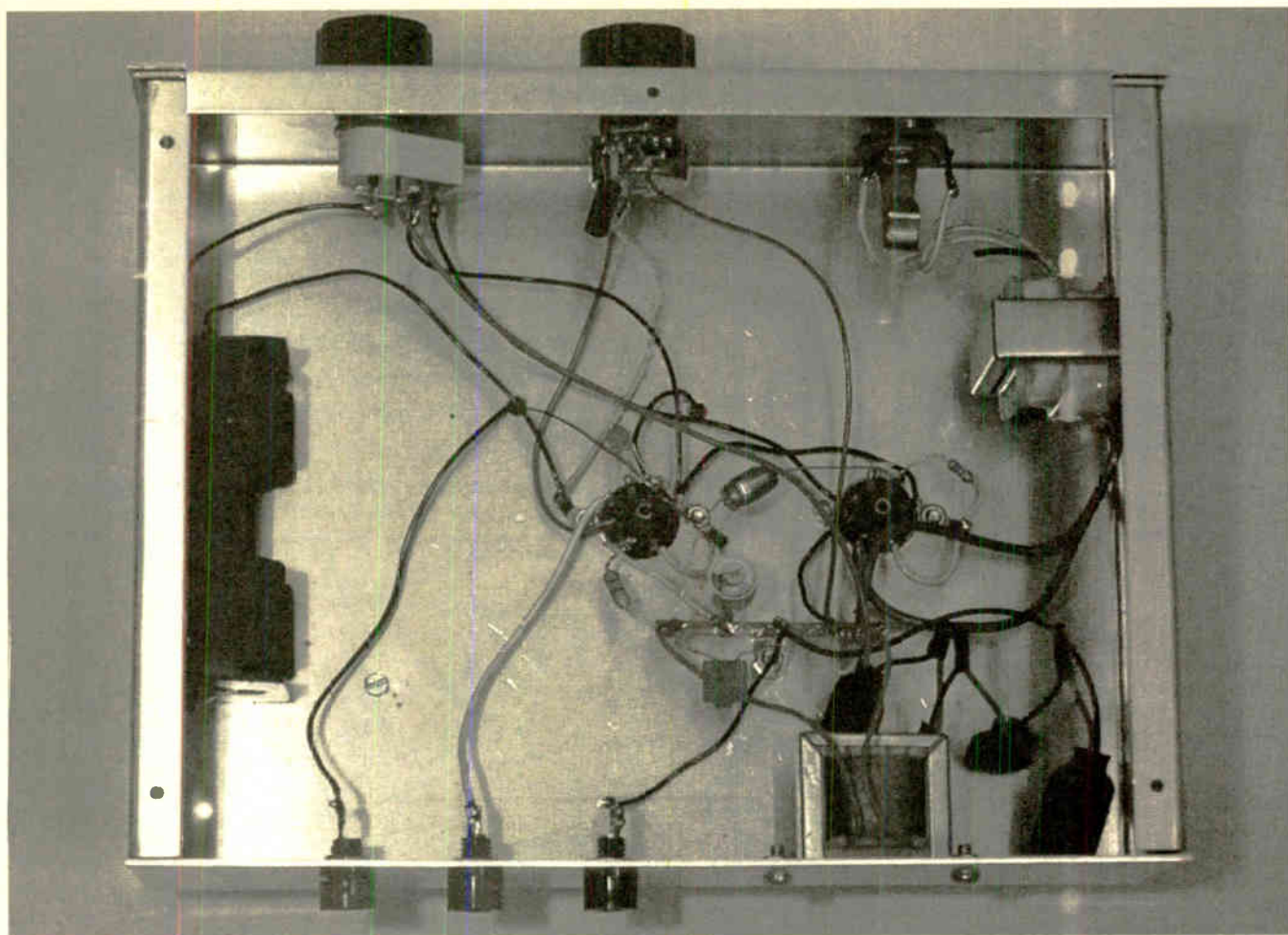

Main assembly underside general component layout and interwiring details. Note the two "transformers" and battery holder mounted on the chassis internal side panels.

The valves should plug into the holders quite easily. Do not try forcing them into place if fitting them proves to be difficult. Examine the pins and carefully straighten any that are significantly bent out of position.

Long aerials do not generally work well with a set of this type. They tend to load the tuned circuit making it difficult to obtain sufficient regeneration, and very strong signals overload the detector. About 0.5 to 1 metre of wire connected to socket SK2 or about 2 to 5 metres connected to SK1 is sufficient to give good results.

If you were looking forward to a nostalgic wait for the valves to warm up followed by a glow from the filaments you will be disappointed. The combined heaters and cathodes give an almost instant warm up and there is no obvious light output from the valves.

## REGENERATION

With Regeneration control VR1 well backed off in a counter clockwise direction it may be possible to receive a few of the stronger broadcast stations by adjusting Tuning control VC1. If not, advance VR1 in a clockwise direction and try again. If there is a lack of reception switch off at once and recheck the wiring.

Band conditions vary according to various factors such as the time of day, the time of year, and "sunspot" activity. Normally at least one broadcast band within the tuning range of the receiver will be "open", and the strength of the signals will be such that the broadcast bands will not be difficult to find.

It is important to realise that VR1 is not a volume control. It can be backed off slightly if the volume becomes excessive, but it must otherwise be adjusted close to the point at which oscillation occurs. It is readily apparent when the detector is oscillating, because there is a change in the background noise level and notes of varying pitch will be heard as the set is tuned across stations.

## OSCILLATION

With some regenerative receivers there is a tendency for the detector to slide into oscillation, and the regeneration control then has to be well backed off in order to take the set out of oscillation. This makes accurate control of the regeneration level almost impossible. There is no such problem with this design, and the feedback can be carefully adjusted to the optimum setting.

Unfortunately, with sets of this type it is not possible to find a universal setting that is suitable for all reception frequencies. Significant changes in the settings of the tuning controls may necessitate readjustment of VR1. This clearly makes regenerative receivers more difficult to use, but it is all part of their charm!

Try experimenting with trimmer capacitor VC3 at various settings. Best results will be obtained with a setting that enables oscillation to be achieved at any settings of the tuning controls, but with VR1 well advanced.

With too little feedback through VC3 it may be impossible to obtain sufficient

regeneration on some bands. With too much feedback through VC3, valve V1 will be operating at relatively low gains and this might adversely affect performance.

If VC1 and VC2 have built-in trimmers, coverage will probably be best if they are set for minimum value. However, there is no harm in trying various settings to find the ones that provide the most useful coverage.

## PERFORMANCE

The simple valve receivers used in the 1960s all seemed to suffer from a lack of audio output. The high volume levels available from this receiver, with its greatly reduced HT voltage, surprised the author. With most headphones it was found to be necessary to back off VR1 on strong signals in order to keep the volume down to a reasonable level. A two-transistor receiver would be unlikely to provide a similar problem.

The precision with which the regeneration level can be set aids the level of performance, which is certainly very creditable for such a simple receiver. The shortwave broadcast bands have plenty of English language transmissions from countries all over the world.

Some dabbling with the 2-Valve SW Receiver over a weekend produced stations from across Europe and into Asia and North America. With skill, patience, and the right propagation conditions it would probably be possible to receive broadcasts from anywhere in the world. □

# Measure pH, Voltage, Humidity, Sound & Light, on your PC!

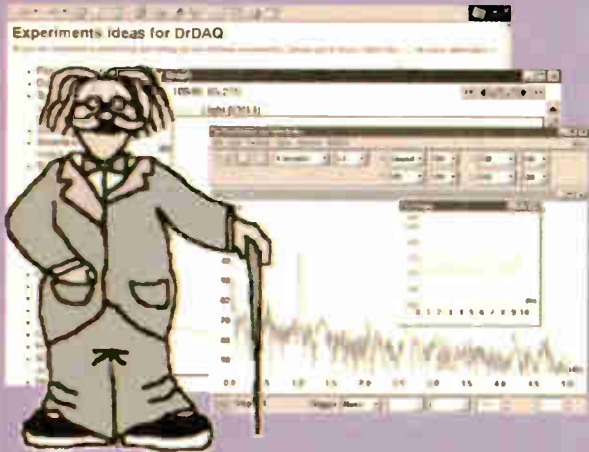

- ✓ Very low cost
- ✓ Built in sensors for light, sound (level and waveforms) and temperature
- ✓ Use DrDAQ to capture fast signals (eg sound waveforms)
- ✓ Outputs for control experiments
- ✓ Supplied with both PicoScope (oscilloscope) and PicoLog (data logging) software

**Only £59!**  
+ VAT

The DrDAQ is a low cost data logger from Pico Technology. It is supplied ready to use with all cables, software and example science experiments.

**DrDAQ represents a breakthrough in data logging.** Simply plug DrDAQ into any Windows PC, run the supplied software and you are ready to collect and display data. DrDAQ draws its power from the parallel port, so no batteries or power supplies are required.

As well as the built in sensors, DrDAQ has two sockets for external sensors. When a sensor is plugged in, the software detects it and automatically scales readings. For example, if a temperature sensor is plugged in, readings are displayed in °C. Details are provided to allow users to develop their own sensors.

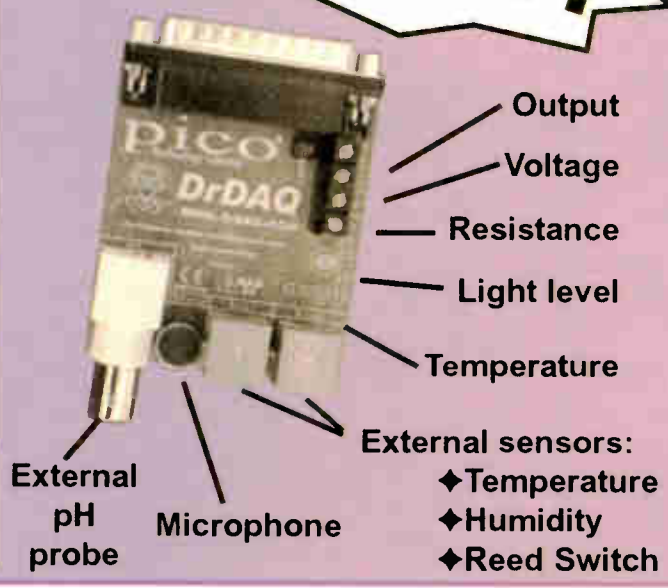

To order the DrDAQ please choose one of the following options:

- i) Visit our web site and place an order over the Internet,
- ii) Place an order over the phone by ringing the number below, or,
- iii) Fill out the order form and either fax it, or post it back to Pico Technology.

DrDAQ Order Form:			
Quantity	Package	Price inc VAT	Total
	DrDAQ + Software	£69.32	
	DrDAQ + 2 Temp Sensors	£92.85	
	DrDAQ + 2 Temp, pH Electrode, Humidity + Reed Switch Sensors	£175.08	
	Delivery	£4.11	£4.11
	<b>Grand Total</b>		£

Name			
Address			
Post code			
Phone			
Credit Card	<input type="checkbox"/> Visa / Mastercard / Switch / Amex		
Card Number			
Expiry Date	/	Start Date & or Issue No.	
Cheque with order	<input type="checkbox"/>		

A Data Logging Breakthrough

**PICO**  
Technology Limited

# READOUT

E-mail: [editorial@epemag.wimborne.co.uk](mailto:editorial@epemag.wimborne.co.uk)

**John Becker addresses some of the general points readers have raised. Have you anything interesting to say? Drop us a line!**

## WIN A DIGITAL MULTIMETER

A 3½ digit pocket-sized l.c.d. multimeter which measures a.c. and d.c. voltage, d.c. current and resistance. It can also test diodes and bipolar transistors.

Every month we will give a Digital Multimeter to the author of the best *Readout* letter.



## ★ LETTER OF THE MONTH ★

### MORE ON ELECTRONICS SHORTAGE

Dear EPE,

I fully concur with your *Readout* Aug '01 correspondent Brian Whittle. When I was made redundant in the early seventies I found it impossible to gain employment in my field. I was a qualified Electrical Engineer with an HND and a Post Advanced Diploma. Redundancy carried a stigma and perhaps it still does today.

I was fortunate to meet up with an American who offered me a trial in Algeria. He asked me what I knew of SCRs, large d.c. motors and drilling rigs. I said I had no experience of these but Electricity was Electricity. I grossly over simplified the subject by stating that there were only three faults: open circuits, short circuits, and intermittent faults and only the intermittent were really difficult to troubleshoot.

On this basis I got a start in the Petroleum industry, and after three weeks I was offered a full time position. I have since spoken to many people in the industry and have heard the same story over and over. At that time the oil industry in the UK was in its infancy, what experienced people we had were already making their name, fame and fortune working overseas. Americans in the UK recruited on the basis that if you think you can do the job, try and I will fire you if you cannot. No one can ask for anything more.

This is where I believe the UK management goes wrong, they are far too cautious in offering employment. Give your applicants a chance, would be my advice. Do not offer low pay until you prove yourself, which I must confess I have accepted many years ago. Do not employ via agencies, which many do and the agency takes a good proportion of what should go to the employee. Simply give one a chance to prove oneself.

My son faced the same problem as many UK University graduates. He has a first class Honours degree in Computer Science from a

prestigious University. He had many interviews, sometimes even up to three and some months later the positions were still being advertised. The usual response was he had no experience or that he was overqualified for the position. He took the opportunity to work on a very short contract in Switzerland and shortly afterwards he was offered a staff position. He is still there after some eleven years.

My original qualifications were in power engineering and I have always wanted to be able to troubleshoot down to component level and only at the age of 63 when I had to leave the North Sea because of ill health did I get a suitable opportunity. I signed up for a City and Guilds diploma in Digital Electronics and Computer maintenance. The course was excellent but I found that I was the only one there of my own volition, everyone else had been sent by the DSS. And much as I applaud the Government for giving others and me the opportunity, forcing people to sign up for courses is not the way to train specialists.

As a final point, one chap who was indeed very good actually found work. Making, installing, and fault finding computer systems. He was offered a derisory wage of £150 and he was told that the DSS could give him extra to bring him in to the level at which he was then receiving from the DSS. He would have had to travel, buy meals etc., look after his disabled wife, and incur the entire extra costs involved in accepting the position. Needless to say, he is still unemployed. I would suggest that it is not that the DSS payments are too high but the rewards for working are too low. We do ourselves no good by being a low wage economy.

**Jim from Derby, via the Net**

*Jim, for once I am lost for words, other than to say that it is hard not to feel very despondent about the way in which technology and its employment opportunities seem to be suffering so greatly in this country.*

*Has anyone any positive comments to make on the subject?*

### SURROUND SOUND

Dear EPE,

Some additional comments and information that some readers might find interesting, on your *Stereo/Surround Sound Amplifier* (July '01):

The technique of extracting a disparity or ambience signal from a stereo pair has been around for some time, it having appeared (under the trade name Dynaquad, I seem to remember?) in the 1960s.

It's actually exactly the same process used by the non-Prologic Dolby Surround system, which goes a bit further in adding a delay of typically 20ms to the surround signal (because in most home environments the listener is closer to the rear speakers than to the front speakers) and adding a bit of noise reduction, based on a modified Dolby B-type processor, to the L-R signal. Even Pro-Logic uses this technique to extract the surround information, but goes even further by generating steering vectors to dynamically

control the levels of the surround and centre levels derived.

The article refers to a "pseudo surround" signal, but the L-R signal in fact contains the true surround component. Dolby Stereo encoding essentially takes the surround signal, and phase shifts it by +90° and -90° before adding it to the original left and right signals respectively, to maintain a two-channel recording. By taking the difference of the two signals on playback, you get the true surround signal, *plus*, unfortunately, any component not common to the original left and right signals. There is no simple analogue signal processing that can eliminate this.

Returning to the project: for most home installations, if the reader already has a stereo setup, the use of an additional amplifier is entirely unnecessary! Exactly the same effect can be achieved by wiring an additional loudspeaker system to the "hot" outputs of the power amplifier, ignoring the ground connection.

With respect to the rear speakers, the amplifier is then operating in bridged mode, but the phase inversion usually required for bridged mode is inherent in the recording itself. This wiring method works because almost all stereo amplifiers use a common speaker ground connection for both channels.

If the stereo system normally uses 8Ω loudspeakers, then a pair of rear speakers also rated 8Ω, and wired in series (to present 16Ω to the "bridge" amplifier) provides a more-or-less correct sound volume in relation to the front speakers. The rear speakers should not be wired in parallel, but in series, and in the same phase. If the surround volume is too high and the ambience effect intrusive, a large (10W or so) resistor or rheostat of around 8Ω to 16Ω can be inserted to correct this.

The added load on the amplifier shouldn't be a problem to any self-respecting commercial hi-fi amplifier. Most of these are rated for 8Ω, but can happily drive a 4Ω load without stress except at close to their clipping threshold when they might overheat.

Because very little bass information comes through the surround channel (bass is usually mono'd at the recording stage – that used to be done to make LPs more trackable, but they seem to still do it on CDs) the surround speakers can be of a considerably lower power handling capacity than the front speakers. Since directional hearing doesn't work at bass frequencies, this bass-mono characteristic is never a problem. The exception is THX videodiscs, some of which carry a very large bass disparity component – watch out for distortion or overloading.

I have been using this technique on a ReVox B250 and a Teac A70 amplifier for over 10 years in a home environment and have never had any overheating. In fact the overall sound quality provided by this setup *far* exceeds that of a big-brand name amp I unfortunately bought, with its in-board Dolby Pro Logic and multitude of "digitally sampled" surround modes.

**David Tilch M.Sc.,  
via the Net**

*Thank you for the interesting information. We are pleased to share it with readers.*

### PIC TO DISK?

Dear EPE,

I found the *PIC to Printer Interface* in the July issue very interesting – a good use for redundant printers.

On a similar vein – is it possible to interface a PIC to a 3.5 inch floppy disk drive? With all those old PCs that get outdated rapidly, there must be a lot of drives about and the additional (long term) storage would be very useful for any number of PIC projects.

Obviously it would be best if the data recorded was readable on a PC and in that event a PC could be used for formatting.

**Roger Warrington, via the Net**

*Thank you Roger, it probably would be feasible but I can't offer to do it as I do not have a spare drive, nor indeed do I know the command protocol for accessing drives. Does anyone know how easy it might be?*

## RADIO POWER

Dear EPE,

I found both the *Mechanical Radio* (April '99) and *L.E.D. Torch* (Oct '00) very interesting but wondered if some readers would be put off by having to build the generator. My local electronics shop sells old-fashioned DynoTorches (squeeze a lever) for £10. They have an a.c. generator that drives a 2.5V 0.15A bulb, but my digital multimeter showed it would output approximately 5V to 6V a.c. into a 68Ω resistor.

There is not enough room in the front of the torch for much circuitry so either a suitable box would need to be attached to the front of the torch or the DynoTorch could be fitted with a power-out socket and the radio/l.e.d. torch fitted with a power-in plug (this would allow them to share a generator).

Note that the radio would require a protective 5V1 5W Zener diode across the C4 supercap and I think D1 to D4 should be upgraded to fast recovery higher rated diodes such as 1N5818. Also the torch's D1 should be similarly upgraded (and only one bridge would be required).

The DynoTorch is manufactured for Fascinations, Seattle, WA 98148 NB.

Alan Bradley, via the Net

Thanks for the info Alan. Readers can search for Fascinations via the excellent web search engine [www.google.com](http://www.google.com).

## MORE LANGUAGE DEBATE

Dear EPE,

So far the arguments have been on the merits and functionality of various languages C, Delphi etc. However, this is not in my opinion the major issue in choosing a language for use in an educational magazine. The language used for further projects I suggest should be C/C++ for the following reasons:

I have just finished an HNC in electronics of which C was a core module, so articles which relate to C would help those studying electronics.

The C books I have read show very little on how to use C to interface with the rest of the world or use it to program microcontrollers. There are C compilers cheaply available for all computer platforms and for all types of microprocessor.

C is also very often the chosen language for many electronics companies in industry.

C has been around for a long time and is well understood by a great many, therefore requests for problem solving and improving published designs should be forth coming.

Stuart McGhee, Norwich, via E-mail

Thank you Stuart. It's interesting how various "camps" are now becoming apparent. We continue to keep an open mind about whether or not we should embrace any particular "new route".

Anyone wishing to know how C can be used when writing PIC code is recommended to consider buying the "C" For PICmicro Microcontrollers CD-ROM as advertised on our CD-ROM pages.

## SOLDERING TIP

Dear EPE,

Referring to the letter from Arthur Green in July '01 and Alan's reply:

The device that I have used for twenty or more years requires only a mains voltage rated diode having a suitable current passing capability. The diode is connected in series with the soldering iron and in parallel with the diode is a microswitch.

Mechanically the hardware is arranged so that the iron when not in use is hung on a rest. Mine was made from a wire coat hanger, the end of which actuates the microswitch to become "open", the diode is now in circuit putting the soldering iron to half power. Lift the iron off its rest and the switch closes to short the diode and give full power to the iron, which will heat up to correct temperature within seconds.

I cannot claim to be the originator of the above idea. The original article was printed in the long

time defunct *Radio Constructor* magazine many years ago.

Mike Trueblood,  
via the Net

Thank you Mike. We too published something similar many years ago, we also published, in Sept '97, Bart Trepak's Soldering Iron Controller.

## TIME MACHINE

Dear EPE,

I have always been interested in time and have built your *PIC Time Machine* (Nov '97). Having taken early retirement some years ago I took on the task of "looking after" the clock in the parish church. It had gone through many stages of modification up to 1998 when I built a church clock control system around your *Time Machine* design.

The clock has been developed a bit since it was installed and now adds/subtracts the BST, rings the angelus one, two or three times each day and can ring the bell three times on command from the pulpit about 30 metres below. The control system drives an a.c. motor to ring the bell and a photoswitch counts the rings, one per rev. The fingers (about four metres diameter) are driven from a small a.c. motor through a worm box, a photoswitch gives one count per rev, which is 30 seconds on the fingers. Every 30 seconds the control system starts the motor until one count has occurred.

The clock has only malfunctioned twice in the last two years. Both times when the MSF signal from Rugby was down for maintenance and an update took place with no Rugby signal, just on noise, and a purely random time resulted.

It would seem that the checksum cannot always validate the data and, given enough reads, the occasional good data bit will be given on just the noise signal.

Jim Fell, via the Net

As I recall, the software validates incoming data according to information supplied by the National Physical Laboratory. Your problem has not been reported by other readers and I have not experienced it myself.

The only simple suggestion I can make is that the MSF receiver is switched off during Rugby maintenance periods, allowing the clock to run purely under its own crystal control.

## PIC DIVISION

Dear EPE,

Many amateur programmers who do not fully understand binary numbers often find binary arithmetic a daunting prospect and may resort to cheating, i.e. using multiple additions and subtractions to perform multiplication and division.

The following routine divides two 16-bit numbers, the dividend by the divisor, which have been pre-loaded into `dividl,h` and `divisl,h` respectively, and returns the result (quotient) in `dividl,h` with the remainder in `remdrL,h`. The original dividend is lost, being overwritten by the quotient.

Readers who are familiar with arithmetic routines will not find anything unusual in the listing, in fact it is based on a standard algorithm, optimised for the PIC instruction set. Note the lines that show how to compare two 16-bit numbers using the limited instructions of the PIC.

However, it is worth noting that a bug exists in Microchip's standard division routine. It's the carry (or borrow) out from double precision addition or subtraction that I found is not guaranteed to be correct for all possible input values. The double precision addition and subtraction codes are standard ones published in various Microchip documents and must have been used an unimaginable number of times by PIC programmers around the world. The good news is that my division routine is OK because a borrow out from the double precision subtraction is guaranteed not to occur.

; Divide 16-bit dividend (dividl,h) by 16-bit divisor (divisl,h)  
; Result (quotient) in `dividl,h` and remainder `remdrL,h`

```
processor 16f84
include p16f84.inc
radix dec

; Ram equates
dividl equ 0xC ; Dividend and quotient
quotL equ dividl
dividH equ 0xD
quotH equ dividH
remdrL equ 0xE ; Remainder
remdrH equ 0xF
divisl equ 0x10 ; Divisor
divisH equ 0x11
bitcnt equ 0x12 ; Bit count
divd equ 5432 ; Test code for MPLAB simulator

divs equ 22

org 0
test movlw low divd
movwf dividl
movlw high divd
movwf dividH
movlw low divs
movwf divisL
movlw high divs
movwf divisH
call divide
return
divide movfw divisL
iorwf divisH,w
skpnz
goto div0 ; Division by zero !
movlw 16 ; 16-bit division
movwf bitcnt
clrf remdrH ; Clear remainder
clrf remdrL
dvwloop clrc ; Set quotient bit to 0
rlf dividl ; Shift left dividend and quotient
rlf dividH ; Msb into carry
rlf remdrL ; and then into partial remainder

rlf remdrH
movfw divisH ; Compare partial remainder and divisor
subwf remdrH,w
skpz
goto testgt ; Not equal so test if remdrH is greater
movfw divisL ; High bytes are equal, compare low bytes
subwf remdrL,w
testgt skpc ; Carry set if remdr >= divis

goto remrlt
movfw divisL ; Subtract divisor from partial remainder
subwf remdrL
skpc ; Test for borrow
decf remdrH ; Subtract borrow
movfw divisH
subwf remdrH
bsf dividL,0 ; Set quotient bit to 1
; Quotient replaces dividend which is lost

remrlt decfsz bitcnt
goto dvwloop
clr ; Clear error flag (z)
div0 return ; Return with z set if error

end
```

Peter Hemsley, via the Net

Thank you Peter, that's great. This code has been added to our PIC Tricks folder, which is available on EPE Disk 4 and from our FTP site (see EPE PCB Service page for details).

Readers, we now have several hints and code routines of use to PIC programmers in our PIC Tricks folder. If you have any short hints or bits of code you think might be useful to add as well, send it to me for possible inclusion.



## PLCs AND SCHOOLS

Regarding your July '01 Editorial, I rather got the impression that Editor Mike was apologising for the inclusion of the PLC article in that edition. Well, he need not be so concerned - I for one found it useful.

PLC control is making its way into the AS level syllabus, as is PIC programming and the usual electronics. As a Systems and Control teacher, I found the PLC article very useful as it gives details of practical solutions. I have a PLC to demonstrate with, although Ladder Logic represented on its small l.c.d. display is a little difficult to cope with.

Be encouraged with the PIC articles, too. We recently bought PIC Logicator (as reviewed by Robert Penfold in Nov '00) and I was pleased to help one of my A-Level students to (hopefully) success with his major project. He programmed his work in MPASM, including serial in/out at 9600 baud with a PIC16F84. Without the encouragement of EPE, I am sure we'd still be using huge circuit boards and major logic networks.

Much of our school's work is on the technology department's website at [www.roulson.net/techweb](http://www.roulson.net/techweb) and I feel that many would find the site worth a visit.

Ivan Roulson, The King's School, Ottery St Mary, Devon, via the Net

Mike says that he was simply pointing out that we do not feel we can go more deeply into how PLCs work. It is interesting to learn that they are part of the AS level syllabus. Thank you for your observations.

## LOW VOLTAGE PCs

Dear EPE,

I have recently invested in a pre-assembled PIC Tutorial (Mar-May '98) board and have a problem - I can't re-program the PIC on it. The

installation has been followed correctly, yet the PIC continues to run the TUTTEST program as pre-loaded by Magenta. I have checked the software installation, power supply and PC printer port register correctness, and I have tested that the pins can correctly change their logic levels, although the voltage for Logic 1 is around 3-35V for both the pins 12 and 13, dropping back correctly to 0V. The 12V programming voltage has been checked, and is found to be 11-8V d.c.

The computer I am using is a Gateway Pentium III running Windows 98, but the PIC software still refuses to work when the computer is booted straight into DOS mode.

Alan Whallin, via the Net

In his lengthy letter, Alan gave a lot of detail about the tests he had run, the above is merely a summary.

The programming voltage being at 11-8V should be no problem - I've programmed PICs with a Vpp as low as 9V. Alan's reference to 3-3V gave me the answer, though - it certainly was too low. A number of computers being released now output this lower voltage and for this reason Microchip have introduced a variant of the PIC16F84 that will handle these lower voltages, namely the PIC16F84A. I said as much to Alan, who replied:

Thanks for your help! The problem was as you said, the voltage was too little to program the PIC. As I don't live near a supplier I decided to try out a circuit to take the printer pin voltages from my computer (3-3V) and change them to 5-0V. I placed the circuit on stripboard and fitted it to one side of a 25-way D-type connector and then connected the other end to the Centronics printer cable.

An interesting solution but, Readers, if your PC does only deliver a 3V (or so) Logic 1 output, using the PIC16F84A would seem to be the better option.

## BASIC IS EASIER

Dear EPE,

I agree wholeheartedly with Roger Warrington (Readout July '01). I too have around 25 years of programming, mostly in various dialects of Basic and a little assembler. I have also used Visual Basic but prefer Delphi for Windows style programs. I too find Basic easier to pick up again, especially for one-off projects.

My coding skills are not great but I usually pull through. Recently I tried to learn C as a means of programming PICs because I needed to time the reactions of various components in a fast moving machine and thought Basic might be a bit slow. Unfortunately I hardly got off of the starting blocks, partly because of problems with the environment I was using but mainly because at the age of 50 my powers of learning are somewhat diminished, or as I tell my colleagues "after 45 years of cramming my brain with information it is full and cannot take anymore".

Trevor Wilson, Aberdeen, via the Net

Well, Trevor, one of my colleagues suggests that from time to time we should all have a "half-price clearance sale" of any no longer required mental information, thus making room for more - a sort of "defrag" in computing terms! The trouble is you never really know what might become useful and personally I'd hate to discard anything. Perhaps evolution might one day give us the equivalent of "disk data compression" without having to increase our brain size.

But there are many examples of people in excess of 50 years taking up adult education and acquiring new skills and knowledge. And look at all those PIC projects I've designed - they're from a brain considerably more ancient than yours and which still loves the challenge of software!

Whatever your age, don't ever think that you are past learning!

### SPECIAL OFFERS

**TEKTRONIX 2445A**  
4-ch 150MHz delay, cursors etc. Supplied with 2 Tektronic probes.  
ONLY **£425**

TEKTRONIX 2232 Digital Storage Scope. Dual Trace, 100MHz, 100M/S with probes. £450  
H.P. 54501A Dg. Oscilloscope, 100MHz 4-Ch. £425  
H.P. 3312A Function Gen., 0-1Hz-13MHz, AM/FM Sweep/Tri/Gate/Burst etc. £300  
FARNELL Dual PSU XA35-2T, 0-35V, 0-2A, Twice OMD, l.c.d. Display. £180  
CIRRUS CRL254 Sound Level Meter with Calibrator 80-120dB, LEQ. £150  
EDDYSTONE 1002 Receiver, 150kHz-30MHz + Broadcast FM, unused. £125  
FARNELL AMM255 Automatic Mod Meter, 1-5MHz-2GHz, unused. £300

H.P. 3310A Function Gen., 0-005Hz-5MHz, Sine/Sq/Tri/Ramp/Pulse. £125  
FARNELL LFM4 Sine/Sq Oscillator, 10Hz-1MHz, low distortion, TTL output, Amplitude Meter. £125  
H.P. 545A Logic Probe with 546A Logic Pulser and 547A Current Tracer. £90  
FLUKE 77 Multimeter, 3½-digit, handheld. £60  
FLUKE 77 Series 11. £70  
HEME 1000 L.C.D. Clamp Meter, 00-1000A, in carrying case. £60

**RACAL 9008**  
Automatic Modulation Meter, AM/FM, 1-5MHz-2GHz  
ONLY **£95**

H.P. 8494A Attenuator, DC-4GHz, 0-11dB, N/SMA £250  
H.P. 8492A Attenuator, DC-18GHz, 0-6dB, APC7. £95  
MANY OTHER ATTENUATORS, LOADS, COUPLERS ETC. AVAILABLE

**DATRON 1061**  
HIGH QUALITY 5½-DIGIT BENCH MULTIMETER  
True RMS/4 wire Res/Current Converter/IEEE  
**£150**

**TIME 1051 LOW OHM RES. BOX**  
0-01 ohm to 1Mohm in 0-01 ohm steps.  
UNUSED **£100**

### MARCONI 2019A

**AM/FM SYNTHESISED SIGNAL GENERATOR**  
80 kHz - 1040MHz  
NOW ONLY **£400**

MARCONI 893C AF Power Meter, Sinad Measurement. Unused £100, Used £30

MARCONI 893B, No Sinad. £60

MARCONI 2610 True RMS Voltmeter, Autoranging, 5Hz-25MHz. £195

GOULD J38 Sine/Sq Osc., 10Hz-100kHz, low distortion. £75-£125

AVO 8 Mk. 6 in Every Ready case, with leads etc. £80

Other AVOs from. £50

GOODWILL GVT427 Dual Ch AC Millivoltmeter, 10mV-300V in 12 ranges, Freq. 10Hz-1MHz. £100-£125

SOLARTRON 7150 DMM 6½-digit Tru RMS-IEEE. £95-£150

SOLARTRON 7150 Plus. £200

**RACAL TRUE RMS VOLTMETERS**

9300 5Hz-20MHz usable to 60MHz, 10V-316V. £95

9300B Version. £150

9301/9302 RF Version to 1.5Hz. from £200-£300

**HIGH QUALITY RACAL COUNTERS**

9904 Universal Timer Counter, 50MHz. £50

9916 Counter, 10Hz-520MHz. £75

9918 Counter, 10Hz-560MHz, 9-digit. £50

**SOLARTRON 7045 BENCH MULTIMETER**  
4½-Digit bright l.e.d. with leads  
It's so cheap you should have it as a spare  
ONLY **£30**

MARCONI TF2015 AM/FM sig gen, 10-520MHz. £175  
RACAL 9008 Auto Mod Meter, 1-5MHz-2GHz. £200  
LEVELL TG2000AMP RC Oscillator, 1Hz-1MHz. £50  
Sine/Sq Meter, battery operated (batts not supplied)  
FARNELL LF1 Sine/Sq Oscillator, 10Hz-1MHz. £75  
RACAL/AIM 9343M LCR Databridge, Digital Auto measurement of R, C, L, Q, D. £200  
HUNTRON TRACKER Model 1000. £125  
H.P. 5315A Universal Counter, 1GHz, 2-ch. £80  
FLUKE 8050A DMM 4½-digit 2A True RMS. £75  
FLUKE 8010A DMM 3½-digit 10A. £50

### RADIO COMMUNICATIONS TEST SETS

MARCONI 2965/2965A. From £1900  
SCHLUMBERGER 4040. £300

MARCONI 2024 Signal Gen, 9kHz-2.4GHz. £3000

MARCONI 2022E Synth AM/FM sig gen 10kHz-0.1GHz l.c.d. display etc. £525-£750

H.P. 8672A Synth 2-18GHz sig gen. £4000

H.P. 8657A Synth sig gen, 100kHz-1040MHz. £2000

H.P. 8656B Synth sig gen, 100kHz-990MHz. £1350

H.P. 8656A Synth sig gen, 100kHz-990MHz. £995

H.P. 8640A AM/FM sig gen, 500kHz-1024MHz. £400

PHIUPS PMS328 sig gen, 500kHz-512MHz. £550

PHIUPS PMS328 sig gen, 100kHz-180kHz with 200MHz, freq. counter. IEEE. £250

RACAL 9081 Synth AM/FM sig gen, 5-520MHz. £250

H.P. 3225A Synth function gen, 21MHz. £600

MARCONI 6500 Amplitude Analyser. £1500

H.P. 4275A LCR Meter, 10kHz-10MHz. £2750

H.P. 8903A Distortion Analyser. £1000

WAYNE KERR 245 Inductance Analyser. £2000

H.P. 8112A Pulse Generator, 50MHz. £1250

DATRON AutoCal Multimeter, 5½-7½-digit, 1065/1061A/1071. from £300-£500

MARCONI 2440 Frequency Counter, 20GHz. £1000

H.P. 3350B Frequency Counter, 20GHz. £2000

H.P. 3342A 0Hz-18GHz Frequency Counter. £900

FARNELL AP1090B Power Supply. £1000

FARNELL AP7030 Power Supply. £800

PHIUPS PMS418TX Colour TV Pattern Generator. £1750

PHIUPS PMS418TX Colour TV Pattern Generator. £2000

B&K Accelerometer, type 4366. £300

H.P. 11692D Dual Directional Coupler, 2MHz-18GHz. £1600

H.P. 11691D Dual Directional Coupler, 2MHz-18GHz. £1250

TEKTRONIX P6109B Probe, 100MHz readout, unused. £90

TEKTRONIX P6106A Probe, 250MHz readout, unused. £85

FARNELL AMM2000 Auto Mod Meter, 10Hz-2.4GHz. Unused. £350

H.P. 16508 Logic Analyser, 80-channel. £1000

MARCONI 2035 Mod Meter, 500kHz-2GHz. £750

TEKTRONIX 577 Transistor Curve Tracer. £500

### ROHDE & SCHWARZ APN 62

Synthesised 1Hz-260kHz Signal Generator  
Balanced/unbalanced output. LCD display  
**£425**

H.P. 8012B DC PSU, 0-60V, 0-50A, 1000W. £1000

FARNELL AP6050 1kW Autoranging. £1000

FARNELL H6050 0-60V, 0-50A. £750

FARNELL H6025 0-60V, 0-25A. £400

Power Supply HPS301 0-30V, 0-10A. £130

FARNELL L292 0-30V, 0-2A. £80

FARNELL L290 0-30V, 0-1A. £60

Many other Power Supplies available

solving Transistor 250V In/Out 500VA. £40

### WELLER EC3100A

Temperature controlled Soldering Station  
200°C-450°C, Unused  
**£125**

### PORTABLE APPLIANCE TESTER

Megger Pat 2 ONLY **£180**

**GOULD OS 300**  
Dual Trace, 20MHz  
Tested with Manual  
ONLY **£95**

### SPECTRUM ANALYSERS

ADVANTEST RA131B 10kHz-3.5GHz. £3500  
H.P. 8591E 1MHz-1.8GHz, 75 Ohm. £4500  
TEKTRONIX 462 50kHz-180Hz. £3500  
EKTORNAITECH T57 0-001-22GHz. £1500  
H.P. 853A (Dg. Frame) with 8559A 100kHz-21GHz. £2250  
H.P. 8558B with main frame, 100kHz-1500MHz. £1250  
H.P. 3580A Audio Analyser 5Hz-50kHz, as new. £1000  
MARCONI 2382 100Hz-400MHz, high resolution. £2000  
B&K 2033R Signal Analyser. £750  
H.P. 182 with 6557 10kHz-350MHz. £500  
MARCONI 2370 30Hz-110MHz. from £500

### M.P. 141 SYSTEMS

8553 1kHz-110MHz. from £500

8554 500kHz-1250MHz. from £750

8555 100kHz-180Hz. from £1000

H.P. 5372A Frequency & Time Interval Analyser. £2250

### OSCILLOSCOPES

TEKTRONIX TDS380 dual trace, 400MHz, 2G/S. £2000

TEKTRONIX TDS350 dual trace, 200MHz, 1G/S. Unused. £1500

TEKTRONIX TDS320 dual trace, 100MHz, 500M/S. £1200

TEKTRONIX TDS310 dual trace, 50MHz, 200M/S. £850

LECRYO 9400A dual trace, 175MHz, 5G/S. £1500

TEKTRONIX TAS 465 4-ch, 200MHz, etc. Unused. £900

TEKTRONIX THS720A d/trace, l.c.d., 100MHz, 500M/S. Unused. £900

HITACHI VC6523, d/trace, 20MHz, 20M/S, delay etc. Unused. £800

PHIUPS PMS3092 2+2-ch, 200MHz, delay etc. £900 as new. £950

PHIUPS PMS3082 2+2-ch, 100MHz, delay etc. £700 as new. £800

TEKTRONIX TAS465 dual trace, 100MHz, delay etc. £750

TEKTRONIX 2465B 4-ch, 400MHz, delay cursors etc. £1500

TEKTRONIX 2465 4-ch, 300MHz, delay cursors etc. £900

TEKTRONIX 2445A/B 4-ch 150MHz, delay cursors etc. £500-£900

TEKTRONIX 468 dg. storage, dual trace 100MHz, delay. £450

TEKTRONIX 466 Analogue storage dual trace, 100MHz. £250

TEKTRONIX 485 dual trace, 350MHz, delay sweep. £550

TEKTRONIX 475 dual trace, 200MHz, delay sweep. £400

TEKTRONIX 465B dual trace, 100MHz, delay sweep. £325

PHIUPS PMS3217 dual trace, 50MHz, delay. £200-£250

GOULD CS1100 dual trace, 30MHz, delay. £200

HAMEG HM303A dual trace, 30MHz component testerr. £325

HAMEG HM303 dual trace, 30MHz component tester. £300

FARNELL HM203.7 dual trace, 20MHz component tester. £250

HAMEG DTY20 dual trace, 20MHz component tester. £160

### RACAL RECEIVER RA1772

50kHz - 30 MHz LED Display  
Basically working  
**£250**

## STEWART OF READING

110 WYKEHAM ROAD, READING, BERKS. RG6 1PL

Telephone: (0118) 9268041. Fax: (0118) 9351696



Callers welcome 9am-5.30pm Monday to Friday (other times by arrangement)

# VIDEOS ON ELECTRONICS

A range of videos selected by *EPE* and designed to provide instruction on electronics theory. Each video gives a sound introduction and grounding in a specialised area of the subject. The tapes make learning both easier and more enjoyable than pure textbook or magazine study. They have proved particularly useful in schools, colleges, training departments and electronics clubs as well as to general hobbyists and those following distance learning courses etc



## BASICS

**VT201 to VT206** is a basic electronics course and is designed to be used as a complete series, if required.

**VT201** 54 minutes. Part One; D.C. Circuits. This video is an absolute must for the beginner. Series circuits, parallel circuits, Ohms law, how to use the digital multimeter and much more.

Order Code VT201

**VT202** 62 minutes. Part Two; A.C. Circuits. This is your next step in understanding the basics of electronics. You will learn about how coils, transformers, capacitors, etc are used in common circuits.

Order Code VT202

**VT203** 57 minutes. Part Three; Semiconductors. Gives you an exciting look into the world of semiconductors. With basic semiconductor theory. Plus 15 different semiconductor devices explained.

Order Code VT203

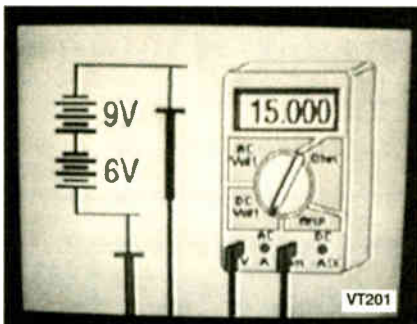

VT201

**VT204** 56 minutes. Part Four; Power Supplies. Guides you step-by-step through different sections of a power supply.

Order Code VT204

**VT205** 57 minutes. Part Five; Amplifiers. Shows you how amplifiers work as you have never seen them before. Class A, class B, class C, op.amps. etc.

Order Code VT205

**VT206** 54 minutes. Part Six; Oscillators. Oscillators are found in both linear and digital circuits. Gives a good basic background in oscillator circuits.

Order Code VT206

**£34.95** each  
inc. VAT & postage

Order 8 or more get one extra FREE  
Order 16 get two extra FREE

## VCR MAINTENANCE

**VT102** 84 minutes: Introduction to VCR Repair. Warning, not for the beginner. Through the use of block diagrams this video will take you through the various circuits found in the NTSC VHS system. You will follow the signal from the input to the audio/video heads then from the heads back to the output.

Order Code VT102

**VT103** 35 minutes: A step-by-step easy to follow procedure for professionally cleaning the tape path and replacing many of the belts in most VHS VCR's. The viewer will also become familiar with the various parts found in the tape path.

Order Code VT103

## DIGITAL

Now for the digital series of six videos. This series is designed to provide a good grounding in digital and computer technology.

**VT301** 54 minutes. Digital One; Gates begins with the basics as you learn about seven of the most common gates which are used in almost every digital circuit, plus Binary notation.

Order Code VT301

**VT302** 55 minutes. Digital Two; Flip Flops will further enhance your knowledge of digital basics. You will learn about Octal and Hexadecimal notation groups, flip-flops, counters, etc.

Order Code VT302

**VT303** 54 minutes. Digital Three; Registers and Displays is your next step in obtaining a solid understanding of the basic circuits found in today's digital designs. Gets into multiplexers, registers, display devices, etc.

Order Code VT303

**VT304** 59 minutes. Digital Four; DAC and ADC shows you how the computer is able to communicate with the real world. You will learn about digital-to-analogue and analogue-to-digital converter circuits.

Order Code VT304

**VT305** 56 minutes. Digital Five; Memory Devices introduces you to the technology used in many of today's memory devices. You will learn all about ROM devices and then proceed into PROM, EPROM, EEPROM, SRAM, DRAM, and MBM devices.

Order Code VT305

**VT306** 56 minutes. Digital Six; The CPU gives you a thorough understanding in the basics of the central processing unit and the input/output circuits used to make the system work.

Order Code VT306

## RADIO

**VT401** 61 minutes. A.M. Radio Theory. The most complete video ever produced on a.m. radio. Begins with the basics of a.m. transmission and proceeds to the five major stages of a.m. reception. Learn how the signal is detected, converted and reproduced. Also covers the Motorola C-QUAM a.m. stereo system.

Order Code VT401

**VT402** 58 minutes. F.M. Radio Part 1. F.M. basics including the functional blocks of a receiver. Plus r.f. amplifier, mixer oscillator, i.f. amplifier, limiter and f.m. decoder stages of a typical f.m. receiver.

Order Code VT402

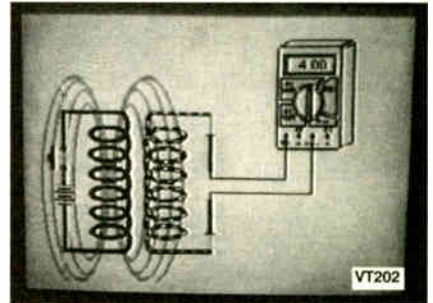

VT202

**VT403** 58 minutes. F.M. Radio Part 2. A continuation of f.m. technology from Part 1. Begins with the detector stage output, proceeds to the 19kHz amplifier, frequency doubler, stereo demultiplexer and audio amplifier stages. Also covers RDS digital data encoding and decoding.

Order Code VT403

## MISCELLANEOUS

**VT501** 58 minutes. Fibre Optics. From the fundamentals of fibre optic technology through cable manufacture to connectors, transmitters and receivers.

Order Code VT501

**VT502** 57 minutes. Laser Technology A basic introduction covering some of the common uses of laser devices, plus the operation of the Ruby Rod laser, HeNe laser, CO<sub>2</sub> gas laser and semiconductor laser devices. Also covers the basics of CD and bar code scanning.

Order Code VT502

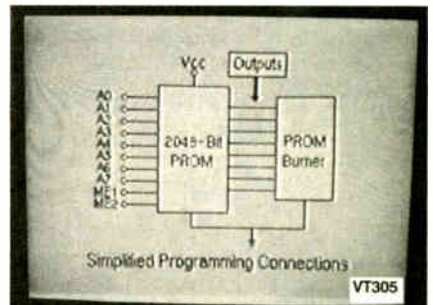

VT305

Each video uses a mixture of animated current flow in circuits plus text, plus cartoon instruction etc., and a very full commentary to get the points across. The tapes are imported by us and originate from VCR Educational Products Co, an American supplier. We are the worldwide distributors of the PAL and SECAM versions of these tapes. (All videos are to the UK PAL standard on VHS tapes unless you specifically request SECAM versions.)

## ORDERING: Price includes postage to anywhere in the world.

**OVERSEAS ORDERS:** We use the VAT portion of the price to pay for *airmail* postage and packing, wherever you live in the world. Just send £34.95 per tape. All payments in £ sterling only (send cheque or money order drawn on a UK bank). Make cheques payable to Direct Book Service.

Visa, Mastercard, Amex, Diners Club and Switch orders accepted – please give card number, card expiry date and Switch Issue No.

Orders are normally sent within seven days but please allow a maximum of 28 days, longer for overseas orders.

Send your order to: Direct Book Service, Wimborne Publishing Ltd., 408 Wimborne Road East, Ferndown, Dorset BH22 9ND

Tel: 01202 873872. Fax: 01202 874562. E-mail: [dbs@epemag.wimborne.co.uk](mailto:dbs@epemag.wimborne.co.uk)

Online store: [www.epemag.wimborne.co.uk/shopdoor.htm](http://www.epemag.wimborne.co.uk/shopdoor.htm)

Are you looking for more hands-on application articles, construction projects, and regular design columns every month?

# CIRCUIT CELLAR®

THE MAGAZINE FOR COMPUTER APPLICATIONS

## Project Articles

Every month Circuit Cellar features a variety of application articles that include diagrams, schematics, code listings, downloadable software for each project. Below are just a few of the kinds of projects you'll read about in Circuit Cellar each month:

Low-Cost Weather Station Project  
-September 2000  
Build a Lightweight R/C Receiver  
-March 2001  
SCUBA Dive Monitor  
-June 2001

## Design Contests

Every year Circuit Cellar sponsors design contests that give you the opportunity to show the world your project as well as win great cash and prizes. The Texas Instruments MSP430 Ultra Low-power Flash MCU Design Contest starts on July 15, so visit [www.circuitcellar.com/contests.htm](http://www.circuitcellar.com/contests.htm) to find out more about this contest and previous contest winners.

With over 120 advertisers in each issue, Circuit Cellar is more than just a resource for great projects, it's also your gateway to some of the most practical design products and services.

Published since 1988, Circuit Cellar brings you 100 pages of quality technical content every month in a style that's easy to read. Having feature articles that are written by everyday designers means that you won't find a lot of hype in Circuit Cellar. It also means that we can cover a variety of technologies ranging from Microchip's PIC processors to the latest FPGA modules. And best of all, you can get this insight and information in either printed magazine format or in an electronic edition! Download your free sample copy of the electronic edition at [www.circuitcellar.com/electronic-edition](http://www.circuitcellar.com/electronic-edition).

## Monthly Themes

Data Acquisition  
Robotics  
Graphics & Video  
Embedded Applications  
Wireless Communications  
Signal Processing  
Embedded Development  
Internet & Connectivity  
Measurement & Sensors

## Regular Columns

Circuit Cellar also gives you regular columns so you can follow the exploits of our columnists from month to month and project to project.

**From the Bench**  
Jeff Bachiochi tackles monthly design projects ranging from vehicle tracking via GPS to solar cells, and everything in between.

**Silicon Update**  
Tom Cantrell keeps you posted on the latest and greatest designs coming out of Silicon Valley.

**Applied PCs**  
Fred Eady has one mission every month—to prove that it doesn't have to be complicated to be embedded!

Get 12 issues  
of the Electronic Edition for only \$15  
[www.circuitcellar.com/electronic-edition](http://www.circuitcellar.com/electronic-edition)

Get the information you need for your next project and find the best deals for all of your component needs in Circuit Cellar. To find out more about Circuit Cellar, go to

[www.circuitcellar.com](http://www.circuitcellar.com)

# SURFING THE INTERNET

# NET WORK

# ALAN WINSTANLEY

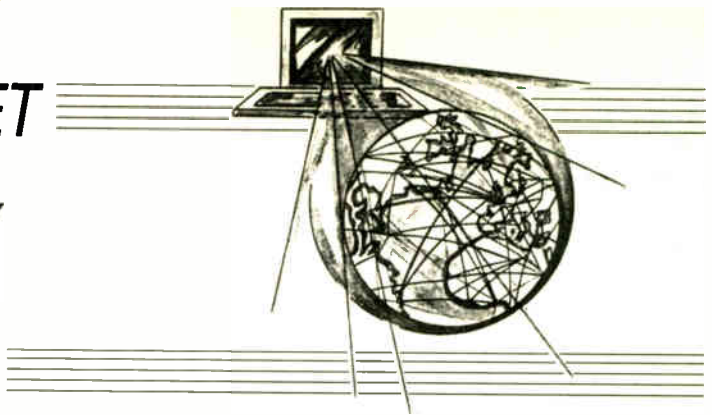

## Arise, Sircam

**W**HAT an eventful month this has been for Internet users. Much of the popular media prophesied an imminent meltdown of the Internet due to the "CodeRed Worm" alert. Defeating *CodeRed* and *CodeRed2* is a technical issue which network managers must confront.

However, the same press and TV could have done everyday Internet users a service by covering a much more troublesome nuisance, a plague in the shape of the *Sircam* worm. This nasty little creature burrows its way towards your Windows Address Book in search of tasty E-mail addresses. The *Sircam* worm also has an appetite for computer files stored on your hard disk: it likes to share them with your friends, so the worm attaches itself to any one of your files – private ones stored in the My Documents folder will do nicely.

Then using its built-in SMTP engine, *Sircam* will E-mail the file to all and sundry, often without the hapless owner ever knowing. Being a gregarious sort of worm, *Sircam* propagates itself using the recipient's address book, but as a supplementary diet *Sircam* is also said to find E-mail addresses lurking in your web browser cache. It could also do more severe damage to host computers – filling a hard disk with junk and trashing essential files, delivering its nasty payload sometime in October. In practice, *Sircam* has caused an awful lot of damage, easily trouncing "ILOVEYOU" according to McAfee.

## The Worm has Turned

One of the benefits of using a fairly obscure E-mail package (Turnpike) is that it uses a proprietary address book that is immune to Windows address book attacks. No worm-holes to be found there. So what about all those incoming files? My first bout of *Sircam*-mania happened in July when strange E-mails started arriving from Argentina, then from Brazil a few days later, then Mexico, and then the USA. Mails then arrived from Korea, Japan, South Africa and eventually mainland Europe.

Each mail contained the same message and Turnpike made it easy to spot that an unsolicited file was attached. Some files were very large – several megabytes long which reduced my mailfeed to a crawl at times. A quick scan with anti-virus software soon revealed the sinister truth, and from then on it was a case of circling the wagons: I sensed something big was about to break out.

The trickle of files turned into a minor deluge, files of every description arriving from people I'd never heard of. Spreadsheets, images and .doc files all tried to wriggle their way onto my hard disk. In the early stages, I would E-mail the senders, thanking them very much but alerting them to the presence of their unwanted guest; if users were on a fast network, they would probably never ever know that the *Sircam* worm had infested their system. In several cases my E-mail bounced back – their mailbox quota had been exceeded, presumably because *Sircam* had created such a logjam that their network couldn't mail the worm out quickly enough.

## Infra Dig

Things took a turn for the worse when I fired up my new infra-red phone (see last month) and a new laptop, in order to fetch some E-mail. You guessed it, *Sircam* was soon trying to wriggle its way through the airwaves via my mobile phone. In fact, it attached itself to a quarter-megabyte file which took an eternity to fetch via the

mobile, which wasn't quite the flying start to mobile communications I had hoped for. Sad to say, *Sircam* finally found its way onto my new laptop, costing me quite a few pounds in phone charges in the process.

Somehow or other an infected file was opened accidentally. Call it lack of familiarity with Outlook Express. Symantec Anti Virus did a good job of isolating the worm, but what it could *not* do was repair any infected files. In the case of my new laptop, *Sircam* attached itself to two files stored in the \_restore folder of Windows ME, and only by disabling the System Restore function could the infected files be quarantined, losing them in the process.

Back to the desktop PC system then: by now *Sircam* worms were being picked off every few hours but, due to an oversight lasting several "ohno-seconds", I accidentally double clicked an offending filename (a single push of the mouse roller, actually) instead of

scanning it, and with one bound *Sircam* was free to roam around my network. Naturally I was kicking myself at this point, but I supposed that if NASA could crash a satellite into the surface of Mars due to an unfortunate mix-up over units of measurement, then mere mortals like myself would double-click an infected filename occasionally. At least, that was my excuse.

The day's work came to an abrupt halt – offending files such as *Sircam32.exe* were deleted but when the PC was rebooted, *Sircam* complained about that missing file and crippled the machine. When the *Sircam* files were restored as a workaround, the worm jumped in and prevented all other programs (Applications) from launching – so the system was totally paralysed.

## The Whys? after the Event

Hot-footing it to another PC, mercifully the Symantec web site ([www.symantec.com](http://www.symantec.com)) offered a *Sircam* removal tool for download. This was loaded onto a floppy disk and after running it I was eventually back in business, a whole lot wiser! A month later, I am amazed to see that the *Sircam* Worm is still being E-mailed to me, presumably by neophyte Internet users.

What are the lessons to be learned? It should go without saying that up to date anti-virus software is crucial: Symantec and McAfee ([www.mcafee.com](http://www.mcafee.com)) are two of the respected brands available. Subscribe! Do us all a service and pay for the regular downloads to keep your virus definitions up to date.

Obviously, if you don't scan all files "on-the-hoof" then all suspicious file attachments should be quarantined for scanning before they are opened. As a corporate service, MessageLabs ([www.messageslabs.com](http://www.messageslabs.com)) offers a 30 day free trial of their service which intercepts any infected mail en-route before it can be delivered.

Worms and viruses are a fact of Internet life and they will only ever get worse, especially with the gradual uptake of always-on Internet access (cable, satellite and DSL). This will make it much easier for worms to propagate quickly without the knowledge of the user.

Another *essential* tool is an anti-intrusion program such as the freeware Zone Alarm ([www.zonelabs.com](http://www.zonelabs.com)) to guard against "Internet background noise" (to quote Steve Gibson of [grc.com](http://grc.com)). Note that in the writer's system, as an added bonus Zone Alarm also "paddedlocked" *Sircam*-infected files ready for scanning/quarantining.

Intrusion attempts are commonplace – expect a few dozen every day. Check your system today, and get your anti-virus and anti-intrusion software up to date this minute! You can contact the writer at [alan@epemag.co.uk](mailto:alan@epemag.co.uk).



Symantec's *Sircam* Removal Tool – a familiar sight for all too many.

# SHOP TALK

with David Barrington

WE commence this month with the news that **Electromail**, the mail order arm of RS Components, no longer exists. However, the good news is that RS components can still be purchased on a "one-off" order basis via their "RS New Business Reception" by telephone on **01536 444079** or through their web site at [rswww.com](http://rswww.com). All goods must be ordered by Credit Card only. They did indicate that a post and packing charge will be incurred and is as follows: orders up to £30 – £4.60 p&p; over £30 to £79.99 –£2.95; over £80 – £1.75.

## Camcorder Power Supply

It is important that readers keep to the specified types for some of the components needed to build the *Camcorder Power Supply* project. The specification of diode D10 and capacitor C8 is especially important.

The diode BYW80 used in the prototype is a high-speed, fast recovery type capable of handling 8A and was purchased from **Farnell** (☎ **0113 263 6311** or [www.farnell.com](http://www.farnell.com)) code 366-705. It is also listed by **Maplin** (☎ **0870 264 6000** or [www.maplin.co.uk](http://www.maplin.co.uk)), code AH57M. You will also need a semiconductor insulating kit to electrically isolate the device from the small fabricated aluminium (15mm x 40mm) heatsink.

Capacitor C8 must have a low impedance at 100kHz and a minimum working voltage of 50V d.c. A Rubycon YXF series capacitor (2 off) ordered from **Farnell** (see above), code 580-612, was used in the prototype. They can only be ordered in multiples of five minimum. The same company also supplied the ZRB500Y03 +5V voltage reference (code 302-4210) and the Newport high current 150µH 4A inductor, code 432-040.

The printed circuit board is available from the *EPE PCB Service*, code 318 (see page 745).

## PIC TOOLKIT Mk3

Most items for the *PIC Toolkit Mk3* are RS components and can be ordered through any *bona-fide* stockist, including some of our advertisers. If you have a credit card, you can place an order with RS on **01536 444079** or through their web site: [rswww.com](http://rswww.com).

The MAX662CPA charge-pump d.c.-to-d.c. converter chip, designed to provide +12V at 30mA from 4.5V to 5.5V inputs, is currently listed by RS as code 299-575. The rest of the semiconductor devices should be readily available.

There should not be any problems finding the optional 2-line 16-character per line alphanumeric i.c.d. module as connection details are included for two possible formats. The one used in the author's model came from **Magenta Electronics** (☎ **01283 565435** or [www.magenta2000.co.uk](http://www.magenta2000.co.uk)). If ordering from **Magenta** you should specify that you wish to purchase one with a pin connector attached.

The printed circuit board is available from the *EPE PCB Service*, code 319 (see page 745). Incidentally, if you browse through our component advertisers' pages you will soon find that PICs are now widely stocked and should not cause any sourcing problems.

## 2-Valve SW Receiver

Being a little out of touch with valve circuit requirements, we asked **Gerald Myers** of **Chevet Supplies** (☎ **01253 751858** or E-mail [chevet@globalnet.co.uk](mailto:chevet@globalnet.co.uk)) regarding the availability of the DF91 valve used in the *2-Valve SW Receiver* project. We were informed that it is becoming in short supply, they only have two in stock at present, but gave us some equivalents, i.e. IT4, W17, CV785 and CV197. We have not been able to check these out. You could also try contacting **Bull Electrical** (☎ **0871 871 1300**), **Cricklewood** (☎ **020 8452 0161**), **J&N Factors** (☎ **01444 881965**) or **Greenweld** (☎ **01277 811042**), who may be able to help.

For the tuning capacitors we suggest you also contact the above companies plus **Mainline Surplus Sales** (☎ **0870 241 0810**), who sometimes have these components "on special offer", including the cheaper solid-dielectric "transistor radio" types mentioned in the article.

A small mains transformer was used for the audio output transformer and one with a high step-down ratio is needed to give good results. One with 3V-0V-3V secondary windings was found to give the best results and was purchased from **Maplin** (☎ **0870 264 6000** or [www.maplin.co.uk](http://www.maplin.co.uk)), code YN12N. Note the full secondary winding is used, the centre-tap not being required.

The above company also supplied the aluminium case (code XB68Y), open style 6-35mm mono jack socket (code HF91Y) and the 4-7mH r.f. choke for inductor L3, code UK80B.

## Perpetual Projects 4 – Gate Sentinel, Solar-Powered Bird Scarer and Register

As pointed out in previous parts of the *Perpetual Projects* and this final instalment, readers are advised to use the Motorola MC4093BCP version of the 4093 quad 2-input NAND Schmitt trigger i.c. This device is listed (code 640-765) by RS Components and can be ordered through any *bona fide* stockists or directly, using your credit card, from RS (☎ **01536 444079** or [rswww.com](http://rswww.com)).

The *Gate Sentinel* magnet-operated reed type switch has normally-closed contacts which may be difficult to find. The prototype uses an RS Form B type (code 361-4961) and can be ordered as outlined above. The same applies to the Honeywell SDP8405 phototransistor used in the *Bird Scarer*, code 195-827. Note the code given last month was for the data sheet. The phototransistor is also listed by **Farnell**, (☎ **0113 263 6311** or [www.farnell.com](http://www.farnell.com)), code 327-505.

The 5mm extreme brightness (6cd) green l.e.d., with a 15 degrees viewing angle, for the *Register* project, came from **Maplin** (☎ **0870 264 6000** or [www.maplin.co.uk](http://www.maplin.co.uk)), code NR87U.

The Uniboard printed circuit board is obtainable from the *EPE PCB Service*, code 305 (see page 745).

# SQUIRES

## MODEL & CRAFT TOOLS

A COMPREHENSIVE RANGE OF MINIATURE HAND AND POWER TOOLS AND AN EXTENSIVE RANGE OF ELECTRONIC COMPONENTS

FEATURED IN A FULLY ILLUSTRATED

532 PAGE MAIL ORDER CATALOGUE

Note: If you have ordered from 2001 copy you will receive the new catalogue automatically

**SAME DAY DESPATCH  
FREE POST AND PACKAGING**

Catalogues: FREE OF CHARGE to addresses in the UK.  
Overseas: CATALOGUE FREE, postage at cost charged to credit card

**Squires, 100 London Road,  
Bognor Regis, West Sussex, PO21 1DD**

TEL: 01243 842424

FAX: 01243 842525

SHOP NOW OPEN



## DISTANCE LEARNING SHORT COURSES with BTEC CERTIFICATION

Analogue and Digital Electronics, Fibre Optics, Fault Diagnosis, Mechanics, Mathematics and Programmable Logic Controllers

- Suitable for beginners and those wishing to update their knowledge and practical skills
- Courses are very practical and delivered as self contained kits
- No travelling or college attendance
- Learning is at your own pace
- Each course can stand alone or be part of a modular study programme
- Tutor supported and BTEC certified

For information contact:  
NCT Ltd., P.O. Box 11  
Wendover, Bucks HP22 6XA  
Telephone 01296 624270; Fax 01296 625299  
Web: <http://www.nct.ltd.uk>

# ELECTRONICS CD-ROMS

## ELECTRONICS PROJECTS



Logic Probe testing

*Electronic Projects* is split into two main sections: **Building Electronic Projects** contains comprehensive information about the components, tools and techniques used in developing projects from initial concept through to final circuit board production. Extensive use is made of video presentations showing soldering and construction techniques. The second section contains a set of ten projects for students to build, ranging from simple sensor circuits through to power amplifiers. A shareware version of Matrix's CADPACK schematic capture, circuit simulation and p.c.b. design software is included. The projects on the CD-ROM are: Logic Probe; Light, Heat and Moisture Sensor; NE555 Timer; Egg Timer; Dice Machine; Bike Alarm; Stereo Mixer; Power Amplifier; Sound Activated Switch; Reaction Tester. Full parts lists, schematics and p.c.b. layouts are included on the CD-ROM.

## ELECTRONICS CAD PACK

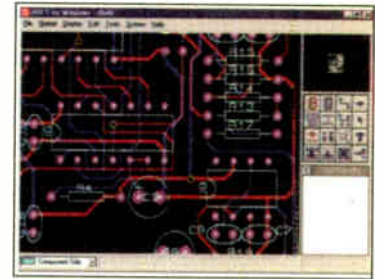

PCB Layout

Electronics CADPACK allows users to design complex circuit schematics, to view circuit animations using a unique SPICE-based simulation tool, and to design printed circuit boards. CADPACK is made up of three separate software modules: **ISIS Lite** which provides full schematic drawing features including full control of drawing appearance, automatic wire routing, and over 6,000 parts. **PROSPICE Lite** (integrated into ISIS Lite) which uses unique animation to show the operation of any circuit with mouse-operated switches, pots, etc. The animation is compiled using a full mixed mode SPICE simulator. **ARES Lite** PCB layout software allows professional quality PCBs to be designed and includes advanced features such as 16-layer boards, SMT components, and even a fully functional autorouter.

## ANALOGUE ELECTRONICS

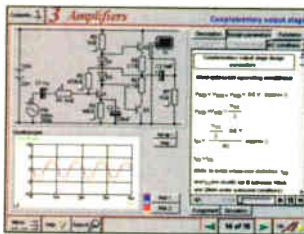

Complimentary output stage

*Analogue Electronics* is a complete learning resource for this most difficult branch of electronics. The CD-ROM includes a host of virtual laboratories, animations, diagrams, photographs and text as well as a SPICE electronic circuit simulator with over 50 pre-designed circuits. Sections on the CD-ROM include: **Fundamentals** – Analogue Signals (5 sections), Transistors (4 sections), Waveshaping Circuits (6 sections). **Op.Amps** – 17 sections covering everything from Symbols and Signal Connections to Differentiators. **Amplifiers** – Single Stage Amplifiers (8 sections), Multi-stage Amplifiers (3 sections). **Filters** – Passive Filters (10 sections), Phase Shifting Networks (4 sections), Active Filters (6 sections). **Oscillators** – 6 sections from Positive Feedback to Crystal Oscillators. **Systems** – 12 sections from Audio Pre-Amplifiers to 8-Bit ADC plus a gallery showing representative p.c.b. photos.

## DIGITAL ELECTRONICS

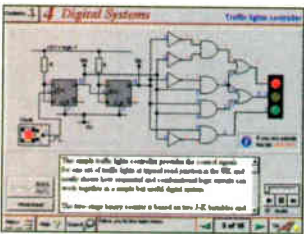

Virtual laboratory – Traffic Lights

*Digital Electronics* builds on the knowledge of logic gates covered in *Electronic Circuits & Components* (opposite), and takes users through the subject of digital electronics up to the operation and architecture of microprocessors. The virtual laboratories allow users to operate many circuits on screen. Covers binary and hexadecimal numbering systems, ASCII, basic logic gates, monostable action and circuits, and bistables – including JK and D-type flip-flops. Multiple gate circuits, equivalent logic functions and specialised logic functions. Introduces sequential logic including clocks and clock circuitry, counters, binary coded decimal and shift registers. A/D and D/A converters, traffic light controllers, memories and microprocessors – architecture, bus systems and their arithmetic logic units.

## FILTERS

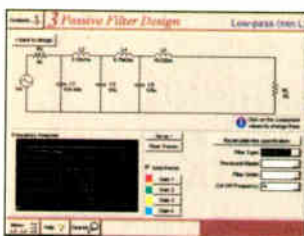

Filter synthesis

*Filters* is a complete course in designing active and passive filters that makes use of highly interactive virtual laboratories and simulations to explain how filters are designed. It is split into five chapters: **Revision** which provides underpinning knowledge required for those who need to design filters. **Filter Basics** which is a course in terminology and filter characterization, important classes of filter, filter order, filter impedance and impedance matching, and effects of different filter types. **Advanced Theory** which covers the use of filter tables, mathematics behind filter design, and an explanation of the design of active filters. **Passive Filter Design** which includes an expert system and filter synthesis tool for the design of low-pass, high-pass, band-pass, and band-stop Bessel, Butterworth and Chebyshev ladder filters. **Active Filter Design** which includes an expert system and filter synthesis tool for the design of low-pass, high-pass, band-pass, and band-stop Bessel, Butterworth and Chebyshev op.amp filters.

## DIGITAL WORKS 3.0

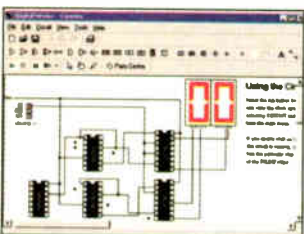

Counter project

*Digital Works Version 3.0* is a graphical design tool that enables you to construct digital logic circuits and analyze their behaviour. It is so simple to use that it will take you less than 10 minutes to make your first digital design. It is so powerful that you will never outgrow its capability.

- Software for simulating digital logic circuits
- Create your own macros – highly scalable
- Create your own circuits, components, and i.c.s
- Easy-to-use digital interface
- Animation brings circuits to life
- Vast library of logic macros and 74 series i.c.s with data sheets
- Powerful tool for designing and learning

## "C" FOR PICMICRO MICROCONTROLLERS



**C for PICmicro Microcontrollers** is designed for students and professionals who need to learn how to use C to program embedded microcontrollers. This product contains a complete course in C that makes use of a virtual C PICmicro which allows students to see code execution step-by-step. Tutorials, exercises and practical projects are included to allow students to test their C programming capabilities. Also includes a complete Integrated Development Environment, a full C compiler, Arizona Microchip's MPLAB assembler, and software that will program a PIC16F84 via the parallel printer port on your PC. (Can be used with the *PICtutor* hardware – see opposite.) Although the course focuses on the use of the PICmicro series of microcontrollers, this product will provide a relevant background in C programming for any microcontroller.

## PRICES

Prices for each of the CD-ROMs above are:

Hobbyist/Student .....£45 inc VAT  
 Institutional (Schools/HE/FE/Industry).....£99 plus VAT  
 Institutional 10 user (Network Licence) .....£199 plus VAT

(UK and EU customers add VAT at 17.5% to "plus VAT" prices)

# Interested in programming PIC microcontrollers? Learn with **PICtutor**

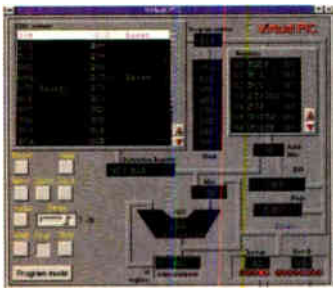

The Virtual PIC

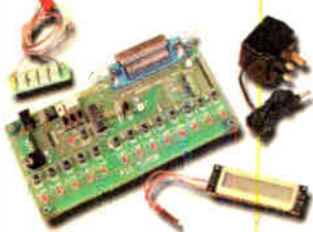

Deluxe PICtutor Hardware

This highly acclaimed CD-ROM by John Becker, together with the PICtutor experimental and development board, will teach you how to use PIC microcontrollers with special emphasis on the PIC16x84 devices. The board will also act as a development test bed and programmer for future projects as your programming skills develop. This interactive presentation uses the specially developed **Virtual PIC Simulator** to show exactly what is happening as you run, or step through, a program. In this way the CD provides the easiest and best ever introduction to the subject. Nearly 40 Tutorials cover virtually every aspect of PIC programming in an easy to follow logical sequence.

### HARDWARE

Whilst the CD-ROM can be used on its own, the physical demonstration provided by the **PICtutor Development Kit**, plus the ability to program and test your own PIC16x84s, really reinforces the lessons learned. The hardware will also be an invaluable development and programming tool for future work. Two levels of PICtutor hardware are available – Standard and Deluxe. The **Standard** unit comes with a battery holder, a reduced number of switches and no displays. This version will allow users to complete 25 of the 39 Tutorials. The **Deluxe** Development Kit is supplied with a plug-top power supply (the **Export** Version has a battery holder), all switches for both PIC ports plus I.C. and 4-digit 7-segment I.E.D. displays. It allows users to program and control all functions and both ports of the PIC. All hardware is supplied **fully built and tested** and includes a PIC16F84.

### PICtutor CD-ROM

Hobbyist/Student .....£45 inc. VAT  
 Institutional (Schools/HE/FE Industry) ...£99 plus VAT  
 Institutional 10 user (Network Licence) .£199 plus VAT

### HARDWARE

Standard Development Kit ...£47 inc. VAT  
 Deluxe Development Kit .....£99 plus VAT  
 Deluxe Export Version .....£96 plus VAT

(UK and EU customers add VAT at 17.5% to "plus VAT" prices)

## ELECTRONIC COMPONENTS PHOTOS



A high quality selection of over 200 JPG images of electronic components. This selection of high resolution photos can be used to enhance projects and presentations or to help with training and educational material. They are royalty free for use in commercial or personal printed projects, and can also be used royalty free in books, catalogues, magazine articles as well as worldwide web pages (subject to restrictions – see licence for full details). Also contains a **FREE** 30-day evaluation of Paint Shop Pro 6 – Paint Shop Pro image editing tips and on-line help included!

Price **£19.95 inc. VAT**

**NEW VERSION 2**

## ELECTRONIC CIRCUITS & COMPONENTS V2.0



Circuit simulation screen

Provides an introduction to the principles and application of the most common types of electronic components and shows how they are used to form complete circuits. The virtual laboratories, worked examples and pre-designed circuits allow students to learn, experiment and check their understanding. Version 2 has been considerably expanded in almost every area following a review of major syllabuses (GCSE, GNVQ, A level and HNC). It also contains both European and American circuit symbols. Sections include: **Fundamentals:** units & multiples, electricity, electric circuits, alternating circuits. **Passive Components:** resistors, capacitors, inductors, transformers. **Semiconductors:** diodes, transistors, op.amps, logic gates. **Active Circuits.** The **Parts Gallery** will help students to recognise common electronic components and their corresponding symbols in circuit diagrams. Selections include: **Components, Components Quiz, Symbols, Symbols Quiz, Circuit Technology.** Included in the Institutional Versions are multiple choice questions, exam style questions, fault finding virtual laboratories and investigations/worksheets.

Hobbyist/Student .....£45 inc VAT  
 Institutional (Schools/HE/FE/Industry) .....£99 plus VAT  
 institutional Site Licence .....£499 plus VAT  
 (UK and EU customers add VAT at 17.5% to "plus VAT" prices)

## ELECTRONICS IN CONTROL

**NEW**

Two colourful animated courses for students on one CD-ROM. These cover Key Stage 3 and GCSE syllabuses. **Key Stage 3:** A pictorial look at the Electronics section featuring animations and video clips. Provides an ideal introduction or revision guide, including multi-choice questions with feedback. **GCSE:** Aimed at the Electronics in many Design & Technology courses, it covers many sections of GCSE Electronics. Provides an ideal revision guide with Homework Questions on each chapter. Worked answers with an access code are provided on a special website.

Single User **£29 inc. VAT.** Multiple User **£39 plus VAT**  
 Student copies (available only with a multiple user copy) **£6 plus VAT**  
 (UK and EU customers add VAT at 17.5% to "plus VAT" prices)

## MODULAR CIRCUIT DESIGN

Contains a range of tried and tested analogue and digital circuit modules, together with the knowledge to use and interface them. Thus allowing anyone with a basic understanding of circuit symbols to design and build their own projects.

Essential information for anyone undertaking GCSE or "A" level electronics or technology and for hobbyists who want to get to grips with project design. Over seventy different Input, Processor and Output modules are illustrated and fully described, together with detailed information on construction, fault finding and components, including circuit symbols, pinouts, power supplies, decoupling etc.

Single User **£19.95 inc. VAT.** Multiple User **£34 plus VAT**  
 (UK and EU customers add VAT at 17.5% to "plus VAT" prices)

Minimum system requirements for these CD-ROMs: Pentium PC, CD-ROM drive, 32MB RAM, 10MB hard disk space. Windows 95/98/NT/2000/ME, mouse, sound card, web browser.

Please send me:

- Electronic Projects
- Analogue Electronics
- Digital Electronics
- Filters
- Digital Works 3.0
- Electronics CAD Pack
- C For PICmicro Microcontrollers
- PICtutor
- Electronic Circuits & Components V2.0

## CD-ROM ORDER FORM

B3

Version required:

- Hobbyist/Student
- Institutional
- Institutional 10 user
- Institutional site licence

Note: The software on each version is the same (unless stated otherwise above), only the licence for use varies.



- PICtutor Development Kit – Standard
- PICtutor Development Kit – Deluxe

Deluxe Export

Note: The CD-ROM is not included in the Development Kit prices.

- Electronic Components Photos
- Electronics In Control – Single User
- Electronics In Control – Multiple User
- Modular Circuit Design – Single User
- Modular Circuit Design – Multiple User

Note: The software on each version is the same, only the licence for use varies.

Full name: .....

Address: .....

.....Post code: .....Tel. No: .....

Signature: .....

I enclose cheque/PO in £ sterling payable to WIMBORNE PUBLISHING LTD for £ .....

Please charge my Visa/Mastercard/Amex/Diners Club/Switch: £ .....Card expiry date: .....

Card No: .....Switch Issue No. ....

## ORDERING

**ALL PRICES INCLUDE UK POSTAGE**

Student/Single User/Standard Version price includes postage to most countries in the world  
 EU residents outside the UK add £5 for airmail postage per order

**Institutional, Multiple User and Deluxe Versions** – overseas readers add £5 to the basic price of each order for airmail postage (**do not add VAT** unless you live in an EU (European Union) country, then add 17½% VAT or provide your official VAT registration number).

Send your order to:

**Direct Book Service**  
 Wimborne Publishing Ltd  
 408 Wimborne Road East  
 Ferndown, Dorset BH22 9ND

To order by phone ring

**01202 873872. Fax: 01202 874562**

Goods are normally sent within seven days

E-mail: [orders@wimborne.co.uk](mailto:orders@wimborne.co.uk)

Online shop:  
[www.epemag.wimborne.co.uk/shopdoor.htm](http://www.epemag.wimborne.co.uk/shopdoor.htm)

# INGENUITY UNLIMITED

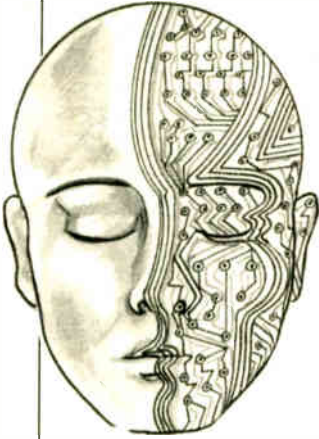

Our regular round-up of readers' own circuits. We pay between £10 and £50 for all material published, depending on length and technical merit. We're looking for novel applications and circuit designs, not simply mechanical, electrical or software ideas. Ideas *must be the reader's own work* and **must not have been submitted for publication elsewhere**. The circuits shown have NOT been proven by us. *Ingenuity Unlimited* is open to ALL abilities, but items for consideration in this column should be typed or word-processed, with a brief circuit description (between 100 and 500 words maximum) and full circuit diagram showing all relevant component values. **Please draw all circuit schematics as clearly as possible.** Send your circuit ideas to: Alan Winstanley, *Ingenuity Unlimited*, Wimborne Publishing Ltd., 408 Wimborne Road East, Ferndown Dorset BH22 9ND. (We do not accept submissions for *IU* via E-mail.) Your ideas could earn you some cash and a prize!

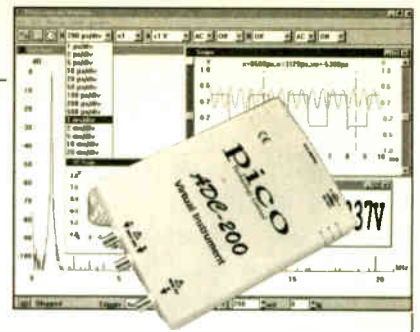

## WIN A PICO PC BASED OSCILLOSCOPE

- 50MSPS Dual Channel Storage Oscilloscope
- 25MHz Spectrum Analyser
- Multimeter • Frequency Meter
- Signal Generator

If you have a novel circuit idea which would be of use to other readers then a Pico Technology PC based oscilloscope could be yours. Every six months, Pico Technology will be awarding an ADC200-50 digital storage oscilloscope for the best *IU* submission. In addition, two single channel ADC-40s will be presented to the runners-up.

## Three-way Lighting – Logically

**T**RADITIONAL three-way lighting circuits (in which a lamp can be operated using any one of three switches) are complicated and they are physically difficult to wire together. The electronic alternative detailed in the circuit diagram of Fig.1 gives much simpler wiring, and as it operates at a switched low voltage it gives an easier and more economical installation.

The wiring to the switches can be in low current alarm cable for example, and it can be used to operate a wide variety of loads, not necessarily mains-powered.

### How It Works

The circuit works in the following way. Logic gate IC1a applies an exclusive-OR function to switches S1 and S2 (two-way switching), then IC1b applies the same function with the output from IC1a and the state of switch S3. This gives the effect of an optional inverted signal depending on the condition of S3. All eight possible combinations are detailed in the truth table shown, an

analysis of which shows that in effect, changing any state of any switch toggles the lamp on or off accordingly.

The RC networks R4 to R6 and C1 to C3 are for improved noise immunity. Resistors R1 to R3 provide a load for the switches which promotes reliable operation at low voltage and also assists with noise immunity by lowering the input impedance of the circuit.

The output buffer transistor TR1 can be any low power n-channel MOSFET which switches the relay. The remainder of the circuit is a low power regulated power supply.

Note that although signal switching is done at a low voltage, if the wiring is run alongside other insulated mains wiring, the same standards must be followed to ensure safety. (Take extra precautions to ensure that there is no possibility of others mistaking low-voltage "signal" wires for live mains wiring, or vice versa – ARW.)

Kate Turner  
St. Leonards-on-Sea

**Table 1: Truth Table**

S1	S2	S3	Lamp
off	off	off	off
off	off	on	on
off	on	off	on
off	on	on	off
on	off	off	on
on	off	on	off
on	on	off	off
on	on	on	on

**WHY NOT SEND US YOUR CIRCUIT IDEA? Earn some extra cash and possibly a prize!**

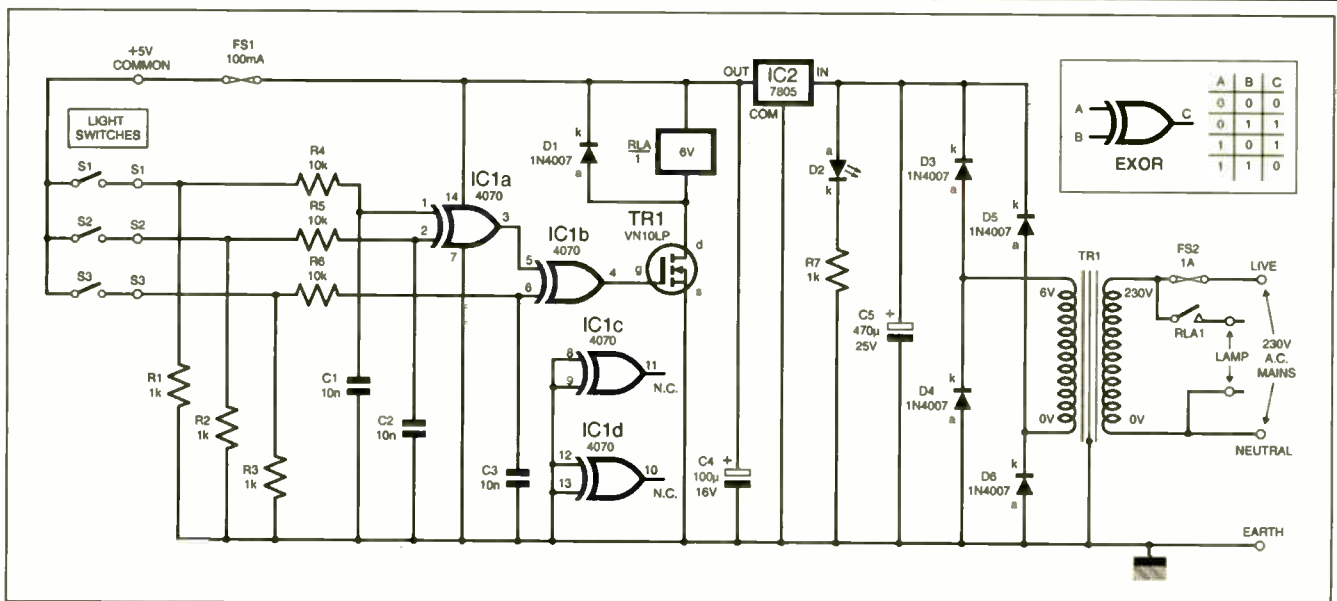
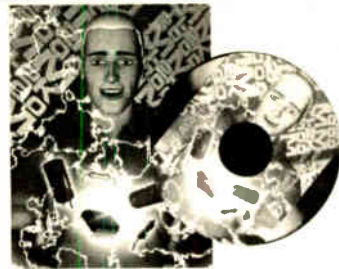

Fig.1. Complete circuit diagram for the Three-way Lighting system.





# EPE TEACH-IN 2000

## Now on CD-ROM

The whole of the 12-part *Teach-In 2000* series by John Becker (published in *EPE* Nov '99 to Oct 2000) is now available on CD-ROM. Plus the *Teach-In 2000* software covering all aspects of the series and Alan Winstanley's *Basic Soldering Guide* (including illustrations and *Desoldering*).

*Teach-in 2000* covers all the basic principles of electronics from Ohm's Law to Displays, including Op.Amps, Logic Gates etc. Each part has its own section on the interactive PC software where you can also change component values in the various on-screen demonstration circuits.

The series gives a hands-on approach to electronics with numerous breadboarded circuits to try out, plus a simple computer interface which allows a PC to be used as a basic oscilloscope.

**ONLY £12.45** including VAT and p&p

We accept Visa, Mastercard, Amex, Diners Club and Switch cards.

NOTE: This mini CD-ROM is suitable for use on any PC with a CD-ROM drive. It requires Adobe Acrobat Reader (available free from the Internet - [www.adobe.com/acrobat](http://www.adobe.com/acrobat))

### TEACH-IN 2000 CD-ROM ORDER FORM

Please send me ..... (quantity) TEACH-IN 2000 CD-ROM  
Price £12.45 (approx \$20) each - includes postage to anywhere in the world.

Name .....

Address .....

Post Code ..... Tel. ....

I enclose cheque/P.O./bank draft to the value of £ .....

Please charge my card £ .....

Card No. ....

Expiry Date ..... Switch Issue No. ....

Note: Minimum order for cards £5.

SEND TO: Everyday Practical Electronics, Wimborne Publishing Ltd.,  
408 Wimborne Road East, Ferndown, Dorset BH22 9ND.

Tel: 01202 873872. Fax: 01202 874562.

E-mail: [orders@epemag.wimborne.co.uk](mailto:orders@epemag.wimborne.co.uk)

Online store: [www.epemag.wimborne.co.uk/shopdoor.htm](http://www.epemag.wimborne.co.uk/shopdoor.htm)

Payments must be by card or in £ Sterling - cheque or bank draft drawn on a UK bank.  
Normally supplied within seven days of receipt of order.

## SAVE UP TO 68p AN ISSUE !

DON'T MISS THE WINDOW OF OPPORTUNITY - MAKE SURE OF YOUR COPY NOW!

FREE 16-Page Supplement

★ PIC TOOLKIT TK3 FOR WINDOWS ★

Plus TEACH-IN 2002 Part 1

Annual subscription rates:

6 Months: UK £15, Overseas £18 (standard air service),  
£27 (express airmail)

1 Year: UK £28.50, Overseas £34.50 (standard air service)  
£52 (express airmail)

2 Years: UK £52.00, Overseas £64.00 (standard air service)  
£99 (express airmail)

To: Everyday Practical Electronics,  
Wimborne Publishing Ltd., 408 Wimborne Road East,  
Ferndown, Dorset BH22 9ND

Tel: 01202 873872 Fax: 01202 874562

E-mail: [subs@epemag.wimborne.co.uk](mailto:subs@epemag.wimborne.co.uk)

Order from our online shop at:  
[www.epemag.wimborne.co.uk/shopdoor.htm](http://www.epemag.wimborne.co.uk/shopdoor.htm)

Name .....

Address .....

Post code ..... Tel. ....



### SUBSCRIPTION ORDER FORM



I enclose payment of £ .....  
(cheque/PO in £ sterling only),

payable to Everyday Practical Electronics



My card number is: .....

Please print clearly, and check that you have the number correct

Signature .....

Card Ex. Date ..... Switch Issue No. ....

Subscriptions can only start with the next available issue.  
For back numbers see the Back Issues page.

If you do not wish to cut your issue, send a letter or a copy of this form.

10001

# GATE SENTINEL

## THOMAS SCARBOROUGH



*Be on your guard against unwanted visitors.*

**W** CONCLUDE this month with the final part of our four-part series of “perpetual” projects. All are based on one small p.c.b. called a Uniboard. Each is powered around the clock – perpetually – by a single, high quality, memory back-up capacitor and a small solar cell (no battery). Each is designed to run unattended for months at a time – in fact for years!

The solar-powered power supply and regulator constructed in the first part (July '01) of this series form the basis for each of the projects and it only remains for you to choose which one most appeals to you! This month we cover the following three Perpetual Projects:

- ☆ Gate Sentinel ☆
- ☆ Solar-Powered Bird Scarer ☆
- ☆ Register ☆

Besides these three projects, suggestions are made for one variation – a Break Contact Alarm.

All the projects are built on a low-cost Uniboard (printed circuit board – one required for each project, unless you are expert at desoldering!). This should also include the *Solar-Powered Power Supply and Voltage Regulator* circuit described in Part 1 (July '01).

Note that all the projects may also be run off batteries – see Part 1.

The solar-powered supply section is only required once, unless you wish to build and keep all the projects as separate modules. It is now over to you to choose which specific project you would like to add to your Uniboard.

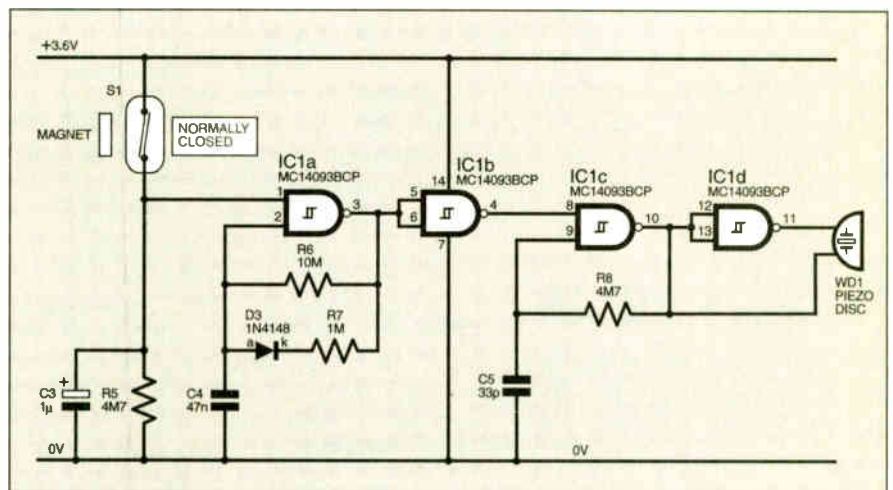

Fig.1. Circuit diagram for the Gate Sentinel. Component references follow on from the Solar-Powered Power Supply and Voltage Regulator (July '01).

### GATE SENTINEL

The full circuit diagram for the Gate Sentinel (minus, of course, the solar-powered supply/regulator) is shown in Fig.1. Note that the component references follow on from the regulator circuit published in the July '01 issue.

The Sentinel is intended to sound when a person enters your front gate. It is not intended so much as an alarm, but rather to give the impression: “You have been noticed.” It therefore emits a pip-pip-pip tone.

Two oscillators are employed in this project, the first of which (a slow oscillator, IC1a) modulates the second (a fast oscillator,

IC1c), to produce the pip-pip-pip tone. Diode D3 and resistor R7 provide an unequal mark-space ratio for the slow oscillator IC1a so that the pip-pip-pip tone is produced rather than a beep-beep-beep.

In order not to give the impression that this is merely a “dumb” device, the Gate Sentinel does more than merely switch on when your gate is opened, and off when it is closed – in that case, an intruder would know that it was directly linked to the gate. It emits some ten pips *after* the gate has been closed, so as to give the impression: “I’m more clever than a simple on-off device.”

This is achieved with the help of capacitor C3. When the gate is closed, switch S1

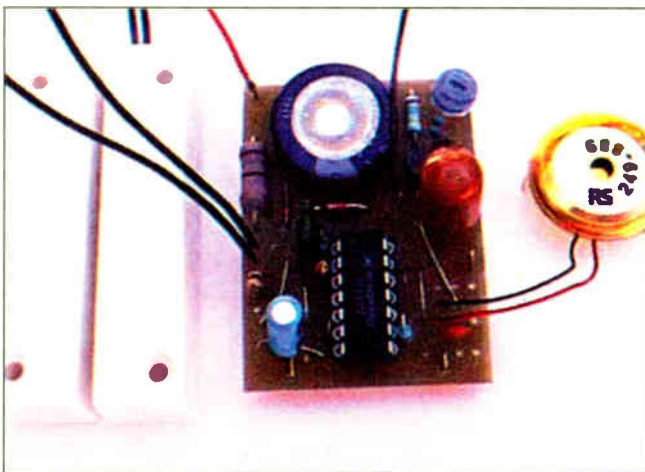

### SUGGESTION 1 – BREAK CONTACT ALARM

This simple Break Contact Alarm has one distinct advantage over last month’s Loop Burglar Alarm. When a door or a window is opened, it will not be silenced simply by closing the door or window again. Instead, it will continue to sound for about ten minutes before falling silent. It also gives a pulsed tone, which is more easily noticed.

Using the circuit of the Gate Sentinel as a guide, make the following modifications:

- Remove diode D3 and resistor R7.
- Substitute a 22 megohms (22M) resistor for R5
- Substitute a 22µF electrolytic capacitor for C3

Any number of normally-closed magnetic switches or microswitches may be wired *in parallel* with S1 so as to cover as many doors or windows as desired.

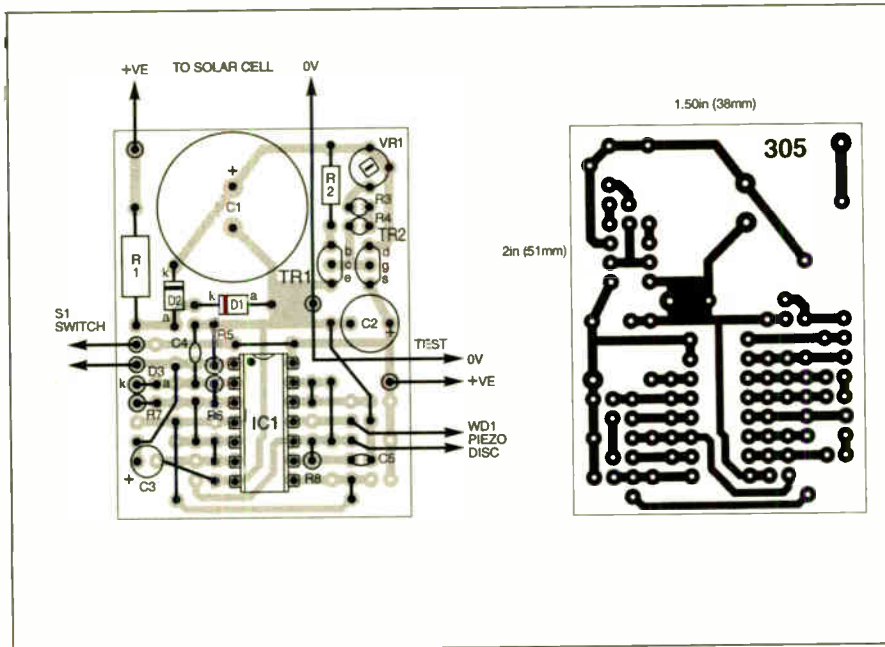

Fig. 2. Uniboard p.c.b. component layout and full-size copper foil master for the Gate Sentinel. Includes components for the power supply regulator – see photograph.

is held open by the “proximity magnet” mounted on the gate. When the gate is opened, S1 reverts to its normal closed state, and capacitor C3 charges up through the switch, taking IC1a pin 1 high (logic 1), thus triggering the Sentinel.

When the gate is closed again, and switch S1 is held open by the “proximity magnet” mounted on the gate, capacitor C3 requires a short period to discharge through resistor R5. This introduces a delay before the Gate Sentinel again falls silent. To increase the period for which the Sentinel sounds after closing your gate, increase the value of C3.

### SWITCHED-OFF

A normally-closed, magnet-operated, reed type switch would be ideal for S1. These switches are harder to come by than normally-open switches of the same type, so it would be worth noting that a magnet may be glued strategically to the side of a normally-open switch of this type, to convert it to a normally-closed switch. A continuity tester will quickly show where the magnet should be glued.

Any number of normally-closed switches (microswitches included, which are cheaper) may be wired in series with switch S1. These open when the gate is closed. Normally-open vibration switches would also be well suited in this position, closing briefly when the gate is opened.

A special challenge of this project was to switch off both oscillators simultaneously when switch S1 opened, so that no oscillator would be left running “in the background” (see Part 1 of the series). This was achieved by using a normally closed magnetic switch to trigger gate IC1a, as well as inverter IC1b.

### LIGHT WORK

Piezo disc sounder WD1 may be replaced with an l.e.d. if desired, or a l.e.d. may be used together with WD1. The l.e.d. is wired between IC1 pin 10 and the positive supply line, with its anode ((a) the longest lead) being taken to positive.

Use a ballast resistor in series with the l.e.d. – use the current limiting formula  $R=(V-V_f)/I$  (see Part 2 – Aug '01). A white l.e.d. requires no ballast resistor, since the effective current flow is limited by the regulator. Only an extreme brightness l.e.d., preferably with a narrow viewing angle, should be used.

### CONSTRUCTION

The Gate Sentinel is built up on the Uniboard p.c.b., as shown in the topside component layout details of Fig. 2, together with the copper foil master. This board (minus components) is available from the EPE PCB Service, code 305. The Solar-Powered Power Supply and Voltage Regulator (July '01) components are included in this diagram.

Commence construction by soldering the link wires and the resistors in position, continuing with the diode and the capacitors. The cathode (k) of diode D3 is banded and should be inserted as indicated in Fig. 2. Finally, insert IC1 in its d.i.l. socket, being careful to observe the correct orientation, as well as anti-static precautions.

### SETTING-UP

Assuming the circuit is being solar powered, once the power supply capacitor C1 has been fully charged in the sun, via the solar cell (see Part 1), adjust the regulator's preset trimmer VR1 until 3-6V is measured across electrolytic capacitor C2 (solder pins are provided on both sides of C2) – while the Gate Sentinel is sounding. This it will do as long as your gate is open. Remember that capacitor C2 causes a delay to any adjustments that are made to the voltage.

Current consumption is virtually nil on standby, and about 60µA when the buzzer is sounding.

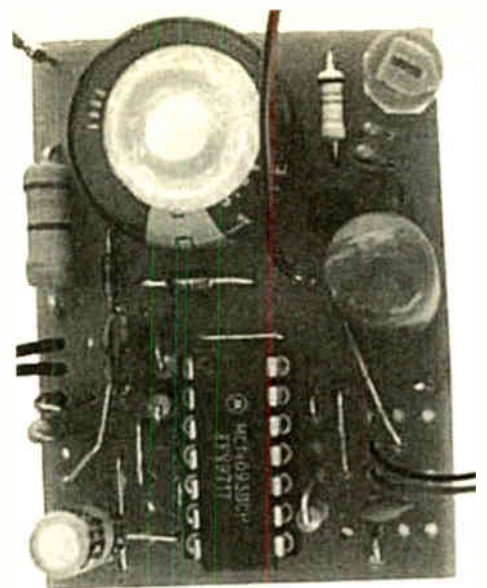

## COMPONENTS

### GATE SENTINEL

#### Resistors

R5, R8	4M7 (2 off)
R6	10M
R7	1M
All 0.25W 5% carbon film	

See

SHOP

TALK  
page

#### Capacitor

C3	1µ min. radial elect 10V
C4	47n polyester film
C5	33p ceramic plate

#### Semiconductors

D3	1N4148 signal diode
IC1	MC14093BCP quad 2-input NAND Schmitt trigger

#### Miscellaneous

WD1	low profile wire-ended piezo sounder
S1	normally-closed reed proximity switch, with bar magnet (see text)

Printed circuit board (Uniboard) available from the EPE PCB Service, code 305; multistrand connecting wire; link wires; solder pins; solder etc.

Note: Component designations run on from the Solar-Powered Power Supply and Voltage Regulator described in the July '01 issue.

Approx. Cost  
Guidance Only

£6

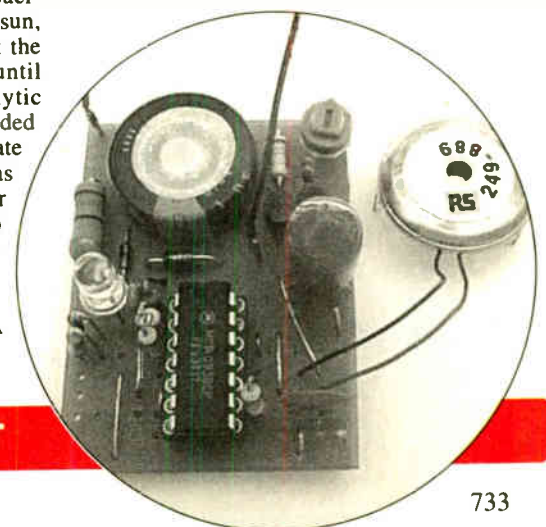

TAKE FLIGHT

# SOLAR-POWERED BIRD SCARER

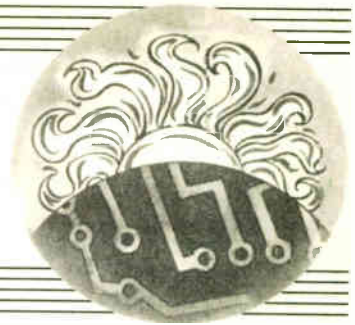

Ruffle a few feathers with this harmless "electronic scarecrow"!

IT HAS been shown that birds particularly dislike a rasping sound around 200Hz, and will for a while avoid it. The present project (could also be called an Electronic Scarecrow) was given to a farmer to test on his grapes, and proved very effective over a radius of three to four metres. In fact the farmer was quite excited about the results.

Having said this, however, after about three weeks the birds grew accustomed to the sound, and it was a sorry looking farmer who asked the author whether he could "get the Bird Scarer working again". This did not mean that it had malfunctioned, as the author imagined – the birds merely paid no more attention to it!

Thus the Bird Scarer would be particularly useful for the temporary protection of seedlings or fruit.

## CIRCUIT DETAILS

Since this project will only be needed during the daylight hours (most birds go to roost in the darkness), we can allow a higher current consumption during the day, and put the circuit to sleep at night. This circuit is more power-hungry than the rest, mainly because its two oscillators (IC1a and IC1b) run continuously during the day. Again, both of the oscillators need to be switched off simultaneously – in this case at night.

The full circuit diagram for the Solar-Powered Bird Scarer is shown in Fig.3. The component references follow on from the supply/voltage regulator circuit (July '01).

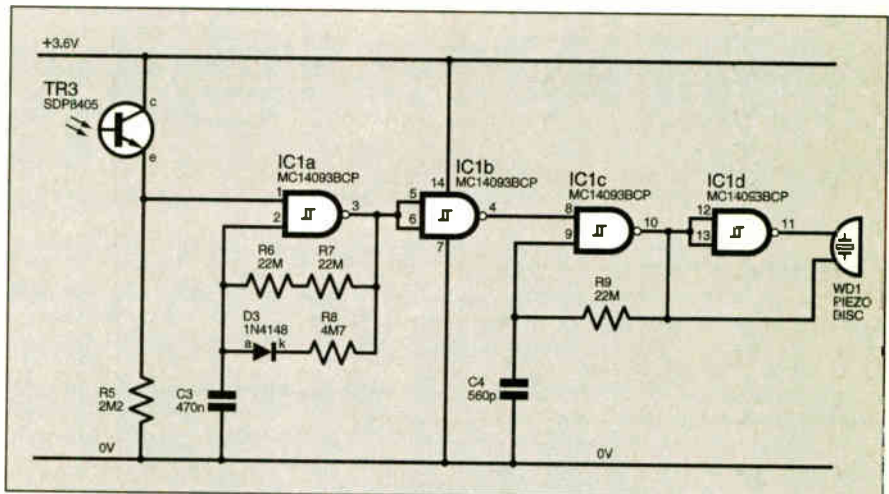

Fig.3. Circuit diagram for the Solar-Powered Bird Scarer. Component numbering continues on from the power supply/regulator published in the July '01 issue.

As with the Gate Sentinel, the low frequency oscillator IC1a modulates the high frequency oscillator IC1c, and the piezo disc WD1 is operated in push-pull fashion for maximum volume by IC1c and IC1d.

An npn phototransistor TR3 is used to switch off the two oscillators in the darkness, and this should be mounted away from any night-time light sources. A phototransistor is used because of its high dark resistance, so that it consumes less power in this position than many other devices would do.

The Bird Scarer is located at the centre of the area which you would like to protect from birds, preferably tucked away among some leaves. The solar panel should, of course, be positioned to receive full sunlight.

## CONSTRUCTION

The Solar-Powered Bird Scarer is built up on the Uniboard p.c.b., as shown in the topside component layout details of Fig.4, together with copper foil master. This board (minus

(Left). Completed Bird Scarer Uniboard p.c.b. It also includes the components (except the solar cell) for the Solar-Powered Power Supply and Regulator from the July '01 issue.

## COMPONENTS

### BIRD SCARER

#### Resistors

- R5 2M2 carbon film  
R6, R7, R9 22M metal film (3 off)  
R8 4M7 carbon film

See  
SHOP  
TALK  
page

All 0.25W 5% or better

#### Capacitor

- C3 470n min. polyester film  
C4 560p min. ceramic plate

#### Semiconductors

- D3 1N4148 signal diode  
TR3 SDP8405 npn phototransistor  
IC1 MC14093BCP quad 2-input NAND Schmitt trigger

#### Miscellaneous

- WD1 low profile wire-ended piezo sounder

Printed circuit board (Uniboard) available from the EPE PCB Service, code 305; multistrand connecting wire; link wires; solder pins; solder etc.

Note: Component designations run on from the Solar-Powered Power Supply and Voltage Regulator described in the July '01 issue.

Approx. Cost  
Guidance Only

£6

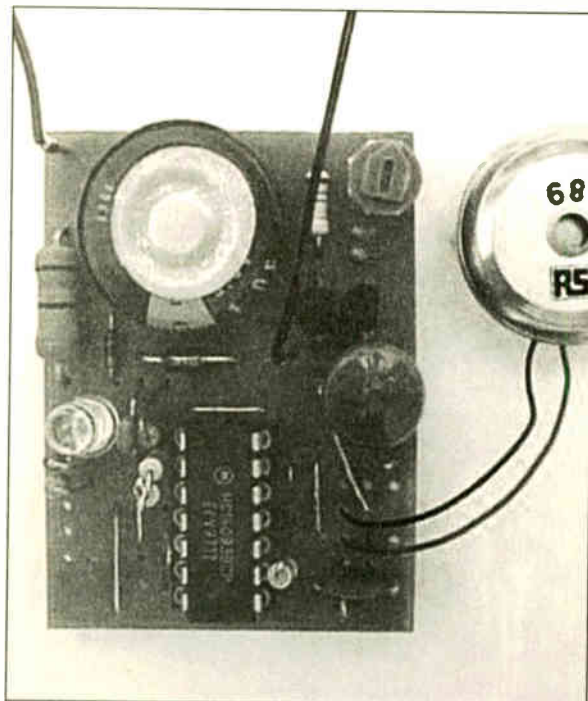

components) is available from the *EPE PCB Service*, code 305. Once again, the *Solar-Powered Power Supply and Voltage Regulator* components are included in this diagram.

Follow the same procedures as previously described, soldering the components to the board in sequence, and finally inserting IC1 in its holder, observing anti-static precautions.

Note that R6 and R7 are wired in series, and together make up the required value of 44 megohms. One end of each of the two resistors should have their leads twisted and soldered together. The opposite (free) ends of the resistors should be inserted in the board, across pins 2 and 3 of IC1, as shown in Fig.4.

### SETTING-UP

Assuming the solar power supply is active, adjust the regulator's voltage to 3.6V – while the Bird Scarer is *sounding*. Remember that capacitor C2 in the regulator circuit causes a short delay to any adjustments that are made to the voltage.

Current consumption is less than 1µA at night, and fluctuates between about 10µA and 30µA when it is in operation.

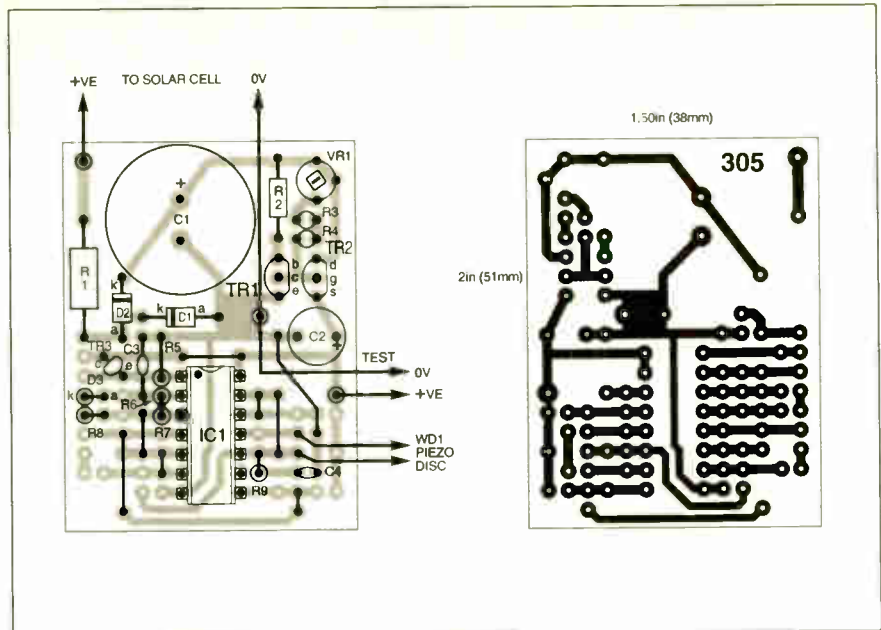
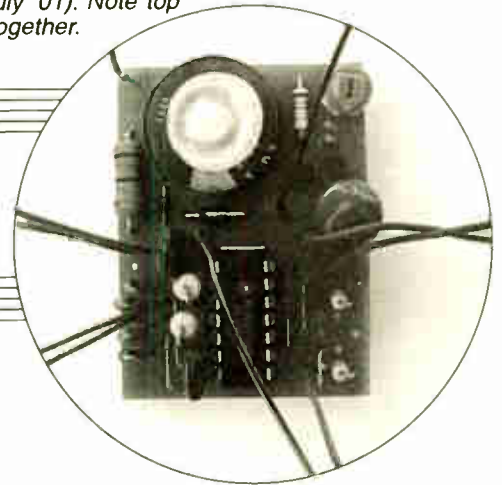

Fig.4. Uniboard component layout and full-size foil master for the Bird Scarer. Includes power supply components (July '01). Note top end leads of R6 and R7 are soldered together.



## SOLAR-POWERED REGISTER

*Is there anyone at home?*

**O**UR FINAL Perpetual Project is a Register. This device is useful especially to indicate whether a person is in or out. It will flash Green if a person is In, and Red if a person is Out. A series of these devices together in a hallway could inform residents of a small "digs" as to who is in and who is out – residents would simply touch a touchswitch as they passed to indicate that they were coming or going.

Alternatively, it could send secret messages to the street from your bedroom window. A green flashing l.e.d. might indicate: "See you at the bowling alley tonight," while a red flashing l.e.d. might indicate: "I'm grounded."

### CIRCUIT DETAILS

The complete circuit diagram for the *Solar-Powered Register* is shown in Fig.5. Like all the previous circuits, the component numbering follows on from the voltage regulator published in the July '01 issue.

Both l.e.d.s are pulsed in order to conserve power. Do not even think of using other types of l.e.d. besides extreme brightness types – other types will be virtually useless. A narrow viewing angle is recommended – a wider viewing angle could seriously compromise brightness.

In this final design, we dispense with buffer gates, to gain more gates to utilise in the circuit.

Note that the specified values for ballast resistors R7 and R10 were chosen experimentally in relation to the forward

voltage ( $V_F$ ) drop of l.e.d.s D4 and D6, which varies with the colour (typically red  $V_F = 1.85V$ , green  $V_F = 2.2V$ ). If either oscillator fails to work, experiment with different values for the respective ballast resistor.

### BISTABLE LATCH

Each of the two l.e.d. flashers, IC1a and IC1b, is turned on or off respectively by a

simple bistable latch circuit made up of IC1c and IC1d. When touchswitch S1 is touched, the input at IC1c pin 8 goes low. According to NAND logic, the output terminal, pin 10, therefore must go high. Both inputs of IC1d (pins 12 and 13) are thus

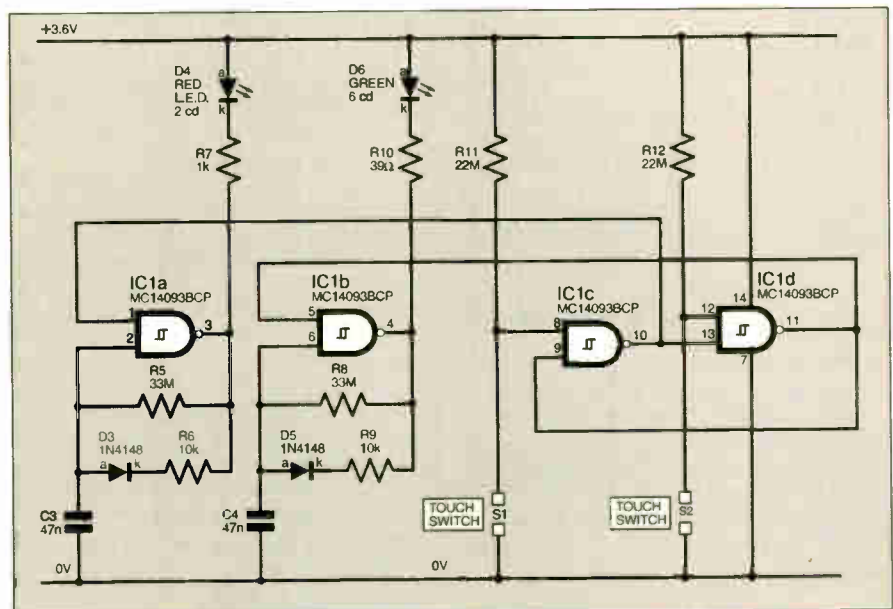

Fig.5. Circuit diagram for the Solar-Powered Register. Note component numbering follows on from the power supply (July '01).

high – its output terminal is therefore low, as well as input pin 9 of IC1c.

When touchswitch S1 opens again, IC1c's output terminal remains high, since one of its inputs is now low. Now, imagine then that the other touchswitch S2 (IC1d) is touched. Follow the same logic sequence, and you will see that the bistable latch changes state.

Since IC1c and IC1d essentially invert one another, when one output is high the other is low, and vice versa. This switches one l.e.d. flasher on while it switches the other off.

## IN SEQUENCE

It is interesting to note that we have here (arguably) a one-bit computer. It has a "keyboard" (two touchswitches), a memory – to memorise your last key-press (logic i.c.s may serve as a form of memory), and a display (the different coloured l.e.d.s).

At any rate, this is the only project in this "Uniboard" series which uses *sequential* logic instead of *combinational* logic. Combinational logic merely reacts to the present state of the inputs (or the *combination* of highs and lows which are present at the inputs). Sequential logic, on the other hand, is influenced by a *previous state* of the inputs.

Also, it is interesting to note just what it is that constitutes "memory". In digital electronics, it is *feedback* which is used to store events. In this case, the outputs of

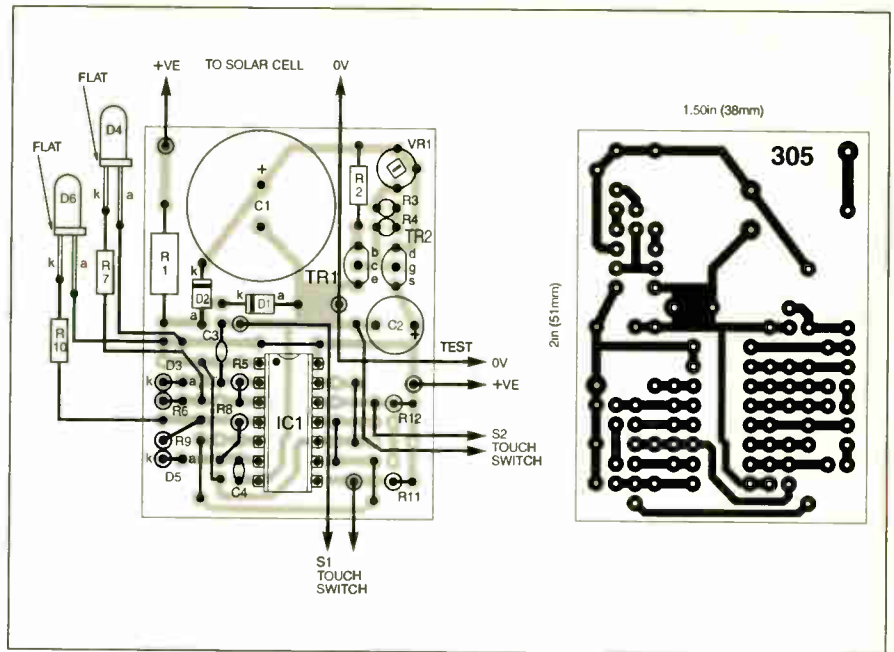

Fig.6. Uniboard component layout and full-size copper foil master for the Solar-Powered Register. Includes power supply from Part 1 (July '01). Note cathode (k) lead of D4 and D6 is shorter than the anode (a) lead.

IC1c and IC1d are fed back to one of the other inputs at pin 13 and pin 9 respectively, to serve as the most basic form of memory – the bistable latch.

The subjective brightness of the two l.e.d.s (D4 and D6) may be increased considerably by changing the values of resistors R6 and R9 to 47 kilohms (47k) to change the flashing mark space ratio. However, the power supply charge life-span would be reduced to about fifteen hours.

The rate of flashing may be increased by decreasing the value of resistors R5 and R8, but this will also reduce the power supply effective life.

One "Goldcap" memory backup capacitor, C1 in the power supply/voltage regulator (Part 1 – July '01) could support two registers in sunnier climes. A few such registers placed in a passageway could keep track of the movements of a few people at the same time.

## TOUCH SWITCH

It was decided to use touchswitches throughout this series, since the symbolism of the "perpetual" might be compromised if any mechanical switches were included.

A touch-switch was constructed by the author from the pieces of a broken ultrasonic transducer, the cavity between the "switch" contacts being filled with quick-set putty. Any "home produced" switch should be constructed in such a way that a finger is sure to close the gap across the two contacts.

It would be worth noting that touchswitches can pick up static. A recommended simple means of protecting all the circuits in this series against static would be to wire a one megohm resistor in series with each touchswitch. This would be desirable especially if there is an expanse of carpeting near the touchswitch.

## CONSTRUCTION

The Solar-Powered Register is built up on the Uniboard p.c.b., which may or may

not already hold the regulator and d.i.l. socket (see July issue, Fig.2) – as shown in the topside component layout details of Fig.6. This board (minus all components) is available from the EPE PCB Service, code 305.

Follow the same procedures as previously described, soldering the components to the board in sequence, and finally inserting IC1, observing anti-static precautions. In order to conserve space, ballast resistors are wired directly to the l.e.d.s as shown.

Note again that some extreme brightness l.e.d.s also require anti-static precautions.

## SETTING-UP

Once the memory retention capacitor (supply/regulator circuit) C1 has been fully charged in the sun (see July '01), adjust the regulator's preset trimmer VR1 until 3-6V is measured across electrolytic capacitor C2 (solder pins are provided for this purpose on both sides of C2). Remember that C2 causes a short delay to any adjustments that are made to the voltage.

Current consumption (excluding the regulator) is below 15µA. If you measure more than 20µA make IC1 your prime suspect. A CMOS i.c. can be partially damaged by static, while seeming to function correctly. If the i.c. is not the version specified in the Components list, this will almost certainly be the problem.

## IN CLOSING

Among other things, this series has been a demonstration of some of the recent advances in electronics technology, and of the practical usefulness of such advances.

This series also illustrates good examples of using capacitance as the primary source of power (with the solar panel, of course, replenishing the capacitor).

May your "perpetual project", whichever one you choose, give life-long and trouble-free service. □

# COMPONENTS

## REGISTER

### Resistors

R5, R8	33M metal film (2 off)	See SHOP TALK page
R6, R9	10k carbon film (2 off)	
R7	1k carbon film	
R10	39Ω carbon film	
R11, R12	22M metal film (2 off)	
All 0.25W 5% or better		

### Capacitor

C3, C4 47n polyester film (2 off)

### Semiconductors

D3, D5	1N4148 signal diode (2 off)
D4	5mm extreme brightness red l.e.d.
D6	5mm extreme brightness green l.e.d.
IC1	MC14093BCP quad 2-input NAND Schmitt trigger

### Miscellaneous

S1 touch-switch – see text

Printed circuit board (Uniboard) available from the EPE PCB Service, code 305; multistrand connecting wire; link wires; solder pins; solder etc.

Note: Component designations run on from the Solar-Powered Power Supply and Voltage Regulator described in the July '01 issue.

Approx. Cost  
Guidance Only

£6

# Radio Bygones

The leading magazine  
for vintage radio  
enthusiasts

Now Also  
Available to  
**BUY ONLINE**  
www.radiobygones.com  
Log on, pay by credit card  
and download the magazine  
to your PC  
**ONLY \$9.99 (US dollars)**  
**FOR 6 ISSUES**  
A free issue is  
available

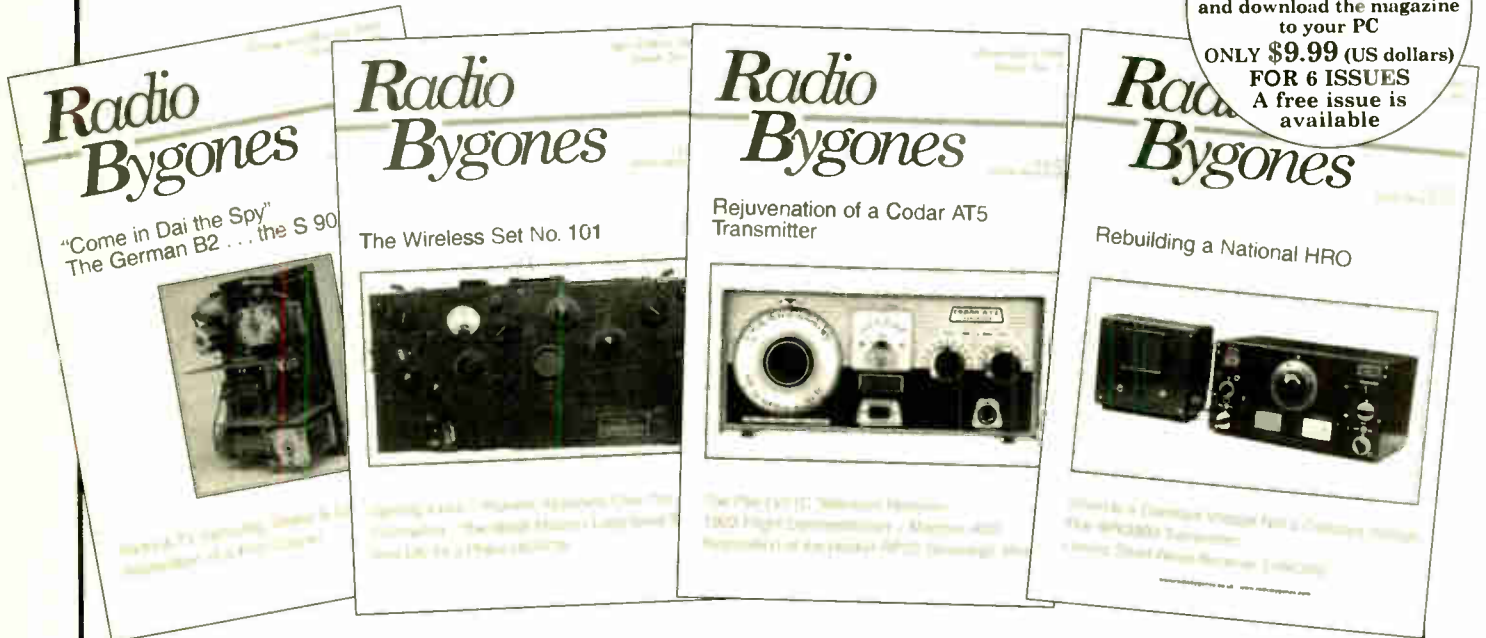

WHETHER your interest is in domestic radio and TV or in amateur radio, in military, aeronautical or marine communications, in radar and radio navigation, in instruments, in broadcasting, in audio and recording, or in professional radio systems fixed or mobile, RADIO BYGONES is the magazine for you.

ARTICLES on restoration and repair, history, circuit techniques, personalities, reminiscences and just plain nostalgia – you'll find them all. Plus features on museums and private collections and a full-colour photo-feature in every issue.

IT'S MOSTLY about valves, of course, but 'solid-state' – whether of the coherer and spark-gap variety or early transistors – also has a place.

FROM THE DAYS of Maxwell, Hertz, Lodge and Marconi to what was the state-of-the-art just a few short years ago . . .

There is also a selection of free readers' For Sale and Wanted advertisements in every issue.

## Radio Bygones covers it all!

THE MAGAZINE is published six times a year, and is available by postal subscription. It is **not available at newsagents**.

TO TAKE OUT a subscription, or to request a sample copy, please complete the form below and return it to:

**RADIO BYGONES, Wimborne Publishing Ltd, 408 Wimborne Road East, Ferndown, Dorset BH22 9ND.**

Tel: 01202 873872. Fax 01202 874562. Web sites: [www.radiobygones.co.uk](http://www.radiobygones.co.uk) [www.radiobygones.com](http://www.radiobygones.com)

### RADIO BYGONES ORDER FORM

A SAMPLE COPY of Radio Bygones . . . . . £3.25  
(Add 70p for overseas Airmail postage)

SUBSCRIPTIONS (post paid):	<b>1 YEAR</b>	<b>2 YEAR</b>
UNITED KINGDOM	£18.50	£35.00
REST OF EUROPE (AIRMAIL)	£20.50	£39.00
REST OF THE WORLD (AIRMAIL)	£24.50	£47.00

- Yes, I would like a sample copy of RADIO BYGONES
- Yes, I would like to take out a subscription for:
- One year (6 issues)     Two years (12 issues)
- I enclose a cheque/Eurocheque/PO for £ . . . . . payable to Wimborne Publishing Ltd
- Please debit my card

**NOTE** Minimum credit card payment is £5

My card number is:

.....  
*Please print clearly, and check that you have the number correct*

Expiry date ..... Switch Issue No. ....

My name is .....

My address .....

.....

Post Code/Zip ..... Tel: .....

Signed .....

*If you do not wish to cut your magazine, send a letter or a copy of this form*

# INTERFACE

Robert Penfold

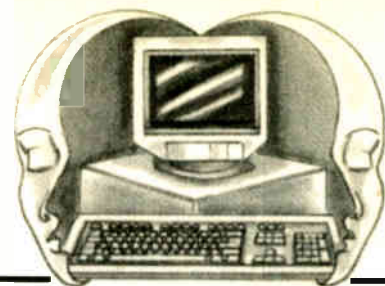

## SINGLE-CHIP 32-BIT OUTPUT PORT

**P**REVIOUS *Interface* articles have described analogue-to-digital and digital-to-analogue converters that use a form of serial interfacing. This method has the advantage of providing eight or 12-bit resolution using only about three lines to provide the interfacing to the PC.

The same basic method can be applied where simple interfacing is required but a large number of digital inputs or outputs are required. It is an output port that is featured here, but similar techniques could no doubt be applied to a digital input port.

Of course, you do not get something for nothing by using serial interfacing. The price that is paid for the lack of wires from the PC to the interface is added complication in the software and a lack of speed. Where an application needs to update the output port every microsecond or so the serial approach is unlikely to be suitable. Of course, in many practical applications the output ports are only altered relatively infrequently, and the serial method is then eminently suitable.

### Single Chip

The circuit featured here uses a three-line interface to a PC printer port and provides some 32 output lines. Furthermore, the circuit uses just two components, and one of these is a supply decoupling capacitor!

This is made possible by using the UCN5818AF serial interfacing chip, which is essentially just a 32-bit shift register. It would probably be cheaper to use

CMOS or TTL shift registers to provide the same function, but the UCN5818AF provides a very neat and reliable way of handling things. This chip is produced by Allegro Microsystems Inc. and is available in the UK from the usual RS outlets.

The pinout configuration for the UCN5818AF is shown in Fig.1. Pin 40 is the normal supply pin while pin 1 is the load supply input. This chip is primarily intended for operation with vacuum fluorescent displays where it is necessary to control loads operating at relatively high voltages.

However, it can operate at normal 5V logic levels throughout, and it is just a matter of connecting both supply pins to the 5V logic supply. The current consumption of the chip itself is only a few milliamps, but overall current drain is somewhat higher if the outputs are used to provide significant output currents.

Data from the PC is applied to the serial input at pin 39. There is also a serial output at pin 2 that permits two or more devices to be cascaded if 32 outputs are not enough. There are three control inputs, but in normal operation only two of these are used.

The timing diagram of Fig.2 helps to illustrate the normal method of interfacing this chip. First the Data input is set at the correct logic level for the first bit of data, which in this example is logic 1. A pulse is then supplied to the Clock input, and it is on the low to high transition that the data is clocked into the first cell of the shift register.

This process is repeated until all 32 bits have been clocked into the chip. For the sake of simplicity, in the example of Fig.2 there are only four bits of data, with the first two at logic 1 and the second two at logic 0.

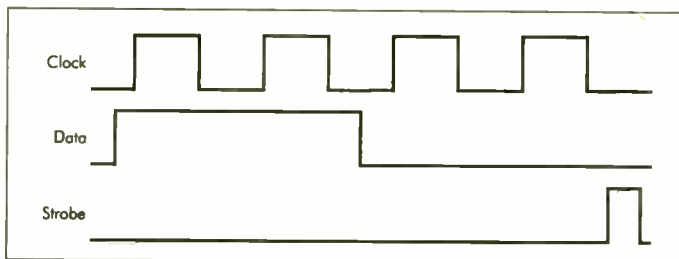

Fig.2. Simplified timing diagram for the UCN5818AF.

### All Change

As each bit of data is clocked into the chip, the data already in the shift register is moved one place further along. The first bit of data therefore appears on output 1 (pin 38) initially, but has worked its way along the line to output 32 (pin 3) by the time the thirty-second bit has been clocked in.

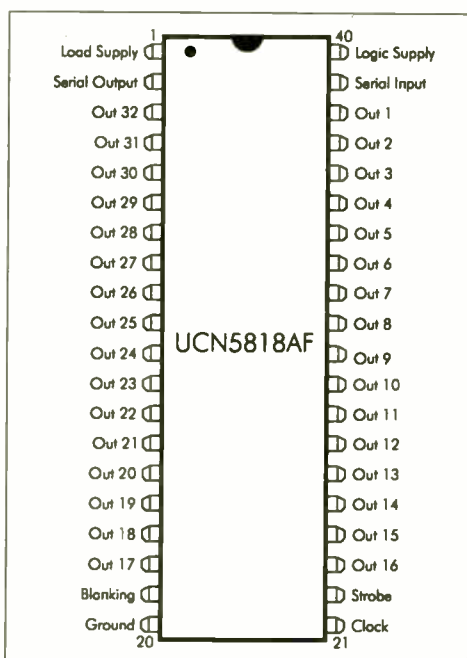

Fig.1. The UCN5818AF 32-bit latched serial input source driver pinout details.

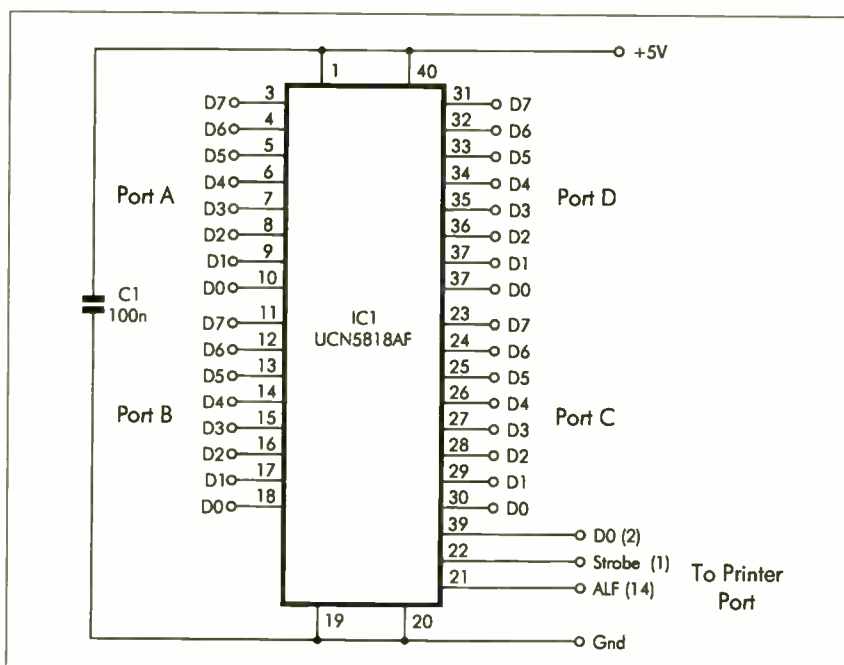

Fig.3. The complete circuit diagram for the 32-bit Output Port. The only external component is capacitor C1.



The data in the shift register is not valid until the final bit in a set of 32 has been clocked into the chip, and it must not be placed on the output pins until then. One solution is to hold the Blanking input at pin 19 high while data is being fed into the chip. This switches on the current sink at each output and switches off the current sources, setting every output low.

In most applications this is no better than allowing the shift register to drive the outputs, since the data on the outputs will still be invalid. For most purposes it is best to tie the Blanking input to ground so that the outputs always operate normally.

Internal latches and the Strobe input are then used to ensure that the data on the outputs of the shift register is not transferred to the output pins until fully valid data is available. This is achieved by having the Strobe input held low until a full set of 32 bits has been clocked into the chip.

A pulse is then applied to the Strobe input to transfer the new data to the output pins and latch it there. Any changes on the outputs of the shift register then have no effect on the output pins until another set of data has been clocked in and another strobe pulse is generated.

### Versatile Output

The circuit diagram for the 32-bit output port appears in Fig.3. The accompanying software uses the 32 outputs as four 8-bit output ports, but they can be used as two 16-bit ports, a single 32-bit type, 32 single bit outputs, or any other set-up that requires no more than 32 output lines.

In order to keep the software straightforward the Data input is driven from D0 of the printer port, while the Strobe and Clock inputs are respectively driven by the printer port's Strobe and ALF handshake outputs. This conveniently places the data and control outputs at separate output addresses, but with suitably clever software it should be possible to use any three outputs of the port.

The 5V supply is not available from the printer port, but methods of obtaining a 5V supply from a PC have been covered in many previous articles. The connections to the printer port are made via a 25-way male D-connector. Connection details are provided in Fig.4.

### Software

The demonstration program for the 32-bit output port was written using Visual BASIC 6 and it requires `input32.dll` in order to run. It uses four vertical slider controls (VScroll1 to VScroll4) to provide values from 0 to 255 that are output to the ports (see photograph above). The main routine is applied to a timer that sends a new set of data to the ports every 50 milliseconds.

The whole listing is too long for inclusion here, but all the files for this program are available from the EPE web site. (It is also available on the *Interface Disk 1* - see *EPE PCB Service* page.) This includes the compiled program.

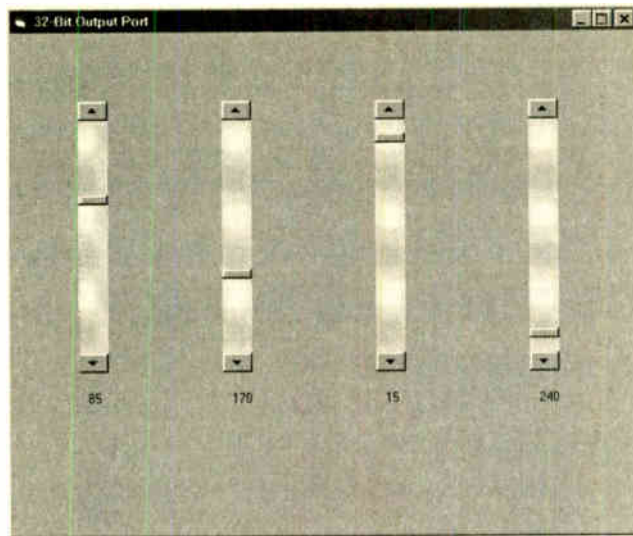

Screen shot of the demonstration program in operation.

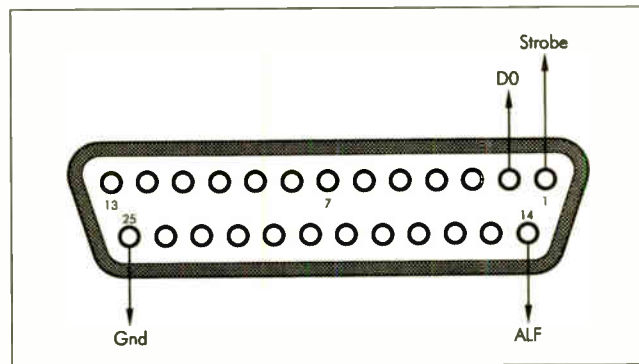

Fig.4 (left). The connections to the printer port are via the 25-way male D-connector. Pins 18 to 25 all connect to ground.

Data is sent to the four ports using what is basically the same routine for each port. This is the last of these four routines:

```

If (VScroll4.Value And 128) = 128 Then
Out Prn1, 1 Else Out Prn1, 0
Out Prn3, 1
Out Prn3, 3
If (VScroll4.Value And 64) = 64 Then
Out Prn1, 1 Else Out Prn1, 0
Out Prn3, 1
Out Prn3, 3
If (VScroll4.Value And 32) = 32 Then
Out Prn1, 1 Else Out Prn1, 0
Out Prn3, 1
Out Prn3, 3
If (VScroll4.Value And 16) = 16 Then
Out Prn1, 1 Else Out Prn1, 0
Out Prn3, 1
Out Prn3, 3
If (VScroll4.Value And 8) = 8 Then Out
Prn1, 1 Else Out Prn1, 0
Out Prn3, 1
Out Prn3, 3
If (VScroll4.Value And 4) = 4 Then Out
Prn1, 1 Else Out Prn1, 0
Out Prn3, 1
Out Prn3, 3
If (VScroll4.Value And 2) = 2 Then Out
Prn1, 1 Else Out Prn1, 0
Out Prn3, 1
Out Prn3, 3
If (VScroll4.Value And 1) = 1 Then Out
Prn1, 1 Else Out Prn1, 0
Out Prn3, 1
Out Prn3, 2
Out Prn3, 2
Out Prn3, 3

```

D0 of the printer port, and then clock the data into the serial register. The value in each bitwise operation is changed to suit the bit being tested.

### Adaptable

Two extra Out instructions are used at the end of the routine, and these generate a pulse on the Strobe output so that the data is latched onto the 32 output pins. Note that these two instructions are only used at the end of the fourth routine, when all 32 bits of the new word of data are available. The program includes lines that print the current value for each port below the slider control so that it is easy to check that the outputs of the ports are responding properly to the slider settings.

It should not be difficult to adapt the software to suit practical applications. The values for the ports can be written to variables that are then used in place of `VScroll1.Value`, etc. It is not necessary to use all 32 output pins, but 32 bits of data must always be written to the UCN5818AF to prevent things getting "out of sync". Dummy data *must* therefore be written to any outputs that are not used.



**WHETHER ELECTRONICS IS YOUR HOBBY  
OR YOUR LIVELIHOOD . . .  
YOU NEED THE MODERN ELECTRONICS MANUAL  
and the ELECTRONICS SERVICE MANUAL**

## THE MODERN ELECTRONICS MANUAL

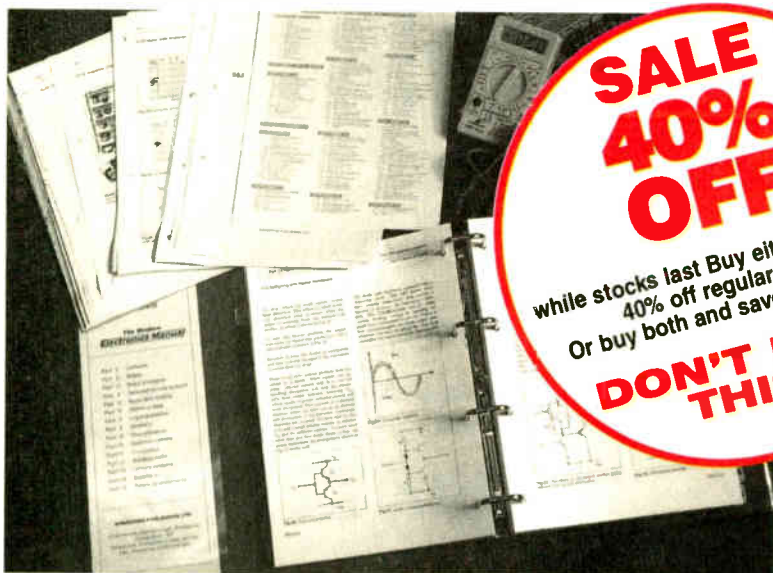

**SALE  
40%  
OFF**  
while stocks last Buy either Manual at  
40% off regular price.  
Or buy both and save even more.  
**DON'T MISS  
THIS!**

*The essential reference  
work for everyone  
studying electronics*

- Over 900 pages
- In-depth theory
- Projects to build
- Detailed assembly instructions
- Full components checklists
- Extensive data tables
- Detailed supply information
- Easy-to-use format
- Clear and simple layout
- Comprehensive subject range
- Professionally written
- Regular Supplements
- Sturdy gold blocked ring-binder

## EVERYTHING YOU NEED TO GET STARTED AND GO FURTHER IN ELECTRONICS!

The revised edition of the Modern Electronics Base Manual contains practical, easy-to-follow information on the following subjects:

**BASIC PRINCIPLES:** Electronic Components and their Characteristics (16 sections from Resistors and Potentiometers to Crystals, Crystal Modules and Resonators), Circuits Using Passive Components (9 sections), Power Supplies, The Amateur Electronics Workshop, The Uses of Semiconductors, Digital Electronics (6 sections), Operational Amplifiers, Introduction to Physics, Semiconductors (6 sections) and Digital Instruments (5 sections).

**CIRCUITS TO BUILD:** There's nothing to beat the satisfaction of creating your own project. From basic principles, like soldering and making printed circuit boards, to circuit-building, the Modern Electronics Manual and its Supplements describe clearly, with appropriate diagrams, how to assemble radios, loudspeakers,

amplifiers, car projects, computer interfaces, measuring instruments, workshop equipment, security systems, etc. The Base Manual describes 13 projects including a Theremin and a Simple TENS Unit.

**ESSENTIAL DATA:** Extensive tables on diodes, transistors, thyristors and triacs, digital and linear i.c.s.

**EXTENSIVE GLOSSARY:** Should you come across a technical word, phrase or abbreviation you're not familiar with, simply turn to the glossary included in the Manual and you'll find a comprehensive definition in plain English.

The Manual also covers **Safety** and **Suppliers**. The most comprehensive reference work ever produced at a price you can afford, the revised edition of **THE MODERN ELECTRONICS MANUAL** provides you with all the *essential* information you need.

## THE MODERN ELECTRONICS MANUAL

**Revised Edition of Basic Work:** Contains over 900 pages of information. Edited by John Becker.

**Regular Supplements:** Approximately 160-page Supplements of additional information which, if requested, are forwarded to you immediately on publication (four times a year). These are billed separately and can be discontinued at any time.

**Presentation:** Durable looseleaf system in large A4 format

**Price of the Basic Work:** ~~£39.95~~ **SALE PRICE £23.97** (to include a recent Supplement **FREE**)

### Guarantee

Our 30 day money back guarantee gives you complete peace of mind. If you are not entirely happy with either Manual, for whatever reason, simply return it to us in good condition within 30 days and we will make a full refund of your payment – no small print and no questions asked.  
(Overseas buyers do have to pay the overseas postage charge)

# ELECTRONICS SERVICE MANUAL

## EVERYTHING YOU NEED TO KNOW TO GET STARTED IN REPAIRING AND SERVICING ELECTRONIC EQUIPMENT

**SAFETY:** Be knowledgeable about Safety Regulations, Electrical Safety and First Aid.

**UNDERPINNING KNOWLEDGE:** Specific sections enable you to Understand Electrical and Electronic Principles, Active and Passive Components, Circuit Diagrams, Circuit Measurements, Radio, Computers, Valves and manufacturers' Data, etc.

**PRACTICAL SKILLS:** Learn how to identify Electronic Components, Avoid Static Hazards, Carry Out Soldering and Wiring, Remove and Replace Components.

**TEST EQUIPMENT:** How to Choose and Use Test Equipment, Assemble a Toolkit, Set Up a Workshop, and Get the Most from Your Multimeter and Oscilloscope, etc.

**SERVICING TECHNIQUES:** The regular Supplements include vital guidelines on how to Service Audio Amplifiers, Radio Receivers, TV Receivers, Cassette Recorders, Video Recorders, Personal Computers, etc.

**TECHNICAL NOTES:** Commencing with the IBM PC, this section and the regular Supplements deal with a very wide range of specific types of equipment – radios, TVs, cassette recorders, amplifiers, video recorders etc..

**REFERENCE DATA:** Detailing vital parameters for Diodes, Small-Signal Transistors, Power Transistors, Thyristors, Triacs and Field Effect Transistors. Supplements include Operational Amplifiers, Logic Circuits, Optoelectronic Devices, etc.

## The essential work for servicing and repairing electronic equipment

- Around 900 pages
- Fundamental principles
- Troubleshooting techniques
- Servicing techniques
- Choosing and using test equipment
- Reference data
- Easy-to-use format
- Clear and simple layout
- Vital safety precautions
- Professionally written
- Regular Supplements
- Sturdy gold blocked ring-binder

## ELECTRONICS SERVICE MANUAL

**Basic Work:** Contains around 900 pages of information. Edited by Mike Tooley BA

**Regular Supplements:** Approximately 160-page Supplements of additional information which, if requested, are forwarded to you immediately on publication (four times a year). These are billed separately and can be discontinued at any time.

**Presentation:** Durable looseleaf system in large A4 format

**Price of the Basic Work:** ~~£39.95~~ **SALE PRICE £23.97** (to include a recent Supplement FREE)

## ORDER BOTH MANUALS TOGETHER AND SAVE ANOTHER £8

A mass of well-organised and clearly explained information is brought to you by expert editorial teams whose combined experience ensures the widest coverage. Regular Supplements to these unique publications, each around 160 pages, keep you abreast of the latest technology and techniques if required.

### REGULAR SUPPLEMENTS

Unlike a book or encyclopedia, these Manuals are living works – continuously extended with new material. If requested, Supplements are sent to you approximately every three months. Each Supplement contains around 160 pages – all for only £23.50+£2.50 p&p. You can, of course, return any Supplement (within ten days) which

you feel is superfluous to your needs. You can also purchase a range of past Supplements to extend your Base Manual on subjects of particular interest to you.

### RESPONDING TO YOUR NEEDS

We are able to provide you with the most important and popular, up to date, features in our

Supplements. Our unique system is augmented by readers' requests for new information. Through this service you are able to let us know exactly what information you require in your Manuals.

You can also contact the editors directly in writing if you have a specific technical request or query relating to the Manuals.

**PLEASE** send me



THE MODERN ELECTRONICS MANUAL plus a FREE SUPPLEMENT

ELECTRONICS SERVICE MANUAL plus a FREE SUPPLEMENT

I enclose payment of £23.97 (for one Manual) or £39.94 for both Manuals (saving another £8 by ordering both together) plus postage if applicable.

I also require the appropriate Supplements four times a year. These are billed separately and can be discontinued at any time. (Please delete if not required.)

Should I decide not to keep the Manual/s I will return it/them to you within 30 days for a full refund.

FULL NAME .....  
(PLEASE PRINT)

ADDRESS .....

.....

.....

.....POSTCODE .....

SIGNATURE .....

I enclose cheque/PO payable to Wimborne Publishing Ltd.

Please charge my Visa/Mastercard/Amex/Diners Club/Switch Switch Issue No.....

Card No. .... Card Exp. Date .....

### ORDER FORM

Simply complete and return the order form with your payment to the following address:

Wimborne Publishing Ltd, Dept. Y10, 408 Wimborne Road East, Ferndown, Dorset BH22 9ND

We offer a 30 day MONEY BACK GUARANTEE

– if you are not happy with either Manual simply return it to us in good condition within 30 days for a full refund.

Overseas buyers do have to pay the overseas postage – see below.

### POSTAGE CHARGES

Postal Region	Price PER MANUAL	
	Surface	Air
Mainland UK	FREE	–
Scottish Highlands, UK Islands & Eire	£5.50 each	–
Europe (EU)	–	£20 each
Europe (Non-EU)	£20 each	£26 each
USA & Canada	£25 each	£33 each
Far East & Australasia	£31 each	£35 each
Rest of World	£25 each	£45 each

Please allow four working days for UK delivery.  
NOTE: Surface mail can take over 10 weeks to some parts of the world. Each Manual weighs about 4kg when packed.

esm2



## EPE TEACH-IN 2000 CD-ROM

The whole of the 12-part *Teach-In 2000* series by John Becker (published in *EPE* Nov '99 to Oct 2000) is now available on CD-ROM. Plus the *Teach-In 2000* interactive software covering all aspects of the series and Alan Winstanley's *Basic Soldering Guide* (including illustrations and Desoldering).

*Teach-In 2000* covers all the basic principles of electronics from Ohm's Law to Displays, including Op.Amps, Logic Gates etc. Each part has its own section on the interactive software where you can also change component values in the various on-screen demonstration circuits.

The series gives a hands-on approach to electronics with numerous breadboard circuits to try out, plus a simple computer interface which allows a PC to be used as a basic oscilloscope.

**ONLY £12.45** including VAT and p&p

Order code Teach-In CD-ROM

## Robotics

### INTRODUCING ROBOTICS WITH LEGO MINDSTORMS

Robert Penfold

Shows the reader how to build a variety of increasingly sophisticated computer controlled robots using the brilliant Lego Mindstorms Robotic Invention System (RIS). Initially covers fundamental building techniques and mechanics needed to construct strong and efficient robots using the various "click-together" components supplied in the basic RIS kit. Then explains in simple terms how the "brain" of the robot may be programmed on screen using a PC and "zapped" to the robot over an infra-red link. Also, shows how a more sophisticated Windows programming language such as Visual BASIC may be used to control the robots.

Details building and programming instructions provided, including numerous step-by-step photographs.

288 pages - large format **Order code BP901** £14.99

### MORE ADVANCED ROBOTICS WITH LEGO MINDSTORMS - Robert Penfold

Covers the Vision Command System

Shows the reader how to extend the capabilities of the brilliant Lego Mindstorms Robotic Invention System (RIS) by using Lego's own accessories and some simple home constructed units. You will be able to build robots that can provide you with 'waiter service' when you clap your hands, perform tricks, 'see' and avoid objects by using 'bats radar', or accurately follow a line marked on the floor. Learn to use additional types of sensors including rotation, light, temperature, sound and ultrasonic and also explore the possibilities provided by using an additional (third) motor. For the less experienced, RCX code programs accompany most of the featured robots. However, the more adventurous reader is also shown how to write programs using Microsoft's VisualBASIC running with the ActiveX control (Spirit.OCX) that is provided with the RIS kit.

Detailed building instructions are provided for the featured robots, including numerous step-by-step photographs. The designs include rover vehicles, a virtual pet, a robot arm, an 'intelligent' sweet dispenser and a colour conscious robot that will try to grab objects of a specific colour.

298 pages **Order code BP902** £14.99

### ANDROIDS, ROBOTS AND ANIMATRONS

John Lovine

Build your own working robot or android using both off-the-shelf and workshop constructed materials and devices. Computer control gives these robots and androids two types of artificial intelligence (an expert system and a neural network). A lifelike android hand can be built and programmed to function doing repetitive tasks. A fully animated robot or android can also be built and programmed to perform a wide variety of functions.

The contents include an Overview of State-of-the-Art Robots; Robotic Locomotion; Motors and Power Controllers; All Types of Sensors; Tilt; Bump; Road and Wall Detection; Light; Speech and Sound Recognition; Robotic Intelligence (Expert Type) Using a Single-Board Computer Programmed in BASIC; Robotic Intelligence (Neural Type) Using Simple Neural Networks (Insect Intelligence); Making a Lifelike Android Hand; A Computer-Controlled Robotic Insect Programmed in BASIC; Telepresence Robots With Actual Arcade and Virtual Reality Applications; A Computer-Controlled Robotic Arm; Animated Robots and Androids; Real-World Robotic Applications.

224 pages **Order code MGH1** £22.99

# DIRECT BOOK SERVICE

**NOTE: ALL PRICES INCLUDE UK POSTAGE**

The books listed have been selected by *Everyday Practical Electronics* editorial staff as being of special interest to everyone involved in electronics and computing. They are supplied by mail order to your door. Full ordering details are given on the last book page.

For a further selection of books see the next two issues of *EPE*.

## Radio

### BASIC RADIO PRINCIPLES AND TECHNOLOGY

Ian Poole

Radio technology is becoming increasingly important in today's high technology society. There are the traditional uses of radio which include broadcasting and point to point radio as well as the new technologies of satellites and cellular phones. All of these developments mean there is a growing need for radio engineers at all levels.

Assuming a basic knowledge of electronics, this book provides an easy to understand grounding in the topic.

Chapters in the book: Radio Today, Yesterday, and Tomorrow; Radio Waves and Propagation; Capacitors, Inductors, and Filters; Modulation; Receivers; Transmitters; Antenna Systems; Broadcasting; Satellites; Personal Communications; Appendix - Basic Calculations.

263 pages **Order code NE30** £15.99

### PROJECTS FOR RADIO AMATEURS AND S.W.L.S.

R. A. Penfold

This book describes a number of electronic circuits, most of which are quite simple, which can be used to enhance the performance of most short wave radio systems.

The circuits covered include: An aerial tuning unit; A simple active aerial; An add-on b.f.o. for portable sets; A wavetrap to combat signals on spurious responses; An audio notch filter; A parametric equaliser; C.W. and S.S.B. audio filters; Simple noise limiters; A speech processor; A volume expander.

Other useful circuits include a crystal oscillator, and RTTY/C.W. tone decoder, and a RTTY serial to parallel converter. A full range of interesting and useful circuits for short wave enthusiasts.

92 pages **Order code BP304** £4.45

### AN INTRODUCTION TO AMATEUR RADIO

I. D. Poole

Amateur radio is a unique and fascinating hobby which has attracted thousands of people since it began at the turn of the century. This book gives the newcomer a comprehensive and easy to understand guide through the subject so that the reader can gain the most from the hobby. It then remains an essential reference volume to be used time and again. Topics covered include the basic aspects of the hobby, such as operating procedures, jargon and setting up a station. Technical topics covered include propagation, receivers, transmitters and aerials etc.

150 pages **Order code BP257** £5.49

### SIMPLE SHORT WAVE RECEIVER CONSTRUCTION

R. A. Penfold

Short wave radio is a fascinating hobby, but one that seems to be regarded by many as an expensive pastime these days. In fact it is possible to pursue this hobby for a minimal monetary outlay if you are prepared to undertake a bit of d.i.y., and the receivers described in this book can all be built at low cost. All the sets are easy to construct, full wiring diagrams etc. are provided, and they are suitable for complete beginners. The receivers only require simple aerials, and do not need any complex alignment or other difficult setting up procedures.

The topics covered in this book include: The broadcast bands and their characteristics; The amateur bands and their characteristics; The propagation of radio signals; Simple aerials; Making an earth connection; Short wave crystal set; Simple l.r.f. receivers; Single sideband reception; Direct conversion receiver. Contains everything you need to know in order to get started in this absorbing hobby.

88 pages **Order code BP275** £4.45

# Computers and Computing

### MULTIMEDIA ON THE PC

Ian R. Sinclair

In this book, you'll find out what a CD ROM is, how it works, and why it is such a perfect add-on for a PC, allowing you to buy programmes, text, graphics and sound on a CD. It also describes the installation of a CD ROM drive and a sound card, pointing out the common problems that arise, and then shows how to use them to create a complete multimedia presentation that contains text, photos, a soundtrack with your own voice recorded as a commentary, even animation and edited video footage.

184 pages **Order code PC112** £12.95

### HOW TO BUILD YOUR OWN PC

Morris Rosenthal

More and more people are building the own PCs. They get more value for their money, they create exactly the machine they want, and the work is highly satisfying and actually fun. That is, if they have a unique beginner's guide like this one, which visually demonstrates how to construct a state-of-the-art computer from start to finish.

Through 150 crisp photographs and clear but minimal text, readers will confidently absorb the concepts of computer building. The extra-big format makes it easy to see what's going on in the pictures. For non-specialists, there's even a graphical glossary that clearly illustrates technical terms. The author goes "under the hood" and shows step-by-step how to create a socket 7 (Pentium) and non-intel chipsets) and a Slot 1 (Pentium II) computer, covering: What first-time builders need to know; How to select and purchase parts; How to assemble the PC; How to install Windows 98. The few existing books on this subject, although badly outdated, are in steady demand. This one delivers the expertise and new technology that fledgling computer builders are eagerly looking for.

224 pages - large format **Order code MGH2** £21.99

### PIC YOUR PERSONAL INTRODUCTORY COURSE

SECOND EDITION John Morton

Discover the potential of the PIC microcontroller through graded projects - this book could revolutionise your electronics construction work

A uniquely concise and practical guide to getting up and running with the PIC Microcontroller. The PIC is one of the most popular of the microcontrollers that are transforming electronic project work and product design.

Assuming no prior knowledge of microcontrollers and introducing the PIC's capabilities through simple projects, this book is ideal for use in schools and colleges. It is the ideal introduction for students, teachers, technicians and electronics enthusiasts. The step-by-step explanations make it ideal for self-study too: this is not a reference book - you start work with the PIC straight away.

The revised second edition covers the popular reprogrammable EEPROM PICs: P16C84/16F84 as well as the P54 and P71 families.

270 pages **Order code NE36** £13.99

### UNDERSTANDING PC SPECIFICATIONS

R. A. Penfold (Revised Edition)

If you require a microcomputer for business applications, or a high quality home computer, an IBM PC or compatible is often the obvious choice. They are competitively priced, and are backed up by an enormous range of applications programs, hardware add-ons, etc. The main difficulty for the uninitiated is deciding on the specification that will best suit his or her needs. PCs range from simple systems of limited capabilities up to complex systems that can happily run applications that would have been considered beyond the abilities of a microcomputer not so long ago. It would be very easy to choose a PC system that is inadequate to run your applications efficiently, or one which goes beyond your needs and consequently represents poor value for money.

This book explains PC specifications in detail, and the subjects covered include the following: Differences between types of PC (XT, AT, 80386, etc); Maths co-processors; Input devices (keyboards, mice, and digitisers); Memory, including both expanded (EMS) and extended RAM; RAM disks and disk caches; Floppy disk drive formats and compatibility; Hard disk drives (including interleave factors and access times); Display adaptors, including all standard PC types (CGA, Hercules, Super VGA, etc); Contains everything you need to know if you can't tell your EMS from your EGA!

128 pages **Order code BP282** £5.45

# Theory and Reference

## Bebop To The Boolean Boogie

By Clive (call me Max) Maxfield  
 Specially imported by EPE - Excellent value

An Unconventional Guide to Electronics Fundamentals, Components and Processes

This book gives the "big picture" of digital electronics.

This in-depth, highly readable, up-to-the-minute guide shows you how electronic devices work and how they're made. You'll discover how transistors operate, how printed circuit boards are fabricated, and what the innards of memory ICs look like. You'll also gain a working knowledge of Boolean Algebra and Karnaugh Maps, and understand what Reed-Muller logic is and how it's used. And there's much, MUCH more (including a recipe for a truly great seafood gumbó). Hundreds of carefully drawn illustrations clearly show the important points of each topic. The author's tongue-in-cheek British humor makes it a delight to read, but this is a REAL technical book, extremely detailed and accurate. A great reference for your own shelf, and also an ideal gift for a friend or family member who wants to understand what it is you do all day.

470 pgs - large format **Order code BEB1** £26.95

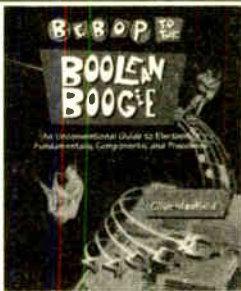

There is a 'blow-by-blow' guide to the use of EASY-PC Professional XM (a schematic drawing and printed circuit board design computer package). The guide also conducts the reader through logic circuit simulation using Pulsar software. Chapters on p.c.b. physics and p.c.b. production techniques make the book unique, and with its host of project ideas make it an ideal companion for the integrative assignment and common skills components required by BTEC and the key skills demanded by GNVQ. The principal aim of the book is to provide a straightforward approach to the understanding of digital electronics.

Those who prefer the 'Teach-In' approach or would rather experiment with some simple circuits should find the book's final chapters on printed circuit board production and project ideas especially useful.

250 pages (large format) **Order code NE28** £17.99

## ELECTRONICS MADE SIMPLE

Ian Sinclair

Assuming no prior knowledge, *Electronics Made Simple* presents an outline of modern electronics with an emphasis on understanding how systems work rather than on details of circuit diagrams and calculations. It is ideal for students on a range of courses in electronics, including GCSE, C&G and GNVQ, and for students of other subjects who will be using electronic instruments and methods.

Contents: waves and pulses, passive components, active components and ICs, linear circuits, block and circuit diagrams, how radio works, disc and tape recording, elements of TV and radar, digital signals, gating and logic circuits, counting and correcting, microprocessors, calculators and computers, miscellaneous systems.

199 pages **Order code NE23** £13.99

## SCROGGIE'S FOUNDATIONS OF WIRELESS AND ELECTRONICS - ELEVENTH EDITION

S.W. Amos and Roger Amos

Scroggie's Foundations is a classic text for anyone working with electronics, who needs to know the art and craft of the subject. It covers both the theory and practical aspects of a huge range of topics from valve and tube technology, and the application of cathode ray tubes to radar, to digital tape systems and optical recording techniques.

Since *Foundations of Wireless* was first published over 60 years ago, it has helped many thousands of readers to become familiar with the principles of radio and electronics. The original author Scroggie was succeeded by Scroggie in the 1940s, whose name became synonymous with this classic primer for practitioners and students alike. Stan Amos, one of the fathers of modern electronics and the author of many well-known books in the area, took over the revision of this book in the 1980s and it is he, with his son, who have produced this latest version.

400 pages **Order code NE27** £21.99

## GETTING THE MOST FROM YOUR MULTIMETER

R. A. Penfold

This book is primarily aimed at beginners and those of limited experience of electronics. Chapter 1 covers the basics of analogue and digital multimeters, discussing the relative merits and the limitations of the two types. In Chapter 2 various methods of component checking are described, including tests for transistors, thyristors, resistors, capacitors and diodes. Circuit testing is covered in Chapter 3, with subjects such as voltage, current and continuity checks being discussed.

In the main little or no previous knowledge or experience is assumed. Using these simple component and circuit testing techniques the reader should be able to confidently tackle servicing of most electronic projects.

96 pages **Order code BP239** £3.45

## DIGITAL GATES AND FLIP-FLOPS

Ian R. Sinclair

This book, intended for enthusiasts, students and technicians, seeks to establish a firm foundation in digital electronics by treating the topics of gates and flip-flops thoroughly and from the beginning.

Topics such as Boolean algebra and Karnaugh mapping are explained, demonstrated and used extensively, and more attention is paid to the subject of synchronous counters than to the simple but less important ripple counters.

No background other than a basic knowledge of electronics is assumed, and the more theoretical topics are explained from the beginning, as also are many working practices. The book concludes with an explanation of microprocessor techniques as applied to digital logic.

200 pages **Order code PC106** £9.95

## DIGITAL ELECTRONICS - A PRACTICAL APPROACH

With FREE Software: Number One Systems - EASY-PC

Professional XM and Pulsar (Limited Functionality)

Richard Monk

Covers binary arithmetic, Boolean algebra and logic gates, combination logic, sequential logic including the design and construction of asynchronous and synchronous circuits and register circuits. Together with a considerable practical content plus the additional attraction of its close association with computer aided design including the FREE software.

FREE SOFTWARE

NEW

## QUICK GUIDE TO ANALOGUE SYNTHESIS

Ian Waugh

Even though music production has moved into the digital domain, modern synthesizers invariably use analogue synthesis techniques. The reason is simple - analogue synthesis is flexible and versatile and it's relatively easy for us to understand. The basics are the same for all analogue synths, and you'll quickly be able to adapt the principles to any instrument, to edit existing sounds and create exciting new ones. This book describes: How analogue synthesis works; The essential modules every synthesiser has; The three steps to synthesis; How to create phat bass sounds; How to generate filter sweeps; Advanced synth modules; How to create simple and complex synth patches; Where to find soft synths on the Web.

If you want to take your synthesiser - of the hardware or software variety - past the presets, and program your own sounds and effects, this practical and well-illustrated book tells you what you need to know.

60 pages **Order code PC118** £7.45

## QUICK GUIDE TO MP3 AND DIGITAL MUSIC

Ian Waugh

MP3 files, the latest digital music format, have taken the music industry by storm. What are they? Where do you get them? How do you use them? Why have they thrown record companies into a panic? Will they make music easier to buy? And cheaper? Is this the future of music?

All these questions and more are answered in this concise and practical book which explains everything you need to know about MP3s in a simple and easy-to-understand manner. It explains:

How to play MP3s on your computer, How to use MP3s with handheld MP3 players; Where to find MP3s on the Web; How MP3s work; How to tune into Internet radio stations; How to create your own MP3s; How to record your own CDs from MP3 files; Other digital audio music formats.

Whether you want to stay bang up to date with the latest music or create your own MP3s and join the on-line digital music revolution, this book will show you how.

60 pages **Order code PC119** £7.45

## AN INTRODUCTION TO LOUDSPEAKERS AND ENCLOSURE DESIGN

V. Capel

This book explores the various features, good points and snags of speaker designs. It examines the whys and wherefores so that the reader can understand the principles involved and so make an informed choice of design, or even design loudspeaker enclosures for him- or herself. Crossover units are also explained, the various types, how they work, the distortions they produce and how to avoid them. Finally there is a step-by-step description of the construction of the *Kapellmeister* loudspeaker enclosure.

148 pages **Temporarily out of print**

## ELECTRONIC MUSIC AND MIDI PROJECTS

R. A. Penfold

Whether you wish to save money, boldly go where no musician has gone before, rekindle the pioneering spirit, or simply have fun building some electronic music gadgets, the designs featured in this book should suit your needs. The projects are all easy to build, and some are so simple that even complete beginners at electronic project construction can tackle them with ease. Stripboard layouts are provided for every project, together with a wiring diagram. The mechanical side of construction has largely been left to individual constructors to sort out, simply because the vast majority of project builders prefer to do their own thing in this respect.

None of the designs requires the use of any test equipment in order to get them set up properly. Where any setting up is required, the procedures are very straightforward, and they are described in detail.

Projects covered: Simple MIDI tester, Message grabber, Byte grabber, THRU box, MIDI auto switcher, Auto/manual switcher, Manual switcher, MIDI patchbay, MIDI controlled switcher, MIDI lead tester, Program change pedal, Improved program change pedal, Basic mixer, Stereo mixer, Electronic swell pedal, Metronome, Analogue echo unit.

124 pages **Order code PC116** £10.95

## THE INVENTOR OF STEREO - THE LIFE AND WORKS OF ALAN DOWER BLUMLEIN

Robert Charles Alexander

This book is the definitive study of the life and works of one of Britain's most important inventors who, due to a cruel set of circumstances, has all but been overlooked by history.

Alan Dower Blumlein led an extraordinary life in which his inventive output rate easily surpassed that of Edison, but whose early death during the darkest days of World War Two led to a shroud of secrecy which has covered his life and achievements ever since.

His 1931 Patent for a Binaural Recording System was so revolutionary that most of his contemporaries regarded it as more than 20 years ahead of its time. Even years after his death, the full magnitude of its detail had not been fully utilized. Among his 128 patents are the principal electronic circuits critical to the development of the world's first electronic television system. During his short working life, Blumlein produced patent after patent breaking entirely new ground in electronic and audio engineering.

During the Second World War, Alan Blumlein was deeply engaged in the very secret work of radar development and contributed enormously to the system eventually to become 'H2S' - blind-bombing radar. Tragically, during an experimental H2S flight in June 1942, the Halifax bomber in which Blumlein and several colleagues were flying, crashed and all aboard were killed. He was just days short of his thirty-ninth birthday.

420 pages **Order code NE32** £15.99

## VIDEO PROJECTS FOR THE ELECTRONICS CONSTRUCTOR

R. A. Penfold

Written by highly respected author R. A. Penfold, this book contains a collection of electronic projects specially designed for video enthusiasts. All the projects can be simply constructed, and most are suitable for the newcomer to project construction, as they are assembled on stripboard.

There are faders, wipers and effects units which will add sparkle and originality to your video recordings, an audio mixer and noise reducer to enhance your soundtracks and a basic computer control interface. Also, there's a useful selection on basic video production techniques to get you started.

Complete with explanations of how the circuit works, shopping lists of components, advice on construction, and guidance on setting up and using the projects, this invaluable book will save you a small fortune.

Circuits include: video enhancer, improved video enhancer, video fader, horizontal wiper, improved video wiper, negative video unit, fade to grey unit, black and white keyer, vertical wiper, audio mixer, stereo headphone amplifier, dynamic noise reducer, automatic fader, pushbutton fader, computer control interface, 12 volt mains power supply.

124 pages **Order code PC115** £10.95

## PC MUSIC - THE EASY GUIDE

Robin Vincent

How do I make music on my PC? Can I record music onto my PC? What's a sequencer? How can I get my PC to print a music score? What sort of a soundcard do I need? What hardware and software do I need? How do I connect a keyboard to my PC?

Just a few of the questions you've probably asked. Well, you'll find the answers to all these questions, and many more, in this book. It will show you what can be done, what it all means, and what you will need to start creating your own music on your PC. It's an easy read, it's fully illustrated and it will help you understand how a computer can be used as a creative music tool.

It covers soundcards, sequencers, hard disk digital audio recording and editing, plug-ins, printing scores with notation software, using your PC as a synthesiser, getting music onto and off the Internet, using Windows, sample PC music setups, FAQs, a glossary, advice on hardware and software, and a list of industry contacts.

116 pages **Order code PC117** £11.95

## HIGH POWER AUDIO AMPLIFIER CONSTRUCTION

R. A. Penfold

Practical construction details of how to build a number of audio power amplifiers ranging from about 50 to 300/400 watts r.m.s. includes MOSFET and bipolar transistor designs.

96 pages **Order code BP277** £4.49

# Circuits, Data and Design

## PRACTICAL ELECTRONIC FILTERS

Owen Bishop

This book deals with the subject in a non-mathematical way. It reviews the main types of filter, explaining in simple terms how each type works and how it is used.

The book also presents a dozen filter-based projects with applications in and around the home or in the constructor's workshop. These include a number of audio projects such as a rhythm sequencer and a multi-voiced electronic organ.

Concluding the book is a practical step-by-step guide to designing simple filters for a wide range of purposes, with circuit diagrams and worked examples.

88 pages **Order code BP299** **£5.49**

## ELECTRONIC HOBBYISTS DATA BOOK

R. A. Penfold

This book should tell you everything you are ever likely to want to know about hobby electronics, but did not know where to ask or refer. Comprehensive contents pages makes it easy to quickly locate the data you require.

The subjects covered include: Common circuits, and related data (including helpful graphs and tables of values); Colour codes for resistors, capacitors and inductors; Pinout details for a wide range of CMOS and TTL devices, plus basic data on the various logic families; Pinout details and basic data for a wide range of operational amplifiers; Data and leadout information for a wide range of transistors, FETs, power FETs, triacs, thyristors, diodes, etc; General data including MIDI message coding, radio data, ASCII/Baudot coding, decibel ratios, etc.

242 pages **Order code BP396** **£6.45**

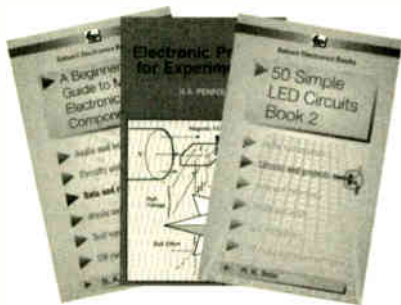

## 50 SIMPLE LED CIRCUITS

R. N. Soar

Contains 50 interesting and useful circuits and applications, covering many different branches of electronics, using one of the most inexpensive and freely available components - the light-emitting diode (LED). Also includes circuits for the 707 common anode display.

64 pages **Order code BP42** **£2.99**

## CIRCUIT SOURCE BOOK 1

A. Penfold

Written to help you create and experiment with your own electronic designs by combining and using the various standard "building block" circuits provided. Where applicable, advice on how to alter the circuit parameters is given.

The circuits covered in this book are mainly concerned with analogue signal processing and include: Audio amplifiers (op.amp and bipolar transistors); audio power amplifiers; d.c. amplifiers; highpass, lowpass, bandpass and notch filters; tone controls; voltage controlled amplifiers and filters; triggers and voltage comparators; gates and electronic switching; bargraphs; mixers; phase shifters, current mirrors, hold circuits, etc.

Over 150 circuits are provided, which it is hoped will be useful to all those involved in circuit design and application, be they professionals, students or hobbyists.

182 pages **Temporarily out of print**

## A BEGINNER'S GUIDE TO TTL DIGITAL ICs

R. A. Penfold

This book first covers the basics of simple logic circuits in general, and then progresses to specific TTL logic integrated circuits. The devices covered include gates, oscillators, timers, flip/flops, dividers, and decoder circuits. Some practical circuits are used to illustrate the use of TTL devices in the "real world".

142 pages **Order code BP332** **£5.45**

## HOW TO USE OP. AMPS

E. A. Perr

This book has been written as a designer's guide covering many operational amplifiers, serving both as a source book of circuits and a reference book for design calculations. The approach has been made as non-mathematical as possible.

160 pages **Order code BP88** **£4.49**

## CIRCUIT SOURCE BOOK 2

R. A. Penfold

This book will help you to create and experiment with your own electronic designs by combining and using the various standard "building blocks" circuits provided. Where

applicable, advice on how to alter the circuit parameters is provided.

The circuits covered are mainly concerned with signal generation, power supplies, and digital electronics.

The topics covered in this book include: 555 oscillators; sinewave oscillators; function generators; CMOS oscillators; voltage controlled oscillators; radio frequency oscillators; 555 monostables; CMOS monostables; TTL monostables; precision long timers; power supply and

regulator circuits; negative supply generators and voltage boosters; digital dividers; decoders, etc; counters and display drivers; D/A and A/D converters; opto-isolators, flip/flops, noise generators, tone decoders, etc.

Over 170 circuits are provided, which it is hoped will be useful to all those involved in circuit design and application, be they professionals, students or hobbyists.

192 pages **Order code BP322** **£5.45**

# Project Building & Testing

## ELECTRONIC PROJECTS FOR EXPERIMENTERS

R. A. Penfold

Many electronic hobbyists who have been pursuing their hobby for a number of years seem to suffer from the dreaded "seen it all before" syndrome. This book is fairly and squarely aimed at sufferers of this complaint, plus any other electronics enthusiasts who yearn to try something a bit different. No doubt many of the projects featured here have practical applications, but they are all worth a try for their interest value alone.

The subjects covered include:- Magnetic field detector, Basic Hall effect compass, Hall effect audio isolator, Voice scrambler/descrambler, Bat detector, Bat style echo location, Noise cancelling, LED stroboscopes, Infra-red "torch", Electronic breeze detector, Class D power amplifier, Strain gauge amplifier, Super hearing aid.

138 pages **Order code BP371** **£5.45**

## PRACTICAL FIBRE-OPTIC PROJECTS

R. A. Penfold

While fibre-optic cables may have potential advantages over ordinary electric cables, for the electronics enthusiast it is probably their novelty value that makes them worthy of exploration. Fibre-optic cables provide an innovative interesting alternative to electric cables, but in most cases they also represent a practical approach to the problem. This book provides a number of tried and tested circuits for projects that utilize fibre-optic cables.

The projects include:- Simple audio links, F.M. audio link, P.W.M. audio links, Simple d.c. links, P.W.M. d.c. link, P.W.M. motor speed control, RS232C data links, MIDI link, Loop alarms, R.P.M. meter.

All the components used in these designs are readily available, none of them require the constructor to take out a second mortgage.

132 pages **Order code BP374** **£5.45**

## ELECTRONIC PROJECT BUILDING FOR BEGINNERS

R. A. Penfold

This book is for complete beginners to electronic project building. It provides a complete introduction to the practical side of this fascinating hobby, including the following topics:

Component identification, and buying the right parts; resistor colour codes, capacitor value markings, etc;

advice on buying the right tools for the job; soldering; making easy work of the hard wiring; construction methods, including stripboard, custom printed circuit boards, plain matrix boards, surface mount boards and wire-wrapping; finishing off, and adding panel labels; getting "problem" projects to work, including simple methods of fault-finding.

In fact everything you need to know in order to get started in this absorbing and creative hobby.

135 pages **Order code BP392** **£5.49**

## A BEGINNER'S GUIDE TO MODERN ELECTRONIC COMPONENTS

R. A. Penfold

The purpose of this book is to provide practical information to help the reader sort out the bewildering array of components currently on offer. An advanced knowledge of the theory of electronics is not needed, and this book is not intended to be a course in electronic theory. The main aim is to explain the differences between components of the same basic type (e.g. carbon, carbon film, metal film, and wire-wound resistors) so that the right component for a given application can be selected. A wide range of components are included, with the emphasis firmly on those components that are used a great deal in projects for the home constructor.

166 pages **Temporarily out of print**

## HOW TO USE OSCILLOSCOPES AND OTHER TEST EQUIPMENT

R. A. Penfold

This book explains the basic function of an oscilloscope, gives a detailed explanation of all the standard controls, and provides advice on buying. A separate chapter deals with using an oscilloscope for fault finding on linear and logic circuits, plenty of example waveforms help to illustrate the control functions and the effects of various fault conditions. The function and use of various other pieces of test equipment are also covered, including signal generators, logic probes, logic pulsers, and crystal calibrators.

104 pages **Order code BP267** **£4.00**

## BOOK ORDERING DETAILS

All prices include UK postage. For postage to Europe (air) and the rest of the world (surface) please add £1 per book. For the rest of the world airmail add £2 per book. Send a PO, cheque, international money order (£ sterling only) made payable to **Direct Book Service** or card details, Visa, Mastercard, Amex, Diners Club or Switch - minimum card order is £5 - to:

**DIRECT BOOK SERVICE, WIMBORNE PUBLISHING LTD.,  
408 WIMBORNE ROAD EAST, FERNDOWN, DORSET BH22 9ND.**

Books are normally sent within seven days of receipt of order, but please allow 28 days for delivery - more for overseas orders. *Please check price and availability (see latest issue of Everyday Practical Electronics) before ordering from old lists.*

For a further selection of books see the next two issues of *EPE*.

Tel 01202 873872 Fax 01202 874562. E-mail: [dbs@epemag.wimborne.co.uk](mailto:dbs@epemag.wimborne.co.uk)

Order from our online shop at: [www.epemag.wimborne.co.uk/shopdoor.htm](http://www.epemag.wimborne.co.uk/shopdoor.htm)

## BOOK ORDER FORM

Full name: .....

Address: .....

.....

.....

.....

..... Post code: ..... Telephone No: .....

Signature: .....

I enclose cheque/PO payable to DIRECT BOOK SERVICE for £ .....

Please charge my card £ ..... Card expiry date: .....

Card Number ..... Switch Issue No. ....

Please send book order codes: .....

.....

Please continue on separate sheet of paper if necessary  
If you do not wish to cut your magazine, send a letter or copy of this form

# PCB SERVICE

Printed circuit boards for most recent *EPE* constructional projects are available from the PCB Service, see list. These are fabricated in glass fibre, and are fully drilled and roller tinned. All prices include VAT and postage and packing. Add £1 per board for airmail outside of Europe. Remittances should be sent to The PCB Service, *Everyday Practical Electronics*, Wimborne Publishing Ltd., 498 Wimborne Road East, Ferndown, Dorset BH22 9ND. Tel: 01202 873872; Fax 01202 874562; E-mail: [orders@epemag.wimborne.co.uk](mailto:orders@epemag.wimborne.co.uk). On-line Shop: [www.epemag.wimborne.co.uk/shopdoor.htm](http://www.epemag.wimborne.co.uk/shopdoor.htm). Cheques should be crossed and made payable to *Everyday Practical Electronics* (Payment in £ sterling only).

NOTE: While 95% of our boards are held in stock and are dispatched within seven days of receipt of order, please allow a maximum of 28 days for delivery – overseas readers allow extra if ordered by surface mail.

Back numbers or photostats of articles are available if required – see the *Back Issues* page for details.

**Please check price and availability in the latest issue.**

Boards can only be supplied on a payment with order basis.

PROJECT TITLE	Order Code	Cost
Light Alarm	FEB '99 218	£6.78
★ Wireless Monitoring System Transmitter	219+a	£9.92
Receiver	220+a	£8.56
★ PIC MIDI Sustain Pedal Software only	–	–
★ Wireless Monitoring System-2 F.M. Trans/Rec Adaptors	MAR '99 219a/220a	See Feb '99
★ Time and Date Generator	221	£7.37
Auto Cupboard Light	222	£6.36
Ironing Board Saver	APR '99 224	£5.15
Voice Record/Playback Module	225	£5.12
Mechanical Radio (pair)	226A&B	£7.40
★ Versatile Event Counter	207	£6.82
PIC Toolkit Mk2	MAY '99 227	£8.95
A.M./F.M. Radio Remote Control – Transmitter	228	£3.00
Receiver	229	£3.20
★ Musical Sundial	JUNE '99 231	£9.51
PC Audio Frequency Meter	232	£8.79
★ EPE Mood PICker	JULY '99 233	£6.78
12V Battery Tester	234	£6.72
Intruder Deterrent	235	£7.10
L.E.D. Stroboscope (Multi-project PCB)	932	£3.00
Ultrasonic Puncture Finder	ALG '99 236	£5.00
★ 8-Channel Analogue Data Logger	237	£8.88
Buffer Amplifier (Oscillators Pt 2)	238	£6.96
Magnetic Field Detective	239	£6.77
Sound Activated Switch	240	£6.53
Freezer Alarm (Multi-project PCB)	932	£3.00
Child Guard	SEPT '99 241	£7.51
Variable Dual Power Supply	242	£7.64
Micro Power Supply	OCT '99 243	£3.50
★ Interior Lamp Delay	244	£7.88
Mains Cable Locator (Multi-project PCB)	932	£3.00
Vibralarm	NOV '99 230	£6.93
Demister One-Shot	245	£6.78
★ Ginormous Stopwatch – Part 1	246	£7.82
★ Ginormous Stopwatch – Part 2	DEC '99 247	£7.85
Giant Display	248	£3.96
Serial Port Converter	249	£4.44
Loft Guard	250	£4.83
Scratch Blanker	JAN '00 932	£3.00
Flashing Snowman (Multi-project PCB)	251	£5.63
★ Video Cleaner	252	£4.20
Find It	253	£4.52
★ Teach-In 2000 – Part 4	MAR '00 254, 255	£5.49
High Performance Regenerative Receiver	256	Set
★ EPE Icebreaker – PCB257, programmed PIC16F877 and floppy disc	Set only	£22.99
Parking Warning System	258	£5.08
★ Micro-PICscope	APR '00 259	£4.99
Garage Link – Transmitter	261	Set
Receiver	262	£5.87
Versatile Mic/Audio Pre-amplifier	MAY '00 260	£3.33
PIR Light Checker	263	£3.17
★ Multi-Channel Transmission System – Transmitter	264	Set
Receiver	265	£6.34
Interface	266	–
★ Canute Tide Predictor	JUNE '00 267	£3.05
★ PIC-Gen Frequency Generator/Counter	JULY '00 268	£5.07
g-Meter	269	£4.36
★ EPE Moodloop	AUG '00 271	£5.47
Quiz Game Indicator	272	£4.52
Handy-Amp	273	£4.52
Active Ferrite Loop Aerial	SEPT '00 274	£4.67
★ Remote Control IR Decoder Software only	–	–
★ PIC Dual-Channel Virtual Scope	OCT '00 275	£5.15
Handclap Switch	NOV '00 270	£3.96
★ PIC Pulsometer Software only	–	–
Twinkling Star	DEC '00 276	£4.28
Festive Fader	277	£5.71
Motorists' Buzz-Box	278	£5.39
★ PICtogram	279	£4.91
★ PIC-Monitored Dual PSU-1 PSU	280	£4.75
Monitor Unit	281	£5.23
Static Field Detector (Multi-project PCB)	932	£3.00
Two-Way Intercom	JAN '01 282	£4.76
UFO Detector and Event Recorder	283	Set
Magnetic Anomaly Detector	284	£6.19
Event Recorder	285	–
Audio Alarm	–	–
★ Using PICs and Keypads Software only	–	–

PROJECT TITLE	Order Code	Cost
Ice Alarm	FEB '01 287	£4.60
★ Graphics L.C.D. Display with PICs (Supp)	288	£5.23
Using the LM3914-6 L.E.D. Bargraph Drivers	289	} Set £7.14
Multi-purpose Main p.c.b.	290	
Relay Control L.E.D. Display	291	
★ PC Audio Power Meter Software only	–	–
Doorbell Extender: Transmitter	MAR '01 292	£4.20
Receiver	293	£4.60
Trans/Remote	294	£4.28
Rec./Relay	295	£4.92
EPE Snug-bug Heat Control for Pets	APR '01 296	£6.50
Intruder Alarm Control Panel	297	£6.97
Main Board	298	£4.76
External Bell Unit	299	£6.34
Camcorder Mixer	MAY '01 300	£5.07
★ PIC Graphics L.C.D. Scope	301	£5.14
Hosepipe Controller	JUNE '01 302	£4.91
Magfield Monitor (Sensor Board)	303	£4.36
Dummy PIR Detector	–	–
★ PIC16F87x Extended Memory Software only	–	–
Stereo/Surround Sound Amplifier	JULY '01 304	£4.75
Perpetual Projects Uniboard-1	305	£3.00
Solar-Powered Power Supply & Voltage Reg.	306	£4.75
MSF Signal Repeater and Indicator	307	£4.44
Repeater Board	308	£5.39
Meter Board	309	£4.99
★ PIC to Printer Interface	AUG '01 310	£5.07
Lead/Acid Battery Charger	311	£6.50
Shortwave Loop Aerial	312	£4.36
★ Digitimer – Main Board	–	–
– R.F. Board	–	–
Perpetual Projects Uniboard-2	SEPT '01 305	£3.00
L.E.D. Flasher – Double Door-Buzzer	305	£3.00
Perpetual Projects Uniboard-3	305	£3.00
Loop Burglar Alarm, Touch-Switch Door-Light and Solar-Powered Rain Alarm	313	} Set £6.10
L.E.D. Super Torches – Red Main	314	
– Display Red	315	
– White L.E.D.	316	£5.94
★ Sync Clock Driver	317	£4.91
★ Water Monitor	318	£5.94
Camcorder Power Supply	OCT '01 319	£8.24
PIC Toolkit Mk3	305	£3.00
Perpetual Projects Uniboard-4	305	£3.00
Gate Sentinel, Solar-powered Bird Scarer and Solar-Powered Register	305	£3.00

## EPE SOFTWARE

Software programs for *EPE* projects marked with an asterisk \* are available on 3.5 inch PC-compatible disks or free from our Internet site. The following disks are available: *PIC Tutorial* (Mar-May '98 issues); *PIC Toolkit Mk2 V2.4d* (May-Jun '99 issues); *EPE Disk 1* (Apr '95-Dec '98 issues); *EPE Disk 2* (Jan-Dec '99); *EPE Disk 3* (Jan-Dec '00); *EPE Disk 4* (Jan '01 issue to current cover date); *EPE Teach-In 2000*; *EPE Interface Disk 1* (October '00 issue to current cover date). The disks are obtainable from the *EPE PCB Service* at £3.00 each (UK) to cover our admin costs (the software itself is free). Overseas (each): £3.50 surface mail, £4.95 each airmail. All files can be downloaded free from our Internet FTP site: <http://ftp.epemag.wimborne.co.uk>.

## EPE PRINTED CIRCUIT BOARD SERVICE

Order Code Project Quantity Price

Name .....

Address .....

Tel. No. ....

I enclose payment of £..... (cheque/PO in £ sterling only) to:



Everyday  
Practical Electronics

MasterCard, Amex, Diners  
Club, Visa or Switch



Minimum order for cards £5 Switch Issue No. ....

Card No. ....

Signature..... Card Exp. Date.....

NOTE: You can also order p.c.b.s by phone, Fax, E-mail or via our Internet site on a secure server:

<http://www.epemag.wimborne.co.uk/shopdoor.htm>

Everyday Practical Electronics reaches twice as many UK readers as any other UK monthly hobby electronics magazine, our audited sales figures prove it. We have been the leading monthly magazine in this market for the last sixteen years.

If you want your advertisements to be seen by the largest readership at the most economical price our classified and semi-display pages offer the best value. The prepaid rate for semi-display space is £8 (+VAT) per single column centimetre (minimum 2.5cm). The prepaid rate for classified adverts is 30p (+VAT) per word (minimum 12 words).

All cheques, postal orders, etc., to be made payable to Everyday Practical Electronics. VAT must be added. Advertisements, together with remittance, should be sent to Everyday Practical Electronics Advertisements, Mill Lodge, Mill Lane, Thorpe-le-Soken, Essex CO16 0ED. Phone/Fax (01255) 861161.

For rates and information on display and classified advertising please contact our Advertisement Manager, Peter Mew as above.

Valve Output Transformers: Single ended 50mA, £4.50; push/pull 50W, £38; 100W, £53. Mains Transformers: Sec 220V 30mA 6V 1A, £3; 250V 60mA 6V 2A, £5; 250V 80mA 6V 2A, £6. High Voltage Caps: 50µF 350V, 68µF 500V, 150µF 385V, 330µF 400V, 470µF 385V, all £3 ea., 32+32µF 450V £5, 4µF 800V oil filled paper block, £10. Postage extra.  
Record Decks and Spares: BSR, Garrard, Goldring, motors, arms, wheels, headshells, spindles, etc. Send or phone your want list for quote.

**RADIO COMPONENT SPECIALISTS**

**337 WHITEHORSE ROAD, CROYDON SURREY, CR0 2HG. Tel: (020) 8634 1666**  
Lots of transformers, high volt caps, valves, output transformers, speakers, in stock. Phone or send your wants list for quote.

**Z88 NOW AVAILABLE WITH 128K AND 512K - OZ4**

**ALSO SPECTRUM AND QL PARTS**

**W. N. RICHARDSON & CO.**  
PHONE/FAX 01494 871319

E-mail: [wnr@compuserve.com](mailto:wnr@compuserve.com)  
RAVENSMEAD, CHALFONT ST PETER, BUCKS. SL9 0NB

**TIS - Midlinbank Farm Ryeland, Strathaven ML10 6RD**  
*Manuals on anything electronic*

Circuits - VCR £8, CTV £6  
Service Manuals from £10  
Repair Manuals from £5  
P&P any order £2.50

Write, or ring 01357 440280 for full details of our lending service and FREE quote for any data

**BTEC ELECTRONICS TECHNICIAN TRAINING**

VCE ADVANCED ENGINEERING ELECTRONICS AND ICT  
HNC AND HND ELECTRONICS  
NVQ ENGINEERING AND IT  
Next course commences SEPTEMBER 2001  
FULL PROSPECTUS FROM

**LONDON ELECTRONICS COLLEGE**  
(Dept EPE) 20 PENYERN ROAD EARLS COURT, LONDON SW5 9SU  
TEL: (020) 7373 8721

**LASERS**

High power Red Diode Lasers  
Green DPSS Laser Modules  
Holographic Optical Effects  
Scanning Systems and Target Mirrors  
Call now for an information pack and price list  
telephone: 01795 439913 or visit  
[www.laservisuals.com/components](http://www.laservisuals.com/components)

**2002 CATALOGUE**

PLEASE SEND SAE FOR A FREE COPY TO:

**FML ELECTRONICS**

FREEPOST NEA 3627 BEDALE  
NORTH YORKSHIRE, DL8 2BR  
TEL: 01677 425840

SUPPLIERS OF ELECTRONIC COMPONENTS AND EPE KITS

**X-10® Home Automation**  
*We put you in control™*

Why tolerate when you can automate?

An extensive range of 230V X-10 products and starter kits available. Uses proven Power Line Carrier technology, no wires required.

Products Catalogue available Online.

Worldwide delivery.

**Laser Business Systems Ltd.**



E-Mail: [info@laser.com](mailto:info@laser.com)  
<http://www.laser.com>  
Tel: (020) 8441 9788  
Fax: (020) 8449 0430



**Test Equipment**



Service Manuals.

Contact

[www.cooke-int.com](http://www.cooke-int.com)

Tel: +44 01243 55 55 90

**THE BRITISH AMATEUR ELECTRONICS CLUB**

exists to help electronics enthusiasts by personal contact and through a quarterly Newsletter.

For membership details, write to the Secretary:

**Mr. M. P. Moses,**  
5 Park View, Cwmaman,  
Aberdare CF44 6PP

Space donated by  
*Everyday Practical Electronics*

EDUCATIONAL ELECTRONIC KITS, GCSE, Physics, Hobbyist. 2 x 1st class stamps for catalogue. Electroteach, PO Box 2594, Cannock, WS12 4YH.

[www.electroteach.com](http://www.electroteach.com).

**Miscellaneous**

C-PAK	£1	NO VAT
Hi-Bri 5mm red l.e.d. x10	L.E.D. Gromets	x10
4/8MHz Xtals	PN2222	x10
1N4007	SMD components also	
10/22/100µ 16V	x20 available	
TLO72	x2 P&P all orders £1	

Full list from:  
**LECTRO AGENCIES**  
4 VICTORIA ROAD, ADDESTONE, SURREY KT15 2PL  
TEL/FAX 01932 846344  
E-mail: [keyelectronics@lafira.com](mailto:keyelectronics@lafira.com)

**PRINTED CIRCUIT BOARDS - QUICK SERVICE.** Prototype and production artwork raised from magazines or draft designs at low cost. PCBs designed from schematics. Production assembly, wiring and software programming. For details contact Patrick at Agar Circuits, Unit 5, East Belfast Enterprise Park, 308 Alberbridge Road, Belfast, BT5 4GX. Phone 028 9073 8897, Fax 028 9073 1802. E-mail [agar@argonet.co.uk](mailto:agar@argonet.co.uk).

**FREE PROTOTYPE PRINTED CIRCUIT BOARDS!** Free prototype p.c.b. with quantity orders. Call Patrick on 028 9073 8897 for details. Agar Circuits, Unit 5, East Belfast Enterprise Park, 308 Alberbridge Road, Belfast BT5 4GX.

**G.C.S.E. ELECTRONICS KITS,** at pocket money prices. S.A.E. for FREE catalogue. SIR-KIT Electronics, 52 Severn Road, Clacton, CO15 3RB, <http://www.geocities.com/sirkituk/index.htm>.

**VALVES AND ALLIED COMPONENTS IN STOCK** - please ring for free list. Valve equipment repaired. Geoff Davies (Radio). Phone 01788 574774.

**SUPER COMPONENT PARCEL** can contain l.e.d.s, i.c.s, pots, boards etc. Offer £5.40 + £1.45 postage. Apogee PC games compilation CD. £4.95. PC accessories etc. Agents wanted. S.a.e. lists. TM Industries, 2 The Square, Skillington, Grantham NG33 5HB.

**BUILD A SHORTWAVE RECEIVER!** Fascinating projects from £8.50. No soldering required, full materials and instructions. Free catalogue for s.a.e.: QRP, 27 Amberley Street, W. Yorkshire BD3 8QZ.

**CHEAP SURPLUS!!** From coin-op games machines - buy complete machines or individual components. For full list send s.a.e. to: Mr J. Cordran, Kirkleigh, Vicarage Road, Minehead TA24 5RP.

**EPE NET ADDRESSES**

EPE FTP site: <http://ftp.epemag.wimborne.co.uk>

Access the FTP site by typing the above into your web browser, or by setting up an FTP session using appropriate FTP software, then go into quoted sub-directories:

PIC-project source code files: **/pub/PICS**

PIC projects each have their own folder; navigate to the correct folder and open it, then fetch all the files contained within. *Do not try to download the folder itself!*

EPE text files: **/pub/docs**

Basic Soldering Guide: **solder.txt**

Ingenuity Unlimited submission guidance: **ing\_unlt.txt**

New readers and subscribers info: **epe\_info.txt**

Newsletters or Usenet users advice: **usenet.txt**

Ni-Cad discussion: **nicadfaq.zip** and **nicad2.zip**

Writing for EPE advice: **write4us.txt**

You can also enter the FTP site via the link at the top of the main page of our home site at: <http://www.epemag.wimborne.co.uk>

Shop now on-line: [www.epemag.wimborne.co.uk/shopdoor.htm](http://www.epemag.wimborne.co.uk/shopdoor.htm)

Ensure you set your FTP software to ASCII transfer when fetching text files, or they may be unreadable.

Note that any file which ends in .zip needs unzipping before use. Unzip utilities can be downloaded from:

<http://www.winzip.com> or  
<http://www.pkware.com>



## TRAIN TODAY FOR A BETTER FUTURE

Now you can get the skills and qualifications you need for career success with an ICS Home Study Course. Learn in the comfort of your own home at the pace and times that suit you. ICS is the world's largest, most experienced home study school. Over the past 100 years ICS have helped nearly 10 million people to improve their job prospects. Find out how we can help YOU. Post or phone today for FREE INFORMATION on the course of your choice

Electrical Contracting & Installation  
Electrical Engineering  
C&S/ICS Basic Electronic Engineering  
C&S/ICS Basic Mechanical Engineering  
TV and Video Servicing  
Radio and Hi-Fi Servicing  
Refrigeration Heating & Air Conditioning  
Motorcycle Maintenance

**FREephone 0500 581 557**

Or write to: International Correspondence Schools, FREEPOST 882, 8 Elliot Place, Cityway Skypark, Glasgow, G3 8BR. Tel: 0500 581 557 or Tel/Fax: Dublin 285 2533.

Please send me my Free Information on your Electronics Courses.

Mr/Mrs/Ms/Miss (BLOCK CAPITALS PLEASE) \_\_\_\_\_ Date of Birth / /

Address \_\_\_\_\_

Postcode \_\_\_\_\_

Occupation \_\_\_\_\_ Tel. No. \_\_\_\_\_

From time to time, we permit other carefully screened organisations to write to you about products and services. If you would prefer not to hear from such organisations please tick box  Dept. ZEEVC111



MANUFACTURER OF HI-FI AUDIO MODULES AND TOROIDAL TRANSFORMERS SINCE 1971

CONTACT US NOW FOR A FREE CATALOGUE

**ILP DIRECT LTD.**

SPONG LANE, ELMSTED, ASHFORD, KENT TN25 5JU  
TEL +44 1233 750481 FAX +44 1233 750578

VISA



## Bowood Electronics Ltd

Suppliers of Electronic Components

Batteries, Buzzers, Capacitors, Connectors, Diodes, Cases, Ferrites, Fuses, Heatshrink, ICs, Inverters, L.E.D.s, P.C.B., Potentiometers, Power Supplies, Presets, Rectifiers, Relays, Resistors, Soldering Equipment, Stripboard, Switches, Test Meters, Thermistors, Thyristors, Tools, Transistors, Triacs...

Catalogue available **NOW**

Send 41p stamp or visit our website

Website: <http://www.bowood-electronics.co.uk>  
sales@bowood-electronics.co.uk



Mail Order Only

7 Bakewell Road, Baslow, Derbyshire, DE45 1RE, UK  
Telephone/Fax: 01246 583777

## Crotech POWER Value for Money

• European Design  
• IEC 1010-1 & CE

• >50K units sold  
• Prices that Please

### ZEBRA

DC Lab Supplies  
(With Two 3Digit DPM's)

ZS3202	0-32V / 0-2A	£ 93/-
ZS3203	0-32V / 0-3A	£ 112/-
ZS3205	0-32V / 0-5A	£ 136/-
ZT3203	0-32V / 0-3A	
	0-32V / 0-2A	£ 232/-
	5V/3A	
ZT3205	0-32V / 0-5A	
	0-32V / 0-5A	£ 323/-
	5V/3A	

### 1KW

DC Lab Supplies  
3U High 19" Rack Adaptable  
(With Two 3Digit DPM's)

L1650	0-16V / 0-50A	£ 645/-
L3220	0-32V / 0-20A	£ 593/-
L3230	0-32V / 0-30A	£ 904/-
L6410	0-64V / 0-10A	£ 645/-
L6415	0-64V / 0-15A	£ 1122/-
L1285	0-128V / 0-5A	£ 818/-
L1288	0-128V / 0-8A	£ 1232/-

Prices are excluding VAT & Delivery Custom Units Available on Request

Crotech Instruments Ltd.  
Unit A1, Faraday Road, Newbury, Berks, RG14 2AD  
Tel: 01635 550789 Email: sales@crotech.co.uk

[www.crotech.co.uk](http://www.crotech.co.uk)

Area Distributors Wanted

We stock thousands of products - send now for our FREE catalogue. Telephone, fax, email or write today!

## Specialist Mail Order Supplier Of Electronic Components

Power Supplies • Surplus Bargains  
Electronic Components & Equipment  
Tools • Valve Radio Kits • Etc

Delivered direct from our new warehouse and distribution facility in Brentwood, Essex

48 pages filled with useful tools, electronic kits, books, hardware, batteries, etc, etc

Visit our website: [www.greenweld.co.uk](http://www.greenweld.co.uk)



GREENWELD

Greenweld Limited  
Unit 24 Horndon Industrial Park  
West Horndon Brentwood  
Essex - CM13 3XD  
Tel: 01277 811042 Fax: 01277 812419  
Email: [service@greenweld.co.uk](mailto:service@greenweld.co.uk)

Office Hours: Monday - Friday 08.00 to 17.00

## N. R. BARDWELL LTD (Est. 1948)

100	Signal Diodes 1N4148	£1.00	80	Asstd capacitors electrolytic	£1.00
75	Rectifier Diodes 1N4001	£1.00	80	Asstd. capacitors 1nF to 1µF	£1.00
50	Rectifier Diodes 1N4007	£1.00	200	Asstd. disc ceramic capacitors	£1.00
10	W01 Bndge Rectifiers	£1.00	50	Asstd. Skel Presets (sm, stand, cermet)	£1.00
10	555 Timer IC's	£1.00	50	Asstd. RF chokes (inductors)	£1.00
4	741 Op Amps	£1.00	50	Asstd. grommets	£1.00
50	Assorted Zener Diodes 400mW	£1.00	80	Asstd. solder tags p/conn's, terminals	£1.00
12	Assorted 7-segment Displays	£1.00	10	Asstd. crystals - plug in	£1.00
25	5mm l.e.d.s. red, green or yellow	£1.00	8	Asstd. di switches	£1.00
75	5mm l.e.d.s. green, 6.5mm legs	£1.00	20	Miniature slide switches sp/co	£1.00
50	Axial l.e.d.s. 2mcd red Diode Package	£1.00	100	Asstd beads (ceramic, teflon, fish spine)	£1.00
25	Asstd. High Brightness l.e.d.s. var cols	£1.00	80	Asstd. small stand offs, Uthroughs etc	£1.00
20	BC182L Transistors	£1.00	30	Asstd. di sockets up to 40 way	£1.00
25	BC212L Transistors	£1.00	10	TV coax plugs, plastic	£1.00
30	BC237 Transistors	£1.00	40	metres very thin connecting wire, red	£1.00
20	BC327 Transistors	£1.00	20	1in. glass reed switches	£1.00
30	BC328 Transistors	£1.00	100	Any one value 1/4W 5% cf resistors range	£0.45
30	BC347 Transistors	£1.00	1R to 10M		£0.45
20	BC547B Transistor	£1.00	10	7812 Voltage Regulators	£1.00
30	BC548 Transistors	£1.00			
30	BC549 Transistors	£1.00			
25	BC557 Transistors	£1.00			
30	BC558 Transistors	£1.00			
30	BC559 Transistors	£1.00			
20	2N3904 Transistors	£1.00			
100	1nf 50V wkg Axial Capacitors	£1.00			
100	4N7 50V wkg Axial Capacitors	£1.00			

288 Abbeydale Road, Sheffield S7 1FL  
Phone: 0114 255 2886 ★ Fax: 0114 255 5039  
e-mail: [sales@bardwells.co.uk](mailto:sales@bardwells.co.uk) ★ Web: [www.bardwells.co.uk](http://www.bardwells.co.uk)  
Prices include VAT. Postage £1.65  
44p stamp for lists or disk



## DIGITAL TEST METER

Built-in transistor test socket and diode test position.  
DC volts 200mV to 1000V.  
AC volts 200V to 750V.  
DC current 200mA to 10A.  
Resistance 200 ohms to 2000K ohms.

**£5.99** incl. VAT

**FREE 240-page  
colour catalogue**

Great value for Speakers, Microphones, Headphones, Aerials, Transmitters, TV Amps, Plugs, Sockets, Leads, CD Storage Cases, CCTV, Security, Connectors, Adaptors, Switch Boxes, Gadgets, Disco Lighting & Effects, Mixers, Amplifiers, Turntables, Musicians' Leads, Car Audio, Test Equipment, Hobby Kits, Computer Leads & Accessories, Power Supplies, Inverters, Transformers, Battery Chargers, Tools, Soldering, Switches, Fuses, Indicators, Cable & Wire, Crossovers, Speaker Hardware, PA Amps, and a great deal more... all for the price of a stamp.

**SKY ELECTRONICS**  
Tel: 020 8450 0995  
Fax: 020 8208 1441

## Sky Electronics

40-42 Cricklewood Broadway London NW2 3ET  
Tel: 020 8450 0995 Fax: 020 8208 1441  
[www.skyelectronics.co.uk](http://www.skyelectronics.co.uk)

The Catalogue is FREE to callers or send stamps to the value of £1.85 to cover postage.

# ELECTRONICS 2001

## COVERT VIDEO CAMERAS

Black and White Pin Hole Board Cameras with Audio. Cameras in P.I.R., Radios, Clocks, Briefcases etc. Transmitting Cameras with Receiver (Wireless). Cameras as above with colour. Audio Surveillance Kits and Ready Built Units, Bug Detector etc.

### A.L. ELECTRONICS

Please phone **0181 203 6008** for free catalogue.  
Fax **0181 201 5359**

E-mail: [surveillance@btclick.com](mailto:surveillance@btclick.com) [www.uspy.com](http://www.uspy.com)

New DTI approved Video Transmitters and Receivers (Wireless)

Major credit cards now taken

## ADVERTISERS INDEX

A.L. ELECTRONICS	748
ANTEX	696
N. R. BARDWELL	747
BITZ TECHNOLOGY	712
B.K. ELECTRONICS	Cover (iii)/705
BOWOOD ELECTRONICS	747
BRUNNING SOFTWARE	683
BULL ELECTRICAL	Cover (ii)
CHEVET SUPPLIES	682
CIRCUIT CELLAR	725
CRICKLEWOOD ELECTRONICS	682
CROTECH INSTRUMENTS	747
CROWNHILL ASSOCIATES	709
DISPLAY ELECTRONICS	678
EPTSOFT	Cover (iv)
ESR ELECTRONIC COMPONENTS	686
GREENWELD	747
ICS	747
ILP DIRECT	747
J&N FACTORS	694
JPG ELECTRONICS	682
LABCENTER	697
MAGENTA ELECTRONICS	684/685
MILFORD INSTRUMENTS	713
NATIONAL COLLEGE OF TECHNOLOGY	727
PICO TECHNOLOGY	720
QUASAR ELECTRONICS	680/681
SERVICE TRADING CO	682
SHERWOOD ELECTRONICS	748
SKY ELECTRONICS	748
SOLID STATE ELECTRONICS (UK)	747
SQUIRES	727
STEWART OF READING	723

**ADVERTISEMENT MANAGER: PETER J. MEW**

**ADVERTISEMENT OFFICES:**

EVERYDAY PRACTICAL ELECTRONICS, ADVERTISEMENTS,  
MILL LODGE, MILL LANE, THORPE-LE-SOKEN,  
ESSEX CO16 0ED.

Phone/Fax: (01255) 861161

For Editorial address and phone numbers see page 687

## SHERWOOD ELECTRONICS

### FREE COMPONENTS

Buy 10 x £1 Special Packs and choose another one FREE

SP1	15 x 5mm Red LEDs	SP133	20 x 1N4004 diodes
SP2	12 x 5mm Green LEDs	SP134	15 x 1N4007 diodes
SP3	12 x 5mm Yellow LEDs	SP136	3 x BFY50 transistors
SP6	15 x 3mm Red LEDs	SP137	4 x W005 1.5A bridge rectifiers
SP7	12 x 3mm Green LEDs	SP138	20 x 2-2/63V radial elect. caps.
SP8	10 x 3mm Yellow LEDs	SP140	3 x W04 1.5A bridge rectifiers
SP10	100 x 1N4148 diodes	SP142	2 x CMOS 4017
SP11	30 x 1N4001 diodes	SP143	5 Pairs min. crocodile clips (Red & Black)
SP12	30 x 1N4002 diodes	SP145	6 x ZTX300 transistors
SP20	20 x BC184 transistors	SP146	10 x 2N3704 transistors
SP21	20 x BC212 transistors	SP147	5 x Stripboard 9 strips x 25 holes
SP23	20 x BC549 transistors	SP151	4 x 8mm Red LEDs
SP24	4 x CMOS 4001	SP152	4 x 8mm Green LEDs
SP25	4 x 555 timers	SP153	4 x 8mm Yellow LEDs
SP26	4 x 741 Op.Amps	SP154	15 x BC548 transistors
SP28	4 x CMOS 4011	SP155	3 x Stripboard, 14 strips x 27 holes
SP29	3 x CMOS 4013	SP160	10 x 2N3904 transistors
SP31	4 x CMOS 4071	SP161	10 x 2N3906 transistors
SP36	25 x 10/25V radial elect. caps.	SP165	2 x LF351 Op.Amps
SP37	15 x 100/35V radial elect. caps.	SP166	20 x 1N4003 diodes
SP39	10 x 470/16V radial elect. caps.	SP167	6 x BC107 transistors
SP40	15 x BC237 transistors	SP168	6 x BC108 transistors
SP41	20 x Mixed transistors	SP172	4 x Standard slide switches
SP42	200 x Mixed 0.25W C.F. resistors	SP175	20 x 1/63V radial elect. caps.
SP47	5 x Min. PB switches	SP177	10 x 1A 20mm quick blow fuses
SP102	20 x 8-pin DIL sockets	SP182	20 x 4-7/63V radial elect. caps.
SP103	15 x 14-pin DIL sockets	SP183	20 x BC547 transistors
SP104	15 x 16-pin DIL sockets	SP187	15 x BC239 transistors
SP105	4 x 74LS00	SP191	3 x CMOS 4023
SP109	15 x BC557 transistors	SP192	3 x CMOS 4066
SP111	12 x Assorted polyester caps	SP193	20 x BC213 transistors
SP112	4 x CMOS 4093	SP195	3 x 10mm Yellow LEDs
SP115	3 x 10mm Red LEDs	SP197	6 x 20 pin DIL sockets
SP116	3 x 10mm Green LEDs	SP198	5 x 24 pin DIL sockets
SP118	2 x CMOS 4047	SP199	5 x 2.5mm mono jack plugs
SP120	3 x 74LS93		
SP124	20 x Assorted ceramic disc caps		
SP130	100 x Mixed 0.5W C.F. resistors		
SP131	2 x TL071 Op.Amps		

**2001 Catalogue now available £1 inc. P&P or FREE with first order. P&P £1.25 per order. NO VAT**

Orders to:

**Sherwood Electronics,  
7 Williamson St., Mansfield,  
Notts. NG19 6TD.**

<b>RESISTOR PACKS - C.Film</b>		
RP3	5 each value - total 365 0.25W	£2.95
RP7	10 each value - total 730 0.25W	£4.20
RP10	1000 popular values 0.25W	£5.95
RP4	5 each value-total 365 0.5W	£3.90
RP8	10 each value-total 730 0.5W	£6.55
RP11	1000 popular values 0.5W	£8.25

Published on approximately the second Thursday of each month by Wimborne Publishing Ltd., 408 Wimborne Road East, Ferndown, Dorset BH22 9ND. Printed in England by Apple Web Offset Ltd., Warrington, WA1 4RW. Distributed by COMAG Magazine Marketing, Tavistock Rd., West Drayton, UB7 7QE. Subscriptions INLAND: £15 (6 months); £28.50 (12 months); £52 (2 years). OVERSEAS: Standard air service: £8 (6 months); £34.50 (12 months); £64 (2 years). Express airmail: £27 (6 months); £52 (12 months); £99 (2 years). Payments payable to "Everyday Practical Electronics". Subs Dept, Wimborne Publishing Ltd. E-mail: [subs@epemag.wimborne.co.uk](mailto:subs@epemag.wimborne.co.uk). EVERYDAY PRACTICAL ELECTRONICS is sold subject to the following conditions, namely that it shall not, without the written consent of the Publishers first having been given, be lent, resold, hired out or otherwise disposed of by way of Trade at more than the recommended selling price shown on the cover, and that it shall not be lent, resold, hired out or otherwise disposed of in a mutilated condition or in any unauthorised cover by way of Trade or affixed to or as part of any publication or advertising, literary or pictorial matter whatsoever.



# POWER AMPLIFIER MODULES-LOUDSPEAKERS-MIXERS 19 INCH STEREO AMPLIFIERS-ACTIVE CROSS/OVERS.

\* PRICES INCLUDE V.A.T.  
\* PROMPT DELIVERY

## OMP MOS-FET POWER AMPLIFIERS HIGH POWER, TWO CHANNEL 19 INCH RACK

10,000's  
SOLD  
TO PRO  
USERS



### THE RENOWNED MXF SERIES OF POWER AMPLIFIERS

FOUR MODELS:- MXF200 (100W + 100W) MXF400 (200W + 200W)  
MXF600 (300W + 300W) MXF900 (450W + 450W)

ALL POWER RATINGS ARE R.M.S. INTO 4 OHMS, WITH BOTH CHANNELS DRIVEN.  
FEATURES:- \* Independent power supplies with two toroidal transformers  
\* Twin L.E.D. Vu Meters \* Level controls \* Illuminated on/off switch \* Jack / XLR inputs  
\* Speakon Outputs \* Standard 775mv inputs \* Open and Short circuit proof \* Latest Mos-Fets  
for stress free delivery into virtually any load \* High slew rate \* Very low distortion \* Aluminium  
cases \* MXF600 & MXF900 fan cooled with D.C. Loudspeaker and thermal protection.

USED THE WORLD OVER IN CLUBS, PUBS, CINEMAS, DISCOS ETC

SIZES:-  
MXF200 W19" D11" H3 7/8" (2U)  
MXF400 W19" D12" H5 1/2" (3U)  
MXF600 W19" D13" H5 1/2" (3U)  
MXF900 W19" D14" H5 1/2" (3U)

PRICES:- MXF200 £175.00 MXF400 £233.85  
MXF600 £329.00 MXF900 £449.15  
SPECIALIST CARRIER DEL £12.50 Each

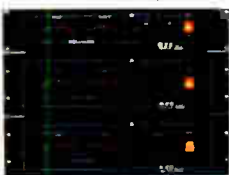

## OMP X03-S STEREO 3 WAY ACTIVE CROSSOVER SWITCHABLE 2-WAY



### FEATURES:-

Advanced 3-Way Stereo Active Cross-Over (Switchable two way), housed in a 19" x 1U case. Each channel has three level controls: Bass, Mid & Top. The removable front fascia allows access to the programmable DIL switches to adjust the cross-over frequency: There are two versions available: X03-S Bass-Mid 125/250/500Hz, Mid-Top 1.8/3/5kHz, all at 24 dB per octave. X03 Bass-Mid 250/500/800Hz, Mid-Top 1.8/3/5kHz, all at 24 dB per Octave. Please make sure you ask for the correct model when ordering. The 2/3 way selector switches are also accessed by removing the front fascia. Each stereo channel can be configured separately. Bass Invert Switches are incorporated on each channel. Nominal 775mV input/output. Fully compatible with the OMP Rack Amplifier and Modules.

BOTH MODELS PRICED AT :- £117.44 + £5.00 P&P

## TEST AND MEASUREMENT Kenwood CS-4125 20MHz Oscilloscope



Inheriting the design concept of the higher-version models the CS-4100 series 2-channel oscilloscopes provide excellent performance for general purpose applications. They feature high quality components ensuring long term reliability, plus relay attenuators which minimise the need for re-calibration. The CS-4100 Series with excellent cost efficiency were designed to meet the needs of engineers over the widest range of applications. CS-4125 Price : £351.33 Free Delivery

## Kenwood FGE-1202 Programmable function generator

The FGE-1202 is a microprocessor controlled programmable function generator providing a full featured, accurate generator in compact low cost instrument. The design incorporates an LED back lit 16x2 LCD giving clear easily read characters. The main output has wave-shapes of sine, square, triangle and DC. The output frequency is continuously displayed along with the current edit parameters. As standard an RS-232 interface allowing remote control via a computer. Output has offset, amplitude and symmetry control. An external input allows for external sweep and modulation (AM and FM). Internal sweep is also provided with a sweep rate of 20mS to 20Seconds with sweep mode on and off.



FGE-1202  
Price : £280.83  
Free Delivery

For full specifications and more equipment view our web site at [www.bkelec.com](http://www.bkelec.com) and press the Test & Measurement button

## 100 WATT ACTIVE SUB BASS AMPLIFIER PANEL



AN ACTIVE SUB BASS AMPLIFIER WITH A TRUE 100W RMS OUTPUT. SUPERB CONSTRUCTION WITH THE FACILITIES TO INTEGRATE SEAMLESSLY INTO MOST HI-FI OR HOME CINEMA SETUPS. USE THIS PANEL PLUS ONE OF OUR LOUDSPEAKERS TO MAKE YOUR OWN SUB WOOFER THAT WILL MATCH OR BEAT MOST COMMERCIALLY AVAILABLE SUB WOOFERS.

FEATURES:- \* 100W RMS INTO 8 OHMS \* HIGH AND LOW LEVEL INPUTS \* TOROIDAL TRANSFORMER \* SHORT CIRCUIT PROTECTION \* D.C. SPEAKER PROTECTION \* FREQUENCY ROLL OFF, LOWER 10Hz, UPPER 60Hz TO 240Hz (FULLY ADJUSTABLE) \* AC3 COMPATIBLE FILTER CAN BE BYPASSED FOR 5-1 FORMATS. \* AIRTIGHT CONSTRUCTION \* TENS OF THOUSANDS OF OUR PANELS ALREADY IN USE. \* COMPLETE WITH LEADS

SPECIFICATIONS:- POWER 100W RMS @ 8 OHMS \* FREQ RESP. 10Hz 15KHz  
-3dB \* DAMPING FACTOR >200 \* DISTORTION 0.05% \* S/N A WEIGHTED  
>100dB \* SUPPLY 230V A.C. \* WEIGHT 2.7Kg \* SIZE H254 X W254 X D94mm

THERE ARE 2 VERSIONS OF THE ABOVE PANEL AVAILABLE :-BSB100/8  
8 OHM VERSION BSB100/4 4 OHM VERSION BOTH PANELS ARE PRICED AT  
£117.44 + £5.00 P&P INCL. V.A.T

## FLIGHTCASED LOUDSPEAKERS

A new range of quality loudspeakers, designed to take advantage of latest loudspeaker technology and enclosure designs. All models utilise high quality studio cast aluminium loudspeakers with factory fitted grilles, wide dispersion constant directivity horns, extruded aluminium corner protection and steel ball corners, complimented with heavy duty black covering. The enclosures are fitted as standard with top hats for optional loudspeaker stands. The FC15-300 incorporates a large 16 X 6 inch horn. All cabinets are fitted with the latest Speakon connectors for your convenience and safety. Five models to choose from.

WEDGE MONITOR



PLEASE NOTE POWER RATINGS QUOTED ARE IN WATTS R.M.S FOR EACH INDIVIDUAL CABINET ALL ENCLOSURES ARE 8 OHMS

15-15 Inch speaker  
12-12 Inch speaker

ibl FC15-300 WATTS Freq Range 35Hz-20kHz, Sens 101dB, Size H695 W502 D415mm  
Price:- £299.00 per pair  
ibl FC12-300 WATTS Freq Range 45Hz-20kHz, Sens 96dB, Size H600 W405 D300mm  
Price:- £249.00 per pair  
ibl FC12-200 WATTS Freq Range 40Hz-20kHz, Sens 97dB, Size H600 W405 D300mm  
Price:- £199.00 per pair  
ibl FC12-100 WATTS Freq Range 45Hz-20kHz, Sens 100dB, Size H546 W380 D300mm  
Price:- £179.00 per pair  
WM12-200 WATTS Freq Range 40Hz-20kHz, Sens 97dB, Size H418 W600 D385mm  
Price:- £125.00 Each

SPECIALIST CARRIER DEL:- £12.50 per pair, wedge monitor £7.00 each

Optional Metal Stands PRICE:- £49.00 per pair Delivery:- £6.00

## 10 INCH AND 12 INCH 100W RMS SUB BASS LOUDSPEAKERS

TWO SUPERB SUB WOOFER LOUDSPEAKER DRIVERS TO ACCOMPANY OUR SUB BASS AMPLIFIER PANEL BE OW. BOTH DRIVERS OFFER GOOD BASS RESPONSE AT A REASONABLE COST. THE BSB12-100 HAS BEEN USED FOR MANY YEARS IN AN AWARD WINNING SUB BASS SYSTEM

FOR TH/SM SPECIFICATIONS VIEW OUR WEB SITE AT <http://www.bkelec.com>

12 INCH LOUDSPEAKER	BSB12-100	10 INCH LOUDSPEAKER	BSB10-100
POWER	100W	POWER	100W
IMPEDANCE	8 OHMS	IMPEDANCE	8 OHMS
SENSITIVITY	90dB	SENSITIVITY	89dB
WEIGHT	3.0Kg	WEIGHT	2.3Kg
PRICE	£24.95	PRICE	£19.99
CARRIAGE	£5.00	CARRIAGE	£5.00

## OMP MOS-FET POWER AMPLIFIER MODULES

SUPPLIED READY BUILT AND TESTED

These modules now enjoy a world-wide reputation for quality, reliability and performance at a realistic price. Four models are available to suit the needs of the professional and hobby market i.e. Industry, Leisure, Instrumental and Hi-Fi etc. When comparing prices, NOTE that all models include toroidal power supply, integral heatsink, glass fibre P.C.B. and drive circuits to power a compatible Vu meter. All models are open and short circuit proof

### THOUSANDS OF MODULES PURCHASED BY PROFESSIONAL USERS



OMP/MF 100 Mos-Fet Output Power 110 watts R.M.S. into 4 ohms, frequency response 1Hz - 100kHz -3dB, Damping Factor >300, Slew Rate 45V/uS, T.H.D. typical 0.002%, Input Sensitivity 500mV, S.N.R. 110dB, Size 300 x 123 x 60mm. Price:- £42.85 + £4.00 P&P



OMP/MF 200 Mos-Fet Output Power 200 watts R.M.S. into 4 ohms, frequency response 1Hz - 100kHz -3dB, Damping Factor >300, Slew Rate 50V/uS, T.H.D. typical 0.001%, Input Sensitivity 500mV, S.N.R. 110dB, Size 300 x 155 x 100mm. Price:- £66.35 + £4.00 P&P



OMP/MF 300 Mos-Fet Output Power 300 watts R.M.S. into 4 ohms, frequency response 1Hz - 100kHz -3dB, Damping Factor >300, Slew Rate 60V/uS, T.H.D. typical 0.001%, Input Sensitivity 500mV, S.N.R. 110dB, Size 330 x 175 x 100mm. Price:- £83.75 + £5.00 P&P



OMP/MF 450 Mos-Fet Output Power 450 watts R.M.S. into 4 ohms, frequency response 1Hz - 100kHz -3dB, Damping Factor >300, Slew Rate 75V/uS, T.H.D. typical 0.001%, Input Sensitivity 500mV, S.N.R. 110dB, Fan Cooled, D.C. Loudspeaker Protection, 2 Second Anti Thump Delay, Size 385 x 210 x 105mm. Price:- £135.85 + £6.00 P&P



OMP/MF 1000 Mos-Fet Output Power 1000 watts R.M.S. into 2 ohms, frequency response 1Hz - 100kHz -3dB, Damping Factor >300, Slew Rate 75V/uS, T.H.D. typical 0.001%, Input Sensitivity 500mV, S.N.R. 110dB, Fan Cooled, D.C. Loudspeaker Protection, 2 Second Anti Thump Delay, Size 422 x 300 x 125mm. Price:- £261.00 + £12.00 P&P

NOTE: MOS-FET MODULES ARE AVAILABLE IN TWO VERSIONS: STANDARD - INPUT SENS 500mV, BANDWIDTH 100kHz OR PEC (PROFESSIONAL EQUIPMENT COMPATIBLE) - INPUT SENS 775mV, BANDWIDTH 50kHz ORDER STANDARD OR PEC



DELIVERY CHARGES:- PLEASE INCLUDE AS ABOVE TO A MAXIMUM AMOUNT £30.00. OFFICIAL ORDERS FROM SCHOOL, COLLEGES, GOVT., PLCs ETC. PRICES INCLUSIVE OF V.A.T. SALES COUNTER. CREDIT CARD ORDERS ACCEPTED BY POST PHONE OR FAX.



# B.K. ELECTRONICS

UNIT 1 COMET WAY, SOUTHEND-ON-SEA,  
ESSEX. SS2 6TR.

TEL.: 01702-527572 FAX.: 01702-420243  
Web:- <http://www.bkelec.com> E-Mail [sales@bkelec.com](mailto:sales@bkelec.com)

REF D4

# 'Electronics and Computing Principles V7'

## '95, '98, NT or 2000 Principles V7'

Interested in PIC microcontrollers, this is the software for you!

**Look what's NEW!**

**FREE TRIAL VERSIONS ELECTRONICS, COMPUTING AND MATHS SOFTWARE FOR EVALUATION BEFORE YOU BUY. Also existing software updates.**

[www.eptsoft.com](http://www.eptsoft.com)

Visit [www.eptsoft.com](http://www.eptsoft.com) or telephone for full details, including a description by Robert Penfold.

Electronics and Computing Principles V7 comprises more than a thousand main topics, covering AC and DC theory, Transistors, Op-Amps, Electrical, Digital techniques, Micro processors and Mathematics. PLUS: Components and Equipment Picture dictionary, SAQ's, Electronics toolbox etc. and more...

Also included is an enormous amount of interactive technical information about PIC micro controllers and the full instruction set.

Schools, colleges and industry use V7 alongside their own programmers enabling students and engineers to play with ALL the Byte, Bit and Literal instructions to explore their effect. V7 is listed on the Microchip university web site as a training resource for PICs.

FREE programming software to accompany EPV7 is available from the Microchip web site. Details provided.

Personal user £99.95 +VAT  
Education\* £299.95 +VAT  
(\* Includes unlimited multi-user site licence.)

For beginners our PIC topics start with an interactive introduction to the PIC program structure and basic operation with a summary of the complete instruction set and code examples.

PIC16F84 Architecture is shown whereby a context sensitive description of its action is displayed. Every PIC operation is discussed (even the more advanced are explained). Just as it occurs inside a PIC, we show it in colour on the screen.

PIC16C71 A/D functions are given the same treatment, along with a full explanation of the A/D conversion process, even the calculations.

A visually attractive set of Windows designed to help you quickly and easily get started in the development of your own PIC programs.

More than 80 PIC topics and it's still only a tiny part of the complete V7 package.

eptsoft limited, Pump House, Lockram Lane, Witham, Essex, UK. CM8 2BJ.  
Tel: +44 (0)1376 514008. Fax: +44 (0)870 0509660. Email: [info@eptsoft.com](mailto:info@eptsoft.com).  
Switch, Delta, Visa and MasterCard accepted.  
No additional postage or airmail charges.