

TO BE COMPLETED IN 40 WEEKLY PARTS

NEWNES PRACTICAL ELECTRICAL ENGINEERING

PRACTICAL E

IN THIS PART

MOTOR CAR
IGNITION SYSTEMS

INSTALLATION OF
SURFACE WIRING
SYSTEMS

VARNISHES, OILS
AND RESINS

ILLUMINATION OF
FLATS AND HOTELS

ELECTRICAL
ACCESSORIES FOR
CARS

FURTHER NOTES ON
ELECTRIC LIFTS

1 1/2

PART
31

A PRACTICAL WORK WRITTEN BY EXPERTS

Indispensable to every Electrical
Engineer, Designer and Manufacturer

THE
**ELECTRICAL ENGINEER'S
DATA BOOKS**

General Editor: E. B. WEDMORE, M.I.E.E.

(The Director of the British Electrical and Allied Industries Research Association.)

This important reference work contains much valuable new data that has hitherto been concealed in the journals of foreign institutions, in the unadvertised publications of research associations and the technical publications of manufacturers.

"The Electrical Engineer's Data Books" provide, in two handy volumes, a collection of all the most recent specialised knowledge, thus forging the necessary link between the scientist, the research worker and the practical engineer.

The detailed nature of the text and the wealth of original illustrations, tables and formulæ make this work indispensable to every Electrical Engineer, Designer and Manufacturer.

VOLUME I.—Lighting; Switchgear; Power Transmission and Distribution; Distribution by Underground Cable; Transmission by Overhead Lines; Traction; Electrical Machinery.

VOLUME II.—Insulation; Magnetic Materials and Testing; Properties of Metals and Alloys; Measurement of Resistance, Inductance and Capacity; Corona Discharge.

APPENDICES.—Mathematical and Miscellaneous Tables, List of Integrals, Electrical, Mechanical and Physical Tables, etc.; Electricity and Magnetism; Wiring Rules; Home Office and Board of Trade Regulations, etc.

**EXAMINE THE WORK IN YOUR
OWN HOME FREE!**

In order to give you an opportunity of examining this invaluable work at your leisure, the Publishers are prepared to supply the two volumes on Five Days' Free Approval. Send p.c. to-day for full particulars and details of the generous deferred payment system, to: Dept. E.E.31, The Home Library Book Co., 23-24, Tavistock Street, London, W.C.2

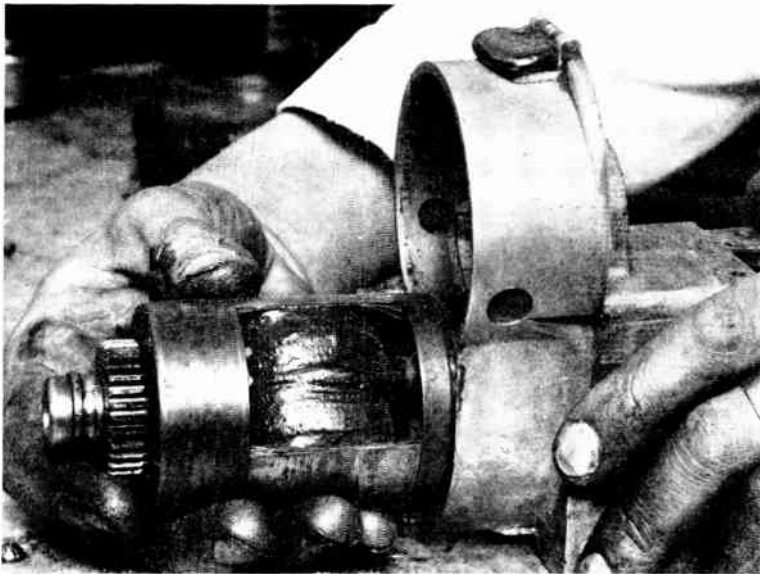

Fig. 9.—WITHDRAWING THE ARMATURE OF A MAGNETO.

This is done after removing the end plate and slow speed gear wheel. When the magnet is removed, a soft-iron keeper should be placed across it to prevent demagnetisation.

working through into the distributor.

Inspecting the Contact Breakers.

The distributor cap is held in place by two spring clips, and when these are pushed aside the cap can be removed for the inspection of the contact breaker. The electrodes in the cap and on the rotor should be kept clean and free from deposit, and the exterior of the moulding cleaned. The points of the contact breaker should be free from grease, oil or other deposit, and should make level contact with each other.

Adjustment of the gap between the points when fully opened should be made when necessary and the gap set to the gauge supplied by the manufacturers, which is usually between .075 in. and .020 in. in thickness. For distributors having double-arm contact breakers it is important to adjust the two gaps to give exactly the same opening. The sparking plugs should be cleaned at regular intervals and the gap between the electrodes set in accordance with the manufacturers' instructions, the usual distance for coil

ignition being between .020 in. and .025 in. High tension cables should be kept clean and free from oil and must be renewed when the rubber shows signs of cracking or perishing.

COIL IGNITION SYSTEM FAULTS.

The faults that may arise in a coil ignition system may be tabulated as follows:—

Low Tension Circuit.

Breakdowns in the low tension circuit which may be due to—

(1) Battery completely discharged. This can quickly be determined by switching on the lights, which will give only a dim glow or show no light.

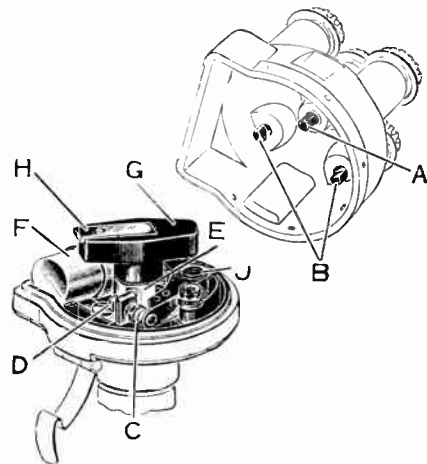

Fig. 10.—TYPICAL DISTRIBUTOR AND CONTACT BREAKER.

A, brush; B, electrodes; C, contacts; D, locking nut; E, rotating cam; F, condenser; G, rotating distributor arm; H, metal electrodes; J, contact breaker pivot.

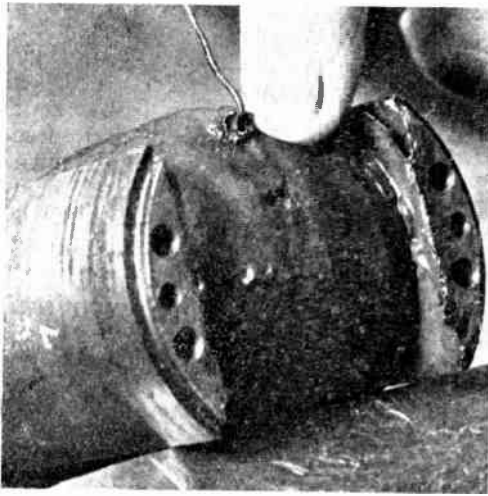

Fig. 11.—A BURNT-OUT ARMATURE.
Note the hole through to the core.

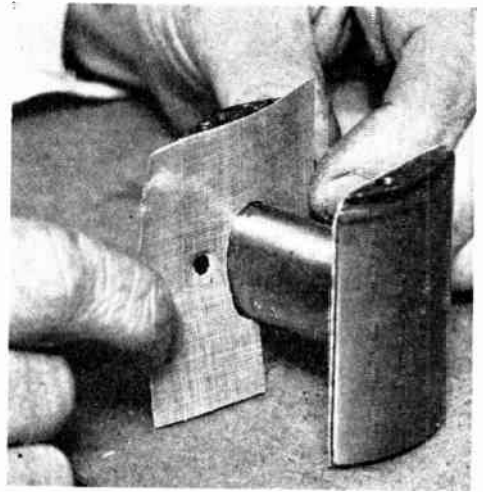

Fig. 12.—REASSEMBLING A MAGNETO.
Showing insulation for armature core.

(2) Broken connection between battery and ignition switch, ignition switch and coil or coil and contact breaker.

(3) Loose contact at battery, ignition switch, coil or contact breaker.

(4) Bad earth contact at battery or distributor.

(5) Bad contact on ignition switch.

(6) Defective contact breaker points due to oil, dirt, pitting or misadjustment.

(7) Throwing of contact lever owing to weak spring.

(8) Heel of contact breaker arm unduly worn, preventing contacts from opening.

(9) Defective condenser.

(4) Faulty electrodes in distributor cap.
(5) Local shorts on cap owing to oil, dirt or cracks.

(6) Terminals of H.T. leads from distributor cap failing to make contact with the electrodes.

(7) Defective H.T. leads.

(8) H.T. leads disconnected from plugs.

(9) Plugs ineffective owing to condensation, soot, oil, cracked insulator, loose gland nut or burnt electrodes.

High Tension Circuit.

Breakdowns in the high tension circuit which may be due to—

(1) Faulty rotor electrode in distributor.

(2) Bad contact between spring or electrode and centre carbon in distributor cap.

(3) Broken or over-worn carbon contact.

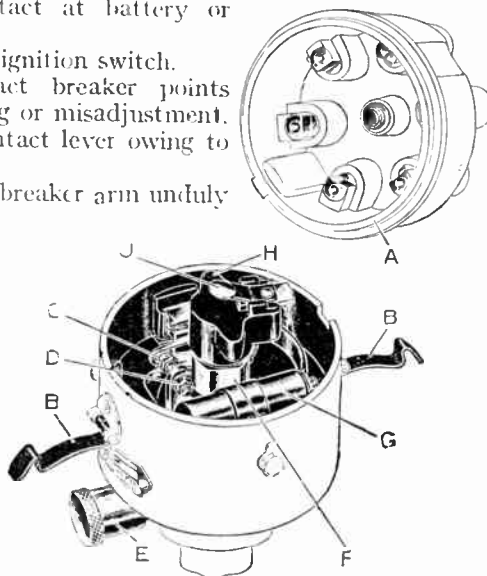

Fig. 13.—ANOTHER TYPE OF DISTRIBUTOR AND CONTACT BREAKER.

A, distributor moulding; B, securing springs for moulding; C, contacts; D, locking nut; E, greaser; F, rotating cam; G, condenser; H, rotating distributor arm; J, spring contact.

To increase the effectiveness of the coil ignition system under high speed conditions, a duplex system has been developed which employs two low-tension inductances combined with a common transformer and a single H.T. distributor. Two contact breakers are used and are operated alternately.



Fig. 14.—REASSEMBLING A MAGNETO.
Showing joint between primary and secondary winding.

THE MAGNETO IGNITION SYSTEM.

The primary circuit of a magneto is made up of a permanent magnet field system in conjunction with a primary winding on the armature, this winding being connected in series with a contact breaker which has a condenser connected across the breaker points. An ignition switch, which is "open" in the on position and earthed in the off position, completes the primary circuit components. The secondary circuit consists of a secondary winding on the armature connected to the centre contact arm of a distributor head, and leads from the distributor terminals to the sparking plugs.

Main Types of Magneto.

There are three main types of magneto, viz. :—

- (1) The rotating armature type.
- (2) The polar inductor type.
- (3) The rotating magnet type.

All three function in a similar manner but have different characteristics.

The Rotating Armature Type.

The rotating armature type has a Π magnet frame of cobalt or tungsten steel fixed to a cast aluminium body. The name is self-explanatory to any electrical engineer.

The Contact Breaker.

The contact breaker for this type of magnet differs from the coil ignition type in that the cam is stationary and the contact breaker plate revolves with the rocker arm and contact stud. A fibre heel on the rocker arm is pressed against the stationary cam and opens the contacts twice in each revolution.

Internal Circuit.

The internal circuit of the magneto has the following path: The primary and secondary windings on the armature are connected at one end to the core, the other end of the primary being connected to the insulated side of the condenser and also to the insulated contact of the contact breaker via the centre screw. The primary circuit is completed by "earth" connection between the core and the rocker arm of the contact breaker. By connecting the centre screw to earth by way of a carbon contact in the contact breaker cap

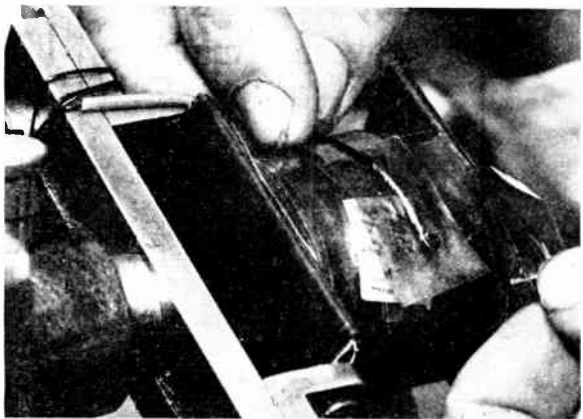

Fig. 15.—REASSEMBLING A MAGNETO.
Connecting high tension lead to secondary winding.

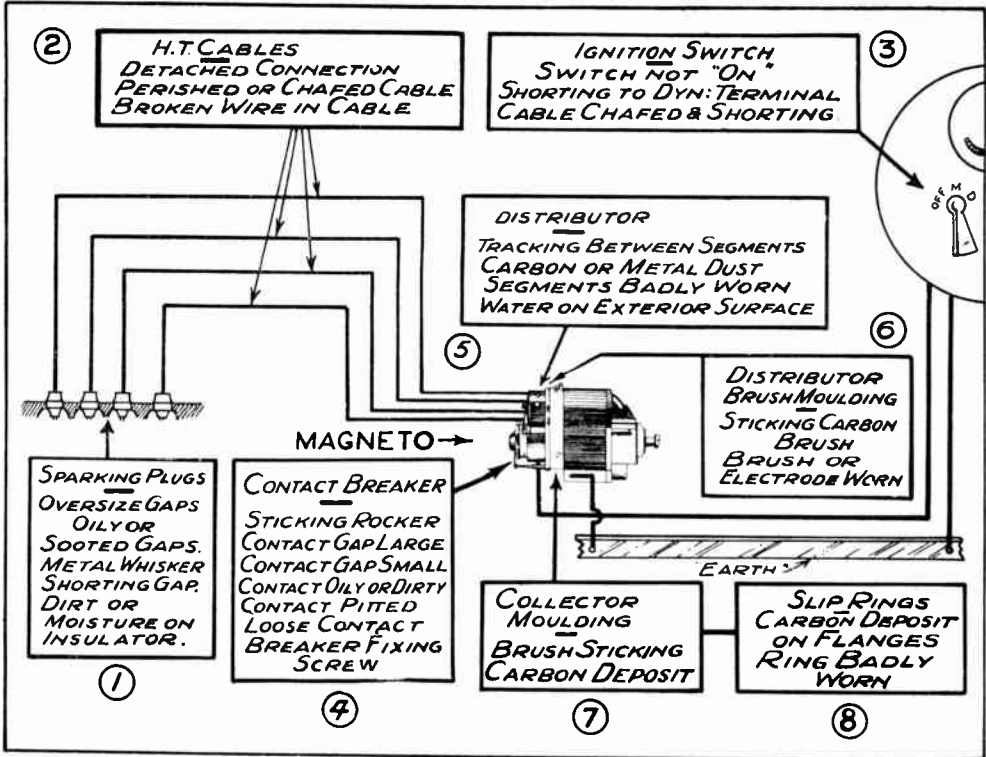

Fig. 16.—WHERE TO LOOK FOR TROUBLE IN A MAGNETO IGNITION SYSTEM. (Pictorial diagram.) See also Fig. 17.

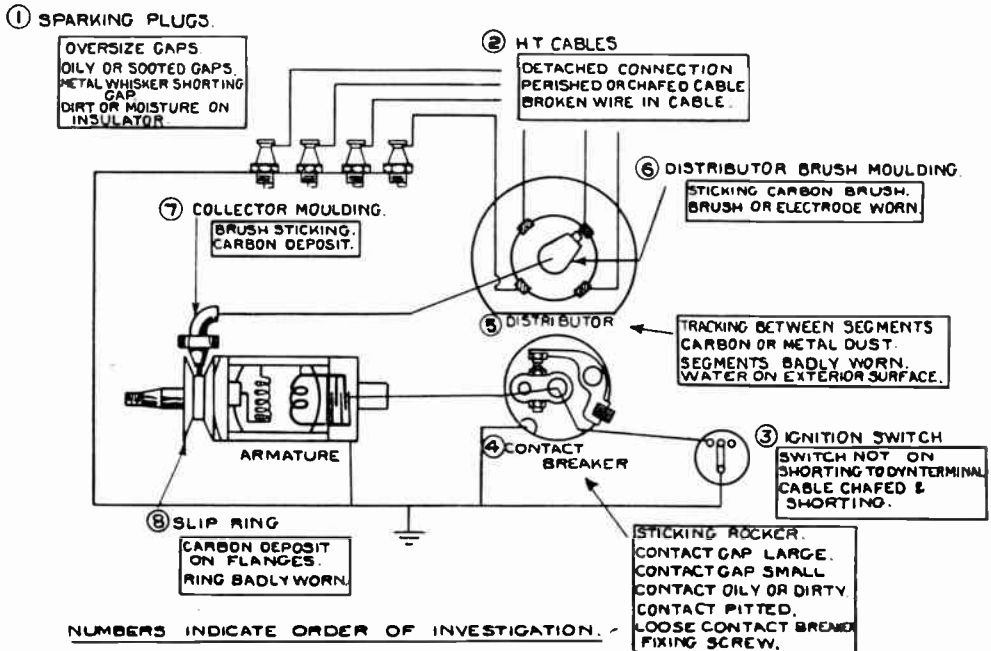

Fig. 17.—WHERE TO LOOK FOR TROUBLE IN A MAGNETO IGNITION SYSTEM. (Technical diagram.) To be studied in conjunction with Fig. 16.

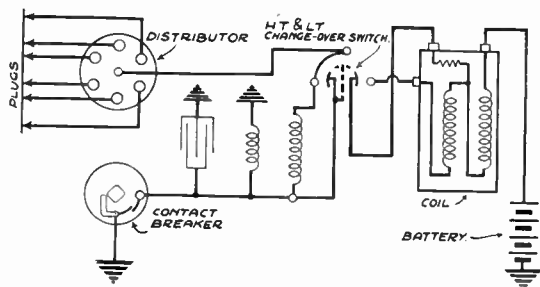

Fig. 18.—Connections for Dual-Ignition System with Polar-Inductor Magnet.

and a cable lead to the earthed side of the ignition switch, the primary circuit becomes a closed circuit and the breaker is inoperative until the ignition switch is opened. The end of the secondary winding remote from the core is connected to the slip ring. The secondary circuit then continues through the carbon pick-up to the contacts in the distributor head and to the sparking plugs. *The rotating armature gives two magnetic flux reversals per revolution and is thus capable of giving two sparks per revolution.* The contacts of the contact breaker are arranged to open when the induced voltage is at a maximum, and this occurs when the core of the H armature is a few degrees beyond the vertical in the direction of rotation. The armature must be driven at a definite ratio to the engine speed.

Magneto Driving Speeds.

As there are two sparks per revolution, the speed must be half-engine speed for a two-cylinder engine, engine speed for a four-cylinder and one-and-half-engine speed for a six cylinder engine, assuming the engines are all of the four-cycle type. The distributor rotor must revolve at half-engine speed so that the gear ratio between the armature and the rotor for two, four or six-cylinder engines will be 1-1, 2-1 and 3-1 respectively. The rotating armature type of magneto is suitable for high speed one or two-cylinder engines, and slow and medium speed four and six-cylinder engines.

For high speed multi-cylinder requirements, the magneto has to be driven at such high speeds that frequent break-

downs may occur, although this type of magneto operates successfully up to 6,000 r.p.m. of the armature.

The Polar Inductor Type.

The development of the polar inductor type of magneto has met the requirements of six, eight and other multi-cylinder high speed engines. The chief advantage of this type is that it can be constructed to give four sparks per revolution and consequently halve the speed required from a two-spark type magneto.

Magnetos for Aeroplane Engines.

For aeroplane engines having a large number of cylinders this factor is particularly useful, and the robust construction of the polar-inductor machine meets the necessities of its application to this class of engine. Rectangular cobalt steel magnets are fitted, one at either side of the frame and making good surface contact with the laminated poles at each end. The rotor has a straight-through shaft of nickel steel, and on this are mounted the soft iron inductors. The laminated armature core is cast in the frame above the rotor recess, and on this the stationary armature is mounted. The primary winding is connected to the core and to the contact breaker, and the secondary winding to the distributor rotor arm without the interposition of a slip ring. The condenser is connected across the contact breaker points and is housed alongside the armature above the rotor. The distributor head is exactly the same as for the moving armature type, but the contact breaker follows the same design as on coil ignition sets.

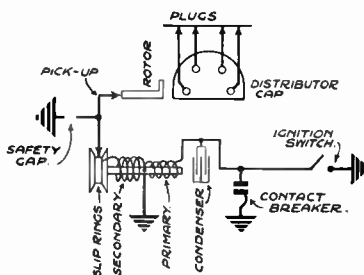

Fig. 19.—Connections for Rotating Armature Magneto.

The Rotating Magnet Type.

The rotating magnet magneto is similar in construction to the polar inductor type, except that the permanent magnet is in cylindrical form and is mounted over pole laminations fixed between two end plates on the rotor shaft. This magnet revolves between laminated poles cast in with the frame. Magnetos of this pattern built within the standard dimensions are made to give two sparks per revolution and therefore run at the same speeds as the rotating armature type for engines having the same number of cylinders. Automatic timing of magnetos may be effected by a mechanical device interposed between the engine and the magneto. The device is centrifugal in action and advances the timing of the magneto as engine speed increases.

The Impulse Starter.

Another device which is useful in assisting in starting heavy engines as used on large commercial vehicles is the impulse starter. This apparatus is cylindrical in shape and is fixed to the drive end of the magneto. It is a helical spring device having one main member fixed to the magneto spindle and coupled to the other member, which is attached to the driving spindle, by means of a helical spring. On turning the engine the spring is wound up and then suddenly released by means of a pawl and ratchet action, causing the magneto armature to be turned quickly so as to produce an intense spark which should be sufficient to start the engine. The pawl is thrown out of engagement by centrifugal force at a low speed and the two parts then rotate as a single unit.

MAINTENANCE OF MAGNETO IGNITION SYSTEM.

The maintenance of a magneto is

exactly similar to that required for coil ignition in regard to the plugs, H.T. leads, distributor head and contact breaker. The contact breaker points are set to give a gap between .012 in. to .015 in., and the interval between the plug electrodes at .018 in. to .020 in. Magnetos with rotating armatures require to have the slip ring cleaned periodically and the pick-up inspected to see that the carbon brushes move freely in their holders. The contact breaker can be withdrawn from the taper fitting on the shaft, after removing the contact breaker cover, by unscrewing the centre screw. The contact breaker engages with a key on the shaft, and when replacing the unit care must be taken to re-engage the key with the keyway in the contact breaker. The ball bearings on which the spindle is mounted should be lubricated with a few drops of oil every 1,000 miles or so.

FAULTS IN MAGNETO IGNITION SYSTEMS.

The faults that may occur in a magneto ignition system are as described for coil ignition, with the addition of possible wear and breakage of the carbon brushes on the pick-up. On some cars dual ignition systems are fitted and employ a complete coil ignition equipment connected to one set of plugs and a magneto connected to another set, either system being applied by operation of the ignition switch. Another method employs a combination of the two systems, consisting of an ignition coil, a distributor with contact breaker and a H.T. generator. Only one set of plugs is required and the coil and generator circuits are made alternately by means of a combined I.T. and H.T. change-over switch.

THE INSTALLATION OF A SURFACE WIRING SYSTEM

By T. LINSTEAD

IN the old days the words surface wiring brought to mind several varying methods of fixing conductors from one point to another; for example, "capping and casing" in its day was considered to be the outstanding method. With the advent of more stringent rules from the insurance companies and I.E.E., this gradually gave place to systems more in conformity with their rules, such as lead-covered cable having conductors only, and lead-covered cable having conductors and a bonding wire.

Materials are Now Standard.

These materials as manufactured by various firms, employed different types of fittings, and it was possible to discriminate between one system and another and to describe the erection of one system, still leaving doubt as to the method to be employed for another. The march of progress however, has tended towards standardisation and these materials and fittings in the majority are manufactured in accordance with rules and stipulations laid down by a body known as the Cable Makers' Association and while one

maker's product may differ from another in slight details it is possible by reason of this standardisation to interchange.

There are three distinct surface wiring systems which stand out as having peculiar differences.

Lead Covered System.

The first is the common lead covered cable method of which there are scores of varieties, but all employing the same principle of sheathing the conductors in a lead casing and gaining electrical continuity of such casing either through the casing itself or by means of a bonding wire incorporated between the casing and conductors during its construction.

Rubber Covered System.

The second system consists of conductors insulated from each other and sheathed with cab tyre rubber. In this system the absence of metal casing dispenses with the necessity of continuity.

Concentric System.

The third system is somewhat different in its nature in that the conductors

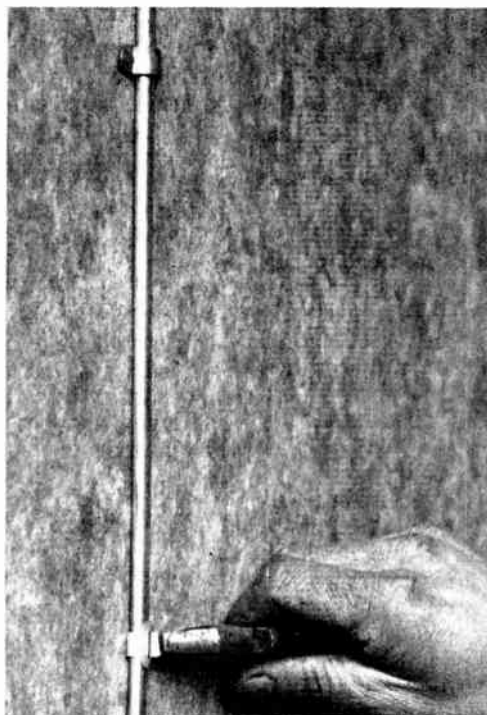

Fig. 1.—Two TYPES OF CLIPS FOR HOLDING SINGLE CABLES.

In the bottom one the tag is folded through a loop and turned backwards.

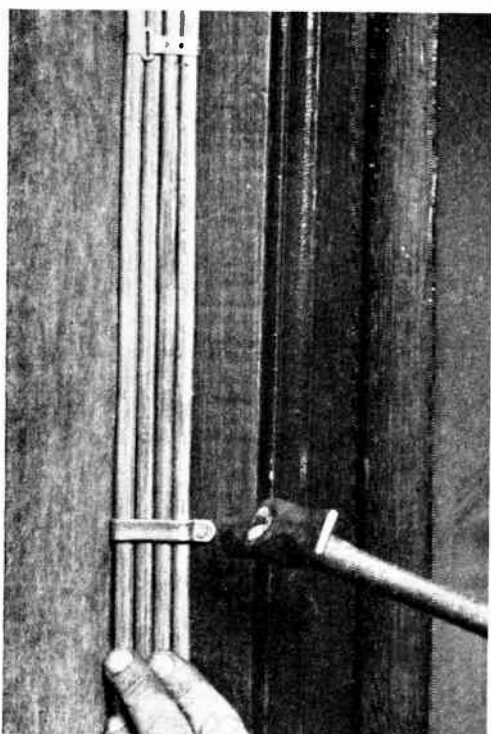

Fig. 2.—FIXING A MULTIPLE OF CABLES.
The same clips as illustrated in Fig. 1 are obtainable in various sizes to facilitate the neat fixing shown above.

are concentric but insulated from each other. The type of construction in the forefront of this class is known as "Stannos." It consists of an inner conductor of tinned copper insulated with V.I.R. and sheathed with a covering of tinned copper. More of this method will be described later.

Choosing the System to Use.

Each of these systems has certain peculiarities which make them suitable for use under different conditions. For example, in a dry factory where it is necessary for the conductors to be run on the surface in a position where they are likely to be continuously knocked but not moved, the tough rubber cable is to be preferred for the reason that lead sheathing is soft and easily damaged and the thickness of the insulation covering these wires is not sufficient to give adequate protection against hard wear. It is true that one will

say that the lead can be covered with a steel covering, but when cost is the consideration this is only a duplication and would be avoided by the use of the rubber covered cable properly fixed against the walls.

Installing a Lead Covered System.

When installing a lead covered system the foremost consideration must be the continuity of the casing, for one must remember that the lead takes the place of conduit, but that it must conform to the I.E.E. rules appertaining to "earthing."

In describing this work one must assume that the wiring is to be installed in a completely built house, and sometimes, where it is required that decorations shall not be disturbed more than is necessary.

Where to Begin.

In beginning an installation all the usual details must be attended to. The planning must be determined and the shortest and neatest runs compatible with the position of the lights must all be considered. Having given these our attention we begin as usual at the farthest point from the fuseboard working backwards in exactly the same manner as would be done if we were running the wires in conduit.

The lead casing should be fixed at intervals of about one foot along its entire length, although discretion must be used. For example, the spacing of the fixing clips may require to be closer if the cable is fixed on a ceiling or sagging is likely to occur. Where the cable lies on a picture rail a slightly greater spacing could safely be allowed.

The Method of Fixing.

The fixing is carried out by means of small lead or alloy clips, of which there are several patterns. Fig. 1 shows two types of clip to accommodate a single cable, whereas Fig. 2 shows two types for holding several cables in position.

Care Required in Handling.

When working with lead covered cable, and especially in long lengths, great care is necessary in its manipulation. The material is supplied with the sheathing

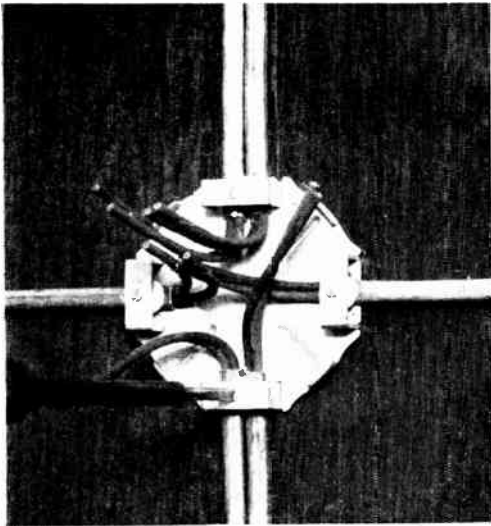

Fig. 3.—FIXING CABLES TO A JUNCTION BOX.
The junction box is shown with the cover removed and the cables being fixed in position. Note the cheese headed screw in each fastener which clamps the outer casing of the cable to ensure continuity.

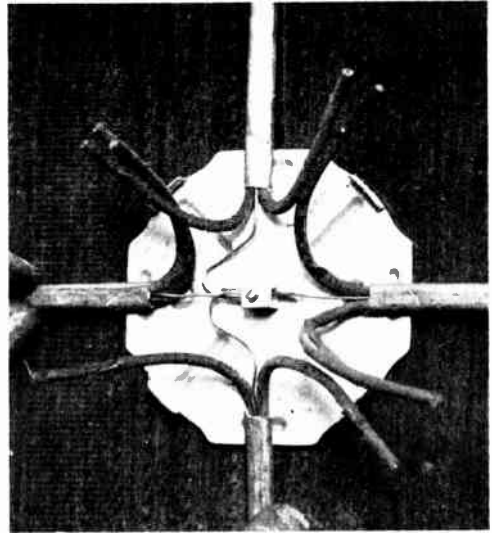

Fig. 4.—ANOTHER METHOD OF ENSURING CONTINUITY.

In this case continuity is assured by the use of a cable with a bonding wire incorporated. These bonding wires are connected to a central terminal in the junction box.

neatly enclosing the cables and is rolled on formers. Careless handling will cause innumerable twists and distortions in this casing which are very difficult to erase in the finished work, and in addition fractures are likely to occur in the casing and escape detection. While the metal around these fractures may be connected for a sufficient length of time to pass an earth test, conditions of heat and cold at some future time may cause them to open and break the electrical continuity.

Acute angles and internal corners again call for special care in working the material and where it is impossible to avoid these the cable must be gently eased around them, and the very malleable nature of the lead

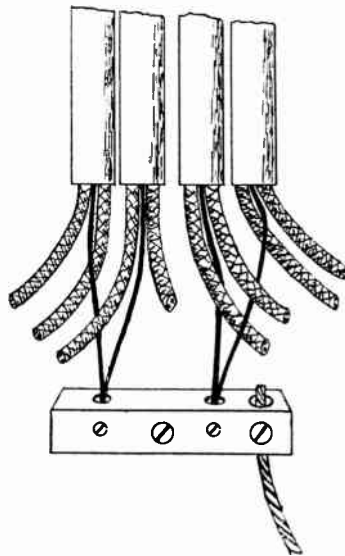

Fig. 5.—A CONTINUITY BAR.
In the surface systems employing the bonding wire a continuity bar is used at the positions of the fuse boards, etc., as a means of bonding the earthing wire.

lends itself to this treatment provided care is taken.

The Use of Junction Boxes.

Having fixed all the cables including the mains and the various branches, the next step is the fixing of junction boxes where these occur. These latter are made also to ensure electrical continuity of the outer casing and are one of the products of the aforementioned standardisation. Fig. 3 is a typical junction box, fixed, with the various connections being made, and you will notice that at points where the lead sheathing enters the junction box a small cheese headed screw is provided which securely clamps the outer casing, thereby obtaining the desired continuity. The various connections of the

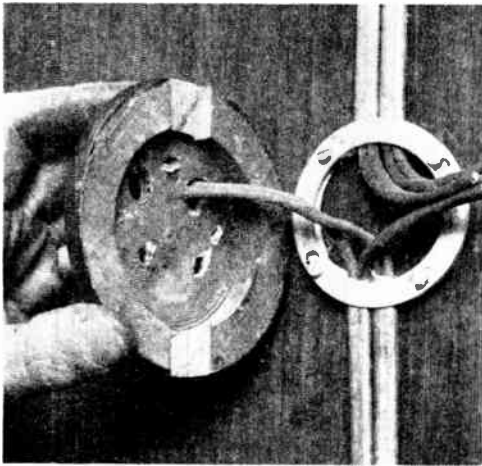

Fig. 5.—WHAT HAPPENS BEHIND THE FITTINGS. Where switches and fittings occur a special bonding ring is used to clamp the casings of the cables, and the blocks are recessed to allow them to fit snugly.

conductors are made by means of single or multiple way china connectors to ensure perfect insulation.

In systems where the bonding wire is used the method of fixing is slightly different, the bonding wires being clamped to special terminals connected to the back of the joint box and secured by grub screws as in Fig. 4. Remember that these joint boxes have no sightly appearance, and should therefore be placed in inconspicuous positions, hiding them in floors where possible.

What Happens at the Positions of Fittings and Switches.

So much then for the continuity, but what happens at places where fittings and switches are to be fixed? For this purpose a special bonding ring is supplied and one such is fixed in Fig. 6. It enables any reasonable number of cables and their casing to be clamped together at various points around the circle, and the block, with its recesses cut to allow it to lie flush over the cables, completely hides it from view.

Where Bonding Bars Are Used.

At the positions of the fuse boards this ring is not always suitable, especially as

in the majority of cases the wires leave the board all in one direction and in such cases continuity is assured by means of a bonding bar such as that shown fitted in Fig. 7. These are made in several sizes to accommodate various numbers of cables but if the number is so great as to require the use of more than one bar, then a wire must be carried from each bar separately to earth or all the bars connected to each other and connected to earth by a common wire.

In the case of the systems employing bonding wire a different type of clamp is used as shown in Fig. 5, the bonding wires being clamped by grub screws in exactly the same manner as is done at the joint boxes in this type.

Types of Fittings.

It has already been mentioned that the fittings used in connection with metal sheathed cable are standard, but these standard makes can be obtained in various sizes. For instance, there is what is known as a small T box and this box will only accommodate at the most one flat triple cable in each of its entrances. Where it is necessary a larger box can be supplied and the entries are variable as shown in Fig. 8. As an example, four cables could enter one

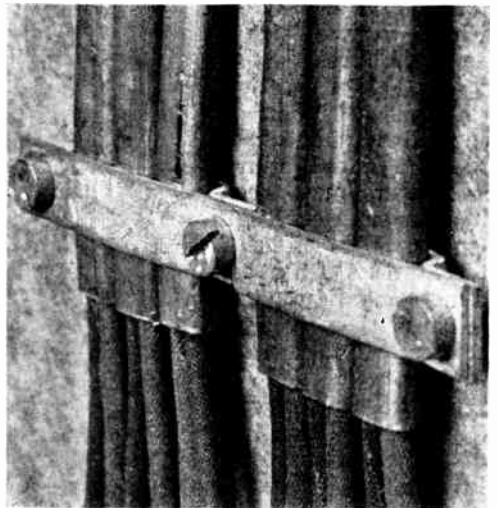

Fig. 7.—WHERE BONDING BARS ARE USED. At the position of the distribution board the cables are clamped together by a multiple bonding bar and this bar is connected to earth.

arm, two into another and one in the remaining, and these positions can if necessary be reversed around the T. For occasions where cables that enter from various directions are required to be joined, a universal box as Fig. 9 must be used, this again being obtainable in two sizes to suit individual requirements.

Fittings for a Tough Rubber Installation.

While all the fittings for metal sheathed systems must necessarily be of metal also, this does not apply to installations using rubber cable. These may be of bakelite or other suitable material. Those of bakelite are an advantage by reason of their insulating properties which allow of terminals being inserted for making connections. This dispenses with the necessity for china connectors and allows the boxes to be of smaller dimensions and therefore less conspicuous.

Concealing the Wiring.

Sometimes it happens that objection is taken to the appearance of surface wiring, but this can be overcome by the use of the varied methods of disguise which at the same time act as a protective covering.

There are made several forms of mouldings, either in wood or some such durable material that may be used as cornices,

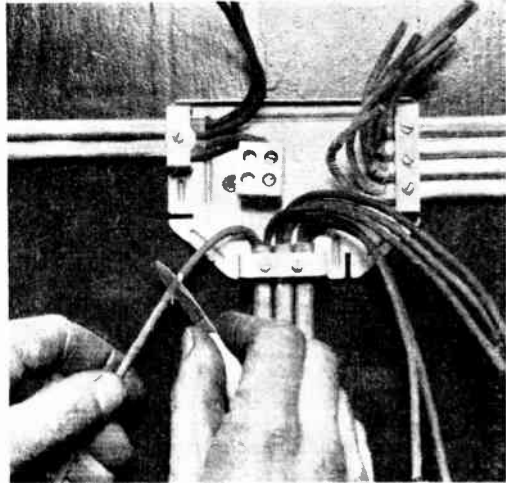

Fig. 8.—INTERCHANGEABLE FITTING.

The fitting illustrated in Fig. 3 can only accommodate two cables at its entrances, as shown, but in the above illustration we see that by the use of special clips the fittings are rendered interchangeable so that a greater number can be accommodated.

architraves, skirtings and even as panel strips on the ceiling, and provided the planning of the runs of wires has been carefully considered, these mouldings can be used with tasteful effect.

The Concentric System.

This method of wiring is distinctly limited in its applications due to the Home Office regulation appertaining to earthing of conductors where they are connected to a public supply. The outer sheathing being used as the second conductor, it must be connected to "earth" to provide a return and the following extracts from the regulations show that this can only be done under certain conditions.

A.—*Earthed concentric wiring shall only be used when connected to systems of supply:—*

(a) *So as to derive the supply from the secondary side of transformers or converters so arranged that the public supply system is electrically insulated therefrom; or,*

(b) *In which earthed concentric wiring has been approved by the Electricity Commissioners; or,*

(c) *Consisting of an independent generating plant.*

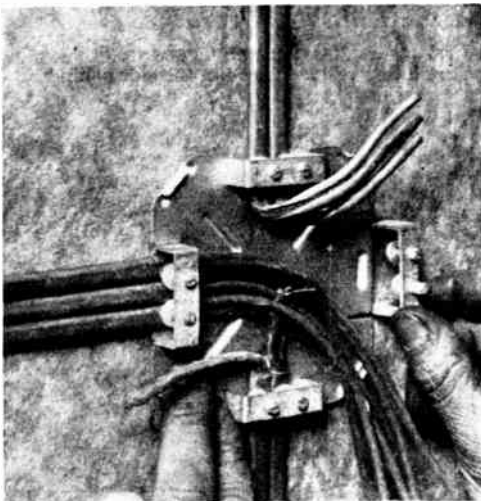

Fig. 9.—A LARGE UNIVERSAL BOX.

This shows how it is possible to make additions when necessary. Another clip is inserted in the two slots and the extra cable clamped in position.

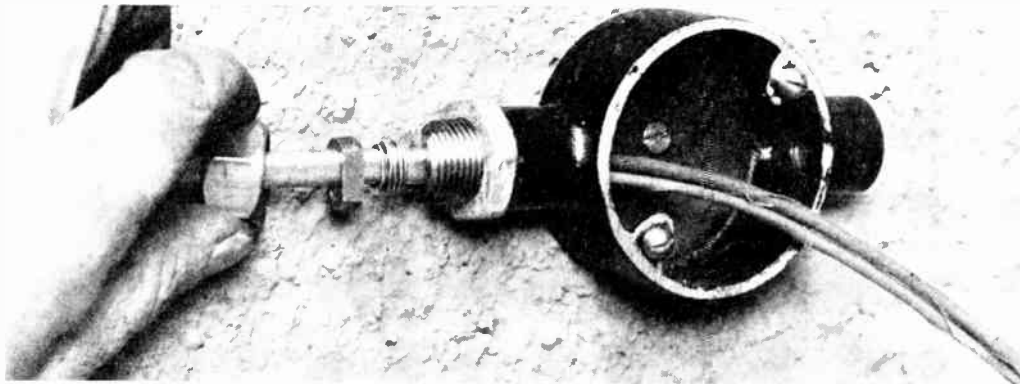

Fig. 10. HOW TO MAKE A WATERTIGHT FITTING BETWEEN LEAD CABLE (1).

An iron box is necessary into which is screwed a special block. The nut and washer are first threaded on the cable as shown, and a piece of lead wire is then rebated around the cable.

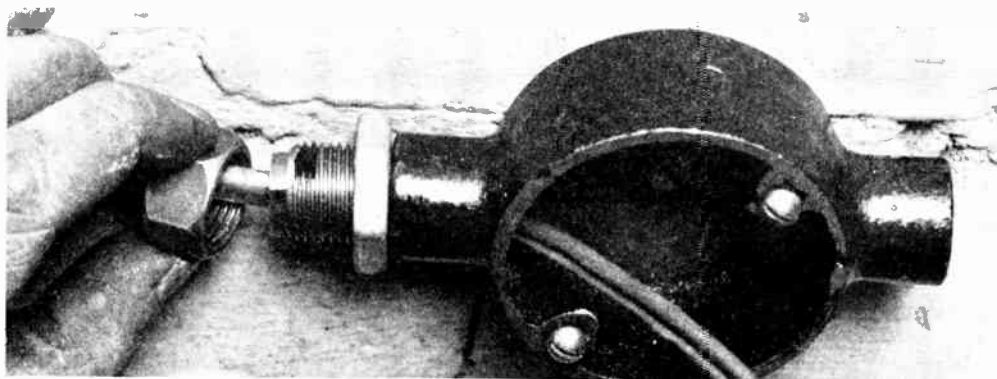

Fig. 11. HOW TO MAKE A WATERTIGHT FITTING BETWEEN LEAD CABLE (2).

The lead wire is now pushed into the slot in the block and the washer placed in the slot behind it.

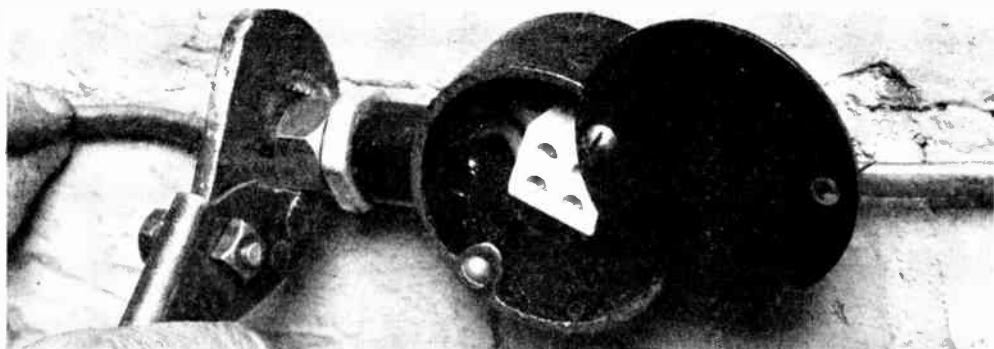

Fig. 12. HOW TO MAKE A WATERTIGHT FITTING BETWEEN LEAD CABLE (3).

The connection is made watertight by screwing the hexagon nut tightly in position. On this nut is a lip which forces the washer against the lead wire and threads it around the cable in the slot provided.

B.—From the position or positions at which the installation is earthed, concentric wiring shall be employed throughout up to all fixed positions for fittings or accessories. At all positions at which the external conductor ceases to surround the internal conductor the latter shall be separated from the surface upon which the fitting or accessory is mounted by an incorrodible metal plate or terminal box to which the external conductor is electrically connected. This requirement does not preclude the interposition of a wooden block between the metal plate and the fitting or accessory mounted thereon, provided that this metal plate covers the principal recess in the wooden block.

C.—Where the metal sheathing of a cable is used as one conductor the resistance of the sheathing shall not be greater than that of the inner conductor when measured at a temperature of 60° F.

D.—Joints, however made, in the external conductor shall be of such a nature that the conductivity of the conductor is not reduced.

E.—All circuits, lamps and appliances shall be controlled and protected by single-pole circuit breakers, or switches and fuses which shall be inserted in the internal conductor of the circuit. No circuit breaker, switch or fuse shall be included in the external conductor.

F.—Ordinary accessories may be used, but if lamp holders having central contacts be employed, such central contacts shall be connected to the internal conductor.

G.—Lamp fittings may be wired with two separate wires, one being insulated and connected to the internal conductor and the other to the metal work of the fitting.

These regulations make it difficult to use such a system as "Stannos" in everyday surface house wiring under its originally intended method.

"Stannos" and similar products, however, may be employed by using the cable as a single sheathed conductor, running them in pairs and earthing the outer casing. One internal conductor is then

used as "red" and the other internal as "black."

Watertight Installations.

To make a surface installation watertight the cables are run in the ordinary manner until they reach the position of fittings or junction boxes, and at this point iron boxes have to be used. The cables are entered into these boxes through a special bush and there are two methods of watertighting. The first is to use a low fusing point metal which is sweated between the bush and the metal casing, which, if properly done, will exclude all water. The second method is to use a special packing gland for connection to the iron boxes. This gland takes the form of a plug and is bored internally, circular or oval, according to the type of cable for which it is to be used. The plug is threaded externally with an electric thread which screws into the iron box. This plug has a slot cut in one end over which fits a washer, and, in addition, the plug is supplied with a hexagon clamping nut and a lock nut.

The Method of Making the Connection.

The metal sheath of the cable should be removed for a sufficient length to enable the connections to be made to the fitting or connector, and the hexagon nut is passed on to the cable followed by the small washer. A piece of lead wire is then wrapped around the cable at the point at which it enters the plug, as shown in Fig. 10. This plug is then passed on to the cable, slotted end first, and the opposite end screwed into the iron box. This is locked into position by means of the lock nut, the washer forces the packing into the slot on the plug and the hexagon nut screwed on to clamp the whole in position, as shown in Fig. 12. By this operation the lead packing wire is forced between the cable and the plug, giving electrical continuity, at the same time rendering the joint completely watertight.

VARNISHES, OILS AND RESINS

USED BY ELECTRICAL ENGINEERS

The Insulating Value of Oils.

PRACTICALLY all oils—animal, vegetal or mineral in origin—have a high insulating value, but mineral oils—and, for cables, resin oils—are used almost exclusively for electrical insulation on account of their greater suitability, and because they can be obtained in a purer and more definite state.

The use of insulating oil is substantially confined to high-voltage switchgear, cables, rheostats and transformers. For the two latter classes of apparatus, the cooling qualities of the oil are at least as important as the insulating, if not more so. In switches, the oil is used primarily to quench the arc between the switch contacts when the switch is opening.

Where Electrical Oils Come From.

The principal sources of electrical oils are America and Russia. Both are mineral, but the former has a paraffin or petroleum base and the latter a bitumen base.

Estimating the Value of an Oil.

The characteristics of an oil that have to be considered when its value for electrical purposes is estimated are: Break-down voltage, thermal conductivity, specific heat, coefficient of expansion, flash-point, viscosity, solidification temperature, sludging and acidity. The thermal qualities may be more important than the electrical, for upon the specific heat, thermal conductivity and viscosity depend the readiness with which oil will conduct heat away from windings and rheostat coils to the cooling surfaces. With oil switches used out of doors in cold climates, the oil must have a very low freezing or solidification temperature, for congealed oil, although it has excellent breakdown strength, is quite useless for quenching an arc. The coefficient of expansion must be known in order that the oil in, say, a transformer, may be given sufficient space in a special "conservator" to expand and contract with the heating and cooling cycles to which the trans-

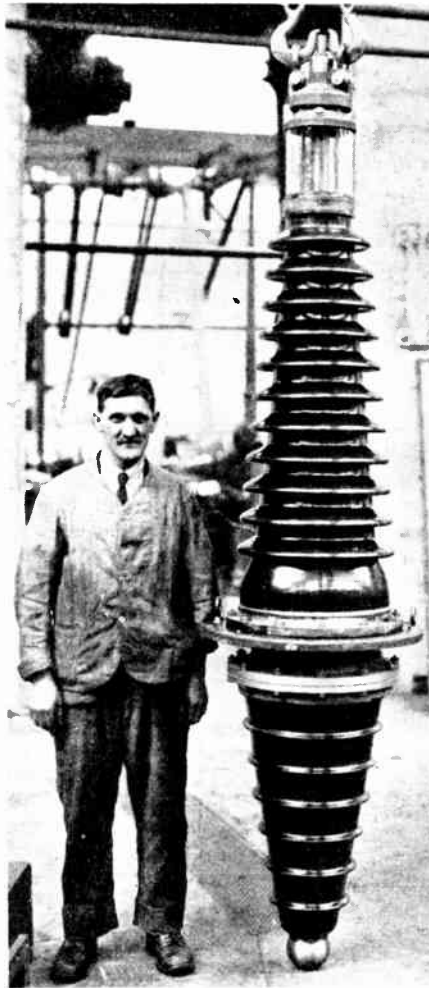

Fig. 1.—OIL-FILLED BUSHING FOR 110,000-VOLT TRANSFORMER. (Ferranti).

former is subject when on load.

What Sludging Means.

Sludging is a property of the oil whereby, when heated in air, it forms a thick brown deposit. In the case of oil-immersed transformers, the sludge settles on the core and windings, choking up the cooling passages and making the coils very much hotter internally. This state of affairs is dangerous, and where the conditions are favourable to the production of sludge, a non-sludging oil is called for. The acidity of the oil is a measure of its tendency to attack fibrous insulation (e.g., cotton).

Why Resin Oil is Useful.

Resin oil is much more viscous (treacly) than mineral oil, and is thus unsuitable for switches and transformers. It is used in paper-insulated lead-covered supply cables. Paper itself absorbs water, and in any case leaves air spaces between the layers. But paper impregnated with resin oil makes an excellent and widely used method of insulating cables up to high voltages.

WAXES.

The best-known insulating wax is paraffin wax. This has the same base as American mineral oil and is obtained from the same source by distillation of petroleum. It is employed in industry for impregnating paper for the manufacture of condensers. It is also coated on to insulating boards for use in the slots of generator and motor armatures, giving a lubricating action which facilitates the insertion of the coils.

How Wax is Used for Insulation.

Paraffin wax is useful in the small workshop or laboratory for impregnating fibrous insulation. For example, a small coil of cotton-covered wire is required to be made moisture-proof and permanent. The simplest way is to bake it at a little over 100° C. (the boiling point of water) and then to drop it into a bath of molten paraffin wax at 115° C. The temperature of the bath is then raised to 125° C. and maintained at this temperature until the bubbles of trapped air cease to rise. The

bath is now allowed to cool, but the coil is not withdrawn until the temperature reaches about 80° C. The wax solidifies at about 50° C. The coil will be found to be well impregnated, so long as the winding is not too deep and fine. For small wire closely wound, it is better to impregnate every few layers.

VARNISHES.

Varnishes, of which there are a great many types, for decoration and preservation as well as for insulating purposes, are essentially gums (or similar materials) dissolved in oil or spirit. The process involved is the application of a coating of varnish to a surface (or the impregnation of a small space filled with loose fibres), followed by the drying out of the solvent (oil or spirit), leaving the film of gum now distributed in a thin, tough, hard or flexible state. Here are some of the chief types of varnish with which we are more particularly concerned:—

Baking oil varnishes, composed of gums such as copal in linseed oil. The latter has to be dried out by baking 4-8 hours at a temperature slightly below the boiling point of water—say 95° C. Such varnishes are electrically good, and are durable. Their chief value is flexibility. In applying baking oil varnish, a “thinner” is used, such as white spirit, to render the varnish less viscous. Baking oil varnishes are very widely used in the manufacture of electrical machinery and apparatus.

Air-drying oil varnishes are the same as the above, except that certain substances termed “dryers” are added to quicken the process of drying and to enable the baking to be avoided. Unfortunately, the dryers lower the electric strength of the varnish film. The process of drying oil is essentially one of oxidising it, and it is the great advantage of the baking process that it can be stopped when a suitable degree of oxidation has been achieved. With the addition of dryers the “baking” so to speak, is continued indefinitely with the result that the varnish eventually becomes brittle.

Air-drying spirit varnishes are chiefly gums dissolved in methylated spirits, and will dry in air within four hours. They

are less flexible than oil varnishes, as there is no oily constituent to retain any flexibility. Thus they can only be used for stationary parts not subjected to mechanical shock or to extremes of temperature. The most familiar varnish in this class is shellac varnish, which is easily made by slaking up shellac flakes (purchased at the oil and colour merchant for a few pence per ounce) with methylated spirits to the required thickness. Another common varnish is black, bituminous varnish, a pitch or asphalt dissolved in benzine. A later but highly important class of varnish is furnished by synthetic resins of the "bakelite" class dissolved in methylated spirits. They can be used at much higher temperatures than natural-gum varnishes.

Cellulose lacquers are a comparatively recent development. They dry very quickly (the solvent being amyl acetate or acetone, which is particularly volatile), but are tough, adherent and flexible. They must not be thickly applied, on account of their tendency to "skin over," leaving the inside soft, and trapping the solvent.

GUMS AND RESINS.

The more important of the ingredients of varnish only will be considered.

Shellac is a widely used gum, obtained from the bark of Eastern tropical trees, in which it is deposited by the action of an egg-laying insect, forming with the sap of the tree a peculiar incrustation.

Copal is a tree-gum product, collected from the trees or from river-beds where it has been dropped from trees.

Bitumen is similar to tar, pitch and asphalt. It occurs in the tropics in streams or pools, and has a variety of uses besides that of varnish. It is often used for insulating cables, especially in mines; for this purpose it is vulcanised in the same way as rubber. The latter can be adulterated or "filled" with bitumen without injury to the electrical properties, and a mixture of soft vulcanised rubber and bitumen is used to prepare the familiar sticky, black friction tape.

Further uses are for cable sealing and jointing, and closing in the tops of battery boxes.

Bakelite holds first place among the classes of synthetic resins. It is named from a Dr. Baekeland, a Belgian chemist, who patented the composition of resins of this type nearly 25 years ago. It is manufactured from carbolic acid and formaldehyde (a product of the distillation of wood), a coarse lumpy material being produced which, when powdered, is known as bakelite "A." In this state it resembles the natural resins, and is soluble in alcohol, acetone, etc., or methylated spirits: thus dissolved it can be used for varnishes. Now natural resin varnishes attain their final protective form by slow drying, or oxidation. Further they can always be redissolved in a suitable solvent. The behaviour of bakelite "A" in powder or varnish form is totally different. The application of heat induces a chemical-physical change called "polymerisation" to proceed, the resin becoming permanently solid and insoluble. It should be emphasised that the new state—bakelite "C"—is quite permanent and cannot change under normal circumstances. It withstands high temperatures up to 200° C., at which it begins to char.

How Bakelite is Applied.

Bakelite has to be applied, therefore, when in its "A" state. As a varnish it can be applied by dipping, impregnating, spraying, brushing, etc., to coils, armatures, papers and fabrics. For example, for the impregnation of coils, wrapped bass and similar items, the article is dried out, then allowed to soak for a few minutes in diluted varnish, drained, and baked in a suitable oven, the temperature of which is gradually raised to 140° C. over a period of half to three or four hours, according to the size of the piece. The heat treatment completes the process, and results in an infusible, insoluble, uniform insulation. There is no danger of the inner layers of varnish remaining soft, as with thick films of oil varnish.

ILLUMINATION OF FLATS AND HOTELS

By E. H. FREEMAN, M.I.E.E.

FLATS.

THE problems involved in scheming out an installation for a block of flats resemble in certain respects those connected with domestic schemes and in others those relating to office buildings.

Wiring in the Separate Flats.

There is one important feature, namely, that the flat must as a rule be wired without consultation with the future tenant. Occasionally tenancies are arranged in the early stages of construction but more often the building work is far advanced and the wiring more or less complete before the tenant has decided to rent the flat.

These facts make it necessary to arrange the lighting from two aspects:—

(1) The original scheme should be such as is likely to suit the average tenant—in other words abnormal schemes of lighting should be avoided.

(2) Ample provision must be made on the circuits so that extra lighting can be provided if desired. A tenant may prefer four brackets to a central pendant or require one or two extra plugs and if circuits cannot be extended without overloading to meet such needs the cost of running new circuits will be a heavy item in a decorated or partly decorated flat.

Wiring Outside the Separate Flats.

Outside the individual flats the requirements resemble those for an office building as far as

the distribution cables are concerned although there is likely to be less variation in the rearrangement of tenancies. The class of building, its location, the rents charged and so forth, will settle the method of letting and though a large flat may later be subdivided into two or three small ones or, alternatively, two or three small flats combined into one large one, such rearrangements are the exception rather than the rule.

Possible Alterations to Small Flats.

Fig. 1 shows a corner of a block of flats with the area divided up into two separate flats each consisting of a bedroom, sitting room and bath room, whilst Figs. 2 and 3 show the same area of the building rearranged to suit different methods of dividing the area.

Fig. 2 shows the area rearranged to form a single flat with two bedrooms, sitting room, dining and bath room.

Fig. 3 shows the area divided into four bed-sitting room flats each with its own bath room and entrance lobby.

It will be seen that the main partitioning is very little altered so that such changes as these could be effected at any time with very little more work than would be involved in redecorating.

In considering how far such rearrangements may be required the class of building must be considered and this will also be an important point in deciding what provision should be made for additional points.

B

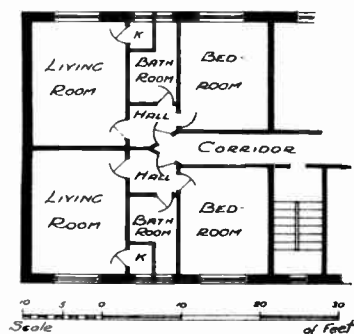

Fig. 1.—CORNER OF A BLOCK OF FLATS ARRANGED TO FORM TWO SEPARATE FLATS.

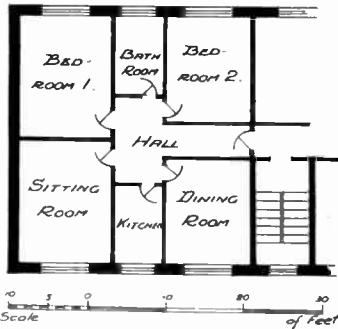

Fig. 2.—CORNER OF A BLOCK OF FLATS ARRANGED TO FORM ONE LARGE FLAT.

Wiring Details for Small Flats.

The most difficult class of building is that shown in Figs. 1, 2 and 3, which lies somewhere between a tenement building and a luxury flat. Such buildings may be of every class between the two extremes and each such building must be considered on its merits. The landlord may have decided definitely against any rearrangement of areas or the plan may not allow of this and in these cases the problem is simplified.

If this is not the case then a scheme should be devised to suit the plan and the distribution cables arranged to meet the possible alterations. It is advisable to make such a scheme as complete and elastic as possible as obviously alterations to the main cables etc., are likely to involve disturbance and damage to corridors and staircases and these will be expensive as well as a cause of annoyance to other tenants.

Each Scheme Needs Separate Treatment.

It is impossible to deal with this subject in full detail as no two schemes are alike and each must be considered specially, but some indication of possible alterations to the flats in Figs. 1, 2 and 3 will be a guide as to what should be provided.

In the case shown in Figs. 1, 2 and 3 there would doubtless be a rising main cable near the staircase which would supply the flats shown and probably a similar group on the other side of the staircase. A connection box or sealable fuse board would be needed on each floor and all wiring run back to this position.

A suitable lighting scheme is shown in Fig. 4 to suit the planning in Fig. 1, and if this is transferred to the modified plan in Figs. 2 or 3 it will be seen that most of the lighting points are suitable.

Alterations to Lighting for Alternative Plans.

For the replanning as in Fig. 2 one of the two hall lights can be omitted and the light near the window in one bedroom in Fig. 1 must be moved to the centre of the dining room in Fig. 2.

For Fig. 3 plan slightly greater changes are required, the two living-room lights in Fig. 1 needing to be moved nearer the windows and extra lights being required for the two extra bath rooms.

The corridor light also needs alteration, as for Fig. 2 this is part of the tenants' lighting, whereas for Figs. 1 and 3 it should be included in the landlord's lighting.

Method of Wiring to Suit Replanning.

To meet these various difficulties, if such rearrangements are likely to take place, it would be best to arrange the original wiring circuits to suit the possible changes. If the wiring is run back for suitable groups of lights these can be combined at the fuse board in any way required and a convenient scheme would be to wire the area in question in five groups.

Groups 1 to 4 would each supply lights for a bed-sitting room and bath room as in Fig. 3, whilst Group 5 would supply the corridor light.

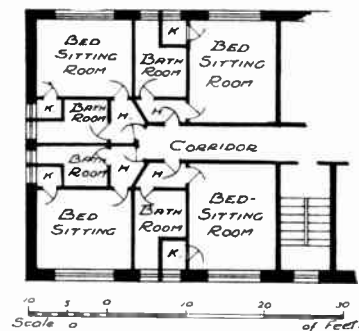

Fig. 3.—CORNER OF A BLOCK OF FLATS ARRANGED TO FORM FOUR SINGLE-ROOM FLATS.

Method of Connecting for Alternative Plans.

For planning as Fig. 1 :—

Groups 1 and 2 could be connected to one meter and Groups 3 and 4 to a second, whilst Group 5 would be connected to the landlord's lighting.

For planning as Fig. 2 :—

All groups would be connected to a single meter.

For planning as Fig. 3 :—

Groups 1 to 4 would each be connected to a separate meter and the corridor light to the landlord's lighting.

Special Fuse Board.

The provision of a fuse board at the staircase with split bus bars and links to couple up the sections of the bus bars in any way desired would enable the changes to be made with a minimum of disturbance to the wiring. The diagram of a suitable fuse board is shown in Figs. 5, 6 and 7, which indicate the methods of bonding across with movable links for the three schemes above.

Such a method of wiring would naturally be much more expensive in the original scheme than ordinary wiring.

Landlord's Lighting.

The remaining problem of the lighting design is the landlord's section, i.e., the lighting of staircases and corridors.

The arrangement of the actual lights need not involve any special problem, the difficulty being to provide a convenient method of switch control. The solution of the problem must depend on the character of the building and on whether any service is provided after locking-up time. If a night porter is always available it may be possible to depend on him to switch on light as and when required, but this is not a complete solution as it does not meet all needs. It is a solution of the problem of switching on for an incoming tenant, but it does not enable a tenant or his visitor leaving late at night to obtain the lighting required if all lights are switched off at a fixed hour.

There are many possible solutions and the selection of the right one must depend

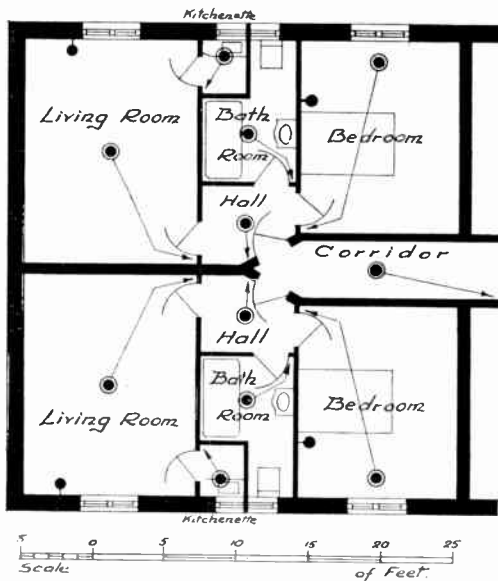

Fig. 4.—LIGHTING SCHEME TO SUIT PLANNING OF FLATS AS IN FIG. 1.

It will be seen that most of the lighting points are also suitable for the arrangements shown in Figs. 2 and 3.

on the character of the building and the conditions under which the building is staffed.

Alternative Methods of Control.

The following are the most usual solutions :—

(1) *All or part lighting left on all night.*—This is simple but may be expensive in running cost but it will probably be the most satisfactory.

(2) *Separate system of pilot lighting.*—Such a system may consist of small Neon or other low power lamps. This is cheaper to run than Scheme 1 but it involves a duplicate system of wiring and higher first cost.

(3) *Two-way switch controls.*—This also is cheaper on running cost providing tenants can be relied on to switch off the lights as well as to switch them on. It is more expensive to install than Scheme 1 and possibly than Scheme 2 and is more suitable to a better class of flat where tenants would consider a glimmer of light to be insufficient.

(4) *Time switch control.*—There are various forms of time switch on the market, simple and inexpensive, that automatically switch off at a selected interval of 2, 3 or 4 minutes after being switched on. The period can be adjusted to suit the conditions—a very short time for example if only for maintaining light when passing from a lift to a flat or longer if required for going up two or three flights of stairs.

Such switches can be arranged in parallel with ordinary switches and connected so that the latter are in use during ordinary hours, say up to 10 or 11 p.m., the time switches coming into action when the ordinary switches are cut out. A master switch to control the whole lighting must of course also be used.

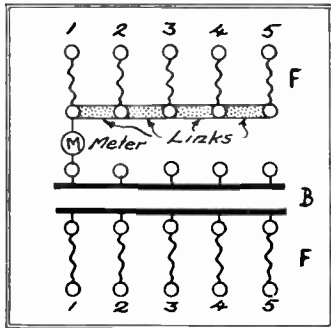

Fig. 6.—SPECIAL FUSEBOARD TO SUIT LIGHTING SCHEME FOR FIG. 2. F, fuses; B, bus bars.

The diagram in Fig. 8 shows the method of connecting up a circuit on such a system as this.

The scheme is unsuitable for outgoing tenants or visitors unless one such switch is connected on every landing arranged to switch on all lights. This involves no difficulty in wiring as will be seen from Fig. 8, but it adds substantially to the cost. It is also rather unsatisfactory if there are cross corridors or considerable distances between staircase landings and flat entrances, as these must be traversed in darkness or extra switches added in corridors with further extra costs and complications.

HOTELS.

In many respects the design of an electric-lighting scheme for a hotel provides

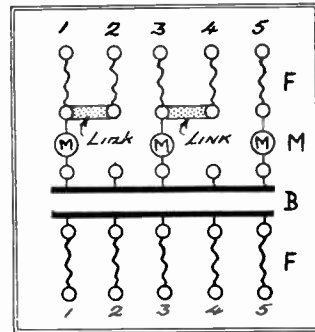

Fig. 5.—SPECIAL FUSEBOARD TO SUIT LIGHTING SCHEME FOR FIG. 1. F, fuses; M, meters; B, bus bars.

a simpler problem than that for any other important building.

Bedrooms.

The most important room in the hotel is the typical bedroom, due to there being so many of them. Once the scheme for the bedrooms has been decided, the lighting for the major part of the hotel is also settled.

Bedroom lighting in hotels in the past has been extremely badly carried out and lighting frequently provided of a quite inadequate character. A single small lamp, with a plain opal shade, controlled only by a switch at the door, has represented the complete lighting scheme in many hotels claiming to be first class.

Minimum Requirements.

Minimum requirements should include a dressing-table pendant with suitably

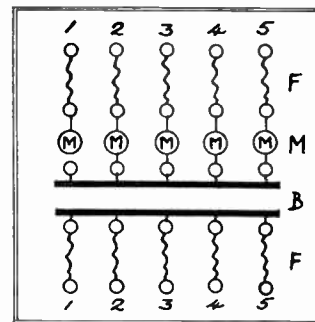

Fig. 7.—SPECIAL FUSEBOARD TO SUIT LIGHTING SCHEME FOR FIG. 3. F, fuses; M, meters; B, bus bars.

screened lamp, to avoid glare from the bed, and a separate bedside lamp. The latter should preferably be a table lamp, supplied from a plug, as a pendant over the bed or a bracket behind it must mean a lamp directly over the head of the guest lying down in bed, and this is most unpleasant and quite unsatisfactory if he or she wishes to read in bed. The hospital patient will usually be sitting up to read and the bracket is then quite convenient, but the hotel guest is more likely to read lying down.

Switch Control.

A further desirable addition is two-way switch control for the dressing-table pendant for operation from door and bed, and in fact this must be provided in addition to the bedside plug in any good class hotel.

Reception Rooms.

The position is entirely different when the problem of lighting the reception rooms is being considered. The lighting of such rooms is very important. The illumination must be carefully designed to give even lighting over the whole area, and the lay-out must be arranged to suit the architectural features of the room. The details of the scheme must of course be of a character to suit the class of hotel, but the design should provide for at least the following illumination:

Dining Room: 6 candle feet, with local lights on tables in addition if possible.

Reading Room: 8 candle feet.

Writing Room: 8 to 9 candle feet if local lights are not used or 6 candle feet if local lamps are added at the writing tables.

Lounge and Smoking Room: 6 to 8 candle feet.

Ball Room: 8 to 10 candle feet.

Modern Lighting Schemes.

Modern designing of lighting schemes for hotels of the better class is tending more and more to become an essential part of the general decoration. Lighting fittings are being abandoned, or are used

only to provide the contrast in intensity of illumination at different points that is essential if the effect is to be architecturally interesting. Such a scheme is that in a dining room in Claridge's Hotel, the lighting of which is provided by lamps concealed in a triple cornice. In this room ample contrasts are provided by the brilliantly lit ceiling and the panelled walls and also by the white tables in contrast with the carpets and furniture. Such schemes in rooms not so furnished are apt to provide over-uniform lighting, and can be avoided by the use of wall brackets and picture-lighting effects.

Mr. O. P. Milne, F.R.I.B.A., who was responsible for the design of this room, has obviously been extremely successful in obtaining the desired result—

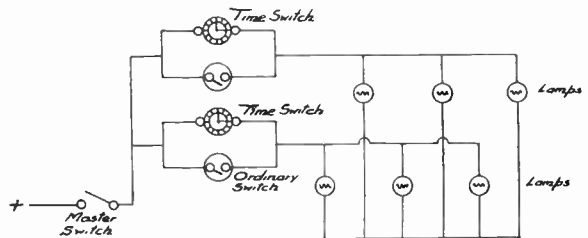

Fig. 8.—DIAGRAM SHOWING STAIRCASE AND CORRIDOR LIGHTING WITH TIME SWITCH CONTROL.

soft, even and yet good lighting without lack of interest in the details.

Increased Cost.

To obtain these results the running cost is necessarily greater than with more direct lighting, and this increased cost is inevitable with (so-called) architectural lighting. This will be referred to in a later article, but a brief summary of the lighting details for the ballroom at Claridge's will confirm this statement. The room is about 80 feet by 40 feet, and as the ceilings are light in colour and the walls partly mirrored, an efficiency of 60 per cent. should be obtainable if purely commercial fittings were used, selected merely to give good lighting. On this basis the lighting would be obtainable from eight lamps of 300 watts, which would give about 6 foot candles. Actually

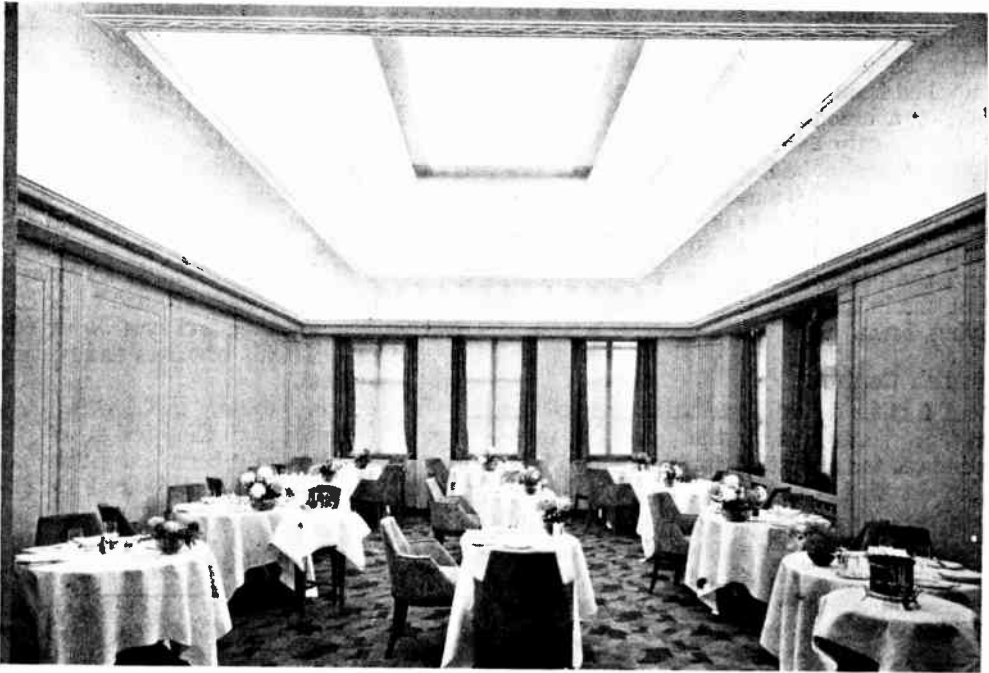

Fig. 9.— HOTEL DINING ROOM WITH LIGHTING PROVIDED BY LAMPS CONCEALED IN TRIPLE CORNICE.

15-watt lamps are used at 6-inch centres and, as there are six rows the entire length of the room, the total load is 14,400 watts or just six times what would be necessary for commercial lighting.

These figures are given to illustrate the fact that lighting of this character cannot be designed on any such principles as have been used for the schemes already considered, and it is practically impossible to deal with installations of this kind on a calculation basis.

Corridor and Staircase Lighting.

Corridors and staircases in hotels must be well lit and the principles that apply to flats also apply to hotels. With ordinary pendant fittings, lights at 30 ft. or so apart

will provide all that is necessary, and any corridor should be wired so that half of the lighting can be switched off during the night. Some pilot lighting must certainly be provided all night in all but the smallest hotels. Apart from the need of providing for this, the corridors and staircases do not call for special lighting.

Service Areas.

These parts of the hotel—kitchens and domestic areas connected with them; offices; staff rooms and so forth also do not call for special treatment. Each must be lit to suit the size and arrangement of furniture and the character of the work to be done in each, all in accordance with remarks made earlier regarding similar rooms in other buildings.

ELECTRICAL ACCESSORIES FOR CARS

USEFUL CIRCUIT DIAGRAMS AND NOTES ON FITTING

By E. HILL

THE car electrical accessories described in this article are those items of the electrical equipment which are not always included in the general car specification.

ELECTRIC HORNS.

Two types of electric horn are in general use, i.e., the motor-driven type and the high frequency type.

Motor-driven Type.

The motor-driven horn consists of a small 6 or 12-volt series motor, the spindle of which carries an actuator, a diaphragm and a bell or trumpet. When current is applied to the motor terminals the armature revolves and the actuator impinges against a hardened steel stud in the centre of the diaphragm and sets up the vibrations that cause the sound note. The diaphragm is clamped at the circumference by the magnet frame case on one side and the trumpet or bell at the other.

The motor armature has a laminated core with 7 or 9 semi-enclosed slots, and runs between bearings set slightly below the centre of the diaphragm. Stamped copper sections are moulded in bakelite to form the commutator and this is pressed on the armature spindle. The windings are of enamelled copper wire for both armature and field coils. There are two pole pieces, and the two coils are connected in series with the armature. Square section

copper gauge brushes are used and are held in box holders, spring loaded depression levers being fitted to obtain the necessary pressure against the commutator.

Adjusting the Horn Note.

Adjustment of the horn note is provided by a thrust screw which can vary the pressure of the actuator against the diaphragm. A removable cover is fitted over the motor and provides access to the commutator and brush gear. The current consumption of the motor type horn varies between 6 and 8 amperes for 6-volt horns and 4 and 5 amperes for 12-volt.

High Frequency Type.

High frequency horns are made with or without the bell trumpet attachment and operate electro-magnetically. The diaphragm is clamped round the circumference between an end plate or grille and the flange of the body. A stem is fixed to the centre of the diaphragm on which the armature is mounted. Beyond the armature the stem is centralised and carried by the magnet poles on which the coil is wound. The end of the stem projects against the mounting of the two trembler contacts, which mounting is fixed to the back of the housing. The coil and magnet system circuit is completed through the two contacts and when the coil is energised the armature is drawn against the

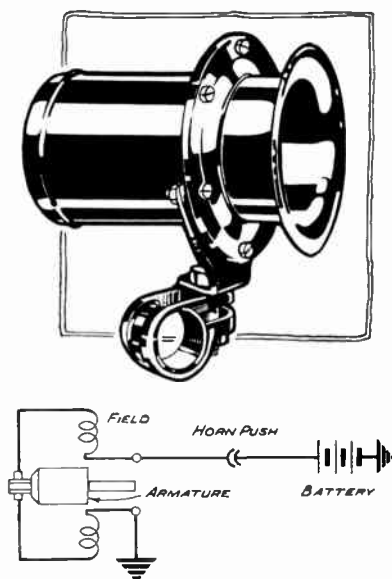

Fig. 1.—MOTOR-DRIVEN ELECTRIC HORN.
Showing connections.

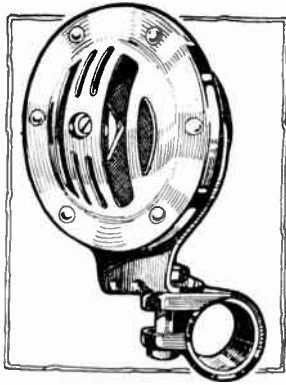

Fig. 2.—HIGH-FREQUENCY ELECTRIC HORN.

magnets. The end of the stem then pushes one contact away from the other and the circuit is broken. The pull of the magnets being released, the diaphragm pulls back the armature and stem and re-establishes the circuit. The current required is from 3 to 4 amps. on 12 volts and 5 to 6 amps. on 6 volts.

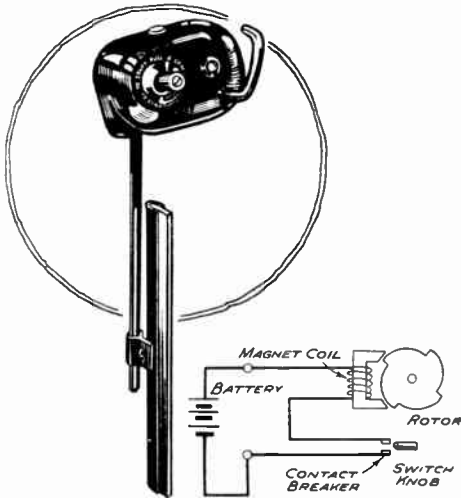

Fig. 4.—IMPULSE MOTOR ELECTRIC WIPER, Showing connections.

Adjustment.

Adjustment is made by altering the length of the stem projection by means of a screwed sleeve provided with a lock-nut. The contacts are usually of tungsten and laminated poles and armature may be

used. In some types of high frequency horns a condenser is connected across the contact points to minimise the sparking.

Importance of Correct Mounting.

The mounting of horns has considerable effect on the note produced and it is essential that the bracket be fixed to a rigid base and that the bell or other part of the horn frame (apart from the bracket) does not touch any other chassis member. The horn or grille should not be mounted directly in line with the air stream from the fan.

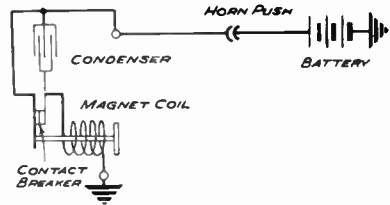

Fig. 3.—CONNECTIONS OF HIGH FREQUENCY HORN.

ELECTRIC SCREEN WIPERS.

Two types of motor are used for electric screen wipers, i.e., impulse motors and plain shunt motors.

How the Impulse Motor Works.

The impulse motor has a laminated rotor mounted on a steel spindle. At one end of the spindle is a four-faced fibre cam, and outside that a switch knob projecting through the case. The cam operates make-and-break tungsten contacts mounted on a plate. When these contacts are closed the circuit is made through the stator windings and the battery leads.

The stator is laminated and has two pole tips radial with the rotor. At the

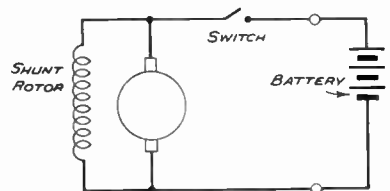

Fig. 5.—CONNECTIONS OF ELECTRIC SCREEN WIPER WITH SHUNT MOTOR.

other end of the motor spindle is a small pinion engaging with a double intermediate gear carried from a pin in the body. The small wheel of the intermediate pair gears with a much larger gear to which is attached a crank plate. This plate is slotted for the crank pin, and has a segment of gear teeth radial with the pivot pin. This segment imparts the reciprocal motion to a pinion mounted on the spindle

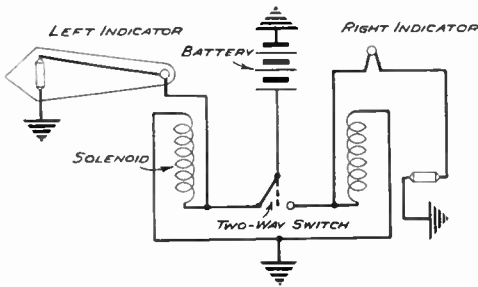

Fig. 7.—CONNECTIONS OF MOVING ARM TYPE DIRECTION INDICATOR.

of the wiper arm. The motor is usually mounted on the inner side of the screen frame, either at the top or bottom. The fixing studs and wiper spindle project through the frame and the squeegee spring-loaded arm is clamped to the spindle.

Operating the Impulse Motor.

To operate this type of motor it is necessary to spin the rotor by turning the starting knob. This knob also acts as the switch, and when pushed in opens the contacts of the contact breaker. The

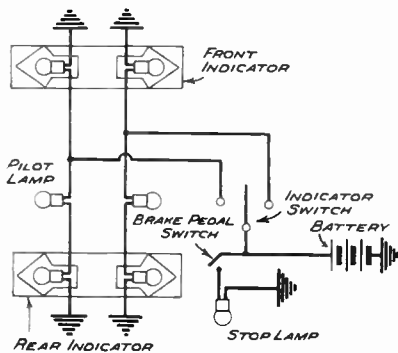

Fig. 9.—CONNECTIONS OF FRONT AND REAR INDICATORS.

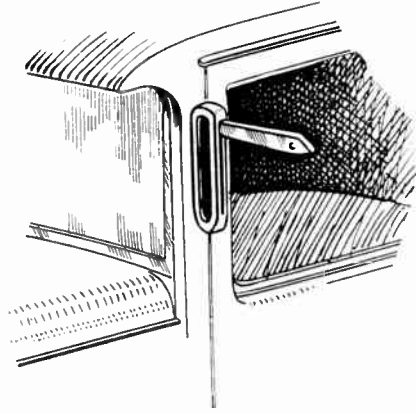

Fig. 6.—MOVING ARM TYPE DIRECTION INDICATOR.

current required to run the motor is less than one ampere, but when the switch is left on and the motor stalled the current increases and will overheat the windings.

Timing the Rotor.

In timing the rotor the contacts should open when the concentric part of the periphery of the rotor is opposite the pole piece, and closed when the edge of the stator pole covers a tooth of the rotor by about one-third of its length. The wiper



Fig. 8.—COMBINED INDICATOR AND NUMBER PLATE.

spindle may have a projecting hook handle which when pulled back disengages a pin clutch on the driving gear and allows the spindle to be operated by hand. When stopping the wiper the arm can be turned so that the end of the hook engages with the switch knob and depresses the latter into the off position, this being retained by spring pressure on the spindle.

The Shunt Motor Type.

The shunt motor type is usually of 4-pole construction, the magnet frame being made up of laminated stampings,

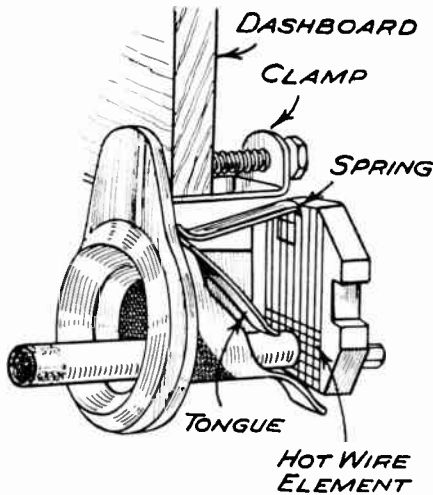

Fig. 10.—ELECTRIC CIGAR AND CIGARETTE LIGHTER.

The frame is enclosed by an aluminium cast body which also houses the gearing. The armature has a laminated core with semi-enclosed slots; the winding is connected to a moulded commutator, and the end of the spindle has a worm thread turned on it.

The worm drives a bronze worm wheel which carries the crank pin of a reciprocating motion. A link pivoted on the crank pin oscillates a toothed segment engaging with a pinion on the wiper spindle. The gear box is lubricated by high melting point grease and is enclosed by a cover plate. Two square section spring-loaded carbon brushes are employed and are carried in box holders attached to a bakelite end frame. A detachable cover provides for the inspection of the commutator and brush gear. An independent switch may be used, or one on the end cap which connects by cam action a contact on the terminal with one of the brush holders. The current taken by motors of this type is 1 to 1½ amperes on 12 volts or 2 to 2½ amperes on 6 volts.

DIRECTION INDICATORS.

Many devices have been designed to indicate the intentions of a driver in regard to turning or stopping. Some cars are fitted with front and rear indicators having illuminated arrows pointing right or left

to indicate turns and a stop light with orange-coloured glass to indicate stopping. A rectangular metal box is sectioned off by partitions, and each compartment has an electric bulb and holder fitted.

How the Lamps are Wired.

Arrow-shaped apertures are cut in the cover of the box and filled with strips of celluloid (red at the rear, green at the front). The lamps are wired in parallel across the battery and a two-way momentary contact switch operates right or left hand lamps as desired. The rear signals may be wired in series with tell-tale lamps on the dashboard so that the driver can see whether the indicators are operating. Various locations are chosen for these indicators, some being above the number plate at the centre of the luggage grid, others at the back of the rear off-side mudguard and others across the rear window of saloon cars.

Front indicators may be mounted with the front number plate or under the canopy on closed cars.

Illuminated Swing Arms.

Another type of indicator which is becoming popular has illuminated swing arms, which, when operated, point in the direction the driver intends to take. This type of signalling device is perhaps the least mistakable, but is considerably more complex in its mechanism. The arms are constructed suitably for mounting against, or let in, the side pillars of enclosed cars or alongside the side frames of windcreens, and normally hang vertically and unnoticeable. Each signal has two main components, one of these being the moving

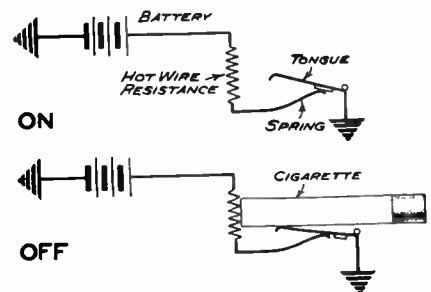

Fig. 11.—CONNECTIONS OF CIGARETTE LIGHTER.

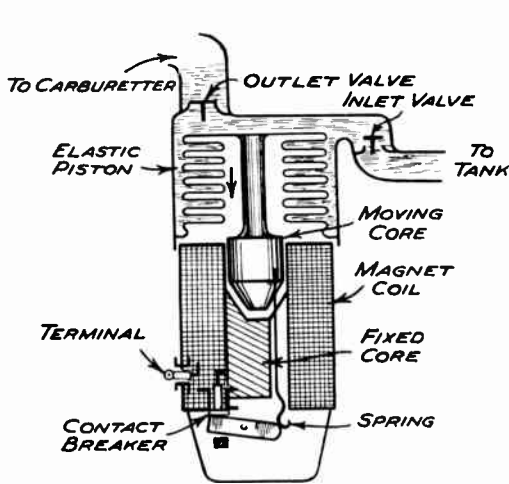

Fig. 12.—DIAGRAMMATIC SECTION OF ELECTRIC PETROL PUMP.

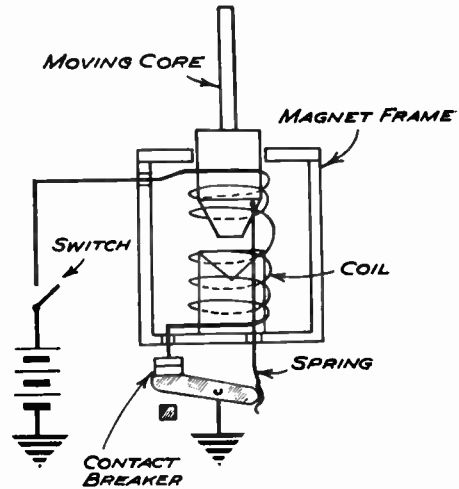

Fig. 13.—CONNECTIONS OF ELECTRIC PETROL PUMP.

arm and the other a fixed container for the solenoid action.

The Moving Arm.

The moving arm consists of a light metal framework with celluloid windows front and back, and holders for a festoon bulb are fitted near the outer end. The arm is pivoted about a pin in the solenoid container, and a link motion connects the arm with the solenoid plunger. The device is connected across the battery through a switch. A special switch is incorporated, and this by movement of a lever to right or left operates either signal at will by energising a solenoid and lighting a lamp. The stop light is usually incorporated in the same casing as the tail lamp, and is operated by a switch attached to the brake pedal.

CIGAR OR CIGAR-ETTE LIGHTER.

Several forms of electric lighter are in use, one of these having a hot wire resistance element clipped to the end of a tubular fitting which is flanged at the other end for attachment to a dashboard. The tube is open to the front and is cut

away on the top side, the space being occupied by a hinged tongue which is normally pressed lightly against the bottom of the tube by a phosphor bronze leaf spring projecting from the top side of the element. An insulating strip separates the leaf spring and the tongue, but when the tongue is raised by the insertion of a cigarette or cigar, metallic contact is made between the two and the circuit completed through the hot wire resistance to the battery. One end of the wire is connected to a terminal and the other end to the leaf spring, the return being made through the tongue and tube to earth or to a negative battery lead. Another form of lighter has a circular detachable hot wire resistance element, which, when in position in its holder, can

be switched into circuit with the battery and removed when glowing after a few moments and used for lighting purposes.

ELECTRIC PETROL PUMP.

The use of electric petrol pumps is rapidly being extended for cars on which the petrol tank is at a lower level than the car-

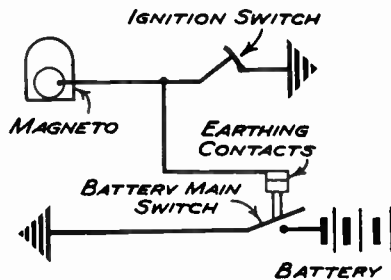

Fig. 14.—CONNECTIONS OF BATTERY MAIN SWITCH.

burette. The device consists of an electromagnet to which is coupled an elastic piston working in a pump chamber and operating an inlet valve from the tank and an outlet valve to the carburetter. There is a pipe connection from the inlet valve to the tank and a similar connection from the outlet valve to the carburetter.

How the Pump Works.

The pump action is as follows. On closing the control switch the moving core is drawn down by magnetic action and the bellows piston is compressed. This increases the capacity volume in the body of the pump above the piston. The pressure on the pump side of the inlet valve is therefore decreased and the valve opens and petrol is drawn in from the tank. At the bottom of the stroke the contacts are opened and the electric circuit broken. The piston then expands by reason of its elasticity and pressure is exerted against the petrol in the pump chamber. This opens the outlet valve and the petrol is pumped into the carburetter. At the top of the stroke the contacts come together and the electrical circuit is remade, and the cycle of operations continues until the carburetter float chamber is full. The needle valve prevents any further action of the pump until refilling is required.

ELECTRIC PETROL GAUGE.

This instrument consists of a dash-mounted indicator dial and a float-operated variable potentiometer in the petrol

tank. The dashboard instrument is a moving iron meter with the dial calibrated in gallons or litres. There are two windings, one being a damping coil connected in parallel with the operating coil, which latter is in series with the resistance of the potentiometer. When the tank is full, the resistance is cut out by an arm operated by a float, and the scale indicates the full capacity of the tank. At a lower petrol level in the tank, resistance is inserted in the circuit, and the scale indication is reduced accordingly. The circuit is connected across the battery, the switch being coupled to the ignition switch so that the two are connected or disconnected simultaneously.

BATTERY MAIN SWITCH.

This switch is interposed in the main battery circuit, preferably close to the battery, to isolate the battery when the car is not in use, or in case of fire. The switch consists simply of a plain make-and-break action with heavy contacts capable of carrying the starter current. The switch contacts may be held open by spring pressure and the on position made by screwing in or depressing and turning a knob. The ignition control may be coupled with the switch. For magneto ignition the off position joins two contacts in parallel with the ignition switch, thus earthing the magneto contact breaker and preventing the engine from starting until the battery circuit is made by operating the switch. For coil ignition the off position prevents any feed to the coil, so that no extra contacts are required.

QUESTIONS AND ANSWERS

What is the current consumption of (1) a motor-driven type of electric horn, and (2) a high-frequency horn ?

- (1) Between 6 and 8 amperes for 6-volt horns, and 4 and 5 amperes for 12-volt.
 (2) Between 5 to 6 amperes for 6-volt, and 3 to 4 amperes for 12-volt.

How would you time the rotor of an electric screen wiper ?

The contacts should be open when the concentric part of the periphery of the

rotor is opposite the pole piece, and closed when the edge of the stator pole covers a tooth of the rotor by about one-third of its length.

What does an electric petrol pump consist of ?

This consists of an electro-magnet to which is coupled an electric piston working in a pump chamber and operating an inlet valve from the tank and an outlet valve to the carburetter.

FURTHER NOTES ON ELECTRIC LIFTS

By L. J. GOOCH, A.M.I.E.E.

MAIN LIMIT SWITCH OPERATING GEAR.

THE ultimate main limit switch should come into action in either direction if the lift travels a pre-determined distance past the point at which the control limit should stop it. This distance varies from something in the order of 3 in. to a foot, depending upon the available over-travel and the speed of the lift. Bear in mind the fact that an improperly adjusted brake or main contactor will affect the stopping of the car. If the brake is too slack, the machine may slide on past the control limit, with the current switched off and the brake on, and may knock out the ultimate main limit switch. As this is almost invariably of the type which does not re-set itself, this constitutes a stoppage of the lift until it receives attention from the lift engineer.

What to Inspect First.

When you first inspect the machine, investigate the action of the main limit switch, and from these, and the previous, notes (see page 905), and your observations, decide how it should be

re-set. The ultimate main limit switch is usually operated by a striker on the car, which strikes a stop on an endless wire rope operating the limit switch in the motor-room through this rope which runs the whole travel of the lift, round a sheave at one end of the lift shaft, and round the operating sheave on the limit at the other end of the lift shaft. Such a stop is clearly seen in Fig. 9, page 912.

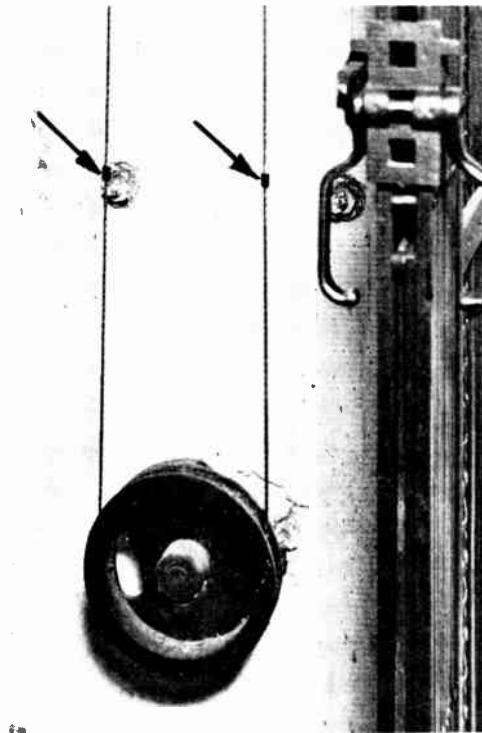

Fig. 1.—How to ensure main limit is properly re-set.

A small piece of insulating tape is wound round each side of the limit line, within reasonable proximity to the operating wheel, as indicated by the arrows. The correct position for re-setting is obtained when the two pieces of insulating tape are opposite.

Adjusting the Stop.

The adjustment is made by moving the stop on the rope in the desired direction, being careful to lock the stop securely when once it is in position. To set it, allow the lift to stop on the control limit (which must be set in accordance with instructions given later); then, with the main limit switch in, move the stop on the rope to the desired distance from the striker, this distance being equal to the distance it has been decided to allow the lift to travel after over-running the control limit, before the main limit operates. The stops should be inspected from time to time to see that they are securely fixed to the operating rope.

If you find that

the lift has knocked out the main limit for any reason, inspect the limit to see in which direction it has been knocked out. That is to say, the direction in which the operating wheel has been rotated. You must then wind the machine away from the limit, and turn the operating wheel in the proper direction, i.e., the reverse direction, to re-set.

A Simple Test.

A simple method of testing the direction in which the limit has been knocked out is

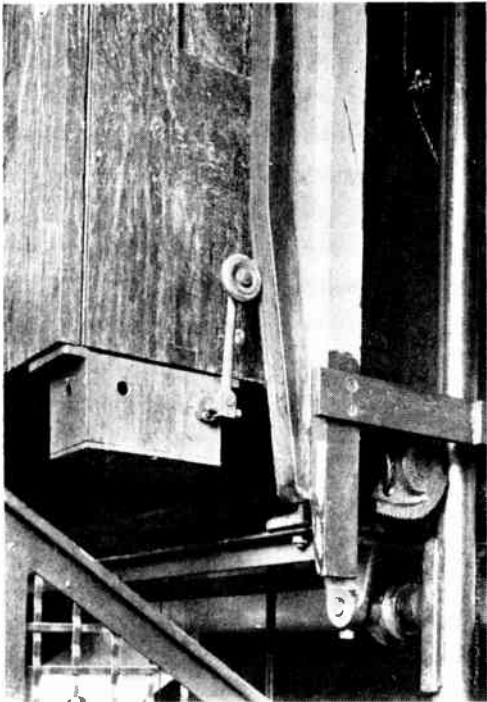

Fig. 2.—CONTROL LIMIT SWITCH MOUNTED ON THE BOTTOM OF THE CAR.

The switch illustrated is the "up" control limit, and the operating ramp is clearly shown. The method of arranging the ramp in this case is interesting and ingenious. The ramp for the control limit is attached to the ramp for the slowing limit, see also Fig. 4.

by turning the wheel backwards and forwards (about half a turn will usually suffice). In one direction the stop will prevent the wheel from being turned far enough to re-set the limit. The

machine must then be wound to permit the wheel being turned in this direction far enough to allow re-setting. This is important, as in the design of most types of ultimate main limit switches, provision has been made for the lift to run some distance after operating the main limit, and it is therefore possible to rotate the main limit wheel through a complete turn and wrongly re-set the limit. When the limit is once properly set, it is a good idea to put a small piece of insulating tape round the rope on each side of the limit wheel (see Fig. 1), the pieces of tape being opposite each other when the limit is set in the correct position. This will act as a permanent indicator for correct resetting.

Main Limit Switch for Drum-driven Lifts.

On drum-driven lifts, the main limit switch is usually operated direct from the drum through a reduction gear, which frequently takes the form of a screw. As the screw rotates, a sliding nut travels along it until, at the end of the lift travel, it comes into contact with a stop, which operates the limit. The adjustment is by unlocking the locking ring, which is that remote from the travelling nut, turning the stop nut a small fraction of a turn in the requisite direction and locking up again. The locking collars are usually fitted with holes for a tommy bar or special spanner.

Main limit switches should disconnect the brake circuit from the remainder of the circuit as well as disconnecting the lift from the electrical supply. This prevents the brake from being held off by regenerated current from the motor and ensures its instantaneous operation.

Test the Main Limit Occasionally.

It is a good thing to test the main limit occasionally by holding in the appropriate contactors on the controller and allowing the main limit switch to stop the lift. It should do this before either the balance weight or car strikes the buffers—according to the direction of travel. Make the test in both directions.

All working shafts and spindles should be lightly oiled to prevent rust and ensure easy operation.

CONTROL OR DIRECTION LIMIT SWITCHES FOR CAR-SWITCH LIFTS.

The setting of the control limit switches may be adjusted by sliding the ramps up or down on their fixing. The "up" control limit should be set to stop the machine level with the top floor when the car is fully loaded. This means that when the car is empty, and is allowed to stop on the "up" control limit, it will overshoot the floor by an inch or two according to the speed of the machine. Similarly, the "down" control limit should be set to stop the machine level with the lowest floor when the car is empty. It will follow from this that when the car is fully loaded, it will stop on the limit an inch or two below the lowest floor.

If this setting is adopted, it is always possible to get the car dead level with the top or bottom floor under all conditions of load. Don't forget that the brake adjustment also affects stopping, so this must be checked before adjusting the control limits.

Adjustments.

Some control limit switches are operated by an arm with a roller, which arm is attached to the spindle of the switch by a friction grip. Small variations of adjustment may be obtained by slightly slackening the friction grip, rotating the operating arm a few degrees round the spindle in the desired direction, and locking up again, Fig. 3. Be careful not to use this adjustment to excess, otherwise a position of the lever may be reached where the ramp would rather bend or smash the lever than rotate it.

Bear in mind the fact that if the control limits are not adjusted so as normally to stop the lift before the ultimate main limit switch is reached, annoying stoppages will occur due to unnecessary operation of the ultimate main limit switch.

Slowing Limits on High-speed Lifts.

On high-speed car-switch lifts fitted with two-speed devices, it is usual to fit auxiliary slowing limits, which definitely bring the machine on to the slow speed before it reaches the control limits at the extremes of travel, Fig. 4. The action of these switches is similar to the control

limits—but they come into operation farther away from the extremes of travel. All limit switches should be kept clean internally, and the spindles should be kept lubricated with light machine oil. It is sometimes advantageous to give a slight smear of oil or vaseline to the contacts if they are of the knife type.



Fig. 3.—MAKING A FINE ADJUSTMENT ON THE CONTROL LIMIT SWITCH.

This is done by rotating the operating arm through a few degrees on the spindle.

Control Limit Switches on Drum-driven Lifts.

These are usually situated in the motor-room, and are operated from the drum through a reduction gearing, arms held by friction grips usually operate the contacts.

The best method of adjusting is slightly to slacken the friction grip, and move the arm about its spindle by gentle tapping, not forgetting to lock up the gripping arrangement before the limit is tested. The direction in which you should move the arm will be obvious by inspection.

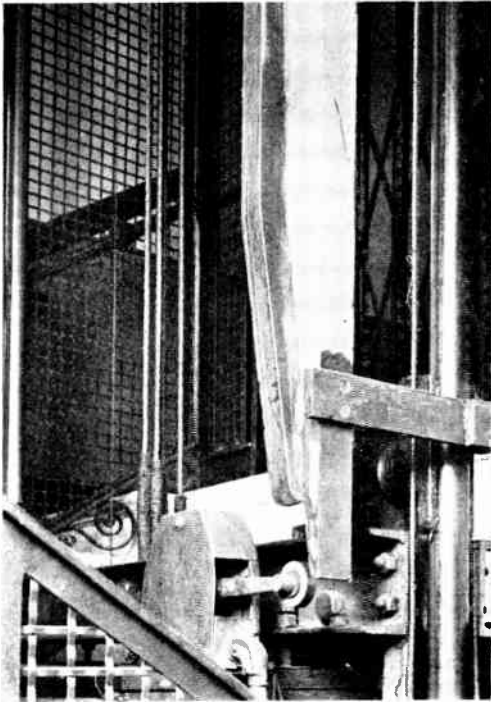

Fig. 4. SLOWING LIMIT SWITCH ARM: JUST ABOUT TO STRIKE THE OPERATING RAMP AUTOMATICALLY TO REDUCE THE SPEED OF THE LIFT WHEN APPROACHING THE TOP FLOOR.

Note method of fixing this in conjunction with the control limit ramp. See also Fig. 2.

Prevention of Stoppages due to Car Gate Vibrating Open.

If you find that a car gate works open, due to vibration during the travel of the lift, and causes annoying stoppages, it may easily be prevented by filing a nick in the top track with a half-round file, at the point which the leading roller reaches when the gate is closed, Fig. 5. About half a dozen strokes with a good half-round file is all that is necessary to make a nick, into which the roller will drop when the gate is closed. The nick should not be filed too deeply, otherwise difficulty will be experienced in opening the gate.

While inside the car, inspect the car switch.

Car Switch.

The cover should be removed and the contacts cleaned. The interior of the switch, particularly the insulation, should

be wiped clean with a piece of rag (with the current switched off). All working parts must be lightly oiled with machine oil. Make sure that good contact is made in the car switch just before the operating handle reaches its extreme position. See also that the centring spring is functioning correctly and returns the switch to the "off" position the moment the handle is released.

Push-button Box (in Car).

With push-button machines, remove the cover of the push-button box and clean the push contacts. Particular attention should be given to the "stop" push. This should be fitted with a strong spring, and should make good contact. A weak "stop" push spring is a frequent source of annoying stoppages on push-button lifts. The same applies to landing-call pushes.

False Car Floor on Push-button Lifts.

Push-button passenger lifts are usually fitted with a false floor in the car, Fig. 6. This is hinged, and when the car is empty the floor is held up about half an inch to an inch above its normal level by means of a spring. As soon as anyone stands on the floor, their weight causes the floor to sink and operate switches situated below it.

The floor must be absolutely free in action. It is essential that the floor should be raised at every maintenance visit and all dust and dirt cleaned out, Fig. 6. The hinges and the spindles of the springs which raise the floor must be lubricated. The switches should receive periodic attention similar to that given to the control limits.

If the floor is not absolutely free in operation, it may stick down, causing a "breakdown" due to its being impossible to call the lift from the outside landings, or it may stick up, so that when anyone is in the car interference can occur from outside landing buttons, and also if a switch is fitted in parallel with the car-gate contact, a dangerous condition may arise due to it being possible to operate the lift from the car with the gate open.

Car Sling and Safety Gear.

The rope anchorages on the car should



Fig. 5.—PREVENTING THE CAR GATE FROM VIBRATING OPEN.

The leading roller of the gate, as well as carrying the gate, operates the gate contact. It drops into the nick indicated by the arrow, which effectively prevents the gate from vibrating open and breaking contact.

be inspected frequently. If they are above the car, inspect them from the top of the car as previously described. If below the car they should be inspected from the pit, by getting into it in a manner similar to that employed for getting on to the top of the car.

Test the Safety Gear.

While inspecting the rope anchorages, test the safety gear. If of the usual "dog" type, catch hold of the dogs or their shafts and make sure that the shafts are free to rotate, Fig. 7. See that the operating mechanism is in order; oil all moving parts with light machine oil. If you examine the safety gear to find the principle on which it works, the parts which require oiling will be apparent. One of your chief aims must be to prevent rust on the safety gear, for as this gear is seldom called upon to operate, it is liable to become solid with rust and dirt if not properly looked after. If the safety gear is ever required, it will be required very badly, and it is up to you to see that it is not found wanting.

Examine the Operating Gear.

If the lift is of the high-speed type, and

the safety gear is of the delayed action governor type, see that the operating drum is free, that the right- and left-hand screws are clean and well lubricated, and that the toggles are free and well lubricated.

Inspect all nuts and bolts on the sling and safety gear and make sure that they are tight.

Guide Shoes and Guides.

Inspect the guide shoes. See that the housings are securely fixed to the sling and, if of the spring loaded type, see that the spring tension is not too heavy. This may be tested by rocking the car backwards and forwards in the direction of a line passing through the two guides. This should be accomplished with ease, but there should be not more than $\frac{1}{4}$ in. side-play.

Correcting Side-play.

If there is abnormal side-play, there is a possibility of the guide-shoes jumping the guides, and the play must be taken up. This side play is *not* taken up by increasing the spring pressure.

If slotted holes are used on the bolts fixing the shoe housings, the housing may be moved nearer to the guides and play thus

taken up on either side. Don't forget that it may be necessary to slacken the spring pressure after you have made this adjustment. If slotted holes are not fitted, the housings and guide-shoes should be removed one at a time and a large washer of the requisite thickness placed on the shoe spindle between the shoe and the housing, Fig. 8.

If the shoes are fitted with oil reservoirs, or spring-feed lubricators, these should be replenished. If not, then the guides must be lubricated by travelling *down* the lift shaft on the top of the car, stopping at intervals to lubricate them.

Correct Guide Lubrication.

Steel guides should be lubricated with machine oil, dropping the oil from a can on to the guides and smearing it over by hand or a piece of rag. Timber guides require infrequent lubrication, and this should be carried out with graphite and water mixed to the consistency of paste, and painted on with a brush. The water dries, leaving the graphite, which, with running, soon acquires a smooth, shiny surface. If you find that timber guides have been lubricated with grease and graphite, or grease alone, it is obviously useless to apply graphite and water, although this would have been the correct lubricant to use in the first place. If grease has once been used, a mixture of tallow and graphite is the most satisfactory and may be applied by hand or with a rag. In either case, it is a dirty job.

Examine the Guides Regularly.

The guides should be examined regularly to see that the fixings have not worked loose, either where the brackets are built into the wall, or where the guides are fixed to the bracket. Looseness may be detected by rocking the car backwards and forwards in the guides, watching at the same time to see if these move.

ROPES.

These should be examined for wear at least once a month on busy lifts. In the early stages, evidence of wear is shown by the polished appearance of the ropes on the portions which pass over the sheaves.

Later on, individual strands of wire break and stick out from the rope. These may be detected by a slight clicking sound as the rope passes over a sheave, or by examining a section of the rope at a time, moving the cage up and down the lift shaft, and lightly rubbing a handful of waste along the rope, being sure that the hand is well covered with waste, Fig. 9. Do not grip too tightly, otherwise nasty scratches may be experienced. The broken strands or "needles" indicate their presence by catching the waste. One or two "needles" are not usually serious if distributed throughout the length of the rope, but a number of "needles" at one place, or general "needling" indicates that a new rope should be fitted at once.

Do Not Lubricate the Ropes.

Steel wire lift ropes should not be lubricated unless they run in the open air or other corrosive atmosphere, when oil or grease should be applied to prevent rust. Otherwise oil or grease is detrimental in that it causes slip on the driving sheave and collects dust and grit, which wears both the rope and the sheave. The hemp core of all steel wire lift ropes is impregnated by the makers with a special compound, which, owing to the pressure exerted on the twisted strands under load, is slowly exuded between individual wires. This compound prevents rust. Ropes should be kept clean by wiping from time to time with a piece of rag damped with paraffin.

LANDING GATES AND GATE LOCKS.

With regard to cleaning and lubricating the locks and the gates, they should have the same attention as the car gate and contact. It is important that the cover of the locks should be securely attached, as this frequently affects the operation of the internal mechanism. When you remove a cover, be careful where you put the fixing screws, so that you will be able to find them again. It is impossible here to give detailed instructions for the adjustment of every type of lock on the market. What you should do is to get on the top of the car, opposite one of the landings, and with the current switched off, remove the lock cover, Fig. 10. Hold the lever of the lock in the "unlocked"

position and close the gate. Now release the locking lever. If you do this half a dozen times, the action of the lock should be apparent, and its adjustment a matter of common sense in conjunction with the following notes. When doing this, be careful that no part of the "works" falls out.

and must be readjusted. If the lock is of the type which is operated merely by the closing of the door or gate, then close the door or gate very slowly, with your mate operating the car switch or push button, as before, until

Testing Landing-gate Locks for Safety.

Each lock should be tested every maintenance visit for safety.

A test may be best carried out as follows:—

1. Try and open the landing door or gate when the lift car is away from the floor level. This should be impossible.

2. Having brought the lift to the floor at which the test is to be made, leave the landing door or gate open and try and run the car away. This should be impossible.

3. Station your mate in the lift car, close the car gate and, if a car-switch lift, tell him to hold the car-switch over, so as to cause the lift to travel in one direction or the other, as soon as the landing door or gate is closed (remember that at the top and bottom floor the lift can only travel in one direction). If a push-button lift, let him keep his finger firmly pressed on one of the buttons for a floor other than that which is being tested, so as to cause the machine to run as soon as the lock circuit is closed.

If the door or gate lock is of the type that is unlatched by the operation of the handle, close the door or gate, holding the handle in the "open" position. Then gradually release the handle until the lift starts to move. Immediately the lift moves, hold the handle in that position and allow the car to move so far away from the floor that the lock-operating ramp is clear of the lock lever. Now release the handle and again try to open the door or gate. This should be impossible. If it is possible, the lock is dangerous



Fig. 6.—RAISING THE FALSE FLOOR OF AN AUTOMATIC PUSH-BUTTON LIFT TO INSPECT AND CLEAN THE CONTACTS.

One of the spring plungers which raises the false floor when the lift is unoccupied is clearly seen, as is also the main junction box, and one of the contacts. (The latter adjacent to the fitter's right foot.)

the lift moves away, stopping the movement of the door or gate immediately the lift moves. Then, when the car is some distance away from the floor, try and open the gate.

Testing Gate Locks for Reliability.

Run the lift and when it is some distance away from the lock which you are testing, try and break the control circuit to stop the lift by operating the lock handle or

pulling the door, according to the type of lock fitted. This should be impossible. If it is possible, then the lock should be readjusted.

After having made any adjustment to the locks, all the foregoing tests should be

from the floor, and, of course, impossible to open the door.

Lubricating the Lead Sheaves.

Don't forget to lubricate the lead sheaves, if there are any. The bearings on these usually have wick feed lubricators, ring lubricators, oil bottles or grease caps of the Stauffer type. If either of the first two are fitted, replenish with machine oil: if the latter, then replenish with grease. If they are of the screw-down type, screw them down while the machine is running, and make sure that the grease works out through the bearings. A better type is the grease lubricator of the spring feed type, which should be filled up at each visit, so that the pressure of the spring gradually feeds the grease to the bearing. Don't forget to release the spring when you have filled the lubricator, to allow the grease to be fed.

Maintenance Sequence.

It is probable that all the foregoing points will not require attention every maintenance visit, but to ensure that every component receives regular attention and is not forgotten, the writer suggests that a printed card, on the lines illustrated in Fig. 16, be hung in the motor-room and entered up every maintenance visit in the same way that the meter card is entered up by the supply company's inspector. In this way a definite record of the dates on which various components received attention is obtained.

The frequency of inspection and adjustment of each component varies with each lift, but experience of a particular machine will decide the proper intervals. Parts such as controller, motor, guides, safety gear, etc., should receive attention every visit.

SLINGING THE CAR AND BALANCE-WEIGHT.

To perform certain major repairs to a lift, e.g., dismantling the gear, renewing



Fig. 7.— TESTING THE SAFETY GEAR.

Making sure that the rope safety gear is ready to operate if required, by rotating the shafts carrying the dogs, while standing in the pit below the car.

carried out before the lock is passed as safe and satisfactory.

Some locks are fitted with two locking positions. The position which locks last when the gate is closed should always operate. If you close the gate or door slowly, so that it locks in the first position only (Test 3, above), it should be possible to break circuit in this position when the lift car is not at the floor, but it should be impossible to open the door. In the final locking position it should be impossible to break the circuit when the lift is away

the ropes, etc., it is necessary to take the load off the ropes by slinging the car and balance-weight. This may be done in a number of ways, depending upon site conditions and the particular repair which is to be carried out. First decide whether the car or the balance-weight should be at the top of the shaft, and having done this, put the car and balance-weight approximately in position.

NOTE.—Before lifting the weight off the ropes, it is desirable to lash the ropes to pieces of wood on either side of all sheaves, in such a way as to maintain the individual ropes in their proper position, Fig. 11. This will greatly facilitate putting the ropes on the sheaves again.

First Method.—Put heavy timber packings under the balance-weight, so that it may be landed at a convenient height above the pit, Fig. 12. Wind the machine by hand, until the balance-weight lands on this timber packing, making sure that the packing is secure. Then, having tied up the ropes as previously described, fix lifting tackle to the overhead joists, fit a wire rope sling round the cross-head of the car and raise the car on the tackle, Fig. 13.

Second Method.—Get the lift car into position in the lift shaft slightly above that at which it is desired to sling it. Put a sling round the cross-head on the car and the overhead joists and make fast. (In using wire rope slings it is desirable to secure them by means of rope clips.) Wind the machine down until the weight of the car is taken by the sling. Then, having tied the ropes as previously described, raise the balance-weight by means of tackle from above, or else by means of a jack from below. An emergency method, which may have rather a detrimental effect upon the guides, is to wind the car down near to the upper level while your mate turns in the safety gear cams at some convenient point. When these cams have securely gripped the guides, you may raise the balance-weight as just described.

Slinging the Car and Balance-weight, Car at Bottom of Lift Shaft.

Cut suitable lengths of heavy timber, e.g., 9 in. by 3 in. section; two lengths will

usually suffice. The lengths should be such as to support the car at a convenient height above the bottom floor to enable you to get into the lift pit below the car. Remember that the only safe place in which to put the struts is such that the car rests upon some portion of its supporting sling or frame. A convenient position is often adjacent to the car guides, the timber being placed alongside the guides and secured to them by means of string, to hold it in position until the load of the car rests upon it.

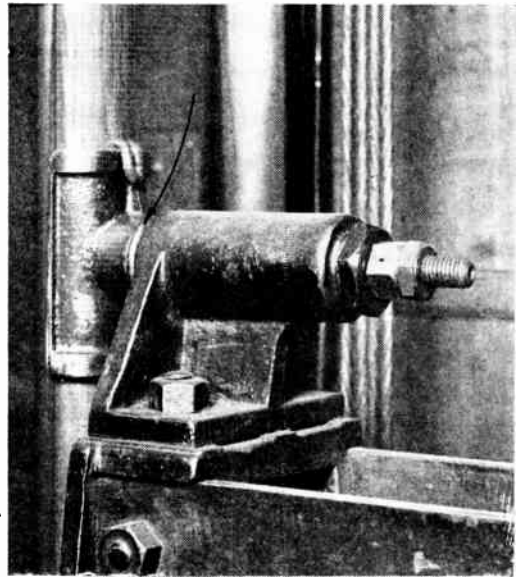

Fig. 8.—TAKING UP SIDE PLAY IN THE GUIDE SHOES BY MEANS OF DISTANCE COLLARS OR WASHERS.

The collars are indicated by the arrow.

Having put the timber in position, wind the machine by hand until the car under-carriage rests upon the timber. The balance-weight can now be raised at the upper level by means of tackle slung from the overhead joists in the same way that the car was raised in the first method described. Don't forget to lash the ropes to pieces of wood before taking the weight off them.

FITTING NEW ROPES.

There are many methods of doing this, varying with site conditions, method of



Fig. 9.—TESTING THE ROPES FOR "NEEDLES."

attaching ropes, etc. One method will be described which will form a useful basis for fitting ropes on any lift.

Preliminary.

The ropes have to be measured and ordered from the makers. One way of measuring the ropes is to switch off the current and run a ball of string over the various sheaves, following the line of the ropes. Remove the string and measure this. Don't forget to allow for the fixings at the ends of the rope, which will probably require several additional feet. Don't forget also that the ropes are probably fixed below the car, so that you must allow for the length of rope which encircles it. Inspect the actual rope fixings on the car and decide whether it would be more convenient to have these made by the rope makers in the works.

"Eye Splice" Type.

For instance, if the anchorage is of the "eye splice" type, it may be possible to have these eye splices formed in the ropes before they come on the job. On the other hand, this may involve threading the whole of the rope (perhaps several

hundred feet) through inconvenient holes in castings, and round awkward corners. Only common sense can guide you in deciding what you ought to do.

Measuring the Size of Rope.

Measure the diameter of the rope with a caliper gauge. If the measurement which you take comes between two standard sizes of rope, then order the larger size, as the reduced measurement which you have obtained will probably be due to rope wear or the strands of the rope having bedded together owing to the tension on them. Do not use the smaller size, as this may drop to the bottom of the "vee" sheave and cause rope slip.

Having obtained the ropes from the rope makers, and had them delivered on the site, get them to the top floor by means of the lift. If you put the lift out of action before you do this, you will have to carry them up the stairs, and they are of very considerable weight. Make suitable provision at the top floor with sacking or dust-sheets, to prevent damage to the surrounding decorations, etc.

Supporting the Balance Weight.

In the case we are considering, the ropes were originally secured below the car by means of leaded ends in cups, and on the balance weight by means of eye splices or clips, and adjustable eye bolts. Get a strut of timber to support the balance weight at such a height that you will be able to get on to the top of the car from the upper floor, and reach the underside of the car from the floor immediately below. If the car is very large, so that you cannot conveniently reach the rope anchorages from the landing, it will be necessary to form a temporary scaffolding below the car from which you can work.

Having wound the machine so that the balance weight rests on its strut, mark the car and some portion of the lift shaft, so that you will be able to compare its position when the new ropes are fitted. Now lash the ropes and sling the car, as previously described, raising it as small a distance as possible (not more than 6 in.).

Removing the Old Rope.

Now unlash one rope. Detach the eye bolt from the balance weight and pull some slack rope back on to the car. Push this slack rope round the car so that you can draw the cup away from its stop, slide the cup back a little way up the rope and bind the rope with twine on the side of the cup remote from the leaded end.

NOTE.—It is always necessary to bind a wire rope with twine or wire before cutting it in order to prevent the strands from unravelling.

Cut off the leaded end with a hammer and chisel and draw off the cup. Now draw the rope back round the car, making careful note of the way it is led round, so that you will be able to put the new rope on in the reverse direction. This gives you the free end of the old rope on top of the lift car. Bind the old rope a distance of about eighteen inches from the end, undo the original binding and allow the rope to unravel for this eighteen inches.

Fixing the New Rope to the Old.

Cut off all the strands except two. Bend these two strands back on themselves and securely bind with twine, so as to form a loop, see Fig. 14. Repeat this process with the end of the new rope, only before you form the loop, pass the two strands through the loop formed in the old rope, see Fig. 14.

Pay Out the New Rope Carefully.

Now station your mate in the pit to haul on the old rope and coil it up in the pit while you pay out the new rope from its coil. It is essential that the new rope is paid out carefully from its coil; otherwise, owing to its springy nature, it may unroll and get into such a tangle that it may take you a day or so to unravel. Let your mate go on hauling until the end of the new rope has come down to him, and your end of the new rope is accessible to you. Now thread your end of the new rope back round the car in the way followed by the old rope. Pass the rope through the anchor lug and through the cup.

Securing the New Rope to the Car.

Form a "Turk's head" in the new rope,

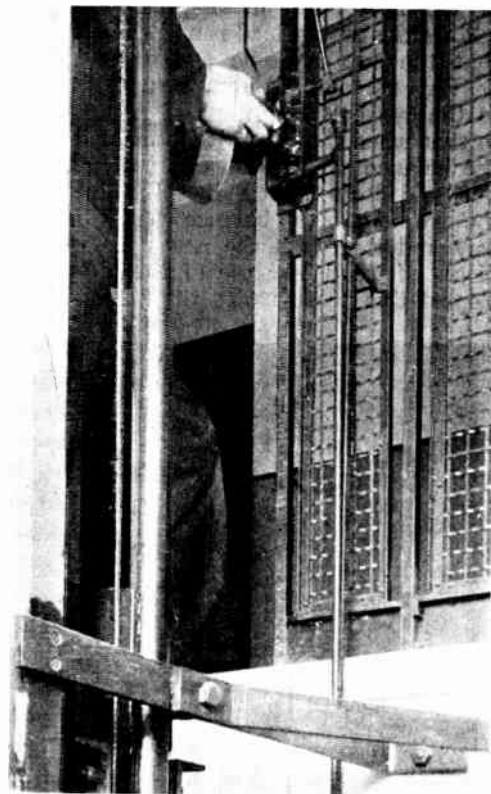

Fig. 10 —INSPECTING THE INTERNAL MECHANISM OF AN ELECTRO-MECHANICAL LANDING GATE LOCK.

The top of the car is being used as a platform from which to work. The car crosshead and one of the guide shoes are seen in the bottom left-hand corner of the illustration.

as shown in Fig. 15. This is a simple and satisfactory substitute for a leaded end and is done by binding some iron wire round the rope about a foot from the end. This binding should be to such a thickness that when the strands of the rope are turned back over it, as shown at A in Fig. 15, it is quite impossible for it to be drawn through the hole in the back of the cup. Undo the string binding at the end of the rope, and bend the strands back on themselves, passing through the strands in the rope and back again, as shown. Cut off the spare ends and draw back into the cup, B, Fig. 15.

Fixing the Eye Bolt to the Balance Weight.

Now let your mate pull up on his end

of the new rope, making sure that it follows the proper lead round the car and that the cup is home against its stop, C, Fig. 15, and let him secure his end to the eye bolt by means of a rope clip, so that when the eye bolt is put back into the balance weight you can just get the nut and lock-nut on it. Let him fix the eye bolt to the balance weight in this way and then lash the new rope to the pieces of wood in place of the old rope. Repeat this process with the other ropes.

from the mark originally made on the car and the lift shaft, and make the eye splice. If you cannot make an eye splice, two rope clips firmly secured will make a perfectly satisfactory, though not so neat, job. Bind with twine and cut off the spare ends of the ropes at the balance weight fixing.

Getting Equal Tension on the Ropes.

Now, having again unslung the car, get equal tension on the four ropes by adjusting

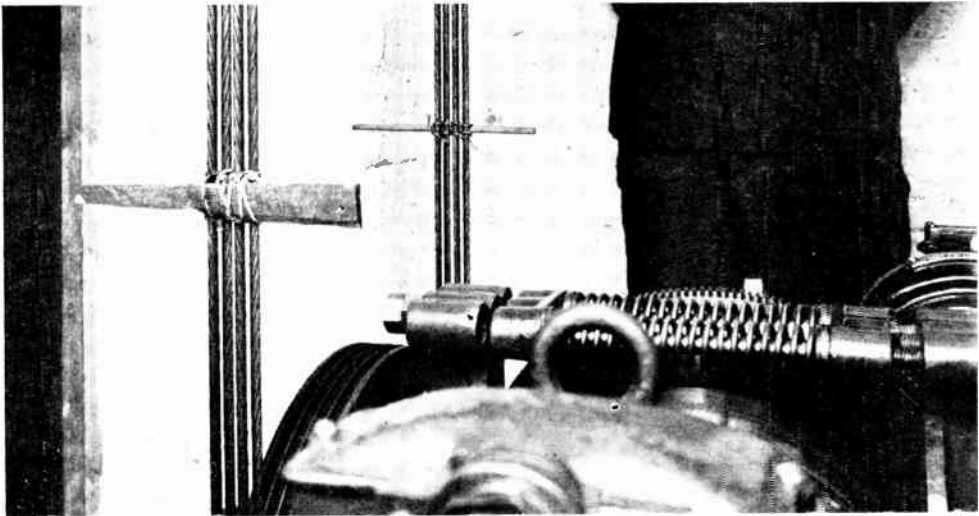

Fig. 11.—METHOD OF LASHING LIFT ROPES TO ODD PIECES OF TIMBER PRIOR TO SLINGING THE CAR AND BALANCE WEIGHT.

Lashing is to prevent ropes becoming crossed when they are slack, and should be carried out on either side of all the sheaves. It is here shown on either side of the "V" driving sheave.

Don't forget to tie up the coils of old rope as these are removed.

Check the Position of the Car.

Lower out the tackle until the car hangs on the ropes. Check its position with the mark you made originally. If it is an inch or so above the mark, this will not matter, as the ropes will probably stretch this amount. If it is an inch or so below, you will probably be able to adjust on the adjusting screws on the balance weight.

If you can make an eye splice on to the eye bolt at the balance weight, then lift the load of the car again on the tackle. Make the necessary adjustment in the length of the rope which you have judged

the individual eye bolts. Test the tension by pressing the rope somewhere near the middle of the lift shaft with the finger, so as to deflect the rope. Try each rope, using, as nearly as you can judge, equal pressure on each, and see that the deflection is the same for each rope. A more accurate method is to use a spring balance hooked on to the rope to deflect the rope a given number of inches from the line of the other ropes, for a given reading on the spring balance.

NOTE.—This is not, as a rule, necessary if equalising gear is incorporated in the rope anchorages.

Unslung the car, unlash the ropes, clear scaffolding, old ropes, slings and tackle out of the shaft.

Make Sure the Main Limit has Operated.

Wind the balance weight on to its buffer and make sure that no portion of the lift car can come into contact with the overhead joists. Also that the floor of the lift car has risen a reasonable amount above the top floor level and the main limit has operated. Wind back again, re-set the main limit and run the car down somewhere near the bottom floor ; wind the car down on to its buffers, make sure that the main limit has operated and that the rope clips do not foul the overhead joists or sheaves. It may be necessary to adjust the length of the ropes or, if the over-travel permits it, adjust the buffers.

NOTE.—If the lift is a push-button lift, with a floor selector in the motor-room, it will probably be necessary to readjust the floor levels. This will be done by taking up one end of the selector drive and slacking out on the other. (See note on "Setting Floor Levels.")

OPENING UP THE GEAR CASE.

If the gear is in any position other than immediately above the lift shaft, it is essential that you sling the car and the balance weight before you break the main gear case joint ; also, if the gear is above and has a spur reduction gear additional to the main worm gear. If the gear is immediately above the lift shaft, and no outer bearing is fitted on the side of the sheave remote from the gear, it is equally necessary to take the load off the sheave. If, however, the gear is situated immediately above the lift shaft and is fitted with an outer bearing, it is not usually necessary to sling the car and the balance weight. If the worm is situated above the worm wheel, it will be necessary to land the balance weight and undo the coupling bolts before the top half of the gear case can be lifted : this is not necessary if the worm is below the wheel.

Mark the Two Halves of the Coupling.

Before you undo the bolts, be careful to mark the two halves of the coupling with a centre punch or scriber, so that the coupling may be reassembled with the two halves in the same corresponding positions. Having undone the bolts

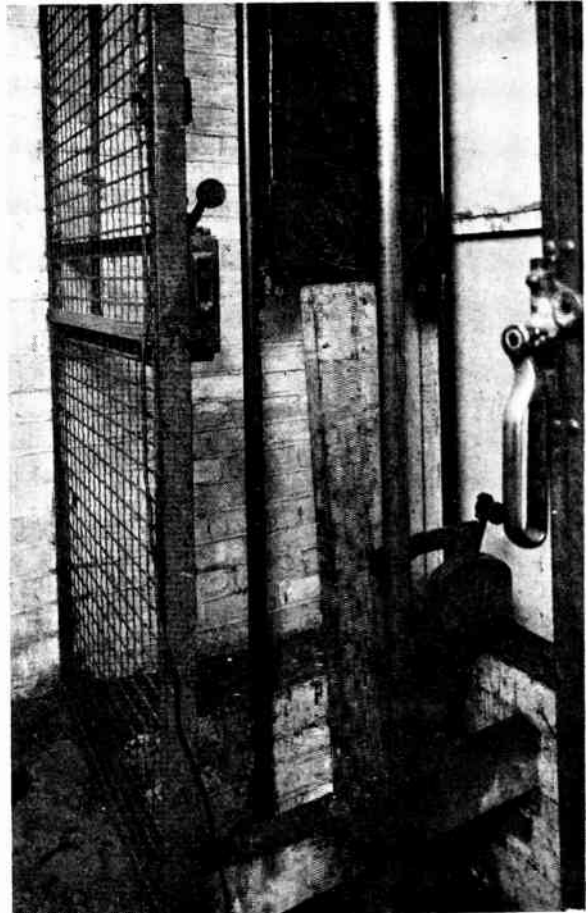

Fig. 12.—METHOD OF STRUTTING UP BALANCE WEIGHT WITH TIMBER PRIOR TO RAISING CAR.

The balance weight is placed slightly above the point at which it is required and the timber is then held in position while the balance weight is wound on to it by hand.

securing the two halves of the gear case together, raise the top half.

Remaking a Gear Case Joint.

Carefully scrape both halves of the joint : that is to say, that on the lower

portion of the gear case, and that on the upper, and get these absolutely clean by scraping with a jack-knife or scraper. If there are any burrs, these should be carefully removed with a fine file. If it was found that brown paper had been used between the two halves of the gear case, a new brown paper washer must be cut.

Cutting a Brown Paper Washer.

The best method of doing this is to get a sheet of brown paper of sufficient size, roughly cut holes in it to allow the worm wheel to pass through, then place the paper on the joint surface and cut the washer to shape by lightly tapping the paper on the edge of the gear case with a hammer. In this way an accurate washer, with the holes in the correct position, may be cut. Be very careful to make sure that the surfaces are free from oil.

Remove paper washer carefully and "paint" the lower portion of the joint with gold size or one of the many jointing compounds now on the market. Place the paper washer in position on the bottom half of the gear case, then evenly "paint" the joint surface on the upper half of the gear case with gold size. Allow this to become "tacky," then lower the top half of the gear case into position, being particularly careful not to disturb the paper washer, and bolt up.

The bolting up should be done by tightening each nut in rotation, a little bit at a time, having in the first place got all the nuts finger tight.

If no paper washer was originally fitted, then merely clean the joint surfaces and "paint" with gold size or other jointing compound.

FITTING A NEW FLEXIBLE CABLE.

Set the lift car so that its underside (where the junction box is almost sure to be fitted) is about three feet or so above the half-way point in the shaft where the half-way junction box occurs. Switch off the main switch and erect some form of scaffold across the lift shaft, below the bottom of the car, so that you may sit or stand on this scaffold and work at the connections in the half-way and car junction boxes. Fix the new flexible to

the old flexible close to one of the junction boxes by means of some insulating tape, leaving a sufficiently long spare end to allow for the ultimate fixing and connecting up of the cable.

Connecting the New Cable to the Old One.

Connect the new cable to the old one throughout its length by insulating tape at intervals of, say, every four feet. Cut off the new cable at the junction box, leaving sufficient length of cable for you to make all the requisite joints. Strip back the outer covering at both ends of the new flexible, so that you may get at the individual cables. You will find that the coverings of the individual cables in the new flexible have distinctive colourings—this will readily enable you to trace them out. The old cable may be coloured in the same way, though it is possible that the colouring will have disappeared, or been obliterated with age. If this is the case, you will have to "ring through."

Tracing the Connections.

Connect a bell in series with a dry battery, leaving the circuit open and having sufficient wire so that one end may be tied in a convenient position at the half-way point, and the other below the car. Disconnect one lead from the half-way point, and connect it to the bell wire. Test in the junction box under the car, with the wire on the other end of the bell circuit, until you find the lead that causes the bell to ring. Disconnect this lead and test again on the lead itself when it is disconnected, to ensure that you have not rung the bell through a circuit on the car. If you have, then replace the lead and try again until you can ring through on the individual flexible when it is disconnected at both ends.

Connecting Up.

Now connect up an individual lead of the new flexible (tracing the ends by the coloured braiding) in place of the old one which you have removed. Repeat this process with all the individual leads in the old cable, and in this way you will gradually substitute the new cable for the old. Disconnect the old flexible from its clamps and clamp up the new flexible. Replace

the lids on the junction boxes, undo the black tape holding the old to the new flexible, clear the old flexible cable out of the way and the job is done.

ADJUSTMENT OF FLOOR LEVELS ON AUTOMATIC LIFTS.

(a) Lifts Fitted with Shaft Direction Switches.

1. Be certain that all the direction switches are on a "plumb" line in the shaft or well hole and that individual switches are vertical.

2. Make sure that the lift is operating at its maximum speed; that the controlling contactors are opening smartly and that the arc is quickly extinguished.

3. See that the brake is adjusted to give as rapid stopping as possible without unpleasant jerk.

4. Test unloaded in the "up" direction and note levels at each floor thus (taking as an example a four-floor lift):—

	<i>Up Empty.</i>	
3rd	1 $\frac{3}{4}$ in. H.	
2nd	2 $\frac{1}{2}$ in. H.	
1st	2 in. H.	
Ground	—	

Make this test once or twice, to see if there is any variation. If there is variation, then further attention is necessary to the brake or contactors.

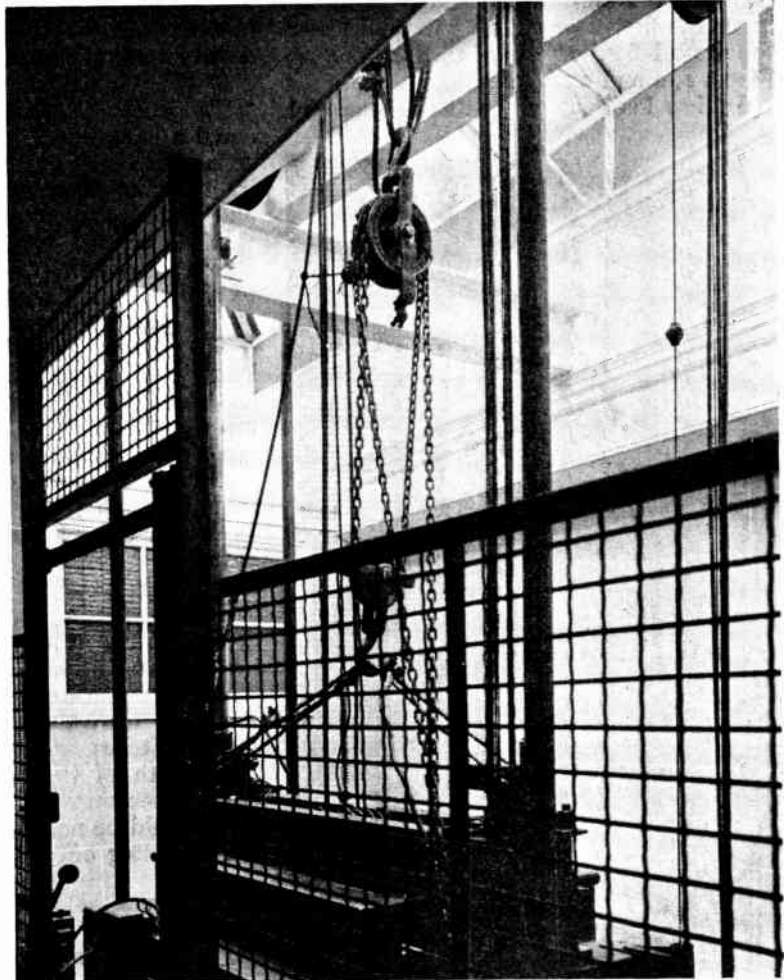

Fig. 13.—RAISING CAR ON TACKLE.

Note: one method of slinging car itself when crosshead is close down on top of car and rope sling cannot be passed under it.

5. Move the direction switches up or down as required to get all the readings alike. Then test again with the car empty.

Up Empty.

3rd	2 in. H.
2nd	2 in. H.
1st	2 in. H.
Ground	—

To achieve this result, the direction switch at Floor 2 was lowered $\frac{1}{2}$ in. and the direction switch at Floor 3 was raised $\frac{1}{4}$ in.

NOTE.—Another way of achieving an

equivalent result would have been to lower the first-floor switch $\frac{1}{4}$ in. and lower the second-floor switch $\frac{3}{8}$ in., thus making Floors 1, 2 and 3 $1\frac{1}{4}$ in. high.

6. Now load the car with full load and

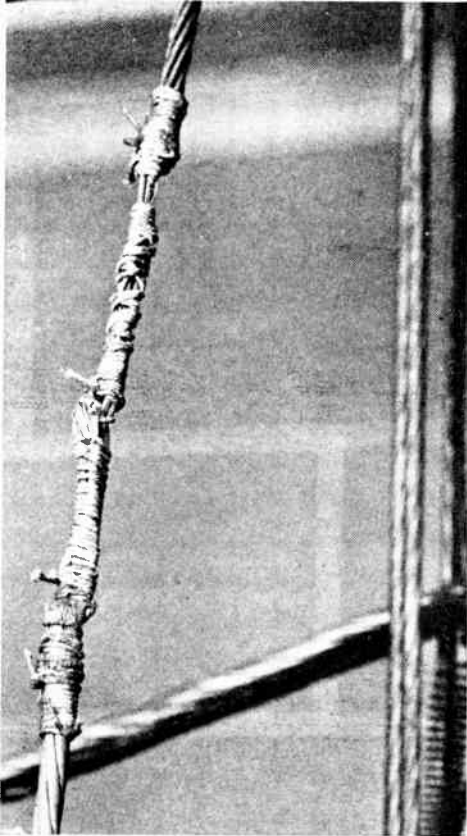

Fig. 14.—METHOD OF ATTACHING NEW TO OLD ROPE PRIOR TO PULLING OVER A NEW ROPE TO REPLACE AN OLD ONE.

Note rough binding on ends of each rope to prevent unravelling, also temporary binding to form the interlacing loops at ends of ropes. This is cut off the spare end of the new rope when it is finally fixed in position.

run down a floor at a time, testing the level at each floor as before.

Suppose the results are as follows:—

	<i>Down Loaded.</i>		
3rd	—
2nd	1 in. L.
1st	1 in. L.
Ground	$\frac{1}{2}$ in. L.

7. Lower the bottom direction switch half an inch, so as to get all the levels down loaded the same.

8. Now make the difference between "Up Empty" and "Down Loaded" equal 2 inches. Which will mean, in this case, that the ramp has to be lengthened by 1 inch. Most ramps comprise a top and bottom throw-in horn, or path, and a vertical central track. It is advisable before dismantling the ramp from the car to make a mark with a pencil from each of the throw-in horns to the car.

The ramp should be shortened or lengthened as required (in this case, lengthened 1 inch) and re-fixed so that the top throw-in and the lower throw-in horns are correct distances from their respective pencil marks (in this case the top throw-in is 1 in. higher and the lower throw-in as it was before). So long as the brake adjustment remains constant the lift will stop within 1 inch of floor level.

This forms a convenient and rapid method for setting floor levels on new lifts where it is generally necessary to correct inaccuracies which occur during erection. Once the correct position of the shaft switches and the correct position and length of the operating ramp have been determined, the only adjustment that should be necessary is to ensure that the retarding effort of the brake is kept constant.

(b) **Lifts Fitted with Gear-driven Selector Switches (Single Speed).**

1. Make sure that the lift is operating at its maximum speed; that the controlling contactors are opening smartly and that any arc is quickly extinguished.

2. Adjust the brake to give as rapid stopping as possible without unpleasant jerk.

3. Find out the "down" direction contact for the bottom floor and the "up" direction contact for the top floor and set the cams or strikers for these contacts to stop the lift some three to four feet before floor level is reached. This will secure you from over-running at the extremes of travel while setting the intermediate floors.

4. Station the lift at the lowest level unloaded, and get your mate to call it up

to the next floor by pressing the landing push, you being in the motor-room watching the selector. When the lift stops, the particular contact on the selector which caused it to do so will be apparent.

5. By trial and error adjust the cam or striker noted in (4) till the lift stops 1 inch above floor level.

6. Load the car with full load and repeat for this floor. The car should stop 1 inch low. If this is exceeded, then you must either readjust the brake or, if you are content with a greater error than 1 inch, you must readjust the cam or striker so that the car stops the same distance above the floor going up empty that it stops below it going up fully loaded.

7. Now adjust the next higher floor going up empty to the same degree of accuracy that you gave to the first floor. In this case it will not be necessary to test with the car loaded as the first test gave you the degree of accuracy to which you could work.

8. Repeat for all floors in the "up" direction.

9. Proceed in a similar manner with the car descending empty to the top floor but one, adjusting the contact cam or striker to stop the car *above* the floor by the amount (e.g., 1 in.) to which you are working.

10. Repeat for all other floors in "down" direction.

Once a selector has been correctly set, the position of the cams or strikers accurately represents the distances between floors, so that if the floor levels go out of adjustment it is only necessary to adjust the brake or main contactor of the lift or else adjust the selector drive; e.g., suppose the machine was originally set to stop within an inch of floor level for any condition of loading.

If the lift stops more than 1 in. high going up empty, and more than 1 in. low going down fully loaded, the brake spring pressure should be increased.

If, however, the lift stops, say, 3 in. high going up empty and 1 in. high coming down fully loaded, i.e., the difference between the two observations is still 2 in., but this "two-inch zone" is not symmetrical about the floor, then the selector

drive must be adjusted. This can be done easily if the drive is by a pilot rope and drum by slacking out the pilot rope 2 in. on the car and taking up 2 in. on the balance weight in the example under consideration. Some adjustment such as this will usually have to be made when new lifting ropes are fitted to the lift.

(c) Lifts Fitted with Gear-driven Selector Switches (Two Speed).

1. Set the lift for floor level, running it entirely on the slow speed, as just described for single-speed lifts.

2. By trial and error set the high-speed side of the selector so that the speed of the lift is reduced to the low value before the slow-speed side of the selector operates to switch off the motor and apply the brake.

NOTE.—All the foregoing methods of setting floor levels on automatic lifts assume that the weight of the balance weight is equal to the weight of the car plus half the rated load capacity of the lift.

If, for any reason, less than half the rated load is balanced (in addition, of course, to the car), then instead of using full load for the tests, the load used must be equal to twice the difference between the weight of the balance weight and the weight of the car.

Automatic Service Lifts.

Automatic service lifts which serve at a serving board above floor level should be set to stop level with or above the serving board under all conditions of load. If this is not done, and the lift stops below level, it will be difficult to unload trays or dishes from the bottom shelf.

EARTHING.

Where one pole or a neutral wire of an electric supply is earthed, it is essential that every component of the lift, e.g., push-button boxes, locks, gate contacts, etc., should be properly earth-bonded. This should be tested from time to time by arranging a circuit from a water pipe to a bell, and with from three to six dry cells completing the bell circuit through the casing of any component which it is desired to test. The continuity and

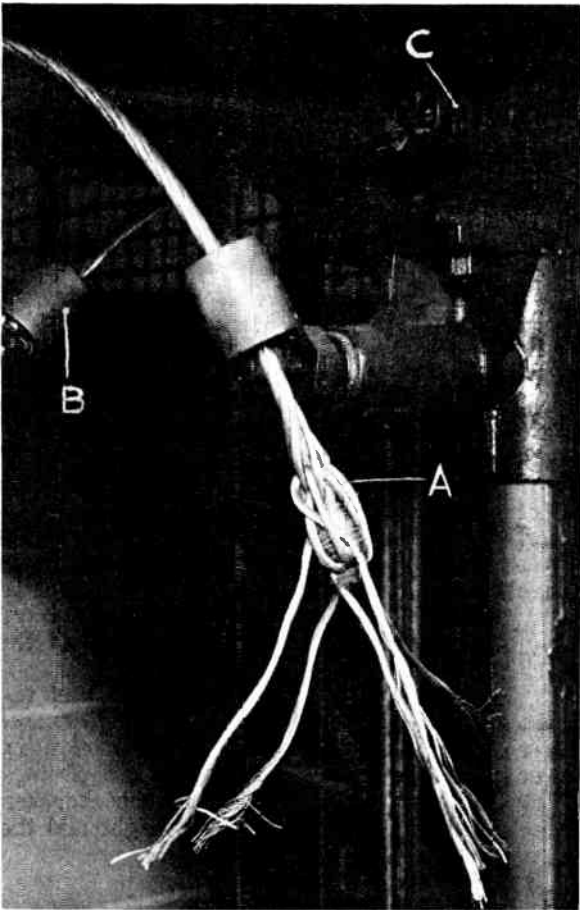

Fig. 15.—METHOD OF FORMING "TURK'S HEAD" FOR ANCHORING ROPES BELOW CAR.

If properly carried out, i.e., if "Turk's head" is so large that it cannot possibly be pulled through the cup, this is superior from the point of view of safety to a "leaded end."

(A) Shows formation of "Turk's head" before ends are cut off.

(B) Ends cut off and "Turk's head" drawn into cup

(C) Finished end in position.

earthing should be good enough to ring the bell.

A Quick Test.

A somewhat quicker method of testing is to switch off the main switch, connect the live side of one of the contacts in the component to be tested to its frame, and switch on the main switch. This should blow the control fuse.

If the earthing is not well carried out,

it is possible for faults to develop on the circuit and cut out one or all of the locks, so that the lift would operate with the doors open. It is unnecessary to stress the danger of such an occurrence.

If the earthing is good, the moment an earth fault develops, a control circuit fuse is blown, and attention called to the fact by the stoppage of the lift.

Unearthed Systems.

There are a few supply companies in this country who do not earth one pole of the supply, and lifts operating on these supplies should frequently have their insulation resistance tested between line and line and line and earth. It is also desirable to make a special test on the lock circuit itself, disconnecting the lock circuit, testing its insulation resistance to the conduit in which it runs and also the resistance between the two sides of the circuit, by opening the gate farthest away (on the circuit) from the controller.

FINDING FAULTS (GENERAL NOTES).

When investigating the cause of a stoppage on an electric lift, it is essential to have a definite sequence for the investigation. The golden rule is to test one thing at a time, and having tested it, try the lift to see if you have discovered the cause of the trouble. If you test several things one after the other, and then test the lift and find that you have corrected the fault, you will not know where the fault lay, and consequently will not know how to remove the cause or put your hand on the trouble should it occur again.

The "best" sequence of investigation varies with the machine and the investigator, depending upon various factors, such as the position of the main switches and fuses, position of motor-room, position in which lift has stopped, etc.

○ MAINTENANCE RECORD ○									
COMPONENTS INSPECTED & TESTED ON DATES INDICATED.									
JOB NO.: 1972 ADDRESS: 20, James St., E.C.17. LIFT NO. - 3 TYPE: Automatic Passenger.									
DATE	LANDING GATE LOCKS	CAR GATE CONTACT & FLOOR SWITCHES	MAIN LIMIT TESTED	CONTROL LIMITS OR SELECTOR	DIRECTION SWITCHES	CAR SWITCH OR PUSH PANEL	LANDING CALL PUSHES	SPECIAL FITTINGS	INSPECTOR
4-1-'31	5th floor	—	yes	Not fitted	4+5 floor	—	5	none	T. Smith
1-2-'31	G. floor	yes	—	}	G+1 floor	yes	6	}	J. Braung
7-3-'31	1st. floor	—	—		2+3 -	—	1		T. Smith
5-4-'31	2nd. floor	yes	yes		3+4 -	—	2		T. Smith
1-5-'31	3rd. floor	—	—		4+5 -	—	3		T. Smith
3-6-'31	4th. floor	yes	—		5+6 -	yes	4		T. Smith
REMARKS -									
8-3-'31	New lifting ropes fitted								S. Jones T. Smith
1-5-'31	Gear cleaned out & changed with fresh oil								

Fig. 10.—TYPICAL MAINTENANCE RECORD SHEET.

As an example, the writer is suggesting an elementary method as applied to a four-floor automatic push-button lift serving basement, ground, first and second floors, having the gear at the top. Experience will, however, enable you in time to go to a lift which has broken down and more quickly find the trouble by observing the position in which the lift has stopped.

Procedure for Tracing Faults.

If you approach the lift from the ground floor, go down into the basement and examine the main switches and fuses at the supply company's point of intake. Make sure that the fuses have not blown and that the main switch is *on*. Now walk up to the motor-room, examine the main switches and fuses there and make sure that the switch is *on*.

Why the Fuses May Have Blown.

If either of these fuses have blown the cause may be :

- (1) Excessive overload in the "up" direction.
- (2) The fuses having been too light in the first place and having warmed up slightly each time the lift was started, thus deteriorating until the current at

which the wire would fuse was reduced to a lower value than the starting current of the lift.

(3) An earth on the main circuit, e.g., motor armature or controller contactors, indicated by the blowing of one fuse only.

(4) A short circuit on the main circuit, indicated by both fuses blowing. This might be due to trouble on the controller connected with the interlocks between the "up" and the "down" directions.

(5) The brake not lifting.

(NOTE.—This description proceeds as if the fault is not found till the final test.)

Examine Circuit Breakers.

Next, examine any overload circuit breaker or phase reversal circuit breaker to see that these are in order.

What to Do if the Lift has Overrun.

Examine the main limit switch. If the lift has overrun, re-set as previously described. Overrunning at the bottom may be caused through :-

- 1. Excessive overload in the car.
- 2. Brake requiring adjustment, or hand release having been left in operation.
- 3. Main contactor sticking in for some cause.

If the lift has overrun in the "up" direction, causes 2 and 3 only are possible.

Now get a suitable piece of wood, or a wooden-handled screwdriver (so as to avoid shock), push in the main circuit breaker on the controller with this, and then instantly release it. If an arc occurs, obviously the electrical supply is available at the control panel. Note at the same time if the brake operates.

Examine the Control Fuses.

Now examine the main switch and fuses again to make sure you have not blown a fuse in doing this. Switch off and examine the control fuses to see if these have blown. If one or other of these has blown, look for the cause in the gate lock or other control apparatus (e.g., the direction switch) adjacent to the point at which the lift stopped.

Test the Gate or Door Locks.

Having made sure that the control fuses are in order, make sure that the main switch is on, and go and examine the top-floor gate. Keep your finger pressed on the button and rattle the gate lock. If this causes the lift to run, then there is obviously a bad contact in the lock, causing an intermittent break in the control circuit. Now test the next floor. If this happens to be the floor at which the car is situated, send your mate to the floor above or the floor below, telling him to keep his finger on the call button at that floor while you test the gate lock as before. Open the landing gate, and make sure that the car gate is properly closed. Close the landing gate again and let your mate try and call the lift once more. Test all gate or door locks in this way.

If the lift still does not work, get into the car, close the landing gate, close the car gate and try and work the lift on the car buttons. If the lift works on the car buttons, then the fault is almost sure to be in the false floor in the car. The action of this floor is such that anyone standing on it causes it to sink a small distance, operating a switch which cuts out the landing call buttons, thus, if a passenger gets out of the car, and the floor does not rise owing to the springs being faulty, or dirt having got into the

joints, then the machine cannot be called on the outside buttons, but will operate on the buttons in the car.

Now press the "stop" push, and slide the finger off it sideways, so that the push springs out with a click. Flick the push in this way once or twice, and then try and operate the lift. A weak stop-push spring is a fruitful source of breakdowns on automatic lifts.

Locating a Fault in the Lock Circuit.

If the trouble has still not been found, go back to the motor-room, and if you are familiar with the controller (as you should be), switch off the main switch, and cut out the lock circuit by twisting a piece of fuse wire round the appropriate terminals your mate must be stationed in the car, on the controller. *At the same time your mate must be stationed in the car.* Now switch on and instruct your mate to try and work the lift. If the lift operates, it is obvious that there is some break in the lock circuit, which your superficial examination had failed to locate. Under these circumstances, each lock must be opened up and examined individually until the fault is found. It is, however, best to commence with the lock on the floor at which the lift has stopped, as this is most probably the source of trouble. *Don't* forget to remove the fuse wire which has cut out the gate lock circuit.

Examining the Controller.

Examine the relays to see that none of these has stuck in. If one has stuck in, then it should be dismantled, cleaned and lightly lubricated, as described under the heading of "Care of the Controller."

The Motor Starting Device.

Examine the motor starting device and see if this has returned to the "off" position, and that the interlocking contact has made circuit. If the lift has stopped at one extreme of travel, pay particular attention to the electrical interlock on the contactor for that direction, which is in series with the coil of the opposite direction contactor.

Generally speaking, the position in which the lift stops gives a fairly good indication of where to look for the fault.

Clearly written and fully illustrated

NEWNES' Home Mechanic BOOKS

TOY MAKING FOR AMATEURS

Tells you how to make toys of every description and lays bare the principles by means of abundant illustrations and simple text. Every mechanical movement known in toy manufacture is included.

SIMPLE ELECTRICAL APPARATUS

An excellent little book for those who wish to make simple and useful electrical appliances, such as galvanometers, electric motors, dynamos, and Leyden jars. All these may be made by anyone with the aid of a few tools and some inexpensive materials. Clear instructions are given in every case.

TWENTY-FIVE TESTED WIRELESS CIRCUIT

A book for the modern wireless enthusiast. All the sets described have been designed to meet modern needs. They range from simple crystal receivers to a seven-valve super-heterodyne, and all the sets have been made and tested before inclusion.

MODEL BOAT BUILDING

There are few more fascinating hobbies than Boat Building. In this book there are designs for a battleship, a speed boat, a paddle steamer and yachts, from which excellent models may be built with the help of the simple directions and diagrams that are given. No elaborate tools are needed, and each model can be made at small cost.

Ready Shortly

MOTOR CAR UPKEEP AND OVERHAUL ACCUMULATORS

Other Titles

THE HANDYMAN'S ENQUIRE WITHIN

THE HOME WOODWORKER

25¹ SIMPLE WORKING MODELS

MODEL AEROPLANES AND AIRSHIPS

One Shilling Each

On sale at all Newsagents and Bookstalls, or by post 1/2 each from
George Newnes, Ltd., 8-11, Southampton Street, Strand, London, W.C.2

Geo. Newnes, Ltd.

Part 32 ready May 20th. Order your copy to-day.

RALPH STRANGER'S WIRELESS BOOKS

The Wireless Library for the
Man in the Street:

MATTER AND ENERGY
ELECTRONIC CURRENTS
ELECTRIFIED MATTER
MAGNETISM AND ELECTRO-
MAGNETISM
BATTERIES AND ACCUMULATORS
SEEING BY WIRELESS (TELEVISION)
MODERN VALVES
WIRELESS COMMUNICATION AND
BROADCASTING
WIRELESS WAVES
HOW TO UNDERSTAND WIRELESS
DIAGRAMS
SELECTION OF WIRELESS SIGNALS
DETECTION OF WIRELESS SIGNALS
AMPLIFICATION OF WIRELESS SIGNALS
REPRODUCTION OF WIRELESS SIGNALS
WIRELESS RECEIVING CIRCUITS
WIRELESS MEASURING INSTRUMENTS
THE BY-PRODUCTS OF WIRELESS

SOME PRESS OPINIONS:—

"The new shilling library aims at giving the wireless enthusiast a sound theoretical and practical grip of his subject. The author employs clear and simple language, and starts practically from zero."—*The Broadcaster*.

"These books deal with a highly technical subject in the simplest language which enables those who have no scientific training to grasp the wonders of wireless, and assist the listener to get the best possible results from a receiving set."—*Railway Review*.

ONE SHILLING EACH

By Post 1/2 each.

On sale at all Newsagents, Bookstalls and Bookshops, or by post from **GEORGE NEWNES, Ltd.**, 8-11, Southampton Street, Strand, London, W.C. 2.

THE MATHEMATICS OF WIRELESS

This book is essential for the wireless amateur who desires to gain a fuller knowledge of his subject. Written by one who has the gift of explaining abstruse matters in a simple fashion, it will enable its readers to attempt research and experiments which at one time were far beyond their powers. 256 pages. Fully illustrated.

5/-, by post 5/3

WIRELESS: THE MODERN MAGIC CARPET

Fourth and Revised Edition

If you know nothing about wireless and do not even possess a receiving set, this book will show you how to provide yourself with an interesting and absorbing hobby. If you are a listener, but rather weak on the technical side, it will save you much unnecessary worry and expense. If you wish to experiment, this volume will provide you with valuable experimental data. If you are an expert and have to lecture, it will give you some useful lecture material.

3/6, by post 3/9

Geo. Newnes, Ltd.