

To be Completed in about 32 weekly parts.

# NEWNES PRACTICAL ELECTRICAL ENGINEERING

## IN THIS PART

REPAIRS TO  
ELECTRIC COOKERS  
ELECTRIC WELDING;  
STREET LIGHTING  
SYSTEMS AND THEIR  
MAINTENANCE

REPAIRS TO  
ACCUMULATORS

COPPER AND ITS  
APPLICATIONS FOR  
ELECTRICAL WORK

ELECTRIC  
GRAMOPHONE  
MOTORS WITH  
NOTES ON ADJUST-  
MENT AND  
MAINTENANCE

1/-

PART  
21

A PRACTICAL WORK WRITTEN BY EXPERTS

STUDY  
AT  
HOME

YOU CAN HAVE A COLLEGE  
TRAINING IN ALMOST ANY  
CAREER FOR A FEW  
SHILLINGS MONTHLY

IN  
YOUR  
SPARE  
TIME

FOUNDED 1900.

32 YEARS OF SUCCESS.

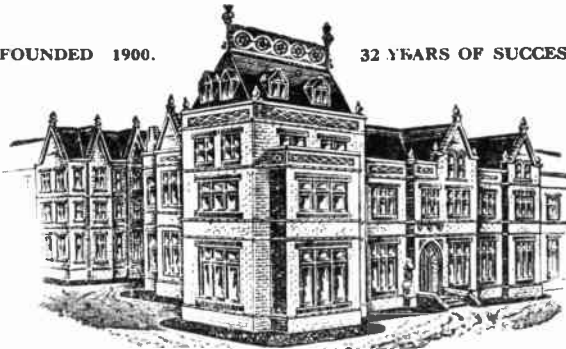

THIS IS THE BENNETT COLLEGE - - ALL OF IT

The Bennett College is not a Rented Room in a well-known street—it is a College. Over 31 years ago the Founder took as his motto what has now become a household slogan:

# LET ME BE YOUR FATHER

In many trades and professions there are more vacancies than trained men to fill them. We do not profess to act as an employment agency, but our gigantic organisation certainly does tell us where the demand exists, thus enabling us to give FATHERLY ADVICE ON ALL CAREERS AND THE POSSIBILITY OF EMPLOYMENT, FREE.



*J. Bennett*

WE TEACH ALL BRANCHES OF THE FOLLOWING VOCATIONS AND SPECIALISE IN ALL EXAMINATIONS CONNECTED THEREWITH.

**THE MOST SUCCESSFUL AND MOST PROGRESSIVE  
CORRESPONDENCE COLLEGE IN THE WORLD**

Aviation Engineering.  
Boiler Engineering.  
Boiler Making.  
U.Sc. (Engineering).  
Civil Engineering :  
A.M.I.C.E.  
Quantities—Specifications.  
Commercial Art

Concrete and Steel.  
Draughtsmanship :  
Electrical or  
Mechanical.  
Electrical Engineering :  
A.M.I.E.E.  
City and Guilds.  
Engineering Mathematics.  
Foundry Work.  
Heat Engines.

Heating, Ventilating and  
Lighting.  
Internal Combustion Engines.  
Machine Designs :  
Theory of Machines.  
Marine Engineering :  
Motor.  
Steam.  
Mechanical Engineering :  
A.M.Inst.B.E.  
A.M.I.Mech.E.  
City and Guilds.  
Pattern Making.

Mechanics.  
Metallurgy of Steel.  
Mine Electrician :  
A.M.E.E.  
Mining (all examinations).  
Motor Engineering :  
A.M.I.A.E.  
Municipal and County  
Engineers :  
M. and C.E.  
Naval Architecture.  
Pumps and Pumping  
Machinery.  
Radio Reception.  
Ship Building.  
Structural Engineering.  
Telegraphy and Telephony.

IF YOU DO NOT SEE YOUR OWN REQUIREMENTS ABOVE, WRITE TO US ON ANY SUBJECT.

IT COSTS NOTHING TO ENQUIRE.

Also ask for Our New Book  
(FREE OF CHARGE)

**THE HUMAN MACHINE**

SECRETS OF  
SUCCESS

WE TEACH BY POST IN ALL PARTS OF THE WORLD

Note Address Carefully:

The BENNETT COLLEGE, Ltd., Dept. 119, Sheffield



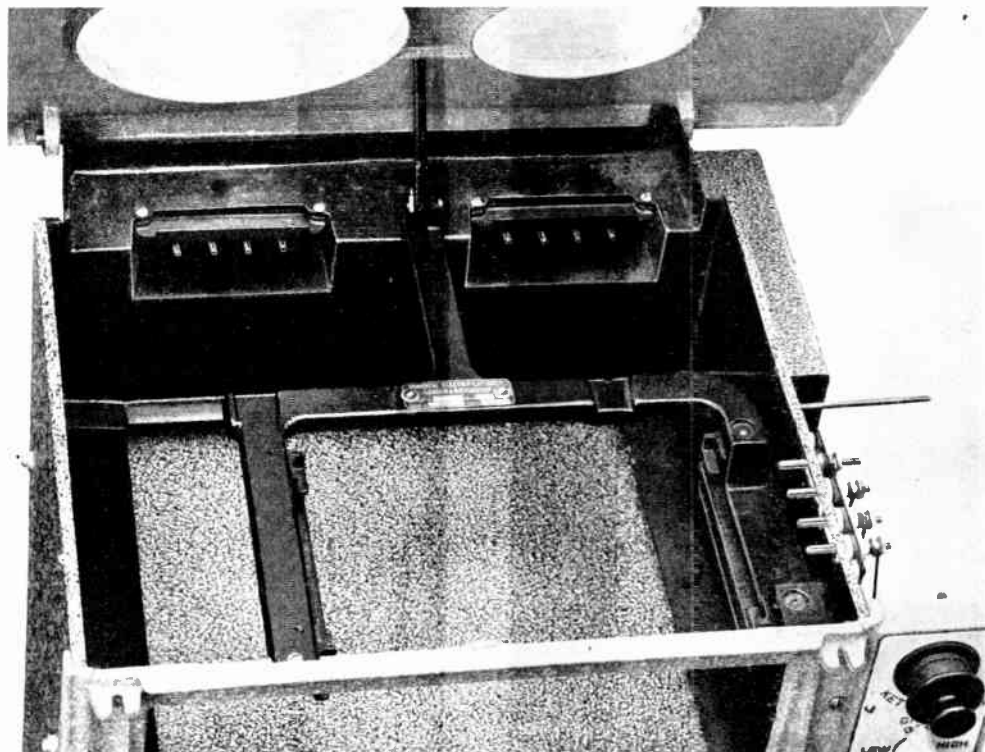

Fig. 4.—THE COOKER WITH THE HOB LIFTED, AND THE SIDES AND BACK OF THE HOT-CUPBOARD REPLACED.

This shows the sockets for the grill and boiling plate, and another view of the terminals of the cooker shown in Figs. 1 and 2.

hence the oven is air-tight when the door is shut, except for the ventilator, which is necessary to allow steam from cooking to escape.

#### Position of Switches and Fuses.

The switches are all at one side and are dust proof, space for a kettle plug is provided on the switch plate immediately under the hob, while the fuses are found immediately underneath the switches in the same order.

#### Maintenance Notes.

These cookers are easily maintained. Fig. 1 shows the removal of a hotplate and at the same time, shows, too, the four pins, one being an earth pin. The hotplate has a cast-iron undercover and the makers ask, in the event of an element

failing, for the complete unit, i.e., hotplate and undercover, or in the case of oven elements, the sheet metal cover and under-tray, to be returned. This makes any repairs on the spot practically negligible. The makers, of course, return the complete element, charging only for any parts replaced if the element in question is out of guarantee.

#### Renewing a Fuse Wire.

The fuses are easily "get-at-able," it being only necessary to remove the white enamel fuse plate, take out the fuse and renew the fuse wire.

#### What to do When a Fuse "Blows" Continually.

The fuses are of knife contact pattern and simply "pull out" and "push in" like

A



Fig. 5.—THE ELECTRIC COOKER IN USE.

Having safely installed the cooker it is now ready for use. Advise your customer to adjust the oven shelves before switching on. This will save keeping the door open and losing heat when putting food in.

the fuses in any ordinary fuse box. If the fuse "blows" when replaced, strengthen it and try again; if it still "blows," see if the element pins are clear of the casing; a porcelain may be broken, but this is very unusual, or a small piece of bone or fat may by some unforeseen circumstances have got across the pins and carbonised. If an oven fuse has gone take off the sheet metal cover as the element may have failed or be touching the cover through being carelessly "banged" down when removed for cleaning.

#### Repairing a Broken Element Wire.

If a spiral on the element, and this applies, too, to the grill, has broken any distance up to  $\frac{1}{2}$ -in. from the terminal, it is safe to "stretch" the element wire and reconnect to the terminal as a temporary measure. If the element wire

has failed in the middle, you can twist the ends together with pliers as a temporary repair.

Be very careful when twisting wires together that you nip off any projecting ends and put the wire back securely in the fireclay former; otherwise, you will get a short on to the oven cover, or in the grill, the protecting wires. Solid hotplates you cannot repair, but they must go back to the makers. The reason is that the solid plates in use to-day consist of element wire laid in a special cement in a cast-iron tray. This element hardens and it is impossible to get the wire out and replace it.

#### Where to Look for Faults.

If you have a blown fuse and, having fitted a new element, find the fuse still refusing to "hold up" you must search further for the cause. Take off the side cover, exposing the wiring and trace back the connections of the faulty circuit, it may be a loose contact or switch or fuse line. If this proves unsuccessful, look to the switch—the spring may have gone and set up an arcing; this again is very unlikely. If the cooker is wired in bare copper strip, see if any of the strips have got bent out and are touching the case. The cooker may have been roughly moved or jarred in transit or cleaning. Your search in one of these directions should prove successful in tracing the fault and effecting a repair.

#### When to Seek the Makers' Advice.

One piece of advice to all who start on cooker repairs, the electrical portion of a cooker is quite a simple affair of straightforward electrical circuits, switches, fuse and elements, so if you cannot trace any fault or do not understand the element wiring or winding, *don't experiment*. Ask the makers; they are only too pleased to be of assistance and help to electricians who have cookers under their charge.

Another point, if you are called to a

customer's house on a cooker repair job do not make a mystery of it. When you go to a cooker repair job, adopt the "Don't suppose we shall be long about it, nothing much to go wrong in a cooker really," attitude. It will pay in the long run.

### How to Set about Tracing Faults.

Also, adopt a regular routine in these matters. You will find you will save yourself a lot of time and trouble. First of all, look at the main switch. I have actually experienced not one, but many cases of service calls to cooker—and other apparatus—resulting from someone carelessly switching off the main switch! Next the main fuses: a fault will sometimes "jump" all local fuses and blow the main; it is annoying to repair a fault on a cooker, find it still refuses to function, waste time examining it all over and then find the main fuse "gone." Next examine the cooker "way" on the heating fuse board if any; generally, cookers are wired on a separate circuit, but in an all-electric home, or one in which cooking, water heating and fires are in use, you may find a fuse board with a "way" for the cooker. Then examine the connections at the cooker control board and the flex leading to the cooker. Having found main switch and fuses O.K., ask your customer "what happened?"

She may be able to tell you at once that its all working except the grill and only half of the wires come on, or "the oven takes ages and ages to heat up." You then know where to start. But do make your repairs seem as simple as possible.

### How to Order Spare Parts.

When ordering spare parts from the makers give as much information as you can. One or two hints as to the details they want may be of use. First, the catalogue number and serial number and voltage. This is generally found on a small plate at the back or side or sometimes just inside under the hob. If an element, state type and any number stamped on it. If the part is of cast-iron, look for a number cast in it. Practically all cast parts have a number on them. If it is a switch, state if on right-hand or left-hand of cooker, if "on and off" or three heat.

It may not be out of place here to give a few words on the cost of using: you may often be asked "how much current should this cooker use?" This is generally from a new user who, perhaps, prefers to have the figures given her by a salesman or demonstrator confirmed by the practical man. The reply is the average cost for an average family of 3-6 people is a unit a person a day.

## QUESTIONS AND ANSWERS

### How can the height of the boiling plate be adjusted?

By means of three adjusting screws which will be found underneath the boiling plate.

### How is the oven of a plug-in element type of cooker fixed in?

The oven interior or inner lining is fitted to the outer lining and the intervening space is packed tightly with a species of asbestos wool and then cemented round the front edges.

### Where will the fuses be found?

Immediately underneath the switches in the same order.

### How should a fuse wire be renewed?

- (1) Remove the white enamel fuse plate.
- (2) Take out the fuse.
- (3) Renew the fuse wire.

### What would you do if a fuse wire "blows" continually?

See if the element pins are clear of the casing, or if a porcelain is broken.

### What temporary repairs can be made to a broken element wire?

If the wire has broken any distance up to  $\frac{1}{2}$  inch from the terminal, it is safe to "stretch" the element wire and re-connect to the terminal. If it has failed in the middle, twist the ends together with pliers.

# ELECTRIC WELDING

By O. SIMONIS, M.R.I., M.I.W.E.

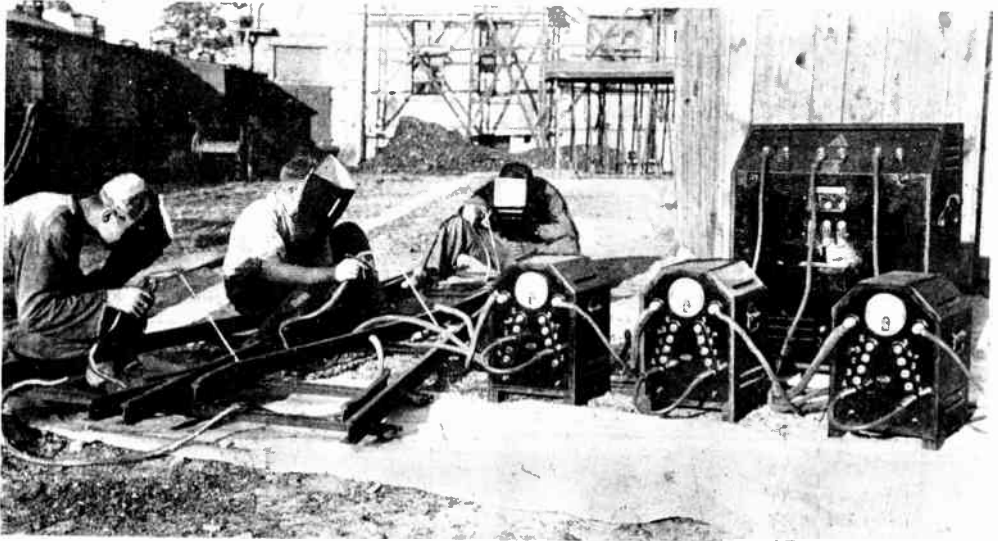

Fig. 1.—A TYPICAL THREE-OPERATOR TRANSFORMER SET WITH THREE STABILISERS. Showing welders at work on metal rails.

## Principle of Welding.

THE electric arc is maintained out between the welding electrode and the job to be welded and in the process of so doing, the electrode itself is burnt off and its metal added to and deposited on the work.

At the arc a pool forms and this is best likened to a miniature metal furnace, a fact which should be well remembered and which will later explain how, with the aid of different electrodes, the metallurgical structure of almost any workpiece can be matched up by the weld metal. It must also be borne in mind that the electric welding process is not merely a means of sticking two pieces of metal together, but is a process of definitely fusing two metals into one. A good and correctly welded piece under a breaking test should break anywhere except at the weld. Throughout welding practice, one terminal must be fixed to the job and the

other to the electrode and with most equipment the positive pole is best connected to the electrode.

## Equipment Required for Welding.

The operator's equipment consists essentially of an electrode holder, which should be of a type to assure good grip and contact to electrode, a clamp for fixing his other terminal to workpiece, and an eye shield. Never look into the arc with naked eye nor even with ordinary coloured goggles. A so-called Arc-eye is painful, though not dangerous. Further, the operator will require a chipping hammer and a strong wire brush.

## TYPES OF ELECTRIC WELDING PLANT.

Electric welding plants fall into two main categories. (a) D.C. generator with resistance; (b) A.C. supply with high-reactance transformer.

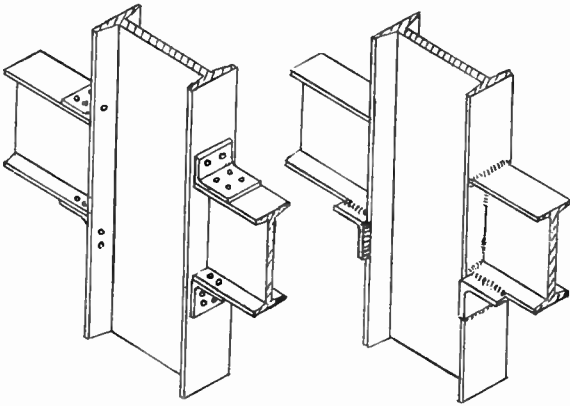

Fig. 2.—COMPARISON BETWEEN A COMMON JOINT IN BUILDING STRUCTURE EXECUTED IN RIVETING AND WELDING.

### Plant for Factories.

For factory purposes, transformer sets have of late years been so perfected in overcoming oscillations of current and over-heating that they are used to a major extent. They necessitate the use of coated electrodes and cannot operate with bare wire. The D.C. set on the other hand, will continue to hold first place for all repair work and jobbing work where the welding set has to be brought to the job. These sets are then, of course, petrol driven. Fig. 10 shows a typical generator set driven from a standard petrol engine, suitably covered in for protection against weather, mounted on a trolley for easy moving, and fitted with hooks for loading by crane. The motor drives a generator giving 200 amperes at 75 volts. About 60 volts are required to strike the arc and about 30 volts to maintain the arc. The current is adapted to requirements by means of a dial which controls the resistance, and there is a shunt contactor controlled by a protective relay. Generator sets are commonly built for from one to six operators, each welding circuit having its own resistance. Fig. 1 shows a typical three-operator transformer with three stabilisers and Fig. 3 shows a normal circuit diagram of a transformer.

### APPLICATIONS OF WELDING.

Before giving practical instruction on how to weld, it is advisable that the

electrical engineer should have some idea of the application of welding and the following brief notes show where its main uses lie, bearing in mind that the great task before electric welding is to supersede the rivet, a good deal the forge and, to a large extent, the steel casting.

#### (1) In the Boiler and Tank Shop.

To-day, practically all tanks for liquids are welded, such as the numberless petrol storage tanks underground, the tanks of the distributing wagons, oil tanks for industrial purposes of all kinds, and tanks in the chemical and brewing industries. Where these lately have been made of stainless steel, the electrode makers have been able to provide the necessary electrodes based on the analysis of the various stainless metals and they are also now being welded. The boilers in our kitchen stoves are welded. Air and gas pressure tanks working up to 300 lbs. per square inch are also being welded.

#### (2) In Industrial Manufacture.

Industry until a few years ago relied on the forge, the rivet and the casting for the building of most of their engineering products, but gradually electric welding has found its way into our engineering shops, first as a medium to assist the old methods, but latterly as the main means of

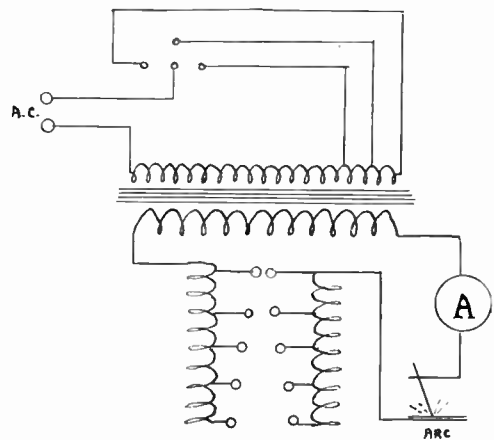

Fig. 3.—CIRCUIT DIAGRAM OF TRANSFORMER FOR WELDING.

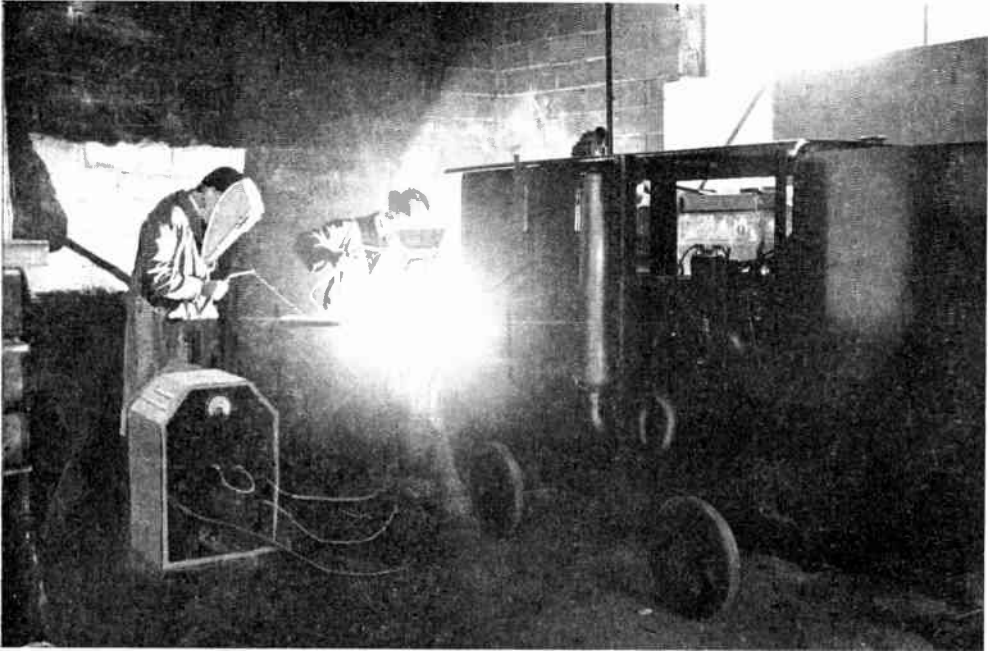

Fig. 4.—ELECTRIC WELDERS AT WORK.

The operator on the left is using a transformer set, while the other operator is working from a generator.

construction, particularly in building up or fabricating constructions, thereby replacing castings. Steel fabrications show a great reduction in weight and the relative freight, in time and space through not requiring patterns and a pattern shop, in greater tightness where liquids are concerned, in more pleasant appearance, less capital expenditure, very much less fitting work, greater strength and last but not least, in cost.

The electrical industry has been one of the first to take advantage of these possibilities, many generator housings are to-day steel fabricated, see Fig. 9, and the writer has seen in America a turbo-generator stator some 18 feet long and some 10 feet in diameter entirely fabricated of steel plate. The number of rings are cut to shape with the aid of an oxy-acetylene cutting machine and they are held together by axial bars welded across; steel cover plates welded to the sides support the feet, which are also made of steel plate. Condensers are frequently constructed in the same way. Housings

of all size motors down to two-horse power, are built up in steel with the aid of the arc.

The possibility of application in industry is almost unlimited, but amongst the most important uses outside the electrical industry may be mentioned crane construction, jig building, in particular for big boring jobs, gear housings, ventilator and fan construction, printing machinery, con-

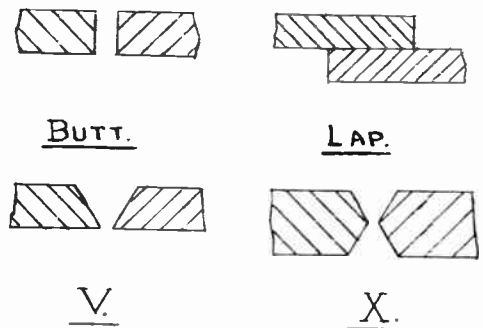

Fig. 5.—TYPES OF WELDS. Showing the correct relative positions and preparation of two parts to be welded.



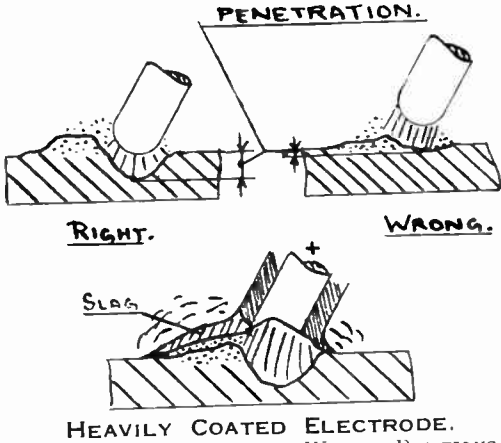

Fig. 6.—THE RIGHT AND WRONG POSITIONS OF HOLDING THE ARC.

An eighth of an inch is the recognised correct distance for holding the end of the electrode from the pool and the metal.

in other countries high buildings have been erected in which riveting has been entirely replaced by the electric arc. Arc welding will essentially give a more rigid structure and will allow for a reduction in the amount of wind bracing required. There will not be the noise from the riveting hammers when putting up a welded structure which is a fact not to be under-estimated, particularly in congested areas, in hospital and residential zones, and is a feature which will also make night work permissible if time is an important factor.

Fig. 2 shows the comparison between a common joint in building structure executed in riveting and welding and it will be self-evident therefrom how weight and labour is reduced. The design being

struction of carriage and locomotive frames, tip wagons, hydraulic-press construction, construction of frames for compressors and steam engines, foundation and bedplates for all classes of machine tools, flanging up valve and tube constructions, and finally in connection with small tools for high carbon steel tips frequently referred to as stellinging.

(3) In Structural Engineering.

Although to-day the building regulations in this country only permit building structures to be welded for single storey buildings,

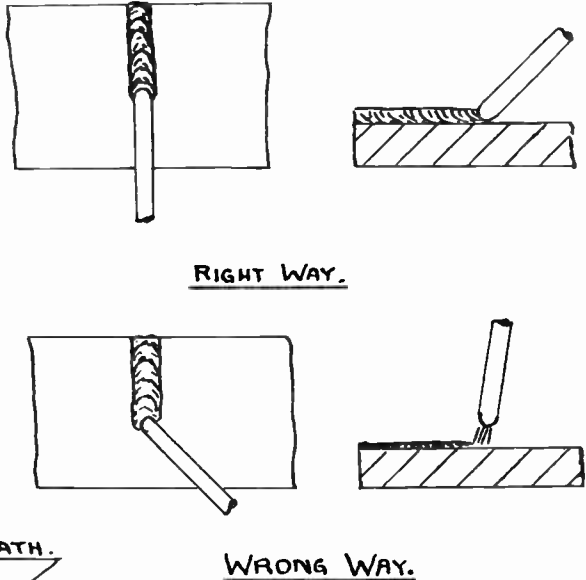

Fig. 7.—THE RIGHT AND WRONG WAY FOR HOLDING AND GUIDING THE ELECTRODE.

carefully adapted to welding both as regards fabrication and joint detail, it will be readily understood that cleats and gusset plates can be entirely dispensed with in the majority of welded constructions, that complete continuity of lines and girders and beams can be maintained and that this in turn often permits the use of smaller members.

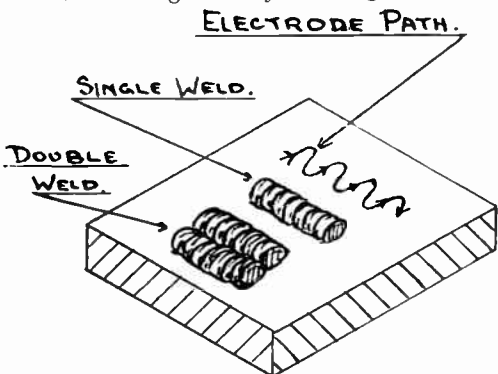

Fig. 8.—A NORMAL ELECTRODE'S PATH & RUNS.

### Comparative Cost of Welded and Riveted Structures.

So far as cost figures are available from elsewhere, where constructional welding on a large scale has already been done, the following conclusions might be arrived at as to the cost comparison of an all-welded structure in place of rivets divided into the various parts of an estimate:—

*Steel.*—12 to 18 per cent. in weight of material is saved.

*Transport on Site.*—This corresponds to the saving in the weight of steel.

*Shop Preparation.*—A very considerable amount of punching is made unnecessary.

*Erection.*—This item is unaltered except for weight.

*Welding on Site.*—One welder does the work of a gang of riveters.

*Painting.*—All painting can be done on site without obstruction through rivets.

*Drawing.*—Given efficient draughtsmen,

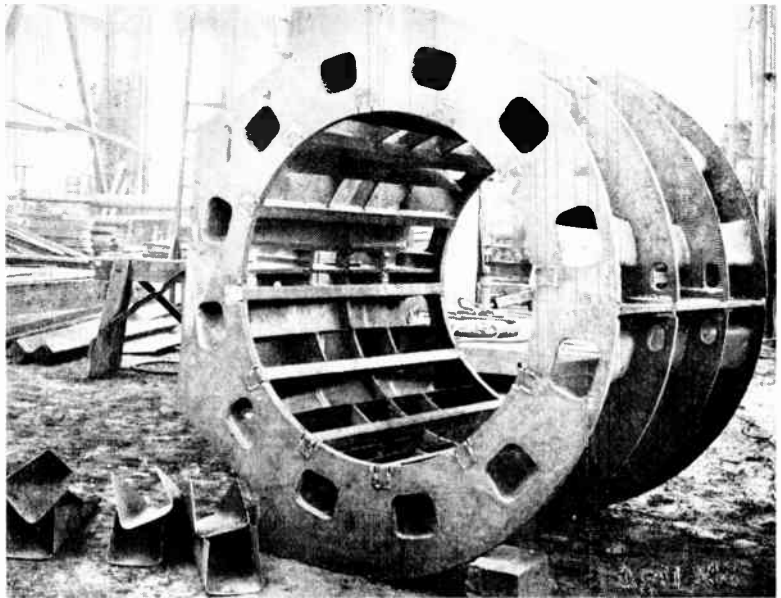

Fig. 9. — How WELDING IS APPLIED IN INDUSTRIAL MANUFACTURE. Showing a steel fabricated stator housing.

thinking in terms of welding, there will be less drawing.

*Inspection.*—At this stage the inspection of work on site may have to be augmented owing to novelty.

Amongst other structures which lend themselves readily to welding, are gas-holders and bridges of which there are quite a number already in Australia, and towers of all descriptions. For example, the towers carrying the cables of the grid system of the Swiss railways are welded. Many towers for radio purposes have been welded.

#### (4) For Repair Work.

The application of electric welding for repairs of all kinds is another almost unlimited field and many are the articles which the electric arc saves from the scrap heap.

Typical examples are the building up of broken teeth of gear wheels, the repairing and building up of broken or worn shafts and broken supports of all kinds, the replacement of broken brackets and almost

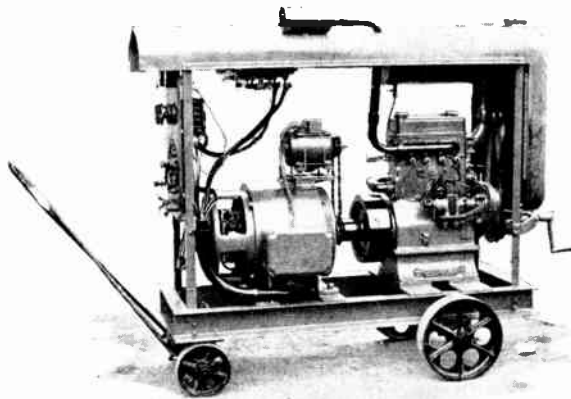

Fig. 10.—A TYPICAL PORTABLE PETROL GENERATOR SET.

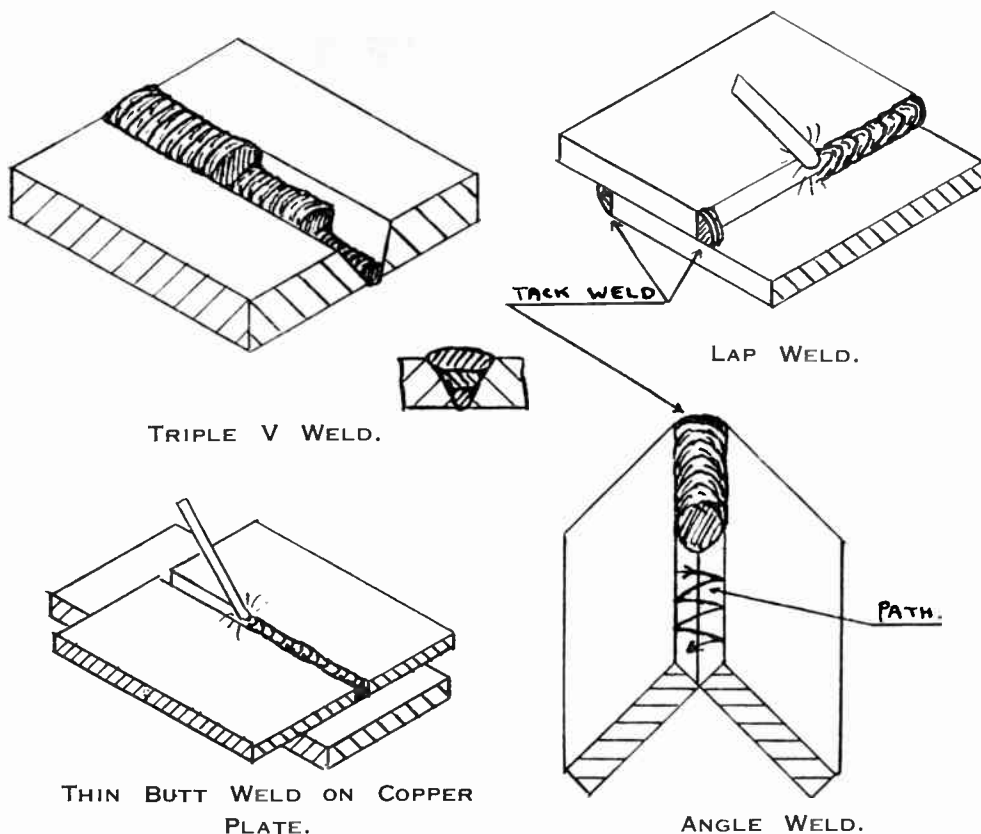

Fig. 11.—THE MOST COMMON FORMS OF WELDS.

In the top figure it will be seen that the bottom run is straight and as the vee widens, so are the upper runs oscillated more and more to bridge the full width of the vee.

Fig. 12.—OTHER TYPES OF WELDS FREQUENTLY USED IN PRACTICE.

When making a weld between any two units, tack them together first at intervals to make sure of correct and straight relative positions.

any part of broken machinery, the filling up of blow holes in castings and the strengthening up of worn faces to which may be added the building up of worn tramway lines, rails and crossings. Other examples are the repair of damage to ships' hulls and keels, the repairing of rolls and wobblers in all kinds of steel mills, sugar mills, etc. The value of this repair work is inestimable very often, particularly if jobs require doing overseas or otherwise out of reach of the original makers.

This brief survey just given will show the practical electrical engineer how, by embodying electric welding in his activities, he opens to himself an almost unlimited field of additional activity, not the least profitable of which is the repair

and jobbing side, particularly if he should be located overseas.

### HOW TO WELD.

A weld has, first of all, to be properly prepared and Fig. 5 shows the correct relative positions of two parts to be welded respectively by a butt, lap, vee or X weld.

### Right and Wrong Way of Holding the Arc.

Fig. 6 shows in the upper pictures the right and wrong way of holding the arc. The skill of a welder lies in his ability to keep a very short arc steady; an eighth of an inch is the recognised correct distance for holding the end of the electrode out from the pool of the metal. If the arc

gets too long, there is no penetration, as the top right illustration shows, and only a useless surface weld would be the result. The shortest arc is the best arc.

The steady holding of such short arc is the most difficult thing to learn and wants practice, for most electrodes will short circuit and therefore stick to the base metal if they actually touch it, as will happen to the novice.

The practical point to remember is that the electrode melts away at a given speed and a given current strength, which latter is that amount which it will carry without showing any red heat. As the electrode melts so it must be kept down towards the work and always at the correct distance of  $\frac{1}{8}$  in. from it.

### Touch Welding.

Fig. 6 also shows a special heavy coated or touch welding electrode. Such touch welding is a quite recent development and is carried out with special electrodes, the heavy coating of which forms a crater and acts as an insulator allowing the edge of the electrode to be kept in touch with the metal. For unskilled welders or novices having to do a job, the use of these electrodes is to be recommended,

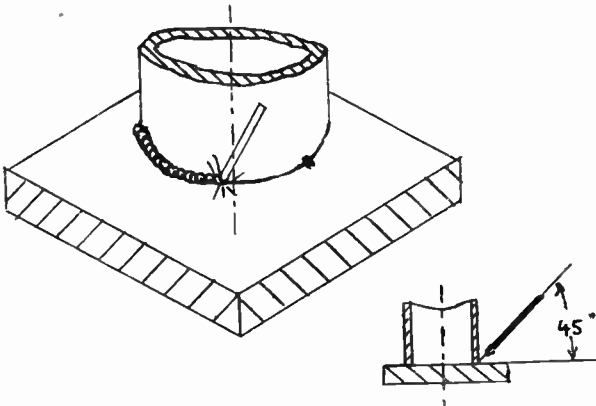

### CIRCULAR WELDING.

Fig. 14.—A TYPE OF WELD THAT REQUIRES SKILL.

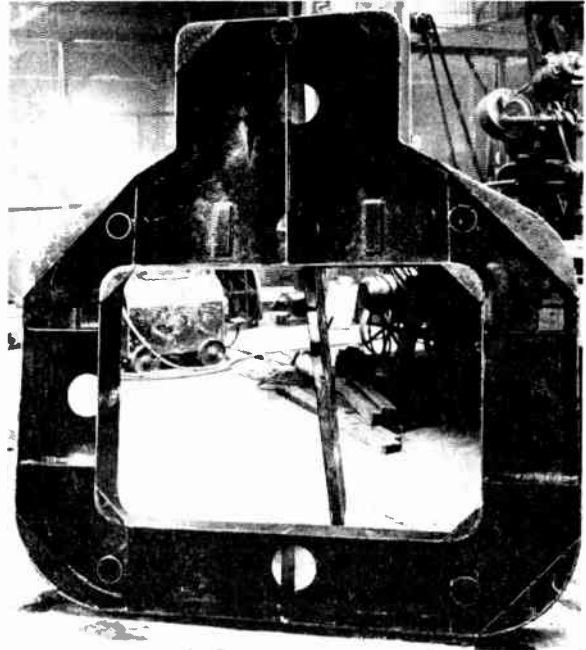

Fig. 13.—A STEEL FABRICATED FOUNDATION PLATE.

as they automatically hold the shortest arc, keep it even and give the hand a guide by resting on the metal.

### Position of the Electrode.

The right and wrong way and the angles for holding and guiding the electrode relative to the work piece are shown in Fig. 7. The electrode must always approach the metal at an angle of approximately  $45^\circ$  and must never be held vertically down on the metal. At the same time, it should with rare exceptions be in a straight continuing line to the weld itself.

### How to Apply the Electrode.

Fig. 8 shows a normal electrode's path and it will be seen that it is an oscillating one. It also shows a single weld run and a double run, as used for building up metal.

### Common Forms of Weld.

Fig. 11 shows what are in

practice the most common form of welds, the bottom run is straight and as the vee widens, so are the upper runs oscillated more and more to bridge the full width of the vee. Some welders believe in filling up with equal single runs or beads like brick work, and there is no objection to this.

between any two units, tack them together first at intervals to make sure of correct and straight relative position, thereafter draw your welds as shown. The lap weld shown is not too easy and it will help if the work piece is lifted so as to bring the weld more into the horizontal plane, like the lower figure. The touch

welding electrodes can do this job extremely well and need only be pressed into the vee as formed and allowed to run themselves off without oscillation, otherwise the path is as shown in lower figure.

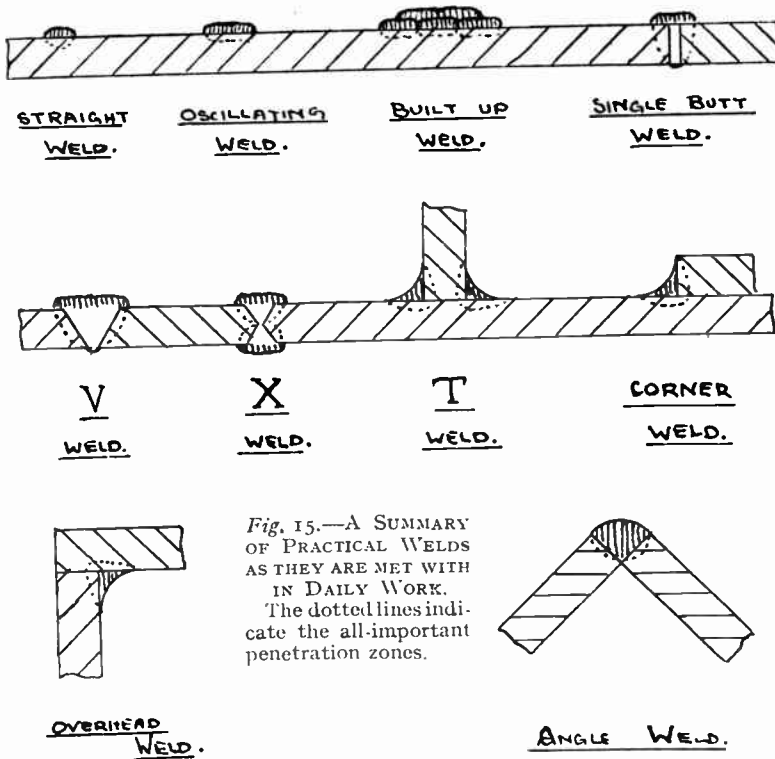

Fig. 15.—A SUMMARY OF PRACTICAL WELDS AS THEY ARE MET WITH IN DAILY WORK. The dotted lines indicate the all-important penetration zones.

**Circular Welding.**

The weld illustrated in Fig. 14 requires more skill. It is often not possible to bring the weld into the horizontal plane, oscillation must therefore be more accurate to get an even weld and care is needed

not to expose the seam itself. The angle shown at which the electrode is to be held is specially important here. Reversed, it is the forerunner to the vertical and eventually the overhead weld, which latter is the acid test of the skilled welder.

Fig. 15 is a summary of practical welds as they are met with in daily work, the dotted lines indicating the all-important penetration zones.

To criticise one's own welding efforts it is recommended to chisel off a layer of weld metal and thus establish that it requires considerable and equal force all along the run to remove it, which is evidence of good penetration. If lumps

**Chipping Off the Slag.**

In using coated electrodes, slag will form over each layer and this must be thoroughly chipped out with hammer and chisel and brushed out with wire brush before the next run is laid over, as any slag remaining will prevent the weld being homogeneous. Fig. 11 also shows a butt weld by the oscillating run, as applied to very thin metal, say 16-20 gauge, which would be found unweldable unless placed firmly down on a copper plate.

**Applying Lap and Angle Welds.**

Fig. 12 shows other welds frequently used in practice. When making a weld

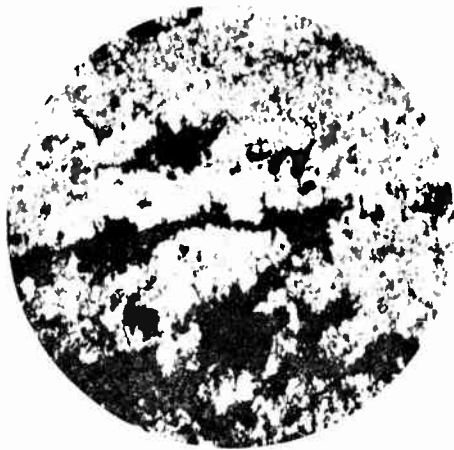

Fig. 16.—MICROGRAPH  $\times 30$  SHOWING WELD METAL FROM BARE WIRE. This is the poorest type of weld.



Fig. 17.—MICROGRAPH  $\times 100$  SHOWING THE WELD METAL FROM FLUXED ONLY ELECTRODE.

come out or unwelded metal appears, it is proof of faulty work. Next bend a straight butt weld built with vee joint, in a vice, gripping just behind the weld. A good job has been made if the metal bends  $60-90^\circ$  before showing any cracks in the weld metal.

As a general guide to welding costs, the table on page 981, is given.

**THE ELECTRODE.**

We will now consider the all-important factor of the electrode, for in this lies the most scientific part of electric welding, which, remember, is likened to a miniature furnace process. If two metals are to be fused into one by a third (the electrode), it is essential that the analysis of the metals match and that the influence of the air is excluded in the process. An oxi-

dised weld is a bad and, therefore, dangerous weld. Moreover, since all grades and kinds of metal may require to be welded, the tensile strengths, elongation and characteristics of the main metals have got to be watched or else the weld may form the weakest part of a structure, and, since same is only as strong as its weakest part, a serious position may arise.

From these considerations it will immediately be clear that the use of bare wire as an electrode medium must be warned against and with the above facts in mind, the principle of electrode constructions will be better understood.

**Essentials of an Electrode.**

An electrode must first have fluxes which, by creating a gas mantle round the arc, exclude the oxygen from the air and

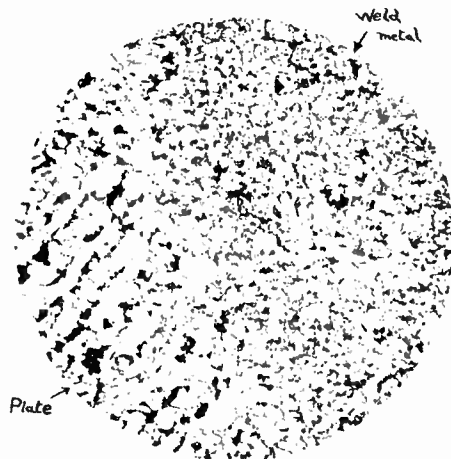

Fig. 18.—MICROGRAPH  $\times 150$  SHOWING A WELD METAL FROM A HIGH QUALITY ELECTRODE WITH A HEAVY COMPOSITE METALLIC COATING.



Fig. 10.—SHOWING HOW WELD METAL CAN BE DEPOSITED WHICH WILL ALLOW THE MAXIMUM COLD BENDING OVER A DIAMETER EQUAL TO THE WORK PIECE'S OWN THICKNESS.

secondly, must have a metal alloy coating or similar means by which its characteristics can be varied to match up the parent metal. This is mostly achieved in manufacture by covering mild steel wire with a composite metallic coating to which may be added by the makers various percent-

tages of manganese, chromium, nickel and other alloys, thus changing characteristics and giving tensiles varying from 20 to 40 tons and elongations from 8 to 30 per cent., according to welders' requirements.

### Importance of Choosing the Right Electrode.

The micrographs illustrate specimen results and show the importance of a most careful selection of the right electrodes for each job. Fig. 16 shows the weld metal from bare wire. It is porous, is bad fusion between the runs of deposited metal and illustrates the poorest type of weld. The strength of this weld was only 13 tons, it broke at an angle bend of  $5^\circ$  and only withstood izod impact of 1.2 foot lbs.

Fig. 17 shows the weld metal from a fluxed only electrode. The metal has still occluded a certain amount of gas from the atmosphere and the structure shows oxide formation and nitride needles. The strength of this weld was 18 tons to the square inch, it broke at an angle bend of  $18^\circ$  and withstood izod impact of 2.4 lbs.

Fig. 18 shows a weld metal from a high quality electrode with a heavy composite metallic coating. Fusion is perfect, the

TABLE FOR ESTIMATING APPROXIMATE COST PER FOOT OF WELD.

Material to be welded.	Preparation for Butt Weld.	Minutes.	Feet of Electrodes.	Gauge of Electrodes.	Power K.W.H.	Mean Ultimate Strength. Tons per Linear Inch of weld.	
						Medium Quality Rod.	Highest Quality Rod.
$\frac{3}{16}$ -in.	1 m m Gap	3	2 $\frac{1}{4}$	10	0.24	5.1	6.7
$\frac{1}{4}$ -in.	1 m m Gap	5	4	10	0.32	6.75	9.0
$\frac{5}{16}$ -in.	70° V	7	4 $\frac{1}{2}$	10 & 8	0.6	8.4	11.2
$\frac{3}{8}$ -in.	70° V $\frac{1}{2}$ m m Gap	9 $\frac{1}{4}$	6 $\frac{1}{4}$	10 & 8	0.8	10.1	13.5
$\frac{1}{2}$ -in.	60° V 1 m m Gap	15	9	10 & 10 & 8	1.6	13.5	18.0
$\frac{5}{8}$ -in.	60° V 2 m m Gap	25	15	10 & 8 & 6	2.6	16.9	22.5
$\frac{3}{4}$ -in.	70° V 2 m m Gap	38	22	10 & 6 & 4	3.0	20.2	27.0

For fillet welds calculate as above, taking material thickness equal to minimum depth of fillet.

The power consumption in K.W.H. depends on the welding current in amps. and the voltage across the arc, plus the losses in the leads, generators, transformers and other apparatus. These losses depend largely both on the type of apparatus and its state of repair. The figures given in the consumption column represent a reasonable average.

structure of the weld metal is excellent. There is a total absence of oxidation, the tensile strength of this metal was 29 tons, it withstood an angle bend of 160° and an izod test of 19 foot lbs.

The efficiency of electrode manufacture has reached such heights that weld metal can be deposited which will allow the maximum cold bending over a diameter equal to the work piece's own thickness, as is shown in Fig. 19 and again to allow handling in the smith's fire, of which Fig. 20 is an illustration. This piece was welded in the centre, then heated, bent over to the double and the weld metal forged down to a knife edge and gives an illustration of what can be achieved with electric arc welding.

From the following base formulas the strength of all welding work and the required thicknesses of welds may be calculated:—

**STRENGTH CALCULATIONS.**

Thickness of material=t.

Width=w.

Tensile Strength=f<sub>m</sub>.

Cross section=A<sub>m</sub>=t × w.

BASIS.—The cross section of the weld must be equal to or greater than that of the material A<sub>w</sub>=A<sub>m</sub>.

Tensile strength of weld or of electrode =f<sub>w</sub>. Breaking load=P.

EXAMPLE.—A flat bar 3 in. × ¼ in. f<sub>m</sub>=28 tons per sq. in. P=28 × 3 × ¼ =21 tons, is to be welded with electrodes f<sub>w</sub>=24 tons in.<sup>2</sup>

**Butt Weld.**

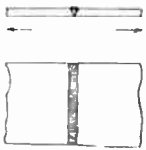

Fig. 21.

$$A_w = \frac{A_m \times f_m}{f_w} = \frac{21}{24} = 0.875 \text{ sq. in.}$$

w=3 in.

Height of weld =  $\frac{.875}{3} = .292$

Increased height of weld = .292 = .25 = .042 in.



Fig. 20.—ANOTHER EXAMPLE OF WHAT CAN BE ACHIEVED BY ELECTRIC ARC WELDING.

This piece was welded in the centre, then heated, bent over to the double, and the weld metal forged down to a knife edge.

**Double-Ended Lap Weld.**

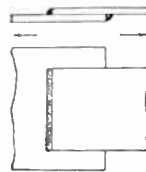

Fig. 22.

Factor for double-ended lap weld = 0.65 in.

$$A_w = 0.65 \times \frac{A_m \times f_m}{f_w}$$

= 0.65 × 0.875 =

0.57 sq. in.

w=3 in.

Minimum height of weld =  $\frac{.57}{3} = .19$  in.



# STREET LIGHTING SYSTEMS AND THEIR MAINTENANCE

By H. W. JOHNSON

**T**HE regular and correct functioning of a street lighting system is most important. Street accidents

and dislocation of vehicular traffic may occur if streets are badly lighted, or a failure of the lighting takes place. The maintenance of an electrically equipped street lighting system will involve keeping in good condition the following equipment:—

1. The systems which are used to support and protect the lighting wires and cables, both overhead and below ground
2. The lighting fittings and lanterns.
3. The lamps.
4. The lighting wires and cables and their connections.
5. The switchgear and fuses.
6. The time regulating devices which ensure the switching on and off the lights at the correct times.
7. The traffic signals and their operating gear.

To make the article comprehensive, the method of the maintenance of the street lighting system of a large city is described.

## The Maintenance and Cleaning Staff.

The whole of the staff engaged will be divided into a repair unit and several cleaning units.

## The Repair Unit.

The repair unit will consist of a suitable number of wiremen and wiremen's mates working under the direction of a foreman. The foreman will receive reports of failures and repairs to be done from the cleaning units, and from his round of inspection. He will then allocate the various jobs to his repair

staff each morning. During the course of the day he will visit his staff at their jobs and inspect the work which is in progress.

The work will include repairs and renewals of lighting lines. The fixing of



Fig. 1.—SUPPORTING THE OVERHEAD LINE BRACKETS FROM SPAN WIRES.

A special iron clamp holds the bracket studs to the span wires. The cable connections to a lantern are connected to the overhead lines with a clamping connector.

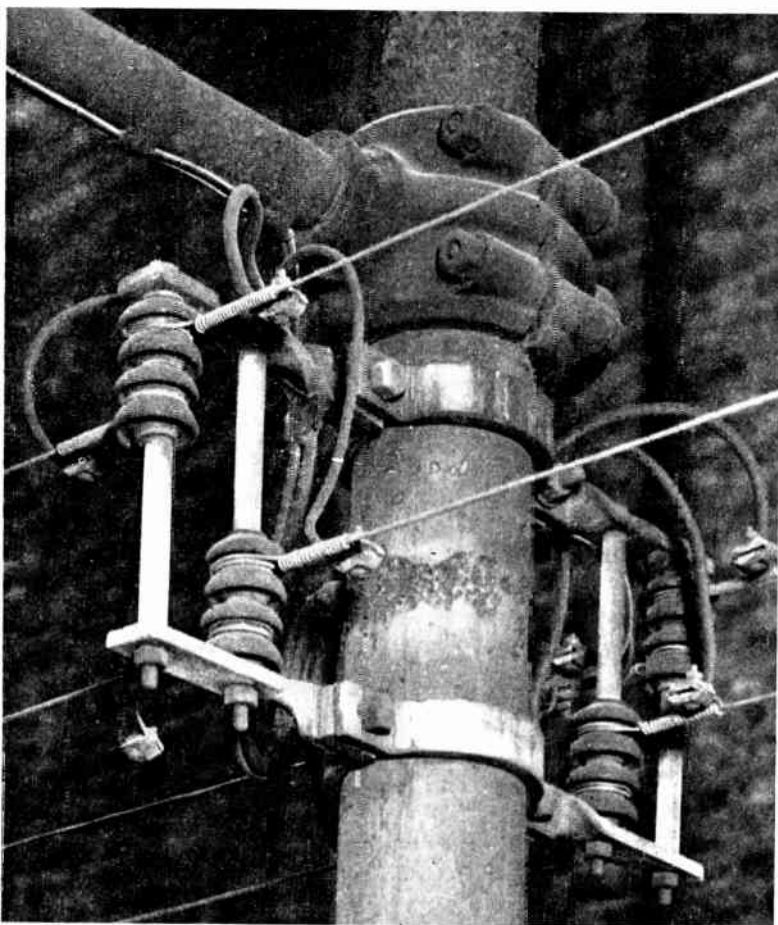

*Fig. 2.*—TERMINATING THE OVERHEAD BARE LINES AT THE END OF A SECTION. The end of the wire is given two turns round the insulator and then formed into a loop, the loop is wound over the wire, leaving the free end for connection to the feeds from the section pillar. Note the feeds passing out from the inside of the post and their connections to the overhead bare wires.

lighting fittings and lanterns. The overhauling and renewals to switchgear and fuses which are fixed in the various section pillars. The renewal of joints from the overhead lines to the lighting fittings and lanterns and general attention to span wires, brackets and insulators.

The repair staff will require the services of a motor tower wagon and driver. Their tools will include the usual wiremen's kit and, in addition, special tools for the erection and straining of span wires and overhead lines.

### The Cleaning Units.

Each cleaning unit will consist of a cleaner and a labourer. All the units will work under the supervision of the foreman of the repair staff.

The whole of the cleaning to be done will be divided into as many sections as there are units, and a unit will be responsible for the cleaning of one of these sections.

Their work will consist of cleaning the lighting fittings, reflectors and globes, renewal of lamps, painting of brackets and iron work. Cleaning the switchgear and fuses in the section pillars and winding the clocks of the time switches. A unit should be able to do completely the whole of the work of a section in about three weeks. This will ensure that the reflectors, globes, lamps will be kept reasonably clean, and that lamp renewals will be regularly made.

A hand tower, a complete set of cleaning materials, and a few tools, including spanners, screwdrivers and pliers, will be required for use by each cleaning unit.

### General Methods of Supporting Lighting Fittings and Lanterns.

In the centre of the city and on the main roads leading to the suburbs the



Fig. 3.—METHOD OF SUPPORTING A LANTERN FROM THE SPAN WIRES AND TERMINATING THE CABLE CONNECTIONS TO IT.

An iron T fitting with inlet holes for the cables is fixed to the top of the lantern. The T fitting hangs on the span wires. A little slack cable is left at the entry of the cables to the lantern. The cables are bound to the span wire with non-corrosive tape.

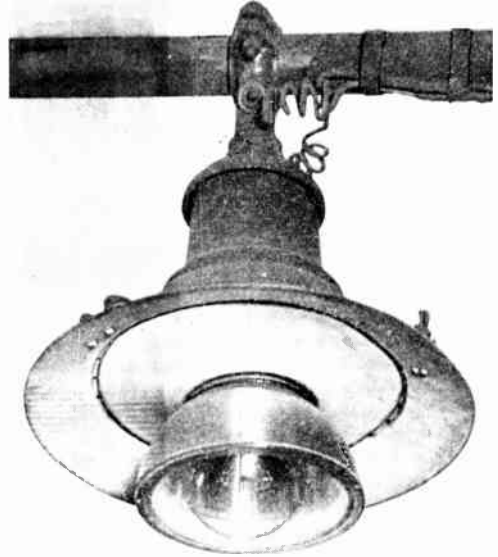

Fig. 4.—A LANTERN FIXED TO THE ARM OF A TRAMWAY POST WITH AN IRON CLAMP.

The clamp is fixed to the top of the lantern case and then bolted to the arm of the post.

lanterns are suspended from span wires, which are erected between opposite tramway poles and strained up to the correct tension with a draw vice, or the lanterns may be fixed to bracket arms on the poles.

In the suburbs, where there are numerous minor roads and streets, the lanterns are fixed at the top of lamp posts which are erected at intervals along the boundary line of the parapet and the road.

### Maintenance of Span Wires and Insulators.

The life of a galvanised steel span wire in a smoke-laden atmosphere is three years. A coating of vaseline on span wires will materially increase their life. Particular care

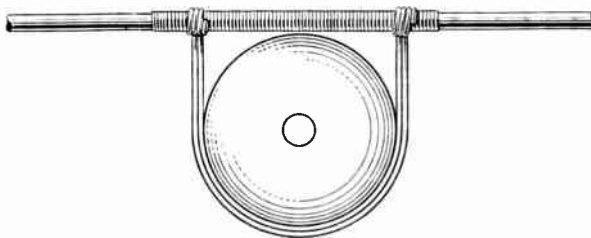

Fig. 5.—BINDING THE LINE WIRES TO INSULATORS.

A copper binding wire is first wound round the overhead wire for a distance of 3 to 4 inches. Then another binding wire is taken round the insulator two or three times and the ends bound over the binding on the overhead wire.

should be taken to ensure that the vaseline completely covers the whole of the wire, even the parts of the wire which are threaded round insulators. Span wires should be renewed when they show signs of corrosion or if any of the strands have broken. If possible, renew the span wire, using a copper weld instead of the galvanised covering. A copper weld wire is a stranded steel wire which has a covering of electrolytic copper. This wire has a very long life. A draw vice is used to strain up the new length of span wire

before the end of the wire is made off to the strain insulator. Strain insulators should be regularly examined and any which are cracked should be replaced.

### Maintenance of Brackets & Lantern Supports.

Tighten up

B

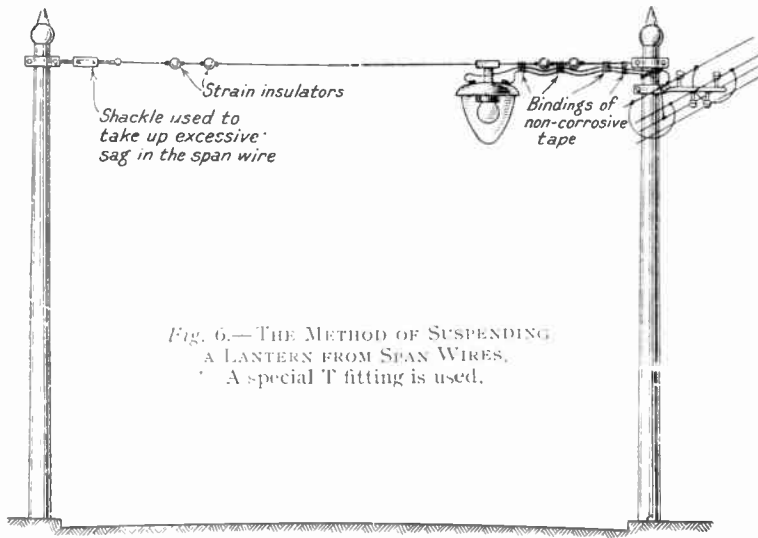

Fig. 6.—THE METHOD OF SUSPENDING A LANTERN FROM SPAN WIRES. A special T fitting is used.

wire about 5 feet on each side of the insulators. The loop passes under the inner wires and has a clearance of about 6 inches from them.

The object of this loop is to "short circuit" the inner wire or wires if they should break. The inner wires are the live wires of the system, and the outer wires are neutral and approximately at earth potential.

loose nuts on bracket bolts; smear a little oil on the bolt threads. (This will facilitate the unscrewing of the nuts when it is desired to remove or dismantle the brackets.) The cast iron T fittings which support the lanterns to the span wires should be regularly examined: these are sometimes found cracked due to change of temperature. Faulty and cracked fittings should be immediately replaced.

When an inner wire breaks the broken end of it falls on the loop, causing the fuses protecting that section of the wire to be "blown." There can then be no danger of coming in contact with the broken wire. The connections from the overhead bare wires to the lanterns are made with rustless cab tyre cable, which is bound to the span wires or the bracket arms of the poles with non-corrosive tape at frequent intervals. The joint between the cab tyre cable and the bare wire is made with a mechanical connector, which is clamped to the ends of the cable and to the overhead bare wire.

**Overhead Bare Lighting Wires.**

Steel brackets, each fitted with insulators, are fixed to the tramway poles along the line of route. In some cases the lines are only run on one side of the road, and in other cases on both sides of the road.

The lighting wires, which are bare hard drawn copper wires, are run in sections along the route. As the wires pass each pole they are bound to the insulators with a binding wire. Where the lighting wires are run on one side of the road, four of them are used, and three when the wires are run on both sides of the road. The total length of a section is about 1,000 yards. The wires are strained up with a draw vice and made off to the last insulator on that section.

The outer wires of the runs are bound together with a semi-circular loop of bare copper

**Maintenance of the Overhead Lines and Cab Tyre Cable Connections.**

The insulators should be frequently examined and any which are cracked should be replaced. The binding wires which hold the wires to the insulators should be tight. Tighten up any loose mechanical connectors. If there is any corrosion at the joints take the connector off, clean the wires and the contact surface of the connector and remake the joint. Do not

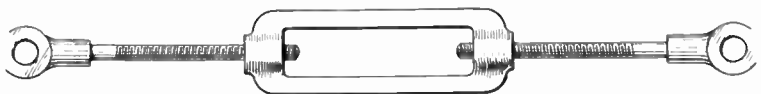

Fig. 7.—SHACKLE FITTED TO THE SPAN WIRES AND USED TO TAKE UP EXCESSIVE SAG IN THE WIRE.

The double nut is rotated over the left and right-hand threads and shortens the distance between the fixing lugs.

allow excessive sag in the wires. Tighten up any such wires with the draw vice, and make off the end of the wire at the insulator again. Cut away any branches of trees which overhang the wires, or any which may foul the wires. The non-corrosive tape bindings which hold the cab tyre cables to the span wires and bracket arms should be renewed when they show signs of deterioration or when they have become loose. Examine the insulation of the cab tyre cables where it passes into the terminal holes of the lantern case.

### The All-night and Half-night Circuits for the Lanterns.

Generally it is arranged that alternate lamps burn all the night, whilst the remainder burn only half the night.

When four overhead wires have been run on one side of the road, the lanterns are connected alternately between one of the inner live wires and the outer, and then between the other inner live wire and the outer. The overhead wires are fed from the section pillar, the inner wires being connected to the + and - outers of a

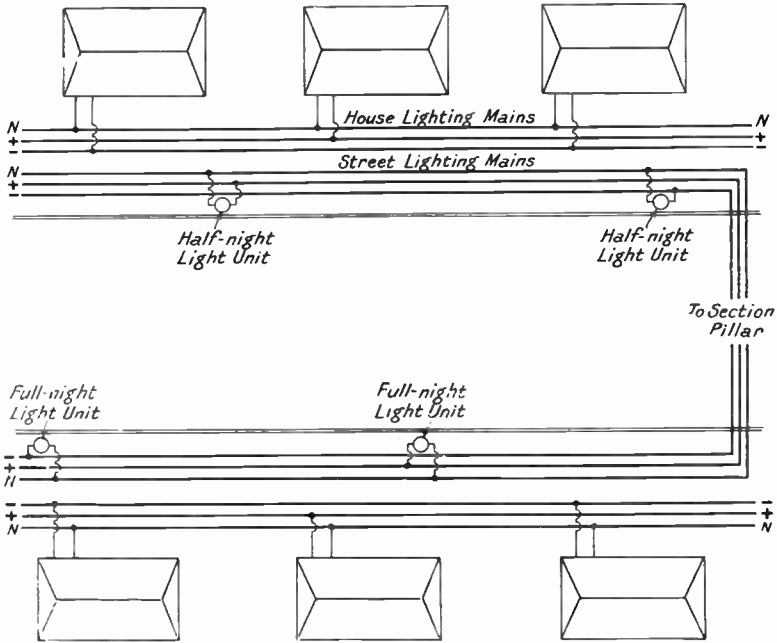

Fig. 8.— STREET LIGHTING CABLE CONNECTIONS FOR SUBURBAN ROADS.

three-wire system D.C. supply, whilst the outer wires are connected to the neutral wire of the system. In the case of an A.C. three-phase supply, the inner wires are connected to two of the phases and the outer wires to the neutral.

When three overhead wires have been run on both sides of the road, the lanterns are fed alternately from each set of wires, the inner wire on one side of the road being the + outer D.C. or one of the phases of an A.C. system and the inner wire on the other side of the road being the - outer D.C. or another phase of an A.C. system. The outer wires on both sides of the road are the neutral. In this way the lanterns are divided into two circuits on each section, each circuit being controlled separately at the section pillar.

### The Feeds to the Overhead Wires.

The overhead lines are fed from section pillars spaced about 1,000 yards apart. The section pillars are cast iron pillars containing the necessary switchgear and fuses to control the lighting circuits, and are fixed on the outer edge of the parapet

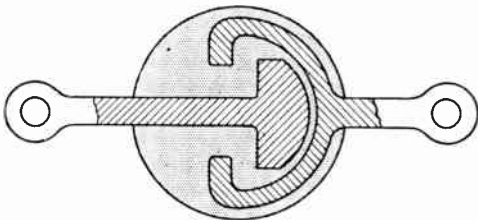

Fig. 9.—A STRAIN INSULATOR.

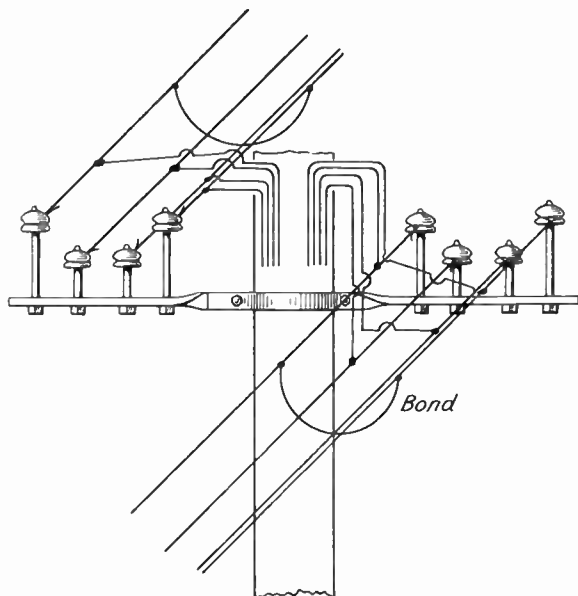

Fig. 10. BONDING THE OUTER WIRES.

The outer wires are bound together about 5 feet from each pole with a semi-circular loop of bare copper wire.

and within a short distance of the poles where the sections of the overhead bare wires terminate.

The feeds from the pillar are brought under the ground to the pole and then up the inside of a pole to a point where the brackets for the overhead wires are fixed. Here the feeds are brought out through a hole which has been drilled in the pole, and the ends of the feeds jointed on to the terminating ends of the overhead wires.

There are four circuits fed from the pillar arranged in two pairs. One pair feeds the section of the overhead wires terminating at the left side of the pole,

and the other pair feeding the wires terminating at the right-hand side of the pole. One of the pairs is connected through the switchgear in the section pillar to the + D.C. or one phase of an A.C. system and the neutral cables of the underground street mains, whilst the other pair is connected to the - D.C. or another phase of an A.C. system and the neutral of the street mains. Each pair of circuits consists of an all-night circuit and a half-night circuit.

This method of feeding the overhead wires materially assists in balancing the electricity supply network.

**The Section Pillars.**

Each of the circuits fed from the section pillar is controlled with a switch and protected with fuses. A time switch is connected in each of the circuits. The electrical energy consumed by the circuits is registered on two meters, one being connected in each of the "live" outers or phases which feed the pillar.

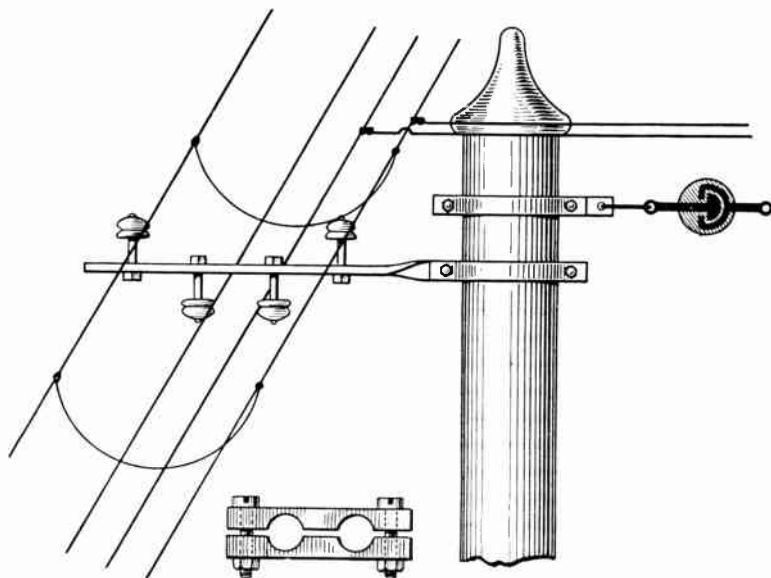

Fig. 11. THE CAB TYRE CABLE CONNECTIONS FROM THE LANTERNS TO THE OVERHEAD BARE WIRES.

These are made with mechanical metal connectors.

### Maintenance of the Section Pillars.

The panels should be kept clean. Switchgear must be examined, contacts and switch blades cleaned with fine glass paper and the spindles lubricated with a little light mineral oil. Note the quick break action of the switches is working and keep a little oil on the springs. Fuses should be renewed regularly and the contacts adjusted to prevent the fuse bridges falling out due to vibration when heavy traffic passes the pillar. Examine the cable connections and tighten up any which are loose.

The time switches should be wound up at regular periods of not less than three weeks. The clock of a time switch will run for 45 days when fully wound.

Examine the switch contacts. The spindles of the operating levers should be lubricated with clock oil.

It is very important that the dust should be removed from the outside of the time switch case before opening the hinged door. No dust must be allowed to penetrate to the inside of the case.

The settings of the hands of the clock should be checked from time to time, and adjusted when necessary.

Time switches are now generally fitted with a solar dial. This dial is designed to permit the switching "on" and "off" operations to vary from day to day to correspond accurately with the times of sunset and sunrise in the particular locality in which the time switch is installed, or any other desired schedule of times.

Instructions for setting the clock hands of the switches are given when buying the switch, and they vary with the make and type of switch.



Fig. 12.—CLEANING THE REFLECTOR OF A STREET LIGHTING LANTERN.

The lamp is taken out and the nuts of the hinged reflector loosened. The reflector can then be turned into a vertical position and easily cleaned and inspected.

When closing the door of the section pillar after overhauling the switchgear, etc., inside, make sure that the joint between the door and case is watertight. Water on no account should be allowed to get inside the pillar.

### Maintenance of the Lanterns.

The reflectors, refractors and globes, also the bulbs of the lamps, should be cleaned and polished at least once every three weeks. The presence of dirt on the surfaces of the above mentioned greatly reduces the illumination, as will be seen by the following figures, which are given by the courtesy of the Salford City electrical engineer:—

Type A Lantern, without enclosing globe.

	Cleaned.	Uncleaned for 22 days.	Fall in illumina- tion.
Max. illumina- tion ..	2.58 Foot candles.	1.8 Foot candles.	30%
Min. illumina- tion ..	.242	.115	52.5%

In the type B lantern the fall in illumination is practically limited to the collection of dirt and foreign matter on the surface of the outer globe.

The lamps should be carefully examined for signs of blackening or loose filaments. Under ordinary circumstances the lamps should not be allowed to burn beyond 1,000 hours.

Examine the cable connections to the lampholders, clean the Edison screw sleeves and contacts if they are corroded.

The iron cases of the lanterns should be frequently painted to prevent rusting.

**Street Lighting in the Suburbs.**

Section pillars are placed in convenient positions and from these all-night and half-night circuits are run underground along the various roads and streets. The lanterns are fixed on the top of lampposts, which are situated at frequent intervals on the boundary lines of the parapets and the road. Feeds

FEEDS TO 8 STREET LIGHTING CIRCUITS  
ALL-NIGHT CIRCUITS HALF-NIGHT CIRCUITS

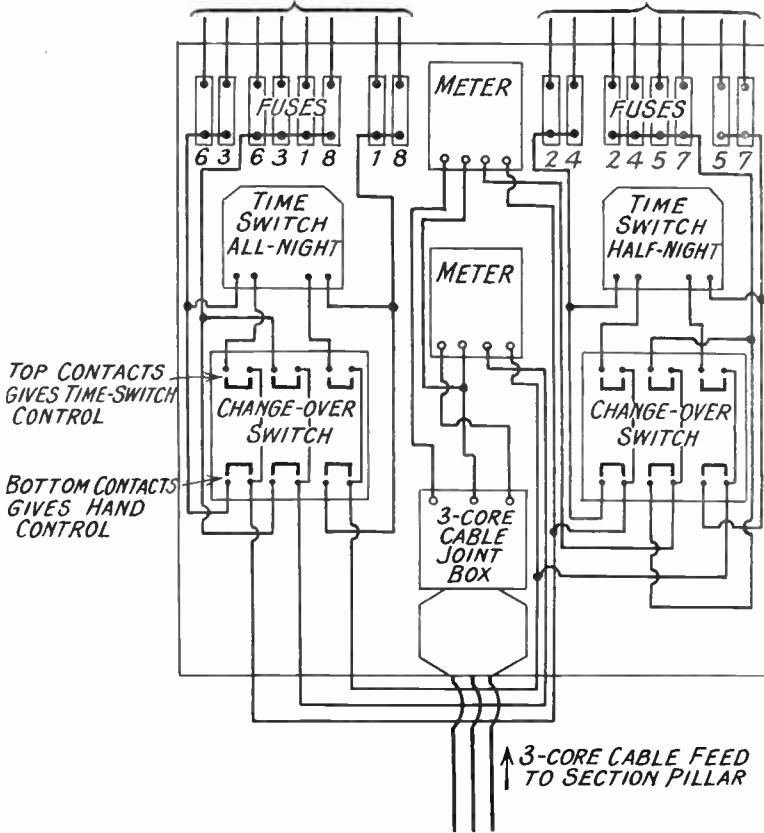

Fig. 13.—THE CABLE CONNECTIONS AND CONTROL GEAR OF AN EIGHT-CIRCUIT SECTION PILLAR.

The change-over switch gives hand control of the circuits when desired.

Type B Lantern, refractor sealed in clear glass outer globe.

	Cleaned.	Uncleaned for 22 days.	Fall in illumina- tion.
Max. illumina- tion ..	1.8 Foot candles.	1.46 Foot candles.	18.9%
Min. illumina- tion ..	.128	.11	14%

to the lanterns are jointed out from the underground circuits and run up the interior of the posts, emerging at the top, and the ends are connected to lampholders of the lanterns.

In some cases the all-night lanterns may alternate with the half-night lanterns on both sides of the road and in other cases one side of the road will have all-night lanterns and the other side half-night



lanterns. The maintenance of suburban street lighting will be considerably less than that required for lighting in the centre of the city and along the main roads. This will be due to the absence of overhead bare wires and supporting span wires for the lanterns.

Also the cleaning of the lanterns will not be so heavy because the atmosphere

is fitted with three light units. The top light in each standard illuminates a red lens, the centre light an amber lens, and the bottom light a green lens. The lenses are fitted in three sides of all the standards, so that they will be visible from all points of approach to the cross roads. When the green lights are showing on one route the red lights are shown on



*Fig. 14.*—SETTING THE DIAL OF A TIME SWITCH.

The secondary dial is turned round with the clock key until the arrow points to the first day of the current month. The dial is then turned round by hand, once round for each day afterwards, until the number of turns correspond with the actual day of the month.

There are two time switches fixed in the section pillar, each of them controls four lighting circuits.

farther away from the centre of the city will tend to become cleaner.

### Traffic Signals.

These are now installed in most towns and cities, and work admirably in dealing with cross-roads traffic. They are very reliable and if installed in a proper manner will continue to function for a long time without breakdowns.

### The Equipment.

Signal standards are erected at the junction of the cross roads. Each stan-

ding is fitted with three light units. The amber lights show between the change from green to red, to enable traffic which is in the act of crossing to get across the junction before the direction of the traffic is changed.

### The Method of Regulating the Time of the Signals.

The three circuits, one for each colour of signal light, are brought from each signal standard to a central control box fixed on one of the standards. The cables are run underground.

At the central control box the signal

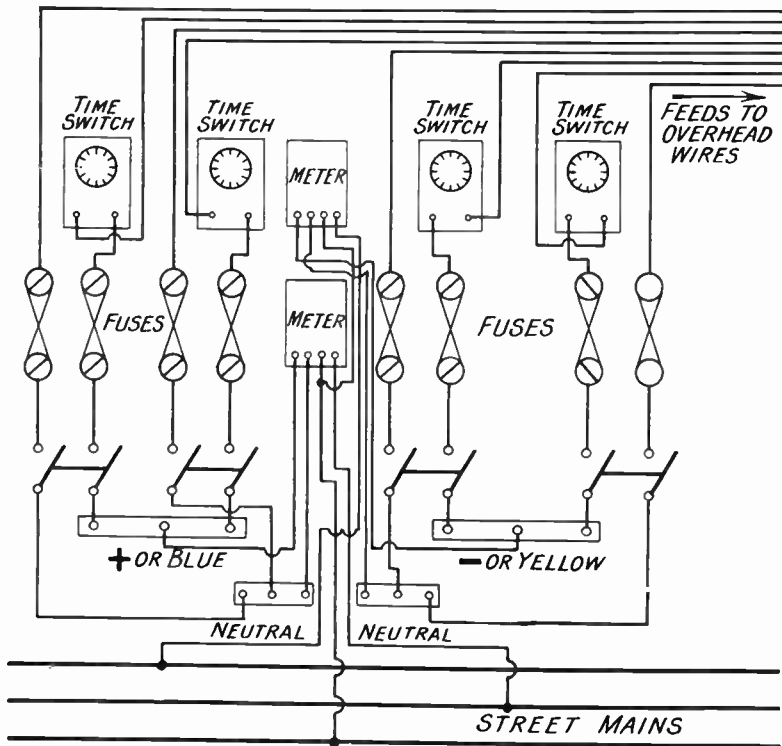
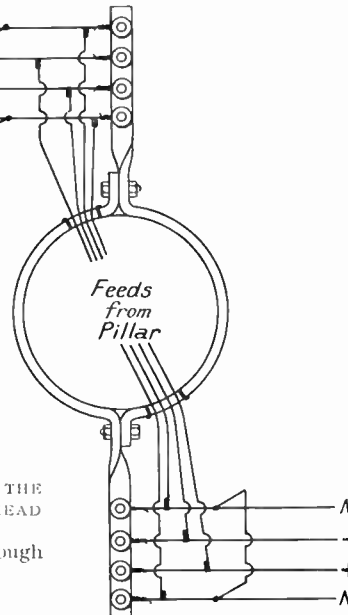

Fig. 15.—SECTION PILLAR CONTROL OF LIGHTING CIRCUITS.

The connections from the street mains to the four circuits feeding the overhead bare wires. Each circuit is controlled with a D.P. switch and two fuses. A time switch is included in each circuit. The electrical energy supplied to the circuits is recorded on the two meters. There are two full night circuits and two half night circuits.

Fig. 16.—THE FEEDS FROM THE SECTION PILLAR TO THE OVERHEAD BARE LINES.

The cables are brought through bushed holes in the post.



light cables are connected to a series of make and break contacts. Each of the contacts is opened and closed by one of a system of rotating cams during one revolution of a slowly rotating shaft to which they are fixed.

The cams open and close the various signal circuits for differing times. The times for which the signal lights are shown are determined by the ratio of the volume of traffic in one direction to that in the intersecting direction.

The periods of the times are capable of being adjusted by a series of dials which are mounted on the front of the control cabinet inside the box.

The rotating cam shaft is driven by a low-powered electric motor, one of the shunt type for a D.C. supply and one of the Foucault or eddy current type when the supply is A.C.

To obtain a slow speed of the rotating cam shaft the motor is geared through a train of wheels to the shaft.

**Hand Control of the Signals.**

When the traffic is

abnormal due to special conditions, the signals may be switched off from the cam shaft control to a hand switch control, which is operated with a cranked handle. The handle is inserted into the operating gear of a special change-over switch which is fitted inside a separate box, fixed on the inside face of the hinged door of the control box. The handle is operated from the outside of the control box.

#### **Maintenance of Traffic Signals.**

The light units in the signal standards must be cleaned regularly and the lamps renewed after burning 1,000 hours. The lenses must be carefully polished with a soft cloth.

No dust must be allowed to collect inside the control box. Examine the lubrication of the motor, and attend to the brush gear if the motor is of the D.C. type. The train of wheels will require lubricating from time to time with a little clock oil.

Examine the make and break contacts and clean carefully with 00's glass paper when necessary.

Make sure the hinged door of the control box is watertight and always close the keyhole covers when locking the box.

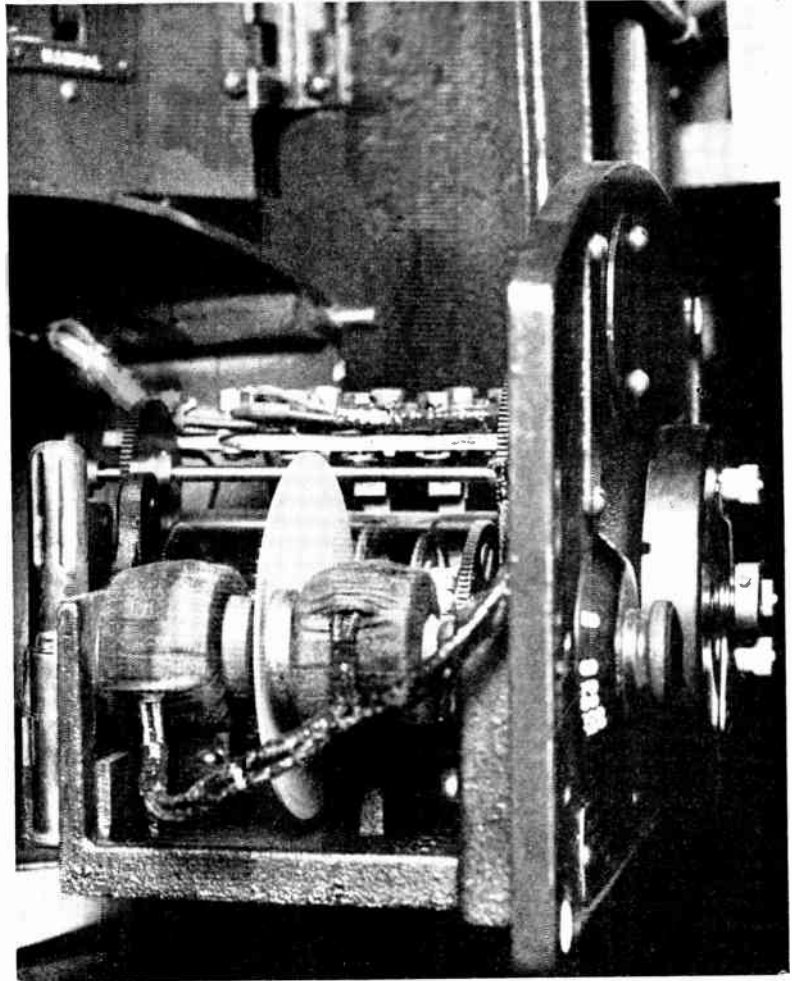

*Fig. 17.*—THE OPERATING MECHANISM OF TRAFFIC SIGNALS.

An eddy current motor drives the cam shaft through a train of wheels. The whole of the mechanism is fitted in a cabinet which can be drawn out from the box for inspection and adjustment.

The control of the time settings of the signals is generally done by the police, as they are responsible for the traffic control. A member of the police force is generally instructed by the makers of the signals as to the general settings of the signals.

#### **Pedestrian Road-crossing Signal Lights.**

Signal posts showing an amber or red light are erected at intervals along main roads, to indicate convenient points of

crossing for pedestrians. These lights are often controlled by a thermal flasher fixed in a box on the post.

The flasher should be examined from time to time and the contacts cleaned when dirty or corroded.

**White Line Illumination.**

A wrought iron frame about 3½ inches wide and 5 inches deep in made-up sections

ensure that no water collects inside the iron frame. The glazing must be water-tight.

Examine the condition of the lamps and lampholders regularly and the cable connections to them.

**The Annual Cost of the Maintenance of a Large Street Lighting System.**

With the kind permission of the City

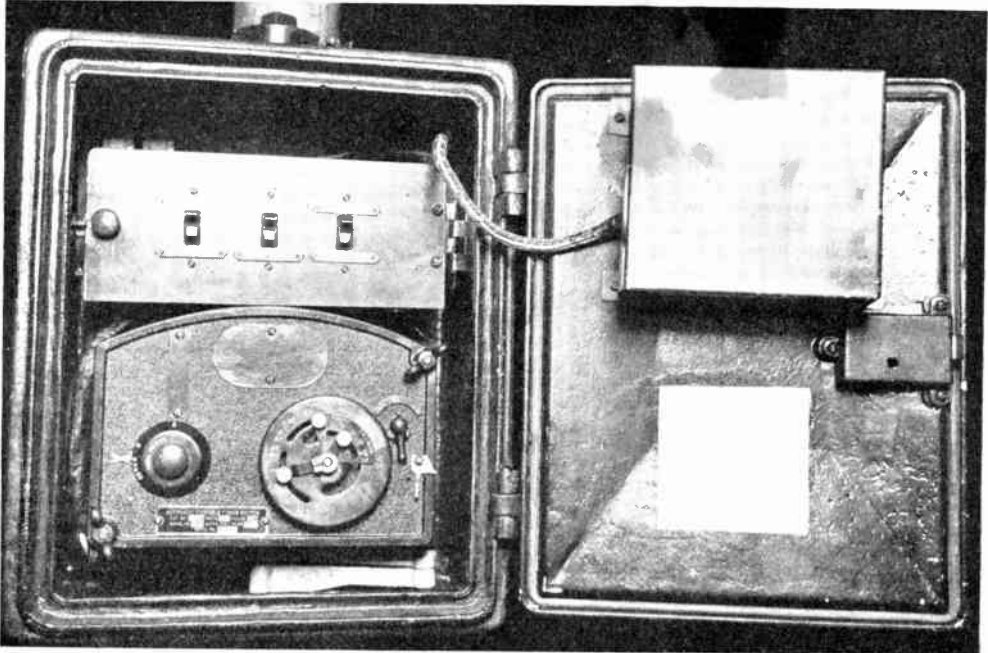

Fig. 18.—SHOWING THE TIMING DIALS OF THE MECHANISM WHICH OPERATES THE TRAFFIC SIGNALS. The timing dials are fixed on the front of the cabinet which holds the operating mechanism. Hand control of the signals is obtained by switching over the circuits to a control box fitted on the hinged door. The hand control is worked with a cranked handle from the outside.

to a length of about 30 feet is embedded in the roadway. In the top of the frame are placed pieces of prism glass and white marble arranged alternately. A row of low-powered lamps is arranged in the recess below the glass and marble glazing. The cables from the lamps are brought under the road and connected to the supply mains at a suitable place and controlled with a time switch.

Special provision is made to protect the lamps from shock due to vibration by using anti-vibration lampholders.

**Maintenance of White Line Illumination.**

Special attention should be given to

electrical engineer of Salford, and the assistance of the mains superintendent and staff, the annual cost of the maintenance of a large electrically equipped street lighting system is given :—

	£	s.	d.
Labour—			
Foreman .. .. .	200	0	0
Two wiremen at £170 each ..	340	0	0
Three cleaners at £150 each ..	450	0	0
Four labourers at £150 each ..	600	0	0
Motor driver .. .. .	160	0	0
	<hr/>		
	1,750	0	0
10% overtime .. .. .	175	0	0
	<hr/>		

	£	s.	d.
Total labour .. .. .	1,925	0	0
Labour for cleaning .. .. .	900	0	0
Maintenance labour .. .. .	£1,025	0	0

Annual Cost of Motor and Hand Towers—

	£	s.	d.
One motor tower wagon .. .. .	60	0	0
Five hand towers .. .. .	60	0	0
Petrol, repairs, licences .. .. .	150	0	0

	£	s.	d.
Hand towers for cleaning .. .. .	45	0	0

Cost of towers for maintenance .. .. .	£225	0	0
Repairs to Fittings—	£	s.	d.
Renewals of lanterns broken .. .. .	00	0	0
Sundry alterations .. .. .	30	0	0

	£	s.	d.
Lamp renewals (after burning 1,000 hours), 3,000 at 10s. each	£1,500	0	0

Total Annual Maintenance and Renewals—

	£	s.	d.
Labour .. .. .	1,025	0	0
Tower wagons .. .. .	225	0	0
Repairs .. .. .	120	0	0
Lamp renewals .. .. .	1,500	0	0

	£	s.	d.
10% overhead charges .. .. .	290	0	0

Total charge .. .. .	£3,100	0	0
----------------------	--------	---	---

Cleaning Costs—

	£	s.	d.
Three cleaners, three labourers .. .. .	900	0	0
Hand towers (three at £15) .. .. .	45	0	0
Materials £5 per unit .. .. .	15	0	0

	£	s.	d.
10% for supervision .. .. .	96	0	0

	£	s.	d.
	£1,056	0	0

Cost of Electricity—

500 half-night lamps burning 2,000 hours per year			
500 all-night lamps, burning 4,000 hours per year			
Cost of electricity, 1½d. per B.O.T. unit.			
Annual charge, 1½ million units .. .. .	£9,375	0	0

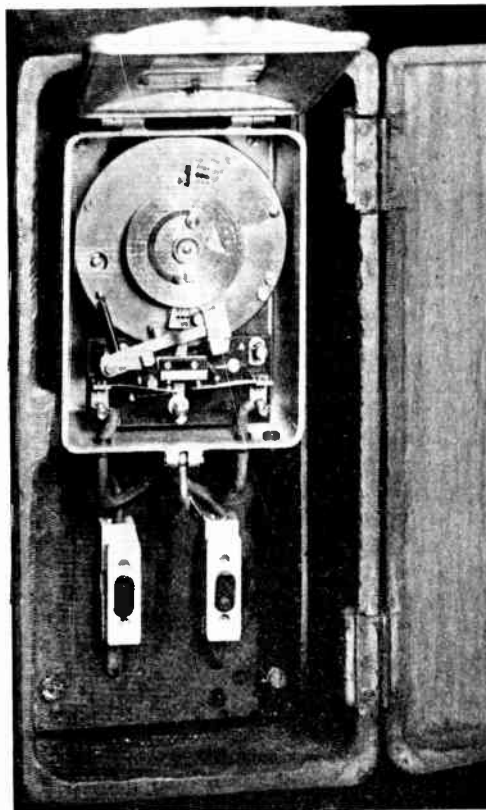

Fig. 19.—TIME SWITCH CONTROL OF STREET LIGHTING.

A time switch which is used to control the times of switching on and off of a lantern fixed to the arm of a post. Fuses are connected in the pole of the circuit. The switch and fuses are fitted in an iron box which is fixed to the side of the post.

Summary—	Total	Per lamp.
	£	£ s. d.
1. Capital charges .. .. .	1,725	1 14 5½
2. Maintenance .. .. .	3,100	3 3 2½
3. Cleaning .. .. .	1,056	1 1 1
4. Electricity .. .. .	9,375	9 7 6
	£15,316	£15 6 3

## QUESTIONS AND ANSWERS

**How are street lanterns suspended in the centre of a city ?**

From span wires which are erected between opposite tramway poles and strained up to the correct tension with a draw vice, or the lanterns may be fixed to bracket arms on the poles.

**How is bonding done ?**

The outer wires are bound together with a semi-circular loop of bare copper wire about 5 feet on each side of the insulators. The loop, or bond, passes under the inner wires and has a clearance of about 6 inches from them.

# REPAIRS TO ACCUMULATORS

By F. G. KIRBY, A.M.I.A.E., F.I.M.T.

**R**EPAIRS to an accumulator can usually be carried out by anyone with a practical turn of mind, providing care is used in details. The only exception is lead burning, a process requiring practical experience and which will be dealt with later. As all manufacturers of batteries supply groups of plates already burnt up ready for insertion into the containers, the repair to a battery reduces itself to dismantling the faulty battery and reassembling with the new group of plates, sealing up, and giving first charge.

## Starter Batteries.

We will deal first with starter batteries. The first operation upon receiving a battery for attention or repair is to test the acid for specific gravity; this ascertained and corrected if necessary, make a high-rate discharge test.

## The High-rate Discharge Test.

It is a good plan to keep what is termed a shooter for testing the condition of starter batteries, as it is difficult to ascertain, on sight, the internal condition owing to their being sealed (wireless batteries, of course, can be observed through the celluloid). A good type of shooter is marketed by the Exide

Company and by Joseph Lucas. It consists of a moving coil voltmeter reading both ways with a heavy resistance bridged between the terminals. The ends of the terminals are two pointed ends which are placed directly across the positive and negative terminals of each cell. If the condition of the plates in the cell is good the voltage shown is constant, if otherwise, a rapid drop in voltage occurs.

This method is an infallible test of condition of plates and will show an immediate drop in voltage which proves which is the faulty cell or cells.

## Cadmium Test for Faulty Plates.

Another test for faulty plates is the cadmium test. The tester consists of a voltmeter which should have a zero reading at the middle of its scale and positive readings to the left and right of it. Two flexible cords are attached to the terminals of the voltmeter. The usual contact spike for making contact with plus or minus terminals of the cells of the battery

is fixed to the positive cord, while the negative cord has a piece of cadmium about 4 inches long by  $\frac{3}{8}$  inch diameter soldered to its extremity.

This cadmium stick is covered with



Fig. 1A.—REMOVING A CELL.

Centre punch the terminal and drill down to a depth of the thickness of the connecting bridge. Insert a screwdriver under the bridge, when with a slight upward pressure the bridge can be removed, leaving the cells ready for the next process, which is to remove the lid. The faulty group of plates can then be removed as shown.

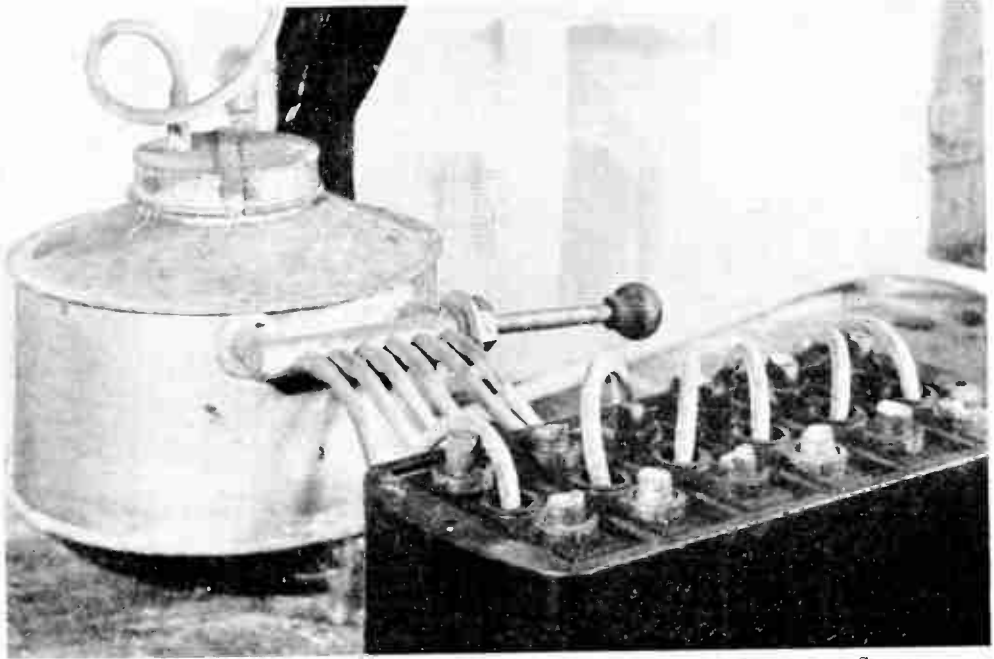

*Fig. 1B.*—HOW TO REMOVE THE COMPOUND FROM THE CELL BY MEANS OF STEAM.

Fit six brass tubes into the side of a kettle or can. The kettle is then partly filled with water, and placed on a gas ring. On to the end of each brass tube fix a piece of rubber tubing, and insert one tube into the vent of each cell. The heat of the steam will soften the compound.



*Fig. 1C.*—REMOVING THE COMPOUND WITH A HOT KNIFE.  
This is done after the compound has been softened as shown in Fig. 1B.

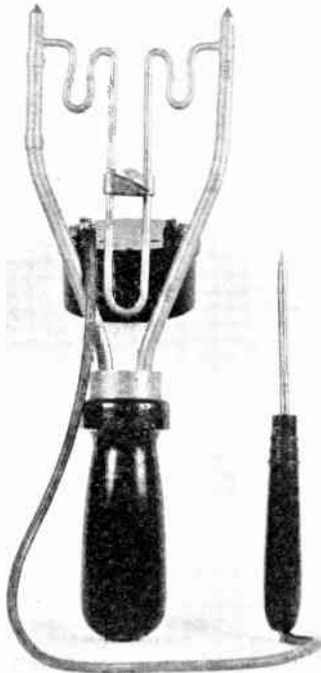

Fig. 2.—DISCHARGE VOLTMETER TESTING SET.

This set enables the voltage of the cell or battery to be taken with a discharge current flowing. The rate of discharge is varied by the movable clip shown on the centre grid.

perforated hard rubber or ebonite tube to prevent direct contact with the plates, and is put through the vent into the liquid of the cell between two plates, preferably in the centre of the sections as position affects the readings considerably.

The cadmium is really another electrode or plate which forms two other cells with the substance of the plus and minus plate and the acid respectively. The e.m.f. of each of these subsidiary cells depends on the condition of the plus and minus lead plates, hence voltage readings between cadmium electrode and either plus or minus lead plate indicate the condition of these plates individually with respect to the cadmium, and not the apparent condition of the cell as a whole. This test will be found useful in indicating defective negative or positive lead plates rather than a general reduction of capacity of the cell as a whole, due to age or bad usage. The connections for the cadmium test are shown in Fig. 3.

When testing a fully charged battery by this means the reading with the contact on the plus terminal should be to the right of zero and about 2.4 to 2.5 volts. The reading with the contact on the minus terminal should be to the left of zero and about minus 0.15 to minus 0.2 volt. This is obviously equal to a voltage of 2.4 plus 0.15 equals 2.55 volts.

When testing a discharged battery with healthy plates a reading between positive lead plate and cadmium should be about plus 2.05 volt, whilst the reading between negative and cadmium should be on the same side of the zero and equal to about plus 0.25 volt. These readings indicate a discharge voltage of 2.05 minus 0.25 equals 1.8 volts.

### How to Remove a Cell.

The faulty cells are marked for removal, which is done in the following manner:—

The tools required are a brace and a  $\frac{3}{8}$  in. twist drill. Centre punch the terminal posts and drill down to the depth of the

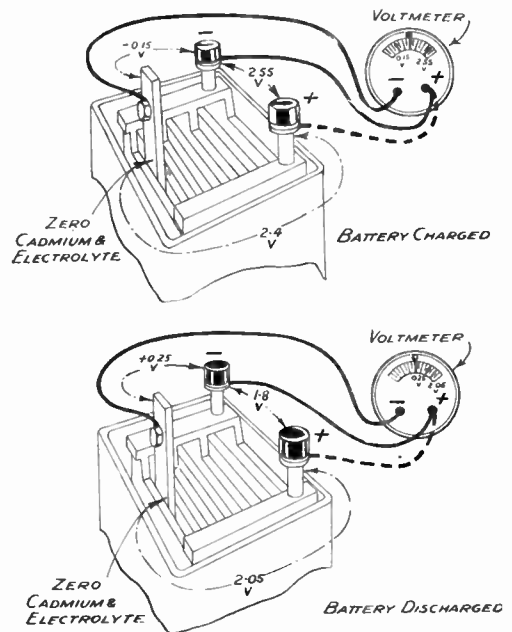
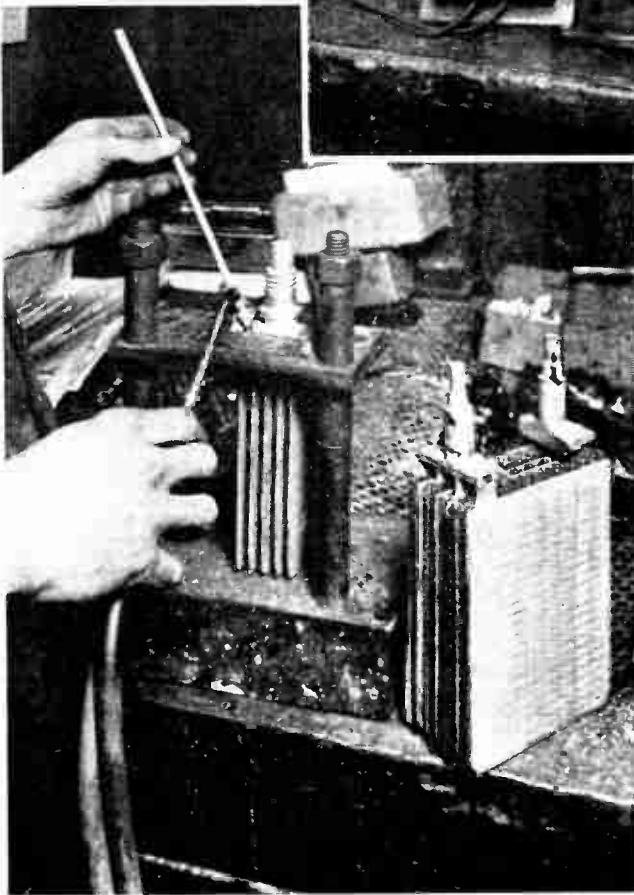
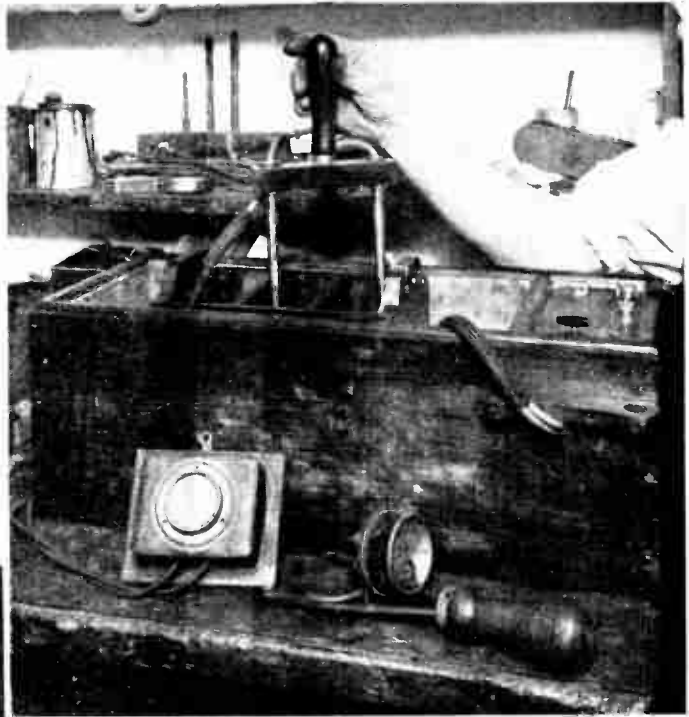

Fig. 3.—DIAGRAM ILLUSTRATING THE CADMIUM TEST.



*Fig. 4 (Right).—TESTING FOR LEAKAGE BETWEEN ONE CELL AND ANOTHER.*

This test consists of a lead-lined box into which the container is placed, each cell being then filled with water. A two-volt battery, a trembler coil and a two-prong fork with insulated handle are used. One prong is placed in one cell and the other prong in the cell adjoining. If there is a leakage a fault will disclose itself through the spark taking the path of least resistance.



*Fig. 5 (Left).—LEAD-BURNING GROUP OF PLATES TOGETHER.*

The plates are made a tight fit on the pillars, an iron ring is placed over the pillar, and the flame applied until the whole assembly is hot. Now apply the strip lead until it runs freely and fills up the whole of the inside of the iron collar. See Fig. 8 for apparatus used in lead burning.



Fig. 6.—PLACING THE POSITIVE GROUP OF PLATES INSIDE THE NEGATIVE GROUP.

trembler coil, also a two-prong fork with insulated handle, are used in conjunction with this test and the complete equipment is shown in Fig. 4. The high tension current lead is connected to the fork, one pole on each side, and when the coil is switched on, owing to the distance separating the two conductors, the resulting high tension spark is allowed to cross a spark gap of approximately

thickness of the connecting bridge, insert a screwdriver under the bridge when with slight upward pressure the bridge can be removed, leaving the cells ready for the next process, which is to remove the lid. The faulty group of plates can now be removed (see Fig. 1A). Next thoroughly clean out the container or containers ready to receive the new group or groups.

8 millimetres. One prong is placed in one cell and the other prong in cell adjoining. If there is a leakage, such as a cracked



Fig. 7.—USING A METAL CONTAINER WITH A LEADING-OUT SPOUT FOR APPLYING THE SEALING COMPOUND.

#### Testing for Leakage Between Cells.

The next test is for leakage between one cell and the other. The test is only carried out for a complete replating and is one that thoroughly commends itself. It consists of a lead-lined box, into which the container is placed, each cell being then filled with water. A 2-volt battery, a

partition, the fault will disclose itself through the spark taking the path of least resistance. The container should then be scrapped.

### Reassembling a Container.

Having satisfied yourself that the container is O.K., proceed to reassemble as follows:—

Assuming you have your groups already burnt up for insertion, the positive group of plates is placed inside the negative group (see Fig. 6). Next place the separators between each plate and the whole assembly is now ready to drop in the container. Care must be exercised that in placing the second group the positive terminal post is the reverse to the preceding one. Having inserted all the groups in their respective containers, and assured yourself that they fit properly, replace the rubber washers over the terminal posts (first making sure they are not perished), and replace the lids. Make sure in doing this operation that the lids are all the same depth from the top of the case. Now screw down the locking rings to a tight fit and finally seal the lids. The sealing compound is supplied by all battery equipment concerns and is in brittle form. It should be broken up and heated to running consistency in a metal container with a leading-out spout (see Fig. 7). Carefully run the compound round the lids to form a good joint, and as a final finish for a neat job a small gas flame should be lightly run over the joints until the compound assumes an even appearance.

### Fixing the Connectors by Lead Burning.

The last process, namely, fixing the connectors is one that requires a certain amount of skill and care as the connectors have to be burnt on by a process known as lead burning. The equipment required for this process is the following: A cylinder of oxygen, a supply of ordinary coal gas and a burner (see Fig. 8) with necessary rubber tubing. The burner has a two-way intake, one being fed from the ordinary gas supply and the other from the oxygen cylinder. The amount of oxygen to be used is controlled by a valve and is dependent on the size

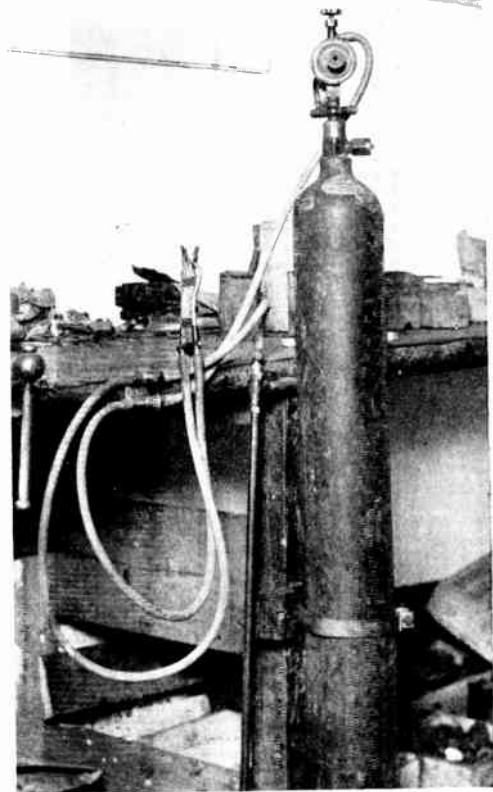

Fig. 8.—APPARATUS REQUIRED FOR LEAD-BURNING.

This consists of a cylinder of oxygen, a supply of ordinary coal gas and a burner with necessary rubber tubing. The burner has a two-way intake, one being fed from the ordinary gas supply and the other from the oxygen cylinder. The amount of oxygen to be used is controlled by a valve and is dependent on the size of the flame and the size of work required.

of the flame and size of work required. The pressure gauge should read about 15 lbs. per square inch. The connectors are made a tight fit on the pillars, an iron ring is generally placed over the pillar, and the flame applied until the whole assembly is hot. Now apply the strip lead until it runs freely and fills up the whole of the inside of the iron collar.

### Filling the Battery with Acid.

The final operation is filling up the battery with the correct specific gravity acid. In the case of starter batteries, the specific gravity should be in the neighbourhood of 1.280. The battery should be



Fig. 9.—THE FINAL OPERATION OF REASSEMBLING A BATTERY.

Showing the connections between the cells being lead burnt.

allowed to stand after filling for say two to three hours to allow the acid to soak into the separators, and a slow charge given until the battery is fully charged.

The battery should then be discharged, the acid emptied, refilled, and given a final charge. Care must be taken that the specific gravity in second filling is correct.

#### CELLULOID BATTERIES.

The operation for celluloid batteries in the case of replating is similar to starter batteries, but care must be taken when opening the case. A sharp, stiff knife is inserted in the seam round the lid which is split all round. After removal of the old plates, the case should be thoroughly cleaned and dried. Reassemble the new groups as previously explained, care being taken, if the voltage is *over* two volts, that the positive and negative terminals are correctly placed for connecting up in series. On some makes of celluloid batteries, a rubber ring is placed over the terminal post, so that when the lid is placed in

position the plates are held rigid. In other makes a locking ring is used for this purpose. After assembly, the lids are replaced, and strips of celluloid placed round the edges and the whole lid, including the sealing strips, is sealed.

Amyl acetate is used for sealing celluloid batteries, the action being partially to dissolve the celluloid so that when two surfaces are treated with the solution and placed together they practically become welded. Care must be taken when filling celluloid batteries with acid for charging that the specific gravity is not more than 1.230; if too strong acid is used the effect is disastrous to the celluloid and will soon ruin the case.

#### Care of Terminals.

The terminals and connectors of celluloid and other batteries should be kept coated with vaseline to prevent corrosion, and attention to this detail will often save a great deal of trouble.



Fig. 10.—ASSEMBLING THE CASE OF A CELLULOID BATTERY.

# ELECTRICAL ENGINEERING MATERIALS

## COPPER AND ITS APPLICATIONS FOR ELECTRICAL WORK

By A. W. JUDGE, A.R.C.Sc., D.I.C., Whitworth Scholar.

**C**OPPER is undoubtedly the most important metal used in electrical work, a very large quantity being employed annually for electric cables, wires, machines and for conductors of various types.

Apart from the fact that copper is available, in the form of natural ores, e.g., copper pyrites, malachite and chalcopyrite, in various parts of the world, and can be manufactured in its commercial forms in large quantities at reasonable prices, this metal has several important properties which render it particularly suitable from the electrical point of view.

### Strong and Easily Worked.

In the first place, it is a hard, tenacious metal that is easily worked, on account of its ductility, i.e., its property of being drawn out into wire without fracturing. It is also malleable, that is to say, it can be beaten out into sheets or sheet metal without cracking—provided it is annealed occasionally.

Copper in the cast condition has a tensile strength of about 12 tons per sq. in.; that is to say, a rod of 1 sq. in. section would require a steady pull of 12 tons to fracture it.

If the cast copper is drawn out, through suitable rolls or dies, into the form of wire, it gradually hardens as the drawing process proceeds. Moreover, its strength also increases. It

is thus possible to obtain drawn rods and wires up to 28 tons per sq. in. tensile strength.

### Electrolytic Copper.

One of the most important methods of copper production is that of obtaining pure electrolytic copper from crude metallic copper. The electrolyte is circulated in lead-lined wood tanks holding about 900 gallons. The crude copper is cut into plates and used as anodes, while the cathodes are prepared by depositing copper on copper sheets coated with graphite and paraffin. After about 24-48

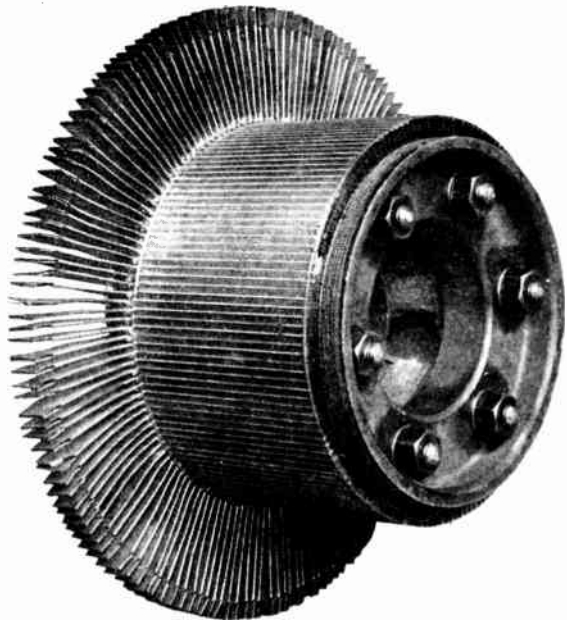

Fig. 1.—A TYPICAL COMMUTATOR FOR D.C. MOTOR. Showing copper commutator segments and copper connecting strips.—(General Electric Co.)

hours the copper is stripped from the backing and the latter is again used as the cathode. Three hundred kw.-hrs. are required to produce 1 ton of copper by this method. Copper tubes can also be obtained by depositing copper electrolytically on a revolving iron cylinder or mandrel. The tube is rotated in the electrolytic bath, thus producing a tube-like deposit of copper. Electrolytic strip copper for electrical conductors is obtained by a similar method, using a mandrel with a sharp V-shaped spiral groove.

cently, however, small quantities of other elements, notably *cadmium* and *silicon*, have been added to copper to increase still further its strength properties and also its resistance to atmospheric corrosion, so that it will withstand better the outdoor conditions of application for cables and conductors.

An example of the use of cadmium copper is that of the wires used for the overhead conductors of electric tramways. In this case only 1 per cent. of cadmium is contained in the copper, but the strength and corrosion resistance are increased appreciably.

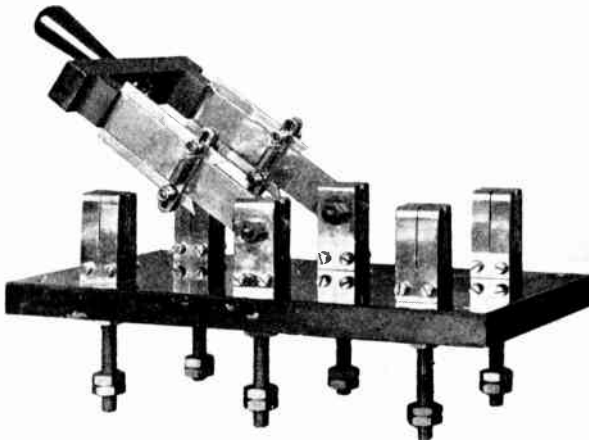

Fig. 2.—200-AMP. DOUBLE POLE, DOUBLE THROW KNIFE SWITCH.  
Showing copper blades and jaws, for circuits up to 660 volts.—(General Electric Co.)

Perhaps the most interesting of the electrolytic methods is that of obtaining copper wire. Copper is deposited on an endless wire of the desired diameter, which is passed through the electrolytic bath and thus coated with copper. The thickened wire is then passed through a draw plate to bring it to its original size so that it is gradually lengthened until finally the increase is cut off.

#### Addition of Cadmium and Silicon.

Because copper hardens as it is drawn out, copper wire is strong enough for overhead cables and various other purposes where wire conductors are required. More re-

#### Electrical Properties of Copper.

Coming next to the *electrical properties* of copper, this metal heads the list of the common metals in the matter of electrical conductivity. Actually, however, silver is a rather better conductor, but its use is, of course, ruled out, commercially, on the score of expense. It may here be of interest to readers to compare the relative conductivities of some of the well-known metals; for this reason the following table has been prepared to show these metals in the relative order of their electrical conductivities, each metal in this table being a better conductor of electricity than those below it.

#### Conductivity Compared with Other Metals.

It will be seen that silver heads the list but is only 2 per cent. better than copper, which comes next on the list.

#### ORDER OF ELECTRICAL CONDUCTIVITIES.

Silver (hard drawn)	..	1.02
Copper (hard drawn)	..	1.00
Aluminium	..	1.85
Iron	.. ..	6.50
Lead	.. ..	12.04
German Silver	.. ..	18.5
Manganin	.. ..	28.8

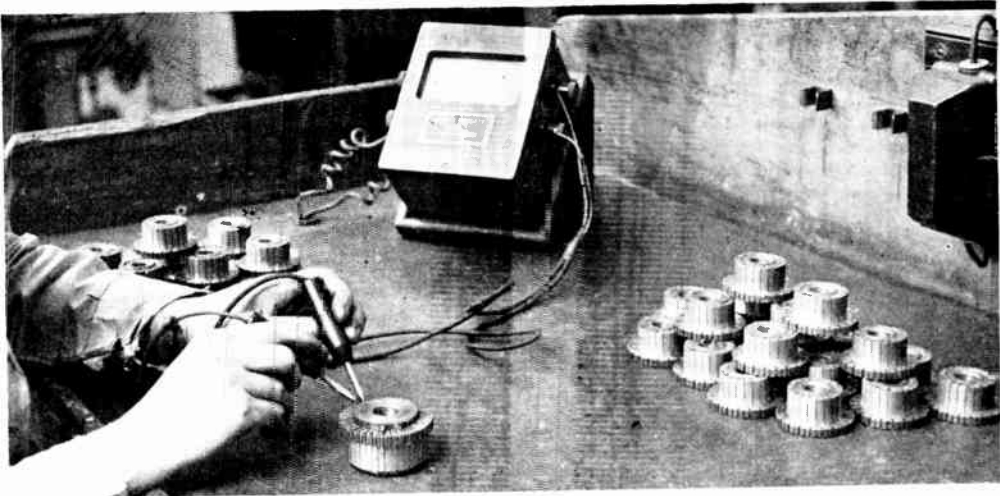

Fig. 3.—AN IMPORTANT APPLICATION OF COPPER IN ELECTRICAL ENGINEERING.

Commutators are invariably built up of copper segments. Here we see a batch of car dynamo commutators being tested by means of a motor driven megger and prod leads.

The next best conductor to copper is aluminium, but it offers nearly twice the resistance to the passage of electrical currents than a copper conductor of equal length and sectional area.

Iron, it will be seen, is a relatively poor conductor, having six and a half times the resistance of copper.

As a contrast, at the bottom of the table two electrical resistance materials, viz., German silver and manganin, are given. These alloys have high resistances and they are therefore used for resistance and heater elements.

#### Resistance to Corrosion.

Copper has a characteristic red colour, being the only metal of this hue. It corrodes in the atmosphere, but the coating of oxides and carbonate formed acts as a protection against further corrosion of the metal beneath. It is for this reason that copper sheeting is used for decorative work on public buildings. As we have already mentioned, however, the addition of cadmium or silicon in very small percentages greatly increases the resistance to corrosion. Incidentally, copper should not be exposed for lengthy periods to salt or moist air as the copper carbonate or verdigris that forms, if kept

moist, is liable to eat into the metal below.

#### Weight.

Copper is a relatively heavy metal, the specific gravity being 8.8 to 9 (according to whether it is cast or drawn). Aluminium, on the other hand, has a specific gravity of only 2.69, so that although it has a lower conductivity (1.85 times that of copper) it is actually lighter than copper when used as an electrical conductor under similar conditions of current and voltage.

#### Heat Conductivity.

Copper is an *excellent conductor of heat*, being better than aluminium. From the electrical viewpoint this is a decided advantage when it is desired to cool certain parts by conducting the heat away quickly.

On the other hand, when soldering copper wires one is liable to heat or melt the insulation more readily than in the case of other metals.

#### Screening Electrical Parts.

Copper is one of the best materials available for *screening electrical parts* from one another. Thus, if there are two coils

in an instrument, or wireless receiver, which tend to interfere with one another, owing to the electrical or magnetic fields intersecting, it is possible to isolate each coil by placing it in a box made from copper plate, or even of copper gauze. This method of screening coils, magnetos, and similar electric field producing parts is much used in wireless and electrical work.

Incidentally, it is now possible to obtain a special plywood, known as Plymax, having a sheet of copper firmly cemented to one, or both, sides. These compound sheets are very useful for electrical cabinet work.

To obtain the best screening effects it is necessary to solder all the joints of the copper compartment about the part to be screened.

#### **Soldering Copper.**

Copper has a fairly high melting point, viz., 1,083° C. It can be soldered either with soft (lead-tin) or hard (silver alloy) solders or brazed without difficulty. In this respect copper has a big advantage over aluminium as the latter metal cannot be joined satisfactorily, except with an oxy-acetylene flame or by electric welding methods. This is one reason that copper conductors and connectors are so widely used in electrical work.

#### **Welding.**

Copper, on the other hand, cannot be welded very easily, as it is a difficult matter to keep the joint free from the oxides which form during the welding operation. Quite recently, however, a new welding process known as the "Pre-mag" one has given excellent results with copper; it is now possible to obtain sound welded joints free from porosity or included impurities.

#### **COPPER ALLOYS.**

Copper forms a number of important alloys with other metals; many of these

alloys are used for electrical parts. The following are brief particulars of some of the more important alloys:—

#### **Brass.**

This is an alloy consisting of copper and zinc. As these two metals can be mixed together in a wide range of proportions, it follows that a variety of brasses can be obtained. Those containing more copper have a golden colour, whilst those having more zinc than copper are lighter and greyer.

The strength properties of these brasses depends upon their composition. Thus brasses containing about 20 per cent. of zinc (80 per cent. copper) are the most ductile; those containing 60 to 70 per cent. zinc are very brittle.

A good brass is one containing 66 to 70 per cent. of copper, the rest being zinc. This alloy is much used for brass castings and has a tensile strength of 14 to 17 tons per sq. in. The cheaper brasses, viz., those containing more zinc (35 to 50 per cent.), are inferior in strength.

#### **Bronzes.**

These alloys contain other elements, such as manganese, iron, nickel and tin, in addition to copper and zinc. *Phosphor bronze* contains approximately 86 per cent. of copper, 13 per cent. tin, and 0.25 per cent. phosphorus. *Manganese bronze* contains manganese and iron (and in some cases tin) in addition to copper and zinc.

#### **Gun-Metal.**

This is another important alloy used for strong non-corrosive electrical parts and fittings. A typical composition contains 87 per cent. copper, 10 per cent. tin and 3 per cent. zinc.

It has only been possible to touch on the fringe of the subject of copper alloys, but it should be mentioned that there is a wide range of commercial alloys of copper now available under various trade names.



# ELECTRIC GRAMOPHONE MOTORS

## WITH NOTES ON ADJUSTMENT AND MAINTENANCE

By A. E. WATKINS

**E**LECTRIC gramophone motors can be divided into three classes: (1) The Universal which can be used for either A.C. or D.C. current; (2) the D.C. motor suitable only for direct current, and (3) the induction motor suitable only for alternating current.

Each type has its particular uses. While a Universal would appear to be an ideal type, it nevertheless has the disadvantage of having a commutator which is apt to cause sparking at the brushes, but, nevertheless, this type of motor should be used in cases where there is a likelihood of the supply being changed from D.C. to A.C. or in instances where the instrument is to be used on different supplies. This would apply to cases where gramophone entertainments are given, such as in the case of public address work, or for garden fetes, etc. The D.C. motor, of course, will only apply in cases where it is desired only to have an instrument which will operate on D.C. supply.

The induction type of motor is now solely used on A.C. supplies, as this motor having no commutator or brush gear is perfectly silent in operation, and can, therefore, be used without hesitation when the instrument is intended for use always on the A.C. supply.

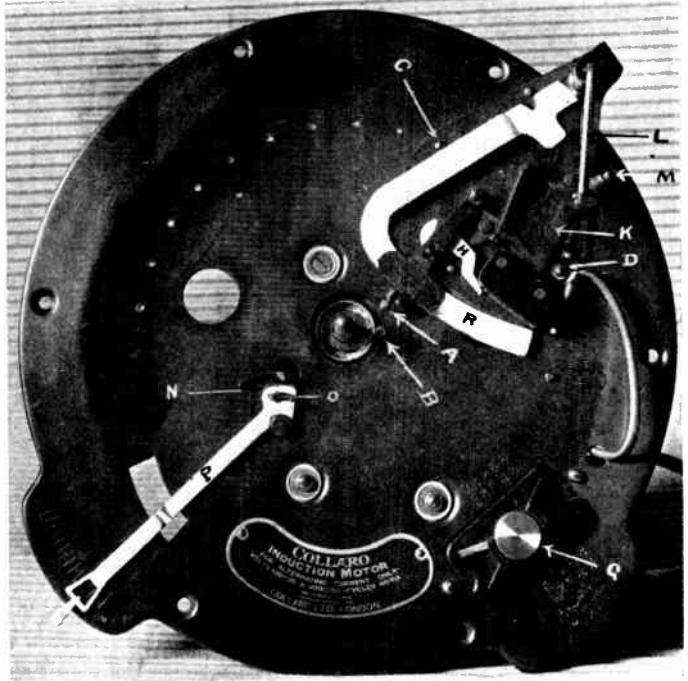

Fig. 1.—COLLARO INDUCTION MOTOR.

This motor operates on voltages between 100 and 130, and 200 and 260. Note the automatic stop, the position of which can be altered by removing the two screws C and D.

### The Correct Speed for Satisfactory Reproduction.

The original sound recorded on a gramophone record can only be reproduced correctly when the turn-table is rotated at the correct speed, which is exactly the speed at which the record was originally cut. Uniformity of speed is also essential, and can only be ensured by the use of a good motor properly adjusted, and the rate of revolution correctly set by the governor on the motor.

### Effect of Incorrect Speed.

A record which runs too slowly or too fast will reproduce sound which differs from the original in several ways. There will be a change of pitch, the music being transposed into a higher or lower key, according to whether the record is running fastly or too slowly. This change of quality occurs, not only in music, but

This simple device is called a stroboscopic indicator.

### How to Make a Speed Tester.

If the accompanying illustration (Fig. 5) is pasted to a piece of cardboard and cut into a circular disc with a hole in the centre to fit the turn-table spindle, it can be used as a quick and accurate speed

tester wherever there is A.C. lighting at 50 cycles frequency. Place the disc on the turn-table over a record, and view by the electric light as it is playing. The speed regulator of the gramophone is adjusted until one of the rings appears quite stationary. The table will then be rotating at 78 r.p.m. for the inner ring, or 80 if the outer is stationary.

The most suitable lamp to view the indicator is a Neon lamp. This shows up the stroboscopic defect very vividly although an ordinary  $\frac{1}{2}$  watt or vacuum lamp is perfectly satisfactory. This test must be

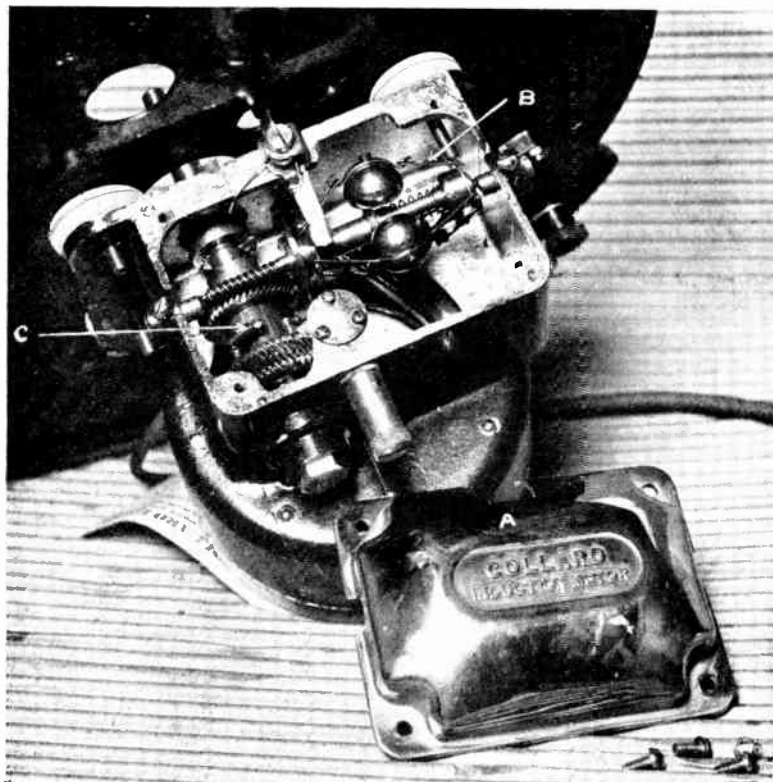

Fig. 2.—COLLARD INDUCTION MOTOR WITH COVER PLATE REMOVED.

Note the links B on the governors, in place of the springs; also the spring drive C on the main spindle.

also in speech. Most records are marked with the correct playing speed, and this is usually 78 revolutions per minute (78 r.p.m.). The revolutions may be checked by means of a stop watch by counting the number of revolutions, but this is rather a tedious process. There is, however, a very simple device which can be used by those who have A.C. electric light of 50 cycles frequency.

carried out in a room free from too much daylight, or the turn-table and lamp shaded in some manner from the direct daylight.

If the motor is running too fast, the rings will slowly move to the right; if running too slow they will go to the left.

Electric gramophone motors, like all other pieces of machinery, require attention from time to time, such as oiling and

adjustment of the automatic stops, for most motors are fitted with an automatic stop which stops the motor when the record is finished.

### Testing Motor for Sufficient Strength.

To test in order to find out whether the motor is sufficiently strong to carry out its work, take a record, in which there are some heavy passages, such as the Hungarian Rhapsody. Place this record upon the turn-table and lay over the centre

reproduction lies in a steadily running motor.

### When the Motor is Cold.

If the motors are cold, they may run a little slowly but after being allowed to run for a few minutes they will quickly obtain a normal running speed. It is, therefore, advisable for users of electric gramophone motors to run the motor for a few minutes before starting to use,

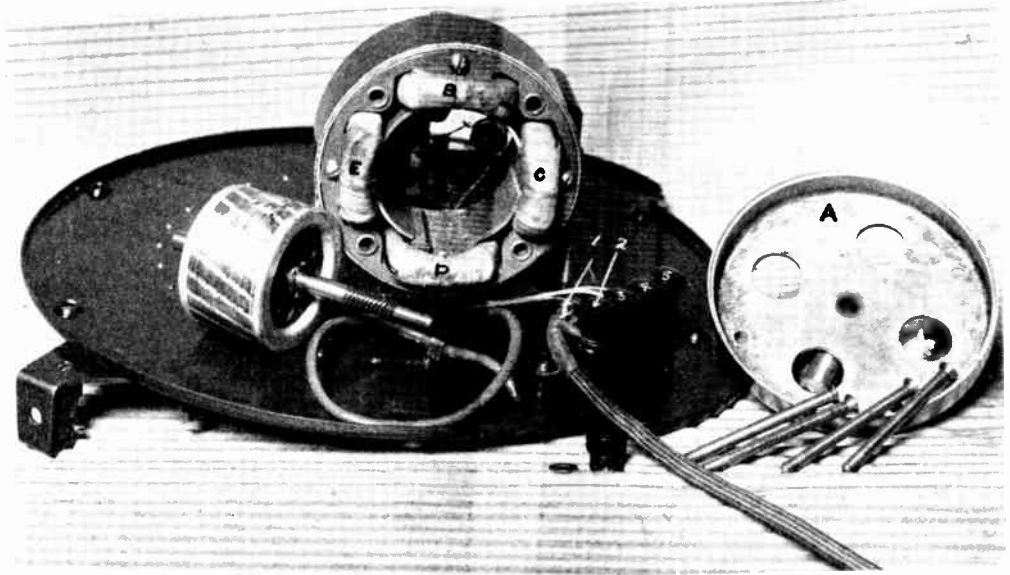

Fig. 3.—THE ROTOR AND STATOR COILS OF THE COLLARO INDUCTION MOTOR.  
The mains are connected to the two terminals 1 and 2 at the end of the terminal block.

spindle the speed indicator previously described. Play the record with a loud-tone needle and if the speed is correct and the motor running regularly, the black spot of the speed indicator will remain perfectly steady.

It is advisable to make this test on a rough rig-up before the motors are fitted, as sometimes a slight adjustment to the governor or a little oil on the spindle will rectify any faults, and these are more easily rectified before the motor is fitted to the cabinet than afterwards and the time expended in cutting a rough board to hold the pick-up and the motor will be well repaid for the whole success of electrical

unless, of course, the instrument is in a warm room.

### Faults that May Cause Speed Variation.

A good motor, however, will handle the load satisfactorily without any alteration of the speed. If the speed does vary it may not be due to a fault other than a hard bearing or oil required at some point in the motor. An incorrect adjustment of the worm of the governor will also cause speed trouble. Most motors have provision for adjusting the distance between the worm and the wheel of the governor, and this should be adjusted so that the motor runs freely.

### NOTES ON THE COLLARO INDUCTION ELECTRIC GRAMOPHONE MOTOR.

This motor operates on voltages between 100 and 130, 200 and 260 and is made in three types to suit the various frequencies of 40 to 60, 25 to 40 and 60 to 100. The working of the motor can be seen from Figs. 1, 2 and 3.

#### Fitting the Motor.

The motor automatic stop and speed regulator being mounted on a metal base

drilled around the base plate so that this may be shifted to any desired position.

Sufficient flex is left in the switch lead so that the automatic stop can be fitted at any desired point.

#### Changing the Voltage.

Should it be necessary to change the voltage, remove the screw G and turn the pointer on the bakelite moulding to whichever position gives the required voltage. Screw down the bakelite moulding into

place. This is the only alteration to change the voltage of the motor.

If the automatic stop fails to operate, it can easily be adjusted. The adjustment is made at the screw A and adjusted so that as the spindle of the motor rotates the striking lever B lifts the small lever H  $\frac{1}{16}$  in. from the quadrant R.

#### How the Auto- matic Stop Operates.

The automatic stop operates as follows:

The tone arm, or pick-up carrier, slowly moves the lever L. As this is moved with a steady movement while the record is playing, the lever H does not touch the quadrant R but at the end of the record, the sharp movement of the cut-out line causes the quadrant to grip the lever H and trip the switch lever K and also the brake M. The switch is closed and the brake is reset by moving the lever I to the tone arm. This in turn starts the motor.

#### Adjusting the Speed Regulator.

The speed regulator is adjusted by



Fig. 4.—RESISTANCE FOR ADJUSTING GARRARD UNIVERSAL ELECTRIC GRAMOPHONE MOTOR TO DIFFERENT SUPPLY VOLTAGES.

The resistance shown is set for working on direct current of 240 volts. The left-hand plug is inserted in one of three holes as marked, depending whether the supply is D.C., A.C. 25 cycles or A.C. 40 to 60 cycles. The right-hand plug is inserted in the hole near the figure corresponding to the voltage of supply.

plate, the whole unit is easily fitted. Decide upon the position in which the centre spindle is required. Cut out a circle of  $3\frac{3}{4}$  in. radius i.e.,  $7\frac{1}{2}$  in. in diameter. This is the only hole which it is necessary to cut in the baseboard. Place the speed regulator to the left-hand side in the front of the instrument. Decide upon the position for the carrier arm of the pick-up and, if necessary, alter the position of the automatic stop by removing the two screws C and D as shown in Fig. 1. It will be noted that there are various holes

loosening the screw O and adjusting the position of the cam N relative to the lever P. This adjustment may be necessary from time to time as the pad slightly wearing on the governor will alter the speed. That is to say, after a time the position of the lever of the indicator may not be correct but, of course, this adjustment is only necessary at very rare intervals.

It may be necessary occasionally to renew the rubber buffer B, as after a time, due to hitting the stop screw A, the buffer becomes worn. This only requires adjustment at rare intervals.

### **Oiling.**

The automatic brake mechanism should occasionally have a little light oil applied to the pivots, also, the main bearing lubricators require filling with light oil periodically. It should be noted that these differ, especially in the case of the

### **How the Mains Supply is Connected.**

The mains are connected to the two terminals 1 and 2 in Fig. 3 at the end of the terminal block taking care that the black wire is returned to the same terminal together with one of the leads from the supply. No connections are made to the terminals with the wires, red, yellow, and green. (Nos. 3, 4 and 5.)

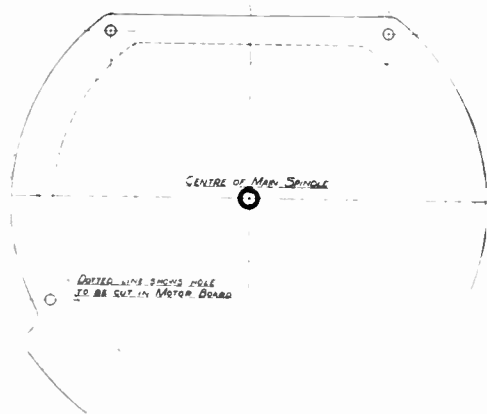

Fig

has been removed. Be careful not to lose the steel ball at the end of the armature.

### NOTES ON THE GARRARD UNIVERSAL ELECTRIC GRAMOPHONE MOTOR—TYPE E.D.

#### Instructions for Fitting and Running.

The "Garrard" motor, Type E.D., will run on all voltages between 100 and 250, either alternating or direct current, and on all frequencies A.C. between 25 and 60.

For supplies of less than 100 volts, or frequencies above 60 cycles, a specially motor is necessary.

For.

plate as Fig. 6 and lay on  
ard of the gramophone, with  
el to the cabinet sides, and  
of the main spindle at the  
from the tone arm.

th the holes for the five  
crews, mark around the  
id cut hole in the motor

For

he side or  
., and  
nect  
e

It should  
at the size of  
two lubricators  
therefore, care  
ould be taken that  
they are returned to the  
same oiler.

The main spindle bearing should be lubricated periodically. This is best done by removing the turntable and filling the oil cup on top of the frame around the main spindle.

The gears should have an occasional oiling and also the pivots of the governor.

The periods at which oiling should be given to gramophone motors vary considerably, according to the amount of use they have, but in ordinary homes, once every three months should be sufficient, but if a lot of playing is done, every month.

More gramophone motors are ruined through neglect of oiling than by anything else, for if a bearing becomes worn through want of oil erratic running will occur very quickly.



*Fig. 5.*—SPEED TESTER FOR CHECKING SPEED OF TURNTABLE.

Mark out a disc as shown above and place it on the turntable. When viewed by electric light (A.C. 50 cycles) the outer ring will appear stationary at 80 revolutions per minute and the inner ring at 78 revolutions per minute.

On removing the cover plate A, Fig. 2, it will be noticed that the governor is of a special design; there are no springs on the governor weight, but a link motion B, this patent floating governor having entirely overcome any tendency of hunting and giving less variations under a fluctuating load.

It will be noted, also, that on the main spindle there is a cushion drive C. This ensures regular playing speed, even should there be any variation occurring in the electric supply.

Re

remains  
the n.  
remove  
withdraw  
removed, b.  
the armature  
experienced due a.  
The only winding being D, E, F, G on the  
stator and these being stationary, there is  
very rarely any fault. The probable  
cause of the motor not revolving is due  
to some stiffness in the bearings or badly  
adjusted governor. If the worm gears are  
correctly adjusted and the motor running  
freely, and yet when switched on fails to  
operate, make sure that the switch is  
properly closing. If the motor then still  
refuses to revolve, see that all the terminals  
are tightly screwed up or that a wire has  
not become broken. If no visual outside  
fault is noticeable, test each circuit of the  
field coils. There are four stator coils and  
they are connected in series for the high  
voltage and in parallel for low voltages.  
A faulty coil can be readily removed by  
pulling out the wedges after the armature

### type Resistor

angular hole in the  
cabinet,  $4\frac{3}{4}$  in. by  $2\frac{1}{2}$  in.  
as shown in Fig. 4. Con-  
of the wire projecting from the  
the casting to the two terminals on  
underside of the motor plate (one tag

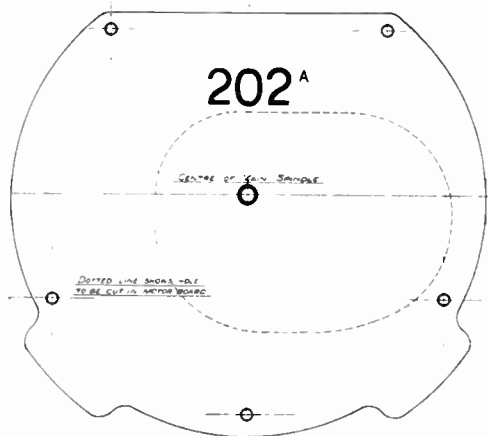

Fig. 7.—SHOWING TEMPLATE FOR FITTING  
GARRARD NO. 202 GRAMOPHONE MOTOR.  
See Fig. 6. for details of use.



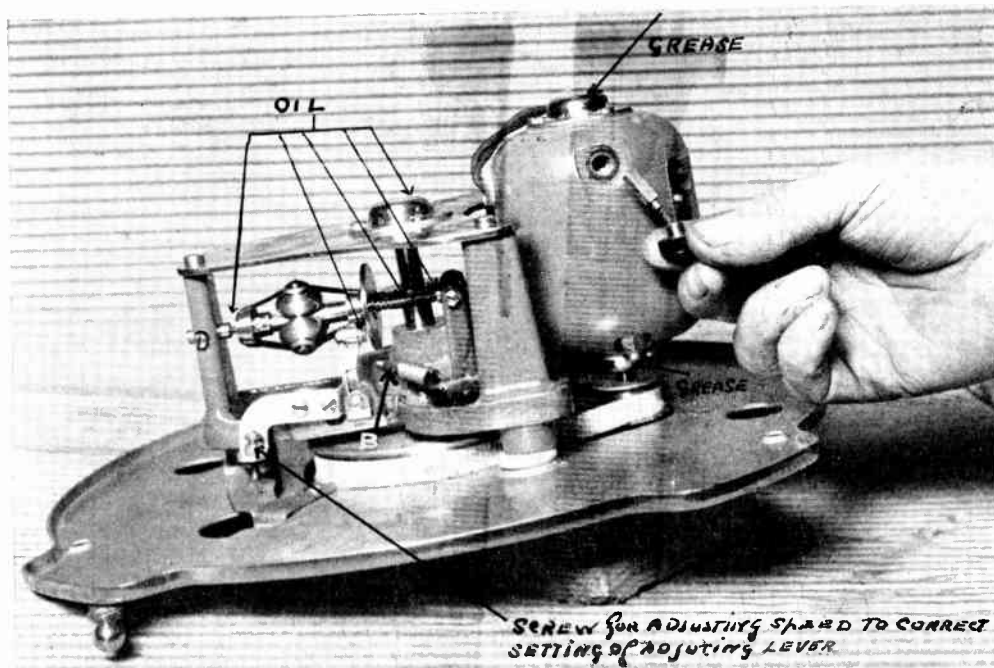

Fig. 8.—INSPECTING THE CARBON BRUSHES OF A GARRARD UNIVERSAL MOTOR TYPE E.D.

This is done by removing the bakelite bush caps and pulling the spring out with the fingers. In this illustration note the points which require oiling.

on right leg of the terminal and the other on the centre leg). The motor can then be screwed down.

The main leads are attached to the connector supplied with the resistance.

To set the resistance, ascertain the particulars of electricity supply.

On the front of the resistance are two plugs which must be inserted in the holes corresponding with the details of the supply, thus:

The left-hand plug is inserted in one of three holes as marked, depending whether the supply is D.C., A.C. 25 cycles, or A.C. 40 to 60 cycles.

The right-hand plug is inserted in the hole near the figure corresponding to the voltage of supply.

The resistance shown is set for working on direct current of 240 volts.

The plugs must be screwed down firmly to ensure good contact. As much air space as possible should be left round the resistance to assist ventilation, and, if possible, a few holes should be drilled in

the back of the cabinet above and below the resistance to provide a current of air.

#### Setting Resistance with Voltmeter.

For greater accuracy and where the voltage of the mains deviates from normal, the voltage indications on the scale can be ignored and the resistance set by connecting a voltmeter across the terminals of the motor, and adjusting the slider or plug until the voltage indicated is in accordance with the table below.

Supply .. .. .	D.C.	A.C. 25	A.C. 40	A.C. 50	A.C. 60
Voltage across motor ..	40	60	75	90	100

*Note.*—To ensure correct setting the following points must be observed:

(1) The turntable must revolve at exactly 78 revolutions per minute as set by a watch or stroboscopic indicator.

(2) The belt tension must be such that when the current is switched on and the turntable spindle prevented from turning by gripping in the fingers, the motor pulley just creeps round slowly. (It does

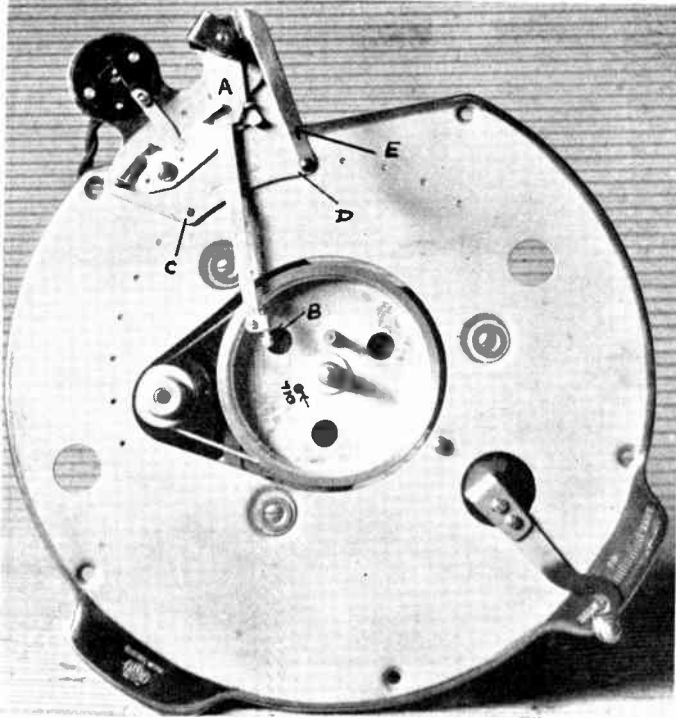

Fig. 9.—SETTING THE AUTO-STOP OF A GARRARD MOTOR TYPE E.D.

Remove the auto-switch from the base by taking out screws C and D. Decide the position it is to be screwed back, and bore a hole  $1\frac{1}{8}$  in. to take switch legs. Refix auto-switch to base and adjust stop.

not harm the motor in any way to do this.)

(3) The values set out in the table give ample power, and no additional allowance should be made for possible voltage drop in the mains.

#### Setting the Auto Stop.

The following is the procedure to adopt in fitting the auto stop for Types 202 and E.D.

(1) Remove the auto switch from the base by taking out screws C and D, in Fig. 9.

(2) Decide the position it is to be screwed back (any of the holes may be used). Bore a hole  $1\frac{1}{8}$  in. diameter to take switch legs.

(3) Refix auto switch to base.

(4) Adjust auto stop: move operating lever to the right and motor should start.

Loosen trip lever locking screw and set trip lever adjusting screw to clear striking bush by  $\frac{1}{2}$  mm. (approx.). To test the setting, run the motor slowly and move the trip lever gently to the left. If the adjustment is correct the revolving striking bush will push the trip lever back to a position supporting brake lever half-way on its ledge as shown at "A."

Set pick-up with needle 3 in. from main spindle and loosen two adjusting screws.

With motor running adjust operating lever to touch tone arm and tighten screws.

If switch operates before the end of record is reached, the setting is too fine and trip lever adjusting screw should be screwed out slightly.

Should brake fail to operate on record with a run-in of  $\frac{1}{8}$  in. the setting is too coarse and trip lever screw should be adjusted in.

#### Maintenance.

A small amount of attention at regular intervals is all that is required to obtain continuous service from the "Garrard" Regd. Electric Motor, Type E.D.

#### Lubrication.

Lubrication of all bearings should be carried out every few months. Points requiring attention are indicated in Figs. 8, 9 and 10. The speed of the turntable should be checked with a watch after oiling, and adjusted if necessary.

#### Brushes.

The carbon brushes fitted to the electric motor may require renewal after a few years. They can be inspected by removing

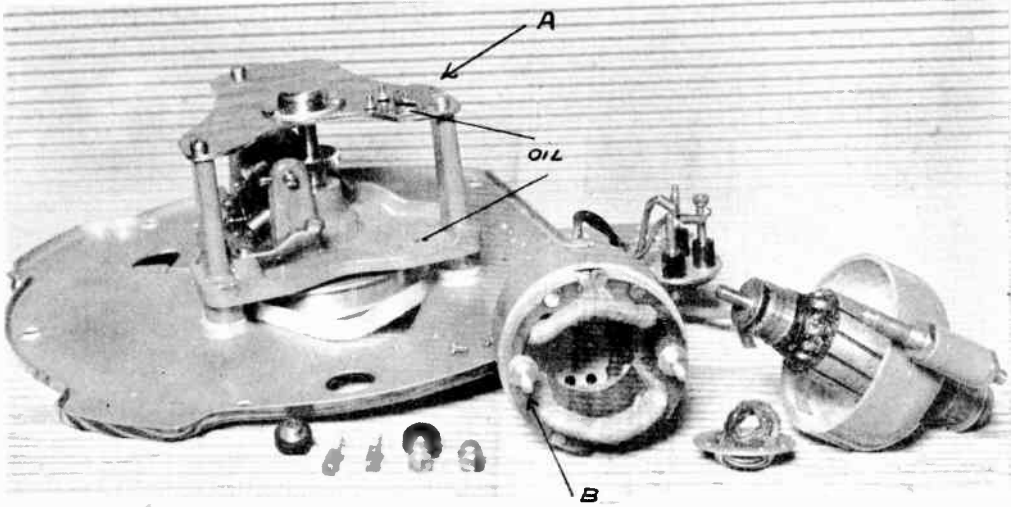

Fig. 10.—How to Take the GARRARD UNIVERSAL MOTOR TYPE E.D. APART FOR CLEANING THE COMMUTATOR, ETC.

Remove screws A and take out brushes. Unscrew the two hex nuts for cleaning bolt B. Carefully draw out half the body. If necessary, clean commutator with fine glasspaper. Repack bearing cups with grease.

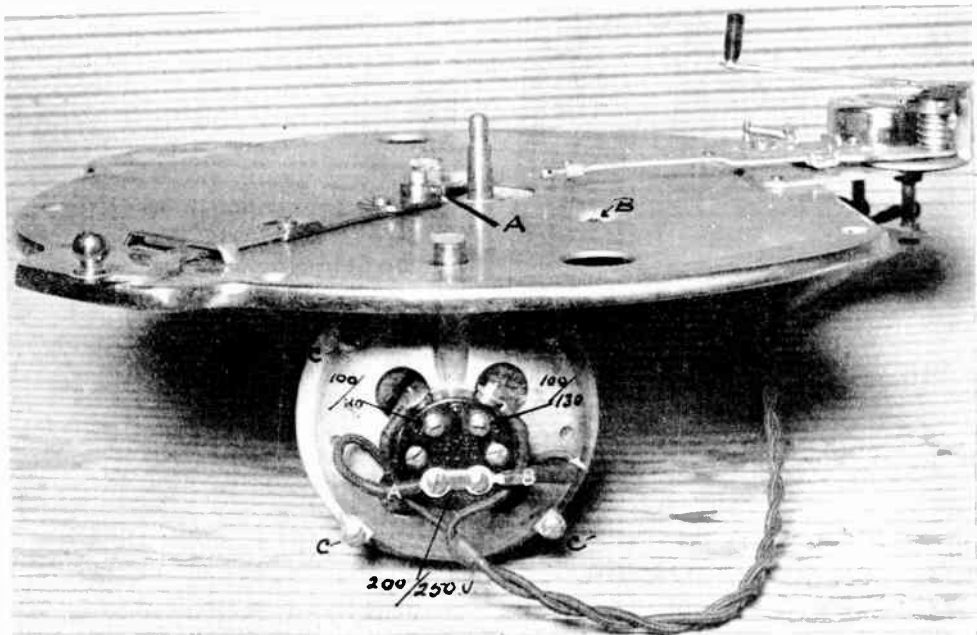

Fig. 11.—TERMINAL BLOCK FOR CHANGING VOLTAGE ON GARRARD MOTOR TYPE 202.

The motor can be used on any voltage between 100/130 and 200/250 by changing the leads A and B (white letters).

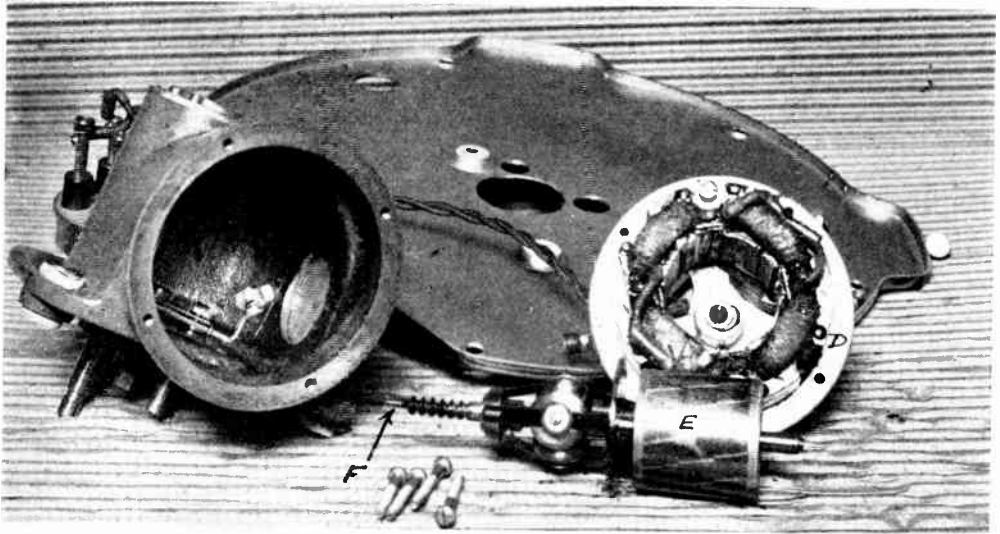

Fig. 12.—ROTOR AND STATOR WINDINGS OF GARRARD MOTOR TYPE 202.  
Care must always be taken not to bend the spindle F.

the bakelite brush caps and pulling the springs out with the fingers as in Fig. 8.

Be careful to replace brushes the same way round as they were in originally. As fitted, the brushes are  $\frac{3}{16}$  in. long under the springs. When they wear to about  $\frac{3}{8}$  in. long they must be replaced by new ones.

#### Taking the Motor Apart for Cleaning the Commutator, etc.

- (1) Remove screws A in Fig. 10.
- (2) Take out brushes.
- (3) Unscrew the two hex nuts for clamping bolt B.
- (4) Carefully draw off half the body.
- (5) If necessary clean commutator with fine glass paper taking care to remove all dust.
- (6) Repack bearing cups with grease.
- (7) After reassembly of motor, when returning to frame, take care that the belt is on the pulley, and the tension spring is in the correct position and the motor rocks freely.
- (8) Should the belt slip extra tension can be obtained by adjusting the nut on the rod B, Fig. 9, which holds the spring to the frame.
- (9) Should the belt become oily place in chalk for a few hours.

#### NOTES ON THE GARRARD No. 202 INDUCTION ELECTRIC GRAMOPHONE MOTOR.

##### Frequency.

The standard model is suitable for 50 '60 cycle alternating current only, a special type of motor being required for periodicities outside this range.

##### Voltage.

The motor can be used on any voltage between 100 130 and 200/250: By changing the leads "A" and "B" in Fig. 11.

##### Fitting the Motor.

Use a template as Fig. 7 and lay on the motor board of the gramophone, with its edges parallel to the cabinet sides and with the centre of the main spindle at the correct distance from the tone-arm or pick-up centre.

Pierce through the holes for the five holding down screws, and cut a hole in the motor board as dotted outline.

Temporarily remove the leads from the automatic stop and also remove the stop from the motor plate by unscrewing the two small holding down screws.

Screw the motor and unit plate down to the motor board, using the five special screws and rubber washers provided,

*Of extraordinary value to every handyman*

# NEWNES' Home Mechanic BOOKS

*Clearly written and fully illustrated*  
*each book contains 96 pages*

## TOY MAKING FOR AMATEURS

Tells you how to make toys of every description and lays bare the principles by means of abundant illustrations and simple text. Every mechanical movement known in toy manufacture is included.

## TWENTY-FIVE TESTED WIRELESS CIRCUITS

A book for the modern wireless enthusiast. All the sets described have been designed to meet modern needs. They range from simple crystal receivers to a seven-valve super-heterodyne, and all the sets have been made and tested before inclusion.

## SIMPLE ELECTRICAL APPARATUS

An excellent little book for those who wish to make simple and useful electrical appliances, such as galvanometers, electric motors, dynamos, and Leyden jars. All these may be made by anyone with the aid of a few tools and some inexpensive materials. Clear instructions are given in every case.

## MODEL BOAT BUILDING

There are few more fascinating hobbies than Boat Building. In this book there are designs for a battleship, a speed boat, a paddle-steamer and yachts, from which excellent models may be built with the help of the simple directions and diagrams that are given. No elaborate tools are needed, and each model can be made at small cost.

### Other Titles

THE HANDYMAN'S ENQUIRE WITHIN

THE HOME WOODWORKER

25 SIMPLE WORKING MODELS

MODEL AEROPLANES AND AIRSHIPS

## One Shilling each

On sale at all Newsagents and Bookstalls, or by post 1/2 each from George Newnes, Ltd., 8-11, Southampton Street, Strand, London, W.C.2

Geo. Newnes, Ltd.

**This article on Electric Gramophone Motors is continued in Part 22. Ready March 11th. Order your copy to-day.**

**GROW FOR YOURSELF and SELL TO OTHERS.**

# *Now's the Time to Make Money out of*

**STRAWBERRIES  
CUCUMBERS  
GREEN PEAS  
MUSHROOMS**

**NEW POTATOES  
CARNATIONS  
CUT FLOWERS  
CARROTS**

**LETTUCE  
TURNIPS  
GREEN BEANS  
CAULIFLOWERS**

because £15,000,000 worth is wanted this year. Supplies to this value formerly came from abroad. Owing to the new import duties it will be almost impossible for foreign produce to sell in our markets and home-grown garden produce *must* take its place.

You can join in the great vegetable and flower-growing boom. You can learn the right way—and how to sell what you grow at top prices—by reading

## **THE SMALLHOLDER GARDENER & POULTRY KEEPER**

*Every Thursday ————— Twopence*

THE SMALLHOLDER is the food-growing paper. Every week it is full of suggestions for all who would make money or save money with home-grown produce. It not only tells you what to do, but how to do it.

### **SPECIAL HOW-TO-DO-IT ARTICLES.**

THE SMALLHOLDER has persuaded famous market growers to write special articles on how they are going to grow the vegetables and flowers the country now needs. Here are some of them.

In issue of Feb. 6th. Strawberries  
(now on sale)  
In issue of Feb. 13th. New Potatoes and New Carrots  
In issue of Feb. 20th. Lettuce and Cucumbers  
In issue of Feb. 27th. Carnations  
In issue of Mar. 5th. Green Peas and Beans  
In issue of Mar. 12th. Cut Flowers  
In issue of Mar. 19th. Mushrooms and Cauliflowers

These articles will tell you everything you need to know to make money.