

To be Completed in about 32 weekly parts.

# NEWNES PRACTICAL ELECTRICAL ENGINEERING



**DEALING WITH**  
ALL PRACTICAL  
APPLICATIONS OF  
ELECTRICITY IN  
EVERYDAY LIFE.

**INTENDED FOR**  
ELECTRIC LIGHTING  
and  
POWER ENGINEERS.  
ELECTRICIANS AND  
WIREMEN.  
WIRELESS DEALERS.  
STUDENTS.  
APPRENTICES AND  
IMPROVERS IN ALL  
BRANCHES OF  
THE ELECTRICAL AND  
WIRELESS INDUSTRIES.

1/-

PART  
18

A PRACTICAL WORK WRITTEN BY EXPERTS

STUDY  
AT  
HOME

YOU CAN HAVE A COLLEGE  
TRAINING IN ALMOST ANY  
CAREER FOR A FEW  
SHILLINGS MONTHLY

IN  
YOUR  
SPARE  
TIME

FOUNDED 1900.

32 YEARS OF SUCCESS.

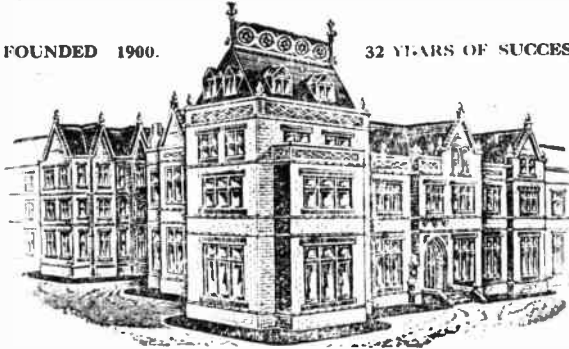

**THIS IS THE BENNETT COLLEGE -- ALL OF IT**

The Bennett College is not a Rented Room in a well-known street—it is a College. Over 31 years ago the Founder took as his motto what has now become a household slogan:

**LET ME BE YOUR FATHER**

In many trades and professions there are more vacancies than trained men to fill them. We do not profess to act as an employment agency, but our gigantic organisation certainly does tell us where the demand exists, thus enabling us to give **FATHERLY ADVICE ON ALL CAREERS AND THE POSSIBILITY OF EMPLOYMENT, FREE.**



*J.A. Bennett*

WE TEACH ALL BRANCHES OF THE FOLLOWING VOCATIONS AND SPECIALISE IN ALL EXAMINATIONS CONNECTED THEREWITH.

**THE MOST SUCCESSFUL AND MOST PROGRESSIVE  
CORRESPONDENCE COLLEGE IN THE WORLD**

Aviation Engineering.  
Boiler Engineering.  
Boiler Making.  
B.Sc. (Engineering).  
Civil Engineering:  
A.M.I.C.E.—Specifications.  
Commercial Art

Concrete and Steel.  
Draughtsmanship:  
Electrical or  
Mechanical.  
Electrical Engineering:  
A.M.I.E.E.  
City and Guilds.  
Engineering Mathematics.  
Foundry Work.  
Heat Engines.

Heating, Ventilating and  
Lighting.  
Internal Combustion Engines.  
Machine Designs:  
Theory of Machines.  
Marine Engineering:  
Motor.  
Steam.  
Mechanical Engineering:  
A.M.Inst.B.E.  
A.M.I.Mech.E.  
City and Guilds.  
Pattern Making.

Mechanics.  
Metallurgy of Steel.  
Mine Electrician:  
A.M.E.E.  
Mining (all examinations).  
Motor Engineering:  
A.M.I.A.E.  
Municipal and County  
Engineers:  
M. and C.E.  
Naval Architecture.  
Pumps and Pumping  
Machinery.  
Radio Reception.  
Ship Building.  
Structural Engineering.  
Telegraphy and Telephony.

IF YOU DO NOT SEE YOUR OWN REQUIREMENTS ABOVE, WRITE TO US ON ANY SUBJECT.  
IT COSTS NOTHING TO ENQUIRE.

Also ask for Cur New Book  
(FREE OF CHARGE)

**THE HUMAN MACHINE** SECRETS OF SUCCESS

WE TEACH BY POST IN ALL PARTS OF THE WORLD

Note Address Carefully:

The BENNETT COLLEGE, Ltd., Dept. 119, Sheffield



the design of the former is usually a compromise with respect to the choice of the number of slots and other electrical features. When two stator windings are necessary, the larger slots required to accommodate these windings have also an adverse effect on the power factor.

The efficiency when operating with a given set of poles is also slightly lower than that of the corresponding single-speed induction motor.

**Applications of Changeable-pole Motors.**

Small four-speed motors (up to about 2 h.p.) are particularly suitable for small machine tools where a direct drive is desirable. Fig. 15 illustrates the modern method of driving a multiple-spindle drilling machine, each spindle of which is direct coupled to a 2 h.p. four-speed motor. The drum-type speed controller is mounted on the motor frame within easy reach of the operator. Thus each drill can be run at a speed appropriate to the work being performed. Larger two- and three-speed motors are used for driving fans and pumps which may be required to run for long periods below their maximum speeds. Such motors for this purpose are cheaper than commutator motors. Two-speed squirrel-cage motors are used for high-speed lifts.

**EXTRA HIGH-SPEED INDUCTION MOTORS.**

Certain types of woodworking machines require very high speeds of rotation (e.g., up to 10,000 r.p.m.) for the cutting spindles. Such speeds cannot be obtained with a direct drive from an ordinary induction motor supplied at standard frequency (50 cycles), as the maximum speed is 3,000 r.p.m. (corresponding to two poles). In these special cases, where a direct drive is particularly advantageous, special two-pole motors, supplied at higher

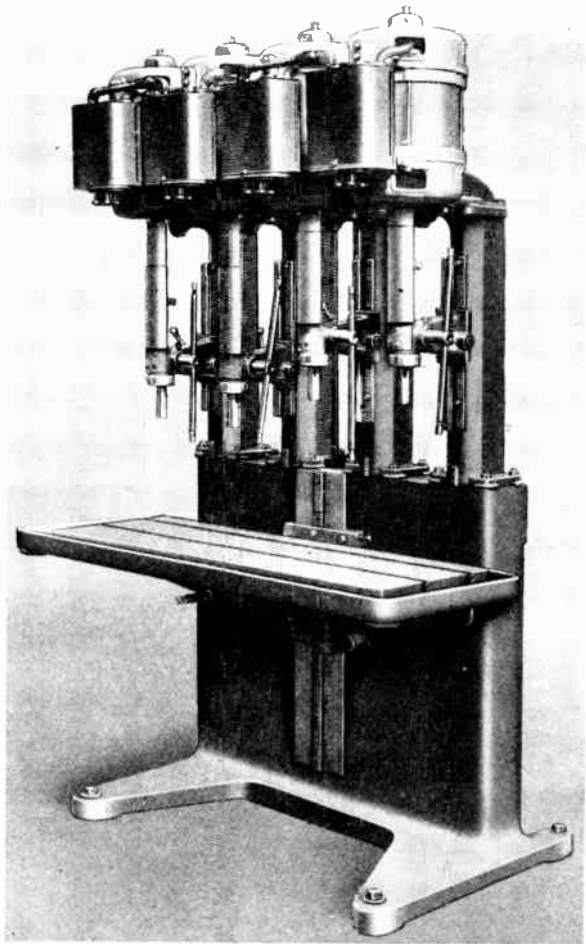

Fig. 15.—FOUR-SPEED INDUCTION MOTORS WITH DRUM-TYPE STARTERS AND POLE CHANGERS DRIVING MULTIPLE-SPINDLE DRILLING MACHINE. (B.T.H. Co.)

Each drilling spindle is directly coupled to its own motor.

frequencies of 120 cycles or more, are used, the higher frequency being obtained from a small motor-generator set.

**DUAL FREQUENCY INDUCTION MOTORS.**

In this country a number of important industrial districts (e.g., North-East Coast, Birmingham, Glasgow) originally operated at non-standard frequencies of 40 and 25 cycles. With the ultimate completion of the Central Electricity Board's scheme, these districts will ultimately operate at the

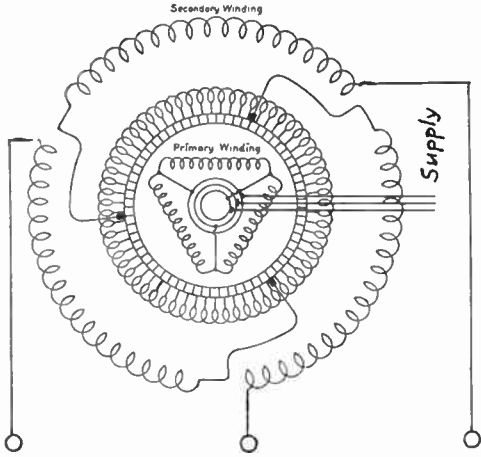

Fig. 16.—CIRCUITS OF COMPENSATED INDUCTION MOTOR.

standard frequency (50 cycles). During the interim period all new motors installed have to be suitable for operating ultimately at 50 cycles and for the present at the existing frequency of 40 or 25 cycles as the case may be.

The 40/50-cycle motors differ from standard 50-cycle motors in the stator and rotor cores, which contain more iron than a standard machine. No change of connections will be required under the new conditions (50 cycles), but the ultimate speeds will be approximately 25 per cent. above the present speeds. Full output will be obtainable on either frequency.

The 25/50-cycle motors have pole-changing windings so arranged that by changing links in the terminal box the number of poles is changed in the ratio of 1 : 2. Thus the motor runs at the same speed on either frequency. With slip-ring motors the rotor connections are changed at the slip rings (where the necessary connections for pole changing are brought out).

**CHARACTERISTICS AND APPLICATIONS OF THREE-PHASE INDUCTION-COMMUTATOR MOTORS.**

COMPENSATED (LEADING POWER FACTOR) INDUCTION MOTORS.

**Cause of, and Methods of Improving, the Low Power Factor of Induction Motors.**

The low power factor of an ordinary induction motor is due to the magnetising

current, or excitation, having to be obtained from the supply system at the supply frequency. One method of improving the power factor is to supply excitation to the rotor from a source of direct current (as in the synchronous-induction motor). Another method, which does not change the shape of the speed characteristic, is to supply low frequency excitation to the rotor, but in this case the frequency of the exciting current must always be equal to that of the normal torque-producing rotor currents. Other methods aim at compensating or neutralising the wattless magnetising currents by equivalent leading currents, obtained by either condensers or wattless current generators connected in parallel with the supply system. Such methods, however, necessitate a relatively large kVA rating of the corrective plant, because the compensating currents are produced at the supply frequency. If, however, the compensating or exciting currents are supplied to the rotor at the correct (rotor) frequency, the kVA rating of the corrective plant, or exciter, will be very small compared with the full-load kVA rating of the motor. This principle is utilised in compensated induction motors, and is applied in two ways : (1) by direct coupling an A.C. exciter to an ordinary slip-ring induction motor ; (2) by incorporating the exciter into the induction motor itself, in which case a special construction, with commutator and slip rings, is necessary. We shall consider here only the second case.

**Chief Parts and Electric Circuits.**

The chief parts are illustrated in Fig. 3, and the electric circuits are shown in

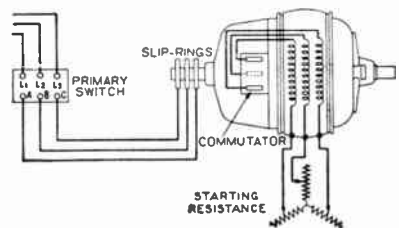

Fig. 17.—EXTERNAL CONNECTIONS FOR COMPENSATED INDUCTION MOTOR, (B.T.-H. Co.)

Fig. 16. There are three circuits, viz.: (1) the primary winding, which is equivalent to the stator winding of an ordinary induction motor; (2) the secondary winding, which is equivalent to the rotor winding of an induction motor; and (3) the compensating winding, which is a D.C. commutator winding with the coils spanning an angle of approximately 120 electrical degrees. The primary and compensating windings are placed on the rotating member and occupy the same slots. The secondary winding is placed on the stator and each phase is kept separate, so that connections may be made to the three sets of brushes and also to a starting rheostat as shown in Fig. 17.

**How Phase Compensation is Obtained.**

The supply currents in the primary winding produce a rotary field which rotates relatively to the rotor at the synchronous speed. This field cuts the conductors of the compensating winding and induces therein e.m.f.'s of constant magnitude. The rotor revolves in the opposite direction, with the result that the field slowly rotates in space, and cuts the secondary (stator) winding. The e.m.f.'s at the brushes are of "slip" frequency and of constant magnitude. Their phase relationship with respect to the e.m.f.'s induced in the secondary windings depends upon the position of the brushes, which is

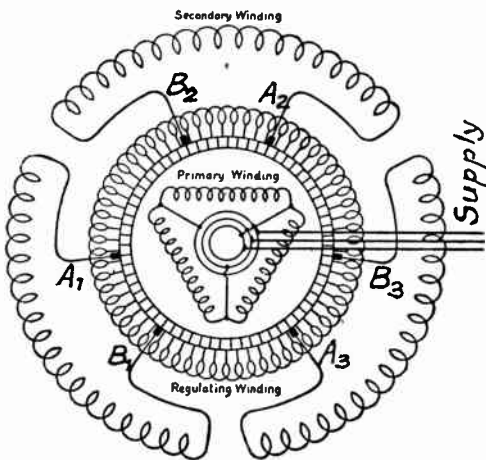

Fig. 19.—CIRCUITS OF VARIABLE-SPEED INDUCTION MOTOR (SCHRAGE TYPE).

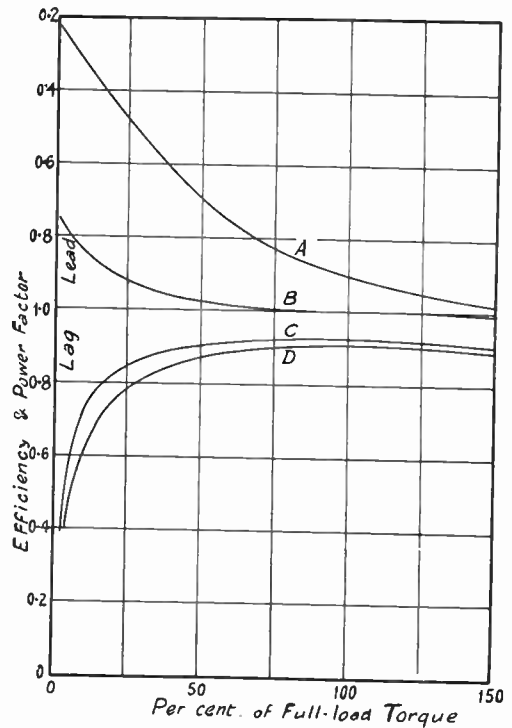

Fig. 18.—POWER FACTOR AND EFFICIENCY CURVES OF COMPENSATED INDUCTION MOTOR.

A, power factor with brushes set for maximum compensation; B, power factor with brushes set for unity power factor; C, efficiency corresponding to brush-setting B; efficiency corresponding to brush-setting A.

NOTE.—The curves refer to a 100-h.p., 750 r.p.m. B.T.-II. motor.

so chosen that the commutator e.m.f.'s have a large leading phase difference with respect to the secondary e.m.f.'s. Hence the stator (secondary) currents lead the secondary e.m.f.'s, and may be resolved into two components, one in phase with the secondary e.m.f. and the other leading this e.m.f. by 90 degrees. The former produces torque, and the latter neutralises, either partially or completely, the wattless magnetising current in the primary.

**Speed and Starting Characteristics.**

These are similar to those of a slip-ring induction motor, except that at light loads the speed may rise slightly above synchronous speed.

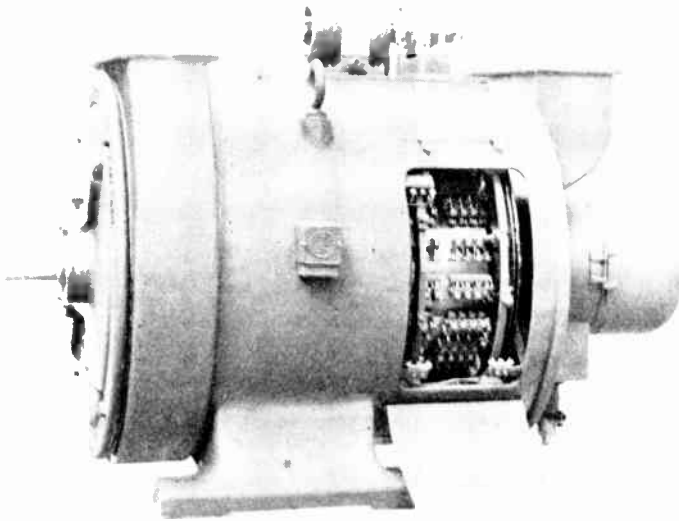

Fig. 20. — PIPE-VENTILATED THREE-PHASE VARIABLE-SPEED INDUCTION MOTOR (SCHRAGE TYPE) WITH MOTOR-OPERATED BRUSH ROCKERS. (English Electric Co.)

One of the commutator inspection covers has been opened to show the two brush rockers and the two complete sets of brushes. The slip-rings are enclosed in the cylindrical cover fixed to the commutator end-bracket.

### Power Factor and Efficiency.

The shape of the power factor characteristic can be controlled by the position of the brushes. Typical curves are shown in Fig. 18, together with an efficiency curve.

### Applications of Compensated Induction (Commutator) Motor.

These motors, in small and medium sizes, may be used in all applications for which a slip-ring induction is suitable. As their initial cost is about 30 to 40 per cent. higher than that of a corresponding induction motor, they should be used only in cases where the tariffs involve rebates for high power factor, in which cases substantial annual savings can be effected. In factories having their own generating plant, economies both in the size and the operation of the generators may be effected by installing a limited number of compensated induction motors in combination with ordinary induction motors.

The compensated induction (commutator) motor is essentially a low voltage

machine (maximum line voltage about 650). Hence, in cases where power factor compensation is required with high voltage motors, a separate A.C. exciter must be used.

### VARIABLE SPEED (SHUNT CHARACTERISTIC) INDUCTION-COMMUTATOR MOTOR (SCHRAGE TYPE).

#### How Variable Speed May be Obtained Efficiently from an Induction Motor.

In an ordinary induction motor the e.m.f. generated in each phase of the rotor or secondary winding, due to its motion in the rotary field produced by the stator or primary winding, must just

balance the impedance voltage due to the rotor currents, and the slip (i.e., the fractional difference between the speed of the rotary field and the speed of the rotor) must adjust itself to maintain this electrical balance. If external e.m.f.'s of suitable frequency are introduced or injected into the secondary circuits to oppose the normal e.m.f.'s, the slip must increase so as to increase the generated e.m.f. to a value equal to: E.m.f. + impedance voltage. By varying the injected e.m.f.'s corresponding changes of slip will occur, and if these e.m.f.'s are reversed in sense, the slip will become negative (i.e., the speed will be above the synchronous speed). This is the fundamental principle involved in obtaining variable speed from an induction motor.

### Electrical Circuits and Construction.

The circuits of the variable speed induction motor are shown in Fig. 19, and comprise: (1) a three-phase primary winding; (2) a three-phase secondary

winding; and (3) a lap commutator winding (similar to a D.C. armature winding), which is called the "regulating" winding. The primary and regulating windings both occupy the same slots on the rotor, and the secondary winding is on the stator. Thus the stator and rotor construction resemble those of the compensated induction motor (commutator type). But the commutator of the variable speed motor is much larger than that of the compensated motor, and the brush gear is also totally different. Two brush rockers, each equipped with the same number of brush spindles, viz., three spindles per pair of poles, are necessary, and provision is made for moving these rockers in opposite directions, either by hand or by a small motor, as shown in Fig. 20. In a two-pole machine there are three brush spindles equally spaced on each rocker, and corresponding brush spindles ( $A_1 B_1, A_2 B_2, A_3 B_3$ , Fig. 19) are connected to the secondary windings as shown in Fig. 19.

**How the Speed is Varied.**

When corresponding brush spindles are in line, the regulating winding has no effect on the secondary winding, and the

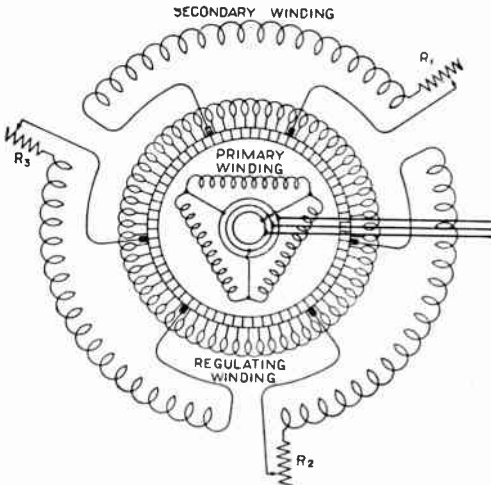

Fig. 22.—CIRCUITS OF VARIABLE-SPEED INDUCTION MOTOR (SCHRAGE TYPE) WITH RESISTANCES IN SECONDARY CIRCUITS FOR CREEPING SPEEDS AND STARTING.

NOTE.—The blocks of Figs. 16, 19, 22 were made from diagrams prepared by the B.T.H. Co.

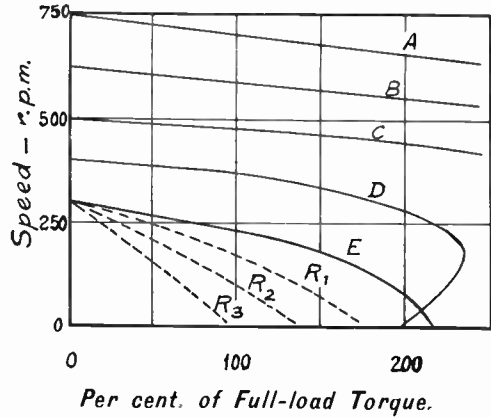

Fig. 21.—SPEED-TORQUE CURVES OF A SCHRAGE TYPE MOTOR CORRESPONDING TO FIVE BRUSH POSITIONS.

Curve C refers to the "middle speed" or "in-line" position of the brush spindles (A, B, etc., Fig. 19); curves D and E refer to these brush spindles, being in the positions indicated in Fig. 19; and curves A and B to reversed positions. The curves  $R_1-R_3$  show the speed characteristics when resistances are inserted in the secondary circuits as shown in Fig. 22.

motor runs as an ordinary induction motor. But when these spindles are separated, e.m.f.'s proportional to the number of segments included between the brushes are injected into the secondary circuits, and the speed of the rotor must therefore adjust itself to the new conditions as explained above. If the magnetic axes of the portions of the regulating winding in use coincide with those of the secondary windings, as shown in Fig. 19, and the injected e.m.f.'s oppose the normal secondary e.m.f.'s, the currents in the regulating winding produce torque which is added to the torque due to the secondary windings, i.e., the portions of the regulating winding in use act as a motor, the energy being obtained conductively from the secondary winding. This energy, which is converted into useful work, is equal to that which in an ordinary motor would be wasted in resistances if the same speed reduction had been obtained by inserting resistances in the secondary (rotor) circuits.

When the movement of the brush rockers is reversed so that the connections between the brushes and secondary windings

overlap, the injected e.m.f.'s are in the same direction as the normal secondary e.m.f.'s and the slip must become negative (i.e., the speed must be above synchronism) to maintain the electrical balance in these circuits. The currents in the portions of the regulating windings in use are now in the same directions as the e.m.f.'s in these windings, and therefore the regulating winding is *supplying* energy conductively to the secondary winding. This energy is obtained from the primary winding by transformer action and is converted to the correct secondary frequency by the commutator and brushes.

**Speed and Starting Characteristics.**

The speed characteristic for each position of the brushes is similar to that of an ordinary induction motor. Typical characteristics corresponding to five brush positions are shown by the curves A-E in Fig. 21. The usual range of speeds over which these characteristics can be obtained is about 4:1 or 5:1 for

small motors and about 3:1 or 4:1 for medium-size motors, but with special windings this range may be extended to 15:1. Alternatively, if the specially low speeds are required only occasionally they may be obtained by connecting resistances in the secondary circuits of a motor having the usual speed range (Fig. 22). But in this case the efficiency will be affected owing to the losses in these resistances. Starting is effected by switching the primary winding directly on to the supply with the brushes in the position for minimum speed. The main switch is interlocked with the brush gear to ensure that the motor can only be started in this manner. The starting current is about  $1\frac{1}{2}$  times full load current and the starting torque is between  $1\frac{1}{2}$  to 2 times the full load torque, according to the size of the motor. Smaller starting torques and currents may be obtained by connecting resistances in the secondary circuits, as shown in Fig. 22.

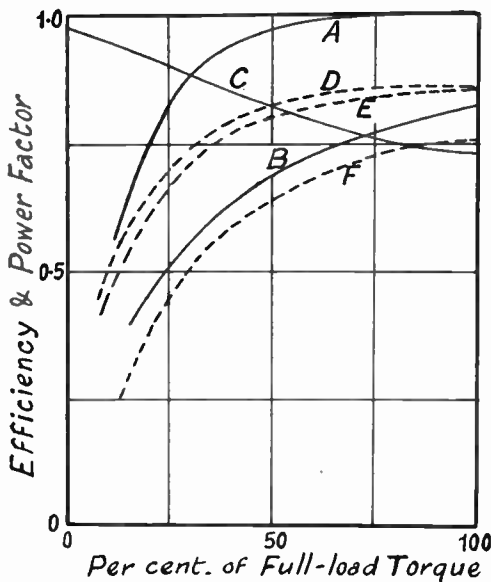

Fig. 23.—TYPICAL POWER FACTOR AND EFFICIENCY CURVES OF A SCHRAGE TYPE MOTOR.

A, B, C, power factor; D, E, F, efficiency. (A, D, top speed; B, E, middle speed; C, F, bottom speed.)

NOTE.—These curves and those of Fig. 21 refer to a 80/27 h.p., 720/240 r.p.m., 12-pole, 50-cycle B.T.-H. motor.

#### Power Factor and Efficiency.

The power factor at maximum speed is approximately unity, but at lower speeds the power factor is usually below unity (lagging), being lower than that of an ordinary induction motor. The power factor at the lower speeds may be improved by moving one brush rocker at a faster rate than the other. This causes the axes of the active portions of the regulating winding to be displaced—in the opposite direction to rotation—with respect to the axes of the secondary winding and so alter the phase of the injected e.m.f.'s in a manner similar to that employed in the compensated induction motor, but the degree of phase compensation is, of course, very different in the two cases. High efficiency is obtained over the greater portion of the speed range, and for constant (full-load) torque the efficiency is practically constant over the upper half of the speed range.

Typical power factor and efficiency curves are given in Fig. 23.

#### Applications.

Owing to the high initial cost of the motor (which in the smaller sizes is of the order of over £10 per rated h.p. at





Fig. 24.—THE SPINNING ROOM OF A MODERN TEXTILE MILL.

There are 60 spinning frames, each of which is driven by a three-phase variable speed induction motor. (*English Electric Co.*)

maximum speed) its applications are limited to cases where variable speed is essential, and in these cases the running costs will be much lower than if the same variation of speed were obtained by other methods. These motors are being used in increasing numbers in textile mills and large printing works, where a wide range of speeds and fineness of speed control are very important. In some cases the brush gear is controlled automatically according as the diameter of the cop varies, so as to obtain a constant spinning speed for the threads.

Fig. 24 is a view of a spinning room in a large modern textile mill in which 60 spinning frames are driven individually by these motors. The brush rockers are controlled by a lever and the main or starting switch is mounted on the top of the frame.

Fig. 25 shows how the motor is arranged to drive a printing press. In this case the brush rockers are operated through sprocket wheels, chains and cables from a handwheel mounted on the press. The main switch is electrically operated and is controlled by push buttons mounted on a pillar adjacent to the speed control handwheel. The motor has a 3 : 1 speed

variation, and creeping and inching speeds are obtained by connecting resistances in the circuits of the secondary winding.

Fig. 26 shows the driving equipment for a large four-deck newspaper press. In this case the motors are located in a pit and the final drive is through a silent chain. The main motor is a variable speed induction-commutator motor and the brushes are moved by a small single-phase motor mounted on the end-bracket, the control being by push buttons. Slow speeds and inching are obtained by a small 5-h.p. induction motor which drives the press through a worm reducing gear and a clutch, which automatically disconnects this motor as soon as the main motor takes up the drive. The whole of the speed control is entirely automatic.

Equipments similar to those illustrated in Figs. 25 and 26 are being used in increasing numbers in the printing industry. They are undoubtedly the most efficient, most economical and most satisfactory methods of operation at present available. Uniform acceleration is obtained under any printing conditions and the energy consumption is proportional to the output of the press.

Further applications include high-speed

TABLE IV.—TYPES OF MOTORS SUITABLE FOR POWER FACTOR CORRECTION, AND THEIR APPLICATIONS.

Type.	Method of Excitation.	Starting Duty.	Chief Characteristics.	Applications.
Synchronous	Direct currents.	Light	Construction similar to alternator. Controllable power factor. High efficiency. Constant speed. Leading power factors of almost any value may be obtained by providing sufficient excitation on field magnets.	Large non-reversing machines running for long periods at full loads, e.g., air compressors, ammonia compressors, motor-generator sets.
Synchronous-induction.	Direct currents.	Heavy	Construction similar to induction motor. Constant speed. Controllable power factor. Leading power factors may be obtained, but range is limited to about 0.8.	Any size (above about 20 h.p.) of non-reversing machine infrequently started and running at constant load.
Compensated induction motor.	Low frequency alt. currents.	Heavy	Induction - commutator motor. Suitable only for low voltages (up to 650 volts). Shunt speed characteristic. Fixed power factor characteristic, which may be set to give unity power factor at all loads, or leading at light loads.	Small and medium size non-reversing machines running at variable loads.
Induction with direct-coupled or external A.C. exciter or phase advancer.	Low frequency alt. currents.	Heavy	Standard slip-ring induction motor and commutator-type A.C. exciter. Shunt speed characteristic. Fixed power factor characteristic; unity to 0.95 lag at full load; lagging at fractional loads.	Large non-reversing machines running at constant loads.

lifts, paper-making machines, calendering machines, calico-printing machines, pumps, fans.

### CHARACTERISTICS AND APPLICATIONS OF SYNCHRONOUS-INDUCTION AND SYNCHRONOUS MOTORS.

#### How Torque is Produced in a Synchronous Motor.

In a three-phase synchronous motor the winding which is connected to the three-phase supply system is designed to produce a rotary magnetic field when excited by the supply currents. This winding is, therefore, similar to the stator

winding of a three-phase induction motor. If the field magnets are stationary and unexcited the rotary field will induce currents in the pole faces and a small torque will be produced. By providing an ordinary squirrel cage winding in the pole faces (see Fig. 4) sufficient torque can be obtained for starting against load and accelerating the rotor to nearly normal speed. If the excitation is now applied to the field winding the field poles will lock into position with the corresponding poles produced by the supply currents.

When running synchronously the torque may be considered to be due to the

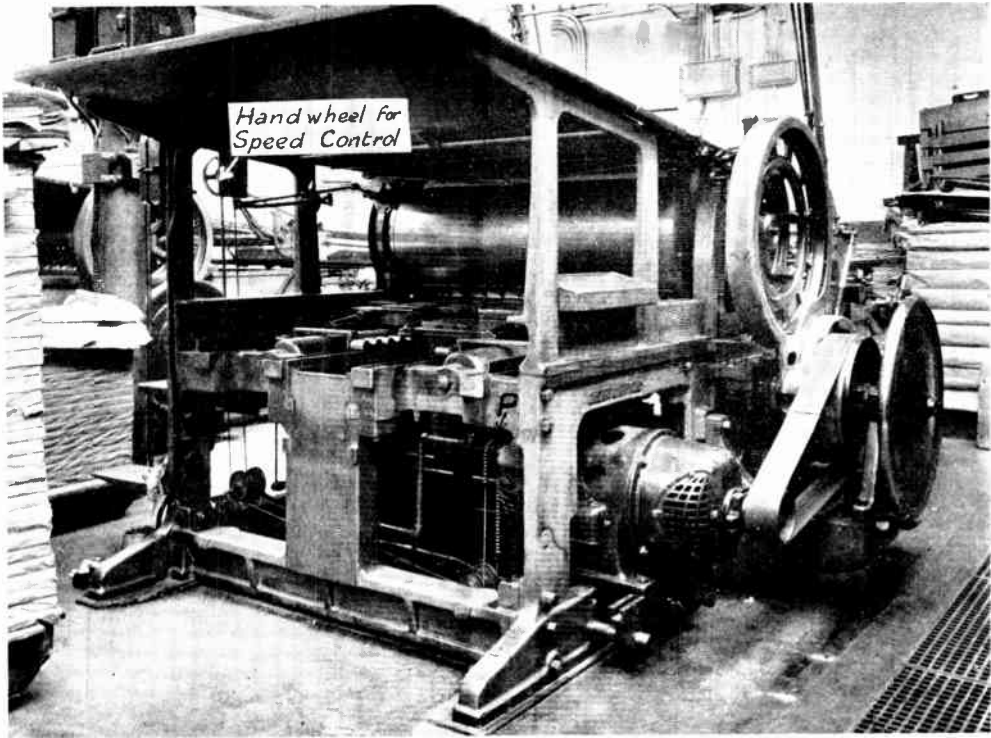

Fig. 25.—THE MODERN METHOD OF DRIVING AND CONTROLLING A SMALL PRINTING PRESS.

The motor (5 h.p.) is of the three-phase variable-speed induction (Schrage) type, and the brush rockers are controlled by the handwheel at the left-hand side of the press. A sprocket wheel, P, is fixed to the brush shifting mechanism on the motor, and this is connected to a similar sprocket wheel on the control handwheel by suitable chains and wire ropes. (A.S.E.A. and Fuller Electric Co.)

magnetic forces between the two sets of rotating poles. An increase of torque, therefore, requires an increase in the relative angular displacement of these poles. Thus the effect of loading a synchronous motor is to cause one set of poles slightly to change their angular position relatively to the other set. Upon the release of the load the axes of the two sets of poles come again into line. The torque increases with the angular displacement and becomes a maximum for a particular displacement, beyond which the two sets of poles are unable to remain locked together. When this occurs the machine falls out of step and comes to rest.

**How the Synchronous-induction Motor Differs from the Induction Motor and the Synchronous Motor.**

The synchronous-induction motor is a machine which is started as a slip-ring

induction motor and, when up to speed, is changed to a synchronous motor by applying direct current excitation to the rotor windings. Thus the machine is able to give the starting torque of a slip-ring induction motor combined with the high power factor and constancy of speed of a synchronous motor. A further feature of the machine is that, if when running as a synchronous motor, a sudden overload pulls the machine out of step, it will continue to run as an induction motor (up to its maximum torque), and will automatically pull itself into step again when the overload is removed. This feature is due to the maximum torque as a synchronous motor being smaller than that as an induction motor.

Although the synchronous induction motor has a stator and rotor similar to those of an ordinary slip-ring induction

motor, the two machines are not exactly similar in construction. For example, the former must be built with a larger air gap than the latter, more copper must be provided in its rotor winding, the type of rotor winding may differ from that of an

synchronous-induction motor and 150 per cent. overload for the synchronous motor).

The starting characteristics of the synchronous-induction motor are practically identical with those of a slip-ring induction motor: those of the self-starting synchronous motor are similar to those of a squirrel-cage induction motor.

### Power Factor and Efficiency.

The power factor may be controlled by adjusting the excitation by means of a rheostat in the field winding of the exciter. The synchronous-induction motor can operate at a power factor of 0.9 leading at full load and at progressively decreasing leading power factors at fractional loads. When considerable power factor improvement is required, a synchronous motor gives better results than a synchronous-induction motor.

The efficiency of the synchronous-induction

motor adjusted to give unity power factor at full load is slightly higher (1 to 2 per cent.) than that of a corresponding induction motor, and the efficiency of a synchronous motor may be very slightly higher than that of the corresponding synchronous-induction motor.

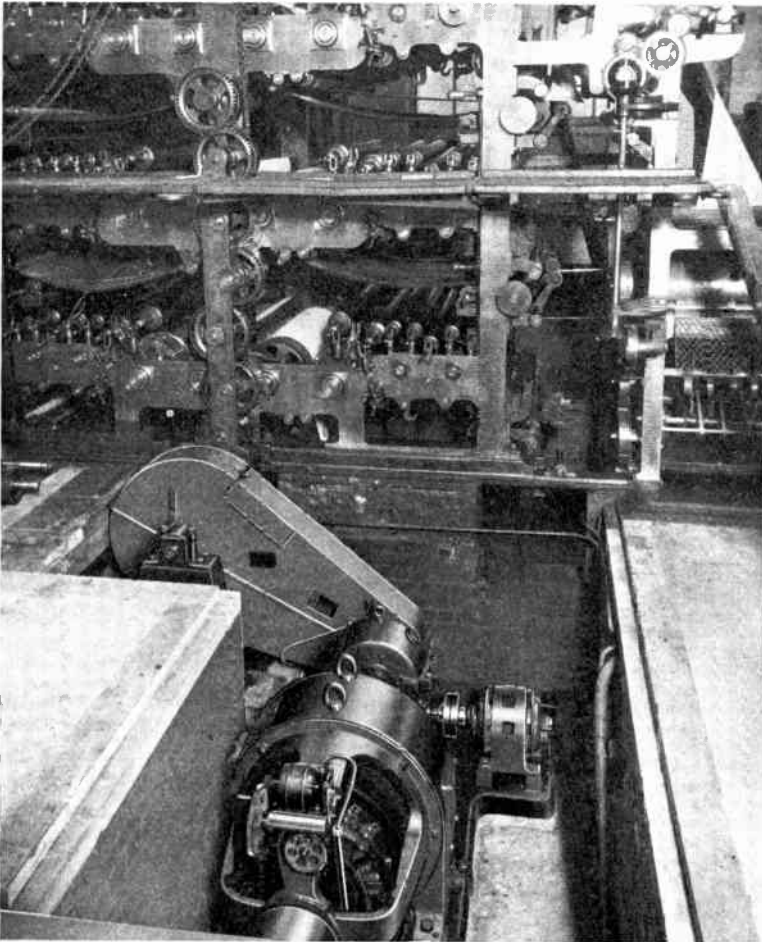

Fig. 26.—A LARGE POSTER FOUR-DECK NEWSPAPER PRESS AND ITS POWER PLANT. (B.T.H. Co.)

This consists of a 56/18½ h.p. 870/270 r.p.m. three-phase commutator motor, with motor-operated brush gear and a 5-h.p. barring motor (of the three-phase induction type). The entire control of the press is effected by push buttons.

induction motor, and the slip-rings and bush gear must carry current continuously.

### Speed and Starting Characteristics.

The speed is constant within the range of synchronous operation (which extends up to about 75 per cent. overload for the

**Applications of Synchronous and Synchronous-induction Motors.**

These machines are used in medium and large sizes for drives where starting and stopping is infrequent. The synchronous-induction motor is available in sizes from about 20 h.p. : it is cheaper than a corresponding synchronous motor and exciter, and can be started slowly against heavy loads. Some of the applications include air compressors, pumps, flour mills, cement works, textile mills, ammonia compressors, etc. Synchronous motors are chiefly used for driving large air compressors, ammonia compressors, motor-generator sets.

One important feature concerned with the application of synchronous and induction motors is that the constancy of speed of the former does not permit rapid fluctuations of the load to be absorbed by the flywheel effect of the rotating parts, as is possible with induction motors, owing to their slightly drooping speed characteristic. In consequence, load fluctuations on synchronous motors are imposed directly on the supply system. Rapid and heavy fluctuations of load may cause instability of a synchronous motor, but will scarcely affect the operation of an induction motor. Another feature concerned with the application of synchronous motors is that they are more sensitive to changes of supply voltage and frequency than an induction motor.

**Summary.**

In view of the number of types of machines which can be used for power

factor correction their applications are summarised in Table IV on page 832.

**SINGLE-PHASE MOTORS. CHARACTERISTICS AND APPLICATIONS OF SERIES-WOUND MOTORS.**

**How Torque is Produced in the Series-Wound Motor.**

In fractional h.p. sizes (which is the form in which the A.C. series-wound motor

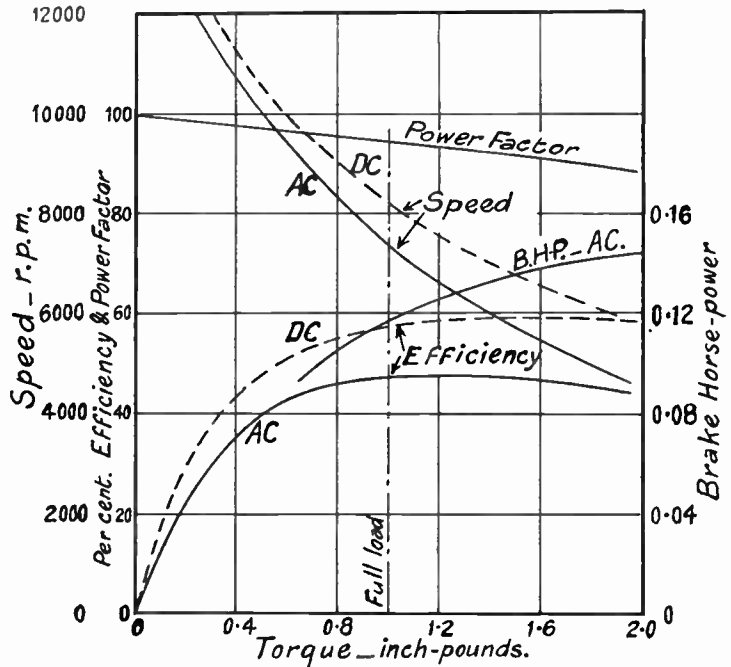

Fig. 27.—TEST RESULTS ON A SINGLE-PHASE SERIES-WOUND UNIVERSAL MOTOR.

The full-line curves show the results when the motor was tested with A.C. and the dotted curves show the results with D.C. A later article deals fully with the subject of testing small motors.

is used on domestic and industrial circuits) this motor is constructed similarly to a D.C. series-wound motor with completely laminated magnetic circuit. The torque is produced in exactly the same manner as that in the D.C. motor, i.e., by the interaction of the armature currents and the flux produced by the exciting currents. For example, the flux is practically in phase with the exciting currents and its



Fig. 28.—STATOR OF REPULSION MOTOR.

Showing the distributed stator (four-pole) winding. The stator core has been built with 36-slot induction-motor punchings, which accounts for the empty slot at the centre of each pole face.

alternations are in step with those of the armature current. Thus armature conductors carrying current under a pole face produce torque in just the same way as those in a D.C. motor, but the torque is *pulsating*. The torque produced by the conductors under a given pole face is always in the same direction, because the currents in the conductors and the flux always have the same relative sign (i.e., the flux is, say, positive when the direction of the armature current is positive, and is negative when the direction of

the armature current is negative). The commutator fulfils the same functions as in a D.C. motor (i.e., it ensures that the currents in the conductors which may be under a given pole face shall always have the same relative direction with respect to the flux of that pole), and it is just as essential in the A.C. series motor as in the D.C. series motor.

**Speed and Starting Characteristics.**

The speed characteristic is similar to that of a D.C. series motor, but its slope is steeper because the magnetic circuit of the A.C. motor must be worked at lower flux densities than that of the D.C. motor on account of the alternating flux.

The starting characteristics are good.

**Power Factor and Efficiency.**

These items are relatively unimportant considering the class of service, and the small sizes, in which the A.C. series motor is used. The curves of Fig. 27, however, are of general interest as they show the results of brake tests on a vacuum-cleaner motor.

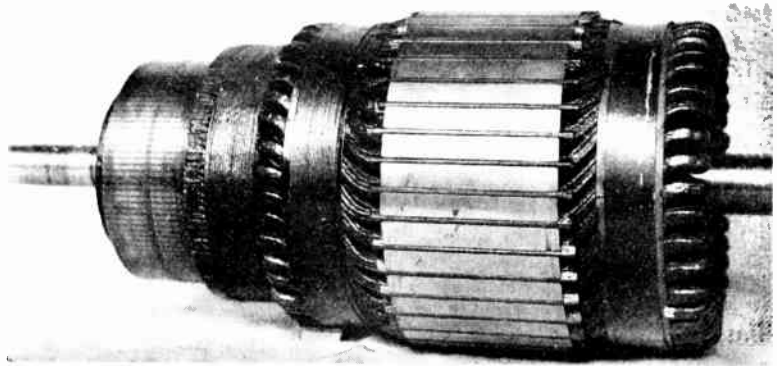

Fig. 29.—ROTOR OF REPULSION MOTOR ILLUSTRATED IN FIG. 28.

The rotor of a repulsion motor closely resembles the armature of a D.C. motor. In the present case the distinctive features are the partially closed slots and the "lap" armature winding (which is indicated by the commutator connections being brought out at the apexes of the coils).

**Applications.**

These motors are used in large numbers for small domestic appliances in which the load is practically constant, e.g., vacuum cleaners, sewing machines, small fans and blowers. In sizes up to about <sup>1</sup>/<sub>10</sub> h.p. they are suitable for both A.C. and D.C. circuits, and are therefore called *universal* motors.

**CHARACTERISTICS AND APPLICATIONS OF REPULSION MOTORS.**

**Chief Constructional Features of Repulsion Motors.**

A repulsion motor has armature and field systems somewhat similar to those of a D.C. motor, with the important differences that :—(1) the field structure is laminated, and has non-salient poles with distributed field windings (see Fig. 28) ; (2) the brushes are short circuited, and the brush axis is displaced from the neutral axis of the field poles, as shown in the circuit diagram of Fig. 30, the armature has partially closed slots and the armature winding is usually of the "lap" type (see Fig. 29).

**How Torque is Produced in a Repulsion Motor.**

The effect of the displaced brushes is equivalent to a division of the armature coils into two groups, A, B, connected in series ; the magnetic axis of one group (A) coinciding with the magnetic axis of the field winding and that of the other group (B) being at right angles thereto. These

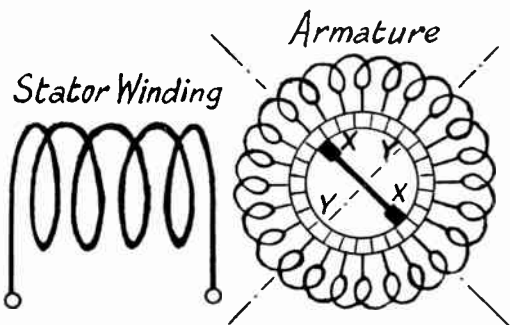

Fig. 30.—CIRCUIT DIAGRAM OF REPULSION MOTOR. XX indicates the axis of the brushes for, say, clockwise rotation, and YY the axis for anti-clockwise rotation (i.e., to change the direction of rotation the brushes must be moved from the position XX to the position YY).

conditions are shown in Fig. 31. Coils A and the field winding, therefore, are equivalent to a transformer. These coils can receive energy inductively from the field winding, but no torque can be produced by any currents in them since their conductors occupy the neutral zones between the field poles. The currents induced in coils A also circulate in coils B which are under the pole faces and are in the correct position for producing torque.

When the armature is stationary the currents in the coils B are practically in phase with the flux produced by the field winding, and so we have conditions which are similar to those in the single-phase series motor. In consequence, the repulsion motor produces torque in the same manner as a series motor, and the commutator fulfils the same functions in both types of motor.

**Why the Torque at Starting Depends Upon the Position of the Brushes.**

The torque is pulsating, as in the series motor, and its value depends upon the position of the brushes. Thus if the brush axis is perpendicular to the magnetic axis of the field winding, the torque is zero, because the armature current is zero, as with this brush position the armature winding cannot be acted upon inductively by the field winding. If the brush axis coincides with the axis of the field winding, the torque is again zero

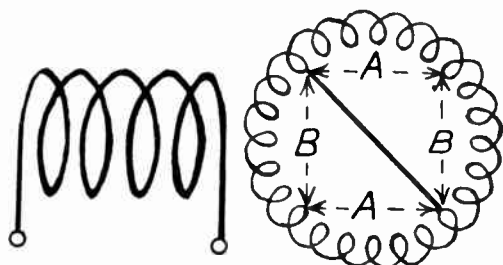

Fig. 31.—SHOWING HOW THE ARMATURE WINDING OF A REPULSION MOTOR IS DIVIDED BY THE BRUSHES INTO A TRANSFORMER SECTION, AA, AND A TORQUE-PRODUCING SECTION, BB.

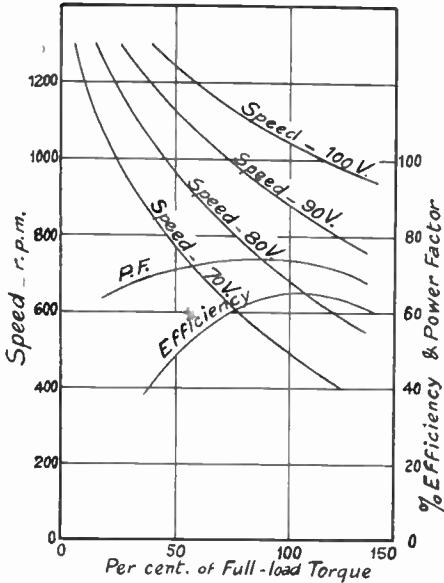

Fig. 32.—CHARACTERISTIC CURVES OF 2 H.P. REPULSION MOTOR.

The four speed curves were obtained by supplying the motor at four different voltages, e.g., 70 per cent., 80 per cent., 90 per cent. and 100 per cent. of normal voltage.

because although the armature current is now a maximum, the conductors under the two halves of a pole face carry currents in opposite directions and their

torques neutralise each other. The maximum torque is obtained with an intermediate brush position, which is about 40 degrees with the field axis.

**The Repulsion Motor Operates with a Rotary Magnetic Field.**

Two important operating features of a repulsion motor are :—(1) that the motor works with a rotary field, which at synchronous speed closely resembles that of a polyphase induction motor, and (2) that at synchronous speed the commutation is as good as that in a D.C. motor.

[NOTE.—The synchronous speed, in revolutions per second, is equal to (supply frequency) half number of poles].

The rotary field is due to the magnetic effects of the currents in the field and armature windings, and to the fact that the armature current, when the armature is running, is due to two e.m.f.'s, viz. : the e.m.f. generated in the coils B by their motion in the main flux, and the e.m.f. induced in the coils A, as before, by transformer action.

**Why Repulsion Motors are Preferable to Series-Wound Motors.**

Series-wound motors are not used above fractional h.p. sizes because of the difficulties of preventing excessive sparking at starting and of obtaining good commu-

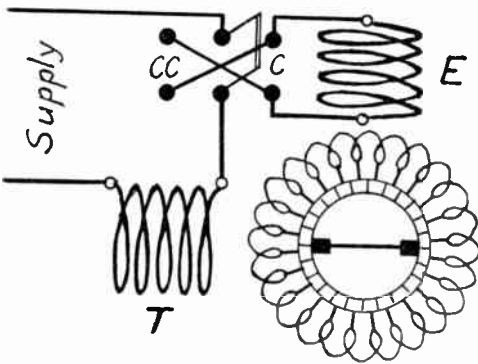

Fig. 33.—USUAL ARRANGEMENT OF STATOR WINDINGS AND CONNECTIONS FOR REVERSIBLE REPULSION MOTOR.

E, stator winding providing excitation; T, stator winding for supplying energy to rotor. These windings do not usually have the same number of turns.

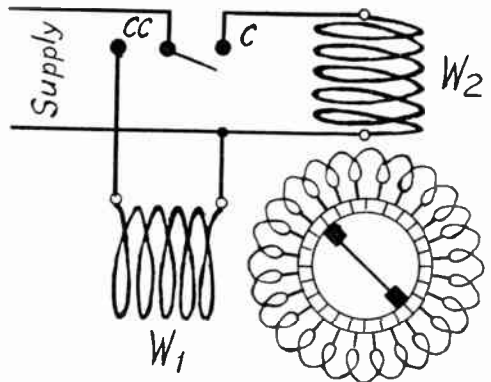

Fig. 34.—ALTERNATIVE ARRANGEMENT OF STATOR WINDINGS AND CONNECTIONS FOR SMALL REVERSIBLE REPULSION MOTOR.

W<sub>1</sub>, stator winding for CC rotation; W<sub>2</sub>, stator winding for C rotation. Both windings have the same number of turns.



tation when running. These difficulties are so great in 50-cycle motors that with a motor of only small output, e.g., 5-h.p., the armature must be supplied at a very low voltage by a transformer connected in series with the field windings. With larger motors additional field windings are also necessary.

Such motors are obviously very expensive.

The repulsion motor, owing to the armature receiving its energy inductively, is free from these defects, as the armature winding can be designed so that no excessive sparking occurs at starting. Moreover, at synchronous speed the commutation is as good as that in a D.C. motor.

**Speed and Starting Characteristics.**

The speed characteristic is similar to that of a series-wound motor. Typical

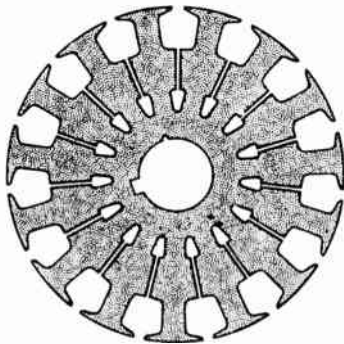

Fig. 36.—ROTOR PUNCHING OF B.T.-H. REPULSION-INDUCTION MOTOR.

The rotor is the special feature of this motor. The outer slots contain a D.C. commutator winding, and the inner slots contain a squirrel-cage winding. The slits between the two sets of slots are for the purpose of obtaining the correct distribution of the magnetic flux when starting and running.

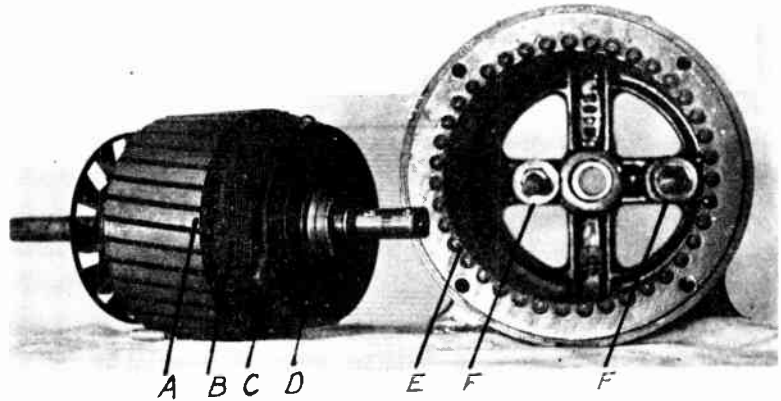

Fig. 35.—STATOR AND ROTOR OF FRACTIONAL H.P. SINGLE-PHASE (SPLIT-PHASE TYPE) INDUCTION MOTOR. (B.T.-H. Co.)

A, starting winding ; B, main winding ; C, centrifugal switch for cutting-out starting winding ; D, slip-rings ; E, squirrel-cage stator winding ; F, brushes and brush holders (fitted to end bracket).

speed-torque curves are given in Fig. 32, and show how the speed can be controlled by supplying the motor at various voltages, which may be obtained from an auto transformer.

The starting characteristics are good when the brushes are set correctly. Both the starting torque and the starting current are influenced by the position of the brushes.

**Power Factor and Efficiency.**

The power factor is lower than that of a series-wound motor, because of the inductive transference of energy to the rotating member.

Typical characteristic curves for a small motor are shown in Fig. 32.

**Applications.**

Owing to its series speed characteristic the repulsion motor is best suited for loads requiring approximately constant torque, and also for loads with heavy starting duty such as :—cranes, hoists, lifts, fans, blowers, etc.

**CHARACTERISTICS AND APPLICATIONS OF SINGLE-PHASE INDUCTION MOTORS.**

**Chief Constructional Features of Single-phase Induction Motors.**

Fractional h.p. motors are usually constructed with the primary or exciting

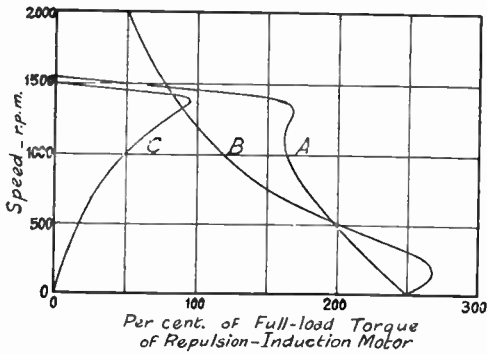

Fig. 37.—SPEED-TORQUE CHARACTERISTICS OF B.T.H. REPULSION-INDUCTION MOTOR (A).

Together with comparative characteristics for corresponding repulsion (B) and induction (C) motors.

windings (which are connected to the supply) on the *rotor* and the squirrel-cage winding on the stator. This construction is adopted because the special winding which is necessary for starting (see the following section) can be directly connected to a centrifugal switch. But, on the other hand, slip-rings and brush gear are necessary to make connections between the windings and the supply (see Fig. 35).

Larger motors are built with the exciting windings on the stator. The smaller sizes have squirrel-cage rotors, and the larger sizes have slip-ring rotors with a star-connected three-phase winding similar to that for a three-phase motor.

Large motors, which are started by an auxiliary motor, have an ordinary single-phase stator winding (similar to those illustrated in Figs. 6 and 28) and a squirrel-cage rotor.

### Why Special Windings are Necessary for Starting.

The single-phase induction motor with a single stator winding (which may be similar to that of a repulsion motor, Fig. 28) and a squirrel-cage rotor is not self-starting, because the magnetic field is alternating, and no currents can flow in the rotor as the resultant e.m.f. is zero (compare the conditions with those in the repulsion motor when the brush axis is perpendicular to the axis of the field winding).

### Split-Phase Starting.

To produce a torque at starting without resorting to a commutator and short-circuited brushes (repulsion motor principle) some sort of rotary magnetic field must be produced. A common method is to provide a second winding (called the starting winding) on the stator, having its magnetic axis displaced 90 electrical degrees from that of the main winding. The starting winding is designed to have a much higher resistance than the main winding so that when the two windings are connected in parallel at starting a fairly large phase difference will occur in the currents, and an imperfect rotary field will result. When the motor has run up to normal speed the starting winding is cut out of circuit either by a centrifugal device or by a change-over switch.

Such methods of "split-phase" starting are frequently used for motors up to about 5 h.p. when the starting duty is light.

They are also used for larger motors with slip-ring rotors, but in this case, at starting, additional resistance is connected in the starting winding and additional reactance is connected in the main winding. With suitably adjusted resistance and reactance and with resistance in the rotor circuits full load torque may be obtained at starting.

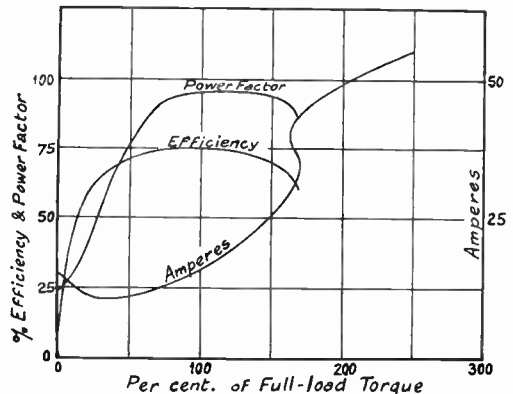

Fig. 38.—POWER FACTOR AND EFFICIENCY CURVES FOR B.T.H. 2 H.P. REPULSION-INDUCTION MOTOR.

**Repulsion Starting.**

The preceding method of split-phase starting is unsuitable when large starting torques are required. To meet these cases the motor is arranged to start as a repulsion motor (e.g., by providing an armature winding, commutator and brush gear as in a repulsion motor) and to change into an induction motor at a predetermined speed, the change being effected automatically by a centrifugal device which short circuits the whole of the commutator segments, and in some motors also lifts the brushes off the commutator. Small motors started by this method can give starting torques of three times the full load torque.

**Speed Characteristics.**

In both the split-phase and the repulsion-start motors the running conditions are those of a single-phase induction motor, energy being transferred from stator to rotor by a rotary magnetic field which is produced by the magnetic reactions of the currents in rotor and stator, and not by the stator currents alone as in a three-phase motor. The speed characteristic is therefore similar to that of a three-phase induction motor. A typical characteristic is shown in Fig. 37, curve C.

**Power Factor and Efficiency.**

Both of these items are lower than those of a corresponding three-phase motor, and the reason is due chiefly to the rotary field having to be produced by the magnetic reactions of the rotor and stator currents.

**Applications.**

These motors in fractional h.p. sizes have numerous applications in industry and domestic services, such as:—Small refrigerators, mincing machines, dish washing machines, small air compressors, small pumps, small lathes and drilling machines, cutter grinders, buffing and polishing machines, etc.

For general service the smaller sizes (up to 5 h.p.) of split-phase motors may be used when the starting duty is light and infrequent. Larger split-phase motors (up to about 25 h.p.) having slip-ring rotors and starting resistances may be used for light and medium starting duty

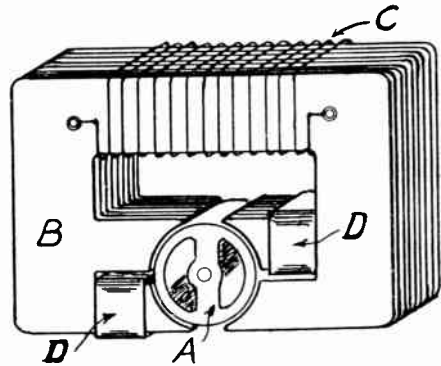

Fig. 39.—ARRANGEMENT OF PARTS OF SMALL TWO-POLE SINGLE-PHASE SYNCHRONOUS MOTOR.

This type is used in "Synlocks" (Everett Edgumbe), and the smallest size is rated at 2 watts. A, iron armature; B, laminated field magnet with divided pole faces; C, exciting winding; D, short circuited copper bands around one half of pole faces.

(where the starting torque does not exceed full-load torque) and infrequent starting. The starting performance of such motors is always very inferior to that of a corresponding three-phase motor.

Repulsion-start motors are used for heavy duty and frequent starting.

**Reversal of Rotation.**

The direction of rotation of a split-phase motor is reversed by reversing the connections of the starting winding.

The direction of rotation of a repulsion-start motor is reversed by moving the brushes to a corresponding position on the other side of the neutral axis, as indicated by the dotted axis YY in Fig. 30.

When frequent reversals are necessary two stator windings are used. Their magnetic axes are displaced 90 degrees from each other and the brush axis coincides with that of one winding T, Fig. 33. The two windings are connected in series and a double-pole reversing switch is connected to the winding E, by means of which the direction of rotation is controlled.

Alternatively, with small motors the arrangement shown in Fig. 34 may be used. In this case two similar stator windings  $W_1$ ,  $W_2$  are provided which are used

separately, one for each direction of rotation.

### CHARACTERISTICS AND APPLICATIONS OF REPULSION-INDUCTION MOTORS.

#### How a Repulsion-Induction Motor Differs from a Repulsion-Start Induction Motor.

The fundamental difference between these motors is that the repulsion-start motor has a *single* rotor winding of the commutator type which is converted automatically into a short-circuited winding when running, whereas the repulsion-induction motor has *two* distinct rotor windings, viz., a commutator winding similar to that on the repulsion-start motor and a separate low-resistance squirrel-cage winding. The two windings are placed in separate slots which are arranged as shown in Fig. 36, in order that at starting the squirrel-cage winding shall be practically ineffective. Under these conditions the motor starts as a repulsion motor and as such gives a large starting torque without an excessive starting current.

As the motor runs up to speed, the rotary field which is produced by the interaction of the stator and rotor currents lowers the reactance of the squirrel-cage winding and results in this winding becoming effective in producing torque. (NOTE.—A somewhat similar action occurs in the double squirrel-cage three-phase induction motor, see p. 822.) Hence with suitable design there is no necessity to short-circuit the commutator segments as is done in the repulsion-start motor.

#### Speed Characteristics.

The commutator winding and the squirrel-cage are designed so that at full load they share the load in the ratio of about 3 : 1 and give a speed characteristic similar to that of an induction motor. Synchronous speed is reached at about half-load and at lighter loads the speed is limited to a maximum of about 3 per cent. above synchronous speed due to the braking action of the squirrel-cage

winding. A typical speed-torque characteristic is shown in Fig. 37, and comparative characteristics are given for a repulsion motor and a single-phase induction motor.

When starting by switching directly on to the supply, the starting torque is about three times full-load torque and the current is about three and a half times full-load current. A lower starting current may be obtained by connecting a starting resistance in series with the stator winding, but this procedure will adversely affect the starting torque, as the latter is proportional to the *square* of the starting current. Thus, if the starting current were halved (e.g., reduced to  $1\frac{1}{2}$  times full-load current), the starting torque would only be one-quarter of its former value (e.g.  $\frac{3}{4}$  full-load torque).

#### Power Factor and Efficiency.

Due to the combined action of the two rotor windings, the power factor is unusually high (about 95 per cent. at full load). The efficiency is also high for a single-phase motor. Typical power factor and efficiency curves are shown in Fig. 38.

#### Applications.

These motors are suitable for all power applications which require a high starting torque and practically constant speed. They are particularly suitable for machine tools, lifts, hoists, centrifugal pumps, fans, blowers, etc.

### CHARACTERISTICS AND APPLICATIONS OF SMALL SELF-STARTING SYNCHRONOUS MOTORS WITHOUT D.C. EXCITATION.

#### How Torque is Produced at Starting and When Running.

These motors (except when of very small output, e.g., less than  $1/20$  h.p.) are provided with squirrel-cage salient-pole rotors, similar to those of the corresponding three-phase machines, and a split-phase stator winding, similar to that of a single-phase induction motor. At starting, the torque is produced in exactly the same manner as that in a single-phase induction motor. When the machine has run up

to speed as an induction motor, and the slip has a very small value, the polar projections on the rotor lock into position with the corresponding poles produced by the stator winding, and the machine then runs at synchronous speed.

Motors of very small output, which are used for clocks and instruments, have salient poles on the stator with "shading" or shielding coils which consist of short-circuited bands of copper embracing about one-half of the pole face as shown in Fig. 39. The currents induced in these coils produce a phase difference in the fluxes in the two parts of the pole face, and the resultant effect is somewhat similar to that obtained with a split-phase stator winding.

**Applications.**

The larger motors are used for driving automatic conveyors used in milk bottling plants and other industries, mechanical rectifiers, etc. The smaller (fractional h.p.) motors are used in sound reproduction and transmission systems, talking pictures, wireless transmission of pictures, submarine telegraphy, automatic telegraphy, speed indicating apparatus, etc. The very small motors are used in clocks, recording (curve-drawing) instruments, master frequency clocks, etc.

**Summary.**

The types of single-phase motors and their chief applications are summarised in Table IIIA (p. 818).

---

## QUESTIONS AND ANSWERS

**What fundamental principles of operation are used in A.C. motors ?**

Conductive and inductive transference of energy from supply to rotating member. Also the interaction of magnetic fields.

**Why are some induction motors fitted with squirrel-cage rotors and others fitted with slip-ring rotors ?**

Because the type of rotor is determined by the starting requirements.

The squirrel-cage rotor is only suitable for light and rapid starting duty. The slip-ring rotor is suitable for both heavy and slow-starting duty, and frequent reversals.

**Which is the most extensively used type of three-phase motor ?**

The three-phase induction motor with squirrel-cage rotor.

**What is the synchronous speed of a motor ?**

The speed of rotation of the rotary magnetic field produced by the supply currents. This (in revolutions per second) is equal to: Supply frequency ÷ half number of poles.

**What is the approximate air gap of a small induction motor (about 10 h.p.) ?**

About 0.03 inch.

**What are the chief disadvantages of induction motors ?**

(1) Low-power factor ; (2) Speed cannot be adjusted.

**Why is a commutator used in a three-phase motor ?**

(1) To obtain unity or leading power factor ; (2) To obtain adjustable speeds at high efficiency and power factor.

**How may two synchronous speeds in the ratio of 1:2 be obtained from a squirrel-cage induction motor with a single stator-winding ?**

By reversing the directions of currents in alternate coils of each phase so as to halve the number of poles.

**How can the starting performance of a three-phase squirrel-cage induction motor be improved without affecting the efficiency ?**

By a double-squirrel cage.

**How can extra high speeds, e.g., 10,000 r.p.m., be obtained from induction motors ?**

By using two-pole motors supplied at special frequency (e.g., 166 cycles for 10,000 r.p.m.) from a small motor generator set.

**What five types of single-phase motors are used for domestic service and small factories ?**

Series wound, repulsion, induction (split-phase start), induction (repulsion start), repulsion-induction.

**What is the chief difference between a single-phase series-wound motor and a repulsion motor ?**

The armature of the series-wound motor receives its energy *conductively* (via the brushes and commutator), but the armature of the repulsion motor receives its energy *inductively*, the brushes being short-circuited and not connected to any part of the stator winding.

**Why is the series-wound motor only built in small fractional h.p. sizes ?**

Because of difficulties with commutation.

**How is the direction of rotation of a three-phase induction motor reversed ?**

By interchanging *two* of the supply leads to the stator.

**How is the direction of rotation of a repulsion motor reversed ?**

By moving the brushes.

**How is the direction of rotation of a split-phase induction motor reversed ?**

By reversing the connections of the starting winding.

**How are the small single-phase synchronous motors used in clocks arranged so as to be self starting ?**

By splitting the pole faces and fitting short-circuited copper bands (shading coils) around one half of each pole face.

**What advantages has a large three-phase synchronous motor over a corresponding size of induction motor ?**

The synchronous motor has a higher efficiency and its power factor is *controllable*.

**What are the chief disadvantages of synchronous motors ?**

Poor starting torque ; direct current required for excitation ; constant and unadjustable speed.

**What are the chief advantages of synchronous-induction motors ?**

Good starting performance (comparable with that of a slip-ring induction motor) ; controllable power factor ; motor changes to induction type when pulled out of step temporarily at heavy overloads.

# INSTALLING ELECTRIC COOKERS

By F. H. HOWELL and R. A. FAULKNER

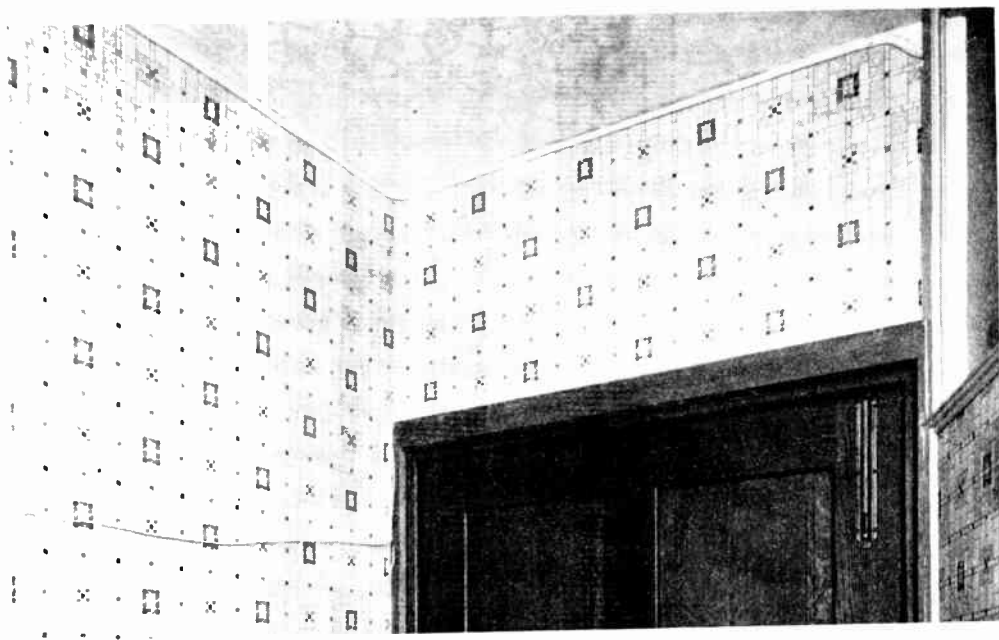

*Fig. 1.*—GOOD AND BAD WORKMANSHIP.

By using sufficient cleats and taking enough care, lead-covered wire can be taken round the ceiling to get over a door. This makes a neat and workmanlike job. This neat piece of work is in striking contrast to the slipshod way in which the bell wiring, just below, has been carried out.

**N**OW that electric cookers are becoming more common, a few practical hints on installation would probably be of some interest.

I should like all my readers to ask themselves just one question, "Is an electric cooker being used in my home?" If the answer is "No," I should like them to make a point of having one as soon as possible. They will then be in a position to answer any query put to them by their customers or would-be users.

## Where to Stand the Cooker.

For the sake of this article let us suppose that an electric cooker has been sold and the reader has been sent out to install it. His first job must be to find

out the position in which the owner wants it installed. He must also help to decide where it is going, bearing in mind that light is required to see into the oven, but at the same time the user does not wish to stand in her own light. The best position is such that when the oven door is open the inside of the oven is facing the window.

## The Cable and Switch.

Now, having decided where the cooker is going to stand, he must consider where his cable is going, also his double-pole switch. Whilst on the question of the double-pole switch, I always recommend that this be fitted with a pilot lamp and kettle plug; this should be fixed on the

right-hand side of the cooker ; the height should depend on that of the person who is to use it.

### **Find out about Wiring Regulations.**

Before you actually proceed with an installation it is best to approach the supply authority on whose mains the cooker is to be fixed and ascertain if they have any special wiring rules in regard to cookers. This may seem an elementary or, perhaps, unnecessary precaution, but it is very necessary. In the first place, in some districts the street cables will not permit of cookers being connected or, if they are large enough, the house service cable may not be large enough and the supply company or electricity department concerned may, or may not, be prepared to put in a bigger service free of cost. With this point settled, then, be sure and be careful to comply with any special instructions they issue as regards cookers.

### **What the Average Family Requires.**

The average family requirements are generally met by a 4-6 person model, taking from 6-7 kw. You need not necessarily, however, provide a main switch, fuses and cable for the full capacity of the cooker. It is an extremely unlikely event for 60 per cent. of the cooker to be switched on at one time. For a 6.5 kw. cooker at 200 volts, i.e., 32 amps., a 7/.036 cable, or, if the run is over 50 feet, a 7/.044 will be sufficient, even if a kettle or iron is being run off the control board. A 25-30 amp. main switch and fuses will suffice for the main control at the meter.

### **Fixing the Main Switch.**

Be sure you get a good fixing for your main switch and fuses ; if you find the wall is inclined to be "flimsy" put a couple of battens of wood up.

### **How to Plan the Wiring.**

As regards the system of wiring, screwed tubing is, of course, the best of all, or a grip-continuity welded tube if possible, sunk in the walls, but lead or tough rubber-covered cables will be found very convenient and easy to run for a cooker, as usually you install these in a finished house and sunk work is out of the

question. Don't rush at your job, but have a good survey of the run first and, if you can get under the floor, do so. Try and avoid running horizontally along the wall in the kitchen for this means a perfect trap along the top for grease and dust mixed with moisture, which runs down the walls in all kitchens from condensation of steam, etc.

### **Make Use of the Skirting Board.**

If you decide to use lead or tough rubber-covered cables you can, if under the floor is impossible, run along the top of the skirting and then at the cooker end of the run, go "up" to the local cooker control board.

It is best to use an ironclad combined switch and fuses for a cooker and have it drilled as you want it ; for instance, it may be more convenient to have outlets top and bottom or all at the top or all at the bottom. If you are using lead-covered cable, get a nipple, "lead cable to ironclad box," as, for example, the Walsall "G" nipple. Have your ironclad case tapped and drilled for two of these in the most convenient place ; you can now screw them in and you have perfect continuity between your lead-covered cable and box.

### **Make the Main Switch Accessible.**

If you are fixing your main switch in a cellar or cupboard, try and fix it in the most accessible place. Even if it means another yard or two of cable it is better to use it than for your client to find his main switch buried under the coke or just in the place where the lawn-mower stands in the winter. If your lead or rubber-covered cable in a cupboard or cellar appears likely to be in danger of having coke, etc., up against it, or boxes pulled in and out or pushed against it, perhaps with nails protruding, just run it through an odd length of tubing, or run it up along the ceiling and then down by the architrave of the door until you come to the level at which you are running out.

### **Don't be Sparing with Cleats.**

Having marked your run and fixed your main switch and fuses, carefully mark out the run to the approximate position of the cooker ; now fix your cleats and do not



be sparing of them, they are quite cheap and a little extra time fixing them is well worth while, especially if you are compelled to run along a wall half-way up and cannot get along a skirting or cornice. Nothing looks worse than surface work making an "S" or imitating a snake. A dead straight line firmly fixed is the sign of a good craftsman's work.

#### Why you need a Control Board.

The next item is the control board. You can, of course, run your cable straight to the cooker terminals, but this is not advisable for many reasons, the chief of which are :—

- (1) It is more convenient and also makes for perfect safety if there is a sub-main switch to cut off the cooker, fixed quite near to it.
- (2) The control board can be easily fitted with an indicator lamp, which is a great advantage to the user.
- (3) This board will also easily carry a switch plug and fuse for a kettle, iron or small fire and save wiring an additional point. A plug is most essential in the kitchen.

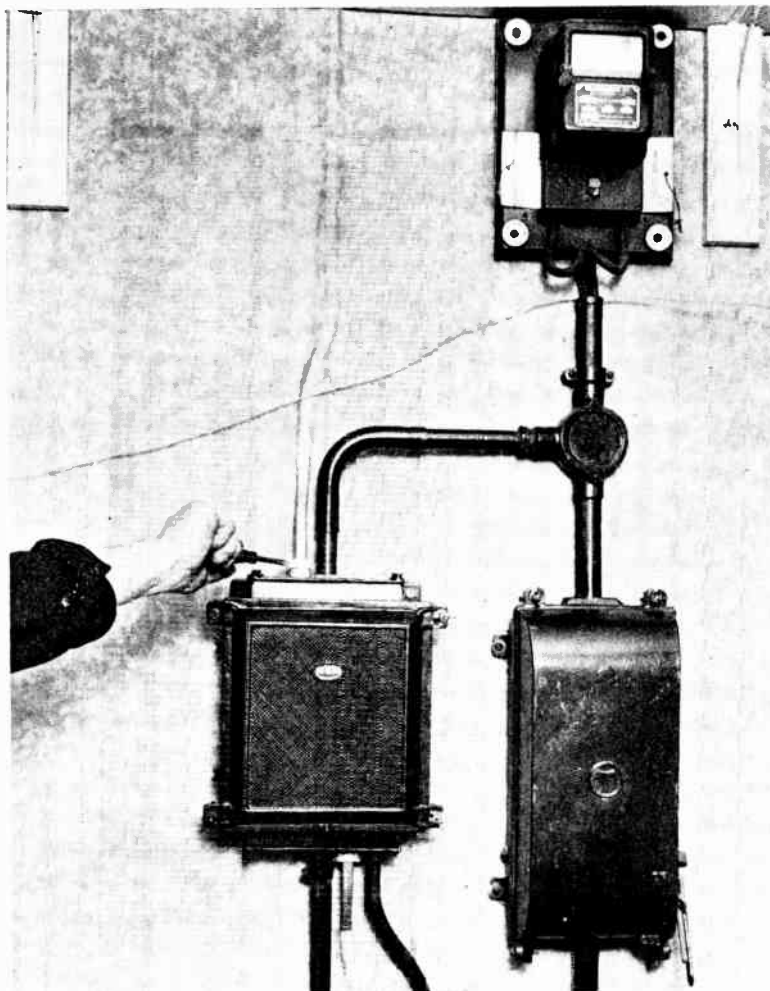

Fig. 2.—THE ADVANTAGE OF THE G NIPPLE FOR TAKING LEAD-COVERED WIRE INTO A CAST IRON BOX.

The cooker circuit shown here has been added to an existing installation in screwed tubing. The nipple should be screwed down tightly. By papering over the lead-covered wire it is practically hidden.

Before fixing the board, ascertain the position or approximate position of the cooker; fix it as near as you can to the cooker, but make sure it does not get in the way of the splash plate and plate rack. Usually, about 4 feet or 4 feet 6 inches from the floor and 1 foot or 18 inches to the right of the cooker will be about the most handy spot.

Make sure, again, of your fixings. Put

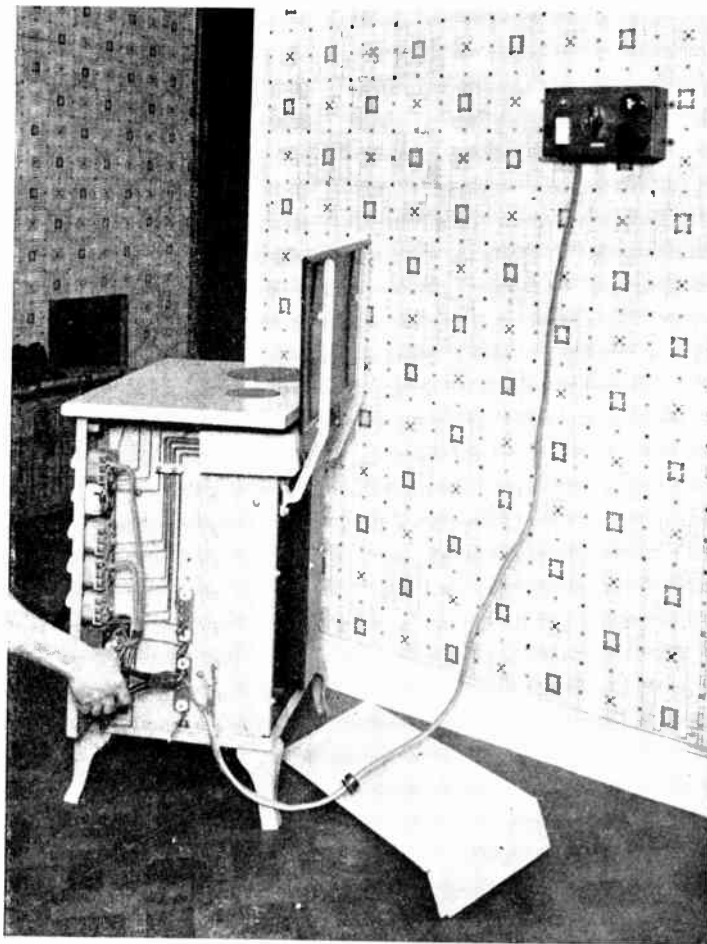

Fig. 3. — THE COMPLETION OF THE COOKER INSTALLATION.

This shows the santon board fixed in position and the three-core cab tyre cable left out ready to connect up to the cooker. The lead-covered wire has been neatly covered up in light wood casing, which has been continued up to the top to make a panel. Notice that the cable has been threaded through the bush before connecting on to the terminals.

up a batten or well plug the wall with wood or Rawlplugs. The board will have a good deal of use and a 25-amp. switch goes "off" with a good positive "jerk," remember, so fix it firmly!

#### Fixing the Cables.

You can get excellent control boards in wood or ironclad. The illustrations show examples of each; if you have ironclad, have it drilled and fitted with nipples, as you did the switch. If you are using

wood, drill or cut out a space for your cables just large enough for them, fit an ebonite or wood bush if you like, but this is not necessary if you smooth round the holes you cut with glass paper. All these may seem minor details, but if attended to they do leave behind the mark of a man who knows his job.

#### Follow the Terminal Markings.

You generally find on turning to the back of your wood control, or opening up the ironclad control, that the terminals are plainly marked, and you cannot go wrong on these. Regarding earthing, this is dealt with in a special paragraph a little later in this article, as its importance warrants far more than a casual reference.

#### Connecting the Cooker to the Control Board.

Cab tyre cable is best for connecting the cooker to the control board. Three core (one for earthing) gives you a neater earthing job, but it is more expensive. Don't skimp this cable, but don't be over-generous. Cookers are not moved about from one place in the kitchen to the other, but remember that they want to be moved occasionally for the floor under the feet to be cleaned and the wall at the back wiped down, so allow enough cable for the cooker to be moved a foot or 18 inches to either side or away from the wall.

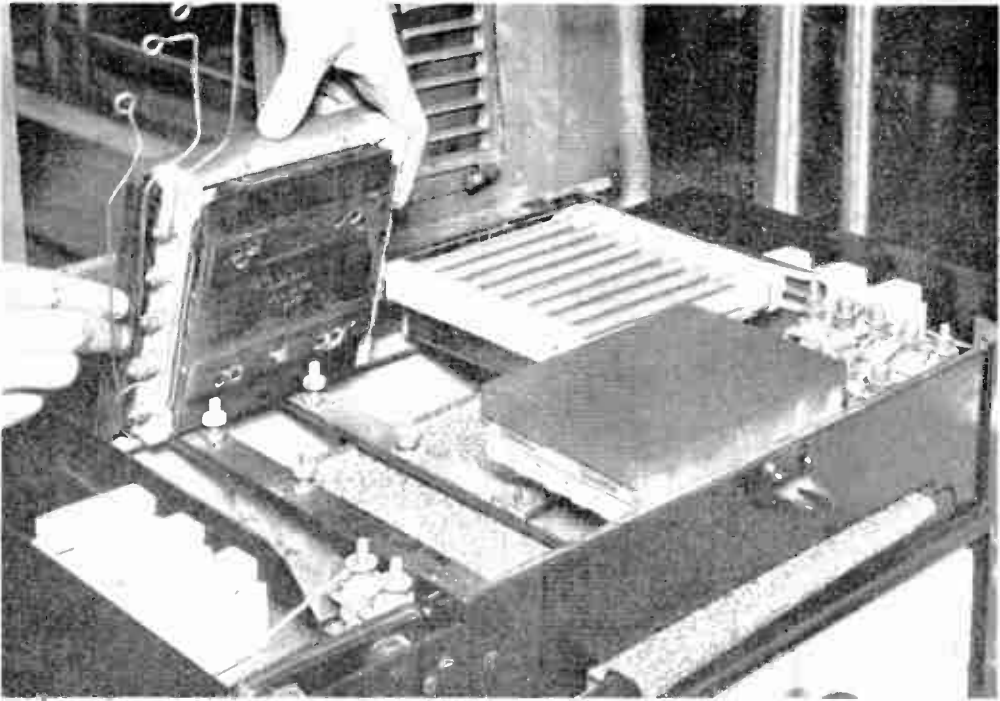

*Fig. 4.*—REMOVING THE HOT PLATE IN ONE PIECE AFTER DISCONNECTING THE SUPPLY WIRES.  
 If necessary, the hob could now be closed down and the cooker used minus one boiling plate. This and the following photographs in this article show the use of Sunray Friction cookers.

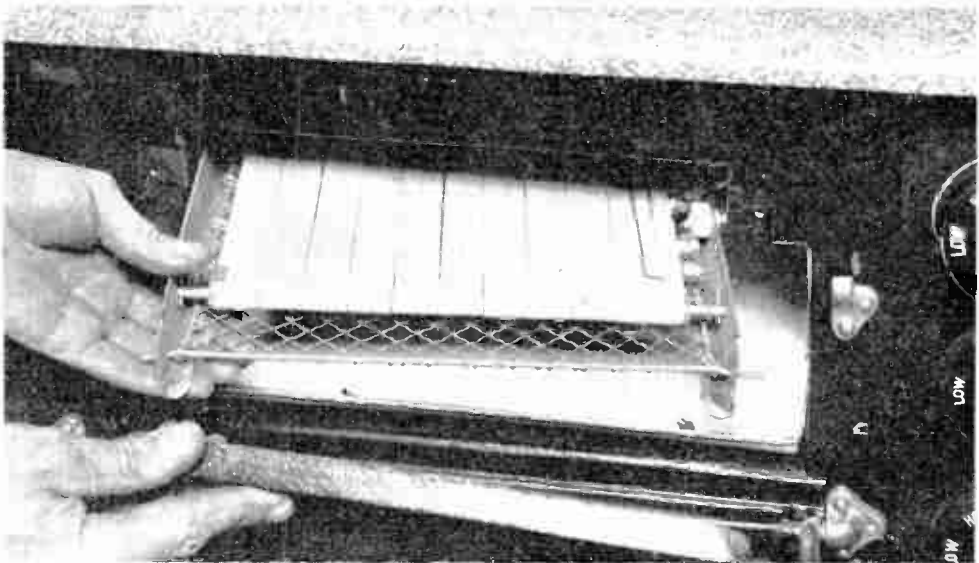

*Fig. 5.*—METHOD OF REMOVING GRILL HEATER ELEMENT.

### “Baring” the Cables.

When you are “baring” your lead- or rubber-covered cables be careful not just to cut through or make a “nick” in the final rubber covering of the strands. This is a fruitful source of trouble later, and is often hard to trace. Another point, when you are leaving out your connections for your meter, be on the generous side and leave out an ample length to reach the meter position and for the meter fixer to bend round and go into his meter with.

this). If you use the water pipe, make sure it is the *main cold* water pipe. If a hot water pipe or a cold water pipe that is fed from the cistern is used, it often happens that the packing used to make joints at the tank forms an insulator, and, therefore, not a good earth.

### Fix the Earth Wire Firmly.

Do not leave earth wire loose ; fix it up out of the way. An extreme case once occurred in which the earth wire had been

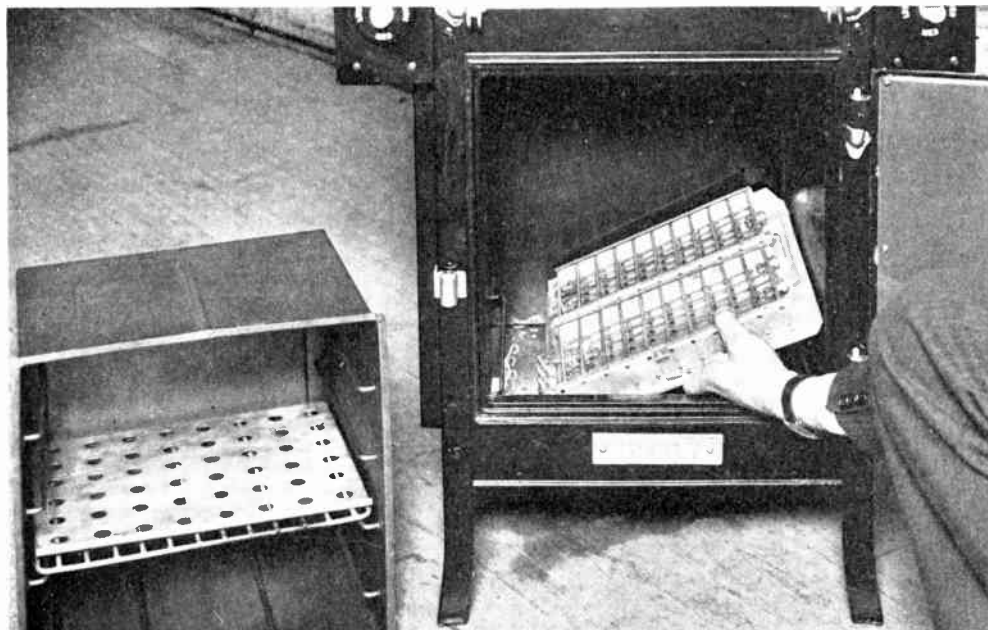

Fig. 6.—REMOVING THE OVEN ELEMENT AFTER DISCONNECTING SUPPLY WIRES.

The oven elements are built in a tray and the bottom element is of a greater loading than the top one. These trays are held in by a fixing screw in the front and if the three terminals just inside the oven are disconnected and this screw taken out the tray is easily removed.

### Make Sure of a Good Earth.

Earthing is most important. You will find on most makes of ironclad gear an earthing screw ; but before you fix an earth wire on to this, have a look and make sure it has not got a coat of enamel on it ; if so, scrape it well clean. If you have used lead-covered cable and the nipples referred to earlier in this section, all that is necessary is to connect tightly to your earth screw on the ironclad main switch and then to the nearest water pipe or the company's service pipe (if they approve

left loose along a wall and the householder wanting a piece of wire for a picture or his wireless or some odd job, just cut the earth wire down !

Once you have made sure of your main end being earthed, pay equal attention to the cooker end. If you have an ironclad control and have used the lead-covered cable and nipples, employ the same method as for the main switch ; if you have a wood board, you must run your earth wire from your lead-covered to the water pipe.

### The Earth Terminal.

The cooker itself will have an earth terminal plainly marked or easily distinguishable; if you use three-core, correct your third (earth) wire to this.

If you are using twin cable or flexible from control to cooker, then wind your earth wire neatly round the outer casing, twisting it firmly round.

### Clean Off Paint or Enamel.

Be sure and see that every point on apparatus, pipe, cable or ironclad to which you fix an earth wire, is scraped and quite free from paint or enamel. Do not rely on wire wrapped round and a twist of the pliers to make an efficient earth. There are plenty of cheap and reliable earth clips. One of the handiest is an adjustable copper band, but even if you use a clip, see that it is fixed tightly. Some electricians always finish up an earth wire with a spot of solder. This may not be necessary, but it does make sure, and it is that attention to small details

which, as has been said before, stamps the worker as a careful craftsman or removes the "amateur" label from a wiring job.

### Making the Connections.

In making the connections on the cooker particular attention must be paid first to see that the thimbles or washers supplied by the manufacturers are correctly fitted, i.e., thimbles should be sweated on or washers should be clamped firmly home. When this is done the "live" cable should be connected to the live terminal,

which is marked, and the neutral to the neutral. In replacing the nuts on terminals be sure that you use the nuts supplied and always use the lock nuts and washers.

### Testing.

Now that all connections are made, see that fuses are correctly loaded, test out with your megger, if your reading is good, then test your cooker out by switching on one switch at a time and testing each switch separately. When you are satisfied that each is working, then switch all on together.

Explain roughly to the user which switch controls the right-hand boiling

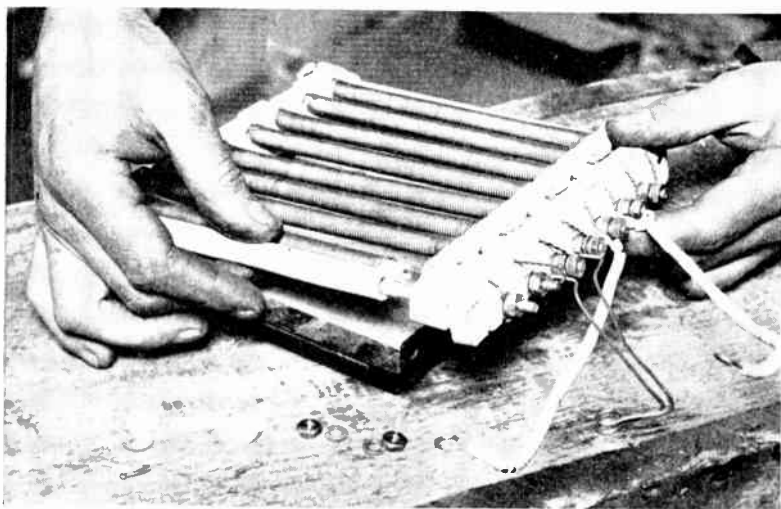

Fig. 7.—METHOD OF FITTING NEW ELEMENT SECTION TO 2-KILOWATT BOILING PLATE.

The boiling plates have eight sets of coils with a steatite tube in each, and these tubes are supported by two steatite end-pieces. Nickel wire must always be used if it is necessary to replace the nickel wire in any type of boiling plate.

plate, etc. Each switch is marked showing what it controls.

Before you leave your customer's house after installing an electric cooker it is a good plan to get her to try the switches herself so that she can ask your advice if necessary.

### NOTES ON THE UPKEEP AND MAINTENANCE OF A SUNRAY TRICITY COOKER.

The following notes refer to the upkeep and maintenance of a No. 772 Tricity

cooker, which is a very good example of best modern practice.

### **The First Point to Remember.**

Before taking down any part of a cooker of any description, it is advisable to make a sketch of the wiring and connections so as to ensure that after the repair is carried out, all connections are replaced correctly.

### **How to Remove the Boiling Plate.**

Take out the bolt which is found under the hob in the front centre, and lift up the hob so that all the boiling plates are exposed. The 2 kw. boiling plate is of the open type and, therefore, the grid is fixed to the hob by means of four lugs. This grid must never be fixed solid; there should always be a little "play" all ways in order to allow for expansion and contraction.

Now follow the nickel wires from the boiling plate to the bridge. You will notice that these wires are connected to three terminals. Take off the nickelled nuts, lift off the wires, put your hands under the boiling plate and lift upwards. If necessary, the hob could now be closed down and the cooker used minus one boiling plate.

### **Examining the Elements.**

You will notice that boiling plates have 8 sets of coils with a steatite tube in each, and these tubes are supported by two steatite end-pieces. If the steatite tubes are examined it will be found that at either end there is a slot. This is so that the end of the coils may be held fast, thus giving the coils the appearance of a spring slightly stretched. It will then be noticed that the turns are all separated. The part where the actual connections are made is known as the steatite terminal bar. The terminals themselves are made of nickel 2 B.A. bolts held tightly by half pieces, and a 2 B.A. nut as a lock nut.

### **When Nickel Wire is Used.**

Nickel wire, and not copper wire, must always be used if you have to replace the nickel wire in any type of boiling plate.

It will be noticed in this element that coils are made in pairs, so that it is quite easy to replace one pair, if only one is faulty.

### **Another Type of Boiling Plate.**

The 1600-watt square enclosed-type boiling plate is constructed somewhat differently. The steatite tubes instead of being inside the coils are on the outside. The coils are made in "fours" and the steatite tubes threaded over them. These are then placed in the top-cast plate in the grooves provided. The steatite end-piece is then put in position—the terminal bar—the fire brick and house, which is held down to the cast top by means of two small screws either side.

### **Why One Terminal is Larger.**

It will be noticed on the terminal bar that one terminal is larger. This is because that terminal is the common and, therefore, is required to carry double the amperage of the other.

The 1050-watt enclosed-type boiling plate is similar to the 1600-watt type, with the exception that it is smaller.

The grill is built on similar lines to the 2 kw. open-type plate, but has only a loading of 1200 watts.

### **Removing an Oven Tray.**

The oven elements are built in a tray and the bottom element is of a greater loading than the top one. The trays are always marked "oven top," or "oven bottom" and the correct tray must always be used. These trays are held in by a fixing screw in the front, and if the 3 terminals just inside the oven are disconnected and this screw taken out, the tray is easily removed.

### **Test With a Megger After Repairing.**

If the repairs are carried out a megger should be put on the cooker to make sure that there is no earth caused through the repair.

### **Plug-in Element Type.**

A later article gives further information on cooker repairs, together with notes on the plug-in element type.

# DISTRIBUTION SWITCHGEAR

By T. J. BARFIELD

**T**HIS article will deal only with distribution switchgear as used for factory and industrial purposes. Such switchgear includes the main switchboard controlling the low tension side of transformers, or the main L.T. supply from the mains, and feeders to sections or bays of the factory or industrial plant, and smaller switchboards at the end of these feeders, controlling the supply to motors, lighting circuits, etc. It does not include switchgear for the control of generating plant, small fuseboards which form a part of the lighting installation, or motor control gear. Since the electricity supply of this country is being standardised as three-phase alternating current, A.C. switchgear will be considered almost exclusively.

## Function of Switchgear.

The function of switchgear is to control and protect electrical circuits, and, incidentally, to measure or indicate the amount of power used. It may not be called upon to operate for months, or perhaps years, yet should be capable at any time of interrupting faults such as overloads or short circuits. Hence suitable design, reliable construction and care in maintenance are of the greatest importance.

## Electricity Regulations.

The type of switchgear to be installed for any particular use is governed very considerably by the Home Office Regulations (Factory and Workshops Acts). Some of the requirements of these regulations, in brief, are :—

(1) Switchboards having bare conductors exposed so that

they may be touched must be located in a room or enclosure set apart for the purpose, to which only authorised persons have access.

(2) Where bare conductors are exposed, there must be a clear passageway of

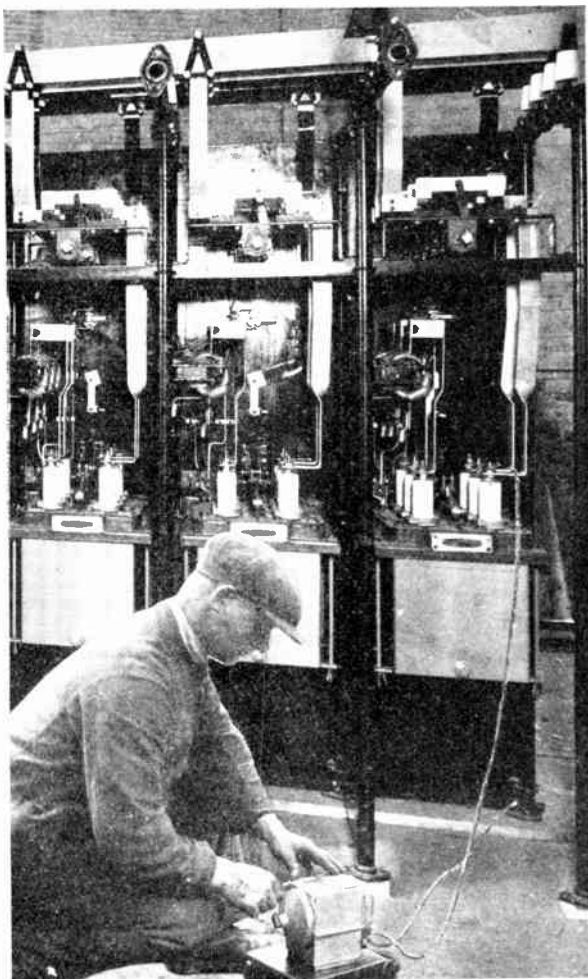

Fig. 1.—BACK OF A FLAT-BACK SWITCHBOARD WITH ISOLATING SWITCHES AND BARRIERS BETWEEN PANELS.  
(Crompton Parkinson, Ltd.)

Showing an erector carrying out insulation test with "Megger." (Evershed and Vignoles, Ltd.)

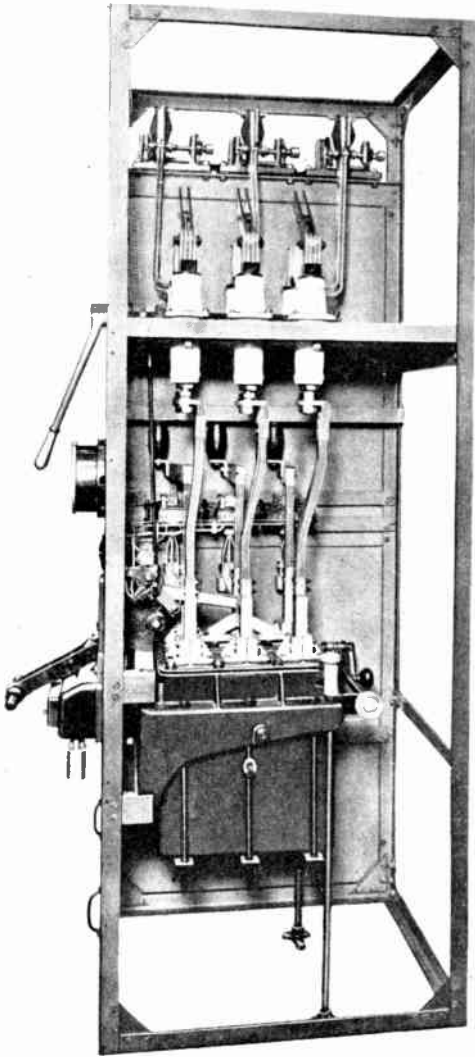

Fig. 2.—SIDE VIEW OF A HEAVY CURRENT CUBICLE, WITH SCREENS REMOVED.

The isolating switches are operated by a lever from the front of the cubicle. (*Crompton Parkinson, Ltd.*)

3 feet from conductors to wall (4 feet 6 inches if conductors are exposed on both sides) and 7 feet from floor to conductors overhead. (These distances refer to systems not exceeding 650 volts between phases).

(3) When work has to be done on a

switchboard, either it must be made dead, or the section on which work has to be carried out must be made dead and screened from adjoining live conductors.

It will be seen that these clauses practically prohibit the use of open type switchboards, except when they are located in proper switch rooms, and require that switchboards and the distribution system in general must be planned so that any section of any board can be made dead (by operating isolating switches, for example) for cleaning.

#### Types of Switchboards.

Industrial distribution switchgear may be divided into four broad classifications:—

- (a) Flat-back or open type switchboards, consisting of knife switches, fuses, circuit breakers, etc., mounted on slate, marble or insulated steel panels.
- (b) Cubicle type boards, of the fixed or truck type.
- (c) Ironclad oil break switchgear, with isolating features of various kinds.
- (d) Ironclad switch and fuse gear.

Typical switchboards of these types are illustrated in Figs. 1 and 2, 4 to 7, and 15.

#### Flat-back Switchboards.

The flat-back board must be housed in a proper switch room or suitably enclosed. If the front has no live metal exposed, and the back is closed by a wall, expanded metal doors and screens at the end form sufficient enclosure. Unless it is possible to make the whole board dead for inspection (which may be possible at week-ends for routine inspection, but may be very inconvenient in case of a breakdown), isolating switches between the busbars and the other apparatus are necessary, together with means for screening other circuits (fixed or temporary divisions) from the one on which work has to be carried out. Boards of this type are low in first cost, particularly for heavy currents (500 amps. and above) and when equipment a little out of the ordinary is required. They occupy rather a large amount of room, the required depth back to front, with passage-way and operating space, being about 8 feet, and





Fig. 3.—EXAMINING AN OIL CIRCUIT BREAKER TO MAKE SURE THAT THE ARCING CONTACTS (A) MAKE BEFORE AND BREAK AFTER THE MAIN CONTACTS (B). (Crompton Parkinson, Ltd.)

they are not suitable for dusty situations. Their chief use is for the control of the main supply and distribution cables when housed in a proper switch room, which may be combined with the transformer room.

#### Cubicle and Truck Type Switchgear.

Cubicle type boards have all live gear enclosed, and therefore need no enclosure. They are clearer than flat-back boards,

cables and any necessary repairs a passage-way at the back, even if rather narrow, is invaluable.

#### Ironclad Switchgear.

The majority of industrial switchgear requirements are met by oil-break ironclad gear, either of the draw-out or drop-down type (Fig. 5), in which the complete breaker unit can be isolated and removed if necessary for overhaul, or the simpler type with or without some device for isolating the main parts from the busbars. This type of gear is compact, safe in operation, even by semi-skilled attendants, is suitable for very damp and dusty situations and can be made suitable for use in fiery mines. For standardised requirements, it is comparatively low in price; for special requirements (as when a large number of instruments have to be fitted) or for large current capacities (over 600 amps.) it may be rather expensive.

Ironclad switchboards built up of iron-clad air-break switches and fuses are very suitable for secondary distribution boards in large installations, or the main board in a small factory, where the maximum current does not exceed about 150 amps. Where there is one incoming feeder of larger capacity, this may be controlled by an oil-break unit connected to the air-break switchboard (Fig. 6). Fuses should not be used where the busbars are directly connected to transformers fed on the E.H.T. side from

large supply systems; in such situations they may fail to interrupt the very large currents which can flow on short circuit.

#### Summary of Comparisons.

The following table summarises the uses of the different types of switchgear and gives an approximate idea of the relative cost and space occupied. These figures must be regarded as subject to considerable variations according to capacity, equipment, etc.

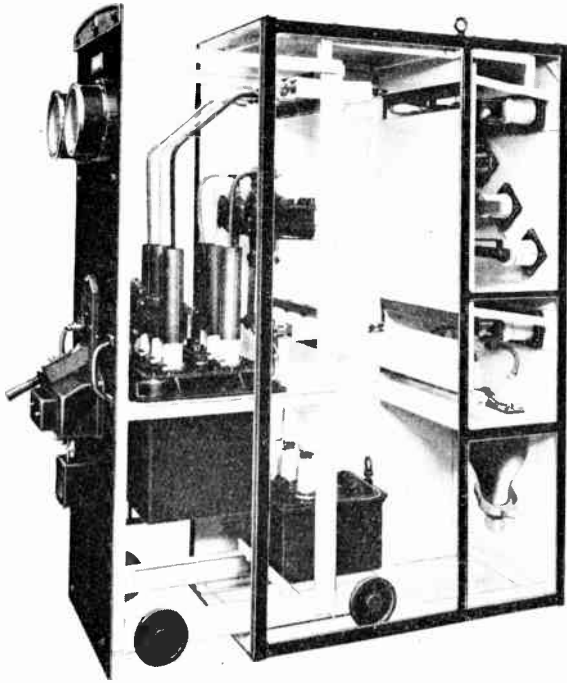

Fig. 4.—A TRUCK TYPE CUBICLE FOR 6,600 VOLTS, WITH SIDE SCREEN REMOVED AND TRUCK PARTLY WITHDRAWN. The safety shutters in the screen in front of the busbars are about to close. (Crompton Parkinson, Ltd.)

occupy about the same amount of room, and are not entirely suitable for really dusty situations or similar severe conditions. Both the fixed and the draw-out type (the former when provided with interlocks) are safer than open type boards, and the latter are particularly easy to overhaul, since all parts needing examination are mounted on a truck portion, which can be withdrawn. Fixed cubicle boards are made which can stand with the back against a wall, but for easy jointing of

Type of Gear.	Use.	Relative Cost.	Floor Space Occupied by One Unit or Panel.*
(a) Flat-back.	Main distribution board, in proper switch room or clean situation. Especially for heavy currents.	100	Sq. ft. 10
(b) Cubicle or truck type	As above. Does not require special enclosure.	120-130	12-15
(c) Iron-clad, oil-break.	Most industrial uses, especially in dusty situations and for use by semi-skilled operators.	75-100	8-10
(d) Iron-clad, air-break.	As (c), but for smaller capacities.	Not comparable.†	4-5

\* Includes any necessary passage at back and operating space in front.

† Within its range, and for very standardised equipment, cheaper than (c).

### EQUIPMENT OF SWITCHBOARDS.

The following recommendations are based on average requirements. When cost permits, the fuller equipment scheduled should be chosen.

#### Main Incoming L.T. Feeder or Control of L.T. Side of Transformer.

Automatic oil circuit breaker, with isolating switches or isolating device on incoming side (and on busbar side unless there is not and is unlikely to be any other incoming supply). Neutral link if a four-wire circuit.

Automatic device consisting of overload tripeoil with time lag on each phase, or, preferably, Merz Price or similar protection for a transformer. No-volt trip (not really necessary if all motor starters have no-volt trips; may be in-

convenient in the case of a temporary failure of supply after dark).

*Instruments.*—Ammeter on each phase, or one ammeter with switch for reading current on each phase.

Voltmeter, with switch for reading voltage between each phase and/or from each phase to neutral.

Watt-hour meter (as a check on the supply company's meters), with maximum demand indicator if desired.

Indicating wattmeter (a "luxury" extra).

Power factor indicator (always useful where there is a large motor load, and practically essential if the supply com-

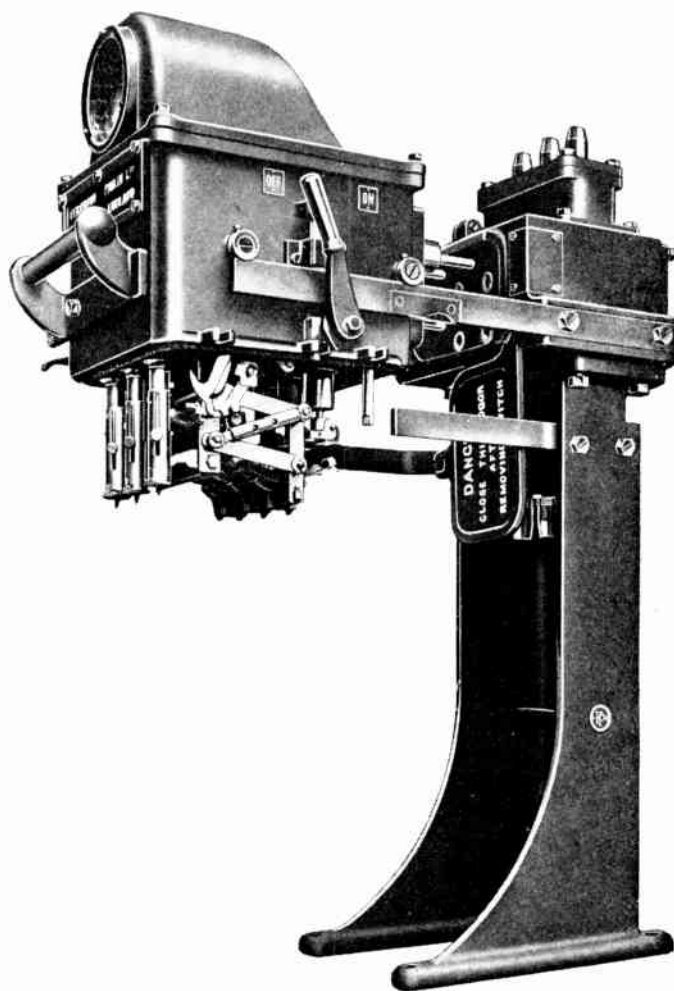

Fig. 5. —A TYPICAL DRAW-OUT IRONCLAD CIRCUIT BREAKER. With carriage withdrawn and tank removed. (Ferguson Pailin, Ltd.)

pany gives a bonus [in the form of reduced terms] for high power factor).

#### Feeder to Secondary Switch-board or Large Motor.

Automatic oil switch with two time limit over loads and one leakage tripcoil. No-volt trip optional. Isolating switch on busbar side. Neutral link if a four-wire feeder.

Ammeter (with switch to read in each phase if there is any single-phase load which may not be balanced).

Power factor indicator for power circuit if desired.

#### Feeder to Lighting Distribution Board.

Automatic oil switch with overload tripcoils (or ironclad fuses).

Isolating switches on busbar side (or ironclad knife switch) and neutral link. Ammeter in each phase (preferable) or one ammeter with switch to read current in each phase.

The above equipments do not list essential accessories supplied by the switch-board maker (such as current transformers, voltmeter fuses, etc.) or necessary cable boxes or conduit fittings to suit the cables.

#### Spares.

It is recommended that a small stock of spares be kept, including :—

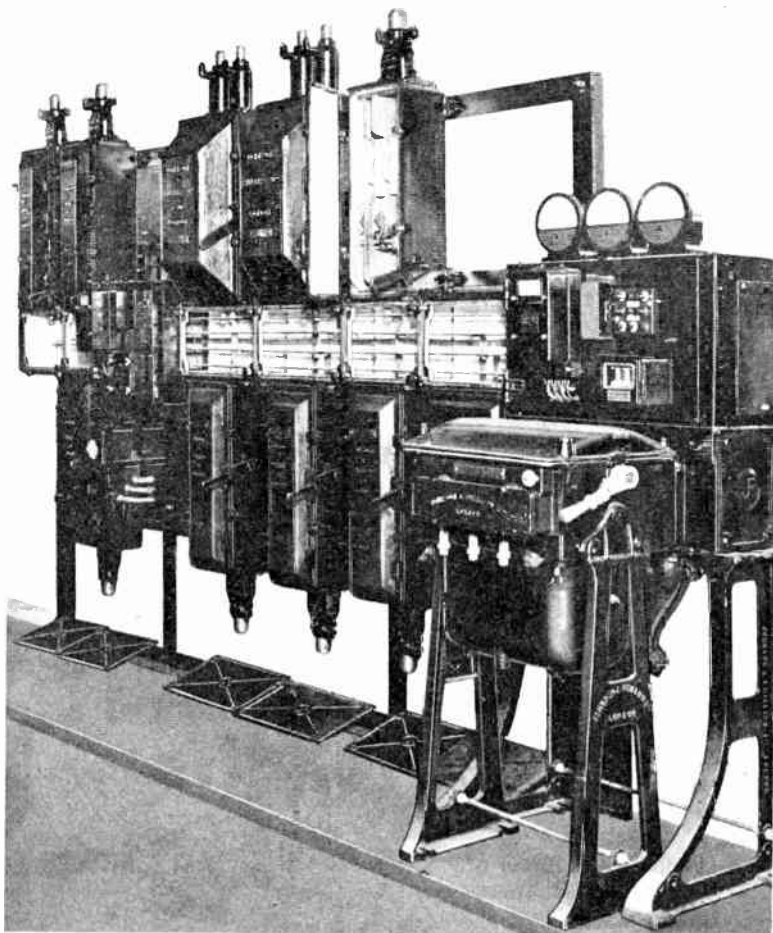

Fig. 6.—AN IRONCLAD SWITCHBOARD.

This consists of ironclad oil circuit breaker (fitted with three ammeters and watt-hour meter) for the incoming feeder and ironclad switches and fuses for the outgoing circuits. (*Johnson and Phillips, Ltd.*)

Complete set of sparking contacts for each size of circuit breaker.

Spare fuse handle of each size.

A few time limit fuses.

Reels of fuse wire of useful sizes.

More complete stocks for larger installations may include, in addition to the above :—

Complete set of contacts for the most important size of breaker.

A few porcelains or busbar insulators, with clamps.

Drum of switch oil.

No-volt tripcoil.

Voltmeter complete with resistances.

## ERECTION OF SWITCHGEAR.

### Flat-back Switchboards.

These will probably be delivered in complete panels, possibly with large oil circuit breakers removed. The instruments will be packed separately and naturally the busbars and any connections between panels will be dismantled. The sub-base of angle or channel iron, on which the board is fixed at the base, should be laid in the required position (carefully measuring the distance from the wall as shown on the erection diagram) and firmly fixed to the floor by means of coach screws, if the floor is of wood, or rag-bolts grouted into the floor if the latter is of concrete. Now carefully mark out and make any necessary holes in the wall for the wall stays. If the latter are fixed to an angle iron, which in turn is bolted to the wall, this angle may be fixed temporarily in position, but it is safer not to grout in the wall bolts with cement in case the measurements are a little out, as otherwise new holes might have to be drilled in the angle iron.

### Using Lifting Tackle.

Next take one end panel and bolt to the sub-base. For this, lifting tackle may be needed if the panels are of marble or slate. Secure the panel temporarily by means of stays or a rope from the ceiling, and bolt on the end wall stay. If this accurately fits the hole in the angle iron bolted to the wall, the latter may now be fixed permanently.

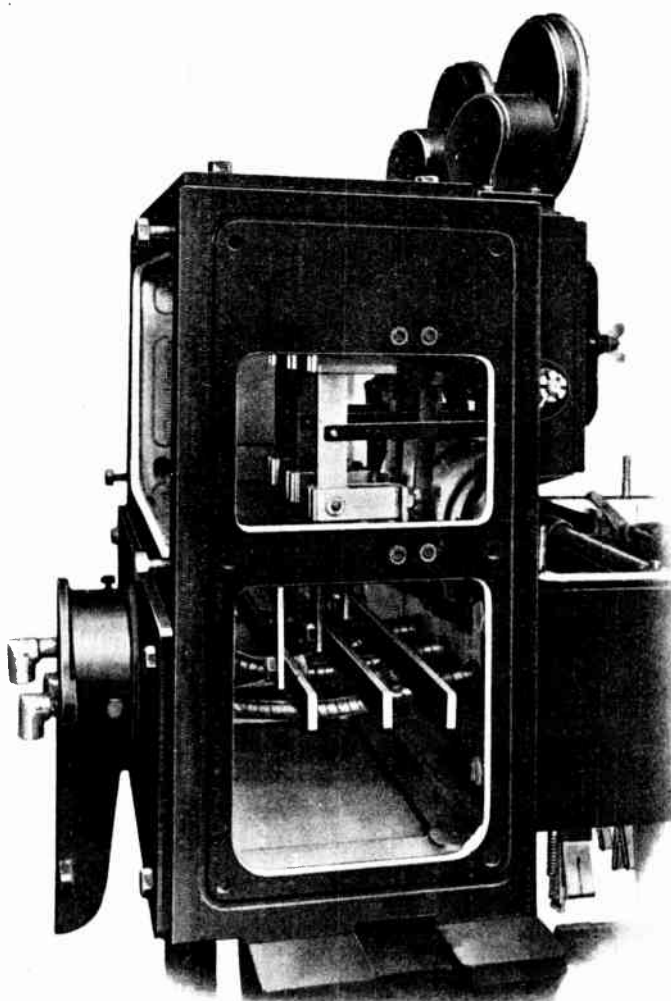

Fig. 7.—ARRANGEMENT OF ISOLATING SWITCHES OPERATED BY EXTERNAL LEVER AND INTERLOCKED WITH THE CIRCUIT BREAKER, ON A NON-DRAW-OUT IRONCLAD UNIT. (Johnson & Phillips, Ltd.)

Use a plumb-line to get the panels vertical, drawing the holes in the wall stays oval with a file if necessary for adjustment.

Now, in turn, erect the remaining panels, and when all are erected go over all bolts and finally tighten up.

### When to Complete Fine Wiring.

Before the busbars and other connections are assembled, any fine wiring for the instruments should be completed.



Fig. 8.—SETTING THE TRIPCOILS OF AN ORDINARY TYPE OF OIL CIRCUIT BREAKER.

This may include a common earth wire or bar which has to be cleated along the whole length of the back of the board. The wiring diagram will indicate any connections of this nature, which cross from panel to panel. Also mount the instruments, taking care to get them in the right positions, which should be indicated by numbers on the backs of the instruments corresponding with numbers on the board in the positions they are to occupy.

Next fit busbar insulators and busbars,

and main connections to the isolating switches or other apparatus on the panels. In clamping up the copper connections, see that the faces are perfectly clean. If the contact surfaces have not been tinned by the switchboard maker, it is worth while to do this by dipping in a pot of solder. The tinned surface, being softer than copper, ensures close contact between the faces when bolted together.

When erection has been completed, carefully attend to the following points.

### Oil Switches.

Fill tanks with switchgear oil (transformer oil is of the same kind) to the required level, having first cleaned out the tanks and made sure that they are dry. Try the levergear and tripping mechanism for easy action. Most tripcoils can be tried by pushing up the plunger with the finger or end of a pencil; quite a light push should suffice to trip the switch, and if it does not, examine for dirt or rust.

### Set the Tripcoils.

The overload coils should be adjusted all coils on the same switch being set to the same mark. Methods of setting vary somewhat with the make of switch; usually adjustment is made by screwing up or down a nut on the plunger, locking the nut when the required position is reached (Fig. 8).

The overload settings to be made will depend on the circuit controlled. A setting of 50 per cent. above normal should be enough for a transformer unless the load fluctuates violently or allowance has to be made for the starting of a large motor, in which case a longer time lag would be preferable to a very much higher overload setting than 50 per cent.; power feeders from 50 per cent. when they supply a number of small motors to 150 per cent. (two and a half times normal load) in the case of a feeder controlling one large motor taking a heavy starting current. In general, the settings should be as low as possible without involving frequent tripping at starting or on normal overloads.

### Adjust the Time Lags.

Time lags should next be adjusted. If of the oil dash-pot type the setting will probably be made by fixing a screwed pin in numbered holes. Adjustment can also be made by altering the variety of oil with which they are filled. Fig. 10 shows the settings obtainable with one common type. Here again the setting will be settled by the time taken to start the largest motors on the circuit. Referring to this diagram, if the overload coil is set to trip at 50 per cent. overload, and the setting of the time lag is No. 9 (transformer oil used), a further 50 per cent. overload, making 150 per cent. plus 50 per cent. equals 225 per cent. normal load, will trip the switch after about four seconds.

### Examine Relays.

It is not likely that delicate relays will be used on industrial gear, but they may be installed possibly on the main switchboard. Examine carefully, see that any cords in relays of the weight-winding type are free, the trip switch or contacts operating properly, and if there are any mercury contacts, fill the cups with mercury. Instructions for any setting required will probably be given on a label or instruction plate under the cover.

### Wire the Fuses.

The various small instrument fuses should be wired before the board is dispatched by the makers. Power fuses may also be wired, but the gauge of wire should be checked with the requirements of the circuit. The following table gives approximate fusing currents of tinned copper wire when used in an ordinary porcelain-handle fuse.

### Approximate Fusing Current for Copper Wire.

When two or more wires are used in parallel they should not be twisted together, or the fusing current will be altered.

Fusing Current in Amps.	S.W.G. of Wire.
10	34
15	29
20	27
30	24
40	22
50	21
70	19
100	18

There are many forms of cartridge fuse in use which cannot be rewired with ordinary fuse wire and for which spare elements or complete cartridges must be carried. One handy way of keeping spares at hand is shown in Fig. 15.

### Insulation Tests.

After erecting any switchboard, and before making it alive, carry out the following tests with a Megger or similar instrument:—

(1) Close all isolating switches and oil

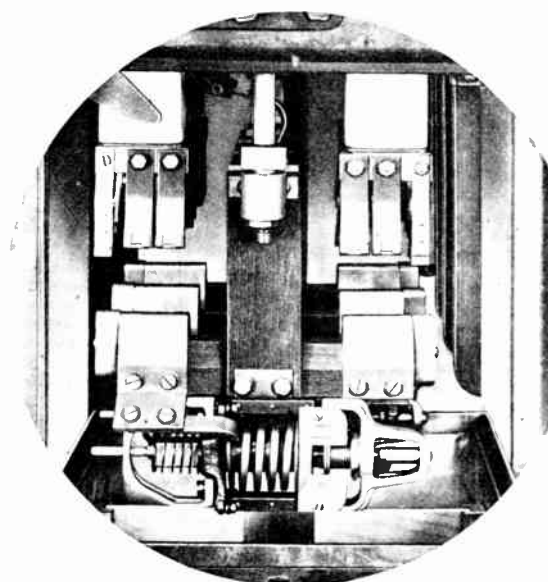

Fig. 9.—SERIES TRIPCOIL OF AN OIL CIRCUIT BREAKER, MOUNTED UNDER THE MOVING CROSSBAR.

Note the calibration plate. (Crompton Parkinson, Ltd.)

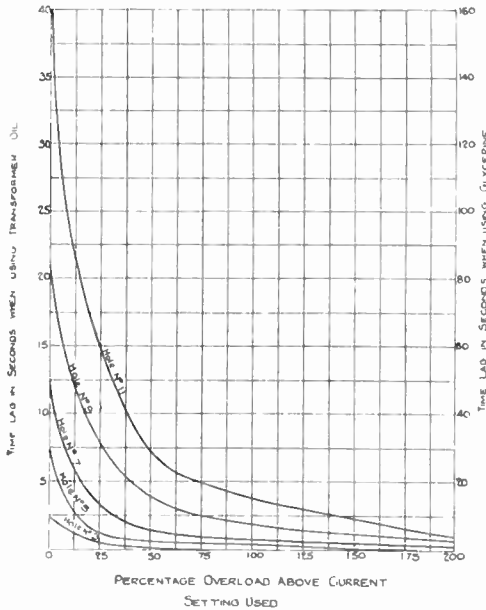

Fig. 10.— CALIBRATION CURVES FOR OIL DASH POT TIME LAGS. (Johnson & Phillips, Ltd.)

switches. Temporarily join the three busbars with a piece of bare copper wire. Connect the earth lead from the Megger to the framework of the board and the other to one of the busbars and test. This measures the insulation resistance of all bars together to earth. Then remove the wire joining the busbars and measure the resistance between pairs of busbars—A to B, A to C, B to C. These tests can be done in two measurements, as follows :

Connect the busbar A to earth and busbars B and C together and test between A and B. Then connect B to earth and A to C and again test between A and B. It will be seen that this checks the insulation between all busbars and earth, and between any two busbars.

All the above readings

should be 20 megohms or more, except perhaps for slate boards consisting of a large number of panels. If very low readings are obtained, open the isolating switches and check each panel in turn, when the cause of the low reading may be found. A general poor insulation may be caused by damp ; keeping the switch room dry and warm for a day or two will probably improve matters. Other possible causes of low readings, apart from short circuits, which should be easy to trace by careful visual examination, are : faulty insulating washers and bushes on knife switch or fuse stems, cracked or very dirty insulators, copper filings or metallic dust partly bridging insulation material, etc.

(2) Before testing secondary wiring to instruments, tripcoils, etc., first study the wiring diagram. It may be found that certain parts of the wiring are connected to earth, and these connections must be temporarily broken before the insulation resistance to earth can be measured. Such points include one terminal of the secondary windings of current and potential transformers, voltmeters reading phase to earth voltage, leakage indicators, etc. When all such earth connections have been removed, test the wiring on each panel in turn to the earth bar or switchboard framework. Make sure that the whole of the secondary wiring is included, if necessary making temporary connections between phases at convenient points such as the connection stems of instruments.

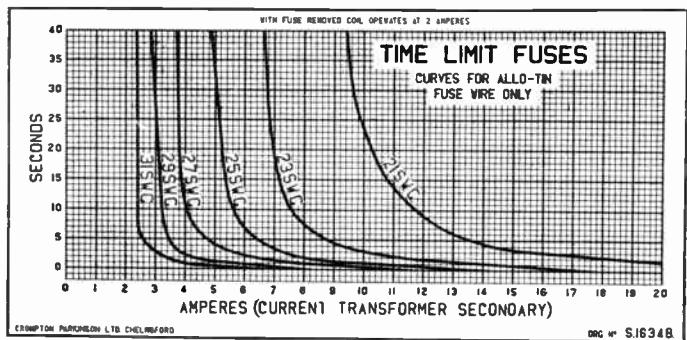
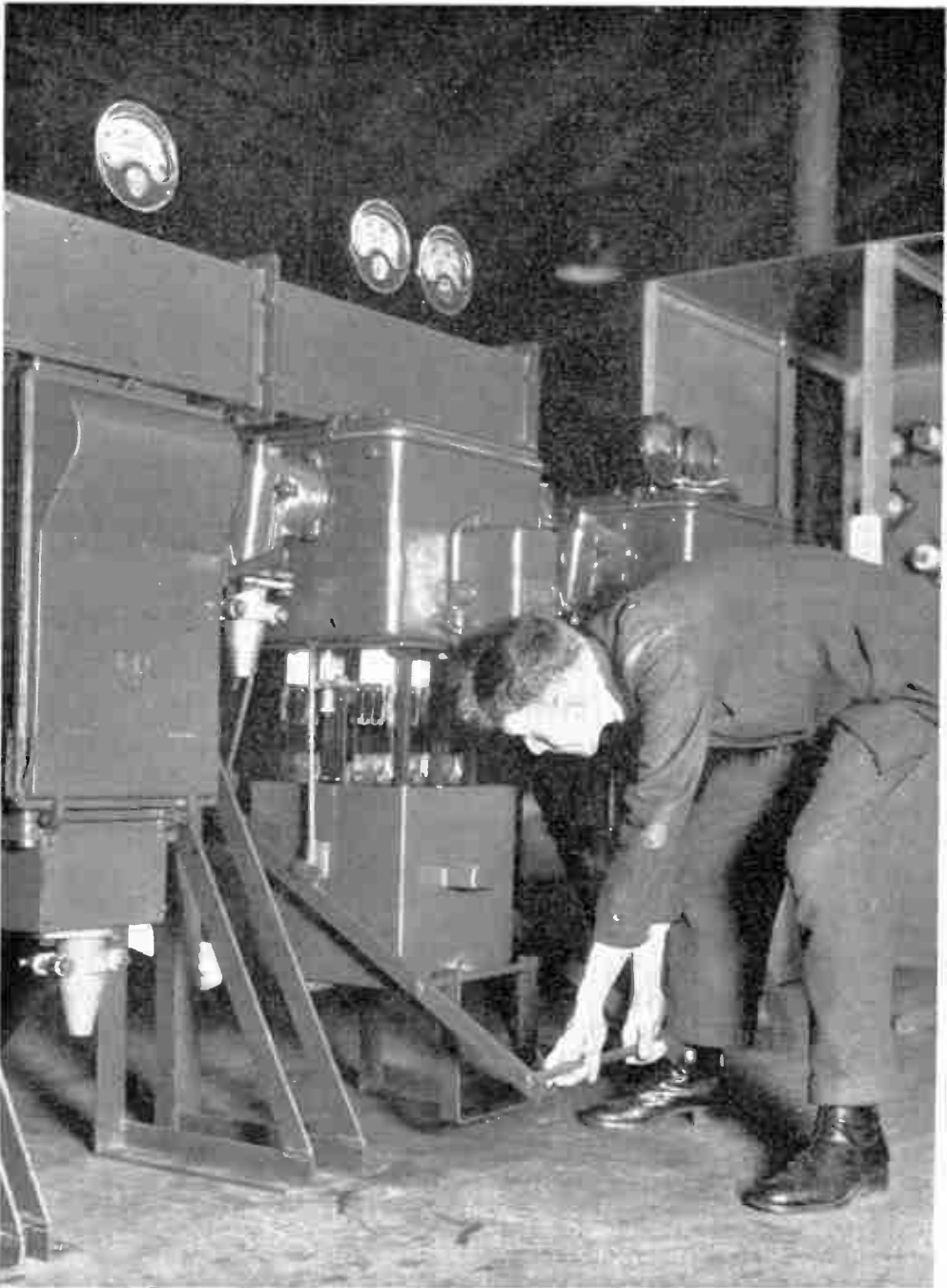

Fig. 11.— CALIBRATION CURVES FOR TIME LIMIT FUSES. (Crompton Parkinson, Ltd.)





*Fig. 12.—USING A TANK LOWERING LEVER. (Crompton Parkinson, Ltd.)*

If this is not available and the tank is heavy, lower the tank on a plank with the help of an assistant, resting one end on a box while one operator unfastens or fastens the tank bolts.

These precautions in regard to disconnecting earth connections apply to tests under (1) when the voltmeters, etc., are connected direct to the main circuit and are not operated through potential transformers.

It is difficult to quote an average figure for the insulation resistance of secondary wiring to earth. On a panel with a large number of instruments and a lot of wiring it may be as low as one or two megohms. If a short-circuit reading is obtained, first look for accidental shorts; if none is found, disconnect the wiring and test each instrument, tripcoil, etc., in turn until the trouble is found.

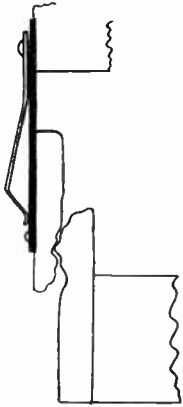

Fig. 13.—BADLY BURNT ARCING FINGERS. Showing "blobs" of molten metal likely to catch and prevent the breaker opening.

### Cubicle Type Switchboards.

Cubicles of the stationary type will be delivered as complete cubicles, only the busbars and possibly the instruments being dismantled.

Erection of the board on a level prepared floor (preferably concrete) should be carried out by lifting the cubicles into position side by side in the correct order and leveling by means of wedges until holes for the bolts securing adjacent cubicles coincide, then bolting up. It is hardly necessary to bolt boards of this type to the floor, but compensation may be made for any irregularities in the floor level by running fluid concrete round the foundation frame members, wood battens cut to suitable lengths being laid on the floor, spaced about  $\frac{1}{2}$  inch from the framework, to hold the concrete until it sets.

Busbars should be slipped into position from one end of the board, the end plate being detached for this purpose. Bolt up the busbars very securely, for once the board is alive it is unlikely that many opportunities will occur for examination of these connections.

Next mount the instruments, fill the switches with oil, attend to tripcoils, etc.,

as detailed for flat-back boards, and make an insulation test before putting the board into commission.

### Cover Cable Trenches.

With cubicle type boards, both fixed and truck type, the cables usually drop down into a trench which runs the length of the board. To prevent rats gaining access to the switch *via* this trench, it should be completely covered with  $\frac{1}{2}$ -inch sheet steel plates fitted with wood bushes accurately fitting the cables. Rats have caused many short circuits on switchboard terminals, particularly on high tension gear, and this precaution is well worth the time involved in making and cutting holes in the sheet steel plates. On some types of cubicle switchboards it will be found that screens are fitted to prevent rats getting from the trench to live gear; in such cases, of course, any extra trench coverings are unnecessary.

### Truck Type Cubicles.

The erection of the fixed portions or housings of truck type cubicles is very similar to that of stationary cubicles, but particular care must be taken not to distort the framework by careless handling or erection on an uneven floor, or it may be difficult to insert the truck carriages.

When the housings are erected, assemble the busbars by slipping them in from one end. If there is a passage-way behind the board, it may be convenient to remove the back sheets of the housings to facilitate bolting up the bars; but usually this can be managed by temporarily wedging open the shutters which cover the holes in the screen plates in front of the busbars, and putting a hand through these holes to get at the bolts.

The trucks should wheel into the housings easily. If much force has to be used, bad alignment may be suspected. This can probably be cured by loosening framework bolts and inserting wedges underneath until the truck will push into position.

To facilitate running the trucks in and out, it is a good plan to lay down on the floor runways of flat iron, about 2 or 3 inches wide, to form rails for the truck wheels.

When all trucks can be inserted, remove them to allow the cables to be connected, and while they are out go over the tripcoils, fill switch tanks, etc. Make an insulation test, before the end plate of the busbar chamber has been replaced, as already described. If it is desired to test the secondary wiring, this must be done for each truck in turn with the truck out.

### Ironclad Switchgear.

If the units are of the draw-out type, first remove the carriage portions, to facilitate handling. Next assemble the pedestal portions in the correct order, loosely bolt together and insert holding-down bolts, engaging the nuts, but leaving sufficient thread for tightening up later. Align the units accurately by means of wedges and tighten the various bolts which fasten the units together. Next run liquid concrete round the feet and into the holes in which the holding-down bolts have been inserted, if necessary covering any holes made in the floor for cables to prevent them being cemented up.

### Assembling the Busbars.

If possible, wait for the cement to set before proceeding with erection. The next step consists of assembling the busbars. To do this, remove the busbar chamber end plate and also the top covers, thread in the bars from one end, and bolt up securely.

### Making the Cable Connections.

Cable connections may now be made. If the board is erected against a wall, it may be convenient to mark off the cable to the length required, detach the cable boxes, and draw the cable forward between the two sides of the pedestal or feet so that the bonding of the lead sheath may be done in a less cramped position; after these operations the cable and cable box can be drawn back and the box bolted into position, one half of the box being left off until the lugs on the cable cores have been bolted to the connecting stems, which pass into the switchgear. The procedure is not possible with all designs, particularly those in which the cable cores have to be taken right through to the switch terminals.

### Test All Phases Together to Earth.

After the cables have been connected, make "megger" tests of the insulation of all phases together to earth, temporarily bridging the busbars with a piece of wire for this test, and from each phase

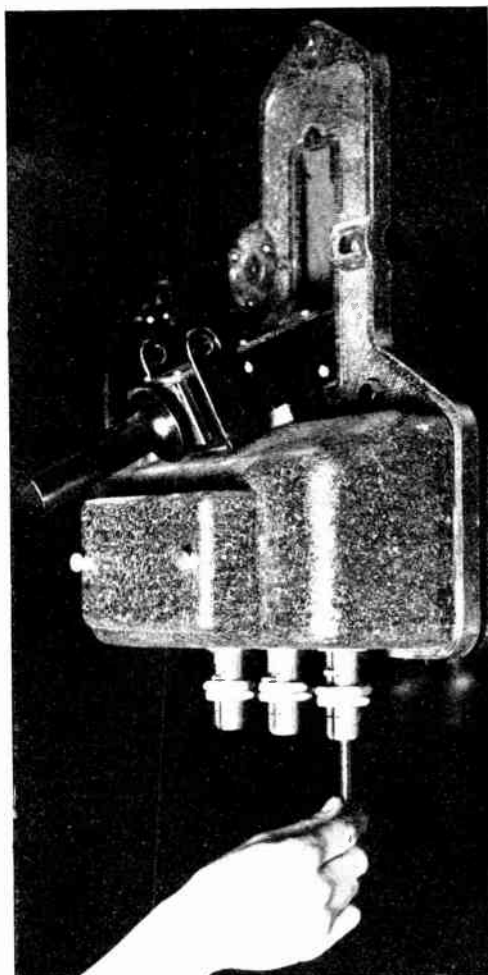

Fig. 14.—TESTING THE TRIPPING MECHANISM OF AN OIL CIRCUIT BREAKER.

This is done by lifting the tripcoil plungers.

to earth. If these tests are satisfactory—and they should show readings of 20 megohms to infinity—the cable boxes may be filled with compound, and also the busbar chambers in gear of the compound-filled type. Pouring in the compound should be done gradually, to

allow any imprisoned air to bubble to the top. The compound may be heated in any clean pail over a coke brazier or a gas ring if available, the pail being kept covered to exclude dirt. A proper com-

down bolts) finally tightened, the carriage portions of draw-out type gear lifted into position on the rails, and the gear is ready for commission after the setting of tripcoils, time-lags, etc.

## OPERATION & MAINTENANCE.

### Operation.

There are a few precautions in the routine operation of switchgear which are worth noting.

Operate all switches and circuit breakers smartly and cleanly, without hesitation and without undue force. Closing switches slowly and with hesitation leads to damage of contacts through sparking and may set up disturbances in the system resulting in damage to machine windings, particularly transformers.

Never open or close a circuit on load by means of a fuse or slow break knife switch if it can possibly be avoided, and never open or close an isolating switch unless the circuit breaker on the same circuit is open.

If a breaker trips repeatedly or a fuse blows on load, try to find the cause before setting the trips higher or using heavier fuses.

Watch ammeter readings, remember the full load of each circuit and investigate the cause of persistent or often-repeated overloads.

### Cleaning.

Before carrying out any cleaning or overhaul work make the apparatus dead, and take any precautions necessary to prevent any other person switching on while work is carried out. If such a possibility exists, as an added precaution fix temporary

earthing connections from the cable terminals to the earth bar.

An exception may be made in the case of surface cleaning of low tension flat-back boards, if the floor is dry and the cleaner uses one hand only for the work so that he cannot easily make

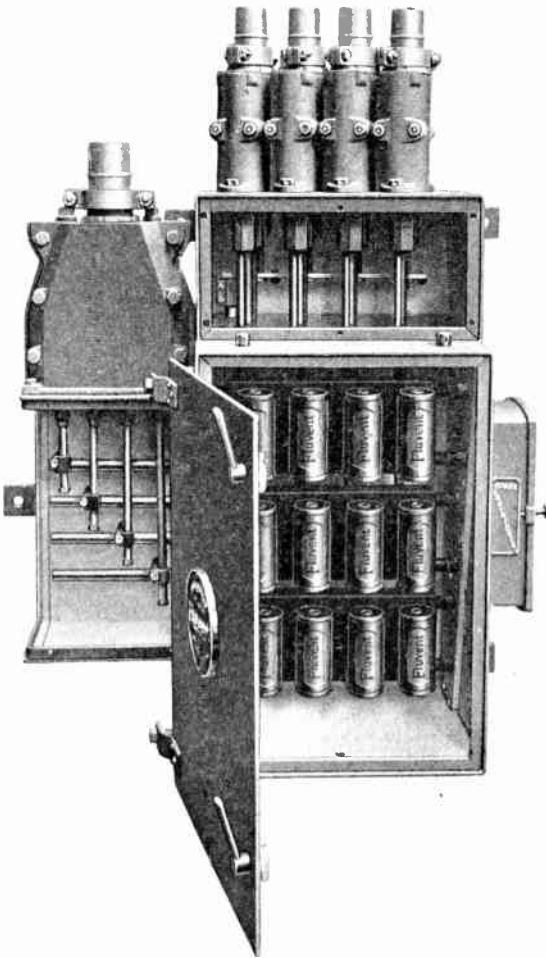

Fig. 15. WALL MOUNTING DISTRIBUTION BOARD WITH CABLE BOX FOR INCOMING FEEDER, CARTRIDGE TYPE FUSES AND CABLE BOXES FOR THE DISTRIBUTORS.

Note that on this board all interconnections are made in the factory, considerably facilitating erection. Note the box for spare fuses. (Parmiter, Hope and Sugden.)

pound bucket, with pouring spout, is preferable if one is to hand. The compound should be heated until it is sufficiently fluid to flow easily and should not be overheated.

The busbar chamber covers may now be replaced, all bolts (including holding-

contact across poles or phases.

Keep the surface of all switchgear clean by wiping regularly with clean waste *very* slightly moistened with paraffin (too much paraffin causes rust). All exposed insulators should be kept free from dust and damp, and the backs of flat-back boards should not be overlooked.

Occasionally go round with an oil-can and drop a spot or two of oil on all operating mechanism, link gear, slide rails of draw-out units, etc. If necessary, use a blower to get dust out of the operating mechanism of oil switches, or it may accumulate and prevent tripping on overload.

The sliding contact surfaces of knife switches and air-break circuit breakers may be cleaned occasionally with a clean rag and a trace of vaseline, which helps to secure low resistance contacts. The same applies to isolating plug contacts of draw-out type gear.

**MAINTENANCE.**

**Oil Circuit Breaker.**

The most important item of equipment is the oil circuit breaker. Regularly test the freedom of the operating mechanism, tripping if possible by lifting one of the tripcoil plungers by means of a pencil, as illustrated (Fig. 14). If the breaker is often called upon to open on overload, every few months (and as soon as possible after it has operated on any severe fault) drop the tank and examine the contacts (Fig. 3).

**Cleaning Arcing Fingers and Plates.**

The arcing fingers and plates should be smooth and free from pitting. Slight pitting may be cleaned up with a file; if the burning has been so severe that

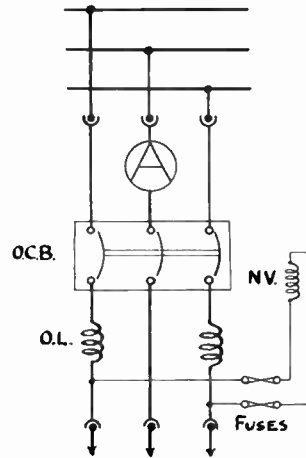

Fig. 16.—A SIMPLE DRAW-OUT TYPE UNIT.

Fitted with two series-operated overload tripcoils, an ammeter connected direct in the circuit and a no-volt coil connected on the load side of the switch and protected by fuses.

much metal has to be removed to secure a smooth surface, fit new fingers and plates. The arcing fingers should make circuit before, and break circuit after, the main contacts; if they do not, it is a sign that they have been badly burnt or distorted. Blobs of molten metal on the arcing contacts may catch and prevent the switch tripping (see Fig. 13).

If the arcing fingers are in good condition, the main contacts should need no attention. After a switch has been on full load for a few hours the tank should be comfortably warm; a higher temperature rise than, say, 30-40° C. measured at the hottest part is a sign of bad contacts unless the full load has been exceeded.

**Renewing Fuses.**

If the breaker trips on slight overloads, it may be that the time lags, if of the fuse type, need renewing. These fuses shunt the tripcoils so that normally the fuses carry the current. On overload the fuses blow after an interval of a few seconds, the current then passing through the tripcoils and tripping the switch. Even if they do not fuse owing to overload, the fuse wire of which they

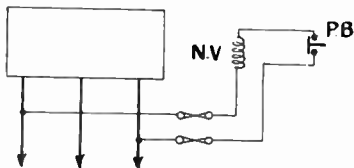

Fig. 17.—ARRANGEMENT FOR DISTANT PUSH-BUTTON TRIP (1).

Here the connection is taken from one of the tripcoil fuses through the distant push-button and back to the no-volt tripcoil.

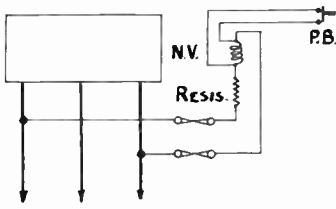

Fig. 18.—ARRANGEMENT FOR DISTANT PUSH-BUTTON TRIP (2).

Here the push-button is of the normal type and short-circuits the coil when the push-button is operated.

are composed may deteriorate in time and fuse at less than their rated current. If the fuses have not been changed during the year, it is a good plan to renew them annually if of the rewirable type; the sealed type fuses should not require renewal. All fuse type time lags are used in conjunction with current transformer operated tripcoils, normal full load in the main circuit corresponding to 5 amps. in the tripcoil circuit.

**Examine the Oil.**

The condition of the oil in the tank should be examined. If dirty and sludged, due to repeated operation of the breaker on load or high operating temperatures, it should be renewed, using proper switch or transformer oil.

The other parts of switchgear needing attention call only for straightforward mechanical examination. Occasionally go over all nuts, particularly on switch and breaker terminals, and tighten when necessary. Contact surfaces such as those on isolating plugs and sockets may be

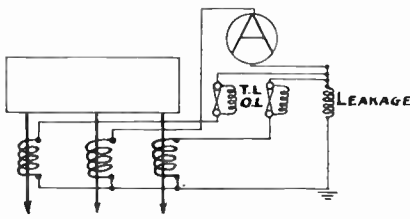

Fig. 20.—CONNECTIONS FOR OVERLOAD AND LEAKAGE PROTECTION.

examined; usually the state of the contacts can be judged from the appearance of the metal, which will be lighter in colour than ordinary copper which has not been in rubbing contact with another copper surface. In conjunction with no-volt and some other tripcoils there may be a small auxiliary switch mounted near or on the oil switch, and the contacts of this should be examined and cleaned and adjusted if necessary; often the contacts are not too substantial and the spring fingers soon take a permanent set.

**When to Renew Tube of Asbestos in Power Fuses.**

Power fuses of the porcelain handle

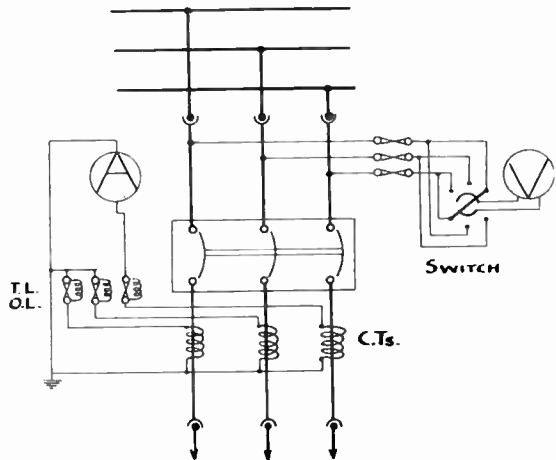

Fig. 19.—OPERATING THREE TRIPCOILS FROM THE SECONDARIES OF CURRENT TRANSFORMERS.

These transformers are arranged so that full load in the primary corresponds to 5 amps. in the secondary.

type usually have a tube of asbestos or similar material which encloses the fuse wire.

This may be damaged when the fuse blows on a heavy overload and should be renewed when necessary. If fuses are badly damaged or shattered by a short circuit, it is clear that they are unsuitable for the large amount of power to be broken, and should be replaced by an oil switch unit.

When overhauling switchgear, the insulation resistance should be measured in the manner already described.



### Checking Connections of Meter.

It is usually known what the approximate power factor of a load may be. An industrial motor load, for instance, will be something between .6 lag and unity. With this as a basis, the connections of the type of meter most often used may be checked as shown in Fig. 21.

Disconnect the voltage leads. With not less than half full load in the current transformers the pointer should rotate in a clockwise direction; if it rotates in the opposite direction interchange the right and middle current connections (as viewed from the back).

Reconnect voltage leads. If the pointer indicates on the wrong half of the scale, i.e., motoring instead of generating, reverse the potential leads.

If the above tests fail to give correct indications and the instrument transformer polarities are correct and the wiring made to diagram, the fault will probably be found to be due to non-standard phase rotation.

### Use of Potential Transformer.

On high tension circuits all potential coils of instruments, no-volt coils, etc., will be operated from the secondary of potential transformers. The primary of a potential transformer is connected to the main circuit through H.T. fuses. Connections from the secondary side are taken through L.T. fuses and the terminals are then regarded for the purpose of instrument connections as the phases of the main circuit. The neutral point of three-phase instrument transformers, or one pole of a single-phase transformer, is earthed. The normal pressure on the secondary side is 110 volts between phases (see Fig. 22). Inaccurate reading of potential instruments on H.T. circuits may be due to a blown H.T. fuse, but this is almost invariably caused by a fault in the potential transformer.

### Medium Power Control Gear.

The installation of smaller control apparatus for individual machines is dealt with in a later article.

## MAGNETIC SUBSTANCES

A SUBSTANCE is described as magnetic when it is possible to magnetise it, either permanently or temporarily, by means of a permanent magnet or magnetic field due to a coil passing an electric current.

Iron is not the only magnetic substance. Most alloys containing iron are magnetic to varying degrees. Certain alloys of iron with small percentages of silicon and aluminium exhibit stronger magnetic properties than ordinary wrought iron. That is to say, they are more permeable. This type of alloy is used for transformer cores and armatures of dynamos and motors.

There is one particular steel alloy containing 13 per cent. of manganese which is almost non-magnetic. This is a useful alloy where it is necessary to use a material of the strength and hardness of steel which must not become magnetic when situated

in a magnetic field. For example, the steel between the poles of a magnetic chuck of a surface grinder must be non-magnetic, or the poles of the magnet would be short-circuited.

Cobalt and nickel are magnetic, but to a lesser degree than iron. Cobalt is better than nickel; neither of them, however, is sufficiently magnetic to be of any commercial importance as an element. Iron loses its magnetic properties at a red heat, but cobalt does not. Cobalt and iron alloyed together produce a steel which is most suitable for permanent magnets.

Lodestone is a magnetic mineral, which, from its occurrence at Magnesia in Asia Minor, the magnet gets its name. It is, however, only feebly magnetic and is of no use as a permanent magnet. A substance, chemically similar, is produced as a black scale when iron is heated in the air.



# ELECTRICAL GRAMOPHONE PICK-UPS

## WITH NOTES ON OPERATION AND MAINTENANCE

By A. E. WATKINS

**P**RACTICALLY all electrical pick-ups of the present day operate on the differential armature principle. Earlier pick-ups were similar to a reed loud-speaker and there was also the electrostatic pick-up. The two latter types, however, have completely disappeared, as they were not satisfactory.

### How the Pick-up Works.

The principle of the modern pick-up is clearly shown in Fig. 3. It consists of a magnet with two pole pieces. An armature, which is usually surrounded by a coil of wire, vibrates between these two pole pieces. As the record causes the needle to oscillate from one side to the other, the flux is changed in the armature, first in one direction and then in the other. This change of flux in the armature produces an electric current in the coil, and as the coil is connected between the grid and the filament of the valve these currents are duly amplified.

### Rubber Dampers.

To prevent the armature oscillating too freely and also to damp out any vibration,

rubber dampers are attached to the top of the armature and usually at the pivot: these dampers also restore the armature to its central position and it is most important that when the armature is in its neutral position it should be exactly midway between the pole pieces so that an equal movement either side of the zero line will give a proportional movement at the armature, thereby transmitting the same amount of flux in either direction so that the amplitude is equal.

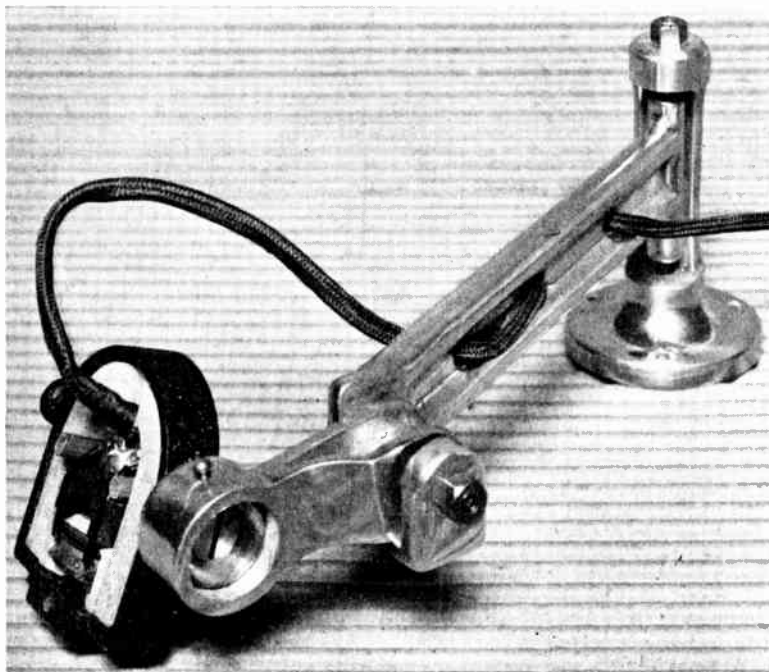

*Fig. 1*—WATMEL UNIVERSAL PICK-UP CARRIER ARM.

This is adaptable to all types of pick-ups with side fittings. Holes are drilled through the arm to carry the flex. The pick-up is shown on the reverse side of the arm for clearness to show the small rocking arm for carrying the pick-up. In practice the pick-up should be fitted to the reverse side.

### Correct Weight of Armature.

The weight of the armature is very important and it should be as light as possible, for should the armature be heavy, a fall of response will occur at the higher frequency, but if made too light and thin resonance will be very noticeable. Stiffness and lightness are the essential points. Also, the screw for clamping the needle must be light otherwise this will load the armature.

give a clear response, attention should be paid to the rubber dampings and adjustments made. In many pick-ups arrangements are made for adjustments, but in some of the cheaper and simpler types adjusters are not fitted. Therefore it is necessary in these cases to replace the dampers with new rubbers.

Another very common fault is that the screw for holding the needle sometimes touches the side of the case, due, to some

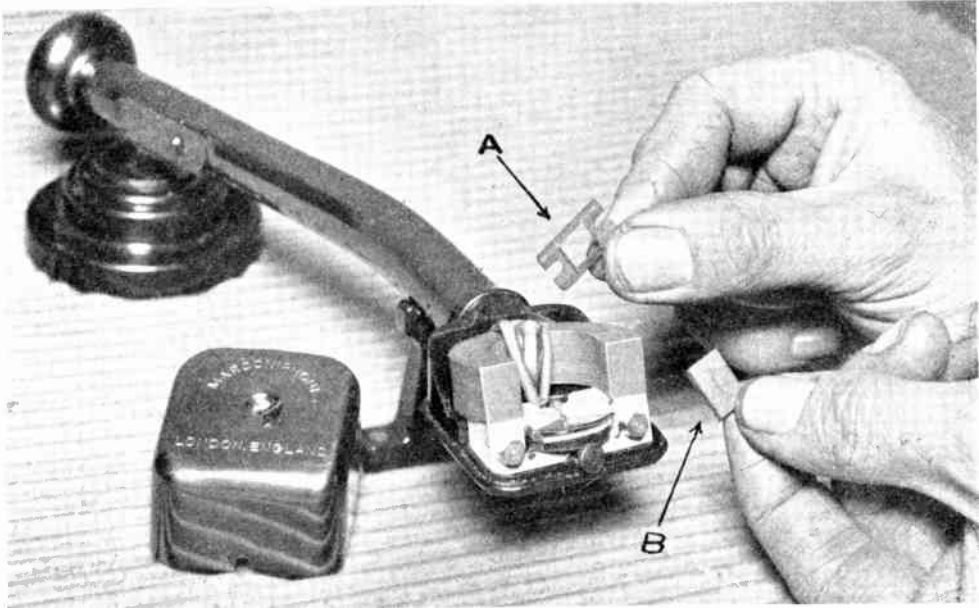

Fig. 2.—MARCONI PICK-UP TYPE 17.

The rubber damper "B" is a slit which engages in the pick-up of the armature. This damper is held in position by the metal holder "A" which must be adjusted so that the armature is in the centre.

The sizes of the armature, pole pieces and coils can only be determined from experimental work. It is practically impossible to design these parts on paper. It is, therefore, only a question of research and experimental work.

### When the Rubber Perishes.

One of the causes of failure in pick-ups is due often to the rubber dampers perishing, but as yet rubber is the only material found to be satisfactory for the purpose, and after it has become hard it very often settles in such a position so as to allow the armature to become out of centre. Therefore if a pick-up fails to

extent, to being badly fitted at the thread.

It is very rare for the windings to break down, but what often happens is that the lead which usually travels along the carrier arm becomes broken at the point where there is continual movement, particularly if there is little flex left when the pick-up is fitted. If when testing a pick-up there is an open circuit, attention should first be given to the lead.

### The Volume Control.

It is essential with every pick-up to include a volume control. This consists of a resistance placed directly across the

*The first time  
at a popular price*

# THE IMMORTAL GILBERT & SULLIVAN OPERAS

**10<sup>1</sup>/<sub>2</sub>**  
WORTH OF  
COPYRIGHT  
MUSIC  
for **1/3**

BY A SPECIAL ARRANGEMENT OUR NATIONAL OPERAS ARE NOW TO BE PUBLISHED IN A NEW AND CONVENIENT FORM WHICH BRINGS THESE FAVOURITE WORKS WITHIN THE REACH OF EVERY LOVER OF GILBERT & SULLIVAN



"THE IMMORTAL GILBERT & SULLIVAN OPERAS" is to be published by arrangement with Chappell & Co., Ltd. and J. B. Cramer & Co., Ltd. Each part will contain the story of the Opera, and Words and Music of the most famous numbers from these delightful creators of Gilbert and Sullivan. To be completed in about 24 fortnightly parts.

## ORDER TO-DAY

On Sale at all Newsagents, Music Dealers and Bookstalls, or Post free 1/43 each part from George Neveus, Ltd., 8-11, Southampton St., Strand, London, W.C. 2.

**PART ONE NOW ON SALE**

Geo. Neveus, Ltd.

This article on Electrical Gramophone Pick-ups will be continued in Part 19. Ready February 19th.

# THE BEST PRACTICAL ADVICE ON—

## CARPENTRY AND CABINET - MAKING

An Illustrated Handbook for the Amateur,  
with numerous Drawings and Designs.  
By W. M. OAKWOOD.

Cloth. Price 1s. 6d., post free 1s. 9d.

This handbook contains a description of the tools most generally used, with instructions how to use them—The choice of woods for various purposes—Fretwork as applied to cabinet-making—A chapter on french polishing, staining and varnishing.

## WOOD CARVING

A Practical Guide for the Home Student.  
By J. H. GARNETT.

With numerous Illustrations and Designs.  
Cloth. Price 1s. 6d., post free 1s. 9d.

Contains—in addition to full instruction on the practice of the Art of Wood-Carving—Chapters on Choice of Wood, Tools, Designs, Appliances, etc.; Chip or Notch Carving, Staining, Polishing, Gilding, Painting, etc.

## METAL WORK

By GEORGE DAY, F.R.M.S.  
Cloth. Price 1s. 6d., post free 1s. 9d.

A Practical Handbook for the Amateur Worker in Iron, Brass, Zinc, Copper, etc. With numerous Illustrations and Designs.

Some of the 16 Chapters are—Tools required for Metal-work—General Methods of Copying the Pattern, drawing and transferring—General Methods of Working—To Etch on Metals—Fretworking in Metals—Useful Recipes for Metals and Metal Workers, etc., etc.

## BASKET MAKING AT HOME

By MARY WHITE.  
With many Diagrams.  
Paper Wrapper.  
Price 1s. 6d., net; post free 1s. 9d.

The Contents include:—Raffia and some of its uses—Weaving a Small Basket—Covered Basket—Basket with Handles—Some Work Baskets—Sweet Baskets—Waste Paper Baskets—Dolls' Furniture—Caning in a Frame or on a Chair, etc., etc.

## PHOTOGRAPHY FOR BEGINNERS

By GEORGE BELL.

Illustrated.

Cloth. Price 2s. net, post free 2s. 4d.

CONTENTS.—How a Photograph is made—How a Camera works—Exposures—Dark Room—Developing—Printing out—Indoor Photography—Outdoor Photography—Home Portraiture—Enlargements, etc., etc.

## THE STARS NIGHT

## BY NIGHT

A Popular Guide to the Constellations

By JOSEPH H. ELGIE,  
M.B.A.S.

With over 100 Diagrams by Author.

Limp Cloth. Price 1s. 6d., post free 1s. 9d.

On sale at all booksellers, or may be had for post free prices direct from The Book Publisher, PEARSON'S Book Dept., 18, Henrietta Street, London, W.C.2.

## HALF-HOURS WITH THE MICROSCOPE

A Popular Guide to the use of the Microscope.

By Edwin Lankester, M.D.  
Cloth. Price 2s., post free 2s. 4d.

CONTENTS.—The Structure of the Microscope—In the Garden—At the Pond Side—At the Sea Side—Indoors—etc.

## ASTROLOGY

How to Read your Fortune in the Stars

By "Sagittarian."  
Cloth. Price 1s. 6d., post free 1s. 9d.

The Contents include:—The Zodiac and Nature of Planetary Aspects—The Houses, their character and purpose—Nature of the Signs—The Horoscope and how to read it—Popular Examples—etc., etc.