

To be Completed in about 32 weekly parts.

NEWNES PRACTICAL ELECTRICAL ENGINEERING

DEALING WITH

ALL PRACTICAL APPLICATIONS OF ELECTRICITY IN EVERYDAY LIFE.

INTENDED FOR

ELECTRIC LIGHTING
and
POWER ENGINEERS.

ELECTRICIANS AND
WIREMEN.

WIRELESS DEALERS.

STUDENTS,
APPRENTICES AND
IMPROVERS IN ALL
BRANCHES OF
THE ELECTRICAL AND
WIRELESS INDUSTRIES.

1/-

PART
11

A PRACTICAL WORK WRITTEN BY EXPERTS

STUDY
AT
HOME

YOU CAN HAVE A COLLEGE
TRAINING IN ALMOST ANY
CAREER FOR A FEW
SHILLINGS MONTHLY

IN
YOUR
SPARE
TIME

FOUNDED 1900.

31 YEARS OF SUCCESS.

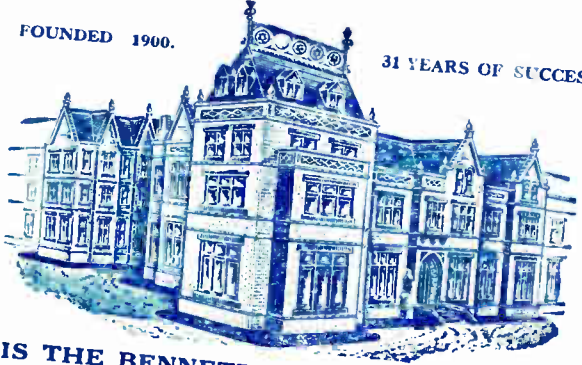

THIS IS THE BENNETT COLLEGE - - ALL OF IT
The Bennett College is not a Rented Room in a well-known street—it is a College. Over 50 years ago the Founder took as his motto what has now become a household slogan:

LET ME BE YOUR FATHER

In many trades and professions there are more vacancies than trained men to fill them. We do not profess to act as an employment agency, but our gigantic organisation certainly does tell us where the demand exists, thus enabling us to give **FATHERLY ADVICE ON ALL CAREERS AND THE POSSIBILITY OF EMPLOYMENT, FREE.**



J.H. Bennett

WE TEACH ALL
BRANCHES OF
THE FOLLOW-
ING VOCATIONS
AND SPECIALISE
IN ALL EXAM-
INATIONS CON-
NECTED THERE-
WITH.

THE MOST SUCCESSFUL AND MOST PROGRESSIVE CORRESPONDENCE COLLEGE IN THE WORLD

Aviation Engineering.
Boiler Engineering.
Boiler Making.
B.Sc. (Engineering).
Civil Engineering :
A.M.I.C.E.
Quantities—Specifications.
Commercial Art

Concrete and Steel.
Draughtsmanship :
Electrical or
Mechanical.
Electrical Engineering :
A.M.I.E.E.
City and Guilds.
Engineering Mathematics.
Foundry Work.
Heat Engines.

Heating, Ventilating and
Lighting.
Internal Combustion Engines.
Machine Designs :
Theory of Machines.
Marine Engineering :
Motor.
Steam.
Mechanical Engineering :
A.M.Inst.B.E.
A.M.I.Mech.E.
City and Guilds.
Pattern Making.

Mechanics.
Metallurgy of Steel.
Mine Electrician :
A.M.E.E.
Mining (all examinations).
Motor Engineering :
A.M.I.A.E.
Municipal and County
Engineers :
M. and C.E.
Naval Architecture.
Pumps and Pumping
Machinery.
Ship Building.
Structural Engineering.
Telegraphy and
Telephony.

Also ask for Our New Book
(FREE OF CHARGE)

IF YOU DO NOT SEE YOUR OWN REQUIREMENTS ABOVE, WRITE TO US ON ANY SUBJECT.
IT COSTS NOTHING TO ENQUIRE.

THE HUMAN MACHINE SECRETS OF SUCCESS

WE TEACH BY POST IN ALL PARTS OF THE WORLD

Note Address Carefully :
The BENNETT COLLEGE, Ltd., Dept. 119, Sheffield



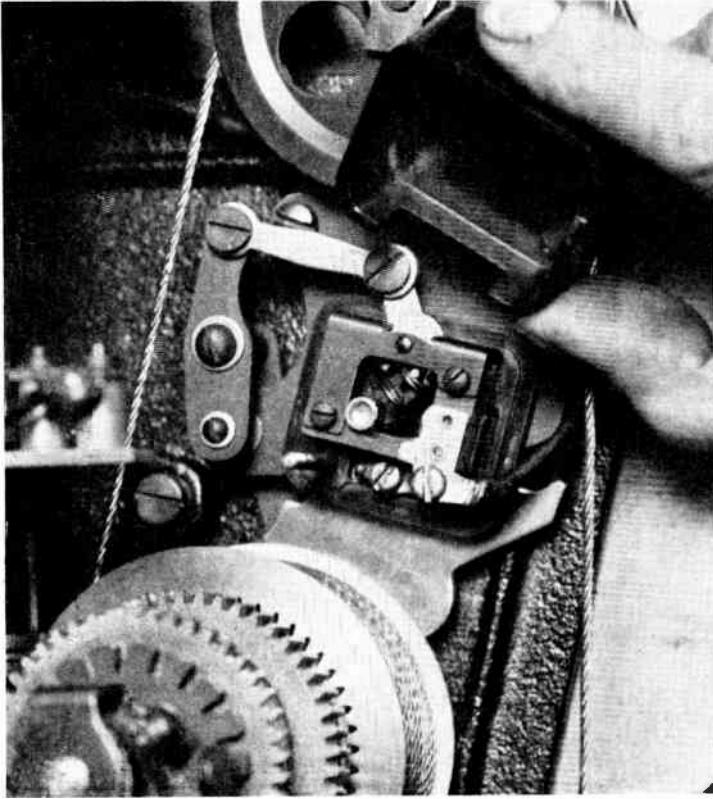

Fig 13.—SWITCH CONTROLLING THE MOTOR ON THE INTERNATIONAL MOTOR-WOUND MASTER CLOCK (SUPERVISED SYSTEM).

Showing how the cover can be removed for inspection of the switch.

The breaking of the electrical contact on the master clock—with consequent cessation of the energising current—allows the pawl to be pushed forward by the tension springs, and in this operation the ratchet wheel is pushed forward a distance of one tooth, i.e., one half-minute. A backstop prevents reverse rotation of ratchet wheel.

There is no winding, and the battery current consumption is only 0.4 of an ampere for one-fifth second, every half-minute, so that the total current consumption is negligible, and there is practically no attention required, beyond the watching of the battery after two years' use, when obsolescence will reduce the voltage.

Erection and Maintenance.

It is quite a simple matter for any intelligent electrical engineer to do this work, after careful reading of printed instructions sent out with the clocks.

Once the installation is completed and the pendulum regulated the three main points to attend to are as follows:—

(1) Check the indicated time and correct it with "Greenwich"; this can be done in a few seconds and should be necessary at intervals of four or five weeks only. Any correction is made by adjustment of the ratchet wheel in the master clock, all the secondary dials responding automatically.

It is important never to interfere with the pendulum adjustment once this has been regulated.

(2) (a) Set all clocks back to "Greenwich" time at the expiration of "summer" time by stopping the master pendulum for one hour.

(b) Set all clocks forward to "summer" time by means of the accelerator in the master-clock case, an operation that takes four minutes.

(3) Battery. Two years after a dry battery is first installed it needs strengthening. Connect up to this battery about ten per cent. additional cells; this will maintain the current for a further six to nine months, after which the battery will have to be replaced by a new one, at nominal cost.

Accuracy.

The master clock, under suitable con-

A

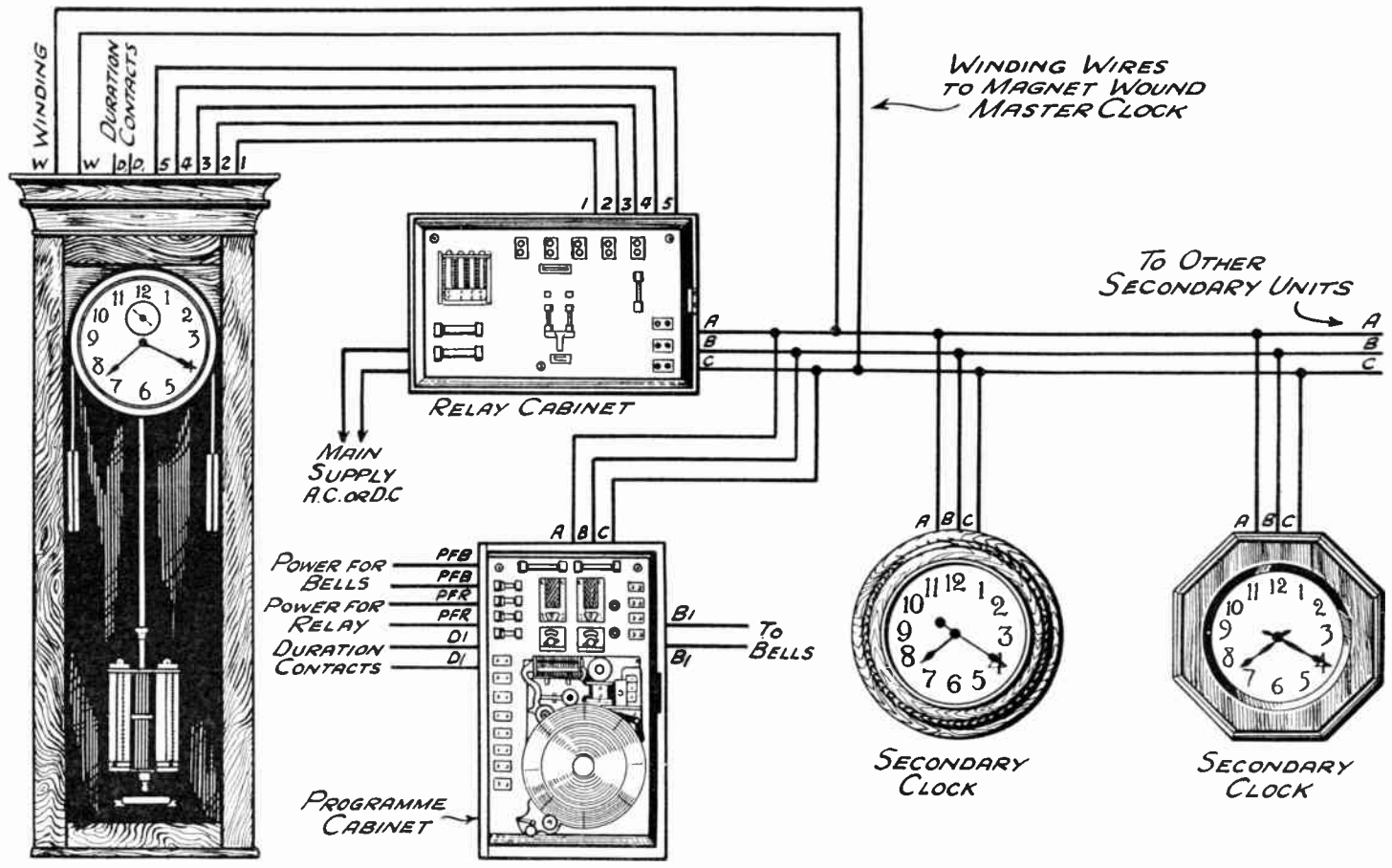

Fig. 14.—WIRING OF INTERNATIONAL FULLY AUTOMATIC SUPERVISED ELECTRIC CLOCK SYSTEM. Each unit must have its terminals connected to the corresponding terminals of another unit. No joints are permissible.

ditions of freedom from vibration and reasonably constant temperature, etc., can be regulated to a commercial error not exceeding one second per week from Greenwich mean time. This error is not necessarily cumulative and is for all practical purposes dead accurate time-keeping. If desired, a time signal attachment, operated direct from Greenwich, can be additionally fitted, but, for general purposes, this is quite unnecessary.

This system is very suitable for outside public clocks, avoiding winding and weight falls. A good example of this is the new *Daily Telegraph* clock, 19 feet overall in height, which with 120 clocks within the building is operated from a "seconds" pendulum master clock.

THE PUL-SYN-ETIC ELECTRIC CLOCK SYSTEM.

The simplicity of the transmitter mechanism of the Pul-syn-etic system is shown in Fig. 9, and this mechanism is described with reference to the named parts and operates as follows:—

The pendulum crutch beats with the pendulum, which is of "seconds beat." It is kept in vibration by the pivoted gravity lever, which is supported normally on the stirrup catch. In vibrating, a driving pawl rotates the scape wheel tooth by tooth, and, normally, the point of the driving pawl passes through the stirrup shown. The scape wheel has teeth corresponding with 15 double swings of this pendulum. Every half-minute the driving pawl engages a tooth deeper than the rest of this wheel, enabling the point of the driving pawl to rise and charge into the upper part of the stirrup (instead of passing through it). This action releases the gravity lever. The roller drops on to the impulse pallet, and on running down the inclined face, imparts to the pendulum an impulse which maintains it in vibration. In descending, the contact piece of the gravity lever meets the contact piece of the armature and, therefore, the gravity impulse to the pendulum is terminated.

How the Clock Hands are Advanced.

The circuit (including the impulse clocks) and the electrical source is now completed, the electro-magnet is energised

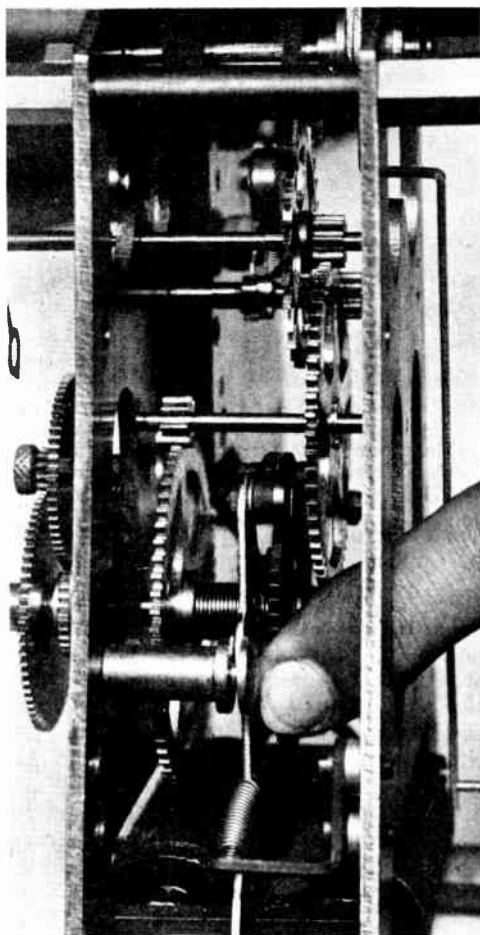

Fig. 15.—GIVING INITIAL WINDING BY HAND TO INTERNATIONAL MAGNET-WOUND MASTER CLOCK.

A slight downward pressure of the finger on the wheel turns it and this winds up the main spring. This master clock has a reserve of one to two hours.

and the armature, while being attracted, replaces the gravity lever. Meanwhile, all the electro-magnets fitted to the impulse clocks have been energised, and all clock hands are advanced a half-minute.

The pendulum of the transmitter will probably be found to be fitted with a rod of special steel known as "Sinevar," which has practically no coefficient of expansion and, therefore, temperature errors are reduced to the minimum.

Dirty oil should occasionally be wiped away from the wheels and a little good

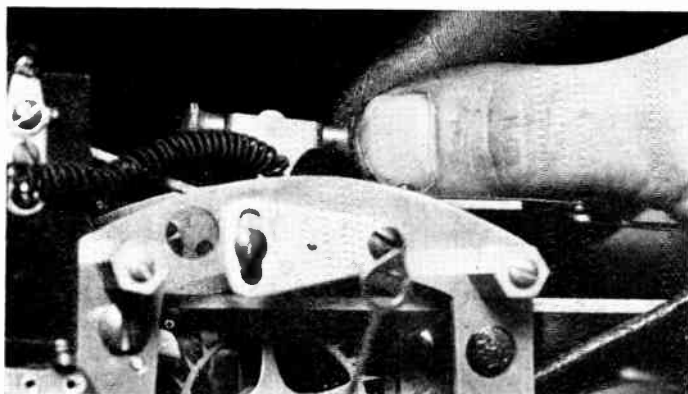

Fig. 16—HOW TO SET THE INTERNATIONAL MASTER CLOCK (SUPERVISED SYSTEM) ACCURATELY IN BEAT.

The screw indicator is turned to left or right until the clock is in beat. When once accurately carried out no further adjustment is needed.

clock oil or good typewriter oil should be applied.

How Insufficient Current is Indicated.

With such a transmitter, when working normally, the gravity lever is lifted instantly the contact pieces meet and while the pendulum is yet swinging to the left. If the gravity lever remains down until the pendulum (and consequently the impulse pallet) returns to the right and assists it, this assisting action is a positive indication that the current flowing through the circuit is insufficient and must be augmented.

What the Impulse Movement Does.

The function of an impulse movement is to advance the hands one tooth only at each electrical impulse. Therefore, adjust the motion of the driving pawl and back-stop pawl so that this mechanical action takes place. Give that clearance to the adjustments to ensure definite and reliable operation.

The electro-magnet must

operate as close to the armature as possible in order to obtain maximum efficiency. When the adjustments are properly set, the armature facing should just touch the magnet at the same time as the top end of the driving lever touches the top spring.

The necessary electric energy taken by the Pul-syn-etic electric clock circuit is 0.22 ampere for approximately one-twentieth second at every half-minute.

Automatic Sounding of Signals.

The automatic sounding of signals may be effected by means of an adjustable contact maker. This instrument is driven in half-minute steps by including same in the time circuit. Upon inserting pins in appropriate holes in the large 24-hour dial, any programme of times can be made by it in 5-minute positions throughout the 24 hours. Signals may be automatically cut out at week-ends by fitting to the instrument a 7-day wheel and cut-out contact.

Syrens, hooters and bells are sometimes fitted in various sizes and with varying carrying powers.

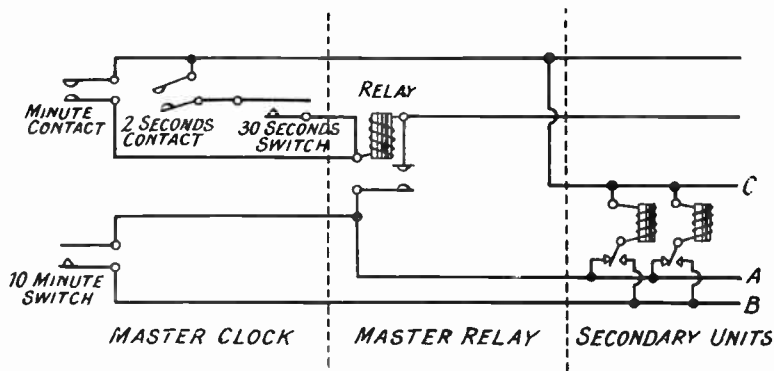

Fig. 16A.—WIRING AND CONNECTIONS INSIDE MASTER CLOCK, MASTER RELAY AND SECONDARY UNITS. (International Time Recording Co.)

The "Waiting Train" Turret Clock.

An interesting development is the "waiting train" turret clock, the movement of which is shown in Fig 11.

It is constructed specially for driving the exposed hands of large clocks. It will be understood that the hands of such clocks are exposed to the full force of the weather, and unless a powerful driving force is applied to the hands, the clock would be liable to be stopped, or the time-keeping seriously interfered with. With the "waiting train" movement, however, the mechanism automatically adjusts the driving force to suit weather conditions.

Working of the "Waiting Train" Movement.

This movement contains an electrically driven pendulum (termed a motor pendulum), the function of which is not to keep time, but to drive a ratchet wheel, the ratchet wheel, in turn, by means of worm gearing, driving the hands of the clock. The motor pendulum is re-energised by an electro-magnet when its oscillations fall below a predetermined arc. Under normal working conditions re-energisation takes place about once per minute, but on heavy work being thrown on to the movement, due to resistance and wind pressure on the hands, the motor pendulum becomes energised more often. On being energised at each complete vibration, it then develops, say, 30 times its normal power, which result is not given by any other clock mechanism.

By it the minute hand is driven through a half-minute space on the dial in approximately 27 seconds. The pawl of the motor pendulum is then automatically lifted out of engagement so that, although the motor pendulum maintains its action, the hands remain stationary for two or three seconds, locked by the worm gear. A current impulse from the transmitter, dead on the half-minute, releases the pawl, and the hands are driven forward for another half-minute on the dial. As a rest of two to three seconds is inappreciable, the hands appear to move with absolutely regular progression.

Current Supply for the Motor Pendulum.

The electrical connections are shown in Fig. 11. The control is connected in the impulse time circuit, and the motor pendulum is kept oscillating by a separate battery, or by the supply mains.

If trickle charged accumulators are used and the relay of turret clock also in the circuit and the accumulator voltage is high enough, the pendulum motor of the turret clock can be operated by the same battery, a resistance being used if voltage is too high.

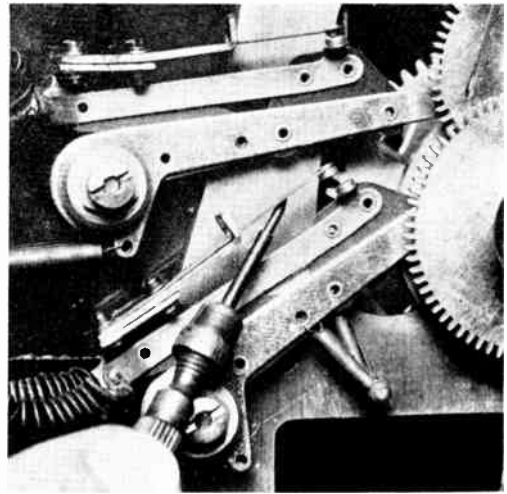

Fig. 17.—INSPECTING THE CONTACTS OF THE INTERNATIONAL MOTOR-WOUND MASTER CLOCK. The impulse contact does not deal with the current required for the whole system, but is connected with the coil of a relay, with the result that these contacts break a circuit in which flows but a few milliamps.

Time-keeping by the master clock renders an accuracy on even the largest turret clocks of a second or so per week easily obtainable. The most striking feature of the "waiting train" movement is the entire absence of the heavy weights so necessary for the propulsion of mechanical turret clocks.

INTERNATIONAL FULLY AUTOMATIC SUPERVISED ELECTRIC TIME SYSTEM.

The International Supervised system of electric time indicating, recording and

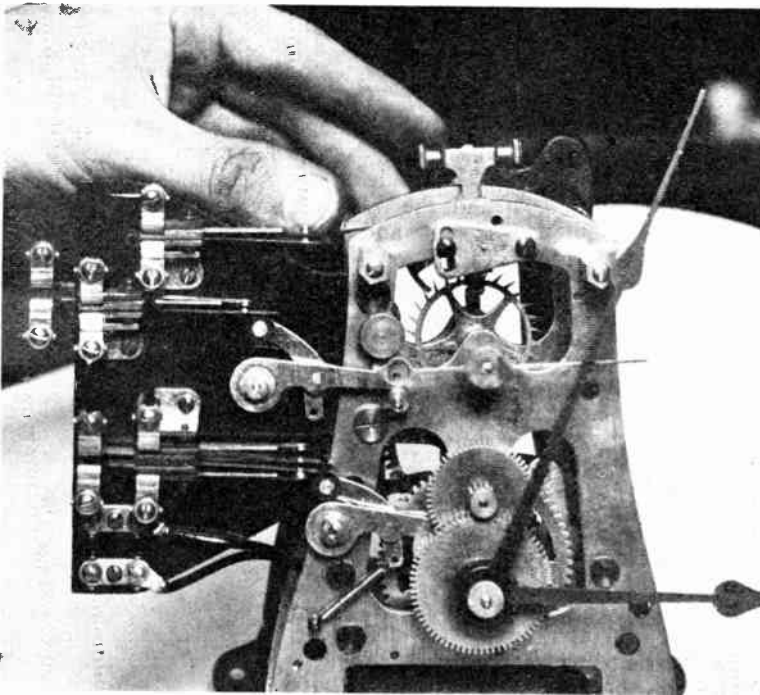

Fig. 18.—SECTION OF MECHANISM OF INTERNATIONAL MAGNET-WOUND MASTER CLOCK.

The thumb indicates the position of the contacts (to the left of clock movement) in connection with hourly supervising device.

signalling, possesses many features that are distinctive and, in many ways, radical departures from previously accepted standard practice in this branch of electrical engineering.

The master clock in this system is not only a transmitter of impulses to other clocks in the system, but is a supervisor and controller. Previous to the introduction of the International supervising principle, electric time systems possessed no means by which each secondary could automatically compare itself with the master clock, and there was no automatic method of correction.

It implies no criticism of any electric clock system when it has to be admitted that secondary units are liable at times to get out of step. Weak impulses, dust, volt-drop, local disturbances of units, are only a few of the possible causes of such errors. Added to these are possible interruptions of current supply, whether de-

rived from mains or batteries. As the chief function of electric clock installations is to give uniform time always, it is essential to have some means of supervision, and in the International system this is secured automatically.

The Master Clock.

Fig. 14 shows the wiring of the International motor-wound master clock system. Regularly each minute the master clock releases an electric impulse to the secondaries, but in addition each hour the master clock checks the

delivery of exactly sixty impulses an hour to each unit it controls and *supervises* the perfect agreement. The clock is double-weight driven, with a total of eight days' operating power, or seven days' reserve over its daily winding cycle. Once a day the weights are rewound to their initial position by a small 1/70th h.p. General Electric Company's motor connected through an enclosed reduction gear to the winding drums. The drums are themselves geared to a mechanical limit switch of the double-break type, which throws the motor on the regular lighting or power current, after a day's unwinding, and off at the fully wound position.

The movement has a Graham dead-beat escapement with an extremely accurately-cut verge, hardened pallets and a micrometer adjustment for balancing time beats. With a mercurial compensating pendulum, true time to within ten seconds a month can be secured.

Automatic Supervision: How It is Effected.

All secondary units are connected up with three wires instead of two. One "common return" (c) and two "operating" wires (a) and (b). Each secondary unit is provided with a selector switch which, once an hour, automatically connects the coil of the driving magnet to the proper one of the two "operating" wires, which transmit the corrective action, if necessary, to the secondary. Such corrective action is supplied by the master clock and its relays. One of the "operating" wires speeds up the secondary units that may be slow, and the other holds up the ones that may be fast—once each hour during the time correction is available.

The Selector is so arranged that the secondary clock magnet is shifted from one operating wire to the other only between impulses so that the Selector contacts will never spark. The master clock is fitted with an ingenious but surprisingly simple system of contacts, which, once each hour, cuts out impulses on the (b) "operating" wire causing it to hold up any fast secondary units that are ahead of the master clock, until the master clock reaches the hour point, when they are allowed to proceed as usual. It also, between the 59th and 60th minute of each hour, steps up by a series of impulses (two seconds apart) sent through the (a) "operating" wire, any secondary units that are behind the master clock providing a maximum of 15 minutes each hour. At the hour point all units in the system

must show correct time and move forward together.

Wiring in Parallel.

As will have been noted from the preceding paragraph, in the International system the usual series method of connecting electric clocks, is replaced by a parallel system of distribution. One advantage of this is the elimination of the possible failure of one clock becoming the cause of

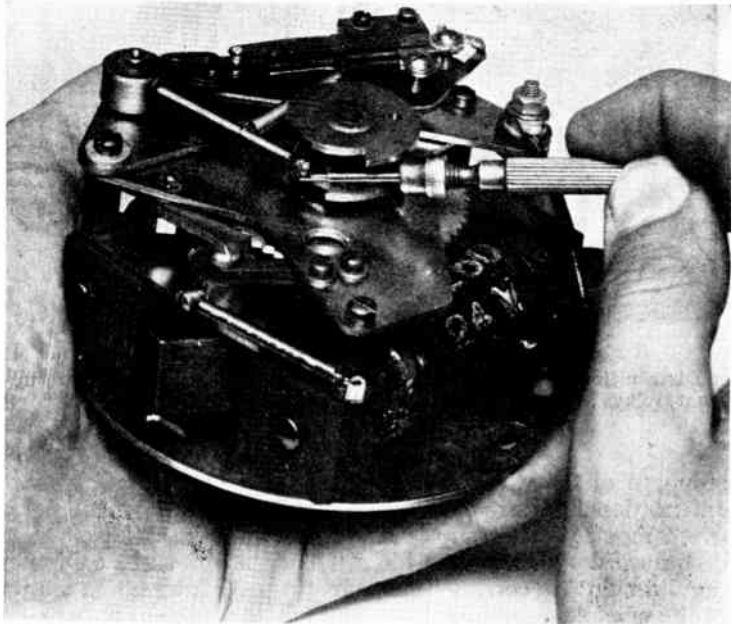

Fig. 19.—SECONDARY CLOCK MOVEMENT. (*International Fully Automatic Supervised Electric Time System.*)

The screwdriver indicates the position of cams, rocker and hourly supervising switch. The rotor, oscillating between the pole pieces of a magnet, is shown to the lower left of the movement. When the mechanism is fixed to the clock dial, the rotor is at the top.

the stoppage of the whole system. Another great advantage of this method of distribution lies in the fact that it is possible to connect various pieces of apparatus such as time recorders, time stamps, programme devices, which may vary in their individual current consumption.

The International is an "all mains" system.

The serious objection to connecting electric clocks to the service mains that has hitherto prevailed, is the fact that an interruption of the current would cause a

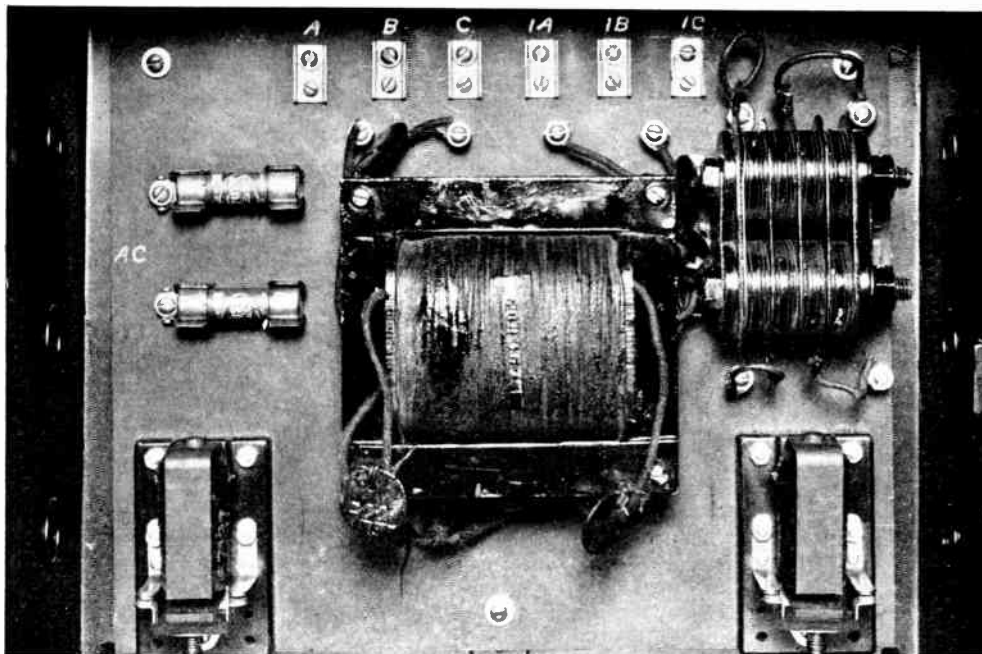

Fig. 20.—A.C. DISTRIBUTION BOARD. (*International Supervised Time System.*)

Distribution boards are required to distribute the load on large installations. Bottom left and right, relays; centre, transformer; top right, rectifier.

stoppage of the whole system, but in the International self-supervising type this is overcome by the supervising devices described, by means of which all units are brought to correct time on return of the current.

Secondary Clocks.

In the secondary clocks the usual ratchet and pawl mechanism is replaced by a device consisting of a rotor, oscillating between the pole pieces of a magnet, resulting in that much appreciated boon, a silent secondary clock. (See Fig. 19.)

Time Recording and Time Signalling.

The International Time Recording Company has specialised in the equipment of factories, works, offices, institutions and commercial houses, although the merits of the supervising principle is extending their electric clock system to every type of building. The mechanism in time-recording machines

and similar devices obviously requires much more power than wall clocks, and the satisfactory electrical direct operation of such equipment is a feature of the International system.

The mechanism in an electric time-recording machine is shown in Fig. 22. Fig. 23 shows a programme cabinet, which is a machine for controlling time schedules for signalling—ringing bells, blowing whistles, etc. This type of programme cabinet is specially suitable for schools where the schedule of time varies from day to day.

The merits of the parallel system of wiring in connection with these units has been referred to above, and the construction in general of the International master clock and secondary units, is designed to meet all possible demands. The duration of the impulse contact is adjustable, making it possible to allow sufficient time to overcome the reluctance and inertia of moving armatures in mechanisms, such as those mentioned above, that possess

large magnets. The impulse contact does not deal with the current required for the whole system, but is connected with the coil of a relay, with the result that these contacts break a circuit in which flows but a few milliamps. This method ensures long life to the impulse contacts; the full load relay current being dealt with by the relay contact which may carry as much as five amps. When the system requires more than that quantity, auxiliary relays can be installed. (See Figs. 17 and 18.)

Installation and Maintenance.

The installation of this system presents little difficulty. A blue print is supplied by the manufacturers in which all connections are shown and numbered. These numbers correspond with numbered terminals on each unit rendering it possible for the average electrician to carry out a successful installation.

The wiring is usually VIR in

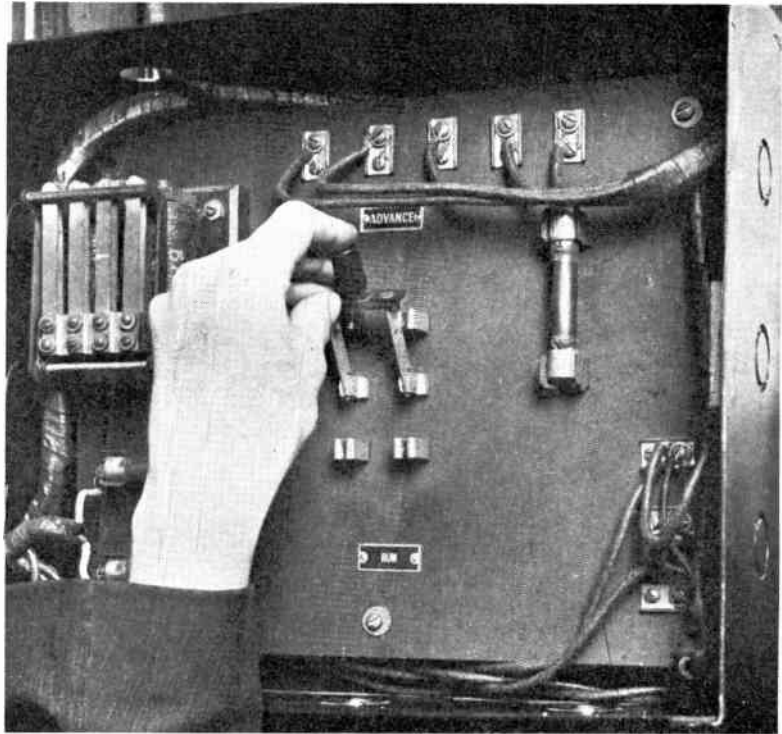

Fig. 21.—HOW TO ADVANCE THE SECONDARY CLOCKS BY HAND FROM THE INTERNATIONAL MASTER RELAY.

This stepping-up lever is only used as a rule on installation of the system and when it is necessary to advance from winter to summer time. The normal place for the lever shown is the downward position

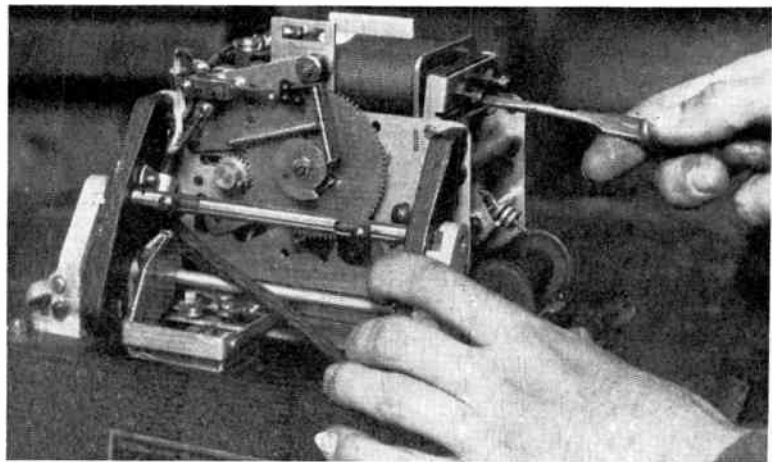

Fig. 22.—ADJUSTING THE AIR GAP OF INTERNATIONAL TIME RECORDING MACHINE.

The air gap for the armature can be reduced, or widened, as required by turning screw indicated to right or left respectively.

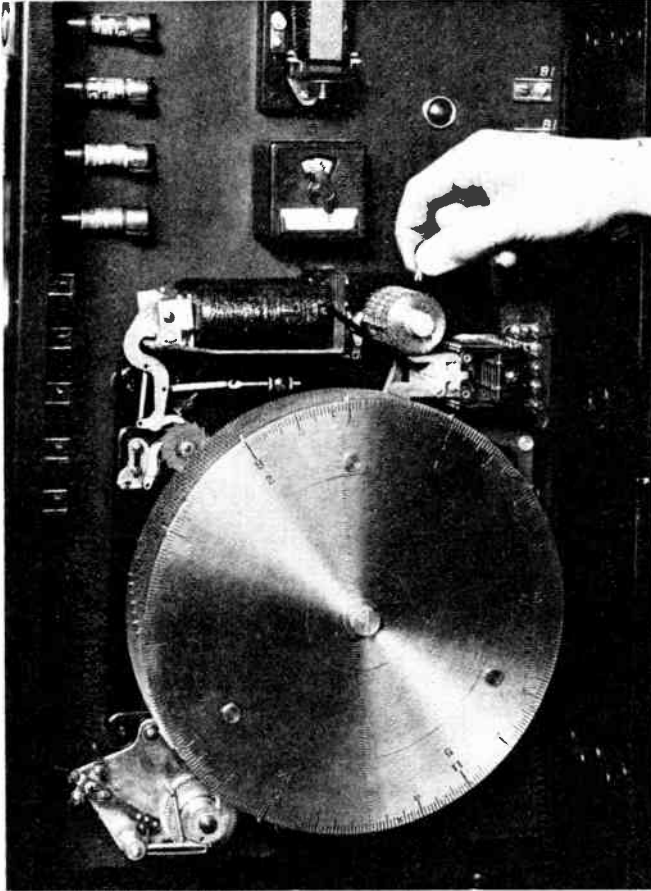

Fig. 23.—PROGRAMME CABINET FOR CONTROLLING TIME SCHEDULES FOR SIGNALLING. (*International Supervised System.*)

The large drum is made up of a series of brass discs with slots at interval spaces of one minute each. Metal pins are inserted into these slots according to the programme schedules. Each disc governs six hours of time. The insertion of metal pins into the series of smaller discs decides the day on which signals are to be obtained. The pins are placed in position by hand and then gently tapped in.

conduit, or CTS and the International Company will always give full wiring specification for an actual installation to any electrical contractor without cost.

Fig. 16A illustrates the wiring and connections in master clock, master relay and secondary units.

Maintenance costs are reduced to a minimum. The only contacts that break a "live" circuit are the impulse contacts and those in the relay. The description that has already been given of these contacts is sufficient to indicate that little

trouble can be anticipated from this source.

The ample power of the master clock, the certainty of a plentiful current supply owing to the elimination of batteries, coupled with the supervising feature, the simplicity of which renders it practically unfailing, leave little that need be done under the heading of maintenance excepting an occasional oiling, and cleaning of contacts.

MAGNETA BATTERY-DRIVEN MASTER CLOCK.

This master clock is driven by a specially designed cell of the Latimer Clark type enclosed in the master-clock case, and this cell should have a life of approximately three years. The clock is a very accurate time-keeper, being fitted with mechanical and magnetic adjustment. The magnetic adjustment is an important feature in that it allows regulation of the pendulum without manual interference therewith. Normally it should not be necessary to regulate the pendulum by means of raising or lowering the bob. The magnetic adjustment covers an error of up to 12 seconds. If the error is in excess of this figure it is

necessary to obtain the approximate regulation by raising or lowering the bob. This bob is scaled on the under side, and movement over one division represents a gain or loss of two seconds per 24 hours. The scale for magnetic regulation covers an error of 12 seconds and each division represents a gain or loss of one second per 24 hours.

The pendulum receives an electrical impulse from the Latimer Clark cell every second through the solenoid coil. This ensures a constant amplitude on the

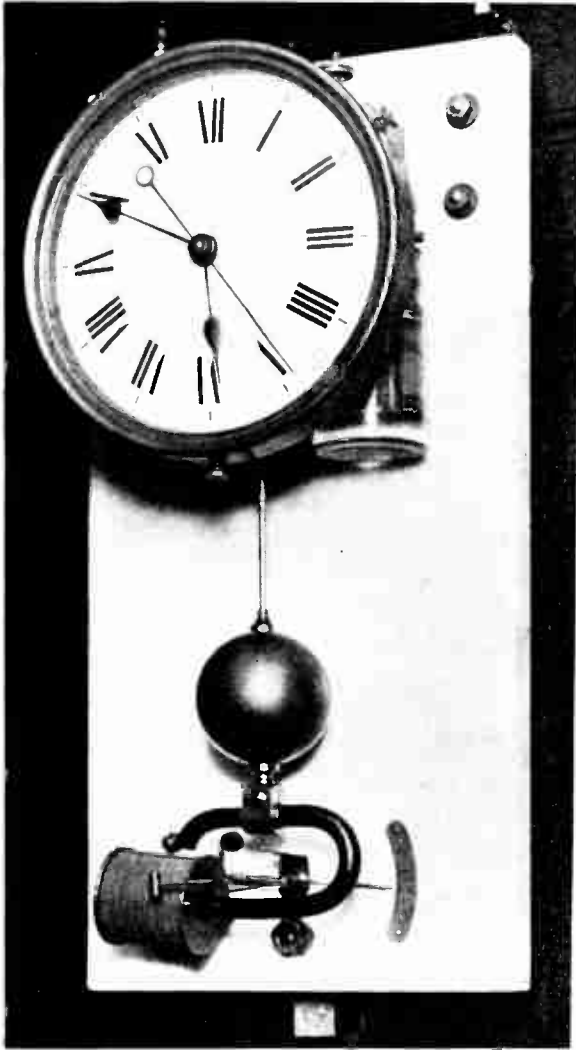

Fig. 24.—MAGNETA BATTERY-DRIVEN ELECTRIC CLOCK SYSTEM.

pendulum, as the output of the cell is constant.

The current required to do this is in the neighbourhood of 2 milliamps., consequently the demand on the cell is particularly small.

The master clock transmits reversing impulses each minute or half-minute as may be required for the operation of the polarised secondary clock movements. As in the case of the Magneta non-battery master clock, a centre seconds hand is

provided. This is mechanically driven by the pendulum, and shows pendulum time as distinct from circuit time.

MAGNETA NON-BATTERY MASTER CLOCK.

This system differs fundamentally from all other systems in that no outside source of current is resorted to, consequently there are no maintenance expenses. The Magneta master clock is a particularly accurate time-keeper, the full seconds pendulum being of Invar steel and therefore not affected by changes in temperature. The Magneta master clock incorporates a Graham dead beat escapement, and the pendulum is mechanically maintained by a remontoir spring, which has sufficient power to maintain the pendulum for approximately 30 minutes. This spring is, however, rewound each minute, which results in the arc of the pendulum being kept at a constant amplitude. The pendulum has no additional work.

The current required to actuate the various secondary clocks is generated by the master clock itself, and transmitted precisely at the sixtieth second of each minute, these impulses are always of precisely equal strength and duration. Every minute the weight falls a fraction of an inch, and by so doing turns the armature of the inductor in a strong magnetic field and generates an

electric current, which passes through the whole circuit and propels simultaneously the minute hand of every secondary clock in the circuit.

The secondary clocks are of a polarised type. There is consequently no gravity or spring replacement of the armature, which is magnetically locked between impulses.

The master clock has a centre seconds hand mechanically driven, thereby providing pendulum time as distinct from circuit time.

ELECTRICITY AS A CURATIVE AGENT

DIATHERMY AND CAUTERY APPARATUS.

By E. M. SUTTON.



DIATHERMY APPARATUS FOR MEDICAL AND SURGICAL WORK.

Fig. 1.—Top left: Adjustable spark gap. Front left: Main regulator. Front right: Voltage regulator.

FOR certain diseases it is advisable to apply heat to the body in order to help Nature to restore her balance. There are, of course, many ways of applying heat to the body externally, but all these methods suffer from the disadvantage that most of this heat is dissipated before it reaches the real source of the trouble. It is a well-known electrical law that when current is passed through a conductor it generates heat in that conductor. The degree of this heat depends upon the resistance of the conductor and the amount of current. A continuous current, or an alternating current of low

frequency, when passed through the human body produces not only heat, but an electrolytic effect. The latter can prove fatal if the current is sufficiently strong. In any case these currents would have a very irritating effect upon the patient.

Why High Frequency Current is Used.

For these reasons currents of very high frequency are used for application to the human body, the frequency being about one million per second. These high frequency currents have no electrolytic action and the patient experiences no electrical sensation whatever. Currents

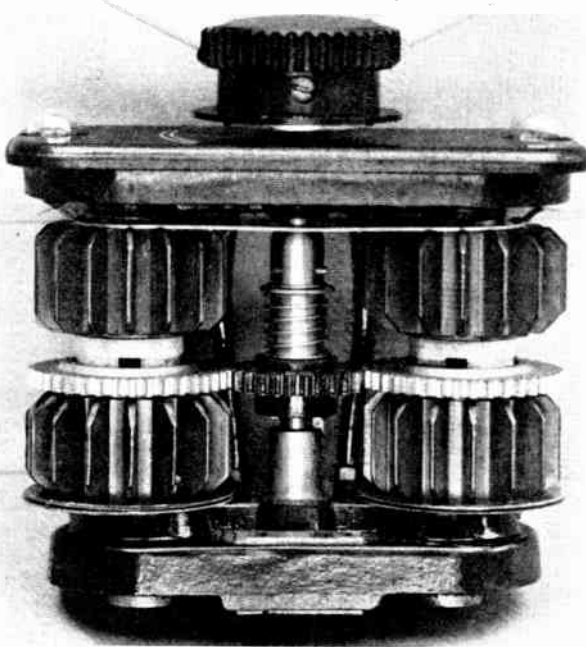

Fig. 2.—ADJUSTABLE SPARK GAP READY FOR INSERTION IN APPARATUS.

When the current sparks across the gap, each spark gives rise to an oscillation.

up to 5 or 6 amperes may then be passed through parts of the body, thus generating the desired heat in the tissues themselves.

The Electric Knife.

This high frequency current can also be utilised for surgical work. In this case one of the electrodes to be connected to the patient takes the form of a blunt knife. This has the effect of localising the heat round the electrode and this heat is then sufficient to coagulate the tissues, thus causing destruction. A perfectly clean aseptic incision can be made in this way, with the minimum loss of blood.

HOW THE DIATHERMY CURRENT IS PRODUCED.

The diathermy current is produced as follows :—An alternating current is fed to the primary of a step-up transformer.

The secondary current of this feeds an oscillatory circuit consisting of inductance, condenser and spark gap. This circuit has to be very carefully designed, as the efficient working of the apparatus depends, to a very large extent, upon the proper electrical balancing of these units. When the current sparks across the gap, each spark gives rise to an oscillation. These oscillations occur in the form of waves of gradually reduced amplitude. The number of sparks per second must be such that no electrical, or faradic, sensation is felt by the patient. To effect this it is necessary for the spark gap to have a good extinguishing effect. In the older types of diathermy apparatus this was done by using coal gas, or some other inert gas, as a dielectric. In modern apparatus, however, it is effected by the use of an efficient cooling device on the spark gap and by careful design of the transformer. As the spark gap is connected directly across the secondary terminals of the transformer, it will be seen that when a spark occurs the transformer is practically short-circuited. At this moment the voltage of the transformer must show a very quick fall, otherwise the spark would be maintained in the form of an arc.

The number of sparks per second must not be confused with the frequency of the oscillations: the latter is decided by the electrical values of the condenser and inductance.

A second oscillatory circuit is inductively coupled to the first: this is the patients' circuit. In this circuit are the regulating resistances and a hot wire ammeter.

A very important point in connection with diathermy apparatus, or with electro-medical apparatus generally, is that the patients' circuit is entirely "earth free." That is to say, the secondary of the transformer is well insulated from the primary, and again the patient's circuit is insulated from the first oscillatory

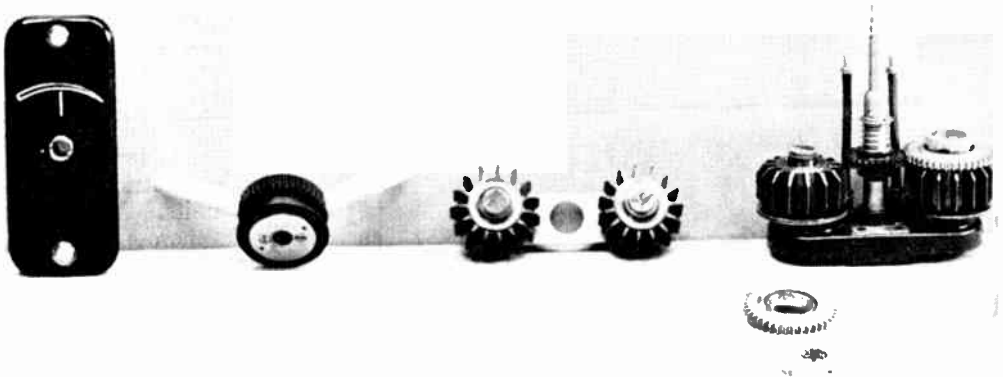

Fig. 3.—SPARK GAP DISSEMBLED.
Note the cooling ribs.

circuit. It is therefore impossible for the patient to become accidentally connected with the main supply.

CONNECTING UP AND WORKING A DIATHERMY APPARATUS.

The apparatus has to be connected to an alternating current supply.

If Only D.C. Supply is Available.

If only direct current mains are available a rotary converter will have to be installed. This should be from 1 to 3 kilowatt capacity depending upon the size of the diathermy apparatus. The apparatus can then be connected to the two slip rings of the converter. The metal frame of the diathermy apparatus should be connected to a good earth. A three-pin plug is provided for this purpose, the centre pin being the earth connection.

Before Switching On.

Before switching on the current care should be taken to see that all regulators are in their weakest positions. The safest way to test the output of one of these apparatus is to connect the patients' terminals to a lamp resistance, giving a total of about 40 ohms resistance. It must always be remembered that a spark from a diathermy current is able to produce a burn on the skin which may prove very intractable. It is for this reason that tests should first of all be carried out by means of an electrical resistance.

How to Test.

When all connections have been made the current may be switched on and the regulators gradually moved towards the "strong" position. The meter should now register the current. The strength of the current, of course, depends upon the external resistance and



Fig. 4.—PLACING SPARK GAP IN POSITION.

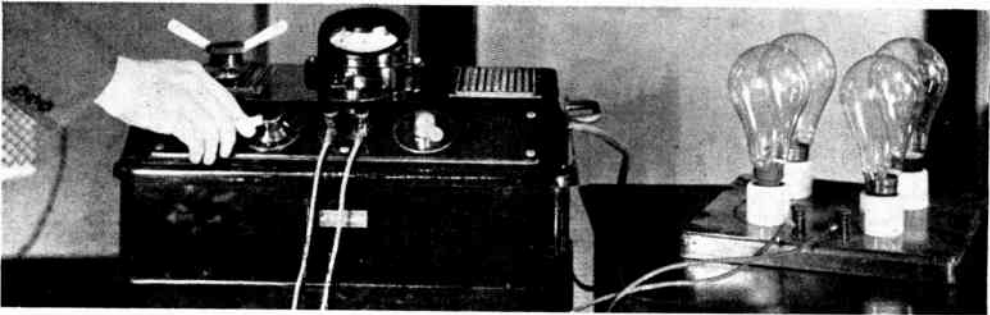

Fig. 5.—TESTING DIATHERMY APPARATUS WITH LAMP RESISTANCE.

This is the best test and should be carried out with a resistance of the same value as that usually met with in ordinary practice; that is, between 40 and 60 ohms.

the capacity of the apparatus. Here it should be noted that the best test for the efficiency of any diathermy apparatus should be carried out with a resistance of the same value as that usually met with in ordinary practice; that is, between 40 and 60 ohms.

A very easy, but a very inaccurate, way of testing the efficiency of one of these apparatus is for the electrodes to be held in either hand. This places the maximum possible resistance in the circuit and such a resistance seldom occurs under actual working conditions. This method can, in fact, be very misleading, as a badly designed diathermy apparatus may show a greater current under these conditions than a more efficient instrument. If the same apparatus were tested under the proper conditions, it would be found that the drop in output would be so great, with the lower resistance values, that the heating effect would be seriously affected.

“Hand-to-Hand” Test.

A useful purpose can be served by the “hand-to-hand” test, however, and that is in order to find out if any electrical sensation is experienced by the patient. If a “faradic” effect is felt, it generally shows that the spark gap is adjusted wrongly. The sparking surfaces should then be brought closer together and the tests repeated. If a spasmodic “shock” is felt, it

points to there being a faulty contact in the patient's circuit. The most probable place for this to occur is in the flexible cables leading to the patient's electrodes. These should be carefully examined and tested separately for any break or fraying of the conductors. Another point to examine for faulty contact is the sliding contact in the resistances in the patient's circuit. These can easily be adjusted and cleaned, after taking off the base or side panel of the apparatus.

Special Adjustments for Surgical Operations

Some types of diathermy apparatus have an additional voltage regulation in the primary circuit of the transformer. This is especially useful in making adjustments of the output voltage in surgical operations. Two or three studs are connected to different tappings on the primary of the step-up transformer. Thus more or less windings are brought into circuit as required.

Using the Ammeter on Multiple Circuits.

Another variation is to be found in a diathermy apparatus which is fitted with two, three or four patients' circuits. These each have a separate regulating resistance. In this case the ammeter is fitted with a change-over switch which enables it to be switched into any one

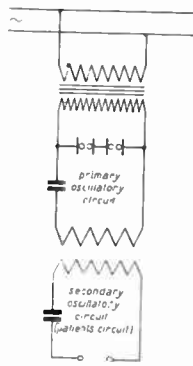

Fig. 6.—WIRING DIAGRAM OF DIATHERMY APPARATUS.

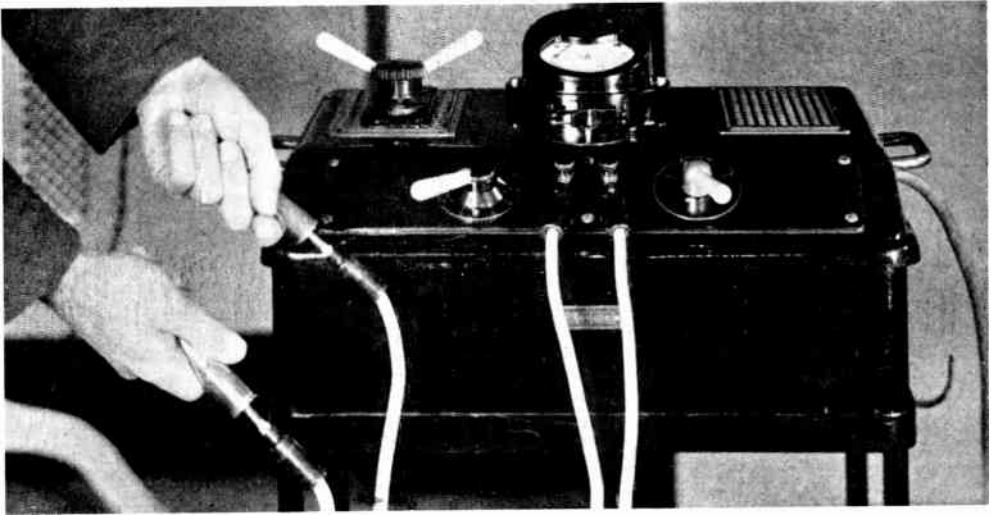

Fig. 7.—ANOTHER METHOD OF TESTING DIATHERMY APPARATUS.

This is called the "hand-to-hand" test. The electrodes are held in either hand, which places the maximum possible resistance in the circuit. This method, however, is apt to be misleading, but is a useful test to find out whether any electrical sensation is experienced by the patient.

circuit or it can be used to measure the total output of the machine.

How to Adjust the Ammeter.

An important point requiring attention on an apparatus of this nature is the zero adjustment of the hot wire ammeter. The meter movement consists of a wire which expands according to the amount of heat generated by the current passing through it. This wire is suitably connected to the meter needle which latter passes over a scale graduated in amperes and milliamperes. Obviously, such an instrument is affected by the temperature of the room, and before switching on the apparatus the position of the meter needle should be noted. If this is not on the zero mark, it may be adjusted by a slight turn of a screw, which will generally be found on one side of the ammeter.

Why a Foot Switch is Provided.

During surgical operations it is necessary for the surgeon to have both hands free for the operation, so that he is unable to operate the rotary switch of the apparatus. In this case a foot switch is provided. This is actuated by a depression of the foot. When the pressure is released the

current is switched off. This is placed in the primary circuit of the step-up transformer and in series with the rotary switch mentioned above.

Important Points to Note.

Diathermy treatment should not, of course, be given except by fully qualified persons, but for the information of those testing the apparatus, the following points should be borne in mind:—

Make sure that good, firm contact is made between the electrodes and the skin before switching on, and ensure that this contact is maintained the whole time the current is on.

Start with all the regulators in the "weak" position, and return them to the "weak" position before switching off.

Make sure that the main current is off before touching any internal contacts.

A CAUTERY AND LIGHT TRANSFORMER.

Another apparatus which is often called for is a cautery and light transformer. This consists of a similar step-down transformer to that used in the Pantostats but is mounted in a different manner. It is fitted inside a metal cylinder, on the top



Fig. 8—DIATHERMY FOOT SWITCH.

It is essential that the surgeon has both hands free, so a foot switch is provided to enable him to operate the apparatus.

of which is an ebonite circular panel holding the two controls and two pairs of terminals. Where this is to be connected to direct current mains, a small rotary converter is mounted on the same base-plate as the transformer.

Testing—and Its Dangers.

A word of warning may be given here regarding the testing of the cautery and light circuits.

If no current can be obtained through the cautery burner, the fault may be in the burner itself, the insulated burner holder, the connecting cables or inside the apparatus. The best procedure to adopt is to disconnect the cautery burner and to connect a piece of 5 amp. fuse wire across the cautery terminals. The cautery current should then be gradually turned on.

is that it can easily be burnt out unless great care is exercised. If there happened to be an intermittent open circuit in the system, which rectified itself at the moment when the current regulator was in the "strong" position, the burner would be fused immediately.

The same applies to the light circuit, except that there is insufficient current here to melt a piece of fuse wire. In its place a low reading A.C. voltmeter may be used, reading up to 10 or 12 volts. If this is not available the lamp may be kept in circuit, care being exercised to see that the current regulator is not advanced sufficiently far to burn the lamp out, should the fault suddenly rectify itself.

A later article will deal with the maintenance and use of X-ray apparatus, and its most recent applications to the medical profession.

CAR DYNAMO

What really matters as regards high charge rate, at a low road speed, is not so much a low cut-in speed of the dynamo as a rapid rise of current between cut-in speed and peak speed values.

Suppose a dynamo cuts in at 350 r.p.m. engine speed, which would correspond to about 8 m.p.h. road speed on top gear, unless the peak speed is reached before 800 r.p.m., which would mean 18 m.p.h., there would be very little

CUT-IN SPEED

gained by having this attractive cut-in speed. It seems, therefore, that the most reliable value to work on is the peak speed. The peak speed is the lowest speed at which the dynamo gives its rated output. The current of a dynamo increases very rapidly at the beginning and once the peak value is reached the value gradually falls off in most dynamos, but in some is maintained almost constant irrespective of the speed increase up to a certain limit, say 5,000 r.p.m. (70 m.p.h.).

B

HIGH TENSION ELIMINATORS AND HOW TO BUILD THEM

By H. E. J. BUTLER and H. J. BALDWIN.

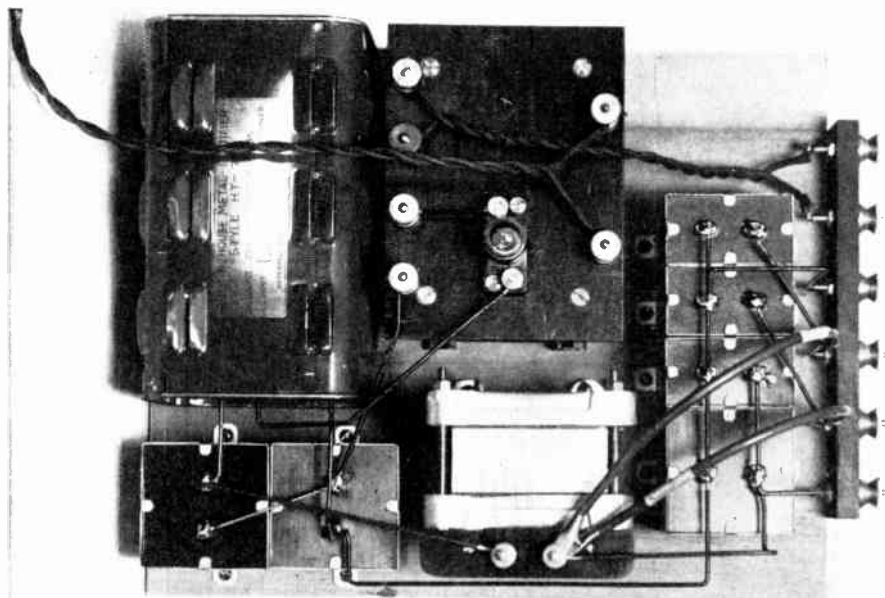

Fig. 1.—AN ELIMINATOR FOR A 3-VALVE SET TO WORK FROM A.C. MAINS.

A 4-volt A.C. supply for mains valves is also included to afford the means for the complete conversion of a battery set to a mains-operated set.

THE object of a high-tension eliminator is to provide an economical and constant supply of high-tension current from the electric light mains in place of dry batteries or accumulators. For the same output the initial cost of an eliminator is less than a high-tension accumulator and only about double that of a dry battery, while the running costs of an accumulator are slightly more than an eliminator, the upkeep of dry batteries is comparatively extravagant.

The Advantages of an Eliminator.

The chief advantage of an eliminator is that there is no maintenance beyond

the very occasional renewing of the rectifier of an A.C. type. There is nothing to wear out in a D.C. unit. An eliminator can be designed to give practically any output, while the operation from batteries of large amplifying valves, which require some 300 volts or more, is very costly. An eliminator giving an output of 300 volts at 50 milliamperes would cost less than a penny for ten hours working if the cost of electricity was fourpence per unit.

Types of Eliminators.

There are two types of eliminators, those which operate from D.C. mains and A.C. operated types. The output

of a D.C. eliminator is limited by the voltage of the supply mains. Thus an eliminator working on 100 volts cannot give an output of more than 100 volts. On the other hand, the voltage output of an A.C. eliminator is independent of the voltage of the supply mains. Where the D.C. supply voltage is not high enough to work a particular set, a D.C. to A.C. rotary converter is used, in conjunction with an A.C. eliminator giving the required output. This is generally necessary for the satisfactory operation of modern multi-valve receivers where the pressure of the D.C. supply mains is less than 200 volts.

D.C. Eliminator Components.

The component parts of a D.C. high-tension eliminator consist of one or more low-frequency smoothing chokes, several fixed reservoir condensers and one or more high resistances.

A.C. Eliminator Components.

An A.C. eliminator has all the components of its D.C. counterpart, but has in addition a mains transformer and a rectifier for producing the necessary uni-directional current for the operation of the eliminator.

Types of Rectifier.

There are four common methods of

rectification used. First there is the *electrolytic rectifier*, which consists of a chemical cell through which the current is passed. This way is inefficient, and continually changing the electrolyte is a messy operation.

Secondly there is the *thermionic valve* requiring a separate winding on the transformer to light it. Its efficiency is low and the high impedance results in a poor voltage regulation.

Thirdly we have the *gas discharge rectifier*, which depends upon a glowing discharge in an inert gas. The electrodes are so arranged that the "striking" voltage is very much greater in one direction than the other. The current from this type has a distorted wave, introducing smoothing difficulties, and it is liable to break into oscillation.

Lastly, there is the *metal rectifier* made by the Westinghouse Company. It has a high efficiency and is extremely durable; this type of rectifier is used in the eliminator described on page 516 in this article. It consists of a number of copper rings coated with copper oxide bolted together with a central bar covered with an insulating sleeve.

The Mains Transformer.

Fig. 16 shows a simple mains transformer cut open so that the interior may

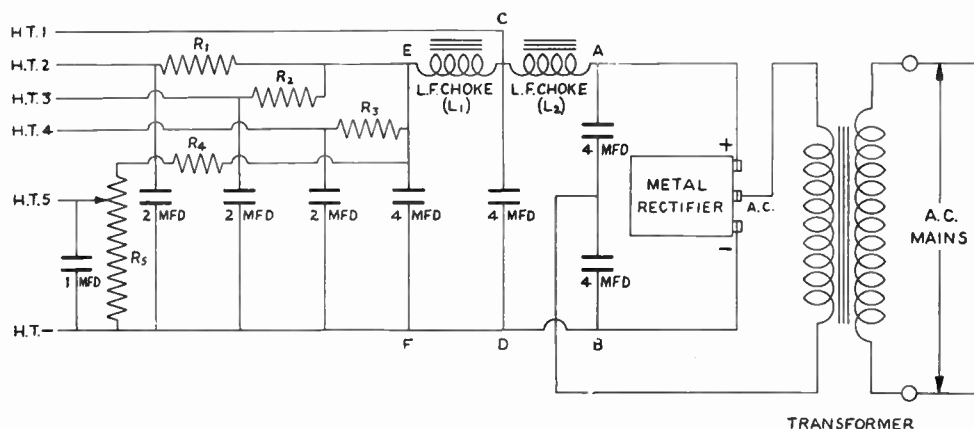

Fig. 2.—THE CIRCUIT OF AN A.C. ELIMINATOR GIVING FIVE DIFFERENT VOLTAGES, ONE OF WHICH IS VARIABLE.

This is suitable for a 4-valve set, including one stage of screened-grid H.F. amplification, or a 3-valve set with pentode output valve and screened-grid H.F. The calculation of the values of the resistances is given in detail in the text.

HIGH TENSION ELIMINATORS

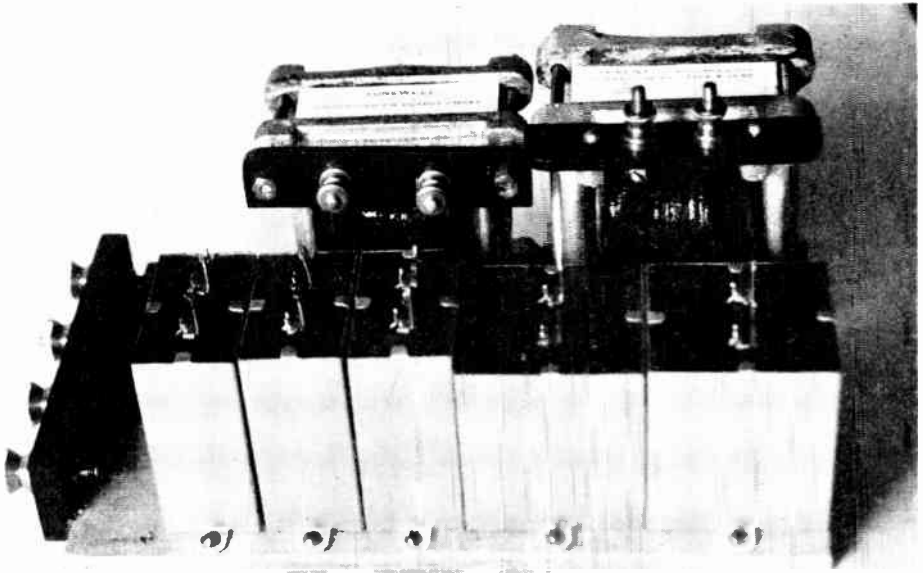

Fig. 3.—THE COMPONENTS OF A 3-VOLTAGE D.C. ELIMINATOR.
Assembled on a baseboard ready for wiring.

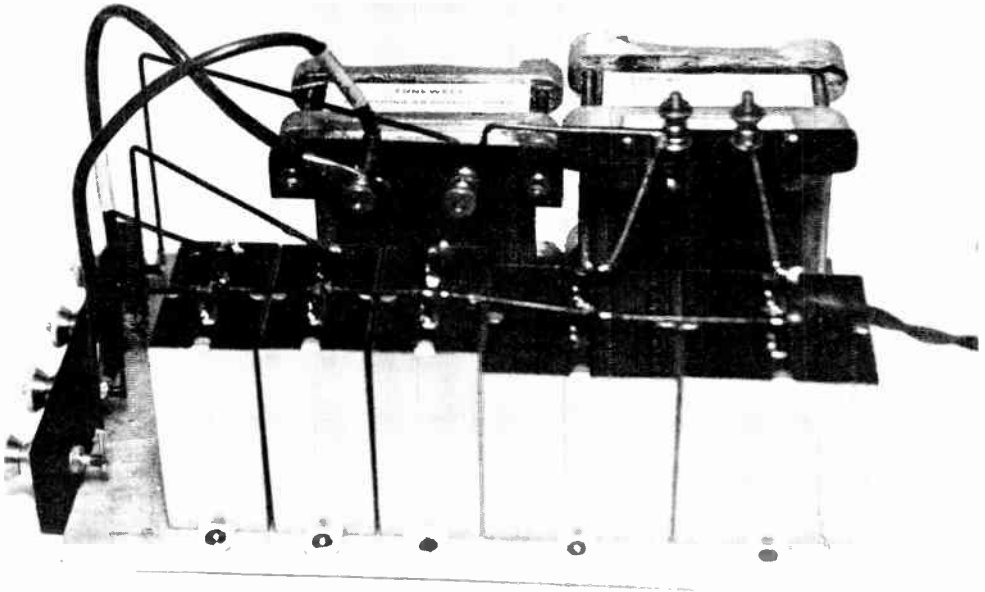

Fig. 4.—THE D.C. ELIMINATOR COMPLETELY WIRED.
This shows the various connections. Fig. 8 shows the wiring diagram.

be seen. The four top terminals are connected to the primary winding which is tapped to suit various supply voltages. It is important to see that the nearest tapings to the supply voltage are chosen. Note that the windings are in separate insulated sections like reels. The lower terminals give the output for the rectifier; here again we have a choice of tapings to suit the type of rectifier. The three common voltages required by metal rectifiers are 135 volts, 110 volts, and 80 volts. Some transformers have a further winding which supplies A.C. current at 4 volts for the heaters of indirectly heated A.C. valves.

A complete A.C. eliminator, giving three different outputs, is shown in Fig. 1.

Smoothing Chokes—

The object of the smoothing chokes is to produce, in conjunction with the reservoir condensers, a perfectly smooth D.C. supply. Smoothing devices are necessary for direct current supplies, for although the voltage of a D.C. main is much smoother than the D.C. obtained by rectifying alternating current, the amplitude of the ripple is too great and uncertain for the anode current supply of a wireless set.

—And Their Design.

A smoothing choke must be designed to satisfy three conditions, namely, the inductance, current and resistance. Thus the specification of a smoothing choke might be 30 henrys at 50 milliamperes, D.C. resistance 500 ohms. Generally speaking an inductance of 20-40 henrys is sufficient for the smoothing choke in an A.C. eliminator while a higher inductance may be necessary on some D.C. supplies. As the inductance of a choke varies with the D.C.

current passing through its winding, it is always essential to specify the current as well as the inductance when ordering a choke. The D.C. resistance should be as low as possible, because the higher the resistance the higher will be the voltage loss. This more particularly applies to a D.C. eliminator, where this loss cannot be made up as it can in an A.C. eliminator by increasing the voltage of the high-tension secondary winding on the transformer. A satisfactory resistance is 500 ohms for 50 milliamperes; 250 for 100 milliamperes. This gives a drop of 25 volts across the choke at the maximum current.

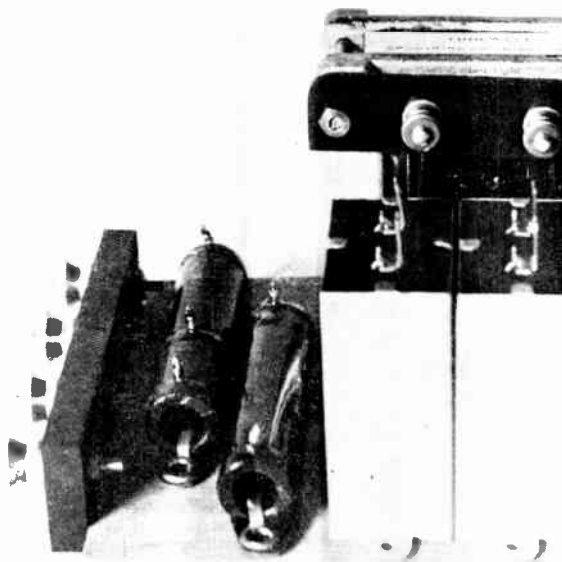

Fig. 5.—FOR LARGER CURRENTS, COLVERSTATS, WHICH ARE RATED AT 10 WATTS, ARE USED.

Care is necessary when soldering connections to these not to damage the wire by contact of the soldering iron.

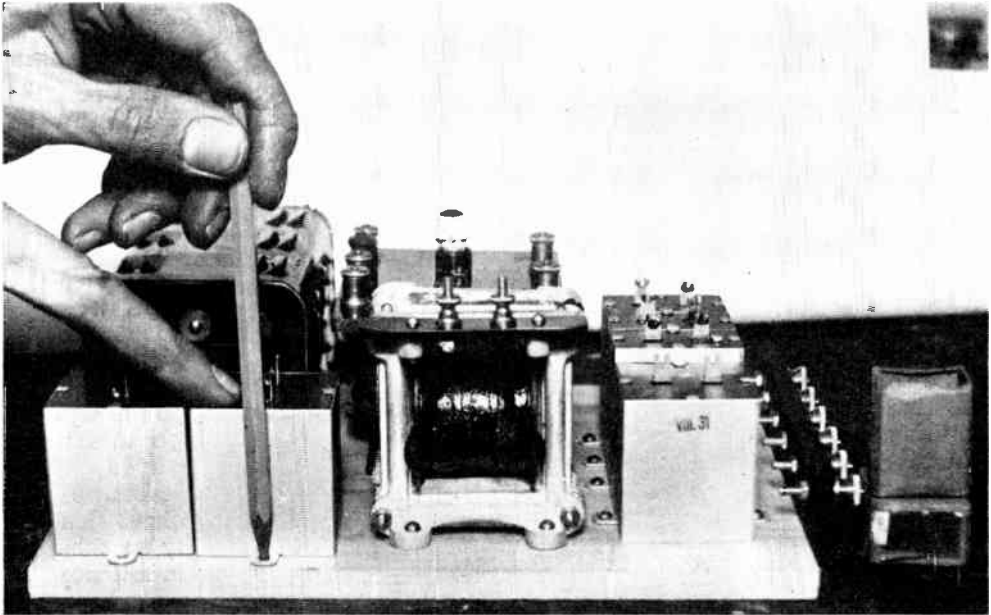

Fig. 6.—MARKING OUT THE POSITIONS OF THE SCREW HOLES IN THE BASEBOARD.

This is done by arranging the components in their correct positions and marking through the lugs with a pencil.

Fixed Condensers.

The fixed condensers used in high-tension eliminators are paper dielectric types of 1-8 microfarads capacity. Small mica dielectric types are also used sometimes for tuned filters and for connecting between the mains and earth for eliminating residual hum. Electrolytic condensers of 8 microfarads capacity are also used for the first smoothing condenser when a high degree of smoothing is necessary.

It is important to use condensers which are tested at twice the maximum voltage which they are required to withstand in use. Thus a D.C. eliminator working from a 200-volt supply will require condensers of 400-volt D.C. test. An A.C. eliminator giving a maximum D.C. of 250 volts would have condensers of 700 volts D.C. test or 500 volts A.C. test.

How Voltage Tappings are Obtained.

Having obtained a smoothed supply of direct current free from pulsations, a means must be found to obtain the voltage at varying values to suit the dif-

ferent valves in the set. There are two methods in common use for obtaining tappings of a lower voltage than the maximum output. First the "potential divider" method, as shown in Fig. 13, and the "anode feed resistance," as seen in Fig. 14.

In Fig. 13 we have a high resistance potentiometer XY of a value of 80,000 ohms across the output leads. The tappings at a and b will depend upon the relative value of the resistance X to the resistance Y . Approximately the values of X and Y must be in the ratio of the required voltage tappings as shown under Fig. 13.

The potential divider should always be used for tappings supplying the screen grid of H.F. valves and the anode of detector valves operating as anode bend rectifiers. This method used for other types of valves leads to back-coupling and L.F. oscillation, known as "motor-boating."

Fig. 14 shows the use of resistances R_1 and R_2 used as anode feeds. The value of these resistances must be such that they absorb the difference between the maxi-

imum available voltage and that actually required. The value is obtained by dividing the difference in voltage by the plate current of the valve measured in milliamperes and multiplying the quotient by 1,000.

Variable Resistances.

Variable resistances are used only when it is necessary to have a variable output voltage, such as for the screen grid of a high-frequency valve or when an eliminator is required for experimental purposes. These resistances must be wire wound.

Fixed Resistances.

The fixed resistances in an eliminator for a multi-valve wireless receiver perform several functions. First, they are used to reduce the maximum voltage to that required by each individual valve, and, secondly, to prevent interaction between the valves. The resistances, in conjunction with their respective condensers, also assist in smoothing the anode current. Resistances must be wire-wound types, and must be proportioned to carry the maximum current passed through them. Fixed resistances are made in several types, each type having a different current rating. The rating of a resistance, whether fixed or variable, is usually stated in so many watts, which is found by multiplying the square of the maximum current by the total resistance. Thus the current-carrying capacity of a resistance of 50,000 ohms rated at 10 watts is determined as follows:—

If I is the current in milliamperes and R is the resistance in ohms then:—

$$I^2R = 10 \times 1,000^2$$

$$I = \sqrt{\frac{10,000,000}{50,000}}$$

$$= 1.4 \text{ milliamperes (approx.)}$$

Single layer resistances such as Colverstats wound on insulating tubes are rated at 10 watts. Spaghetti type wire-wound resistances are rated at one-third to a quarter of this value. Thus a spaghetti type resistance of 50,000 ohms will carry only 5 milliamperes, which is usually ample for a resistance of this magnitude.

Spaghetti resistances can of course be made to carry larger currents.

Calculation of Resistance Values.

As the voltages and anode currents of valves vary over wide limits for different types of valves, no definite values of resistances can be given. It is therefore necessary to calculate the values of the resistances so that the correct voltage is applied to the valves.

If R = Value of resistance in ohms,

$E_1 - E_2$ = Difference between volts applied to the resistance and volts required by valve,

I = Current in milliamperes taken by the valve at E_2 volts, then

$$R = \frac{E_1 - E_2}{I} \times 1,000$$

Consider as an example the calculation of the resistances for the eliminator shown in Fig. 2. Start at the output end and work backwards to the input. The screen-grid potentiometer R_4 and R_5 will have to pass about 3 milliamperes plus the screen current, say 1 milliampere. H.T.4 is the screen-grid tapping to give 200 volts at 4 milliamperes, and H.T.3 the detector anode tapping 150 volts at 5 milliamperes, while for a pentode valve such as Mullard PM24A, H.T.2 gives 200 volts at 6 milliamperes for the screen-grid, and H.T.1 21 milliamperes at 300 volts for the anode supply. Thus the total current is $21 + 6 + 5 + 4 + 4 = 40$ milliamperes. This total current must be delivered by the rectifier and must pass through the smoothing choke L2. A Westinghouse metal rectifier style H.T.8 used with a 200-volt A.C. input gives the voltage across A-B of 340 volts at this current. As H.T.1 is to be 300 volts it is necessary to lose 40 volts across the choke L2 to give 300 volts across C-D.

From the formula:—

$$R = \frac{E_1 - E_2}{I} \times 1,000$$

$$R = \frac{40}{40} \times 1,000$$

$$= 1,000 \text{ ohms.}$$

The total current passed by the choke L1 is $40 - 21 = 19$ milliamperes. If the choke is a Tunewell type 20/25, the D.C.

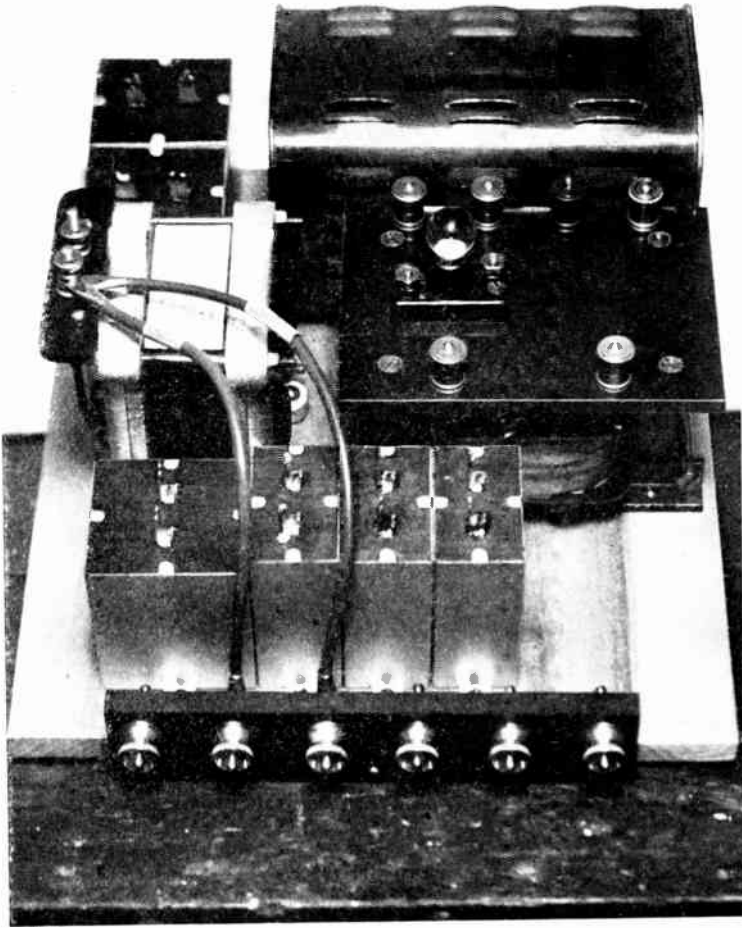

Fig. 7.—THE COMPONENTS OF A 3-VOLTAGE A.C. ELIMINATOR. These are shown assembled on a baseboard ready for wiring up. The set is shown wired in Fig. 1.

resistance of which is 625 ohms, the drop due to this is 12 volts. This gives a voltage of 288 across E-F.

The resistance of R_1 is therefore found as follows:—

$$R_1 = \frac{288-200}{6} \times 1,000 \\ = 14,700 \text{ ohms.}$$

A resistance of 15,000 ohms is therefore used for R_1 .

H.T.3 is also to be 200 volts, thus R_2 , which carries a current of 5 milliamperes, has a resistance of 17,500 ohms.

The value of R_3 for the screen-grid

anode voltage, also 200, is given by:—

$$R_3 = \frac{288-200}{4} \times 1,000 \\ = 22,000 \text{ ohms.}$$

R_4 and R_5 must together be of such a resistance to pass 3 milliamperes at 288 volts:—

$$R_4 + R_5 = \frac{E}{I} \times 1,000 \\ \therefore R_4 + R_5 = \frac{288}{3} \times 1,000 \\ = 96,000 \text{ ohms.}$$

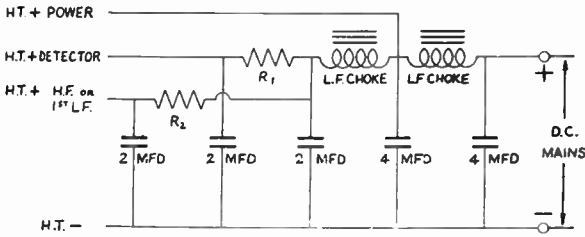

Fig. 8.—THE WIRING DIAGRAM OF THE D.C. ELIMINATOR SHOWN IN FIGS. 3 AND 4.

Fuses.

In order to protect the various components against damage it is advisable to include a fuse in the high voltage secondary circuit of the transformer, as indicated in the diagram shown in Fig. 9. Two types of fuses are available, bulb types and cartridge fuses. The bulb types have the advantage that they light up when the eliminator is in use and so indicate that the set is working. The fusing current of

either type should be at least one and a half times the working current.

HOW TO MAKE A D.C. ELIMINATOR.

Components Required.

The components required for a D.C. eliminator to give a maximum of 80 milliamperes at 200 volts from 230-volt mains are as follows:—

Tunewell choke, type S20/50, resistance 590 ohms.

Tunewell choke, type S20/25, resistance 625 ohms.

Two 4 mfd. fixed condensers, 500 V.D.C. test.

Three 2 mfd. fixed condensers, 500 V.D.C. test.

Four terminals and ebonite terminal block.

Baseboard 8½ in. × 5½ in. × ¾ in.

Metal or wooden cabinet; the former is preferable.

Short lengths of Glazite and flex with adapter or plug.

Assembling the Components.

The positions of the various components on the baseboard are shown in Fig. 3. The smoothing chokes should be screwed into position first. The components are

For the sake of using standard values of resistances 90,000 ohms is satisfactory as it gives only an extra .2 milliampere. The maximum screen voltage of the H.F. valve may be taken at 75 volts. The variable resistance must therefore be 25,000 ohms, to give a drop of 75 volts at 3 milliamperes. Thus:—

$$R_4 = 90,000 - 25,000 \text{ ohms,} \\ = 65,000 \text{ ohms.}$$

The values of the resistances and chokes are therefore as follows:—

- L1=625 ohms, 30 henrys at 19 m.a.
- L2=1,000 ohms, 30-40 henrys at 40 m.a.
- R1=15,000 ohms, fixed, to carry 6 m.a.
- R2=17,500 ohms, fixed, to carry 5 m.a.
- R3=22,000 ohms, fixed, to carry 4 m.a.
- R4=65,000 ohms, fixed, to carry 4 m.a.
- R5=25,000 ohms, potentiometer to carry 4 m.a.

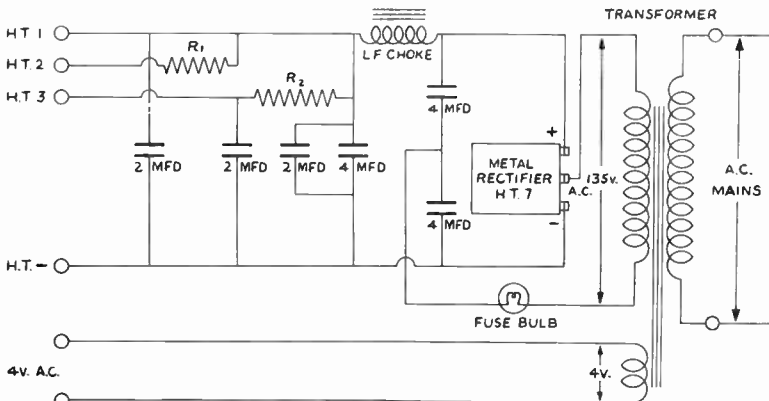

Fig. 9.—THE WIRING DIAGRAM OF THE A.C. ELIMINATOR.

This circuit, which is described in the text, is to give an output of 200 volts at a total current of 28 milliamperes. The same circuit may be used for an output of 250 volts 60 milliamperes by using a metal rectifier style H.T.8 with a transformer having a secondary winding to give 200 volts at 120 milliamperes. The same condensers are suitable.

all set out on the baseboard and the positions for the holes marked out with a pencil as shown in Fig 6. The screw holes are then made with a drill or bradawl.

Wiring.

The wiring is done with insulated 18 S.W.G. tinned wire, Glazite producing a neat-looking job. The first step is to

secure the two spaghetti resistances under their terminals. If a larger current is required from the two lower voltage tappings Colverstat fixed resistances are used as shown in Fig. 5. The baseboard needs to be an inch longer, that is 9½ inches, to accommodate these. Next run the common negative wire to one tag on each condenser and to the negative

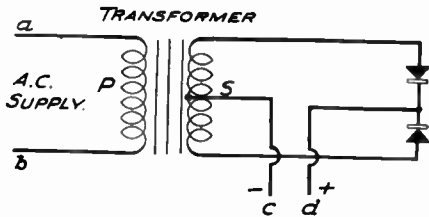

Fig. 10—CENTRE TAP METHOD OF GETTING FULL-WAVE RECTIFICATION.

Terminals a and b of the transformer are connected to the A.C. mains; the secondary winding gives an A.C. output at a voltage suitable to pass through the rectifying units, which are shown as arrows, the points indicating the direction of the flow.

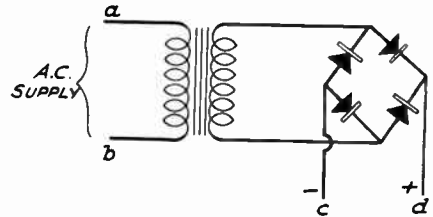

Fig. 11.—THE "BRIDGE" METHOD.

This has advantages over the method shown in Fig. 10, because the voltage across the secondary winding of the transformer approximates to that of the D.C. output required by the rectifier.

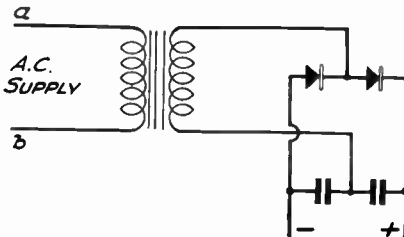

Fig. 12.—THE "VOLTAGE DOUBLER" CIRCUIT.

This is particularly popular as a cheap means of obtaining full-wave rectification. The secondary winding of the transformer carries double the rectified current.

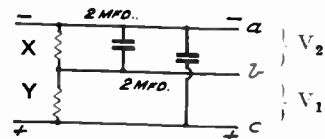

Fig. 13.—THE POTENTIAL DIVIDER USED TO GET A TAPPING BETWEEN a AND c.

$X + Y = 80,000$ ohms.
 $V_1 + V_2 =$ Total Voltage.
 The ratio of X to Y must be the same as V_2 to V_1 .

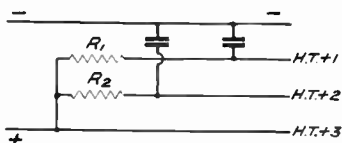

Fig. 14.—THE ANODE FEED RESISTANCE METHOD OF OBTAINING FIXED TAPPING.

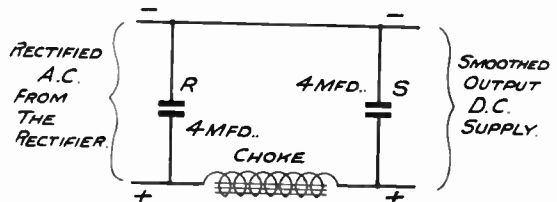

Fig. 15.—A SIMPLE SMOOTHING CIRCUIT.
 The smoothing choke is 20-40 henrys.

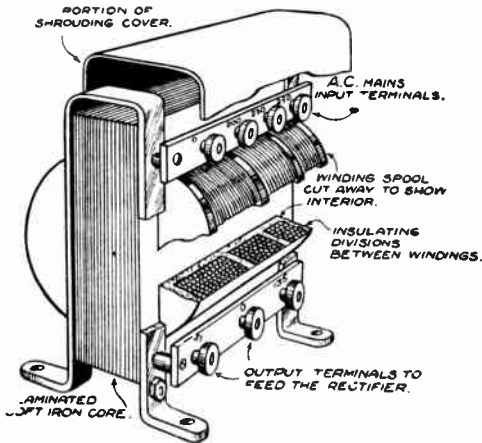

Fig. 16.—A SECTION OF A MAINS TRANSFORMER.

terminal. The leads for connecting to the mains are made by soldering a length of lighting flex to the first 4 mfd. condenser. The eliminator is shown completely wired in Fig. 4 and the circuit diagram is shown in Fig. 8.

Polarity of the Mains.

It is essential to ensure that the positive terminal of the eliminator is connected to the positive of the light mains, and in order to be able to do this it is necessary to determine the polarity of the mains before using the eliminator. This may be done without the use of any special apparatus in the following way. Connect two short leads to H.T. positive and H.T. negative and dip the ends in a cup of water. Then connect the eliminator to the mains the way round which gives most bubbles at the end of the wire connected to H.T. negative. To ensure the correct reconnection of the eliminator when a lamp adapter is used the adapter and the holder are marked on the same side. The best way is to use a non-reversible plug and socket with one pin larger than the other. Then there can be no mistake.

Precaution.

Sometimes the positive lighting main is earthed, so that to avoid a short circuit on the mains always put a 1 mfd. fixed condenser in series with the earth lead to the wireless set. This condenser must

be of a high voltage test type, 400 D.C. volt test for 200-volt mains and 500 D.C. volt test for 230-250-volt mains.

HOW TO MAKE AN A.C. ELIMINATOR.

The construction of a 200-volt 28 milli-ampere eliminator is shown in Figs. 1, 6 and 7. This also provides for a 4-volt 3-ampere A.C. supply for indirectly heated valves.

Components Required.

The following parts are required for a 3-voltage output :—

1 mains transformer with primary to suit mains ; secondary, 135 volts 60 milli-amperes, and 4 volts 3 amperes, if required.

1 Westinghouse Style H.T.7 metal rectifier.

Three 4 mfd. fixed condensers, 500 V.A.C. test.

Three 2 mfd. fixed condensers, 500 V.A.C. test.

2 fixed resistances, spaghetti type.

1 Tunewell choke type S20/50 or Ferranti B.1.

6 terminals and ebonite block.

1 wood baseboard 10½ in. × 8½ in. × ¾ in. Lengths of Glazite and lighting flex.

Telsen fuse holder and 100 milliampere fuse bulb.

The details for constructing the mains transformer for this eliminator are given in a previous article entitled "Small Power Transformers and How to Make Them," on pages 204-216.

Assembling the Components.

The first step is to make the terminal block which is 8 in. × 1½ in., with 6 terminals equally spaced. Three screw holes are drilled ⅜ in. from the bottom edge for securing the block to the ends of the baseboard. The components are then set out as shown in Fig. 7 and the condensers and rectifier secured in position with No. 4 round-head wood screws, ⅜ in. long. The choke and transformer are fixed with No. 5 screws ½-in. long. If it is desired to rearrange the components to give a narrower assembly, this may be done without affecting the working of the eliminator in any way.

Before screwing the terminal block, with its terminals, in position, file the ends of the terminal threads flat and tin

them to facilitate soldering. The condensers shown are Hydra make with tinned soldering tags. If the constructor wishes to avoid soldering, any other make, with terminals, may be substituted. The fuse bulb, and its holder, is shown screwed to the top of the transformer in Fig. 1. This may be fixed on the baseboard if desired. Screwed on top of the transformer the bulb may act as an indicator by cutting a hole in the top of the eliminator cabinet.

Wiring.

The set is shown ready for wiring up in Fig. 7. Before any wires are soldered to the terminals the spaghetti resistances are fastened under the terminals for H.T.2 and H.T.3. If different coloured wires are used there is less likelihood of mistakes being made. A good plan is to use red wires for the A.C. leads from the transformer to the rectifier and centre of the voltage doubling condensers, black wires for the negative common wire, and yellow leads for the positive circuits. The circuit diagram of the eliminator is shown in Fig. 9. The 4-volt A.C. is connected from the transformer to the terminals with twisted flex. The object of using twisted flex is to prevent an A.C. field being formed round the wires which might give rise to hum in the receiver.

To obtain the centre point of the 4-volt A.C. supply, a potentiometer of about 35 ohms is connected across it and the moving arm earthed. This may be put in the receiver or the eliminator as desired.

The Cabinet.

A metal cabinet of tinned iron or enamelled iron is preferable to a wooden one because it not only acts as a screen from the receiver but, if earthed, prevents shocks which might occur from the use of damp wood. The cabinet must be ventilated, for although the rectifier and transformer do not give out much heat, they

will become unnecessarily heated if mounted in a closed box.

Eliminator Hum.

Although the smoothing of an eliminator may be adequate, some residual hum may be present. This is usually overcome by one of two expedients. First try connecting one terminal of the transformer input to earth in series with a mica condenser of .01 mfd. capacity. If this does not cure the hum try earthing the condenser cases and the cases of the transformer and choke.

ANOTHER TYPE OF A.C. ELIMINATOR GIVING COMBINED H.T. AND L.T. SUPPLY.

This eliminator will give an output of H.T. current of 175 volts at 25 milliamperes and will charge accumulators up to 6 volts at half an ampere. Such an output is considerably above the performance of the small ready-made models usually sold in shops. It will supply anything up to a 6-valve set, permitting the use of a large power valve. The joy of using a big power valve must be experienced to appreciate its merits.

Components Required.

- 1 Bulgin L.F. choke.
- 3 fixed condensers, 2 mfd.—Formo.
- 3 fixed condensers, 4 mfd.—T.C.C.
- 1 combined transformer and rectifier, Type AO2—Heyberds. (This component incorporates a Westinghouse rectifier R421.)

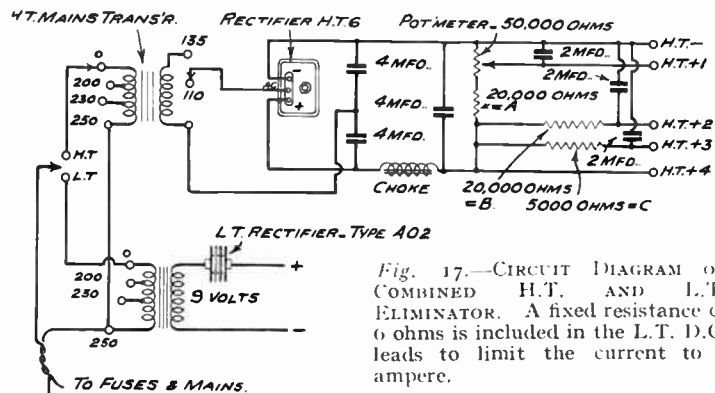

Fig. 17.—Circuit Diagram of Combined H.T. and L.T. Eliminator. A fixed resistance of 6 ohms is included in the L.T. D.C. leads to limit the current to $\frac{1}{2}$ ampere.

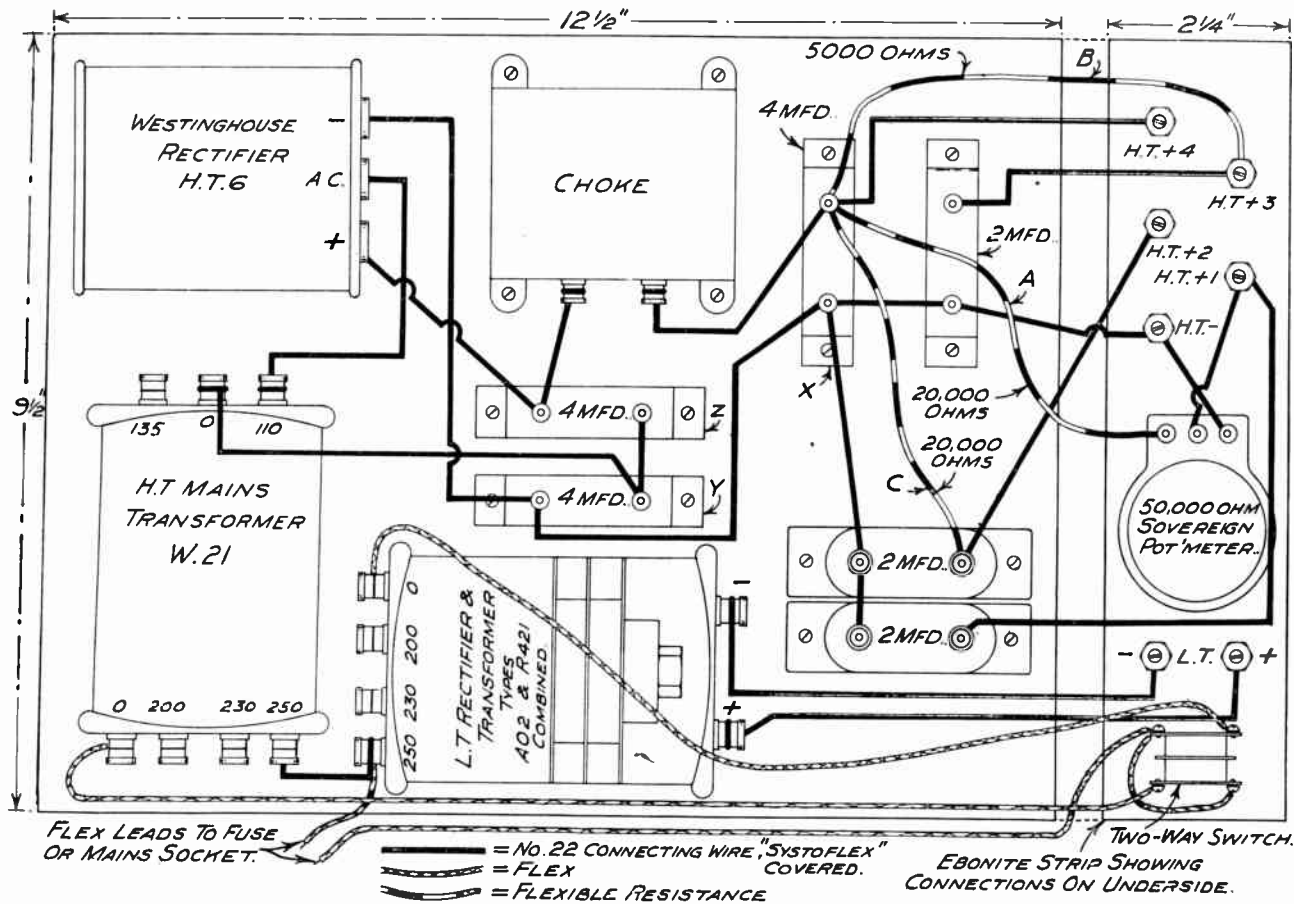

Fig. 18.—Shows the Position of the Components Together With the Actual Wiring Connections for the High-Power Eliminator.

1 mains transformer, Type W21—Heayberds.

1 Westinghouse metal rectifier, Type H.T.6.

1 potentiometer 50,000 ohms—Sovereign.

1 two-way switch—Bulgin.

1 50,000-ohm fixed resistance.

2 20,000-ohm fixed resistances.

7 terminals.

Strip of ebonite.

Connecting wire.

Baseboard and sheet

of tin for the cover.

Fig. 17 shows the theoretical circuit of the eliminator. The circuit is in two distinct parts, the H.T. section being entirely independent of the L.T., so that those readers who only require a H.T. instrument can omit the charger portion, while the accumulator charger can be made separately if desired. This is the reason why two transformers are used instead of one with an extra winding for the L.T. circuit.

Details of Output.

It will be seen from Fig. 17 that full-wave rectification is made use of and that H.T.+1 has a potential divider control, making it suitable for S.G. valves, while the other tappings have anode resistance tappings. Using the fixed resistances as shown the value of the tappings is as follows:—

- H.T.4, 175 volts up to 25 milliams.
- H.T.3, 150 " " 5 " "
- H.T.2, 120 " " 3 " "
- H.T.1, variable from 35 volts to 100 volts up to 2 milliams.

Of course, the maximum value of each tapping depends upon the amount of current drawn from the lower tappings. The given resistances will be found to suit the average 4-valve set.

Assembling the Components.

Take a piece of plywood $\frac{3}{8}$ in. thick, the required size for the baseboard, and at one end glue and pin the two wooden uprights which support the ebonite terminal strip.

Then set out the position of the holes to take the terminals, switch, and potentiometer; when these have been drilled, screw the ebonite strip in position on the

wooden uprights, as shown in fig. 19. The main components can then be fixed in position on the baseboard, as shown in Fig. 18. For the connections between the switch and the transformers flex is advisable, while No. 22 tinned copper wire covered with sistoflex is suitable for the remainder of the wiring.

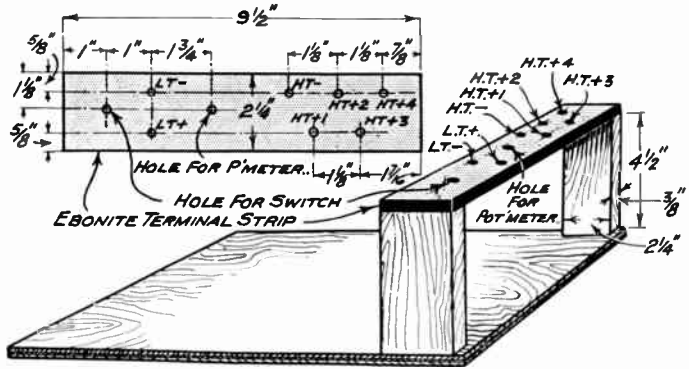

Fig. 19.—How the Ebonite Terminal Strip is Mounted in Position at One End of the Baseboard.

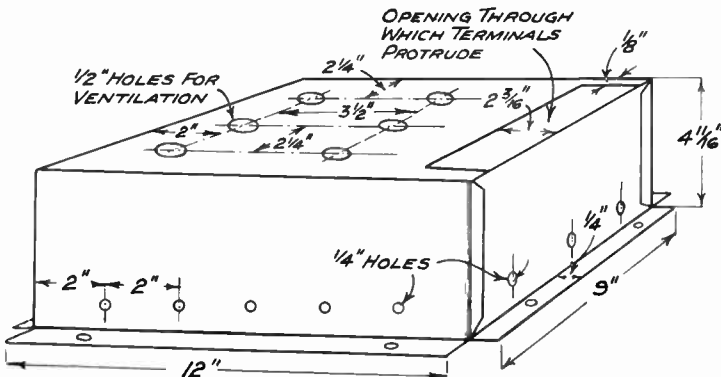

Fig. 20.—The Metal Earthing Cover.

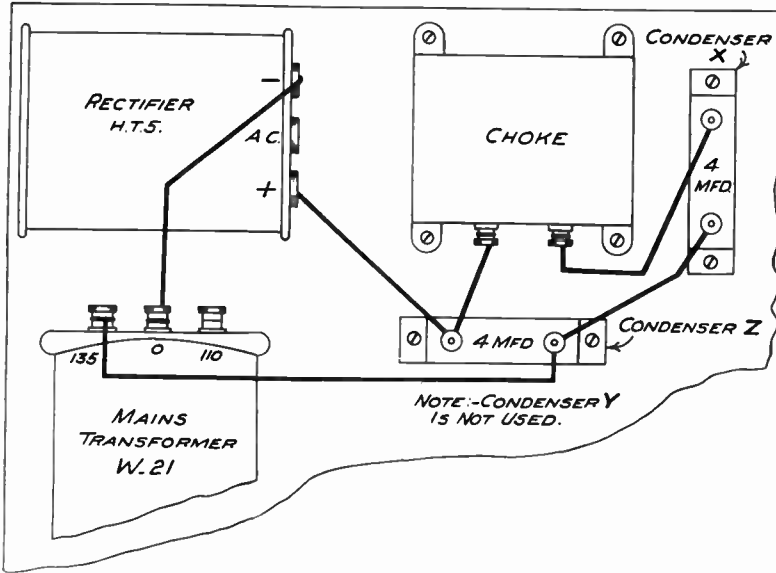

Fig. 21.—THE NECESSARY MODIFICATIONS FOR THE LOWER POWER ELIMINATOR.

All the other connections are the same as shown in Fig. 18.

There is no need to solder the connections; make neat loops at the ends of the wire links with a small pair of round-nose pliers and secure under the terminals of the various components.

Fuses.

Some readers may desire to include fuses in the leads to safeguard the instrument. These are especially necessary when the eliminator draws its energy from the power mains. For this purpose a very neat double-pole fuse with bakelite holder, housing two glass-covered fuse-

into operation, and it is as well to try out this section first.

When the switch is moved to the left then the H.T. portion functions. The H.T. eliminator must not be switched on unless it is connected to a set the valves of which are alight, otherwise the absence of load causes the voltage to rise to dangerous limits which may cause the condensers to break down.

Remember it is useless to try to measure the voltage across the terminals with a cheap voltmeter; only a high resistance meter will give a true reading.

Modifications.

Some readers may find the above eliminator too powerful for their requirements, but a few simple modifications will limit the output to 120 volts at 20 milliamps.

This lower power is obtained by substituting metal rectifier H.T.5 in place of H.T.6 and making a half-wave circuit, as shown in Fig. 21. This diagram shows the slight alterations in wiring necessary. Note that the 135-volt tapping on the transformer

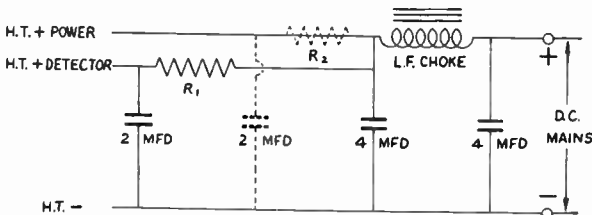

Fig. 22.—WIRING DIAGRAM OF A 2-VALVE D.C. ELIMINATOR.

The condenser and resistance shown dotted are necessary only when the mains voltage is higher than that that required by the power valve.

wires is sold by the Bulgin Company; it is known as type A.3.

Fig. 20 shows a suitable metal earthing case which fits down on to the base-board and covers up all the "live" parts, permitting only the terminals to project through.

Operating the Eliminator.

It should be noted that when the switch is pulled to the right the L.T. section comes

is used and that the connections to the rectifier are slightly different, the A.C. terminal not being used at all, while only two 4 mfd. condensers are needed instead of three, as in the high-power model which uses the voltage doubling circuit. All the connections between the terminal strip and the last four condensers are the same as shown in Fig. 18.

The resistances A, B and C, however, will have to be lower and the following values are suggested as being suitable for an average set:—

- A = 10,000 ohms.
- B = 5,000 ohms.
- C = 10,000 ohms.

Final Precautions.

Always light the valves before switching on the H.T. current; switch off the H.T. before putting out the valves. The observance of this simple rule will prevent a damaged condenser and ensure a long life to the instrument.

OTHER ELIMINATOR CIRCUITS.

D.C. Eliminator for 2-Valve Set.

Fig. 22 shows the circuit of a D.C. eliminator for a 2-valve set. When the mains voltage is much in excess of that required by the power valve the resistance R2 and condenser shown dotted must be included.

A.C. Eliminator for 2-Valve Set.

A 2-valve eliminator for A.C. mains is shown in Fig. 23. For an output of 120 volts 20 milliamperes a metal rectifier style H.T.5 is used with a transformer giving 80 volts 40 milliams. secondary output. If the detector valve is transformer-coupled to the power valve, a resistance of 50,000 ohms for R will be generally satisfactory. The smoothing choke may be either R.L. Hypercore, Ferranti B1 or Tunewell S20/50 or S20/25. The S20/25 choke has a higher resistance than the S20/50 type

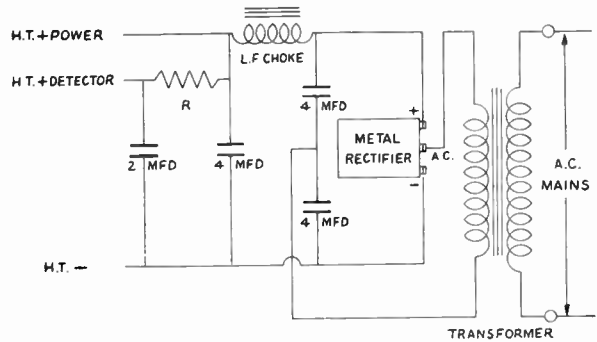

Fig. 23.—THE WIRING DIAGRAM OF A 2-VALVE A.C. ELIMINATOR USING A METAL RECTIFIER.

so that a slightly lower output voltage is obtained when this one is used.

A.C. Eliminator With Two Variable Voltages.

Fig. 24 shows how two variable tappings are obtained when it is desired to have an eliminator for experimenting with different types of valves. This circuit is shown with a valve rectifier, to indicate the principle of eliminators with full-wave valve rectifiers. The transformer has a secondary winding of 400 volts centre-tapped and a 4-v. filament winding, across which a potentiometer R1 of 35 ohms is connected for obtaining the electrical centre of the filament. A rectifying valve such as Mullard D.W.2 or Philips 1R21 is used. These valves give a maximum output of 250 volts at 60 milliamperes with a transformer having a 500-volt centre-tapped winding.

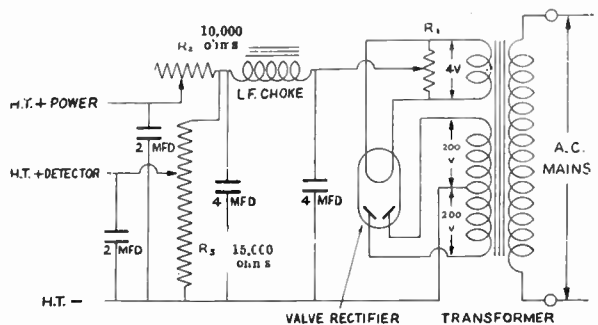

Fig. 24.—THE CIRCUIT OF A 2-VALVE A.C. ELIMINATOR USING A VALVE-TYPE RECTIFIER.

This is arranged to give two variable outputs by means of the rheostat R2 and potentiometer R3.

TALKING PICTURE APPARATUS



Fig. 1.—How to Start the Reproducer on the Record.

Note especially that the reproducer or soundbox starts on the inside of the record and works outwards. When setting up the start of the disc, hold the turntable steady with the fingers of the left hand and work the record into its correct position with the thumb of the same hand, holding the reproducer in the right hand.

IT is not proposed in this article to deal with the theoretical side of sound reproduction, which, although of considerable interest, is not of great practical value to the average electrician. The theoretical side will, however, be dealt with fully in a later article.

BRIEF OUTLINE OF REPRODUCTION PROCESS.

Sound on Disc.

The records used for talking picture reproduction are very similar to those used for the more familiar gramophone, except that they are usually 16 inches in diameter and are run at a speed of $33\frac{1}{3}$ r.p.m. as against 78 r.p.m. used for the latter, and they start near the centre instead of the outside edge. The standard 16-inch record can accommodate sufficient sound track to accompany a standard 1,000-ft. reel of film, which lasts for about 11 minutes when running at the correct speed of 90 feet per minute.

How the Effect of Sound is Produced.

The wavy circular grooves forming the sound record produce mechanical vibrations of the needle of an electrical pick-up device, which takes the place of the usual gramophone sound-box, and which converts these vibrations into electrical impulses. These feeble impulses are amplified and passed on to the horns or loud-speakers placed behind the screen, where the electrical energy is converted into mechanical energy causing the diaphragms of the receivers attached to the horns to vibrate, thus producing alternating waves of compression and depression in the air column in the throats of the horns, which produce the effect of sound.

How Synchronisation is Obtained.

Synchronisation with the picture is secured by driving the turntable through mechanical gearing from the same motor as that which drives the motion picture projector. The record having been made

in synchronism with the film, it is only necessary to ensure that the start of the film corresponds with the start of the disc, and they will continue to remain in synchronism unless physically displaced.

Sound on Film.

In this case the sound is photographically recorded on a narrow strip on the side of the picture (see Fig. 4). This strip extends the whole length of the film and

lies between the picture and the sprocket holes on one side of the film.

Since the overall width of the film (35 millimeters) remains the same, the picture is about 10 per cent. smaller in width than if the sound were recorded on disc or if the picture were a silent one. The height remains the same in all cases.

The actual point on the film at which the sound record is taken off is approximately 14½ inches in advance of the picture.

What Happens When the Film has Passed Through the Picture Projector.

After having passed through the picture projector (from which the scene is reproduced on the screen) the film is drawn downwards through the sound gate at an absolutely constant speed of 90 feet a minute (see Fig. 2). At the sound gate, a narrow horizontal slit of light one-thousandth of an inch (or one mil) in thickness and ⅛ inch wide is directed through an aperture plate on to the sound track on one side of the film. The length of the slit is at right angles to the length or direction of travel of the film. As the film travels through the sound gate, the amount of light transmitted through it at any particular instant is dependent on either its density (if the photographic record was made by the variable density

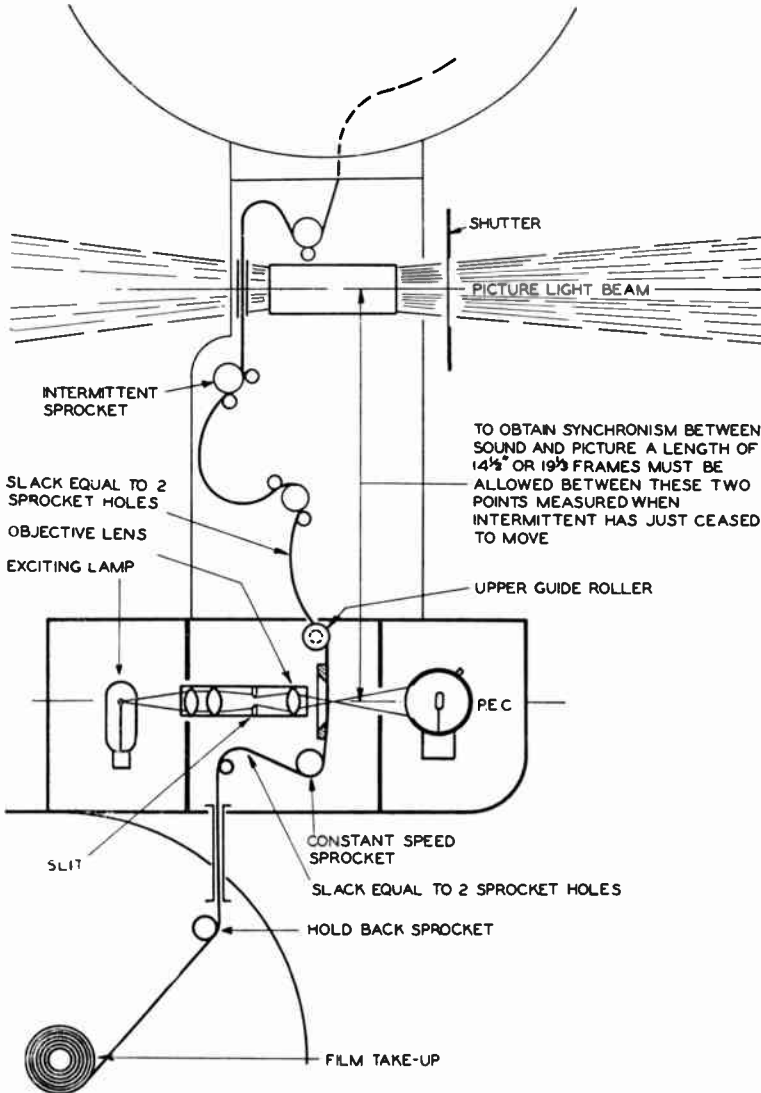

Fig. 2.—How the Film Travels Through the Motion Picture Projector and Western Electric Sound Unit

method) or the proportion of white to black of its sound track at the same particular instant. The transmitted light is directed on to a photo electric cell, which is a device whose resistance changes in proportion to the amount of light falling on it.

The photo electric cell is connected in series with a high resistance to a 90-volt dry battery. The changes in resistance of the photo electric cell produce changes in voltage across its terminals and these extremely small changes are applied to a small amplifier, the output from which gives electrical impulses comparable in strength to those from the electrical pick-up device used for reproducing sound on disc. These impulses are further amplified and passed on to the loud-speakers.

Standard Theatre Equipment.

A standard theatre equipment consists of at least two sound reproducers (situated in the operating box), together with the necessary mechanical gears and driving motors. Upon these are mounted the usual motion picture projectors or mechanisms as used for silent pictures, together with the arc lamps for providing illumination for the scene. The reproducers usually take the place of the pedestal and lower spool box of the old silent projectors and include a turntable and electrical pick-up device for disc reproduction, and a sound unit and, in some cases, a preliminary amplifier for film reproduction.

Why the Amplifier is Close to the Sound-box.

The object of having this amplifier

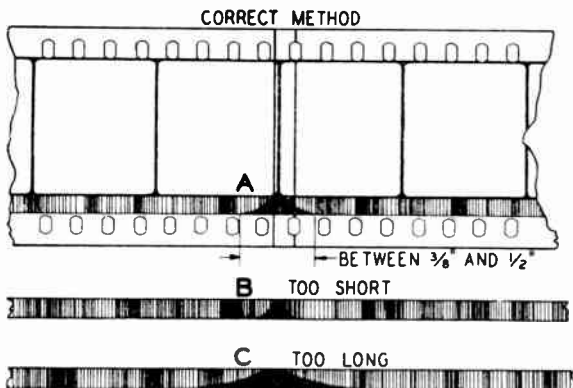

Fig. 4.— THE CORRECT SPLICE FOR SOUND FILM.

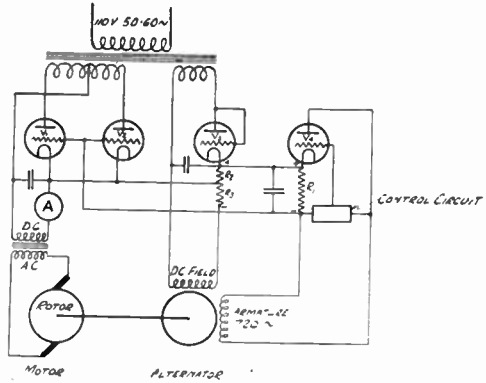

Fig. 3.—SIMPLIFIED DIAGRAM OF MOTOR CONTROL BOX. (Western Electric System.)

close to the sound unit is that the electric currents at the photo electric cell are so small that it would be difficult to transmit them any distance without them becoming so attenuated or overwhelmed by extraneous noises picked up from neighbouring electric apparatus or wiring. For those who are not familiar with the film reproduction process, it should be explained that two projectors are employed in order to obtain continuity in the presentation of the film, which might be several thousand feet in length.

Preparing Alternate Machines.

As each individual part is usually limited to a length of 1,000 feet and a maximum of 2,000, it is necessary to have a second machine which can be prepared with the next consecutive part and brought into operation immediately the previous part has passed through the first machine. This is done by lacing up one part on one machine and the next consecutive part on the second machine or reproducer. The operator knows by experience just how long it takes for each machine to attain full speed after switching on the motor. When the first film is nearing its end, the motor of the second machine is switched on in time to allow it to attain its full speed just as the first film is ending,

and at which moment the shutters are operated, one of which douses the light from the outgoing machine and the other opens up the shutter controlling the light of the incoming machine. When all the trailing portion of the film of the first machine has been wound on to its lower spool, this machine is shut down and is later prepared for the next part.

Controlling the Output.

The electrical output from each reproducer passes through a fader which controls the volume or output of either machine

gramme, or for providing effects, etc., is often included. This consists of an apparatus comprising two electrically driven turntables and electrical pick-ups or reproducers, a fader for controlling the volume and output from either turntable at will, and signalling lamps and controlling switches for the motors. The main amplifier rack in the operating box is provided with a switch so that the amplifier and horns may be connected to the motion picture reproducers in the operating box, or to the non-sync. as desired.

Equipment is sometimes provided so

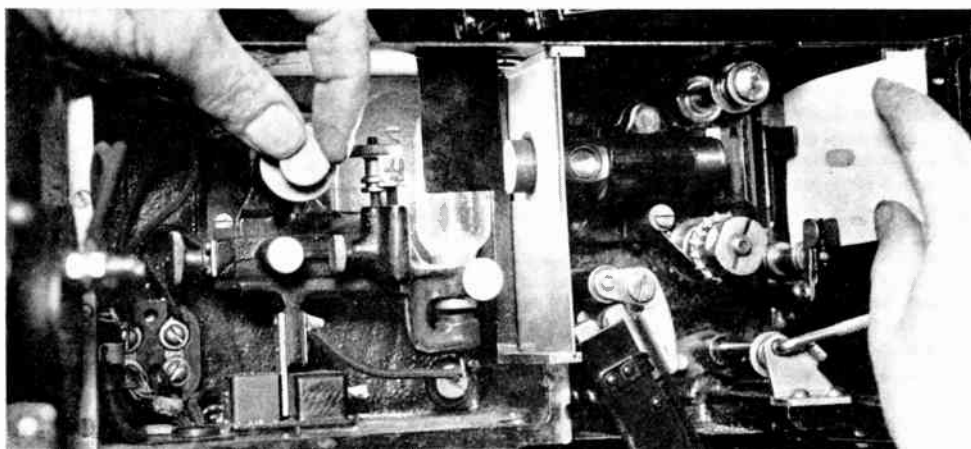

Fig. 5.—How to Focus the Exciting Lamp in the W.E. Apparatus.
Make sure that all clamping screws are tight after focusing the exciting lamp.

as desired, before passing it on to the main amplifier, which is also situated in the operating box, and which is used for raising the intensity of the speech currents and for providing power for operating the speakers or horns which are placed behind the screen. An additional horn is provided in the operating box for monitoring purposes, so that the operator can follow and control the volume of the reproduction in the auditorium.

Reproducing Gramophone Records.

Non-synchronous equipment for reproducing gramophone records for providing incidental music before the commencement or during the intervals of a pro-

gramme, that certain seats in the theatre can be fitted with sockets into which telephone headsets can be plugged for the use of deaf people. In this case, these sockets are connected to a special amplifier, which is in turn connected to the main amplifier circuit.

NOTES ON WESTERN ELECTRIC EQUIPMENT.

The Sound Unit.

This is the point at which the photographic record of the sound on the film is converted first into light and then into electrical energy. The sound unit is divided into three parts; on the left is the compartment which contains the exciting lamp, which provides a light of constant

intensity. In the middle is the film compartment, which contains the lens assembly for focusing this light into a narrow slit on to the film, and the sound gate through which the film passes on its way from the picture projector to the lower magazine. On the extreme right is the photo electric cell compartment, where the light which has passed through the sound track is picked up by the photo electric cell.

The Exciting Lamp.

The exciting lamp, which takes a current of 3.6 to 3.9 amps. at about 7 volts, is mounted on a bracket which plugs in so that it can be easily replaced. The adjustment of the lamp in this bracket is provided for in three directions so as to permit of easy focusing.

The Lens Assembly.

The lens assembly comprises a narrow slit or aperture, a condenser and lens for concentrating the light from the exciting lamp on to one side of this slit, and an objective lens for focusing the image of this slit through a hole or slot in the aperture plate on to the film. A tension pad maintains a light pressure on the film as it passes the aperture plate so that the position of the film does not change. The light emerging on to the other side of the film, which is varying in intensity in accordance with the density or the proportion of white to black of the sound track, passes through the "window" or the unsilvered portion of the photo electric cell, where the changes in light are converted into electrical current changes.

The Motor.

It is of extreme importance in the presentation of talking pictures that there shall be no appreciable variation of speed of the reproducers, as changes in speed produce changes in pitch, and even very small changes in pitch, especially if sudden, are easily detected and are very irritating. To ensure constancy of speed when the voltage and frequency of the supply is subject to variation, a special kind of motor combined with an electrical

governing device called the motor control box is employed. The motor control box is a rectangular metal cabinet about 22 inches high by 12 inches by 8 inches wide, placed alongside the machine and connected to the motor by flexible conduits. This contains a number of valves, transformers, condensers, chokes, etc.

Type of Motor Used.

The motor is of the four-pole alternating current repulsion type operating from 110-volt 50 or 60-cycle supply. The stator is very similar to that of an ordinary induction type motor and is connected direct across the mains. The rotor or armature is fitted with a commutator and has four sets of brushes and is similar to that of an ordinary D.C. motor. When the brush circuit is open there is no current circulating in the armature and, therefore, no torque is produced and the motor will not run, but when this circuit is closed the motor will run at a speed depending upon the load and on the amount of resistance or reactance in the armature circuit. The voltage at the brush terminals is alternating of the same frequency as the supply. Control of the speed of the motor is obtained by varying the reactance in the rotor circuit.

The Motor Control Box.

If a coil of insulated wire, through which an electric current is passing, is wound around an iron core, a magnetic flux is produced in the core, but this flux does not go on increasing indefinitely as the value of the current increases; after a while, a large increase in current produces only a very small change in flux, or in other words, the core becomes magnetically saturated. Now the reactance or resistance to alternating current of a choke coil is dependent upon *the change in flux* produced. So if we can provide some means of varying the degree of magnetic saturation of a choke through which an alternating current is passing, we can vary its reactance or choking effect. This can be done by producing a constant flux in the core by means of an additional coil wound around it and through which is passed a D.C. current, and it is this method

which is adopted. The rotor current is caused to pass round two legs of a three-cored choke in the motor control box, and the winding around this third core is connected to a source of D.C. which are the two rectifying valves V_1 and V_2 in Fig. 3.

How the D.C. Output is Controlled.

The D.C. output of V_1 and V_2 is controlled by the voltage drop across the

voltage across this bridge controls the phase relationship and voltage of the grid of V_4 . A very small change in frequency causes a very large change in the phase relationship and voltage of the grid relative to the plate of V_4 .

Fader.

This piece of apparatus is used to control the output or volume from either machine as desired. It consists of a network of resistances calibrated in steps and so arranged that variation in the output is obtained without affecting the impedance matching of the associated amplifiers. It takes the form of a metal box about 10 inches square and 6 inches deep mounted on the front wall of the projection room between the two reproducers. It is fitted with a knob and pointer and has a double-sided scale; one for each reproducer.

Main Amplifier Rack.

This may consist of a voltage amplifier (41 type) and one or more power amplifiers (42 and 43 types) mounted on a rack or channel frame. Alternatively, it may comprise a combined voltage and power amplifier (46 type) used alone or followed by another

power amplifier (43 type).

In every case the outputs of all last-stage amplifiers are reduced to a low impedance so that the circuits between them and the loud-speakers on the stage will not be susceptible to interference from neighbouring electrical apparatus or cables.

Output panels are used in all cases except when the 46 type amplifier, which has a switch for cutting out the stage horns, is used alone. When the output of the last amplifier is already of low impedance, the output panel is provided with switches

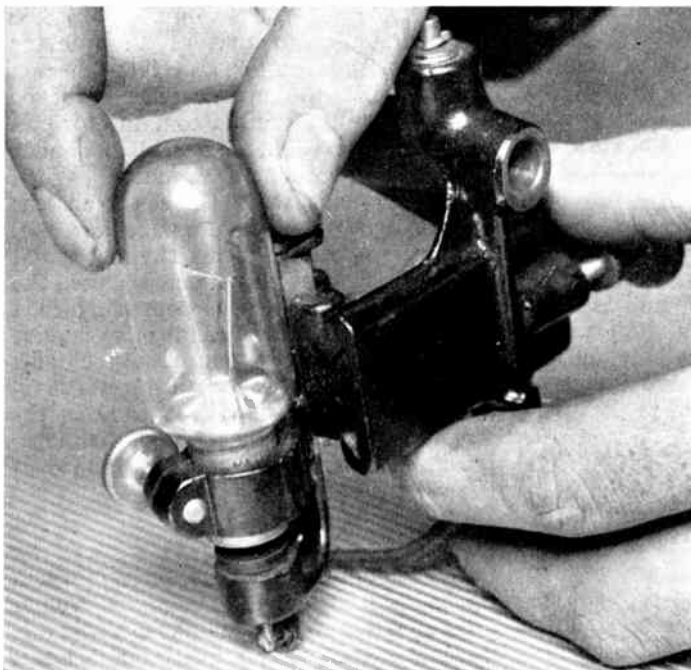

Fig. 6.—FIXING EXCITING LAMP IN BRACKET.

When setting up an exciting lamp set the filament square with the length of the bracket and screw clamp up tight.

resistance R_1 in the plate-filament circuit of V_4 , and this in turn is dependent on the plate current in V_4 , which again is dependent on the grid of V_4 . Combined in the same housing as the motor is a small alternator, which generates 720-cycle A.C. current when the motor is running at its normal speed of 1,200 r.p.m., and it is from this alternator that V_4 obtains its plate supply. Also across this 720-cycle circuit is connected an electrical bridge, one arm of which contains a resonant electrical circuit having a natural frequency of 720 cycles. The

for controlling each stage receiver and a separate volume control for the monitor horn. In other cases the output panel has incorporated in it an auto-transformer with tappings to provide for impedance matching of receivers and is provided with switches controlling individual receivers or horns.

Where non-synchronous equipment is used a switching panel is provided so this can be connected to the main amplifier equipment in place of the picture projector as desired. Notification is given to the non-synchronous operator by means of a signal light when the non-synchronous is connected to the main amplifier.

AMPLIFIERS.

49 Type.

This is the preliminary amplifier mounted on the front of the reproducer and is used for coupling the photoelectric cell to the main amplifier and raising the intensity of the film out-

put. This is a two-valve transformer-coupled amplifier employing two 239-type valves, the filaments of which are operated in series off a 12-volt battery supply. H.T. supply for the amplifier and photo electric cell excitation is obtained from 90-volt dry batteries situated in one corner of the operating box. Grid bias is obtained automatically by the drop across the resistances in the filament circuit.

41 Type.

This is a three-valve transformer coupled input and output with two stages of resistance coupling for the inter stages. 239-type valves are used, operating in series off a 12-volt battery supply. H.T. is obtained from the 42-type power ampli-

fier through a filter circuit. Grid bias is automatic. This amplifier is fitted with a gain control on the input side calibrated in steps of 3db. A meter is inserted in the filament circuit and another can be switched into the plate circuit of each valve for measuring plate current as desired.

42 Type.

This is an entirely self-contained A.C.

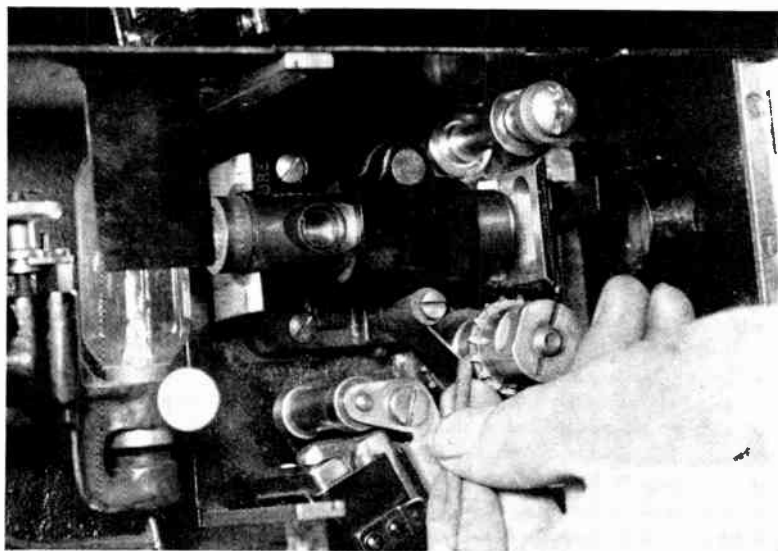

Fig. 7.—CLEANING DIRT OFF THE SPROCKETS OF THE 707 DRIVE.
This should be done with a hard wood stick.

main operated power amplifier employing one stage of push-pull. Two half-wave rectifying valves are used for the H.T. supply, and a tapping is provided for feeding the 41 amplifier. The same type of valve is used for both amplifying and rectifying stages. In the case of the rectifiers, the grids and plates are connected together. A milliammeter is inserted between the amplifying and rectifying stages to measure the plate current. A special three-way snap switch is provided so that the filaments can be switched on first so that the filaments can be given time to warm up before the plate current is switched on. 205-type valves are used and the output impedance may be 8, 250 or 500 ohms.

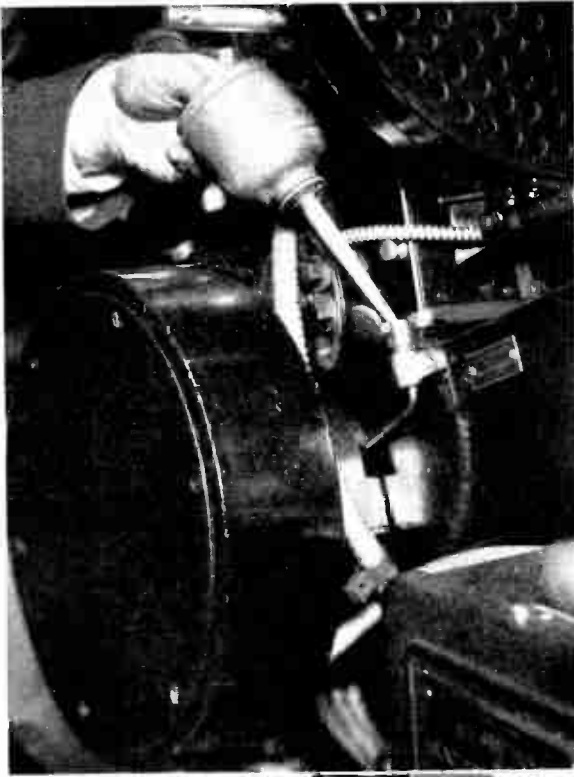
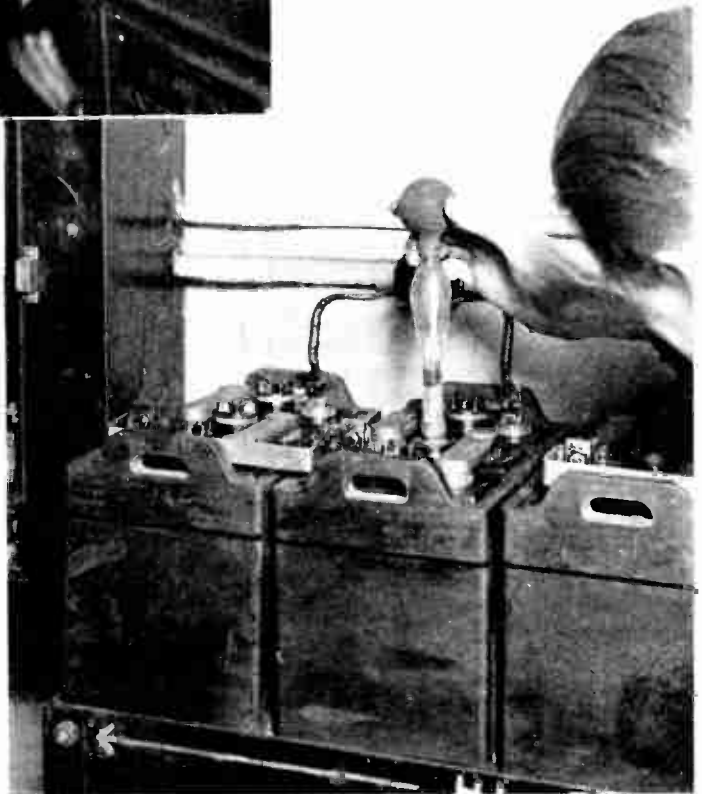

Fig. 8 (Left).
LUBRICATING THE 707 DRIVE.

This should be done with the special oil can provided. Make sure that the oil goes down the pipe and enters the p.b. bush by pressing the end of the spout right into the bottom of the lubricator and pressing smartly on the button at the bottom of the can. Should any excess oil exude into the sound unit, wipe this away.

Fig. 9 (Right).
TAKING SPECIFIC GRAVITY READINGS OF CELLS OF 12-VOLT BATTERIES.

When taking specific gravity readings of the batteries let the eyes be on a level with the acid in the hydrometer and take the level at lowest point of the liquid column.



43 Type.

This is a larger edition of the 42 type amplifier. The voltage of the amplifier plate circuit is approximately 750. The output impedance is 8, or 500 ohms, and the 211 type of valve is used in this amplifier.

46 Type.

This is a combined voltage and power amplifier employing two 239-type valves with resistance inter-stage coupling and filaments operated in series from 12-volt battery supply transformer coupled to

moving-coil, diaphragm-type, receiver, which is separately excited, taking about 1½ amps. at about 7 volts. The efficiency of this receiver is in the neighbourhood of 30 per cent. In the case of the wood type horn, one or two receivers may be used with each, and the metal type horn may have two or four receivers.

L.T. Batteries.

These are provided in two banks made up into batteries of 12 volts from 6-volt monobloc units of three cells each.

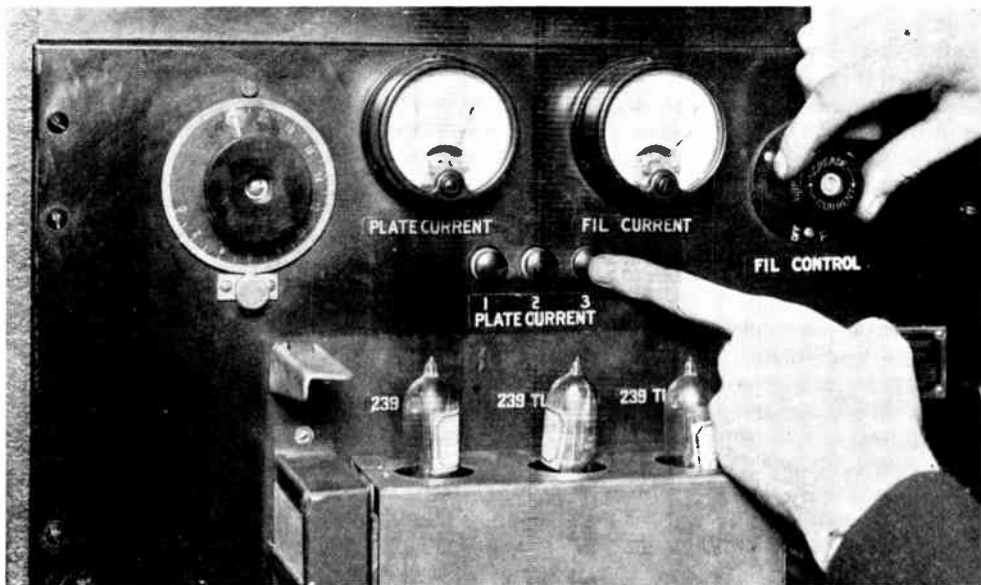

Fig. 10.—How to TEST the EMISSION OF THE VALVES IN THE 41 AMPLIFIER. This is done by observing the plate readings when varying the filament current.

one stage of push-pull with two half-wave rectifying valves operating from 110-volt supply. 205-type valves are used in the push-pull and rectifying stages. The output impedance is 8, or 500 ohms.

Horns.

All loud-speakers or horns are of the folded exponential type, having an approximate developed length of 12 to 14 feet, and an opening nearly 4 feet 6 inches square. They have a lower cut-off of between 50 and 60 cycles. They are sometimes made of wood and metal or entirely of metal. They are driven by a particularly efficient type of

One bank is available for operating while the other provides a standby or is being charged. In some large systems each bank consists of six 6-volt units, two of these units being connected in series supplying current for the amplifier filaments and exciting lamps, and the other four units being connected into lots of two 6-volt units in series parallel for supplying horn excitation. The present practice is to use four units per bank connected in series parallel for supplying both horns and filament and exciting lamp current. These units are of a slightly larger capacity than where 12 units are employed. Smaller



Fig. 11.—HOW TO HANDLE THE 211E VALVES WHEN CHECKING THEIR EMISSION. As these valves get very hot it is advisable to use a rag or cloth as indicated.

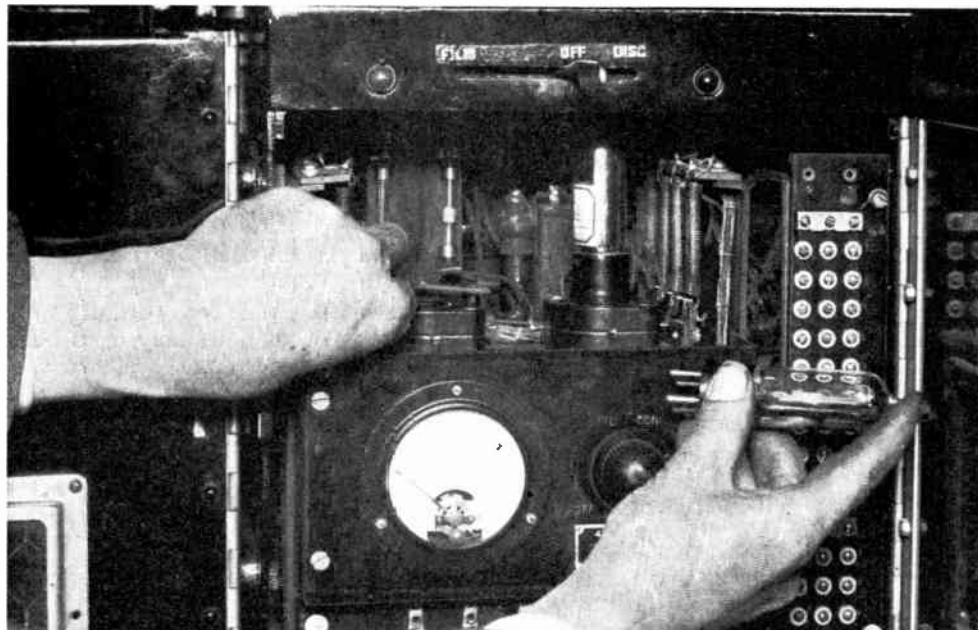

Fig. 12.—METHOD OF REMOVING A VALVE FROM THE MACHINE AMPLIFIER.

Hold the cradle with the left hand and grip the base of the valve between the thumb and middle finger and place the index finger on the end of the valve to prevent the valve coming into contact with the metal top of the enclosing compartment.

systems employ banks, each of which is made up of two units of a still larger capacity supplying both horn and filament current.

Battery Charging.

Where the supply is 50 to 60-cycle A.C., tungar rectifiers are used. In systems employing six units per bank, the horn batteries are charged in series off a 30-volt supply from two half-wave rectifiers and the filament batteries from a 15-volt supply using one half-wave rectifier.

Where each bank comprises four units these are charged in series from a 30-volt supply from two half-wave rectifiers and in the smaller systems the charging supply is obtained from two half-wave rectifiers operating at 15 volts. Where the theatre supply is D.C. a small motor generator supplying current at about 15 volts is generally used.

OPERATION AND MAINTENANCE OF WESTERN ELECTRIC APPARATUS.

Organisation in the Projection Room.

In the cinema business the success of the performance rests very largely with the operating personnel, and since the advent of "sound" the responsibility of the projectionist is greater than it ever was. It is therefore of the greatest importance that the work of the staff, whether large or small, should be properly organised. It should be one man's job to examine the films; another should be delegated to look after the batteries, to see that they are being charged and properly maintained. Another duty would be to check the reproducers, amplifiers and receivers, and some-

one should be given the job of seeing that adequate spares are always on hand. Provision should be made that when the person normally responsible for any one of these duties is away, another takes over the job.

One of the most important duties of all is the maintenance of scrupulous cleanliness in the operating box and its adjoining passages. Dust and dirt are the greatest enemies to good reproduction. Films are very easily scratched and the



Fig. 13.—CLEANING LEGS OF VALVES OF MOTOR CONTROL BOX. This should be done once a month.

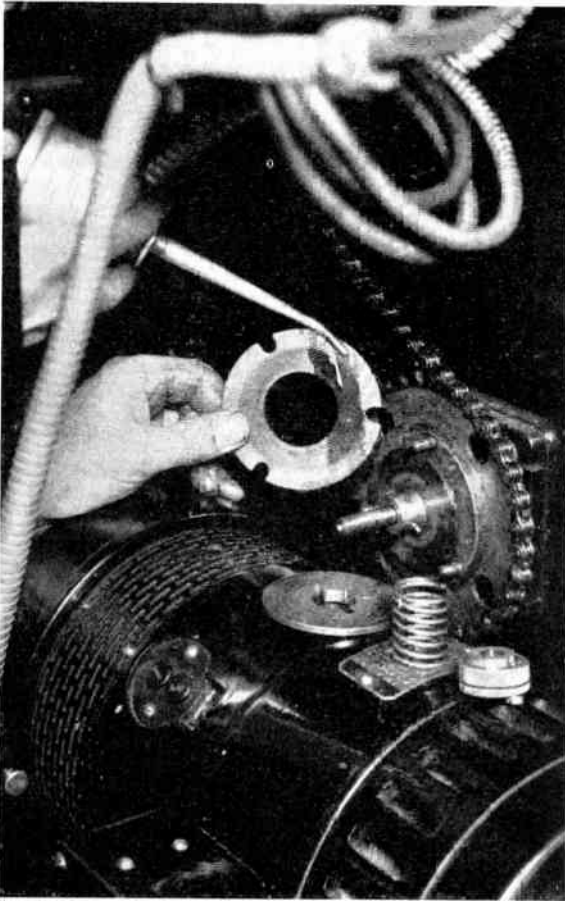

Fig. 14.—CLEANING THE FRICTION DRIVE OF THE 710 MACHINE.

This shows the friction drive dismantled for lubricating, which should be done at least once a week.

delicate mechanisms of the machines are liable to excessive wear and corresponding deterioration in their operation, resulting in increased cost of maintenance.

Treating the Floors Where Apparatus is Installed.

Probably the most prolific causes of dust are the unprotected cement floors. If possible, the floors of the operating box and its adjoining passages and rewind room should be covered with linoleum. If this cannot be done, the floor should be painted, or, better still, treated first with a hardening solution and then oiled

or painted. An inexpensive hardening solution can be made up by dissolving sodium silicate or "water-glass," one part to four or five parts of water. The floor should be first thoroughly washed, allowed to dry and then washed over with silicate solution and again allowed to dry. At least three applications of silicate solution should be given. One or two final coatings of boiled linseed oil thinned with a little petrol will greatly add to its durability and freedom from dust.

Ventilation of the Operating Box.

Another cause of trouble is due to inadequate ventilation of the operating box. Ample provision should be made to withdraw fumes from the arcs immediately so that the metallic salts, which are so often incorporated in the manufacture of lamp carbons, will not deposit themselves over everything in the operating box.

The reproducers should be wiped down every day. Oil and grease should never be allowed to accumulate.

WHAT TO DO EVERY DAY.

Make it a daily practice to carry out the following routines:—

(1) Amplifiers and Receivers.

After switching on amplifiers and horns test out the receivers.

In all cases, except those where a 46-type amplifier is used alone, each horn or receiver should be switched on in turn by means of the key on the output panel, and a card or finger flicked in front of the aperture plate in the sound unit. When carrying out this test the exciting lamp and film amplifier must be switched on and the pressure pad should be in the "off" position. A loud pop should be heard from each of the stage horns in turn when listening through one of the portholes after removing the glass.

Where the main amplifier consists of one of the 46 type only, the above test should be carried out both with and without the monitor volume control on.

Should there be no response from one receiver, make sure that the fuse in "B" box (if any) has not blown, otherwise replace defective receiver.

If on "disc," put F.D. switch over and after putting fader up, test out by tapping lightly on needle holder of 4-A reproducer. Do not stroke needle in a direction away from the diaphragm.

Test Both Machines.

After carrying out the above test on one machine, proceed to test the second machine to make sure that it is functioning satisfactorily. This applies to both "film" and "disc."

(2) Rack Amplifiers.

A check should be made on all meter readings to see that they are quite normal.

The filament current of all 239-type valves used in 49, 41 and first stages of the 46-type amplifier should be 270 milliamps. The plate current of all the valves in the 41 amplifier should read between 1.2-1.5 m.a., with normal filament current. Should the plate current fall rapidly when the filament current is lowered to 250 m.a., then the valve should be changed. This test is an arbitrary one, and account should be taken of its previous behaviour. Sudden changes in behaviour should be looked upon with suspicion and, should any doubt exist, it is

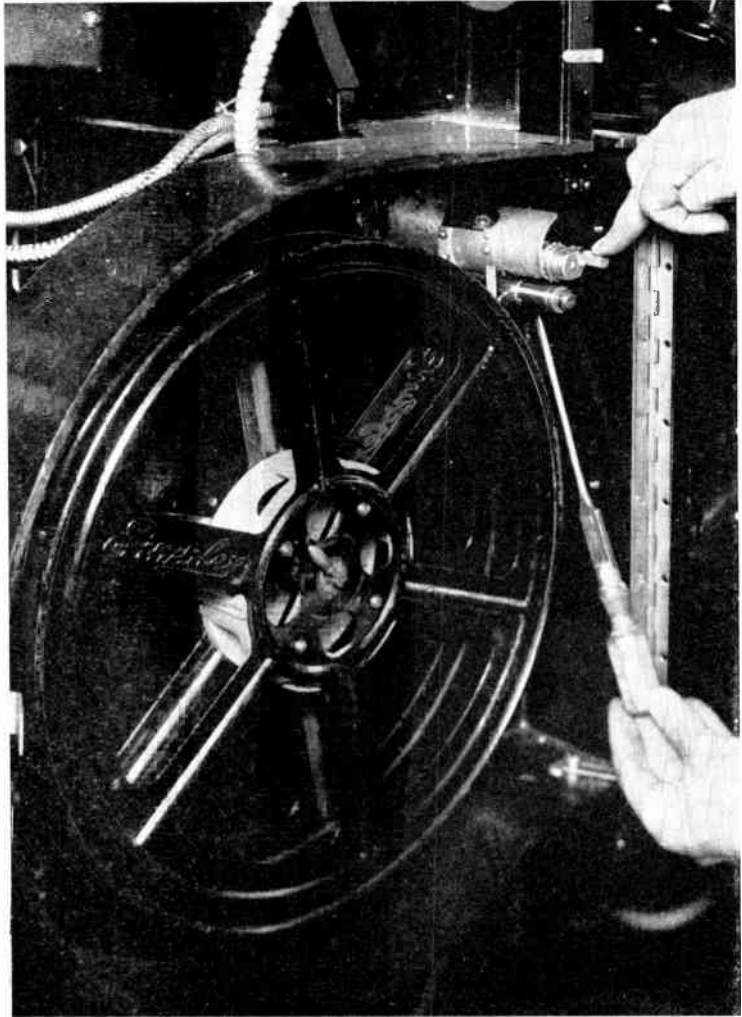

Fig. 15.—ADJUSTING THE IDLER ROLLER OF 711 DRIVE. This should be made to a maximum clearance of two film thicknesses and can often with advantage be made to less than this.

better to change the valve and consult the service engineer on his next visit. This applies to all valves in whatever position they may be used.

The value of this daily check is that it may give warning of the impending failure of a valve.

Testing Plate Current.

The plate current of the first stage 239 valve in the 46-type amplifier should be between .8 and 1.2 m.a., and the second

valve should read 1.3 to 1.5 m.a. The plate current of the 205's in the 46 amplifier should be between 50 and 60 m.a.

The meter on the 42-type amplifier should be about 60 m.a. and in any case should be within the red portion of the scale. Each valve in turn should be withdrawn and checked against its partner and in the case of amplifying valves there should not be a greater difference than 5 m.a. between these two. This remark also applies to the 205 valves in the 46 amplifier. In this latter case the amplifying valves are on the right-hand side and the rectifiers on the left.

How to Handle the Amplifier Valves.

The 211 valves in the 43-type amplifier

should be checked in the same way, but considerable care must be used as the amplifier valves, in particular, get very hot and should be handled by using a piece of cloth in each hand, gripping the body of the valve close to its base with the left hand, and steadying it with the right. The normal reading should be about 125 m.a., but in any case should be within the red portion of the scale. No individual valve should vary more than about 10 points from its partner in the amplifier position.

When testing out any valve in the push-pull stages do not prolong the test for more than is absolutely necessary.

What Bright Spots on Valve Filament Indicate.

Bright spots appearing on the filaments of valves are generally an indication that a valve is nearing the end of its useful life; especially if this symptom appears after considerable use and in this case close observation should be kept on the valve in question.

(3) Batteries.

These should be charged to specific gravity not exceeding 1.270. The specific gravity of the pilot cells in each bank of batteries should be recorded accurately on the battery log sheet, together with the *average* charging current and hour and the discharge current and time.

(4) Lubrication.

The following points on the reproducers require lubrication daily: The 707 and 708 drives; use the special oil can provided and in the case of the 707 make sure that

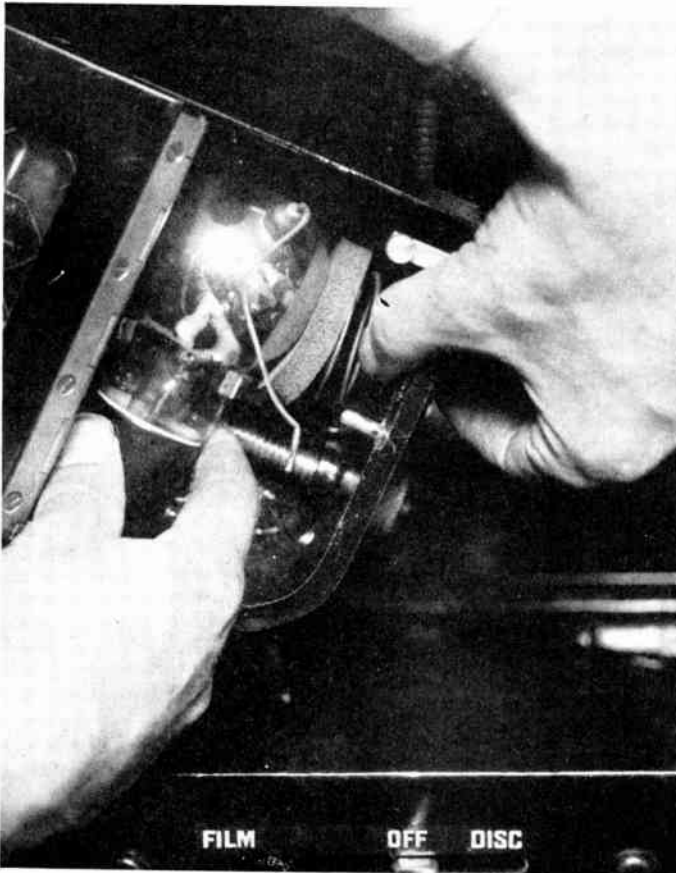

Fig. 16.—REMOVING THE PHOTO-ELECTRIC CELL.

Great care should be taken when handling the photo-electric cell, so as not to loosen the socket from the glass.

the oil goes down the pipe and enters the p.b. bush by pressing the end of the spout right into the bottom of the lubricator and pressing smartly on the button at the bottom of the can. Should any excess oil exude into the sound unit, wipe this away.

Other points requiring daily lubrication are the knuckles of the 702-A shaft, the lubricator of the 712 drive, in the case of Simplex Heads, or its equivalent when other makes of projectors are used. The 711 drive and the spindle lubricator of the 710.

WHAT TO DO EVERY WEEK.

(1) Batteries.

The S.G. of all cells should be taken and a note made of any difference greater than 10 points in any one unit, or 15 points between cells of units belonging to the same group.

Charge batteries up to a final gravity of 1.280. Top up with distilled water any cells in which the electrolyte is low or not covering the plates. Wipe clean the tops of all cells.

Dust the charging panel and switches and wipe clean the blades of the switches and smear contact surfaces with vaseline.

Examine and clean if necessary the fuse contacts on charging panels.

(2) Lubrication.

Dismantle and thoroughly clean the friction discs of the 710 drive; lubricate with fresh KS-Oil; reassemble and adjust.

(3) Conversion Plant (if Installed).

Examine commutators and slip-rings of all motors and alternators; make sure that all brushes are free in their holders, and that the pressure is approximately equal.

Should any brush be jammed in its



Fig. 17.—FILLING 703 DRIVE WITH OIL.

When adding fresh oil, pour between worm wheel and case and not over filter springs.

holder, this is almost certain to be due to dust in between. Make sure that the brush is released and blow out the machines with a bellows or blower if available.

Should any of the commutators show signs of ridging, make sure that the tracks of adjacent sets of brushes are overlapping.

If the commutator is smooth and running true, wipe with a clean bit of rag, free from lint, and do not attempt to clean up with sandpaper, even if it is a dark chocolate in colour.

Examine starter and switch contacts and clean and lubricate if necessary. If D.C. motor generators are installed for

or snap switches on the power amplifiers be stiff or harsh in action, wipe contacts with clean rag and smear small quantity of vaseline on same.

To remove covers of switches on the 42 and 43 type amplifiers unscrew knobs in anticlockwise direction, when cover can be withdrawn. In the case of 46-type amplifiers, pull the knob about $\frac{3}{8}$ inch towards you and then unscrew in anticlockwise direction, when cover can be removed.

Cleaning the Contacts of the Fader.

If your operating box is badly ventilated or very dusty, it may be advisable occasionally to remove the cover of the fader and wash off any dirty grease or vaseline with carbon tetrachloride and put on small quantity of fresh vaseline. This should not be done more often than once a fortnight, even under the worst conditions. Only pure carbon tetrachloride should be used and this should be applied with a tooth-brush.

What to Do Before Lacing Up.

Before lacing up make sure that all sprockets and the faces of all parts against which the film has to pass are entirely free from dirt. Emulsion adhering to the face of the aperture

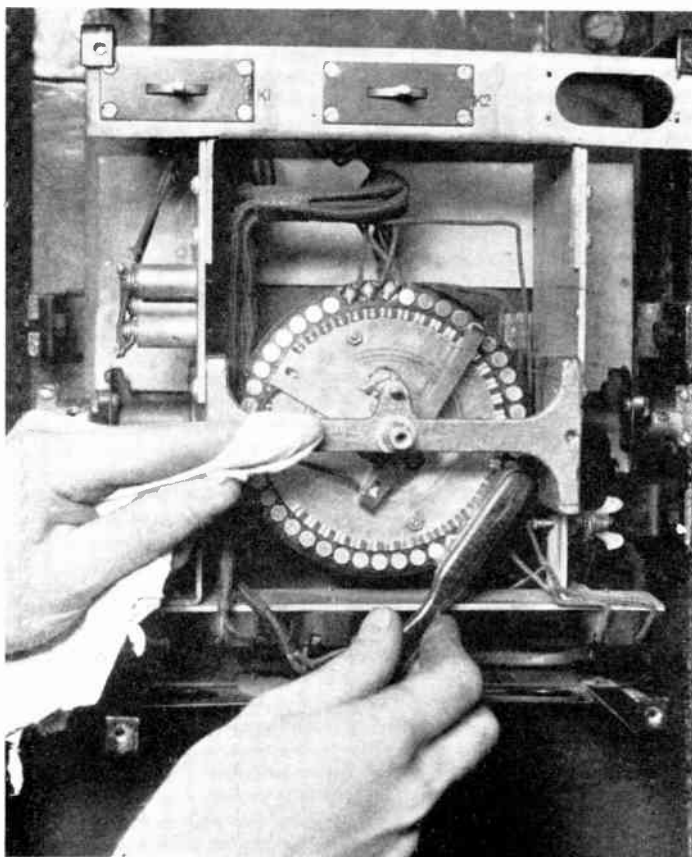

Fig. 18—How to Clean the Fader.
Always use a clean brush and make sure that all dirt is removed from the fader contacts and wiper arm.

battery charging, examine auto cut-out. See that there is adequate mercury in cups and that this is covered by a small film of oil.

Examine all fuses; replace any which show signs of overheating.

(4) Operating Box.

Should any of the horn or power switches

plate will not only tend to damage the delicate face of the film, but will tend to put the film out of focus with the light beam from the exciting lamp; this will result in loss of volume and quality as the higher frequencies will not be reproduced. Dirt on the 707 sprocket may result in an uneven pull on the film and may introduce "flutter."

**Indispensable to every Electrical
Engineer, Designer and Manufacturer**

THE
**ELECTRICAL ENGINEER'S
DATA BOOKS**

General Editor: E. B. WEDMORE, M.I.E.E.

(The Director of the British Electrical and Allied Industries Research Association.)

This important reference work contains much valuable new data that has hitherto been concealed in the journals of foreign institutions, in the unadvertised publications of research associations and the technical publications of manufacturers.

"The Electrical Engineer's Data Books" provide, in two handy volumes, a collection of all the most recent specialised knowledge, thus forging the necessary link between the scientist, the research worker and the practical engineer.

The detailed nature of the text and the wealth of original illustrations, tables and formulæ make this work indispensable to every Electrical Engineer, Designer and Manufacturer.

VOLUME I.—Lighting ; Switch-gear ; Power Transmission and Distribution ; Distribution by Underground Cable ; Transmission by Overhead Lines : Traction : Electrical Machinery.

VOLUME II.—Insulation ; Magnetic Materials and Testing ; Properties of Metals and Alloys ; Measurement of Resistance, Inductance and Capacity ; Corona Discharge.

APPENDICES.—Mathematical and Miscellaneous Tables, List of Integrals, Electrical, Mechanical and Physical Tables, etc. ; Electricity and Magnetism ; Wiring Rules ; Home Office and Board of Trade Regulations, etc.

**EXAMINE THE WORK IN YOUR
OWN HOME FREE!**

In order to give you an opportunity of examining this invaluable work at your leisure, the Publishers are prepared to supply the two volumes on Five Days' Free Approval. Send p.c. to-day for full particulars and details of the generous deferred payment system, to : Dept. E.E.7, The Home Library Book Co., 23-24, Tavistock Street, London, W.C.2

Geo. Newnes, Ltd.

This article on Talking Picture Apparatus is continued in Part 12, published January 1st, 1932. Order your copy to-day.

RALPH STRANGER'S WIRELESS BOOKS

*The Wireless Library for the
Wireless Enthusiast:*

MATTER AND ENERGY
ELECTRONIC CURRENTS
ELECTRIFIED MATTER
MAGNETISM AND ELECTRO-
MAGNETISM
THE MATHEMATICS OF WIRELESS
BATTERIES AND ACCUMULATORS
SEEING BY WIRELESS (TELEVISION)
MODERN VALVES
WIRELESS COMMUNICATION AND
BROADCASTING
WIRELESS WAVES
HOW TO UNDERSTAND WIRELESS
DIAGRAMS
SELECTION OF WIRELESS SIGNALS
DETECTION OF WIRELESS SIGNALS
AMPLIFICATION OF WIRELESS SIGNALS
REPRODUCTION OF WIRELESS SIGNALS
WIRELESS RECEIVING CIRCUITS
WIRELESS MEASURING INSTRUMENTS
THE BY-PRODUCTS OF WIRELESS

SOME PRESS OPINIONS:—

"The new shilling library aims at giving the wireless enthusiast a sound theoretical and practical grip of his subject. The author employs clear and simple language, and starts practically from zero."—*The Broadcaster*.

"These books deal with a highly technical subject in the simplest language which enables those who have no scientific training to grasp the wonders of wireless, and assist the listener to get the best possible results from a receiving set."—*Railway Review*.

ONE SHILLING EACH

By Post 1/2 each.

On sale at all Newsagents, Bookstalls and Bookshops, or by post from **GEORGE NEWNES, Ltd.**, 8-11, Southampton Street, Strand, London, W.C. 2.

**WIRELESS:
THE MODERN
MAGIC CARPET**

Fourth and Revised Edition

If you know nothing about wireless and do not even possess a receiving set, this book will show you how to provide yourself with an interesting and absorbing hobby. If you are a listener, but rather weak on the technical side, it will save you much unnecessary worry and expense. If you wish to experiment, this volume will provide you with valuable experimental data. If you are an expert and have to lecture, it will give you some useful lecture material.

SOME PRESS OPINIONS:—

"Mr. Stranger . . . gives a simple, yet authentic introduction to all the 'mysteries,' and explains them away in an exceedingly interesting and readable way. . . . A book which should go on every listener's bookshelf."—*The Star*.

"A good book simply written."—*The Daily Mirror*.

". . . It will be surprising if such an ably written book as this does not find a wide sale."—*Daily News*.

". . . Mr. Stranger has succeeded in doing one thing that will endear him to all students interested in electricity. He has succeeded in making static electricity fascinating. . . . The book should prove of great value to all those who have a set or contemplate the construction of one."—*World-Radio*.

". . . The subject, in both theoretical and practical aspects, is dealt with in a lucid manner guaranteed to inculcate knowledge without pains."—*Amateur Wireless*.

3/6 nett.

By Post 3/9.

George Newnes, Ltd.