

To be Completed in about 32 weekly parts.

# NEWNES PRACTICAL ELECTRICAL ENGINEERING



**GIVEN INSIDE**

Pictorial Diagram for

**WESTERN  
ELECTRIC  
SOUND  
PROJECTOR  
SYSTEM**

**Printed in Two Colours**

**1½**

**PART  
4**

**A PRACTICAL WORK WRITTEN BY EXPERTS**

YOU CAN HAVE A COLLEGE TRAINING IN ALMOST ANY CAREER FOR A FEW SHILLINGS MONTHLY

STUDY AT HOME

IN YOUR SPARE TIME

FOUNDED 1900.

31 YEARS OF SUCCESS.

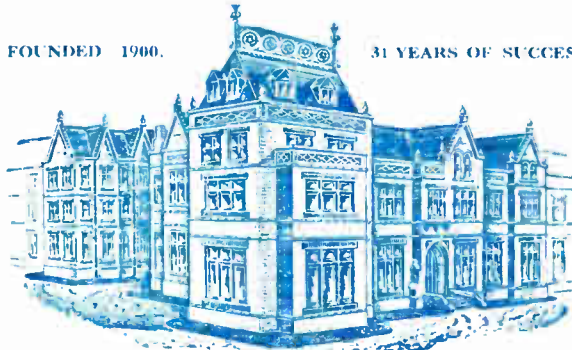

THIS IS THE BENNETT COLLEGE - - ALL OF IT

The Bennett College is not a Rented Room in a well-known street—it is a College. Over 30 years ago the Founder took as his motto what has now become a household slogan :

# LET ME BE YOUR FATHER

In many trades and professions there are more vacancies than trained men to fill them. We do not profess to act as an employment agency, but our gigantic organisation certainly does tell us where the demand exists, thus enabling us to give FATHERLY ADVICE ON ALL CAREERS AND THE POSSIBILITY OF EMPLOYMENT, FREE.



*J.B. Bennett*

WE TEACH ALL BRANCHES OF THE FOLLOWING VOCATIONS AND SPECIALISE IN ALL EXAMINATIONS CONNECTED THEREWITH.

## THE MOST SUCCESSFUL AND MOST PROGRESSIVE CORRESPONDENCE COLLEGE IN THE WORLD

Aviation Engineering.  
Boiler Engineering.  
Boiler Making.  
B.Sc. (Engineering).  
Civil Engineering :  
A.M.I.C.E.  
Quantities—Specifications.  
Commercial Art

Concrete and Steel.  
Draughtsmanship :  
Electrical or  
Mechanical.  
Electrical Engineering :  
A.M.I.E.E.  
City and Guilds.  
Engineering Mathematics.  
Foundry Work.  
Heat Engines.

Heating, Ventilating and  
Lighting.  
Internal Combustion Engines.  
Machine Designs :  
Theory of Machines.  
Marine Engineering :  
Motor.  
Steam.  
Mechanical Engineering :  
A.M. Ins., B.E.  
A.M.I. Mech.E.  
City and Guilds.  
Pattern Making.

Mechanics.  
Metallurgy of Steel.  
Mine Electrician :  
A.M.E.E.  
Mining (all examinations).  
Motor Engineering :  
A.M.I.A.E.  
Municipal and County  
Engineers :  
M. and C.E.  
Naval Architecture.  
Pumps and Pumping  
Machinery.  
Ship Building.  
Structural Engineering.  
Telegraphy and  
Telephony.

IF YOU DO NOT SEE YOUR OWN REQUIREMENTS ABOVE, WRITE TO US ON ANY SUBJECT.

IT COSTS NOTHING TO ENQUIRE.

Also ask for Our New Book (FREE OF CHARGE)

### THE HUMAN MACHINE

SECRETS OF SUCCESS

WE TEACH BY POST IN ALL PARTS OF THE WORLD

Note Address Carefully:

The BENNETT COLLEGE, Ltd., Dept. 119, Sheffield



Dept. 119

TABLE I.  
SUMMARY OF APPLICATIONS OF STANDARD MOTORS.

Type of Enclosure.	Suitable For.
Protected and screen-protected.	Engineering workshops (individual and group drives); wood-working plants; printing works; textile factories (weaving and printing, but not desirable in spinning mills or card rooms where the atmosphere is laden with cotton fibre or fluff); pumping plants; lifts.
Canopy protected or drip proof.	Laundries and wash-houses; basement pump rooms in power stations; outdoor plants (gantry cranes, sawmills) not exposed to driving rain; auxiliary services (in engine room) on ships.
Pipe ventilated . .	Boiler house fans (induced draught); textile factories (spinning mills and card rooms); chemical works; paint and varnish factories; cement works; flour mills; paper mills.
Totally enclosed . .	Boiler-house plant (mechanical stokers, forced draught fans, coal handling machinery); overhead travelling cranes; foundries; steel mills; cement works (when pipe ventilated motors cannot be installed); coal-cutting machines; capstans; winches.

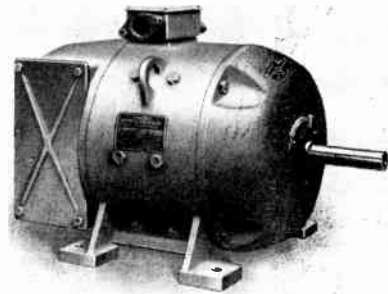

Fig. 10.—TOTALLY ENCLOSED WEATHERPROOF MOTOR.

This is a further modification of the motor of Fig. 6. Cast-iron covers with packed joints are fitted at the commutator end, and a special solid end bracket is used at the driving end. (B.T.-H. Co.)

**SPECIAL TYPES OF MOTORS AND THEIR APPLICATIONS.**

**Fractional H.P. Motors.**

In these motors the field frame is constructed of steel laminations in order to ensure high and consistent magnetic

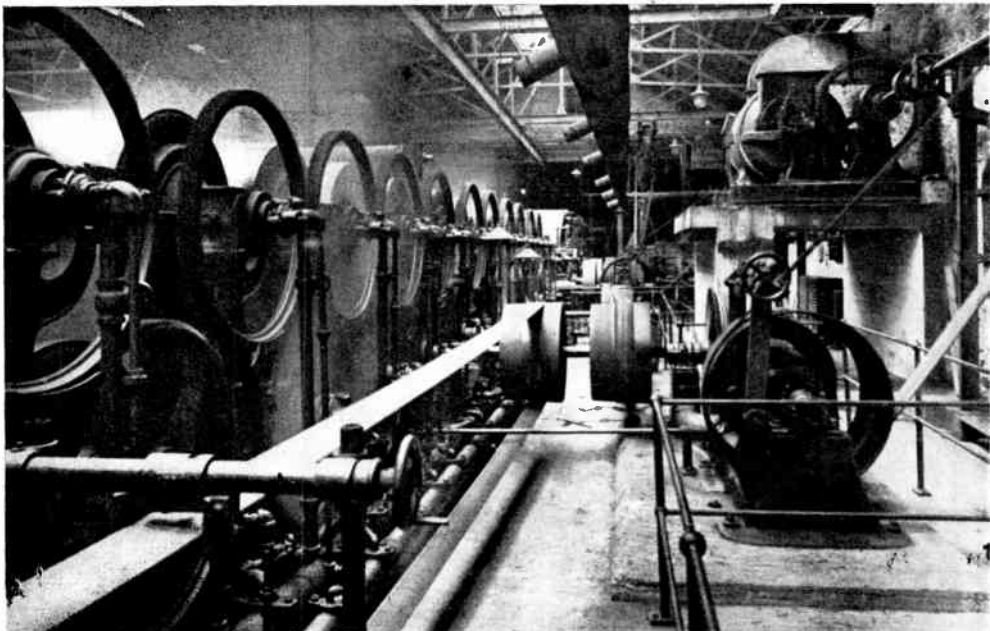

Fig. 11.—80 H.P. PIPE-VENTILATED MOTOR DRIVING PAPERMAKING MACHINE.

This illustration gives a good idea of the method of installing a pipe-ventilated motor. In this case the "pipes" or air trunks are built up of sheet iron. (General Electric Co.)

A

Fig. 12.—KEY DIAGRAM TO FIG. 13.

Showing the general layout of the motor, motor-generator set and control equipment.

The switches 6 and 7 are operated by strikers fitted to the table of the machine.

The change-over switch 10 controls the push - button stations 8 and 9.

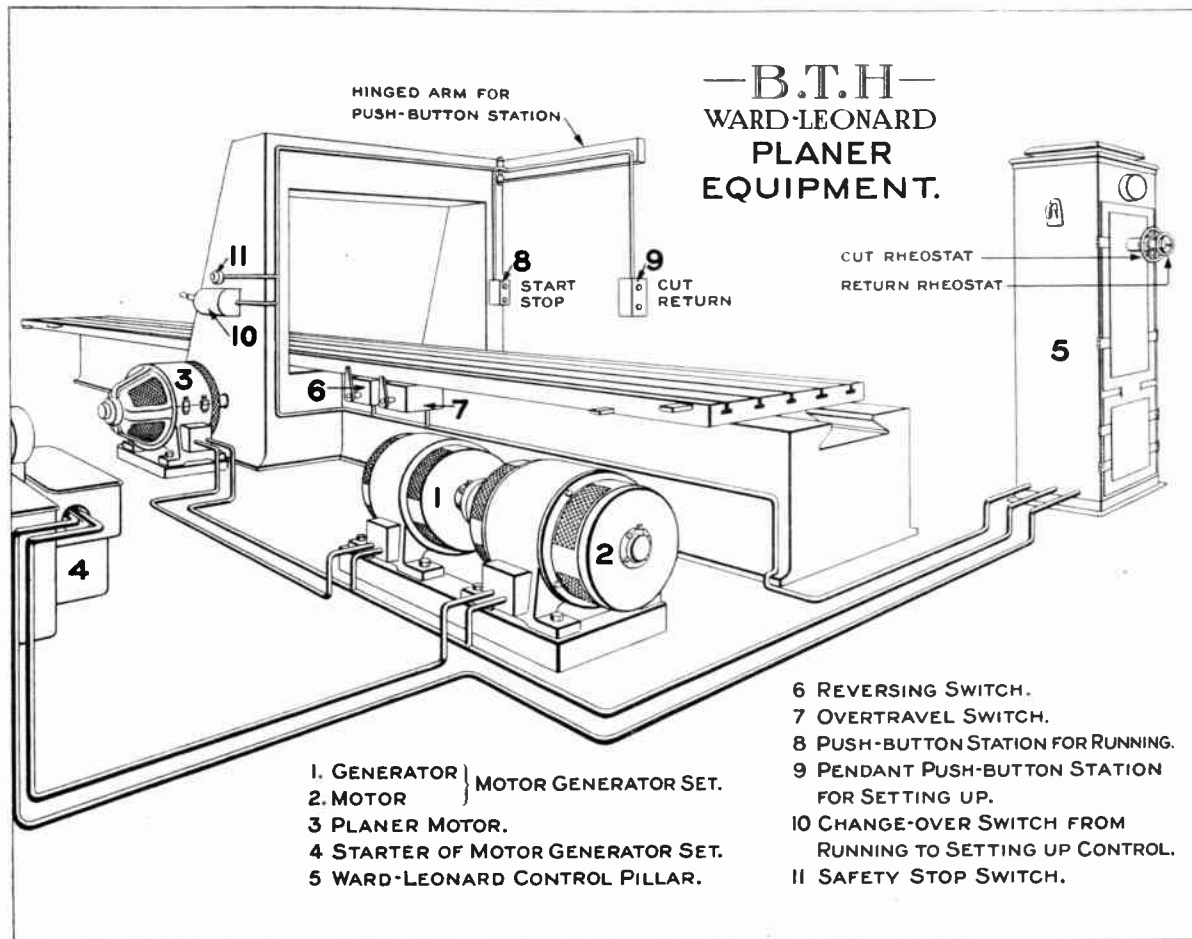

quality, together with cheapness in manufacture. Each lamination is complete with the yoke ring, poles and pole tips, so that no subsequent machining operations are necessary. The laminations are assembled and riveted between thicker end plates which are machined to receive the spigots in the end shields. In consequence of the laminated frame, the feet are arranged on the end shields.

The medium sizes ( $\frac{1}{8}$  to  $\frac{1}{4}$  h.p.) have drip-proof enclosure, as these motors are largely used in laundries for individually driven machines.

#### Universal Motors.

The smaller motors (up to about  $\frac{1}{10}$  h.p.) are totally enclosed and are used in large numbers for vacuum cleaners, sewing machines, etc. These motors, *when series wound*, are capable of running on either direct- or alternating-current circuits, and, in consequence are universal motors.

#### Marine Motors.

Electrical plant for use on ships must in general be unaffected by both the corrosive action of the salt-laden atmosphere and the extraneous forces due to the motion, pitching, and rolling of the ship. The plant, other than generating plant, may be divided into two classes:— (a) motors for general and auxiliary services; (b) propulsion motors.

The chief features of motors for *general service* are a robust design which is splash- and vermin-proof, and which occupies a minimum of deck space. Both the

horizontal-shaft and the vertical-shaft construction are employed, the latter possessing the advantage of occupying minimum deck space.

The general features of a horizontal shaft motor for general service are shown in Fig. 16.

A special horizontal-shaft motor has been developed for cargo winches. The motor is totally enclosed and watertight,

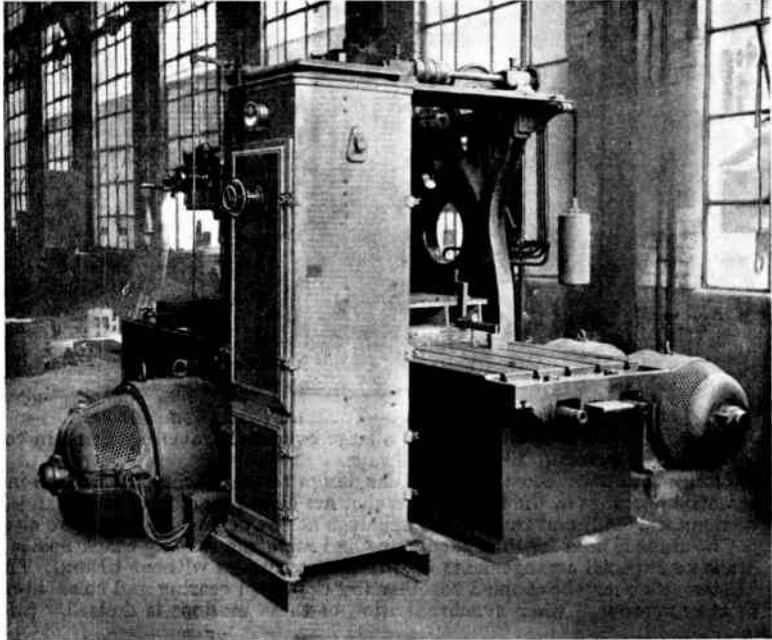
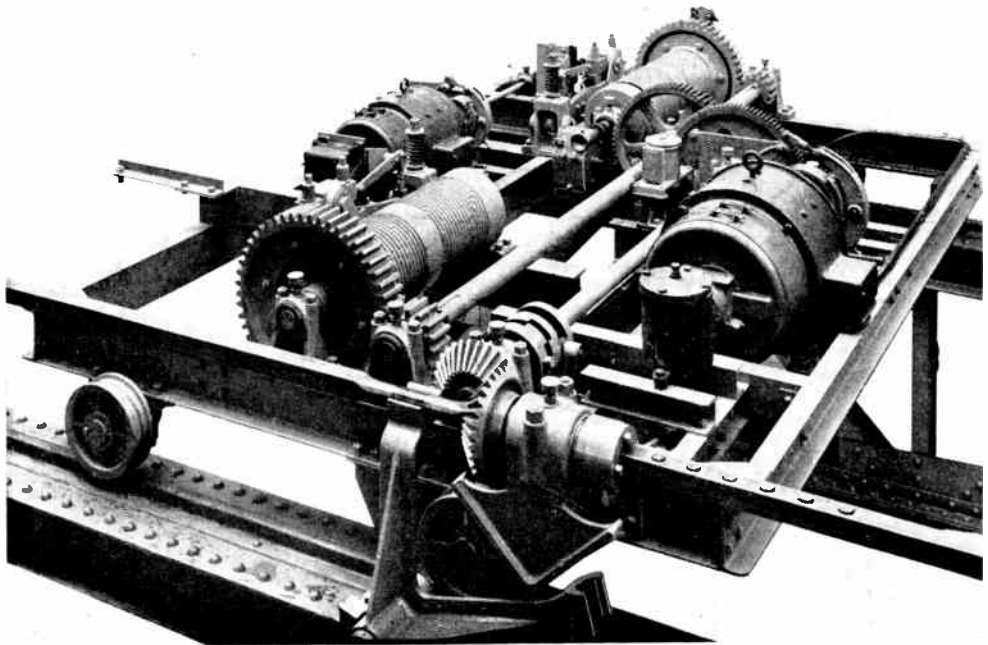

Fig. 13.—SCREEN-PROTECTED MOTORS.

These drive a large planing machine in the Rugby Works of the B.T.-H. Co. The planing machine motor (shown on the left) is supplied by the motor-generator set (shown on the right) and is controlled on the Ward-Leonard (variable voltage) system by the control gear in the pillar. The general layout is shown in Fig. 12 on the facing page. (B.T.-H. Co.)

and is built directly into the winch, as shown in Fig. 15. The driving end of the armature shaft is fitted with a worm and an extension is fitted with both an internally expanding foot brake and a centrifugal brake. The commutator end of the shaft is extended and is fitted with both an automatic magnetic brake and a handle (for operating the winch in the event of a breakdown of the motor). The upper part of the frame of the motor is extended to form a watertight case for the master controller, the main (contactor-type)

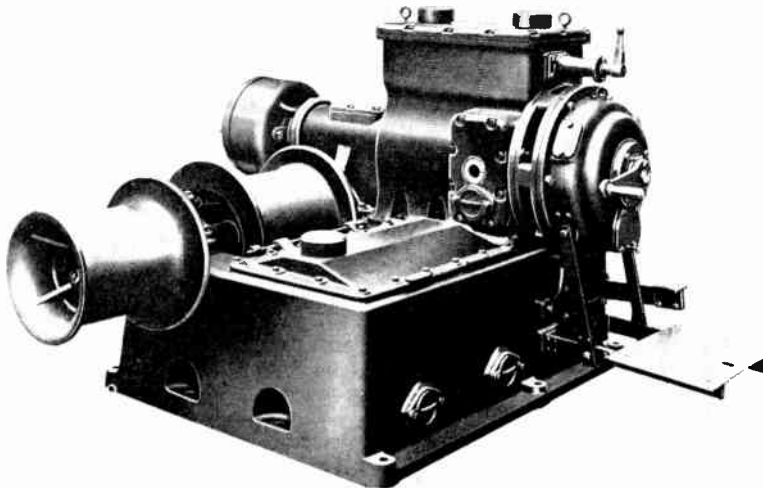

*Fig. 14.*—TOTALLY ENCLOSED MOTORS.

These are on one of the crabs of a large overhead travelling crane in the repair shops of the London Underground Electric Railways.

Notice that the motors are of similar design to the machine illustrated in Fig. 1. The circumferential openings in the rear end bracket are closed by a sheet steel band (similar to that at the commutator end) and the normal openings at the commutator end are closed by steel plates.

The crane is used for lifting, carrying and replacing railway coach bodies: it is fitted with two crabs and special arrangements for lifting the coaches without tilting. The hoisting motions of the two crabs may be coupled together (by the bevel gearing and solenoid-operated clutch shown in the foreground) when synchronisation of these motions is desired. (*Metropolitan-Vickers.*)



*Fig. 15.*—ELECTRIC CARGO WINCH.

The motor is totally enclosed and is water-tight. The contactor-type main controller is built into the bed plate, and the master controller is located above the motor.

(*Metropolitan-Vickers.*)

controller being located in the bedplate. A vertical-shaft motor is illustrated in Fig. 17. This motor is deluge proof and the commutator inspection covers and terminal box covers are watertight. The ventilating fan is mounted above the upper end shield, and is protected by a canopy. Screened openings are provided in the lower end shield, and similar openings are provided in the upper end shield, so that the fan draws air through the motor. These motors are used for driving centrifugal pumps.

### Propulsion Motors

are of various types and sizes according to the class of vessel and service conditions.

Fig. 18 illustrates a motor ( $1\frac{1}{2}$  h.p.) for a small pleasure launch. The motor is totally enclosed and watertight: It is supplied from a battery of 20 Exide accumulators, and is directly coupled to the propeller as shown in Fig. 20.

Ship-propulsion motors are built with a large number of poles and run at slow speed. They are usually forced ventilated on the *closed-circuit system*, i.e., the same

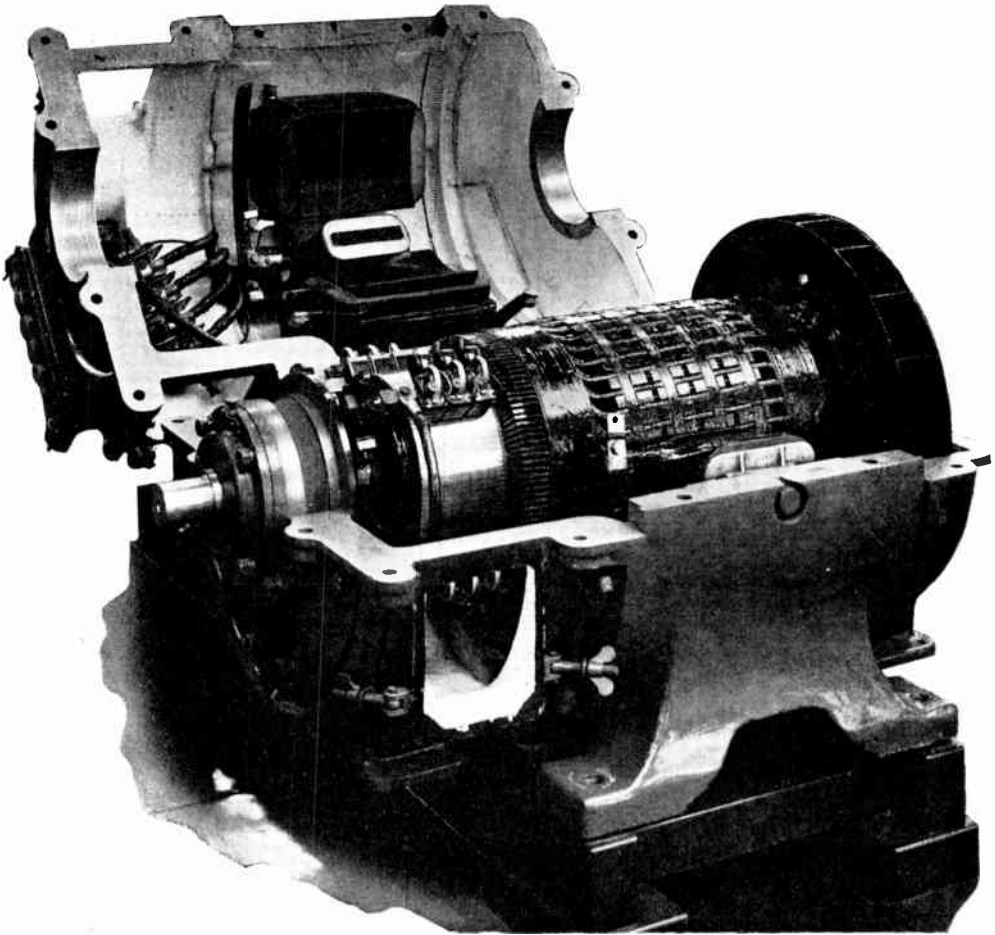

Fig. 16.—50 h.p. MARINE MOTOR WITH FRAME OPENED TO SHOW INTERNAL CONSTRUCTION.

Notice the robust construction and the large roller bearings. The inspection openings at the commutator end and the ventilating openings at the rear end have louvred covers (similar to Fig. 8) with a punched metal guard between cover and frame to keep out vermin.

This type of motor is intended for general service in engine rooms, etc. (*Metropolitan-Vickers.*)

ventilating air is circulated (by an external fan) continuously through the motor, air trunks and a tubular cooler (with water as the cooling medium). This system of ventilation, which is used with large turbo alternators, possesses the important advantages that large quantities of air may be passed through the machine without the necessity of filtering the air to remove the dust particles (which would, with an open system of air circulation, gradually choke the ventilating ducts in the armature), and that the fire hazard is less with the closed-circuit system than with an open system, owing to the small oxygen content in the air in circulation.

### Dry-Dock Pump Motors.

Pumping plant for dry docks has to be capable of handling large quantities of water in a relatively short time, e.g., with a large dock discharges of 1,000 tons of water per minute may be required. In some cases, speed adjustment is necessary and a direct-current motor is then installed. The motor

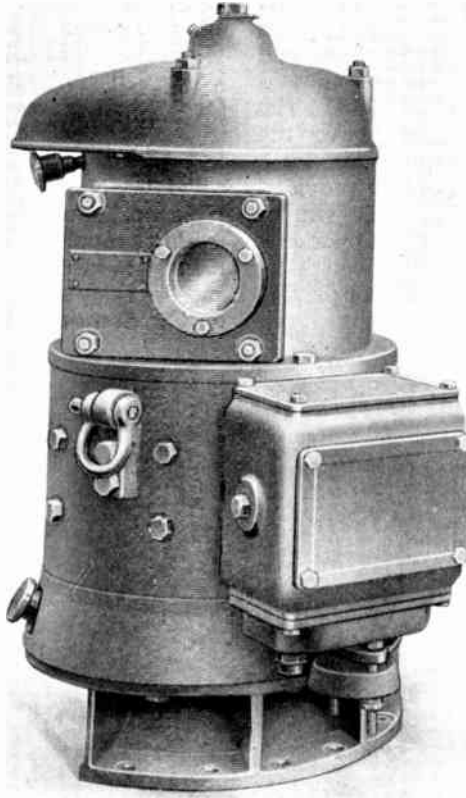

Fig. 17.—DELUGE-PROOF MARINE MOTOR.

Notice the special watertight terminal box and commutator inspection cover. (B.T.-H. Co.)

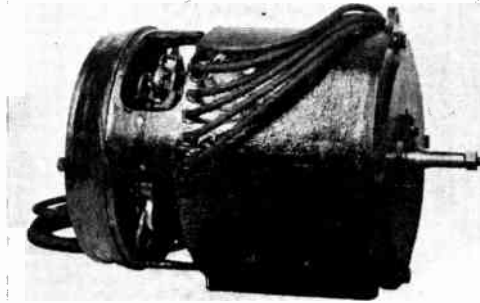

Fig. 18.—SPECIAL TOTALLY-ENCLOSED-SERIES WOUND PROPULSION MOTOR.

This is for a small pleasure launch. The cover at the commutator end has been removed. (Metropolitan - Vickers.)

is usually, of the open type and runs at a moderate speed.

### Mill or Steel Works Motors.

These machines require to be of robust construction on account of the heavy duty to which they are subjected. Moreover, as the service involves frequent and rapid starting and stopping, the armature diameter must be kept as small as possible in order to reduce the energy required for the rotary acceleration of the armature. In consequence the ratio (length/diameter) of the armature core is much greater than that for an ordinary motor, and for large outputs double motors are necessary.

Mill motors may be divided into two classes (1) those for driving the auxiliary gear of the mill (screw-downs, live rolls, manipulators, mangles, etc.); (2) those for driving the main rolls of the mill.

The auxiliary motors (40 to 100 h.p.) are built with cast-steel frames and endshields, and are either totally enclosed or enclosed ventilated (screen-protected). The construction is well



illustrated in Figs. 21 and 22.

The *main mill motors* are of the open type. For moderate outputs and non-reversing mills single armature construction is employed.

For large outputs and reversing mills double motors are necessary. The duty on these motors is exceptionally severe, e.g., in rolling operations the motor has to be accelerated in one direction, then rapidly brought to rest, accelerated in the opposite direction, and so on, for periods of  $2\frac{1}{2}$  to 3 minutes, during which from 16 to 20 reversals or "passes" may occur. The time interval between full speed in one direction to full speed in the other direction may be less than 10 seconds. During the initial "passes" (when the largest reductions in the cross section of the ingot or slab occur) torques approaching 2,000,000 lb.-ft. may be required.

Due to the slow speeds of the motors forced ventilation is necessary, and large volumes of filtered air (e.g., 50,000 cubic feet per minute) may be required. The air

is blown into the central space between the magnet frames and is deflected by baffles over the armatures and commutators. The air-ducts are built into the foundations.

A typical double motor is illustrated in Fig. 23.

### Winding (Mine Hoists) Motors.

In an electric winding plant for a mine the motor is direct coupled to the winding drum. The duty cycle involves acceleration to maximum speed, running at this speed for a brief interval, electric braking to rest, and a brief interval of rest. The time of such a cycle may be from one to two minutes or longer, according to the depth of the pit and the speed of the wind.

The magnet frame of a large electric winder is shown in Fig. 24. The motor is of the open type and is built with a large number of poles on account of the large output (12,500 h.p.) and slow speed (32.7 r.p.m.). The large diameter of the armature enables efficient cooling to be obtained with natural ventilation.



Fig. 19.—METHOD OF REMOVING ARMATURE OF MOTOR ILLUSTRATED IN FIG. 17.

Notice the position of the ventilating fan outside the upper end shield. The fan is protected by a canopy which is shown in position in Fig. 17. (B.T.-H. Co.)

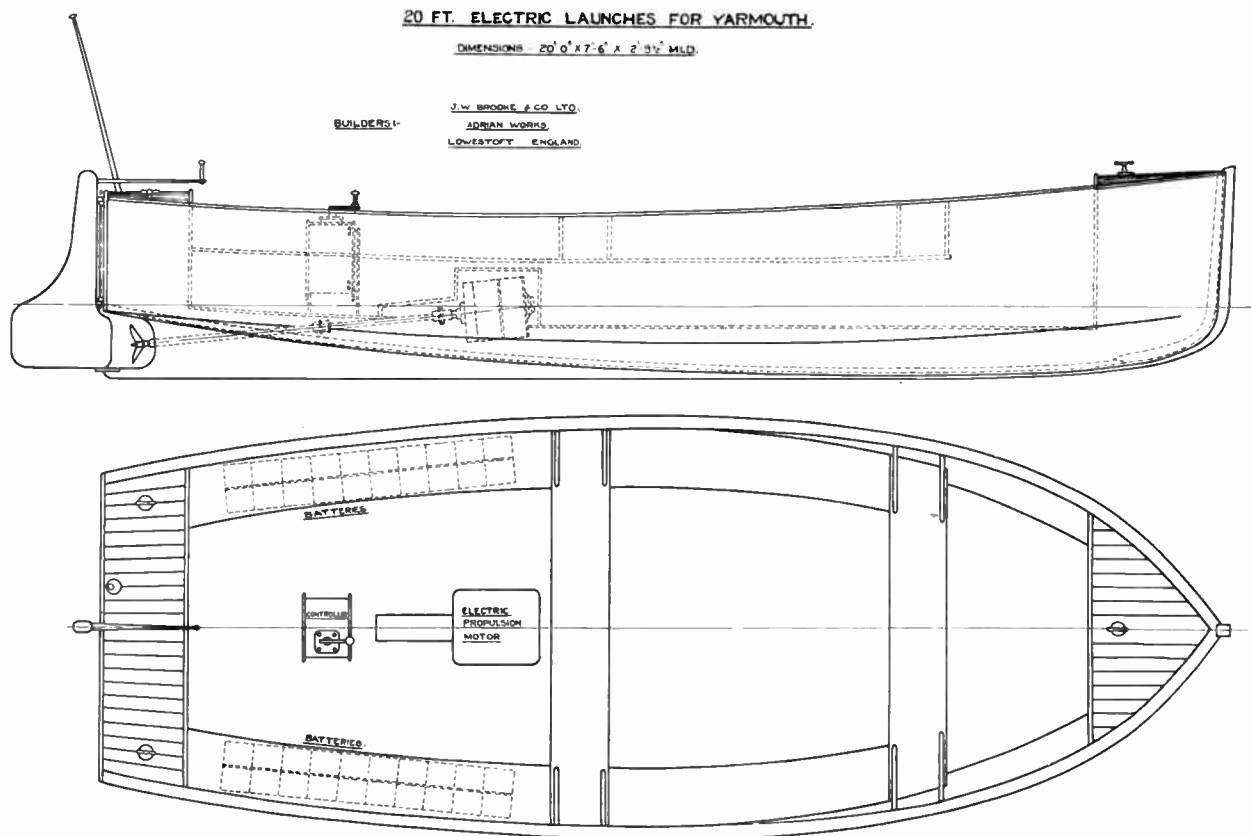

Fig. 20.—ARRANGEMENT OF PROPULSION MOTOR, CONTROLLER AND BATTERIES ON 20-FT. ELECTRIC LAUNCH.  
(Courtesy of Messrs. J. W. Brooke and Metropolitan-Vickers Electrical Co.)

**Traction Motors.**

For traction service the motors must be of robust construction and of light weight.

The armatures must withstand high rotational speeds. An important feature is that the overall dimensions of the motor must conform to definite limiting values, as the space available is restricted by the size of the car wheels and the gauge of the track rails. Other features are dealt with in a later section.

**ELECTRICAL FEATURES.**

**Excitation.**

The excitation may be supplied by shunt, series or compound field windings, according to the speed and torque characteristics required.

**Shunt Windings**

are designed to receive the full supply

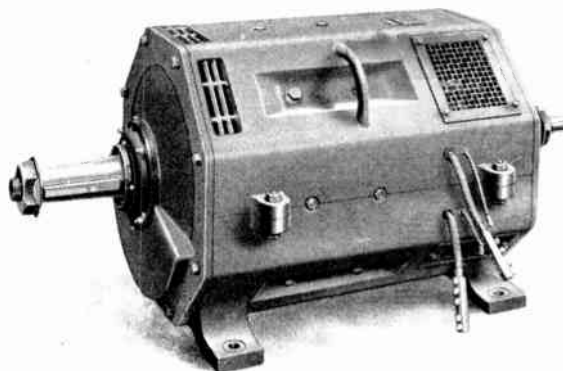

Fig. 21.—SCREEN-PROTECTED MILL-TYPE MOTOR FOR EXCAVATOR AND AUXILIARY DRIVES. (B.T.-H. Co.)

voltage and consist of a large number of turns of relatively fine wire. Except for the slight change of resistance of the field coils, due to heating, the field ampere turns are constant and are unaffected by the armature current.

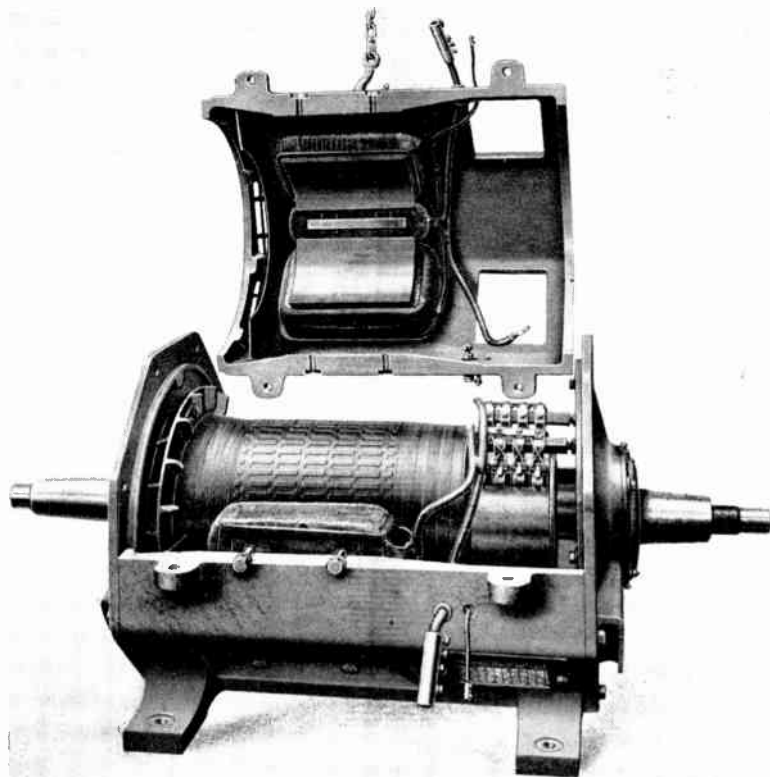

Fig. 22.—MILL-TYPE MOTOR OPENED TO SHOW INTERNAL CONSTRUCTION. Notice the robust cast-steel frame, the double ventilating fan and baffle, the roller bearings and the absence of radial ventilating ducts in the armature. The ventilating air is drawn in at the commutator end and is circulated in two parallel paths (inside and outside the armature), being expelled at the rear-end openings. (B.T.-H. Co.)

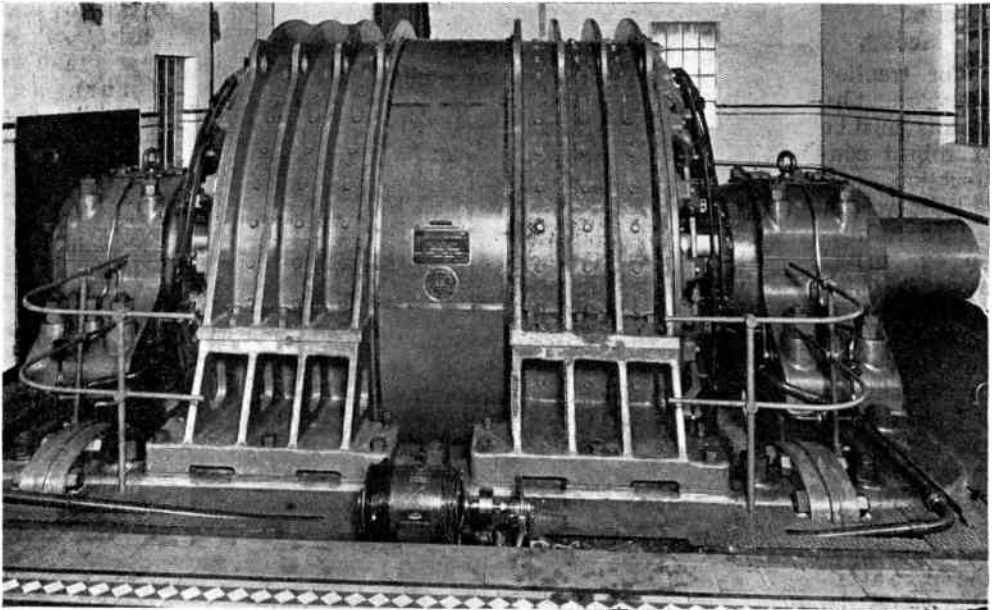

Fig. 23.—14,000 H.P. REVERSING ROLLING MILL MOTOR.

This drives a 40-in. slabbing mill at the Consett Iron Co.'s steel works. Notice the double-unit construction, the massive cast-steel magnet frames and main bearings (which are flooded with oil supplied by the motor-driven pump in the foreground). The motor is forced ventilated, the air being supplied to the centre of the machine from ducts built into the foundations. The weight of the motor as illustrated is nearly 200 tons. (*English Electric Co.*)

**Shunt-Wound Motor.—Speed Characteristics.**

The speed of rotation of the armature of any motor is proportional to  
 Counter-e.m.f. in armature

flux cut by armature conductors

The counter-e.m.f. is equal to (supply voltage—voltage drop, due to resistance, in armature circuit).

Except with very small motors the voltage drop in the armature circuit at full load is less than 5 per cent. of the normal supply voltage, so that the counter-e.m.f. may be considered to be approximately equal to the supply voltage. Actual approximate values of the voltage drop at full load are :—

Rate 1 h.p. of motor ..	3	5	10	20	50	75	100
Percentage voltage drop at full load ..	9	7.5	6	5	4	3.8	3.5

Hence in a shunt motor supplied at constant voltage the speed will be practically constant over the working range of

armature currents. Thus a shunt motor possesses self-governing speed characteristics and is eminently suitable for driving a varying load where constant speeds are desired.

The relationship between the speed and armature current, when the voltage drop in the armature circuit is taken into account, is shown in Fig. 25. The relationship between the armature current and torque is shown in Fig. 26, and the speed-torque characteristic is shown in Fig. 27.

**Applications of Shunt-Wound Motors.**

The principal applications are for machine-tool drives such as lathes, drilling machines, milling machines, boring mills, centrifugal pumps, printing machinery, wood-working machines, and other machines having a direct rotary motion. This type of motor is also used for machines requiring adjustable speeds (above normal), the speed being adjusted by a rheostat connected in series with the field winding.

In practice with standard shunt motors, this simple and efficient method of speed control is limited to a speed range between normal speed and approximately 20 per cent. above normal speed. For a larger speed range a compound field winding with a light series winding is necessary to obtain stability, and for exceptionally large ranges of 3 : 1 or 4 : 1 a special design of motor is necessary.

### Series Windings

are designed to receive the full current of the motor, and are connected in series with the armature. They consist of relatively few turns of a conductor suitable for carrying the required current.

### Series - Wound Motor — Speed Characteristics.

With series excitation the flux in the magnet frame varies with the armature current. If the flux varied *directly* in proportion to the armature current, as shown by the dotted line, *B*, in Fig. 28), the speed would be approximately inversely proportional to the armature current. Thus *if the armature current were halved the speed would be approximately doubled.*

In practice, however, the relationship between flux and exciting current (called the magnetisation, or saturation, curve) is as shown by the full-line curve *A* in Fig. 28,

and accordingly the relationship between speed and armature current is shown by curve *A* in Fig. 29. Curve *B* in this diagram represents the hypothetical case when the flux varies directly with the armature current as shown by the line *B* in Fig. 28, and the resistance of the motor is taken into account.



Fig. 24.—MAGNET FRAME OF 12,500 H.P. ELECTRIC WINDER.

This motor has 20 poles and the maximum speed is 33 r.p.m. On account of the large diameter of the armature natural ventilation is sufficient for cooling purposes. (*Metropolitan-Vickers.*)

Hence, in practice, *magnetic saturation tends to flatten the speed curve and reduce its slope.*

The manner in which the resistance of the motor affects the shape of the speed curve is shown by curves *A* and *C*, the former representing the actual speed curve of a motor and the latter the speed curve which would be obtained if the

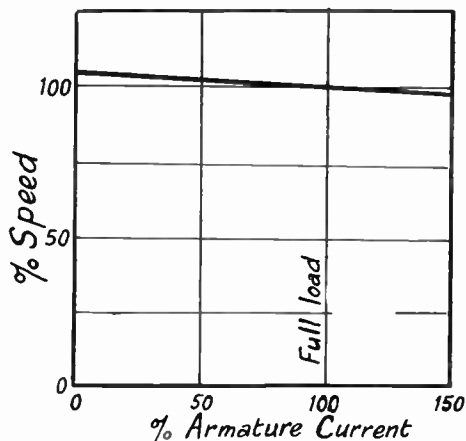

Fig. 25.—SPEED CHARACTERISTIC OF SHUNT-WOUND MOTOR.

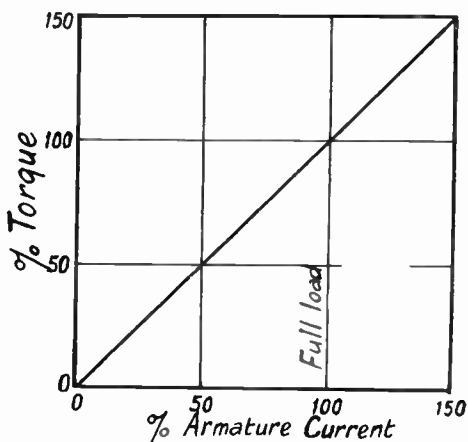

Fig. 26.—TORQUE CHARACTERISTIC OF SHUNT-WOUND MOTOR.

NOTE.—The gross torque (i.e., the torque exerted by the armature conductors) is shown.

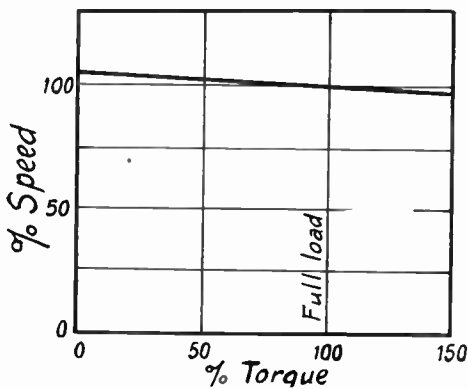

Fig. 27.—SPEED-TORQUE CHARACTERISTIC OF SHUNT-WOUND MOTOR.

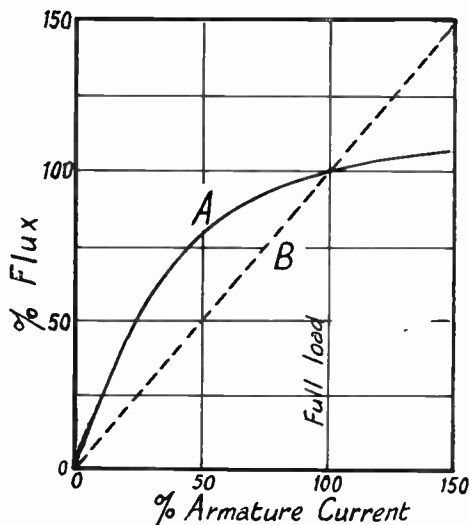

Fig. 28.—MAGNETIC CHARACTERISTICS (SATURATION CURVES) OF SERIES-WOUND MOTOR.

A, actual; B, hypothetical (unsaturated magnetic circuit).

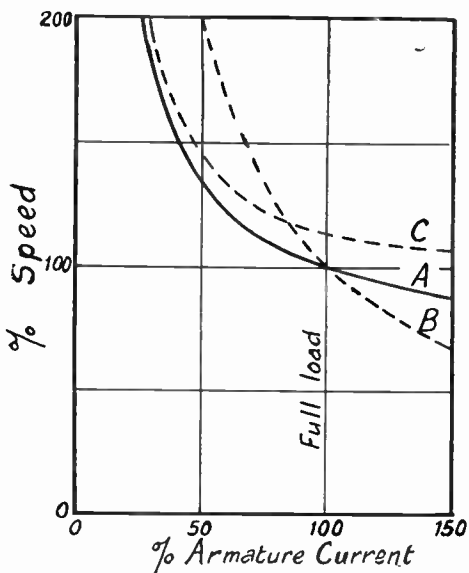

Fig. 29.—SPEED CHARACTERISTICS OF SERIES-WOUND MOTOR.

A, actual motor; B, hypothetical motor with unsaturated magnetic circuit (curve B, Fig. 28) and resistance; C, hypothetical motor with normal magnetic circuit (curve A, Fig. 28) and zero resistance.

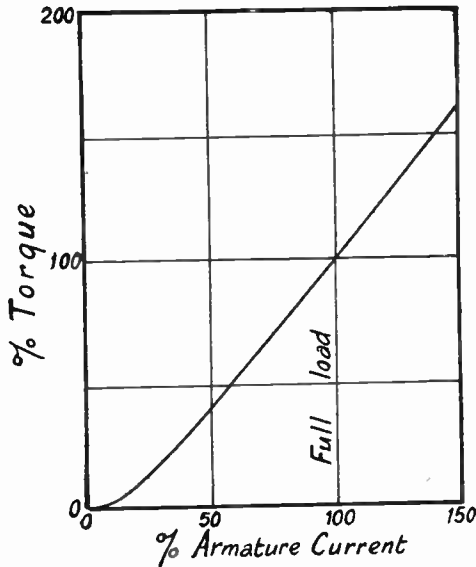

Fig. 30.—TORQUE CHARACTERISTIC OF SERIES-WOUND MOTOR.

NOTE.—The gross torque is shown.

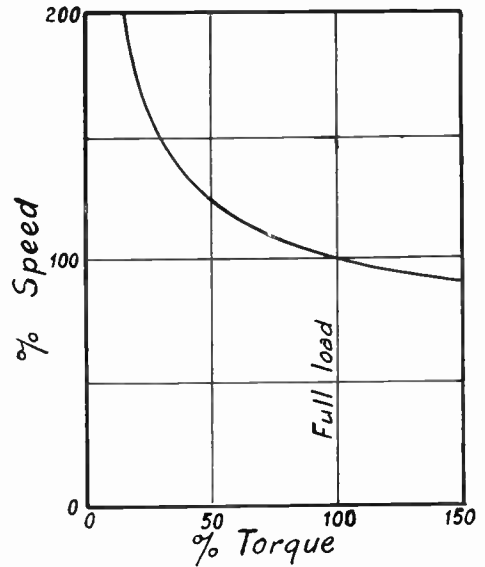

Fig. 31.—SPEED-TORQUE CHARACTERISTIC OF SERIES-WOUND MOTOR.

motor resistance were zero. This effect is more marked in a series motor than in a shunt motor, as the percentage voltage drop in the series motor (armature and field circuits) at full load is always greater than that in a corresponding shunt motor. Approximate values (for a series motor) are:—

Rated h.p. of motor ..	3	5	10	20	50	75	100
Percentage voltage drop at full load ..	20	16	13	10	7.5	7	6.5

The relationship between the armature current and torque is shown in Fig. 30, and the relationship between the speed and torque is shown in Fig. 31.

**Application of Series-Wound Motors.**

The torque-current characteristics—Fig. 30—show that a large torque can be obtained with a smaller armature current than with shunt excitation. Hence the series motor is used when exceptionally large torques are required at starting and when heavy overloads occur during running, *provided that the load conditions are such that the load cannot be entirely removed.* Unlike the shunt motor, the series motor possesses no self-governing feature, and the entire removal of the load would cause the motor to race and to reach a dangerous speed.

The speed of the motor automatically adjusts itself to the load or torque, i.e., the speed decreases with an increase of load, and increases with a decrease of load. The drooping speed characteristic is a

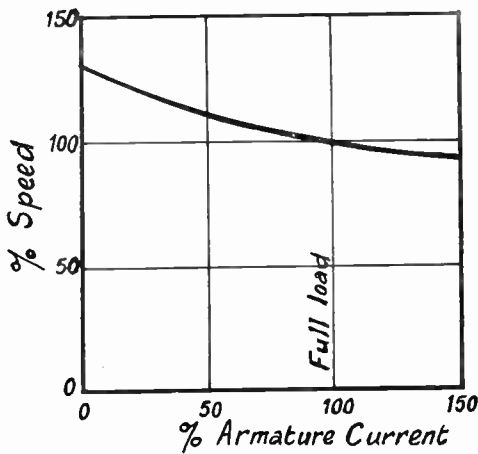

Fig. 32.—SPEED-TORQUE CHARACTERISTIC OF COMPOUND-WOUND MOTOR.

valuable asset when overloads occur as the drop in speed tends to limit the output, and the increase in excitation tends to maintain a "stiff" flux in the air gap which is conducive to good commutation. Thus a series motor is able to withstand without detriment hard usage and even abuse, whereas a shunt motor so treated would soon develop trouble at the commutator.

Series motors are suitable for loads requiring approximately constant torque, such as fans, blowers, air compressors with automatic control for starting and stopping the motor, small launches (Fig. 18), etc. They are also suitable for cranes, winches, excavators, large bending rolls, plate mangles, auxiliary gear in connection with rolling mills, or any other service for which a steam engine without governor has hitherto been employed. The ability to exert a large torque at starting makes the series motor ideal for traction service.

**Compound Field Windings**

are a combination of shunt and series windings.

**Compound-Wound Motor.—Speed Characteristics.**

Due to the combined shunt and series excitation the speed characteristic is intermediate between those of a shunt motor and a series motor. A typical speed curve is shown in Fig. 32. The amount of "droop" in the speed curve can be arranged to suit the load conditions by suitably proportioning the ampere-turns of the series and shunt windings when the field windings are designed. For ordinary industrial motors the windings are proportioned to give a full-load speed, approximately 75 per cent. of the no-load speed, but for special cases, such as haulages, a much greater variation is desirable, and the shunt excitation is reduced to such a value as to limit the no-load speed to a safe value.

**Application of Compound-Wound Motors.**

The compound-wound motor combines some of the advantages of both series-wound and shunt-wound motors. Thus

*the shunt winding limits the no-load speed to a definite value, and the series winding enables the motor not only to give larger starting torque than the shunt motor but also to take heavier momentary overloads than could be carried by a shunt motor.* These features make the compound-wound motor suitable for lifts, capstans, haulage gears, rolling mills, winders, etc. Compound-wound motors are also used to drive machines having rapidly fluctuating loads or those which are subjected to severe momentary overloads, such as punching machines, shearing machines, small bending rolls, planing machines, slotting machines, etc.

**SUMMARY.**

The applications and uses of the different types of motors are summarised in tabular form below.

TABLE II.

SUMMARY OF APPLICATIONS OF SHUNT, SERIES, AND COMPOUND-WOUND MOTORS.

Type of Winding.	Suitable For.
Shunt . . . .	Machines which require to run at approximately constant speed independent of load. Machines requiring speed adjustment above normal speed. Machines having a direct rotary motion, such as the following:— Machine tools, including lathes, drilling machines, milling machines, boring mills; wood-working machines; printing machines; centrifugal pumps; coal conveyers; mechanical stokers.
Series . . . .	Machines in which the torque is approximately constant, such as:— Fans, blowers, air compressors, launches. Machines with heavy starting duty, such as:—Cranes, winches, large bending rolls, auxiliary gear on rolling mills. Traction service.
Compound . .	Machines with heavy starting duty in which the load is subject to large fluctuations, such as:—Lifts, capstans, haulages, r.a.n. pumps, rolling mills, winders, small bending rolls, excavators. Machines having a reciprocating motion (either of work or of cutting tool), such as:—Planing machines, slotting machines, presses, punching machines, shearing machines.



# TESTING A LIGHTING INSTALLATION

By E. H. FREEMAN, M.I.E.E.

THE necessity for making tests to ensure that an electrical installation, when complete, is in a suitable condition for connecting up to a supply company's main cables is obvious. The essential feature of the test from the supply company's point of view is to ensure that there is no appreciable leakage current. If there should be, the fault might be sufficiently serious to blow main fuses controlling a large area, and it is for this reason that supply companies are authorised to refuse to connect up any installation of which the leakage current exceeds one ten-thousandth part of the maximum current supplied.

This result agrees sufficiently well with the insulation test prescribed by the wiring rules of the Institution of Electrical Engineers for an average lighting installation.

## Tests to be Made.

Whilst the insulation test, on account of its being practically the only test that a supply company can enforce (with the exception of a few authorities with special powers), is the most important, there are others which are necessary in a greater or less degree. These include tests to decide: Continuity of wiring circuits; polarity of conductors; continuity of tube or lead sheathing; effectiveness of earthing of tube or lead sheathing; voltage drop on conductors between two points; current carried by conductors; voltage of supply; and, in some cases, illumination obtained.

These tests are of varying degrees of importance in different circumstances. Some can at times be dispensed with, and whilst most of them are desirable, it is by no means always necessary to carry them all out on every installation.

## Apparatus required for Insulation Tests.

Insulation tests are now universally made with instruments of the ohmmeter or megger type. Such instruments consist of a small electric generator driven by a handle and giving a fairly constant voltage within a reasonable range of speed of

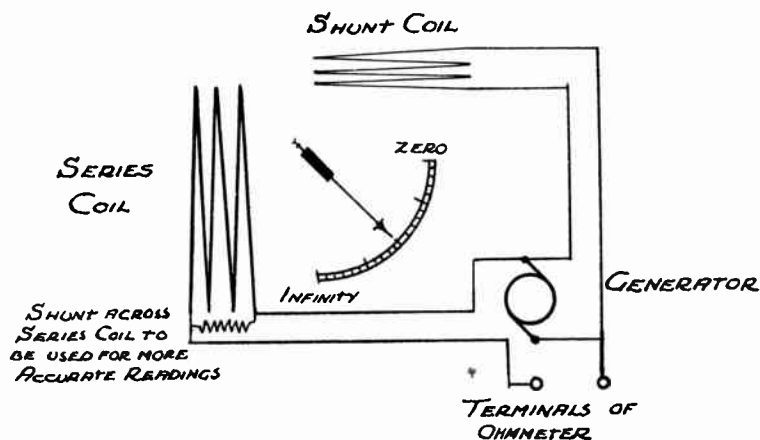

Fig. 1.—A SIMPLE FORM OF INSTRUMENT FOR INSULATION TESTS. Showing the construction of the ohmmeter or megger type. If the leakage current is high the series coil tends to pull the pointer towards zero.

turning, combined with a recording pointer attached to a soft iron needle which is under the influence of opposing magnetic coils. The ohmmeter contains two coils of wire, one of which (the shunt coil) is connected across the terminals of the generator, whilst the other (the series coil) is connected to the external terminals of the testing machine, the external circuit under test being thus in series with this coil. By



*Fig. 2.*—MAKING A POLE TO POLE TEST.

For the test between conductors the two leads from the megger are connected to the two fuse clips of one circuit. This test should be taken with the switches on and the lamps removed, for if the test is taken with the circuit complete it does not include any test between the two poles of every fitting, flexible cord, etc. Compare this illustration with that on page 34, which shows a megger being used for testing the possibility of leakage to earth.

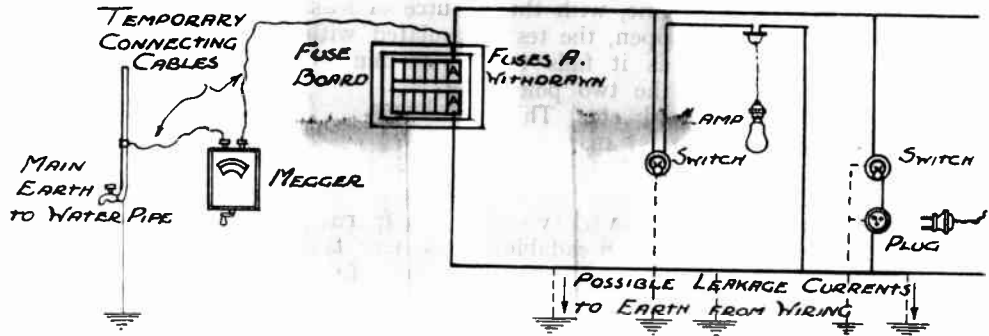

Fig. 3.—TESTING THE POSSIBILITY OF LEAKAGE TO EARTH.

Showing the general arrangement of the connections and the possible leakage currents which tend to bring down the insulation.

switching a small shunt coil across the main series coil, the current in the latter can be reduced in a fixed proportion and the instrument can thus be used to register low external resistances (in the circuit under test) with greater accuracy. The details are shown in diagrammatic form in Fig. 1.

#### How the Coils are Arranged.

The two coils are arranged so that they exert opposing pulls on a soft iron needle which is attached to the pointer that indicates the insulation of the circuit. If the series coil exerts no pull at all (indicating an infinity test), the pointer is actuated solely by the shunt coil and points to one end of the scale. On the other hand, if the leakage current is high, the series coils tend to pull the pointer in the opposite direction (towards zero insulation). The pointer eventually occupies a position depending on the relative pulls exerted by the two coils and this position indicates the strength of the leakage current, i.e., of the insulation resistance of the circuit.

Lengths of cable, the length and size of which are not important, are required to connect the megger to the circuit and to the earth contact, but otherwise no other apparatus is required.

#### Other Forms of Insulation Tests.

Various other forms of insulation testing machines are available, but the methods of using these are the same, although the internal construction varies mainly to

ensure more accurate results and to obtain lighter or more convenient instruments.

In making all insulation tests, two separate tests must be made—one to test the possibility of leakage to earth and the other of possible leakage between the two conductors.

For the former, one pole of the megger will be connected to the wiring under test and the other to some effective "earth," such as a main cold water pipe (not a hot water pipe).

Fig. 3 shows the general arrangement of the connections and the possible leakage currents which tend to bring down the insulation.

#### What the Test Shows.

This test should be made after drawing the fuses on the main switch or fuse board and connecting to the "dead" side of the fuse clip, so that only the actual wiring (beyond the fuse clip) will be connected up. It is best to make such a test with all the lamps in position and the switches open. The test on one pole then includes the wiring on one side of the system up to the local switch and the switches themselves, and on the other pole, all the lamps, fittings, ceiling roses and flexible cords.

#### Testing between Conductors.

For the test between conductors the two leads from the megger are connected to the two fuse clips of one circuit and this test should be taken with the switches on and the lamps removed. If the test

## TESTING A LIGHTING INSTALLATION

is made, as is frequently done, with the lamps in and the switches open, the test is not nearly so reliable, as it fails to include any test between the two poles of every fitting, flexible cord, etc. This will be clear from Figs. 4A and 4B.

**Explanations of Low Tests.**

A low test may be due to a variety of causes. If it is so low as to be unreadable on the megger, i.e., a "dead earth" or a "short," it is probably a single bad fault, such as a complete breakdown of the wiring system, a faulty lamp, a broken piece of apparatus, and so on. In such a case the fault must be located to one circuit and then each section of this examined item by item until the cause has been located and removed. Generally such a fault will cause the fuse of the

source of leakage. The actual wires are insulated with rubber or paper through which minute leakages may occur.

**Leakages.**

Every switch, lampholder and plug is insulated with porcelain or other material, through which or over the surface of which (particularly if damp), other leakages may take place. Thus, even with the best of workmanship, some leakage is possible and the greater the length of wire and the more the switches, etc., the greater will this leakage be. Apart from surface leakage due to damp, these possible leakages are so minute that they will not cause any appreciable loss of insulation and an installation of some scores of lamps should give readings of several megohms in any conditions.

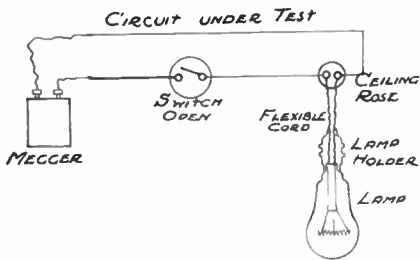

Fig. 4A.  
TESTING BETWEEN CONDUCTORS.

The wrong way, for this leaves the ceiling rose and fitting and lamp all of one polarity, and does not test the insulation between the poles of these accessories.

circuit to blow, so that elaborate preliminary testing will be unnecessary.

**Why Insulation may be Lower with Large Number of Lamps.**

In testing a newly finished installation it is more usual to find one or more circuits giving a poor test rather than a dead earth or a short circuit. The I.E.E. rules state that the test must be not less than 25 megohms, divided by the number of points connected to the circuit. In other words, the more lamps there are on a lighting system the lower may be the insulation. This is to be expected, as each part of the installation consists of various items, each of which is a possible

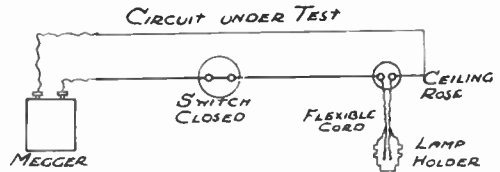

Fig. 4B.—TESTING BETWEEN CONDUCTORS.

With lamps removed and switches on, the test includes insulation test between two sides of the ceiling rose, flexible cord and lamp-holder.

**Common Causes of Failure.**

If tests below the I.E.E. regulations are obtained—for example, .1 or .2 megohms only on a system supplying 20 or 30 lamps—the cause must be located and it will be generally found in some minor failure in the workmanship. Apart from dampness or a faulty lamp (a not infrequent cause of a low test), the most common cause is careless stripping of the tape or braiding on cables or flexible cord, or the failure to ensure that a strand of a flexible wire is not touching a lampholder case. The wiring system must be disconnected item by item and each section tested in turn or carefully examined until the

cause of the low test has been found and rectified.

If there is a general low test and the building is still not properly dried out (or if the test is made on a wet day), the

probable cause is general leakage across the surface of the switches, plugs, etc., and this will usually be cured as the building dries out or as current is used. A test later under more favourable conditions will prove if this is the trouble.

**CONTINUITY OF WIRING.**

This test is almost entirely one that is carried out during the progress of the wiring work. The failure of lamps to light at the end of the wiring will be the most effective test, but during progress it is necessary to make sure that the right wire of several in a tube, for example, is connected up.

**Apparatus Required and How to Use It.**

The almost invariable method of making the test during progress is by using an ordinary electric bell and a dry battery. A testing circuit is completed by connecting a portable wire to one end of the wires under test and the other end to the bell and battery, the bell ringing when the correct wire is connected up. Once any one wire has been tested, that wire can be used for future tests instead of the portable lead, or the tube or lead sheathing can be used on a properly installed tubing or lead cased job.

Fig. 5 shows the method of making the test, one end of the testing wires from the bell being connected to a selected wire of a group in the conduit and the other testing wire being connected in turn to

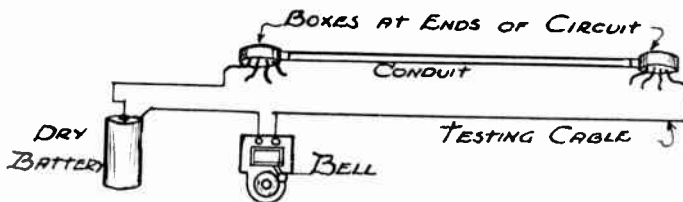

Fig. 5.—TESTING CONTINUITY OF WIRING.

One end of the testing wires from the bell is connected to a selected wire of a group in the conduit and the other testing wire is connected in turn to the wires at the other end of the circuit until the bell rings, indicating that the other end of the wire under test has been found.

the wires at the other end of the circuit until the bell rings, indicating that the other end of the wire under test has been found.

**POLARITY OF CONDUCTORS.**

This is also a test that is principally carried out during the progress of the work, its most important function, in a lighting installation, being to ensure that the switches are all connected to one pole of the system, which must be the outer, or insulated, side of the company's supply.

**Reason for Test.**

On all three-wire or three-phase distribution systems the middle wire is earthed—sometimes only at the generating station and sometimes at other points, such as a sub-station, and it is essential to connect the local switches of the lighting circuits to the outer conductor. Even on a two-wire system it is essential that all switches shall be connected on one pole throughout and a polarity test is the simplest means of ensuring this. A test is not really necessary for this purpose if the wiring has been properly carried out with red and black coloured cables and the switches all connected, as they should be, to the "red" conductors, which in turn should be connected to the unearthed pole of the system.

**Method of Testing.**

Various tests for polarity can be used, the simplest being so called "Pole Testing Paper." This consists of blotting or other absorbent paper which has been soaked in a solution of sodium sulphate and phenolphthalein. It can be obtained at any electrical supplies shop ready prepared.

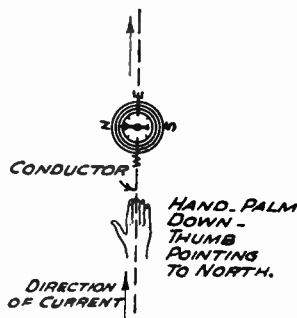
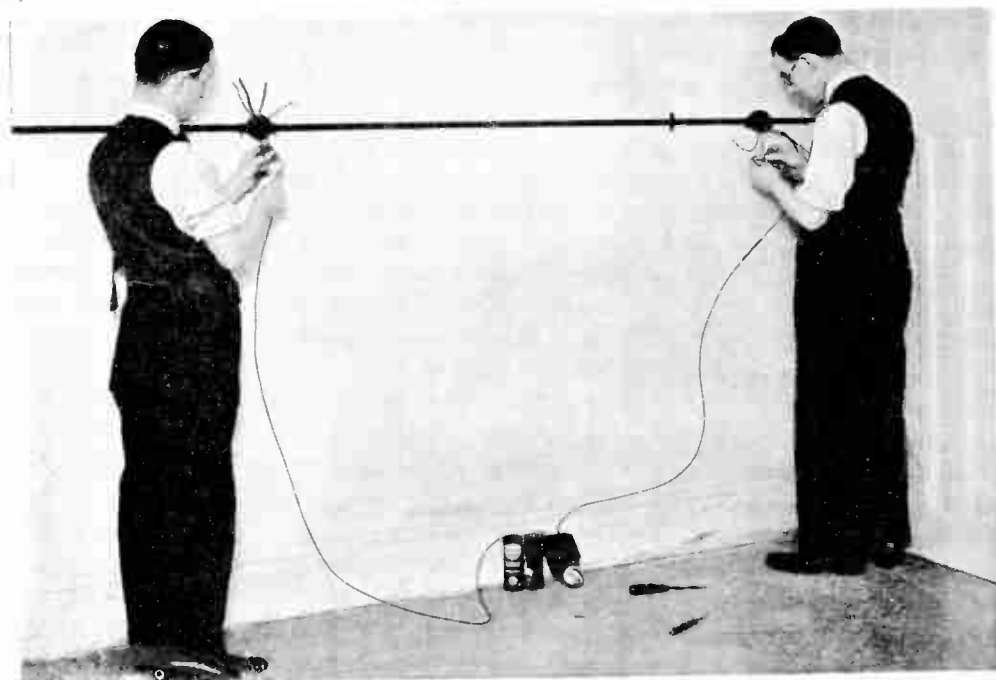

Fig. 6.

**TESTING FOR POLARITY.**

This test can be made by using an ordinary compass needle.



*Fig. 7. THE BELL AND BATTERY TEST.*

A testing circuit is completed by connecting a portable wire to one end of the wires under test and the other end to the bell and battery, the bell ringing when the correct wire is connected up.

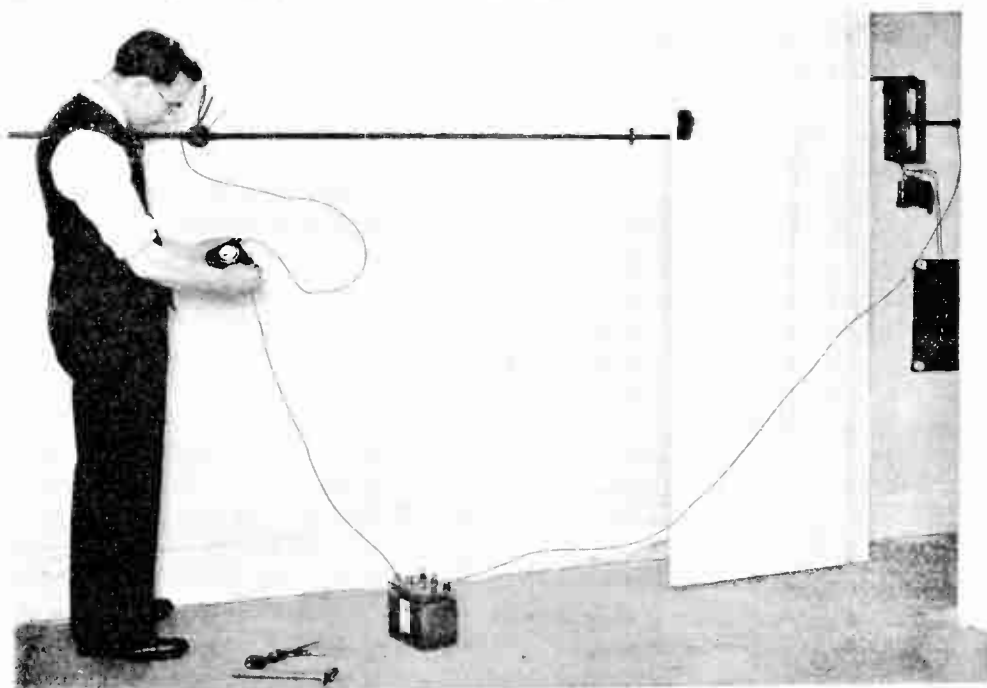

*Fig. 8. TESTING FOR CONTINUITY OF CIRCUIT.*

A small secondary battery and a low reading ammeter are connected up to the tube ends and from the current passing, the resistance of the tube can easily be calculated.

When moistened and touched on a live conductor a dark stain is formed if the conductor is connected to the negative pole, whilst it remains unchanged if touching the positive pole.

#### Using a Compass Needle.

Another test can be made by using an ordinary compass needle. This should be placed above the conductor under test when the needle will take up a position at right-angles to the conductor. The direction of flow of current can then be decided by placing the right hand with the thumb pointing to the same direction as the north pole of the compass, the hand being placed palm down (see Fig. 6). The current in the wire will then be found to flow in the direction from wrist to finger-tips, and as the current passes in the wires from positive to negative, the polarity of the two ends of the wire will be thus ascertained.

These tests, of course, only apply to direct current systems, there being no positive and negative conductors in an alternating current supply. For A.C. systems it is therefore necessary to rely on the proper use of red and black conductors and on continuity tests of the conductors.

### CONTINUITY OF TUBING OR LEAD SHEATHING AND EARTHING.

#### Importance of Test.

Tests for continuity of the metal protection of the insulated conductors and its effective earthing, whether this protective covering is any one of the various types of tube, lead sheathing, copper (as in Stannos wiring), or steel tape or wire armouring, are scarcely second in importance to those for insulation. On these tests depends the proof as to whether there is a serious risk of shock from the tube, etc., in the event of any leakage of current. The tests and principles involved apply to all forms of metallic covering to the insulated conductors, and for simplicity tube will be taken as typical of the rest.

The importance of the effective continuity of the tube and of its effective connection to earth will be evident if it is considered what will occur if the insulation

of the wires in a tube or of that of any apparatus connected to the wires should fail. Current will then tend to leak through to "earth" and will take whatever path is available. If the tube is electrically continuous and is properly earthed, the resistance of the conducting path thus provided will almost certainly be less than that of any person touching the tube or the framework of a motor, cooker or other apparatus, and the leakage currents will therefore pass to earth by way of the tube and the earth connection provided. On the other hand, if the tube is not continuous or not earthed, any person touching the tube, particularly if making good contact by having wet hands, standing on wet ground and so on, may form the leakage path of lowest resistance and consequently obtain a shock of greater or less severity according to the conditions.

#### Results to be Obtained.

The importance of ensuring good conductivity in the tube system will be evident and all regulations insist on this. The I.E.E. test for continuity states that the maximum resistance of the tube from a point near the main switch and any other part of the installation shall not exceed 2 ohms.

#### Method of Testing.

The test can be easily made in a variety of ways, the easiest being with a small secondary battery and a low reading ammeter. The farthest point of the tube system should be selected for test and a length of cable of known size run back from this point to the main switch and carefully bonded to the tube at the far end. The battery and ammeter are then connected up to the tube ends and from the current passing, the resistance of the tube can easily be calculated (see Fig. 8).

#### How to Calculate the Results.

Suppose, for example, that the current used for the test is a 50-yard length of 7/.029. This has a standard resistance of 5.281 ohms per 1000 yards, so that the 50-yard length will have a resistance of .264 ohms. If the test is made with a 2 cell 4 volt secondary battery, the

current must not be less than 4 volts divided by the total permissible resistance, viz., 2 ohms for the tube, plus .264 ohms for the wire, or  $\frac{4}{2.264}$  or, say, 1.75 amps.

If the current is less than this, the total resistance must be over 2.264 ohms and as the resistance of the wire used is known, the excess resistance must be in the tube.

### Simple, Rough Test.

The simplest and most usual method of testing continuity of tube is the same as that used for testing continuity of wiring, viz., with a bell and battery (see Fig. 9), but whilst this may be suitable for a rough test during the progress of the work, it is not sufficiently reliable for a final test. A very poor joint in the tubing may give a sufficient connection for the current required to ring a bell, but be quite unsatisfactory for the heavier current that the tube may need to carry in the event of a serious leakage.

### More Drastic Test.

A more drastic test, formulated by Professor Clinton, of University College, takes into account this need, for ensuring that the tube will carry a possible heavy leakage current. This test calls for the tubing to carry a current of 5 amps. when tested with a 4 volt accumulator, for every 1000 feet run of tube. This means a resistance of .8 ohm per 1000 feet of tube, and as it is rare for any point on an installation to be more than a few hundred feet away from the main switch, the actual resistance allowed on an ordinary installation would be only about one-quarter to one-half of one ohm. The test is thus much more severe than that specified under the I.E.E. rules. In addition, it ensures that the joints will carry a heavy current. Assuming the length of conduit is 250 feet and that 100 yards of 7/.036 is

used to connect the far end to the testing point, the test would be made as before with the 4 volt battery and ammeter. Suppose the current passing is found to be 7.5 amps., the total resistance of wire and tube is therefore  $\frac{4 \text{ volts}}{7.5 \text{ amps.}} = .53 \text{ ohms.}$

The resistance of the wire is .3427 ohms (the resistance of 1000 yards of 7/.036 is 3.427 ohms) and the resistance of the tube alone is .53 — .3427 or, say, .19 ohms. The current that would pass if the tube only were in circuit would therefore be 4 volts ÷ .19 or 21 amps., as compared with the test requirement of 20 amps. for 250 feet of tube—equal to 5 amps. for 1000 feet—and the test would therefore show that the system fulfils the requirements of the specification. Although good

work is required to satisfy this test there should not be any difficulty in running the tube to comply with it if care is taken in ensuring properly

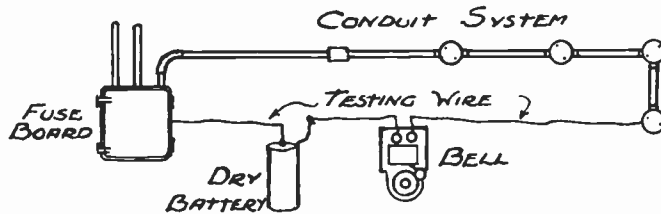

Fig. 9.—TESTING CONTINUITY OF TUBE (1).

The simplest method, showing the use of a dry battery and bell. This method is not sufficiently reliable for a final test.

screwed joints—the most likely source of a too high resistance.

The connections and method of making the test are exactly as shown in Fig. 10, but the battery must be capable of giving out a comparatively heavy current, say 15 to 20 amperes or more, for ordinary tubing systems, and the testing leads must also be of substantial size.

### EARTH CONNECTIONS.

The earth connection is, of course, also of vital importance, but the I.E.E. rules do not specify any exact test. The earth connection must be made to a main cold water pipe or a special earth plate. It must *not* be made to a hot water pipe, gas pipe or to the general metal framework of a building, as these may not be effectively earthed themselves. The connection must be made with a properly designed clamp; loose ends of wire twisted round the pipe are not satisfactory. The size



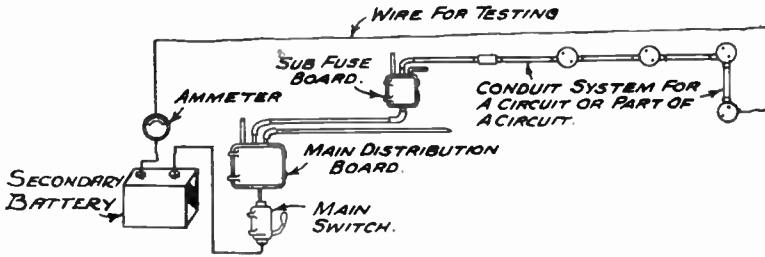

Fig. 10.—TESTING CONTINUITY OF TUBE (2).

This is a very thorough test and calls for the tubing to carry a current of 5 amps. when tested with a 4-volt accumulator for every 1,000 feet run of tube.

of the earthing connection must not be less than  $7/1029$  (.0045 sq. in.) in section, and must not be less than one-half the section of the largest conductor used, with a maximum size of .100 sq. in. It must be suitably protected against mechanical damage, i.e., risk of accidental disconnection or breakage.

ing of the installation rather than its safety. The candle-power of the lamps falls off rapidly if run on a voltage below that for which they are made, and heating apparatus of all kinds also only works at its best on its correct voltage, though voltage drop on heating circuits is less important as a rule than on lighting wiring.

All these conditions would form the basis of careful inspection rather than actual tests.

**VOLTAGE DROP.**

**Reason for Test.**

Tests for voltage drop are required to ensure the proper work-

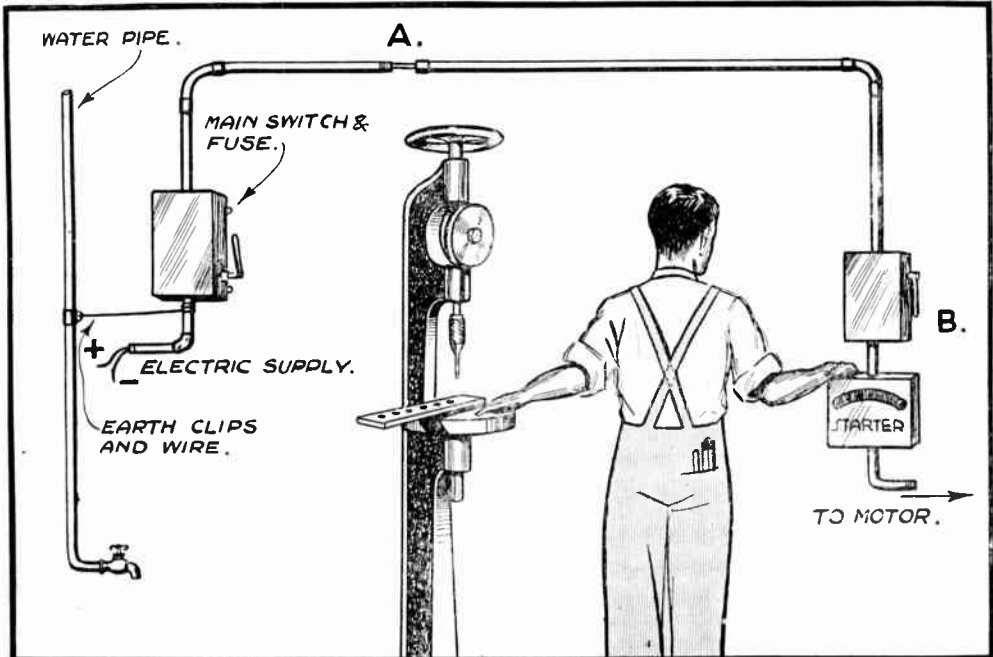

Fig. 11.—HOW A FATAL OR DANGEROUS SHOCK MAY OCCUR.

A break in the continuity of the conduit at A and a leak from the position cable through a fault in the switch-fuse at B, make the conduit and motor starter "alive." The mechanic is thus made into a conductor by touching the starter with one hand and the drilling machine with the other. The switch-fuse, the motor-starter and the main switch-fuse may have been perfectly "earthed" through the conduit when installed but the continuity of the conduit is destroyed by bad workman-hip in the fitting of the socket joint A. If the continuity of the tubing was effective the man would receive no shock as it would be a far more effective conductor for the leakage current.

### Result Required by I.E.E. Rules.

The I.E.E. rules specify that the voltage drop to any point shall not exceed 3 per cent. of the supply voltage, plus 1 volt "under practical conditions of service." This may imply a current well below the connected load and the class of installation

point needing comment is the necessity of ensuring that the instruments are not damaged by the test, as, for example, by connecting up a voltmeter suitable for 200 volts to a 500-volt supply. If the conditions are quite unknown the instruments first used should be for currents or

voltages well above what is likely to be obtained and lower reading instruments substituted later for more accurate records.

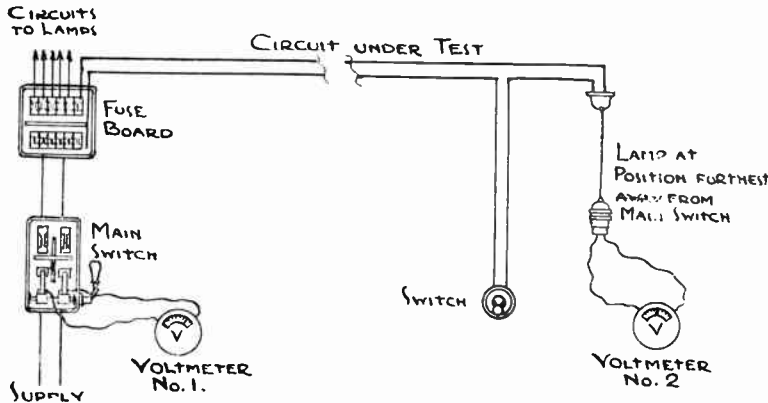

Fig 12.—TESTING FOR VOLTAGE DROP.

Two voltmeters are used, one connected up at the point of supply and the other at the position at which the test is made, i.e., at the lamp farthest away from the main switch. The difference between the readings gives the voltage drop.

must be taken in account to some extent in deciding this point, but for the average lighting scheme the test should be made with all lights in use.

### Method of Making Test.

The test is made with two voltmeters one connected up at the point of supply and the other at the position at which the test is made, i.e., at the lamp farthest away from the main switch (see Fig. 12). The difference between the readings gives the voltage drop. The instruments should, of course, be checked to see they both register correctly, and if there is any doubt as to this the readings can be taken twice, changing over the instruments for the two tests and taking the average as the correct result.

### CURRENT CARRIED BY CONDUCTORS VOLTAGE OF SUPPLY.

These two tests are not often required and do not call for special treatment as the results can be ascertained by an ordinary ammeter or voltmeter. The only

as the subject is dealt with in the articles on illumination the reader is referred to those articles for further information.

### THE IMPORTANCE OF GOOD WORKMANSHIP.

Although all the tests described above are necessary to ensure that an installation is in satisfactory condition, a careful examination is equally important as it is quite possible for defective work to pass all tests. For example, a system of wiring run in dry wood casing might show very good insulation results, and yet be quite unsatisfactory. On the other hand, a first-class tubing installation might give low tests due to temporary surface dampness which will disappear as the building dries out. Such matters can only be decided by experience and judgment of the conditions and the same applies in many other cases. Tests alone do not imply that an installation is good or bad, but the results must be considered in conjunction with the general workmanship and quality of material.

### ILLUMINATION.

Illumination tests do not often need to be made as a part of the testing out of the average wiring installation. It is hardly necessary to state that they are important in many cases, but

## THE PRINCIPLES OF SOLDERING

THE practical electrician is so frequently called upon to make soldered joints and connections that it is necessary for him to be thoroughly familiar both with the principles as well as the practice of soldering processes. Once the main essentials of these processes have been mastered it is then only a matter of practice to obtain sound reliable joints and other connections by soldering.

### Strength of Soldered Joints.

The solder actually unites or alloys with the other metals to be joined, at the surfaces of contact, provided the process has been carried out satisfactorily.

The strength of the soldered joint thus made will depend upon that of the solder used; and this brings us to the question of the type of solder to be used in each case that has to be dealt with by the electrician.

### Joints in Wires and Cables.

Thus, for soldering copper wires in various sizes of cable, either single, or stranded, there is nothing to beat a good quality soft solder, known as "Tinman's Solder"; this is very widely used for all types of electrical cable soldering (see also page 8).

### Lead-sheathing.

On the other hand, for making strong joints in lead-sheathed parts a softer solder, known as "Plumber's Solder," is used. Thus, when two lead pipes or covers have

to be joined, the familiar "wiped" joint of the plumber is used in electrical work.

### Electrical Instrument Work.

When joining bronze, hard-brass or even steel parts in electrical apparatus, as in instrument work, where the joints require the maximum strength, a silver solder is employed.

### Lead Burning.

Another method used for joining lead parts, such as the battery plates and terminal bars of accumulators, is to run molten lead around and between the joints—this is known as *Lead Burning*; it is an important method used in accumulator repairs.

Fig. 2 shows a typical example of this method, in which the lead terminal rod of a battery plate is to be joined to a connector bar. A trough is formed around the part to be joined and molten lead is poured into the trough. The sides of the trough are greased with vaseline, or are blackened with carbon to prevent the lead from sticking. When the lead has cooled the trough can be removed and we have left a strong joint made with lead as the "solder."

### Hard and Soft Soldering.

Hard soldering is the process, or method, of uniting two metals of relatively high melting point with a hard solder, such as silver solder—a silver-copper alloy. If the metals are united with a grade of brass known as *Spelter*, the process is known as *Brazing*; actually, it is

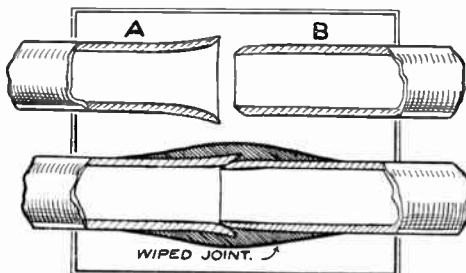

Fig. 1.—A LEAD WIPED JOINT. One end of the lead pipe A is expanded for the end B of the other pipe to fit. These are butted together and lead wiped.

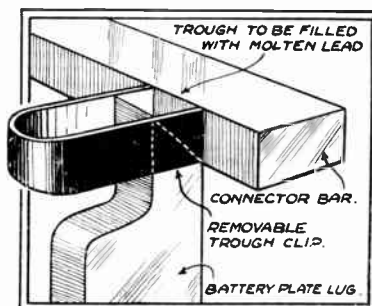

Fig. 2.—SHOWING METHOD OF LEAD BURNING ACCUMULATOR ELECTRODES.

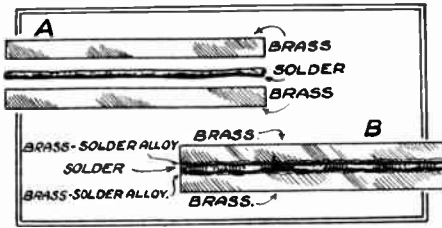

Fig. 3.—SHOWING PRINCIPLE OF METHOD OF SOFT SOLDERING.

For use when two pieces of brass or copper, such as two flat plates or terminal strips, have to be united.

a kind of hard soldering, but at a higher temperature than in the other two cases.

Soft soldering is the method of making joints or connections by melting a low-fusing point lead-tin alloy, known as *Soft Solder*.

The advantage of soft soldering for electrical work is that it does not require the use of high temperatures, so that not only is it an easier and more convenient method than the others described, but it does not heat unduly the metals to be united; the strength properties of these metals, which is depreciated by higher temperatures, is therefore not affected to any appreciable extent.

It is proposed to deal with the subject of soft soldering first, since from the electrician's point of view it is the most important method of those described.

**Soft Solders for Electrical Work.**

The soft solders used for electrical work are composed of tin and lead. These two metals will unite when melted together and can be made to form a whole range of alloys from practically pure tin with very little lead to practically pure lead with only a trace of tin.

Now, the metal tin melts at a temperature of 450° Fah., whilst lead melts at 619° Fah. It is interesting to note that the various alloys of lead and tin melt at *lower* temperatures than that of lead. Thus, a solder consisting of equal parts of lead and tin will melt at 401° Fah.

The following table shows very clearly the melting points of various possible soft solders of lead and tin :—

Tin (percentage) ..	0	10	20	30	40	50	60	70	80	90	100
Lead (percentage)	100	90	80	70	60	50	40	30	20	10	0
Melting Point ° F.	619	577	532	491	446	401	369	365	388	419	457

The hardest and strongest solders are those containing between 60 and 70 per cent. of tin and 40 and 30 per cent. of lead. Actually, the strongest solder is one containing 66 per cent. of tin and 34 per cent. of lead; it has the lowest melting point of any, namely, 356° Fah.

Soft solders are known in the trade as "common," "medium" and "fine," according to the tin content; the most expensive are the latter, as they have the highest tin content; incidentally, they have the lowest melting points. The

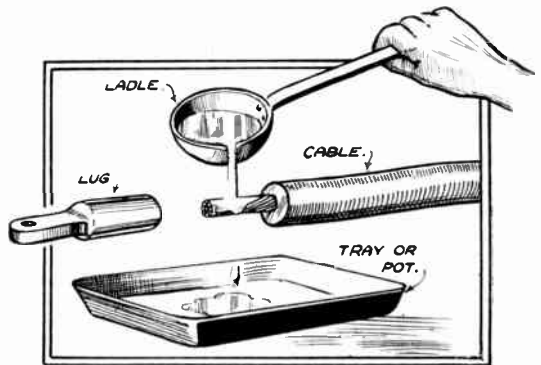

Fig. 4.—METHOD OF SOLDERING A LUG TO END OF CABLE.

following are some typical solders :—

- (1) **PLUMBER'S SOLDER.**—This consists of two parts lead and one part of tin;
- (2) **TINMAN'S SOLDERS.**—These range from the "Fine," with 66 per cent. tin and 34 per cent. lead, to the "Coarse," with equal parts of lead and tin.

The best grades of solder, it should be noted, are those made from pure lead and pure tin. Impurities such as zinc, antimony, or aluminium have a detrimental effect upon the strength and fusion properties of the solder.

**THE PROCESS OF SOFT SOLDERING.**

Let us suppose that two pieces of brass or copper, such as two flat plates or terminal strips, have to be firmly united

so as to give a strong joint and perfect electrical continuity.

### Cleaning.

Each surface is first cleaned by filing, or rubbing with emery cloth, so as to remove all traces of dirt and grease.

### Tinning.

Each part is then heated in the blue flame of a gas stove or torch—any other convenient method of heating can be used, so long as there is no carbon deposit or dirt left on the metal being heated—until, on testing with a stick of solder, the latter melts into globules on the surface of the metal.

### Applying the Flux.

A composition known as a *Flux* is then applied to the heated surface and the stick of solder rubbed over the latter. The solder will melt and run over the parts fluxed, forming a thin silvery layer.

Each of the two parts is treated in this manner, when they are said to be "tinned"; they are then ready for joining together.

### Joining.

All that is necessary is to apply a little more flux to each surface, heat the parts gradually until the solder layer melts, and finally, press the two soldered faces together. Allow them to cool afterwards, still maintaining the pressure. It is convenient for different jobs to devise clamps to hold the parts together whilst they are being "sweated"; this ensures a firm joint in each case.

### Using a Soldering Iron.

This method is used

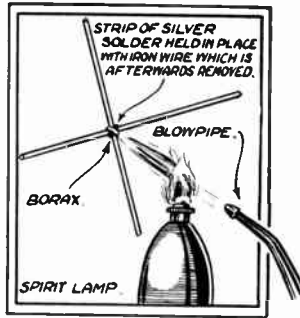

Fig. 5.—HOW A SPIRIT LAMP AND BLOW TORCH ARE USED FOR HARD SOLDERING WIRE PARTS.

for small parts such as single wires, small stranded cables, terminals, wiring lugs, etc. The parts to be soldered should be much smaller than the soldering iron used. It is a good rule to employ a soldering iron the copper bit of which is at least ten times the volume, or size, of the part to be heated for soldering.

To solder a small copper or brass part, the soldering iron is heated in a clean blue gas or spirit flame until the tinning on its faces is melted. Continue the

heating for a little while longer and then apply one of the tinned faces of the iron to the part to be tinned, rubbing it across the surface constantly. A stick of solder is taken and a little melted on to the part in question. On applying some flux the molten solder will run over the surface of the metal. Any other tinned part can be joined to this article merely by heating the two and pressing them together.

To solder a terminal lug to a large cable, for example 19 or 37 strand, the individual wires should be tinned as described, and then re-twisted to their original position. The exterior should then be coated with solder, by using one or two ladles of molten solder at a time, dipping each into the melting pot. The exterior of the wires should be well fluxed before and during this pouring operation, until the whole surface has a uniform coating of solder.

The interior surface of the hole in the terminal lug is usually supplied already tinned.

To make the final connection, heat both the lug and cable end until their temperatures are above the melting point of the solder, and force the

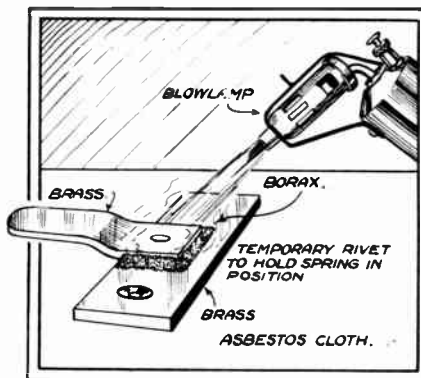

Fig. 6.—HARD SOLDERING A BRASS LUG TO A METAL PLATE.



Fig. 7.—RESIN CORED SOLDER,  
By means of which the solder is melted on to the job and the flux automatically applied in about the correct amount at the correct place.

cable end into the hole in the lug; it is an advantage to first melt a little solder into the hole in the lug so as to ensure the joint being "solid" with solder in all the spaces between the wires.

In some cases, electricians do not trouble to tin the individual wires, but merely to solder the outside surfaces by the pouring method described; this does not give such a good electrical or mechanical joint as the one we have just described.

### SILVER SOLDERING.

Although the electrician is not often required to make any stronger joints than those obtained by the ordinary soft-soldering process, it is as well to know how hard soldering is performed. Occasions may arise when strong joints in electrical instruments, switches and other electrical apparatus have to be made; broken metal parts are often repaired by hard soldering.

#### Composition of Silver Solder.

In hard soldering a special silver solder in the form of rod or strip is employed; this contains silver, copper, zinc or brass. A typical solder for electrical purposes contains 33 per cent. copper, 50 per cent. silver and 17 per cent. zinc.

#### Method of Working.

It is necessary to use a much higher soldering temperature than with soft

solders. The blowpipe or blow torch is generally employed for this purpose.

The cleaned parts are heated to a dull-red heat, in the case of iron or steel, and the silver solder melted with the blowpipe, using powdered borax as a flux. The molten metal runs into the joint and, if the process has properly been carried out, alloys with the metal on each side of the joint. The soldering irons previously described cannot be used for hard soldering, but a small gas-muffle, coke or charcoal fire can be used for this purpose.

Hard-soldered joints in brass, gunmetal or bronze usually have a strength equal to that of the metal itself.

In this respect, parts liable to vibration in electrical work will not stand up for long periods if soft soldered, but will stand up permanently if hard soldered.

#### Soldering by Dipping.

When making certain types of electrical joints such as those of cables, it is not always convenient to employ the soldering-iron method. They are, therefore, soldered by first thoroughly cleaning all the parts, then applying the flux and finally by immersing in a bath of molten solder, using a metal-wire brush to make the solder run into all the parts.

#### SOLDERING FLUXES.

The object of a soldering flux is to keep the heated metal surfaces clean, and to dissolve any surface impuri-

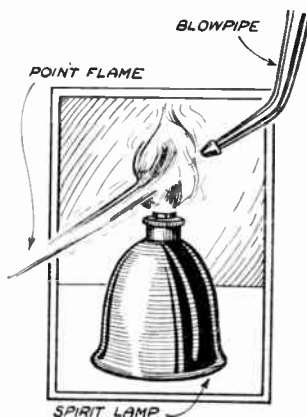

Fig. 8.—How to Use a BLOW PIPE FOR SOLDERING.

Showing how a steady stream of air is blown across the flame of a methylated spirit lamp.

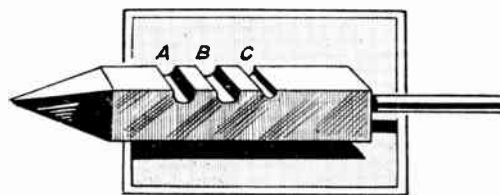

Fig. 9.—A HANDY GROOVED SOLDERING IRON.

For cable ends, wires, etc. Three sizes of wire can be employed.

ties during the soldering operation; moreover, it enables the molten solder to flow more readily.

From the point of view of electrical work the choice of a suitable soldering flux is one of much importance, for the question of subsequent corrosion of the joint arises.

It is possible to use a number of different fluxes each of which will give a strong soldered joint, but several of these fluxes have a slow corroding action on the metals of the joint so that, ultimately, fracture of the joint occurs and the electrical continuity is therefore broken.

From our present point of view, therefore, it is only necessary to describe those fluxes that may be considered suitable from the electrician's view point.

### The Best Fluxes for Electrical Work.

The best flux for electrical work is resin. Rosin is also quite satisfactory; it has a different composition from resin, the former being a vegetable product and the latter a fossil gum. There are several proprietary fluxes on the market, of which SOLDERINE and FLUXITE are claimed to be non-corroding. BAKER'S SOLDERING PREPARATION is also used for certain electrical work, but the soldered joints should be well cleaned afterwards.

Fluxes such as ZINC CHLORIDE (known also as "killed spirits"), SAL AMMONIAC (or Chloride of Ammonia), and HYDROCHLORIC ACID, should not be used for electrical work.

In an emergency, however, when no other flux happens to be available, the well-known "killed spirits," made by dissolving zinc in hydrochloric acid, can be used, but the joint should be well washed with hot soda water, so as to neutralise any acid left on the joint. Electricians who have occasion to make soldered joints in, or on, lead-sheathed

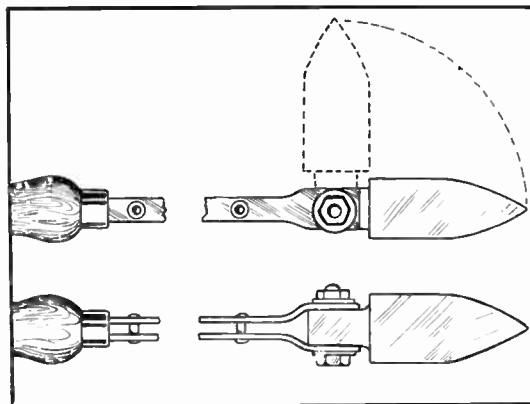

Fig. 10.—A SWIVELLING SOLDERING IRON.

cables will find that *Russian Tallow* is a very good flux.

### Resin Cored Solder

An excellent aid to soldering is the use of special soldering rods of tubular form having resin cores as shown in the accompanying illustration (Fig 7). The advantage of this form of solder is that as the sol-

der is melted on to the job, the flux is applied automatically in about the correct amount, at the correct place. This form of solder is now supplied by most electrical and wireless dealers. This solder is simply melted on to the metal to be tinned, or joined, with a heated soldering iron, when the flux melts at the same time as the solder and keeps the metal surface clean; it will thus be seen that it is used in exactly the same way as ordinary solder, but, as explained above, requires no additional fluxing.

### SOLDERING IRONS AND APPARATUS.

The method of heating the work to be soldered will depend upon the size of the parts to be joined. For larger objects the best plan is to employ a blow pipe or gas torch to heat it up to the soldering temperature. When, however, the objects to be soldered are smaller than the copper bit of the soldering iron available, the latter should be employed.

### How to Use a Blow Pipe.

For very small work a *blow pipe* can be used to direct the heat on to any particular spot. The illustration shows a blow pipe in use. (See Fig. 8.)

The ivory end of the pipe is held in the mouth and a steady stream of air is blown across the flame of a methylated spirit lamp. A little practice will enable the user to maintain a continuous stream of air and to direct the fine heating jet to any given spot on the work.

The soldering irons now available to the electrician comprise practically every conceivable method of heating the copper bit. The simplest and most widely used soldering iron is the ordinary copper bit held in the split end of an iron rod, the other end of which is fastened into a wooden handle.

### Common Soldering Irons.

Two common types of soldering iron are those known respectively as the "straight" and "hatchet" patterns. Each has its special applications, depending upon the nature and shape of the work to be soldered. It often pays the mechanic to make his own particular type of bit to suit the work he is doing regularly.

Thus, if he has to tin the ends of round wires or rods he will find it an advantage to have a copper bit with two or more half-round grooves in one face, as shown in Fig. 9. It then becomes simple and expeditious to solder the ends of wires or rods.

### A Protected Soldering Iron.

The principal drawback to the ordinary soldering iron is that it has to be heated in an open flame or fire with the result that frequently the tinning on the copper bit is burnt off; in some cases also the copper itself becomes pitted.

There is another disadvantage, namely, that the tinning becomes dirty with a scum or dross from the heating flame; this scum has to be wiped off before the iron can be used.

To overcome these drawbacks a special form of soldering iron, known as the "Peerpoint," has been marketed. In this case there is an inner iron that is heated in the flame and an outer copper sheath, with a tinned end, that can rapidly be swung over the iron part when the latter is hot enough.

In this way the copper portion is never introduced into the flame and, therefore, always keeps clean.

### A Handy Pattern.

The straight and hatchet pattern soldering irons can readily be combined into a single model by hinging the copper bit to the stem member of the soldering iron, as shown in Fig. 10. It is an easy matter to make such a bit, the only point of importance being the provision of a good friction joint.

Another useful soldering iron is the "Tinol" telescopic one. This, when not in use, can be telescoped into the stem, thus reducing the length to about 5 inches; this will be found useful for stowing into the electrician's tool kit.

### Gas-heated Soldering Irons.

Instead of having to take the iron to the gas stove every time, it is now possible to have a gas-heated iron with a length of flexible tubing (for the gas

supply), so that the iron can be moved about whilst it is kept heated by the gas flame.

In the latest type the gas is concentrated inside the iron and not outside as in older patterns; the bit keeps much cleaner in consequence. There is a gas-regulating valve for varying the degree of heating to suit both large and small work.

Various other patterns of gas soldering irons are now on the market. In selecting an iron of this type, it is advisable to make certain that it has a convenient means of regulating both the gas-air proportions and also the amount of mixed gas and air to the burner; further, the flame should not play on the tinned part of the copper bit.

### Petrol and Benzene Soldering Irons.

The petrol and benzene (or benzoline) types of soldering iron are particularly

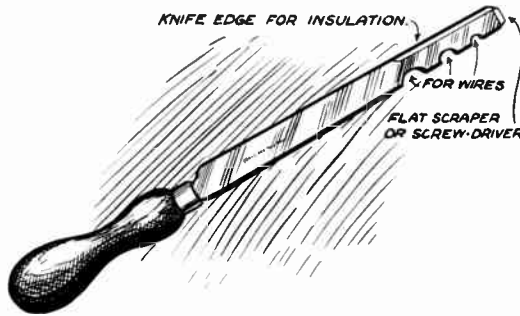

Fig. 11.—A USEFUL TOOL FOR STRIPPING CABLE INSULATION.



suites to work in the open, since they can be kept at a uniform temperature for long periods.

One make of petrol soldering iron can also be used as a blow-lamp by swinging the copper bit out of the way so that both large and small objects to be soldered can be dealt with.

A small benzoline soldering iron is suitable for electrical work on wire terminals and small connections.

### Electric Soldering Irons.

There is little doubt that where an electric supply is available the electric soldering iron is the most convenient of all the available types.

It is perfectly clean, portable and without risk of fire. The electric soldering irons on the market are made in a number of different patterns, varying according to the nature of the work on which they are to be employed.

Apart from the different shapes of the copper bit, such as the straight, hatchet, hammer, pin-point and inclined, these irons are made in a range of sizes, or heating capacities.

The usual sizes are the 60 to 75 watts, 100 to 125 watts, 150 to 175 watts and 200-300 watts.

The 75-watt type on a 225-volt supply will take  $\frac{3}{4}$ -amp. current. The 300-watt type takes  $1\frac{1}{4}$  amp.

Three different types of electric soldering iron are made by the G.E.C. The 60-watt size (Type A) weighs 12 ozs. without its flexible cable, and is suitable for small work. For use in confined spaces, such as the back of telephone switchboards, Type B is suitable; it consumes 100 watts. Type C is a heavier iron, made in 175 and 300-watt capacity, for larger work than the other two models described. Each pattern is provided with an earthing terminal and is wired with a length of three-core cab-tyre sheathed flexible cord with a substantial cord grip; the largest (300 watt) size of electric iron weighs 3 lbs. with its flex.

Electric soldering irons usually take from 4 to 6 minutes to heat up after the current is switched on.

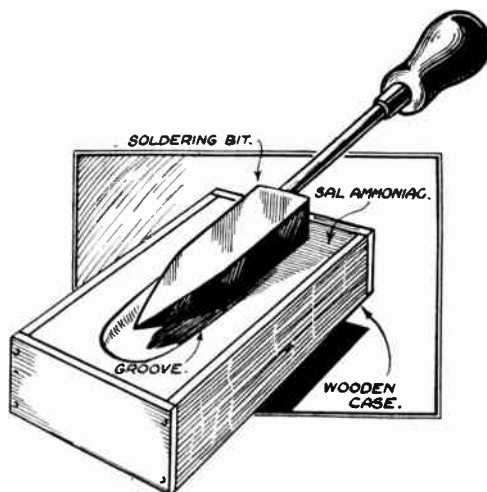

Fig. 12.—TINNING THE SOLDERING IRON WITH SAL AMMONIAC.

### TINNING.

Many soldering irons when first purchased will be found to have an un-tinned copper bit. The soldering faces of this bit will, therefore, require tinning before the soldering iron can be used.

#### The Usual Method.

The process of "tinning the bit" consists in coating the soldering faces with solder, or tin.

To solder a new bit, the working faces should be cleaned with a file or emery cloth, and the bit heated up to a temperature above that of the melting point of solder. It is here important to note that the copper bit must not be heated until the heating flame turns green, or the bit glows a dull red.

Next, dip the end of the bit in any suitable flux, such as Fluxite, and then apply a stick of solder to each face in turn when the solder will be found to flow over the surface and adhere to it; any surplus solder should be wiped off with a rag.

#### Using a Block of Sal Ammoniac.

A block of Sal Ammoniac is another excellent means for tinning the iron.

In this case, a trough is first scooped out of the Sal Ammoniac, as shown in Fig. 12, which can be made rectangular

and mounted in a wooden case, like an oil stove. After the bit has been heated, it is rubbed along the trough in the Sal Ammoniac, when dense white fumes will be created and the surface of the salt will become fused. Next melt a few pieces of solder—such as solder beads—and place in the trough. When rubbed with the heated bit, these will at once spread over the surface of the copper.

Most electricians will find it an advantage to carry a piece of Sal Ammoniac in their tool kit, for re-tinning purposes. It should be kept in a closed wooden box, or away from other tools, however, as it has a rusting action.

#### **Tinning With “Soldo.”**

It is an exceedingly simple matter to tin a soldering bit, or indeed any iron or copper surface, with a patented preparation known as “Soldo.” This is a grey powder containing the tin, or solder, and its own flux. The part to be tinned

is heated and then dipped into the powder, afterwards wiping the surface with a piece of cloth; it will be found to have a coating of solder. In this case, it is not necessary to clean the bit, as the flux used appears to get rid of all dirt, which is wiped off in the dross that forms. Rusty iron, hard steel and even painted iron sheet can be tinned with this compound.

#### **Tinning Cast Iron and Steel.**

As it is sometimes necessary to make soldered electrical connections to cast iron or steel, it is well worth while noting that these metals can be tinned as follows. First clean the part to be tinned, thoroughly with a file or emery paper. Next, take a piece of copper sulphate—the “blue vitriol” or “blue stone” of the workshop, wet it and rub on the surface, when a coating of metallic copper will be deposited. This can readily be tinned in the ordinary way.

## QUESTIONS AND ANSWERS

**What is the best solder to use for (1) copper wires; (2) lead-sheathed parts; (3) bronze, hard-brass or steel parts?**

- (1) A good quality soft solder known as “Tinman’s Solder.”
- (2) A soft solder known as “Plumber’s Solder.”
- (3) Silver solder.

**What is another method of joining lead parts?**

By means of lead burning in which lead is made to act as a solder.

**What is the difference between hard and soft soldering?**

Hard soldering is the process or method of uniting two metals of relatively high melting point with a hard solder such as silver solder. Soft soldering is the method of making joints or connections by melting a low-fusing point “lead-tin” alloy.

**What is the most important thing in soldering?**

Cleanliness.

**What is the purpose of using a flux?**

Flux is used to keep the heated metal clean and to dissolve any surface impurities; moreover, it enables the molten solder to flow more readily.

**What are some safe fluxes for electrical work?**

Resin and rosin. For joints in, or on, lead-sheathed cables, Russian tallow is often used.

**What is “tinning”?**

“Tinning” means coating the copper bit of the soldering iron with solder or tin, and it is done by heating the bit, dipping it in flux and applying a stick of solder to each face in turn when the solder will be found to flow over the surface and adhere to it.

**What is the best method of heating the work to be soldered?**

By means of blow-pipe or gas torch.

# STRIPLIGHTING

## AND ITS APPLICATION FOR BUSINESS PREMISES

**A**S a striking change from an electric sign some firms outline their business premises with electric lamps.

In this field of electric illumination, the "Fairyland" system fills a very important part, both in permanent and temporary installations. It is unlike all other wiring systems because no wood casing, steel conduit, or other mechanical protection to the cables are employed, and as the wires or cables used on the system are very flexible, the Strip can be bent and worked into any design required. Briefly the system consists of a flexible wire or cable, either with single or double conductors, upon which are hermetically sealed, at any predetermined distance apart, the various types of patented holders, to be used with either bayonet capped lamps or screwed socket lamps. After the holders are attached to the cables the backs of the holders are filled in with a special insulating compound at boiling-point. This insulating compound gets a firm grip all round the cable, and when set is perfectly hard.

### Type of Cable Used.

The type of cable most generally employed is

a flat twin 7/22 V.I.R., taped, braided and compounded, and is manufactured especially for the purpose by a well-known firm of British cable manufacturers. Such Strip is perfectly non-hygroscopic and watertight and will last for a period of from ten to twenty years, even when employed on installations exposed to sea air and all conditions of climatic changes.

There are over twenty-four patterns of "Fairyland" Strip supplied, ranging from the miniature types to large Edison screw patterns for ship lighting and multiple circuits.

### Taking off the Insulation.

This "Fairyland" Strip is mounted up on special long benches upon which are placed metal jigs with holes to receive the "Fairyland" holders at stated intervals. At each end of these benches are mounted cable drums, one containing a coil of special twin cable the other one at the opposite end being empty. The cable from the full drum is drawn along the full length of the bench and the stripper proceeds to take off the insulation and attach the wires to the first holder. This



*Fig. 1.*—STRIPPING OFF THE CABLE INSULATION.

A special knife must be used for this purpose, and the wire has to be bared very carefully to avoid cutting any of the strands of cable.

FIG. 2—  
(Below) FOR-  
CING THE  
CABLE OVER  
THE SCREW  
ENDS.

The cable wire has been bared in the manner shown in Fig. 1, and the cable with its twin conductors is forced over the two pointed screw ends of the lamp-holder terminals.

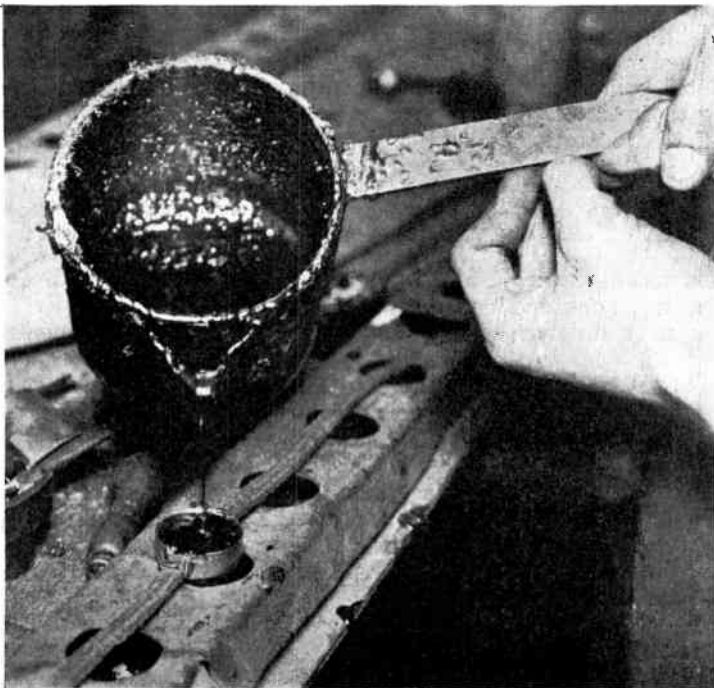
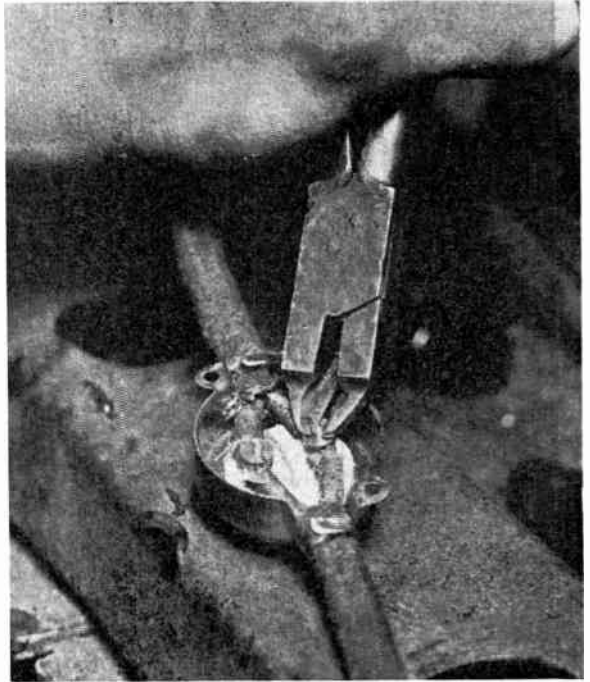

Fig. 3.—(Above) SCREWING ON THE BRASS SLOTTED NUTS.

This illustration shows the methods of connecting up a single conductor cable for wiring holders in series. This illustration also shows how the holders are spaced out on special long benches. At each end of the bench is mounted a cable drum, one containing a coil of wire and the other one empty. The cable from the full drum is drawn along the full length of the bench and the wire attached to the holders.

*Fig. 4.—(Right) CUTTING OFF THE SCREW ENDS.*

Before the insulating compound is poured into the holder, it is necessary to cut away the superfluous ends of the threaded screws so that they do not project through the insulating compound. This operation is done by using a pair of metal cutters as shown in the illustration. Incidentally, this picture shows a bayonet capped type of holder and not, as in the three previous pictures, a screwed socket type of holder.



*Fig. 5.—(Left) POURING IN THE INSULATING COMPOUND.*

A metal mould is placed round each holder and into each is poured a special sealing compound at boiling-point. This completely fills up the back of the holder, thus insulating the bare portions of the cable and all live parts. This insulating compound gets a firm grip all round the cable and when set is perfectly hard. It is then wound up on to the empty drum.



*Fig. 6.*—MOUNTING A BAYONET CAPPED STRIP ON WOOD BATTENS.

The strip is mounted on wood battens by means of pins or tacks, the holders being provided with holes for this purpose.

process is repeated until all the holders are attached to the cable.

#### **Filling with Sealing Compound.**

Around each holder is then placed a metal mould into which is poured a special sealing compound at boiling-point which completely fills up the back of the holder, thus insulating the bare portions

of the cable and all live parts. When this sealing composition has cooled the Strip is then wound up on to the empty drum. A fresh supply of holders is then placed in the jigs and the process repeated until the coil of cable is finished. The Strip before being removed from the bench is tested for continuity by being connected to the electric light supply service and lamps being put in the holders indiscriminately.

## **WHAT IS A ROTARY CONVERTER?**

A rotary converter is a machine with only one armature. It will convert one kind of supply to another, or it may, if driven mechanically, generate two different supplies simultaneously. It is then known as a double current generator.

Where a D.C. supply is available a rotary converter can give the following outputs:—

(1) D.C. at a higher or lower voltage than the supply, for supplying the H.T. current for wireless in the former case and for charging low tension batteries in the latter instance.

(2) Single-phase A.C. at the same, higher or lower voltage than the supply

for supplying the power to an A.C. all-mains wireless receiver.

(3) Polyphase A.C. for experimental purposes.

Where a single-phase A.C. supply is available a rotary converter may be used for the following:—

(1) D.C. supply at a higher or lower voltage than the supply for supplying high tension for wireless or for charging accumulators.

(2) Polyphase A.C. for experimental purposes.

Later articles deal thoroughly with the installation and upkeep of this important type of machine.

# HOW TO MAKE A VIOLET-RAY APPARATUS

By H. J. BALDWIN

**W**HEN ordinary white light is decomposed by passing it through a prism we find that it splits up into the seven primary colours, with red at one end of the spectrum and violet at the other. We now know that there are invisible rays beyond the violet, known as actinic or ultra-violet rays, which are widely used by the medical profession for curative and tonic treatment. Special lamps have been made which produce these rays, and in this article two methods are described. An earlier article on

page 143 described the methods of operating and adjusting the mercury type of lamp as manufactured commercially. A small lamp of the violet-ray arc type can be constructed by the practical electrician.

## Material for the Lamp.

A piece of sheet copper or tin plate, gauge 22 to 24, 32 inches by 22 inches, for the body of the lamp.

Strip of iron, 2 feet by 2 inches by  $\frac{1}{8}$  inch, for the "U" bracket.

Round iron rod, 1 foot by  $\frac{1}{4}$  inch diameter, to form the carbon holders.

Ebonite tube, 10 inches by 1 inch, with  $\frac{3}{4}$ -inch bore, for the handles.

Brass rod,  $1\frac{3}{4}$  inches by  $\frac{7}{8}$  inch and 2 inches by  $\frac{3}{4}$  inch.

6 inches of stout spring approximately  $\frac{3}{8}$  inch diameter, and two split pins.

Strip of red fibre, 10 inches by  $1\frac{1}{2}$  inches by  $\frac{1}{4}$  inch, for the bushes.

Wood for the feet, 1 foot 4 inches by 3 inches by 1 inch.

$1\frac{1}{2}$  dozen 4B.A. bolts, two 2B.A. bolts, and a pair of  $\frac{1}{4}$ -inch bolts with winged nuts.

A few large glass beads and 2 yards of 10 ampere flex.

## Material for the Resistance Box.

Piece of wood, 1 foot 6 inches by  $10\frac{1}{2}$  inches by  $\frac{1}{2}$  inch.

Sheet tin, gauge 24, 21 inches by 24 inches, and strip 44 inches by  $2\frac{1}{2}$  inches.

1 double-pole switch.

Sheet asbestos, 8 inches by 5 inches by  $\frac{1}{8}$

inch, and a supply of mica washers (or old sparking plug).

$1\frac{1}{2}$  dozen 2B.A. bolts, eight 6B.A. bolts, and strip brass, 3 inches by  $\frac{3}{4}$  inch by  $\frac{1}{8}$  inch.

4 inches ebonite rod,  $\frac{3}{4}$  inch diameter.

Filament from an electric fire, element rated at 750 watts, as used in a bowl fire.

The whole outfit should cost under 25s., and many of the small requirements are to be found in the kit of most handy men.

## How to Make the Lamp Body.

First cut out a piece of odd wood the shape of one of the ends, then mark out one of the ends on the sheet copper, as shown in Fig. 2, allowing for the flange, which has to be turned up. Place the piece of sheet metal centrally on top of the wooden block and gently tap the overhanging portion so that it turns over at right angles. While still on the wooden template (drill the holes round the flange.

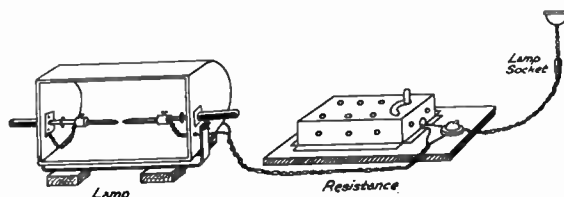

Fig. 1.—VIOLET-RAY APPARATUS CONNECTED UP AND READY FOR USE.

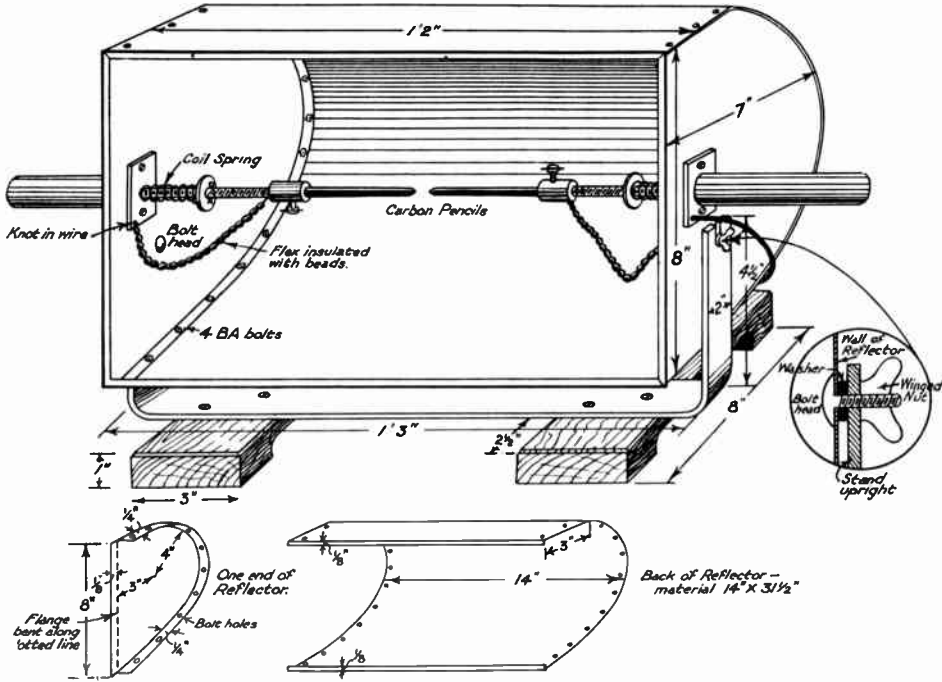

Fig. 2.—HOW THE VIOLET-RAY LAMP IS CONSTRUCTED. Showing also dimensions of back and ends of the reflector.

When the second end is completed cut a piece of sheet metal 14 inches by 31½ inches for the curved back, making sure that it is perfectly square, then turn up the ends at right angles.

Bend the back roughly to shape, then hold one end in position and mark on the rear piece the position of the first bolt hole. Repeat the process the other end; drill the holes in the back and then screw home the first two bolts. Gradually bending the back into position, drill the holes one at a time, and bolt up before proceeding to the next.

**Making the Handles.**

Take 5 inches of the ¼-inch iron rod and

with a die cut a thread down the whole length, then at intervals of 1 inch drill 3/32-inch holes to take the split pins (see Fig. 3A). Cut off 1 inch of the 3/4-inch brass rod and drill a hole through the centre slightly less than ¼ inch diameter. Now tap this hole with the same thread as used on the iron rod. In the side of the brass drill a 7/64-inch hole and tap this 4B.A. to take the grub screw which secures the ebonite handles (Fig. 3).

When making the carbon holders take a piece of 5/8-inch rod and drill a hole slightly under ¼ inch diameter, this is then tapped half way through with the ¼-inch thread, the other half being opened out to 3/8 inch diameter to accommodate the

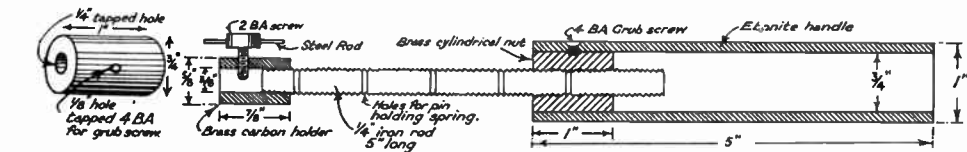

Fig. 3.—DETAILS OF BRASS CYLINDRICAL NUT FOR THE EBONITE HANDLE.

Fig. 3A.—SECTION OF CARBON HOLDER AND INSULATOR HANDLE.



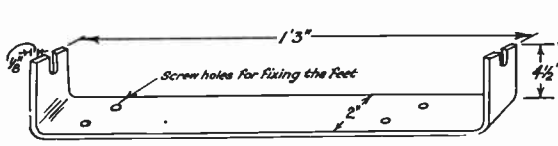

Fig. 4.—LAMP-STAND "U" BRACKET.

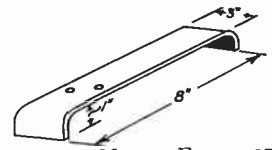

Fig. 4A.—METAL FOOT FOR STAND.

If preferred, can be used in place of wood.

carbons. About  $\frac{1}{4}$  inch from the end drill a hole sideways, and tap 2B.A. ; this is for the clamping screw which holds the carbon pencil. The screw which fits this hole has a small hole drilled through the head and a short piece of steel rod put into it ; this is used as a finger grip (see Fig. 6). Those readers who do not possess  $\frac{1}{4}$ -inch screwing tackle can get this part of the work done by a good plumber or garage hand for a trifle.

The ebonite tubing should fit tightly on to the cylindrical brass nuts ; if slack, tin the brass. A small hole should be drilled in the side of the ebonite to admit the grub screw. As the head of this screw will be alive when the lamp is in use, an ebonite or rubber sleeve should be slipped over the outside of the handle.

**The Stand.**

The bending of the "U" shaped bracket is quite obvious from Fig. 4. Wooden feet are shown in Fig. 2. These are quite safe, but iron ones, see Fig. 4A, can be used if preferred.

**Fitting up the Lamp.**

Drill two holes in each end piece of the

lamp, one to take the  $\frac{1}{4}$ -inch swivel bolt and the larger one,  $\frac{3}{4}$  inch diameter, to admit the carbon holders. Take great care to see that the larger holes are exactly opposite to each other so that the carbons come in line with one another. The head of the swivel bolt should be soldered to the end of the lamp. Note that the fibre bushes, through which the carbon holders pass, have a  $\frac{1}{4}$ -inch hole in the centre, while the hole in the lamp side is  $\frac{3}{8}$  inch. Be careful when fixing these bushes to see that the hole in the fibre is placed centrally over the hole in the side of the lamp, as it is very important that the iron rods attached to the handles are not in electrical contact with the body of the lamp. It will be seen from Fig. 5A that the iron rods screw into the hollow handles and are held firm by a spring. The spring is compressed as far as possible, and the split pin slipped into one of the small holes in the rod. As the carbon burns and the rod is screwed out the tension will slacken and necessitate moving the pin to a fresh hole. This operation is, of course, carried out when the lamp is not in use.

The flex is led through the fibre bush and knotted on the inside (see Fig. 5A) ; a

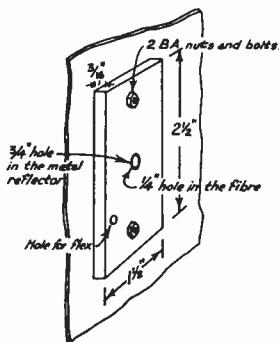

Fig. 5.—DETAILS OF FIBRE BUSHES ON END OF REFLECTOR.

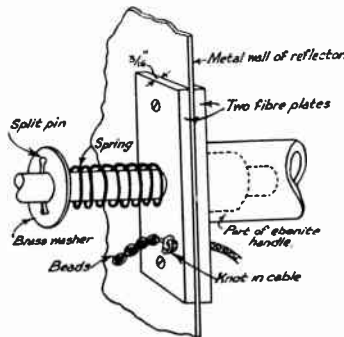

Fig. 5A.—HOW THE HOLDERS ARE FITTED TO WALLS OF REFLECTOR.

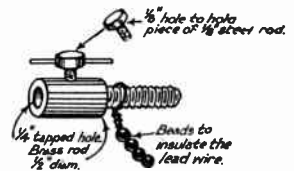

Fig. 6.—THE CARBON HOLDER, SHOWING THE FINGER GRIP.

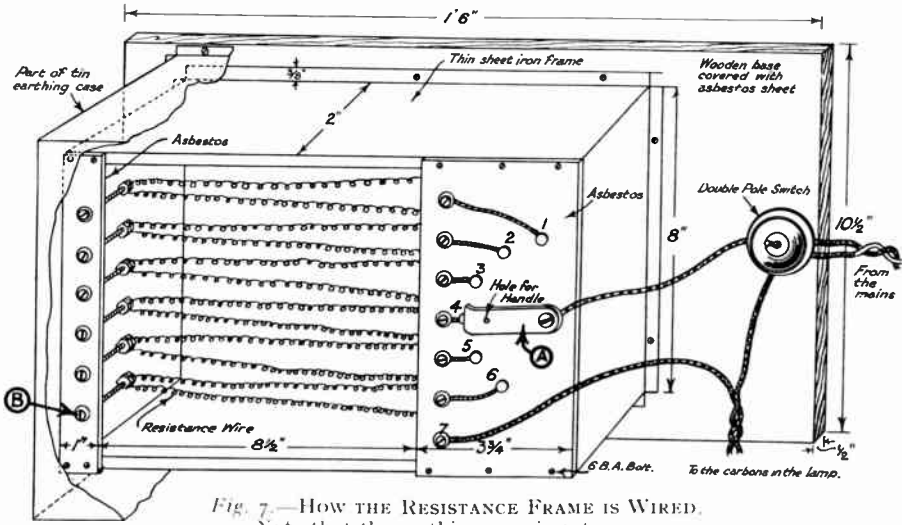

Fig. 7.—How THE RESISTANCE FRAME IS WIRED.  
Note that the earthing case is cut away.

length of 5 or 6 inches is then stripped of insulation and glass beads threaded on in its place. The body of the lamp may now be supported on the "U" bracket and should tilt backwards and forwards when the winged nuts are slackened.

**The Finish.**

The inside of the lamp should be highly burnished with metal polish, finishing off with rouge, and finally lacquered. The outside of the lamp can be coated with a good-quality heat-resisting paint.

**Making the Resistance Frame.**

This is like a metal box without bottom or lid, and is quite easy to make. Take a strip of tin  $2\frac{3}{4}$  inches by  $43\frac{1}{2}$  inches long and mark two lines  $\frac{3}{8}$  inch from each edge and four vertical lines where the corners will come. First bend over the two  $\frac{3}{8}$ -inch flanges, noting that they are bent

in opposite directions, then cut out small triangular pieces in the flanges immediately above the vertical lines which mark the corners. Now bend the strip into the form of a box and solder up one corner. Drill holes, as shown in Fig. 10, to hold the asbestos strips.

**The Asbestos Strips.**

Cut these to size and mark out the position of the various bolts and studs; those forming the selector switch are on the arc of a circle and slightly closer together than the width of the selector arm. The 2B.A. bolts are best bolted in position before the strips are fastened to the frame. Under the head of each, and between the asbestos and the fixing nut, are mica washers. Suitable ready-made washers can be made by dismantling the mica insulation of an old sparking plug.

**The Resistance Wire.**

Obtain an element rated at 750 watts for the correct voltage of your electrical supply and carefully remove the wire resistance; this should then be fastened between the studs, as shown in Fig. 9. Note that the wire is wound round the bolt and locked between two nuts screwed up tightly. The first six bolts are connected

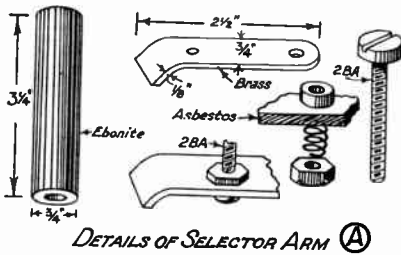
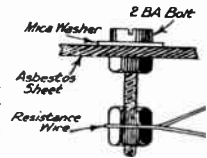

Fig. 8.—THE SELECTOR SWITCH.  
(See A in Fig. 7.)



DETAILS OF (B)  
Fig. 9.—FASTENING THE RESISTANCE WIRE TO THE SUPPORTING STUDS.  
(See B in Fig. 7.)

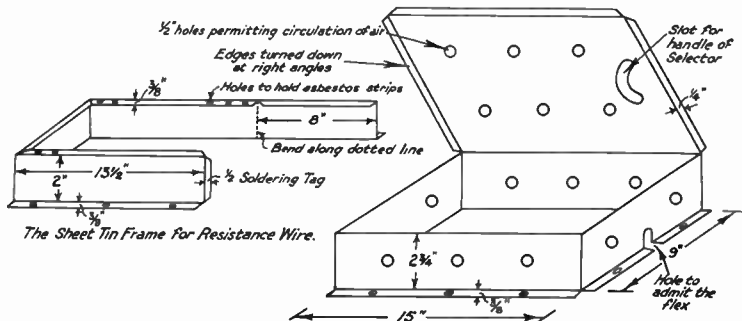

Fig. 10.—CONSTRUCTING THE RESISTANCE FRAME AND COVER. The left-hand sketch shows the frame partly completed, and the right-hand sketch shows the earthing cover.

across to their respective studs in the selector (see Fig. 7); the connections can be made underneath the asbestos sheet if preferred. It should be noted that bolt number 7 is joined to the flex from one of the carbons in the lamp.

**The Selector Blade.**

This is made out of stout brass strip, the handle being screwed on to a 2B.A. bolt fastened through the blade. The fulcrum end is packed up with one or more washers, and a small spring is threaded on to the fixing bolt on the under side; this ensures that there is good contact between the blade and the studs (see Fig. 8). Note that a piece of flex connects the selector with a terminal in the double-pole switch.

**Mounting up the Resistance.**

When the resistance wire is secured to the frame, mount the unit on a piece of board 1 foot 6 inches by 10 1/2 inches which has the top surface covered with a thin sheet of asbestos. At one end of the board fix a double-pole switch. This has four terminals; the two remote from the frame are connected with a length of flex to a lamp holder or plug, while the remaining terminals nearer the resistance are connected thus: one to the fulcrum of the selector and the other to one of the carbons in the lamp (see Fig. 11).

**The Earthed Cover.**

The whole of the resistance is covered with a metal case which is connected by a wire to earth. This is not necessary for

the working of the lamp, but is a safety measure that should be adopted. Fig. 10 gives details of size and construction, it being like a box without a lid inverted over the frame. A curved slot permits the handle of the selector coming through. Several 1/2-inch holes are bored in the metal to allow circulating currents of air to cool the resistance wire. It is very important to mount the cover centrally on the board out of contact with the resistance frame.

**The Carbon-lighting Circuit.**

If the lamp is to work from the lighting circuit the carbons should be 6 mm. in diameter. These can be purchased at various firms who sell this type of lamp, and some of them are "cored" with chemical earths to increase the quantity of ultra-violet rays. When fixing the carbons in the holders, first screw the feeding

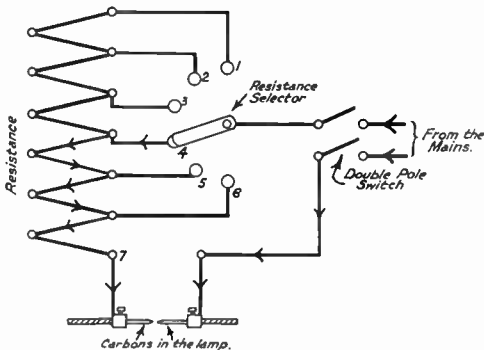

Fig. 11.—SHOWING THE WIRING CIRCUIT OF THE APPARATUS.

rods right back into the handles, and then firmly clamp the plain end in the socket with the setscrew.

N.B.—If the carbons exceeds 6 mm. in diameter they must be guaranteed not to consume more than 5 amperes.

### The Carbons—Power Circuit.

Those readers who propose to use the lamp on a power circuit can use 8 to 10 mm. carbons rated to use not more than 8 amperes. It should be carefully noted, however, that if the larger size carbons are used the resistance wire used on the frame must be from a heating element rated at 1,000 to 1,250 watts.

### How to Use the Lamp.

Connect up the lamp and resistance, as shown in Fig. 1, with the double-pole switch "off," the carbons just parted, and the selector arm on stud No. 1, that is, all the resistance "in" the circuit. Now switch on the current and screw up the carbons until they touch, when a hissing noise will be heard and the tips will glow red. Now slightly part the carbons (approximately  $\frac{1}{8}$  inch apart), when a dazzling light will appear between the tips.

If the arc breaks down when the carbons are parted there is either too much resistance in circuit, which can easily be remedied by moving the selector on to stud No. 2 or 3, or the gap is too large.

When "striking" the arc have the whole resistance in circuit, and, when necessary, move the selector arm to reduce the resistance as the carbons are parted.

Should the fuse "blow," it indicates that there is not sufficient resistance in the circuit, but this is very unlikely if the selector arm is on stud No. 1 when the arc is struck.

The rays should be applied to the bare skin or a covering of artificial silk may be

worn, as the rays will penetrate this fabric; not more than ten minutes exposure per day should be attempted without medical advice.

### HOW TO ADAPT A BOWL FIRE.

It is an easy task to convert a bowl fire into a small sunshine lamp by making an adaptor which holds a bulb of the "Solarium" type in place of the element. This will in no way interfere with the use of the bowl as a fire when required.

### Making the Adaptor.

Fig. 12 shows a simple form of adaptor.

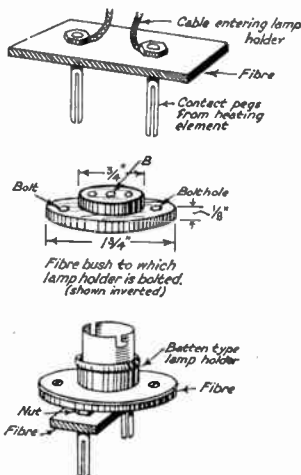

Fig. 12.—(Top) HOW THE PINS ARE FASTENED TO THE FIBRE. (Centre) THE CIRCULAR FIBRE BUSHES. (Bottom) THE ADAPTOR FOR USE WITH A BOWL FIRE.

The two contact pins which have been taken from a heating element are bolted to a piece of fibre, the distance between them varying with the distance between the sockets in the bowl fire. On to this strip of fibre are bolted two circles of fibre, the smaller one being underneath, lifting the larger disc clear of the nuts which secure the contact pins. A lamp holder is then bolted to the larger disc of fibre. Before buying the lamp holder purchase the bulb, as some makes require a screw type and not a bayonet holder. Take two short lengths of good flex and attach the bare ends to the contact pins, securing the ends under the nuts,

then thread the wire through the holes in the fibre into the terminals of the lamp holder. The socket may then be bolted down on to the upper fibre disc, taking care that the bolts do not touch the contact pins or the nuts.

### Special Cautions.

Remove the heating element from the bowl, push in place the adaptor and fix the bulb in the socket, when the current may be switched on.

Always wear dark-tinted glasses, preferably blue, when using the lamps, then no injury to the eyes will result.

# ERECTING AN AERIAL

## PRACTICAL ADVICE ON OUTDOOR AND INDOOR TYPES

**I**T is the intention of this article to describe the correct and practical method of erecting an aerial. There are many variations of size and design to be decided upon, according to position and space available for the erection. Fortunately, however, with modern broadcasting receivers, a very small aerial only is necessary, and one has not to give a lot of attention to height, especially in the case of towns within reasonable radius of a broadcasting station.

### Erecting a Mast or Pole.

In the first place, however, we will assume that it is the intention to erect some form of mast or pole.

Every consideration and care should be given in erecting the mast, otherwise, due to the weather conditions, it is possible that it may fall, and cause serious injury to property or, possibly, persons, for even a small pole, falling suddenly, would do a tremendous amount of harm.

So, after all, one should make a good job of the erecting.

### The Sort of Pole to Buy

The most suitable poles are those which are called "rigging poles" and can be obtained from any good builders' merchant or timber suppliers. A pole of 25 feet is ample for all conditions, but buy a new pole—not a second-hand one.

### Preparing the Pole.

This should now be stripped of bark and given two or three coats of good paint, preferably finished with white paint. At the top of the pole some form of pulley fixture is necessary, and, above all,

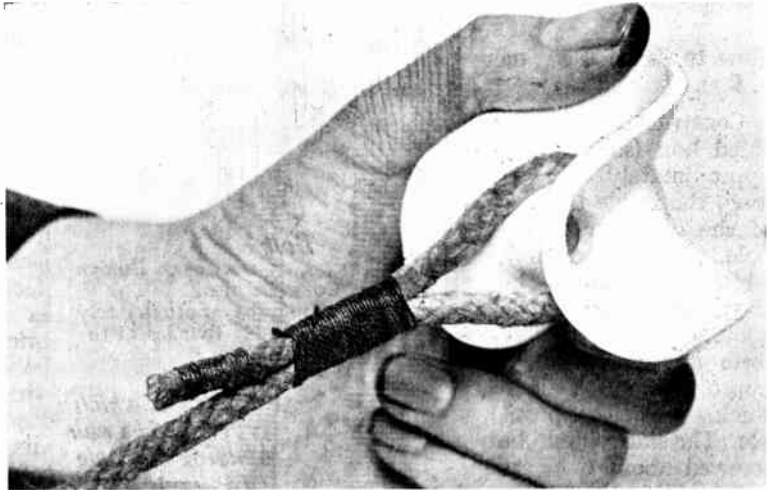

*Fig. 1.*—How to JOIN ROPE TO THE INSULATOR.

The rope should be threaded through the insulator and the end bound in the manner shown. Do not tie a knot as this is likely to come undone.

it is necessary that a disc or cap is fixed to the top. This is not only for ornamental purposes but is to prevent rain soaking down the pole and causing the top to split. A suitable galvanised pulley and pulley hook can easily be obtained. It is better to use a hook which can be bolted right through the pole as this is safer. If this cannot be procured, ordinary screw rings will do.

### Use a Fixing Box.

The pole is now ready for erection, but it is no use thinking that all there now remains to do is to dig a hole and drop the pole into it. This is where trouble occurs, for, although a pole will stand

upright for a little while it will soon rot through and fall. To make a satisfactory job, a proper fixing box set in concrete must be used. The advantage of a proper fixing box is that the pole can be lowered it at any time the rope line should break; also, the pole will remain in a vertical position.

### How to Make a Fixing Box.

Construct a three-sided box (see Fig. 2), approximately 5 feet long, the inside the size of the diameter of the pole. The wood from which this should be constructed must be good, sound and free from any defects, and approximately 1 inch thick. Use oak if possible. The sides should be screwed about 6 inches apart, and in the following manner:—

Taking the back board, drill a series of holes the size of the diameter of the screws used. Now countersink holes must be drilled in the side pieces of wood to conform with the back to the depth to which the screws will have to go. The size of these holes must be approximately the diameter of the core of the size of the screws used and if the drill is chosen correctly, the screw will easily be screwed in without any difficulty whatsoever, particularly if a little grease is

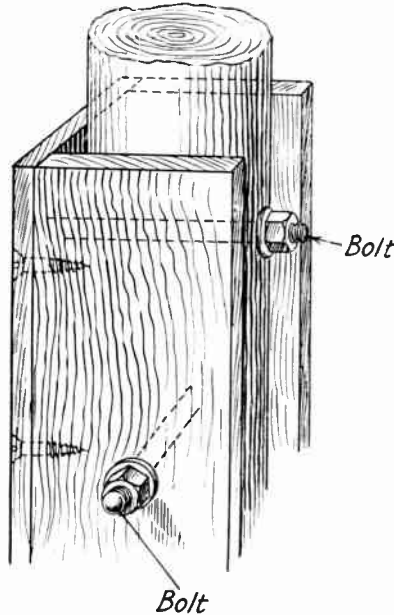

Fig. 2.—HOW A THREE-SIDED BOX IS CONSTRUCTED.

The box should be approximately 5 feet long, the inside the size of the diameter of the pole.

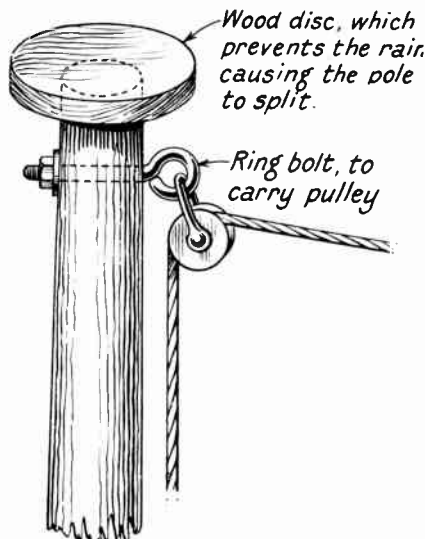

Fig. 3.—HOW TO FINISH OFF THE TOP OF THE POLE.

A disc or cap should be fitted to the top of the pole so as to prevent rain soaking down the pole and causing it to split. When fixing the aerial to the pole it is best to use a hook that can be bolted right through the pole.

applied to the screw. The type of screw recommended for this purpose is  $2\frac{1}{2}$  inch, 12 gauge.

### Coat the Box with Creosote.

The box must now be given three or four coatings of creosote at intervals of an hour or so. The more creosote that is soaked into the wood, the longer the wood will stand the weather.

### Setting the Box in Concrete.

A hole should now be dug in the ground at least 2 feet 6 inches deep, and the box set in concrete. Any old bricks or rubble will be suitable for mixing with the concrete or sand and cement. In mixing the concrete, proceed as follows:—

Mix the sand and cement together, firstly in their dry state in the proportions of one of cement to three of sand. After they are thoroughly mixed, add water until it is of a consistency that will freely run between the old bricks.

Now place a layer of bricks and cement at the bottom of the hole, ramming the old bricks in first so that they form a good hard base, and then set the box in a perfectly upright position and secured so that it does not move, and fill in the remainder of the hole with the

bricks and cement, adding a few bricks at a time with the cement so as to bind together thoroughly. Do not forget, however, to wet the bricks before laying them in the hole. In place of bricks, large stones, "well washed," will be quite suitable or, if no suitable waste is handy, buy rough shingle.

### Fixing the Pole.

The pole is fixed in the box by the

*By taking out this bolt  
the pole can be lowered  
for repairs, painting  
etc*

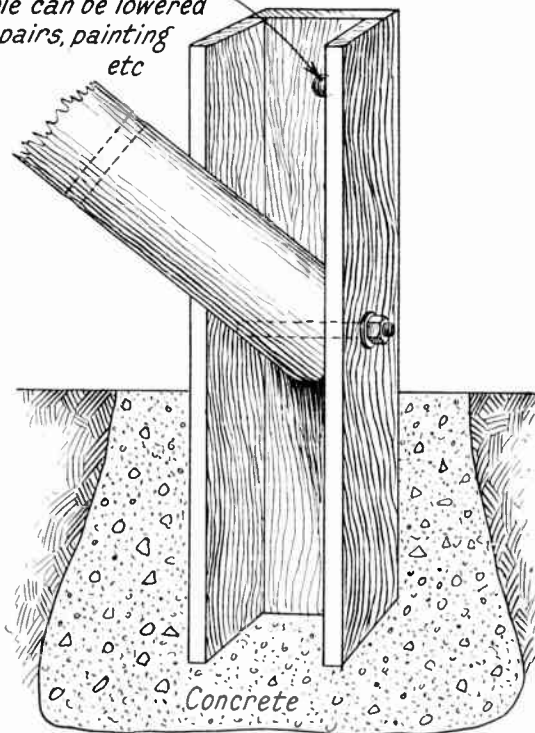

Fig. 4.—FITTING THE POLE INTO THE BOX.

The pole is fixed in the box by the simple method of a bolt through the bottom so that the pole can lay flat on the ground, and another bolt at the top bolted through to hold the pole in position when it is upright.

simple method of a bolt through the bottom so that the pole can lay flat on the ground, and another bolt at the top bolted through to hold the pole in position when it is upright. When a pole is fitted in this manner, it will last for many years, and it always has the advantage that it can be easily lowered

for repainting or in the event of it becoming necessary, to replace the rope. If the concrete base is properly fitted, that is to say, if it is large enough, no stay ropes will be necessary.

If an extra pulley and line is fitted it can also be used as a flag mast and, therefore, add a little ornament to the garden. Also, there is no reason why a weather vane should not be fitted to the top of the pole.

### Fixing the Aerial to the House.

The next consideration is house end fixing. In this it is in many cases essential to plug the brickwork to hold the necessary fixing. It is surprising how few people understand the correct method of plugging a wall so that it will be neat and yet strong, and, curiously enough, it is easier to do the job correctly than to make a poor job.

### How to Use a "Jumper."

The tool necessary to make the hole suitable for the plug, is termed a "jumper." This can easily be made from a piece of gas barrel about  $\frac{1}{2}$  inch in diameter. At one end are filed teeth, as shown in Fig. 5.

The teeth are placed in position on the wall where the hole is to be made, and the "jumper" is given a few taps with a hammer. The "jumper" must now be turned slightly and a few more taps given. This must be continued until the hole is of the required depth. By continually twisting the "jumper" and

hitting it squarely with the hammer, a round hole will be produced, no matter how thick or hard the wall is. This method is particularly useful when it is necessary to make a hole through a wall to take a leading tube through, and if it is carefully done, the wall will not be damaged.

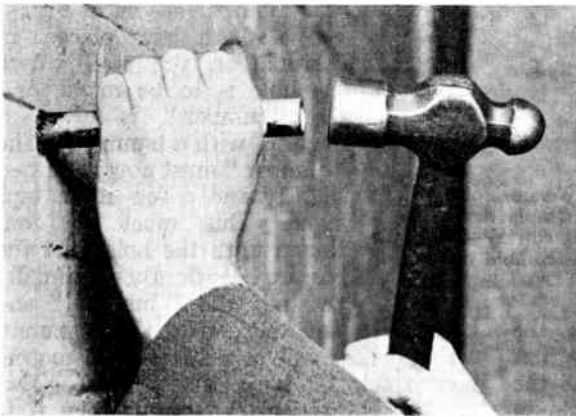

*Fig. 5.—How TO CUT A HOLE IN A WALL (1).*

The tool necessary to make a hole suitable for a plug is called a "jumper," and can be made from a piece of gas barrel, at one end of which teeth are filed.

Having now made the necessary hole for the plug, which should be of a depth suitable for the desired screw, cut a piece of wood to the size of the hole, so that it can be pushed in flush to the wall. Now cut a wedge-shaped piece of wood.

Place the wood plug into the hole, split



*Fig. 6.—How TO CUT A HOLE IN A WALL (2).*

Place the "jumper" with the teeth against the wall and tap it with a hammer. Now turn the "jumper" slightly and give it a few more taps. Keep turning and tapping until a hole of sufficient depth is produced.

the plug in the centre with a chisel, place the wedge in the cut and drive it home; this will expand the plug and compress the wood tightly into the brick.

### **Preparing the Rope.**

Having prepared the pole and house end fitting, you are now ready to consider the method of joining the rope and the aerial wire to the insulators.

Firstly, the ends of the rope must be whipped

in the manner shown in Fig. 12, that is, about  $\frac{1}{2}$  inch is tightly wrapped round with twine and drawn underneath the last few turns.

Lay a length of twine along about  $\frac{1}{2}$  inch of the rope, leaving about three or four inches free, wind over carefully and tight about  $\frac{1}{2}$  inch, and when nearly to the last three or four turns, wind over and pass through loop and draw end of loop. This will pull the end of cord inside the wrappings. By this means, the end of the rope will be prevented from fraying. The rope should now be threaded through the insulator and the end bound as in Fig. 1. Do not tie a knot as this is likely to come undone, but if properly bound with twine it will stand all the necessary wear and will never come undone through swaying in the wind or through vibration.

### **Fixing the Insulators.**

It is advisable to use at least three insulators at each end of



the aerial, and these should be placed about 1 foot apart, and joined with rope in a similar manner to that before described, that is, the ends should be turned over and looped together. Fig. 11 shows the correct way of lining up the insulators.

Take the aerial wire through the last insulator and twist over to about 3 inches as shown in Fig. 13.

Decide on the length of the aerial and pass the remainder of the wire through the first insulator of the other end. This should then be twisted over for an inch or two and the remainder left for the down lead.

### What Wire to Use.

*A warning here in regard to the wire used for the aerial.* This should be copper or silicon bronze. Unfortunately, there is a quantity of wire which has been placed upon the market which is steel wire and only has one small strand of copper in it, and is insulated. This insulation does not serve any purpose, but the trouble is this: the steel wire rusts and causes trouble very quickly, for a broken rusted steel wire sets up noises in the receiver. Insulated wire for the outside of the aerial is absolutely unnecessary, and the only time when insulated wire is required is when it is passed through the frame of a window or when it is inside the house. Then, of course, the insulation of the wire must be good.

The best wire to use is the high-tension wire similar to that used for leading the current to the sparking plugs on motor cars, and this type of wire can be used for leading through a window frame, and it is most satisfactory for this purpose, but of course it must be soldered to the outside aerial wire. *A dry joint is certain to cause trouble very quickly.* If it is not possible to solder these two wires together, they must be securely clamped with a proper metal joining clip, but this should be given frequent attention as it becomes dirty and the two wires oxidise

and make poor contacts; but there is no reason whatsoever why the two wires should not be soldered together.

### Soldering the Wires.

To do this clean both ends of the wire with emery cloth; twist them together and apply a flux such as "Fluxite"; if a soldering iron is not available, and particularly in view of the fact that it would have to be used out of doors, take a spirit lamp or a blow lamp, make



Fig. 7.—INSERTING A PLUG.

The wood plug is cut to the size of the hole so that it can be pushed in flush to the wall.

the wire hot and apply a little blowpipe solder, as shown in Fig. 14. If the flux is applied properly, the solder will run together and join the wires successfully. You have no doubt noticed the telephone engineers soldering their wires in the roadway, you will also have noticed that they always use a spirit lamp.

### An Easily-made Spirit Lamp.

A convenient spirit lamp for this class of work can easily be made with a piece of tube, the end of which is capped, and the tube filled with wadding soaked in methylated spirit. The tube should be

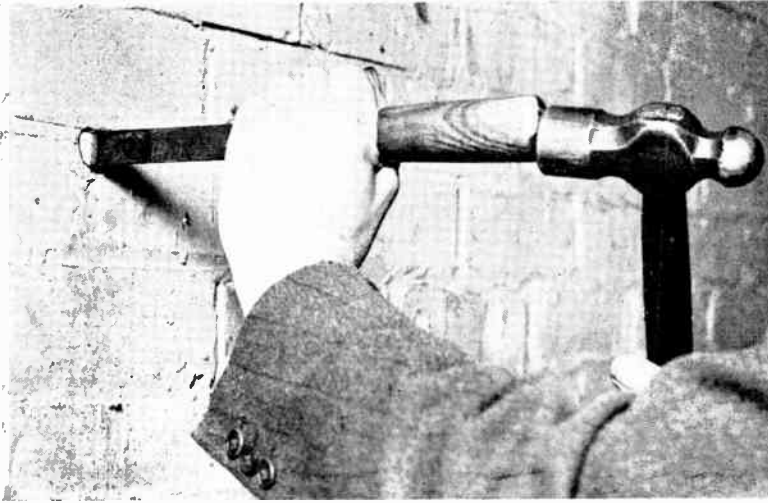

*Fig. 8.*—SPLITTING THE PLUG WITH A CHISEL.

After the plug has been placed in the hole, it is split down the centre with a chisel prior to inserting the wedge shown in Fig. 9.

about  $\frac{3}{4}$ -inch in diameter. This is a useful tool to carry for wireless work, for with its aid a small soldering iron can also be



*Fig. 9.*—INSERTING THE WEDGE.

The wedge is placed in the cut made by the chisel and is driven home with a hammer. The plug is thus expanded and compresses the wood tightly into the brick.

made hot to make a repair to the receiver itself, as very often it is inconvenient to use a fire or even gas for heating an iron.

### The Lead-in Wire

The lead-in wire if insulated can be tacked or stapled with insulated staples along the picture rail. There is no need to fear much lost energy with this as in the modern broadcasting there is always plenty to

spare with a reasonable aerial.

### Fix an Earthing Switch.

It is advisable to fix an earthing switch so that the aerial may be earthed in the case of heavy thunderstorms. While we do not fear much trouble in this country regarding thunderstorms, it is, nevertheless, a very necessary precaution, and as these switches are only about 1s. each, it is well worth the extra labour involved.

### The Importance of a Good Earth.

We must now consider the question of an earth. This is equally as important as that of the aerial and the very best form of earth, if it is convenient, is a main water pipe. Unfortunately, however, these are mostly situated a long way from the receiver and this causes a disadvantage, as the shorter the earth wires, the better the results.

### Using a Main Waterpipe.

Assuming that a main water-pipe can be used, it is essential to use a good earth clip,

# RALPH STRANGER'S WIRELESS BOOKS

*The Wireless Library for the  
Wireless Enthusiast:*

MATTER AND ENERGY  
ELECTRONIC CURRENTS  
ELECTRIFIED MATTER  
MAGNETISM AND ELECTRO-  
MAGNETISM  
THE MATHEMATICS OF WIRELESS  
BATTERIES AND ACCUMULATORS  
SEEING BY WIRELESS (TELEVISION)  
MODERN VALVES  
WIRELESS COMMUNICATION AND  
BROADCASTING  
WIRELESS WAVES  
HOW TO UNDERSTAND WIRELESS  
DIAGRAMS  
SELECTION OF WIRELESS SIGNALS  
DETECTION OF WIRELESS SIGNALS  
AMPLIFICATION OF WIRELESS SIGNALS  
REPRODUCTION OF WIRELESS SIGNALS  
WIRELESS RECEIVING CIRCUITS  
WIRELESS MEASURING INSTRUMENTS  
THE BY-PRODUCTS OF WIRELESS

## SOME PRESS OPINIONS:—

"The new shilling library aims at giving the wireless enthusiast a sound theoretical and practical grip of his subject. The author employs clear and simple language, and starts practically from zero."—*The Broadcaster*.

"These books deal with a highly technical subject in the simplest language which enables those who have no scientific training to grasp the wonders of wireless, and assist the listener to get the best possible results from a receiving set."—*Railway Review*.

**ONE SHILLING EACH**

By Post 1/2 each.

On sale at all Newsagents, Bookstalls and Bookshops, or by post from GEORGE NEWNES, Ltd., 8-11, Southampton Street, Strand, London, W.C. 2.

## WIRELESS: THE MODERN MAGIC CARPET

**Fourth and Revised Edition**

If you know nothing about wireless and do not even possess a receiving set, this book will show you how to provide yourself with an interesting and absorbing hobby. If you are a listener, but rather weak on the technical side, it will save you much unnecessary worry and expense. If you wish to experiment, this volume will provide you with valuable experimental data. If you are an expert and have to lecture, it will give you some useful lecture material.

## SOME PRESS OPINIONS:—

"Mr. Stranger . . . gives a simple, yet authentic introduction to all the 'mysteries,' and explains them away in an exceedingly interesting and readable way. . . . A book which should go on every listener's bookshelf."—*The Star*.

"A good book simply written."—*The Daily Mirror*.

" . . . It will be surprising if such an ably written book as this does not find a wide sale."—*Daily News*.

" . . . Mr. Stranger has succeeded in doing one thing that will endear him to all students interested in electricity. He has succeeded in making static electricity fascinating. . . . The book should prove of great value to all those who have a set or contemplate the construction of one."—*World-Radio*.

" . . . The subject, in both theoretical and practical aspects, is dealt with in a lucid manner guaranteed to inculcate knowledge without pains."—*Amateur Wireless*.

**3/6 nett.**

By Post 3/9.

George Newnes, Ltd.

 This article on Erecting Aerials is continued in Part 5 published November 13th. Order your copy to-day.

Of value to every handyman

**NEWNES'**  
**Home Mechanic**  
**BOOKS**

Clearly written and fully illustrated

each book contains 96 pages

**SIMPLE ELECTRICAL APPARATUS**

An excellent little book for those who wish to make simple and useful electrical appliances, such as galvanometers, electric motors, dynamos, and Leyden jars. All these may be made by anyone with the aid of a few tools and some inexpensive materials. Clear instructions are given in every case.

**MODEL BOAT BUILDING**

There are few more fascinating hobbies than Boat Building. In this book there are designs for a battleship, a speed boat, a paddle steamer and yachts, from which excellent models may be built with the help of the simple directions and diagrams that are given. No elaborate tools are needed, and each model can be made at small cost.

Other Titles

THE HANDYMAN'S ENQUIRE WITHIN

THE HOME WOODWORKER

25 SIMPLE WORKING MODELS

MODEL AEROPLANES AND AIRSHIPS

**One Shilling each**

*On sale at all Newsagents and Bookstalls, or by post 1/2 each from George Newnes, Ltd., 8-11, Southampton Street, Strand, London, W.C.2.*

*Geo. Newnes, Ltd.*

Printed in Great Britain for the Proprietors, GEORGE NEWNES, LTD., 8-11, Southampton Street, Strand, W.C.2, by WILLIAMS, LBA & Co., Ltd., Clifton House, Worship Street, E.C.2. Sole Agents: Australasia: GORDON & GORCH (Australasia), Ltd. South Africa: CENTRAL NEWS AGENCY, LTD.