

A MONTHLY MAGAZINE OF ELECTRICAL PROGRESS

The **PRACTICAL**
ELECTRICAL
ENGINEER



VOL. 1.—No. 8

APRIL, 1933

For every voltage
let **HENLEY CABLES**
carry the current



Henley single core
66,000 Volt Oil-filled
Cable.
(Pirelli System).

W. T. HENLEY'S TELEGRAPH WORKS CO., LTD., HOLBORN VIADUCT, LONDON, E.C.1

GEORGE NEWNES LTD.

1¹/₂



ELECTRO-HYDRAULIC

THRUSTORS

The BTH Thrustor is a device which will

Apply pressure
Actuate lever mechanisms
Eliminate muscular effort

Among the many applications are the electrical operation of

Power press clutches
Hopper gates
Lattice gates
Swing & sliding doors
Control valves
Change-gear mechanisms

WRITE FOR DL. 2734-1

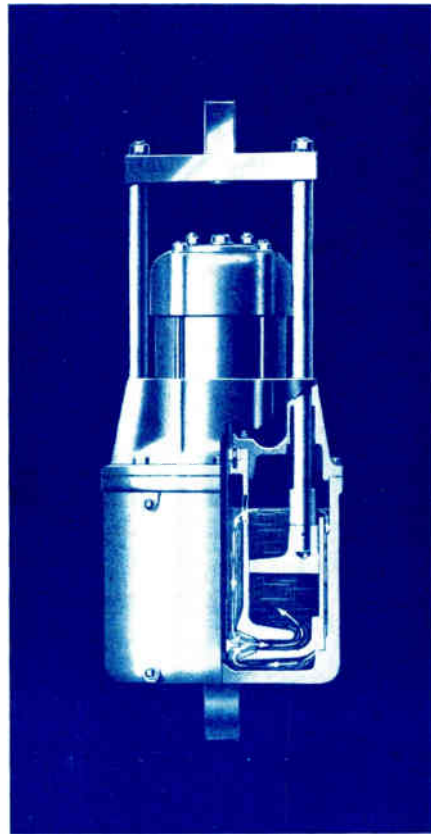

The BTH Thrustor is a self-contained unit giving a smooth straight line thrust up to 500 lb. through a stroke up to 5 ins. This motion is obtained by oil pressure generated beneath a piston by an impeller on the shaft of a small high speed motor.

BTH RUGBY

THE BRITISH THOMSON-HOUSTON COMPANY LIMITED, RUGBY, ENGLAND

(A1402N)



If your present telephone "lets you down" in the middle of an important conversation, puts you on to the wrong department . . . it's time you installed an Ericsson Telephone System.

In this we have specialised in clear speaking, sturdy construction and "handiness" (study the illustration of our new instrument).

We shall be glad to quote you for installation. Write us to-day for literature sent post free.

ERICSSON TELEPHONES LTD.

67/73, Kingsway, London, W.C. 2.
Telephone : Holborn 3271. Works :
Beeston, Notts.

Ericsson

INTERCOMMUNICATION TELEPHONES

POWER TRANSMISSION

The most economical drive is a Rope Drive. Suitable for drives from Steam Engines, Steam Turbines, Oil Engines, Gas Engines or Motors. Rope Driving is positive, and shock absorbent

"LAMBETH"

**THE WORLD'S
BEST KNOWN
AND MOST
EFFICIENT
DRIVING ROPE**



**FOUR
STRAND
OR
THREE
STRAND**

Less stretch, more pliable and will carry more power than any other make of Driving Rope :: The Rope you can fit and forget

Enquiries Solicited. Technical help freely given

THOMAS HART LTD.

The Rope Driving Specialists

LAMBETH ROPE WORKS, BLACKBURN



Purveyors of
Electric Lamps
By Appointment



Manufacturers
and Purveyors
of Electric Lamps
By Appointment

EDISWAN

'The name that means' EXCELLENCE

FOR RELIABILITY



EARTHED
SYSTEM

This earthed junction box possesses many exclusive features. No screws; cover clips into position; automatic bonding takes all normal house wiring cables; bonding clips externally visible. The only reliable box for sunk work.



EDISON SWAN CABLES

are supplied for all purposes. V.I.R., C.T.S., Bitumen and Paper Insulated types and 'Virite' are manufactured under ideal conditions at Lydbrook, Glos.

COPYRIGHT
EDISON SWAN
LONDON

EDISWAN TIME AND LABOUR SAVING WIRING SYSTEMS

The many novel improvements in ease and speed of assembly, and in electrical efficiency, incorporated in the Ediswan systems have proved profitable to many electrical contractors. Good stocks of both earthed and unearthed systems, together with suitable Edison Swan Cables are held at all Ediswan branches. Send for latest catalogue.

Unearthed Systems. No external channel clips visible; rough channel ends shrouded by surface entry extensions; connecting pillars cross-drilled for ease of wiring; boxes available in various finishes.

Both systems can be supplied complete with fittings such as switches, ceiling roses, wall brackets, plug boxes, etc.

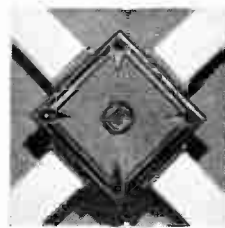

UNEARTHED SYSTEM

THE EDISON SWAN ELECTRIC CO. LTD.



155 CHARING CROSS RD., LONDON, W.C.2

Bring your lighting problems to **EDISWAN**

L. A. 138

The PRACTICAL ELECTRICAL ENGINEER

A MONTHLY SURVEY OF MODERN PRACTICE IN ELECTRICAL ENGINEERING

VOL. I

APRIL, 1933

No. 8

Published by GEORGE NEWNES, Ltd.,
8-11, Southampton Street, Strand, London W.C. 2.

Telephone—Temple Bar 7760

Telegrams—"Newnes, Rand, London"

Price - 1/- Monthly
Yearly Subscription, 14/- Post Free
6 months' Subscription, 7/- Post Free
Registered for Transmission by Canadian Magazines Post
Canadian Rate: Yearly Subscription, 13/6 Post Free
6 months' Subscription 6/9 " "

**More about
Lamp Prices** It is not surprising that the leading article in last month's issue has excited a good deal of interest amongst electrical engineers. It will be remembered that we put forward a basis for price fixing as follows:—

The economic price for any mass produced article is the price which will yield the highest net profit to the firm or group of firms manufacturing the article.

Many interesting communications have been received and a selection of these will be published in next month's issue. In most cases the comments received have been favourable. Criticism, either constructive or otherwise, is invited.

**When Lamps
are Exported** One well-known engineer asks how this law can be reconciled with the fact that lamps sold in this country at ring prices are obtainable abroad at a very much lower figure. The answer is that whilst we are not in a position to judge what price should be charged for lamps exported to other countries, we believe that the manufacturers concerned have fixed these prices at or near the optimum figure, i.e., the figure which will give them the highest net profit. In doing so they are acting not only

in their own interests but in the best interests of the electrical industry.

Another correspondent asks "Could you give us a basis for fixing the optimum price for any manufactured article?" A very shrewd question. We wish we could. However, we think the solution would require the three following qualifications:—

- (a) Long experience in the particular market concerned.
- (b) A scientific outlook.
- (c) Some knowledge of human nature.

This brings us to another interesting question, viz., Do Engineers Make Good Business Men? Taking the words engineer and business man in their best sense and not in the restricted sense in which they are often employed—we should say that when an engineer devotes his attention seriously to the business side, he makes a very fine business man. Henry Ford is one of the outstanding examples of this. Uninformed people sometimes make disparaging remarks on the Ford system, but anyone who will take the trouble to read the books explaining how the Ford business was developed, or, better still, to visit a Ford factory

FF

and see the system in operation, must admit that the Ford system is one to be admired.

There is, however, one very important point to be remembered, viz., that the great majority of engineers devote many years to a close study of their own job, which may be defined broadly as finding out how to harness the forces of nature to serve the requirements of modern civilisation. This is a fascinating study. So much so that *many forget that the human side is of even greater importance.*

Take two men of equal intelligence—one with a deep knowledge of engineering and a slight knowledge of human nature; the other with a slight knowledge of engineering and a profound knowledge of human nature. Which of these two men will make the most of his life and get the most out of life?

Undoubtedly, the student of human nature.

The engineer who can add to his strictly logical training an equally sound knowledge of his fellow men is indeed fortunate.

What we Like to See

In the February issue of the Magazine we asked readers whether they had — amongst many other electrical luxuries—a battery charging plant installed in their garage. We now learn that the Westinghouse Brake and Saxby Signal Company have just placed on the market an apparatus designed specially for this purpose. The first models are now available to the public, and these are being supplied in two sizes—one designed to deliver a charging current of 1 ampere at 12 volts and another designed for a 2-ampere charging rate at 6 volts. The transformer supplied with this charging set has tapplings on the primary to enable it to be used on any ordinary A.C. supply. A special charging socket is fixed to the facia board of the car, so that all the user need do, is plug in and switch on. The charging current is lead through the ammeter of the car, so that no separate instrument is required. We compliment the manufacturers on their enterprise and wish it the success which it deserves.

FURTHER ADVANCE IN NEON LIGHTING

A NEW development in the Neon industry is the application of Neon Tubes to internal illumination. This has been practised for some time with success on the Continent, but until recently it has been comparatively unknown in this country.

Under this system three tubes of different colours are used, viz., red, blue and green. The tubes themselves are usually concealed, and the blended light is used for indirect illumination. Rheostats in the form of rotary dimmers are included in the circuit of each tube, so that the

three colours may be blended in any desired manner. One of London's best known restaurants is now being equipped with a Claudegen Neon installation, which will provide through the use of various colours a close approximation to daylight, and the possibility of any desired shades.

Readers will notice that in this system the colours are mixed "mechanically" to obtain a light approximating to daylight, whilst in the sunlight tubes, referred to in our March issue, the effect is obtained by a single tube containing the appropriate gases.

ON THE MERCURY ARC RECTIFIER

By SIR AMBROSE FLEMING, F.R.S.

We have been fortunate in securing the following article by Sir Ambrose Fleming, and we feel sure that every reader will be interested in his description of the development and use of the mercury arc rectifier

ALMOST exactly 30 years ago patents were taken out by Mr. Peter Cooper-Hewitt, of New York, U.S.A., for a method of rectifying or converting alternating electric currents into direct currents, which methods have been since developed into extremely important practical appliances in electrical engineering.

Advantages of the Direct Current Motor for Traction Purposes.

It has long been recognised that for all traction purposes the direct current electric motor has very great advantages in weight and bulk per horsepower, ease of speed control, and simplicity of construction compared with any alternating current motor.

Advantages in the Generation of Alternating Electric Currents.

On the other hand, alternating electric currents can be generated at low voltage, raised to high voltages by static trans-

formers for transmission by relatively small sectioned conductors and re-transformed down again to low voltages by static transformers which need no attention and can be placed even in the open air in iron water-tight cases.

The Problem of Interconnecting the Two Appliances.

The problem then was to interconnect the two appliances or rectify the alternating currents into direct currents (D.C.) for use with D.C. motors.

Rotary Converters.

This can be done by rotary converters consisting of an alternating current motor coupled to a direct current dynamo, but such machines must be housed in a proper building and require constant attention and therefore cannot be left alone for any considerable time.

Development of the Mercury Arc Rectifier.

An adequate solution of the problem has, however, been found in the develop-

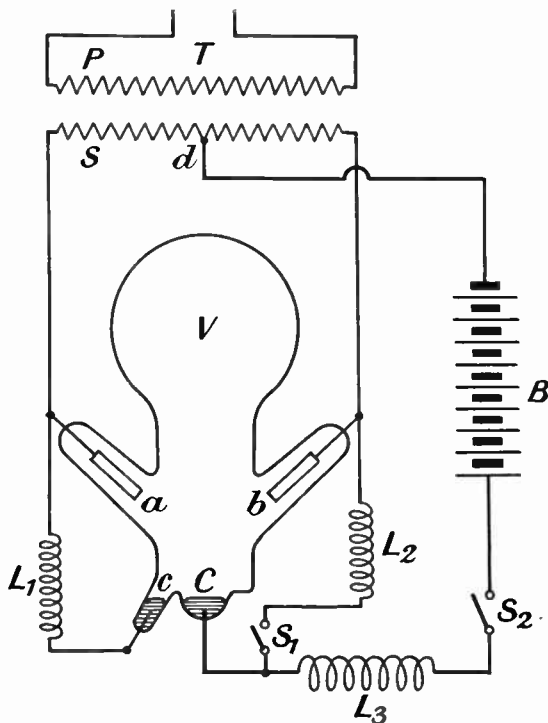

Fig. 1.—MERCURY ARC RECTIFIER IN GLASS BULB. For rectifying single phase alternating current from a transformer T, to charge a storage battery B. V is the mercury rectifier valve; a, b, iron anodes; C, mercury cathode; c, starting cathode; L₁ L₂ L₃, inductance coils to limit current; S₁ S₂, switches.

ment of the mercury arc rectifier into an appliance which requires little or no attention and has a high efficiency at low loads, which is not the case with the rotary transformer.

The Technical Action of the Mercury Rectifier.

The technical action of this mercury rectifier may be explained as follows :—

We place in a glass bulb, which is subsequently exhausted of its air, a little mercury and make an electrical connection with this mercury by a platinum wire sealed through the glass, and we also provide another electrode of iron or carbon also attached to a platinum wire sealed through the glass. We shall then have an arrangement which can act like a valve to electric currents, or permit electricity to pass only in one direction through it.

Let us suppose the mercury pool to be connected to the negative pole of a dynamo or battery and the iron or carbon pole to the positive terminal and let the bulb be tilted for a moment so as to bring the mercury in contact with the iron or carbon anode. Then an electric arc will start between them and be maintained, but it cannot start if the mercury is made the positive pole.

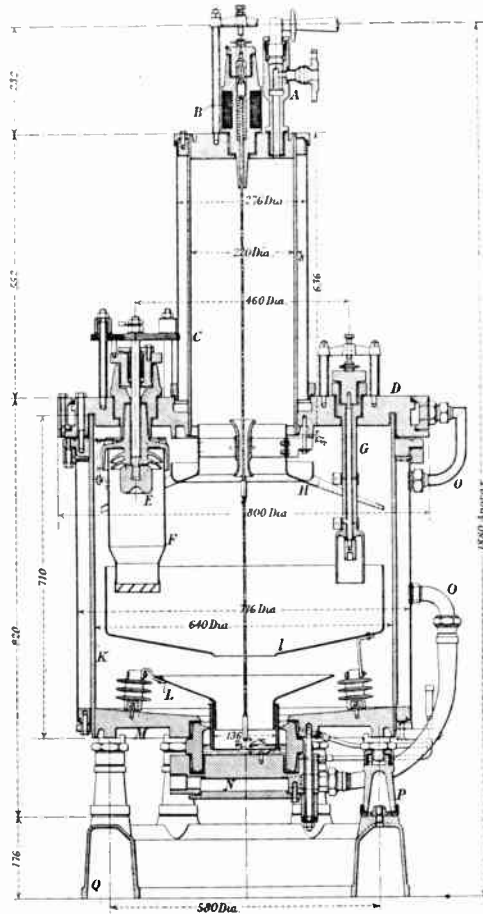

Fig. 2.—SECTION OF AN ALL-METAL RECTIFIER BY BROWN BOVERI.

A, cock connecting rectifier with vacuum pump; B, ignition coil; C, condensing cylinder; D, anode plate; E, main anodes; F, arc guides; G, auxiliary anodes; H, collector; I, collecting funnel; K, steel cylinder; L, funnel; M, plate; N, cathode base; O, connections; P, insulators. This illustration is from a paper by R. L. Morrison, A.M.I.E.E., before the British Association some years ago and is of interest for comparison with present day British practice.

Why the Mercury Pool Must be Connected to the Negative Pole.

The explanation is as follows :—

Mercury is an element with large atomic weight (200.6) and large atomic number (80). This means that the nucleus of the atom is massive and there are a large number (80) of negative electrons surrounding it. This atom easily loses one or more electrons and becomes ionised and the ion is positively charged. Mercury has also a low boiling point or is converted into vapour at a temperature of 350° C.

Accordingly, when contact is made between the mercury (cathode) and iron (anode) poles some mercury is volatilised and ionised.

The positive ions or massive mercury atoms minus one or more electrons are then drawn powerfully to the mercury cathode and bombard it, thus liberating more electrons,

which are drawn to the iron or anode. The iron, however, being cool, does not emit electrons, but absorbs them as it is positively electrified.

Flow of Electrons Only in One Direction.

Thus there is a flow of electrons only in one direction, viz., towards the iron pole. But the direction cannot be reversed as

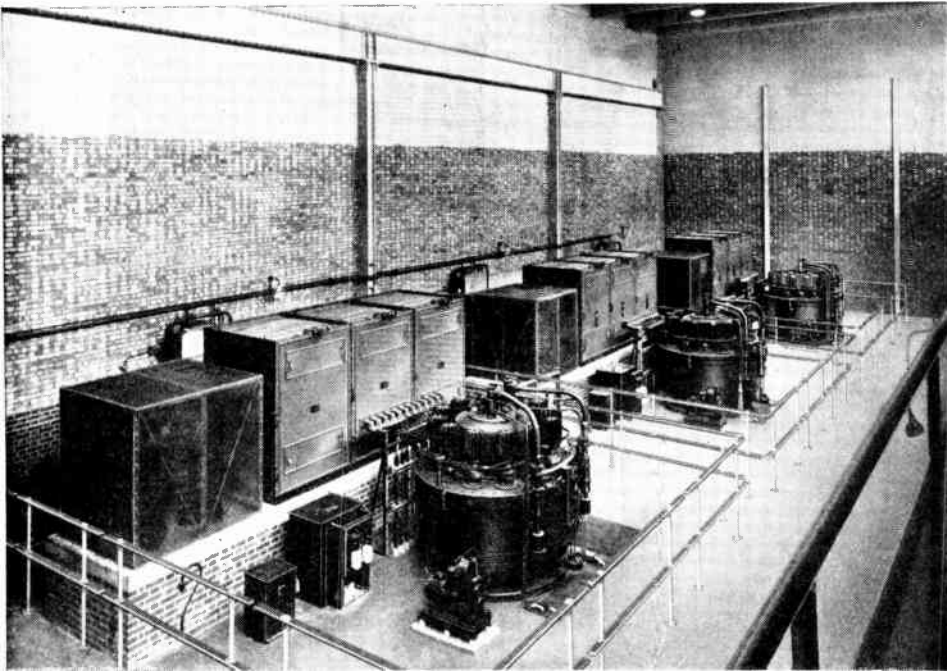

Fig. 3.—THREE 1,500 kW. G.E.C. MERCURY ARC RECTIFIERS INSTALLED AT THE CHISWICK PARK SUBSTATION FOR THE WESTERN EXTENSION OF THE LONDON ELECTRIC RAILWAY Co. Power is supplied at 11,000 volts, 3-phase, $33\frac{1}{3}$ cycles at the main distribution station and is rectified to 630 volts D.C. at the substations. An important feature in the design of the rectifiers is the method of insulating the anodes from the top plate. A seal capable of withstanding an electrical pressure of over 20,000 volts is used and consists of a top and bottom member between which are inserted a number of iron cones separated by a special vitreous enamel having a coefficient of expansion similar to that of iron. (By courtesy of the G.E.C.)

the iron does not emit electrons until it is at a white heat. Hence this air exhausted bulb full of mercury vapour acts as a valve for large electric currents.

The Action is the Same as that of the Fleming Thermionic Valve.

It acts just as a Fleming thermionic valve acts for small currents as used in wireless work. In this last case the incandescent tungsten filament emits electrons and these are absorbed by the cold positively electrified metal cylinder or anode which surrounds the filament.

How the Mercury Rectifier is Used to Rectify Larger Alternating Currents.

We can utilise this Cooper-Hewitt mercury rectifier to rectify larger alternating currents, single or poly-phase as follows.

Rectifying a Single-phase Alternating Current.

To rectify a single-phase alternating current the bulb must have two iron or carbon anodes and one mercury pool cathode as shown in Fig. 1. If the alternating current is supplied from a transformer we can connect it up through the mercury rectifier as shown in Fig. 1. The outer ends of the secondary circuit of the transformer are connected to the two anodes and the middle point of this circuit to the mercury cathode; and the article, whether motor, arc or storage battery, is connected as shown to the mercury cathode and the middle point of the secondary circuit. It will be seen, then, that when an alternating electric current flows in the secondary circuit first one and then the other iron anode becomes

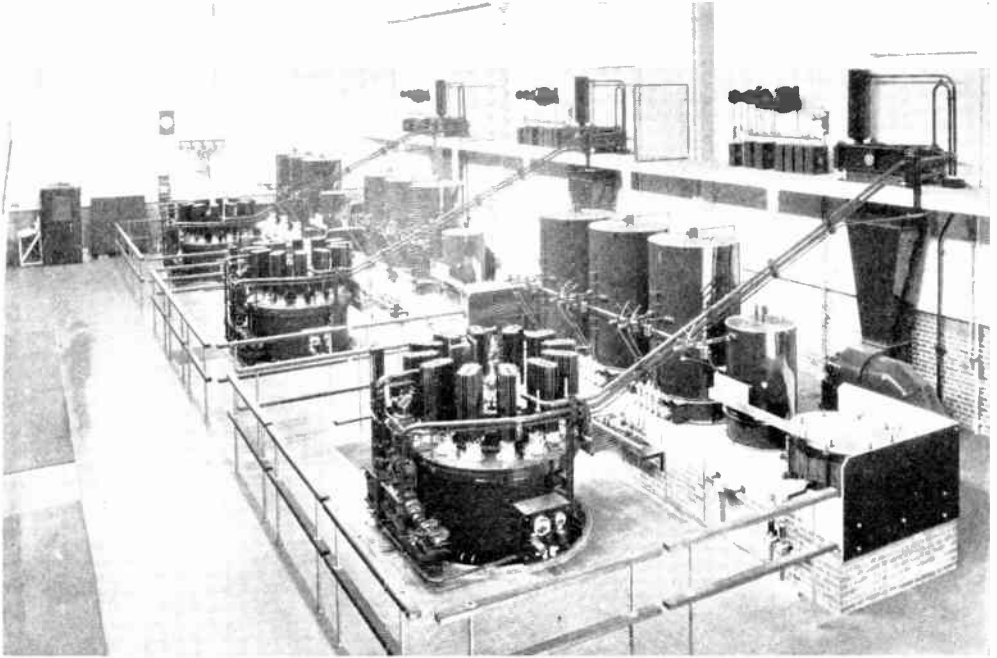

Fig. 4.—INTERIOR OF MANOR HOUSE SUBSTATION.

Showing three 1,500 kW. B.T.H. mercury arc rectifiers for converting the incoming alternating current at 11,000 volts to direct current at 630 volts for driving the trains. Filter circuits on the narrow gallery at the right prevent interference with telephone communication. (By courtesy of the B.T.H. Co.)

positive and the mercury cathode is always negative. Accordingly, an electric arc in the mercury vapour jumps from one to the other anode and the current through the external circuit is always in one direction.

Starting the Arc.

In order to start the arc we require a small supplementary mercury anode marked *a* in Fig. 1, and the arc is started by tilting the bulb and then setting it upright again. The object of the large glass bulb is to afford a surface for condensing the mercury vapour, and it then trickles back into the pool again. Thus no mercury is used up in the operation of the bulb.

Rectifying Three-phase Alternating Currents.

When three-phase alternating currents have to be rectified, which is usually the case on commercial or public electric supply, the transformer which steps down the alternating electric current must

have its three secondary circuits star connected with middle points all joined to the mercury pool of the rectifier.

There have then to be six iron anodes placed at equal distances round the bulb and also a starting anode as above-described.

The three-phase alternating current is then rectified into a slightly pulsating direct current, which is taken off from circuits attached to the middle point of the transformer secondaries and from the mercury pool respectively.

Some Commercial Uses for the Glass Bulb Mercury Rectifier.

Such glass bulb Cooper-Hewitt rectifiers have been used much for rectifying commercial alternating currents into direct currents for use with arc lamps in cinema projectors or for charging storage cells or working direct current motors, even up to a power of 50 kilowatts.

Mercury Rectifiers for Large Power Supply.

For large power supply such as railway

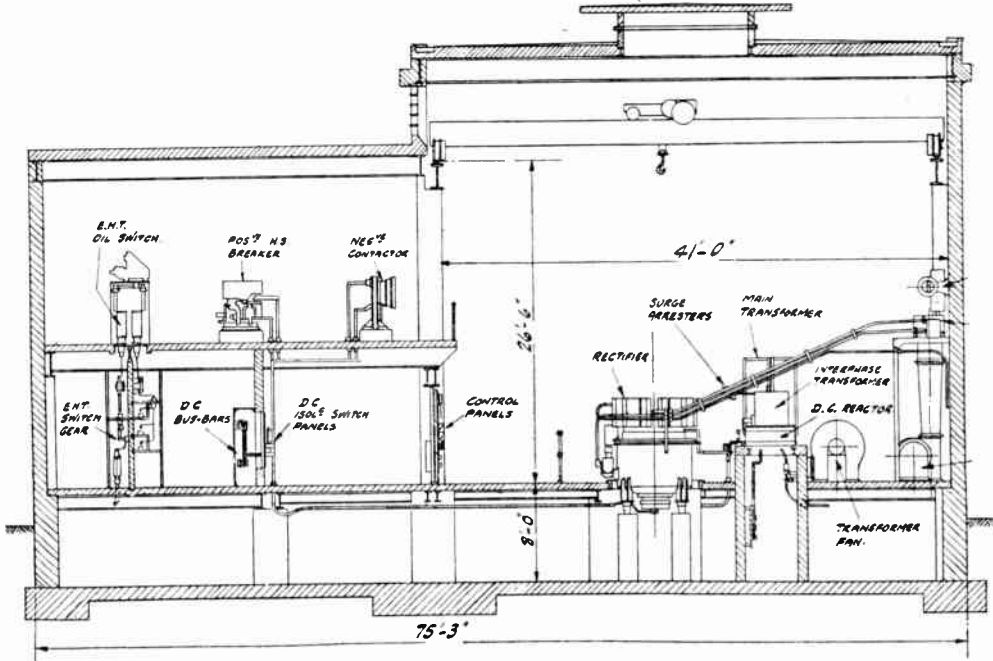

Fig. 5.—SECTIONAL ELEVATION SHOWING GENERAL ARRANGEMENT OF SUBSTATIONS.

The D.C. isolating switches are placed on a wall, the other side of which carries the D.C. bus-bars. This enables these switches to be placed in the direct run of the cables to the D.C. circuit-breakers on the gallery above, thus rendering the main connections short and neat. Similarly, the location of the oil switches directly above the A.C. bus-bar chambers simplifies the layout of the high tension connections. (By courtesy of the B.T.H. Co.)

and city tram work, it would be inadvisable to employ rather fragile glass bulb mercury rectifiers and therefore immense ingenuity has been expended by the British Thomson Houston Co. and the General Electric Co. in this country and Brown Boveri & Co., on the Continent, in translating this device into a metal container rectifier of a non-fragile character suitable for large electrical engineering uses.

Present Form of the All-metal Mercury Arc Rectifier.

The present form of this all-metal mercury arc rectifier is as follows. The glass bulb is replaced by a welded steel cylinder, which is double walled for cooling water circulation. The top and bottom of this cylinder are closed by steel plates and in the upper plate there is a second smaller condensation cylinder, also water-cooled. In the upper lid are eight glands or airtight openings through which pass the conductors of the iron

anodes. In the bottom plate there is a sort of basin containing mercury and the whole cylinder is carried on porcelain insulators.

How the Glands are Made Airtight.

The glands are made airtight by washers of asbestos covered with mercury and the lid and other joints in the same way. Fig. 2 shows a section of the all-metal rectifier as made by Messrs. Brown Boveri & Co.

How the Three-phase Transformer is Connected to the Rectifier.

Associated with it is a three-phase transformer with three secondary star connected circuits, the six ends of which are connected to the six main anodes. The other two smaller anodes are connected to the secondary terminals of a small single-phase transformer, the purpose of which is to maintain a small arc in the interior so as to keep the mercury cathode

"alive," that is, emitting electrons even if the main transformer currents fall to zero for a time. This auxiliary discharge is cut off automatically when the main discharge starts again.

The second important addition is the pump for keeping up a high vacuum.

Air Pressure in the Interior.

The mercury arc rectifier will not work well unless the air pressure in the interior

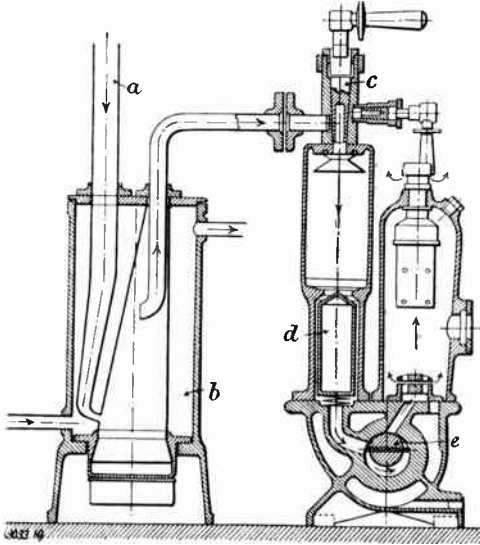

Fig. 6.—SECTIONAL DRAWING OF THE PUMP USED TO KEEP A VACUUM IN THE INTERIOR OF THE MERCURY ARC RECTIFIER.

a, pipe; *b*, chamber containing pool of mercury; *d*, non-return valve. (As used with the rectifier shown in Fig. 2.)

is less than 0.001 mm. of mercury; in other words, less than about one millionth of an atmosphere.

How the Vacuum is Made and Kept.

To make and keep this vacuum a pump is associated with the rectifier, comprising a rotary oil pump driven by a $\frac{1}{2}$ h.p. electric motor, which reduces the pressure to about 0.02 mm., and this backing pump is in series with a mercury condensation pump operating on the principle of the steam injector. In the Piccadilly line extension rectifier plant, the vacuum is obtained in two stages, the first stage consisting of a mercury diffusion pump which

operates in a manner similar to a steam ejector, while the second stage comprises an oil-immersed rotary box pump and is driven by a small motor off the 230-volt A.C. operating supply.

Measuring the Vacuum.

In order to measure the vacuum and tell when to start the pump a very ingenious arrangement is employed. If an electric current is passed through a fine wire of pure metal the wire is heated and its electrical resistance increases. If the wire is in air the cooling action of the air keeps down the resistance, but in a good vacuum the resistance of the wire for the same current is greater than that of an equal wire in air. One of these wires is then included in the rectifier cylinder and the other is in the open air.

By a simple electrical arrangement similar to that known as a Wheatstone bridge the ratio of the resistances of these two wires can be measured, and it has a certain value when the vacuum has the right reduced pressure.

An improvement on this is the Pirani gauge recently developed by the G.E.C. in which an instantaneous reading of the vacuum is obtainable.

A water supply circulates through the jacket of the rectifier and condenses the mercury vapour and it trickles back into the cathode basin.

Power for Railway Working.

For railway working power is supplied along the line by overhead three-phase high voltage circuits. At certain stations current is tapped off and reduced in voltage by a static transformer and fed into one or more mercury arc rectifiers. The high tension direct current at about 1,500 volts or so is then fed to an overhead line from which the running contacts on the electric locomotive pick up the current for the driving motors.

How the Iron Anodes are Protected.

One other point in connection with the construction of the all-metal rectifier is that the iron anodes are protected by insulating tubes which prevent discharge in the form of an arc taking place between the iron electrodes and thus causing emission of electrons and failure to rectify.

THE PROTECTION OF FEEDERS

By H. W. RICHARDSON, M.I.E.E.

In this article, the third in the series dealing with the protection of electrical apparatus, Mr. Richardson describes methods for the protection of feeders, using the G.E.C. system of protection which is based on McColl patents

ONE of the most important applications of modern protective apparatus relates to the isolation of faulty feeders. If a fault on a transmission system is allowed to persist it may quickly lead to a maximum of inconvenience to consumers. Methods employed for feeder protection must therefore be reliable and decisive in action.

Three Principal Arrangements of Feeders.

There are three principal arrangements of feeders employed in present day practice, and each demands its own scheme of protection. We have to consider (1) single feeders and interconnectors, (2) parallel feeders, and (3) parallel interconnectors. One advantage of the parallel arrangement of feeders is that pilot wires for the circulating current are eliminated, and further, the apparatus employed in the system under consideration can be adapted to parallel feeder protection in a very simple and economical manner.

Interconnectors.

The grid transmission system in this country, now rapidly approaching completion, has obviously led to the introduction of interconnectors on a large scale, and as power may be fed into them from either end special treatment is called for. In view of the extending use of intercon-

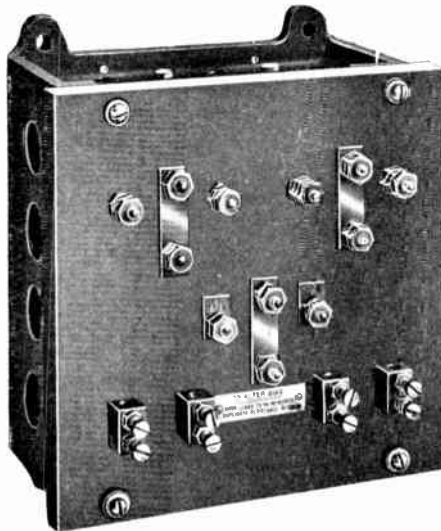

Fig. 1.—DUPLICATE RESISTANCE AS USED IN SCHEMES FOR THE PROTECTION OF SINGLE FEEDERS AND INTERCONNECTORS.

nectors it should not be overlooked that a feeder originally installed to feed only from one end is liable to be used subsequently as an interconnector, or as part of a ring main, which is of course virtually the same thing.

Turning now to the general schemes which meet the three classes of feeder arrangement referred to above, feeders call for rather more protective apparatus than is required for the protection of generators and transformers, described in the previous article of this series.

Duplicate Resistance.

One added item of apparatus required for single feeder schemes is known as a duplicate resistance. It is mounted in a box very similar to that used for an ordinary motor starter resistance (Fig. 1). The function of this duplicate resistance may be understood readily from a study of the diagram of a single feeder scheme given in Fig. 2. This scheme employs the circulating current method, pilot wires joining the current transformers at opposite ends of the feeder, with the restraining coils of the relays in the circuit. The duplicate resistance is thus necessary in a local circuit in order that the secondary currents may divide equally between pilot wire and local circuits when all is sound. Thus the necessary balance is effected between the operating coil and the restraining coil of the relay. Actually both

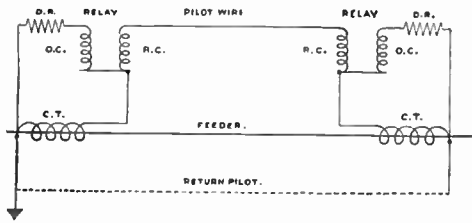

Fig. 2.—DIAGRAM SHOWING METHOD FOR PROTECTION OF SINGLE FEEDERS AND INTERCONNECTORS.

these coils have the same number of turns, and the fulcrum is displaced a small distance from the middle of the beam towards the trip contacts, giving a 5 per cent. bias in favour of the restraining coil.

The pilot circuit has just twice the impedance of each dummy circuit (the return path for the pilot current being assumed to have no impedance). But there are two current transformers in series to drive the current through it, as compared with only one for each dummy circuit. Thus the secondary current from the transformers divides equally between the two circuits when the feeder is in a healthy condition, and in consequence, the pulls of the operating coils of each relay are indetical. The lever bias of 5 per cent. is sufficient to ensure stability under all load or through fault conditions with standard current transformers and feeders of usual length.

The Fault Current.

A fault current, which flows out of the feeder somewhere between the two current transformers, produces an excess flow in the home current transformer secondary. There are again two paths open for this current, but that through the operating coil has now only one-third as much impedance as that through the restraining circuit, which includes the two relay coils and the duplicate resistance at the distance end.

When the Relay will Trip.

Three quarters of the excess current therefore passes through the operating, and one quarter through the restraining coil, and the relay tends to operate. If the

forces on the two sides of the beam be calculated, on the assumption that they are proportional to the square of the currents, it will be found that the pull of the operating coil is very nearly proportional to the load plus the fault, and that of the restraining coil proportional to the load only. The relay will then trip when the fault current reaches 5 per cent. of the load current passing at the time.

Apparatus for Three-phase Feeder.

It will be seen that the apparatus required in the scheme just described, if applied to a three-phase feeder (Fig. 3), consists essentially of three current transformers, three single-biased beam relays (in one case) and three duplicate resistances. If overload protection is required, three time-element fuses will also be necessary.

A Two-pilot Scheme.

A considerable saving in apparatus may however be effected with little loss of sensitivity by the use of a two-pilot scheme (Fig. 4) instead of the three-pilot scheme. Only one biased beam relay is required and one duplicate resistance. The current transformers are so connected and designed that a difference current is passed through the operating coil of the appropriate relay or relays for a fault to earth on any phase or between phases.

A peculiarity of this two-pilot scheme is that the sensitivity varies somewhat in each phase as indicated in the diagram at Fig. 5. In many cases, however, this variation in sensitivity is not of real moment, and, as shown in a previous article, a very high degree of sensitivity is always a feature of protective schemes employing McColl patents.

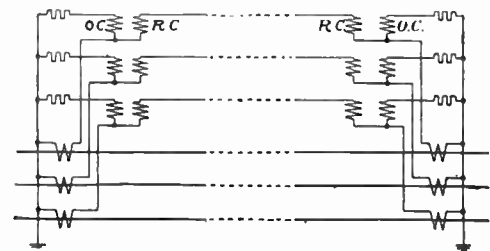

Fig. 3.—SCHEME FOR PROTECTION OF THREE-PHASE FEEDER OR INTERCONNECTOR.

Beam Relay in the Three-pilot Method.

Some rather interesting points arise from a consideration of the characteristic of a beam relay (Fig. 6), as employed in the three-pilot method. The tripping current increases with rising load, following the line of bias. At zero load, however, should the form of the curve be maintained, there would be trouble due to capacity currents (the effect of which is explained in an earlier article).

For this reason the no-load end of the curve is raised, as indicated, by means of an adjustable counterweight at the restraining end of the beam. Its effect is relatively great at light loads when the magnetic forces on the plungers are small; but as the load reaches the full normal value, the curve approaches the line representing a true 5 per cent. bias, and becomes asymptotic to it as the load still further increases.

What Happens in Practice.

In practice, the no-load tripping point is adjusted by means of the counterweight so that it is safely beyond the possible charging current of the line. As the latter is in quadrature with the load current, its effect decreases as the load rises. This is similar to the effect of the counterweight.

It should be observed that capacity current in the pilot wires flows through the restraining coils only, and brings about a small additional restraint which is constant at standard frequency. At high frequencies, such as those of surges and similar phenomena, the extra restraint

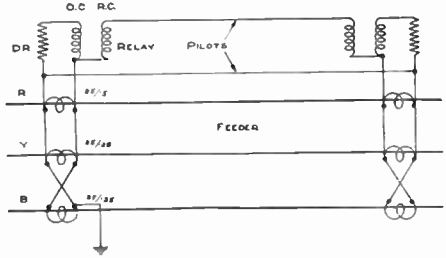

Fig. 4.—PROTECTION OF THREE-PHASE FEEDER OR INTERCONNECTOR BY TWO-PILOT METHOD.

increases very much, and renders it impossible for the relays to trip incorrectly when these occur. Capacity currents, therefore, which have occasioned so much trouble with opposed voltage schemes of protection, not only do not necessitate sheathed pilots in this system, but are actually an advantage in securing stability at all frequencies, an essential which has necessitated complicated accessories in certain other schemes.

A Marked Advantage of the Methods of Single-feeder Protection.

One very marked advantage of the methods of single-feeder protection which we have discussed is that immediately there is a break in a pilot wire tripping is bound to occur, and the fact that the protection is not in operation is at once evident. This feature compares very favourably with certain systems in which the pilot wires have to be frequently tested to ensure that the pilot is sound and the system capable of operation.

Protection of Parallel Feeders.

As already stated the protection of parallel feeders is relatively simple. These feeders are usually identical, and when there is no fault present the currents flowing in them are equal. Should these feeders for any reason not be identical so that the currents in them are different, the protective apparatus can be designed to allow for the difference.

When considering the protection of single feeders it was necessary to compare the currents at opposite ends of the feeder, involving pilot wires. In the case of parallel feeders, however, the comparison is made between currents flowing at the

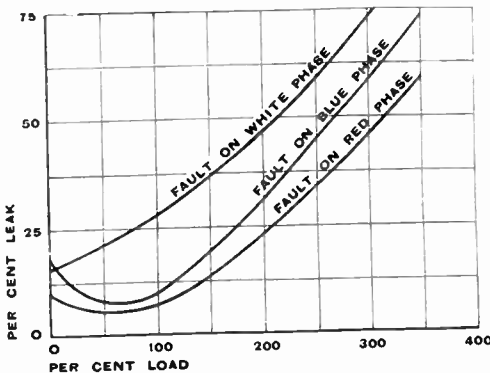

Fig. 5.—PERFORMANCE CURVES OF TWO-PILOT SCHEME. (See Fig. 4.)

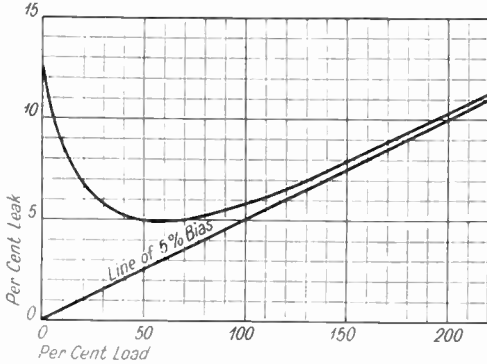

Fig. 6.—CHARACTERISTIC OF A BEAM RELAY AS EMPLOYED IN THE THREE-PILOT METHOD. The tripping increases with rising load, following the line of bias.

corresponding ends of the parallel feeders (Figs. 7 and 8), and pilot wires running from end to end of the feeder are eliminated.

The Home End of the Parallel Feeder System.

The diagram at Fig. 7 refers to the home end of a parallel feeder system, power flowing into the feeder. It will be seen that the two similar coils of each beam relay are connected in series in what may be termed a "ring" circuit, and the pulls are therefore balanced when there is no fault. The excess current due to a fault passes only through the operating coil of the appropriate relay, and thence through the auxiliary switch into the common lead, returning to the current transformer through the restraining coil of the next relay. When this excess current is of sufficient value to overcome the bias of the beam (which is usually fixed at 10 per cent.), the relay operates. The auxiliary switch then cuts out the protective gear on the faulty line and remakes the circuit for the remaining apparatus.

Apparatus Required.

The apparatus required for the home end of each three-phase feeder comprises three current transformers, three beam relays (which are accommodated in one case) and a triple pole double break, double throw auxiliary switch.

It should be particularly observed that

the scheme described for the home end of parallel feeders is not suitable for the distant end, because the relays employed are not directional; they cannot therefore discriminate between a fault which enters and a fault which leaves a feeder.

The Distant End of Parallel Feeders.

A suitable scheme for the distant end of parallel feeders is shown in Fig. 8. Direction relays are employed, in which the relay operating coils form the bridging paths, being connected as shunts to the transformer secondaries. If the connecting leads had no appreciable resistance, no current would normally pass through the relays whatever the current in the ring circuit. But the insertion of the biasing resistances "R" compels a certain fraction of the secondary current to pass through the operating coils, and at the distant end this will force the relay contacts in a non-operating direction. An excess current in one transformer secondary must reach a sufficiently high value to cancel this forward current before causing tripping, and thus the scheme is biased.

An Alternative Scheme.

An alternative to this scheme for the distant end of parallel feeders is that to be described next. It is the scheme which is used for both ends of parallel interconnectors (Fig. 9). Directional relays are employed, but a small biasing electromagnet is incorporated in each relay instead of the biasing resistances employed in the scheme shown in Fig. 8. It is connected in the ring circuit and thus the current flowing through it is proportional to the load in the feeders. It exerts a

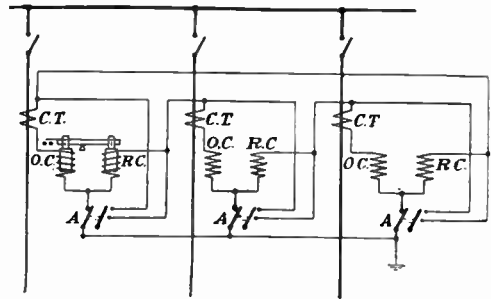

Fig. 7.—SCHEME FOR PARALLEL FEEDERS. This shows the home end.

pull upon an armature attached to a short arm fixed at the upper end of the relay spindle, and a direct restraint is thus exercised upon the movement of the relay itself.

An important feature of this method of biasing is that the pull is always a positive one, and the restraint does not reverse and become an operating force when the power flow reverses in the feeders as with the previous scheme.

Apparatus Required.

The apparatus required at the distant end of each three-phase parallel feeder, or for either end of each three-phase parallel interconnector, consists of 3 standard current transformers, 3 biased directional relays, 1 triple pole single-throw auxiliary switch, 3 time-element fuses (if overload or stand-by protection is to be added), and 1 three-phase potential transformer.

Somewhat different results are given by the relays at the two ends, the one at the home end being always more sensitive than the other. This feature in protective gear is in accordance with the require-

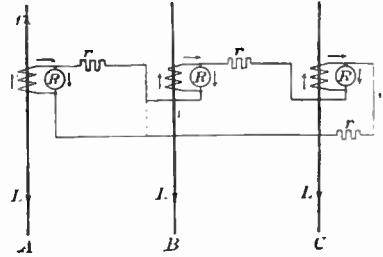

Fig. 8.—SCHEME FOR PARALLEL FEEDERS. This shows the distant end.

ments of parallel feeder protection, where it is an advantage that the home relay shall operate first.

In this connection it should be borne in mind that either end may be the home or the distant end, depending upon the direction of flow, and it is the latter alone that determines which of the relays shall have the lower setting. The result is achieved through the reversal of the voltage drop across the impedance of the small biasing magnet, which exerts a negative effect upon the bias at the home end and a positive effect at the distant end.

Sensitivity of a very high order is obtained.

The schemes which have been described in this and preceding articles cover the forms of protection which are most usually required. There are of course many other arrangements of plant which can be protected by the methods described, such as for instance, the protection of a feeder and transformer as a combined unit. In this and similar cases the schemes do not present any complication, and with the diagrams already given the reader should not have great difficulty in applying the methods described.

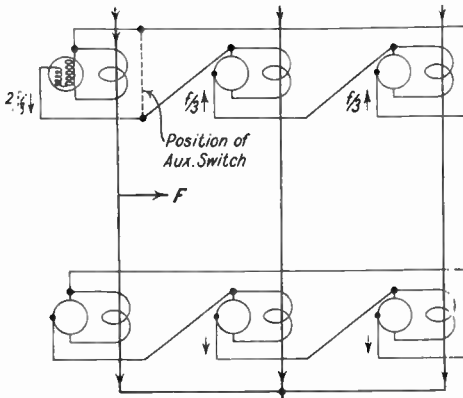

Fig. 9.—SCHEME USED FOR BOTH ENDS OF PARALLEL INTERCONNECTORS.

Owing to the rapid progress in the design of electrical apparatus and to our efforts to keep our readers in touch with the latest developments, we give no warranty that apparatus described in our columns is not the subject of Letters Patent.

DEMAGNETISING A WATCH

IN the following article are given two methods by which a watch can be demagnetised.

Using a Powerful Electromagnet.

A watch may be demagnetised by placing it between the poles of a powerful electromagnet whose windings are connected through a reversing switch and a sliding resistance, to a D.C. supply.

Take the Fingers Off the Watch.

The fingers of the watch are taken off, and the watch is then fixed in position between the poles of the electromagnet and the current is switched on. The current is then constantly reversed about 30 times a minute, and at the same time the current is gradually reduced to zero, by operating the sliding resistance, moving it from its minimum resistance position to its maximum resistance position.

About five minutes should be taken to reduce the current to zero. If the fingers of the watch are not removed, they may be bent during the demagnetising opera-

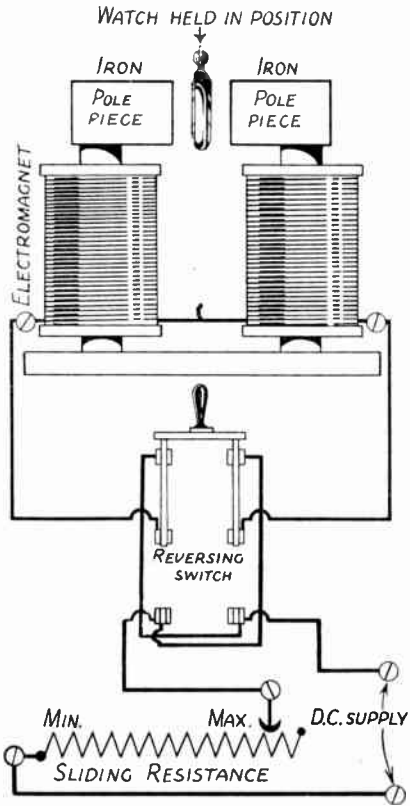

DEMAGNETISING A WATCH BY PLACING IT BETWEEN THE POLES OF A POWERFUL ELECTROMAGNET.

The supply may be obtained from a 4 or 6-volt accumulator. If the supply mains are used precautions should be taken to prevent too large a current passing through the circuit by having a permanent suitable resistance inserted which cannot be cut out. A maximum current of about 5 amperes will in most cases be suitable.

tion, because they are generally made of steel.

Using an Air-cored Choking Coil.

If a supply of A.C. and an air-cored choking coil is available, the watch is fixed at one end of the coil and the current is switched on. The current is then gradually reduced in the same manner as with the D.C. circuit, taking about five minutes to reduce the current to zero. In this case, no reversing of the current with the switch is necessary.

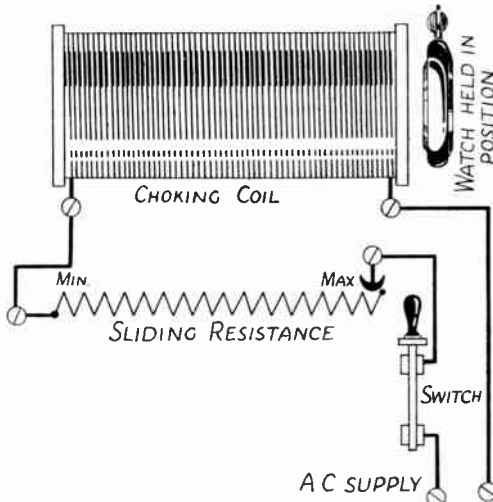

DEMAGNETISING A WATCH BY USING AN AIR-CORED CHOKING COIL.

A maximum current of about 3 amperes with a suitable choking coil will be satisfactory and a permanent resistance should be inserted in the circuit in order to prevent the current rising above this value. Too large a current may damage the main spring and metal works of the watch, due to the heavy eddy currents induced in them.

SPOTLIGHTING FOR CINEMAS AND THEATRES

By L. G. APPLEBEE

THEODORE FUCHS, the eminent American Theatre Consulting Engineer, in his book on Stage Lighting, defines the spotlight for stage work as:—

“A piece of stage lighting apparatus used for lighting a small portion of the stage, or a character, to a higher intensity than the remainder, and thus unconsciously focusing the attention of the audience to either that part of the stage or that character so lighted. It consists principally of a concentrated light source, and a lens mounted in a housing that restricts the escape of light to the opening occupied by the lens.”

Lenses.

It will be seen, therefore, that given a concentrated light source the entire function of the spotlight is dependent upon the lens.

For the benefit of the reader who has no knowledge of optics, we will explain briefly the functions of this section of the apparatus. Light travels in straight lines as long as it continues to traverse a medium of uniform density, but on entering a medium of a different density it is bent out of its course or “refracted.”

A Typical Example of Refraction.

A typical example of this is to thrust some object at an angle into water—then the portion in the water appears to be bent at the point where the water joins the air. Lenses are made of glass, being a clearer medium than the surrounding air, the light rays passing through are bent, or in other words, refracted, according to the particular curvature of the lens face.

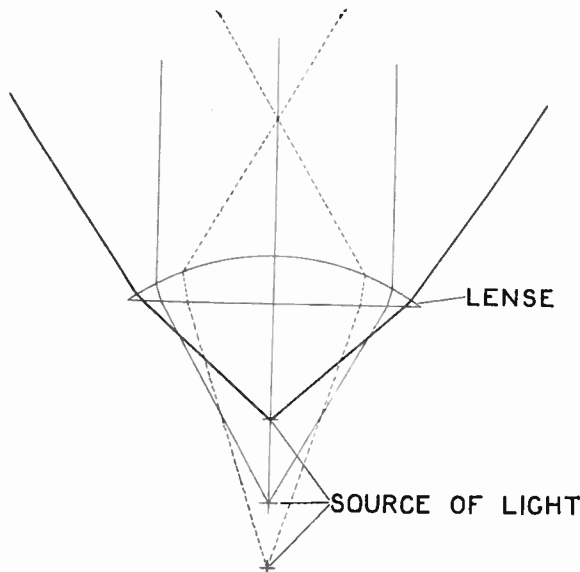

DETAILS OF THE “PLANO CONVEX” LENS.

The “Plano Convex” Lens.

The plano convex lens is the type commonly used for spotlights.

They are flat on one surface, and curved on the other, and made in various diameters and curves, according to the requirements of the spot to be obtained. This latter is determined by the focal length.

For example, a 6-in. focus lens means that a source of light placed 6 in. away from the flat side of the lens will direct rays of light through the lens so that the rays of light are bent to a parallel beam on passing out of the curved surface.

This will quickly be seen by reference to the first diagram.

It follows, therefore, that if the spotlight beam is to diverge or spread out beyond the parallel beam, the light source has to

be brought nearer the flat surface of the lens—when the rays will be as shown.

Alternatively, if the source of light is taken farther away from the lens, then the beams of light will be concentrated on to a spot.

Note:—The plano convex lens is very often described as a condenser, which is quite incorrect. The condenser consists of two plano convex lens placed curved face to curved face, and is used in optical lanterns to project lantern slides.

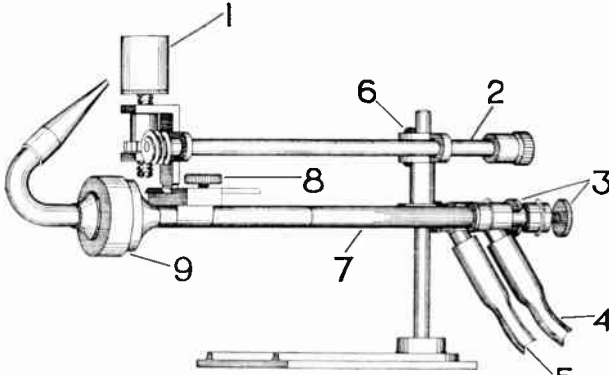

DIAGRAM OF THE LIMELIGHT APPARATUS USED AT DRURY LANE THEATRE.

1, cylinder of lime; 2, revolving spindle for turning and raising lime as it is burnt away; 3, gas valves; 4, oxygen tube; 5, hydrogen tube; 6, centring screw; 7, pipe union; 8, screw for adjusting distance of lime from jet; 9, mixing chamber.

Spot lights are made so that either the light source can be moved to and from the lens, or the lens to and from the source of light. The former is the usual procedure.

It is also of extreme importance that the source of light should be both vertically and horizontally in the centre of the lime, and means must always be provided for this adjustment.

SYSTEMS OF LIGHT SOURCE.

Various systems of light source have been used since "spotlights" were first used in stage lighting.

The "Limelight" or "Drummond" Light.

The first known source was the "limelight" or "Drummond" light. Its inventor, Thomas Drummond, in 1816,

found that if a piece of lime was raised to a great temperature it became highly incandescent and gave out a very brilliant white light. Various methods of heating the lime were tried, and the finest results were obtained by burning a mixture of oxygen and hydrogen, the flame of which was directed on to the cylindrical block of lime. This system of illumination became known as "limelight" in this country.

The First Spotlight.

Fuchs tells us that the earliest the limelight was used in connection with a lens, and thus the first spotlight, was in 1837 (the year Queen Victoria came to the Throne), although it was about 20 years later before they came into general use. They were then used in large numbers to augment the other lighting of the stage, which was by gas, and had been invented by William Murdoch, a Scotch Engineer and Inventor, in 1781, and installed at the Lyceum Theatre, London, in 1803, remaining in use at this theatre to the exclusion of electricity until the year 1902, which seems incredible.

The quality of the limelight was beautifully soft and mellow, and gave what is known in America as a "soft edge spot," the light gradually dying off towards the edge.

How the Oxygen and Hydrogen are Supplied.

Up to the year 1880 the oxygen and hydrogen was supplied to the theatres in rubber bags which the operator usually sat on to obtain the necessary pressure, but a serious accident occurred at Drury Lane in 1880, one of the bags bursting, with fatal results, and the rubber bags were replaced with iron cylinders. Eventually these also disappeared, and were replaced by permanent tanks, fitted in the theatre, with gas pipes run to the various points.

Limes from the Auditoriums.

The inventor of the limelight led pro-

ducers of the day to try to do away with the footlights by lighting the stage with limes from the auditoriums, but the fact that each limelight necessitated the services of an operator to adjust the pressure of the gas and continually turn the cylinder of lime, made the front lighting unpopular for the time, but the use of limes on the stage itself hung on for many years after the coming of electricity.

In fact, our "National" Theatre, Drury Lane, still uses the lime light for some productions and a diagram of the apparatus is reproduced here.

This method of obtaining a spot was used for so many years that the name "limelight" has remained, and is used in the theatre to describe those particular spotlights that are used to follow artists, particularly in theatres devoted to variety turns, irrespective of the source of light employed.

The Electric Arc.

Sir Humphry Davy invented the electric arc in 1808, and demonstrated it at the Royal Institution in 1810—six years before Drummond produced the limelight, but strange to say it was not until 1860 that there is any knowledge of its being used in the theatre, as the source of light for a spotlight, when it was used at the Paris Opera House, in a lantern devised by a Frenchman, Duboscq.

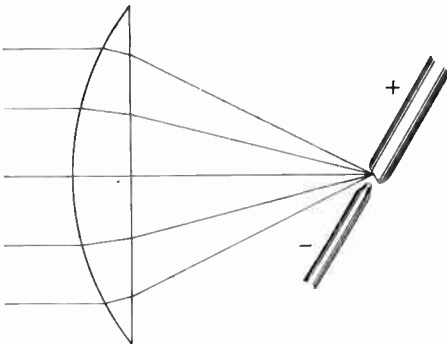

THIS SHOWS THE ANGLE AND POSITION OF POSITIVE CARBON IN TYPICAL STAGE ARC.

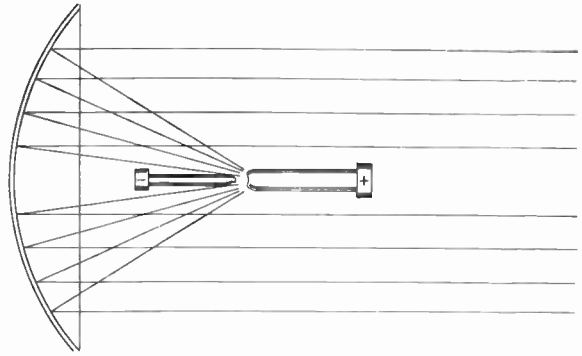

PRINCIPLE OF THE "MANCHESTER" ARC LAMP. The light from the positive carbon was thrown on to a polished metal parabolic reflector and reflected back on to the object.

The "Manchester" Arc Lamp.

Davy had obtained his arc lamp by means of voltage piles or batteries, and it was not until dynamos and other mechanical means of generating electric current were invented and became commercial propositions, that the arc lamp for spotlights really came into general use in this country, and in about 1886 Austin Walters, a theatre engineer of Manchester, produced his "Manchester" arc lamp. This was practically the same as the modern searchlight, and no lens was employed. The light from the positive carbon was thrown on to a polished metal parabolic reflector, and reflected back on to the object, as shown. Ultimately lenses were employed.

How the Electric Arc Works.

To those readers who are not familiar with the electric arc, the following brief description is given:—

An electric arc occurs when the flow of current is broken by means of a definite break in the continuity of the circuit, such as the opening or closing of a switch.

Sir Humphry Davy's Discovery.

Sir Humphry Davy found that if two pieces of carbon (one connected to the positive and the other to the negative terminals of a direct current supply) were touched together, current would flow in the completed circuit, and if these carbons were just separated, then the current would "jump" or "arc" across the gap,

GG

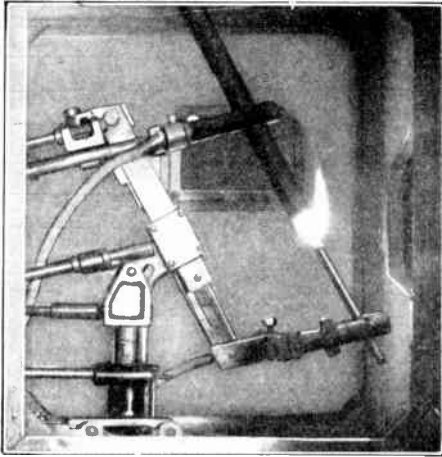

TWO ADJUSTMENTS TO WHICH THE ARC IS VERY SUSCEPTIBLE.

First, the angle of the two carbons relative to the condenser should be as shown. Secondly, the centre line of the negative should be advanced from 2 to 4mm. towards the condenser. In this way the 60° crater angle seen below will be obtained. (Courtesy of Ship Carbons.)

and eventually heat the two points of the carbons to a white heat, forming a vapour of molten carbon of high illuminosity, and providing a path for the current to pass from one carbon to the other.

This high temperature eventually burns the carbons away, and the gap increasing, the current fails to jump across. If, however, the correct distance is kept more or less constant by closing the carbons together as they burn away, the arc is maintained.

Why a Resistance Must be Placed in Series with the Carbons.

It has been found that in order to keep the current constant within certain limits, a resistance must be placed in series with the carbons, otherwise the arc will not be maintained, owing to the fluctuations in the resistance of the arc itself, due to the varying size of the gap between the carbons.

Further, it is advisable to have a fair margin of voltage from the supply source beyond that required, at the arc lamp terminals, and this excess of voltage has to be absorbed in the resistance. This may be thought to be a waste, but the resistance acts more or less as a damper to prevent sudden surges in the value of the

current which may be due to changes in the formation of the carbon crater, or to the varying of the gap between the carbons.

Voltage Across the Arc.

The pressure across the arc should be between 35 and 50 volts. For arcs up to 30 or 40 amperes, fixed resistances are generally used, but over that a varying resistance should be used, provided with a certain number of steps, so that the current can be raised step by step, and is used to "strike the arc" and run for a short time on a low current to allow the carbons to be burnt in.

A Disadvantage of the Arc for Spot Lamps.

One of the disadvantages of the arc as the source of light in spot lamps was that the quality of the spot was exactly opposite to that obtained with the lime-light. The high intensity of the light appeared at the edge of the beam, which made the centre contain a dark spot, whilst prismatic colours appeared around the edge of the beam when cheap lenses were used.

How these Disadvantages were Overcome.

These difficulties were overcome by placing a diffusing screen of either ground glass or frosted gelatine in front of the lens, whilst another method employed and patented by the writer's father, G. A.

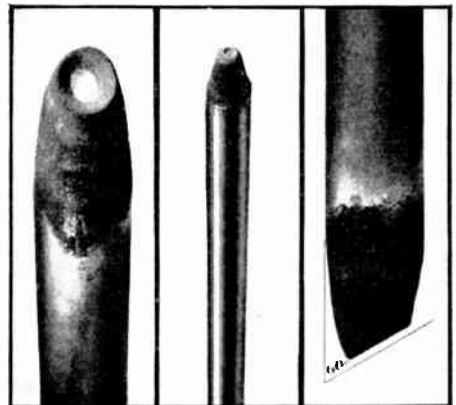

THE 60° CRATER ANGLE.

The correct adjustments to obtain this angle are described above. (Courtesy of Ship Carbons.)

Applebee, was to place a screen of ground mica between the lens and the arc. Thomas J. Digby really placed the arc spotlight on a commercial basis, and was the pioneer of this system in this country. The reader will readily understand the extent of its use when I mention that as many as 40 spot arcs were used by Sir Herbert Tree in his productions at His Majesty's Theatre in the pre-war days.

Other Disadvantages.

Other disadvantages are :—

1. Operators are required for each spot, in order to feed the carbons as they burn away.
2. Direct current is essential, as on alternating current the intensity of the light is very poor, whilst there is a distinct "hum" which is sufficient to be heard by the audience, and thus distract attention from the play and spoil the illusion.
3. The heavy cost of providing motor generators or rectifiers if the main supply in the theatre is A.C.
4. The constant renewal of carbons.
5. The heavy current consumption, and, therefore, the heavy wiring required.

Modern Spot Arcs.

The modern spot arcs as now manufactured are extremely fine pieces of work, and still all arc hand fed. Each arc must be provided with adjustments, as follows :—

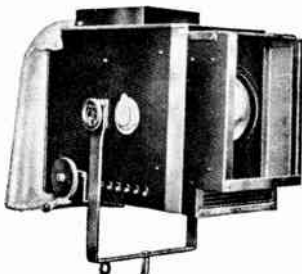

A TYPICAL ARC SPOTLIGHT.

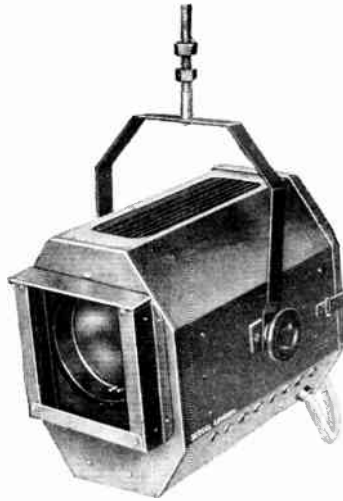

A 1,000-WATT INCANDESCENT SPOTLIGHT.

main light source is obtained, can be adjusted so that the light is thrown forward towards the lens. (See diagram.)

(b) Rack and pinion movements that allow the carbons to feed together.

(c) Centring movement so that the crater which is the light source can be raised or lowered vertically to the centre of the lens.

(d) Lateral movement to centre the light source horizontal to the crater of the lime.

(e) Angle tilt so that the carbons can be tilted at an angle to throw the light forward towards

the lens.

(f) Focusing movements to move the arc to and from the lens.

Attachments to Arc Spotlight Housings.

Much has been done in recent years to the various attachments to arc spotlight housings, to assist the working of the apparatus, such as vertical and horizontal shutters (commonly called the barn door shutter) for masking the light so that only a given area in the stage is illuminated.

Iris Diaphragms.

Iris diaphragms for producing various size pin spots—changing lens apparatus so that various size lenses can be brought into operation quickly—colour mediums in magazine receptacles in the fronts of the lamp.

These are all usually operated by means of levers and rods with controls at the back of the lamp.

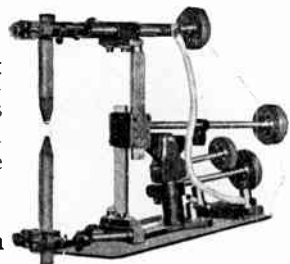

HERE CAN BE SEEN THE ADJUSTMENTS FOR A SPOT-LIGHT ARC.

Suitable Position for Spot Arcs.

Spot arcs are generally used in

connection with stage lighting from the following positions:—

1. On small platforms right and left of the stage near the curtains about 10 ft. off stage level.

2. From either a special chamber situated in the main ceiling or from the bioscope room, where such is provided.

NOTES ON CARBONS.

The usual path of the current in the carbons is from positive to negative, and the passage of the current gradually forms a hollow or crater in the tip of the positive carbon.

light is emitted from the crater of the positive—15 per cent from the negative—and 10 per cent from the arc itself.

It is, therefore, now quite clear why the carbons are placed at the angle shown, with the positive just behind the negative, as shown in the photograph.

“Feeding” the Arc.

In order that the arc may burn steadily and without “jump” or “flicker,” the carbons must be constantly adjusted by means of the lamp mechanism, so as to maintain an even gap. This is commonly known as “feeding” the arc.

We do not propose to go into the chemical constituents of the carbons or their process of manufacture as this is a specialist's job, and all carbon manufacturers work to their own formulas.

Size of Carbon for Different Currents.

It is, however, obvious that for various currents different size carbons are re-

quired, and the undermentioned list, which we publish by courtesy of Messrs. Charles Champion, of “SHIP” carbons, gives the sizes required:—

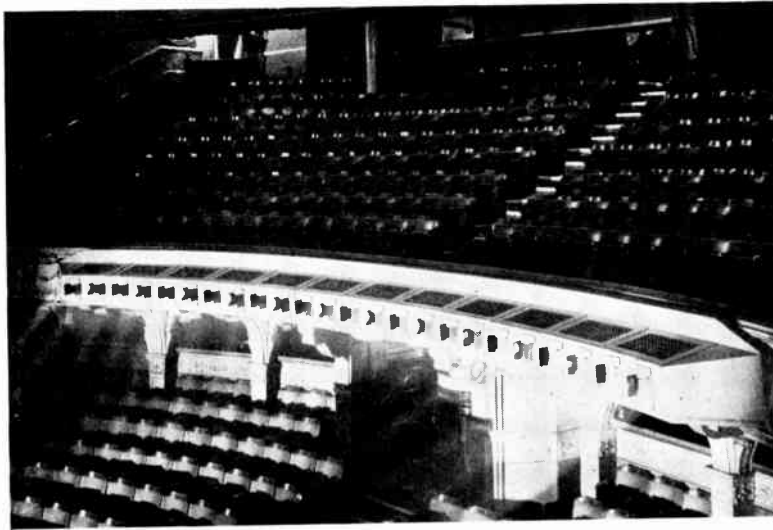

SPOTLIGHTS FITTED TO THE CIRCLE FRONT OF A LONDON THEATRE.
(Courtesy of the Strand Elec. and Eng. Co.)

On direct current the positive carbon is burnt away much faster than the negative, due to the high temperature. It has been found that about 80 per cent. of the useful

Amperes.	Diameter of Positive.	Diameter of Negative.	Arc Volts.	Approximate Burning. Positive.	Rate per Hour. Negative.
10-15	12 mm.	8 mm.	45-50	1 $\frac{3}{4}$ in.	1 $\frac{3}{4}$ in.
15-25	13 mm.	10 mm.	45-50	1 $\frac{1}{2}$ in.	1 in.
25-30	15 mm.	12 mm.	45-48	1 $\frac{1}{8}$ in.	1 in.
40-50	18 mm.	9 mm.*	45-48	2 $\frac{1}{8}$ in.	2 in.
50-65	20 mm.	10 mm.*	45-48	1 $\frac{1}{2}$ in.	2 in.
65-80	22 mm.	11 mm.*	45-48	2 $\frac{1}{2}$ in.	2 in.
85-100	25 mm.	12 mm.*	52-56	2 in.	2 $\frac{1}{4}$ in.

* Copper-coated negatives.

Carbons are always measured in millimetres and you will note that in all cases the positive carbon is described as cored.

The Core.

This means that through the centre of the carbon a small core like the lead of a pencil is provided, of a different chemical composition, to enable the centre of the carbon to vaporise more easily, and thus "centre" the arc in the crater and prevent unsteadiness. For the higher currents it has been found that a core in the negative is also an advantage.

Copper Coated Carbons.

Carbons in certain cases are coated with a copper coating. This increases their conductance, and decreases the rate of consumption, but for stage work the copper coating has been found unsuitable, as the melting copper in the top of the negative, becomes luminous, and its image projected through the lens on to the stage.

THE INCANDESCENT SPOT.

Swan invented his incandescent electric lamp in 1879, but it was not until 1913 that projector lamps as they are known, were first used as a light source in spotlights. The filaments of these lamps are the nearest (commercially) that the lamp manufacturers have been able to produce with a point source of light such as the old limelight and arc gave us. These were first used successfully in this country by Arthur T. Earnshaw, a pioneer of modern stage lighting equipment, in a play called "The Willow Tree," produced at the Globe Theatre, in 1916.

They rapidly became universal for stage lighting, having the following advantages:—

1. Low current consumption.
2. They could be "dimmed."
3. They required no operator.
4. They could be placed in all sorts of positions not previously possible with the arc, or limelight.
5. Silent in operation.
6. They work equally well on A.C. or D.C.

The Incandescent Projector Spotlight.

In modern theatres of to-day, the incandescent projector spot lamp plays a very important part, particularly in the non-musical play, such as a comedy or drama.

Sometimes as many as ten to twenty incandescent spots are hung up amongst the sky borders, each lantern picking out some particular portion of the stage, where important acting required additional light, in order to make the actor or actress stand out more prominent from the surroundings.



A MAGNETICALLY CONTROLLED COLOUR-CHANGING SPOT-LIGHT. (Courtesy of the Strand Elec. and Eng. Co.)

Difficulty of Obtaining a Small "Spot."

The incandescent spotlight has one disadvantage, namely, the difficulty of obtaining a small "spot," as when the lamp is drawn away from the lens, thus reducing the light to a small circle, an image of the filament is projected upon the surface where the light is thrown.

Spotlights are now usually of either 1,000 or 2,000 watts capacity.

Incandescent Spots Situated in the Auditorium for Stage Lighting.

During the last few years the practice of using spotlights attached to the fronts of circles has greatly found favour with the play producers, and up to about two

years ago it was the practice to use one or two for this purpose.

In 1931 a sudden "wave" came over the London productions, starting with the *Alhambra* show — "Waltzes from Vienna," where Hassard Short, an American producer, had rows of spots installed on both the first and second circlefronts. This was quickly followed by Charles B. Cochran with Noel Coward's production of "Cavalcade" at Drury Lane, and here a fresh innovation was provided by operating the change of colours to the spotlights electrically, by means of solenoids, and controlled from a remote point, namely the stage switch-board. These have been installed at the Gaiety and Adelphi theatres, whilst the Hippodrome and the Palace (for the "Cat and the Fiddle" production) also installed many spotlights on both circles, and hence there started another step in the history of stage lighting.

Colour Effects on Screen.

This practice is also being adopted by the cinema to project colour effects on the screen and screen curtains: For example, Gaumont Palace, Lewisham, where the spots

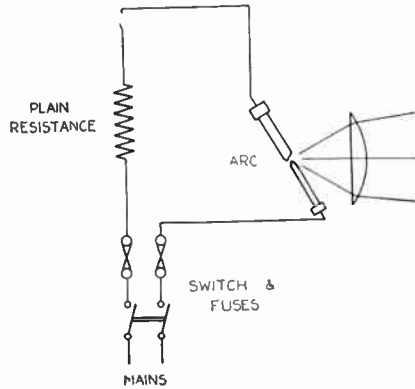

ARC LAMP WITH RESISTANCE WOUND FOR A DEFINITE FIXED RESISTANCE.

are installed in the roof.

In 1929 the Seecol Stelma spotlight was invented; this, at any rate for the small theatre, has replaced in some cases the front of house arc.

It uses a combination of specially curved reflectors and refractors, together with a condenser lens, and a 30-volt 30-ampere projector lamp.

Floodlighting by Spotlights.

Readers who remember the recent flood lighting of London will be surprised to hear that Nelson's statue was, on this occasion, lighted by only three 900-watt lamps only, used in three of these lanterns.

When it is realised that the throw was about 300 ft. and the low wattage, one must admit that the results on a statue that was practically black were effective.

These lanterns play an important part in the stage lighting of the Shakespeare Memorial Theatre at Stratford-on-Avon, where four are concealed in the main ceiling, to light the fore stage.

In this theatre, Messrs. Ridge and Aldred, the theatre lighting consultants, also in conjunction with the architects, concealed twelve 1,000-watt spot lanterns in the circle front.

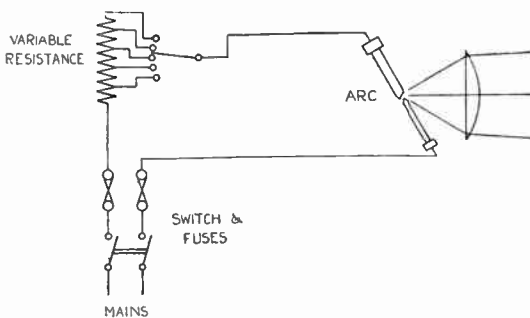

HERE WE SEE HOW CURRENT CAN BE VARIED BY MEANS OF THE RADIAL SWITCH CONNECTED TO TAPPINGS ON THE RESISTANCE.

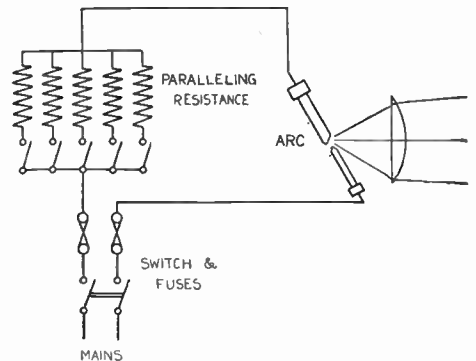

ANOTHER METHOD, IN WHICH EACH SECTION IS WOUND TO GIVE A DEFINITE CURRENT THROUGH THE ARC. AS EACH SECTION IS SWITCHED IN CIRCUIT THE CURRENT IS INCREASED BY THE AMOUNT FOR WHICH THE SECTION IS WOUND.

CARRIER CURRENT TELEPHONY

By H. E. HUTTER, A.Am.I.E.E.

The problem of satisfactory wire telephone communication between points on a high-voltage transmission line is an important one. In this article Mr. Hutter describes how this problem has been solved

THE article on "Electric Power Generation," by Mr. A. T. Dover, M.I.E.E., which appeared in the December issue, mentions the use of carrier current telephony or wired wireless as a means of communication between the various substations.

The question of communications has been of the greatest importance ever since power transmission over high voltage lines came into operation. The problem of satisfactory wire telephone communication between points on a transmission line is admittedly difficult. This

is due to the fact that the telephone line is often carried on the same towers as the overhead line, and under these circumstances the telephone line is directly exposed to electrostatic and magnetic fields from the power line.

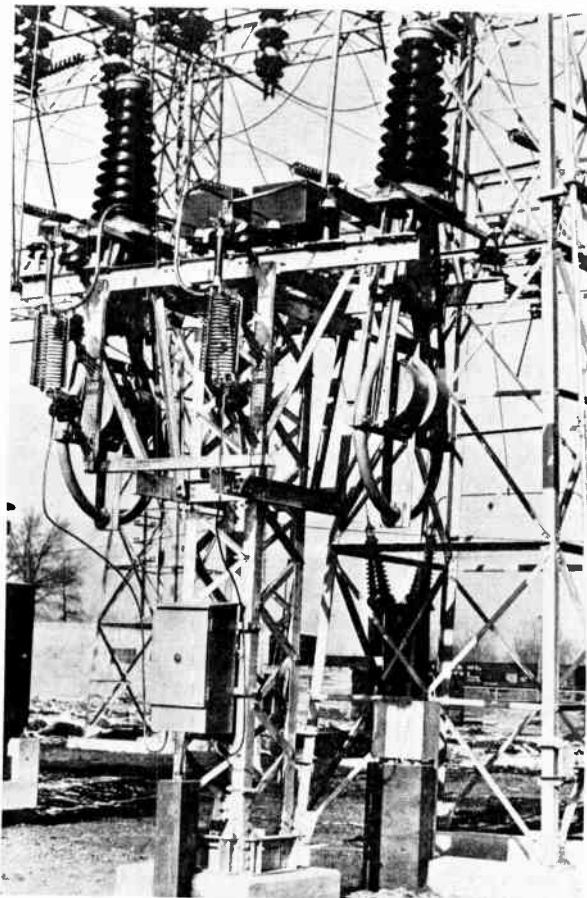

TWO CABLE TYPE COUPLING CONDENSERS WITH PROTECTIVE EQUIPMENT,

Installed in a 132 kv. substation.

Advantages of the System.

To overcome these deficiencies a telephone system using the transmission line conductors as a channel for a high-frequency voice modulated wave was developed. The advantages of this system are of real importance, namely, the circuit is as strong as the line, inductive effects are eliminated, the system is not affected by the failure of an insulator or some of the lines, and lightning, unless a continuous discharge has no effect. The initial cost is cheaper than a telephone line for distances exceeding fifty

miles, while there are no line maintenance costs.

How the Apparatus Works.

In the process of transmission the apparatus produces a high frequency

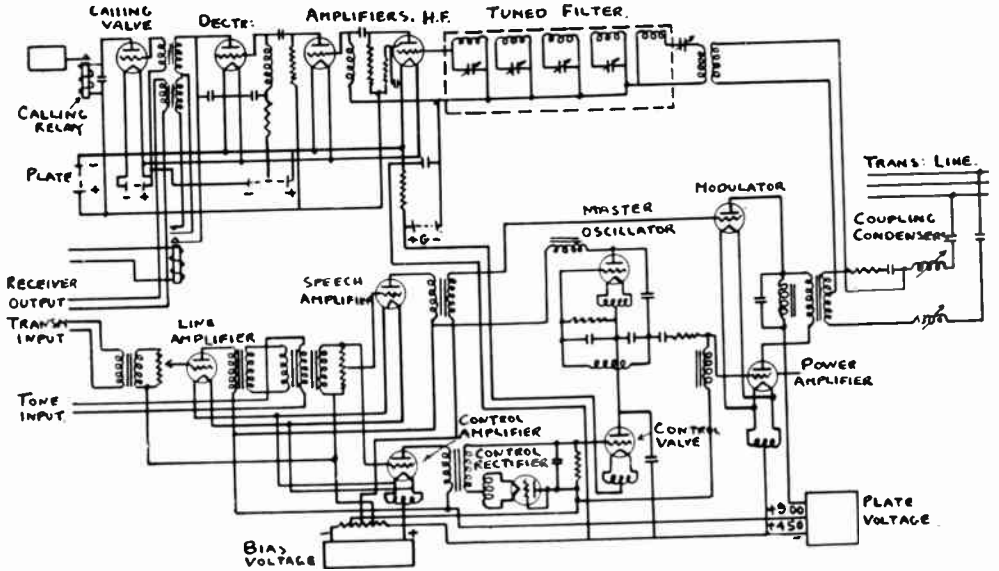

BASIC CIRCUIT FOR CARRIER CURRENT TELEPHONY.

This shows a B.T.H. system. The apparatus required at each station consists of a radio receiver, radio transmitter and the apparatus for coupling to the transmission lines together with accessory apparatus.

alternating current varying from 8 to 150 kilocycles per second. When the operator speaks into his telephone instrument the intensity of the carrier wave is varied in a manner which is directly related to the frequency and intensity of the sound vibrations which make up the operator's voice. This process is known as modulation, and the modulated carrier wave is impressed upon the transmission line through coupling apparatus which does not pass, to any considerable degree, the high voltage low frequency energy from the line.

as demodulation, the modulated carrier wave is made to produce currents which cause the operator's telephone receiver to produce sound vibrations, the nature of which is dependent on the manner in which the carrier wave has been modulated at the sending end by the transmitting operator's voice.

Difference Between Common Radio and Carrier Current Communication.

The only essential difference between the common radio and carrier current communication is that the later is transmitted through a metallic circuit between stations.

What Happens at the Receiving End.

At the receiving end, by a process known

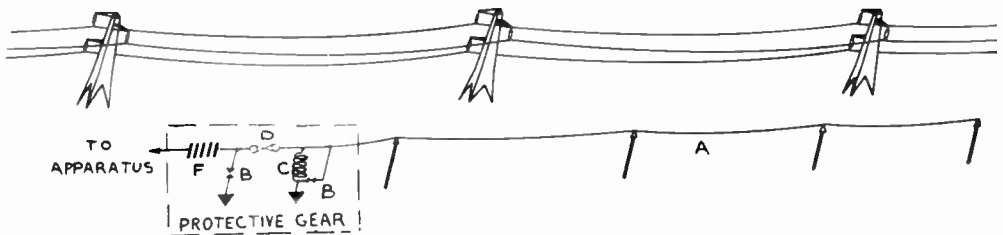

DIAGRAM ILLUSTRATING PRINCIPLE OF COUPLING AERIAL.

A, coupling aerial; B, spark gaps; C, drain coil; D, H.T. fuse; F, condensers.

Single or Double Frequency Duplex Systems.

The most common systems are duplex, thus two-way communication can be carried on similar to the usual telephone, again this may be divided into single or double frequency duplex, using either one frequency for transmitting and reception or a different frequency for each.

Apparatus Required.

The apparatus required at each station consists of a radio receiver, radio transmitter and the apparatus for coupling to the transmission lines together with accessory apparatus.

The operation of the system is independent of open switches and it is possible to bridge over the gap between power lines of different voltages.

How Another Station is Called.

The calling of another station is effected by the operation of a dial similar to the usual telephone of the automatic type; the receiver at each station being always in operation the calling bell will ring until the receiver is unhooked, or alternatively, will ring for a specified time according to the system; conversation can then be carried on.

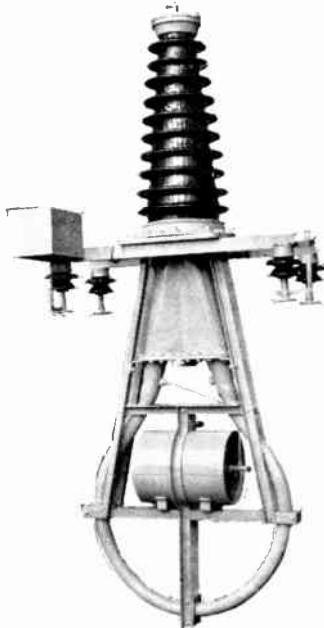

CABLE TYPE COUPLING CONDENSER.

For 132 kv. working voltage. The capacity of the condenser is 0.001 mfd. and it is mounted on a tower or frame as shown on page 359.

How Line Noises are Prevented.

The radio apparatus is usually

located near to the line, the telephone instruments being placed in the control rooms. The application of a high voltage to a line gives rise to line noises from various sources, and to prevent these noises from affecting the reception, the power valve used is of comparatively high power, the usual wattage being about 250.

Coupling the Apparatus to the Line.

The coupling of the apparatus to the line is accomplished in two ways; by means of aerials, or coupling condensers. One system using aerials utilises three, each approximately 2,000 feet long, one used for reception and the other two for transmitting. The conductor used is the same material as the line, ensuring the same sag and mechanical strength.

Coupling Condensers.

Coupling condensers may be of two different types, the condenser type for use at any voltage or the cable type made by the American General Electric Company, which is much used for 110 to 132 kv. work.

Details of the Condenser Type.

The condenser type consists of a suitable condenser unit mounted inside a porcelain bushing or else in a tank with a single bushing, the whole in either case being oil filled. The capacity of the unit can be varied between limits, a capacity of 0.01 mfd. can be obtained for 22 kv. working varying to 0.003 for 132 kv. working.



CARRIER CURRENT COUPLING CONDENSER.

(Bullers Ltd.)

A capacity of 0.01 mfd. can be obtained for 22 kv. working, varying to 0.003 mfd. for 132 kv. working.

Details of the Cable Type.

The cable type consists of a loop of oil filled cable as used for high voltage underground transmission, the two ends of the conductor are clamped together and taped to the correct insulation, being brought out through the top of the bushing to serve as the high voltage terminal, a pressure reservoir is added consisting of a tank and air bellows to ensure that the cable is always filled with oil, the carrier current equipment is connected to the lead sheath. The minimum capacity used at a terminal station is 0.001 mfd.

Protective Equipment.

Protective equipment is provided to prevent damage to the operator or equipment from any high voltage that might reach the apparatus, either through indirect contact or induction.

To meet the requirements of short lines, sets of 15 watt capacity can be obtained,

the entire apparatus being self-contained; a more common use for this set is to provide an additional channel of communication over existing telephone lines which are either overloaded or inherently noisy.

Portable Set for Linesmen.

The use of a portable set for linesmen will give easy communication with the central station from points along the line; a 15-watt set is used for the work, short aerials being strung at distances of five miles, the linesman coupling his set to this aerial when communication is required. A similar set can be used on a motor van; in this case the aerial is strung up as required, the maximum length of 800 feet giving a range of 50-100 miles. The power from these portable sets is obtained from self-contained batteries.

The author is indebted to the British Thomson Houston Co. for the loan of illustrations.

IMPROVING THE POWER FACTOR OF AN A.C. SUPPLY SYSTEM WITH SYNCHRONOUS MOTORS

THE power factor of an A.C. system may be brought to a low value when induction motors are connected to it, especially if they are not well designed, and consequently the efficiency of the system is considerably reduced. Synchronous motors are often used in conjunction with an installation of induction motors to improve the power factor of the system.

These motors run in synchronism with the generators, which supply the current to the installation, and when the excitation current to their fields is adjusted so that their armatures take the minimum current from the system, their power factor is unity. If the excitation current be now increased, the current taken by their armatures will increase, first slowly, and then more rapidly, per step of the field

rheostat. The current now leads the impressed voltage and the motors now have a leading power factor.

The armatures can be made to take their full load currents by continually increasing their excitation although the motors may be running idle, giving an increased leading power factor. Induction motors have a lagging power factor, and if the leading power factors of the synchronous motors are adjusted to counteract the lagging power factors of the induction motors then the power factor of the installation will be improved and the efficiency of the A.C. supply system increased.

In later issues the important question of power factor correction will be dealt with in detail by an eminent engineer who has specialized in this subject.

VENTILATION SCHEMES FOR SHOP WINDOW LIGHTING

By E. H. FREEMAN, M.I.E.E.

In this article Mr. Freeman deals with the important problem of providing ventilation for shop window lighting displays



TYPICAL EXAMPLE OF SHOP WINDOW LIGHTING.

Showing fascia and lettering with Neon tubelighting. Compare this with the illustration on page 158, which shows the same window by daylight.

SHOP windows with lighting schemes designed on the principles described in the article in the December issue, even if not arranged for colour lighting, provide special problems on account of the heating effect of the lamps. A window 15 ft. in frontage and say 5 ft. deep and 10 ft. high has a cubic content of 750 watts and a single 1 kW. radiator would be suitable for warming such a space.

Why Special Provisions Are Necessary.

With even ordinary lighting at 100 watts per foot run of frontage and one or two spot lights the lamp load will be about 2 kW. and most of this is given out in

the form of heat. With windows with larger loadings or designed for colour lighting, or arcade windows lit from two sides, the problem becomes serious and calls for special provision in the way of ventilation. In a window at Messrs. Drages' shop in Birmingham a window is lit from two sides with three colour reflectors and various spot and flood lights in addition, the total load being over 12 kW. for a total space of under 2,000 cubic feet.

Almost All Classes of Goods Liable to be Affected.

In such conditions almost any class of goods except ironmongery will suffer.

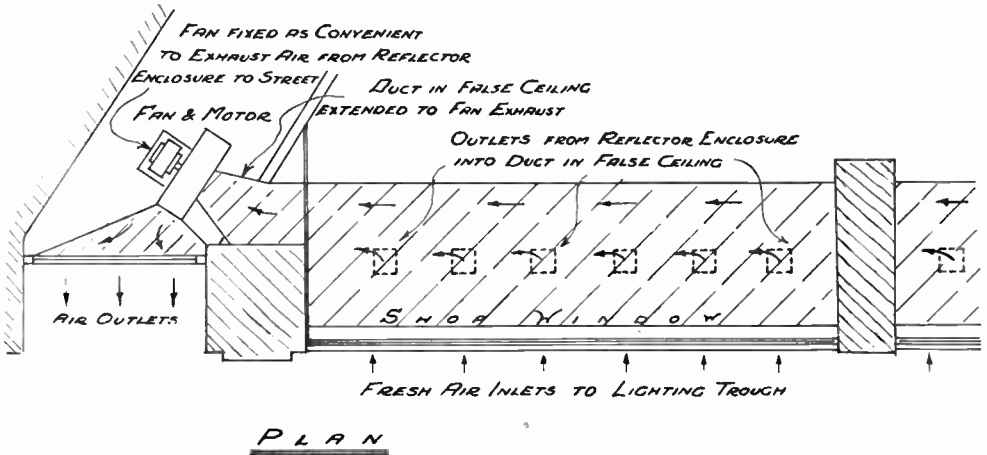

CEILING PLAN OF SIDE OF WINDOW.

Showing fresh air inlets from front or arcade with exhaust air duct above and fan to discharge heated air above window.

Wax models would certainly melt, as they do in even ordinary windows with a single row of reflectors. Furniture might crack in the panels; fabrics would deteriorate and many other goods would be affected.

Disadvantage of Openings at Top and Bottom.

Under such circumstances some precautions must be taken to avoid an undue rise of temperature and some form of ventilating scheme must be devised. In ordinary windows loaded to about 100 to 150 watts per foot run, ventilation openings at the top and bottom of the windows may suffice but this is not a satisfactory solution. Such a scheme must result in the entry of dust into the window as if air filters are used to prevent this they also prevent the proper working of a ventilation scheme relying only on natural draught for air circulation. Dust entering the windows means possible damage to goods displayed; spoils

the effect of the window if not frequently removed and involves extra work in dusting and more frequent window dressing, and these objections are usually sufficient to make dust tight windows a necessity.

A ventilation scheme that exhausts the entire content of the window at frequent intervals—say 6 to 12 times an hour or perhaps more—means a comparatively large fan with risk of noise and high cost of running and also involves problems in finding an outlet for the large volume of air, which is not easy where a shop only occupies a ground floor.

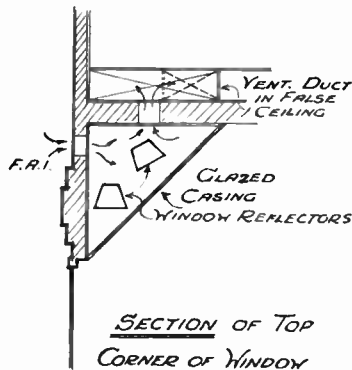

SECTION THROUGH TOP OF WINDOW.

Showing ventilation enclosure with fresh air inlet and exhaust into duct in false ceiling.

Providing Ventilating Fans.

The solution where practicable probably lies in the enclosure of the window reflectors in glazed ducts and the provision of ventilating fans to draw the air from these only, and such a scheme is shown here.

The details must depend on the plan of the particular shop as the difficulty of finding suitable inlets for cold air and

outlets for heated air are considerable. A scheme of this kind was designed for Messrs. Drage and although the temperature in the glazed duct rose, with the fans working, to over 120° the temperature in the display area of the window did not rise above 72° . Without the fans the temperature in the duct would probably have risen to 150° or more but the experiment was not made on account of the risk of damage to the rubber insulation of the wires.

Why it is not Practical to Utilize Heat from Windows for Warming the Shop.

Attempts have been made to utilize the heat from the windows for warming the shop but the complications involved are likely to render such schemes uneconomical. Heat may be wanted in the shop when windows are not lit up or only partly lit as on a bright cold day. On the other hand heat may be definitely *not* wanted



SWITCH CONTROLS FOR WINDOW REFLECTORS.
Correct arrangement for even lighting with alternate lamps.

when windows are lit as on a warm dull day. To meet these conditions the air flow should be reversible and provided with adjustable inlets and outlets to meet all requirements. Ordinary heating must be provided in any case to meet the first condition above (a cold day with windows not lit) and the possible saving in running cost as a result of using the window heat would not be sufficient as a rule to justify the extra capital outlay.

If the shop were electrically heated with thermostat controls the scheme might be workable and in favourable circumstances it would be worth consideration.

Simultaneous Operation of Fan and Lights.

There is one further point that must be provided for in such ventilation schemes viz., the necessity of interlocking the window lighting switch with the ventilating fan starters. This must be arranged either mechanically or electrically both for starting and stopping. Obviously the

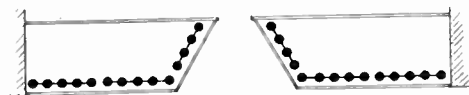

SWITCH CONTROLS FOR WINDOW REFLECTORS.
Incorrect arrangement giving patchy lighting.

fan must start as soon as the lights are switched on or over-heating will occur. It must also stop when they are switched off or the fan will be running uselessly with consequent waste of current. There should be no difficulty in devising methods of dual control and probably electrical devices will be best so that they can be operated by the time switches for switching off after closing hours.

Entrance Lobbies.

It is necessary to ensure ample lighting in the entrance to the shop. This has already been mentioned when the entrances consist of comparatively long arcades leading through the windows to an inner entrance, but even if no such feature exists care should be taken to ensure that even a small entrance is well lit. The method of lighting, whether by a pendant, ceiling fitting, ceiling panel with concealed lights or concealed cornice lighting must depend on the plan, and no hard-and-fast rules can be laid down. Such lights should be controlled by the window time switches.

Interior Displays.

Additional value of the entrances can sometimes be obtained if the doors are glazed by placing displays of goods on suitable portable tables inside the doors after the shop is closed. These are best lit by spot lights placed above the entrance and arranged to direct the light on the display table. They could not be used when the shop is open as the display table would be an obstruction, and such lights thus form a part of the after-hours

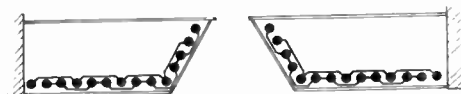

SWITCH CONTROLS FOR WINDOW REFLECTORS.
Correct arrangement for even lighting for one-third or two-thirds illumination.

window lighting only and should also be controlled by the time switches.

Switch Controls.

The method of connecting up reflectors for control by different switches is a matter of importance, as the grouping must be arranged so that even illumination is provided under all conditions. It is not satisfactory to switch the lights in groups as shown, as if only half light is required the illumination in different parts of the window will differ widely.

Switch Alternate Reflectors.

In most cases it is satisfactory to switch alternate reflectors, i.e. Nos. 1, 3, 5, 7, etc., on one switch and Nos. 2, 4, 6, 8, etc., on another. It is rarely necessary with ordinary window lighting to provide for any greater subdivision of lighting than this, which allows half or full lighting evenly distributed.

When Greater Subdivision may be Necessary.

In special cases—for example where colour lighting is used at times—greater subdivision may be necessary, and in all

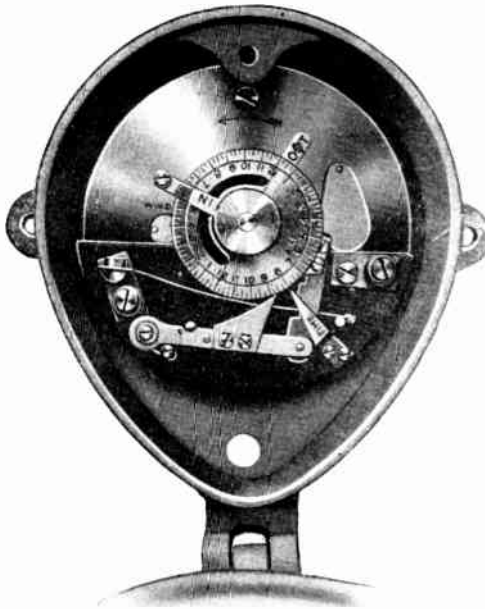

SIMPLE TIME SWITCH SUITABLE FOR SMALL WINDOWS FOR SWITCHING OFF ONLY.

such cases the lamps controlled by each switch must be evenly distributed through the window. One shop may wish to use one-third; two-thirds or all lights and two switches would then control reflectors Nos. 1, 4, 7, 10, etc., and Nos. 2, 3, 5, 6, 8, 9, etc., respectively.

If two rows of reflectors are in use each row should be dealt with separately on the above principle.

Plugs and spot lights in any case must be switched separately from the window reflectors and one switch to each is desirable.

Time Switch Control.

The use of windows for display after closing hours has led to the general adoption of time switches, and these are now designed to give very elaborate controls as mentioned later.

Simple Time Switches.

In its early form the time switch was little more than an ordinary alarm clock with the mechanism slightly modified to operate a switch inside instead of ringing a bell. Such switches could be used for simple systems of window lighting that

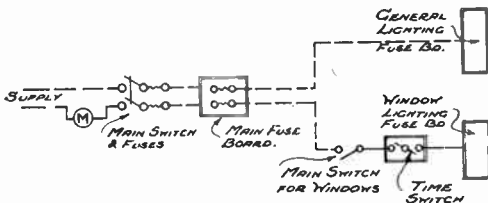

DIAGRAM OF CONNECTIONS FOR TIME SWITCH CONTROL OF SMALL WINDOW TO SWITCH OFF ONLY.

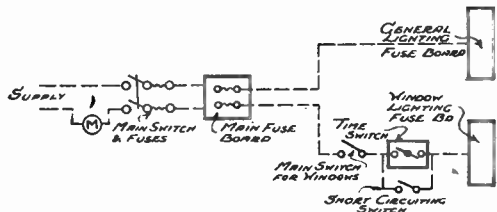
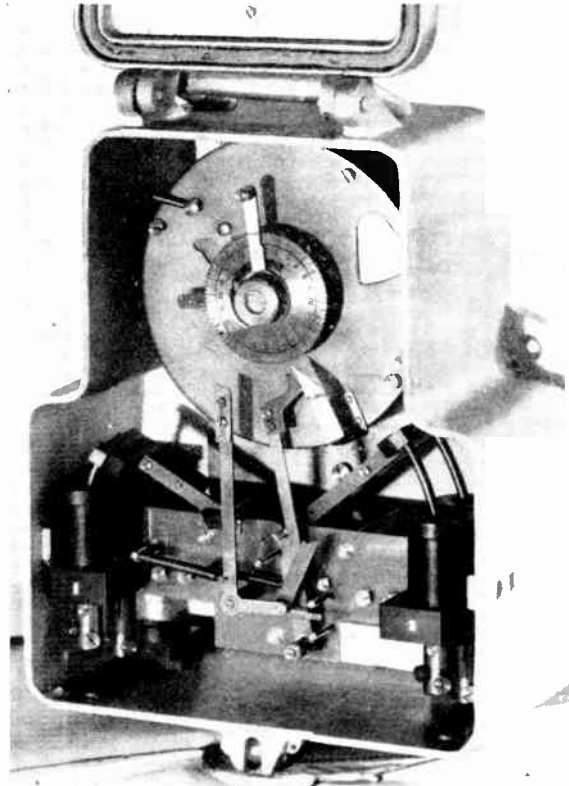

DIAGRAM OF CONNECTIONS FOR TIME SWITCH CONTROL WITH SHORT CIRCUITING SWITCH TO CUT TIME SWITCH OUT OF ACTION ON SPECIAL OCCASIONS.

only needed to be switched off at a definite time and which could be switched on by hand when required. Such a clock is shown in the photograph and a simple diagram of connections showing the method of connecting is given.

Automatic On and Off Switching.

The next stage in development was to provide automatic switching on as well as off, but this was found to be unsatisfactory in one detail, namely, that it was necessary to reset the clock mechanism if the window lighting was needed at abnormal hours due, for example, to a fog or a dark evening. This difficulty can be overcome by adding a short circuiting switch which cuts the time clock out of circuit. If lighting is required at special hours the short circuiting switch is closed and the windows are then under hand control, but when the switch is again opened the time clock operates as before, as shown. This arrangement obviates any need for altering the setting of the clock in any special emergency.



MODERN TIME SWITCH WITH SPECIAL ATTACHMENTS FOR CONTROL OF LARGE WINDOWS.

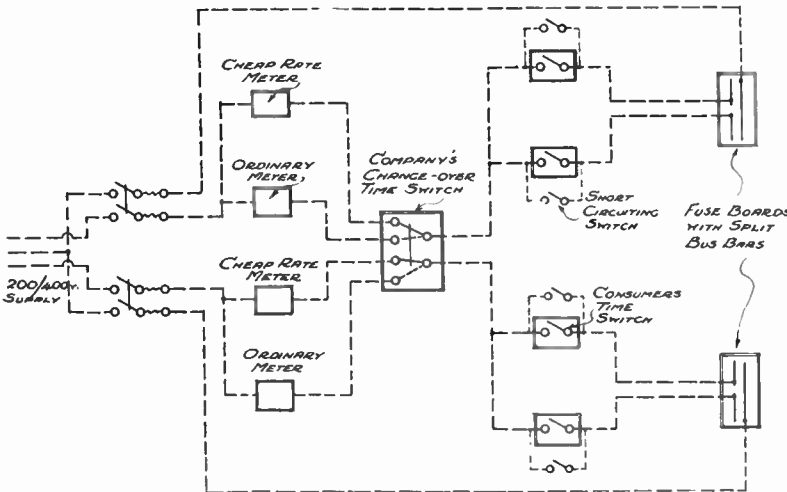

DIAGRAM OF CONNECTIONS FOR LARGE WINDOW DISPLAYS WITH THREE-WIRE SUPPLY.

Showing company's time switch for two-rate tariff and consumer's time switches for separate sections of the lighting.

What the Modern Time Clock Will Do.

Gradually other complications arose and were provided for in the modern time clock which will now give almost any form of control required as, for example, leaving the lights out of use on one or more days a week; switching all lights on at one hour and half off at one time

and the rest at another; changing the lighting load over from one meter to another to meet varying charges for current at different times.

All these operations might not be possible with a single time switch but a combination of two or three will provide almost unlimited control.

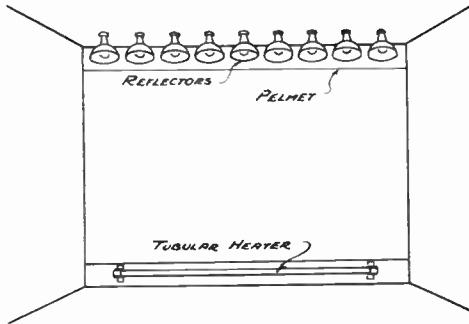

TUBULAR HEATER AT BOTTOM OF WINDOW TO PREVENT CONDENSATION ON GLAZED FRONT.

Duplicated Control to Suit 3-Wire Supply.

A more complicated scheme is given with duplicated control to suit a 3-wire supply. The Company's time switch is connected to the outers of their 3-wire 200/400 volt system and changes the whole window lighting over from one meter to another at closing time and back again at a late hour—after the window lighting is cut off by the other (consumer's) time switches. This allows for a tariff giving special rates for current used after shop hours.

The four consumer's time switches are arranged two on each side of the 3-wire supply, and each of these controls part of the window lighting, thus allowing, say, half lighting to be switched off at 9.30 and the remainder at 11.0 or whatever hours may be suitable to the district.

Why Four Switches Are Most Suitable.

The consumer's switches might be reduced to two, each 3-wire, but this has the disadvantage of giving the ordinary shop assistant who sets the switches from month to month, according to the end of daylight, access to 400 volt wiring which is not always advisable. The extra control is also often useful, as some windows may

receive less daylight than others and will therefore need to be switched on slightly earlier.

The diagram shows two fuse boards for the windows with split bus bars, but it would make no difference if four separate boards were used—one controlled by each of the consumer's time switches.

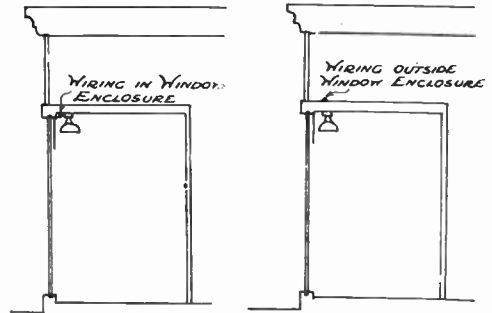

WIRES INSIDE WINDOW ENCLOSURE AND LIABLE TO DAMAGE FROM HEAT OF LAMPS.

WIRES OUTSIDE WINDOW ENCLOSURE WHERE THERE IS NO UNDUE HEAT AND NO RISK OF DAMAGE.

Double Push Button on the Time Switch.

A recent development is the provision of a double push button on the time switch. One button cuts the clock mechanism out of action and the other puts it into operation again. This device makes the short circuiting switches unnecessary and is cheaper and better. A form of time switch required for these more complicated operations is shown.

Illuminated Backgrounds.

Striking effects may be obtained by the use of illuminated backgrounds to windows, but these are probably not suited to the ordinary shop. They would be very valuable in certain special cases, such as a railway or tourist agent's window to show off pictures of places of interest, but such windows do not as a rule display any other goods for sale. No special problems arise in providing such illuminated backgrounds if a foot or more of space is available behind the screen or picture to be lit. In such a case lamps can be distributed behind the area to be lit, which must have a semi-opaque backing

TRANSFORMER FOR METAL RECTIFIER

THE following design is for a transformer suitable for use in conjunction with a metal rectifier such as the Westinghouse RF4-24-1 which has a D.C. output of 120 volts, $\frac{3}{4}$ amperes, with an A.C. input of 180 volts.

In order to isolate the rectifier and its output from the A.C. mains, a double-wound transformer is used. The windings given are suitable for connection to any A.C. supply, 50-60 cycles, provided that the correct primary winding, as given in the table, is used.

Materials Required.

Sankey's Stalloy stampings, 100 pairs; Bakelite $\frac{1}{8}$ -in. thick, $3\frac{3}{8}$ -in. sq., 2 pieces; Bakelite $\frac{1}{8}$ -in. thick, 6×3 in., 1 piece; Bakelite $\frac{1}{2}$ -in. thick, 12×3 in., 1 piece; Bright steel angle, $\frac{3}{4} \times \frac{3}{4} \times \frac{1}{8}$ in., 2 feet; $\frac{1}{4}$ -in. B.S.F. steel bolts $2\frac{1}{8}$ -in. long with nuts and washers, 4; 21 S.W.G. enamelled copper wire, 2 lbs.; Primary wire (see table), 2 lbs.; Terminals and block if required.

Bobbin.

The bobbin is built up from two thicknesses of bakelite sheet. The tube of the bobbin is formed from $\frac{1}{16}$ -in. material. It

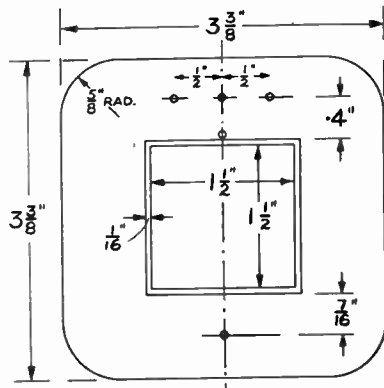

DETAILS OF THE BOBBIN.

PRIMARY WINDINGS.

Mains Voltage.	Primary.	
	S.W.G.	Turns.
100	19 D.S.C.	350
110	19 "	375
115	19 "	402
120	19 "	420
125	19 "	437
200	21 enam.	700
210	21 "	735
220	21 "	770
225	21 "	788
230	21 "	805
240	21 "	830
250	21 "	875

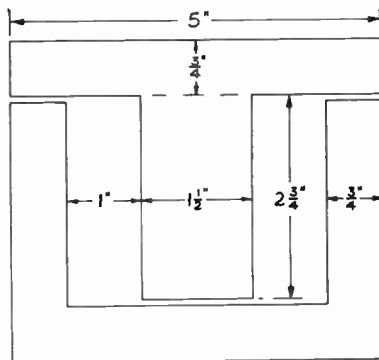

DETAILS OF THE STAMPINGS.

is first made pliable by soaking in hot water, then bent round a piece of material $1\frac{1}{2}$ -in. square. The bobbin may be cemented together with Durofix. One of the bobbin cheeks is drilled to provide for the primary leads and the starting end of the secondary. The positions of these holes is indicated in the drawing.

The Windings.

The primary winding is put on first and the voltage tapplings, if required, are made at the finishing end of the winding. A single layer of $\frac{1}{2}$ -in. bakelite is used to insulate the primary from the secondary winding. Irrespective of the primary winding, the secondary consists of 670 turns of 21 S.W.G. enamel-covered wire. Paper insulation is used between each layer of enamel-covered wire, while the double silk-covered 100-125 volt primary is wound straight on without any interlayer insulation.

Using the Table.

It will be noticed that the table contains particulars for the primary winding only. This is to enable the reader to select the winding suitable for his supply voltage. The secondary winding is the same in every case.

FIFTY AMPERES FROM TWO THERMOCOUPLES

WE have just seen an interesting demonstration of a fact which may surprise some of our readers, viz., that it is possible to obtain as much as 50 amperes from two small thermocouples.

Messrs. Griffin and Tatlock, the well-known scientific instrument makers, have recently manufactured apparatus to demonstrate this. This apparatus consists of two iron plates, the lower one containing a recess to accommodate the two sides of a copper bar bent into a loop. The thermo-junctions are formed by two short pieces of constantan joined across the open ends of the loop. The lower plate has attached to it a cylindrical weight.

These with the plate and cylinder weigh altogether about 15 lb. The demonstration is illustrated in the first, second, and fourth pictures herewith.

The Demonstration.

Look at the first

picture. Note that one end of the bar is dipped into a beaker of cold water, whilst the other end is heated by means of an ordinary bunsen flame. After about half a minute, when the heat has travelled

along the bar to one end of the thermo-junctions the whole apparatus can be lifted by the ring bolt, as shown in the second picture.



Fig. 1.—APPARATUS USED FOR THE DEMONSTRATION.

On the right can be seen the thermojunctions which are joined across the two arms of a stout loop of copper. A recessed iron plate with a weighted base and an armature or cover for the plate complete the apparatus.

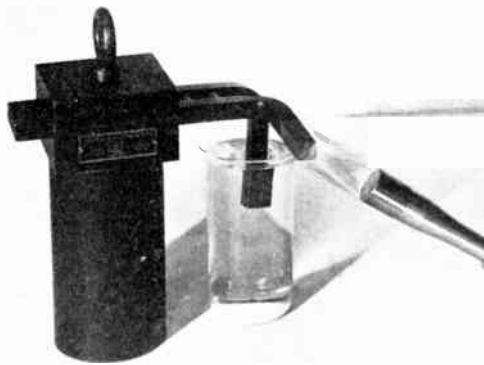

Fig. 2.—HEATING AND COOLING THE THERMO-JUNCTIONS.

One end of the copper bar rests in a beaker of water and the other end is heated by means of a Bunsen burner.

The Reasoning.

In order to magnetise plates sufficiently for such a weight to be lifted, the current flowing in the bar must

amount to about 50 amperes. This is demonstrated in the last picture. Here we see the same apparatus, except that the copper bar and thermo-junctions have been replaced by a coil consisting of 50 turns of No. 20 D.C.C. wire. This coil is supplied with current from an accumulator through a variable resistance. The resistance is adjusted until the magnetism produced in the plates is just sufficient to

enable the whole apparatus to be lifted, as before, by means of the ring bolt. It is found that a current of one ampere is required to produce the desired effect.

Now, one ampere flowing through 50 turns produces a magnetising force of 50 ampere turns, i.e., a magnetising force of 50 ampere turns is required to magnetise the plates sufficiently to enable the apparatus to be lifted *en bloc* from the ring bolt. In the first experiment, however, we had only a single turn, and from this it follows that a current of 50 amperes must have been flowing round the loop when the second photograph was taken.

An Interesting Speculation.

These four photographs demonstrate quite clearly that it is possible to obtain very heavy currents from thermocouples. Of course, the voltage at which the current is delivered is very small, but it will be seen that quite appreciable magnetic effort can be obtained by allowing a heavy current to flow round one or two turns of an electromagnet.

So far as we are aware the thermocouple has not up to the present been used in practice to any appreciable extent, except in connection



Fig. 3.—THE DEMONSTRATION. After a short time it is found that the whole apparatus can be lifted bodily owing to the magnetic effect between the armature and plate.

with the making of electrical pyrometers and certain scientific instruments. It seems not unlikely that this property of the thermocouple may at some time be utilised in a manner which takes advantage of the property demonstrated above.

A Word of Warning.

Readers are, however, warned against expecting to find that the use of thermocouples will provide an easy method of converting heat into electrical energy.

Many Attempts Made to Produce Batteries.

Many attempts have been made to produce batteries comprised of a number of thermo-electric elements arranged in such a way that all the hot junctions could be heated at the same time.

Avoid the Difficulties Encountered by Previous Investigators.

So far, none of these attempts has met with commercial success, therefore, if any reader feels inclined to engage in experimental work in this direction he is strongly advised to make himself acquainted with any existing patents and other literature on the subject so that he may avoid the difficulties encountered by other investigators.

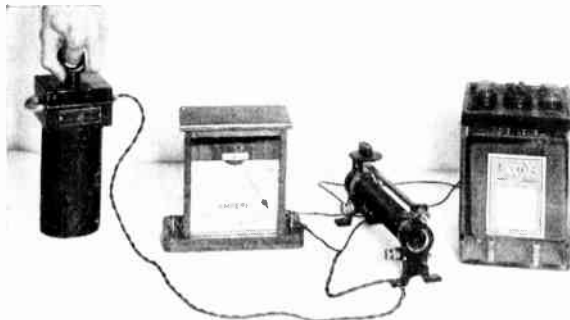

Fig. 4.—THE PROOF. Here the copper loop has been replaced by a coil of 50 turns. It is found that a current of 1 ampere is necessary to give the same lifting effect as before.

HOW TO CALCULATE WINDINGS FOR HEATING ELEMENTS

ALTHOUGH heating elements for various types of fires, ovens, etc., can be purchased from the manufacturers—the wiring contractor and practical man may have occasion from time to time to construct elements or to rewind burnt-out elements for the same or different voltages.

The following brief notes show how to calculate the amount of wire required for any given size of element.

The Reasoning.

For convenience the reasoning is given first in algebraic symbols, but readers who may be a little rusty in their book learning will find that the practical methods of arriving at the result required are given later :—

Let V = Supply voltage.

W = Wattage required in element.

Then current through winding = $\frac{W}{V}$ amps.

Resistance of winding = $\frac{\text{Voltage}}{\text{Current}} = \frac{V}{\frac{W}{V}} = \frac{V^2}{W}$

The maker's table of standard resistance wires must now be used to arrive at the required size. Here is an extract from a table published by the London Electric Wire Company and Smiths dealing with their nickel chrome resistance wire.

An Actual Case.

We will now abandon symbols and deal with an actual case :—

Voltage, 200. Size of element, 1,000 watts. To run at 600° C.

From our formula we have seen that :—

$$\begin{aligned} \square \text{ Resistance of winding} &= \frac{\text{Voltage}^2}{\text{Wattage}} \\ &= \text{in this case } \frac{200^2}{1,000} = \frac{40,000}{1,000} \\ &= 40 \text{ ohms.} \end{aligned}$$

Also, we find from the previous formula that the current required is :—

$$\frac{\text{Wattage}}{\text{Volts}} \text{ i.e., } \frac{1,000}{200} = 5 \text{ amps.}$$

So we see that we require a winding which will have a total resistance of 40 ohms, and which will run at a temp. of 600° C. when a current of 5 amps. is passing through it.

From the table below, it can be seen that No. 22 gauge wire maintains a temperature of 600° with a current of 5.1 amps. This, therefore, is the size of wire required.

Next we notice that 1,000 yards of No. 22 gauge wire has a resistance of 2,820 ohms. The question is what length of No. 22 wire will be needed to give a resistance of 40 ohms.

This is a matter of simple proportion, i.e., length required

$$= \frac{1,000 \times 40 \text{ yards}}{2,820} = 14.19 \text{ yards.}$$

A useful list of resistance wires will be sent free to any reader of this magazine who writes to The London Electric Wire Co. and Smiths, Ltd., Church Road, E.10.

NICKEL CHROME RESISTANCE WIRE.

Size S.W.G.	Approximate Resistance per 1,000 yards. Standard Ohms.			Approximate Amperes at			Weight per 1,000 yards. lbs.
	200° C.	400° C.	600° C.	200° C.	400° C.	600° C.	
16	452	494	538	7.1	12	18	37.6
17	591	646	703	6.0	9.6	14	28.9
18	802	879	957	4.3	7.7	11	21.2
19	1154	1266	1378	3.7	5.7	8.4	14.8
20	1426	1590	1700	3.3	4.7	6.8	12.0
21	1809	1978	2151	2.7	4.2	6.2	9.41
22	2360	2583	2820	2.2	3.5	5.1	6.71
23	3237	3535	3860	1.8	2.8	4.1	5.31
24	3828	4187	4555	1.6	2.4	3.3	4.46
25	4732	5061	5505	1.4	2.1	3.1	3.69
26	5720	6250	6870	1.1	1.9	2.6	2.98
27	6890	7535	8400	1.0	1.6	2.4	2.48
28	8460	9250	10070	.93	1.4	2.0	1.95
29	10000	10950	11920	.78	1.3	1.8	1.69
30	12040	13170	14320	.68	1.1	1.6	1.42

OIL FILTRATION AND THE ELECTRICAL ENGINEER

STREAM-LINE FILTERS FOR INSULATING OIL TREATMENT

By ALBERT BEALE, Wh Sch., A.M.I.Mech.E., A.M.I.N.A.

In view of the large number of high voltage transformers and switches now coming into everyday use as a result of the Grid scheme, the particulars given in this article of a method of maintaining the good condition of the insulating oil which plays an important part in their design will be of interest to our readers

The Oil Problem.

OIL is used in large circuit-breakers and transformers for cooling and insulating purposes. The oil selected is of low viscosity and high dielectric strength, that is, of good insulating value. The latter quality is very greatly impaired by the presence of even minute quantities of moisture or solid impurity; hence it is of importance to ensure the supply of clean, dry oil, to select a grade which does not itself deteriorate by sludging, and to provide means for removing any contamination which may arise.

Breathers.

Insulating oil is highly hygroscopic, but modern transformers are pro-

vided with breathers charged with calcium chloride or silica-gel which prevent moisture from the atmosphere gaining access to the oil. In a transformer in service

the electrical properties of the oil are now lowered chiefly by fibrous material ultimately becoming detached from the windings and by the semi-solid sludge which forms in time even in the best oils. In the presence of a bare trace of moisture such impurities provide a relatively conductive path through the oil, and the insulating protection given by the oil is correspondingly reduced.

Effect of Arcing.

In circuit-breakers there is a further source of contamination in the products formed

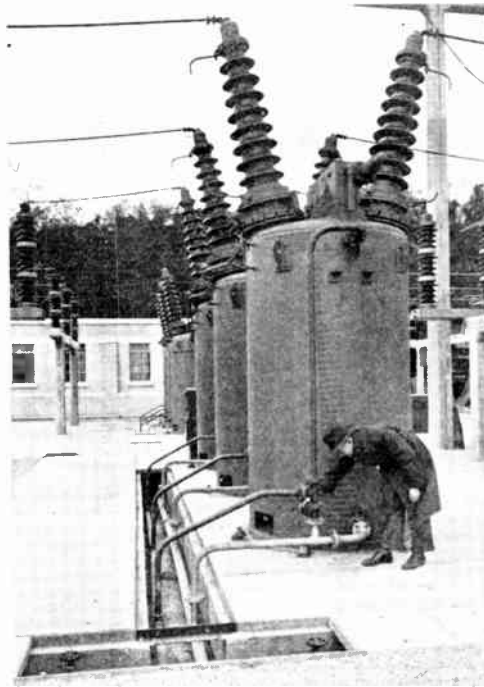

CIRCUIT BREAKERS ON A GRID SCHEME STATION. Showing oil piping and filter-plant house in background.

by arcing when a circuit is broken. Notably, colloidal carbon is produced—carbon in a state of subdivision so great that it will not settle out of the oil however long it is left standing. This carbon tends to collect where it is least wanted in the circuit-breaker, and with moisture present very little carbon is necessary to reduce the dielectric strength of the oil below a safe limit.

Magnitude of the Problem.

The largest sizes of modern transformers, and the three phases of circuit-breakers, may contain as much as 10,000 gallons of oil. An average Grid-scheme sub-station may have 40,000 gallons of oil in the breakers and transformers.

A British Engineering Standards Association specification defines how the dielectric strength of insulating oils shall be measured. Under these conditions a good new oil will withstand 30,000 volts on a gap of 0.15 inch, whilst a specially good oil will withstand 45,000 volts. These oils by brief exposure to a damp atmo-

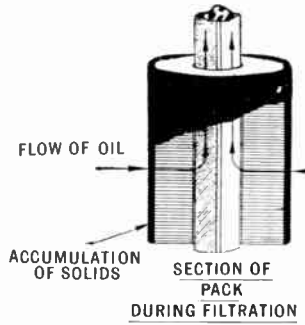
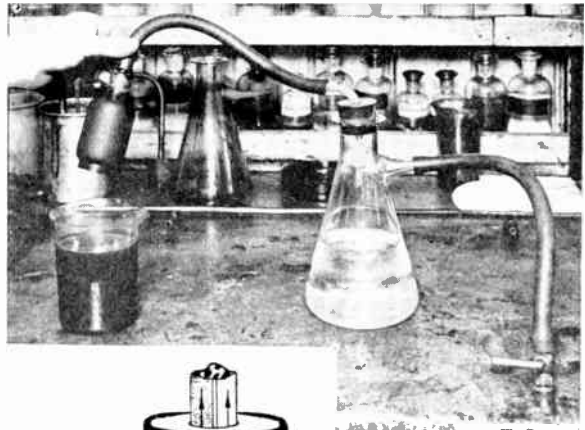

PRINCIPLE OF FILTER.
Vacuum-operated laboratory filter lifted from beaker of unfiltered liquid to show the solid cake formed on filter pack.

sphere, or by contamination so slight as not to be detected by eye, will be reduced to a dielectric strength of only 7,000 to 10,000 volts. Such figures enable the importance of efficient and easily used oil purification plant to be judged; and the matter is of equal relative importance to users of transformers on a smaller scale than that indicated as applying to the National Grid system.

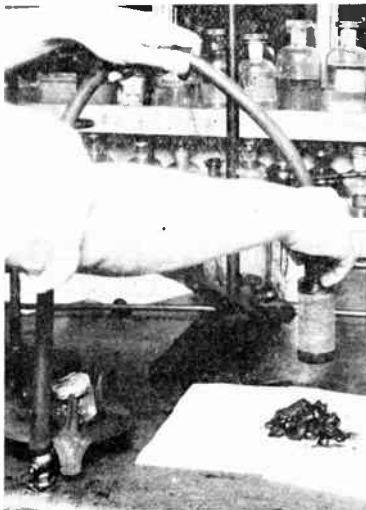

PRINCIPLE OF THE STREAM LINE FILTER.

Laboratory filter at the instant of cleaning by reversal with compressed air. Note the filter pack made up of specially prepared paper discs.

Desirable Purifier Characteristics.

A good purifier for insulating oil must easily remove all traces of solid impurity and moisture from the used oil. It should be of such design that the purified oil can be delivered back into the circuit-breaker or transformer without exposure to the atmo-

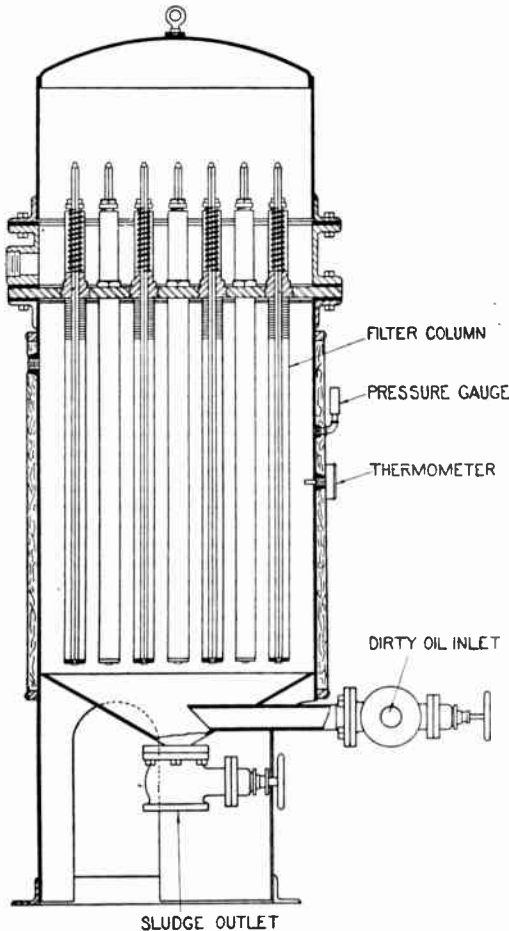

SECTION OF T91 FILTER.

Each column consists of nearly 10,000 discs and is spring-loaded as shown.

sphere, and should be capable of dealing with the oil in a transformer by circulation, while it is on load. The colloidal carbon formed in circuit-breakers is so fine that it cannot be removed (without previous chemical treatment) by ordinary filters or centrifugal separators, whilst complete dehydration demands treatment under vacuum. Streamline filter equipment conveniently combines fine filtration with vacuum dehydration, and the plants described have been widely adopted.

The Streamline Filter—How it Works.

The filter itself operates on the principle of edge filtration between paper discs.

A single filter column for the laboratory is shown on page 374. It consists of discs of specially prepared paper about four-thousandths of an inch thick, which are maintained under end compression by spring loading, so that only interstices of infinitesimal size caused by the fibrous nature of the material remain between consecutive discs. The liquid to be filtered passes between the discs, leaving the impurity entirely deposited at the paper edges. It is possible by this means to remove particles so fine that they would readily pass through the pores of the paper if used in the ordinary "surface filtration" process.

The passage of the liquid through the filter may be carried out under the agency of vacuum applied to the inside of the packs or of pressure applied to the liquid surrounding the packs. When the accumulation of solids has become sufficient to slow up the rate of filtration appreciably the pack is cleaned by reversal with compressed air. This simple process completely removes the solid "cake" and restores the rate of filtration.

Vacuum Dehydration.

A vacuum-operated streamline filter provides exceptionally favourable conditions for dehydration. So soon as the oil passes the solid cake outside the filter discs, it is exposed to 26 ins. to 29 ins. vacuum and being already at 80° C., it is well above the boiling-point of water for the reduced pressure. Thus, the moisture is vaporised while the oil is in layers of only molecular thickness, and the separation of oil and water is very complete for that reason.

Removing the Vapour from the Oil.

It still remains to remove the vapour from the oil. They pass together from the filter itself into a vacuum receiver of special construction. The oil encounters a series of heaters and flows over a number of trays where the full benefit of heat and vacuum is obtained, thus preventing condensation of the moisture already evaporated. Clean dry oil is withdrawn continually from the bottom of the vessel (see diagrammatic drawing), whilst air, gases and water vapour pass off from the

top of the vessel and out to atmosphere through the dry vacuum pump. The level of the oil seal above the dry oil outlet is maintained by float-gear operating on a valve in the oil line.

It is an interesting fact that the action of the filter itself is essential to complete dehydration of the oil. The absolute elimination of all moisture is not readily obtained by the use of a vacuum vessel alone.

Accessory Equipment.

To ensure complete dehydration the oil must be heated to 80° C. and subjected to a vacuum of 26 ins. to 29 ins. of mercury. In the smaller filters electric heaters are included in the construction of the filter body itself, whilst in larger filters

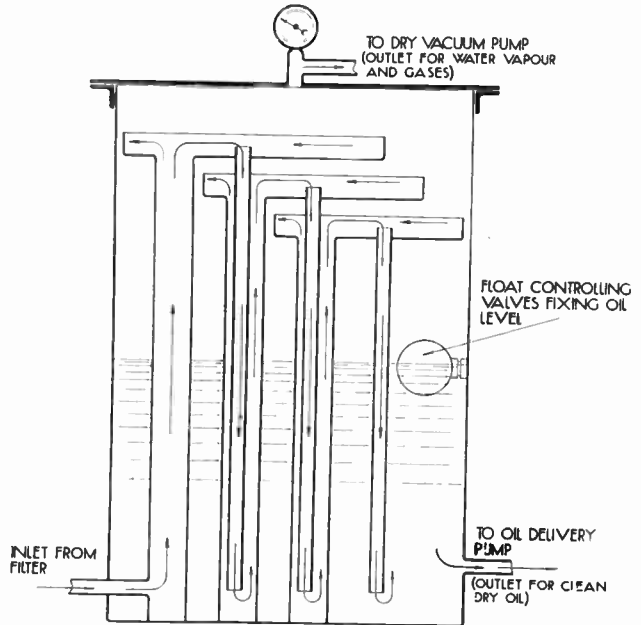

DIAGRAMMATIC SECTION OF VACUUM DEHYDRATOR.

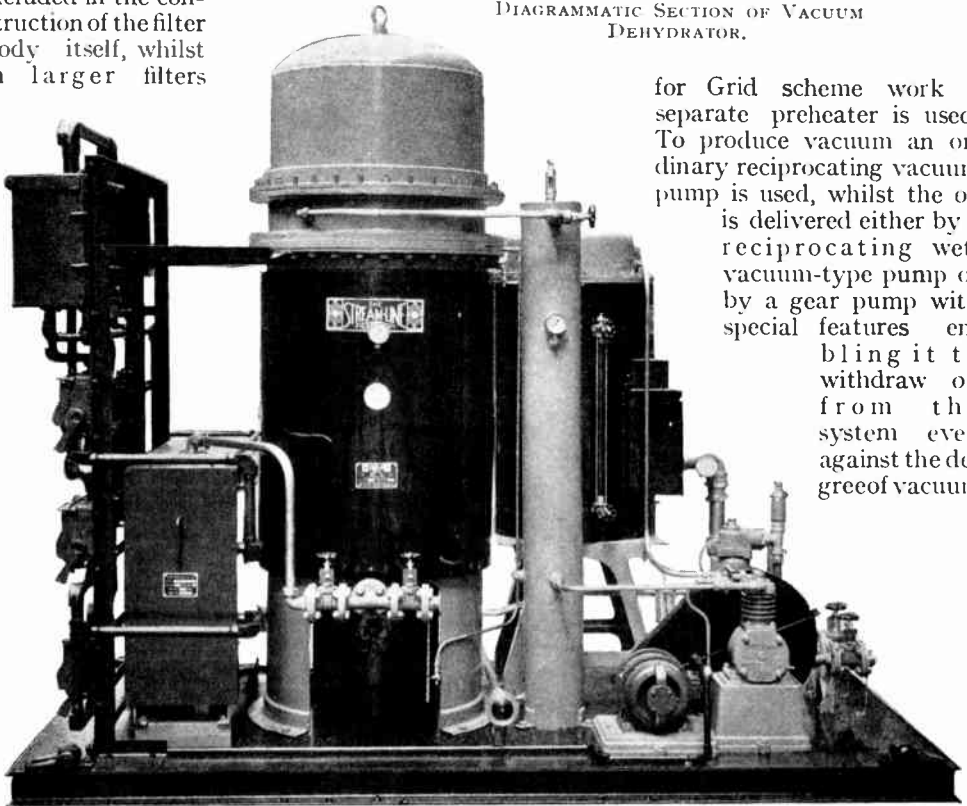

ASSEMBLY OF FILTER PLANT AS SUPPLIED TO GRID SCHEME STATION.

for Grid scheme work a separate preheater is used. To produce vacuum an ordinary reciprocating vacuum pump is used, whilst the oil is delivered either by a reciprocating wet-vacuum-type pump or by a gear pump with special features enabling it to withdraw oil from the system even against the degree of vacuum

produced by the other pump.

How Compressed Air is Obtained.

Compressed air for cleaning the filter is obtained by running the dry vacuum pump for a few minutes as a compressor to charge a suitable air bottle.

In the photograph of a

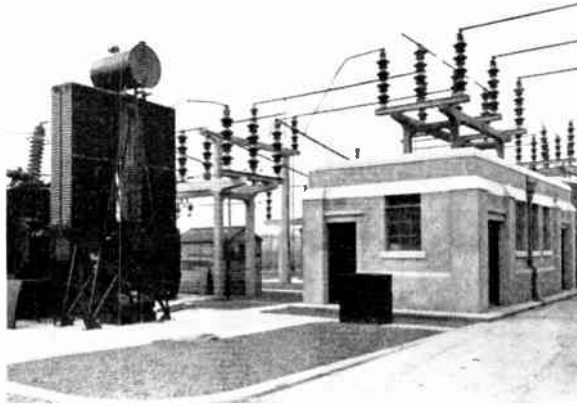

GRID SCHEME TRANSFORMER AND FILTER PLANT HOUSE.

large plant to deal with 300 g.p.h. of oil, the following features may be seen stretching from left to right (see previous page):—

Switchgear and contactor for thermostatic control.

Preheater.

T91 filter.

Compressed air bottle, with, behind it, the vacuum dehydrator.

Pumping set, with dry-vacuum pump in front, and oil delivery pump (half-hidden) behind.

The oil inlet and outlet valves can be seen on the extreme right.

Purifying Plant for Large Grid Scheme Stations.

The photographs of Grid scheme circuit-breakers and transformers give some idea of the size of the oil-filled vessels whose functioning depends on the maintenance of the oil in good condition. A diagram is given to illustrate the lay-out of an electrical equipment in a substation of no more than moderate size.

All oil-filled electrical equipment is connected by permanent piping to a plant house containing filtration plant. Steel pipe mains of 2½ in. or more diameter are used for dirty oil and copper pipe mains of 2 in. or more for clean oil. The pipework also links up with large storage tanks for clean and dirty oil, and, in the plant house, with oil transfer pumps of considerable capacity.

Output of Oil Purification Equipment.

The oil purification equipment has an output of 300 gallons per hour, whilst the transfer pumps will deal with several thousands of gallons per hour. The operator has the choice of two methods for dealing with the oil in the electrical

equipment; he may either circulate it through the purifier at 300 gallons per hour, thus gradually bringing the bulk of oil in any one transformer (or circuit-breaker) up to standard, or he may pump the dirty oil rapidly into the dirty oil storage tank, refill the transformer from the clean oil storage tank, and then deal with the dirty oil at leisure, passing it through the purifier into the clean oil tank ready for the next call.

Transformers are usually dealt with by circulation and circuit-breakers by batch treatment; in the case of the former the treatment can without objection be carried out while the transformer is "on load."

Clean Oil Storage Tank.

The clean oil storage tank is equipped with a calcium chloride breather, so that the clean dry oil shall not be exposed to contamination by atmospheric moisture. The pipe mains are provided with cross-connections so that all pipes can be circulated with clean oil to dry them out when first installed or after any subsequent accidental exposure. All pipework runs in underground chases (with portable covers) except where actual connection to the electrical equipment is established. The chases are drained to prevent the pipework becoming waterlogged, and the pipes themselves are sloped to convenient points from which they can be emptied

of oil in the event of repairs being necessary.

The Plant House.

In the plant house the oil transfer pumps are located in addition to the purifying plant, all electrical controls being conveniently grouped. The applications of the pumps and purifier are governed by a valve bank shown in a typical photograph above. Externally, the valves necessary are confined solely to the shut-off valves at each transformer and circuit-breaker, and the sectionalising valves considered to be expedient for dividing the pipe mains into groups.

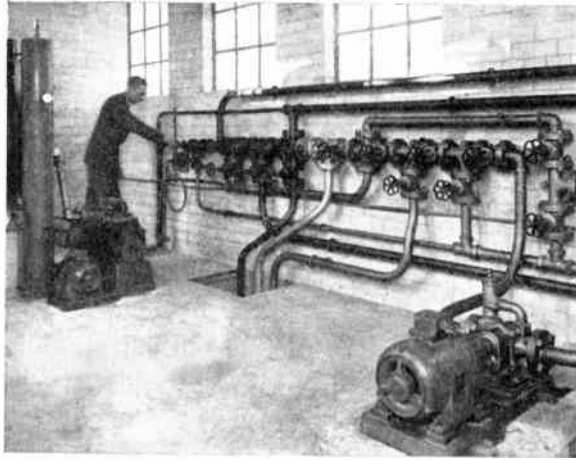

OIL MAINS PIPING CONTROL WALL IN FILTER HOUSE.

circulated at a rate of 100 gallons per hour.

How the Trailer Type Filter Plants are Moved.

The trailer-type filter plants are moved from station to station by a towing lorry. When delivered to the site they can be moved from one transformer

to another by hand, and the purifying plant operated by electricity obtained by plugging-in to a suitable source of power provided at each necessary position.

When the inspection doors of the trailer-type plant are closed, this plant is thoroughly weatherproof. It can function out-of-doors however inclement the weather.

Filters for Groups of Secondary Grid Stations.

The smaller transforming stations do not warrant the installation of fixed filter-house plants and permanent piping.

To meet their requirements special portable filters have been designed, mounted on pneumatic-tired trailers suitable for travelling for hundreds of miles over a wide area. These plants embody all the features of the fixed filter-house equipments except the oil storage tanks and transfer pumps; they are taken alongside the transformers to be treated, connected up by means of flexible hose, and the oil is

Filter for Individual Power Stations.

The requirements of single stations may be met by the use of portable filters not designed to travel the roads, but suitable for wheeling over a level floor.

Such filters are usually mounted on low trolleys fitted with castors, and no attempt is made to render them weatherproof.

Otherwise, they embody the same essentials as the more mobile plants already described.

Filters are made in this type for outputs of 100 gallons per hour down to as little as 5 gallons per hour. The smallest com-

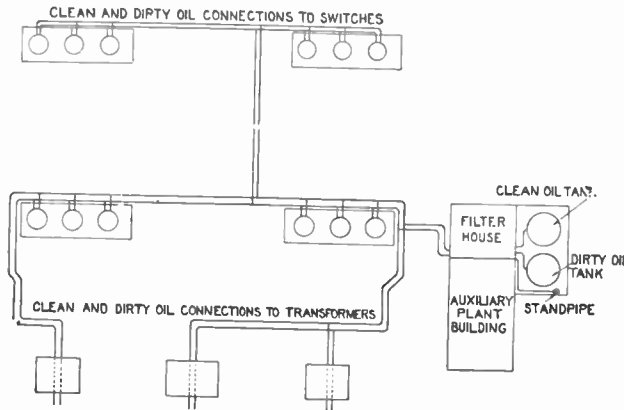

TYPICAL PIPEWORK LAYOUT FOR LARGE SUB-STATION.

mercial filter of this size is only 32 inches long, 22 inches wide and 31 inches in height. It is adequate for dealing with transformers containing 50 to 100 gallons of oil without undue delay.

Choosing a Filter
—Output Necessary in Given Circumstances.

(1) *Batch Treatment.*

If the oil is to be dealt with in batches, i.e., by filtering from a dirty oil tank to a clean oil tank, the requirements of a good purifier are, first, that it should deliver the oil *after a single passage* at or above the desired dielectric strength, and second, that it should do this at a rate consistent with the complete treatment of a batch of oil in reasonable time. The application of these requirements is straightforward, and as the batch of oil is usually not required for immediate use, but only for storage in the clean oil tank until a demand is made for it, the output of the purifier need not be very large. This accounts for the choice of filter with the relatively low output of 300 gallons per hour for use in grid scheme stations where there may be a total of 40,000 gallons of oil to maintain.

(2) *Treatment by Circulation.*

The requirements when a

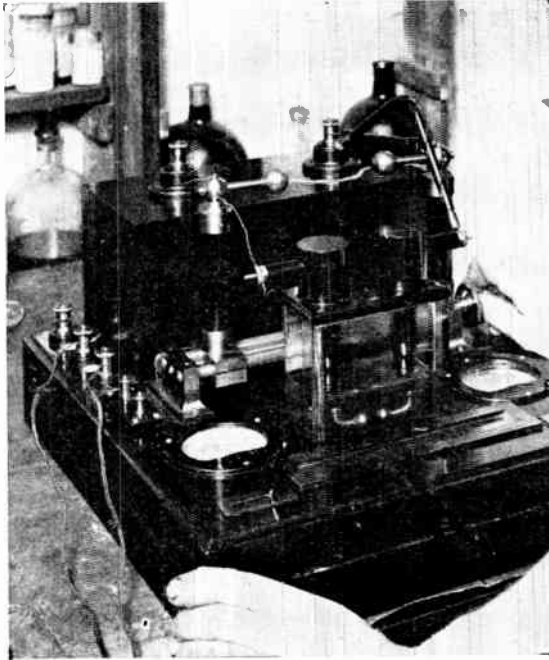

TESTING THE DIELECTRIC STRENGTH OF FILTERED OIL.

Strengths of over 60,000 volts are obtained.

bulk of oil in a transformer is to be upgraded by circulation are not quite so obvious as the above. In this case it can be shown that the degree of purification obtained in passing the oil through the filter is even more important than the filtration rate, i.e., there is a distinct advantage in the ability of a purifier to deliver oil well above the dielectric strength actually required in the transformer itself. The matter is susceptible to treatment by

straightforward mathematics:—

Let Q (gallons) = Quantity of oil in transformer.

q (g.p.h.) = Rate of circulation through purifier.

x_1 (k.v.) = Dielectric strength of oil at start.

C (k.v.) = Dielectric strength of oil delivered by purifier.

t (hours) = Time from commencement of circulation.

x (k.v.) = Dielectric strength of oil in transformer after time t .

Then

$$Q \cdot dx = q \cdot dt (C - x)$$

is the fundamental differential equation expressing the process of purification of the oil in the transformer.

Solving this equation in the usual manner,

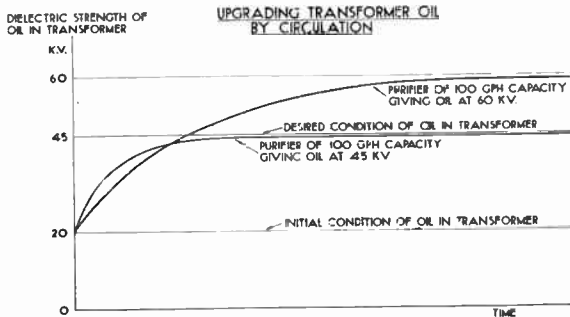

CURVES ILLUSTRATING CHOICE OF PURIFIER EQUIPMENT.

and substituting constants expressing the known initial conditions gives

$$x = \frac{c}{c - (c - x_1)} e^{-qt}$$

As would also be obvious from general considerations, this result shows that it would take an infinite time for the dielectric strength of the oil in the transformer (x) to reach the value given to the oil actually leaving the purifier (C). Thus, if the purifier were only just capable of giving to the oil passed through it the dielectric strength desired in the transformer, the bulk oil in the transformer could *never* be brought right up to the desired state, no matter how great the output of the purifier. On the other hand, a purifier of small output but high efficiency would attain the desired result in a reasonable time.

Comparative Curves.

As between two purifiers, both giving more than the dielectric strength called for, but one giving much more together with a low output, and the other giving a little more together with a high output, the comparison is shown by the curves. It will be seen that for a short time after the commencement of purification the latter plant appears to be the better, but that before the desired object has been achieved the curves cross and the former plant is seen to be really the better.

The choosing of a purifier therefore calls for careful consideration, but to demand high efficiency is sound in all cases.

Maintenance Work with Insulating Oils.

The consequences of a considerable drop in the insulating value of oil in switchgear or transformers may be disastrous, and will occur without warning if the condition



ADJUSTING FILTER PACK COMPRESSION OF GRID SCHEME FILTER.

of the oil is not studied. Periodic filtration without waiting for any signs of breakdown is a good policy.

In large stations it is worth while to take regular tests of the condition of the oil, so that filtration can be immediately undertaken when necessary. The British Engineering Standards Association lays down standard conditions for testing. Spherical balls of specified diameter are immersed in the oil to be tested, contained

in a cell of given form, and separated by a gap fixed at 0.15 inch. Increasing voltage differences are applied to the two balls, and the establishment of an arc through the oil fixes the voltage described as the dielectric strength.

When test transformers giving up to 60 k.v. in convenient stages are available the test is applied by these means. Otherwise an approximate figure can be obtained by means of the dielectrometer shown on page 379, in which an induction coil is used.

Samples from transformers and circuit-breakers should always be drawn off near the bottom, where the condition of the oil is likely to be *at its worst*.

Adjustments to the Streamline Filter.

Solid impurities are removed from the filter periodically by reversal with compressed air, whilst water vapour and gases pass out continually through the dry vacuum pump. The only actual adjustment required by the plant is attention about once a year to the filter pack compression. Shrinkage of the paper leads to a loss of compression, and although the springs follow this up, they must be tightened to normal length again occasionally.

USEFUL CIRCUIT DIAGRAMS

In this and the facing page are shown the connections for different types of D.C. starters, for series wound and shunt wound motors, and also the simple starting connections for one, two and three-phase A.C. motors. Figs. 1 to 4 show connections for D.C. series wound motors and Figs. 5 to 7 the connections for D.C. shunt wound motors. The starting connections for A.C. motors are shown in Figs. 8 to 12

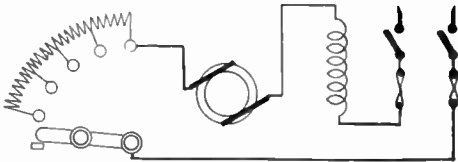

Fig. 1.—PLAIN FACE-PLATE STARTER CONNECTIONS FOR D.C. SERIES WOUND MOTOR. The starter shown is a simple starter without no-volt release or over-load release. This means of starting can only be used for small motors up to, say, 1 horse-power.

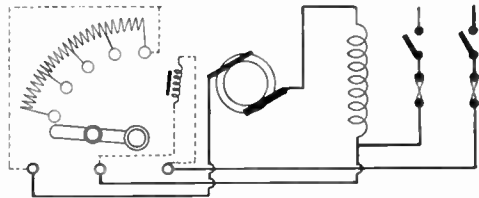

Fig. 2.—FACE-PLATE STARTER CONNECTIONS FOR D.C. SERIES WOUND MOTOR. In this case the starter shown is similar to Fig. 1, but with the addition of a no-volt release and should be used only in similar cases.

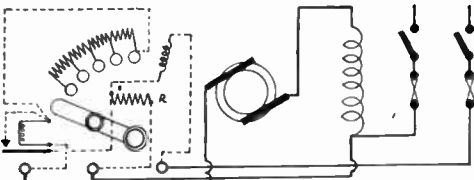

Fig. 3.—FACE-PLATE STARTER CONNECTIONS FOR D.C. SERIES WOUND MOTOR. This starter is similar to the two above, but with the addition of an over-load release. R is a resistance in series with the no-volt release to eliminate the possibility of a dead short when the over-load release acts.

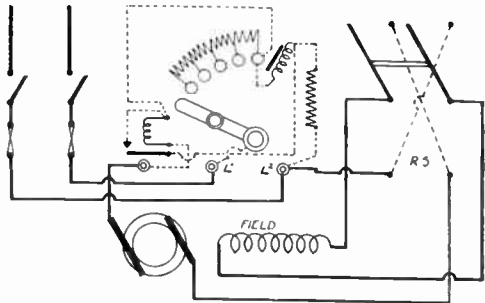

Fig. 4.—A D.C. FACE-PLATE STARTER WITH REVERSING SWITCH FOR SERIES MOTOR.

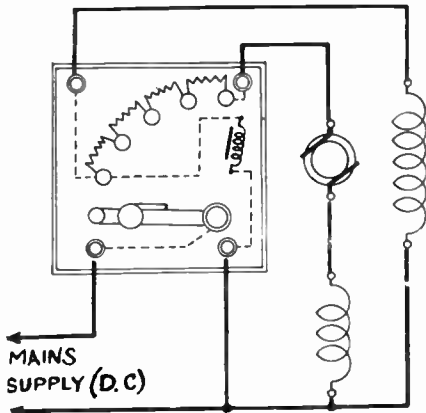

Fig. 5.—D.C. MOTOR (SHUNT WOUND). The spring-controlled starting handle is moved step by step to the full-on position, where it is held by the magnet, through the windings of which the current flows.

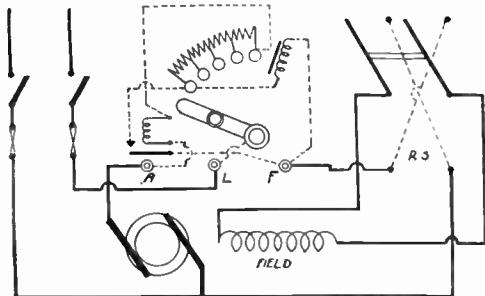

Fig. 6.—A D.C. FACE-PLATE STARTER WITH REVERSING SWITCH FOR SHUNT MOTOR.

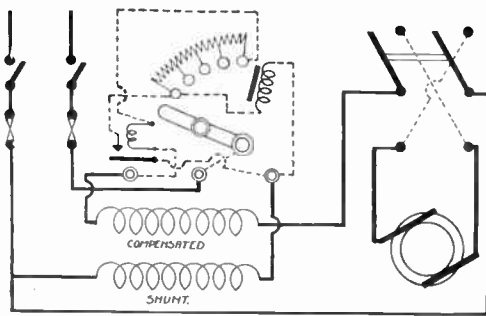

Fig. 7.—THE INTERNAL AND EXTERNAL CONNECTIONS OF A D.C. STARTER WITH REVERSING SWITCH FOR A COMPENSATED MOTOR.

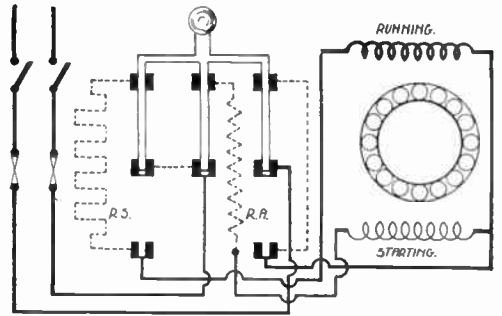

Fig. 8.—STARTING INDUCTION MOTORS. The internal and external connections of starting switch with a single-phase induction motor. R.S. is the resistance and R.A. reactance.

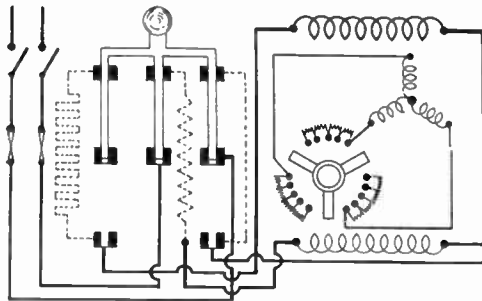

Fig. 9.—STARTING INDUCTION MOTORS. A wiring diagram of starting switch for a single-phase induction motor with rotor and rheostat.

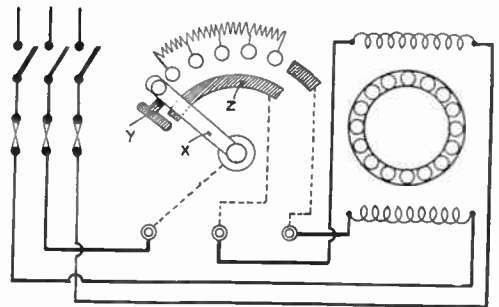

Fig. 10.—STARTING INDUCTION MOTORS. A starting rheostat for a small two-phase motor. Y is a separate brush insulated from X, but making contact with segment Z.

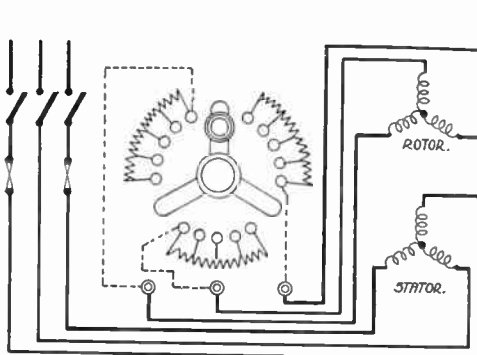

Fig. 11.—STARTING RHEOSTAT FOR A THREE-PHASE INDUCTION MOTOR WITH ROTOR RESISTANCE.

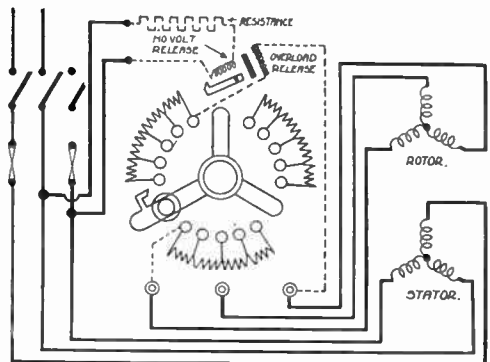

Fig. 12.—STARTING FOR THREE-PHASE MOTOR WITH ROTOR RHEOSTAT WITH NO-VOLT AND OVER-LOAD RELEASE.



The Editor invites correspondence from readers on any subject of general interest to members of the electrical engineering profession. Letters should be addressed to THE EDITOR, The Practical Electrical Engineer, 8-11, Southampton Street, Strand, W.C.2.

An Adaptation of the "Keepalite" System.

SIR,—With reference to your article on the "Keepalite" system in PRACTICAL ELECTRICAL ENGINEER for January, I am enclosing a point from an adaptation of the above system, which I think may be of interest to many readers.

Briefly, the scheme is to use existing points in a building as emergency lighting. An extra contact is added to the "Keepalite" contacts, or in the example (Fig. 1) shown the alarm contact is used to supply current to a duplicate switch feed so that whether the local switch is on or off, on failure of supply all emergency lights are brought into action. As will be seen the switches are ordinary 2-way and under usual conditions function normally, but as explained must in either position cause the emergency lights to operate.

I should imagine a system of this kind would be invaluable in public buildings and would do away with the necessity for gas exits and staircase lights and bring the all-electric age appreciably nearer. Trusting you will find this of interest.

W. WATSON (E. Ham).

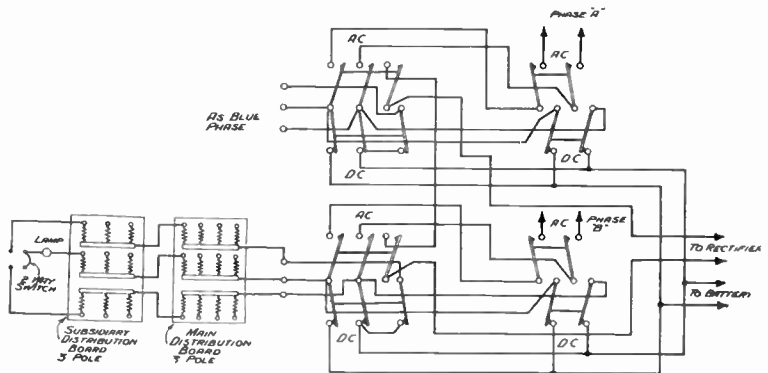

Fig. 1.—THE ADAPTATION OF THE "KEEPALITE" SYSTEM REFERRED TO IN MR. WATSON'S LETTER.

A Cell That Has Been Charged the Reverse Way.

SIR,—Will you please let me know what can be done with a cell that has been charged the reverse way?

R. T. (Grimsby).

If an accumulator has been reversed due to charging in the wrong direction it may be restored to normal condition by giving a long continued charge in the correct direction at quarter the normal charging rate. The plates will be mechanically weak and the accumulator must be carefully handled. At the end of the charge test the acid

for correct S.G. 1.2 to 1.25 and restore to the correct strength if necessary. This treatment is only correct provided the accumulator is not in too bad a condition, and the plates have not disintegrated.

Testing a Discharge Ampere-hour Meter.

The following letter is in reply to Mr. Williams's question in the March issue:—

Where separate recording ampere-hour meters are used in a battery installation, the two meters may be coupled in series or arranged to operate off the same shunt. Reversal of rotation of the two meters is prevented by a ratchet and

pawl attachment, so that one meter records all the charge passed into the battery and the other meter all the discharge taken from the battery. The accuracy of the meters can easily be checked by reversing the connections of the charge meter so that both meters temporarily record the battery discharge.

The discharge meter is never designed to run fast, but sometimes the charge meter is geared to run slow to the extent of 10 per cent., i.e., for every 100 ampere-hours indicated on the dial of the charge meter, the battery has received 110 ampere-hours. The practice cannot be

recommended for the theory is unsound since the ampere-hour efficiency of a battery cannot be arbitrarily fixed at 90 per cent. It is advisable, therefore, that both meters record actual ampere-hours without any compensation. The engineer in charge can

then easily carry out the battery makers' instructions to the effect that on all ordinary charges the battery should be given 10 per cent. more ampere-hours than the amount shown on the discharge meter for the previous discharge, but that once a week, or at least once a fortnight, the meter readings should be ignored entirely and the charge should be continued until the battery shows all the indications of being absolutely fully charged. With this arrangement, at the end of any period, say one year, the dials of the two meters will show the aggregate of all the charge and all the discharge over that period, and as a rule, the ampere-hour efficiency will work out much nearer 85 per cent. than 90 per cent.

E. C. MACKINNON
(Chief "Engineer Chloride Electrical Storage Co.).

Winding a Small 6-volt Motor.

SIR, — Will you please advise me the gauge and number of turns to wind a small motor for 6-8 volts, 1½-2 amps. The particulars are as follows :

- Armature 1¼ in. diameter, ¾ in. long ;
- 7 slots circular about ¼ in. diameter ;
- 7-part commutator ;
- Field winding space, ½ in. by ½ in.

C. L. REDSHAW
(Spalding).

This motor has both armature and field magnet built up from Stalloy laminations, in order

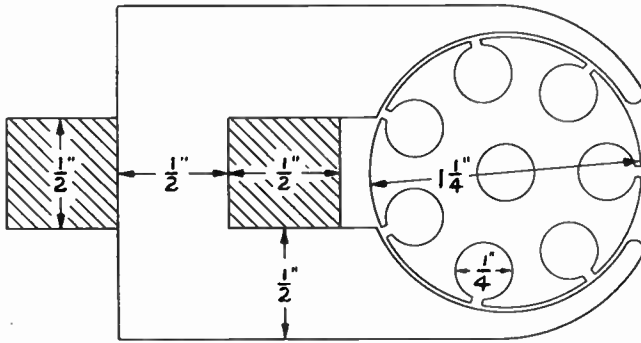

Fig. 2.—PRINCIPAL DIMENSIONS OF THE SMALL 6-VOLT MOTOR.

that when series wound the machine will run on either D.C. or A.C. Fig. 2 shows the principal dimensions. The thickness of the laminations is 3/8 inch.

Armature.

The armature is of the 7-hole type with a 7-part commutator.

Before winding the armature, the ends are insulated with presspahn and the slots are lined with a single layer of empire cloth. This thin slot insulation is sufficient for a low-voltage motor, while it allows more room for the wire.

For 6-8 volts, the armature is wound with 26 S.W.G. double silk covered wire. The winding consists of 7 coils of 26 turns each, as shown in Fig. 3. The coils are wound in the following order :—

- Wind round slots 1 and 4, then 1 and 5, 5 and 2, 2 and 6, 6 and 3, 3 and 7, finally, 7 and 4.

After winding the coils and soldering the connections to the commutator, a slip of thin bakelite or hard fibre is threaded between the top of the winding and the top of the slots. The armature is dried in an oven for an hour and then soaked, while hot, with insulating varnish. It is then baked for another half an hour to dry the varnish.

The field winding consists of 270 turns of 22 S.W.G. single silk-covered wire. This is wound on a wood former having a core 3/4-in. square, so that the coil can be threaded over the stampings when taped up. The field coil and the brushes are connected in series, that is, one end of the field is connected to one brush and the second end of the field and the second brush is connected to the battery.

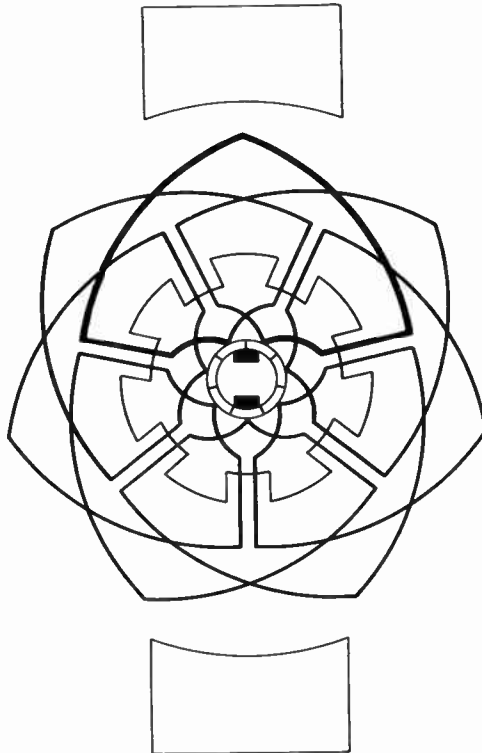

Fig. 3.—DIAGRAM SHOWING THE ARMATURE WINDINGS WHICH CONSIST OF 7 COILS OF 26 TURNS EACH.

PITMAN'S PRACTICAL BOOKS

ELECTRICAL CONTRACTING ORGANISATION & ROUTINE

By H. R. Taunton. This book discusses the duties of the various departments of the electrical contractor's business and gives valuable information which will help to increase turnover and reduce costs, as well as contributing to the efficiency of the technical work. 342 pp. 12s. 6d. net.

ELECTRIC WIRING TABLES

By W. Perren Maycock, M.I.E.E. Revised by F. C. Raphael, M.I.E.E. A collection of 24 tables for electricians and electrical engineers engaged in installation work. It provides them with essential data and information in compact form. Sixth Edition. 3s. 6d. net.

ELECTRIC WIRING DIAGRAMS

By W. Perren Maycock, M.I.E.E. A handy series of wiring diagrams, illustrating circuit connections for supply mains, distribution boards, transformers, lamps, heaters, motors, bells, etc. 246 illustrations. 5s. net.

**SIR ISAAC PITMAN & SONS, LTD.,
PARKER ST., KINGSWAY, W.C.2**

THE BEST OF OPPORTUNITIES

More than 430,000 men have studied I.C.S. Electrical Courses since 1894. A very considerable percentage of them now hold important and well-paid positions. The reason for this is that these Courses are absolutely the best in the world, having been specially prepared and constantly revised for correspondence tuition by many experts of very high standing at a cost, exclusive of printing, of more than £80,000.

If you wish to make rapid progress in the wonderful and fascinating field of electricity, you owe it to yourself to obtain all particulars of I.C.S. Training and what it can do for you. Among our Courses are the following—

**Complete Electrical
Engineering
Electrical Designers
Hydro-Electric
Electric Lighting
Electric Traction
Steam Electric
Gas Electric**

**Engine and Dynamo
Running
Lift Operation and
Maintenance
Water-Power Electrical
Mining Electrical
Practical Telephony
Wireless Engineering**

Professional Exams.

Write to-day for our 80-page FREE BOOKLET,

"ELECTRICAL ENGINEERING"
stating the subject in which you are most interested

**International Correspondence Schools, Ltd.
238 International Bldgs., Kingsway, London, W.C.2**

Indispensable to the Motorist

NEWNES' MOTORISTS' TOURING MAPS AND GAZETTEER

This new Road Guide of the British Isles contains 96 beautifully coloured Maps. The Class A main roads are clearly shown in Red and the Class B in green. Each road bears its appropriate Ministry of Transport number. *The new arterial roads are clearly indicated.*

These Maps have been specially prepared by Messrs. John Bartholomew & Son, Ltd., the world-famous cartographers, and are absolutely up to date.

They measure 9½" by 7½" each, and are mostly on the liberal scale of 4 miles to the inch, which is ideal for the motorist.

Altogether, the Maps form a complete survey of Great Britain and Ireland, and should be in the possession of every enthusiastic owner-driver.

Transparent flaps, marked in inch squares, are attached to the two front edges of the cover in such a way that they can be inserted in any part of the book.

Price, £1. 1s.; or by post, £1. 1s. 9d.

NEWNES' MOTORISTS' TOURING MAPS

Contains same Maps as in above volume. Bound in Water-proof Leather Cloth, with Protecting Flap and Press Button

Price, 15s.; by post, 15s. 9d.

Published in conjunction with John Bartholomew & Son, Ltd., by

GEORGE NEWNES, LTD. 8-11 Southampton St., Strand, London, W.C.2

George Newnes, Ltd.



*We teach successfully
by correspondence in
all parts of the World*

This 250 PAGE BOOK

ON SUCCESSFUL ENGINEERING CAREERS

free
ON
REQUEST

Our Handbook "ENGINEERING OPPORTUNITIES" contains a vast amount of useful information and indicates many ways in which a successful career may be planned and followed. It is not merely a pamphlet, but a 250-page book of reference that will alter your entire outlook and earning power.

Among other things, our Handbook outlines courses in *all* branches of Engineering Those appealing specially to Electrical Engineers include :—

I.E.E.	B.Sc.	G.P.O.	CITY AND GUILDS
ELECTRICAL ENG.			MAINS ENG.
ALTERNATING CURRENT			TELEGRAPHY
ELECTRICAL INSTALLATIONS			TELEPHONY
POWER HOUSE			WIRELESS
TRACTION			TALKING PICTURE ENG.
TELEVISION			ELECTRICITY SUPPLY
ELECTRICAL DESIGN			ELECTRICAL METERS

In the last seven I.E.E. Examinations B.I.E.T. students have returned the remarkable average Pass record of

95.72% SUCCESSES

We undertake to return full fees to any unsuccessful candidate. This is a unique and welcome departure in the Examination coaching field

"ENGINEERING OPPORTUNITIES" should really be in your hands, irrespective of your position or age, education or experience.

Send for your copy to-day—**FREE** and **POST FREE**. A specialist's advice on your particular career is also awaiting your request—without obligation.

BRITISH INSTITUTE OF ENGINEERING TECHNOLOGY

383, SHAKESPEARE HOUSE, 29-31, OXFORD ST., LONDON, W.1