

The PRACTICAL ELECTRICAL ENGINEER

A MONTHLY MAGAZINE FOR PRACTICAL MEN

VOL. I—No. 1

SEPTEMBER, 1932



INTENDED FOR

POWER ENGINEERS

**MAINTENANCE AND
DISTRIBUTION
ENGINEERS**

**CONTRACTORS AND
WIREMEN**

CINEMA ENGINEERS

GARAGE ENGINEERS

GEORGE NEWNES LIMITE

A NEW ERA IN INDUSTRIAL CONTROL

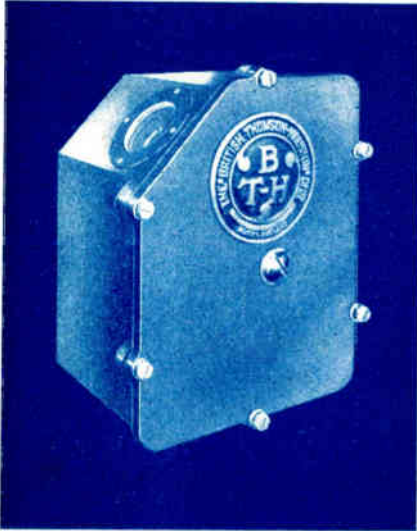

TYPICAL B.T.H. PHOTO-ELECTRIC RELAY FOR AUTOMATIC CONTROL OF PUBLIC LIGHTING FITTED WITH PHOTO-CELL WINDOW AT SIDE.

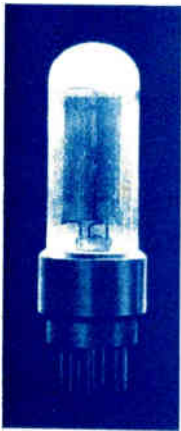

TYPICAL B.T.H. PHOTO-ELECTRIC CELL, THIN FILM CAESIUM TYPE, USED IN B.T.H. TALKING-FILM EQUIPMENT IN OVER 700 CINEMAS IN GREAT BRITAIN.

*Write
for
full
particulars*



PHOTO-ELECTRIC RELAY

Robust & Reliable

A new device which enables a machine or apparatus to be controlled by a beam of light visible or invisible.

This light, falling on a B.T.H. Photo-Electric Cell, sets up a current which is amplified by a valve to the value necessary for operating the machine or apparatus.

The following successful applications have already been made:—

Automatic lighting control.

Safety first device for Machinery.

Control of Electric signs.

Opening and closing of doors in Restaurants, etc.

Control of mechanism according to colour, shape or transparency of the actuating object.

Burglar Alarms.

Counting of moving objects.

The B.T.H. Company are prepared to investigate fully any scheme in which it is thought that use could be made of the Photo-Electric Relay.

The British Thomson-Houston Co., Ltd.

ELECTRICAL ENGINEERS AND MANUFACTURERS

Head Office: Rugby, England.

London Office: "Crown House," Aldwych.

Works: Rugby, Birmingham, Willesden, Coventry and Chesterfield.

AI21-N

NEW NON-INDUCTIVE RESISTANCE

TYPE 3

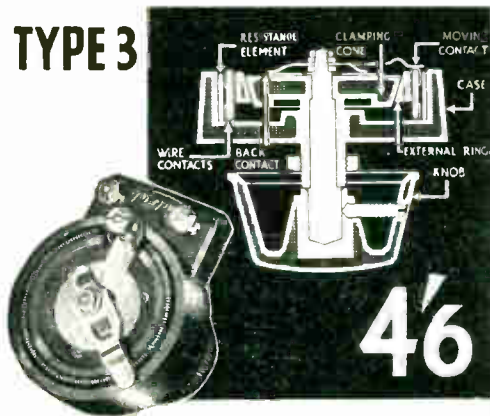

THIS new all-British resistance embodies many new and novel features which guarantee far steadier performance than resistances constructed on old and obsolete principles.

ADVANTAGES:—

- 1 Non-Inductive. This is because the resistance element is not wire.
- 2 Furthermore, the wire contacts shown make contact with the resistance element so that the moving contact does not wear out the element. This guarantees even and true contact always.
- 3 The extremely firm and even contact with the element. This is obtained by a new patented clamping cone, which directly it is screwed down forces the spring external ring against the wire band. The pressure is so great that perfect all-round contact is made with the element, which will not vary under any circumstances.
- 4 Self-cleaning wiping contacts. This ensures perfectly clean contact always.
- 5 Silent in operation.

PRICE 4/6

We recommend this Resistance (Type 3) only for values above 50,000 ohms, where wire-wound potentiometers are not required. Patents for this new Resistance have been applied for. Type 1. Wire Wound, any value up to 50,000 ohms.

Watmel

COMPONENTS

GET THE BEST OUT OF

Write for Free Component Catalogue and our Free Calculation Service

If you have any difficulty in choosing components, WRITE DIRECT

TRADE ENQUIRIES TO

WATMEL WIRELESS

IMPERIAL WORKS, HIGH STREET, BIRMINGHAM

TELEPHONE: BRIG 2222

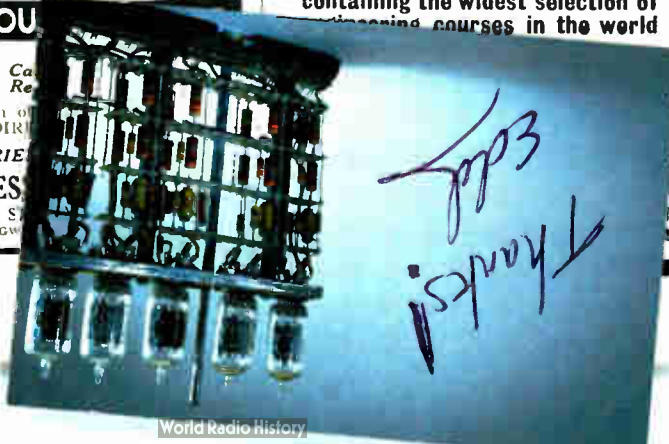

World Radio History

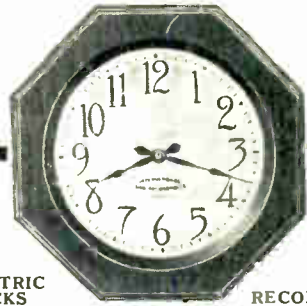

ELECTRIC CLOCKS

TIME RECORDERS

INTERNATIONAL FULLY AUTOMATIC SUPERVISED ELECTRIC TIME SYSTEM

A Three-Wire System so designed that it ensures uniform time being shown always by every unit in a circuit, without manual supervision.

Every Electrical Engineer should know about this system.

Full particulars sent free. Write to
INTERNATIONAL TIME RECORDING CO., LTD.
International Works, Beavor Lane, London, W. 6.
London Showrooms: 112, Strand, W.C. 2.

Send to FOYLES FOR BOOKS

on all technical and other subjects. New and second-hand. 100-page Technical Catalogue free on request

119-125, CHARING CROSS ROAD, LONDON, W.C. 2.
Telephone: Gerrard 5660 (7 lines)

Engineers' Guide

containing the widest selection of engineering courses in the world



Thanks!
Ed 303

INFORMATION UNOBTAINABLE ELSEWHERE

— in this entirely New publication —

PRACTICAL ELECTRICAL ENGINEERING

will

INCREASE YOUR
EARNING POWER

MAKE YOU
PROFICIENT

This comprehensive new work has been written by practical men for the practical man. It is not for the arm-chair engineer, but for the man who is interested in practical methods, rather than design and theory. It shows the approved methods of applying theoretical principles in actual practice. It is invaluable for reference purposes, and contains a great deal of data on the practical side which cannot be found in any existing text-book. PRACTICAL ELECTRICAL ENGINEERING is worth pounds to anyone engaged in the electrical industry.

PREPARE FOR THE FUTURE.

The man who is able to combine a sound theoretical knowledge with ability as a craftsman has a wonderful opportunity for advancement in this expanding industry. PRACTICAL ELECTRICAL ENGINEERING will help the reader to acquire this valuable combination.

ABSOLUTELY COMPREHENSIVE.

The most modern applications of electricity, including sound-film reproduction, wireless, etc., have been dealt with fully, and in all cases the articles have been written clearly and accurately by practical men.

Whilst special emphasis has been placed on the practical side of electrical engineering, it is understood that a sound knowledge of theory is essential to the progressive man. Valuable circuit diagrams are given, and, whenever necessary, the theory of operation has been simply explained. To the man who is "clever with his head" this book will well repay study. The man who is "clever with his hands" will find something of value to him on every page.

VALUABLE ILLUSTRATIONS.

Every illustration has been included with a definite purpose. In constructional articles the illustrations enable the reader to see the whole of the process from the early stages to the finished product.

EXPERT CONTRIBUTORS.

The contributors to this work include many famous members of the profession. Sir John Ambrose Fleming, Sir Richard Tetley Glazebrook, Professor Miles Walker, Professor A. T. Dover, Mr. Kenelm Edgcumbe, Colonel Sir Thomas F. Purves are a few examples.

PRACTICAL ELECTRICAL ENGINEERING is conveniently bound in five handy vols. This binding is oil, acid, and water proof, and has been specially designed so that the volumes may be referred to at any moment without possibility of damage. The cover is full bound in Brown Rexine.

POST 
**COUPON TO-DAY
FOR FREE ILLUSTRATED FOLDER
CONTAINING FULL
DETAILS OF THIS
MOST VALUABLE
REFERENCE WORK**

To THE HOME LIBRARY BOOK CO.,
23-24, Tavistock St., London, W.C.2

Please send me a copy of your FREE Illustrated Folder giving full particulars of "PRACTICAL ELECTRICAL ENGINEERING," without placing me under any obligation to purchase.

NAME

ADDRESS

F.L. 1932.

Indispensable to every Electrical Engineer, Designer and Manufacturer

THE
**ELECTRICAL ENGINEER'S
DATA BOOKS**

General Editor: E. B. WEDMORE, M.I.E.E.

(The Director of the British Electrical and Allied Industries Research Association.)

This important reference work contains much valuable new data that has hitherto been concealed in the journals of foreign institutions, in the unadvertised publications of research associations and the technical publications of manufacturers.

"The Electrical Engineer's Data Books" provide, in two handy volumes, a collection of all the most recent specialised knowledge, thus forging the necessary link between the scientist, the research worker and the practical engineer.

The detailed nature of the text and the wealth of original illustrations, tables and formulæ make this work indispensable to every Electrical Engineer, Designer and Manufacturer.

VOLUME I.—Lighting ; Switch-gear ; Power Transmission and Distribution ; Distribution by Underground Cable ; Transmission by Overhead Lines ; Traction ; Electrical Machinery.

VOLUME II.—Insulation ; Magnetic Materials and Testing ; Properties of Metals and Alloys ; Measurement of Resistance, Inductance and Capacity ; Corona Discharge.

APPENDICES.—Mathematical and Miscellaneous Tables, List of Integrals, Electrical, Mechanical and Physical Tables, etc. ; Electricity and Magnetism ; Wiring Rules ; Home Office and Board of Trade Regulations, etc.

**EXAMINE THE WORK IN YOUR
OWN HOME *FREE!***

In order to give you an opportunity of examining this invaluable work at your leisure, the Publishers are prepared to supply the two volumes on Five Days' Free Approval. Send p.c. to-day for full particulars and details of the generous deferred payment system, to : Dept. E.E.932. The Home Library Book Co., 23-24, Tavistock Street, London, W.C.2

THE BEST OF OPPORTUNITIES

More than 430,000 men have studied I.C.S. Electrical Courses since 1894. A very considerable percentage of them now hold important and well-paid positions. The reason for this is that these Courses are absolutely the best in the world, having been specially prepared and constantly revised for correspondence tuition by many experts of very high standing at a cost, exclusive of printing, of more than £80,000.

If you wish to make rapid progress in the wonderful and fascinating field of electricity, you owe it to yourself to obtain all particulars of I.C.S. Training and what it can do for you. Among our Courses are the following—

Complete Electrical Engineering
Electrical Designers
Hydro-Electric
Electric Lighting
Electric Traction
Steam Electric
Gas Electric

Engine and Dynamo Running
Lift Operation and Maintenance
Water-Power Electrical
Mining Electrical
Practical Telephony
Wireless Engineering

Professional Exams.

Write to-day for our 80-page FREE BOOKLET.

"ELECTRICAL ENGINEERING"

stating the subject in which you are most interested

International Correspondence Schools, Ltd.

238 International Bldgs., Kingsway, London, W.C.2

*Insulation troubles you can forget
by using Spicers' Sistoflex*

SISTOFLEX

(REGD.)

BRITISH MADE

INSULATING SLEEVING

0.5 m.m. to 30 m.m.

USUAL COLOURS

SUPPLIED ONLY BY

SPICERS

LIMITED

INSULATION DEPARTMENT

19, New Bridge St., London, E.C.4

Telegrams:
"Nykoping Ltd.,
London"

Telephone:
City 6251
Extension 49

THE WEEKLY FOR EVERYONE WITH A HOBBY

Whatever your hobby you will find it dealt with in this famous journal. The latest developments and the latest news regarding every practical hobby, handcraft and pastime are faithfully mirrored in its pages. Accomplished writers who are experts on their particular subject contribute regularly. Their advice on any subject is at your command, for the free advice bureau unravels readers' problems—and promptly.

HOBBIES and Practical Wireless

EVERY WEDNESDAY

TWOPENCE

On sale at all Newsagents and Bookstalls, or post free, 3d. (6 months 6/6), from George Newnes, Ltd., 8-11 Southampton Street, Strand, London, W.C.2

Telephone:
RIVERSIDE, 5151.
(3 LINES)

Contractors to the
ADMIRALTY, WAR OFFICE, POST OFFICE, INDIA OFFICE, ETC. ETC.

Telegrams:
SAXATILE, PHON. LONDON

ESTABLISHED 1855

JULIUS SAX & COMPANY

LIMITED

MANUFACTURING ELECTRICAL ENGINEERS.

Regd. Offices & Showrooms,
"WEST LODGE"
27, Lower Mall, Hammersmith,
LONDON, W.6.

HIGH GRADE BELL ACCESSORIES

Specialists in

ELECTRIC BELLS
RELAYS
INDICATORS
FIRE ALARMS
BURGLAR ALARMS
BATTERIES

HIGH GRADE LIGHT ACCESSORIES

Specialists in

WALL PLUGS
PLUG ADAPTORS
LAMP HOLDERS
CANDLE FITTINGS
HOLOPHANE GLASS AND FITTINGS

Works, Warehouse and Wharf
LOWER MALL, HAMMERSMITH.

Goods Entrance
ASPEN PLACE
FROM WATERLOO STREET,
KING 5TH HAMMERSMITH.

THE PRACTICAL ELECTRICAL ENGINEER

A MONTHLY SURVEY OF MODERN PRACTICE IN ELECTRICAL ENGINEERING

VOL. I

SEPTEMBER, 1932

No. 1

Published by GEORGE NEWNES, Ltd.,
8-11, Southampton Street, Strand, London, W.C. 2.
Telephone—Temple Bar 7760
Telegrams—"Newnes, London"

Price - 1/- Monthly
Yearly Subscription, 14 - Post Free
6 months' Subscription, 7 - Post Free
Registered for Transmission by Canadian Magazine Post

NEW Developments in Engineering Practice; New Inventions and Discoveries; Modifications in Existing Theory; and Methods of Fixing, Using, or Adjusting Electrical Plant and Accessories, will form the main theme of the Magazine.

It is, we realise, a difficult matter to cater for all tastes, even in this specialised branch of engineering, but fortunately engineers of all grades have many interests in common.

The Apprentice and the Consultant

The Engineering Apprentice, in common with the Consulting Engineer, earns his living by using the laws and forces of nature to the best advantage. If the designer of a Hydro-electric scheme does not take proper account of mechanical and electrical laws the scheme will be a failure. No amount of clever and plausible arguments will alter this hard fact. In the same way, the would-be cable jointer who takes no account of the fact that solder will not adhere to an oxidised surface will never be able to make a satisfactory joint.

Whilst the consulting engineer is rarely called upon to engage in the manual work of engineering, he must know the very best methods and the latest improvements in the practice of his profession.

The engineering apprentice is not likely to be asked to plan a wiring scheme or to design a generator, but *every apprentice and junior engineer worth his salt hopes one day to be engaged in the higher branches of his chosen profession.* This is why we hope that the Magazine will make an equal appeal to those engaged in every phase.

Some of our friends have criticised the design which we are using for the first number of the Magazine. There is, nevertheless, a good reason for our choice.

The cleverest designs and the most abstruse calculations made by engineers, are all brought to fruition by the trained artisan. Show us the engineer who has never actually worked with his hands in an engineering workshop, and we will show you an engineer whose training is incomplete. We believe that practical men in the electrical profession will endorse this view.

B

TESTING A MAGNETO

By E. HILL

In this article Mr. E. Hill gives automobile engineers some useful advice on testing magnetos

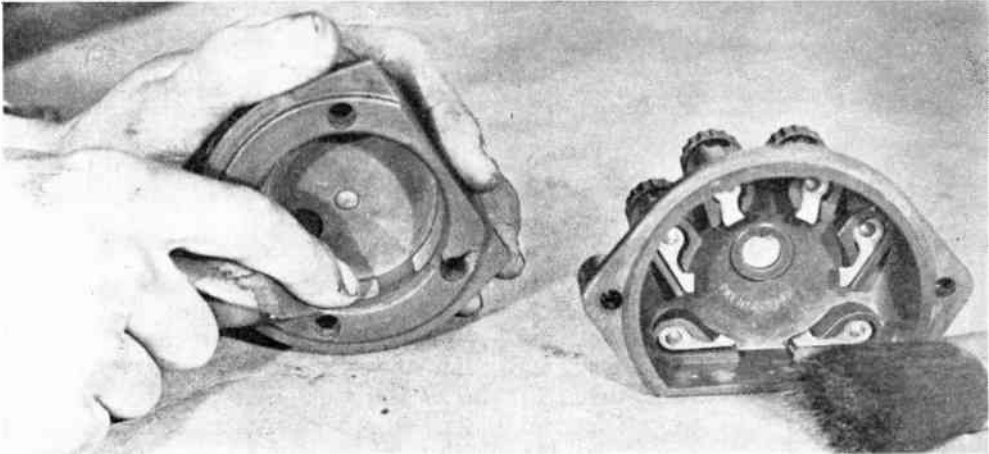

DISTRIBUTOR HEADS.

There are two types of these—the jump spark and brush wipe. To clean the jump spark a stiff dusting brush is generally used. If segments are badly pitted it means a new distributor, as these segments are specially pinned and cannot be replaced. On the brush type, if it is black or sooted, a piece of fine emery is used, but if the distributor and segments are badly scored it means refacing.

Armature Testing.

A SIMPLE and effective test can be made with the aid of a 6-volt battery and a condenser.

Connect the positive lead from the battery to the centre screw at the contact breaker end of the armature.

Twist a turn of copper wire—16-G. bare—round the slip ring, using one end of the wire to retain this in position, and bringing the other end within $\frac{1}{4}$ in. of the armature core laminations to form a spark gap.

The condenser, which can be taken from a coil ignition distributor, is connected between the positive and negative leads from the battery.

The negative battery lead should then be used to make intermittent contact with the armature core laminations. This can be done by holding the lead against the core and then withdrawing it.

Each time the battery circuit is broken

there should be a flash across the improvised gap if the armature windings are sound.

Testing Continuity of Windings.

A test lamp can be used to test the continuity of the primary and secondary windings.

To test the primary coil the test leads should be held one against the centre screw and the other against the core, and for the secondary one against the core and the other against the slip ring. The secondary coil has a very high resistance, so that the lamp will only give a faint glow unless high voltage is used.

To test the condenser on the armature it is advisable to dismantle the armature by removing the ball race, slip ring bobbin and the core. The connection between the primary coil and the condenser can then be unsoldered and the

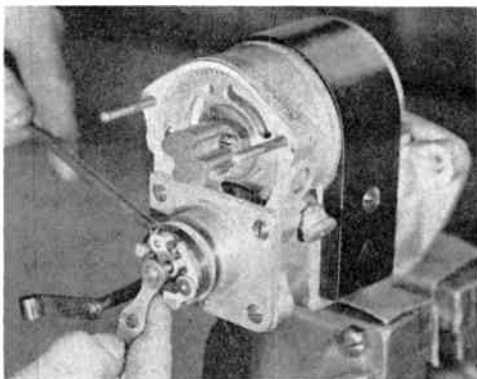

DISMANTLING A MAGNETO—POINTS TO NOTE.

To remove contact breaker take out centre screw, then with a little easing it will come out.

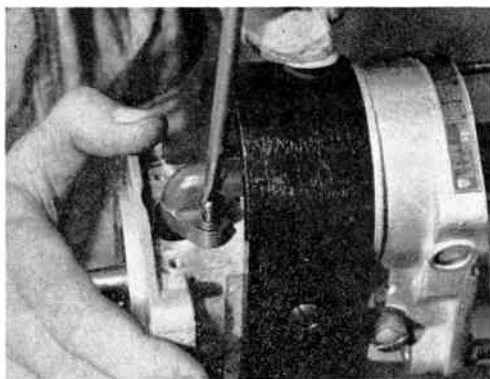

REMOVING COLLECTOR CARBON HOLDER.

Care must be taken to see that screws or washers do not drop into machine.

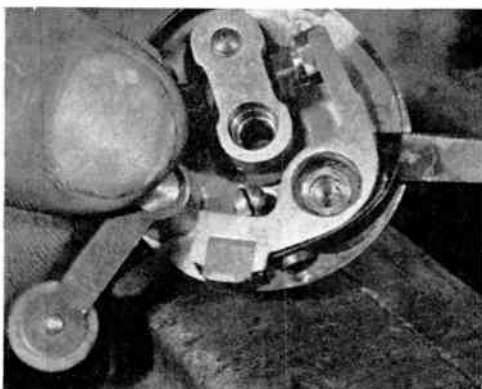

CONTACT BREAKER.

A quick method of examining face of contact points is to turn retaining springs, and prise rocker arm off the bush.

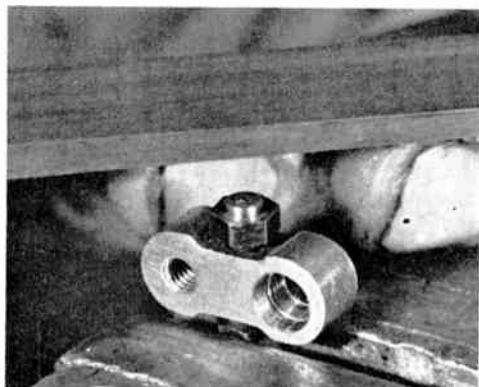

TO CLEAN PLATINUM POINTS.

See that all marks are removed and that the surface is perfectly flat, otherwise the points will be bearing only on the highest parts.

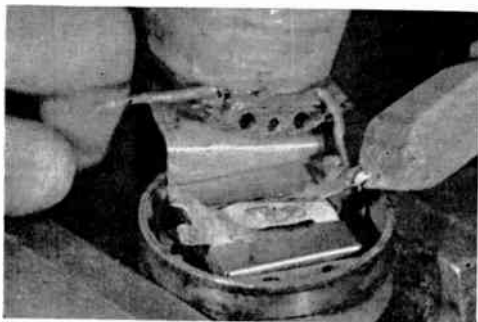

TO EXAMINE AND TEST CONDENSER.

Remove the four housing screws and unsweat armature connections. Remove condenser fixing screws, and remove condenser from its housing, which should be thoroughly cleaned out. Examine empire cloth; replace if brown or burnt.



TESTING THE CONDENSER (1).

The easiest way to do this is to take two leads off an ordinary light with a lamp in circuit, then tap the two leads into each lug of the condenser. If the lamp should light there is a dead short in the condenser and it is of no use. (Euston Ignition Co., Ltd.)

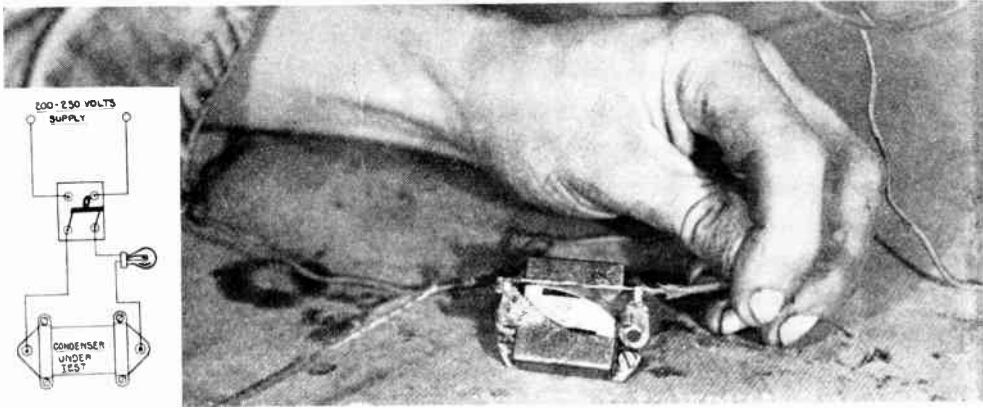

TESTING THE CONDENSER (2).

Should the lamp fail to light, then take one wire off and bridge the two lugs with the other. A spark should be given off showing the condenser discharging. The insert shows the circuit arrangement for the tests illustrated in this and the previous illustration. (Euston Ignition Co., Ltd.)

test lamp used to determine whether there is any leak between the condenser terminals.

To ascertain the source of the trouble, run the engine and test for spark discharge from each plug, either by a screw-driver blade held against the plug terminal and just clear of the cylinder head, or by removing one plug and laying it on the cylinder head. If no spark is visible, remove the end cap of the make and break device and retest.

If still ineffective, remove the magneto and test for loss of magnetism, breakdown of armature or condenser, and examine for mechanical failure in gears or in bearings.

Should no defect be apparent it is probable that the earth connection between the magneto base or flange and the mounting bracket is ineffective owing to the surfaces being oily or dirty.

Failure located in the condenser may be due to the plug spark gaps being too wide apart and the safety spark gapped up through overoiling.

Demagnetisation.

Failure through demagnetisation of the magnets may be due to the lead from the contact breaker cap to the earthing switch coming in contact with the battery positive connection, or by the short circuiting of the armature at high speeds on account of "sooted up" plugs. Earthing the magneto by operating the ignition switch when running at a high speed will also have a deleterious effect on the magnets.

Mechanical Breakdown.

Mechanical breakdown may be due to overheating caused by the magneto being mounted with its spindle out of alignment with the driving shaft.

Failures in the external circuit may be:—

1. Defective plugs or plug leads.
2. Defective ignition switch which shorts the primary winding in its on position.
3. Shorting of the primary winding by contact between the ignition switch lead and loose wires on the switchboard.
4. Defective ignition switch lead.
5. Defective earthing.

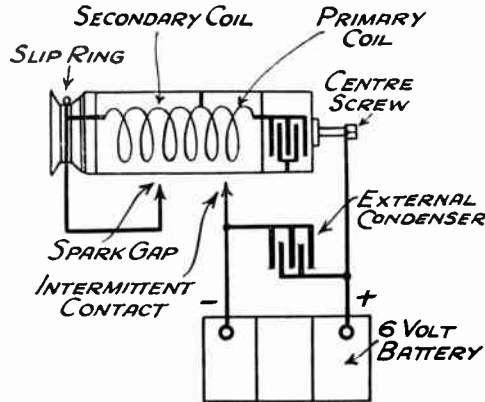

CONNECTIONS FOR TESTING ARMATURE.

How SOUND FILMS ARE MADE

By J. I. MARTIN, A.M.I.C.E.

The recording of sound for films is one of the most important aspects of the motion picture industry with which the electrical engineer is vitally concerned. In this article Mr. J. I. Martin describes the electrical processes involved in the recording of sound both on disc and on film, and discusses some of the difficulties that have still to be solved.

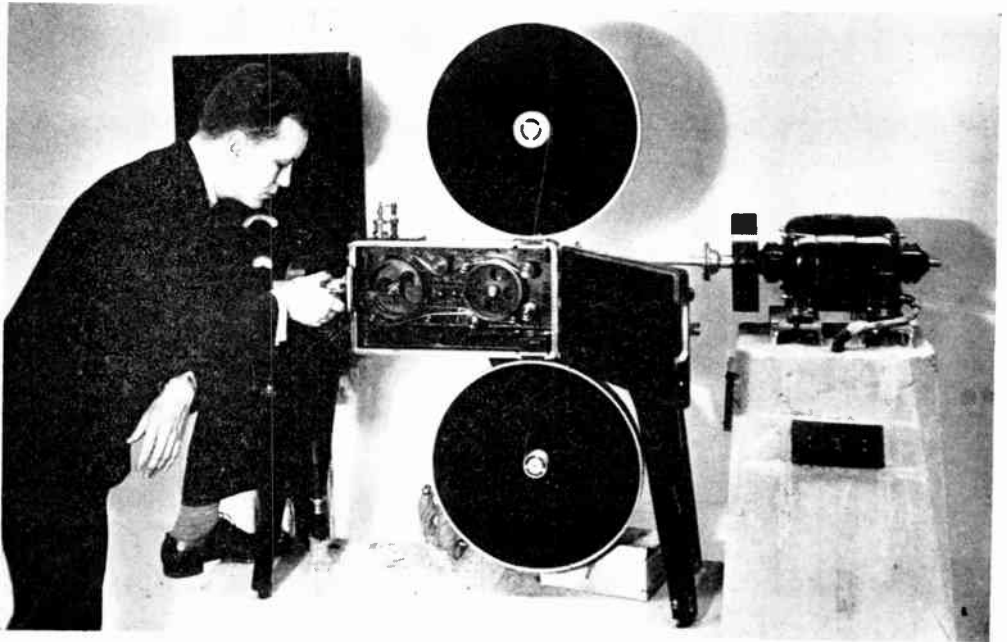

FILM RECORDING MACHINE WITH MAGAZINE AND EXPOSURE CHAMBER DOORS OPEN. The driving motor can be seen on the right. (Western Electric Co.)

THERE have been recent developments in the technique of disc recording which give this method certain advantages over the other system, i.e., recording on film.

Unless there are corresponding improvements in the technique of film recording, it is highly probable that there will be a tendency in the near future to revert more to disc for studio recording, using up-to-date methods. There are many advantages gained by employing disc for the major part of all studio recording and then to re-record on to film for copies to be issued to the theatres.

ABOUT THE MICROPHONE.

Position.

In straight studio recording, after the camera and the lighting have been suitably arranged, the microphone is brought into position. This is usually suspended from the end of a boom, which can be raised or lowered at will, and this is mounted on a mobile truck so that it can easily be moved about.

Condenser-type Microphone Generally Used With 2-Stage Amplifier.

The microphones most commonly in use at the present time are of the con-

denser type. These are usually rather insensitive and of high impedance and require to be polarised. For these reasons, their associated circuits are liable to pick up extraneous electrical disturbances from neighbouring electrical apparatus and cables. To overcome these difficulties it is usual to incorporate with them a single or two-stage valve amplifier the output of which is connected to the main amplifiers by means of low impedance circuits.

THE RECORDING ENGINEER.

The Mixing Room.

Before going on to the main amplifier rack the microphone cables are taken to a control panel, which is usually situated in a position, insulated acoustically from, but overlooking the studio where the action is taking place. This is called the mixing room, and it is here that the engineer who controls the input to the main amplifier takes up his position.

How Sounds are "Mixed" or Combined.

Sometimes more than one microphone is used simultaneously. One may be used to pick up the voices of the principal actors while another may be used to pick up the noises of a crowd in an adjoining room or nearby. The outputs from each source are combined and passed on to the main amplifier. It is one of the duties of the engineer to control the relative inputs from each source, and it is from this function that he gets his title of "mixer."

"Monitoring" During Recording.

To enable the engineer to judge the volume of the output, he is provided with suitable measuring instruments and headphones and loud-speakers connected to the main amplifiers. In the Western Electric Co.'s system of film recording, additional provision is made so that either headphones or loud-speakers can be connected to a photo electric cell which is situated behind the film as the latter is passing over the recording drum. This cell picks up the light impulses exactly as they are photographed on to the sound film. These impulses are amplified by a separate amplifier situated close to the recorder and passed back to the mixing

room so that the engineer is enabled to judge the quality of the sound as it is being actually recorded on to the film.

The Main Amplifier Rack.

At the main amplifier rack the electrical intensity of the speech or music or other sounds is raised to a suitable level and distributed to the requisite film or disc recorders and loud-speakers or headphones.

Simultaneous Recording on Disc and Film.

Sound is frequently recorded simultaneously on both disc and film, even if the disc record is not required to accompany the film when complete, as the disc record can be "played back," immediately after it has been taken, for the benefit of the director or others interested. A disc record may also be taken if it is desired to keep a permanent sound record of a particular "shot."

DISC RECORDING.

The material on which disc records are made is a metallic soap having an extremely fine texture and the appearance of a highly refined beeswax, but of much harder consistency. The cakes are usually about 16 inches diameter, and when new are about $1\frac{1}{2}$ inches to 2 inches in thickness. Before being used they are very accurately machined all over to a high polished finish on special machines.

The Cutter—Ruby or Sapphire.

The electro mechanical recorder itself comprises an armature, which is pivoted on a knife edge and is energised by the electrical currents from the main amplifiers. This is caused to oscillate, in a plane at right angles to the direction of rotation of the disc, between the poles of a separately excited electro magnet. To the armature is attached a stylus or cutter terminated by a sapphire or ruby cutting edge.

The Cutter is Traversed from Inner to Outer Edge of Disc.

During the recording process the recorder itself is caused to move at a uniform rate of feed from near the centre and towards the outer edge of the disc. The average pitch of the grooves thus produced is about .01 inch. When no sound is being

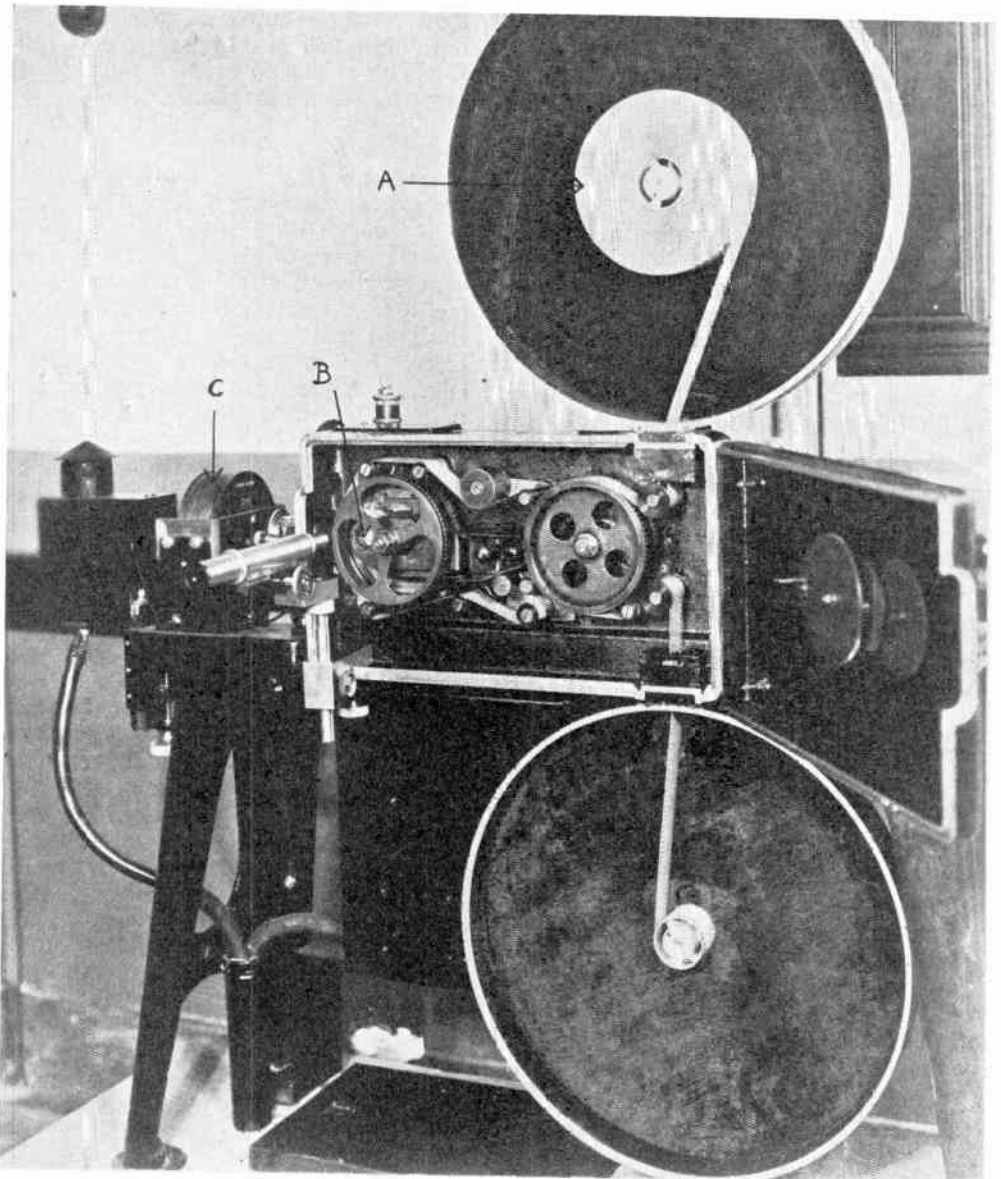

FILM RECORDING MACHINE SHOWING MICROSCOPE IN POSITION FOR FOCUSING LIGHT VALVE.
(Western Electric Co.)

A, unexposed film in upper magazine which is never opened except in dark room or when empty. B, photo electric cell inside main recording drum. C, magnet coil of light valve. The lantern containing the exposure lamp is on the extreme left-hand side.

recorded the grooves take the form of a uniform spiral and when signals are being received the grooves take the form of wavy spiral lines slightly oscillating from side to side from the normal.

What Happens to the Shavings.

Provision is made during the recording process for the shavings to be immediately removed by suction nozzles placed close to the cutter as soon as they are formed.

Amplitude of the Oscillations.

The characteristic of the Western Electric recorder is such that the amplitude of the oscillations is inversely proportional to the frequency, from 250 cycles upwards, for constant signal input; and of constant amplitude for frequencies below 250 cycles down to about 30 cycles.

This is a limitation that is introduced for the practical consideration of keeping the spacing of the grooves within certain limits and would result in a falling off in loudness of frequencies below 250 cycles were it not for the fact that compensation for this is provided for in the reproducers by giving these a rising characteristic at the lower end of the frequency range.

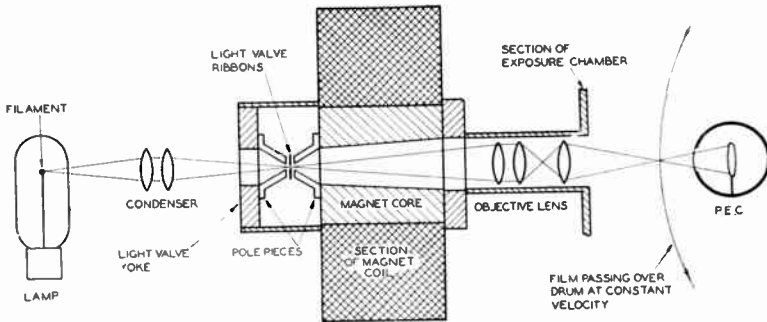

DIAGRAMMATIC VIEW OF WESTERN ELECTRIC LIGHT VALVE RECORDING ASSEMBLY.

The light valve yoke, upon which the ribbons are supported, is detachable from the light valve assembly.

The turntables are run at a constant speed of $33\frac{1}{3}$ r.p.m.

When a particular record is no longer required it can be obliterated by machining off the surface of the disc, which will then be ready for a further recording.

FILM RECORDING.

In film recording the sound record is first made on an entirely separate film to that used for the camera.

Why Positive Film Stock is Used.

Positive film stock is used for this purpose, as it is cheaper than negative camera stock and has a finer granular texture and for this reason it gives better quality reproduction. The main amplifier is connected to the light valve of the recorder.

In the Western Electric system the light valve or shutter consists of a loop of duralumin ribbon 6 mils wide by $\frac{1}{2}$ mil in thickness stretched between the poles of a powerful electro magnet.

Pole Pieces.

One pair of pole pieces is attached to the end of the magnet cone, which has a hole through its centre. The other pair of pole pieces is attached to a flat rectangular-shaped piece of iron, which also has a hole through it, and this is called the light valve yoke. Each pair of pole pieces has a narrow gap between its edges. When the valve yoke is in position the flat faces of the two pair of pole pieces are within 8 mils to 10 mils of one another, and it is across this gap that the magnetic field is created.

The Duralumin Loop.

The duralumin loop is supported by, but insulated from, the valve yoke. The working portion of the loop is stretched across

two bridge pieces or pincers so that the narrow edges of the ribbon on two sides of the loop are within 1 mil of one another, and the flat sides of the ribbons are about 4-5 mils from the faces of the pole pieces. The gap between the edges of the ribbon is also parallel with and in the middle of the gap between the edges of the pole pieces.

Provision is made for adjusting the tension of the loop, the middle of which passes around a small pulley to ensure uniformity in each side of the loop. The ends of the loop pass over small capstans and are connected to two terminals on the valve yoke.

The Optical System.

A condensing lens system concentrates the light emitted by an incandescent electric

lamp, consuming 18 amps. at 6 volts, through the hole in the middle of valve yoke, on to one side of the duralumin loop. An objective lens, enclosed in a light-tight tube, focuses the image of the 1 mil gap between sides of the loop, through a hole in the case of the exposure chamber, on to the film as it passes over the recording drum. This objective lens effects a two to one reduction so that the image of the normal gap when focused on to the film is only $\frac{1}{2}$ mil instead of 1 mil.

How the Light Valve Operates.

When speech currents are caused to pass through the loop the ribbons on each side move farther away from or closer to one another, according to the direction and intensity of the currents at any particular instant.

The Recording Drum.

The recording drum, over which the film passes, is situated inside the exposure chamber, and is provided with teeth which engage with the sprocket holes in the film. The drum is provided with a gap about $\frac{1}{8}$ inch in width extending over its entire periphery and this gap is opposite the portion of the film upon which the sound is recorded. This permits the remaining light which is not absorbed by the film, amounting to about 5% of the original, to pass through the film. It is then picked up by a photo electric cell, which is located inside the recording drum and connected to the monitoring apparatus.

The speed of the film during recording is 90 feet per minute.

MOTORS FOR DRIVING CAMERAS, ETC.

The motors which are used to drive the camera and the film and disc recording and re-recording machines are all three-phase type having three-phase wound rotors. The stators are all connected together in parallel to the main A.C. supply. To the same supply is also connected the stator of a distributor.

The rotors of the motors are connected together in parallel and to the rotor of the distributor. This ensures that all the rotors run together in synchronism.

Why a Distributor is Used.

The distributor is a machine having a standard three-phase stator and a three-phase wound rotor which is mechanically coupled to a special D.C. machine with which is associated a special electrical control device which keeps the speed absolutely constant and independent of variations in the frequency or voltage of the

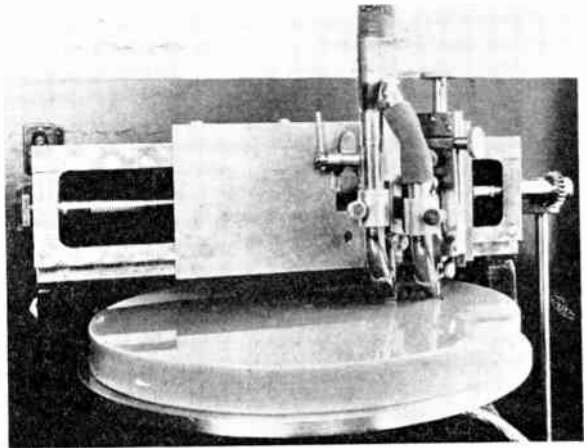

"WAX" BLANK SHAVING MACHINE.
Showing suction nozzles for removing shavings.

main A.C. supply. Thus the speed of all the motors is kept constant.

HOW A FILM IS TAKEN. Synchronising the Action and Sound Negative Films.

When everything is ready for a "take" the cameraman and engineer in charge of the film recorder open the exposure chambers of their respective machines and mark on the film with a special pencil the "take" number and any other information which may be required to identify the part. A hole is then punched or some other mark made in both the action and sound negative films and the motors are turned by hand until these marks are exactly opposite the lenses of the respective machines.

The motors and distributor are then all interlocked by switching in on one phase.

Starting the Motors.

When the director in charge of operations considers everybody is ready he calls for silence and gives the signal to start. A button is pressed which operates a relay connecting up all phases of the supply to the motors and starting the distributor. All motors now speed up together in a few seconds.

How the Editing Machine Works.

The action or scene is viewed through a magnifying lens and the film being illuminated from underneath by a small incandescent lamp. The sound is picked up by passing the sound print through a sound gate similar to that which is fitted to a standard theatre reproducer. The output is amplified up so that a small loud-speaker or headphones can be used. The machine is driven by a small motor which is under the control of the operator and can be run in either direction and at

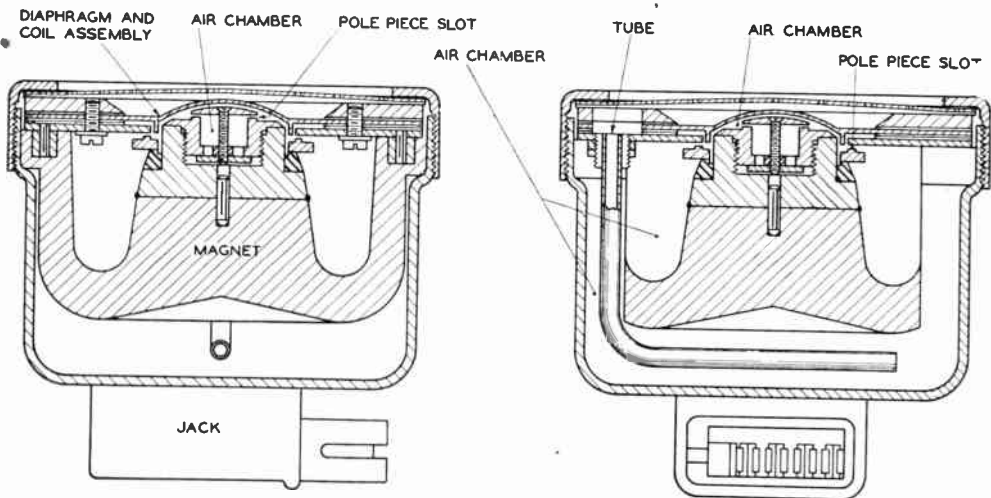

DETAILS OF MICROPHONE CAPABLE OF A SUBSTANTIALLY UNIFORM FREQUENCY RESPONSE OF FROM ABOUT 30 TO 10,000 CYCLES. (*Western Electric Co.*)

When the "shot" is complete all motors are stopped together and camera and recording machines prepared for the next "take."

When enough film has been exposed the separate negatives of the action and sound are developed and printed on to separate positive stock.

The Editing Machine.

A considerable amount of the preliminary editing and cutting may be done before the film is properly reviewed. A number of the "takes" which it is known will not be required are eliminated after examining the film by passing the action and sound prints through a small machine called an editing machine. This is a small machine which can be operated by one person,

any speed, as desired. The film after passing over the machine is allowed to deposit itself into baskets.

Position of the Sound on the Film.

In the printing process the start of the sound portion is $14\frac{1}{2}$ inches or $19\frac{1}{2}$ frames in advance of the corresponding start of the action, to provide for the difference between the light and sound gates of the reproducing machines.

News Reel Work.

For some kinds of news reel work the sound may be recorded on to the same film as that upon which the action is photographed.

Photographing Action and Sound on the Same Film.

In this case the recorder is incorporated with the camera; the film after it has passed the camera shutter passes through the sound recording compartment, the distance between the two points being $14\frac{1}{2}$ inches.

Using a "Neon-type" Lamp.

A special "neon-type" lamp is used which is fed from a source of constant potential. A speech transformer is interposed between the supply and the lamp. The primary of this transformer is connected to the microphones through suitable amplifiers. At the chosen supply pressure these lamps are very sensitive to small voltage changes and the modulation of the lamp voltage produces considerable changes in the light intensity.

The light from the lamp is condensed by means of a lens which forms part of the lamp assembly. The film actually passes in contact with this lens, which is silvered. A slit is engraved on the silvered portion and it is through this narrow slit that the light reaches the film. As there is only one film, the positive prints are taken direct from the original negative.

ADDING SOUND TO A SILENT PICTURE.

In some other kinds of news reel work and for special films where the sound accompaniment may be descriptive or only incidental to the action the scene may be taken as a silent picture and the sound added at a later stage. In this case the picture negative is developed and printed and reproduced in a small theatre. After rehearsal the incidental music, speech or sound effects may be recorded while the picture is being shown on the screen.

Disc Recording.

The sound may be recorded on disc or film. If on disc it is usual to re-record on to film and to marry the sound and scene negatives.

Film Recording.

If the sound is recorded on film the sound and scene negatives are married without any further re-recording.

AN IMPORTANT PROBLEM THAT HAS TO BE SOLVED.

It is to the question of frequency response and the reduction of extraneous noise that the greatest attention is required.

Correct Reproduction of All Audible Frequencies.

Intelligibility of speech and music is largely dependent on the correct reproduction of the frequencies in the middle and lower end of the scale, but the quality which distinguishes one person's voice from that of another or enables one to identify one instrument from another even when playing the same fundamental note is the predominance of certain harmonics or overtones accompanying the fundamental.

Limit for Satisfactory Results.

Broadly speaking, it can be said that satisfactory results would be obtained if we could reproduce up to 8,000 cycles for the human voice and most instruments. Percussion instruments really require a range up to 10,000 cycles, but it cannot be said that these instruments usually predominate or that a falling off in the higher ranges would greatly affect the general results.

Limit for Disc Reproduction.

At the present time it must be said that for disc there is very little reproduction of the original sound at 5,000 cycles, and at this frequency the greater part of the sound produced consists of needle scratch, most of which is produced by the abrasive material that is incorporated with the material of which the records are made.

Limit for Film Reproduction.

Film reproduction, when well recorded and properly processed, is capable of a better frequency response than this when reproduced over a good-class reproducer, but there is still a very considerable and steady falling off in the higher ranges, and there is very little reproduction of value above 6,000 cycles. Above this frequency the noise begins to predominate.

Why Reproduction of Higher Frequencies is Limited.

It might be said here that there is very little difficulty in designing and producing amplifiers capable of handling frequencies up to 8,000 or even up to 10,000 cycles. The limitations in producing the higher frequencies have been mainly due to the following: microphones, material of which the records are made, in the case of disc reproduction, losses in transfer of energy on to and from the film and during the processing of the film, and limitation in the response of loud-speakers.

The Hill and Dale Method of Recording May be Used.

In disc recording new materials are available for the purpose of making records and with the reversion to the hill-and-dale methods* of recording in place of the lateral cut methods it is no longer necessary to introduce abrasives for the purpose of grinding the needles, and the spacing of the grooves is not governed to the same extent by the amplitude of the movements or oscillations of the cutter. Improvements in the design of the recorders and pick-ups have kept pace with the improvements in the material and it is now possible to reproduce on disc frequencies up to 10,000 cycles.

Records Made of Cellulose Compounds.

With the new records made of cellulose compounds it is possible to provide enough sound track for a 16-inch record running at $33\frac{1}{3}$ r.p.m. to play for 20 minutes. Records made of this new material are flexible, not so easily damaged, have a longer useful life and do not require the same care in storage and handling. There is no longer the necessity for changing needles every time a record is played, as the pick-ups are provided with sapphire points.

**In this system the recording needle moves up and down, as in the original phonograph, instead of from side to side.*

Improvements in Loud-speaker Design.

Hitherto there has been little necessity for loud-speakers capable of reproducing over 6,000 cycles, but in the matter of frequency response speaker design has more than kept pace with the improvements in recording. For theatre work it is now possible to extend the upper range response of existing speakers of the logarithmic horn type by placing inside them a very much smaller speaker which has a frequency range from 3,000 cycles to 10,000 cycles, giving the combined arrangement a frequency response from about 60-10,000.

New Western Electric Microphone—

This instrument is of the moving coil type and the field is provided by a permanent magnet. The diaphragm is made of duralumin. The moving coil is made of duralumin ribbon wound on edge. The adjacent turns are held together and insulated from one another by a special varnish which is also used to secure the coil to the diaphragm.

The centre of the diaphragm being dome shaped can be said to be rigid in itself and therefore moves as a complete unit. Flexure of the diaphragm takes place in the annular portion between the dome and the part of the diaphragm where it is gripped by the securing ring. The various air cavities and restrictions play a very important part in securing the uniformity of response from 35 to 10,000 cycles.

—And Its Advantages.

The advantages of this microphone, apart from its frequency characteristics, are: (1) robust; (2) not subject to atmospheric conditions; (3) has a low impedance output and can therefore be removed some considerable distance from its associated amplifier; (4) does not require polarising; (5) has a higher efficiency than the condenser type microphone and not so susceptible to wind noise.

A QUICK MEANS OF MEASURING CURRENT

An instrument of particular value to power station, distribution and works engineers is one that enables them to measure currents without the need for breaking connection. This article shows how to use such an instrument for measuring direct or alternating current from 1 amp. up to 200 amps.

INSTRUMENTS for measuring current without the need for electrical connections consist of an iron circuit, usually in the form of a ring or rectangle, which can be opened and then closed round a conductor.

In the case of the instrument described here the iron circuit is broken at one point (as well as between the two halves which open) and a movement somewhat similar to those used in moving iron ammeters is inserted.

How to Work the "Tongs."

The trigger opens the "tongs," which must be opened and closed just before a *direct* current reading is made to prevent errors due to hysteresis in the iron. In many circuits some length of cable can be found where readings can be taken in this way.

How to Take a Reading at the Fuseboard.

If the whole of the cable is enclosed, however, then a reading can be taken at the fuseboard as shown.

What to Do if the Circuit Cannot be Broken.

If the circuit cannot be broken, it may be possible to hook the two bare ends of a short length of cable round the contacts into which the fuse bridge is inserted, and then remove the bridge; but this is an operation requiring some care.

Range of Readings Obtainable.

Normally the instrument reads from 5 amps. to 200 amps., but lower currents can be read by winding two or more turns of the cable round the limbs of the tongs. With four turns, for example, the actual current is a quarter of that indicated.

How Readings of Fractions of an Amp. Can be Made.

For measuring the current taken by very small motors, such as those in fans,

two bobbins can be made up having, say, 100 turns of wire as shown. By this means readings of fractions of an amp. can be made.

How to Measure Higher Currents.

For higher currents, if the high reading movements are not available, various devices are available for increasing the range. If the "tongs" are not closed round the conductor, but are kept wide open, the real current will be about three times the indicated current. These methods of measuring high currents are not officially recommended by the makers, but are useful hints.

Some Uses in the Garage, the Factory and on Installation Work.

Some of the measurements which can be made with this instrument include the load on motors which are not provided with ammeters, to determine their starting current for the purpose of fusing the circuit correctly or getting the right overload setting on the starter; to measure the running current of motors, to check overloads or to see whether a motor is considerably larger than is required and, consequently, is working inefficiently; to determine the capacity of electrical apparatus, such as fires, which have no rating plates; and to measure the load on feeders or the maximum load on a lighting installation when it is desired to add more lamps or additional apparatus and it is not easy to check up the consumption of the total connected load.

A Useful Point About Power Measurements.

In connection with power measurements, it is useful to remember that on a 400-volt, three-phase system an average 3-h.p. motor takes about 5 amps. on full load. The Tong Test instrument described above is manufactured by Messrs. Crompton Parkinson, Ltd.

THE "TONG - TEST" INSTRUMENT, TYPE A, IN OPEN POSITION.

This shows the instrument just prior to measuring current in the insulated cable. When the tongs are closed the instrument gives a direct reading of the current in the cable.

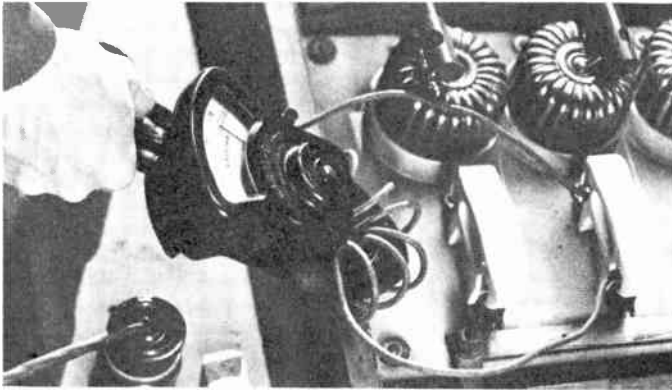
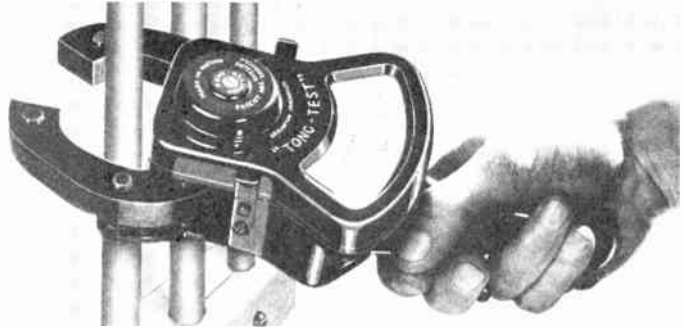

HOW TO TAKE A READING AT A FUSE-BOARD.

When the cable containing the current to be measured is inaccessible, a reading may be obtained by removing the fuse wire and connecting a short piece of wire to the terminals, as shown. The reading should, of course, be divided by the number of turns round the tongs.

READING FRACTIONS OF AN AMP.

In this case, the current required to be measured was so small that it was necessary to multiply it by 100, so two coils, each with 50 turns, were put round the tongs. The reading was then 45 amps, which, divided by 100, gave .45 amp. as the current flowing. The number of turns round each limb should be equal.

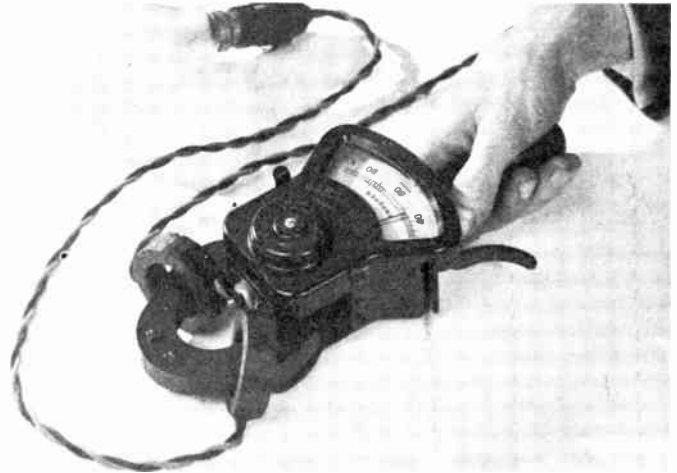

HOW TO MEASURE HIGHER CURRENTS.

By putting an ordinary hexagonal pencil between the jaws of the "Tong-test" instrument the reading is approximately halved. For example, if the reading is 60 amps., the current flowing is 120 amps.

ALTERNATOR MAINTENANCE

By G. A. NEILD

In this article Mr. G. A. Neild, of W. H. Allen, Sons & Co., Ltd., gives some really practical notes on the care of turbine driven alternators. These notes, in general, are equally applicable to direct current machines. In particular the remarks relating to the care and attention to exciter commutators and brush gear are appropriate to commutators and brush gear of ordinary direct current generators.

Cleanliness.

CARE must be taken—no matter what particular system of filtering or cooling is employed—to keep the surface of the coils and air passages through the core free from any accumulation of dirt which will be deposited from the air drawn through the machine. Such accumulation will impede the ventilation of the machine, and may cause injurious overheating.

The length of time which may elapse between successive cleanings will depend on the locality, the amount and nature of the impurities in the air, and the efficiency of the filtering or cooling system, so it must be determined by frequent examination, i.e., at least twice a year.

When it becomes necessary to clean the machine thoroughly the rotor must be taken out.

The following instructions should be noted when taking out and replacing the electrical rotor.

TAKING OUT ELECTRICAL ROTOR.

Remove Slip Rings, Brushes and Exciter Connections.

The machine having been shut down, disconnect slip-ring leads and raise slip-ring brushes. Disconnect any exciter connections necessary to enable the

exciter to be removed, and raise exciter brushes.

Next Remove Bearing Caps and End Cover.

Remove centre and alternator outboard pedestal bearing caps, and also end cover of alternator outboard bearing housing, so as to gain access to the exciter coupling bolts. Take out these coupling bolts and support the exciter armature in the magnet frame with suitable packing, such as a piece of fibre sheeting.

Withdrawing the Exciter Armature.

Remove exciter bearing pedestal and withdraw exciter armature coupling from electrical rotor shaft, then after undoing the magnet frame holding-down bolts, lift off the complete exciter.

Next the Main Coupling Bolts and Top Halves of Main Bearing.

Remove electrical rotor main coupling bolts and top halves of both bearings.

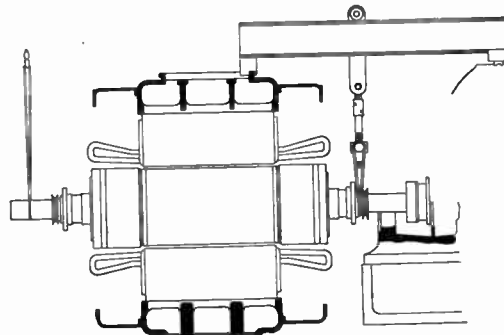

TAKING OUT ROTOR—FIRST POSITION.

Shaft at exciter end is supported from crane hook and at other end by adjustable sling of stretcher beam. (By courtesy of B.T.-H. Co., Ltd.)

Air Shields and End Shields.

Dismantle air shields and end shields, take the precaution of seeing that isolating links are removed and that all connections are made dead, then disconnect stator main leads.

Oil Guards

Remove end cover

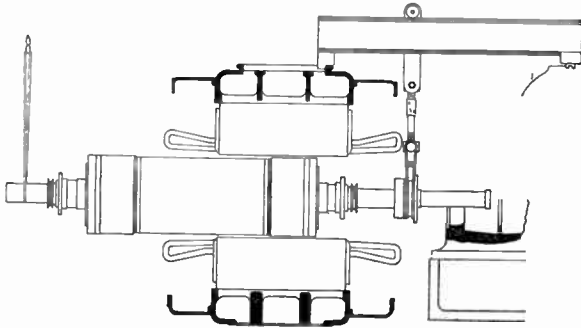

TAKING OUT ROTOR—SECOND POSITION.

The rotor is moved towards the exciter end sufficiently far to enable a lifting pin extension to be screwed into the rotor at the turbine end. (Courtesy of B.T.-H. Co., Ltd.)

oil guard housing, from the alternator centre bearing pedestal, and oil guard from the alternator outboard bearing pedestal; also the air shields and end shields.

Removing the Rotor.

Take the weight of the electrical rotor at coupling end and remove the bottom half centre bearing, pack up the rotor, using special blocks where provided for this purpose, and then repeat the process at the outboard bearing pedestal end. Remove the outboard bearing pedestal and it will now be possible to take out the rotor.

Using the Stretcher Beam.

A wooden plank may be used as a stretcher beam. In the case of larger machines a special lifting beam, stretching between and attached to the turbine exhaust casing and the alternator stator, is usually supplied. This beam acts as a runway for a suspended arm which is mounted on ball bearings, and to which an adjustable sling is attached. The shaft at the exciter end is supported by a sling from the crane hook and at the other end by the adjustable sling of the stretcher beam. After the weight has been taken the bottom half of the alternator centre bearing as

well as the bearing housing is removed.

Fixing the Lifting Pin.

The rotor is then moved towards the exciter end sufficiently far to enable a lifting pin extension to be screwed into the rotor at the turbine end. The rotor is now allowed to rest in the stator while the stretcher beam sling is moved to the end of the extension pin, and the rotor is then carried forward.

How the Rotor is Lowered to the Floor.

One end of the rotor is now allowed to rest in the stator and the other end supported on suitable packing, while the stretcher beam sling is removed, and the sling from the crane hook arranged around the rotor so that the weight is balanced. The rotor can now be moved forward until it is clear of the stator, and then lowered on to the floor.

Windings.

The dirt must now be removed from the winding surfaces, within the ends of the rotor and at the ends of the stator, care being taken that the ventilating spaces between the stator windings are left quite free from obstruction.

Ventilating Ducts.

All ventilating ducts in the stator and rotor cores must be cleaned out with a

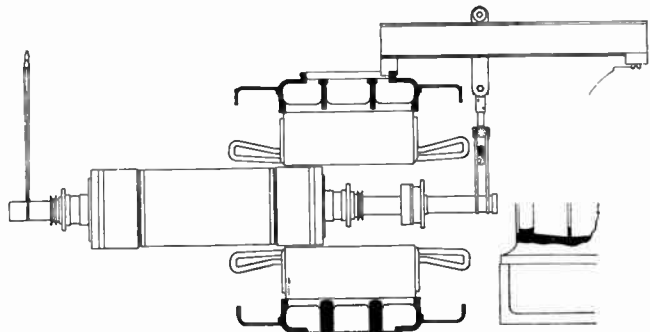

TAKING OUT ROTOR—THIRD POSITION.

The rotor is allowed to rest in the stator while the stretcher beam sling is moved to the end of the extension pin and the rotor is then carried forward. (Courtesy of B.T.-H. Co., Ltd.)

suitable brush. Before reassembling, all the parts should be blown out with dry compressed air to remove the loosened dirt. The use of a small portable air compressor to supply compressed air for this purpose is recommended.

CLEANING.

Shaft Journals and Oil Guards.

The shaft journals should then be examined and any roughness or burrs removed with an oil stone, similar defects and hard marks in the bearings being removed with a scraper. The oil guards should also receive attention and be touched up if damaged.

REPLACING ELECTRICAL ROTOR.

After cleaning the rotor it can be put back in the stator, noting that the various stages of this operation are in reverse order to that when taking the rotor out. The remainder of the parts dismantled should then be similarly reassembled.

Locating the Outboard Bearing Pedestal.

The alternator outboard bearing pedestal is located by means of dowels which are supplied with the machine for this purpose only. After the pedestal has been bolted down in its correct position, *the dowels must be removed*, and stored away for future use.

It should be also noted that this pedestal is insulated from the baseplate to prevent currents, the fixing bolts and oil-pipe connections being also insulated for a similar purpose.

Testing the Pedestal for Insulation.

After the pedestal is in position, all the oil piping in place, and the electrical rotor raised up so that it is not in contact with the outboard pedestal bearing, the pedestal should be tested for insulation to the baseplate, with a megger, and any obvious connection to earth searched for and remedied.

Check the Balance after Assembly.

After the complete alternator has been

reassembled it is advisable to run the machine up to speed and check the mechanical balance before lowering the brushes. The brushes should be inspected, bedded and renewed if necessary, and the machine then run up again to check excitation; raise machine volts steadily and everything being found satisfactory, the machine will be ready for load.

If the stator leads have been disconnected, see that they are reconnected to the same terminals as originally.

Slip Ring Brush Gear.

Care must be taken to keep the slip

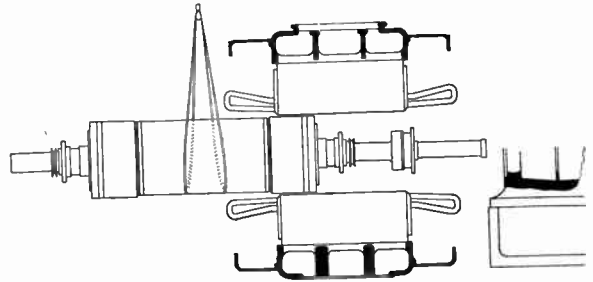

TAKING OUT ROTOR—FINAL POSITION.

The sling from the crane hook is arranged round the rotor so that the weight is balanced. (Courtesy of B.T.H. Co., Ltd.)

rings, brush holders and brushes clean. The brushes must be bedded properly on the slip rings and the spring tension adjusted to give a pressure of about 2 lb. per sq. inch of brush contact surface.

The brush holders should be staggered sufficiently to distribute the brushes over the entire width of the slip ring, in order to ensure even wear. The slip ring surface must occasionally be wiped with an oily rag to keep it in good condition.

THE EXCITER.

All parts of the exciter, especially exposed live parts, must be kept clean and free from moisture or carbon dust.

Commutator Troubles.

Commutator troubles are almost always of a mechanical nature, due to inattention or neglect of small irregularities, such as sparking. The latter, if not attended to at once, will lead to further complications and the commutator will quickly get into an unsound condition and ultimately require

to be trued up again either by turning or grinding, while a new set of brushes will probably have to be fitted.

Commutator troubles are, therefore, cumulative, and expensive repairs can be avoided by careful attention and the application of simple remedies to small irregularities immediately they arise.

HOW TO CURE SPARKING.

If any sparking should take place, it should be dealt with first of all by wiping the commutator, while rotating, with canvas slightly coated with vaseline. If no improvement results, the trouble will be due to other causes, usually mechanical, but occasionally electrical; under these two headings particulars now follow of defects likely to arise and how they can be remedied.

(1) Mechanical Defects Causing Undue Sparking.

Before despatch from the makers' works, exciters are given a prolonged test at full load, followed by shorter periods at overload, and this serves to discover any defect in the design and workmanship of the machine.

Mechanical defects which may subsequently arise and cause commutation trouble are as follows:—

(1) Brushes not properly bedded on the commutator, or incorrect pressure on the brushes.

(2) The commutator may develop one or more high or low bars.

(3) With the normal wear of the commutator surface, mica between the bars will appear and cause irregular contact with the brushes.

(4) Abnormal slackness in the exciter bearings.

(5) Buckling of coupling discs, due to mishandling when dismantling, or some other cause, giving rise to vibration of the exciter armature.

Bedding Down the Brushes.

The brushes must be carefully bedded on the commutator by passing beneath them No. 0 sandpaper, the smooth side being held down firmly against the surface of the commutator. Move the sandpaper in the direction of rotation of the

armature, with the brush under pressure taking up its correct setting in the box, and on drawing the sandpaper back for the next cut, raise the brush to free it from the sandpaper. No. 2 sandpaper may be used at first if necessary, but the final bedding must be done with No. 0. If any attempt is made to fit the brushes without raising them when drawing the sandpaper back, satisfactory results will not be obtained.

The Question of Oiling.

It will also be found advantageous to touch the surface of the commutator from time to time with a clean oily pad, so that the part of the brush near the rubbing surface may accumulate a small charge of oil; this will improve the running properties of the brush. It is advisable to repeat this lubrication after the brushes have been in service for some time, as the original charge of oil may then be used up.

Brush Pressure.

The pressure on each brush should be about 2 lb. per sq. in. Care should be taken to replace brushes before they get too short, as when the spring pressure is decreased sparking may result.

Brush Replacements.

The brushes supplied with high speed exciters are of a fairly soft quality, and therefore, as they are liable to chip and break, require very careful handling. They should not be replaced by brushes of any other type without the approval of the makers.

Sandpapering.

If the surface of the commutator appears to be irregular when running it must receive immediate attention. A piece of fine sandpaper applied to the commutator running at full speed, with the brushes raised, will usually remedy this.

Using a Commutator Stone.

It will frequently be found, however, that the commutator, while too rough to be properly smoothed with sandpaper, is not sufficiently bad to require turning; in such cases it can be put in good order by

the application for a few minutes of a suitable commutator stone.

Before applying the stone, the windings and bearings of the machine must be protected, as far as possible, from the dust which will be produced.

After stoning and polishing, all dust and grit must carefully be cleaned away, particularly from the brushes and armature winding, using a brush or dry compressed air for this purpose.

The brushes must always be raised when the commutator is being stoned or polished.

Undercutting the Mica.

It is very essential on high-speed commutators to reduce the mica between the segments to a depth of about $\frac{1}{16}$ -in. below the surface of the copper, as the mica is harder than the copper and will remain above the surface after the copper is slightly worn away. A short length of hack saw blade makes a suitable tool for accomplishing this work. Great care should be taken to see that no small flakes of mica are left on the segments.

It is necessary to clean out carefully between the segments after turning, stoning and polishing, in order to make sure that no conducting material is lodged between the segments, thus forming a bridge across them. When the commutator copper wears down to the level of the mica, the latter must again be reduced.

Commutator Clamping Nuts.

The commutator clamping nuts sometimes require tightening, particularly in the case of new machines. Tightening must be done with the commutator hot after running, and before stoning or polishing.

ELECTRICAL DEFECTS CAUSING UN-DUE SPARKING.

Wrong Internal Connections.

When undue sparking occurs at the exciter commutator and it cannot be remedied by any of the foregoing methods the cause of the trouble should be looked for in the connections to the commutating poles or shunt poles, as these may have been broken or wrongly connected. The connections are arranged uniformly from pole to pole, and should agree with the

diagram furnished with each machine. If, on examination, the arrangement arouses suspicion, a test should be made with the sequence of the suspected connections reversed.

Incorrect Brush Setting.

Another cause of trouble may be the wrong setting of the brushes. In the event of the brush setting being in doubt, and rocking the brush holder does not have effect, a simple test can be made to check the correct running neutral position of both positive and negative brushes.

Before taking a brush volt test, examine the commutator to see that it is in good condition and that there are no rough spots or high mica on the edges of the segments.

How to Test for Incorrect Brush Setting.

When the machine is running on load, the two leads "A" and "B" from a low reading voltmeter "V" are placed in contact with the commutator close to the leading and trailing tips of the brush.

The leading tip of a brush is the tip first reached by a commutator segment, and the trailing tip is that which the commutator segment leaves after having passed under the brush.

Over Compensation.

For over-compensated conditions the leading tip of a positive brush will be positive and the trailing tip negative, and on a negative brush the leading and trailing tips will be negative and positive respectively.

Under Compensation.

For under-compensated conditions the leading tip of a positive brush will be negative, and of a negative brush positive, whilst the trailing tips will be positive and negative respectively.

If the brush is set in the correct running neutral position there should be practically no difference in potential between the two tips, and the voltmeter should not register more than 0.1 volt, indicating that the machine is slightly over-compensated, which gives the best commutating conditions.

How to Check the Brush Spacing.

Brush spacing should also be checked at this stage. A strip of paper about an inch wide should be wrapped around the commutator and cut off to a length exactly equal to the circumference.

Remove the strip and divide it up into as many equal parts as there are brush arms, by folding it on itself the requisite number of times. Replace the strip on the commutator and, if necessary, adjust the brush boxes so that the tips of the brushes of each brush arm exactly coincide with the marks of the folds on the strip. The brushes should then carefully be rebedded with fine sandpaper, which should be pulled through a few times in the direction of rotation, and not backwards and forwards.

Method of Setting Brushes in Neutral Position.

When the brush boxes have been disturbed in any way it is desirable, after spacing the brushes, to set them in the neutral position whilst the armature is stationary. An accurate way is to employ the electrical "flick" method, involving the use of a D.C. supply of about half the nominal exciter voltage and a low reading voltmeter, of say, 1.5 volts full-scale reading. A millivoltmeter could be used with advantage. With the exciter stationary, connect the voltmeter across brush arms of opposite polarity. Excite the main field off the D.C. supply, with a switch in circuit so as to make and break the circuit, and on each make and break watch the "flick" of the voltmeter needle. The end shield carrying the brushes should be gradually moved round until the "flick" is reduced to a minimum. If moved too far the "flick" will increase again, but in a reverse direction.

The position giving minimum "flick" of the voltmeter needle is then the electrical neutral position on which the brushes should be set for running.

The Final Adjustment of Brushes.

This neutral position may not be quite correct when the exciter is running on load, owing to certain factors, such as armature reaction and compensation. The brushes should then be finally adjusted to the

running neutral position for the normal load conditions, by the tests described for determining the compensation by taking the voltage drop across a brush.

A Peculiar Fault.

A peculiar kind of exciter trouble sometimes develops even after the machine has been in service for some time. This is evidenced by serious sparking as the machine is excited previous to synchronising. This effect arises from a certain inherent instability of the magnetic system of a shunt-wound machine at low voltages, and may be cured either by the use of the alternator rheostat at low loads, when such a rheostat is available, or by increasing the air gap of the main poles by withdrawing a shim from the back.

REVERSED POLARITY OF EXCITER.

How Caused.

On rare occasions a heavy short circuit or surge on the system may so react through the alternator rotor and the exciter as to reverse the polarity of the exciter, so that when the fault is cleared, the instrument leads require reversing. During the period of depressed voltage while the fault lasted, the alternator will have slipped a pole, so that when the fault clears, this new condition, combined with the fact that the exciter polarity is reversed, will leave the machine in proper phase and synchronism with the recovered busbar voltage.

There is no need to be anxious about the alternator on such occasions, because the voltage of the alternator is depressed during the period of fault, and therefore contributes the minimum amount of current and energy to the fault.

This phenomenon is most likely to occur when the alternator is lightly loaded and the exciter is consequently carrying a weak field.

Precautions Against Reversal of Polarity.

After the alternator has been taken off the busbars, move the main field rheostat to the "all-in" position, and afterwards, the exciter field rheostat to the "all-in" position. The exciter field switch may then be opened.

ELECTRICAL CIRCUIT DIAGRAMS

By Prof. S. PARKER SMITH, D.Sc., M.I.E.E.

CAR DYNAMO CIRCUITS

THE automobile furnishes one of the commonest and most useful applications of automatic regulation of the voltage—indeed, it may be said that for this purpose it is indispensable.

For the 12-volt battery, a voltage variation of about 50 per cent. is needed to cover the range of cell voltage from the fully discharged condition of 1.8 volts to the fully charged condition of 2.7 volts. The charging dynamo on the other hand has a speed variation from zero to the maximum speed of the engine. To exclude the range below which the dynamo voltage is less than 12 volts, an automatic cut-out is essential, but even if this operates at an engine speed of 1,000 revolutions per minute, there still remains variation of 300 to 400 per cent., for engine speeds of 3,000 to 4,000 revolutions per minute. Since the electromotive force induced in an armature winding is proportional to the product of the magnetic field and the speed at which the machine rotates, an automatic device is required to maintain a practically constant voltage as the speed of the vehicles changes.

Constant Current and Constant Voltage Methods of Regulation.

The two methods most commonly used

for this purpose are often referred to as the constant current and the constant voltage method. In the former a three-brush dynamo is employed; in the latter an automatic voltage regulator. The three-brush dynamo is the system commonly employed on private motor vehicles in this country; whereas the voltage regulator finds general use in Germany, and it is also used on motor buses and coaches in Great Britain.

THE REVERSE-CURRENT RELAY (OR AUTOMATIC CUT-OUT).

The type of automatic cut-out employed on automobiles is the reverse-current relay. This consists of two coils—the *voltage* or *shunt* coil connected across the dynamo terminals, and the *current* or *series* coil connected in the circuit between the generator and the battery. The coils are mounted on a core which forms part of an all-iron magnetic circuit, except for a small air-gap. The upper part of the magnetic circuit consists of a light movable arm, hinged at one end and provided with a contact at the other end. Opposite this movable contact is a stationary contact to which the current coil is connected, so that the circuit between the generator

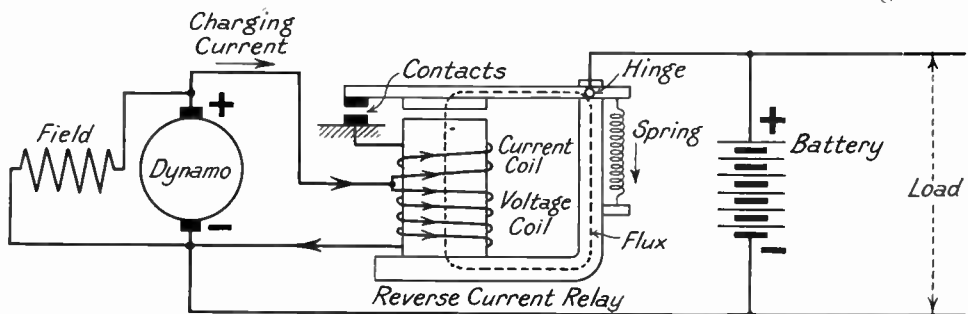

ESSENTIAL CONNECTIONS OF AN AUTOMOBILE CUT-OUT.

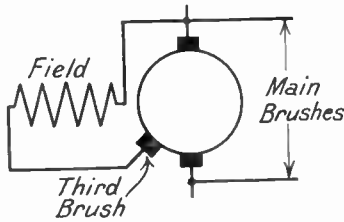

CONNECTIONS FOR THREE-BRUSH GENERATOR.

If instead of exciting the field off the main brushes, the exciting voltage be obtained between a main brush and an auxiliary or third brush, the voltage on load will not rise so rapidly as in the plain shunt generator.

and battery is made when the contacts are closed. The spring tends to keep the contacts apart.

The Action of the Cut-out.

The action of the cut-out is very simple. As the voltage of the generator increases, the pull exerted by the flux produced by the exciting current in the voltage coil also increases until eventually the opposing force of the spring is overcome and the contacts are closed. This is made to occur when the dynamo voltage is approximately equal to the battery voltage. The dynamo can now send a charging current into the battery, or supply current to a load. (Although the dynamo voltage is now more or less anchored by the battery voltage, unless the battery is comparatively large, the combination with the plain shunt dynamo would be unsatisfactory to maintain constant voltage over a wide speed range—hence the three-brush dynamo.) It will be noticed that any current supplied by the dynamo passes through the series coil and reinforces the pull exerted by the shunt coil.

What Happens When Dynamo Speed Falls.

When the dynamo speed falls so that the generated voltage becomes less than the battery voltage, a reverse or discharge current flows from the battery to the dynamo through the current coil.

As soon as this reverse current becomes large enough to weaken the magnetic pull sufficiently, the spring causes the contacts to open, and they remain open until the dynamo voltage becomes high enough to close them again.

THREE-BRUSH GENERATOR.

If instead of exciting the field off the main brushes, the exciting voltage be obtained between a main brush and an auxiliary or third brush, the voltage on load will not rise so rapidly as in the plain shunt generator. This arises from the field distortion produced by the reaction of the armature current, which makes itself felt much more between the exciting than between the main brushes. This effect alone, however, would not suffice to maintain the dynamo voltage constant as the speed varied. For this purpose a battery is required.

The Battery in the Third Brush Control System.

Although a battery of ample capacity (low resistance) is needed to anchor the voltage effectively, the arrangement is much more satisfactory with a three-brush than with a plain shunt machine. At the same time, the large battery is useful for starting.

From this it follows that the three-brush dynamo, as used for automobiles or train lighting sets, not only requires a battery, but that the battery is indispensable. There must be no isolating switch between the battery and the bus bars.

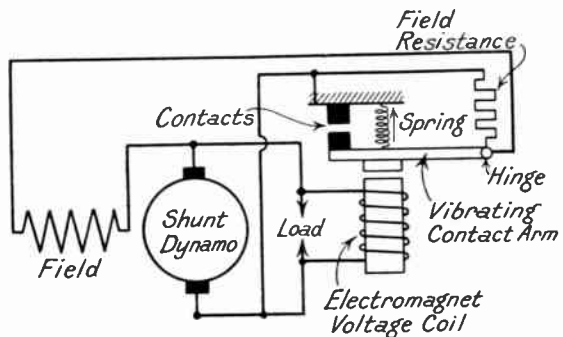

CONNECTIONS FOR SIMPLEST FORM OF AUTOMATIC VOLTAGE REGULATOR.

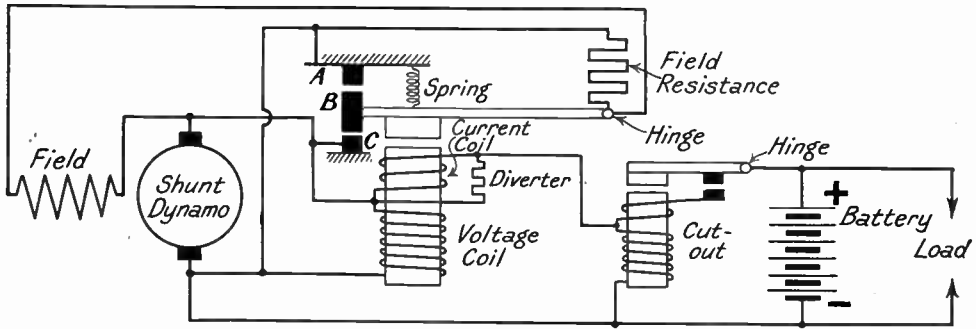

CONNECTIONS FOR AUTOMATIC VOLTAGE REGULATOR WITH BATTERY AND CUT-OUT.

Showing how the action of the voltage or shunt coil is reinforced by a current coil placed in series with the load. The three-brush generator is connected in a similar manner.

A Defect of the Three-brush Generator.

The three-brush dynamo is a bad partner for the battery, for the output of the dynamo rises with the battery voltage—thus the higher the state of charge of the battery the greater the charging current, and conversely.

AUTOMATIC VOLTAGE REGULATOR.

The principle here involved is the same as in the Tirrill regulator, used for controlling automatically the voltage of machines in power stations. By means of a vibrating contact, a resistance can be switched in and out of the field circuit, or, alternatively, the field winding itself can be short-circuited. In this way the voltage of the generator can be controlled as desired independently of the battery. When used on an automobile, an automatic cut-out is needed, as also with the three-brush generator, to cut out the dynamo when the engine is running slowly or is at rest.

The Connections.

The generator is a plain shunt machine. The field resistance is connected across contacts, which are closed by the spring; while the contacts are opened by an electromagnet excited off the dynamo brushes. As the speed and voltage of the dynamo rise, the pull of the electromagnet increases until eventually the iron vibrating arm is drawn towards the magnet, the contacts being thereby separated and the resistance inserted in the field circuit. This causes the voltage

and consequently the current in the electromagnet to fall, thus enabling the spring to close the contacts again. The cycle then recommences, and the contacts are opened and closed as the iron bar rapidly vibrates to and fro.

It will be noticed that this action is in no way dependent on the battery, and the voltage can be maintained at its desired value on no load or on load, with or without battery.

The Current Coil.

In the actual regulator used on the automobile, the action of the voltage or shunt coil on the electromagnet is reinforced by a current coil placed in series with the load. Across the current coil a diverter is connected, and by varying the resistance of the latter, the designer can adjust the ampere-turns of the electromagnet.

Addition of Stationary Contact.

A further refinement of the voltage regulator is the addition of the stationary contact C. In this case a field resistance of lower value is employed, and as soon as the contacts A and B no longer suffice for maintaining the voltage at its required value, the arm is drawn to the electromagnet until the contacts B and C meet. When this occurs the field winding is short-circuited, and the field resistance is placed across the dynamo terminals. The former rapidly reduces the dynamo voltage, while the latter prevents a rush of current between brushes before the field has collapsed.

FURTHER CAR DYNAMO CIRCUITS

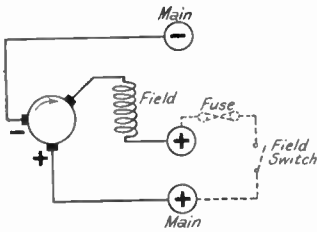

THIRD BRUSH CONTROL. FIELD ON POSITIVE SIDE.

With this type of regulation the dynamo is a variable speed self-regulating machine capable of generating an approximately constant current over a wide range of speeds.

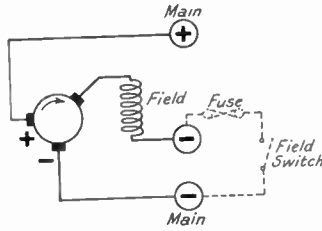

THIRD BRUSH CONTROL. FIELD ON NEGATIVE SIDE.

The field switch shown in this and the previous diagram is used for switching the dynamo off when the battery is charged and the lights are not in use.

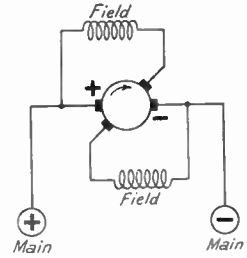

TWO - POLE DYNAMO WITH TWO MAIN AND TWO CONTROL BRUSHES.

Half the field circuit is connected across one main and one control brush and the other half of the field circuit connected across the other pair of brushes.

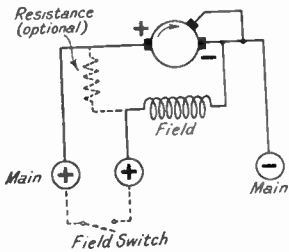

SHORT CIRCUITED BRUSH CONTROL.

In this case the shunt field circuit is connected across the main brushes and the control brush connected to a main brush.

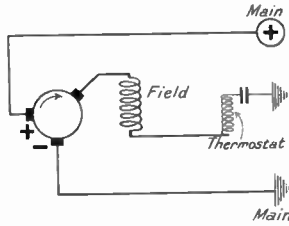

OUTPUT ADJUSTMENT BY THERMOSTAT.

In some systems a thermostat is included in the regulated shunt field circuit to reduce the output of the generator at a pre-determined temperature, usually about 180 F. This device acts as an overload circuit breaker and the resistance may be used in place of a fuse.

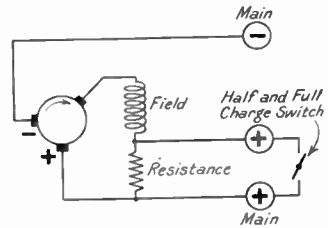

OUTPUT ADJUSTMENT BY RESISTANCE.

When the switch is closed the resistance is short-circuited and the dynamo then generates its full current.

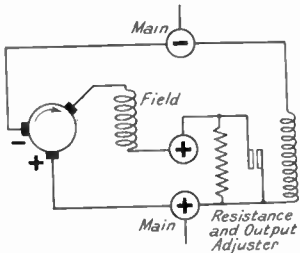

THIRD BRUSH CONTROL WITH OUTPUT ADJUSTER.

This shows in a simple form the vibrating contact type of regulator. Notice that the contacts take the place of the full charge and half charge switch shown in the previous diagram.

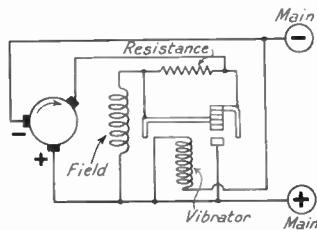

OUTPUT ADJUSTMENT BY VIBRATOR.

This illustrates the same system as is shown at the top of page 23, applied to a three-brush generator.

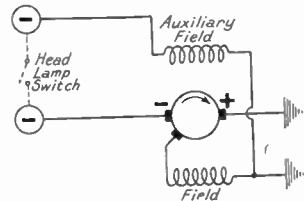

OUTPUT ADJUSTMENT BY LAMP SWITCH.

Note the auxiliary field winding. In this method the headlamp current is taken through series coils on the dynamo and boosts the output when the lamps are on.

DESIGN AND CONSTRUCTION OF A POWER AMPLIFIER

By A. E. WATKINS

In this article Mr. A. E. Watkins, the well-known wireless expert, tells how to construct a power amplifier that can be used for public-address systems, gramophone or radio amplification. Readers will appreciate the simple design and layout of this piece of apparatus.

AMONGST radio apparatus a high quality amplifier is one of the most useful pieces there is, for it is readily assembled and possesses lasting utility. Once constructed it will not go out of date as it is the nucleus around which we may build either an electric gramophone or radio receiver, it being only necessary to add either a pick-up for gramophone amplification, or a detector and, if required, H.F. stages for a high quality radio.

Output of the Amplifier.

Unlike a complete radio receiver, which is a specialised apparatus and in some cases of only a temporary interest, the components for the amplifier are an invaluable acquisition, for the L.F. amplifier has so many uses. It can be used for public-address systems, gramophone amplification or radio amplification. By using the components mentioned, the amplifier will have

a fairly flat overall output from 50 to 8,000 cycles, falling off gradually to about 15,000 cycles.

Specification.

Variable input to first L.F. valve followed by two stages of L.F. amplification push-pull, 24 watts anode dissipation. All A.C. operation, automatic grid bias.

Should it be necessary to operate this

amplifier from D.C. mains or accumulators, this can be done conveniently by means of an M.L. convertor, this being the most satisfactory manner of operating an amplifier of this description for it requires 500 volts at 120 m.a.

LIST OF COMPONENTS.

Mains transformer, output 500-500, 7.5-volt, 4-volt (*Varley EP24*).

Smoothing choke, 45 henries at 120 m.a. (*Parmeko*).

Output filter choke, 30 henries at 50 m.a., centre tap (*Parmeko*).

Push-pull transformer AF3C (*Ferranti*).

Condensers, 800-volt working—

C. 1, C. 2, 1 mfd. (*T.C.C.*).

C. 6, C. 7, C. 9, 4 mfd. (*T.C.C.*).

C. 5, C. 8, C. 3, C. 4, 2 mfd. (*T.C.C.*).

C. 11, C. 10, .0003 mica.

C. 12, C. 13, .01 (*T.C.C.*).

Resistances—

R. 1, 1,000 ohms, wire wound (*Watmel*).

R. 2, R. 3, 100,000 ohms, wire wound (*Watmel*).

R. 4, R. 5, 25,000 ohms, wire wound (*Watmel*).

R. 8, 15,000 ohms, wire wound (*Watmel*).

R. 9, 2,500 ohms, to carry 150 m.a., wire wound (*Watmel*).

R. 10, 50,000 ohms, Type 3. Potentiometer (*Watmel*).

R. 7, 600 ohms, Type 1. Potentiometer (*Watmel*).

R. 6, 15 ohms, Type 3. Potentiometer (*Watmel*).

H.F. choke, Type D.X. 3 (*Watmel*).

Input and output terminal blocks (*Belling and Lee*).

Mains plug (*Belling and Lee*).

Valves—

V. 1, 354 V. (*Mullard*).

V. 2 and V. 3, P.X. 4, for push-pull (*Osram*).

U. 8 Rectifier (*Osram*).

Advantages of Push-pull Output.

For high quality output for operating one or more large moving coil loud-speakers, push-pull output is undoubtedly the most satisfactory for the following reasons:—

1. It greatly reduces the har-

monic caused by curved characteristics.

2. It gives at least double the power of one valve because of the reduction of harmonics.

3. The arrangement enables the D.C. magnetisation due to the steady plate current of the valve to cancel each other out, and therefore there is less chance of distortion due to high D.C. magnetisation of the iron core.

4. The signal passes from the valve plate to valve plate; practically none passes through the H.T. supply, hence there is less chance of feeding back to previous stages with consequent self-oscillating or motor-boating.

5. Any ripples in the H.T. supply, grid bias or filament supply do not appear in the transformer or speaker, since they affect each half of the winding by equal amounts in the opposite directions.

Power Control.

High quality output has been the aim in the design of this amplifier, but this does not mean that the power is overwhelming, for the input can be controlled by the potentiometer in front of the first L.F. valve, but the vastly different relative

amplitudes of voltage can be accommodated by the grid and, due to the generous output, the valves may be under-run so that effect of the curvature of the characteristics becomes insignificant while considerable power output is available when occasion demands.

The Circuit Diagram.

Before describing the construction it would be as well to look at the circuit diagram, which is quite straightforward and contains no complications. Should the reader wish, the values of the various resistances may be varied to suit other makes of valves. This, of course, particularly applies to the grid bias resistances and the voltage dropping resistance in the anode circuits, for the resistance of the transformers and chokes will remain constant.

Calculating the Value of the Resistances.

The calculation of the value of the resistances is very simple. First, we must refer to the valve maker's data. Take, as an example, the P.X.4. The maximum anode voltage is 250 with an average anode current of 48 milliamps. with a grid

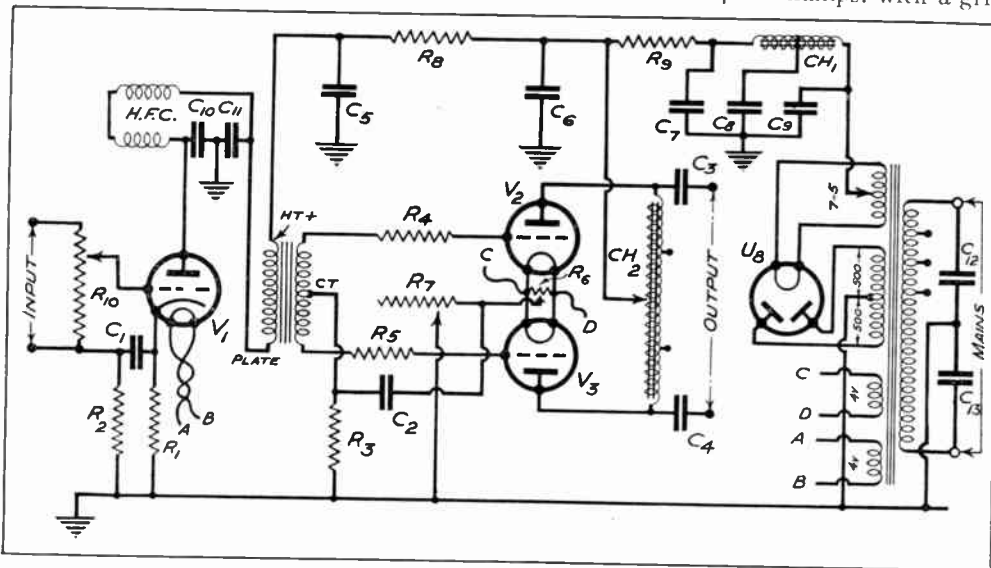

CIRCUIT DIAGRAM FOR POWER AMPLIFIER.

The values of the resistances and condensers are as follows: R.1, 1,000 ohms (20 m.a.); R.2, 100,000 ohms; R.3, 100,000 ohms; R.4, 25,000 ohms; R.5, 25,000 ohms; R.6, 15 ohms; R.7, 600 ohms (150 m.a.); R.8, 15,000 ohms (20 m.a.); R.9, 2,500 ohms (150 m.a.); R.10, 50,000 ohms; C.1 and C.2, 1 mfd.; C.3 and C.4, 2 mfd.; C.5, 2 mfd./800 volts; C.6 and C.7, 4 mfd./800 volts; C.8, 2 mfd./800 volts; C.9, 4 mfd./800 volts; C.10 and C.11, .0003 mfd.; C.12 and C.13, .01 mfd.

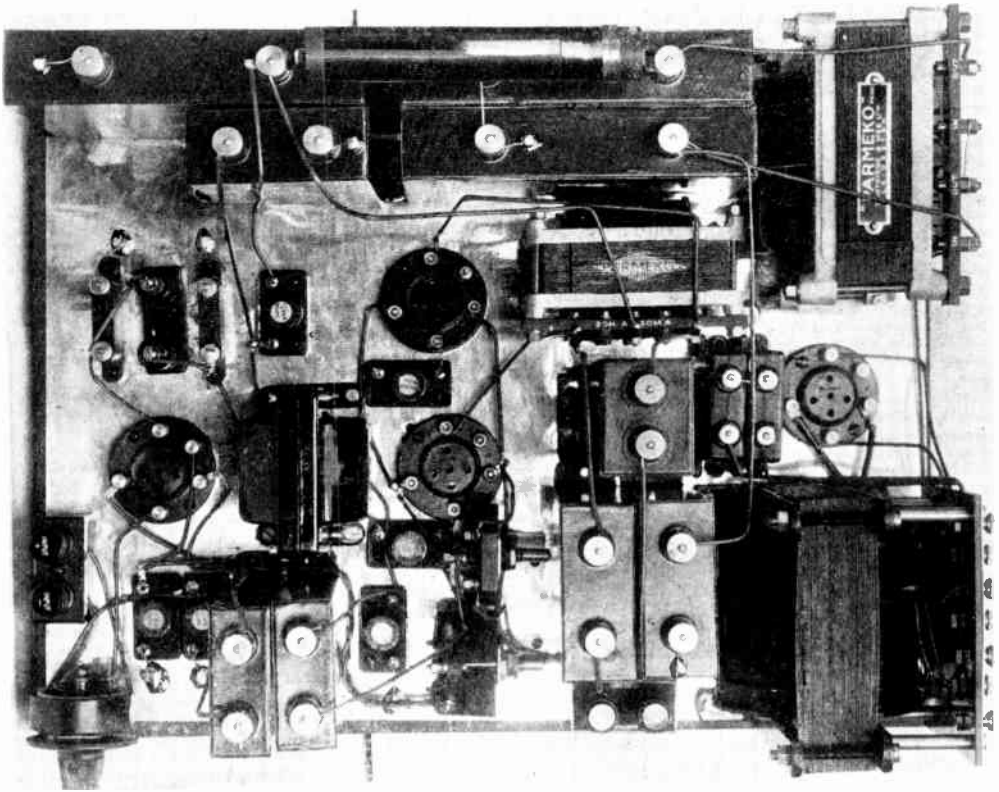

PLAN SHOWING THE ARRANGEMENT OF COMPONENTS AND WIRING.

Note how simple the wiring is, due to earthing direct to metal baseboard covering.

bias voltage 34. Now 250 and 34 equal 284. Therefore, the remainder of the voltage from the rectified H.T. current must be dropped between the smoothing choke, anode choke or transformers, and any resistances in the plate circuit.

Output after Smoothing.

Using a rectifier valve of the Osram U.8 type with 500 volts on each anode, the output after smoothing will be approximately 475 volts at 120 milliamps., and it is from this voltage that the calculations for the resistances in the various circuits are made. In making these calculations it is as well to work backwards, that is, from the output valves, as any resistance in the anode circuit of the output valve is usually used as part of the resistance for the earlier valves. The resistance of the filter choke has a total of 370 ohms. This is the Parmeko filter

choke, Type F. As only half of this choke is in each plate circuit of the P.X.4 output valves the resistance is divided by two and each side of the choke will carry approximately 50 milliamps. and will, therefore, only drop 9 volts, which need hardly be taken into consideration.

Resistance with Tapping Points.

Using the P.X.4 valves, therefore, we will have to drop another 101 volts in the resistance. As this resistance will also be carrying the anode current of the first L.F. valve it will be passing, approximately, 101 milliamps., with a 345 Mullard valve which is being used. As the first valve may be varied to suit the conditions it would be advisable to have a larger resistance with tapping points so that it can be altered according to the conditions.

When passing 101 milliamps. the resistance will be, approximately, 2,000 ohms;

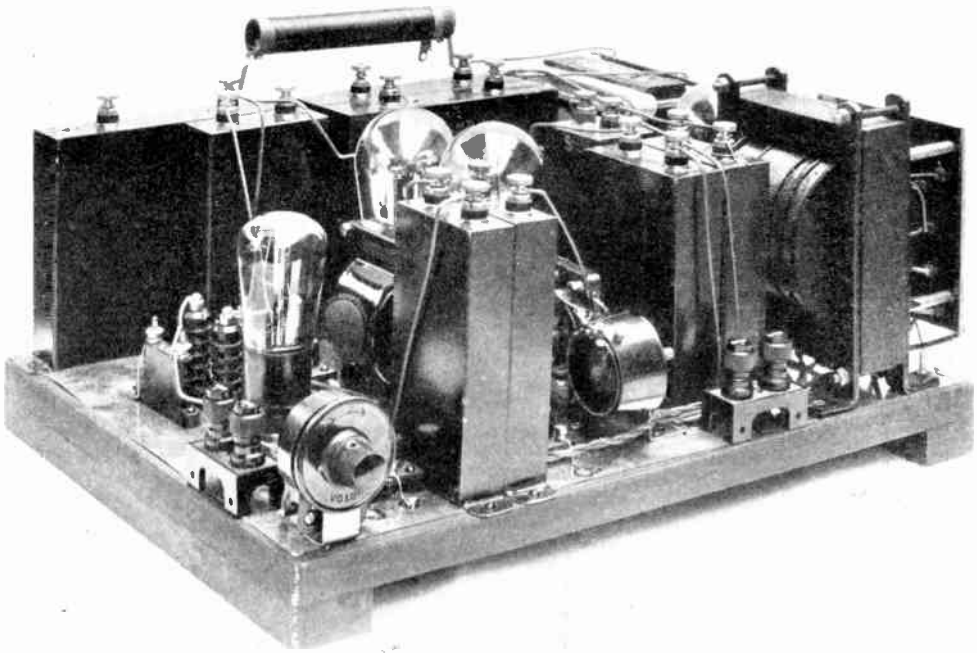

FRONT VIEW, SHOWING THE VOLUME CONTROL ON THE LEFT.
The first L.F. valve is just behind.

therefore, the resistance is adjustable and can be adjusted to suit almost any valve which it may be desired to use, either in the first amplifier or the principal output stage.

The author will be pleased to supply a simple line chart for easy calculation of resistances to any reader who writes to him. c/o the Editor.

The Circuit Described in Detail.

We will now describe the circuit in detail, beginning from the input.

First, there is a 50,000-ohm potentiometer placed between the grid and cathode of the first valve, and is of the Watmel Type 3 non-inductive.

In the cathode lead are the grid bias resistances and the by-pass coupling condensers. In the anode circuit it will be noticed that an H.F. choke is included with two by-pass condensers .0003. While it is not essential to use this H.F. choke when the amplifier is used purely as a radio gramophone, it is nevertheless an advantage when it is used for radio

reception as it effectively prevents any H.F. current being transferred to the output valve. Secondly, if the first valve was used as a detector, reaction could be used from the plate.

Transformer.

The transformer is a Ferranti AF3C push-pull, and will effectively carry the anode current necessary for the first valve.

In circuit with the primary is the necessary voltage dropping resistance of 15,000 ohms and by-pass smoothing condenser .2 mfd.

In each output grid lead from the transformer are two resistances, the value of these being approximately 25,000 ohms, any value near this being perfectly satisfactory. They are included to prevent self-oscillation if the valves are slightly defective or soft.

How the Anodes of the Valves are Coupled.

The anodes of the valves are coupled by an output filter choke, but this may be replaced with a suitable push-pull output

transformer if preferred, or, in some cases where the speaker itself is fitted with an output transformer, it may be connected direct. In the case of high resistance wound speakers, the output choke is the best system to use as owing to the tapping it can be adjusted to suit the impedance of the speaker, but it must be remembered that each tapping must be adjusted so that there is equal balance between the centre points.

H.T. Smoothing Choke.

The H.T. smoothing choke is wound in two sections, being joined together in the centre and the condenser coupled between earth (in some cases this condenser is better left out). This in effect gives two smoothing chokes in series.

Mains Transformer.

The mains transformer is the Varley E.P. 24, which is easily adapted to any supply for the input voltage of 200 to 250 in steps of 10 volts. The output for the valve rectifier is 500 plus 500 volts while there are various tappings to suit the filaments of the valve and also the rectifier valve. This, therefore, gives a very flexible unit suitable for all conditions of supply but for voltages below 200 a special transformer will be needed.

Smoothing Condensers.

It is most important that the smoothing condensers used in the anode circuit of this amplifier should have a high voltage break-down test and 800 volts working condensers are chosen, for on certain parts of the circuit we

have a steady voltage of approximately 500 volts and at times surges will be set up greatly in excess of this voltage; also, the two output condensers should be of the high voltage type as between these condensers and earth we have a high voltage and a short circuit in the speaker leads may cause a breakdown of these condensers unless they can withstand at least 800 volts.

Decoupling Condensers.

The decoupling condensers in the grid bias circuit will be perfectly satisfactory if they are capable of standing 250 volts working, but the two condensers C. 11 and C. 10 should be of mica dielectric.

In the output valve filament circuit a resistance across the filament will be noted. This is to adjust the centre point and to reduce hum.

Adjustable Grid Bias Resistance.

The resistance R. 7 is adjustable so that the correct grid bias may be obtained. By making this adjustable, the anode current can be quickly adjusted to the correct values, if any other type of valves is fitted in an emergency. The value of

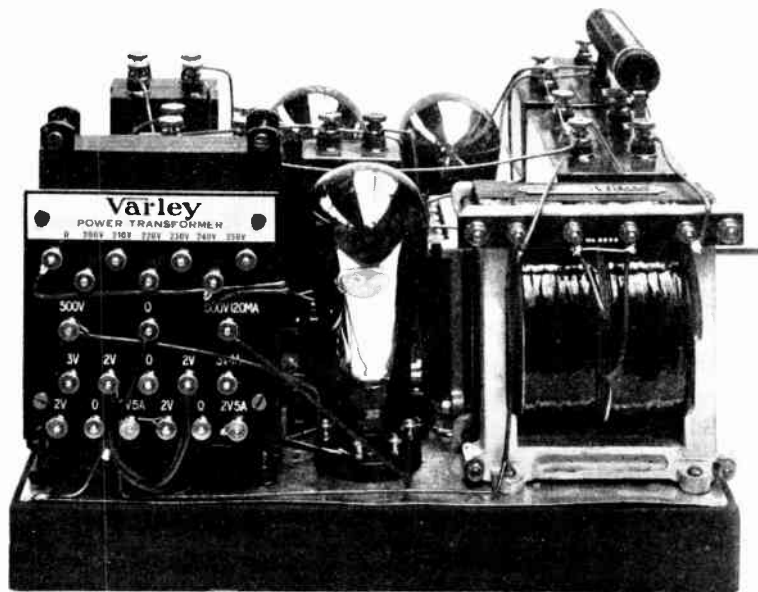

END VIEW, SHOWING MAINS TRANSFORMER, RECTIFYING VALVE AND SMOOTHING CHOKE.

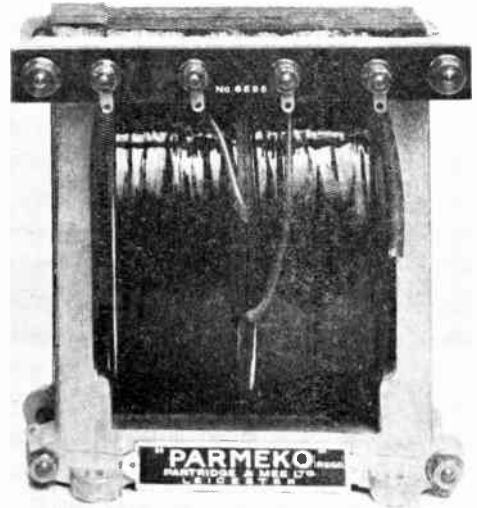

THE MAINS TRANSFORMER AND SMOOTHING CHoke.

The mains transformer has multiple tapings to suit the conditions of power supply. The smoothing choke is wound in two sections, the centre terminals being bridged and, in the case of this amplifier, connected to a 2 mfd. condenser.

this resistance is in excess of that required for the correct grid bias voltage for the valves chosen, but should a valve be fitted which consumes lower anode current, it can readily be adjusted, for the less the anode current the greater the resistance usually required to produce the necessary voltage for proper bias.

Valves should be Matched.

When ordering valves for push-pull output it is advisable to tell the makers that they are required for this purpose. They will then send matched valves, which greatly improve the working, as otherwise the grid bias on each filament must be separately adjustable and we should then require a transformer with two secondary windings, but this is not necessary if the precaution is taken in ordering correctly matched valves.

CONSTRUCTING THE AMPLIFIER.

Having now described the component

parts of the amplifier in detail, we will proceed with the construction. This has been kept as simple as possible.

All the components are mounted upon a base board lined with metal so as to earth every component, which is a very necessary precaution with high voltage amplifiers.

Those who wish may construct a metal cover completely to house the whole instrument, but ventilation holes should be made in the sides to allow for the free circulation of air for valve cooling as the valves will get appreciably warm when in use. The cover must make effective earth contact with the base board.

Base Board Size.

A convenient size for the base board is 13 in. by 17 in. by 1 in. with two battens along each end securely screwed so as to prevent warping. Heavy components, such as the transformers and smoothing chokes, should be bolted through the base board, for wood screws are not sufficiently

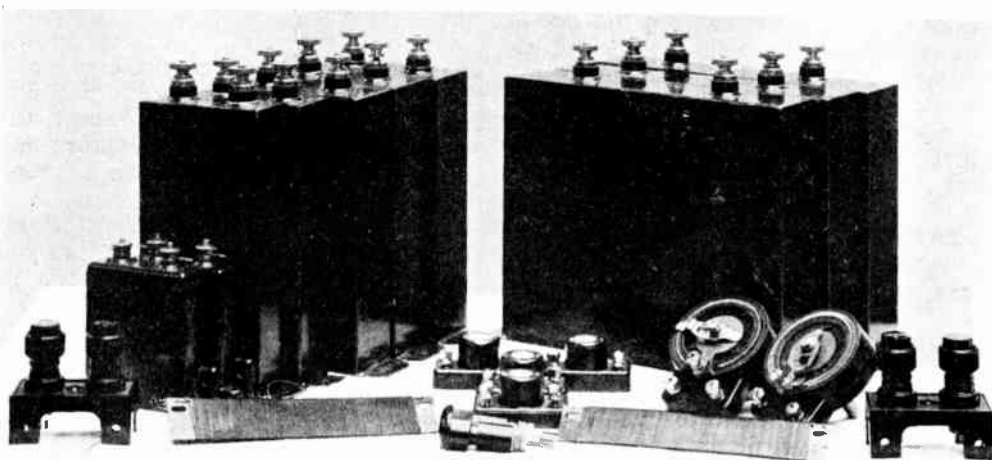

A GROUP OF SMOOTHING CONDENSERS, RESISTANCES, POTENTIOMETERS AND TERMINAL BLOCKS.

It is important that the condensers in this amplifier should be capable of standing a pressure of 800 volts working (not 800 volts test).

strong to carry these heavy components. The lighter pieces, such as condensers, valve holders, and resistances, may be fitted with wood screws as all these are light.

Layout.

A convenient form of layout is that shown on page 27. It has been carefully arranged so as to simplify the wiring as much as possible and prevent any interaction between the various components; but as most of the components are of the L.F. nature, a small rearrangement is not likely to affect the operation.

Hints about Wiring.

All the wires used in the amplifier should be covered with high-voltage sleeving, particularly those carrying the anode voltages. Where there are terminals on a component, if the wire is properly twisted round the terminal and tightly screwed it will be just as effective as soldering; in fact, there is not the likelihood of a broken joint occurring as in the case of a soldered tag which has a poorly made joint. When the wires are twisted round the terminals it is advisable to place a washer on the top so that when screwing down

the terminal nuts the loop is not distorted. Where the terminals are small use a heavy gauge solder tag, passing a wire through the hole, bending it over and well soldering. Do not just solder the wire on to the tags as this is not mechanically strong.

Wires from Filaments should be Twisted.

The wires from the filament of the valve should be of heavy gauge and twisted together. The reason for twisting the filament wires is that they are carrying raw A.C. current, and if not twisted they set up hum in the amplifier due to interaction between the other leads. A large independent earth terminal is an advantage as an amplifier should always be earthed.

ORDER OF ASSEMBLY AND CONSTRUCTION.

Cover the base board with a piece of tin or copper, turning up the corners and driving into the board. Clean the paint from under the condensers, transformers, etc., so that they make good contact with the metal earth plate. Now proceed as follows:—

1. Fix the mains transformer, smoothing

choke, output filter choke, push-pull transformer, then the three 4 mfd. condensers and the one 2 mfd. condenser at the back of the board.

2. Fix the three 2 mfd. condensers by the side of the mains transformer.

3. Fix the two 1 mfd. condensers in front of the push-pull transformer.

4. Arrange the small resistances and valves holders in a convenient position, making sure that there is sufficient clearance for the valves.

5. Fit the three variable resistances on brackets, which can be made from pieces of brass bent at right-angles. *It is important* to note that the potentiometer for the volume control and also the variable 15-ohm resistance (R. 6) must be insulated from the bracket, so make the holes in the bracket sufficiently large to allow for an insulating bush.

6. The H.F. choke and the two small by-pass condensers are now fitted near to the first valve holder, where there is plenty of room.

7. Lastly, the input and output terminal blocks are screwed into position, and as these are not fitted until after the wires are attached they can, therefore, be left until the last moment.

Why Control Knobs are Omitted.

It will be noted that the control knobs for the filament resistance and the grid bias resistance are omitted. This is done purposely, as without the knobs there is not the likelihood of anyone turning and altering the adjustment, for if this adjustment was altered, particularly in the case of the bias resistance, serious damage might be done to the valve. If one wishes, this variable resistance may be replaced by a fixed one; but the advantage of the variable resistance is, that it may be adjusted to suit various types of valves.

The resistance R. 9 has been designed so that it may be fitted across the terminals of the smoothing condenser. This makes a convenient fixing.

The gauge of wire used in this resistance must be of ample size, as it is passing 120 m.a. approximately.

WIRING THE AMPLIFIER.

Having now fitted all the components

in position, we may proceed with the wiring. It is better to begin from the mains transformer end. First connect up the two small condensers across the primary, then wire up the rectifier valve and filament supply continuing on through the smoothing choke, resistances, output and push-pull transformer, as in the diagram, to the input terminal.

After having completely wired the amplifier, test out all the circuits so that you are certain that the correct values of resistances are used in the right position and that all condensers, where shown, are earthed. Here will be seen the advantage of using a metal base board as the earth connections may be made direct to the metal casing of the condenser or from the terminal of the component and soldered to the metal covering. This adds to the neatness and saves long wiring, making a short return to earth where necessary.

What to do if Hum Occurs.

If the amplifier has been carefully constructed with the components described, in operation it should be hum free. If hum is encountered, first look to the brushes of the gramophone motor should one be in use. Next, earth the frame of the gramophone motor and look to the leads of the pick-up. These leads should be screened and the carrier of the pick-up should be earthed. If there is still any sound of hum it may be traced to a bad earth connection of one of the components.

Using the Amplifier in a Radio Gramophone.

If built into a radio gramophone cabinet the L.F. amplifier may be placed at the bottom and the detector and H.F. stages at the top, deriving the filament current and H.T. voltage from the common amplifier, for if the valves as specified are used, we have still approximately 10 to 12 milliamps. to draw upon.

In conclusion, the constructor will be amply repaid for constructing this amplifier, as without any doubt an amplifier of this description is an exceedingly useful instrument, being flexible with sufficient power to meet all the demands which will be required under ordinary conditions. It will be perfectly suitable for a small dance hall, tennis court, garden parties, etc.

CABLEGRIP SERVICE JOINTS

Cable jointing is one of the most important operations that the electrical engineer has to perform. The following series of photographs illustrate various stages in making a service connection to a main cable, and give a splendid idea of the latest modern practice in carrying out this operation. Thanks are due to Mr. W. H. Nichols, manager of the engineering department of Messrs. W. T. Henley's Telegraph Works Co., Ltd., for permission to reproduce these photographs.

MARKING OFF THE CABLES WITH A TEMPLATE.

This is done after the cables have been laid in position. Where a template is not available the lower half of the box should be placed in position and the cables marked to allow serving to project $\frac{1}{4}$ in. inside armour clamps. A wire binder is then placed around serving of service cable $\frac{1}{4}$ in. outside point at which it is to be removed. The armouring and serving is then stripped off and the lead sheath removed.

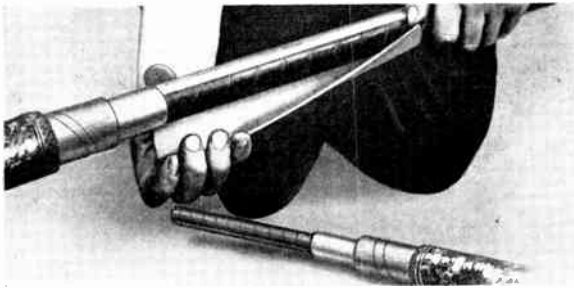
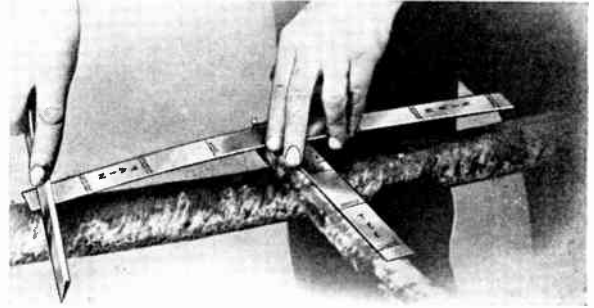

PREPARING THE MAIN CABLE.

This is prepared in a similar manner to the service cable. Where the template is not being used, allow armouring to project $\frac{1}{4}$ in. inside outer wall of the box and lead sheath $\frac{1}{4}$ in. inside cast-iron shuttle.

REMOVING BELT PAPER.

Bind the belt papers with thread $\frac{3}{8}$ in. away from ends of lead sheath. Remove belt paper to within 1 in. of each end of lead sheath. The belt papers are also stripped from the service cable and the cores splayed out. The cores are then lapped with impregnated selvage cotton insulating tape.

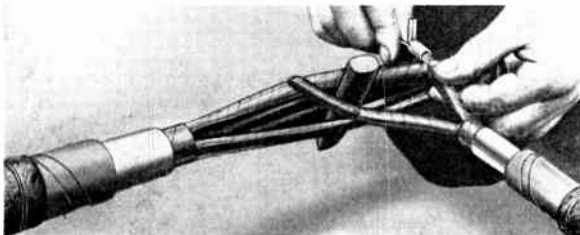
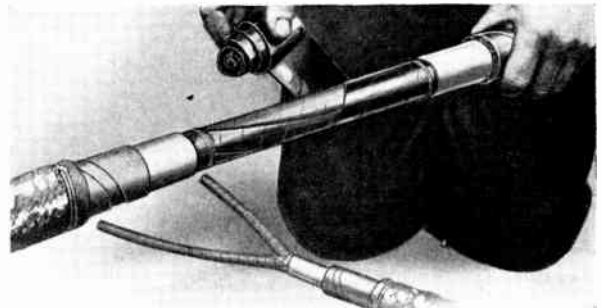

FITTING CLAW CONNECTORS ON SERVICE CABLE CONDUCTORS.

After inserting a wood wedge in the main cable, claw connectors are slipped on the conductors of the service cable.

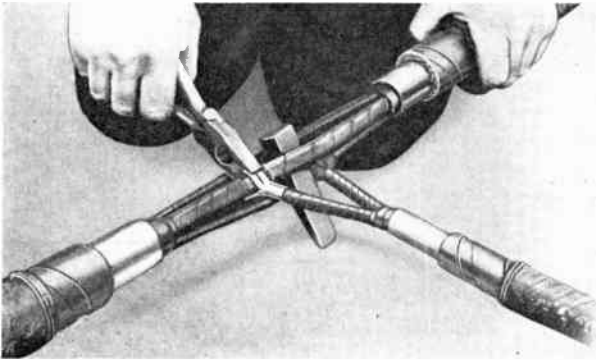

CONNECTING SERVICE CABLE TO MAIN CABLE.

Bare the two conductors of the main cable just sufficiently to take the claw connectors. The position of the service cable should be checked with the template or lower half of box.

INSERTING A PAPER CHUTE.
After connecting the service cable to the main cable by means of the claw connectors, a paper chute should be inserted underneath the claw connector to direct the flow of the solder.

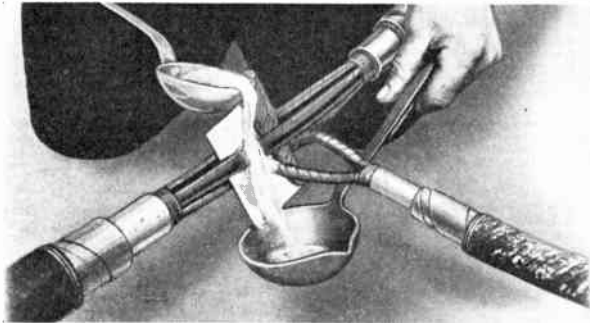
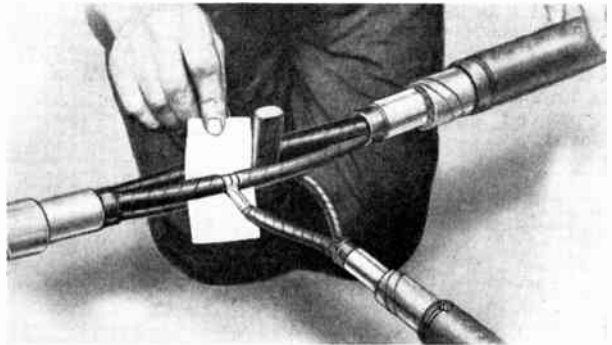

SWEATING THE CLAW CONNECTORS.

The paper chute is used to direct the flow of the solder. To determine whether the solder is at the correct temperature, fold a piece of white paper and plunge it into the metal for about two seconds, when it should turn brown. If it ignites, the metal is too hot.

LAPPING THE JOINTS.

This is done after removing the paper chute. The joints should be lapped with impregnated selvedge cotton insulating tape. If preferred, plain selvedge cotton tape for impregnating on site can be used. To impregnate this tape it should be boiled in compound until all moisture has evaporated, which is indicated by the fact that bubbles cease to appear on the surface of the boiling compound.

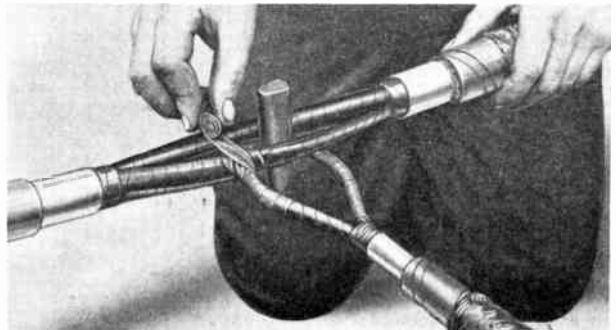

LAPPING LEAD STRIP ON TO LEAD SHEATH OF CABLE.

Thoroughly clean and brighten $\frac{1}{2}$ -in. wide lead strip and then lap it on lead sheath of cable so that its diameter is rather more than the maximum diameter over lead for the box in question. Place a temporary wire binder round the lead strip.

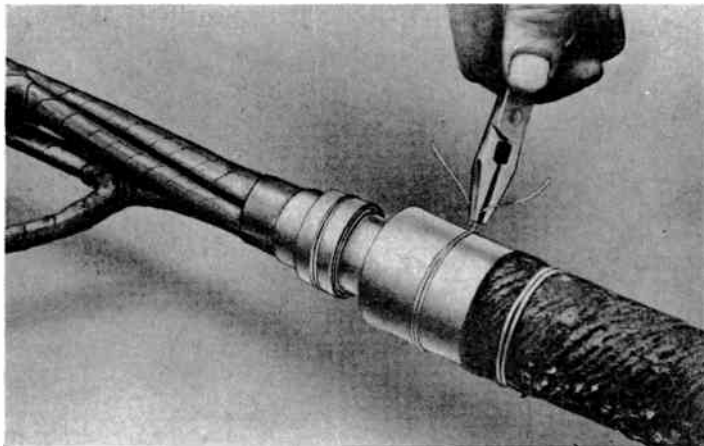
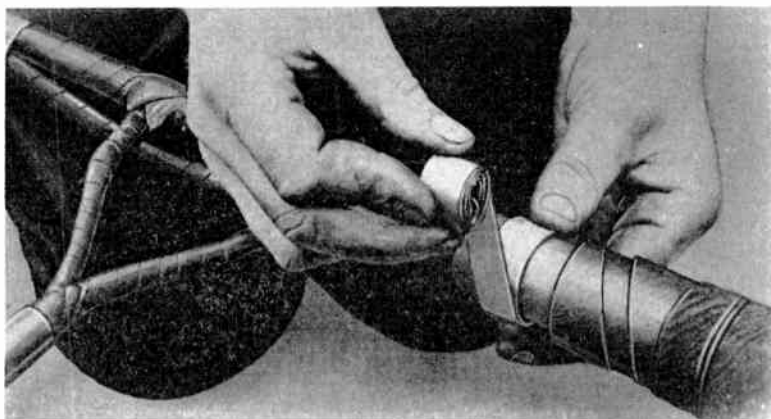

MAKING A TEMPORARY WIRE BINDER ON LEAD STRIP.

This is done after thoroughly cleaning $\frac{1}{2}$ -in. wide lead strip and lapping it on armour of cable (having first slipped end of strip under free end of armouring) until diameter is rather more than the maximum diameter over armouring for box in question.

PLACING THE LOWER HALF OF THE BOX IN POSITION.

All boxes are coated with Dr. Angus Smith's solution. Where the lead strip has to be in contact with the cast iron, viz., inside glands and armour grips, this coating should be removed with coal tar naphtha from both lower and upper halves of the box.

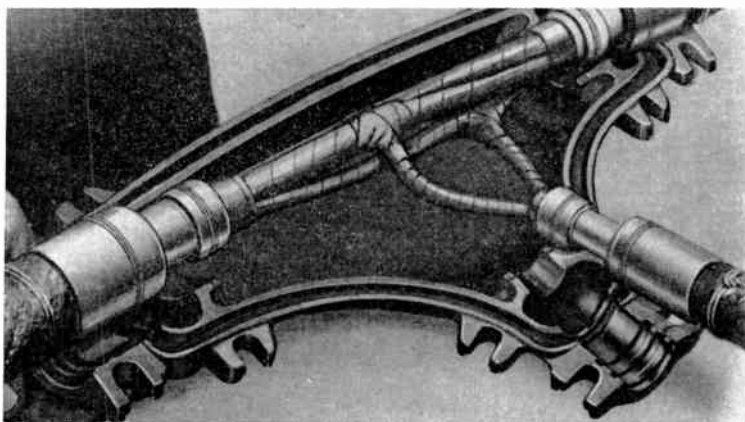

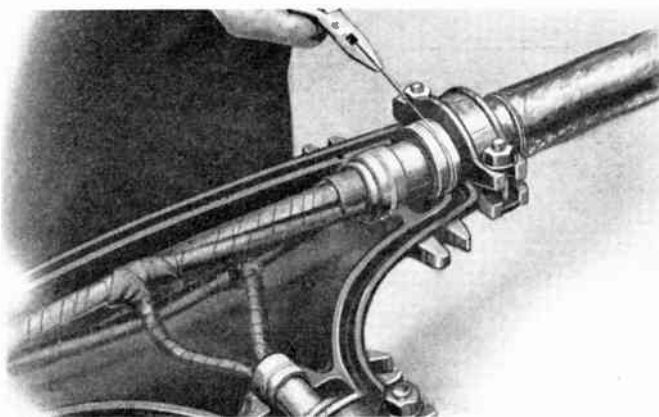

REMOVING THE WIRE BINDERS.

This is done after the armour grips have been placed in position and tightened down. The next step is to remove the cover plates from the top half of the box, prior to warming the lower half with a blow lamp.

WARMING LOWER HALF OF BOX.

After removing the cover plates from top half of the box by unscrewing the nuts, slacken the shuttles but do not remove the shuttles and bridge pieces from the top of the box. The lower half of the box is now warmed preparatory to filling groove with compound.

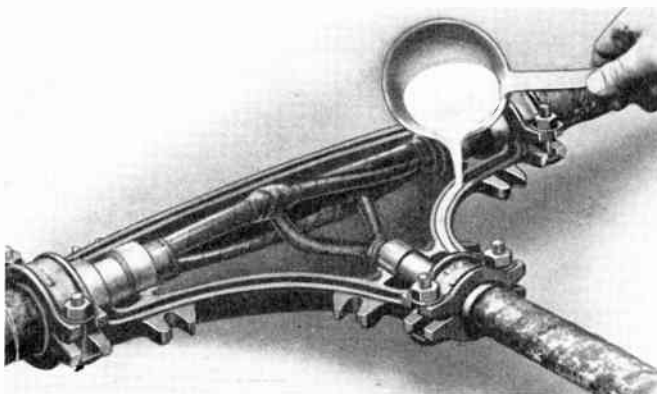

FILLING THE GROOVES OF THE BOX WITH COMPOUND.

This is done after the box has been warmed and the top half prepared as described. The lower half is now ready for the top half to be placed in position.

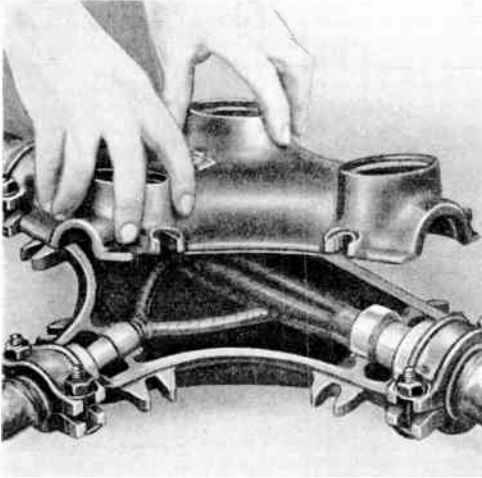

PLACING THE TOP HALF OF THE BOX IN POSITION.

This should be done as soon as possible so that the compound does not have time to chill. The bolts are then tightened on the box. Warm the box again and further tighten down the bolts.



TIGHTENING THE SHUTTLES ON TO LEAD BONDING STRIP.

A special spanner is supplied for this purpose. This operation is done after tightening the bolts on the box, and the box is now ready for the gland pockets to be filled with compound.

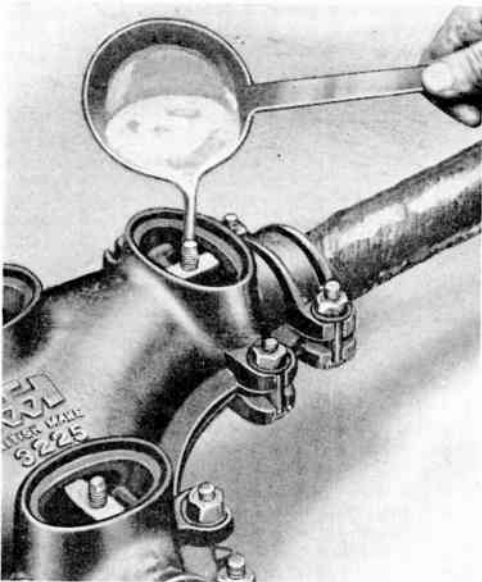

FILLING THE GLAND POCKETS OF THE BOX WITH COMPOUND.

This is done after tightening the shuttles on to the lead banding strip with the special spanner supplied for this purpose.

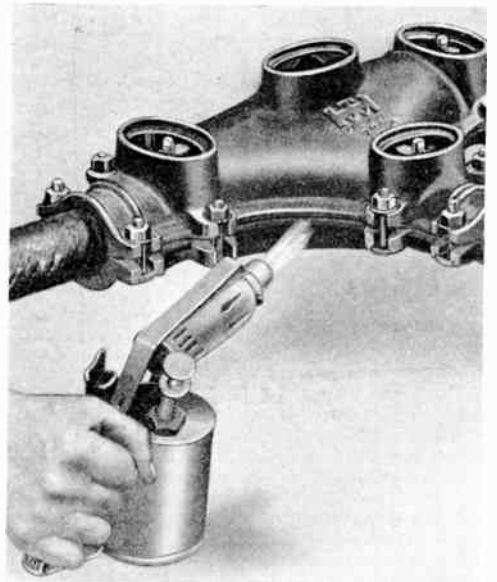

WARMING THE BOX AGAIN BEFORE GIVING THE BOLTS A FURTHER TIGHTENING.

This is done after filling the gland pockets with compound.

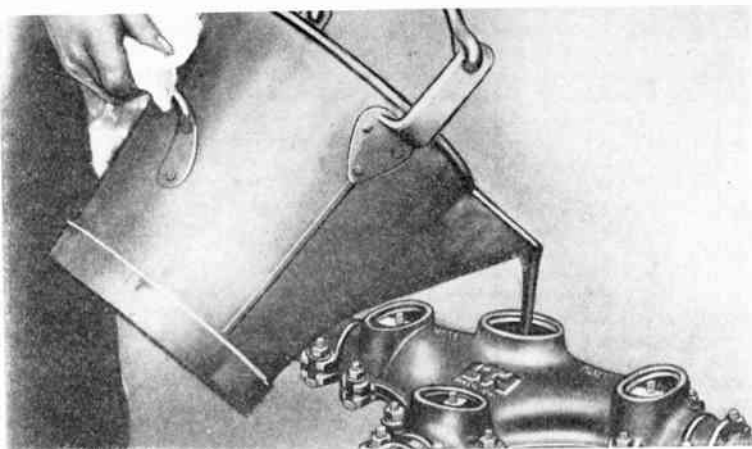

**POURING COM-
POUND INTO THE
Box.**

Fill the box three-quarters full with compound. Then temporarily replace cover plates to keep out dust, etc., and allow compound to cool to temperature of surrounding air.

**FLOODING THE COVER
PLATES WITH COM-
POUND.**

This is done after topping up the box with compound and replacing cover plates in position. The box should not be filled completely in one operation or there will be a tendency for a vacuum to form, due to shrinkage of the compound in cooling.

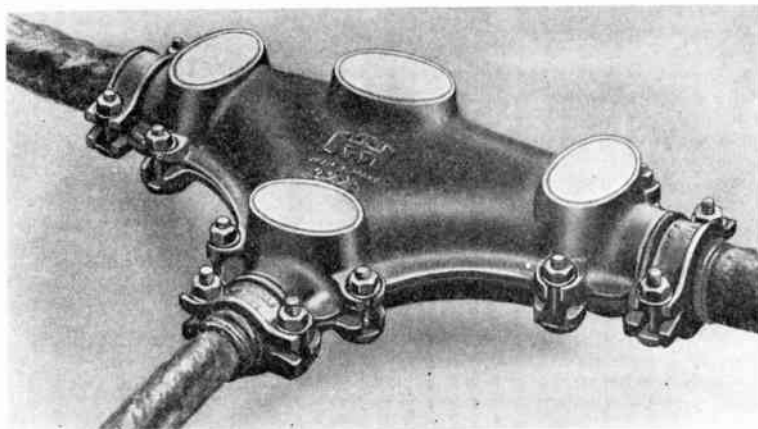

**THE COMPLETED
SERVICE JOINT.**

The ends of the box have been caulked with tarred jute, and all the cover plates have been flooded with compound.

THE MERZ-PRICE PROTECTIVE SYSTEM

By H. W. JOHNSON

In this article Mr. H. W. Johnson describes the working and maintenance of the Merz-Price system of protection for the prevention of dangerous currents in alternator, transformer and feeder circuits.

ONE of the most widely used and successful systems of protection for the prevention of dangerous and excessive currents in alternator, transformer and cable feeder circuits is that of Merz-Price.

The Principle of the Merz-Price System.

Under normal conditions the current which leaves an electric circuit will be the same as the current passing in. Should a "fault" develop in the circuit, for example a leak to earth, then the outgoing current will differ from the incoming current. This difference of currents in the two parts of the circuit can be arranged to operate a tripping device through a relay and open the circuit, thus preventing a dangerous current. This arrangement is independent of the direction of the flow of current. The relays may be arranged to operate either when the voltages are different, called a balance of voltages, or when the currents are different, called a balance of currents.

When the system is applied to feeder cable protection a balance of voltage is used, and when used for the protection of alterna-

tors and transformers, a balance of current is used.

Application to Alternator Protection.

A current transformer is connected in each end of each leg of the generator windings. The pair of transformers which are connected in any leg are identical, so that the induced currents in their secondaries will be similar when conditions are normal.

The secondaries of the transformers are connected together with pilot wires, and the mid points of these pilot wires are each

connected to a relay coil which operates the tripping circuit of the main circuit breaker of the alternator. The protective transformer secondaries are always earthed direct.

Direction of Currents in Secondary Winding.

The direction of the currents in the secondary windings of each pair of transformers is such that at any instant they oppose each other, so that when conditions are normal the relays are not energised, as no current will pass through their coils. Should a fault occur between windings or

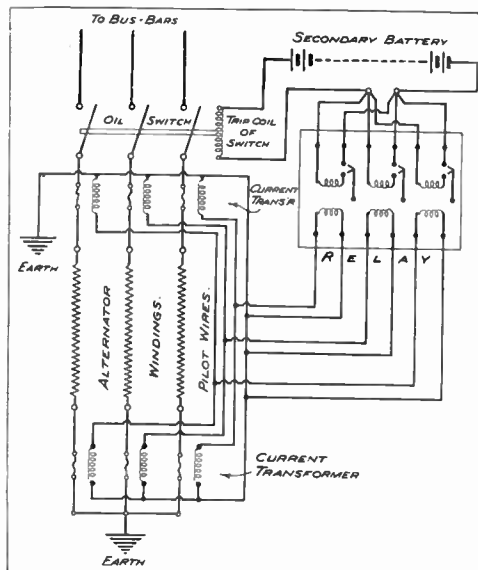

CONNECTIONS FOR MERZ-PRICE PROTECTIVE SYSTEM APPLIED TO AN ALTERNATOR.

The star points of the generator windings and the current transformers are earthed. The three pairs of D.C. terminals of the relay are connected in parallel, enabling the trip coil of the oil switch to be connected to them.

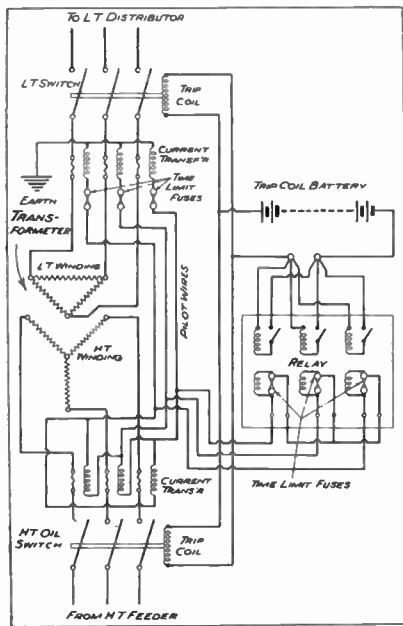

CONNECTIONS FOR MERZ-PRICE SYSTEM APPLIED TO TRANSFORMERS.

Time limit fuses are connected in series with the secondary windings of the current transformers. In the event of a sustained short circuit on the L.T. side the fuses melt and the main breakers are tripped, due to the current being diverted from the lower set of transformers and through the relays.

any of the windings be "earthed," then the system will be unbalanced and a current will flow through the pilot wires to the relay coils, which are now energised. The trip coil circuit of the alternator main breaker is now closed and the breaker is opened.

Transformer Protection.

Similar current transformers are connected in each of the primary, and secondary windings of the transformer to be protected. It is desirable also to protect the transformer from the effect of a sustained short circuit on its low tension side. To effect this, time limit fuses are connected in series with the pilot wires,

which connect the pairs of the secondary windings of the current transformers together. In order to prevent the main breakers being tripped when switching in, due to a large magnetising current which may occur, fuses are connected in parallel with the relays. These fuses, if made of small capacity (2½ amperes), do not impede the instantaneous action of the relays to any great extent, in the event of a fault occurring on the transformer to be protected.

Merz-Price protects both high and low voltage windings. Stand-by overcurrent protection is employed to protect transformer from damage due to sustained faults at other points in the system.

Application to Feeder Cable Protection.

The widest sphere of application of the Merz-Price protective gear is to that of protecting cables. In this case the current transformers are of special construction. These transformers should be capable of running with open circuited secondary, and the secondary voltage characteristics of the pair of transformers which normally oppose each other must be exactly similar under all conditions.

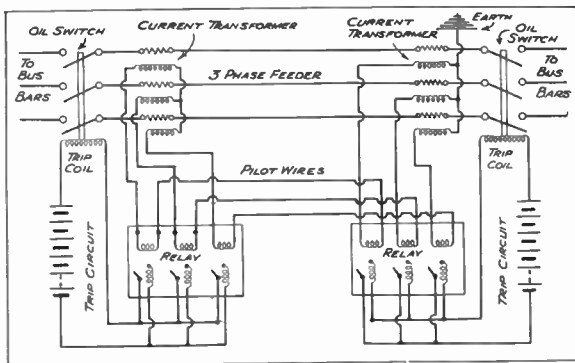

CONNECTIONS FOR MERZ-PRICE PROTECTIVE SYSTEM APPLIED TO FEEDERS.

The currents at the two ends of the feeders are balanced one against the other. In the event of a fault, the current flowing in will exceed the current flowing out and the balance of voltage in the two sets of transformers will be upset causing the relays to trip both oil switches simultaneously. Normally no current flows in the pilot wires, the secondary voltages being balanced against each other.

Each transformer is tested for balance with a standard test transformer, being connected "back to back" with it, and the various readings taken should be equal in numerical value and also be in phase.

What Happens When a Current Flows Through the Relays.

A pair of current transformers is connected in each end of the cables to be protected. The secondaries are connected together through pilot wires to relays which close the trip circuit of the feeder switches. When a current flows through the relays, due to the balance in the secondary circuit being upset by the occurrence of a "fault" on the feeders, the trip coils of the switches are energised by the closing of the relay and the feeders are disconnected.

Elimination of the Capacity Currents in the Pilot Wires.

The capacity current of the pilot wires in the balanced voltage system is sometimes enough to cause the relays to trip unless their settings are high. Then the cable is subjected to overloads. To reduce the capacity current, and so prevent overloading, the wires are provided with a metal tape sheathing, which is wound spirally over the insulation. The sheath is not continuous but has a break near the centre of the wire.

Effect of a Break in the Pilot Wires of a Balanced Voltage System.

A break in the pilot wire circuit of the balanced voltage system will render the protective gear inoperative should a fault occur, and consequently frequent inspection and testing of this circuit is necessary. With the balanced current system, as used for the protection of alternators and transformers, a break in the pilot wire circuit will cause the switches to trip if the current flowing at the time is large enough to operate the relays.

The Power to Operate the Trip Coils of the Main Switches.

The power necessary to operate the trip coils of the main switches is generally obtained from a battery of accumulators. This battery should be kept fully charged

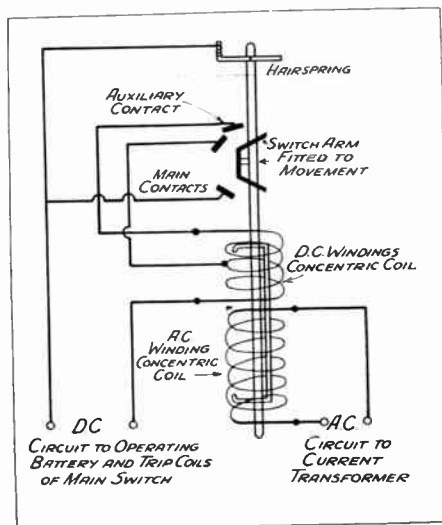

CONNECTIONS OF FAWSETT AND PARRY'S RELAY FOR USE WITH MERZ-PRICE SYSTEM.

When a "fault" occurs the A.C. winding is energised and the switch blade is moved on to the auxiliary contact causing the D.C. circuit to be closed, through the D.C. winding of the relay. The switch blades now move completely into the main contacts and the D.C. current of the relay is completed through them shunting the hairspring connection to the switch arm.

at all times, and for this purpose a motor generator is used.

When it is not possible to have a D.C. source of power, an A.C. trip may be used. In this case the relays in operating close the circuit of the current transformers through the trip coils. When the feeders to be protected are short, it is necessary to increase the resistance of the pilot wires in order that when a fault occurs sufficient voltage may be induced to operate the trip coils. Artificial resistances are connected in series with the pilot wires to increase their resistance to the required amount.

Relays for Merz-Price Protective System.

One interesting type of relay used in connection with the protective system is that of Fawsett and Parry. The principle (of action) of this relay is similar to that of a repulsion type moving iron ammeter.

How the Core is Built Up.

The core of the relay is built up of rectangular iron stampings with a rectangular space in the centre.

This space is bridged across by fixed and moving irons in such a manner as to leave small air gaps. These irons are surrounded by two concentric coils: one carries the fault current and the other the tripping current which operates the trip coils of the switch. The moving iron is fitted to a pivoted spindle which carries a switch arm, and the whole movement is controlled by a spiral spring. The spring also serves to conduct the current from the switch arm to the auxiliary contact. When a "fault" occurs the out of balance

current flowing round one of the concentric coils causes the moving iron to be repelled, thus closing the trip coil circuit.

The current flowing in this circuit is also made to flow round the second of the concentric coils, so that an extra torque is placed on the switch arm. This improves the contact of the switch. The main switch is thus opened by the trip coils, and in breaking, the tripping coil circuit is opened by an auxiliary switch which causes the relay movement to return to its normal position. The relay is very sensitive and will operate with a consumption of about .02 volt ampere, thus enabling very low fault settings to be obtained.

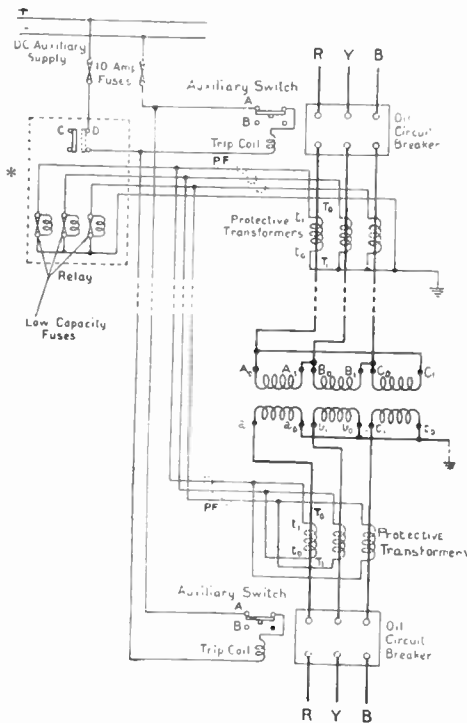

THE B.T.-H. SYSTEM OF CIRCULATING CURRENT PROTECTION FOR THREE-PHASE TRANSFORMERS.

The windings of the protective transformers are proportioned so that normally the two ends of each relay coil are at equipotential. If a fault develops the relay coils operate and close the trip coil circuit. Interior details of the relay are shown on the page opposite.

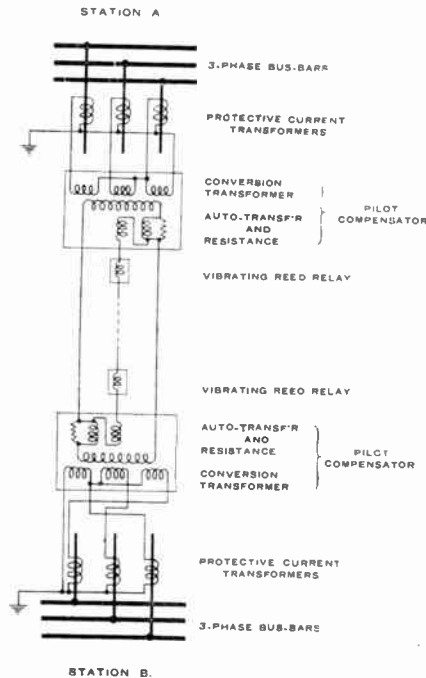

THE B.T.-H. METHOD OF SELF-COMPENSATING PILOT WIRE PROTECTION FOR THREE-PHASE A.C. FEEDERS.

This method is an improvement on the original Merz-Price system. Note that the relays are connected at each end of the middle pilot wire. The ends of the latter are connected to an auto-transformer and resistance in such a manner that pilot capacity currents are eliminated.

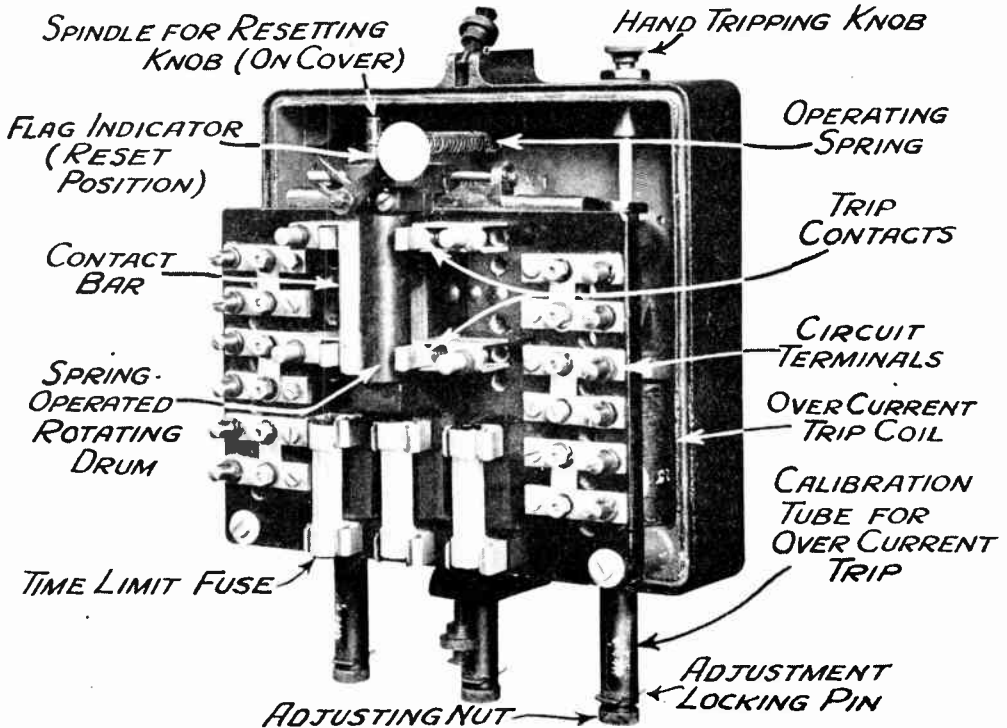

This illustration shows the details of the relay used in the B.T.-H. system of transformer protection. Compare with * on opposite page.

TWO PRACTICAL APPLICATIONS OF THE SYSTEM.

Circulating Current Protection of Three-phase Transformers.

The circuit details of this are shown clearly in the left-hand diagram opposite. Note the auxiliary switch A B. This opens automatically when the circuit breaker is tripped and must not be closed until the relay has been reset.

The Self-compensating Pilot Wire for Feeder Protection.

This ingenious modification of the Merz-Price system is illustrated in the right-hand diagram opposite. The pilot compensator has three parts: a conversion transformer, a resistance and an auto-transformer. The resistance and auto-transformer are adjusted at each end of the pilot wire so that capacity currents are entirely eliminated. This obviates the need for sheathed pilot wires and has been found to be highly satisfactory in practice.

Maintenance of Merz-Price Protective Gear.

Examine and test regularly the continuity of the pilot cables; their connections to the transformers and relays should be clean and secure and should be soldered. The movements of the relays must be quite free. A little clock oil on their pivots will prevent sticking. Examine the contacts of the relay switches and clean when necessary with fine glass paper.

Keep all parts of the relays clean and free from dust. Examine the relay settings and tighten any adjusting screws which may be slack.

When the balance of a pair of current transformers is suspected, they may be checked by connecting a low reading voltmeter in their pilot wire. No appreciable reading should be obtained when conditions are normal.

FUSED PLUGS

Something to remember when buying or selling electric clocks, table lamps, mains units, etc.

If small appliances are to be adequately protected from short-circuit damage, the wireman is compelled to fuse them at a much lower value than 5 amperes.

The up-to-date method is to use a fused plug. The simplicity of fuse renewal is well illustrated in the pictures below, which show the "Crabtree" pattern.

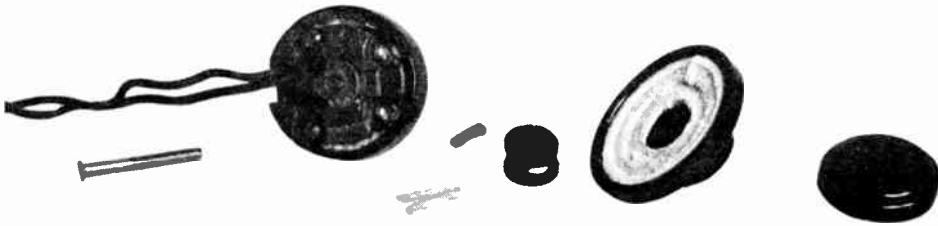

THE FUSED PLUG DISMANTLED FOR RENEWING FUSE WIRE.

This is done by unscrewing the screw between the two plug points. Note the spare supply of fuse wire which is contained on the small bobbin which forms part of the plug.

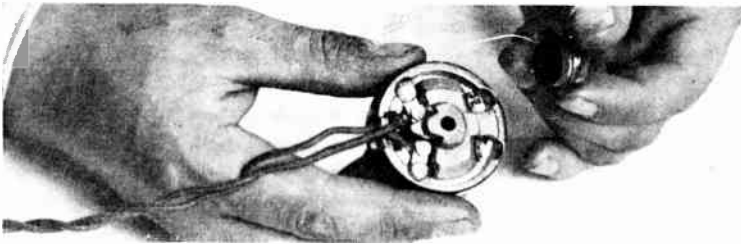

INSERTING THE NEW PIECE OF FUSE WIRE.

The old wire has been removed and the new wire is being unwound from the bobbin of spare wire.



REPLACING THE ASBESTOS CORD IN POSITION.

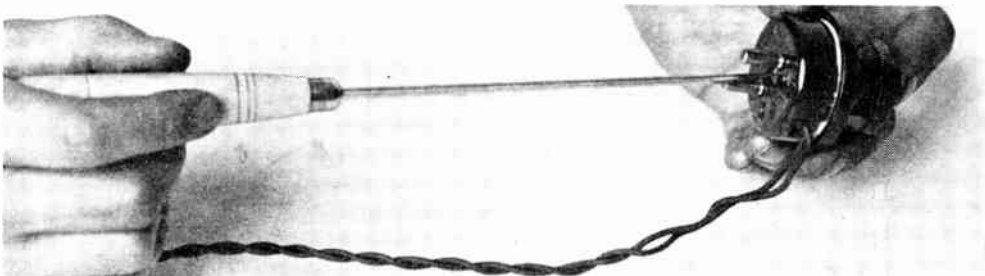

THE FUSED PLUG BEING REASSEMBLED.

PRACTICAL TIPS ON WIRELESS WIRING

The following series of photographs shows some useful tips for making a neat job when erecting an aerial or wiring up a wireless set.

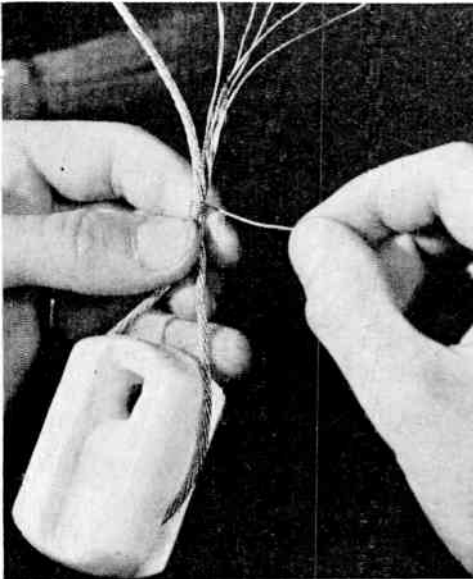

LASHING AERIAL WIRE TO INSULATOR (1).
After unravelling and straightening the strands for two or three inches put the wire through the insulator and begin lashing by binding one strand tightly around the aerial and the free strands.

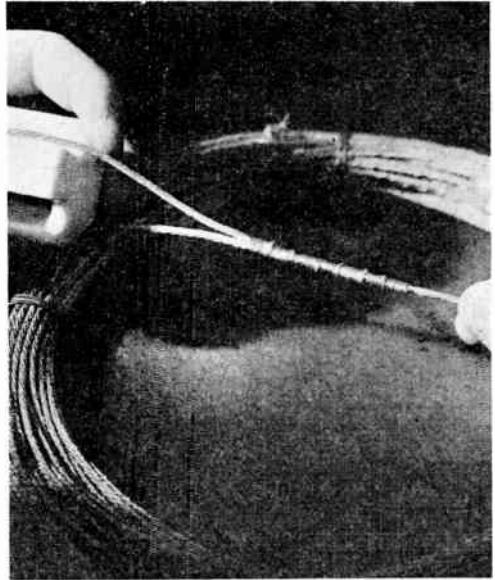

LASHING AERIAL WIRE TO INSULATOR (2).
As each strand comes to an end, begin binding with another strand, keeping each winding close up to the previous turn. The final strand will be on the aerial only, making the neatest and strongest binding possible.

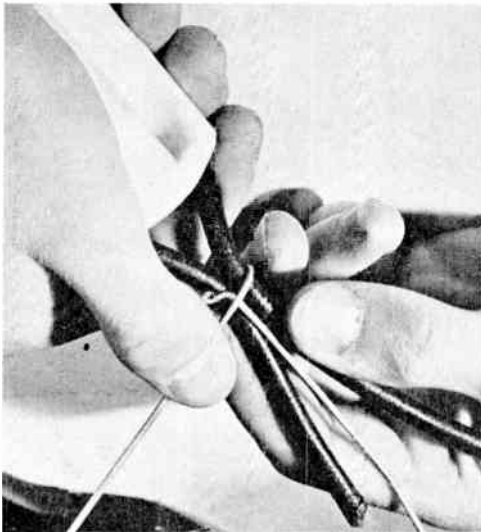

LASHING COVERED AERIAL TO INSULATOR (1).
Put wire through insulator and begin binding with galvanised wire as shown. The binding secures both strands of aerial as well as the short end of the binding.

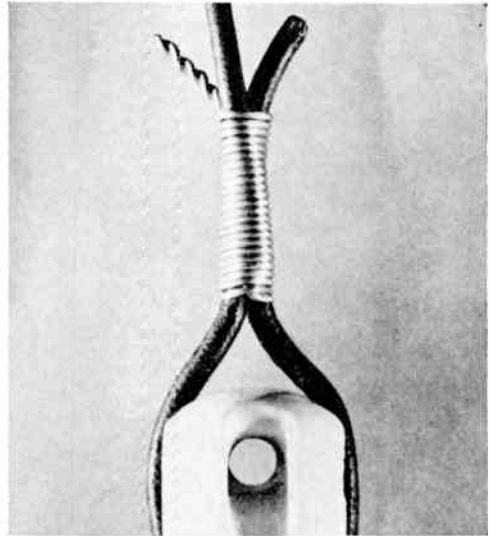

LASHING COVERED AERIAL TO INSULATOR (2).
Continue binding tightly and twist the two ends of the galvanised wire. Cut off ends neatly to complete the job.

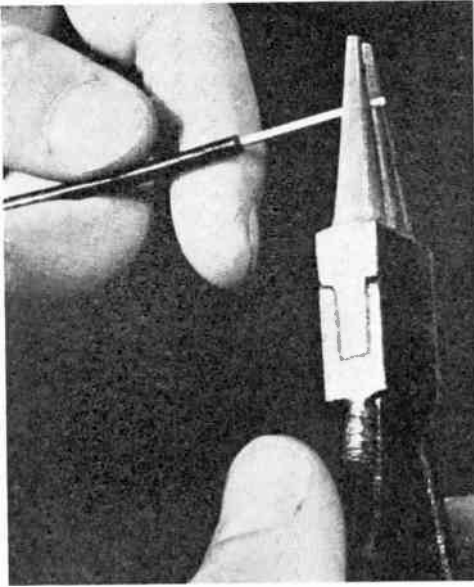

MAKING NEAT ENDS TO WIRING (1).
Bare about four times the diameter of the loop you wish to make.

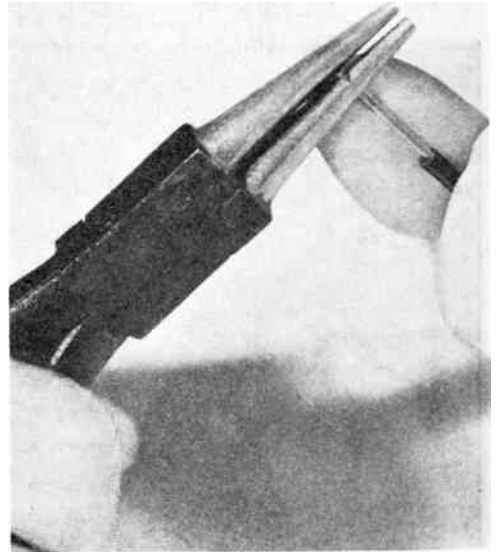

MAKING NEAT ENDS TO WIRING (2).
Grip the end in round-nose pliers and make a complete turn, pressing wire against pliers with the thumb.

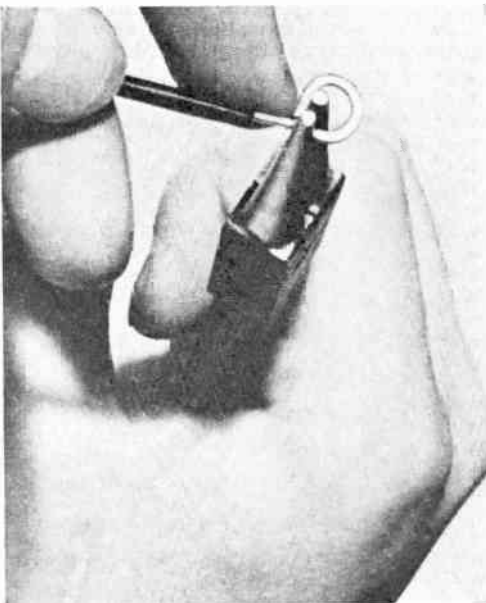

MAKING NEAT ENDS TO WIRING (3).
When turn is complete, turn pliers backwards in the loop until they meet the stem and give a sharp bend by pressing with finger-tip.

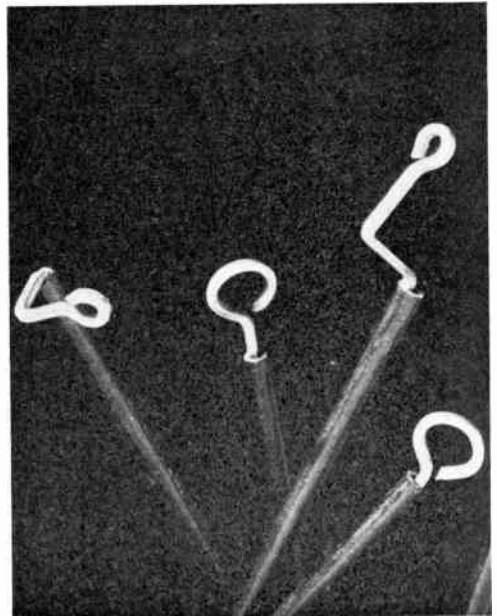

MAKING NEAT ENDS TO WIRING (4).
Showing results obtained by method described above. These are obtained as quickly as by affixing spade terminals.

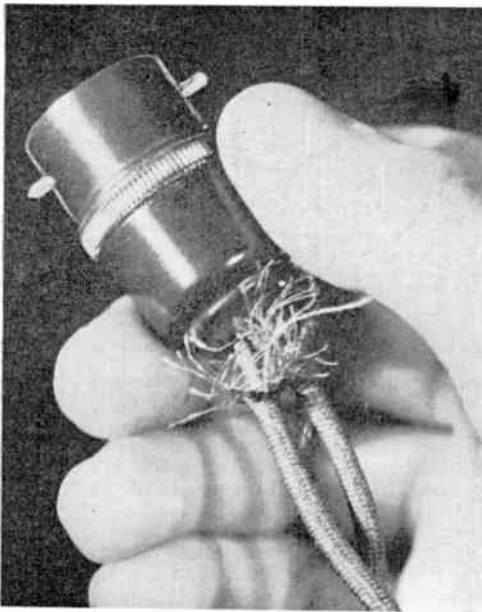

PREVENTING FRAYED FLEX (1).

When making a connection to an adapter, there is no need for the above unsightly frayed ends.

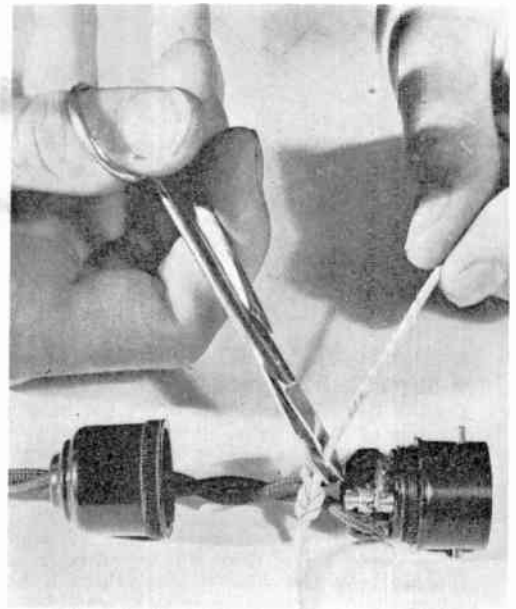

PREVENTING FRAYED FLEX (2).

Before screwing up the cover of the adapter, tie a piece of thick string tightly round the flex.



ATTACHING ENDS OF FLEX TO TERMINALS (1).

Wires should always be attached with their free ends to the right so that when the terminal is tightened the wire tends to draw closer to the shank.



ATTACHING ENDS OF FLEX TO TERMINALS (2).

This shows what often happens when soft or multiple wire is placed the wrong way round on the terminal:



The Editor invites correspondence from readers on any subject of general interest to members of the electrical engineering profession. Letters should be addressed to THE EDITOR, The Practical Electrical Engineer, 8-11, Southampton Street, Strand, W.C. 2.

The Diesel Electric Generator.

SIR,—I have been keenly interested in the collection of valuable information which was contained in "Practical Electrical Engineering," and am very glad to know that you have decided to publish a monthly magazine dealing with practical electrical engineering problems.

I venture to suggest that many of your readers would be glad of an opportunity of discussing their particular problems through the medium of a correspondence column, and I would like to initiate such a discussion on the claims of the Diesel electric generating plant for providing power for industrial undertakings.

In these days of keen competition cheap power is of vital importance to the manufacturer, and a saving on the power account means a reduction in production costs. For average industrial undertakings the price of current from a distributing company is not less than 1d. a unit, and often it is dearer. For a medium load, say, of 100 k.w. a Diesel electric plant will generate at about .6d. per unit, this figure taking into account capital, maintenance and attendance charges, and the saving is obvious.

It would be interesting to have the views of your readers on the important issues involved in the consideration of the question of the independent Diesel electric plant as against the public supply, and I do hope you will be good enough to open your columns to a discussion of this matter.

A. P. Q. (YEOVIL).

The question raised is of great importance to the electrical industry. If, as claimed, a Diesel-electric generator will enable an industrial works or factory to generate its own power at an "all-in" cost of 0.6d. a unit, this method must receive serious consideration by electrical engineers and consultants. We invite readers to give their views.

[ED.]

Scale Models for Electrical Testing.

SIR,—Recently attention has been drawn in the technical press to the expense of testing circuit breakers designed for use on the grid system. One authority states that the expense of carrying out rupturing tests may amount to 25 per cent. of the manufacturing costs. As a

non-specialist in switchgear matters I should like to know whether the use of scale models has been tried in this connection. From a purely mechanical standpoint there would presumably be little difficulty, but the scaling down of the electrical quantities might present some new problems. If the method has been tried I should be interested to know how the voltage, current and energy are "scaled down" to correspond to a reduction of the mechanical dimensions.

A. J. T. (WEMBLEY).

Whilst scale models are used with success in other branches of engineering, notably in aeroplane design and ship design, it appears doubtful that the problems of electrical switchgear design could be successfully solved in this manner. The suggestion, however, is an interesting one and readers' views are invited.

[ED.]

A Wiring Problem.

SIR,—Recently I have wired two houses for electric bells, in each case using Sax bells and indicators, and employing wet cells of the Leclanché type to supply electricity. One house was already wired in capping and casing with a 100-volt D.C. plant to provide current for lighting. There was also a battery-driven wireless set employing an indoor aerial. This set drove two loud speakers, one by the set, and the second (in an outhouse) was fed by a pair of overhead wires. We had one bell and one push in the outhouse, both fed from the house by overhead lines parallel to about 15 ft. away from the speaker feeds. With the set working and either this bell rung or the push depressed the sound was heard on the speakers.

In the second house, which was supplied for lighting by the local supply company at a pressure of 100 volts A.C., an all-mans wireless set was used. This time all the bells and the loud speakers were in the house, and any bells rung sounded on the speakers.

In both cases all our bell wiring was kept as far as possible from the lighting wiring, and nowhere came in close proximity to the extensions for the loud speakers or the aerial or earth leads. Is there any way of overcoming this trouble?

W. H. C. (FARNHAM)

SUCCESS

FROM ALMOST TO THE

UTTERMOST



If you intend to SUCCEED—
If you intend to get above the "Hammer and File" Brigade—

If you intend becoming a **Qualified Electrical Engineer**, and not just an Electrician—

then you cannot *afford* to carry on without reading "**ENGINEERING OPPORTUNITIES.**"

This free book explains many ways of carving out a successful career in the rapidly growing field of Electricity. For instance :—

Do you realise that there are Examinations open to you that lead definitely to jobs carrying a salary rising from £4 10s. per week to over £1,000 per year, without requiring any particular experience?

Our Handbook explains such opportunities, and is, in fact, filled with matter of vital importance to you from cover to cover.

The Handbook also outlines modern Home-Study Courses in all branches of Engineering, including :—

GENERAL ELECTRICAL ENGINEERING.	ELECTRICAL INSTALLATIONS.
ALTERNATING CURRENT ENGINEERING.	POWER HOUSE DESIGN AND OPERATION.
ELECTRIC TRACTION.	MAINS ENGINEERING.
TELEGRAPHY; TELEPHONY.	TALKING PICTURE ENGINEERING.
WIRELESS AND HIGH FREQUENCY.	TELEVISION, etc., etc.

Full particulars are also given of all recognised Engineering Examinations, including :—

I.E.E.
B.Sc.
I.W.T.

City and Guilds.
G.P.O.
A.Rad.A., etc., etc.

Our record of successes in the above Examinations is remarkable. *In the I.E.E. alone we have returned 100% successes at the past three Examinations*—a magnificent record.

WE ALONE GUARANTEE—"NO PASS—NO FEE."

We repeat, you cannot *afford* to carry on without reading "ENGINEERING OPPORTUNITIES." Send for it to-day, stating the subject which is of most interest—FREE, and without obligation.

BRITISH INSTITUTE OF ENGINEERING TECHNOLOGY, LTD.,
350, SHAKESPEARE HOUSE, 29/31, OXFORD STREET, W.1.

Free

**Get this
Lightning Calculator**

RAWLPLUGS

R. 99.

EVERY electrician and builder should have one of these useful calculators. Without any figuring on your part it tells you the exact size of screws or coachscrews to use with any particular Rawlplug, the diameter size of Rawlplug or Rawl-drill required, the strain which the fixture will resist and the price per box of the Rawlplugs. All this information is obtained by merely revolving a circular indicator. Get one to-day. It's free in exchange for your letter-heading or business card.

The Rawlplug Company, Ltd.,
Rawlplug House, London, S.W.7

Of extraordinary value to every handyman

NEWNES HOME MECHANIC BOOKS

Clearly written and fully illustrated

MOTOR CAR UPKEEP AND OVERHAUL.

This practical book is right up to date, and a valuable work of reference to the owner who wishes to do his own running repairs.

TOY MAKING FOR AMATEURS.

Tells you how to make toys of every description and lays bare the principles by means of abundant illustrations and simple text.

MODEL BOAT BUILDING.

Contains designs for battleship, speed boat, paddle-steamer and yachts. No elaborate tools are needed, and each model can be made at small cost.

MODEL AEROPLANES AND AIRSHIPS.

Full details of easy-to-make models that will fly. Crammed with illustrations.

THE HOME WOODWORKER.

How to make a large variety of articles, together with many useful hints on woodworking.

ACCUMULATORS.

Dealing with every type of accumulator, methods of charging them at home, care and maintenance, also explains how to erect a charging station.

SIMPLE ELECTRICAL APPARATUS.

An excellent book for those who wish to make simple and useful electrical appliances, such as galvanometers, electric motors, dynamos and Leyden jars.

25 TESTED WIRELESS CIRCUITS.

All sets described have been designed to meet modern needs. They range from simple crystal receivers to a seven-valve super-heterodyne; all have been made and tested before inclusion.

25 SIMPLE WORKING MODELS.

Ingenuous and practical designs for electric, steam and clockwork models.

THE HANDYMAN'S ENQUIRE WITHIN.

Hundreds of practical ideas and hints of value to the man who is clever with his hands.

1/- each; post free 1/2 each

Obtainable from all Newsagents and Bookstalls, or by post from George Newnes, Ltd., 8-11, Southampton Street, Strand, London, W.C. 2.

Geo. Newnes, Ltd.

Printed in Great Britain for the Proprietors, GEORGE NEWNES, LTD., 8-11, Southampton Street, Strand, W.C. 2, by WILLIAMS, LEA & CO., LTD., Clifton House, Worship Street, E.C. 2. Sole Agents: Australasia: GORDON & GOUGH (Australasia), Ltd. South Africa: CENTRAL NEWS AGENCY, Ltd.