

Top 10
pocketables

Practical Computing

85p February 1984
Volume 7 Issue 2



CHIPS – special 12-page guide to CPUs

Exclusive reviews: Multi-user Seiko 8600

New 64K Tandy Color Computer LSI Octopus

Save on heating bills with a BBC Micro

Interfacing Apple II Commodore 64 games

Denmark DKr34.50, Greece Dra 245, Holland DFL8.50, Italy L4100, Spain Pts 360, Switzerland SFr7.40, Germany DM8.50, France Fr32.60, Canada C\$4.50,
Australia A\$3.00, Singapore M\$6.35, USA \$3.95(D72162)

IS THIS LEVEL OF RELIABILITY REALLY NECESSARY?

ACCUTRACK



If you've ever lost data due to a faulty disk, you know how important reliability can be.

That's why Accutrack disks are critically certified at 2-3 times the error threshold of your system. Why they're precision fabricated for higher signal quality, longer life and less head wear. And why we take such extra steps as testing single-density mini disks at double-density levels. So you don't have to worry about the reliability of your media.

Accutrack disks. OEMs have specified them for years. You can trust them for your data.

Distributed in the United Kingdom by:

Penbie International (C.A.) Ltd.

23 Addington Road

Reading RG1 5PZ

Berkshire

Tel: (734) 664361

KV **ACCUTRACK**
BE **Dennison KYBE (UK)**

9 Colonial Way
Watford WD2 4JY
Tel: (923) 50596
Telex: 923321

Offices and representatives worldwide

● Circle No. 101

LIST

PRACTICAL COMPUTING FEBRUARY 1984

>NEWS

13 HARDWARE NEWS
More new micros, including professional models from Tandy and Texas, plus the Koala graphics tablet for the Commodore 64.

21 SOFTWARE NEWS
Digital Research's new languages, compilers for the Commodore 64 and Apple program generators.

29 PRINTOUT EXTRA VISITS DEBENHAMS
Glyn Moody on how a major chain store is aiming for business buyers.

49 IBM PC NEWS
More details of the XT/370, more look-alikes, more add-ons and more software.

>REVIEWS

50 IBM PC JUNIOR
More details of the forthcoming Peanut — the newest low-cost PC-compatible micro.

64 NEW 64K TANDY COLOR COMPUTER 2
A hands-on review of a micro launched at the Which Computer Show.

66 LSI OCTOPUS EIGHT/16-BIT MICRO
An expandable British micro, previewed by Glyn Moody.

70 SEIKO 6800 MULTI-USER MICRO
We set a pair of reviewers working together on this smart new Japanese machine.

74 NEC'S MODEL 8201A LAP COMPUTER
Chris Bidmead compares the NEC offering with its brother, the Tandy Model 100.

77 BBC DIARY
Battery-backed ROM makes life pleasant for Neville Maude, trying out the Acacia diary.

78 WINDOWS IN VISI ON
Ian Stobie looks at Visicorp's long-awaited Lisa-like integrated software Visi On, and its forthcoming competitors.

118 COMMODORE 64 GAMES
Paul Bond tried over 30 games for the 64. This is his selection.

161 BOOK REVIEWS 8086/8 ASSEMBLER
Paul Myerscough reviews books for programmers of the IBM PC and similar 16-bit micros.

>CHIPS



102 ALL YOU NEED TO KNOW ABOUT CPUs
Ray Coles presents a special 12-page guide to the major microprocessors, including eight-bit favourites like the Z-80 and MOS 6502, and the popular 16-bit types currently competing for a share in the market.

>FEATURES

80 INSURING YOUR MICRO
Ian Hopkins provides a guide to keeping your micro covered.

82 SAVE MONEY ON CENTRAL HEATING
Use John Smith's BBC Micro program before you call in the plumbers.

86 APPLE II INTERFACING
Part 1 of a beginners' guide to the ins and outs of connecting an Apple to the outside world.

90 PROGRAMMING AN INDEX
How to use the Soundex algorithm to code a useful phone index or similar database, with a listing for the Pet.

94 FICTION TOMORROW'S WORLD
Andrew Walker's latest story explores the world somewhat beyond 1984.



99 TOP 10 POCKETABLES
Ian Stobie surveys the pocket-computer world to see what's available.

>REGULARS

5 EDITORIAL — TOP 10
Do we need lists of the top micros and software? If so, who should prepare it?

7 FEEDBACK
The morality of war games is among the topics raised by readers this month.

35 CHIP-CHAT THE TRANSPUTER
Ray Coles' monthly column turns to Inmos and the British challenge.

88 PROGRAMMERS' PAGES TABLE MANNERS
Mike Lewis introduces a new monthly column written from the programmer's point of view.

129 OPEN FILE SOFTWARE
Listings for the BBC, Apple, Commodore, Sharp, Sinclair, Atari, Newbrain and Tandy.

173 LAST WORD
Chris Naylor, expert-systems expert, plans to computerise the human brain.

Thanks to Motorola, Intel, Zilog, Maplin, and Rapid Terminals for supplying the processors shown on the cover.

**Just because you
need it in a flash,
don't expose
yourself!**



You've a deadline to meet, the right CP/M Software package is needed, the right decision has to be made; which format, which product, when can it be delivered, at what price?

You need good advice, and just as important, you need to talk to someone who has a large enough range to be able to offer honest advice. Someone who can then deliver on time, someone whose catalogue is fast becoming the byword of the software industry.

So don't expose yourself, talk to Software Limited. Choice, advice and delivery, all aimed at meeting your deadline.

Software Limited...
Because there's more to choose from, we're the only choice to make.

01-833 1173/6

Software Limited
No. 2 Alice Owen Technology Centre
251 Goswell Road, London EC1

CP/M is a trademark of Digital Research



Attractive quantity & dealer discounts available

● Circle No. 102

Practical Computing

EDITORIAL 01-661 3609

Editor
Jack Schofield
 Assistant Editors
Ian Stobie
Glyn Moody
 Art Editor
Steve Miller
 Production Editor
John Liebmann
 Sub-editor
Carol Hammond
 Editorial Secretary
Sue Jordan
 Consultants
Chris Bidmead
Peter Laurie

ADVERTISING 01-661 3612

Advertisement Manager
Ian Carter 01-661 3021
 Assistant Advertisement Manager
Paul Braybrooke 01-661 8626
 Advertisement Executives
Jacqui Ball 01-661 3633
Lynne Brennan 01-661 8100
Mike Crimp 01-661 8425
 Advertisement Secretary
Janet Thorpe
 Midlands office:
David Harvett 021-356 4838
 Northern office:
Geoff Aikin 061-872 8861
 PUBLISHING DIRECTOR
Chris Hipwell

Published by Electrical Electronic Press, Quadrant House, The Quadrant, Sutton, Surrey SM25AS. Tel: 01-661 3500. Telex/grams 892084 BISPRS G.

Distributed by Business Press International Ltd, Quadrant House, The Quadrant, Sutton, Surrey SM2 5AS.

Subscriptions: U.K. £13 per annum; Overseas £19 per annum; selling price in Eire subject to currency exchange fluctuations and VAT; airmail rates available on application to Subscription Manager, Business Press International Ltd, Oakfield House, Perrymount Road, Haywards Heath, Sussex RH16 3DH. Tel: 0444 459188.

Printed in Great Britain for the proprietors Business Press International Ltd by Eden Fisher (Southend) Ltd, Southend-on-Sea. Typeset by Centrepoint Typesetters, London EC1.

© Business Press International Ltd 1984

Would-be authors are welcome to send articles to the Editor but PC cannot undertake to return them. Payment is at £35 per published page. Submissions should be typed or computer-printed and should include a tape or disc of any program. Handwritten material is liable to delay and error. Every effort is made to check articles and listings but PC cannot guarantee that programs will run and can accept no responsibility for any errors.

Who needs a top 10?

LISTS OF the top 10 records, cars, books and television programmes exercise a curious fascination. It is hardly surprising that a number of micro magazines publish top 10s or 20s of computers or programs.

At best a top 10 can provide three things: first, entertainment; second, an indication of which companies and/or products are selling; third, help in deciding which products might be worth looking at in more detail.

In the first case, it does not matter much if the list is accurate or not. Who cares if the 10 most beautiful words or top 10 tie-wearers really are or are not the top 10?

In the second case, however, accuracy is essential. A top 10 sales chart is worth only as much as the data on which it is based. Even then, a guide to sales is not necessarily a guide to success. For example, Texas Instruments has just dropped out of the home-micro market when, according to Dataquest, it was number 2 in the world after Commodore in the category of micros under \$1,000. The company's recent huge quarterly losses show that even these sales were unprofitable.

In the third case, the value of even an accurate list is very much a matter of taste. There is not necessarily a connection between any of the items listed. All that *Coronation Street* and *This is Your Life* have in common, essentially, is that they are popular.

Neither is popularity a guarantee of quality. The *Sun* newspaper sells twice as many copies as *The Times*, *Guardian*, *Daily Telegraph* and *Financial Times* put together. This does not make it a more comprehensively reliable guide to world affairs. It is certainly a more accurate indicator of popular taste and is also cheaper, which counts for a lot in the U.K.

Yet in the microcomputer business there is nothing quite as strong as the bandwagon effect.

The whole industry is crying out for standards, and quality may take second place to the widespread use which establishes a *de facto* standard.

Few people would claim that CP/M is the best possible micro operating system, or that in hardware terms either the Sinclair Spectrum or IBM PC represent the optimum hardware for games playing or business use. These products do not sell only insofar as they are good or bad: they sell because they sell.

Another factor is that, by and large, most of the people currently buying micros and software do not have the slightest idea what they are doing. It is easy to buy, say, a Commodore 64 without knowing it needs a considerable amount of programming just to draw a straight line. It is easy to order an Electron without considering how joysticks, discs and printers can be plugged into it. That is not to say that these are rotten machines, but it is the case that most of the people who buy them are, in computer terms, innocents. The problem is that a list of best-sellers can be used to avoid thinking about what is being purchased. "Thousands of other people have bought it so it must be good" — if only that were true.

So top 10 lists are important in computing, and we only wish there was one we felt we could rely on. Unfortunately a reliable guide is only likely to come from the independent analysis of confidential sales figures. In the current market, where whopping lies are far from unknown, which companies would be willing to release them, and to whom?

The Computer Retailers Association, as desperate for information as the rest of us, is trying to answer this very question. It is possible the CRA will produce a guide, at least to the best-selling business software.

It would be a start. We live in hope. □

5 Years ago ...

Commodore has reduced the price of its Kim 1 to £99.95. This price puts it well in the range of students, hobbyists and schools, but it remains ideal for control applications and training industry.

Commodore stresses that the Kim 1 is not a kit, but a complete microcomputer with a fully assembled PC board, needing only a power supply to operate. Based on the MOS 6502 microprocessor, it has 2K bytes of ROM, 1K byte of RAM, a keyboard and six-digit LED display. The system can be expanded significantly, starting with the Kim 38K

RAM memory boards (£193.32 inc VAT). This can be wired in by the user — all the required connectors are built-in — or attached more neatly by using a Kim 4 motherboard (£96.12 inc VAT).

An ordinary audio cassette unit can be attached to provide auxiliary storage. All interface circuits provided on the Kim 1 board including a Teletype interface are ready for connection. If the Teletype has the facility, Kim can also handle paper-tape input and output.

Practical Computing, Volume 2 Issue 2

The Abbey National Building Soci
127 Cross Street
Manchester M49 3SC

October 18th 1983

Dear Sir,

I would be much obliged if you
to the repayment

Mr A Carter,
Brown, Carter & Co.,
118 Smallbridge Road,
Edenbridge KT15 4NW

Dear Mr Carter,

Please find your copy of FETCH
instruction sheet you should
late satis

The Chief Engineers Department,
Tapex Computer Limited,
North Hill,
Birmingham B63 1NJ

Dear Sir,

This is the fourth time it has
you with respect to the noisy
and effective action

Mr P W Brown, Manager
Barclays Bank Ltd
175, The High Street
LONDON N22 7UY

your ref: 90564435

Dear Mr Brown,

In response to your letter of
every effort will be

For £46, your word processor can get personal.

The trouble with most CP/M* word processors is that they can't work out who's who.

While they're fine at sending one letter to large lists of people, they're virtually useless for one-off communications.

In fact, getting one name from your name and address file is such hard work that your secretary probably retypes it every time it is needed, wasting time, money and an expensive name and address file that is only used for mailing shots.

Business Data Capture, however, have now developed a new program which personalizes CP/M* word processing.

It's called FETCH. And that's exactly what it does.

When you call up a key name or number, it dives into your name and address file and transfers the name and address that you need to the document you're processing.

It can be formal or familiar, according to the relationship you have with each individual.

It also adds the day's date automatically. And a reference if necessary.

There's no limit to the number of names and addresses that FETCH can handle, even if they are in Datastar format.

So besides saving a great deal of time, it cuts out all

possibility of error and embarrassment with your clients.

Yet, the cost is only £46, including VAT, post and packing. Just send the coupon with your cheque or credit card number to: Business Data Capture Ltd., 262 Regents Park Road, London N3 3HN.

Or if you would like to order by telephone with your credit card, ring 01-349 4095.

You'll receive your program disc with a clear instruction manual within 14 days.

And if you are not satisfied for any reason, you are free to return them to us within 7 days for a full refund.

BDC FETCHTM
The program that
names names.

To Business Data Capture Ltd., 262 Regents Park Road, London N3 3HN. PC2

Please send me your FETCH program disc and instruction manual.

I enclose a cheque for £46 including VAT, post and packing, payable to Business Data Capture.

I would like to pay by credit card. My number is _____

(Visa/Access only)

My computer is: _____ My disc size is: 5 inch/8 inch

(please circle)

Name _____

Address _____

*CP/M is the registered trade mark of Digital Research.

Registered at 262 Regents Park Road, London N3 3HN. Registered in England No. 1326021.

● Circle No. 257

War games

IN THE December issue of *Practical Computing* you reviewed several games, among them Eastern Front. You praise it as a good game with amazing graphics.

Is that all you have to say about it? After all, the object of the game is to plan the death of men most effectively. The player is encouraged to do better than Hitler while sitting in the armchair.

Children might believe that this is what war is like. Adults should know that war is no fun and Hitler is not JR.

Oliver Völckers,
Osnabrück,
West Germany.

● The Editor replies: Does the fact that Eastern Front offers a fairly accurate historical simulation of the Barbarossa campaign make it less acceptable than other war games such as chess, or make it more educational? What do other readers think?

HP Model 16

MANY THANKS for the copy of December's *Practical Computing*, and your review of the HP series 200 Model 16. I thought I had best let you know of a few inaccuracies which have crept in, just to keep the record straight.

HPL is not a version of APL, nor indeed does it resemble it. The nearest one can say is that it looks rather like a cross between Basic and Algol 60.

The Model 16, unlike some other members of the HP Series 200, cannot run Unix. Finally, the Basic manuals described are included in the cost of the system.

All of these are relatively minor matters and in no way spoil my appreciation of your very good review.

Ron F Weeden,
Hewlett-Packard Ltd,
Wokingham,
Berkshire.

Bad service

I HAVE BEEN trying to use a 48K Spectrum to help in the day-to-day running of my dental practice for the last 12 to 14 months or so. I have written my own software, which I also sell to my professional colleagues in a small way. The system is now proving to be a great help.

However, one thing that has certainly not helped is the unhelpful and ill-mannered attitude of the majority of firms

in the British computer hardware / peripheral industry. I no longer expect to receive replies to eight out of 10 letters of enquiry that I write, even though I always send an SAE.

When I eventually do find a firm that will condescend to soil its hands with the sordid business of actually selling me something, I no longer expect the things to function as advertised, if at all.

One of the latest offenders has been Kempston Electronics — a Centronics interface that had the driving software recorded on the leader tape of the cassette, and an interface unit that locked up the computer completely. These were eventually replaced, but two enquiries that I have made to the firm since then have had no reply. One of them was to ask why I cannot use the complete character set supplied with my printer, a Star DF-510, or even the complete character set of my Spectrum. The printer is recommended in Kempston's advertising as being completely compatible.

The other firm that I have had recent contact with is the Spectrum group. I phoned a number of the group's local dealers to enquire about the Viscount disc drives for the Spectrum and was greeted with ignorance, apathy and downright rudeness. One salesman was helpful — I expect he's been sacked by now.

I daresay we shall all soon be treated to the sight of the British computer retail and manufacturing trade wringing

its collective hands, and bemoaning the fact that they are going out of business, while the Japanese — or whoever happens to be the latest scapegoat — are flourishing. Will I feel sorry for them? I'll leave you to guess the answer to that one.

I realise that my experiences are far from unusual — indeed, a lot of people will probably feel that I've got off very lightly so far. However, I don't see why we should have to put up with this situation. The money comes from our pockets, after all, and if the bad firms are constantly exposed, then maybe other customers will go elsewhere, until only the decent firms are left. My local Micromanagement dealer was most helpful recently when I was looking for a new printer — needless to say, he got my order.

W H Roberts,
Pencoed,
Mid Glamorgan.

IBM PC XT

PERHAPS you would care to note the following points relating to your review in the October issue of *Practical Computing*.

The use of the word Multiplan is invalid since it is more than eight letters long, so it is thus shortened by DOS to Multipla.

When creating a path, there should not be any spaces after the \ symbol. The current path can be checked simply by typing Path, when at command level. This would have shown up these points. The Path command is only for use in batch or command situations, and is not a default route to a data file if not in the current directory.

When searching for a file not in the current directory, DOS expects the drive letter as part of the file identifier; otherwise it only searches the logged drive. Furthermore, directory searches are carried out on each drive only by the previously set CHDIR pathways for the individual drive, and files that are actually in the volume may be invisible.

By keeping important files, such as utilities, in a specific directory and setting the appropriate path, it may be possible to use them from any current drive or directory position.

To a newcomer, the DOS 2.0 manual is without doubt an intellectual challenge second to none. It makes learning the Highway Code an exercise to be enjoyed in comparison.

Martin Guyer,
London SW6.

What about Tandy?

IN OUR FAMILY we have several systems which we use for the normal home-computing activities, and we often get asked for advice on purchasing computers. Therefore we were interested in Jack Schofield's article "Home Truths" and recognise the validity of his general principles.

Many journalists, including some in *PC*, mention way-out ideas such as the Spectrum and Microdrives for business use. A basic knowledge of business costs would show that a cheap unit and expensive labour are not cost effective. Any competent typist will double their output on a good keyboard, and the error-count on a poor machine will prohibit its use for business.

Where we would disagree with Jack Schofield is that the TRS-80 is, by implication, considered poor. It is a reliable machine that has suffered no significant compatibility problems for years and has a mass of good software at all prices. We consider that LDOS and Newdos 80 are superior to the DOSs available for the Apple and certainly the Commodore 64.

The ROM-based word processor of the BBC is simple to use but lacks the power of Scripsit, let alone Superscripsit; and Enhanced VisiCalc for the TRS-80 seems to have more commands than the Apple

(continued on next page)

Our Feedback columns offer readers the opportunity of bringing their computing experience and problems to the attention of others, as well as to seek our advice or to make suggestions, which we are always happy to receive. Make sure you use Feedback — it is your chance to keep in touch.

(continued from previous page)

version. We have never bothered to add the high-resolution peripherals as colour and high resolution gobble up memory.

When our TRS-80 was destroyed by fire we had the opportunity to purchase some new equipment at the insurance company's expense. Sharing Jack Schofield's view that in a few years there will be much better machines, we chose to buy a Model 1 TRS-80 which was available from our local Tandy store, but added a non-Tandy 64K memory which brought the total cost to just over £200. A further £230 added a single disc drive.

During the period when we were without a computer, we were able to walk into any Tandy store and the management were pleased to let us use the demo machine. Despite the fact that Tandy is now using the Model 4, all our Model 1 software can be made to run under LDOS without problems. This, combined with the fact that Tandy actually makes a profit on computer sales and is therefore likely to stay in business, must make them at least a reasonable buy.

W Trayler,
Hornchurch,
Essex.

Calling by name

I WAS very interested to read John Hooper's article in the November *Practical Computing*. Calling sub-routines by name certainly aids readability of Basic programs but, as I am sure many readers will have realised, in many dialects of Basic there are better ways of achieving it.

If the line number in Goto can be an expression, as on the

Atari, Spectrum or Oric, then Hooper's switching routine can be eliminated completely. Instead the subroutine names are simply the names of variables, initialised to the appropriate line numbers. For instance, in his example he enters subroutine Answer via

```
5040 SUB$ = "ANSWER":
GOSUB 100
```

in the main program, and

```
120 IF SUB$ = "ANSWER"
THEN 1200
```

in his switching routine. We can streamline these by

```
5040 GOSUB ANSWER
```

plus an earlier initialisation statement

```
ANSWER = 1200
```

The result is clearer to read and more efficient.

If this is not permitted, many dialects — Commodore is one — allow the switching to be improved by means of On Goto, which is much more efficient than a string of If statements. The switching routine is now a single statement:

```
100 ON SUB GOTO 100,
1200...
```

the jumps to the switching routine look like

```
5040 SUB = ANSWER: GOSUB
100
```

and we still need an earlier initialisation like

```
ANSWER = 2
```

Admittedly, in neither of these methods can we pass arguments by concatenating on to the subroutine name, but surely it is anyway clearer and more efficient to use a separate argument variable? Referring again to John Hooper's example, the line:

```
1260 SUB$ = "DELAY01":
GOSUB 100
```

with the associated decoding exercises

```
130 IF LEFT$(SUB$,5) =
"DELAY" THEN 1300
1310 DEL$ = RIGHT$(SUB$,2):
DEL = VAL(DEL$)
```

would be replaced by

```
1260 ARG = 1: GOSUB DELAY
```

in the first method; or, in the

second method, by

```
1260 SUB = DELAY: ARG = 1:
GOSUB 100
```

and no decoding is required. Furthermore, explicit argument passing is much better when the argument is not a constant, as is nearly always the case.

Compare:

```
1260 SUB$ = "DELAY" +
STR$(X + Y): GOSUB 100
1310 DEL$ = RIGHT$(SUB$,
LEN(SUB$) - 5):
DEL = VAL(DEL$)
```

with

```
1260 ARG = X + Y: GOSUB
DELAY
```

or

```
1260 SUB = DELAY: ARG =
X + Y: GOSUB 100
```

Tony O'Hagan,
Department of Statistics,
University of Warwick.

Commodore 64 bugs?

I HAVE JUST COMPLETED a writing *Study Guide to the Commodore 64* for Pitman Books and have discovered various bugs in the Commodore 64 and Vic-20 Basic ROM.

Commodore 64 owners should try

```
10 T = 1
20 T = T/2 PRINT T : GOTO 20
```

to produce a long sequence of numbers, becoming smaller. After a time the numbers go to zero:

```
5.87747176E - 39
2.93873588E - 39
0
```

which is what should occur. Altering the value of T in line 10 to -1 while keeping line 20 exactly the same, produces a sequence which ends

```
- 1.17549435E - 38
- 5.87747176E - 39
2.93873588E - 39
0
```

which is in no way correct. There should not be a change from a minus to a plus.

Now try

```
T = 4.25352959E + 37 : PRINT
*2
```

to which the response is
?OVERFLOW ERROR
Entering Print T+T produces the value 8.50705917E + 37.

For further interesting results try

```
V = 1.70141183E + 38 : PRINT V
V = (V/2)*2 : PRINT V
```

to gauge the amusing possibilities open to the adventurous user.

Boris Allan,
Stockport,
Cheshire.

Not Julian, but Gregorian

I AM SURPRISED and alarmed to learn from your November 1983 issue, pages 161 and 178, that the present calendar is Julian. During my lifetime so far all calendars and diaries for use in this country have used the Gregorian, not the old-style calendar which was abolished in Britain and Sweden in September 1752.

Perhaps this explains why I am always about a fortnight behind in my work, but more likely someone has confused the Julian calendar with the Julian day used by astronomers. This day runs from noon to noon, not midnight to midnight, and starts on noon Monday - 4712, ending noon, Sunday December 31, 3268. The cycle of 7,980 years then repeats, various lunar and solar cycles starting off again in step. Noon on January 1, 1984 is the start of Julian day 2,445,701.

However confused the nomenclature, Mr Wade's program rises above it. I have not tried it out, having neither an Atari nor the time, but line 70 is essentially Gregorian.

R A Fairthorne,
Farnborough,
Hampshire. ☐



Tandy® TRS-80™: Setting The Standard

With Dot Matrix Printers...



9 1/2" Dot-Matrix

£399

- With Colour Computer and Parallel Interfaces

DMP-120. This versatile 9 1/2" dot-matrix printer has high speed data processing and graphics modes, that makes light work of many many tasks. It prints ten and 16.7 characters per inch, or elongated five and 8.3 characters per inch at up to 125 characters per second. A very compact printer it uses fanfold, single sheet or roll paper and has built in parallel and colour computer compatible serial interfaces. 26-1255

Colour Graphics

£149

- Uses Easily Replaceable Ink Cartridges

CGP-115. Ultra-compact colour graphics printer helps you create beautiful graphics in red, green, blue and black, and it prints alphanumeric. Built-in commands make it easy! Text mode prints 40 or 80 characters per line at 12 characters per second. Uses easily replaceable ink cartridges. A selection of colour pens is available. Set measures 2 5/16 x 8 1/4 x 8 1/2". 26-1192



Low Cost Dot-Matrix

£79⁹⁵

- Print Graphics and Alphanumerics
- Whisper Quiet!

TP-10 Thermal Printer. Perfect for use with the MC-10 Colour Microcomputer, and our other colour computers. You can print both screen graphics and alphanumerics. Textmode prints 32 characters per line at 30 characters per second on 4 1/8" wide thermal paper. Special repeat function to make graphics programming easier. Colour computer-compatible serial interface only (600 baud). 26-1261

Computer Cassette Recorder

£39⁹⁵

- Designed For The TRS-80
- Mains Or Battery Operated

Specially designed for use with TRS-80 microcomputers, the CTR-81 computer cassette recorder is ideal for loading and recording programs and data on cassette tapes. It can easily be connected to Models I, III, 4 and the new TRS-80 Model 100 portable computer. Smart white finish. Mains operation or requires four "C" batteries (not included). 26-1208



...Or Choose The Daisy Wheel Printer To Meet Your Needs



"Letter Perfect"

£1199

With Free Bi-Directional Tractor Feed (26-1459)

DWP-410. Ideal for SCRIPSIT™ word processing! Select ten or 12 characters per inch, or proportional pitch. Forward and reverse paper feed and 1/2 line feed, underline and programmable backspace. Includes 1/120" space and 1/48" line feed. Automatic paper set makes paper insertion easy. Uses interchangeable print wheels for type selection. EPM mode for special wheels. 26-1250

"Letter Quality"

£599

- With Automatic Wheel Positioning



DWP-210. A low-cost printer for that "professional look"! Select ten or 12 characters per inch, or proportional pitch. Prints over 200 words per minute (18 characters per second) at ten characters per inch. Easily handles an original plus two copies, features 1/200" space and 1/48" line feed, ribbon end, cover open and paper empty sensing. With carbon ribbon and Courier 10 print wheel. 26-1257

This computer to be designed



Only one person could design precisely the right computer for your business.

You.

But unless your name is Clive Sinclair, you'll probably need help from someone with a little more experience.

Like LSI computers. (That's us.)

We've had seven years' experience of developing micros and software exclusively for business. (You won't find us in primary schools or amusement arcades.)

The result of which is the most flexible system ever offered – Octopus.



Computer design starts here, here or here.

Around fifteen hundred pounds will buy you an Octopus system at its simplest.

The central computer with a fully programmable keyboard and one disc drive. With the optional carrying case, you can take it home, to business meetings, to your hotel; anywhere a TV screen is available.

A couple of thousand pounds will buy a fully-fledged business computer system, including two disc drives and a high resolution monitor. And, quite free, over a thousand pounds worth of software: a package called 'Axis.'

It's capable of controlling stock, invoicing and keeping your sales, purchase and nominal ledger, and would almost certainly be the first software package you'd have to buy.



For an appreciably greater investment the ultimate Octopus starter kit offers the extra speed and capacity of a Winchester disc drive, integrated with the central computer.

Keep your options open.

This is where your designing comes in. (And the back of the box is where it goes in.)

er is designed ned by you.

We've left room for four option boards and are offering, already, a choice of seven.

For example, a telecommunications board facilitates all kinds of links through the standard Telecom network.



A graphics board conjures up all kinds of shapes and sizes.

Others offer colour display, expanded RAM, links for printers and other peripherals and, ultimately, the ability to connect up an

entire Octopus network.

And because you'll be able to get up-dated option boards, the Octopus system means you can keep your options open for the foreseeable future.

Better by a Zilog.

With all this inbuilt flexibility, we had to be doubly sure about the abilities of the central processor:

So we included two of them.

Namely the Intel 8088-2 and the Zilog Z80B.

In plain English (well, plainish), this means Octopus can operate both the tried and tested 8-bit programs and the new, faster 16-bit ones; even, if



necessary, switching between the two.

It can also speak five languages or more and work on any of five operating systems.

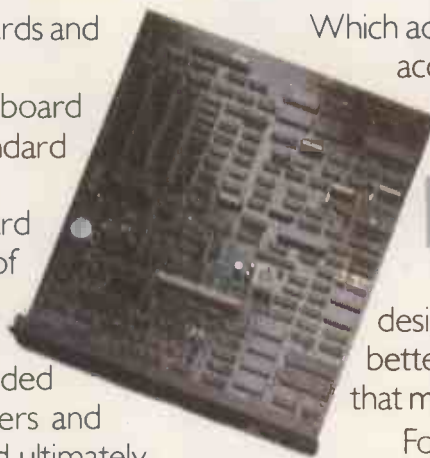

Which adds up to the fact that Octopus will accept virtually all of the business micro software that's currently on the market.

Hard-nosed software.

Not that we let that stop us from designing our own. And designing it better, with the kind of thoughtful detail that makes for real convenience.

For instance, we provide a mat to lay over the keyboard when its function keys are re-programmed. So you won't have to re-train staff to use a keyboard that says one thing and means another. Or re-train them whenever you up-date or expand the program.

An advantage, we might add, which you could only enjoy with a computer system that doesn't become obsolete or outgrown.

No matter what size of business you've got designs on.



Please send me details of the Octopus computer system.

Name _____

Position _____

Company _____

Address _____

Postcode _____

Telephone _____



The growing business computer.

To LSI Computers, Coase Rd., St Johns, Woking, Surrey GU21 1FX Tel: 04862 23411.

PC7/R4

Never before has so much been available from so little, to so many.



Never before in the history of modern computers has there been available a totally portable machine with the ability to cope with so many demands, to so many people, in so many different business areas.

Epson, with over 20 years experience in designing and manufacturing high quality printers, have produced the HX-20, a precision machine with its own rechargeable power supply that can be used for just about any task within today's discerning business: from data capture to word processing, from card indexing to sales order entry. Communicating with other machines is no problem and the HX-20 is easily coupled to one of our fine printers. You can even link in another main computer system by using an acoustic coupler.

Don't be fooled by its size, the HX-20 has all the software back-up you'd expect from a much larger machine and incorporates many "bigger computer" features - 16k RAM expandable to 32k with serial interfaces, a full size typewriter keyboard, its own built in

LCD screen and a dot matrix microprinter. A micro-cassette facility is available as an optional extra.

A complete computer that will either stand on its own or could be the obvious extension to your existing system.

More and more people are finding out just how big the small compact HX-20 is. Why don't you find out for yourself - you owe it to your business.



EPSON

**Extraordinary product.
Exceptional quality.**

Epson (UK) Limited, Freeport,
Wembley, Middlesex HA9 6BR.
Sales Enquiries: Freephone EPSON.
General Enquiries: 01-902 8892.
Telex: 8814169.

- I would like a demonstration of the HX-20 Portable Computer.
- Please send me details of my local stockist.

Name _____

Position _____

Company _____

Address _____

Tel: _____

PC2/20

• Circle No. 106

Professional Tandy

TANDY CORPORATION has launched its professional micro Model 16B, with integral 1.25Mbyte 8in. floppy and a 15Mbyte Winchester. The cost is £5,999 including VAT.

The powerful Z-80A/68000 system runs under TRS-Xenix, a multi-user operating system that is said to be supported already by multi-user software. The system can be expanded up to 768K RAM and there is a

user-accessible card cage allowing additional RS-232C cards to be slotted in for extra users. The model 16B comes with a 12in. screen, detachable keyboard and two RS-232C ports, as well as a parallel printer interface.

More information from Tandy Corporation, Tameway Tower, Bridge Street, Walsall, West Midlands WS1 1LA. Telephone: (0922) 648181.

TI business portable

TEXAS INSTRUMENTS has joined the portable bandwagon with the Portable Professional Computer. It is fully compatible with the desk-top version, and offers the same high-resolution graphics, colour options, memory-expandability and keyboard, but with a 9in. screen.

The system has an IBM-type configuration: 8088 processor, up to 768K RAM, with single or dual half-height 320K floppies. A 10Mbyte Winchester will be available shortly.

TI has also announced an 8087 maths co-processor option for both the Professional and Portable systems, and an Ethernet local area network for linking the Professional family with network file servers and printers. A further product, Ethermail, allows the LAN to function as an electronic mailbox, with messages and replies despatched instantly throughout the network. Programs, text or data files may be sent.

The TI Portable will cost from about £2,000. Further information may be obtained from Texas Instruments, Manton Lane, Bedford MK41 7PA. Telephone: (0234) 67466.

Baked Apples

IF YOU EVER thought of connecting a blast-furnace to your Apple, then Xcalibur Computers Ltd has the device

for you. The XTC module allows an Apple to read up to 16 thermocouples functioning over a range of 0°C to 500°C with a typical accuracy of $\pm 3^\circ\text{C}$.

The XTC costs about £120, as does the XDA four-channel analogue-to-digital converter which interfaces to an Apple slot. More information from Xcalibur Computers Ltd. Telephone: (0604) 21051.

Manchester fair

TO THE CASUAL VISITOR the Northern Computer Fair provided a daunting prospect: a large number of schoolchildren playing a seemingly endless range of computer games with eye-jolting graphics and mind-numbing sound effects. But as well as the beeping, flashing games there was a more serious side to the show which spelt out good business for the intrepid band of personal-computer suppliers and systems houses participating in the exhibition.

Speaking on the Newton Computer Furniture stand Roger Carrington of Micro-factor Computerland said that the response was fantastic. "We have sold about 30

Hardware flashes

● **Future Computers** has now added to its range of micros with the introduction of the FX-30 range including integral Winchester discs. Options range from 5Mbyte to 50Mbyte, and the entry price is about £3,000. Details from Future Computers Ltd at 01-683 0111.

● **Tandy** has announced its TRS-80 Model 2000 personal computer, powered by the Intel 80186, and running under MS-DOS. The new professional machine will offer Microsoft windows and an integrated applications package called Ovation. Plans for the U.K. launch have not yet been finalised. At the other end of the market, prices of the Color Computer have been cut. The 16K version now sells at £179, while a full £80 has been cut from the 32K price to bring it down to £299.

● **Krypton 400K** is a business machine from Transtec. It costs £995 including bundled software valued at £1,500. Contact Transtec at 01-247 1327.

● **Talking computers** for the blind are now available from John Bradburn Ltd. The machine from Maryland Computers Inc. includes a voice synthesiser and a Braille output device. More information (0604) 55142.

● **Hewlett-Packard** computer owners dying for a passive

dongle — that is, one which requires no external power — are now served by Protek Electronics. The cost is about £200. Telephone: 01-834 3602.

● **Thomson-CSF**, the French computer company, has joined the gigabyte club with its read/write laser video disc GD-1001. The specifications are very close to those of the Shugart disc previewed in last month's *Practical Computing*.

● **Hard-disc options** can now be added to the 16-bit Orb machine without spoiling its elegant lines. Both 10Mbyte and 20Mbyte add-ons are available as either integral or external units. Prices start at £2,000. Details from ABS Computers at (0273) 421509.

● **Shugart Corporation**, not content to rest on its copious laurels, has developed a 3.5in. micro-floppy capable of storing 1Mbyte. A hard-shell cartridge with automatic spring-loaded shutter protects the disc.

● **Osborne U.K.** is by no means down and out, whatever its American relative is doing. It has launched a disc upgrade for the Osborne which doubles total capacity from 400K to 800K. Details from Osborne at (0908) 615274.

● **Inmac** has produced a 64K printer buffer suitable for the IBM PC, Apple, TRS-80 in conjunction with many leading printers. It costs £225. Contact Inmac at (09285) 67551.

computers off the stand," he claimed, with one customer handing over a £5,000 cheque as a deposit on five hard-disc Wang computers. By the second day of the show orders had also been taken for 14 Portico Miracle computers at £1,800 each and Roger Carrington was a happy man. "It's a very good show. We're going to book for next year before we leave," he said.

Also pleased with the exhibition was Phil Cook of Umbra Software, a systems company specialising in Apple computers and add-ons. "There is genuine business interest and not just from small companies," he asserted. "We've made useful contacts with people from companies such as British Nuclear Fuels

and Shell. If we don't pay for the exhibition over the next week, something's wrong," he said.

Some of the largest business micros at the show were being exhibited by LSI Computers North West. As well as demonstrating its older M-Two and M-Four Logical systems, the latter operating with OCR input, LSI was featuring the new Octopus multi-tasking micro, previewed on page 66 of this issue.

LSI dealer manager, Bob Wells-Gaston said that anyone looking for business systems had come to his stand. "There is a tremendous amount of interest in Octopus and we've got a lot of leads to work with," he added.

(More news on page 15)

"This One Decision Saved our Business and Grossed over \$1,000,000. in Sales"

So said the chairman of an American manufacturing company.

Read what else he had to say . . .

"In 1979, our recreational manufacturing business was booming. And we had developed a new product that looked like a real winner. The new product was extremely important, in that it appeared to be the answer to a seasonality problem associated with our other product lines.

By early summer, our order book was bulging. It really looked as if our off-season sales and production problems were over. Then just as quickly the roof fell in. Gas shortages devastated the recreational vehicle market overnight. And our order book for over two million dollars worth of the new product disintegrated.

Faced with a fall and winter of virtually no sales, many thousands of dollars of unneeded parts and excess production staff, I had no choice but to shut down the production lines. And if a solution to our problem couldn't be found, the business itself was in jeopardy.

A life saving decision

I spent many sleepless nights trying to come up with a solution to this nightmarish situation. Then I remembered a course I had taken in decision analysis. I spent the rest of that night reviewing course material and other books I had bought on the subject. The next day, I called an emergency meeting.

Using the decision making techniques I had learned, we spent the rest of the week searching for and analysing potential solutions. The net result was that not only was the company pulled back from the brink of destruction, but we added over \$1,000,000.00 in gross sales during that off-season.

A way of life

From that point on, almost every critical decision (and there were many) regarding new products, marketing channels, pricing, advertising, production equipment, engineering projects, received this same type of analysis.

Although the process was very time consuming and clumsy, because it had to be done by hand, our decisions were much improved. And there were some real benefits that we had not anticipated.

1. Our understanding of each problem was greatly increased.
2. We uncovered opportunities that we would not have thought of in any other way.
3. Our decisions were documented, preventing us from slipping off the selected path or 'rehashing' the same things over and over.
4. Consensus became easier because we were forced to focus and resolve each part of the problem, one piece at a time."

The birth of Decision ~ Analyst™

Decision ~ Analyst was created because the process of evaluating complex decisions with multiple alternatives and many criteria is very tedious and time-consuming if you do it on paper. And doing it in your head is virtually impossible.

Any complex decision usually requires multiple revisions to

criteria, alternatives, weights and values assigned to them. If done manually, the ordeal of rewriting, recalculating and redocumenting tends to discourage revisions, thus producing poor results.

Decision ~ Analyst overcomes these problems by asking for the minimum input possible from you, in the correct sequence. It leads you step by step through the decision making process, then does all the necessary calculations and produces polished reports without any further effort. And all of your input is stored on your disk so that revisions and updates can be made easily at any time.

Comprehensive but easy to use

Decision ~ Analyst is probably the easiest program you'll ever use. You can literally learn to operate the program using only the 'help' screens. But it comes with a thoroughly indexed manual which includes many pages of examples plus a step by step guide to the decision making process.

And Decision ~ Analyst is no fly-weight. It uses over 100,000 bytes of fast compiled code and a 40,000 character help file. The program is extremely 'bullet proof' and does all the work . . . you do the thinking. And there is no danger of missing a critical step because your analysis is guided through each of the eight menu-driven sections.

Endless opportunity for use

If you're saying to yourself that you really don't have any earth shattering applications for

Decision ~ Analyst . . . then consider this. If you're in business, chances are that the most important thing you do is make decisions.

Decision ~ Analyst can help you select key personnel, decide on new machinery or equipment, prioritize major projects and allocate resources, choose a new product or a better price strategy, select new offices or plant locations, select the most profitable marketing channel or the best piece of computer hardware or software. Use it to analyse any decision which has more than one viable alternative.

In your personal life, it can help you choose the best job, select the right business, career or franchise, determine the best field of investment or even the right home, boat or car. In fact, improving your decisions is probably the most rewarding thing you can do.

Let us help you make a £120 decision

If there's a chance that Decision ~ Analyst could help you improve even one decision, would it pay for itself? Chances are it would. In fact, it's likely that it could save you the price many times over!

So why not take advantage of this opportunity by calling us today. We know you won't regret it.

Available for virtually every make of micro-computer using CP/M, CP/M-86, MS-DOS or PC-DOS operating systems. Requires an 80 column screen and an 80 column printer for reports.



MICROCOMPUTER
PRODUCTS
INTERNATIONAL
LIMITED

THE HOME OF
MICROCOMPUTER
SOFTWARE

Room ES2,
Central House,
Cambridge Road,
Barking,
Essex IG11 8NT.

Tel: 01-591 6511
Telex: 892395

● Circle No. 107

Intertec Headstart

INTERTEC'S 16-bit Headstart, successor to the Superbrain, is now distributed by Icarus in the U.K. Combining eight- and 16-bit processors, the machine offers one 0.5Mbyte micro-floppy as standard, together with 512K RAM. Both can be upgraded to 1Mbyte. A key feature is the RAM-disc option whereby the RAM may be partitioned into a virtual-disc area.

The system has been built with networking in mind. Four stations and a 10Mbyte file

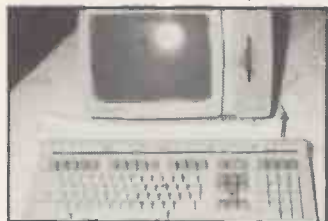

server will cost about £10,000. The basic 512K system, complete with 12in. screen and detachable keyboard, costs £2,895 plus VAT.

Further details from Icarus Computer Systems Ltd, Deane House, 27 Greenwood Place, London NW5 1NN. Telephone: 01-485 5574.

Koala graphics

A GRAPHICS PAD for the Commodore 64 has been produced by Audiogenic. The Koala Painter allows colour graphics to be drawn, stored and manipulated using menus of commands. As well as drawing with a stylus on the 4in. by 4in. pressure-sensitive pad, standard routines for lines, circles, etc. can be called, and colours added successively. Individual portions of the



screen can be blown up and worked on in detail.

The system is disc based and costs £89.95 including VAT. The curious name apparently stems from the original American designers. Further details from Audiogenic Ltd, PO Box 88, Reading, Berkshire RG1 2SN. Telephone: (0734) 595647.

Bromley's Superstar

SUPERSTAR 16 is a 16-bit multi-user system from Bromley Computers. It has an interesting dual-processor architecture surrounding a 16-bit master processor. Multi-user units can be added by buying additional eight- or 16-bit processors which plug inside the main Superstar unit. Terminals are then connected and may be run as independent systems. This contrasts with the normal system of distributed processing power in the terminals.

The new machine runs CP/M, MS-DOS and Xenix. Bromley Computers has



produced a range of applications software.

The entry system comes with an eight-bit slave, 10Mbyte Winchester, one 400K floppy, screen and keyboard, and costs £2,450. Up to 16 users can be accommodated sharing a Winchester storage capacity of 160Mbyte. Further information from Bromley Computer Consultancy Ltd, 417-421 Bromley Road, Bromley, Kent. Telephone: 01-697 8933.

Micro modem

A NEW low-cost ultra-miniature modem measuring just 4.5cm.

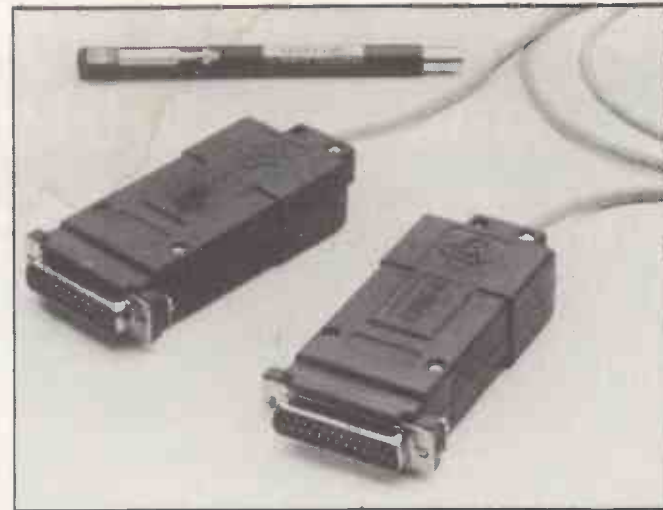

by 2.2cm. By 10.6cm. has been produced by Tech-Nel. Designed for short-range data transmission up to 25km., the unit requires no power supply or batteries.

The modem plugs directly into the standard RS-232C port and is powered from signals emitted by the host machine. Transmission rates of up to 19,200 baud are possible. A pair of SRM-6 units costs £140. Contact Tech-Nel Data Products Ltd. Telephone: (0295) 65781.

can be expected to run with 192K RAM using bank switching. A multi-user version is also promised later in the year.

The 5 + 5Mbyte system costs £4,500 plus VAT; a 10 + 10Mbyte version is planned.

More details from Country Computers Ltd, Pipers Road, Park Farm Industrial Estate, Redditch, Worcestershire B98 0HU. Telephone: (0527) 29826.

Xmas cheer

AT A SPECIAL ceremony held to celebrate the millionth Spectrum rolling off the production line on December 9, Sir Clive Sinclair was given his Christmas present a little early. Yes, it was a Spectrum.

Oric also obtained a useful Christmas bonus in the form of £4 million raised through its new parent company called Edenspring. The money will fund new developments and a substantial advertising campaign.

Removable Winchester

COUNTRY COMPUTERS has extended its range of computers with the C-3010, featuring one fixed Winchester and one removable cartridge version. This particularly lends itself to security-sensitive data and situations. The Z-80A system



A multi-user CP/M compatible system with high performance and reliability.

The Sirton MIDAS-MPS

Sirton Computer Systems' new Distributed Processing System; MIDAS-MPS, has been specially designed to be a flexible, multi-user system. Each user terminal added to the system has its own local processor, expanding the computing capacity of the system. The MIDAS-MPS is CP/M compatible,

has sophisticated password protection, it is easily installed and, as with all our systems, reliable.

If you'd like to learn more about MIDAS-MPS why not write or 'phone for our leaflet which includes full specification. We'd be pleased to help you with your enquiry.

Features:

- ★ CP/M Compatible
- ★ Multiple Directories with Hierarchical Access
- ★ Easily Expandable
- ★ High Throughput
- ★ High Speed Communication
- ★ Individual Processors at each Terminal
- ★ Easily Installed
- ★ Reliable
- ★ User Friendly

sirton
computer systems

Sirton Computer Systems

Unit 14, 29 Willow Lane, Mitcham, Surrey, CR4 4NA. Telephone: 01-640 6931/2/3

● Circle No. 108

If your microcomputer job involves managing information, you'll need a Compssoft Data Management System. It's your guarantee that computerisation will be a success.

Compssoft are world leaders when it comes to easy to use database programs. There is nothing quite so genuinely user friendly, and nothing quite as powerful. And Compssoft were the winners of the 1983 RITA (Recognition of Information Technology Achievement) Awards 'Software Product of the Year'.

We can give your *Computer the power to breeze through the management of any record keeping situation, — effortlessly, efficiently, and more accurately than you ever dreamed possible. From sales ledger to stock control, purchaser ledger to personnel, clubs to customers, and in a thousand other ways, we can lend a helping hand.

You don't have to be a computer expert to use Compssoft's DMS or Delta. Both programs offer fast, accurate and elegant database power for both first time computer users and professional systems designers.

You owe it to yourself to know more. Either return the coupon to us, or simply telephone the office and we'll send you a complete guide to our versatile database programs — today.

* Delta is available for almost any microcomputer with the MSDOS, PCDOS, CP/M, or MP/M operating systems, including IBM, DEC Rainbow, SIRIUS, XEROX, ICL, EPSON and many others.

DMS is also available for Commodore computers.



Compssoft Limited
Hallams Court
Shamley Green
Nr Guildford, Surrey
England GU4 8QZ

Telephone: Guildford (0483) 898545
Telex: 859210 CMPSFT

Please send me further details

Company _____

Contact _____

Address _____

PC _____

Tel No. _____





AT YOUR FINGER COMPLETE NEW RANGE

This is Sanyo's new range of normal to high resolution graphic display monitors. Designed for the customer who specifically demands a high quality product at a realistic price.

A complete range in every sense (size, colour capability and input versatility) that has evolved directly from the experience and advanced technology of one of the



SEE OUR COMPLETE RANGE AT THE
"WHICH COMPUTER SHOW" NEC, 17-20 JAN 1984.

Name _____
 Company _____
 Position in Company _____
 Address _____
 Telephone No. _____
 Return to Marketing Department,
 Sanyo Marubeni (UK) Ltd.,
 Sanyo House, 8 Greycaine
 Road, Watford, Herts.
 ● Circle No. 110



TIPS, THE KEY TO A RANGE OF DATA MONITORS.

world's leading colour television and computer product manufacturers.

A range that's available now at your fingertips.

If you're investing in business micros for the first time, or just simply extending your present system, phone STC on 0279 26777 or Micro Peripheral on 0256 3232.

Alternatively, clip the coupon and we'll tell you all about Sanyo, the key to a complete new range of data monitors.

SEE SANYO, THEN DECIDE



SOFTWARE AND TECHNOLOGY 4

A disk for every micro. While 8-bit micro-computers may boast a 'standard' operating system, one of its gravest shortcomings has been the lack of a common disk format. It has meant that data created with the same software package but on different computers could not be moved from one machine to another running the same operating system. With 16-bit micros running MS-DOS, this situation has been remedied. MS-DOS uses one data format common across all machines. This means that files from Multiplan or documents from Microsoft Word are completely transferable between any MS-DOS micros.

Enhancing high-level languages. Today's computer hardware offers a staggering array of new facilities, particularly where graphics and sound are concerned. As hardware develops, software writers have a choice between buying a special package just to achieve the most rudimentary on-screen graphics or music, or using a high-level language with built-in graphics and music commands. In fact, it would be foolish to expect proven languages like BASIC not to evolve as hardware becomes more sophisticated. With the latest version of its GW BASIC Interpreter, Microsoft has enhanced BASIC one step further for this new hardware. The language has a large number of graphics and sound extensions supporting new input devices such as joysticks and light pens, with graphics commands that can rotate defined objects at will on the screen, and the ability to open windows and see objects shrink or expand automatically as window sizes alter. The combination of advanced hardware and software like GW BASIC means that programs written in Interpretive BASIC can now run at speeds approaching those of programs written in lower-level languages. Features of this type would have been unheard of two years ago – but just think what sort of facilities may be available in tomorrow's high-level languages.

Europe's leading Financial Planning package. Even though the European Economic Community sometimes finds it hard to agree just who pays how much to whom and for what, it has at least reached a firm decision on one aspect of financial planning. When it comes to spreadsheets there appears to be great accord between France, Germany and the UK. Microsoft's Multiplan, translated to work in the natural languages of those countries has come out as the number one European spreadsheet package. According to a recent European survey in one of the monthly computer journals, Multiplan has emerged as the favourite spreadsheet. Microsoft has brought the same linguistic resources to bear on Word, its text processing package, and hopes that in 1984 Word will achieve the same international success as Multiplan.

How does a standard evolve? The microcomputer industry has traditionally established its standards by two routes. The S-100 bus, MS-DOS and 8-bit CP/M evolved while some manufacturers have consciously attempted to set standards as with the Ethernet network and the 3.5" Winchester disk format, hoping that others will follow in their footsteps. There has, however, recently been a new approach. At the end of 1983, an unprecedented commitment was made by 23 of the industry's leading microcomputer manufacturers to a new product from Microsoft. The product was Microsoft Windows – an enhancement to the MS-DOS operating system. Never before in microcomputing history has such a forceful public commitment been made to one product. Companies like DEC, Wang, Tandy, Apple/Rana, Altos, NCR, Compaq, TeleVideo and Eagle will all be offering the product on their MS-DOS based micros in 1984. More recently, the UK's leading 16-bit microcomputer manufacturer, ACT announced that it too, would be supporting Windows on the hugely successful Apricot. By mid-1984 we will be reaping the benefits that such standardisation offers – portable software running in the same manner on different machines; integrated software with different applications running together on the same machines; and software that's a whole lot easier to use.

MICROSOFT

Microsoft Ltd, Piper House,
Hatch Lane, Windsor, Berkshire.

Digital Research's new language strategy

DR FORTRAN 77 is the first of five planned new language compilers from Digital Research. Pascal, C, PL/1 and CBasic compilers will follow shortly. All these languages will use a new compiler writing technique which promises to increase the portability of application programs between systems, and to make new language compilers available more quickly across the range of microcomputers.

A major problem facing a system-software company like Digital Research is the number of different operating systems and processors used on microcomputers. Suppose seven language compilers were to be produced to run under, say, four different operating systems

on micros built around the 8086, 8088 and 68000 chips. This means producing, if not quite 84 separate products, still a large number of completely different pieces of code.

Digital Research's new approach is to split each compiler into two, with a front-end syntax processor and a back-end code generator. This way the front-end syntax processor only has to be written once for each language. The Digital Research front-end processors all generate a common intermediate language. This CIL code is then fed into the back-end code generator for each operating-system/processor combination to produce the final optimised

machine-code program.

Although this approach is not new — it has been used with mini and mainframe languages for years and is reminiscent of the Pascal p-code system — Digital Research's across-the-board use of the technique represents a further growth of professionalism in the microcomputer software market. The advantage to language users claimed by Digital Research is that source code written in a given language on one system will work across the complete range of micros.

Designed for scientific and engineering programmers, DR Fortran 77 supports 32-bit real numbers and runs programs up to the 1Mbyte addressing

capacity of the 8086 and 8088 processor family. On smaller systems large programs can be overlaid in 128K chunks. Digital Research says the new compiler is a full implementation of the ANSI-77 Fortran standard.

Concurrent CP/M and CP/M-86 versions should be available immediately, and MS-DOS and IBM PC versions are promised for March, priced at £385. Further versions will probably follow, with Unix high on the list.

These products will be available through retail channels, but if you require further information Digital Research's telephone number is Newbury (0635) 35304.

Commodore/Atari program generator

HOME FILEWRITER is a program generator for disc-based Atari and Commodore 64 systems. It will be most useful for database applications. The user types a layout on to the screen and Home Filewriter then generates the necessary code. A typical application would be club membership records.

Home Filewriter costs £39.95. Details from Dynatech Microsoftware, Rue du Commerce, Bouet, St Peter Port, Guernsey, Channel Islands. Tel: (0481) 20255.

Applesoft compiler

THE EINSTEIN compiler is for Apple IIe and Apple II Plus disc-based systems. It is an optimising compiler for translating Applesoft Basic programs into Apple machine code. The £89 utility program supports the full range of Applesoft and

DOS 3.3 commands, including high- and low-resolution graphics and shape tables.

Details from Pete and Pam Computers, New Hall Hey Road, Rossendale, Lancashire BB4 6JG. Telephone: (0706) 212321.

Version 3 of The Last One

VERSION 3.0 of The Last One — which must surely be a contradiction in terms — is now out. The Last One is a program generator, and one of the most heavily publicised programs of all time. Version 3.0 has several enhancements, including the ability to have final programs in any national language. It costs £330 for the IBM PC, Apricot, Sirius, DEC Rainbow, Orion and most CP/M machines, and £199 for the Apple II Plus and IIe.

Version 2.0 of The Last One is still available for the Commodore 64, with disc drive, for £85. Contact D J AI Systems, Station Road, Ilminster, Somerset TA19 9BQ. Telephone: (04605) 4117.

(More news on page 23)

In brief

Battle 1917 is a World War I strategic simulation game for several players, running on the Spectrum. The price is £6 from Cases Computer Simulations. Telephone: 01-858 0763.



The Incredible Jack is an integrated software package for the Apple IIe. Word processing, calc, filing and mailing are all integrated and run off one disc. The price is £129.50 from Pete and Pam Computers.

Base Invaders is a game with a more modern scenario. You have to dodge policemen and cut down the fence at Greenham Common to get to the cruise-missile bunkers. Running on the Sinclair Spectrum or BBC Micro it costs £8 from Magination. Telephone: Newcastle (0632) 653224.

Total Health for the Commodore 64 helps you plan a balanced diet and exercise program. Tape and disc versions cost £17.95 and £19.95 respectively from Marketing Micro Software Ltd. Telephone: Ipswich (0473) 462721.

Epson has issued a free brochure explaining how to get the best out of its printers when connected to the BBC Micro. Telephone: Freephone Epson.

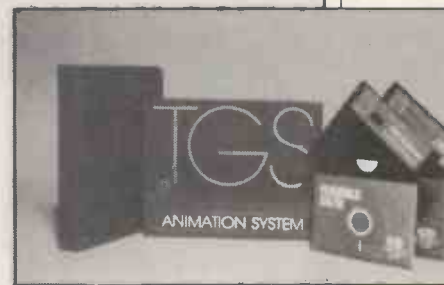

The Graphics Solution is a graphics editor and animation system for the 64K Apple II Plus or IIe with disc drive. It lets you prepare mixed text and high-resolution charts, three-dimensional graphs and animated sequences. It costs £99 from Pete and Pam Computers.

HIGH QUALITY GREEN SCREEN VIDEO MONITORS

Designed for use with Professional and Personal Microcomputers where a high resolution display is required. Ideal for applications requiring 80 column mode or higher, high resolution graphics, etc.

CHECK THESE FEATURES:-

- ANTIGLARE SCREEN
- P31 GREEN FOR MINIMUM FATIGUE
- VIDEO RESPONSE 10Hz - 22MHz \pm 3db
- SUPERB RESOLUTION - UP TO 132 CHARS/LINE
- EXCELLENT GEOMETRY/LINEARITY
- HIGH STABILITY
- 230 VOLT 50Hz MAINS OPERATION
- COMPOSITE VIDEO 0.5/2.0V INPUT
- FLICKER FREE DISPLAY

£89



▲ 12" MODEL HM123

£85



▲ 9" MODEL HM911

£87



▲ 9" MODEL HM910

ADD £5 Carriage/Postage

DEALER ENQUIRIES WELCOME

THE LOWEST PRICE ANYWHERE

£389



FOR A PC WITH THESE FEATURES . . . LOOK AT THE SPEC. OF THE AMAZING UNITRON 2200 . . .

- Dual processors - 6502 and Z80
- 64K of RAM
- 24K ROM with softswitch control
- Selectable 80 or 40 column text display
- Detachable keyboard
- Apple® II-compatible
- CP/M® compatible
- High and low resolution graphics capabilities
- Two disk I/O for your disk drives
- Game paddles/cassette/video interfaces

Prices exclusive of VAT
Same day despatch. Access welcome.

CHILTERN ELECTRONICS

HIGH STREET, CHALFONT ST. GILES, BUCKS. HP8 4QH
TELEPHONE: 02407 71234 TELEX: 262284

ADD £9 Carriage/Insurance

Compilers for Commodore Basic

OXFORD COMPUTING SYSTEMS has launched a range of disc-based Basic compilers covering the whole Commodore range. Most interesting is Portspeed, costing £125, a cross-compiler generating Commodore 64 machine-code programs from 8000-series Pet Basic source code.

Petspeed, also costing £125, is a conventional compiler for 4000- and 8000-series Pet Basic. It optimises the output machine code, ensuring that the resulting programs are not prohibitively long, a problem with non-optimising compilers. Oxford Computing Systems also has a £75 Integer Basic Compiler for 3000-, 4000- and 8000-series Pets.

Contact Oxford Computer Systems, Hensington Road, Woodstock, Oxford OX7 1JR. Telephone: Woodstock (0993) 812700.

HX-20 nominal ledger and cash register

PHIPPS ASSOCIATES has produced a nominal-ledger package for the battery-powered portable Epson HX-20. It can analyse accounting data over 100 headings. The audit trail is produced on the Epson's built-in printer. Phipps says the program, which costs £26, is suitable for the travelling

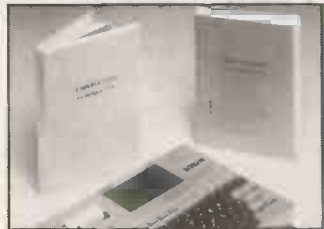

auditor or anyone faced with a complicated multi-column expense sheet.

Phipps Associates also does a program called Cash Register, which turns the HX-20 into a point-of-sale terminal. Used in conjunction with the Epson barcode reader package it can be

used to read EAN/UPC-coded labels directly from products. Another option is a cash drawer which links to the HX-20 through its remote On/Off socket. Phipps Associates says the program is also likely to appeal to van salesmen.

Further details from Phipps Associates, 172 Kingston Road, Ewell, Surrey KT19 0SD. Telephone: 01-393 0283.

K-tel double-siders

K-TEL, of TV-advertised record fame, is launching a series of TV-advertised Spectrum and Vic-20 games. Under the slogan "twice the fun with two on one"



the programs will come two at a time on a double-A-side cassette for a price of £6.95.

The initial five cassettes include It's only Rock 'n' Roll plus Tomb of Dracula, and Battle of the Toothpaste Tubes plus Castle Colditz, both for the Spectrum, with Supavadars/Bomber Run for the Vic. Commodore 64 programs will follow in a later batch.

The programs should be readily available at the usual retail outlets. Otherwise contact K-tel on 01-992 8055.

Hands-On training packs

HANDS-ON MULTIPLAN and Hands-On dBase II will be the latest additions to the Hands-On range of self-teaching micro-computer-training products. Although prices have not yet been announced, the packages

should be available in early 1984.

Hands-On CP/M Plus, Hands-On MS-DOS 2 and Hands-On CP/M 2.2 are already obtainable, price £80, for the majority of computers running these operating systems. Hands-On Basic, based on Microsoft MBasic, and Hands-On Cis Cobol, cost £150.

The Hands-On range all use a split-screen technique. The top half mimics the product in question while the tutorial guide runs in parallel underneath.

Details from Vector International (U.K.), 64A Lower Teddington Road, Kingston-upon-Thames, Surrey KT1 4ER. Telephone: 01-943 1257.

Home word processor

HOMEWORD is Sierra On-Line's new word processor designed especially for the home user. The program has fashionable features like graphic icons and can be used with an optional joystick to achieve a mouse-like effect cheaply.

Homeword is intended to be easy, and it comes with an audio cassette explaining how to use the program. Available now for the Apple II Plus and IIe, price £33.95, versions of Homeword are also promised for the Atari



and Commodore 64. Contact Pete and Pam Computers. Telephone: Rossendale (0706) 212321.

Expert systems from Acorn

BRIAN ALDISS on Science Fiction, Sheridan Morley on Theatre, Steve Race on Music, John Julius Norwich on History, Anthony Holden on Royalty and Julian Symonds on Crime: each of Acornsoft's Grandmaster Quiz series each presents 300 questions compiled by one of these experts on their specialist subject area.

The quizzes can be played competitively between two people or alone against the machine. The six programs cost £12.65 each, including VAT, and run on the BBC Model B — or the Acorn Electron, if you can get hold of one.

Details from Acornsoft, 4A Market Hill, Cambridge CB2 3NJ. Telephone: (0223) 31640.

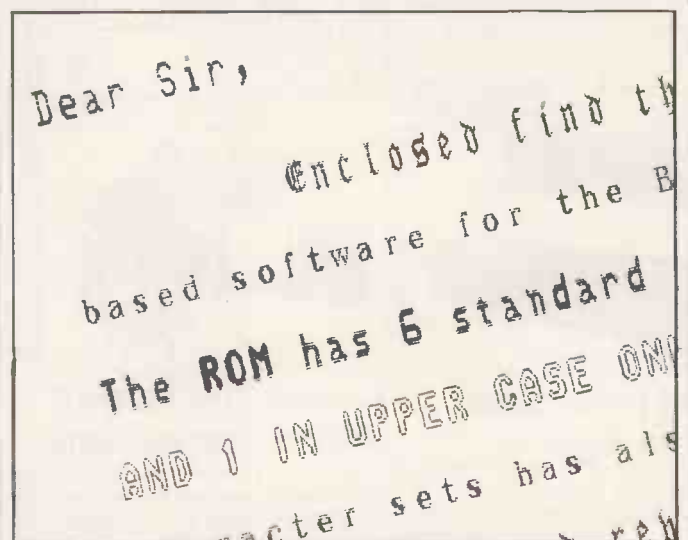

Beebfont is a character ROM for the BBC Microcomputer which gives you five pre-defined 16-by-16 dot fonts and facilities to define your own. Fonts can be displayed on the screen or printed on an Epson printer, according to the supplier, Watford Electronics. Beebfont costs £45 for the ROM, manual and supporting disc or tape software. Details from Watford Electronics, 33/35 Cardiff Road, Watford, Hertfordshire WD1 8ED. Telephone: (0923) 40588.



Shredders for computer printout

The increasing use of word processors, printers and computer installations means that Business Aids' electronic Scimitar Data Shredders are in greater demand than ever. The Compact Data 1001 is ideal for the smaller computer user; models 2001 and 2002 accept 25 sheets or eight streams of continuous stationery, while the high-security 2002XC converts paper into illegible 2 x 15mm chips. Data 4001 is a wide-throated console model; the heavy duty Data 5000 and 6000 have a 30-sheet capacity and process up to 20 streams of printout simultaneously. Contact me now.

426 on enquiry card

Telex terminal of tomorrow

Streamline your telex operation with the Trend Telex Terminal, a system marketed by British Telecom as the 'Puma'. Similar in appearance to an electronic typewriter, the Puma supercedes paper tape terminals by incorporating a 16,000-character memory and the ability to communicate with WP/Micro computer systems. Messages are edited and dialled from the keyboard and the system can transmit unattended — anywhere in the world, if necessary re-dialling until a busy line is free. Let me put you in touch with the telex trend-setters.

427 on enquiry card

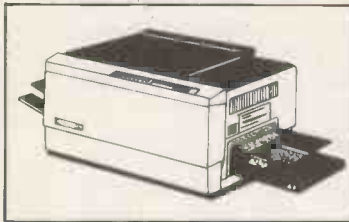
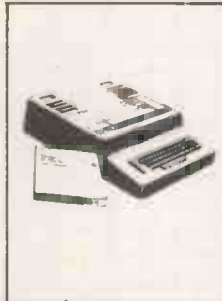

Clear crisp copies

If you require needle sharp, edge to edge copies, clear black and white from virtually any colour, the Roneo 230 Copier from Roneo Alcatel will suit you. It produces 30 copies per minute, has a touch sensitive keyboard to minimise misfeeds and a key control to monitor usage. The 230 will copy standard documents, books, flimsy originals, even three dimensional objects, onto standard bond, address labels, etc. in sizes A3, A4, B4 and B5. An automatic sorter and feeder are also available. Contact me for further details.

428 on enquiry card

A fast and efficient mailing system

If your computer can produce invoices in a matter of minutes it seems crazy to then spend hours mailing them by hand. The Neopost System Five-2 from Roneo Alcatel is designed to fold, insert, seal and frank in a fraction of the time it takes manually. The 'system' can be controlled by a single operator saving many costly man-hours and its modular construction gives it the flexibility to match your needs exactly. If you're interested in saving time and money circle this number today for more details. 429 on enquiry card

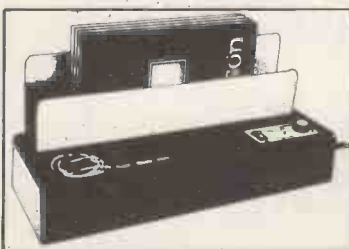

Perfect presentation

Earn top marks for presentation with the Easi-bind system. Easi-bind is the low cost, desktop binding machine that will give your sales literature, quotations, proposals and manuals that extra professional touch. Easi-bind is neat, simple and effective. Perfect binding means no punched holes, or messy glue pots. Choose from a wide range of stock covers or Midland Binding Machines will quote for the design and printing of top quality customised covers which are available in any size from A6 to full computer printout. I have full details.

24

430 on enquiry card

Twinlock VDU furniture range — new additions

Twinlock have extended their successful VDU furniture range with the addition of two VDU workcentres. One is designed to accommodate separate VDU screens and keyboards with a height adjustable platform that tilts back and forth to avoid eye-strain or glare. The other is fixed and designed for an adjustable VDU, or an integrated VDU and keyboard system. Both have an extra large work surface which will accommodate a table-top printer. Optional accessories, such as a printout catcher and a 5-tray housing are also available. Just circle this number.

431 on enquiry card



PP

PAGE PLUS Computers

COMPILED BY-

Chris Sula
Hewitt

65 Shawley Way Epsom Downs
Surrey KT18 5PD 07373 52031



The Xerox 16/8 PC the two-in-one micro

The Rank Xerox 16/8, by offering to you both 8 Bit AND through 16 Bit processing, is the two-in-one micro to meet your business needs now — and in the future. It can utilise all your existing 8 Bit data and programs and all the much faster processing 16 Bit software now becoming more widely available. It comes with three operating systems — CP/M®, MS-DOS™ and CP/M86. It is the micro designed to combat obsolescence so find out more by contacting me now.

432 on enquiry card

A cut above the rest . . .

Continuous stationery can create as many problems as it solves, with paper-cutting bottlenecks holding up output. But according to Bell & Howell their Fimafold 1000 provides a low-cost solution for small or medium computer installations. The accent is on ease of use and maximum versatility, with electronic control systems keeping the operator fully informed and in complete control. Interested? Circle the number and I'll be happy to send you full details.

433 on enquiry card

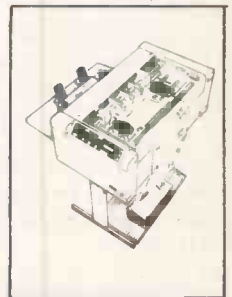

How much is your data worth?

Buying floppy disks for your computer? Maxell floppies come in 3in, 5¼in and 8in sizes, single and double density and you'll get absolute reliability every time. It makes sense to entrust your vital data to a reputable brand and Maxell's wide acceptance with major users such as software publishers and government departments endorses their claims for top reliability. The rapidly expanding dealer and distributor network means easy availability too. Contact me now for more information.

434 on enquiry card



A free Microwriter course

I'm offering free Microwriter self-teach courses to the first 250 business or professional people to circle the number below. This is your chance to find out for yourself how easily you can touch-type with the Microwriter within minutes. Thousands of business people all over the world are using the Microwriter portable word processor daily for correspondence, reports, notes and any other written work. The remarkably simplified five-finger keyboard can produce the entire alpha/numeric range and other functions.

435 on enquiry card



Dictation: let's talk

One of Dictaphone's most advanced portables, the 324 gives you a full two hours' recording on a cassette one-third the size of the standard C-type. So it's a handy and convenient way to catch up with that backlog of correspondence when you're out of the office. You can even use the 324 as a note-taker at meetings. Press the conference button and you've got an instant record of the main speaker's voice. All this in a machine that measures a mere 4½ x 2¼in. I have full details.

436 on enquiry card



IS POOR SOFTWARE KEEPING YOU POOR ?

A good tool is worth its weight in gold.

GOLDEN TOOL

software for the 64.

CREATE YOUR
LIFE MORE
SUCCESSFUL!

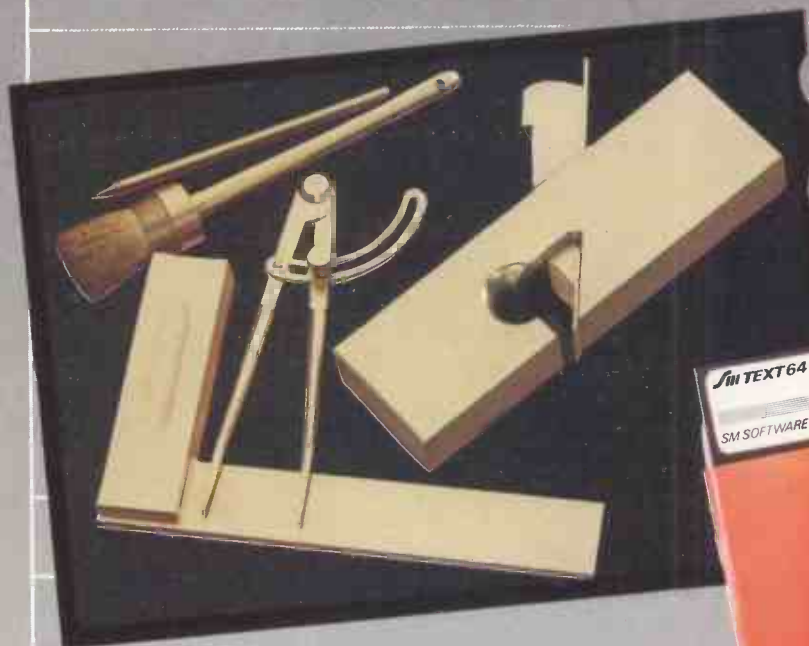

SM TEXT64

The professional text processor with more than 80 functions to aid productivity; multi-colour display; up to 120 columns without extra hardware; search & replace; enhanced block handling; direct access to addresses in CUDA files; etc etc

ONLY £50

SM CUDA64

Your professional standard, personal address filing system. Direct access to 620 addresses per disk; 5 extra lines per address for comments; totally menu-driven; powerful editing and back up facilities; several hardcopy facilities.

ONLY £40

SM KIT64

The famous programming tool for Commodore micros. Extends BASIC - merge, find, re-number, dump, trace, enhanced floppy monitor (disk doctor), highly efficient machine language monitor with built-in assembler, disassembler, trace, and many other helpful features. A real golden tool!

ONLY £40

SM ISM64

This index sequential file manager gives you a new dimension on direct access file handling. Up to 40 keys, variable record lengths, simultaneous handling of 10 files. How can you program without such a tool?

ONLY £40

SM MAE64

The definitive tool for the would-be master of the 64. If you are ready for programming in assembler, buy it now. Not for beginners, this tool will help you to fashion masterpieces of the programmer's art. Coexists with Commodore BASIC.

ONLY £40

PLACE YOUR ORDER NOW!

If your Commodore dealer cannot supply, contact us direct. Cheque with order please. Prices include vat, packing and carriage within the UK. Allow 7 days for delivery. All programs on disk and described in detail in a manual. Prices firm to end 1983



SM SOFTWARE (UK) Ltd
Raglan House, Long Street
Dursley Glos.
tele: 0453 46065 & 2101

Part of the SM Software group, supplying international software.



Dealer enquiries invited.

Personal and Profe



MTX512: 64K RAM - £315
MTX500: 32K RAM - £275

Please phone for the address of your nearest Dealer

Professional



The All-Purpose System

The MTX Series is a new departure in micro-computer technology. Whether your needs as a user are for personal programming, games playing, scientific or process control, educational or business use the MTX Series is already capable or very easily adaptable to almost every application. Glance through the standard features below - you'll see what we mean.

Hardware - 32K RAM on the MTX500, 64K on the MTX512.

The MTX500 has 32K of user RAM as standard (64K on the 512), expandable to 512K plus 16K of video RAM, controlled by a separate Video Processor. Sixteen colours, 40 column text, 256 x 192 high resolution graphics with all sixteen colours available, and 32 easily moveable user defined graphics characters (Sprites) combine to make effective screen displays quick and simple to achieve. Standard outputs are centronics printer port, two joystick ports, an uncommitted I/O port, 2400 Baud Cassette port, separate TV and Video Monitor ports, 4 channel sound with hifi output plus a dedicated cartridge port. Other standard features include the Z80A processor running at 4MHz, real time clock, full moving key keyboard with 79 keys including eight 2-function keys and separate numeric pad.

Software

The MTX's 24K ROM contains several languages and routines which enable the novice or the experienced programmer to make full use of the machine. Standard languages are MTX BASIC, MTX LOGO commands, NODDY. ROM routines include an ASSEMBLER/DISASSEMBLER with screen display of the Z80 CPU registers, memory and program, which can be manipulated from the keyboard. Machine code programs can be stepped through one instruction at a time, and easily called from within BASIC programs. A further feature is the Virtual Screen facility which enables the programmer to split the screen into a maximum of eight sections to work independently whilst maintaining all full screen facilities. Pascal is available as an add-on ROM pack.

The Disc Based Computers from Memotech

Designed to use the full power of the MTX computers the FDX and HDX make perfect business systems at prices which make perfect business sense. Both feature the CP/M operating system, giving instant access to a wide range of proven application software. Available in October these feature:

- Full Western Digital floppy disc controller set with SASI interface for 4 drives, CP/M types 0-13.
- minimal latency, very high data transfer rates
- optional Colour 80 Column Board
- optional Silicon Discs (1/4 Mb) which dramatically increase the efficiency of 8 bit software to those of 16/32 bit software; increases life and reliability of mechanical drive
- permits single disc CP/M operation

FDX— Floppy Disc System

1 or 2 5 1/4" Qume drives 500K unformatted, 347K formatted,

HDX— Hard Disc System

5 1/4" Qume drive, 500K unformatted, 347K formatted,
5 1/4" Winchester which may be 5, 10, or 20 Mb

All Memotech products are designed and manufactured in Oxfordshire, England

CP/M is a trademark of Digital Research Inc.

MEMOTECH MTX SERIES

CONTINENTAL SOFTWARE



We're not just playing games...

BLOBBO

A fast maze chase with untold perils and hazards.

TOADO

Get the toad back to his nest - but don't get run over or drown on the way.

SUPER MINEFIELD

You may have seen other Minefield games but ours has tanks that lay invisible mines, and spiders that are *very* tricky to avoid.

CONTINENTAL INVADERS

Classic arcade action, with all the features that make this game so popular.

KILOPEDE

This one is very fast - its not easy to get past level two.

RADAR/SONAR

Eliminate submarines with a combination of radar screen and sonar, very realistic.

FLIGHT SIMULATOR

Take off, navigate and land your high powered light aircraft. All the features of true flight.

ALSO AVAILABLE:

RESCUE, BEAVER, CONTINENTAL RAIDERS, PILE UP, SIGNAL MAN and many more.

we mean business too.

MTXCALC

Sophisticated and powerful, the professional spreadsheet program.

MTX WORD PROCESSOR

All necessary features are included to give a powerful business tool.

ACCOUNTING PACKAGE

Sales and Purchase Ledgers, stock control, payroll - the complete business system.

PROJECT PLANNER

Speaks for itself, and helps you achieve deadlines efficiently and effectively.

STRATEGY BOARD GAMES

CHESS, BACKGAMMON, OTHELLO, DRAUGHTS.

EDUCATION PROGRAMS

MATHS 1 PHYSICS 1

The first two programs in a series of specially written software designed to teach at the pace and level best suited to the user.

Software for the
MTX
SERIES

BY NATURE business people and professionals are a cautious lot, and never more so than when it comes to buying computers. Torn between a fear of being left behind in the micro race on the one hand, and on the other of being taken for an expensive ride, many small businesses have held back from the initial plunge. The activities of a minority of cowboy dealers have threatened to shake people's confidence in buying for business.

Any scheme that aims to provide a total service for the keen but careful business user is to be welcomed, and should help to allay these fears. The Debenhams group hopes to have done just this. Greens Business Systems, a wholly owned subsidiary of the well known chain store, officially launched its micro service to businesses. It is claimed to be unique, and certainly incorporates a number of interesting ideas.

The centres are not independent shops but will be placed in existing Debenhams stores as self-contained sections distinct from the general hurly-burly. Debenhams' market research shows that business users are reluctant to go to conventional dealers, but no such reluctance has been found in the more free-ranging atmosphere of large department stores. Greens hopes to capitalise on this, though acknowledging an initial credibility gap: after all, who would expect extensive business-micro expertise in the store you go to for a pair of tights or a new saucepan.

A key feature of the new project is Debenhams' reputation — according to those market researchers again — for reliability and stability. To reinforce this idea of dependability, Greens offers the following ingredients in its standard micro package:

1. Extensive professional expertise, both in the form of sales advice and free seminars. Using the stores' existing training and catering facilities, Greens provides free evening seminars on such subjects as micros in business, the ACT Apricot and the IBM PC.
2. Authorised dealerships from IBM, Apple and ACT. IBM has scrutinised the scheme and has so far granted dealerships to centres in four stores.
3. A full range of training programmes backing up the machines and software available. There are 28 different courses ranging from introductory micro-appreciation sessions to two-day courses on using dBase II. The cost varies from £75 to £100 per day.
4. Installation with on-site training. The aim is, not unreasonably, to leave the end-user with a fully working system, and with enough knowledge to run it.
5. A 24-hour maintenance service. In addition to running a help-line phone number, Greens guarantees that an engineer will visit within 24 hours of a call being made. Maintenance for a typical Apricot system from Greens will cost about £150, excluding parts; maintenance contracts can be taken out

The shop of things to come

Glyn Moody discovers how a national chain store is planning to deal in business micros.



at current rates for up to four years.

6. The Debenhams' "price promise" is offered. If a customer can find the same equipment on offer locally at a lower price, he or she may return within seven days and Greens will match it. Leasing options are also available; a typical Apricot system, for example, would cost around £54 a month. It will be possible to trade in a leased computer for a newer model merely by increasing payments.

Initially seven Debenhams stores operate the business-micro scheme — those at Oxford, Harrow, Romford, Guildford, Southampton, Staines and at Harvey Nichols in Knightsbridge. The Guildford store has been running as a prototype since March 1983; the rest followed six months or so later.

Greens is at pains to emphasise the complete separation from the cheaper games-oriented sector. Through in-store centres and travelling representatives the company sees itself as offering complete professional systems. Only four machines are currently sold: Apple II, ACT Sirius and Apricot, and the IBM PC, a choice

which has been largely dictated by the range and availability of software. The software itself is restricted mainly to broad applications systems rather than specialised vertical-market packages.

The frequent reference to the ACT Apricot is no accident. Greens' joint managing director Michael Milman waxes lyrical about the machine, and goes so far as to suggest that it could do for the U.K. business market what the IBM PC did in the U.S. To back this up he points out that the average attendance at Apricot seminars has been running at over 50, and already over 100 machines have been sold by Greens alone.

Whether this prediction turns out to be true or not, Greens is certainly thinking big. The first target turnover is £10 million, and the plan is to have 20 centres open by the end of 1984 with another 40 a year later, eventually taking space in non-Debenhams stores. According to Milman, Greens intends to become the biggest dealer in the U.K. So next time you need some business micro equipment it could well be worth looking in your local department store. □

*****THE NEW DBMS III (series III of the world's first 'task-robot-programs')*****

*****FEATURES*****

1400 character record sizes.....	32000 records per filename.....	12 online file architectures.....
mathematical scratchpad.....	20 main/200 sub fields per record.....	240 fields using cross-referencing.....
record relational indexes.....	field and record related formulae.....	cross-record calculations.....
translateable to any language.....	'Jump-to' any of 32000 records per file.....	'Jump-to' any record in 12 files.....
User defineable reporting.....	random/binary/key/multiple field search.....	User defineable files/field words/sizes.....
field protection/classification.....	'if-then' questioning.....	endless 'either-or' matching.....
either-or, same as, greater, smaller.....	file protection/password entry.....	formulate/recall on selection criteria.....
sorts 'alpha or numeric' any window.....	range match, not match, integer match.....	13 interrogation question types.....
12 online file architectures.....	sort speed 500 records per 20 seconds.....	short filing output/audit trails.....
		Word-star & Mbasic compatible.....

DBMS III.7 NEW SWITCH MODE FACILITY ENABLES YOU TO CROSS UP TO 12 DIFFERENT FILES (32000 RECORDS PER FILE) PRE-SELECTING ANY OF UP TO 20 FIELDS PER RECORD/FILE FOR DISPLAY/PRINT OUTPUT (240 FIELDS) IN ALL. ONE MASSIVE ENQUIRY CAN PASS THROUGH 384,000 RECORDS

You might have two files whose records are directly related to each other, so that the first file (say containing names and addresses) refers to the second file (say financial and other information relating to the same record numbers in the first file) directly. Then you can simply select that in file 1 you are interested in just the name and telephone numbers, whereas in file 2, you are interested in the income, trading period and number of branches, information. Your enquiry can then pass through both files highlighting that information only. Actually there doesn't need to be a strict correlation between the same record numbers in different files, and you can also on just one JUMP command go to any record in any of the 32000 records in any of the twelve files and carry on cross-referencing from there onwards.

DBMS'S MACROS WORK FROM THE MOMENT YOU INSERT THE 'TASK DISK' IN THE COMPUTER

Simply design your file, give its fields your words, setup your report mask, and then enter your records. Switch to 'automatic drive' and formulated any task you wish to program to fulfill, the task is stored as a macro. Take a copy of the program on another 'task disk' and from then on, the task disk will function without a single key-stroke. Think of a number of such 'task disks' such as "stock-re-order reports"; "stock-valuation reports"; "analysis"; "patient history analysis"; "research-analysis"; "budgetting-analysis"; "vehicle-location control"; "librarian analysis"; "plus more?"

Not only does this program surpass most of its kind that you might buy elsewhere, but if you buy the hardware from us, then you get it FREE... DBMS II (WITHOUT MACROS) AND DBMS III ARE FULLY IMPLEMENTED UNDER CPM-86 (tm) AND MS-DOS (tm) I.E.: SIRIUS/VICTOR/IBM DBMS II IS £395.00 (or £250.00 by mail order ex. training) ... DBMS III is £575.000 (or £295.00 by mail order ex. training).

The ALL YOU NEED system deal that is the best package on the market.

The personal budget system . . .		The professional office system . . .	
Sirius I (128k ram/1200k disks)	2195	IBM (256k ram/5.6mb dsk)	3995
Oki microline 80 printer	295	Nec 3550 daisy printer	1895
Diskettes	150	Diskettes	150
Cables and testing	85	Cables and testing	85
Word-star word processor	295	Word-star word-processor	295
Mail-merge	95	Mail-merge	95
Super-calc spreadsheet	195	Super-calc spreadsheet	195
Dbms III.7 database management	575	Dbms database management	575
Basic interpreter	150	Basic interpreter	150
	4035	Basic compiler	195
G.W's price as a system		Spelstar word-check	95
SAVES 1040.00		The 'KEY'	995
	2995.00	Transactional-database for invoicing/ mailshot/sales ledger/purchase ledger/ order-entry/personnel files/aged debt analysis/ letters/disk spreadsheet etc Direct telephone link to our system by modem	295
		modem software	95
Why not phone in for details of other systems we have to offer. Our range includes: Ibm/Dec/Sirius/Superbrain/Epson Televideo/Sanyo/Texas/North-star Nec/Qume/Diablo/Oki/Olympia/Dre Anadex/Corvus/Compac/Corona/ and many others!!.		Dos 2.00	60
		Cpm 86	60
We specialise in network systems using resources such as spools/port-expanders/modems/hard-disks/ramdisks/concurrent ramtasks etc.		Concurrent cpm 86	375
		Cbasic 86	95
			9700
		G.W's price as a system	
		SAVES 2005.00	
			7695.00

If you want serious advice by the experts: just call 01-636-8210 or 01-6310-4818 and leave your name & address on our 24 hour answerphone. We will send you a complete info-pack. Terms: C.W.O./C.O.D. prices exclude VAT. Showroom demonstrations only by prior appointment. Unless otherwise agreed, all warranties are the standard 'return to base' manufacturer's warranty. Annual maintenance facilities are available nationwide upon request.

Telephones: 01-636-8210 01-631-4818 Telex: 892031 TWC G.

G.W. Computers incorporated in Boston. Mass. USA.

30 Grama (Winter) Ltd. 43/55 Bedford Court Mans, Bedford Avenue, London WC1.

AN IMPORTANT ANNOUNCEMENT FOR POTENTIAL SYSTEM BUYERS

Any serious buyer knows that although the HARDWARE and SOFTWARE are both inter-dependant, the choice of software is CRITICAL to the consequence of having useless piece of hardware nor not.

With this in mind our standard system deal gives you the software free with a system purchase. However, if you want more!

NOW we have a piece of software that is a challenge to the highest state of the art on micro-computers today. It's the first of its kind world-wide. It is called THE KEY, and it will unlock the power of your micro to the limits of your imagination. It is very expensive however, because it is the first to embody many features of other programs, in one single program that has over-lapping functions. It costs 995.00 Stg., and is available with a system purchase.

it features, the entire list of functions already covered by our program called DBMS III.7a to be seen elsewhere in our advertisement. PLUS. + + + + + + + +

Paint any form including upwards from 100 (depending upon size of ram in hardware) data fields on the screen. Screen width up to 250 columns. Page lengths 100 lines.

The form might be a letter where data fields on the screen. Screen width up to 250 columns. Page lengths 100 liens.

The form might be a letter where data fields are name-addresses. Search files and accept any fields on teh database into any fields on the letter. The form might be a spreadsheet, where searches call records (in columnated

style) from the database and perform calculations, the difference here is that unlike other 'calc' programs giving you 254 lines per spreadsheet, THE KEY gives you 32000 lines if your database has that many records.

The standard attributes of any field, allow you to SEARCH OTHER FILES for fields to accept into any field on the current form, plus allowance to POST OTHER FILES any fields from the current form into any fields on that file. RELATE TO AS MANY OTHER FILES, as the number of data fields you have on the master form. Make data fields CALCULATE AGAINST FORMULAE, and other data fields. VALIDATE DATA INPUTS critically character by character; numerically, alphabetically and date-wise.

NO MANUAL NEEDED, all help menues accessible by hitting 'esc' at any point in the three major modes of activity (create, data entry, data query).

You can set up dozens of individual files that eventually are inter-connected through one master form; like an invoice, order, personnel-file, stock control, mail-shot. The master form may at every juncture of a data field, go outside the current form to supplementary forms for data retrieval, or post-filing.

Come along the computing road with us. We're out in front so you'll get the best there is at the price. On IBM and SIRIUS.

The first robot-concurrent-forms-database-text-processor-spreadsheet-no-manual-all-in-one-program.

G. W. COMPUTERS LTD — Tel: 01-631 4818

Contains the highest state of the art software available today
FORMS/TEXT/CALC/DBMS IV ALL IN ONE PROGRAM — "KEY" — at £995

When you budget for a complete system of software you eventually end up with a host of packages like, Sales, Purchases, Nominal, Data, Text, Calc, Mailshot, Invoice, Order, Workflow, Personnel, and so on.
The list is endless and the outlay several thousands of pounds.

- Features.** Design a form as wide as a window of 250 characters, long as needed. Cursor movements are 'left, right, up, down, delete left delete right, tab right-left-up-down' Paint your form as you like directly on the screen.
- Text.....** Write a letter as you see it on the screen, edit it then simply enter ^P to print.
- Calc.....** Set into the form, your data fields, "££££££" and specific file-related activities, formulae and validation checks.
Enter values and see the spreadsheet calculate itself.
- Database.** Search files for data to be inserted to fields specified.
All the features of DBMS III, explained elsewhere in our ad.

Here's an example of an invoice you might design for your stationery

You could design your own spreadsheet, order form, statement, or any other kind of form that is required to fit your existing stationery.

INVOICE <0>££££££££££				
To £<1>££££££££££££££	From: G.W. Ltd			
£<2>££££££££££££££££	55 Bedford Court Mans.			
£<3>££££££££££££££££	Bedford Avenue			
£<4>££££££££££££££	London W.C.1.			
£<5>££££££££££	Tel: 01-636 8210			
Date <6>££.££	Tax point <7>££.££	Agent <8>£££		
Quantity	Description	Cost	Tax	Total
<9>£££	<10>££££££££££££££	<11>££	<12>££	<13>£££
<14>££	<15>££££££££££££££	<16>££	<17>££	<18>£££
and so on...				
Total...<19>££££££		Tax...<20>££££		

- <??> items <1> to <5> internal command to request name input, and then search an address file for details.
- <??> items <6> to <7> request date input and validate.
- <??> item <8> request agent number and validate range.
- <??> <9> request quantity, validate range.
- <??> <10> request description, search file, accept, and calculate fields <11>, <12>, <13>, if finished invoice then calculate fields <19> and <20>

Now comes the more valuable facility, you can provide the 'FORM' with file-related instructions, not only to request a 'console' input for a file search against names, and stock, but after the invoice is finished the fields you have selected may be passed to related files.

EG: Send fields <0>, <1>, <6>, <7>, <11>, <12>, <13>, <19>, <20> to a sales ledger.

Then send fields <9>, <10>, <11>, to product analysis file.

Then send fields <0>, <1>, <7>, <19>, <20> to V.A.T. file

Then send fields <10>, <11>, <12>, <13> to Nominal ledger.

Available at present only on SIRUS/IBM PC.

● Circle No. 115

31

CLIP WINCHESTER BACKUP

NOW also **dBASE™**
available
packaged
with
Contact your dealer

CLIP — Compressed Library Interchange Program

CP/M CPM 86 MS DOS MS DOS 2-0 £95.00

- Backs up a Winchester on to floppies.
- Compresses text or data to less than half size.
- Large files can span multiple discs.
- Selective backup or retrieval, on an inclusive or exclusive basis.

CLIP has no equal in reputation, convenience, power or economy. **CLIP** comes standard with the **CIFER** Business Management System, and with all Winchester systems supplied by **COLT** and **RML**.

CLIP offers effortless backup.

You can create new commands using a menu procedure, and give each command a name, for later use. To repeat that command, the name alone is sufficient.

With **CLIP's** powers of selection and compression, the user can expect a four-to-one saving over global copying, with no effort except to feed discs on cue.

Or, **CLIP** can select just the new/updated files and reduce the backup load still further.

All prices excl. VAT, post free in U.K.
Most popular disc formats from stock.



KEELE CODES LTD

University of Keele, Keele, Staffordshire, U.K. Tel: (0782) 629221 Telex: 36113

Access accepted

dBASE II is a trademark of ASHTON-TATE

● Circle No. 117

Datalife Datalife Datalife™

WORDFLOW ELECTRONIC OFFICE SERVICES LIMITED

The Datalife People

DISK PRICES PER BOX OF TEN	1-3	4-7	8+
	£	£	£
5¼" Mini Disks			
MD525-01/10 SSSD/DSDD	18.79	18.30	17.84
MD550-01/10 DSDD	26.71	26.01	25.36
MD577-01/10 SSQD	29.00	28.26	27.53
MD557-01/10 DSQD	35.07	34.16	33.30

8" DISKS			
FD34-9000 SSSD 26SEC 128 BYTES/SEC	26.50	25.00	23.00
FD32-9000 SSSD 32SEC HOLES + 1			
INDEX HOLE	26.00	25.00	24.00
FD10-4008 DSSD 8SEC 512 BYTES/SEC	31.00	29.00	28.00
DD34-4001 D2TM DSDD			
UNITALISED/INDEX HOLE	31.00	28.50	27.00

STOP PRESS

We are currently taking orders for the new 3" and 3½" compact disks. Ring now for the best possible price.

19 SHEPCOTE ROAD HARROW MIDDLESEX
Telephone 01 863 0994 865 4463

● Circle No. 116

COMPUTER FURNITURE



Many
other
models
available

Write or phone for full details to:

Crowther-Cosine
6 Middleton Rd., Whittington,
Lichfield, STAFFS WS14 9NB
Tel: 0534 432376

● Circle No. 118

ORIC & B.B.C. OWNERS- UNLEASH REAL COMPUTING POWER WITH I.T.L. KATHMILL



BYTE DRIVE 500

first Disc Drive with Hybrid Interface Cable and Master D.O.S.

For too long, the performance potential of your computer, has been limited by the lack of a suitable Disc Drive. Now I.T.L.'s Byte Drive 500 meets this need.

With its 500K Bytes (440K Bytes

formatted) capacity, and access time of only 3ms, Byte Drive 500 opens up a new era of computing capability for the more ambitious user.

Byte Drive 500 is compact,

economically priced and easy to operate. Systems will shortly be available to interface with Dragon, Spectrum and Vic computers.

The full D.O.S. included in the price consists of:

3" F.D.D. Unit

* Power supply unit & mains cable

* A single P.S.U. can power 2 drives.

Hybrid interface cable

Power unit cable

Master D.O.S. disc

100 page manual

RECOMMENDED RETAIL PRICE £260.00 + V.A.T.

Byte Drive 500 is available from most quality computer retailers. In case of difficulty contact:
I.T.L. KATHMILL LTD.
The Old Courthouse, New Road, Chatham, Kent ME4 4QJ.



● Circle No. 119

Strengthen your hand

with Superbase 64

The complete information control system for the Commodore 64

The World Famous Commodore 64.



No matter what your business or interest, with Superbase 64 you have a totally flexible 'record' system, as big as you want it, as fast as you need it.

Create your own formats, enter your records, change layouts and datafields. Superbase gives you unrivalled control in home or office, business or professional practice, with a range of features including:

YOUR OWN RECORDS

- Design your layout using text, numeric, linking and key fields.
- Record size up to 1100 characters's spread over up to 127 items.
- Number of records limited only by your equipment.
- As many databases as you want - each with up to 15 files.
- Learn fast through built-in HELP screens - then add your own notes.

FAST ACCESS

- Keyst records for high speed retrieval - 3 secs for any file size.
- Select and search for any name, description, number, date etc. in multiple combinations.
- Sort records into any order.
- Display selections or generate printed reports.
- Browse through records matching on any criteria.

TOTAL CONTROL

- Links to other programs and EASY SCRIPT for mailshots, high-quality letters, quotes, tables, etc.
- Effective management of invoices, addresses, stock, membership, appointments - any and every kind of record.
- English like commands for easy conversational programming, plus built-in BASIC.

DATABASE MANAGEMENT

- Easy to understand menus or alter length - no file rebuilding needed.
- Update files with automatic batch processing option.
- Calendar arithmetic for effective time management.
- Display quantities, values, totals, as you enter them.
- Formulas for on-screen result calculation.



Superbase 64

Precision Software Limited,
Park House, 4 Park Terrace,
Worcester Park,
SURREY KT4 7JZ ENGLAND.
Telephone: 01-330 7166
Telex: 8955021 PRECIS G



Britain back in front

Ray Coles on the story behind the Inmos Transputer.

THERE CAN BE little doubt that the establishment of the Inmos high-technology semiconductor operation with large chunks of British taxpayers' money was a risky venture. Too often in the past, such government interference in the market place has resulted in the creation of unstable, inefficient industries which are constantly returning for more cash, without ever delivering the profits which were expected from them.

It is too early yet to state definitely that Inmos will break this mould, but all of its activities to date seem to suggest that it will. Already it has performed wonders for Britain's international image by consistently producing innovative products which have put the country back in the forefront of high technology. I for one have all my fingers and toes crossed in the confident hope that this well organised, highly motivated, ingenious — and, damn it all, British — company can pull it off.

The Inmos operation was boldly planned and cleverly executed by a group of expatriate British engineers and scientists who had been forced to work in the United States to develop their talents as chip designers. Iann Barron, now managing director, led the search for funds with the simple but informed message that there was no reason why the American microchip miracle should not be repeated here. All you had to do was to think big and use the best brains and equipment in the business.

New breed

The marketing strategy was simple too: start with the fastest static RAMs in the world; then move into 64K dynamic RAMs; then set the electronics world on its head with a totally new breed of high-performance microprocessor which would be a revolution in itself. How different to the usual ultra-cautious approach so much favoured by other British semiconductor manufacturers: "Let's wait until someone else has done it, then we will have a dabble. But don't spend too much on it, as we probably won't succeed."

Inmos set up its first manufacturing and design centre in Colorado Springs, in the western U.S. Its first static RAM parts designed there, the 1400 series, went on to become world beaters as predicted. A CAD design centre in Bristol followed, and then a second manufacturing facility in Newport, Gwent. By early 1983 the 64K dynamic-RAM family was in production.

One of the main tasks of the Bristol design centre was to work on the microprocessor, and once again no easy options were taken. Inmos wanted a product that the market would be desperate for: not just another 8086 or 68000 clone, but something new which could offer a quantum leap in processing power so that the world would be breaking down the factory doors to get at it.

The new microprocessor, called the T-424 or Transputer, has now been revealed after months of rumour and

speculation. What a machine it is! Designed from the outset to change the way we think about computer architecture, the Transputer is a 32-bit processor with a 4Gbyte address range. It can work by itself or as part of a processor array to deliver astonishing performance.

Inside the 1.15in. square, 84-pin Transputer package there is a single CMOS silicon chip containing the equivalent of 250,000 transistors. They are themselves interconnected to form the main functional blocks including a 32-bit CPU, a 32-bit multiplexed data/address bus, a separate eight-bit peripheral bus, four duplex serial communication links and an array of 4Kbyte of 50 nanosecond static RAM.

Used alone, a single Transputer will be a powerful system in its own right. As part of an array of similar processors, the Transputer provides the basic building block for the design of fifth-generation machines which will be able to execute over 10⁹ instructions per second.

If there is one word which best describes the Transputer approach, it has to be "concurrency". On the chip itself, the memory interface bus, the peripheral interface bus and the four serial buses all act independently and at high speed. Put an array of Transputers together and each chip can operate alone, communicating with its fellows over the serial links to receive instructions or operands and to transmit intermediate results. With four serial channels available, any one chip in an array can send or receive data in the up, down, left and right directions all at the same time.

Programming

The problems of programming such a highly parallel system have also been tackled by Inmos. As usual it has come up with an ingenious solution in the form of the brand-new Occam language. Occam handles concurrency by the definition of "processes", which are independent computation units complete with their own programs and data, and "channels", which

provide the mechanism for communication between processes. The same Occam program can be executed either by a single Transputer or by an array of any size. To make things easy, the Transputer architecture and instruction set directly support the Occam methodology.

Keep it simple

Occam was developed by Inmos in conjunction with Professor C A R Hoare, director of the Programming Research Group at Oxford University. One of Hoare's academic predecessors was the 14th-century philosopher, William of Occam, who first formalised the concept now known as Occam's Razor. Translated from the Latin it states: Entities should not be multiplied beyond necessity — or in other words, keep it simple.

The Occam programming system is already on sale for use on a variety of other machines, including the Apple II and the ACT Sirius, but the real power of the language will not be fully utilised until the first Transputers start to roll off the Inmos production line in late 1984. The basic Transputer instruction set is very simple, with less than 70 instructions. Some of them execute in a single minor cycle of just 50 nanoseconds; others, such as division, take up to 2 microseconds. The on-chip RAM array can be used for data or instructions and gives the great advantage of short access times. Memory accessed outside the chip itself will be slower because of the need to buffer the interconnections to conventional TTL levels. Up to 10,000,000 instructions per second can be achieved by a Transputer operating from internal memory. Following the T-424 32-bit Transputer will be the T-222 16-bit device with the same instruction set, and after that the G-213 graphics processor and the M-212 disc controller.

Personally, I would like a few shares in Inmos. I wish the company every success with its current quest for extra funding. It deserves to succeed, and so do we. 

WIN



14" COLOUR TV with TELETEXT and FULL REMOTE CONTROL!



SHARP PC 1500 PORTABLE COMPUTER!



£50 VOUCHER to spend on any product on this page!

easy to enter
competition

HOW TO ENTER: BUY JUST ONE OF THESE PRODUCTS TO RECEIVE YOUR ENTRY FORM — BUT HURRY — CLOSING DATE IS 31.1.84 — AND YOU CAN'T BUY BETTER!

COMPARE OUR PRICES

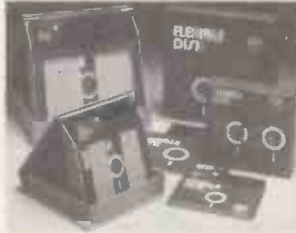

COME TO US LAST!!!

CDC DISKETTES AT CRAZY PRICES!

STATE SOFT 10 or 16 SECTORED

Code Type	Price
TD1 5 1/4" 40 TRK single sided	£1.70
TD2 5 1/4" 40 TRK double sided	£2.05
TD3 5 1/4" 80 TRK single sided	£2.85
TD4 5 1/4" 80 TRK double sided	£2.99
TD5 8" 40 TRK SS-SD	£1.78
TD6 8" 40 TRK DS-SD	£2.10
TD7 8" 40 TRK DS-SD	£2.85
TD8 8" 40 TRK DS-SD	£2.96

10 per box. Prices per diskette quoted. Discounts for quantity
ADD 15% VAT + £1.50 P&P

MINIMUM ORDER FOR PAPER = 5 BOXES

**LARGE RANGES OF PAPER AND RIBBONS AT
GREAT PRICES**

e.g.: Listing Paper

Code Type	Price
TD9 11" x 8 1/2" 60 GSM Plain	per 1000 £3.75
TD10 11" x 9 1/2" 60 GSM Perf'd Margins	per 1000 £3.95
TD11 11" x 14 1/2" 70 GSM Music Ruled	per 1000 £5.95
RIBBONS: 10 off EPSON FX-80	£49.95
RIBBONS: 10 off EPSON FX-80	£49.95
10 off EPSON FX-100	£42.50

(Refill for metal cartridges)

ADD 15% VAT + £1.50 CARR. PER ITEM (PAPER) OR BOX OF 10 RIBBONS.
DELIVERY 10-14 DAYS

MANY MORE AVAILABLE — PHONE FOR DETAILS NOW!
01-965 0672

Very powerful and versatile, from Rade Systems the R150 multiprocessor SBC £385!! (ex. VAT + carr). Amazing spec. Look what you get: Z80A at 4MHz with 64K RAM 5 1/8" disk controller, Z80A CTC, Z80A DMA, Z80A P10, memory mapped VDU uses M6845 CRT, got 25 x 80 char display, you can use all the TDB option cards to build your own powerful system, or build your own TDB1 Suitable power supply £95. Keyboard from £85. Cased Video Monitors from £95. Keyboard from £85. Cased Video Monitors from £95. Supplied with full technical documentation. Demand for this excellent machine is high! Order now! Power requirements: +5V@1.5A, +12V@25A. — 12V required for RS232 option — available on our standard PSU.



**DON'T WASTE MONEY!
ON OTHER COMPUTERS: COMPARE THE TDB
WITH OTHERS — COME TO US LAST!!**

FROM £995

(ex. VAT and monitor)
PHILIPS 12" VDU 25 x 80 char.
display



£149

TDB SYSTEM
PROCESSOR

Dual Serial
Ports £995
10MHz



TDB Keyboard

For dual 250KB disk system with 25x80 char. VDU, 93-key keyboard, user definable char. set 128KB RAM (no upper limit to expansion, due to our unique bus structure. This also allows CPUs to be mixed). 4KB ROM with MIC monitor, bootstrap, dual RS232 ports to 19.2K baud, software controlled. Unique 'stackable' option modules allow easy and cheap expansion of your system — the first rational development from S-100 bus based machines!

CP/M80 £139. CP/M86 £225. 8088/7 with 128KB £495 extra gives you THE most powerful machine in its class. You could spend £6,000 for a machine of this specification.

Other options include: 84KB RAM expansion £135. 192KB RAM £249. IEEE488 £97.50. Sync comms £78. Dual Parallel Ports £59. Dual RS232 £59. 88000 CPU ETBA, 16032 CPU ETBA. A to D and D to A converters, high res. graphics, floppy and hard disk controllers and drives, tracker ball, real-time clock/calendar with BBU and more on the way!

CHOOSE YOUR SOFTWARE
FIRST THEN COMPARE OUR
HARDWARE ...



SOFTWARE: WordStar, Mailmerge, D Base II, Personal Pearl, MBasic, CBasic, Pascal 2, MT+, Fortran, CIS Cobol, C, Cardbox, FMS, Datastar, CalcStar, Supercalc, Mathemagic, Peachtree Sales Nominal, Purchase Ledgers, Inventory management, Payroll, etc., ADA, Charger, Ratfor, Act 80, Act 65, 68, 69, 86/88, Trans8, Catchum and much more!

PHONE TO ARRANGE DEMO

01-965 0627

24 HOURS — SEVEN DAYS

Complete TDB system (as illust.) with Keystar, Epson RX-80, disk filing box, CPM 2.2 and WordStar, VDU and keyboard.

ONLY £1895!

ADD £19 carr. Does not include desk unit. Price is ex. VAT & carr.

OR with HR15 Daisy Wheel — £1995

(ex. VAT, £14 carr)

KEYSTAR

SCALE COPY OF KEYSTAR KEYBOARD
SHOWING THE FUNCTIONS PROVIDED



NO MORE FUMBLING
FOR THE 'CONTROL'
KEY!



ONLY £189.95 ex. VAT & carr. Add £2 P&P

SUITS MOST MACHINES:
Keystar's friendly keyboard allows you to work more efficiently saving time and mistakes! Demand is high for this amazing addition to the world's most popular WP package.

SD ORDER NOW!
01-965 0627 Telex: 24708

ITS
HERE!

The answer to all your WP problems!! If you use WordStar, Keystar will allow even those unfamiliar with WP to use the system straight away!

INCREDIBLE!

A high quality daisy wheel printer with RS232 interface, 3KB character buffer, and a host of other features like full WordStar function support, dual colour (red/black) printing
ONLY £475 (ex. VAT + £12 carr)



SPECIAL OFFER UNTIL JANUARY 1, 1984
FREE DATA CABLE WITH EVERY BROTHER HR15!

Use this printer with the low-cost TDB micro for the ultimate in low-cost WP systems.

FROM
£12

DATA CABLES
MADE TO YOUR SPEC/OFF SHELF

TALK ABOUT CHEAP!

Philips 12" Video Monitor — 25 x 80 characters, P31 green phosphor attractive case.
Ex. VAT & Carr.

ONLY £84.50!

KEEP RUNNING OUT OF SPACE!
BOOS ERRORS? ADD AN EXTRA DISK DRIVE
TO YOUR MACHINE

CASED
AND
UNCASED
UNITS

New LSIs make
the FD-55 Series
better than ever



WITH
OR
WITHOUT
POWER
SUPPLY
MODULES

BBC COMPATIBLE

CASED AND PSU:
250KB SS 40 TRK.....£139
500KB DS 40 TRK.....£195
500KB SS 80 TRK.....£195
1 MB DS 80 TRK.....£229
1.6MB DS 80 TRK.....£289
2 drive PSU Module.....£69
4 drive PSU modules.....£89

FD-55 features

- Half the height of conventional drives
- Capacity from 125 Kbytes to 1.6Mbytes
- Perfect disk registration
- Brushless DC direct drive motor
- High speed data access
- Low power generation (4.9 W, operating)
- LED photo sensor system

DUAL DRIVE UNITS
WITH PSU

Twin 250K SS 40 TRK £299
Twin 500K DS 40 TRK.....£425
Twin 500K SS 40/80 TRK£425
Twin 1MB DS 40/80 TRK.£495
Twin 1.6MB DS 80 TRK...£000

3.2MB

2MBytes

£675! £495!

inc. case and PSU inc. case and PSU

ex VAT ex VAT. Carr. £4.

TRADE ENQUIRIES
WELCOME

Post now to: TELEDIGITAL COMPUTERS, 42 GORST ROAD, PARK ROYAL INDUSTRIAL ESTATE, LONDON NW10 6LD

Name _____ Please send me

Address _____

Phone us if you require more
information on any of the
above
01-965 0627



Qty	Description	£	+ VAT & Carr

**I enclose cheque

£.....

*My Access/Visa

is

Allow up to 28 days
delivery on non
products. Your entry may
be sent by return.

*Delete where applicable.

It's what's behind our products that puts our dealers even further in front.

X-DATA



- Unrivalled price/performance
- Immediate availability
- Full dealer support package
- Consistent quality
- No-nonsense warranties
- National coverage

BACKED BY the Dyneer Group, X-Data has resources to buy the highest quality products at best possible prices, so the dealer gets the deal he deserves. Superb depot service facilities, unrivalled technical support and fast action telephone service are all X-Data hallmarks.

And for the dealer, fast response. Sensible stock-levels allow rapid delivery against dealers' orders. Fast response to technical queries gives you the help you want when you want it. True specifications, so the dealer knows that whatever he buys will do its job properly, and guaranteed quality which ensures no hidden costs.

X-Data supports the dealer. X-Data ensures the dealer gets what he needs. X-Data will be here to serve you when the others have gone.

- OKI matrix printers
- Dyneer daisywheel printers
- IMI Winchester disk drives
- Dyneer disk sub-systems
- Xebec disk sub-systems
- Dyneer colour/mono monitors

X-DATA

THE NAME BEHIND
THE PRODUCTS IN FRONT

X-DATA LIMITED, 750 DEAL AVENUE, SLOUGH TRADING ESTATE, SLOUGH, BERKS SL1 4SH. TEL: SLOUGH (0753) 72331

a **Dyneer** company

THE RAINBOW 10



0 + HAS ARRIVED

In the deluge of computers, at last there's a ray of light.

The Rainbow 100+ personal computer. The latest addition to the Rainbow range from Digital.

It allows you to cope with increasing business demands by having a more powerful memory. (Up to 896Kb for the technically minded.)

It lets you change programmes from CP/M to MS DOS by simply pressing a key. (When using the integral 10MB Winchester Disk drive.)

A choice of monitors is available. High resolution monochromes or colour;

for graphics and text.

Lotus 1-2-3 has been added to the leading range of software that already covers most types of businesses.

Two days at one of our 25 personal computer training courses are included in the price of £4,200.

As are full customer support, and twelve month on-site servicing warranty.

And of course our telephone helpline.

Call our Customer Information Centre on 0256 59299 for more about the new Rainbow 100+.

Think of it as the pot of gold.

1-2-3 is a Trade Mark of Lotus Development Corporation.

digital™



AUTHORISED
digital
PERSONAL COMPUTER
DEALER

LONDON

Beauchamp Computer Systems Ltd.,
115 Fulham Road, London SW3 6RL.
Telephone: 01-589 1975.

Beauchamp Computer Systems Ltd.,
22 Deerpark Road, Morden Road, Merton
SW19 3UN. Telephone: 01-589 1975.

Circulas Ltd.,
69-73 Theobalds Road, London WC1X 8TA.
Telephone: 01-242 0223.

Computacenter,
290 Kensington High Street, London W14 8PA.
Telephone: 01-602 8405.

Computerland - Marble Arch (Fotodisc Ltd.),
38 Edgware Road, London W2 2EH.
Telephone: 01-723 3071.

CLM/Matmos Ltd.,
Opticians
262 Earls Court Road, London SW5.
Telephone: 01-373 4508.

Digitus Ltd.,
Lading House, 10-14 Bedford Street,
London WC2E 9HE. Telephone: 01-379 6968.

DSR (UK) Ltd.,
27 Princes Street, Hanover Square,
London W1R 8NQ. Telephone: 01-409 0077.

Demotab Ltd.,
Victory House, 99-101 Regent Street,
London W1. Telephone: 01-439 3971.

Guestel Ltd.,
40 New Bridge Street, London EC4.
Telephone: 01-248 0416.

Hamilton Rentals Limited,
Hamilton House, North Circular Road,
London NW10 7UB. Telephone: 01-961 6777.

Hoskyns Group Limited,
Africa House, 64-78 Kingsway,
London WC2B 6BL. Telephone: 01-242 1951.

Micro Business Systems PLC.,
St. Mary Abchurch House, 123 Cannon Street,
London EC4N 5AX. Telephone: 01-626 2181.

Oyez Professional Services Limited,
Legal profession
Oyez House, PO. Box 55, 237 Long Lane,
London SE1 4PU. Telephone: 01-407 8055.

Personal Computers Ltd.,
220-226 Bishopsgate, London EC2.
Telephone: 01-377 1200.

Planning Consultancy Ltd.,
46-47 Pall Mall, London SW1Y 5JG.
Telephone: 01-839 8890.

Programs Unlimited Computer Centres,
35 Baker Street, London W1N 1AE.
Telephone: 01-487 3351.

Spartex Micro,
3-16 Woburn Place, London WC1 0JE.
Telephone: 01-833 1867.

Steiger Computers Ltd.,
Steiger House, North Circular Road,
Stonebridge Park, London NW10 7QZ.
Telephone: 01-961 6000.

Sumlock Bondain Ltd.,
263-269 City Road, London EC1V 1JX.
Telephone: 01-250 0505.

Systems Plus Ltd.,
47 Berkeley Square, London W1.
Telephone: 01-629 0065.

The Computer Terminal,
44 Cathedral Place, London EC4M 7ED.
Telephone: 01-236 2187.

BERKSHIRE
Bytech Limited,
Unit 57, Sultons Industrial Park, Earley, Reading,
Berkshire RG7 1AZ. Telephone: 0734 61031.

Care Software Technology Limited,
81 London Street, Reading, Berkshire RG1 4QA.
Telephone: 0734 55521.

Micro Business Systems PLC.,
119-120 High Street, Eton, Berkshire SL4 6AN.
Telephone: 07535 68171.

Microsystems Centre (Slough) Ltd.,
56 High Street, Slough, Berkshire SL1 1EZ.
Telephone: 0753 769767.

Norbain Micro Ltd.,
Norbain House, Boulton Road, Reading,
Berkshire RG2 0LT. Telephone: 0734 752201.

BEDFORDSHIRE

SWW Ltd.,
Ketwell House, 75-79 Tavistock Street,
Bedford MK40 2RR. Telephone: 0234 40601.

BUCKINGHAMSHIRE

Minicomputer Commercial Software Limited,
Insurance brokers
Computer House, Thames Industrial Estate,
Marlow, Bucks. SL7 1TB. Telephone: 06284 71011.

Rapid Recall Ltd.,
Rapid House, Denmark Street, High Wycombe,
Bucks. HP11 2ER. Telephone: 0494 26271.

CAMBRIDGESHIRE

Cambridge Computer Store,
1 Emmanuel Street, Cambridge CB1 1NE.
Telephone: 0223 65334/5.

GST Computer Systems Limited,
13 The Mall, Bar Hill, Cambridge CB3 8DZ.
Telephone: 0954 82061.

CHESHIRE

Micro Business Systems PLC.,
The Genesis Centre, Garrett Field,
Birchwood Science Park, Warrington WA3 7BH.
Telephone: 0925 822261.

Rapid Recall Ltd.,
28 High Street, Nantwich, Cheshire CW5 5AA.
Telephone: 0270 627505.

CO. DURHAM

Whessoe Business Systems,
Brinkburn Road, Darlington, County Durham
DL3 6DS. Telephone: 0325 60188.

DERBYSHIRE

Davidson-Richards Ltd.,
Systems House, 29 Charnwood Street,
Derby DE1 2GU. Telephone: 0332 383231.

Micro Business Systems PLC.,
Wirksworth, Derbyshire DE4 4EZ.
Telephone: 062-982 3120.

Midlectron Computer Systems and Terminals,
Midlectron Ltd., Midlectron House,
Nottingham Road, Belper DE5 1JQ.
Telephone: 077-382 6811.

DEVON

Devon Computers Ltd.,
The White House, 39 Totnes Road, Paignton,
Devon TQ4 5LA. Telephone: 0803 526303.

DORSET

South Coast Computers Ltd.,
South Coast House, Wimbourne Road, Ferndown,
Dorset BH22 9NG. Telephone: 0202 893040.

ESSEX

Dataview Ltd.,
Portreeves House, East Bay, Colchester,
Essex CO1 2XB. Telephone: 0206 865835.

STC Micros,
West Road, Harlow, Essex CM20 2BP.
Telephone: 0279 443421.

GREATER MANCHESTER

Cylek (UK) Ltd.,
Sandringham House, 9 Warwick Road,
Old Trafford, Manchester M16 0QQ.
Telephone: 061-872 4682.

Hamilton Rentals Limited,
Grove House, Skerton Road, Old Trafford,
Manchester M16 0WL. Telephone: 061-848 8338.

Mancos Computer Services Ltd.,
269-271 Barlow Moor Road,
Chorlton-Cum-Hardy, Manchester M21 2GJ.
Telephone: 061-860 6600.

GREATER MERSEYSIDE

Rockliff Micro Computers Ltd.,
2 Rumford Street, Liverpool L2 8SZ.
Telephone: 051-227 2568.

HAMPSHIRE

Computerland (Sperrings Computer Shops Ltd.),
Spencer House, 12-14 Carlton Place,
Southampton SO1 2EA. Telephone: 0703 39571.

Quest International Computer Systems Ltd.,
School Lane, Chandlers Ford,
Hampshire SO5 3YY. Telephone: 04215 66321.

HERTFORDSHIRE

Tesco Business Centre,
Bessemer Road, Welwyn Garden City,
Herts. AL7 1HB. Telephone: 07073 39333.

HUMBERSIDE

Microware Computers Ltd.,
Priory House, 1133 Hessle High Road,
Hull HU4 6SB. Telephone: 0482 562107.

KENT

Bromley Computer Consultancy Ltd.,
417-421 Bromley Road, Bromley, Kent BR1 4PJ.
Telephone: 01-697 8933.

M. W. Systems, (M. D. Wright Data Services Ltd.),
64 Burgate, Canterbury, Kent CT1 2HJ.
Telephone: 0227 69090.

LEICESTERSHIRE

Hogg Robinson Systems Ltd.,
Pegasus House, 17 Burleys Way, Leicester LE1 3BH.
Telephone: 0533 50131.

MERSEYSIDE

Rockliff Micro Computers Ltd.,
2 Rumford Street, Liverpool L2 8SZ.
Telephone: 051-227 2568.

MIDDLESEX

Cord Design Ltd. (Sytec Products Division),
Victor House, Staines, Middlesex TW18 4DS.
Telephone: 0784 56601.

Ferrari Software Ltd.,
683 Armadale Road, Feltham,
Middlesex TW16 5DA. Telephone: 01-751 5795.

Hawke Electronics Limited,
Amotex House, 45 Hanworth Road,
Sunbury-on-Thames, Middlesex TW16 5DA.
Telephone: 01-979 7799.

Morse Computers,
Unit 9, Hampton Farm Industrial Estate,
Feltham, Middlesex TW13 6DB.
Telephone: 01-898 2772/9934.

Newbury Data Recording Limited,
Hawthorne Road, Staines, Middlesex TW18 3BJ.
Telephone: 0784 61500.

NORFOLK

Anglia Computer Centre,
88 St. Benedicts Street, Norwich,
Norfolk NR2 4AB. Telephone: 0603 667032/34.

NOTTINGHAMSHIRE

Computer Services Midlands (Sales) Ltd.,
Dunlop India House, Abbeyfield Road,
Lenton Industrial Estate West,
Nottingham NG7 2SZ. Telephone: 0602 866366.

OXFORDSHIRE

Oxford Data Systems,
29 Pound Way, Cowley Centre, Oxford OX4 3XX.
Telephone: 0865 717720.

Zygal Dynamics PLC.,
Zygal House, Telford Road, Bicester,
Oxon OX6 0XB. Telephone: 0869 253361.

SHROPSHIRE

Jentech Services Ltd.,
4-5 Victorian Arcade, Mardol, Shrewsbury,
Shropshire SY1 1TS. Telephone: 0743 57345.

SURREY

GSJ Ltd.,
Motor dealers
Stanhope Road, Camberley, Surrey GU15 3PS.
Telephone: 0276 62282.

Key Computer Centres,
Enterprise House, Terrace Road,
Walton-on-Thames, Surrey KT12 2SD.
Telephone: 09322 42777.

Microfacilities Ltd.,
7-9 Church Road, Egham, Surrey TW20 9QL.
Telephone: 0784 31333.

Novus Systems Technology Limited,
Weymead House, Millbrook, Guildford GU1 3YA.
Telephone: 0483 69933.

SUSSEX

Amplicon Micro Systems Ltd.,
Richmond Road, Brighton, East Sussex BN2 3RL.
Telephone: 0273 608331.

Bartholomews Business Systems Ltd.,
Farming: agricultural suppliers
Portfield, Chichester, Sussex PO19 2NT.
Telephone: 0243 775111.

South East Computers Ltd.,
Unit 2, Castleham Road, Castleham Road
Industrial Estate, Hastings, Sussex TN38 9NR.
Telephone: 0424 426844.

TYNE AND WEAR

Key Computer Services Limited,
28 Osborne Road, Jesmond, Newcastle NE2 2AJ.
Telephone: 0632 815157.

WEST MIDLANDS

Computer Services Midlands (Sales) Ltd.,
Refuge Assurance House, Sutton New Road,
Erdington, West Midlands B23 6QX.
Telephone: 021-382 4171.

Hamilton Rentals Limited,
Crawford House, 84 Caroline Street,
Birmingham B3 1UP. Telephone: 021-236 3561.

Sumlock Bondain Ltd.,
Carleton House, 268 Stratford Road, Shirley,
Solithull, West Midlands B90 3AD.
Telephone: 021-745 8616.

WILTSHIRE

Computacenter,
Theatre Square, Swindon, Wilts. SN1 1GN.
Telephone: 0793 694997.

Whymark Computing,
20 Milford Street, Salisbury, Wilts. SP1 2AP.
Telephone: 0722 331269.

YORKSHIRE

ComputerStyle Ltd.,
Park House, Park Square, Leeds LS1 2PS.
Telephone: 0532 444337.

Microware Computers Ltd.,
Diamond House, Whitelock Street,
Leeds LS7 1AL. Telephone: 0532 434377.

WALES

SOUTH GLAMORGAN
Sigma Systems Ltd.,
266 North Road, Cardiff CF4 3BL.
Telephone: 0222 621414.

SCOTLAND

GRAMPIAN
Hamilton Rentals Limited,
Unit 4, Howemoss Drive, Kirkhill Industrial
Estate, Dyce, Aberdeen AB2 0GL.
Telephone: 0224 770816.

Pilgrim Business Machines Ltd.,
30 Northfield Place, Aberdeen AB1 1XQ.
Telephone: 0224 645104.

STRATHCLYDE

Ayrshire Office Services Ltd.,
22 Douglas Street, Kilmarnock KA1 1RB.
Telephone: 0563 24255.

Counterpoint Industries Limited,
7/8 Blythwood Court, Anderson Cross Centre,
Glasgow G2 7PH. Telephone: 041-248 5544.

Micro Business Systems PLC.,
Burlington House, 183 Bath Street,
Glasgow G2 4HU. Telephone: 041-248 5665.

WEST LOTHIAN

Micro-Centre (Complete Microsystems) Ltd.,
30 Dundas Street, Edinburgh EH3 6JN.
Telephone: 031-556 7354.

Pilgrim Business Machines Ltd.,
Solicitors in Scotland
28 Walker Street, Edinburgh EH3 7HR.
Telephone: 031-226 5528.

NORTHERN IRELAND

Systems Plus (N.I.) Ltd.,
19 Glengormley Park, Newtownabbey,
Northern Ireland. Telephone: 023-134 2636.

To: Digital Equipment Co. Ltd., Customer Information Centre,
Jays Close, Basingstoke, Hants. RG22 4DE.
Please send me details on the Rainbow 100+ and associated software.

Name _____

Position _____

Company _____

Address _____

Telephone No. _____

Market specialists
where available are
shown in italics.



YOU HAVEN'T SEEN ANYTHING LIKE THIS ON A COLOUR MONITOR BEFORE.

An RGB monitor from JVC offering a resolution of 370x470 pixels for less than £150?

We guarantee you won't see another bargain like that in this or any other micro mag—or in any other supplier's showroom.

For we've managed to acquire the sole distribution rights to these superb machines and we are able to offer them at an unbeatable price.

There are two models available: medium resolution (370x470 pixels) at £149.95; and high resolution (580x470 pixels) at £229.95. (Both excluding VAT.)

The units have a 14" screen and are suitable for the BBC Micro, Lynx, Oric, Apple, and most other leading micros.

They are robustly constructed in a handsome cream casing. And come with a full year's guarantee.

Delivery is good: your monitor should arrive by courier service within ten days of our receiving your order.

You can order by filling in the coupon below and posting to: Opus Supplies Ltd., 158 Camberwell Road, London SE5 0EE. Or by telephoning 01-701 8668 quoting your credit card number. Or, of course, you can buy in person at our showroom between 9am-6pm Monday-Friday, 9am-1.30pm Saturday.



To Opus Supplies Ltd., 158 Camberwell Road, London SE5 0EE.

Please send me _____ Medium Resolution Colour Monitor(s) at £149.95 each (ex. VAT).

_____ High Resolution Colour Monitor(s) at £229.95 each (ex. VAT).

_____ Connection lead(s) at £6.00 each.

I understand carriage per monitor will cost an extra £7.00.

(N.B. A Medium Resolution Monitor including VAT, lead, and carriage costs £187.39. A High Resolution Monitor including VAT, lead, and carriage costs £279.39.)

I enclose a cheque for £ _____ Or please debit my credit card account with the amount of £ _____ My Access/Barclaycard

(please tick) no. is _____

Please state the make of your computer: _____

Name _____

Address _____

Telephone: _____

Opus.
Opus Supplies Ltd.

PC4

MODEL REFERENCE	1302 1 Medium Resolution	1302 2 High Resolution
RESOLUTION	370x470 Pixels	580x470 Pixels
CRT	14"	14"
SUPPLY	220 240v; 50 60Hz.	220 240v; 50 60Hz.
E.H.T.	Minimum 19.5kv Maximum 22.5kv	Minimum 19.5kv Maximum 22.5kv
VIDEO BAND WIDTH	6MHz.	10MHz.
DISPLAY	80 characters by 25 lines	80 characters by 25 lines
SLOT PITCH	0.63mm	0.41mm
INPUT VIDEO	R.G.B. Analogue/ TTL Input	R.G.B. Analogue TTL Input
SYNC	Separate Sync on R.G.B. Positive or Negative	Separate Sync on R.G.B. Positive or Negative
EXTERNAL CONTROLS	On off switch and brightness control	On off switch and brightness control

Why should you be the one who finds out whether a floppy disk works or not?



With their ability to store everything from a production line's stock control to a complete filing cabinet of records, floppy disks can hurl a company into the computer age. Or set it back years.

Because abrasive coatings on a disk can cause all your precious information to be lost forever.

Ever mindful of the catastrophes caused by data loss, 3M make floppy disks that are at least 32 percent less abrasive than the industry average.

They can exceed 10 million passes (equivalent to changing data every hour for centuries) as opposed to the mere 3½ million expected by disk drive manufacturers.



And each and every one is subjected to analogue and digital tests before leaving the factory.

Which is why we can confidently guarantee them for life.

Of course, we're not trying to suggest that every single one of our rivals' disks are faulty.

But who wants to play Russian roulette with a business?

If you would like to know more about 3M floppy disks or where your closest distributor is, give us a ring at 3M on Bracknell (0344) 58502.

Who's brave enough to choose the floppy disks in your company?

LONDON COMPUTER CENTRE

NEC ADVANCED PERSONAL COMPUTER

16 bit 8086 128K Ram
2.4Mb Disk Storage
CP/M86 - MS DOS
Green Screen
Colour Display

£1985
£2595



LCC SPECIAL BUNDLE.

NEC APC- R.R.P. £1985
NEC Dot Matrix Printer R.R.P. £ 395
Benchmark WP Software R.R.P. £ 311
Cables R.R.P. £ 30

£2721

you pay £1985
you save £ 736

apricot
256K
from
£1495



SIRIUS 1

1.2 Mb Disk Storage £2195
2.4 Mb Disk Storage £2895
10. Mb Disk Storage £3995

Hard Disk for IBM PC, Sirius, QX10 NEC

10 Mb £1545
15 Mb £1695
20 Mb £1995
20 Mb Tape Streamer £1495



CORONA PC

IBM PC COMPATIBLE

*256K RAM *Twin Floppy Disk Drives
*Big 9" Screens *Serial & Parallel Ports
*Concurrent CP/M, multimate (Wangwriter)
Word processing software £2295

New TANDY Model 4

CP/M 3.0* Optional extra
64K-128K RAM
from £1299

TELE-VIDEO 806/816

the Multi User Computer System

LAP PORTABLES

EPSON TANDY 100 HX20

Portable with built-in printer from £402

Portable with built-in 4 Programmes: Word Processor, address book, scheduler, and communications. Large 40 x 8 char. line display £433

NEC PC 8201 16K RAM EXPANDABLE to 96K

Lap Portable with 8 built in programmes, Word Processor, Investment Portfolio, Loan Evaluator, Appointment/Schedule, Bar Code Reader, Calculator, Tank & Snake Game, Music Generator.

Large 40 x 8 LCD Display
Built-in Serial, Parallel & Bar Code Reader Ports. £475

Free 12" monitor with 9" SCREEN ZORBA

Portable full 80 x 24 display 800K disc storage Free software worth £800 £1395

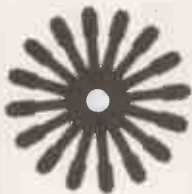
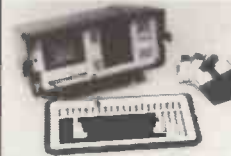

FLOWRITER RP 1600 60 CPS
Fast and reliable 8K buffer £1600

TEC F10 40 CPS

Diablo 620 compatible Japanese reliability £1350

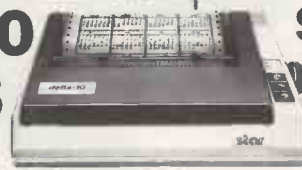

Star Printers*

Delta 10-160 CPS serial & parallel interfaces built-in 8K buffer £359
Gemini 10X 120CPS. Parallel interface £219

*Epson compatible control codes.



3 in One TOSHIBA P1350

24 Needles - high speed drafts 190 CPS Letter Perfect Printing 100 CPS Addressable Pin Graphics £1130 Options: Tractor £87: Sheet feeder £520

EPSON FX80/100 160 CPS

New JUKI 6100 Daisywheel 18 CPS

Bi directional Adler daisywheels Diablo 630 protocols £399



3 TRAY AUTO SHEET FEEDER

For originals, copies and envelopes. £695



SINGLE SHEET FEEDER £375

SENDATA 800 SERIES ACOUSTIC COUPLER £220

Buzz Box

Direct Connect Modem £70

SUITABLE FOR MOST DAISY PRINTERS

All prices are Exclusive of VAT and Delivery. Dealer Enquiries invited on all Products. Large range of CPM Software available. Please phone for catalogue & price list

Demonstrations on all models.

43 Grafton Way, London W1P 5LA (Opposite Maples)

Opening Hours: 10-7 Mon-Fri. 12-4 Sat.

01-387 4455 (4 lines) Telephone Answering Service After Office Hours Telex: 8953742

The right software for your application from

COMPUTECH



Authorised Dealer
Service Centre
System Consultancy



COMPUTECH FINANCIAL ACCOUNTING PACKAGES

Payroll	£375
Invoicing and Stock Recording	£295
Sales, Purchases and General Ledgers	each £295
Also costing and group consolidation	

COMPUTECH UTILITIES DISK

for reliable error checking copying, diskette scan, interpret and patch, etc £20
VisiCalc, Applewriter and other Apple software (Prices on request)

COMPUTECH CHAIN MAIL

A mailing merging document processor which may be used with text files, including random files and Applewriter 1.1 binary files £45

COMPUTECH GRAPHICS DISK

for printing Apple pictures and graphs on Epson and Microline (free with printers purchased from Computech) £30

COMPUTECH TERMINAL UTILITIES

Apple to Apple and Apple to mainframe from £130

COMPUTECH hardware...just plug it in and go!

switches and jumpers provide hardware options without soldering



DIPLOMAT VIDEO DIGITISER

store a frame from video camera in a fiftieth of a second, process and print — for Apple II £195
for APPLE II/e, including 64K Extended 80 Column Card £345

DIPLOMAT PARALLEL interface £80

DIPLOMAT SERIAL COMMUNICATIONS interface £85

DIPLOMAT RAM 16 Memory Expansion £95

DIPLOMAT CLOCK/CALENDAR £80

LOWER CASE Character Generator with Applewriter 1.1 enhancements £50

MICROMUX Data Exchange (Max 16 Ports) from £850

MATRIX PRINTERS, Microline and Epson with graphics and up to 200 cps from £222

MICROLINE Optional Character Generator £15

DAISY WHEEL PRINTERS, Olympia, Qume, Ricoh from £798

Prices exclude VAT, Carriage and Packing

For full details phone for data sheets and a FREE demonstration

COMPUTECH SYSTEMS

168 Finchley Road, London NW3 6HP. Tel: 01-794 0202

OVER 20,000 PEOPLE CAN'T BE WRONG

ACT SIRIUS 1

£2,195

Powerful 1.2Mb data storage with 128K RAM and including two of the industry standard operating systems at 16-bit level, CP/M-86 and MS-DOS. PLUS Basic 86.

£2,895

2.4Mb data storage with a big 256K RAM for the really demanding business applications. Includes CP/M-86, MS-DOS and Basic 86.

Above are two very good reasons why more people have bought the ACT Sirius 1 than any other 16-bit microcomputer in the U.K. Here are a few more:

ACT Sirius 1 is a superb user-friendly machine incorporating a comprehensive 'soft' keyboard, a 12" high resolution screen for crisp, clear definition and a wide range of memory options including a 10Mbyte Winchester version and a choice of three plug-in expansion boards.

The range of available software is simply unrivalled in the personal computer field.

Over 1,000 software packages now exist to provide complete solutions to the needs of large and small businesses alike.

And of course the ACT Sirius 1 is backed by the strength and resources of ACT. The Pulsar range of true 16-bit software for accounting, planning and word processing; ACT Training Centres open to all; nationwide field service; a full range of printers and consumables.

And, the most complete and professional dealer network in the U.K.

Over 20,000 people are rightly convinced that the ACT Sirius 1 is the best machine of its kind in the country.

CAN YOU REALLY AFFORD TO BE WRONG?

ACT SIRIUS 1, THE UK'S BEST SELLING 16-BIT MICROCOMPUTER.

Please send me details of the ACT Sirius 1.

Name: _____

Position: _____

Company: _____

Address: _____

46

Tel. No: _____

● Circle No. 127

P.C. FEB.



ACT (UK) Limited

Shenstone House,

Dudley Road, Halesowen, West Midlands B63 3NT.

Telephone: 021-501 2284

Telex: 337007



Are you the QX-10 that undertakes financial modelling, stock control, word processing, information analysis, book-keeping...?

"I am"



With over 20 years of experience in producing high quality printers, Epson have now perfected a fully integrated desktop computer. All the evidence has gone to prove that the QX-10 is capable of performing all the tasks you will ever require of it, quickly and efficiently.

Installation of the QX-10 can be carried out with the minimum of interruption, and with its easily understandable keyboard, it is simplicity itself to operate.

Having such a diverse range of software packages available such as database from Pearl and office productivity and accountancy from Peachtree with C P/M and multifont BASIC as standard, the QX-10 can supply all the answers whatever your business.

Just look at what's on offer: a big memory - 192k upgradable to 256k RAM and all the graphics you'll ever need - and high resolution graphics at that.

The ability to communicate easily with other machines, including our own HX-20 and

the advantage of using our fine range of printers, make the QX-10 a totally versatile system at a price you'll find impossible to equal - £1735 plus VAT.

If you're looking at micros, look at the QX-10.

The system with all the answers.



EPSON
Extraordinary product.
Exceptional quality.

Epson (UK) Limited, Freepost, Wembley, Middlesex HA9 6BR.
 Sales Enquiries: Freephone EPSON.
 General Enquiries: 01-902 8892.
 Telex: 8814169.

I would like a demonstration of the QX-10.

Please ask my Epson dealer to contact me.

Name _____

Position _____

Company _____

Address _____

Tel: _____

PC2/10

PC XT/370

THE XT/370 mainframe-on-a-desk version of the IBM PC — see the report in our January issue, page 29 — has been announced by IBM U.K. It offers three modes of operation. First, it is a standard XT Personal Computer with 10Mbyte of hard-disc storage. Second, it emulates an IBM 3277 Model 2 display terminal connected to a mainframe. Third, it runs under the new Virtual Machine/Personal Computer operating

system, which enables it to run many programs for the IBM mainframe Virtual Machine/Conversational Monitor System on a desk-top computer.

The XT/370 carries three extra cards which carry a standard Motorola 68000 chip, and two customised IBM chips — one based on the 68000, another on the Intel 8087. The second card carries 512K of extra RAM. The third provides the coaxial communications

which are needed for terminal operation.

The XT/370 will be manufactured in Greenock, Scotland, for a September 1984 launch in the U.K. The price is a mere £8,228 plus VAT, plus £919 for a VM/PC software licence. When the IBM 370 mainframe was current it usually cost around £1 million.

Contact IBM United Kingdom Ltd, PO Box 41, North Harbour, Baltic House, Portsmouth PO6 3AU.

IBMulators

MORE computer manufacturers are following the fashion of offering IBM compatibility. Among the latest are ITT, Televideo and Olivetti.

ITT will be launching the Xtra, with an Intel 8088 CPU, 128K of RAM, a 10Mbyte hard disc and one floppy — an IBM PC XT look-alike. Televideo's 1605 will be an IBM PC compatible micro, and is expected to be launched in the U.S. early in 1984.

Olivetti will be making its own version of the Corona PC look-alike for sale outside the U.S. Like Texas Instruments with the Professional, and Tandy with the Model 2000, Olivetti now appreciates that it has no choice but to offer IBM PC emulation. The long-term future of the Z-8000 based M-20 is presumably unaffected, as Olivetti has an 8086 card for it.

Columbia PC relaunch

THIS WELL KNOWN IBMulator has been relaunched in the U.K. by Icarus. Its Compaq standard of IBM compatibility has made it the leading look-alike on the U.K. market in the continued absence of the Compaq transportable.

The major change is that it is now supplied with an amber monitor, which is preferred in many European countries. Other new features are the free

suite of Perfect software and a graphics package, in all worth £750, plus a little heart logo on the front which features in the new advertising campaign.

Contact Icarus Computer Systems, Deane House, 27 Greenwood Place, London NW5 1NN. Telephone: 01-485 5574.

PC back-up

ALLOY has introduced a nine-track magnetic tape sub-system for the IBM PC. The ITS-PC offers 42Mbyte of back-up storage or, more interestingly, allows data to be interchanged

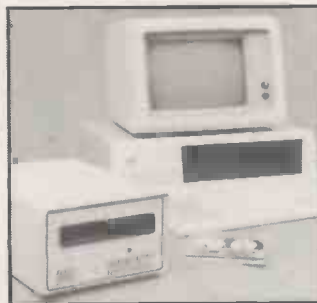

between a PC and a mainframe. For this you also need Alloy's PC-Tip tape-interchange program.

Alloy's other products are PC-Stor, which is a hard disc with built-in tape cartridge for back-up, and PC-Backup, which is a separate tape cartridge for backing up your PC XT.

Contact Alloy at Cotteswold House, Gloucester Street, Cirencester, Gloucestershire GL2 2DQ. Telephone: (0285) 68709.

Fun and games

THE IBM PC is already starting to monopolise the professional/executive software scene with products like Lotus 1-2-3, Multimate, Oz and Expert-Ease. But now about 40 percent of America's best-selling games, as listed by Softsel, already run on the IBM PC. For comparison, over 80 percent run on the Atari micros, over 70 percent on the Apple, while about 60 percent run on the Commodore 64.

The top 20 includes 10 games that run on the IBM PC, including Zork I, II and III, Frogger, Temple of Apsai, Deadline, Planetfall, Miner 2049er, Enchanter, Serpentine and Witness, plus the famous Microsoft Flight Simulator.

With up to 1,000,000 PCjrs to be sold in 1984, the current flood of IBM games will become a torrent. This is particularly good news for a small British company whose Advance computer is currently being manufactured by Ferranti, and which promises to provide IBM PC compatibility for only £400 — see our October 1983 issue.

Software shorts



● **ACT** has announced its Micromail package, reviewed in the November issue of *Practical Computing*, as Micromail Blue for the IBM PC. Telephone: 021-454 8585.

● **Prospero Software** has a new Pascal compiler for the 8086 family of chips. See our June 1983 issue for a review of Pro Pascal on eight bits, as the 16-bit version is said to be fully compatible. Telephone: 01-785 6848.

● **Sky Software** is not a new company, just a new name for what was Comsoft. Its new range of Blue Sky packages are Skymaster, Skymail, Skycost and Skybuild. They run under the Skymos multi-user operating system on IBM PCs linked using PC-Net. Telephone: (0527) 36299.

● **Inner Loop** software of Los Angeles has launched Scrollmate, which provides up and down scrolling of up to 14 screenfuls of text under MS-DOS. Telephone: (Area code 213) 822-2800.

● **Graphic Communications** of Massachusetts has produced a suite of 24 programs to simplify the design of presentation graphics on the IBM PC and XT. Pete & Pam is importing it. Telephone: 01-677 7631.

● **GCS Communications** has extended its range of products to include P-Cox, a 3270 coaxial interface for the PC and its look-alikes. It costs £900. Telephone: 01-898 2121.

● **Sophco** of Boulder, Colorado, has introduced Protec, a \$250 master-menu and security-control program for the PC and XT. It not only shuts out unauthorised users but prevents passing humourists from typing commands like Format C: on the XT. Telephone: (Area Code 303) 444-1542.

AFTER INTENSE industry speculation, IBM finally launched the "Peanut" micro-computer — now called the Junior or PCjr — in the U.S. on November 1 last year. One month later some 1,000 machines were delivered to dealers for demonstration purposes. Sales were not scheduled to begin until January — after the Christmas rush on which so many micro companies have come to depend.

The timing of the announcement was presumably to encourage those considering a micro to wait until after Christmas, instead of buying another model in December. The only two surprises were the name, and the infra-red keyboard connection.

Whether you like the name or not, it is accurate, although some Americans are already calling it the "Pee Wee", to distinguish it from the "Pee Cee". The infra-red keyboard connection is a logical part of the design. The deskless home user wants to relax in an armchair, not be cabled to the system box.

The thinking behind the PCjr is interesting. IBM's problems with the PC are twofold. First, it is too successful; second, it is too expensive for Everyman, even in America. Most home buyers of the PC and XT — and there are many — have some business justification for their purchase. People who don't generally cannot afford it. Schools, colleges and even some corporations have also found the price of the PC a disincentive: just think

IBM PCjr

Jack Schofield takes a hard look at the spec of the "Peanut" and assesses how it will fare against the established home-micro competition.

about the cost of buying them by the thousand.

Of course, IBM could not solve the second problem by reducing the price of the PC again. That would merely exacerbate the first problem. It can already sell PCs and XTs faster than it can make them. And, of course, reducing the price of the PC would mean smaller profits.

The PC is over-specified for the home/school market, and the PCjr offered the chance to make a more suitable machine. The easy way would have been to make the new machine largely incompatible with the previous models, like Commodore with the Vic-20. However, this did not mesh with IBM's overall strategy of taking over the entire microcomputer industry with a string of PC products from the top to the bottom of the range.

It was far better, both for IBM and for the user, to make the jr, as far as possible, a

PC-compatible machine. The problem then was that while the PCjr had to be good enough to take advantage of the huge software market created by the PC itself, it also had to be not too good, or it would take sales from the more profitable elder brother.

IBM's solution was to retain the Intel 8088 CPU, the PC-DOS operating system and disc format, and fundamentally the same Microsoft Basic, so as to largely retain software compatibility. This enables the PCjr to be offered in large volumes by IBM's corporate sales force, either for use as a cheap work station or for executives to use at home.

To make the system more suitable for the home/education market, IBM added colour graphics as standard, cartridge slots, joystick ports, and expanded the PC's single-tone sound to three channels. These decisions offer an interesting contrast with



Acorn, which deliberately offers less rather than more in all these areas in order to make the Electron a conspicuously inferior machine compared to the BBC Micro.

IBM has ensured that the Junior's weaknesses are in areas where the home/school user does not suffer too much, but where the business buyer is affected. So it has an inferior keyboard and, for now at least, only one disc drive. The PCjr does not have the same internal expansion system as the PC, so business users will not be able to add large quantities of RAM, clock/calendar cards, etc. And while the text display is good, it is not of the exceptionally high quality of the IBM PC.

Not crippled

However, as the keyboard is detached from the main unit, no doubt third parties will offer replacement keyboards and add-on disc drives sooner rather than later, and internal expansion is possible. So though the PCjr may have had one hand tied behind its back, unlike the Electron it has not been deliberately crippled.

The 62-key cordless keyboard is powered by four AA batteries, and weighs 25 ounces. It communicates by infra-red signals with the main unit at distances of up to 20 feet, as long as it is within view. An optional 6ft. adaptor cord is required if more than one PCjr is to be used in the same room.

As the PCjr keyboard has 21 fewer keys than the PC model, something has had to give. For a start, the 10 dedicated function keys are missing, though as on the Electron the functions can still be used by pressing the function key and the number keys. The separate numeric keypad has gone too, though there are now four cursor control keys arranged in a neat cross. The spurious Backslash key — sited between the

left Shift key and Z on the PC — has also disappeared, just when we were learning to accept it as the new standard and Elan had carefully added it to its new micro.

For software compatibility, the PCjr keyboard can produce all the codes produced by the standard PC model, though in some cases the key combinations required are less convenient. Still, that is not too bad a limitation. The keyboard has two other distinguishing features: rubber key caps and no labels, as the key labelling is on the keyboard itself. The layout can be customised by reprogramming any of the keys and adding a keyboard overlay.

The rubberised key caps are squishy but apparently not hard to type on for limited periods. In this respect the keyboard is the worst part of the PCjr. It is regrettable that what will be, when it arrives, one of the most expensive home/education micros on the market should have a keyboard that is inferior to cheaper rivals.

The PCjr comes in two models: an entry-level system, and a full-specification model with a built-in disc drive. The system box measures about 14in. long by 11in. deep by 4in. high. Both models have the same detached keyboard, separate power transformer, a *Guide to Operations* manual and *Hands-On Basic* booklet.

The system box has two cartridge slots on the front, plus ports for a cassette recorder, two joysticks, external amplifier and speaker, a keyboard cable, a light-pen and various video displays. There is one spare socket. Unfortunately these ports all seem to be non-standard designs. IBM evidently expects people to pay outrageous prices like \$30 for a TV-set connector or cassette-tape adaptor cable. Some schools and corporations will probably shell out, but enthusiasts will rapidly find cheaper alternatives.

Both models have 64K of ROM. It

includes self-test diagnostics, as do the Atari XL micros, and a program called Keyboard Adventure which uses graphics and sound to introduce the keyboard. The entry-level model has 64K of RAM and produces a standard 40-column display on a TV set, composite video or RGB colour monitor. In addition to 320-by-200 pixel resolution in four colours, and 640-by-200 pixels in two colours — both of which are offered by the standard IBM PC with colour-graphics card — the entry-level PCjr also offers a 16-colour mode with 160-by-200 pixel resolution.

The other PCjr has 128K or RAM, with no room for more inside, and a 360K half-height 5.25in. floppy-disc drive that uses the same PC-DOS operating system and format as the standard PC. It has better graphics too, and can display 80 characters per line.

OS costs extra

The enhanced model comes with two discs. The first, *Exploring the PCjr*, is a tutorial which includes system use and simple programming. Your IBM PCjr contains sample programs for home use including a word processor, address file, etc. This model costs \$1,269, but you need to spend \$65 more for the PC-DOS 2.1 operating system.

There is another catch. With both models the sound, graphics and some peripherals are fully supported only by a plug-in cartridge Basic, for which IBM charges an extra \$75. It is tempting to complain about charging extra for a Basic language cartridge, and it did not win Atari friends for the 400. However, the Commodore 64 has proved successful in spite of the fact that the hardware is virtually unsupported by the Basic. At least IBM will probably supply a useful extended Basic, a feat which seems to be beyond Commodore.

The entry-level PCjr can be upgraded by adding a disc drive and a 64K expansion, mainly used for colour graphics. With the PC, video RAM is held on a separate card, but with both models of the PCjr it comes out of main memory. Both models can be upgraded by adding a modem — in the U.S. at least — and serial or parallel printer connections.

The PCjr Basic cartridge is a superset of the original Microsoft Basic. It supports the enhanced graphics and sound capabilities, the light-pens, the three-voice sound and asynchronous communications. As such it is more a necessity than an option.

The IBM PC Compact Printer is a 50cps thermal unit which uses single-sheet, fanfold or rolls of thermal paper. It costs \$175. The IBM PC Color Printer prints in up to eight colours. It offers 200cps in draft mode, 110cps in correspondence mode, and 35cps in letter-quality mode. It can use single-sheet, fanfold and rolls of paper up to almost 15in. wide and costs \$1,995. Both



The PCjr is a downgraded model, and there are 21 fewer keys than on the PC.

(continued on next page)

(continued from previous page)

printers can be used with all versions of the PC, right up to the XT/370 "desk-top mainframe".

Three groups of programs were launched with the PCjr. There are two new programs intended for all models of the PC. The first of these, the Personal Communications Manager, provides access to other computers via the telephone lines and thus to Dow Jones and The Source, in the U.S. The second is the Fixed Disk Organiser program — not much use with the PCjr.

The second group comprises updated versions of seven programs for all models of the PC. They are Casino Games, Strategy Games, EasyWriter PFS:File, PFS:Report, Basic Program Development System and Time Manager. In all some 30 of the programs in IBM's own PC line-up are said to run on the enhanced PCjr.

The third group comprises new IBM-badge cartridges and disc-based programs for home and educational use. They include Homeword, Home Budget Jr and Turtle Power. Homeword is a simple picture-based word processor from the Apple/Atari software house Sierra On-line. Home Budget Jr is from the Software Publishing Corporation. Turtle Power is a turtle-graphics program from The Learning Company, though IBM already has a Logo. Games on cartridge include Mouser, Mineshaft and Crossfire.

Software flood

Given the vast number of software houses producing programs for the IBM PC, other third-party software will undoubtedly flood the market. There is already a PCjr magazine.

The entry-level system looks a bad buy. In the sound and graphics departments it offers no advance over the Atari 800XL while it is more than twice the price. The keyboard seems grossly inferior, and the entry-level PCjr is at a major disadvantage when it comes to software. The Atari has hundreds of good programs available, while initially this model of the PCjr has only a handful. After the unveiling of the PCjr, Atari announced a price increase — from after Christmas — on its range.

The Commodore 64 has similarly little to fear from the entry-level PCjr. The Commodore is a bit of a seven-stone weakling in terms of its pathetic Basic and cassette-tape software — are there more than three good games? Nonetheless the Commodore 64 hardware looks much more powerful. A PCjr plus Basic costs more than a Commodore 64 plus disc drive: in all the Commodore is a far better buy.

The enhanced PCjr is a different basket of chips. While the price is still not going to worry Commodore, or Atari's 1450XL model with built-in disc drive, it should certainly worry Apple. With 128K of RAM, an 80-column screen and PC-DOS 2.1 the PCjr can rival any small micro on the market thanks to being able to share

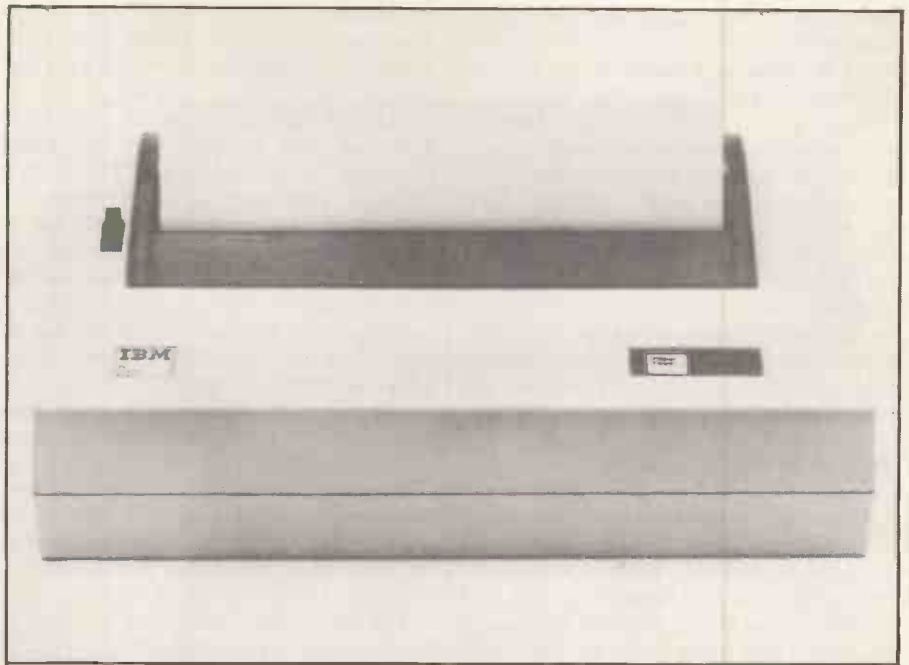

software with the IBM PC. The Basic, graphics and sound are all superior to the Apple IIe, and the PCjr price is very competitive.

At its launch, the Apple IIe without disc drive had a list price of \$1,400 — just twice as much as the entry-level PCjr, and more than even the disc-based model. While the Apple II still has more software, and more good software, than any other micro, the PC is catching up fast. The PCjr could well tip the balance.

Further, the PCjr offers an upgrade path, which the Apple IIe conspicuously fails to do. The PCjr is simply the bottom rung of a ladder through which the user can progress via the IBM PC and XT right up to the XT/370. Not many individuals will go all the way, but the facility certainly matters to schools, colleges and corporations.

However, a glance at the sparsely-populated Apple IIe board suggests Apple can slash the American price to make it competitive and still make a comfortable profit. In the U.K. the situation is more uncertain. Here the competition is not Apple but the superior Acorn BBC Micro. Apple has basically ignored the home-into-business market well represented among readers of this magazine — just try looking for Apple advertisements in *PC!* — and has left the BBC Micro to capture tens of thousands of sales unopposed.

The BBC Micro has massive support from serious home/educational/small-business users. It also probably has a year's grace before the PCjr finally arrives. By this time the BBC software base will be that much stronger, especially in the area of small-business and executive tools where it is currently weakest. It should continue to prosper, possibly at the same price as today, though with a profit margin for dealers. Apple may be squeezed between the BBC and the PCjr, and the IIe's price might well need to drop to under £500.

Whenever the PCjr arrives, and

whatever the price, it looks likely to establish PC compatibility as a major factor at the bottom end of the micro market. This will benefit the Advance and other IBM look-alikes due to appear on the home-micro market. Machines which have a strong user base or can develop one before that happens should be OK. Trying to establish a new standard, like the Japanese manufacturers with the Microsoft MSX eight-bit system, looks like a complete waste of time.

Conclusions

- The main advantage of the PCjr is that it offers compatibility with the IBM PC, and thus both a share of the software base and an upgrade path.

- The main disadvantage is the keyboard. It looks as though its deficiencies are deliberate, in order to protect sales of the IBM PC itself.

- A further disadvantage is that it has non-standard ports and the nominal price does not include numerous extras that will in fact be required — like DOS 2.1 with the enhanced PCjr. The new models are more expensive than they look — but then, this applies to many other machines too.

- The PCjr entry-level system is under-powered and overpriced at \$669 plus extras. If it comes to the U.K. at £500 to £550 it should not hurt the BBC Model B, though it might.

- The enhanced PCjr is very competitive at \$1,269 including disc drive. If it arrives in the U.K. at around £1,000 it looks likely to hurt Apple.

- The PCjr will be a success thanks to the excellence of IBM's marketing and the strength of the name. PC compatibility could be established as a major force at the bottom end of the micro market, wiping out those firms who do not have a large user base.

GamePak
Piggy-backs
above edge connector

MemPak
Available in 128K or 256K
does not interfere with next slot

SECOND SERIAL PORT (optional)
configurable as COM1 or COM2
100% IBM compatible

PARITY CHECKED MEMORY
socketed from 64K to 256K

QPlus II

CLOCK/CALENDAR
Clip-on battery
Automatically
sets time & date

PRINTER PORT
configurable as
LPT1 or LPT2
100% IBM Compatible

**PARITY CHECKED
MEMORY**
socketed from
64K to 38K

ASYNCHRONOUS PORT
configurable as COM1 or COM2
Programmable parity, baud rate, etc.
IBM compatible RS232-C Serial

Game Adapter
(optional)

SixShooter

THE ONLY BOARDS YOU REALLY NEED FOR YOUR IBM PC OR XT

QPlus II and the **SixShooter** are America's most popular pair of enhancements for the IBM PC & XT. They offer the most comprehensive list of features available while occupying just one slot in your computer. State of the art engineering along with the most rigorous quality controls in the industry result in a product in keeping with the high standards set by IBM.

The **Qplus II** comes standard with clock/calendar, asynchronous serial port (RS232C), and your choice of memory from 64K to 256K. Options include: a second asynchronous port, a parallel printer port, a game port on a plug-in "piggy-back" board, and a choice of 128K or 256K MemPaks. The MemPaks give you the ability to add 384K or 512K of memory in one slot.

The **SixShooter** is ideal for the XT model. It offers a battery powered clock/calendar, asynchronous port, parallel printer port, SuperDrive & SuperSpool software, and your choice of memory up to 384K, all standard. Optional is an IBM compatible game port adapter.



Also included with both boards is the SuperDrive™ disk emulation software. It allows you to create up to three "electronic disk drives" in memory which access your programmes at the speed of RAM memory. You also get SuperSpool™, a programme which allows you to assign a portion of memory to act as a print spooler.

Both boards are backed up by a one year parts and labor warranty and 48 hour turnaround on any warranty repairs. Visit your local dealer and pick up a brochure with the full details. If he doesn't have the information have him give us a call. Your PC will really thank you.

Suggested List Prices:

64K £319 128K £389 192K £459 256K £529
Options: Second async port, printer port, game port, and
GamePak, each £40. MemPak 128K £199,
MemPak 256K £349.

QUBIE' DISTRIBUTING LTD.

Tempo House, 15 Falcon Road
London, SW 11
(01) 223-4569, 223-7662

A HIGH PERFORM MULTI-USER

GRASP THE FACTS AND SAVE UP TO 50%

Pay much less for much more computing power per user

Class	BROMCOM SuperStar Super-Micro (Multi-Processor)	Conventional Mini-Computers				
		IBM System 34	DEC PDP11/34	ICL System 25	Olivetti System M40	Burroughs B95
Processing Power	Up to 16 8 bit (Z80A) or 16 bit (iAPX 186)					
Memory Per User	8 bit up to 128Kbyte 16 bit up to 1Mbyte					
Disc Storage & Backup	From 10Mbyte up to 160Mbyte + 40Mbyte tape					
Expandability	Up to 16 users more with networks. Up to 512Mbyte storage					
Lowest Entry Cost	£2450 (including VDU)					
Cost of 2 User 10Mbyte System 2 off VDUs	£5975 (8 bit) £6975 (16 bit) (including VDU)					
Incremental Cost for Each Additional User	£995 (8 bit) £1495 (16 bit) (including VDU)					
Hardware Compatibility	World Standard S100					
Software Compatibility	World Standard CP/M & MS-DOS					

Systems Architecture

Each user has its own processing power each with 16 bit and up to 1Mbyte Memory or 8 bit and up to 128Kbyte.

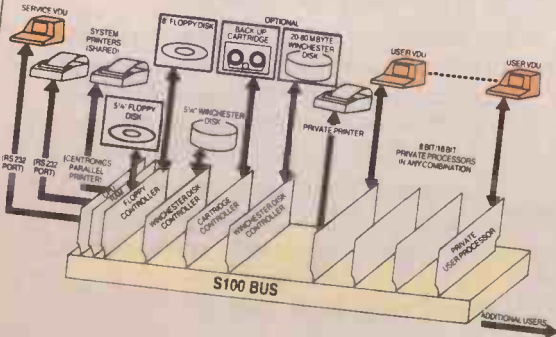

Available Software

BROMCOM Standard Range	BROMCOM Specialised Packages	Text & Database	Languages
Sales Ledger Purchase Ledger Nominal Ledger Stock Control Order Processing Job Costing Payroll (with SSP)	Property Management Energy Management Membership M'gement Betting Office Chain Insurance Brokers Wholesale/Retail Automatic Invoicing Planned Maintenance Garment Trade	WordStar SpellStar Mailmerge DataStar ReportStar Spellbinder SuperCalc dBasell Rescue Microplan	BASIC COBOL FORTRAN PASCAL C PL/I APL

BROMCOM Bespoke Programming -
Can be carried out by BROMCOM or a growing number of OEMs and Dealers in all areas.

All CP/M and MS-DOS software will run without any modification at all.

SuperStar is a trademark of Bromley Computer Consultancy Ltd.
CP/M is a trademark of Digital Research.
MS-DOS is a trademark of MICROSOFT.

ANCE, GENUINE, R SYSTEM.

Some installations are a little more difficult than others!

Such as the one at Banham Patent Locks, Limited, in London.

BROMCOM® supplied hardware and software that would have taken a respectable-sized minicomputer from, say, DEC or IBM or Olivetti at twice the price for hardware, three times the price for software and four times as long to implement.

The Hardware – BROMCOM SuperStar™ – is handling six terminals (expandable to 16) and three printers with 20Mbyte disk storage and tape backup. The operators work round the clock, so the speed and reliability demanded of the system are high.

Operators can simultaneously enter Invoices, Payments, etc, while other functions such as word processing and database operations (over 15000 entries!) are in constant use by other terminals.

BROMCOM

Bromley Computer Consultancy Ltd
417-421 Bromley Road, Bromley, Kent, BR1 4PJ.
Telephone: 01-697 8933 Telex: 896691



- * POWERFUL – HIGH PERFORMANCE – FLEXIBLE
- * VERY COST-EFFECTIVE WITH LOW ENTRY PRICE
- * FULLY MODULAR AND EASY LOW-COST EXPANSION
- * WORLD-STANDARD S100 HARDWARE AND OPERATING SYSTEM – CP/M OR MS-DOS
- * FULL MULTI-USER CAPABILITY WITH RECORD/FILE LOCKING AND PRINTER SPOOLING
- * FIELD-PROVED OVER TWO YEARS WITH A LONG LIST OF SATISFIED CLIENTS
- * STYLISH NEW DESIGNS FOR 1984 AND BEYOND
- * MODEL 10 CATERS FOR UP TO 6 USERS, MODEL 20 UP TO 16 USERS

SuperStar

OUTPERFORMING MINICOMPUTERS WITH MICROCOMPUTER ADVANTAGES.

SS

BRITISH MULTI-USER SYSTEM

Put some colour into your printing without going into the red

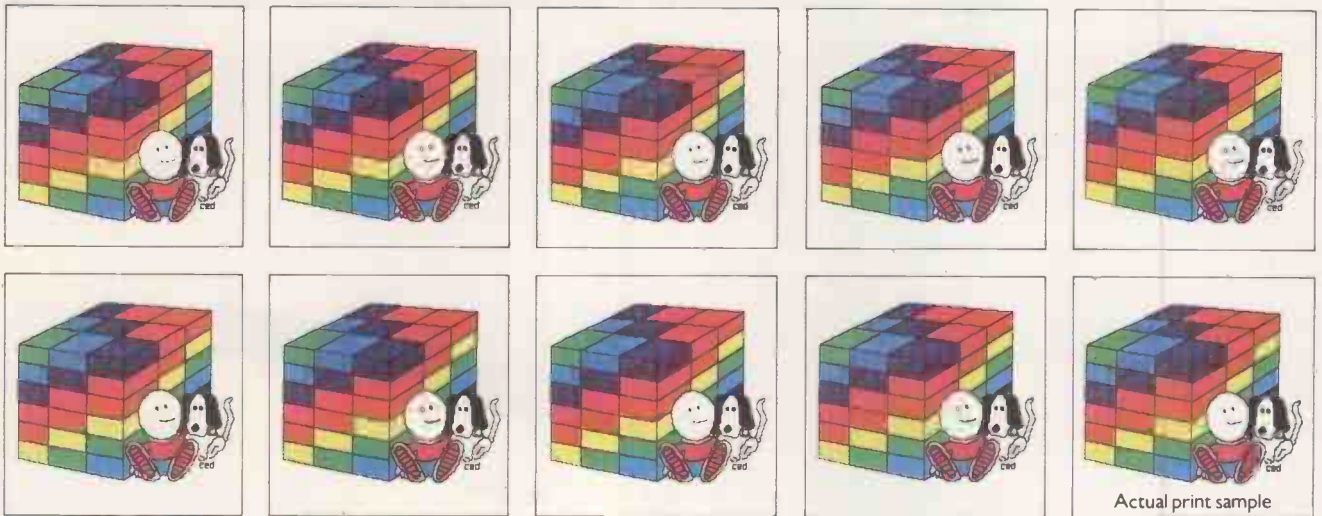

The new **PRISM** impact matrix printers let you put colour into your printed output, at a cost you can afford. Both the **PRISM 80-column** and the **PRISM-132 column** make most single colour printers look pale by comparison.

- Added versatility: the four basic colours (black, cyan, magenta and yellow) can also be mixed precisely to give up to 144 different shades.
- Correspondence quality at 110 cps.
- High quality draft printing at 200 cps.
- 84 x 84 dpi high resolution graphics capability.
- Staggered 9-wire print head – ideal for precision word processing applications.
- Bi-directional printing to maximise throughput.
- Proven reliability.
- Selectable automatic justification and character sizes.
- Optional manual and automatic sheet feeding.

PRISM printers. They brighten up your day.



- Compatible interfaces to most micros including Apple, IBM and Sirius.

Dealer Enquiries
Welcomed.



Teleprinter Equipment Ltd.

Akeman Street, Tring, Herts. HP23 6AJ. Telephone: Tring (0442 82) 4011/5551
International Telephone: + 44 44282 4011/5551. Telex: 82362

Regional Sales and Service: Manchester (061-626) 3371.

Associated Companies GADC/CAE/ME

CAE Group. UK distributors for computer peripherals from General Electric, Geveke, GNT, Integral Data Systems, Navtel, NEC, Mitsui, Qume, Silver Reed, Spectron Northern Telecom, Teleray, Teletype and Texas Instruments.

● Circle No. 131

Microware and IBM — an unbeatable combination.

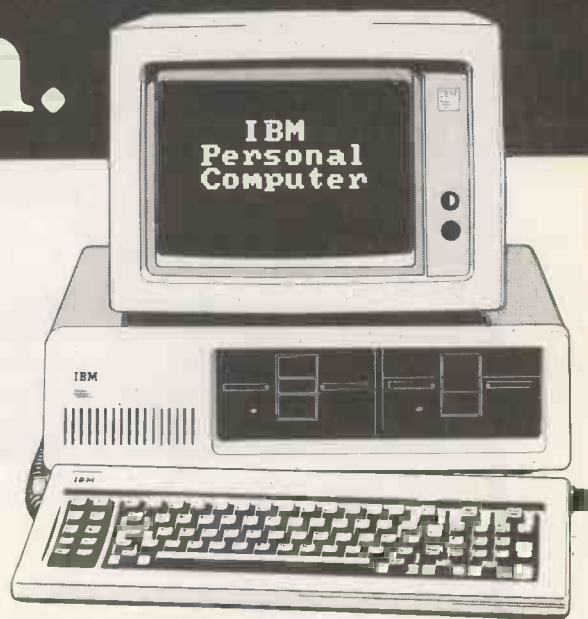

We promise to:

- Analyse and identify your requirements.
- Advise on your system needs.
- Supply and install your equipment.
- Provide the widest range of software support.
- Offer comprehensive maintenance contracts.
- Take pride in our unparalleled after sales service.

MEMORY EXPANSION

1. Memory expansion from 64-512K
2. Memory expansion with extended features:
 - Printer port
 - R232
 - Games control
 - Battery clock/calendar
 - Expansion up to 512K
3. Memory expansion for electronic disk (RAM) providing capacity of up to 2 Mb

MULTI-TASKING

- Multi-tasking software is now available for PC DOS – up to 9 tasks can be run
- Concurrent CPM

WINCHESTER DRIVES

1. PC Pair
Hard disk storage
 - 3.9" Winchester drives
 - Single board DTC controller plugs directly on to PC Bus
 - No additional power required
 - Fixed or removable second drive
2. Our range of 5¼" external Winchesters provides up to 80 Mb of storage
 - Easy back up facility

NETWORKING

- PC net
- Local area network and shared resource
 - Independent of disk type ie XT, corvus etc
 - Independent hard disk system
 - Remote PC
 - IBM PC DOS 1.1, 2.0
 - Disk and file sharing
 - Low cost, easy to use
 - Simple to set up
 - Up to 16 PC's per file sharer

SOFTWARE

- Pegasus - Business application systems
- Sales Ledger
 - Purchase Ledger
 - Nominal Ledger
 - Invoicing
 - Payroll
 - Stock Control
 - Order Entry
 - D Base II Applications

Our complete list of software is too long to publish, but the widest range is available from stock including:
Wordstar, Mailmerge, Supercalc, D Base II, Fortran 80, Easyfiler, Easywriter, Visicalc

TRAINING

- We offer training to our IBM PC customers:
1. Computer aided training, which, after initial set-up, your PC guides you through the software
 2. On site personal training by our experienced professional instructors

MONITORS

- We recommend from our range the following:
- The new IBM colour monitor
 - LUXOR – high res. colour
 - AMDEK – the only IBM compatible amber screen monochrome available
 - HANTAREX – 14" high res. colour

SERVICE

- We offer a number of service options including:
1. Warranty/non-Warranty repairs
 2. Extended Warranty contracts
 3. Quick response service contracts covering both parts and labour

PURCHASE TERMS

1. Rental agreements
2. Leasing contracts
3. Approved credit purchase
4. Credit cards

⊕ Microware

Microware (London) Ltd.
Showroom at: 637 Holloway Road, London N19 5SS.
Phone 01-272 6237/6398 or Telex 297598.

IBM Authorised Dealer

IBM

Personal
Computer

SUPPLIES SURPRISE!



Simply the best catalogue of
Computer & Word Processor Supplies available.
We would be pleased to send you a copy.

Name _____
Company _____
Address _____
_____ Tel _____



AWS Computer Supplies Limited, 57, Surbiton Road,
Kingston-upon-Thames, Surrey KT1 2HG Tel: 01-541 1188

● Circle No. 133

Work on your own where you're not alone

A place where you can set up alone or start a business or open a branch office and not have to worry about who answers the phone when you're out.

And the location gives swift access to M4/M3 motorways, the North Circular, the Underground, British Rail and Heathrow Airport in a leafy environment with the Thames nearby.

It's London without the hassle.

UNITS FROM 100 SQ. FT. AT £28 pw. INCLUSIVE

Call in, phone or write: **Barley Mow Workspace, 10 Barley Mow Passage, Chiswick, London W4 4PH. Telephone 01-994 6477.**



● Circle No. 134

PRODUCTS FOR COMMODORE

SPEED UP ANY BASIC PROGRAM WITH OUR COMPILERS

Up to 40 times speed increase, reduced program size.

BASIC COMPILERS

Petspeed Compiler for 4000/8000 series _____ £125.00

Integer Basic Compiler for 3000/4000/8000 series £75.00

CROSS-COMPILERS FOR BASIC

Portspeed: Compiles source on 8000 series to run on CBM 64 _____ £125.00

X-64: Integer compiler compiling on 8000 series giving machine code executable on CBM 64 _____ £125.00

B-Port: Compiles source on 8000 series to run on 700/B-128 series _____ £450.00

X-700: Integer compiler compiling on 8000 series giving machine code executable on 700/B-128 _____ £450.00

GIVE YOUR VIC OR 64 FULL IEEE AND RS232

Not a cartridge. Compatible with any software.

Interpod: Free-standing interface giving IEEE488 and RS232C capabilities to CBM64/VIC20 _____ £99.95

SPECIAL OFFER

Order 5 or more Interpod and get a free Portspeed!

All prices are exclusive of VAT. There is also a small charge for post and packing. Dealer discounts are available on all products except the 700 cross-compilers.

Compilers are supplied ex-stock; Interpod supplied 7-days ex-stock.

COMMODORE SOFTWARE

Native compilers for the CBM 64 and the 700/B-128 are available only from Commodore.

Oxford Computer Systems (Software) Ltd.
Hensington Road, Woodstock, Oxford OX7 1JR, England
Telephone (0993) 812700 Telex 83147 Ref. OCSL

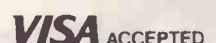

● Circle No. 135

No 1 source for software

1984 PRICE LIST NOW AVAILABLE

Phone for your **FREE** copy



Make Soft Option your No 1. Chances are we'll have the right product, in the right format, in stock in quantity.

- Full technical support
- Friendly service
- **SAME DAY DESPATCH**
Wherever possible

All products are supplied complete with full originator's documentation.

RING THE SOFTLINE Grantham (0476) 860171



Soft option

SOFTWARE CENTRE

The Soft Option (UK) Ltd. Home Farm House Colsterworth
Grantham Lincolnshire NG33 5HZ Tel: Grantham (0476) 860171

• Circle No. 136

CAMEL PRODUCTS

firm up your software with an

EPROM PROGRAMMER

AT LAST! for the Spectrum user.

Put your programs, utilities, Assemblers into EPROMS for instant load from the unique ROM-SP

ROM-SP NEW for Spectrum

Ingenious unit for Spectrum, with 2X28 pin sockets and a Reset button allows up to 16K of Basic or M/C program to RUN or LOAD instantly from EPROMS. Cabled connector and full extender card. NOTE: Does not disable Sinclair ROM. £29.95

PROMER-SP NEW for Spectrum

A brand new Spectrum programmer for 2764/128. Zero insertion force socket & software on tape. Delivery Jan. 84. Order now at £29.95

PROMER 81-S NEW for Spectrum

The very popular PROMER-81 for the ZX81 has been adapted to the Spectrum and the price kept low. £22.95

ROM-81

Provides two 24 pin sockets for up to 8K of EPROM memory in the 8-16K area. Can use 2516/32 or 2716/32 £14.95

PROMER-81

At last! A low cost reliable programmer for 2516/32, 2716/32 EPROMS. This is the solution to using EPROMS instead of tape. Requires 4XPP3 batteries for a regulated 25 volts. Remarkably priced at £19.95

BLOPROM-81

A uniquely sophisticated EPROM PROGRAMMER

In use at various labs incl. Sinclair Research

Eprom programmer for the 2516, 27XX single supply families, yes, even the 27128 from Intel. Check, Read, Program + Verify all or part of Eprom.

So immensely user friendly you'll hardly need the manual. Designed for the beginner but includes a single key entry route for the professional. Supplied as firmware, the m/c driver routine alone is worth more than the price of BLOPROM-81. No Personality Cards, or other additions, just a ZX81. Several inbuilt safety features. On-board Vpp generation. 28pin ZIF socket. Cabled connector and extender plug. ABS case.

Note: Can provide up to 36 inputs or 40 outputs as an I/O £79.95

DREAM-81
Full 64K Rampack with link options to disable 0-8-16K. Plus a 28 pin EPROM socket for 2716, 2732/2764 and even the latest 27128 from Intel. Fast/slow Eprom option, professionally built and tested. In an ABS case with an LED indicator. £59.95

DHOB1 1 UV ERASER £18.95

DHOB1 2 £22.95

With automatic timer.

MEMIC-81 £29.95

A 4K CMOS RAM and lithium battery unit. Easy SAVEing, 10yr storage and instant retrieval of programs. Resides in 8-12K or 12-16K of ZX81.

CRAMIC-81 £79.95

Ingenious hardware/software allows this 16K CMOS RAM with lithium battery to Co-exist in same memory area as ordinary RAM. ZX81 can multitask on two completely independent programs.

PRINTER/MONITOR ACCESSORIES

MSB Monitor Stand for BBC micro. Sits over the Beeb 17"X12"X3.75" £19.95

P&P £3.50

PSS Standard printer stands for OKI, Epson etc. 15"X12"X4.5". P+P £3.50 £16.95

PSL Large model 17"X14.5"X3.75" P&P £3.50 £19.95

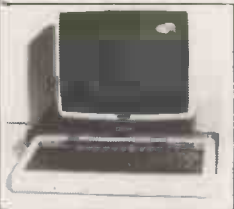

PSC-3 for Epson MX-100 etc. 21"X14"X3.75". P&P £3.50 £22.95

CUSTOM PRINTER STANDS for larger printers P.O.A.

POT Printer Output Tray for 11" fanfold paper P&P £3.50 £16.95



UK. VAT extra. No VAT on exports P+P UK. Free Europe +5% — Overseas +10% TLX 81574

Cambridge Microelectronics Ltd. One Milton Rd. Cambridge CB4 1UY tel (0223) 314 814

A+G COMPUTERWARE

* ALL THE BEST FROM A + G *

APPLE SOFTWARE

New 1984 catalogue now available — lower prices
Lots of new items — 24 pages of bargains
Send now or phone for your free copy

MONITORS

Phoenix Green Screen Hi-Res £89 Amber £98

Wordprocessor integrated package with Apple IIe, complete with professional software & Daisywheel printer from £1414

Printer buffers — external or internal 32K/64K
Serial — parallel competitive prices

Printer Ribbons — Typewheels — Paper — Labels — Cleaner kits

We are only a phone call away

Acoustic covers for most printers at sensible prices

Printers at unmentionable prices!
Over 80 models on our lists — send now or call

Video Terminals — Lots to choose from stock

Do it Now! Ring for our bargain offers.

Govt. & Educ. orders welcome.
Fast delivery by Interlink Courier — FREE delivery!
Mainland U.K.
Please add VAT to all totals

P.O. Box 34, Cheadle, Cheshire, SK8 4PT
Telephone 061-428-2014



• Circle No. 138

STOCK TAKING SALE



olivetti Praxis 35

only £385

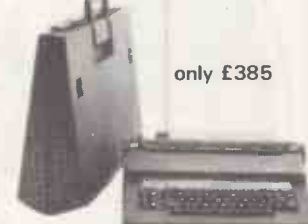

- * Daisywheel Electronic Typewriter Printer
- * Centronics Interface
- * Correction Ribbon
- * Choice of Typefaces

128K RAM. 1.2 Mb CP/M & MS DOS operating systems. only £1850

Other printers at unbeatable prices

+ two free cassettes £139



Seikosha GP100A £170
Seikosha GP250X £220
Epson RX80 £260
Epson FX80 £360



Add VAT but Delivery is Free

ASCO BUSINESSES

43 Windmill Way, Reigate, Sy RH2 0JB Tel: (07372) 48055

• Circle No. 139

A PERFORMANCE AND PRICE BREAKTHROUGH IN APPLE II[®] & IIe HARD DISC STORAGE



High Performance AID hard disc systems of 5-20 megabyte capacities, specifically designed for use with the Apple, are now available running under DOS, CP/M & Pascal. The units cold boot and throughput speeds are really impressive. If you want to leave others standing, try our fast DOS option!

The range features the 5+5 and 10+10 drives which enable you to configure half the drive as primary and half as secondary storage for ease of archiving.

The systems have been designed around the concepts of data reliability and convenience of operation.

They are simply the most competitive hard discs on the market. So why pay more for less.

interface **INTEC** technology

AID

LOW PRICE

5 Mb **£990**

10 Mb **£1270**

20 Mb **£1490**

All prices ex-VAT.
Apple is the registered
trade mark of Apple Inc.

**DEALER ENQUIRIES
WELCOME**

PULSAR BUSINESS SOFTWARE

The star performer for apricot

The Pulsar range of business software will turn Apricot into a powerful management tool.

Software engineers working hand-in-hand with the Apricot development team have enhanced the range of accounting, word-processing and modelling packages to maximise Apricot's exciting fourth generation features.

Already 10,000 users of Sirius and IBM PCs have given Pulsar their seal of approval.

STAR PERFORMER

PULSAR takes the mystique out of computing without sacrificing performance. From the design of the software through to the documentation, the accent is on friendliness and ease of use, making it an effective business partner in a matter of hours.

And by harnessing the new fourth generation features of Apricot – like the unique MicroScreen™ – Pulsar has become the friendliest business software around.

Pulsar is true 16-bit software developed by ACT at a cost of over £1 million for today's business computers. Pulsar owes nothing to early 8-bit software, being developed from powerful programs written by ACT's engineers for its own bureau mainframe computers. It draws on over 18 years experience in creating packaged business software.

DESIGNED TO PLAY A LEADING ROLE

The Pulsar range has been designed to meet all the management information needs of business users. Consisting of some 15 integrated packages, the range includes commercial accounting functions, office systems for word processing and electronic mail, and management tools for planning and modelling. The integration between packages is powerful and flexible.

Shared information means files don't have to be duplicated and data does not have to be re-entered.

AND IN SUPPORT

ACT's investment in Pulsar goes beyond the software to encompass full training facilities for users and 'hot-line' support for your dealers to make sure you get the best service possible.

In addition to a nationwide network of over 500 independent dealers ACT has hand-picked 60 Pulsar Software Centres who specialise in Pulsar and can give immediate on-the-spot advice and action.

A STAR-STUDDED CAST

The Pulsar Range for Apricot:

Sales Ledger	£195	dGraph™	£195
Purchase Ledger	£195	MicroModeller™	£595
Nominal Ledger	£195	Mars™	£395
Payroll	£195	SuperCalc 2™ (Upgrade)	£95
Stock Control	£195	SuperCalc 3™ (Upgrade)	£195
Invoicing	£195	Multiplan™	£175
Data Analysis	£195	Wordstar™	£295
Informer Database	£295	Mail Merge™	£95
dBase II™	£395	SuperWriter™	£295

For more information on Pulsar the Star Performer for Apricot clip the coupon and return to

ACT (Pulsar) Ltd

Freepost Birmingham B16 1BR
or call 021-455 7000

Please send me details of Pulsar Business Software for Apricot



Name _____

Position _____

Company _____

Address _____

62

Telephone _____

● Circle No. 141



™ indicates registered trade mark. Ownership details on request. All prices exclude VAT.

SEE THE STAR PERFORMER
The apricot and SMIUS
SHOW '84
FEBRUARY 7-9

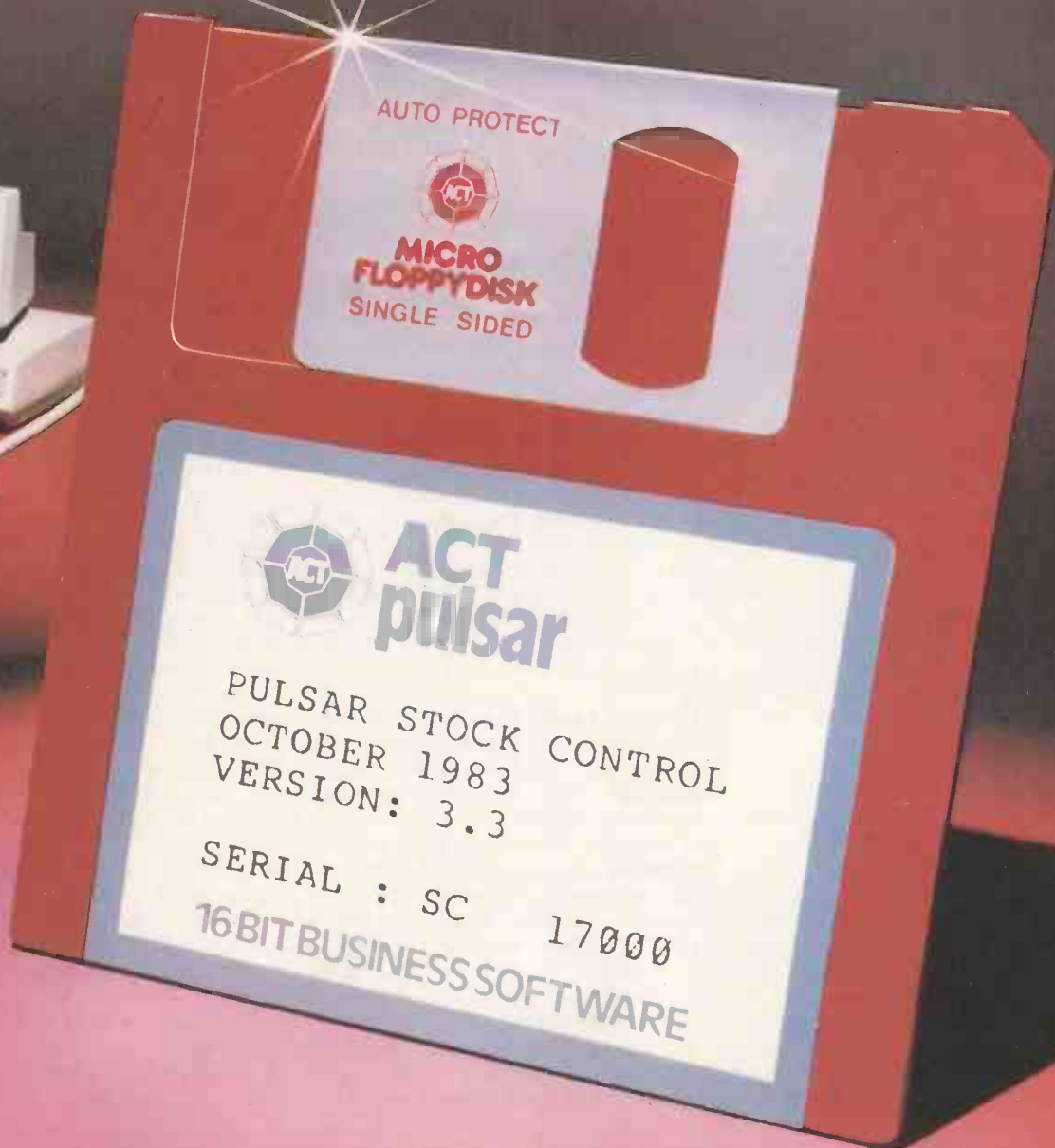

TANDY COLOR COMPUTER 2

The 64K Color Computer is being launched this month. Jack Schofield sees if at last Tandy can slay the Dragon 32.



THE TANDY Color Computer was launched in late 1981, and represented a significant shift in approach by Tandy Radio Shack. It used the powerful Motorola 6809 chip, rather than the Tandy standard Zilog Z-80, and it offered colour, sound, a cartridge slot and joystick ports. Like the Texas Instruments TI-99/4a and Atari micros, it was aimed at the consumer rather than the enthusiast.

Unfortunately, Tandy had not reckoned on a mythical fire-breathing monster from the Welsh hills, which devoured the U.K. market before the Color Computer really got going. The Dragon 32 offered remarkably similar features to the Color Computer. In addition, it had a better keyboard, twice as much memory, and cost a lot less. In fact, when the 32K Color Computer was born, the Dragon was virtually half the price.

Tandy could not outsell Dragon on the availability of software, because by choosing the 6809 it had cut itself off from its own software base. Neither could it sell on the availability of peripherals: few Dragon 32 buyers realised how long it would take Dragon Data to offer a proper system, and even fewer cared. Nor could Tandy beat Dragon at marketing, because the Dragon 32 was taken up by Boots the

Chemist — one of every Briton's favourite stores.

Now Tandy is having another attempt. It has given the Color Computer a face-lift: more memory, a better keyboard and a fresh lick of paint. Also it has cut the price of the existing models fairly dramatically. The 32K Extended Basic model is down from £379.95 to £299.95, and the 16K standard model from £239.95 to £179.95. The cost of a disc drive with controller has dropped too, from £459.95 to £349. In spite of all this, the 64K Color Computer remains an ugly duckling, as will be seen later.

However, Tandy has provided it with the potential to be a swan, by implementing the Unix-like OS-9 operating system on the 64K model. This offers real concurrent operation or multi-tasking. It offers multi-user facilities, so you can hang an extra terminal off the CoCo's serial port, plus login, password protection and tree-structured directories. In several respects the 64K CoCo gives machines like the IBM PC a good run for their money, since the 6809 is as much of a 16-bit chip as the Intel 8088 which powers the IBM.

The new Color Computer makes a good first impression, and sports a smart grey finish instead of Tandy's usual silver. The

case is solid and extremely well finished. The Tandy leaves the Dragon slain in overall appearance.

The keyboard also appears to be good. Gone are what the Americans call Chicklet keys, after the popular sugar-coated chewing gum. However, the keys have a stiff touch and very little travel. The typing quality is well below that of the Atari XL range, BBC Model B, Sharp MZ-711, and even the Dragon. Chicklet keys positioned over a membrane worked better than they looked; the new keyboard looks better than it works, but it is an improvement.

Like the 32K CoCo and the Dragon itself, the new model has a limited number of keys and a very limited character set. The 64K CoCo has only 53 keys: no function keys, no numeric keypad, no Escape key, not even a Control key, and the keys still lack auto-repeat. The character set is still more limited. The 53 keys produce only 63 alphanumeric characters and symbols. The rest of the 255 available mainly comprise a weird and wonderful collection of block-graphics characters in a range of unexciting colours.

Thus, like the Dragon, the 64K CoCo lacks a lower-case character set, which even the Apple IIe has. Of course it is possible to use inverse caps in place of lower-case

letters, or you could reconstruct the character set to include true lower case, but in this day and age it should not be necessary. It is not good enough, and that applies for the 64K Dragon too.

Powering-up reveals the familiar CoCo/ Dragon hideous green screen with black letters, and only 32 characters by 16 rows of text. The display is not as awful as that of the *Practical Computing* Dragon, but most current machines do better.

Only 24,871 bytes of RAM are free to Basic. It seems that, again like the Dragon 64, the 64K CoCo is a 32K machine that allows you to grab extra memory if you want it. Unfortunately the review machine had no documentation and I never calculated how to do so. Typing Exec did not work and on the 64K Dragon this gives 41,241 bytes free, which is more than the Commodore 64. On the CoCo it crashed the machine.

In its 32K mode, the CoCo has the same good but slightly old-fashioned Microsoft Extended Color Basic as before, and the same rotten Microsoft line editor. Again, this is not adequate by today's standards. Atari have had full-screen editing since 1979, so Tandy and Dragon should be able to offer it now too.

The Color Computer becomes a more attractive machine when you plug a disc-controller cartridge into the port on the right-hand side, then plug in one or two disc drives. Preferably two, because copying a full disc with one drive involves five insertions of the source disc and five insertions of the destination disc.

With discs connected, the 64K CoCo offers 22,823 bytes free to Basic. The discs take up less RAM than Atari discs, but more than the Commodore 64 ones. Disc operation is simple and straightforward, though the drives are slow and noisy. The regrettable thing is that, without warning,

the operating system writes over your old files if you happen to use the same name as an existing file. There is no friendly

Are you sure (Y/N)?

or

Replace existing file?

The 64K CoCo comes into its own after booting the OS-9 disc-operating system, which I had never used before. It was written by Microware Systems Corporation in America especially for the 6809 chip, and was modelled on the Bell Labs Unix operating system.

Anyone who is familiar with Unix, or the Unix-like MS-DOS/PC-DOS version 2 from the IBM PC, will find OS-9 even easier to use. Tandy's excellent documentation comes in a slip case and consists of one booklet *Getting Started with OS-9* plus three spiral-bound manuals.

Disc feature

OS-9 is on a single disc and the whole package costs £69.95. It has many sophisticated features normally found only on very expensive machines of, say, £5,000 to £50,000. It has a kernel, a shell and a hierarchical file structure, so you can organise material in directories, sub-directories and so on. It has device-independent input and output, with Pipes so that the output of one program can become the input of another.

In Unix you can run several programs simultaneously if you have enough memory, by adding & to the command. Similarly with OS-9 you can have multi-user operation and hang an extra terminal from the back of your Color Computer. Pretty amazing for a toy home micro.

OS-9 allows Unix-like commands such as `dir ! sort >IP&` which does a file directory, sorts it and sends it to the printer but hands the prompt

back straightaway so that you can do something else at the same time. Or, for example,

```
dir >IP& list myfile& copy oldfile newfile;
del yourfile
```

sends a directory to the printer at the same time as typing Myfile on the screen and, concurrently, copying from the old file to the new file. When that's done it deletes your file. It is all done by one command line.

OS-9 comes with a good assembler, a text editor and an interactive debugger, so the assembler programmer will be very happy with it. There's an OS-9 Basic too, not supplied for review. The OS-9 prompt is tedious, reading "OS-9" all the time. However, you only have to type -P to kill it, then remove the echo, and the environment is so convincing that in a few minutes you believe you are using Unix on a DEC mini — except that you cannot browse through Usenet, the anarchic message network.

The 64K CoCo is not perfect. Screen width is a problem because of the way copious directory information is wrapped around. Also, Unix commands are traditionally all lower case, so the CoCo's insistence on capitals only, mixed with inverse capitals pretending to be lower case, is a pain. Finally, the software-driven real-time clock which OS-9 provides is hopelessly inaccurate, being configured for the American mains. Still, short of spending £5,000 on an IBM PC XT or Fortune 32:16, a 64K Color Computer with OS-9 provides the most fun you can have in computing other than playing Defender.

Incidentally, OS-9 has a serious purpose: to make available a substantial amount of business software which runs under this operating system. However, none was available for review, and it is probably all American anyway.

Conclusions

- On its own, the 64K Tandy Color Computer is a moderately good home micro with a number of serious limitations, particularly in the screen display and lack of lower-case letters.

- With the OS-9 operating system, the 64K Color Computer becomes a powerful and interesting machine which potentially offers the serious user facilities far above its price level.

- If OS-9 software becomes available, and the Color Computer proves big enough to take it, this could give it serious business applications.

- In any event, the wealth of error messages, excellent assembler facilities and Unix-like power make OS-9 far superior to CP/M, and a valuable learning tool for anyone interested in current developments in operating systems.

- The 64K Color Computer will be available from Tandy stores and computer centres at a price to be announced. Contact Tandy, Tameway Tower, Bridge Street, Walsall, West Midlands. Telephone: (0922) 648181.

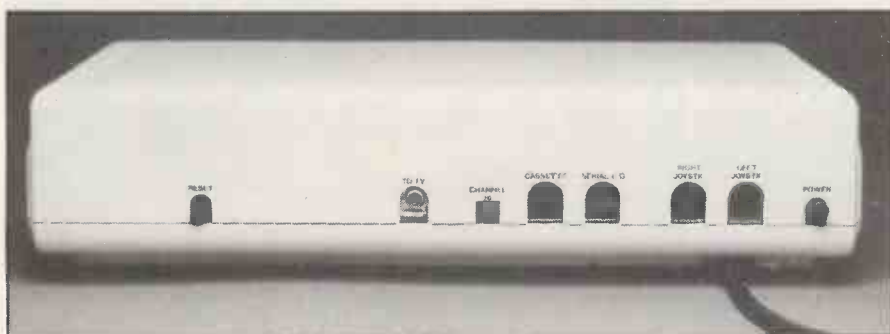

From the back it looks like a toy, but with discs it becomes something special.

Benchmarks

	BM1	BM2	BM3	BM4	BM5	BM6	BM7	BM8	Av
BBC Model B—6502	1.0	3.1	8.3	8.7	9.2	13.9	21.9	52.0	14.8
Commodore 64*—6510	1.4	10.5	19.2	20.0	21.0	32.2	51.6	116.0	34.0
Tandy 64K CoCo—6809	1.4	10.5	20.4	22.3	24.0	34.7	51.1	132.6	37.1
Sinclair Spectrum—Z-80	4.8	8.7	21.1	20.4	24.0	55.3	80.7	253.0	58.5

*portable version

The 64K Color Computer is fast at writing to the screen, but the standard Benchmarks show the Microsoft Basic running at its usual leisurely pace.

LSI OCTOPUS

A new image and a massive promotion budget are to accompany the launch of LSI's business micro. Glyn Moody has been finding out what the fuss is about.

A LITTLE OVER a year ago, LSI computers launched its M-Four, which combined eight-bit and 16-bit CP/M operating systems on one machine, implemented via dual processors. At the time there was plenty of tried and tested software for the ageing CP/M-80 but too little for the up-and-coming CP/M-86 to justify a leap of faith in that direction. During this last year things have moved on, and practical 16-bit software is starting to come through. Any system that can offer the best of both worlds is clearly attractive.

LSI has now extended the M-Four to include a wide-ranging expandability while adding CP/M Plus and Concurrent CP/M in dual 86/80 form and MS-DOS. Since the obvious name for the new product has been pre-empted by Sord, the new machine has been duly christened Octopus.

Hitherto LSI's marketing people have been content to maintain a fairly low profile, and sales have grown quite respectably on their own. However, the Octopus is being launched with the full treatment — Channel 4, no less — and an overall publicity budget of over half a million pounds.

It is big money for a firm that had sales of £3.5 million in the year to June 1983. But LSI forms part of the CPU group, which has over five times the turnover and is quoted on the Unlisted Securities Market.

The LSI range is sold through an interesting mixture of 12 franchises and a dealer network.

Three-box format

The Octopus adapts the standard three-box format: the monitor and keyboard are separate and there is a low, squarish main unit in off-white polyurethane. On a desk top it is a rather more manageable than its predecessor.

The entry-level system includes one 400K floppy disc and 128K RAM but no monitor. It costs £1,530 plus VAT. The first real usable option offers two 400K floppies and a monitor, together with

bundled accounting software for £2,090. Winchester options start at £3,290 for one 5Mbyte floppy.

Two hexagonal screws secure the back of the main unit. A neat modular layout with tidy wiring is to be found inside. Everything possible is earthed, a feature which is indicative of LSI's long-term plans. After the British and European launches the company intends to start marketing the Octopus in the U.S., where stringent safety regulations prevail.

The power supply occupies the left-hand side of the unit, viewed from the front, positioned next to a small fan and loudspeaker. Two half-height Shugart 5.25in. floppies, or one floppy plus a

Benchmarks

The Octopus will be released with Digital Research's Personal Basic as standard. It was not available on the preview machine, so Microsoft Basic-80 Version 5.2 running under Concurrent CP/M-86/80 was used. It requires about 24K of RAM. The full 16-bit PBasic, when it comes, is unlikely to perform Benchmarks very much better. All timings are in seconds.

	BM1	BM2	BM3	BM4	BM5	BM6	BM7	BM8	Av
HP Series 200 Model 16— 68000	0.2	0.6	1.4	1.6	1.7	2.8	4.3	15	3.4
Orion—8086	0.6	2.1	4.8	4.9	5.8	10.5	16.7	13	7.3
Octopus Z-80/8088	0.8	2.5	7.5	7.4	7.9	13.6	21.9	38.5	12.5
IBM PC—8088	1.2	4.8	11.7	12.2	13.4	23.3	37.4	30	16.9



The twin-floppy business system costs just over £2,000; other disc options range from a single 400K floppy to a 40Mbyte Winchester.

Winchester, are mounted in the front. Along the back of the unit you find: a socket for the serial keyboard input; a parallel I/O, which is a superset of the Centronics port; two RS-232C ports; a TTL output that connects to an RGB monitor or TV set VHF input; and a composite-video monochrome plug. There is a tiny Reset button — no danger of accidentally pressing it. Finally there is the mains input, along with a socket to allow the monitor to be powered from the Octopus itself.

Inside, the motherboard nestles partly under the disc units at the front, and is mounted so as to slide out as a single unit. The PCB itself is of an advanced multi-layer construction which allows very neat and compact board layout, and reduces circuit noise. It is populated in Scotland. The few wires and piggybacks visible would, I was assured, be incorporated on to the main board for the production models.

The two processors are an Intel 8088-2 running at 8MHz and a Zilog Z-80B at 6MHz. The standard model comes with 128K plus parity. A 32K EPROM contains

the system firmware, and there is room for another. An 8087 maths co-processor chip can be piggybacked into the 8088 slot as an extra. There is a real-time clock powered by a rechargeable battery. It lasts about 3½ weeks when the Octopus is switched off.

One striking feature of the board is the large expansion slot towards the back, next to the I/O ports and circuitry. It is perhaps the key element of the Octopus and its philosophy. A superset of the Multibus system is used, and up to four expansion boards can be progressively stacked on top of each other. One card mates via a bridging piece with the bus slot beneath and provides a similar slot for further expansion. The bus effectively flows through the additional boards.

Options include a communications board with four RS-232C and one RS-422 ports. Extra RAM up to 512K and an Arcnet-type LAN will also be available. A graphics board allowing a 325-by-800 resolution and a BT-approved internal modem are also promised. LSI is encouraging third-party suppliers to add to this range.

The keyboard is connected via a 14ft. coiled cord which plugs into the rear of the Octopus. LSI offers a straight IBM look-alike keyboard — even down to the tedious Backslash key where Shift should be. Alternatively, you can have a slimmed-down version of the popular M-Four word-processing keyboard which has no fewer than 32 programmable function keys. This may sound like overkill but it can be put to good use.

The LSI-supplied monochrome monitor is a 12in. Panasonic which uses a P-34 green phosphor. A colour option is fitted as standard on the Octopus, so colour monitors of varying resolution are also available. Other features include a sound channel installed as firmware, and provision for a cartridge tape back-up. A mouse will be available later.

On powering-up, the machine goes into a self-diagnostic routine. The screen shows the following in succession:

Testing ...

Main Processor
PROM
DMA Controllers
RAM
Interrupt Controllers
Floppy discs

Any intelligent option boards present on the expansion bus show up in a similar way.

The system may be reset at any time by pressing Control, Shift and Delete simultaneously — the same three-key system as the IBM. After the diagnostic routine the Octopus gives a choice of booting up the Winchester or the floppy. Four operating systems are available: CP/M, MP/M, MS-DOS and the company's proprietary system Elsie. After you select a disc the system searches for all bootable systems and then presents a menu of options.

Since CP/M-86/80 and MP/M-86/80 have been available for some time on the M-Four, the most interesting developments on the Octopus are the LSI versions of CP/M Plus and Concurrent CP/M for the dual-processor architecture. The CP/M Plus running on the preview machine was only the beta-test version, though evidently Digital Research has assured LSI that the final release is to be available "real soon now". It will then form the basic operating system offered as standard on the Octopus.

Loading CP/M Plus produces the following screen output:

Available Drives

A:W
B:W
C:LH drive 48 tpi automatic
M:128K memory
P:patchable format

This shows a floppy and Winchester system where the hard disc has been partitioned by system software into two

(continued on next page)

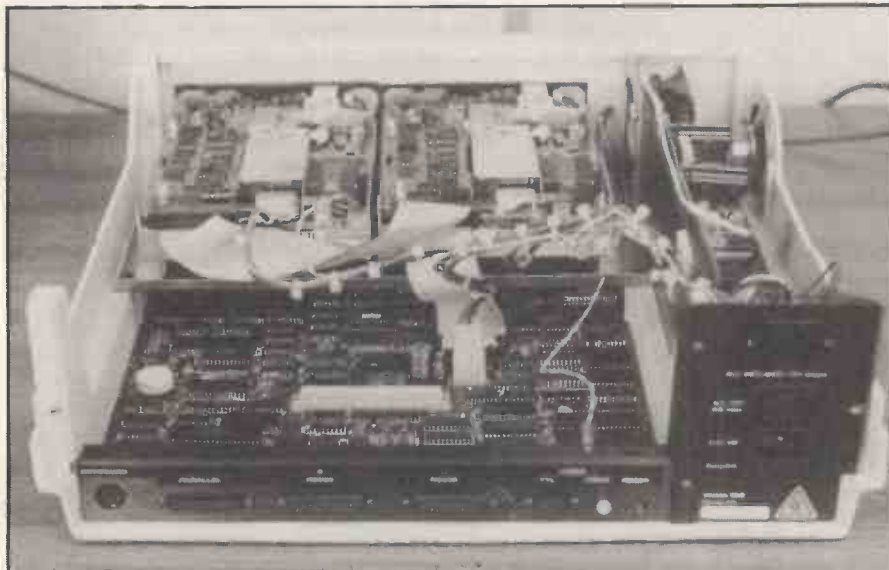

Construction is of a high standard, with an eye to U.S. regulations.



Buyers have a choice of keyboards, including an IBM PC look-alike.

(continued from previous page)

drives A: and B:. Drive C: is the 400K floppy drive to the left of the Winchester unit.

Drive M: represents the virtual disc storage allocated in RAM by CP/M Plus, and the 128K its total extent. With a 256K system, 128K is normally allocated as a RAM disc, and the remaining 128K then serves as normal RAM.

The P: drive refers to a patchable format option. The physical drive C: is set up to read IBM PC and LSI disc formats automatically. Using the configurable P: drive, practically any other disc format — except the Sirius — can be read by specifying the relevant parameters using the Parmgen command.

This is a standard routine supplied as part of the 370K of system utilities. The version that I saw also allowed scroll speed to be varied from a gentle flow to a hiccupping line-jump. Various display-width and colour options may also be set. The final version will have the command structure for matching the P: drive's parameters to other disc formats, either via menus or directly.

Two other useful utilities are included with the Octopus. Keygen allows the 32 function keys to be programmed via a series of menus. The program detects automatically whether the keyboard is of IBM or LSI type and adjusts the options accordingly. An obvious choice is the set of standard WordStar commands, and booting CP/M Plus sets them as default. LSI produces a keyboard overlay for

people using the function keys in this way.

The Fontgen command allows whole character sets to be set up and modified. The Octopus comes with two standard files of founts, for 80-character screen width, and a narrower one for 132-character display. Up to 256 characters can be defined in two blocks of 128. Using simple menus of instructions, new characters can be defined or old ones modified.

Attractive

In 80-column format the character is displayed as a blown-up 13-by-nine pixel representation. Moving around this grid with the cursor-control pad, individual pixels can then be added or expunged. Working with the 132-column fount the character is formed on an 11-by-six pixel grid. The founts can then be stored and loaded at any time. This whole feature is very attractive and well implemented.

Similar options are available on the Concurrent CP/M-86/80 system. It is fully operational now, but because it requires about 128K of RAM Concurrent CP/M is not supported on machines with less than 256K RAM; the recommended level is 512K. CP/M Plus, by contrast, takes only 40K including buffer and command interpreter, most of which is separate from the 64K directly addressable by the Z-80 under CP/M.

The Octopus uses the 8088 as a slave to the Z-80. All I/O is handled by the 16-bit processor and so is coded exclusively in 8088 instructions. Only about 2K of the Z-80's precious 64K address space is therefore taken up by systems software. This arrangement also enhances response times — so much so that LSI says well tested eight-bit implementations of applications software are often still preferred to bug-ridden 16-bit upgrades. WordStar is a case in point.

Concurrent CP/M is signalled by an A > prompt for User 0, and 1A > for User 1 — up to 3A > for user 3. A status line appears at the bottom of the screen. One of the neat uses of concurrency is to allow different levels of operation at the same time. For example, while modifying one fount using Fontgen, quick reference can be made to another, simply at the touch of a key. CP/M listings of a directory can be checked for the presence or otherwise of files while a WordStar file is read or modified. Eight-bit and 16-bit programs can be run concurrently on the different virtual screens.

MP/M-86/80 supports the same operations with the addition of multi-user capability. Up to six intelligent terminals can be hooked up to the system via the RS-232Cs, though quite what the response would be is another matter. The system showed no obvious degradation with two users and, like Concurrent CP/M, allowed eight-bit and 16-bit software to be mixed. A multi-user concurrent version is also promised.

As in the case of CP/M Plus, LSI is still rather waiting on Digital Research for the networking option. The promised DR Net — a system like Arcnet that uses token-passing to give priority for transmission to each machine in turn — will apparently look like a distributed MP/M system with concurrency. The speed is about 2.5Mbit/second.

The basic system includes CP/M Plus 86/80 and Digital Research's Personal Basic. The £2,090 business system comes with an accounting, invoicing and stock-control package called Axis. For an extra £295 you can buy the Octosoft range of software. It consists of Plannercalc, a fairly cheap and rather idiosyncratic spreadsheet system; Lexicom, a menu-driven word-processor; and Rescue a well thought of database package. Clearly LSI felt the need to offer the canonical three applications, but this seems rather a motley bunch. The manuals for each are reasonably full if unexcitingly produced.

Unfortunately the same cannot be said of the manual for the Octopus itself. One slim A5-size ring-bound volume introduces the machine, CP/M-80/86 Plus and Personal Basic. There is no index. Too much is assumed for it to be much use to a beginner, and it is too skimpy for the practised user. When the basic product is so well thought-out it seems a shame to spoil the ship with such flimsy documentation.

Conclusions

- The Octopus is a well designed machine. It is soundly based in established technology but also incorporates some original features.
- The dual-processor architecture is a real gain, in terms of both present performance and future upgrading.
- Perhaps the most significant feature of the Octopus is its versatile expansion bus. A small business could safely buy the machine secure in the knowledge that upgrade paths will be readily available.
- With its wide range of operating systems, the Octopus is well placed to benefit from new software as it comes through. The systems software includes useful extra utilities like Parmgen and Fontgen.
- The bundled accounting software is a poor choice for a system which is otherwise well suited to the business user. It would be far better to make the price even more competitive, and allow end-users to choose their own application software. Businesses are no longer content to accept any old system. The Octosoft package is also unexciting.
- The Octopus user manual is a disappointment, though LSI has promised a revision. Manuals represent potentially the most important link with the user and should be as full and easy to understand as possible. When LSI produces a worthy companion to its machine, the Octopus will represent a good buy. □

Specification

CPU: Intel 8088-2 and Z-80B
RAM: 128K, expandable to 768K
Portability: typical main unit weighs 15lb.; a carrying case is available
Size: main unit is 15.7in. deep by 17.7in. wide by 5.7in. high
Display: monochrome 12in. allowing 80 columns x 25 lines or 132 columns x 29 lines, characters are formed on 12 x nine and 11 x six matrices respectively
Keyboard: detachable; choice of IBM-type or LSI word-processing model
Interfaces: Centronics-type parallel port; two RS-232Cs
Discs: one or two 5.25in. Shugart half-height floppies, formatted capacity 400K per drive; 800K optional; Winchester discs of 4, 10, 20 and 40Mbyte available
Software in price: CP/M Plus 86/80 and Personal Basic from Digital Research; Axis accounting package with business system
Hardware options: expansion boards for RAM, communications, internal modem, and networking; also 8087 maths co-processor
Manufacturer: LSI Ltd, St John's, Woking, Surrey. Telephone: (04862) 23411
U.K. prices: £2,090 for 128K system comprising screen, keyboard, twin disc drives plus Axis software

U-NET

...real
micro-networking now.

**ASK
US
ABOUT**

***BBC
micro networking!***

U-MICROCOMPUTERS

U-Microcomputers Ltd
Winstanley Industrial Estate,
Long Lane, Warrington,
Cheshire WA2 8PR, England
Tel. 0925 54117
Telex 629279 UMICRO G

US Subsidiary—
U-Microcomputers Inc
300 Broad Street, Stamford,
Connecticut 06901, USA
Tel. 203 359 4236
Telex 4995877 UMINC



'make it easy on yourself'

● Circle No. 162

dBASE



THE RELATIONAL DATABASE SYSTEM

FOR MICROCOMPUTERS

- TRAINING?
- ADVICE, GUIDANCE, CONSULTANCY?
- PROGRAMMING?
- DATABASE 'PRIMER' MANUAL featuring 'dBASE II'

For further details, contact:

Lionel Boreham
LANTECH Information Systems Ltd.
55 Peascod St. Windsor, Berks SL4 1DE
Tel: Windsor 58182/58013

LANTECH
Information Systems

● Circle No. 163

aculab

data switches

- * RS232 serial.
- * Centronics compatible parallel.
- * Two way and four way versions.
- * Passive operation.
- * Fully bidirectional.
- * High quality.
- * High reliability.
- * No hand soldered connections.

2 Into 1 Serial	£95.00
4 Into 1 Serial	£126.00
2 Into 1 Parallel	£101.00
4 Into 1 Parallel	£126.00

All prices exclude VAT & P&P.



For further information,
Telephone 0525 371393

aculab Ltd.

**Unit A, Station Approach,
Leighton Buzzard,
Beds. LU7 7LY**

● Circle No. 164

SEIKO 8600

Multi-user systems seem attractive — as long as software is there to run them. We put the Seiko to the test and Glyn Moody discovered it to be a practical proposition for business use.



THE ENTRY PRICE for the Seiko Series 8600 micro is £3,587 plus VAT for a 16-bit machine with 128K RAM and one 655K floppy. So it is hardly cheap, but then neither is it really representative. The Series 8600 is designed as a multi-user system for small professional offices and businesses.

A more realistic starting price would be £5,270 for two users. That includes one floppy and one 10Mbyte Winchester with 256K RAM, in addition to the two terminals with keyboards. Three-user options start from £8,256.

The hardware for the 8600 is produced in Japan. The systems software in America, from a company called Seicom which is jointly owned by Seiko and Science Management Corporation. Sole distribution rights in the U.K. are held by Intelligence Distribution Ltd. The plan is to sell the 8600 through a network of 80 dealers.

We reviewed here a two-user system with 20Mbyte Winchester. Physically, it is arranged as the natural progression from the IBM three-box configuration: one central processing unit connected to two terminals, each with a separate keyboard and VDU.

The squat rectangular box of the central unit has two convenient recesses in its base for easy lifting. At the front, to the left, is the floppy and next to that the Winchester. At the back you find the mains input socket and On/Off switch, printer port, four RS-232Cs and a recessed Reset button.

Two simple locks at the top of this back panel release the upper lid.

The interior layout is almost spartan, chiefly because of the total invisibility of the motherboard with its 8086 processor. The board is tucked away safely in a separate compartment underneath; access is difficult, though not explicitly forbidden. By contrast, the disc-drive units are a model of easy installation and removal. The excellent blow-by-blow account in the manual gives full details — with illustrations — of which wire to put where. Good design means that it is practically impossible to hook anything up incorrectly.

Three extra 128K RAM cartridges take the total RAM to 512K and are similarly easy to load. A fourth slot is for commu-

nications. Although the hardware is available now, the software that will allow direct mainframe interfacing and terminal emulation — all at a cool 300Kbaud — has not yet been produced. The power unit is sealed off in a further separate compartment, with a small, fan opening on to the main recess containing the discs.

The 12in. monitor with standard P-31 green phosphor is set in a swivel unit that can be locked in various tilted positions. At the back there is a printer port, an RS-232C interface connecting it to the main unit, some Dip switches setting baud rates, and the keyboard port.

The keyboard is equipped with standard QWERTY-layout keys, a numeric pad with separate Enter key and cursor controls, and

Benchmarks

Timings are in seconds. Those for the Seiko were produced from the eight standard routines — see last month's issue — written in Basic-86 running under MP/M. It is perhaps not surprising that running the Benchmarks simultaneously on two terminals took about twice as long as running one terminal only. What is surprising is that running the Benchmarks while the second terminal supported Basic, but ran no program, produces almost identical figures. This is a result of Basic's constant keyboard interrogation, which uses the central processor.

	BM1	BM2	BM3	BM4	BM5	BM6	BM7	BM8	Av
OEM Orion — 8086	0.6	2.1	4.8	4.9	5.8	10.5	16.7	13.0	7.3
Seiko 8600 — 8086									
single user	1.2	4.0	8.7	8.6	10.3	19.1	29.7	23.7	13.2
two users	2.4	8.4	17.6	18.0	20.7	39.0	60.5	47.8	26.8
IBM PC — 8088	1.2	4.8	11.7	12.2	13.4	23.3	37.4	30.0	16.8

a host of defined and definable functions. Common keys like Esc and Ctrl are joined by others such as Tpw and G1/G0. Tpw switches on Typewriter mode: pressing any key then produces lower case, and pressing a key with Shift held down gives the upper case or typewriter equivalent. Its setting is signalled by a built-in LED. The G1/G0 key then produces lower case, and pressing character sets available on the terminal, also has an LED warning. The default option G0 is the standard American ASCII set. When G1 is pressed each key produces a graphics symbol which closely resembles Sumerian cuneiform. Perhaps this forms part of some far-sighted marketing plan. Apart from the 10 function keys, there is also a range of edit function keys, used for on-screen editing.

The monitors with their keyboards are no mere dumb terminals. Each set comes complete with an 8085 processor and a large 64K memory used for buffering, and for local activity independent of the main processor. The overall feel of the keyboard is slightly shallow, but generally acceptable. That this is a high-quality unit is reflected in the price of £1,493 for a complete user upgrade — though this also includes a plug-in 128K RAM expansion for the main unit.

Diagnostic checks

On powering-up, the user 0 terminal identifies itself as part of the Seiko 8600 computer system, and then goes into a hardware diagnostic routine. The machine then normally requests specification of a disc drive from which it could boot the operating system. On the review machine, part of the partitioned Winchester had been set as the default.

When using the 8600 machine, one of the first things you notice is that keystrokes beep, which is rather trying for those of us who have been conditioned over the years to regard beeps as tantamount to input errors. Happily, the Seiko's rich set of control sequences allows, among other things, the keyboard to be silenced.

Control sequences are entered as a string of characters following the Esc key. Although they can in theory be entered at any point in a computation, you run the risk of them being misinterpreted by the central processor which could then lock itself into something nasty. Seiko has devised a clever system of isolating the terminals for such set-up sequences, so you should be able to stay out of trouble.

Pressing the Shift and Set-up keys simultaneously calls up a 25th line to the screen display, which is normally 80 columns by 24 lines. The extra line is the status line, and is divided into 16 sections. By using the cursor controls it is possible to change the option for the terminal by pressing the Set-up key until the desired function appears. Thus smooth scroll may be replaced by jump scroll, auto repeat set on or off, baud rates may be adjusted and, most relevantly for the Esc command



Modular construction permits easy replacement of major components.



Terminals are connected via RS-232 links; a Centronics interface is also provided.



Up to three 128K RAM packs drop into purpose-designed sockets.

sequences, the relationship of the terminal with the main processor can be altered.

Apart from full-duplex and half-duplex modes, the terminal can be made purely local. Then any characters generated at the keyboard are sent to the screen but not the main processor. There is also a blocking option which allows an entire screenful of input to be built up at a terminal, and then sent all in one go to the 8086 processor when you press the Send key.

You should choose Local mode when using the Esc set-up codes. They are entered without any echo on the screen — something the manual omits to mention. You press Shift and Set-up once more to

remove the status line and return to the current program. Using this very powerful facility practically every aspect of the terminal can be modified: screen mode may be set to blinking or double width; windows can be created, the keyboard disabled, and so on. The manual is commendably clear in this generous facility.

The manual is generally well produced and clearly written with plenty of diagrams and examples. It includes two glossaries and a list of Do's and Don'ts. Although it could have been slightly less technical, and so less offputting for the first-time user, its main fault is the lack of an index.

(continued on next page)

Multi-user MP/M-86

Judging by the flood of new machines, 1983 was the year of the 16-bits. Signs are that "multi-user" will be one of the catch phrases of 1984. This is partly a natural consequence of the new processors: for example, multi-tasking is an automatic option for the Motorola 68000 running under Xenix. But now, even the humble CP/M is offered in its Concurrent form — a kind of poor man's multi-user system.

MP/M is Digital Research's full multi-tasking operating system. As such it shares many of the features and infelicities of CP/M. Apart from standard utilities such as Dir, Era, Pip and Type there are a number of new features specific to the multi-user environment.

The first distinction to be made is between user and console. Each physical terminal is allocated a number from 0 to 15. The system console is designated 0, and it is here that the main bootstrap messages appear. The physical console number plays no visible role during use; it is merely used by the computer for housekeeping purposes.

Independently of the console number, each terminal may be assigned a user number from 0 to 15. The maximum number of users, as opposed to consoles, under MP/M is 16. The user number refers to the space allocated on all the disc drives, whether floppies or partitioned Winchester. Each file is stored with an attached user number and only those pertaining to the user at the terminal may be accessed.

On booting up, the user number on each console is set by convention to the physical console number: user 0 on console 0, user 1 on console 1 and so on. The user number may be changed at any time by means of the User command: keying User 6, for example, sets the current user to 6. Unlike physical console numbers, which are unique, user numbers may be shared between different consoles. Thus two consoles may be logged

into user 1 for example, and they may both access user 1's files on any drive.

Certain files from other users' disc drives can also be tapped. Any file can be stored with one of two attributes: Dir and Sys. Dir locks the file into the particular user's area on the disc: only the specified user may access it. If the file is stored with the Sys attribute by user 0 — but not other users — then other users may also gain access. Files which are generally available are systems files, hence the name, and provide general utilities like Dir and Era which are needed by all users.

Information on the attributes of a file can be obtained from an extended Dir command, called SDir. This detailed directory gives the number of bytes and records taken up by the file and the attributes of the file such as Dir / Sys, Read / Write.

Although users may only access files in their own user area, it is easy to switch user number. So in real environments password protection is vital if access to sensitive files is to be limited. Entire discs or individual files, including command files, can be protected and at three levels: read-, write- or delete- protected. To set a local password, a global password for the entire system must first be entered. This may sound labyrinthine, but in fact is only logical. If the password-setting command structure were accessible to all users, the password option on all files could then be turned off.

Booting-up MP/M on the review machine produced a main boot message on console 0 and user 0, and a subsidiary signal on console 1 and user 1. The prompts for the two terminals are respectively 0A> and 1A>, which signals the user numbers and drive, A being one of two partitions on the Winchester. The prompt P: is obtained when using the floppy drive. Drives are changed, as in CP/M, by entering the appropriate letter followed by a colon.

(continued from previous page)

Seiko's prices do not include any bundled software. Since the 8600 runs MP/M, CP/M-86 and MS-DOS, with the new Oasis-16 operating system promised, there should be no shortage of software. Cis-Cobol is also supported, allowing access to a wide range of business programs. The main problem is the lack of true multi-user products.

Conclusions

- The Seiko 8600 represents a well thought-out and well produced system.
- As a one-user option, it is not cheap. The

full benefits are only obtained with two or three users.

- Naturally, with more users, the response time begins to falter. The Seiko is not suited to solid multi-user processing, but is ideal for professional or business use where two or three terminals are accessed frequently.
- The user-definable characteristics of the terminals are very impressive, if slightly superfluous for the intended end-market.
- There is no bundled software, so a working system will cost more than the prices quoted. For example MP/M costs £475 plus VAT.
- An otherwise excellent manual is flawed by its lack of an index, making it unnecessarily hard to use.

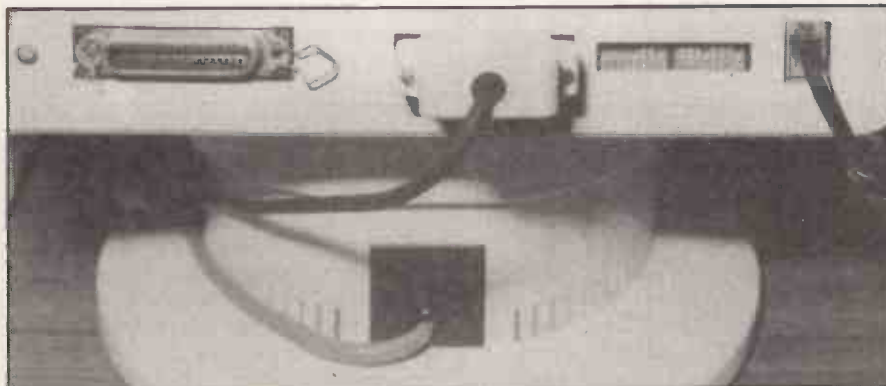

Each user can have a separate printer, connected direct to the terminal.

Specification

CPU: Intel 8086, 16-bit running at 5MHz
RAM: 128K, expandable at 512K
Dimensions: main unit is 19in. wide by 6in. high by 16.5in. deep
Display: 12in., 25-line by 80-character CRT; character matrix 10 by 14; two character sets supplied including ASCII, various cursor modes
Keyboards: Detached 100-key QWERTY, 10 programmable function keys, 18-key auxiliary pad, five special function keys
Interfaces: four RS-232Cs, Centronics-type printer interface, each terminal has one RS-232C and printer interface
Discs: one or two 5.25in. double-sided, double-density 655K formatted; 10Mbyte and 20Mbyte hard discs optional
Software: CP/M-86; MP/M, MS-DOS, main languages and applications available but not included in price
Hardware options: communications interface, but without operating software
Manufacturer: Seiko, Japan
U.K. distributor: Intelligence Distribution Limited, Nelson House, 271 Kingston Road, London SW19 3NW. Telephone: 01-543 3711
U.K. prices: £3,587 one-user, one floppy, 128K RAM, £7,168 two user, 20Mbyte hard disc; 256K RAM

No one else handles CP/M Software quite like us!



We handle one of the largest ranges of CP/M Software in the country. And since our range covers most of the major formats and is available off-the-shelf, the delivery is equally impressive.

But we don't stop there. After all it's no good having a large range if we don't handle it professionally. That's why we produce no less than a 68 page catalogue, full of information about our entire range. Back this up

with honest and friendly advice, and we believe that we can offer a helping hand you won't find anywhere else.

Software Limited... Because there's more to choose from, we're the only choice to make.

01-833 1173/6

Software Limited
No. 2 Alice Owen Technology Centre
251 Goswell Road, London EC1.

CP/M is a trademark of Digital Research



NEC PC-8201

Chris Bidmead looks at the latest lap portable in the Kyocera family.

TOWARDS THE END of 1982 the Epson HX-20 blazed a trail into a new market for briefcase-size computers. An ambitious machine, it is in many ways still the most interesting of what have become known as lap portables. However, it has suffered in comparison with newcomers such as the Tandy Model 100, the Olivetti M-10 and the NEC PC-8201A which offer a screen of 40 characters by eight lines, instead of the Epson's poky 20-character by four-line LED display.

Regular readers of *Practical Computing* will notice that we are tracking the development of these machines closely, with reviews of the Tandy 100 in the August issue, and the Olivetti M-10 in December. I suspect this is because lap portables, with their emphasis on word processing on the move, hold particular interest for journalists.

Their price of around £500 for a 16K model and their inability to hook up to a colour TV distinguish them sharply from home computers like the Vic-20 that they resemble physically. Nevertheless, they do represent a class of machine that is going to be mass produced in such quantities that prices will fall quickly.

Differences

The striking similarity between the three successors to the HX-20 is not accidental. They are all versions of the same design from the Japanese firm of Kyocera, which built the original and sold it to NEC. But although they are all based on the same kernel hardware, and run similar software from Microsoft, the machines are certainly distinct from one another. Negotiations between Tandy, NEC and Kyocera have resulted in complex trading agreements, with the outcome that NEC is permitted to market its own version, the NEC 8201, in the U.K.

Comparisons with the more widely available Tandy Model 100 are inevitable. The wedge-shape of the NEC makes it significantly bigger. The increase in physical size does two things for the NEC: it allows for a comprehensive collection of I/O ports at the rear; and it makes room for a large cartridge socket on the left-hand side which is closed by a spring-loaded flap when out of use.

Another noticeable feature is the cluster of sizeable and geographically oriented cursor keys instead of the miniature in-line keys of the Tandy. Otherwise, the basic QWERTY arrangement is identical, with changes being confined to the function keys and more esoteric computer keys. On the

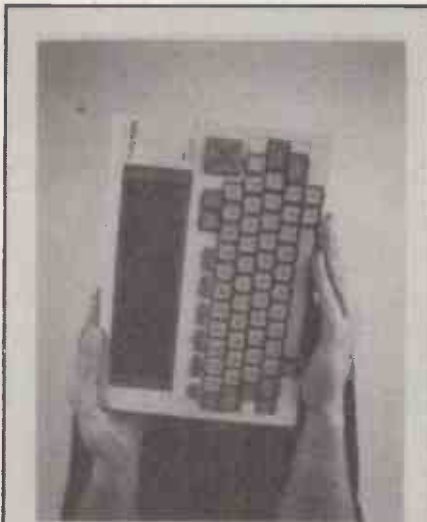

NEC the function keys are larger and fewer, from eight down to five, although they operate as 10 keys since, with the help of Shift, each one does double duty.

The Tandy has a ghost numeric keypad that allows the three rows of keys immediately below the 7, 8 and 9 on the top row to serve for numeric entry with the Num key locked down. On the NEC this arrangement has been omitted, and so has the Code key that permits access to foreign characters.

As in the other Kyocera machines, 32K of the address space is occupied now by ROM, with a further 16K of RAM — 8K on the Tandy — being sold as standard. Also like them, the memory size can be upgraded. The Kyocera CPU is an 80C85, the CMOS low-power version of the 8085 and a close relative of the ubiquitous Z-80. RAM enhancement ought to stop at 32K since 32K RAM plus 32K ROM makes 64K. But the NEC allows bank-switching of the RAM segment, which allows you to go on adding RAM internally up to a maximum of 64K.

The flap-covered cartridge socket is designed to take a further 32K in the form of a CMOS RAM pack with its own batteries, which appears to the system as a third banked-out segment. This is one of the exciting aspects of the NEC, allowing you to create text or collect data in the

Specification

CPU: OKI 80C85 running at 2.4MHz
ROM: 32K Microsoft Basic with Telcom and Text
RAM: 16K standard, expandable to 96K
Size: 300mm. by 215mm. by 61mm.
Weight: 1.7kg. approx
Power: four AA batteries in interchangeable battery pack or optional NiCad rechargeable pack and recharger; additional built-in NiCads for back-up
Display: 40 characters x eight lines
LCD; 64 x 240 dot addressable graphics
Keyboard: full-size QWERTY; five dual programmable function keys, operating as 10 geographically oriented cursor keys
Interfaces: eight-pin DIN cassette; RS-232, programmable for 75-19,200 baud; Centronics printer; HP-compatible bar-code reader; S-101 and S-102 reserved for future use, system slot for RAM cartridge
Software: 25-program cassettes supplied as standard in addition to ROM-based software
Manufacturer: Kyocera, Japan for NEC
U.K. distributor: NEC (U.K.) Ltd



The striking cursor-control keys instantly distinguish the NEC from its cousins.



Communications are well catered for with a variable baud-rate RS-232 interface.

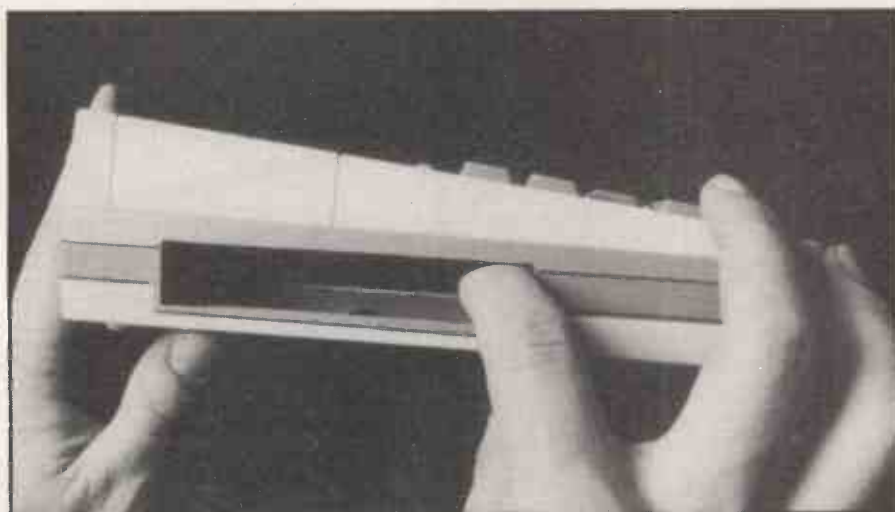

ROM-based software plugs into a socket on the side, as does up to 32K of RAM.

RAM pack, detach it and despatch it back to base. One obstacle is that the RAM pack is not available yet; a further obstacle is the price. The pocket-size RAM packs each cost as much as a cheap dot-matrix printer, so you will probably settle for downloading data to a cassette machine.

All three new lap portables offer variations on the same suite of built-in software from Microsoft. Microsoft Basic is supplied burnt in to the ROM, but surprisingly it is not the same Basic across all the machines. NEC has said goodbye to the SCHDL and ADDRSS programs that on the Tandy and Olivetti are integral with the machine. The additional space is used to offer more comprehensive Basic, closer to GWBasic now appearing on all the new 16-bit hardware.

The word processor Text was covered in detail in the August 1983 issue of *Practical Computing*. SCHDL and ADDRSS are elementary database programs that act as diary plus name-and-address book respectively. They offer nothing that you could not knock up for yourself using the Find facility in Text, but NEC provides them in Basic in the Personal Application Kit — a cassette of 25 programs of varying utility.

Be warned that applications programs are not necessarily transportable across these superficially similar machines. Transfer rate and coding differences in the cassette interfaces make it impossible to get data from a Tandy cassette on to an NEC machine, and vice versa.

A machine of this sort can be expected to make heavy use of the RS-232 interface in communication with non-portables. All the Kyoceras come with a terminal emulating program that allows you to configure the baud rate and transfer files. Unfortunately, the XOn/XOff handshaking did not work convincingly, and I had difficulty matching baud rates.

One advantage of the NEC is the way it lets you carry out file housekeeping at the level of the menu presented at start-up. All you have to do is push a few function keys, using the cursor to identify files you want to delete or rename. Saving to and from cassette can be done interactively at this level. This is more convenient than the way the Tandy requires you to go into Basic and write out the Basic commands in full.

Conclusions

- The NEC is functionally very similar to the Olivetti M-10 and the Tandy Model 100, being from the same manufacturer Kyocera.

- It is significantly cheaper than the Tandy. The basic 16K NEC costs £475 and the 8K Tandy costs £499.

- Unique in its class, it can be enhanced up to 96K, equivalent to 12,000 words of text.

- The doubt hanging over the serial comms line is unfortunate. Like others who have mentioned this problem, I cannot swear it was useless because of the complexities of the RS-232 standard. □

BBC Microcomputer System

OFFICIAL BBC COMPUTER DEALER



This is the best microcomputer currently on the market. 32K RAM, 32K ROM, 8 modes of operation, full colour, full-size keyboard, internal expansions such as disc interface, speech synthesizer, Econet interface - In short, it is a personal computer capable of expanding into a small business system.

BBC Microcomputer Model B	£348	VAT	£399.00
BBC Mod B - disk interface	£409	VAT	£469.00
BBC Mod B - Econet interface	£389	VAT	£447.35
BBC Mod B - disk and Econet interfaces	£450	VAT	£517.50
BBC 100K disk drive	£230	VAT	£264.00
BBC dual 800K disk drive	£699	VAT	£803.85
Torch 280 disk pack including 280 2nd processor, 64K RAM and CPN operating system + Free Perfect Software	£699	VAT	£803.85
BBC Teletext receiver (Aug)	£196	VAT	£225.40
BBC cassette recorder and lead	£26	VAT	£29.90
Disk interface kit (free fitting)	£86	VAT	£96.60
Mod A to Mod B upgrade kit	£50	VAT	£57.50
Fitting charge for A to B upgrade kit	£20	VAT	£23.00
16k memory upgrade kit	£11	VAT	£12.65
Games paddles	£89	VAT	£102.35
12" Monochrome monitor incl. cable	£208	VAT	£240.35
16" Colour monitor incl. cable	£10	VAT	£10.00
User guide	£60	VAT	£69.00
Econet interface (free fitting)	£47	VAT	£54.05
Speech interface (free fitting)	£30	VAT	£34.50
BBC disk manual - formatting disk	£10	VAT	£11.50
Parallel printer cable	£52	VAT	£59.00
BBC word processor (view)	£15	VAT	£17.25
BBC Fourth language cassette	£15	VAT	£17.25
BBC Lisp language cassette	£15	VAT	£17.25

100% BBC COMPATIBLE MITSUBISHI AND TEAC SLIMLINE DISK DRIVES

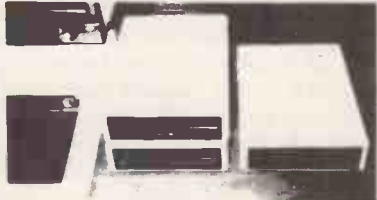

These drives are supplied ready cased with all the necessary cables, formatting program and user disk system guide.

There are some useful utilities included, e.g. Epson Screen Dump Program, Memory Dump, Free Duplicate Merge and Relocate. Power consumption of these drives is very low (0.2A typ. at 12V, 0.4V typ. at 5V per drive). Power is taken from the BBC computer.

Single drive 100K 40 tracks	£169	VAT	£194.35
Dual drive 200K 40 tracks	£329	VAT	£378.35
Single drive 400K 80 tracks	£239	VAT	£274.35
Single drive 400K 40 80 tracks switchable	£259	VAT	£297.85
Dual drive 800K 80 tracks	£449	VAT	£516.35
Dual drive 800K 40 80 tracks switchable	£469	VAT	£539.35

COMPLETE WORD PROCESSOR FOR ONLY £1,099 + VAT

This package consists of BBC Microcomputer, View wordprocessor, 400K Slimline disc drive, Juki high resolution 12" Green monitor, Juki 6100 18CPS Daisy Wheel printer and all the necessary cables and documentation. The above package can be supplied with components of your own choice, e.g. 800K disc drive or a different printer. Please phone us for a price for your particular requirement.

Special package deal £1,099 + VAT = £1,263.85

PROFESSIONAL MONITORS

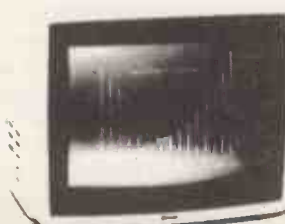

GREEN MONITORS			
12" Green screen monitors with composite and sync input. Suitable for most computers			
* 18 MHz band width, high resolution	£89	VAT	£102.35
* 15 MHz band width, normal resolution	£69	VAT	£79.35
COLOUR MONITORS			
* MICROVITEC RGB input 14" monitor supplied with RGB lead for BBC	£208	VAT	£240.35
* SANYO SCM 14" Normal res. 14", 400 dots, RGB input supplied with RGB lead	£199	VAT	£228.85
* SANYO SCM 14M Medium res. 14", 600 dots, RGB input supplied with RGB lead	£299	VAT	£343.85
* SANYO SCM 14H High res. 14", 800 dots, RGB input supplied with RGB lead	£399	VAT	£458.85

EPSON FOR RELIABILITY



EPSON FX80 80 column, 160 CPS, normal, italic and elite characters, 256 user definable characters, superscript, subscript, 11 x 9 matrix, bi-directional logic seeking, hi-res bit image printing (960 x 8 dots line), friction and pin feed, 9 international character sets, Centronic parallel interface	£349	VAT	£401.35
FX80 PRICE			
EPSON RX80 80 column, 100 CPS, normal, italic and elite characters, 11 international character sets, hi-res bit image printing, bi-directional logic seeking, 4 to 10" adjustable pin feed, Centronic parallel interface	£239	VAT	£274.84
RX80 PRICE			
MX-100 136 column, 100 CPS, friction and tractor feed, up to 15" adjustable carriage, hi-res bit image printing, true descenders, Centronic parallel interface	£399	VAT	£458.85
MX-100 PRICE			
RS232 interface for all above printers	£55	VAT	£63.25
EPSON RX80/FX80/RX80/FX100 Roll holder for FX80	£479	VAT	£550.85
Ribbon for MX80, FX80, RX80	£12	VAT	£13.80
Ribbon for MX100	£8	VAT	£9.70
	£12	VAT	£13.80

SEIKOSHA DOT MATRIX PRINTERS WITH HIGH-RES GRAPHICS



GP-100A 80 column, 50 CPS, dot addressable hi-res graphics, 10" wide, fully adjustable, tractor feed, 7 x 5 pmi matrix, Centronic parallel interface	£175	VAT	£201.25
GP-100A 50CPS PRICE			
GP-250X 80 column, 50 CPS, 10" wide, fully adjustable, tractor feed, true descenders, 64 user definable characters, double height and or double width printing, 8 x 5 pmi matrix, Centronic parallel and RS232 (serial) interfaces both included	£219	VAT	£251.85
GP-250X PRICE			
NEW GP-700A 7 COLOUR PRINTER			
This latest addition to Seikoshia range gives you print in seven colours, 10" wide carriage, friction and tractor feed, 50 CPS print speed, dot addressable hi-res graphics, 4 hammer printing mechanism, 10 CPI or 13.3 CPI, special Quiet printing mode, Centronic parallel interface	£349	VAT	£401.35
GP-700A SPECIAL INTRODUCTORY PRICE			

GUARANTEED LOWEST PRICES

We guarantee that our prices are the lowest on the market. If you can find any item advertised and in stock at less than our price we will match that price.

NEW LOW PRICES ON STAR



The most cost effective quality matrix printers to be launched this year. DPS10 and DPS15 features include friction and tractor feed and roll holders as standard. 100 CPS print speed, bi-directional logic seeking, 9 x 9 matrix gives true descenders, 2.3K buffer as standard, hi-res bit image plus block graphics, sub and super script, italic printing, auto underlining, vertical and horizontal tabulation, left and right margins set, skip over perforation, back space and self test.

STAR DPS10 10" carriage 80 columns	£239	VAT	£274.85
SPECIAL PRICE			
STAR DPS15 15" carriage 136 columns	£359	VAT	£412.85
SPECIAL PRICE			
RS232 INTERFACE FOR ABOVE	£50	VAT	£57.50

POCKET COMPUTERS AND CALCULATORS

* CASIO PB-100 Basic language pocket computer, 544 program steps, Qwerty keyboard, 12 char display	£34.75	VAT	£39.95
* CASIO FX-700P Basic language, scientific functions, 1568 program steps, Qwerty keyboard, 12 char display	£43.44	VAT	£49.95
* CASIO FX802P Basic language computer, scientific functions, 1568 program steps, built-in mini printer, Qwerty keyboard, rechargeable batteries and charger, 12 char display	£78.22	VAT	£89.95
* CASIO FA-3 Cassette adaptor for PB100, PB300, FX700			
	£17.35	VAT	£19.95
* CASIO FP-12 Printer for BB100 and FX700	£39.09	VAT	£44.95
* SHARP PC-1211 Basic language computer, scientific functions, 1424 program steps, 24 char display, Qwerty keyboard	£60.83	VAT	£69.95
* SHARP PC-1251 Basic language computer, 4K RAM, 24K system ROM, 24 char display, Qwerty keyboard, user defined key, numeric pad	£69.52	VAT	£79.95
* SHARP CE-125 Cassette recorder and mini printer for use with PC-1251, incl. built charger	£86.91	VAT	£99.95
* SPECIAL PRICE PC-1251 + CE-125	£146.95	VAT	£169.00

TEXAS INSTRUMENTS TI 99/4A



This microcomputer is based on TMS9900 16-bit microprocessor. It includes 16K RAM, 16 colour high resolution graphic (192 x 256). The screen display is 32 characters, 24 lines TI-BASIC. Full-size keyboard. For Software there are about 1000 programs to choose from. There are a lot of peripherals available, e.g. Disk Drives, Disk Interface, Speech Synthesizer, Extra RAM, Additional Language (PASCAL, TI-LOGO, ASSEMBLER).

TI HOME COMPUTER HARDWARE		Price inc VAT
Title	Description	
TI99-4A	Complete with UHF modulator and power supply + free cassette lead	£99.95
PERIPHERALS		
Speech Synthesizer	When used with selected modules will reduce electronic speech	£41.95
Peripheral Expansion System	This unit takes all card peripherals and on internal disk drive	£79.95
Disk Drive - Internal	92K formatted drive, mounts internally in peripheral expansion system	£149.95
Disk Controller Card	Controls up to 3 disk drives, complete with disk manager command module	£109.95
Disk Drive Double Sided	92K formatted capacity per side acts as 2 drives DSK1 & DSK2 total capacity 184K bytes	£219.95
Disk Drive External RS232	Complete with own case, power supply & connecting cables	£259.95
Expansion Card RAM	Provides 2 serial RS232 ports, and one parallel port for interfacing	£79.95
Expansion Card P-Code Card	Adds 32K bytes extra RAM bringing total capacity to 48K bytes	£79.95
	Includes the UCSD-PASCAL P-code interpreter	£129.95
Matrix Printer	80 column matrix printer/pinter GP-100A + cable	£219.95
Matrix Printer GP250X	80 column matrix printer with RS232 and Centronic parallel interface	£273.95
Epson RX80 Printer	80 column, 100 CPS matrix printer	£297.85

Please send S.A.E. for software prices

THE AFFORDABLE DAISYWHEEL PRINTER

ONLY £369 + VAT

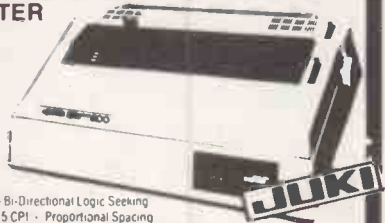

- * 18 CPS - Bi-Directional Logic Seeking
- * 10, 12, 15 CPI - Proportional Spacing
- * "Drop in" Daisywheel - Triumph Adler Compatible
- * Supports all Wordstar features
- * Diablo protocols - IBM Selectric ribbon
- * 2K Buffer as standard - 100 character Daisywheel

SPECIAL OFFER JUKI 6100 DAISYWHEEL £369 + VAT = £424.35

THE CP80 QUALITY PRINTER

ONLY £239 + VAT



- * 80 CPS - Bi-Directional Logic Seeking 80 Columns
- * Friction and Adjustable Tractor Feed
- * Patented Square Needles up to 9 x 13 matrix
- * Hi-Res Graphics and Block Graphics

SHINWA CP80 PRINTER £239 + VAT = £274.85
SPARE RIBBON FOR CP80 £5 + VAT = £5.75

NEC 8023BE-C PRINTER



This is a high speed printer using bi-directional logic seeking operation. 7 x 9 matrix for alphanumerics, 8 x 8 for graphics and bit image printing. Programmable paper feed, original plus three copies. Greek characters and high resolution graphics. The print quality is exceptional, and the price is affordable.

Price	£299	VAT	£343.85
* OKI Microline 80 Printer	£199	VAT	£228.85
* OKI Microline 82A Printer	£329	VAT	£378.35
* Dragon 32 Computer	£139	VAT	£159.95

Akhter Instruments Limited

Dept. E.C., EXECUTIVE HOUSE, SOUTH RD.,
TEMPLEFIELDS, HARLOW, ESSEX CM20 2BZ, UK.
TEL: HARLOW (0279) 443521 OR 412639
TELEX 995801 REF - A18

ORDERING INFORMATION

All orders which accompany a cheque, cash or postal orders are CARRIAGE FREE (UK only). Please make cheques and postal orders payable to "AKHTER INSTRUMENTS". A carriage charge of 3% of invoice total is applicable to BARCLAYCARD and ACCESS orders. We accept official orders from Government and Educational establishments. We accept VAT FREE EXPORT orders, please phone or write to check shipping cost.

OPENING HOURS: MON-FRI 9am-5.30pm, SAT 10am-2pm.

We welcome callers, no parking problems.

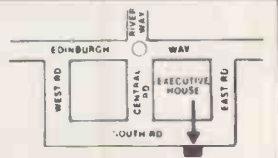

The memory lingers on

Neville Maude makes a date with a combined diary, real-time clock and non-volatile add-on RAM for the BBC Micro.

ONE OF the annoying things about computers is that when the current is switched off everything held in memory is lost. Files can be saved to tape or disc, of course, but they then have to be fed back in on each occasion. The idea behind the Acacia non-volatile real-time clock and RAM system for the BBC Micro is to store diary information in RAM which has its own back-up battery.

The Acacia unit is housed in a substantial case which measures 8in. by 5.5in. by 3in. A ribbon cable links it to the micro's 1MHz bus connector, and a four-strand connector goes to the auxiliary power socket.

The all-important back-up power is supplied by a Tadrian TL-5104P lithium battery. Acacia quotes a rather conservative three-year battery life, after which a replacement will cost around £5. New batteries can be inserted by anyone who can handle a soldering iron without damaging CMOS components, and Acacia will do the job for those who lack the courage to do it themselves.

Sideways ROM

Interfacing software comes on a ROM which should be placed in the first socket from the right. It is formatted as sideways ROM so only 256 bytes of workspace are needed. The current version is compatible

Apple Diary

The Oasis Diary Card provides a clock/calendar for the Apple II computer. The software, in ROM, provides commands to create, review, search and exit from the diary information, which is held in battery-backed RAM. Data retention is stated to be a minimum of five years. The 16K of RAM allows about 240 diary entries, but a factory upgrade to 64K of RAM is possible. The diary card can be installed in any slot except slot 0, and the diary can be accessed without disturbing any program in RAM. Contact Oasis Electronics Ltd, University Village, Norwich NR4 7TJ. Telephone: Norwich (0603) 503275.

with Torch, second processors and so on.

The RAM filing system is very swift indeed — three times faster than disc for Load and Save. It is also very reliable since there are no moving parts, and operation is completely silent. Time and date can be automatically included into files.

Setting up

Only 4K of memory is available, but that is enough to be useful for small things such as setting-up data. For example, if using the Wordwise word-processor chip it is useful to let the non-volatile RAM feed in things like *TV255,0 and *FX6,0. Other useful instructions might set the second values for the user-definable keys to provide single-key controls, standard page settings, and any commands required to ensure that the printer produces a £ sign instead of a #.

The idea of instantaneously switching in Snapper, Planetoids or more serious long programs must wait until more RAM is available. Acacia can provide a 26K upgrade with no change in base software,

though this costs about £150 extra. When 8K chips become cheap enough to replace the present chips, full expansion will be possible up to 64K.

The diary system is based on a real-time clock which can provide readings of the year, month, date, hour and minute. Reminder messages are available if required; they could be yearly for birthdays or an approaching MOT test, or monthly, like cheque-card repayments. Temporary messages for things like switching off the cooker can be programmed in. An alarm can be made to sound even if you are in the middle of another program. The current version holds dates up to the year 2014.

You can search the diary for particular entries. Suppose you were a keen golf player, entering

* DIAK GOLF

would select and display all entries showing this keyword. If you wanted to know when you met Mr Brown the computer would pick the relevant entry or entries. Useful refinements are that upper and lower case can be used. There is a wild-card facility so if you are not sure whether the name is spelt with an e or not, typing

Brown*

would cover both contingencies.

- * DIAA—add a reminder to diary
- * DIAD—display and/or delete all reminders for specific or subsequent dates
- * DIAK—display and/or delete items containing keyword
- * DIAR—read and/or delete items that activated alarm
- * TIME—enable continuous date and time display
- * DATD—display non-continuous time and date
- * TIMD—disable continuous time and date display
- * TIMS—set the time
- * DATS—set the date

Table 1. Diary system commands.

- * ACCESS—locks or unlocks file
- * INFO—determines load address, length, and execution address file
- * OPT 4n—controls autoboot, 1 Load, 2 Run, 3 Execute
- * EXEC—treats file as if typed in
- * SPOOL—directs output to screen, printer, RS-423 etc
- * RAM—access to Acacia filing system

Table 2. Filing system commands.

Conclusions

● The diary and RAM filing system are a very clever piece of programming, with well thought-out commands.

● A commendably clear 36-page A5 manual is supplied.

● The instant loading offered by non-volatile RAM storage is attractive, but the standard 4K is large enough only for frequently used set-up routines rather than full programs.

● Good old-fashioned desk diaries and real-time clocks with built-in alarms can both be had for a few pounds; whether a micro-based version of the same things is worth 10 times as much must be a matter of personal priorities.

● The Acacia Diary and RAM filing system is supplied by Acacia Computers Ltd, 5 Coombe Lea, Bickley, Bromley, Kent BR1 2HQ. It costs £147 including VAT; the 26K RAM upgrade costs about £150. □

A YEAR AFTER the Apple Lisa pioneered a new approach to software the first of the major imitators has arrived. Visi On from Visicorp has, like Lisa, a friendly mouse-controlled user interface. Also like Lisa, Visi On lets you run several applications concurrently, displaying them in separate windows on the screen, and it lets you pass data between them.

Unlike Lisa, Visi On does not require special dedicated hardware — it will run on a range of machines. But it is not an operating system, but an “operating environment”. You load it on top of your operating system, which is one reason why it is machine independent. The initial version, available immediately, is for the IBM PC XT.

Visi On comes in two parts. The Visi On Applications Manager sits immediately on top of the OS, which in the initial release is MS-DOS. The VAM seizes control of all interaction between the machine and the user, doing things like displaying the output from application programs in user-defined windows on the screen and accepting commands entered using the mouse or keyboard. Visi On application programs then sit on top of the Applications Manager.

Initially Visicorp is releasing three application programs for Visi On: a spreadsheet, a word processor and a graphics package. They are called Visi On Calc, Visi On Word and Visi On Graph, names which are sure to lead to confusion with Visicorp's older series of programs, the VisiCalc/VisiWord/VisiPlot range. The company intends to bring out other Visi On applications, with a database called Visi On Query to be followed by mainframe-to-micro communications.

Data transfer

Data from the Visi On programs can be transferred from one program to another, from Calc to Graph to produce a bar chart for instance, and then from Graph to Word to incorporate the bar chart in a report. At least that is the intention. In fact the initial release, Version 1.0, that I saw running on the IBM could not manage to move charts across into a Word document.

It took Apple some time to get similar functions working on the Lisa, but with a year's start the Lisa provides a more completely data-integrated environment. On the other hand Visi On's response time seems good compared to the sluggish standard set by the Apple Lisa, especially when opening up an additional window for a new application program.

The mouse supplied by Visicorp has two buttons and is of novel design. Instead of having a large ball-bearing in the base like the Lisa and Microsoft mice, underneath it has a light emitter and a light detector. You move the mouse about on a 9in.-by-6in. flat mirror with a grid marked on it. This optical system seems to work reasonably well and is claimed to be more

VISI ON

Ian Stobie looks at Visicorp's long-awaited mouse-controlled integrated software system: how it compares to the Lisa and to competing products promised by Digital Research and Microsoft.

reliable. Visicorp says later versions of Visi On will support other manufacturers' mice.

The general approach embodied in both Visi On and Lisa is to simulate the familiar desk-top paper environment on the computer screen. I personally find this makes unfamiliar packages easier to use. The consistency between applications makes it easier to remember what to do when you return to a package after not using it for several weeks.

All the same, I find it difficult to be very

excited by Visi On, perhaps because it is so very like the Lisa. Where Visi On differs from the Lisa it is generally less ambitious. It does not make such extensive use of graphic symbols on the screen for instance, being content with displaying keywords.

As with Lisa, the problem most people find with Visi On is the price. Before you can do anything you need the Visi On Applications Manager costing £375 and the mouse at £185. The Visi On applications themselves cost an additional £295 for Visi On Calc, £285 for Visi On Word and £195 for Visi On Graph. When you add on the cost of an IBM PC XT you are not far off the price of Lisa, which is £6,500 with all six integrated Lisa applications.

Visi On will be launched for several other machines including the Texas Professional, the Wang PC and the standard IBM PC, but the overall cost is unlikely to be much lower because Visi On requires a hard disc. The VAP code alone takes up 1.5Mbyte. It is crucial to the success of Visicorp's strategy for Visi On to get third-party suppliers writing independent application packages for Visi On. Above all, Visicorp has to achieve a large installed base quickly. So the all-in end-user system price matters a great deal.

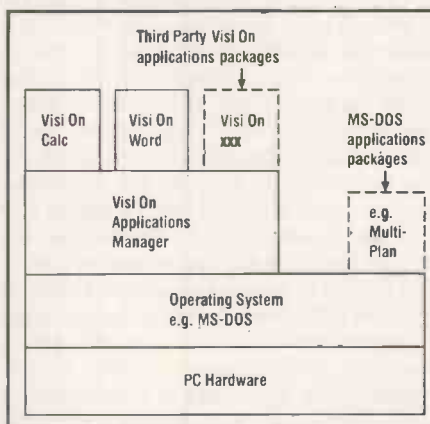

Applications Manager sits between the OS and Visi On applications.

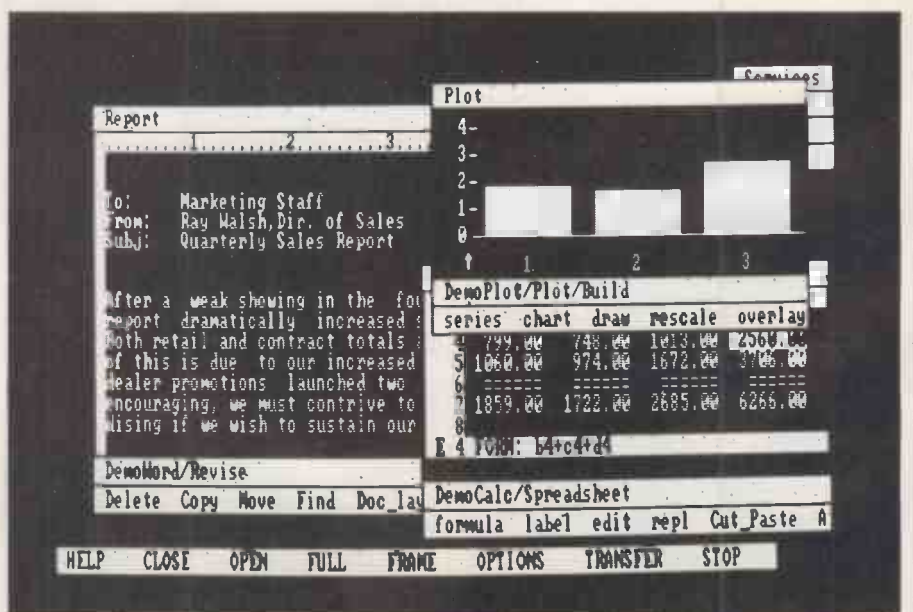

Graph, Word and Calc applications running at the same time on Visi On.

To encourage third-party suppliers to develop Visi On application programs Visicorp is releasing full details of the VAP's program-level interface. This is not as useful as it sounds, as Visi On applications will have to be written in C and you will need the Visi On toolkit to build mouse control and windows into your application package.

The toolkit will run only in a Unix environment at the moment, which means that whatever your target machine is you will need a Vax or a good 68000-based machine to develop your software on. Further, the Visi On toolkit is expensive: the Vax version costs £7,500, and the 68000 version £5,000. A version of the toolkit to run on the IBM PC, which presumably will be cheaper, is promised for early 1984.

Since Visi On sits on top of a standard operating system running on a standard

machine, the key question for any commercial software developer is why not simply write directly for the OS. Immediately this would open up the huge potential market of possibly one million MS-DOS systems already out there, compared to an installed user base for Visi On, at the time of writing, of zero.

It could be argued that it might make better commercial sense to write your own set of routines and put them in with the application code, like in Lotus 1-2-3 or Multiplan for example, or to forget about such frills altogether. This assumes that the standard operating systems are going to remain simple, with a fairly spartan user interface. What is happening is that both Microsoft and Digital Research are putting elaborate user-friendly features into their OSs, and are bringing out powerful software tools to help with system development. Now both have

announced concurrent windowing for future products.

At a press conference timed to the hour to match Visi On's launch, Microsoft showed Windows, or rather an early mock-up version. The real product will, it is claimed, be available in April 1984. A year ago Visicorp pre-announced Visi On to journalists at the height of the excitement over the Lisa. It is ironic that in this instance Visicorp is having its thunder stolen in the same way.

Windows is really part of MS-DOS 2, the latest release of Microsoft's 16-bit OS. Windows is still a provisional product, but the demo I saw running on a DEC Rainbow 100+, the new hard-disc Rainbow, looked very good. It has better-resolution graphics than Visi On and made full use of Lisa-style icons. However, the response time of the eventual product was impossible to judge given the artificiality of the demonstration.

Less ambitious

Microsoft's MS-DOS 2 with Windows is a less ambitious product than Visi On in that it looks as though it will not have virtual-memory management. This suggests that the number of tasks you can do concurrently may be more limited, or the response time may suffer in some circumstances. Nonetheless I would judge it to be a real threat to Visi On in the market place. Already Microsoft has signed deals with 23 computer manufacturers to put MS-DOS with Windows on their machines. As an OEM product MS-DOS with Windows will sell in volume to system suppliers. To the end-user it will appear to be come free with the system. Visi On, on the other hand, has to be bought like any other application product, and it is not cheap.

Microsoft's activities will have the most immediate impact on Visicorp because all the early versions of Visi On will be for MS-DOS machines. But Visicorp intends to release Visi On for Digital Research operating systems at some stage. Again, Digital Research has rapidly followed the Visi On launch with an announcement of its own. Version 3.1 of Concurrent CP/M-86, due for release in March, is to have windows. DR's windowing facilities are limited to four windows active at one time, but there will be support for data transfer between windows, which is probably more important.

Between them, Digital Research and Microsoft have not left Visicorp much time to start an unstoppable Visi On bandwagon rolling. And then there is Apple, pioneer of the mouse/windows/integrated-software approach. Is it content to let things rest with the Lisa? In next month's *Practical Computing* we reveal the shape of Apple's answer.

Visi On's U.K. distributor is Rapid Terminals, Rapid House, Denmark Street, High Wycombe, Buckinghamshire HP11 2ER. Telephone: (0494) 26271. 

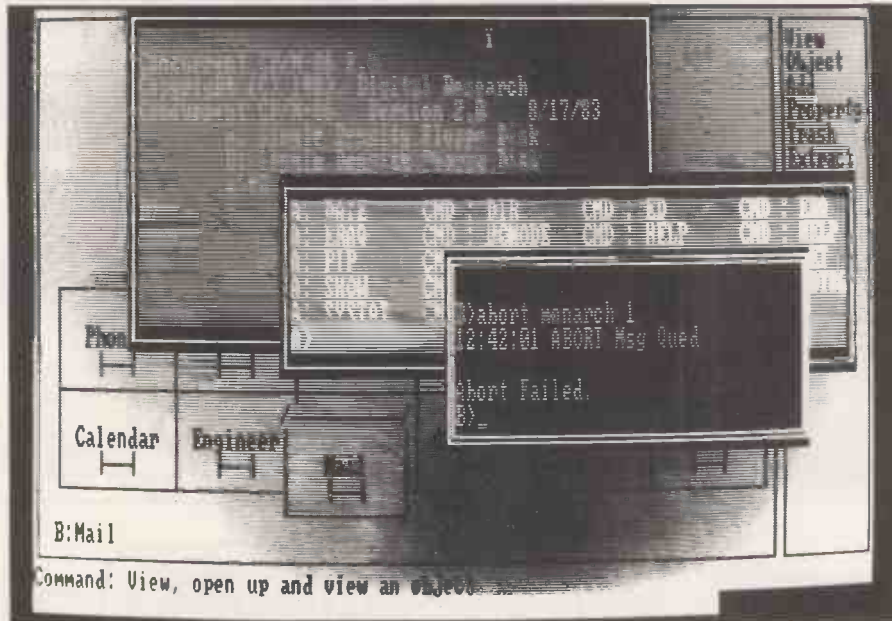

Concurrent CP/M, with four windows, is due for release in March.

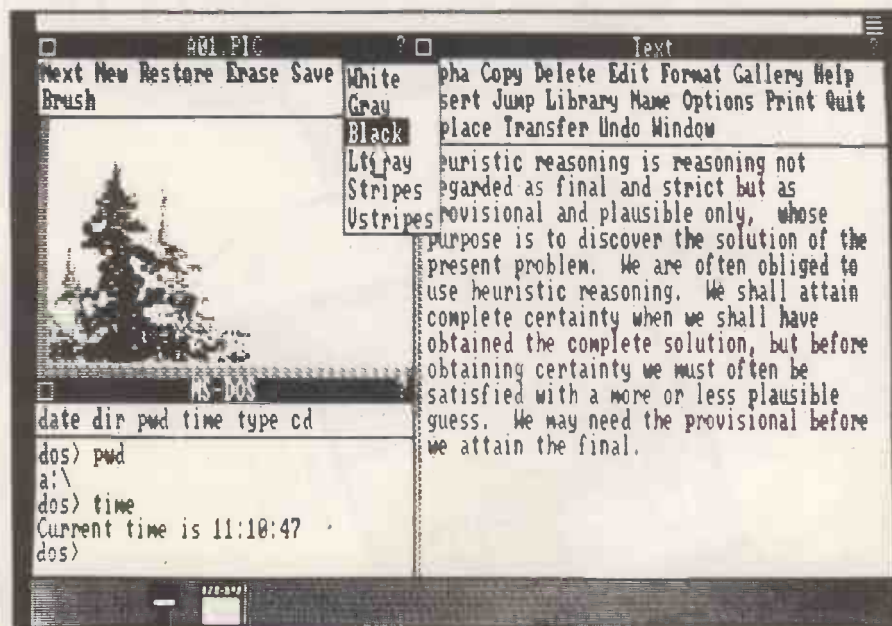

MS-DOS with Windows showing Word simultaneously with another program.

THE MAGIC of the micro is great to begin with. It obediently displays the latest profit figures, the answers to homework or the latest state of your single-handed battle to save the world from extra-terrestrial invasion. However, as with the TV and the hi-fi, at some point things are liable to go wrong.

It may be that a fault develops in the mysterious little box, or the keyboard refuses to function. Maybe your Dragon ends up in a burglar's swag-bag while you are at Butlins, or the ZX-81 loses an argument with the vacuum cleaner. As with most of the little tragedies of life, however, some solace can be found if you plan in advance — and take out insurance.

It is possible to insure practically anything in which you have a financial interest, but the insurance companies have been slow to adapt to computers, compared with their obsession for cars, houses and lives. At first they were happy to insure micros, and even larger machines, as an item in a business-contents contract, or to add the personal micro to the list of other electrical gadgets among the personal effects covered by a house-contents policy.

Embarrassment

It has taken some time for the companies to realise the special problems relating to computers and to see that these are risks of a different nature than those applicable to the washing machine. It is still normal to go to a broker or the local branch office of a major company and be met with an embarrassed stare when you enquire about micro insurance.

There are three ways of approaching the insurance of your micro, and each has advantages and disadvantages. The simplest is to add it to the appropriate section of an office or house-contents policy, usually on an "all risks" basis. For home computers this involves simply contacting your insurers and asking them to add the machine to your policy and informing them of its value. The annual premium is then likely to be adjusted to take it into account.

Premiums are usually calculated as so many pence per £100 insured. Rates vary not only from company to company but from area to area. Norwich Union, for example, would ask 35p per £100 in low-risk country areas but as much as 90p per £100 in the burglar-infested wastes of inner London. Provincial's asking rate is £1 per £100. However, the cheapest policy is not always the best since exclusions and excess — the sum you remain liable for, such as the first £100 of each claim — vary from company to company.

The problem with this type of insurance for a micro is that while it is cheap it only covers normal risks such as fire, theft and, to quote the Provincial, "loss or damage by any accident or misfortune". It does not cope with cooked chips or head crashes, still less with any financial loss which you

The best policy

Ian Hopkins details the crucial clauses to look out for when you are insuring a micro

incur because the machine is out of action. It may, however, be the economical choice for casual home users or smaller businesses.

A growing number of companies now produce computer policies that will cover the specific needs of small machines. For example, in addition to fire, theft and accident cover they will give protection for data media, costs of replacing data on tape or disc and similar expenses. Some of these companies are small engineering subsidiaries of the larger ones. For example, British Engine belongs to the Royal Insurance Group, National Vulcan is associated with Sun Alliance, and Scottish Boiler is part of General Accident. They tend to concentrate on commercial installations, especially mainframe

Dr Ian Hopkins is a
Director of Kosmos Computing

computers, but will also cover micros. British Engine has a special Mini and Micro policy. Other companies catering specially for computers include household names such as Cornhill, Commercial Union and Eagle Star, while Prudential and Norwich Union have still to wake up to the potential in computer insurance.

What these companies offer varies in detail but there are a large number of similarities. The significant differences are often simply the cost of premiums and the excess imposed. In the event of theft or total loss by fire or damage, most companies will replace the machine with a new one of the same specification. This new-for-old approach is important for computers because of the poor state of the second-hand market.

In motor insurance it is normal to indemnify the customer. In other words, if

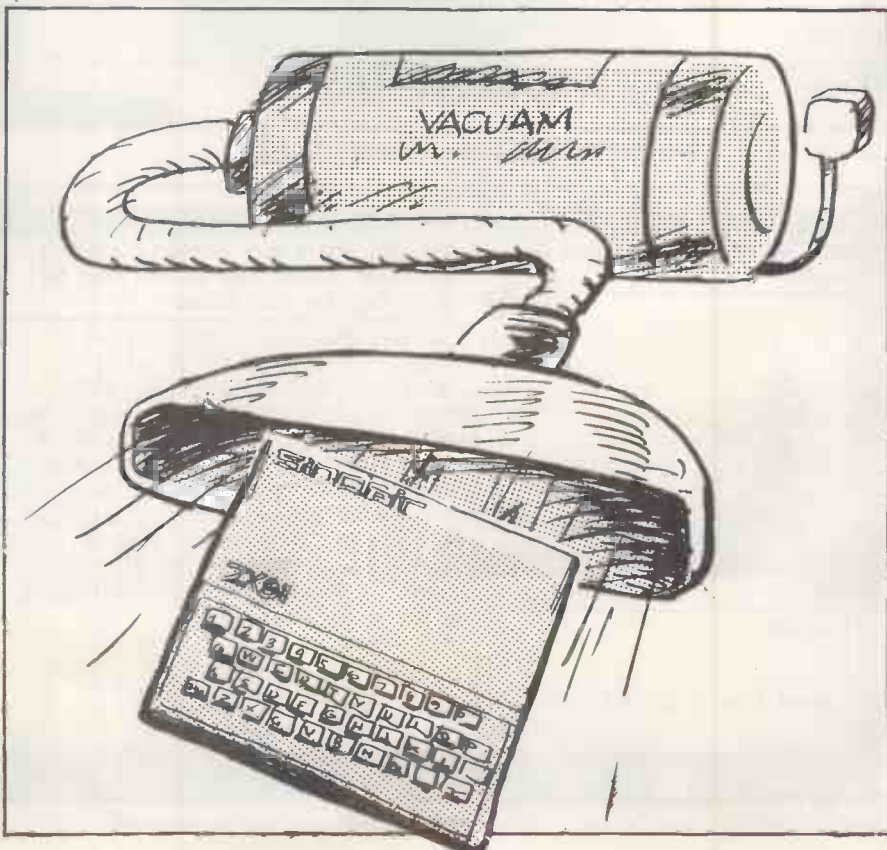

your four-year-old Cortina is hit by a runaway lamp post you get the value of a four-year-old Cortina — no more, no less. You could then go out and buy one if you wanted to replace like with like. However, it is not so easy to get an Acorn Atom or Pet of a particular vintage. By and large the insurance companies recognise this, though there are a few exceptions, such as Guardian Royal Exchange. Many companies limit new-for-old to fairly recent models.

Along with the loss of the machine, loss of tapes and discs is an important risk, especially if they are carried about or lent to other people. Most of the specialist policies make some attempt to finance the resurrection of software. Some do not compensate for loss of the actual media, and the degree to which they will support data recovery also varies. Commercial Union is more generous on this than many others but it is important to get a clear understanding of the extent of compensation before you go ahead and sign the agreement.

Consequential loss

A third important area of cover is what is known as consequential loss. It covers loss of income and other costs resulting from computer breakdown or loss of access to the machine. British Engine summarises this cover as "additional expenditure up to the limit of the sum insured, incurred in order to continue the work normally done on the computer for up to six months . . .".

It is in the area of consequential loss that the traditional home-contents policies fall down because they will not offer any compensation for this type of loss. Office policies tend to include some cover of this nature often designated "interruption of work", although it may not be adequate for the potential loss of a database or large software system. The average home-computer owner, of course, may suffer little or no real loss of earnings if the micro is used solely for entertainment or pleasure. An identical machine used as the heart of a business-accounts or customer-record system could lead to financial problems in the event of theft or damage.

All risks?

If you are considering a so-called all-risks policy it is important to remember that it does not in fact cover literally all risks. There are a number of exclusions, which vary from company to company, but again they show a fair amount of common ground. Most policies exclude problems resulting from wear and tear and especially "derangement", by which is meant breakdown resulting from loose connections rather than a faulty part. Nearly all policies exclude loss or damage following "war, riots and civil commotion" and there are particular limitations in Northern Ireland. The effects



of nuclear radiation and changes in atmospheric pressure changes, such as sonic booms, are also excluded from nearly all policies. If your micro is insured on the basis of home use only you may have difficulties with a claim arising from business use. Domestic and General is especially keen on this point.

Failure of the electricity supply is often excluded, except for long periods, and this is a vital element in computer stoppage. For example, British Engine only insures against failure of supply for more than four hours and excludes "deliberate acts of the supply authority or drought". Eagle Star has a more complicated power-failure clause, but Commercial does not exclude this problem.

As with all insurance policies, there are excess clauses. You are expected to pay the first £10 per claim with Commercial Union and Cornhill, up to £50 per claim with Scottish Boiler.

Special policies

Finally, there are special contracts for certain models. Domestic & General produces policies geared to the Genie, Vic-20 and Commodore 64, and also insures the computer trade. Another type of special policy is the computer-fraud contract of Legal and General, but this is more likely to interest larger financial businesses than the owners of micro systems.

The cost of specialist computer policies varies from about £8 upwards, and depends on the value of the equipment covered and the potential loss of business. The average home or small-business user always needs to consider carefully the cost of a special policy compared with an extension to a home/office-contents contract. The decision really hinges on whether serious problems would emerge if the machine were to be out of action for more than a few days.

A final type of cover deals with the exclusions of wear and tear and derangement found in most regular policies. Many micro users, especially those

with business interests, find the insurance companies' exclusions irritating. As far as they are concerned, if the machine is down they want it put right as quickly and as economically as possible, whatever the cause. The traditional answer to this problem has always been a maintenance agreement of a similar nature to that which many of us have to look after our central heating. For an annual fee, an engineering company will agree to service the equipment free of labour and we just have to pay for the parts.

Datacover

However, computer users now have an alternative which is growing rapidly in popularity. It is known as Datacover and is organised by the Bristol firm of insurance brokers, Halsey and Company. Its distinctive feature is breakdown cover. The Datacover policy includes parts as well as labour on an all-risks basis, and expenses of recompiling data, hiring alternative equipment and normal loss or damage are included. The idea is that the average computer user needs a policy which really covers all insurable risks and is simple to claim on. Datacover is cheaper than a maintenance agreement, and the user has the freedom to contact any engineer and then present the bill to the insurers.

Critics of Datacover argue that maintenance agreements ensure that the engineer places the contracted customer high on the priority list. In other words if you ring XYZ Engineers Ltd when your machine is down someone will come today if you have a maintenance contract but you will have to wait till next week if you use Datacover. There is some doubt, however, whether things are really quite as bad as this. Surely, where there is competition between engineering firms there is ample incentive to deal with all customers promptly. The Datacover concept looks like catching on and represents a very good deal.

There are few professional advisers who can offer help in choosing a policy to insure a micro. On the whole, if a machine is being used for personal use then an extension to a home-contents all-risks policy may be adequate unless a lot of software is being produced. If the micro is being used regularly for personal or business purposes and any breakdown would be costly or inconvenient, then Datacover may well be the answer. For firms which can do their own maintenance or the individual who enjoys soldering PCBs a normal special computer policy may be enough.

As with all insurance policies it pays to get what advice you can and to read the small print. What are the exclusions? Does it cover transit? How much consequential loss is covered? The day when the micro can be insured as easily as the car may be some way off, but a little shopping around should produce a suitable policy for home and business users. □

A WELL THUMBED book of tables is an indispensable part of most central-heating engineers' equipment. The vital information it contains includes data on the heat output of radiators of a given size, water flow in the pipes, boiler sizing and plenty more besides. A rough-and-ready convertor specifying what size of radiator is required for a room of a particular size is likely to be particularly well used.

However, an efficient system calls for some extensive calculations to make sure that fuel is not wasted in overheating some rooms while others remain chilly. In the first place you need to work out precisely how much heat is required in each room. The inside and outside temperatures, the volume of the room and how often the air in the room is changed are the most crucial factors. The area of glass in the room, the temperature of the house next door and the insulating properties of various building materials also need to be taken into account. It all amounts to quite an involved series of calculations which must be repeated for each room in the house.

If you have ever done the exercise for yourself the thought is bound to have dawned that this is work more suited to a computer than a human. With this program you can repeat the calculations for a series of external temperatures and compare the results. A bonus is that any errors in your raw data can easily be corrected without having to spend hours checking the knock-on effect in other rooms: you just run the program again.

Making changes

The program makes it particularly easy to change the target temperature in any room. Other parameters can be altered by changing the appropriate program line. Likely candidates are: number of rooms, variable name Nrooms% at line 120; external temperature, variable name Outside at line 100; and the temperature in adjoining building: variable name Ndoor at line 110.

The data itself is placed in Data statements. It is not worth using a data file if you just want to run the program a few times. If you need to run the program regularly you can modify it to read from such a Data file; the data is simply loaded into an array for analysis in lines 180 to 220.

The program assumes that each room has six rectangular surfaces, so lighthouse-keepers will have to make approximations. Only one window is allowed for in each wall, but you can aggregate the areas of several windows. No allowance is made for internal doors; errors arising from this assumption are negligible as it is bad practice to design for large temperature differences across internal walls. External doors present a slightly different problem, which can best be dealt with by adding a few tens of watts to the heating requirements of the room in question.

The program calculates the heat loss and ventilation loss for each room. The heat-

Home heating

John Smith's program takes the hard labour out of calculating radiator sizes and the boiler rating for a domestic central-heating system.

Heat loss calculation uses the general formula:
Heat loss = area of surface × U value of surface × temperature difference across surface

where area is in square metres, the temperature in °C and the heat loss is in

watts. In each surface a separate calculation is done for the window area and non-window area.

Ventilation loss is calculated from the formula:

Ventilation loss per room = number of air

```

>L.
10MODE6
20PRINT"CENTRAL HEATING PROGRAM 'HEAT'"
30PRINT"  BY John Smith. (C) 1983"
40TIME=0:REPEAT UNTIL TIME>250
50VDU3:CLOSEE0:REM ensure printer is off and any files from other programs cl
osed
60%=310
70VDU 23,240,24,24,0,0,0,0,195,195
80REM DEFINE SOME CONSTANTS
90shfactor=0.37:REM INCLUDES SPECIFIC HEAT OF AIR
100outside=-1:REM OUTSIDE TEMPERATURE
110ndoor=-12:REM NEXTDOOR TEMP
120nrooms%=9:REM NUMBER OF ROOMS
130valuesperroom%=48
140maxdata%=valuesperroom%*nrooms%
150I%=0:REM a search pointer
160DIM data(maxdata%)
170REM fill the array
180FORI%=1 TO maxdata%
190READ data(i%)
200NEXT
210READeof%
220IFeof%<>10000 PRINT"missed end marker":STOP
230CLS:PRINT"Process entire data ? (P)";"Change a room temp ? (C) "
240PRINT"Choose option -> ";
250opt%=GET%
260PRINTopt%
270 IF (opt%="P") OR (opt%="p") GOTO 470
280 IF (opt%<>"C") AND (opt%<>"c") GOTO 230
290PRINT"ROOM / CODE"
300FORI%=1 TO nrooms%
310PROCroom(i%*-1)
320PRINTroom%," (";I%;")"
330NEXT
340INPUT"Enter code of room to be changed ";r%
350INPUT"what is the desired temp ";t%
360PRINT
370REM find the room
380FOR I%=1 TO maxdata%
390IF data(i%)=r% *-1 GOTO 410
400NEXT
410data(i%+1)=t% :REM change to new temp
420REM Tell user what's been changed"
430PROCroom(r%*-1)
440PRINT"Temp in the ";room%:" is now ";t%
450PRINT"Press SPACE to continue":A=GET
460GOTO 230
470 REM
480REM START PROCESSING
490PRINT"Output to printer ? (Y/N) ";
500opt%=GET%
510PRINTopt%
520IF (opt%<>"Y") AND (opt%<>"y") AND (opt%<>"N") AND (opt%<>"n") GOTO500
530CLS:PRINTTAB(0,23);"-----"
540PRINT"Press SPACE for next page of results!"
550PRINT"-----"
560IF (opt%="Y") OR (opt%="y")VDU2:REM printer on
570VDU30:REM Cursor home
580PRINT"-----"
590PRINT"! Lowest outside temp assumed = ";outside%!"
600PRINT"! Temp next door is assumed = ";ndoor%!"
610PRINT"-----"
620VDU28,0,19,39,6:REM Define text window
630total%=0
640FORp%=1 TO maxdata% STEP 48 :REM for each room
650q%=p%
660roomid%=data(q%):q%=q%+1:REM which room

```

changes per hour × volume of room × specific heat capacity of air × temperature different to outside.

The boiler losses are simply estimated as being 10 percent of the total losses so far. An additional 3kW is then added for domestic hot-water requirements to arrive at a total figure for the minimum boiler capacity needed. A conversion factor is applied to give results in BTU per hour, as manufacturers still quote radiator and boiler outputs in these units.

Before entering the data, draw a rough plan of each floor of the building. Label each room with a unique identification number, starting at -1 and going on to -2, -3, etc.; this number corresponds to program variable RoomID. Mark the desired temperature in each room in °C. Then draw up a table with the dimensions in metres of each room and, where appropriate, the size of the windows. Assume one wall to be north and then work round east, south and west, which is a help when checking the data afterwards.

The program expects data in the

Surface	U value
Cavity wall	1.9
Cavity wall with foam infill	0.5
Brick internal wall	2.1-2.5
Breeze-block internal wall	2.4
Tile/slate roof on battens with felt	2.0
Tile/slate roof, insulated with glass-fibre	0.5
Wood floor, uncovered	1.8
Wood floor, carpeted	1.1
Solid floor	1.1
Intermediate floor	1.6
Intermediate floor	1.2
Single-glazed windows	5.6
Double-glazed windows, sealed	2.7
Double-glazed windows, non-sealed	4.0

Table 1. U values.

Sitting room	2
Bedroom	1.5
Bathroom	2
Kitchen	3
Hall	1.5

Table 2. Air changes per hour.

following order: RoomID; temperature; X_{surf} , Y_{surf} , U_{surf} , $x_{glass, surf}$, $y_{glass, surf}$, $U_{glass, surf}$, Tag — repeated for each of the six surfaces; x,y,z — dimensions of room in metres; number of air changes per hour. This makes a total of 48 items of data, which you repeat for each room followed by the value 10000 as the last data item as an end-of-file marker. There is considerable redundancy in the data, but the format is convenient and quick to enter, and simplifies the program as each room is represented by a record of fixed length. The Tag variable must be one of the following:

- the absolute value of the RoomID of the room adjoining this surface;
- 999 if the surface is an outside wall;
- 1000 if surface adjoins other building.

The Tag is the key to the operation of the program. The temperature difference across each surface is required to calculate the losses, and the program picks up a Tag and scans the entire data looking for a RoomID corresponding to it. RoomIDs are negative and so can be easily extracted from

(continued on next page)

```

670destemp=data(q%):q%=q%+1:REM what temp for this room
680Totalroomloss=0
690PROCroom(roomid%)
700PRINT "room%": Desired temp = "destemp
710FOR k%=1 TO 6:REM for each surface of the room
720adjroomid%=data(q%+6)*-1
730 IF ABS(adjroomid%)=999 adjroomtemp=outside:GOTO780:REM it's an external wa
11
740 IF ABS(adjroomid%)=1000 adjroomtemp=ndoor:GOTO780:REM this wall is 'shared
with nextdoor
750FOR l%=1 TO maxdata%:REM find out which ROOM is adjacent to this wall.
760IF data(l%)=adjroomid% adjroomtemp=data(l%+1)
770NEXT
780IF l%>maxdata%+1 PRINT "Oops - can't find room "adjroomid%:STOP
790tempdiff=destemp-adjroomtemp
800btuloss=((data(q%)*data(q%+1)-data(q%+3)*data(q%+4))*data(q%+2)+data(q%+3)
*data(q%+4)*data(q%+5))*tempdiff)*3.4121
810total=total+btuloss
820Totalroomloss=Totalroomloss+btuloss
830PRINT "Surface "k%": Loss = "INT(btuloss);" Btu/hr"
840q%=q%+7:REM on to the next surface
850NEXT
860vol=data(q%)*data(q%+1)*data(q%+2)
870airch=data(q%+3)
880ventfactor=(vol*airch*(destemp-outside))*shfactor)*3.4121
890PRINT "Ventilation loss = "INT(ventfactor);" Btu/hr"
900Totalroomloss=Totalroomloss+ventfactor
910total=total+ventfactor
920IF opt="Y"PRINT "Radiator needed = "INT(Totalroomloss);" Btu/hr" ELSE PRINT
CHR$240;" Radiator needed = "INT(Totalroomloss);" Btu/hr"
930PRINT "****"
940IF opt<"Y") OR (opt="y") A=GET:CLS
950NEXT
960PRINT "Sum of losses so far = "INT(total);" Btu/hr"
970PRINT "Add 10% for the boiler losses:"
980total=total+total*0.1
990PRINT "this makes the losses up to "INT(total);" Btu/hr"
1000PRINT "Now allowing 10000 Btu/hr for domestic hot water."
1010total=total+10000
1020PRINT "boiler capacity must be at least = "INT(total);" Btu/hr ("INT(total
*.293);" Watts)"
1030VDU3,26
1040PRINTTAB(0,22);" PROGRAM COMPLETE "
1050END
1060DEFPROCroom(roomid%)
1070IFroomid%=-1 room%="Living room":ENDPROC
1080IFroomid%=-2 room%="Lounge":ENDPROC
1090IFroomid%=-3 room%="Kitchen":ENDPROC
1100IFroomid%=-4 room%="Lower hall":ENDPROC
1110IFroomid%=-5 room%="Rear bedroom":ENDPROC
1120IFroomid%=-6 room%="Front bedroom":ENDPROC
1130IFroomid%=-7 room%="Small bedroom":ENDPROC
1140IFroomid%=-8 room%="Upper hall":ENDPROC
1150IFroomid%=-9 room%="Bathroom":ENDPROC
1160ENDPROC
1170DATA -1,22
1180DATA 3.56,2.3,1.9,1.68,1.49,5.6,999
1190DATA 3.7,2.3,2.5,0,0,0,3
1200DATA 3.56,2.3,2.5,0,0,0,2
1210DATA 3.7,2.3,2.5,0,0,0,1000
1220DATA 3.7,3.56,1.1,0,0,0,999
1230DATA 3.7,3.56,1.6,0,0,0,5
1240DATA 3.7,3.56,2.3,2
1250REM
1260DATA -2,20
1270DATA 3.56,2.3,2.5,0,0,0,1
1280DATA 3.85,2.3,2.5,0,0,0,4
1290DATA 3.56,2.3,1.9,2.92,1.47,5.6,999
1300DATA 3.85,2.3,2.5,0,0,0,1000
1310DATA 3.85,3.56,1.1,0,0,0,999
1320DATA 3.85,3.56,1.6,0,0,0,6
1330DATA 3.85,3.56,2.3,2
1340REM
1350DATA -3,16
1360DATA 2.11,2.3,1.9,1.78,1.17,5.6,999
1370DATA 4,2,3,1.9,1.14,1.15,5.6,999
1380DATA 2.11,2.3,2.5,0,0,0,4
1390DATA 4,2,3,2.5,0,0,0,1
1400DATA 2.11,4,1.1,0,0,0,999
1410DATA 2.11,4,1.6,0,0,0,9
1420DATA 2.11,4,2.3,3
1430REM
1440DATA -4,16
1450DATA 2.11,2.3,2.5,0,0,0,3
1460DATA 4.15,2.3,1.9,0,0,0,999
1470DATA 2.11,2.3,1.9,2.11,2.3,5.6,999
1480DATA 4.15,2.3,2.5,0,0,0,2
1490DATA 4.15,2.11,1.1,0,0,0,999
1500DATA 4.15,2.11,1.6,0,0,0,8
1510DATA 4.15,2.11,2.3,1.5
1520REM
1530DATA -5,21
1540 DATA 3.56,2.36,1.9,1.68,1.33,5.6,999
1550DATA 3.7,2.36,2.5,0,0,0,9
1560DATA 3.56,2.36,2.5,0,0,0,6
1570DATA 3.7,2.36,2.5,0,0,0,1000
1580DATA 3.7,3.56,1.2,0,0,0,1
1590DATA 3.7,3.56,0.5,0,0,0,999
1600DATA 3.7,3.56,2.36,1.5
1610REM
1620DATA -6,20
1630DATA 3.56,2.36,2.5,0,0,0,5
1640DATA 3.85,2.36,2.5,0,0,0,7
1650DATA 3.56,2.36,1.9,2.92,1.47,5.6,999
1660DATA 3.85,2.36,2.5,0,0,0,1000
1670DATA 3.85,3.56,1.2,0,0,0,2
1680DATA 3.85,3.56,0.5,0,0,0,999
1690DATA 3.85,3.56,2.36,1.5
1700REM
1710 DATA -7,21
1720DATA 2.11,2.36,2.5,0,0,0,8
1730DATA 1.95,2.36,1.9,0,0,0,999
1740DATA 2.11,2.36,1.9,1.1,5.6,999
1750DATA 1.95,2.36,2.5,0,0,0,6
1760DATA 2.11,1.95,1.2,0,0,0,4
1770DATA 2.11,1.95,0.5,0,0,0,999
1780DATA 2.11,1.95,2.36,1.5
1790REM
1800DATA -8,16
1810DATA 2.11,2.36,2.5,0,0,0,9
1820DATA 2.54,2.36,1.9,1.4,1.9,5.6,999
1830DATA 2.11,2.36,2.5,0,0,0,7
1840DATA 2.54,2.36,2.5,0,0,0,6
1850DATA 2.11,2.54,1.2,0,0,0,4
1860DATA 2.11,2.54,0.5,0,0,0,999
1870DATA 2.11,2.54,2.36,1.5
1880REM
1890DATA -9,19
1900DATA 2.11,2.36,1.9,1.12,1.16,3.9,999
1910DATA 3.15,2.36,1.9,0,0,0,999
1920DATA 2.11,2.36,2.5,0,0,0,8
1930DATA 3.15,2.36,2.5,0,0,0,5
1940DATA 2.11,3.15,1.2,0,0,0,3
1950DATA 2.11,3.15,0.5,0,0,0,999
1960DATA 2.11,3.15,2.36,2
1970DATA 10000

```

>RUN
CENTRAL HEATING PROGRAM 'HEAT'
BY John Smith. (C) 1983

| Lowest outside temp assumed = -1 ;
Temp next door is assumed = 12 ;

Living room: Desired temp = 22
Surface 1 Loss = 1947 Btu/hr
Surface 2 Loss = 435 Btu/hr
Surface 3 Loss = 139 Btu/hr
Surface 4 Loss = 725 Btu/hr
Surface 5 Loss = 1137 Btu/hr
Surface 6 Loss = 71 Btu/hr

Ventilation loss = 1759 Btu/hr

Radiator needed = 6217 Btu/hr

Lounge: Desired temp = 20
Surface 1 Loss = -140 Btu/hr
Surface 2 Loss = 302 Btu/hr
Surface 3 Loss = 2252 Btu/hr
Surface 4 Loss = 604 Btu/hr
Surface 5 Loss = 1080 Btu/hr
Surface 6 Loss = 0 Btu/hr

Ventilation loss = 1671 Btu/hr

Radiator needed = 5771 Btu/hr

Kitchen: Desired temp = 16
Surface 1 Loss = 981 Btu/hr
Surface 2 Loss = 1295 Btu/hr
Surface 3 Loss = 0 Btu/hr
Surface 4 Loss = -471 Btu/hr
Surface 5 Loss = 538 Btu/hr
Surface 6 Loss = -139 Btu/hr

Ventilation loss = 1249 Btu/hr

Radiator needed = 3456 Btu/hr

Lower hall: Desired temp = 16
Surface 1 Loss = 0 Btu/hr
Surface 2 Loss = 1051 Btu/hr
Surface 3 Loss = 1576 Btu/hr
Surface 4 Loss = -326 Btu/hr
Surface 5 Loss = 558 Btu/hr
Surface 6 Loss = 0 Btu/hr

Ventilation loss = 648 Btu/hr

Radiator needed = 3509 Btu/hr

Rear bedroom: Desired temp = 21
Surface 1 Loss = 1818 Btu/hr
Surface 2 Loss = 148 Btu/hr
Surface 3 Loss = 71 Btu/hr

Surface 4 Loss = 670 Btu/hr
Surface 5 Loss = -54 Btu/hr
Surface 6 Loss = 494 Btu/hr

Ventilation loss = 1295 Btu/hr

Radiator needed = 4445 Btu/hr

Front bedroom: Desired temp = 20
Surface 1 Loss = -72 Btu/hr
Surface 2 Loss = -78 Btu/hr
Surface 3 Loss = 2281 Btu/hr
Surface 4 Loss = 620 Btu/hr
Surface 5 Loss = 0 Btu/hr
Surface 6 Loss = 491 Btu/hr

Ventilation loss = 1286 Btu/hr

Radiator needed = 4530 Btu/hr

Small bedroom: Desired temp = 21
Surface 1 Loss = 212 Btu/hr
Surface 2 Loss = 656 Btu/hr
Surface 3 Loss = 987 Btu/hr
Surface 4 Loss = 39 Btu/hr
Surface 5 Loss = 84 Btu/hr
Surface 6 Loss = 154 Btu/hr

Ventilation loss = 404 Btu/hr

Radiator needed = 2539 Btu/hr

Upper hall: Desired temp = 16
Surface 1 Loss = -128 Btu/hr
Surface 2 Loss = 1231 Btu/hr
Surface 3 Loss = -213 Btu/hr
Surface 4 Loss = -205 Btu/hr
Surface 5 Loss = 0 Btu/hr
Surface 6 Loss = 155 Btu/hr

Ventilation loss = 407 Btu/hr

Radiator needed = 1249 Btu/hr

Bathroom: Desired temp = 19
Surface 1 Loss = 822 Btu/hr
Surface 2 Loss = 963 Btu/hr
Surface 3 Loss = 127 Btu/hr
Surface 4 Loss = -127 Btu/hr
Surface 5 Loss = 81 Btu/hr
Surface 6 Loss = 226 Btu/hr

Ventilation loss = 792 Btu/hr

Radiator needed = 2888 Btu/hr

Sum of losses so far = 34607 Btu/hr

Add 10% for the boiler losses:

this makes the losses up to 38068 Btu/hr

Now allowing 10000 Btu/hr for domestic hot water,

boiler capacity must be at least = 48068 Btu/hr (14083 Watts)

(continued from previous page)

the data; the program just multiplies the Tag by -1 before beginning its search for a RoomID. When the program finds a RoomID which corresponds to the Tag, the temperature in that room is simply the entry following that RoomID in the array.

In the example for which data is given,

the hall was treated as two rooms, as the geometry of the building lent itself to that approach; remember to add one to Nrooms% if you do this. Changes should be made to the procedure in lines 1070 to 1150 to associate the RoomID with the name of the room for your application.

The program runs on the BBC

Microcomputer Model B in Mode 6; change line 10 to read Mode 7 to run on a Model A. It takes about a minute to compute the results for a whole house and output can be sent to a printer as one of the options. Page mode is engaged when output goes only to the screen, and is disengaged for printer output. 

LOVE STORY

“ Gordon Baker had often thought about buying a computer, but his courage always failed him at the vital moment. "I'm not a technical man", he explained. "I need patience and understanding and when I saw Columbia in a recent issue of a computer magazine, it looked so attractive and uncomplicated that I just had to send for more details."

A package arrived from Icarus the following Monday. With trembling hands Gordon opened it and read through the letter and introductory brochure. It seemed too good to be true: Columbia embodied all that had been missing from his previous relationships.

A meeting was arranged.

Gordon passed that afternoon with his local Icarus dealer in a state of near ecstasy! Columbia was not only attractive to look at, but, as the dealer explained and demonstrated, proved extremely competent without being overly complicated.

Soon after that initial contact Gordon had to fly North on business and it was a fortnight before he could contact the dealer to fix another meeting. It was decided to bring Columbia round to Gordon's office to be introduced to the staff. It was vital to establish as soon as possible whether Columbia could operate efficiently in his own business environment.

Things could not have gone better. Columbia was a big hit with everybody; Accounts, Stock Control, Sales, Research and Forecasting were all of one accord: Columbia was terrific.

They enthused over the high resolution amber screen, were effusive about the choice of CP/M 86 and MS-DOS operating systems and IBM PC compatibility, and then became quite emotional over Columbia's floppy and Winchester disc configurations, its expandability up to 896K RAM and the access it gave to hundreds of 16 BIT 'off the shelf' software packages.

The dealer asked Gordon if he would like to see Columbia again. "Oh, please", said Gordon, "could it stay for just a couple more days?"

Within a week Columbia had moved in permanently, and Gordon was on top of the world.

"I'd just about given up hope of ever finding my perfect partner", he said, "until Columbia came along and changed my life!"

In the background, the warm glow from the amber screen seemed to indicate that Columbia too was well pleased with the situation . . . ”

If you think the Columbia PC could be your perfect partner too, we'll be pleased to send you more intimate details in complete confidence.



The Columbia 16BIT

Personal Computer

Columbia
Your perfect partner
ICARUS
Computer Systems Ltd

ICARUS COMPUTER SYSTEMS LTD, Deane House, 27 Greenwood Place, London NW5 1NN. Tel: 01-485 5574. Telex: 264209

Apple operations

Peter and Owen Benson set up the Apple II as a process controller.

THE GATEWAY between your Apple II and the big, wide world outside is that little socket which has so far been monopolised by the game paddle and joystick. An A/D converter is built into the Apple, so analogue signals received through the games port can be converted into digital form. They can then be stored or manipulated by the computer.

The essential component of a games paddle is a variable resistor or potentiometer, the value of which depends on the position of the paddle knob. When reading the games port the Apple checks the current value of the potentiometer by measuring how long it takes to charge an internal capacitor through it. The value produced is a number between 0 and 255, corresponding to resistances in the range zero to 150k Ω .

Suppose games paddle 0 is in the middle of its travel, and you enter the instruction PRINT PDL (0)

The number 127 appears on the screen. If you were playing a game, the value of the paddle setting would not be printed, but would be used to provide instructions as to how to move something on the screen.

The Apple obviously has no means of knowing what kind of resistor is connected to the Game I/O socket so any resistive devices can be used instead of a paddle. There are a huge variety available, but one of the simplest is a thermistor, which is just a resistor that changes its value according to its temperature. Thermistors can be bought for a few pence from electronics stores, Tandy shops, etc.

Clearly a thermistor can be used to enable the Apple to measure temperatures, then graph them, manipulate them or store them. These values can even be used as triggers to instruct the computer to switch heaters, fans or warning devices on and off.

Listing 1 shows a program to take temperature readings each minute and graph the results.

As written, the program produces results in arbitrary units. To give temperatures in conventional units such as $^{\circ}\text{C}$ or $^{\circ}\text{F}$ you have to calibrate the thermistor. The first problem is that thermistors come in a variety of types. For example, some increase in resistance as the temperature

rises, while others decrease. Either type will do. The next variable is the thermistor's resistance. It is probably best to choose one with a resistance between 60k Ω and 100k Ω , since this is near the middle point of the Apple's measuring capacity.

To calibrate the thermistor, place it in crushed, melting ice to find its resistance at 0 $^{\circ}\text{C}$, and then next to a household

thermometer under a lamp or other heat source. Allow a few minutes for the temperature to stabilise in each case.

The Apple has provision for four games paddles, so it can handle up to four separate thermistors at once, which are read by PDL (0), (1), (2) and (3). Data from two sensors could be used to monitor outside and inside temperatures, or two chemical baths in a dark-room, and control heaters accordingly.

You can do a similar sort of thing with other resistive devices. A light-dependent resistor, LDR, can be bought from Tandy for about £1. As the name implies, the value of the resistor depends on the amount of light striking it, so you could use it to monitor light levels, compare the output of supposedly similar light bulbs, or control operations in the dark-room.

An LDR can be used to count the number of times a light beam is interrupted, since the resistance suddenly changes when the light is blocked. A limiting factor here is that the LDR does not respond instantly, so it can only be used for events happening less frequently than about 100 times per minute.

You can use a set-up of this kind in the physics lab to measure the speed of a moving cart. The computer starts counting when the beam is first interrupted, and stops when the beam is reinstated. By converting the count value into seconds and dividing the length of the vehicle by the calculated time you obtain a very useful value for its speed. Only one LDR is needed, and the light source can be daylight from a window. If possible, choose an LDR with a resistance of about 80k Ω , so that it normally lies near the middle of the Apple's measuring range.

The LDR is also the key to measuring other factors, which are not in themselves variable resistances. For instance, a voltage

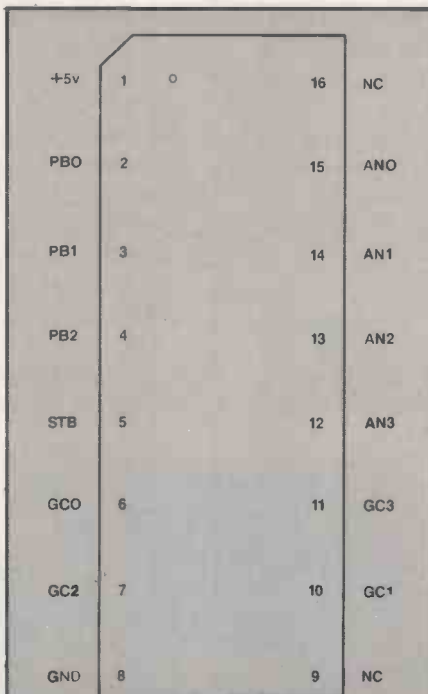

Pin 1 — +5V at up to 100mA
 Pins 2 to 4 — used for the push buttons
 Pins 6, 7, 10, 11 — used for the paddles
 Pin 8 — electrical earth
 Pins 12 to 15 — annunciator outputs, up to 10mA

The connector plugs in with pin 1 towards the front of the Apple.
Figure 3. Game I/O connector.

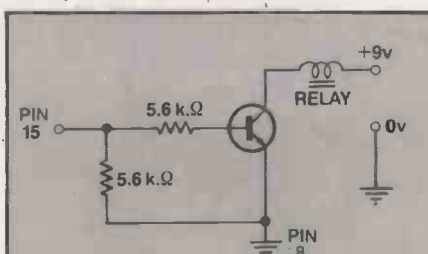

Figure 1.

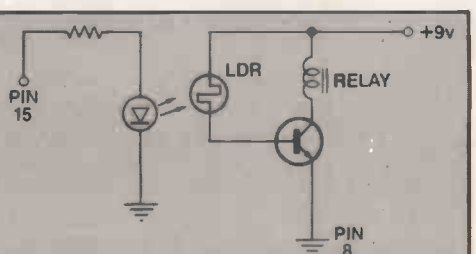

Figure 2.

Peter Benson is director of studies at Aiglon College, Switzerland.

or current to be monitored can be used to operate a light bulb or LED which shines directly on to the LDR. If screened from the ambient light — you can use a plastic 35mm. film canister — the resistance of the LDR will vary with the changing voltage or current, allowing the computer to track it. The values will not be known directly, but this is often not necessary.

It is almost as easy for the Apple to control external electrical devices as it is for it to receive data. By arranging for it to do both, the computer can be used to run a sophisticated control system.

The Game I/O socket includes four outputs, known as annunciators, which can be turned on or off by software. They are labelled AN(0) - (3). The voltage level at these outputs is normally close to zero, but when they are turned on the voltage is set to +5V. Suitably buffered for the safety of your computer, this change can be used to turn on or off an electrical device.

The command to turn on annunciator (0) is Poke -16295,0. Pin 15 then remains at +5V until turned off by the command Poke -16296,0. The only complication

arises from the fact that the Apple can only provide a few milliamperes of current, so some degree of amplification is called for.

In figure 1, the annunciator output is taken to the base of an NPN transistor such as a 2N-2222, with a relay placed in the collector circuit of the transistor. When the +5V signal arrives at the transistor base, the transistor allows current to flow through the relay coil, which in turn switches on whatever appliance is connected to the relay contacts. The power to operate the relay coil is best derived from an external source, such as a 9V battery.

In figure 2, complete electrical isolation is achieved by having the annunciator output turn on an LED which shines on an LDR in the control circuit of a similar transistor. The LED will not draw more current than the Apple can safely provide. The optical coupling to the LDR prevents any expensive surprises which might result from accidental connections between the computer and the apparatus being controlled.

The program in listing 3 could be used to switch on a fan and give a warning beep if

the temperature rises too high. The value 200 in line 110 should be adjusted to suit the characteristics of your thermistor and the switch-on temperature required.

The Game I/O connector is shown in figure 3. In most cases, only four or five wires will be needed. Since the connector is small, it is best to keep down the number of wires and use very thin, stranded wire. The connection is made using a 16-pin Dip header obtainable from Tandy, for example. Carefully solder the wire in place, using a soldering iron with a very small bit. If you are a novice with the soldering iron, be very careful that no solder bridges are formed which might connect one pin with another inside the header plug.

A lead length between 18in. and 24in. should be adequate. You can start by experimenting with just two wires, connected to the +5V on pin 1 and GC(0), pin 6. The other ends of these wires can be terminated with insulated alligator clips, or soldered directly to the thermistor or LDR leads. Take great care that the bare wires do not touch each other, or any part of the Apple, otherwise expensive damage could occur. □

Listing 1.

```

100 REM: PLOT THE GRAPH AXES
110 HOME
120 FOR I = 1 TO 20
130 IF I = 10 THEN PRINT "TEMP": GOTO 150
140 PRINT " I"
150 NEXT I
160 PRINT " ";
170 FOR I = 2 TO 15
180 PRINT "-";
190 NEXT I
200 PRINT "TIME (MINS)";
210 FOR I = 26 TO 39
220 PRINT "-";
230 NEXT I

400 REM: RECORD DATA & DISPLAY
410 FOR TIME = 1 TO 30
420 X = PDL (0)
430 TEMP = X*(40/255)

440 REM: CONVERSION FACTOR DEPENDS ON THERMISTOR
450 VTAB TEMP: HTAB TIME: PRINT "+"
460 FOR DELAY = 1 TO 46800: NEXT DELAY

470 REM: 1 MINUTE DELAY
480 NEXT TIME
490 VTAB 23
    
```

Listing 2.

```

100 INPUT "LENGTH OF OBJECT (CMS) ";L
110 REM: CONVERT TO METRES
120 L=L/100
130 X=0
140 REM: P = BASE LEVEL OF LIGHT
150 P= PDL (0)
160 REM: MONITOR LDR FOR INCREASED RESISTANCE
170 R=PDL(0)
180 IF R < 1.1*P GOTO 170
190 X=X+1
200 R=PDL(0)
210 IF R > 1.1*P GOTO 190
220 REM: CONVERT TO SECONDS
230 X=X/67
240 PRINT X" SECS"
250 REM: CALCULATE SPEED & ROUND OFF
260 S=INT(100*L/X+0.5)/100
270 PRINT "SPEED = "S" M/SEC"
280 END
    
```

Listing 3.

```

100 X = PDL (0)
110 IF X < 200 GOTO 100
120 POKE -16295,0
130 FOR BEEP = 1 TO 50
140 S = PEEK(-16336)
150 NEXT BEEP
    
```

NOT SURPRISINGLY, there are well established techniques for sorting, searching and manipulating tables. Since this column is dedicated to helping you get the best out of your programming I will be discussing some of these techniques, as well as other programming topics, in this and future issues.

One of the problems that good table handling can solve is direct access to disc files by means of a symbolic key. Suppose you want to access the membership file of your local tennis club. If each member can be identified by means of a simple, consecutive serial number there is no problem. The Get command in Microsoft Basic, allows you to read data from disc by means of a record number, and most other programming languages allow you to do the same. So to get member number 5 you simply read record number 5.

But it would be much more convenient if

Table manners

Call it an array, matrix, vector or what you will, the humble table is one of the programmer's best friends. Mike Lewis explains how to use it properly.

you could reach your members' records with an alphanumeric key such as their initials or their names, rather than by an impersonal, easy-to-forget number. Some

languages include the means to access files in this way: the Find command in dBase and the symbolic key option in Cobol are examples. But most micro languages do not, which is where the table comes in.

The first step is to build a table holding the keys in the same sequence as the records in the file. Your program must look at every record in turn, extract the key — which obviously must have been stored in the file in the first place — and add it to the table. The sequence of the records within the file is immaterial, and the keys do not all have to be the same length. Then, when you want to access a specified member's record, you search the table for the key. The position of the key within the table specifies the member's record number.

How to sort the table

Exchange sort. Far and away the easiest sort to code, and also the least efficient. You compare each pair of adjacent table entries, swapping them if they are out of sequence. Keep repeating until you have done an entire pass of the table without any swaps.

Binary insertion. For each entry in turn except the first, look to see where it fits in the sequence of the entries before it. Move all the entries below this insertion point down one place, then place the current entry in the gap thus created. The method is similar to the one you would use to sort a hand of cards. It can be very fast, especially if a binary search is used to find the insertion point.

Counting sort. Here the aim is not to put the entries in sequence, but to determine the ranking of entries within the table. You end up with a second array, which follows the same sequence as the main table and which contains an integer to indicate the rank — 1 = first, 2 = second, etc. — of the corresponding entry. Compare each entry in the main table with each of the subsequent entries. For each comparison, increment the count in the second table that corresponds to the lower of the two entries being compared.

Heap sort. Put each adjacent pair of entries in sequence. Then merge each pair with the next pair, creating a run of four. Merge these four with the next four to create a run of eight; and so on. This is the most practical method for very large sorts where the intermediate groupings must be held on disc files.

Shell sort. Similar to the exchange sort, except that you start by comparing far-apart elements. It is reasonably fast.

Merge sort. This is another method that comes into its own for large sorts. Start by loading a small section of the file into a table, and sort it using any of the previous methods. Write the sorted table to a work file on disc. Then sort the next section of the original file, but this time merge it with the work file. Repeat, merging each sorted section with an ever-increasing work file. After the final pass, the work file will have become a sorted version of the original file.

Crude search

The program in listing 1 shows a crude way of doing a linear search. It is the simplest possible table search and it requires no further explanation. You look at each table entry in turn until either you find the one you want or, if the key is not in the table, you drop off the end.

I have used Basic for this and other examples because it is still the most widely known language. It is the technique that I

This column is dedicated to helping you get the best out of your programming. Even if you are one of those sensible micro users who normally tries to avoid programming at all costs, please stay with us as every month Mike Lewis will be passing on tips for using popular packages like WordStar, dBase II, Supercalc and the like.

Listing 1.

```
2000 REM --      SIZE% is the number of items in the list; ARRAY$(SIZE%) is the
                list; ITEM$ contains the item which we are searching for.
2010 FOR J%=1 TO SIZE%
2020     IF ITEM$=ARRAY$(J%) THEN GOTO 2100
2030 NEXT J%
2040 REM --      Come here if required item not found
                ...      ...      ...
                ...      ...      ...
2100 REM --      Come here if found; J% is the required record number
```

wish to illustrate; the logic can be coded just as easily in other languages, such as Pascal and C.

The simple linear search is extremely easy to program, but it suffers from being very slow. On average, a successful search must test half the entries in the table, while an unsuccessful one must test them all. Most of the methods of improving the search depend on the table being pre-sorted so that the keys are in ascending sequence, but it is only worth doing if you are likely to be performing many searches in the same session. In fact there are dozens of ways of sorting a table. Andrew Featherstone described several of them in a series of articles "Know Your Sort" published in the March and April 1983 issues of *Practical Computing*, and they are summarised in the box on the opposite page.

The trouble with sorting the table is that you can no longer rely on the position of the key within the table to indicate the record number. To get round this, you must keep a separate list of record numbers which you sort in parallel with the main table.

Time halved

Once your table is in sequence you can improve the performance of the search by branching out as soon as a table entry is greater than the specified key. This will not speed up a successful search but it will, on average, halve the time needed to discover if a key is absent.

If you are going to the trouble of sorting the table, you might as well go further and do a binary search. This is the classic way of searching a table, and while it is a little

trickier to code it will greatly improve the speed of the search.

In the binary search program shown in listing 2 you start by testing the searched-for item against the middle entry in the table. If your key is below this value, you confine the next stage to the lower half of the table; if it is above, you confine it to the upper half. You then test the middle entry in the chosen half, thus confining the next stage to one-quarter of the table.

Homing in

You repeat the same process, halving the search area each time. As you can see, you very rapidly home in on the required item. Whatever the size of the table, the number of comparisons is kept to a minimum, giving a very fast search.

Another approach to table searching is the percolated search, which does not require the table to be sorted. Instead it takes advantage of the fact that some entries are accessed more frequently than others. The percolated search is just like the simple linear search, except that each time that you find a hit, you swap the entry with the one immediately before it. So the more frequently used elements will gradually percolate through to the start of the table, making each subsequent search a little faster.

This technique really comes into its own if you can arrange to write the table back to disc at the end of each session, thus accumulating the benefit. An idea similar to percolation forms the basis of the least used/first discarded algorithm, which has many uses in programming and will be dealt with in a later article in this series. □

Listing 2.

```

2000 REM --      SIZE%, ARRAY$ and ITEM$ as in
                  previous examples; a separate
                  list RECNO% (SIZE%) contains
                  the record numbers, and is in
                  the same sequence as ARRAY$.

2010 LOW%=0: HIGH%=SIZE%
2020 WHILE LOW%<=HIGH%
2030     J%=(LOW%+HIGH%)/2
2040     IF ITEM$<ARRAY$(J%) THEN
                HIGH%=J%-1
        ELSE
                IF ITEM$>ARRAY$(J%) THEN
                LOW%=J%+1
        ELSE
                GOTO 2100

2050 WEND
2060 REM ---      Come here if required item not found
                ...      ...      ...
                ...      ...      ...

2100 REM ---      Come here if found; the record number is in RECNO%(J%)
    
```

When things crash

I PICKED UP a useful trick from a group of enthusiasts who revel in the name CPMUGUK, which stands for CP/M Users Group United Kingdom. The idea is to have a quick way of getting back into a CP/M program when it crashes — that is, when a BDOS error or similar tragedy causes a return to CP/M command level.

Before you can use this dodge your disc directory must contain a COM file of length zero. This is easily achieved by typing, at command level:

```
SAVE 0 RESTART.COM
```

Of course, Restart is just an example. Any valid name will do.

Next time your program crashes, just type Restart. The effect is to pass control back to the program that was running when the crash took place, without disturbing the transient program area, TPA.

With a bit of luck, everything in the TPA will be just as it was before. For example, in MBasic your source file and variables will be preserved. I cannot guarantee that this will work every time, but think how much aggravation it could save you when it does.

WordStar wisdom

I HAVE BEEN USING Micropro's WordStar word-processing package regularly for the last four years. Yet I am still discovering new tricks and techniques.

Take, for example, the dummy Find and Replace, which is useful if you wish to type a particular word or phrase many times in the same text. You might perhaps be writing a thesis on logical positivism. It would be nice to have a quick way to type these two words over and over.

You do it as follows. Enter Control-QA. WordStar asks

```
"FIND?"
```

Press Return, and WordStar asks

```
"REPLACE WITH?"
```

Type "logical positivism", or whatever, and WordStar asks

```
"OPTIONS?"
```

then press Return.

From now on, every time you want to type "logical positivism", just enter Control-LY. WordStar interprets the Control-L as a dummy Find, and it duly finds whatever is at present under the cursor. It then asks if you want to replace it, and interprets the Y as "yes", so the required word or phrase appears at the current cursor position.

and date of birth. If this failed to produce the required match, the second stage could be to search on Soundex, sex, and year of birth. The particular search method employed depends on the application and the importance being attached

Figure 1.

```

WATT
WITHE
WAITE
WHITE
WYATT
    } all code to WTAA

GURNEY
GRIM
GOREN
GREEN
    } all code to GRMA
    
```

to finding exact and close matches.

Various data structures could be used to create the index. The simplest would be a serial array or file. Additions would always follow the last-used record in the array, the array having been declared large enough for anticipated expansions. Deletions require the index to be searched for the entry to be deleted, and this set to a special value such as Deleted or "", the null string. If there are a lot of deletions there will need to be a procedure to recover the deleted records. Searching the index for all matches requires every record to be examined.

A more useful structure is the linked list. It is used in the program and is a structure widely employed within more comprehensive data structures and data-

base-management systems. A pointer is added to each record, indicating the location of the next record in sequence; the pointer corresponds to the value of the subscript of the appropriate record. Because Basic does not allow you to mix string and numeric variable types the pointers are held in a separate array, PT%, which is maintained in parallel with the main data array, TP\$.

Initially all the elements of the array are assigned to a free list. The pointer to the first element in this list is held in FF and each element of PT% is set to point to the next, so:

PT%(1)=2

PT%(2)=3

the last element in PT% is set to zero, indicating the end of the list. Another pointer, FU, gives the subscript of the first used record. The structure is shown diagrammatically in figure 2.

Any new record is assigned to the location given by FF, the first record in the unused record list; it is subscript 7 in the example. The free-list pointer is then reset to the value of the pointer corresponding to this record, 18 in this case.

The new record is linked into the used list so that records are kept in sequence. Therefore the pointer for the record of key GHK is set to the subscript of the new record 7 and the pointer of this record set to point to the record 4, formerly pointed to by GHK.

Deletion of records is simpler. The free-

```

1605 INPUT#1,N$:NN=VAL(N$):PRINT
1610 IFNN<200ORNN>250THENPRINT"20-250 IS THE LIMIT. RE-ENTER ":GOTO1605
1620 DIMTP$(NN),PT%(NN)
1630 FU=0:FF=1
1640 FORI=1TONN-1:PT%(I)=I+1:NEXT
1650 PT%(NN)=0:RETURN
1800 IFUD<>1THEN1850
1810 PRINT"DO YOU HAVE CHANGED THE FILE. DO YOU"
1820 PRINT"WISH TO SAVE IT?"
1830 GETA$:IFA$="N"THEN1850
1840 IFA$<>"Y"THEN1830
1845 GOSUB1400
1850 CLOSE1:RETURN
2000 SD$=LEFT$(NM$,1):L$="":N=0
2010 FORI=2TOLEN(NM$):A$=MID$(NM$,I,1)
2020 IFA$="B"ORA$="F"ORA$="P"ORA$="V"THENC$="P":GOTO2090
2030 IFA$="C"ORA$="G"ORA$="J"ORA$="K"THENC$="S":GOTO2090
2035 IFA$="T"ORA$="D"THENC$="T":GOTO2090
2040 IFA$="Q"ORA$="S"ORA$="X"ORA$="Z"THENC$="S":GOTO2090
2050 IFA$="M"ORA$="N"THENC$="M":GOTO2090
2060 IFA$="L"ORA$="R"THENC$="A":GOTO2090
2070 IFA$=" "THENI=99:GOTO2110
2080 L$=A$:GOTO2110
2090 IFC$=L$THEN2110
2100 SD$=SD$+C$:N=N+1:L$=C$
2110 NEXT
2120 IFN=3THEN2150
2130 IFN<3THENS$=SD$+LEFT$("AAA",3-N):GOTO2150
2140 SD$=LEFT$(SD$,4)
2150 S$=SD$+S$
2160 RETURN
2200 ER=0:IFFF=0THENER=1:RETURN
2210 NP=FU:IP=0:CP=0:TP$(FF)=RC$
2220 IFNP=0THEN2280
2230 GOSUB2400:A$=LEFT$(TP$(CP),5)
2240 IFSD$>A$THEN2220
2250 IFIP=0THENFU=FF:GOTO2270
2260 PT%(IP)=FF
2270 N=PT%(FF):PT%(FF)=CP:FF=N:GOTO2350
2280 IFCP=0THENFU=FF:GOTO2300
2290 PT%(CP)=FF
2300 N=PT%(FF):PT%(FF)=NP:FF=N:GOTO2350
2350 RETURN
2400 IP=CP:CP=NP:NP=PT%(CP):RETURN
2600 RC$=TP$(CP):L=LEN(RC$):J=0:K=0
2610 FORI=6TOL
2620 IFMID$(RC$,I,1)<>"@ "THEN2650
2630 IFJ=0THENJ=I:GOTO2650
2640 K=I
2650 NEXT
2660 NM$=MID$(RC$,6,J-6):AD$=MID$(RC$,J+1,K-J-1)
2670 TL$=RIGHT$(RC$,L-K)
2680 PRINT" ";NM$:TAB(20);TL$:PRINTAD$
2690 ND=ND+1:RETURN
2800 GOSUB3000:IFER<>0THENRETURN
2810 GOSUB2400
2820 IFSD$=LEFT$(TP$(CP),5)THEN2850
2830 IFNP<>0ANDSD$=LEFT$(TP$(CP),5)THEN2810
2840 PRINT"NO MORE MATCHES":RETURN
2850 PRINT"DELETE THIS RECORD? (Y OR N)":GOSUB2600
2860 GETA$:IFA$="N"THEN2830
2870 IFA$<>"Y"THEN2870
2890 IFIP=0THENFU=PT%(CP):GOTO2910
2900 PT%(IP)=PT%(CP)
2910 PT%(CP)=FF:FF=CP:TP$(CP)="":UD=1:RETURN
3000 ER=0:IFNN=0THENPRINT"USE 'N' OR 'L' TO CREATE/LOAD A FILE":ER=1:RETURN
3010 IFFU=0THENPRINT"NO RECORDS ON FILE":ER=1:RETURN
3020 PRINT"ENTER NAME, SURNAME FIRST. DO NOT USE":PRINT"COMMAS":PRINT
3030 INPUT#1,NM$:PRINT
3040 PRINT"ENTER SEX ('M' OR 'F' OR 'O' FOR):PRINT"BUSINESSES ETC) ":
3050 INPUT#1,SX$:PRINT
3060 IFSX$="M"ORSX$="F"ORSX$="O"THEN3080
3070 PRINT" 'M' OR 'F' OR 'O' PLEASE. REPEAT":GOTO3050
3080 GOSUB2000:IP=0:CP=0:NP=FU
3090 PRINT" ":RETURN
    
```

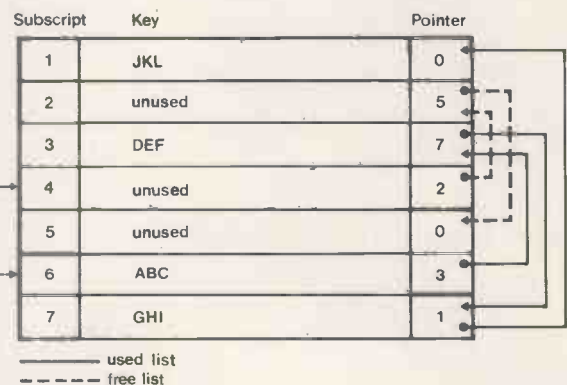

Figure 2.

list pointer FF is set to the subscript of the record being deleted, while the pointer for this record is set to the former value of FF, thus linking the deleted record to the head of the free list. The record that previously pointed to the deleted record is set to point to the record formerly pointed to by the deleted record. Both these procedures require additional coding to deal with addition/deletion to or from the start and end of the list.

Searching is carried out sequentially following the pointers. This ensures that keys are scanned in ascending sequence and the search is complete when the key of the record being compared exceeds the key being sought.

The linked-list structure is quite suitable
(continued on next page)

(continued from previous page)

for records held entirely in RAM but requires the addition of one or more index when extended to use backing store. It may still form the basis of such a system, having the particular virtue of allowing additions and deletions without major file restructuring.

The program to implement these procedures has been constructed in a modular fashion, as modular programming simplifies coding, testing and subsequent enhancements. The art of coding is in solving the problem and designing the solution. The first step is to define the problem; coding should be left as late in the programming cycle as possible. If the program has been well

planned and designed from the outset, coding becomes a largely mechanical process.

The next step is to reduce the solution to a set of modules. At this stage you may prefer to use a structured pseudo-language or a flowchart. The main requirement is that modules should be functionally well defined and small enough for their purpose to be clear. It should also be possible to code each one in a reasonable number of lines. I always assign routines to line numbers advancing by 200 and expect to code the module within the 200 lines with line numbers advancing by 10, allowing space for 20 lines of code.

In Basic, each model except the controlling module should be coded as a

subroutine. Because the purpose of the modules can be clearly stated, and they are not too large, they should present no coding difficulties. Furthermore they can be implemented top-down.

Each subroutine is initially coded as a stub, which may simply be a Return or more usefully a line of code to print the subroutine name and then Return. As each subroutine is coded it replaces its stub, and so the program is gradually built up. Where necessary the stub may set values in variables to simulate its actual function, the routines being added and tested one at a time. As the process continues the common routines will be frequently used and you will become increasingly confident in their correctness. □

Variables.

NN — number of records assigned to Index
 TP\$(NN) — telephone index
 PT%(NN) — record links
 RC\$ — index entry
 NM\$ — name
 SX\$ — sex
 AD\$ — address
 TL\$ — telephone number
 SD\$ — Soundex code
 NP — pointer to next record
 IP — pointer to previous record
 CP — pointer to current record
 FU — pointer to first record of index
 FF — pointer to first unused record
 IP\$ — input action key
 LF\$ — name of file to be loaded
 SF\$ — name of file to be saved
 UD — update flag, set to 1 if file is created/amended
 ER — error flag
 ND — number of records being displayed
 SE\$ — separator character, ""
 CD\$ — cursor-movement string
 A\$, N, I, N\$, L\$, C\$, J, K, L — general-purpose variables

Routines.

Cursor-movement characters peculiar to the Pet are shown by codes inside square brackets. The codes used are: CD, cursor down, HOM, cursor home; and CLS, clear screen.

Master Routine, lines 200-310. Calls the initialisation and instruction routines. Accepts input of action key and calls the corresponding routine.

Initialisation, lines 400-410. Sets up constants and initialises UD to zero, showing that initially the Index does not require saving. Open 1,0 in line 410 opens the keyboard as an input device. Data can then be accepted from the keyboard by Input #1. The advantage of this is that pressing the Return key on its own does not cause the Ready display, but is ignored. The disadvantage is that a literal prompt may not be used with Input #1 and the Return which completes entry does not produce a new line on the screen. These disadvantages are easily overcome and are a small price to pay for a program that does not leave the user wondering what Ready means.

Instructions, lines 600-665.

Straightforward display.

Load routine, lines 800-890. NN is initially zero; if it is not, an index has already been created/loaded and the user is told of this. The named file is opened and read and the user may extend the file if desired. The additional records are linked into the existing ones by lines 860-870.

Add control routine, lines 1000-1170.

Line 1000 ensures records cannot be added until the file has been loaded or created. Details of record to be added are provided for, with error checking, in lines 1010-1100. Commas cannot be used in the input strings as Basic treats a comma as a separator. Subroutine 2000, called in lines 1110, creates the Soundex code. Line 1120 creates the record by concatenating its separate parts. Subroutine 2200, called in line 1130, adds the new record into the index. Lines 1140-1170 cope with the File Full condition detected by subroutine 2200. The user is asked to save the file and then rerun the program and expand the file when it is loaded.

Search routine, lines 1200-1290. Lines 1200-1210 accept the search key.

Lines 1220-1240 search through the index one record at a time. The subroutine at 2400 returns CP with the pointer to the next sequential record. Line 1250 detects if there have been no matches, and displays an appropriate message showing that the search was unsuccessful and all matches have been found. Line 1270 prints the matching record and checks that the screen is not full. If it is, lines 1280 and 1290 allow the user to examine the matches before displaying the remainder. The Wait 59410,4,4 in line 1290 is specific to the Pet; it waits for the space bar to be pressed. If this instruction is not entered exactly the Pet is liable to hang on the Wait statement in an un-interruptible state. Some safer alternative code is:

```
1290 GET A$: IF A$ <> " " THEN 1290
1300 PRINT "[CLS]": GOTO 1240
```

Save Index, lines 1400-1430. The index is saved to a named cassette-tape

file. The comma separator between variables must be forced on to the tape by including it specifically in the Print #2 statements.

New Index, lines 1600-1650. Details of the new file are requested, and the corresponding arrays are set up. Lines 1640-1650 link all the elements of the array into the unused list.

End routine, lines 1800-1850. The keyboard file is closed. If the Index has been changed the user is given an opportunity to save it.

Soundex, lines 2000-2160. This follows the description given in the text.

Add New Entry, lines 2200-2350. If FF = 0, line 2200, there are no unused records and the new record therefore cannot be added. Line 2210 places the record in TP\$(FF) and sets up a loop to scan for the correct place at which to add the record; lines 2220-2240 form the body of the scan. The scan is left either when the correct point has been found or all the used records have been examined and NP = 0. Line 2250 caters for addition at the start of the index. Lines 2260-2270 add the new record into the index. Line 2280 caters for an addition to an empty index. Lines 2290-2300 cater for an addition at the end of the index.

Next Record, line 2400. Resets IP, CP and NP.

Record Display, lines 2600-2690. The main part of the routine, lines 2610-2670, separates RC\$ into name, address and telephone number. The actual display is at line 2680. Line 2690 increments a counter of the records displayed.

Delete, line 2800-2910. The key of the record to be deleted is entered in line 2800, and the index scanned to find it in lines 2810-2840. Lines 2850-2880 give the user an opportunity to abandon the delete. Lines 2890-2910 delete the record as described in the text.

Key Entry, 3000-3090. The name and sex are accepted as input by lines 3020-3070, and the Soundex code is created by line 3080.

DIRECT DISK SUPPLIES

OUR NAME SPEAKS FOR ITSELF

FREE OFFERS!

*SEE 10 LIBRARY BOX WITH EVERY 10 DISKS

*VIDEO TAPE (E180 VHS/BETAMAX) WITH EVERY 30 DISKS

4 Star Service

What Direct Disk Supplies means:

- ★ Value for money
- ★ Top quality disks
- ★ DIAL-A-DISK telephone ordering
- ★ Immediate despatch

NO-NONSENSE WARRANTY

Full exchange or refund if not satisfied. Your satisfaction is our best-advertisement. Our parent company has been selling mail-order for 7 years.

DDS PRICE MATRIX

Easy pricing. Use the DDS Price Matrix for the right price first time. Or DIAL-A-DISK, for firm quoted prices.

	BASF				Verbatim® Datalife 5 year warranty				maxell®				FUJI			
	CODE	1-3	4-9	10+	CODE	1-3	4-9	10+	CODE	1-3	4-9	10+	CODE	1-3	4-9	10+
5.25" single sided disks																
s/density 48tpi soft sect	1SSD	16.99	15.99	14.99												
d/density 48tpi soft sect	1SSD	19.99	18.99	17.99	525.01	21.99	20.99	19.99	MD1-D	23.99	22.99	21.99	MD1D	24.99	23.99	22.99
d/density 48tpi 10 sect	1SSD/10	19.99	18.99	17.99	525.10	21.99	20.99	19.99	MH1-10	23.99	22.99	21.99				
d/density 48tpi 16 sect	1SSD/16	19.99	18.99	17.99	525.16	21.99	20.99	19.99	MH1-16	23.99	22.99	21.99				
q/density 96tpi soft sect	1/96	26.99	25.99	24.99	577.01	27.99	26.99	25.99	MD1-DD	31.99	30.99	29.99				
q/density 96tpi 10 sect	1/96/10	26.99	25.99	24.99	577.10	27.99	26.99	25.99	Maxell quality, consistently high. Keenest prices.				FUJI disks are high-grade Japanese quality at a price you can justify. You know the film, try the disk. It's phenomenal FUJI.			
q/density 96tpi 16 sect	1/96/16	26.99	25.99	24.99	577.16	27.99	26.99	25.99								
5.25" double sided disks																
s/density 48tpi soft sect	2SSD	26.99	25.99	24.99	550.01	28.99	27.99	26.99	MD2-D	31.99	30.99	29.99	MD2D	32.99	31.99	30.99
d/density 48tpi soft sect	2SSD/10	26.99	25.99	24.99	550.10	28.99	27.99	26.99	MH2-10	31.99	30.99	29.99				
d/density 48tpi 16 sect	2SSD/16	26.99	25.99	24.99	550.16	28.99	27.99	26.99	MH2-16	31.99	30.99	29.99				
q/density 96tpi soft sect	2/96	34.99	33.99	32.99	557.01	35.99	34.99	33.99	MD2-DD	41.99	40.99	39.99	MD2D-96	43.99	42.99	41.99
q/density 96tpi 10 sect	2/96/10	34.99	33.99	32.99	557.10	35.99	34.99	33.99	You'll never regret buying Maxell. It even looks right.							
q/density 96tpi 16 sect	2/96/16	34.99	33.99	32.99	557.16	35.99	34.99	33.99								
p&p per 10 disks		.95	.65	foc		.95	.65	foc						.95	.65	foc
See 10 library boxes		1.95	1.95	1.75	Prices per box of 10 disks exc. VAT.											
p&p per box		.50	.50	foc	Next-day delivery service per ORDER:- All orders under 100 disks £7.50. Orders of 100 disks, or mixed orders of similar value are shipped FREE OF CHARGE. Same day delivery:- By despatch rider, cab, TNT, or Red-Star. Subject to quotation.											
ABA Lockable disk boxes																
Smoked perspex lockable lid																
model M35 - 40 disks		14.99	13.99	POA												
model M85 - 80 disks		17.99	16.99	POA												
p&p per lockable box		1.75	1.25	foc												

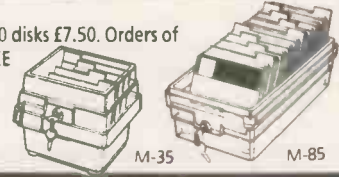

DIAL-A-DISK

Order Hotline.

01-541 1144

Call Richard Mortimore or Felix Benzimra to order your disks. Our answering service will record your order out of hours.

HOW TO ORDER:

1. Complete the coupon below and post with your cheque. Use our FREEPOST address for minimum cost, or send first class for extra speed.
2. Urgent orders:- DIAL-A-DISK, 01-541 1144. Dictate your order with a credit card number and they're as good as received. COLLECT FROM OUR OFFICES - phone and they will be waiting for you. From 10.00 to 17.00 Weekdays. (Other times by arrangement).

3. Crucial Orders Same day service, phone 01-541 1144 to arrange. We guarantee you will receive them. If not we'll refund the carriage.
4. Official orders - Orders from Official bodies are very welcome (eg Govt. Depts. Local Authorities, Universities etc.). Tenders for large purchases will receive immediate attention and low bulk prices. Urgent official orders by telex to 932905 (LARCH G).

APRICOT DISKS - Sony 3.5" micro-disks
Ex-Stock Only £39.95 + VAT

LISA DISKS - DIAL-A-DISK for our prices. Ex-stock

All offers and prices subject to change without notice. Video tape offer ends 30th April 1984.

Direct Disk Supplies Ltd., 29 Dagmar Road, Kingston, Surrey KT2 6BR

BARGAIN BOX

BASF disks at low, low prices. £12.99 + VAT. BASF 1SSD single sided single density disks (BASF equivalent for Dysan 104/1). APPLE, COMMODORE 64, VIC-20, BBC, or any other single density machine. Why pay more for unused double density, they don't last any longer!

£14.99 + VAT BASF 1SSD single sided double density disks (BASF equivalent for Verbatim 525-01, Dysan 104/1D). Special prices are so low that promotion items are excluded. A chance to buy at genuinely low prices, offer ends 30th April 1984, so don't hesitate. DIAL-A-DISK... 01-541 1144.

To: Direct Disk Supplies Ltd., FREEPOST, 29 Dagmar Road, Kingston, Surrey KT2 6BR.

PC2/84

Code	Qty	Description	Price
E180		E180 videotape per 30 disks*	foc

*excluding Bargain Box

Name _____ Net price _____
 Address _____ Carriage _____
 Subtotal _____
 Postcode _____ Tel _____ VAT 15% _____
 Total payable to DDS £ 93

Cheques payable to DDS. Debit my Access/Barclaycard No: _____

Signature: _____

Circle No. 144



Tomorrow's world

DE CRECY watched Madame Zsa-Zsa's ample bosom heaving after their exertions. Only a true patriot could make *l'amour* so passionately; she could not be an English spy.

Suddenly the door burst open and the macho Don Sebastian, Ambassador to King Philip of Spain, strode in holding his weapon.

"French whore," the Spaniard declared. "This is how you keep faith with me."

His rapier rested upon De Crecy's nipple.

"Prepare to die, you cur."

Fearlessly, the brave De Crecy awaited the final thrust.

INSPIRATION EXHAUSTION
ABORT

"Oh shit," said Lord Seymore.

A monocle fell from his eye.

"Ouch," said the gold-rimmed monocle as it hit the floor.

The trappings of his ancient peirage surrounded him in the library of the family's medieval mansion: bookshelves piled high with fusty books; deathwatch beetle tap, tap, tapping overhead; dust collecting on the disc drives, keyboard, and VDU, even on Seymore himself. Dirty sunbeams oozed through dirty window panes, staining the floor with anaemic light.

Seymore had struggled all day dictating another best-seller into his word processor, but the story had gone. His second Nobel prize would have to wait: he could not

afford to buy another one at the moment.

He glanced outside at the police storming the gates.

"Shit," he repeated. He slammed the microphone on to the desk.

"Ouch," said the microphone.

"Oooh," squealed the masochistic desk with pleasure.

Seymore muttered something under his

by Andrew Walker

breath about "goddamn intelligent machines".

"Curtains," he commanded, and the curtains drew across the window just as one of the policemen mounted the fence and was fried in a laser beam.

"Three-D TV," Seymore commanded, swivelling in his chair to face the screen.

The picture was fuzzy. He had had to repair it himself, because the rental company was reluctant to lose any more staff. They were still suing him over the last five repair men, who had been disintegrated by his over-zealous bodyguards.

The President was speaking.

"Furthermore," she said, projecting her voice across the country, "it is my view — and the view of the American people — that this man should not escape punishment lightly, that his advantaged position should not afford him the slightest clemency. Therefore, in accordance with the powers vested in me, I decree that he

should spend no less than 25 years in the state penitentiary for the crime of attempting to pervert the course of justice." She paused to allow her audience to stand and cheer and clap and pick each other's pockets.

It was election year and the man she was sentencing was a senator on her own staff. He was the vote-saving sacrificial goat. He had originally been convicted of underbribing a public official and sentenced to 50 lashes. Being 93 years old he had died of exposure the moment his shirt was ripped from his back.

The public cry of outrage had shaken the foundations of the White House. A presidential aide had gone unpunished: had his money tipped the scales of justice? Had the President bent the law to suit her own ends? Had his lawyers found a new loophole in the penal system? Rumour abounded.

Defeat had previously been inconceivable. She had risen to power with a landslide victory: Mount Rushmore had mysteriously crumbled and her opponent was crushed in the rubble of Washington's left nostril. She was the idol of the American minorities. Her biography showed her to be black, Roman Catholic and of Chinese and Puerto Rican descent, which gave her the backing of 75 percent of the people.

Despite this, her position had been threatened by the moral indignation surrounding the senator's indiscretions.



The senator was also disliked by her biographer, the influential chief programmer for Robo-of-America, who had designed and still maintained her.

Mad Dan the gardener walked rudely between Seymore and the television carrying his blood-stained axe. Tall and gaunt, he spoke to no one but carried out his duties while whistling a tune.

He swiped at a fly as he left the room. The fly dodged.

"Missed me you old . . ." Its curse was cut short as it flew into the wall.

It picked itself up, dusted itself off, and followed Dan from the room into the large cobweb-ridden hallway. There it ignored Dan and made for the nearest of the mousetraps that littered the floor. The cheese looked good but a mouse beat him to it and pounced. The trap snapped shut.

"Ouch," cried the mousetrap.

"Aaaagh," screamed the mouse, which otherwise kept its trap shut.

The cook rushed from the kitchen, her heart set on the fresh ex-rodent.

"Mouseburger and chips for His Lordship's lunch," she chortled, licking her lips enviously.

The fly, grateful to her for opening the door, flew into the kitchen. A slab of steaming red meat lay on the window sill, playground for a gang of bluebottles and a million bacteria.

"Lord Seymore — enemy of the people!" An instinct that had been burned into his memory flashed before him. His mission: to assassinate Lord Seymore by contaminating his food.

The American Nationalist Army of liberation had plotted the mass murder of all imperialist oppressors for 10 years. They had designed the super bluebottle at a cost of several billions, and each one was individually programmed for a specific target.

The creature's eyes lit up when he glanced into the corner where the potatoes lay in a pile. A soft, warm pile of doggy-droppings. As he made the approach run

his senses were raised to new heights. The excrement's aroma grew, his lust became insatiable, a tidal wave of desire washed over him.

INTERRUPT

"COME-INTO-MY-PARLOUR" WARNING

With a swipe of contempt he brushed aside his logic chips and landed.

He could not move. With all his might he tried to lift his feet but not one of them would budge. Panic seized him, a subconscious awareness of danger. He looked around to cry for help . . . his friends on the sill. He called out. They did not hear.

A fast-rising horizon blotted them from view. This mass that once promised heaven now threatened hell. It swelled before him, putrefying as it did so.

And then it was a mountain, towering above him, engulfing him, burying him in an insecticidal tomb.

"My god, these fiendish humans," was his final thought.

And now a word from our sponsors," the TV blasted.

Ted Teeth, smiling adman, was earning another million plugging the latest micro-products.

"Yes folks, take it from me — it really fools all known insects. Remember the name: Crap-a-Fly, the world's first fly-catching dog turd. Made by Turdomatic Inc., a subsidiary of tonight's sponsors, Robo-of-America."

So now what? Should he return to De Crecy's predicament? He shook his head: not in the mood. What about the children's story he was dabbling with? What was it called? He searched his memory, drumming his fingers on the desk top, sending its insatiable sensors into electro-orgasm.

"Susan the Dragon and the Robot Gang-bang," he recalled aloud. It had a certain ring to it.

Queen Henry was executing orphans for not writing games programs on their micro-computers. Prince Peregrine was playing Dungeons and Dragons with the real thing,

while King Twit III was molesting sheep on the croquet lawn.

It was rubbish, Seymore knew, but that was what the kids wanted. He just could not conjure up any enthusiasm for it though. Perhaps tomorrow.

"I'm not waiting all day," thought the microphone, and switched itself off.

He considered setting the machine on auto. His agent had insisted that he had his brain profile saved on disc.

Brain profiles were all the rage. Every cell was copied — the sum total of his thoughts for the rest of his life. The computer could use the disc to generate new ideas, working in parallel on up to four novels, writing in hours what would have taken Seymore a lifetime.

Many rejected the whole thing as inhuman, claiming that literature was the last bastion of natural creativity and that it should be defended against the invading automaton hordes. Most writers set them to work and retired to live off the 10 best-sellers a year that they produced. Unscrupulous publishers killed their authors, taking the profit from the obedient, prolific emulators.

"It'll guarantee this year's Nobel," Seymore pointed out. But he shook his head. It was too impersonal. He preferred the human touch.

"Curtains."

Daylight flooded the room, and before Seymore's admiring eyes lay the scenery of Death Valley. It was all there: the Tower of London, Buckingham Palace, Ben Nevis, Blackpool's Golden Mile: most of Britain had been shipped to the States, leaving only Scunthorpe and bits of Manchester behind.

Mad Dan walked across the garden cutting the grass, short and black as it was. All the time he looked to the sky. The flowers were in midsummer bloom with charred petals on withered stems. The goldfish were sunbathing, or so Seymore thought. Actually they had died from radiation poisoning, which caused them to glow in the dark, a phenomenon that had always puzzled him.

(continued on next page)

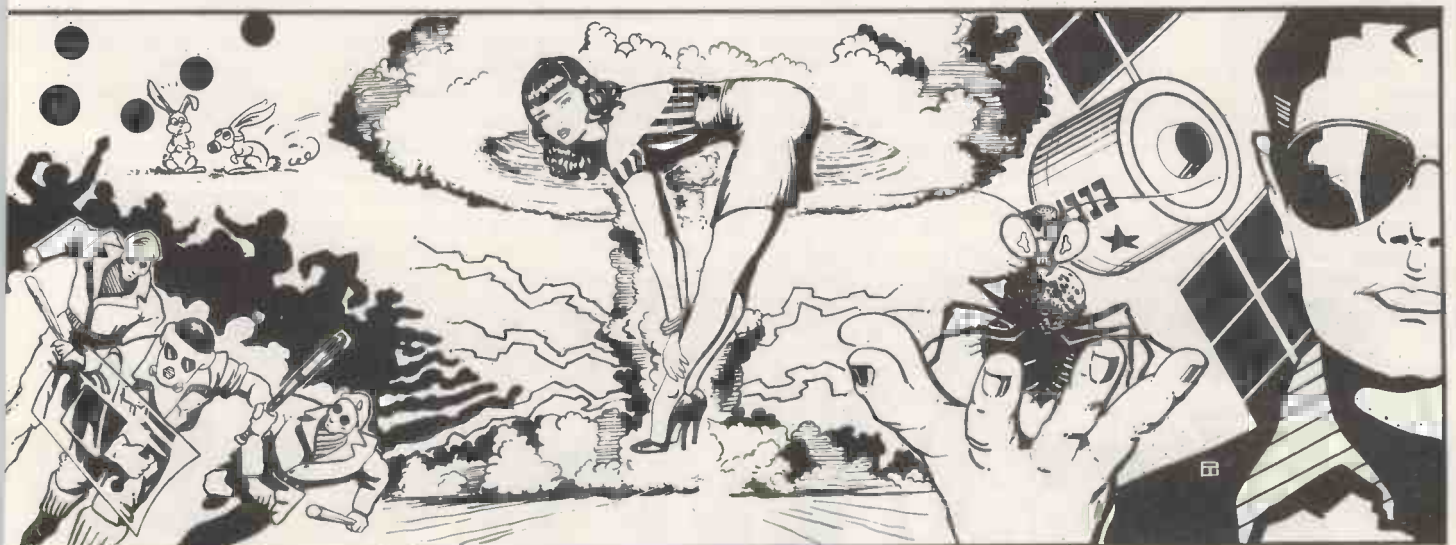

Tomorrow's world

(continued from previous page)

Albert was watching the fish: he had nothing better to do. Being Lord Seymore's favourite gnome was no fun; being his only gnome made it unbearable. The others had run off because of the conditions and poor wages. They had gone to work on the Paris Underground, getting jobs as Metro-gnomes.

Albert rolled his trousers down and began defecating on the flowers. A duck-billed-chicken-rabbit hopped across the garden, its fluffy feathers ruffled by the hot nuclear breeze. It was one of the few Nubreds still permitted to roam wild.

Amateur Genetic Engineering had taken off in a big way until the world's governments had banned the disastrous experiments of the less ethically minded participants. The last straw was the nesting of the elephant-sparrows, and the terror of the red-admiral-piranha still lived in the memories of the survivors.

Seymore himself had built up a large safari park of these quirks of science. His rhinocerhorse, resembling the unicorn of legend, had been a great crowd-puller, while around thanksgiving the delicious octopus-turkey sold well to large families who all wanted a leg.

"Quack," said the lion-giraffe-duck. Despite government orders, Seymore refused to destroy all his creatures. It bit Albert's head off.

"Ouch," cried Albert's head, the cry echoing down the long throat as he slid slowly along. His body squatted above the flowers, nonplussed, wondering where his head had gone.

A laser flash caught Seymore's eye. The security team was defending his freedom again. Police Commissioner Macdonald had been converted to a heap of cinders as he dropped over the fence, shot-gun in hand.

Seymore tut-tutted. All that money in bribes and this was how the likes of Macdonald repaid him.

"Damned unemployed scroungers," he cursed.

Ever since he had been replaced by Commissioner Macrobot, Macdonald and his men had lain siege to the Seymore estate.

Seymore had never understood people's rejection of phased leisure progression. Why work when the government was

willing to let you retire and have a machine to do your job? He shook his head in wonder.

The police no longer had to face day-to-day dangers: no more homicidal maniacs, no more shootouts with liquor-store robbers. Anyway, most of the big-time crooks had robots of their own built to do the jobs for them.

Who else was out there? Seymore panned the camera. It was hard to recognise anyone, charred and bloodied as they were from the pounding they were taking from the Cybercops.

The media were there in force with their autofocus, remote-control cameras, relaying live television pictures and their image-translators that turned the pictures into the written word for the newspapers. Vultures gorged on the carrion of the day's crises. The auto-reporters paid particular attention to the old journalists, who with the ex-cops and others were trying to tear down the fences.

Le Blanc was there, the physicist famous for perfecting hand-held laser weapons. Wilson and Tate, the science-fiction writers, had reached the inner perimeter but had fallen into the clutches of the voracious doberman-cockroaches and were quickly being devoured by the seven-foot-wide genetic abominations. The members of the Computer Programmers Union had long since perished in the same way.

The defences were gradually being overwhelmed as more of the rioters climbed over the wires, pushing the Cybercops back step by step, drowning them in numbers.

The drone of engines caught everyone's attention. The fighting stopped, all eyes cast to the sky. Mad Dan burst into aimless, rabid action.

The aeroplane came out of the sun, unmarked and mysterious. As it passed overhead, a single parachute began to descend. A deathly silence fell over the Valley. Rioter and Cybercop stood side by side. The chilling thought ran through all minds: "Was it the enemy's super-bacteria? Was this the end of the world?"

Lives flashed before eyes. Who would remember them when tomorrow had come? The insignificance of their existence hit them like a slap in the face. How could they start again, afresh? Images of what could have been, what still could be, reflected in the tear-stained mirrors of their eyes, shining through the dim myopia of reality. But it was too late.

The package cradled beneath the parachute landed with a thud. Mad Dan ran forward through the concentrated gaze

of the onlookers, ripping it open to reveal the coffin-like box within. He prised the lid up and stopped, wide-eyed.

She was beautiful: an Amazon. He pulled her from the container and stood her up to admire her full glory. "I'm gonna turn you on, baby," he promised fearfully. His hand strayed nervously to her left breast, and with a hasty jab of his finger he flicked the bright red switch on the nipple.

She simmered into life, stretching finely, displaying every elegant sensuous curve. "Hello Big Boy," she oozed, letting rip with a slow, deliberate wink. "Robo-of-America made me yesterday. You can make me today." She was barely able to keep her feet as Dan dragged her home.

A wave of relief washed over the rioters. It had not been the super-bacteria after all. When tomorrow came they would still be there. They could build a new tomorrow.

Le Blanc started it. He lashed out at the nearest robot with a length of broken gatepost. The victim crumbled to the ground and pandemonium broke out all around. As the blood poured from the shattered skull Le Blanc realised that he had made a mistake.

"Ouch," cried the fence as it fell down under the weight of the Artists Against Robots society. Le Blanc's head skimmed across the grass, severed from its shoulders by the slash of a razor-sharp laser, and landed at the feet of a guard-roach.

"Gulp. Yummy," said the Doberman cockroach as it licked its lips.

The Nuke Warning light suddenly flashed red. Lightning instincts crashed Seymore's fist on to the Alert button.

"Ouch," screamed the button.

Sirens wailed, blast-proof shutters clamped down on doors and windows. The Cybercops stopped beating the invaders and retreated to the safety of the fallout shelters. The guard-roaches withdrew into the woodwork. The rioters simply stopped, puzzled, looking for something to fight.

Seymore was livid: this was an unscheduled attack and a blatant infringement of the right to riot.

Silence fell on the rioters, then death.

Through heavily filtered screens Seymore watched the flash of the bomb. Then the crowd outside melted away.

"Unemployment Down," cried the headlines.

Albert ran blindly for his own shelter, but without a head he bumped into trees, ricocheting like a pinball until at last he fell into the pond. Seymore sadly watched his last gnome turning to jelly in the intense heat.





REGISTERED REFERRAL CENTRE
FOR THE BBC PROJECT
**BEEBUG FOR THE
BBC MICRO**
INDEPENDENT NATIONAL USER
GROUP FOR THE BBC MICRO

MEMBERSHIP NOW EXCEEDS 20,000

18,000 MEMBERS CAN'T BE WRONG — BEEBUG PROVIDES THE BEST SUPPORT FOR THE BBC MICRO. BEEBUG MAGAZINE — NOW 62 PAGES INCLUDING NEW PRODUCT GUIDE SUPPLEMENT — DEVOTED EXCLUSIVELY TO THE BBC MICRO.
Programs — Hints & Tips — Major Articles — News — Reviews — Commentary. PLUS members discount scheme with National Retailers. PLUS members Software Library — a growing range of software from around £3.50 per cassette. 10 Magazines a year. First issue April 1982. Reprints of all issues available to members.

November issue: Program Features: Reversi, a challenging board game, Lunar Escape, an addictive arcade type game, Snarfer, a very useful disc recovery program, Shaper for defining multiple character shapes, Rapids, another short game, Demolition, a sizzling display with matching sound effects. Plus articles on a Clock Display, the Teletext Mode (part 2 of a series), an Introduction to Interrupt Programming, a new Mode 8 and The Beeb in Slow Motion. Plus Extension ROM Board Reviews, Games Reviews, Book Reviews, M-TEC Torch Basic Review. Plus News, Hints and a new Competition.

December Issue — Program Features: Killer Dice game, Galactic Invasion, a fast moving space invasion game, LINK, a very useful disc utility for program development, ASTAAD, a really excellent program for Computer Aided Design, the Percussion Machine, moving Chequer Board display, Screen Freezer, a routine to freeze your favourite game in mid-play, and a musical rendering of the Twelve Days of Christmas to add a seasonal flavour. Plus articles on the Teletext Mode (part 3) and Fitting an External Speaker. Plus Disc Drive Reviews, Book Reviews, Hints and Tips.

Magazine programs now available on cassette to members at £3.50 inc: VAT & p+p — see April/May issue for details

BEEBUG NEW OPERATING SYSTEM OFFER
BEEBUG members can now obtain the new 1.2 OPERATING SYSTEM ROM at around HALF PRICE

See BEEBUG Magazine February, March or April for details. As a result of BEEBUG negotiations with Acorn the ROM now may also be offered by other user groups to their members.

MEMBERS SOFTWARE LIBRARY +
BEEBUGSOFT: BEEBUG SOFTWARE LIBRARY
offers members a growing range of software from £3.50 per cassette.

1. STARFIRE (32k). 2. MOONLANDER (16k). 3D NOUGHTS AND CROSSES (32k). 3. SHAPE MATCH (16k). MINDGENDER (16k). 4. MAGIC EEL (32k). 5. Cylon Attack (32k). 6. Astro Tracker (32k).

Utilities: 1. Disassembler (16k). Redefine (16k). Mini Text Ed (32k).

Applications: 1. Superior (32k). 2. Masterfile (3k).

13% discount to members on the excellent wordwise word processing package — this represents a saving of over £5.00.

Send £1.00 & SAE for Sample.
Membership: UK £5.40 for six months
£9.90 for one year

Overseas one year only:
Europe £16.00 Middle East £19.00
Americas & Africa £21.00
Other Countries £21.00

Make cheques to BEEBUG and send to:

BEEBUG Dept 5, 374 PO Box 109

Baker Street, High Wycombe,

Bucks HP11 2TD.

St Albans, Herts, AL1 1AR

● Circle No. 149

Diskly[®]

AAA Grade diskettes
Top Quality Media - at the
right price from the number
one supplier.

HAL's huge stocks mean immediate availability of the right diskette whatever your system. Write or phone for your free Diskly compatibility list.

Or, to place your order, dial direct on any one of our six telephone sales lines.

- ★ NO FUSS
- ★ NO WAITING
- ★ TOTAL SERVICE FROM A TEAM THAT UNDERSTANDS DISKETTES AND COMPUTERS.

Sales hot line number

0252 517171

Exclusive U.K. Agent

HAL Computers Ltd.,
Invincible Road,
Farnborough,
Hants.
GU14 7QU

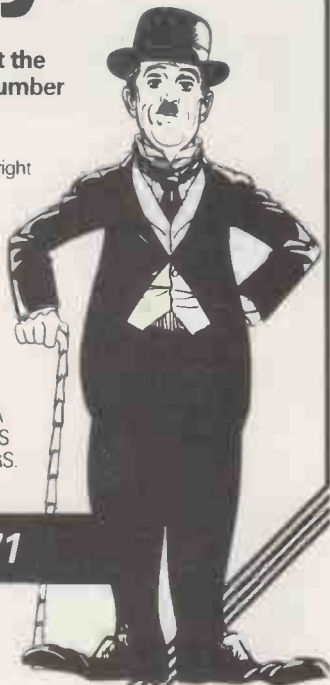

COMPUTERS LIMITED

● Circle No. 148

Flexibility for Spectrum users!

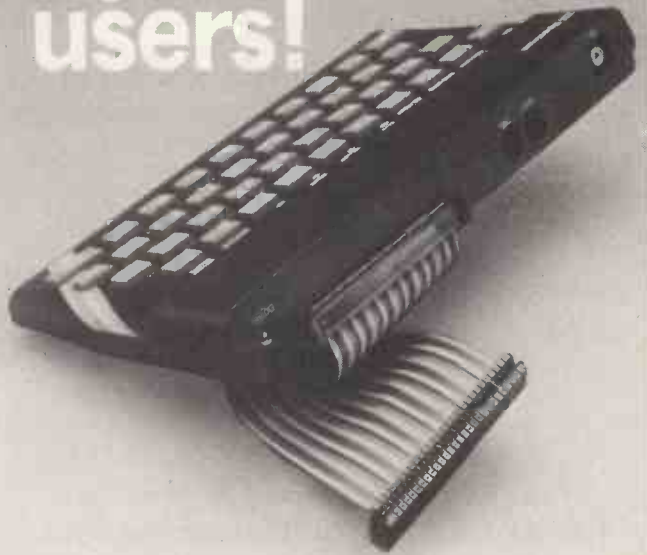

56-way I.D.C. connector and ribbon cable assembly, designed and manufactured by Varelco in conjunction with C.P.S. Ltd., to fit the Sinclair Spectrum computer.

Available in both single and double end format. Also available, paddle board to convert female connector to male plug format.

Please send me the following:

Insert Quantity here

6" grey cable with connector each end	£8.99 each	<input type="text"/>
9" grey cable with connector each end	£9.49 each	<input type="text"/>
9" colour coded cable with one connector	£5.99 each	<input type="text"/>
12" colour coded cable with one connector	£6.49 each	<input type="text"/>
Connector only	£4.95 each	<input type="text"/>
Paddle board for conversion to male plug format	£1.99 each	<input type="text"/>

Prices include VAT and Post & Packing

I enclose cheque/PO value £

Block capitals please

Name

Address

Town

County Post Code



If paying by Access, enter number here

Available from:

Hawnt Electronics Limited
Firwood Road, Garretts Green, Birmingham B33 0TQ

Reg. in England No. 306808

PC2/84

● Circle No. 150

Isn't it time you stopped running your computer at printer speed?

In ten seconds, your computer can output enough print data to keep your printer busy for five minutes, or longer.

Instead of waiting around for the printer, you could install a print buffer, and free your computer for its next task in seconds.

Print buffers take care of the printing — and the waiting. And the more you print, the more time a buffer will save.

Buffers for any combination of micro and printer/plotter. Internal buffers for Epson printers; Apple Computers. 'In-line' buffers for IBM PC, Sirius, Commodore 20/40/80 series, Super Brain, BBC, Tandy, etc.

Data transfer in RS232c serial, Centronics-parallel, IEEE-488 formats. Protocol conversion. RAM sizes from 2K to 256K.

A-Line Computer Systems

1 Church Farm Lane,
Willoughby Waterleys,
Leicestershire LE8 3UD.

Telephone:
Peatling Magna (053 758) 486

**Talk to the specialists.
We have the answers.**

● Circle No. 151

Deal with the experts on Portable Computers



Apricot **NOW IN STOCK!** from **£1495**

256K RAM ● Dual 315K drives both upgradable concurrent CP/M and MS-DOS

Sanyo MBC 1150 **£1695**

64K ● CP/M ● Dual disc drives 320K

Osborne 01 & Exec **£call**

Epson HX20 & QX10... from **£411**

FREE bundled software with every disc based system

On site training, servicing and support.

(0280) 816087
Call for a portable price

Fraser Associates Ltd.

1 Bristle Hill, Buckingham. Bucks
MK18 1EZ (0280) 816087

● Circle No. 152



The First Name In Computer Packaging



Ring us on 01-607 9938 for quotations on computer presentation packs and sleeves printed in one to four colours.

● Circle No. 153

POCKET COMPUTERS do not seem to have caught the popular imagination in the way home micros, office personal computers and even the larger-sized portable computers have done. It seems that there has to be a certain necessary power crammed into the package before you have a computer worth anyone's while. Until recently the bottom limit has been machines like the Epson HX-20 and Tandy Model 100, which have full-sized keyboards and reasonable sized displays. Their main advantage is that you can also run practical software on such machines without having to write it yourself.

But a new wave of technical advance is beginning to transform prospects for the very small computer. The notebook-sized Husky Hunter packs CP/M into its small 2.5lb. bulk, and is capable of running WordStar or Supercalc just as fast as the desk-top Sirius I am using now. VisiCalc, the genuine article from Visicorp, can be run on the lighter weight Hewlett-Packard 75C. Admittedly these two machines are the most expensive in this survey, but now is a convenient time to take a look at what is available over the whole range of pocket computers, from super-calculator to super-compressed office system.

Battery powered

For the survey we are defining the pocket computer category to include all machines which offer a version of the Basic programming language, which are battery-powered with at least one working day's battery life, but which are too small to have a full-sized keyboard. Rather than quibble about the size of the standard pocket computer we will include anything with a keyboard smaller than the standard typewriter — calculators are excluded because they lack Basic.

The machines in this survey find at least two distinct kinds of use. Commercial organisations and even the military are using the two successful Sharp machines and the Hunter for data collection, as well as calculation "in the field". Here a prime requirement is to have some means of storing the data collected — micro-cassettes in the case of the Sharps and battery-backed RAM in the case of the Hunter. The other major use for pocket computers is as super-calculators, which are used predominantly on the desk top, but can be moved around.

Machines like the smaller Casios are adequate in the super-calculator role. But some people are tempted to buy such machines as a cheap introduction to programming, and it must be said that the mains-powered home computers from the ZX-81 upwards offer a preferable buy, with their better display, sound facilities, vast range of entertainment software and heavy support from specialist magazines.

Battery-powered portability is not worth paying for if you do not want it, since at present the low power consumption CMOS

Shrinking the computer

Ian Stobie discusses squeezing the computer into a calculator's shell in an examination of 10 pocket-sized battery-powered machines with Basic.



Suppliers

Canon X-07 Canon (U.K.) Ltd, Waddon House, Stafford Road, Croydon CR9 4DD. Telephone: 01-680 7700.

Casio Casio Electronics Co Ltd, Unit 6, 1,000 North Circular Road, London NW2 7DJ. Telephone: 01-450 9131.

HP-75C Hewlett-Packard Ltd, PC Group, King Street Lane, Winnersh, Wokingham, Berkshire RG11 5AR. Telephone: (0734) 784774.

Husky Hunter Husky Computers Ltd, PO Box 135, Foleshill Road, Coventry CV6 5RW. Telephone: (0203) 668181.

Sharp PC-1251, PC-1500 Sharp Electronics (U.K.) Ltd, Sharp House, Thorp Road, Manchester M10 9BE. Telephone: 061-205 2333.

Texas CC:40 Texas Instruments Ltd, Manton Lane, Bedford MK41 7PA. Telephone: (0234) 67466.

technology used in battery-powered computers is slower and more expensive than conventional NMOS. Major investment has been going into CMOS, and it is now producing results in the form of cheaper and faster circuits.

Portable flat-screen display technology is also improving fast, with larger LCD arrays coming in further up the market on machines like the Gavilan, Tandy Model 100, Olivetti M-10 and NEC PC-8201. Already Hitachi has a flat-screen TV at the experimental stage.

Finally, various technologies are being explored to get rid of conventional cabling. This offers great advantages for portable computing. The Canon X-07 we have in the office is connected to its mains-powered printer by an infra-red link.

Seiko is introducing a product in Japan in early 1984 which takes matters a step further. Using the induction loop principle, Seiko designers have built a pocket computer split into three components, just like a miniature conventional office computer but without the cables. The processor and 2K of user RAM fit in a box measuring 5.5in. by 8in. which goes on the desk, or into a briefcase or pocket; a completely detached mini-keyboard fits into a shirt pocket, while the display can be worn, watch-like, on the wrist.

The Seiko "wrist computer" is programmable in Microsoft Basic and features a tiny printer built into the system box. The Japanese price works out at around £160. At the moment Seiko in the U.K. pleads ignorance about any wider marketing plans, but if the idea proves successful in Japan we can expect other multi-pocket computer systems.

Details of our top 10 pocketables can be found overleaf. All prices are for unexpanded systems: for the Husky Hunter and HP-75C they do not include VAT; prices for Casio and Sharp machines are VAT inclusive.



CANON X-07 around £200

If you have room in your pocket for a hardback novel then you could carry an X-07 around instead. The LCD screen shows four lines of 20 characters, and it is just possible to touch-type on its 10mm-wide button keys. The standard machine has 6.6K of RAM free to an enhanced Microsoft/Canon Basic. Battery-backed memory-expansion modules — the size of credit cards, but thicker — slot in the back. The X-07 is well set up as a system machine via its cassette port, serial port, parallel printer port and expansion port. It can communicate with its own peripherals, including four-colour mains-powered printer/plotter, via an optional infra-red module. Unfortunately, no U.K. version has been produced, but we live in hope.

For. Expandable system. Novel features such as RAM cards and infra-red communications.

Against. Not available. Canon (U.K.) may decide not to import it.



CASIO PB-100 £49.95

A straightforward machine, the PB-100 is aimed at the beginner. It is the size of a largish calculator at 6.5in. by 2.75in., there is a small QWERTY keyboard with separate numeric keypad and a 12-character LCD display. The PB-100 comes with the simple Casio Basic in ROM, and 1K of RAM, expandable to 2K by adding a £14 module. The user manual is particularly good. Up to 10 programs can be held in memory while the machine is switched off. Numeric results are displayed to 10 significant digits but string handling is limited. A cassette interface costs £26; the printer is £60.

For. Low cost. Good manual. Better than a calculator.

Against. Limited memory expansion. No string handling in Basic.



CASIO FX-700P £59.95

This is the same machine as the PB-100 with a similar Basic, but more technically biased. For the extra money you get single-key entry of scientific functions and 2K of RAM, which is not expandable. The FX-700P is good for numerical work — much simpler to program than a calculator — but the Casio Basic is limited. You are only allowed one string variable, limited to 30 characters, and there are no sub-string manipulation functions. You can use string constants in Print and Input statements. The FX-700P will accept the same peripherals as the PB-100, including cassette interface. No commercial software is available, but a book of useful program listings is supplied with the machine.

For. Scientific functions. 2K of RAM.

Against. No further memory expansion. No third-party software.



CASIO PB-300 £99.95

Similar to the PB-100 but with a slightly larger QWERTY keyboard and numeric keypad, a built-in printer and more memory. The 20-column printer uses 38mm. rolls of thermal paper. Basic and display are the same as the PB-100. Standard RAM is 2K, but is not expandable. An optional interface costing £26 lets you save and store programs and data on a standard audio cassette recorder. The PB-802P is a scientific version of the PB-300.

For. Good manual. Built-in printer.

Against. Limited string handling.

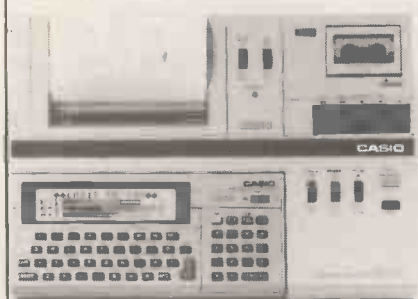





CASIO PB-700 £139

Top of the small-key Casio range, with a larger display, more memory and a wider range of peripherals. The LCD panel shows four lines of 20 characters or 32-by-160 dot graphics. Standard memory is 4K, expandable to 16K internally. The Basic includes plotting commands and string functions like Left\$, Mid\$, Right\$ and Inkey\$. An optional battery-powered slip-on four-colour printer/plotter costing £179 also provides an interface to a domestic audio cassette, or for £70 you can fit the Casio micro-cassette deck to form a single battery-powered unit. Other options include Centronics-type parallel printer port.

For. Better Basic. Larger screen. Good peripherals.

Against. Small keys. Little third-party software. No RS-232 option.

	<p>HEWLETT-PACKARD 75C £763</p> <p>Luxury machine with wide range of battery-powered add-ons; it measures 10in. by 5in. The HP-75C has calculator-style keys with almost typewriter spacing, and a single-line 32-character LCD display. Standard 16K of RAM is expandable to 24K. The 48K of ROM contains a very powerful Basic with 12-digit numeric precision and good diary/alarm and address-list programs. Genuine VisiCalc is available on ROM for £154. The built-in card reader lets you store 1.3K per thin magnetic card. Wide range of mainly technical software available on cards or on ROM chips. The HP-75C comes fitted with an HP-IL socket which connects it to a wide range of HP plotters, printers, measuring instruments, a full-size display and larger HP computers.</p>	<p>For. Excellent Basic. Optional VisiCalc. Versatile HP-IL interface.</p> <p>Against. Expensive. Software and peripherals are expensive too.</p>
	<p>HUSKY HUNTER £997</p> <p>The smallest battery-powered machine to offer CP/M. It measures 8.5in. by 6in. and is housed in a rugged cast-aluminium case with a sealed, waterproof keyboard. The eight-line by 40-character LCD display can also show 64-by-240 dot graphics. Standard RAM is 80K, expandable to 208K, some of it configured as a silicon disc. CP/M 2.2 and Microsoft Basic are supplied in the machine's 48K ROM. The NSC800-4 CMOS CPU runs at 4MHz, so it is no slower than an eight-bit mains-powered micro. RS-232 interface included as standard for linking to printers and other computers. Options include modem and mains-powered disc drive.</p>	<p>For. Fast. Very tough, Vast CP/M software base.</p> <p>Against. Price.</p>
	<p>SHARP PC-125 £79.95</p> <p>Compact enough to fit in a jacket breast pocket this smaller companion to the successful PC-1500 also has good expansion options. It measures 5.25in. by 2.75 in. The standard machine has a 24-character LCD and comes with 4.2K of RAM. A powerful Basic comes in 24K of ROM, offering two-dimensional arrays, scientific functions and a full range of string operations. An optional battery-powered clip-on unit costing £99.95 adds a 24-character thermal printer and a micro-cassette drive. This expanded system has been taken up by commercial users particularly in the financial and engineering fields. A number of third-party programs are available on micro-cassette.</p>	<p>For. Good Basic. Neat printer/cassette option. Commercially available software.</p> <p>Against. Limited maximum memory.</p>
	<p>SHARP PC-1500 £169.95</p> <p>Longer established than the PC-1251 and offering a wider range of peripherals, greater memory expansion and a larger base of independent software. It measures 8in. by 3.5in. and has a 26-character LCD display. The standard 3.5K RAM is expandable to 11.5K; the 16K ROM contains a powerful Basic with full string handling, arrays and scientific functions. A range of scientific, engineering and financial programs are available on plug-in ROMs. The £149.95 printer/plotter unit uses a four-colour ball-point pen carousel mechanism and also provides a cassette interface. Other battery-powered options include a combined RS-232 and parallel interface suitable for connecting larger computers or modems. Tandy sells the same machine for £159 as the Tandy PC-2.</p>	<p>For. Good Basic. Printer/plotter and RS-232 options. Software.</p> <p>Against. Small keys. Micro-cassette would be an asset.</p>
	<p>TEXAS CC-40 around £170</p> <p>Long-delayed machine first announced in February 1983; should be available in 1984 according to Texas Instruments. It runs an eight-bit CMOS CPU with 6K of RAM, expandable to 16K; the 34K of ROM contains a very comprehensive Basic. ROM software cartridges of up to 128K can be slotted in to the right of the 31-character LCD. The CC-40 weighs 1.3lb. and measures 9.5in. by 5.75in. and is designed to have a large family of battery-powered peripherals including a 36-character four-colour printer/plotter, a stringy-floppy drive similar to the Sinclair Microdrive, and a combined RS-232 and parallel printer interface. We were allowed to examine a sample machine last year, so the CC-40 is not a complete myth.</p>	<p>For. Excellent Basic. Range of peripherals.</p> <p>Against. Not yet here, a year after announcement.</p>

Many-legged beasties

Ray Coles reveals what goes on inside those little black rectangular packages sitting on the circuit board of your micro.

THE TALE of the chip began back in 1948 when the first transistor was made in the U.S. Researchers in both the U.K. and abroad soon realised the potential of this new solid-state component as a switch to replace the bulky and unreliable electromagnetic relays and thermionic valves then used in the digital computers of the day. It was this breakthrough more than any other which turned laboratory curiosities into the powerful data-processing machines which have become so indispensable.

Transistors may have made the digital computer a practical proposition, but the machines they were used in were by no means easy to live with. They were so enormously expensive that only large government or industrial concerns could even dream of tapping their problem-solving potential. Before long, however, semiconductor manufacturers packaged several transistors together on a single sliver of silicon. There they formed a complete functional circuit such as a logic gate, the basic building block of the computer.

These integrated circuits revolutionised the design and manufacture of computers. This eventually led to the introduction of minicomputers in the mid 1960s which, for the first time, brought data processing into smaller companies and scientific laboratories. The great benefits of these miniature circuits with such low price tags created a tremendous pressure to squeeze more and more transistors on to a single chip. The so called small-scale integration, SSI, of the logic gate soon led to the medium-scale integration of the counter or register, and beyond.

At this point the semiconductor manufacturers began to turn away from the conventional bipolar transistor. The new breed of field-effect transistors were simpler and smaller, which allowed even more functions to be squeezed on to silicon chips now containing over 1,000 transistors each. Thus large-scale integration, LSI, was born. With several thousand transistors to play with, complete functional systems such as the innards of an electronic calculator could be built with only one integrated circuit. It was not long before Intel realised that a calculator could

be transformed into a general-purpose computer.

The first device which was actually given the name "microprocessor" was the Intel 4004. This four-bit general-purpose digital processor was first designed for a calculator manufacturer which wanted to be able to reprogram its calculator chip to produce variations on the theme. Along with a few other pioneers who bought the new device for use in non-calculator applications, Intel soon realised the potential of this new general-purpose digital component.

By the mid 1970s Intel had introduced its eight-bit 8080A microprocessor. It had many features in common with the

minicomputers of the day, including a 64K address range, a unified data and instruction memory space and an extensive repertoire of 78 different instructions. Although some diehards still felt that such a puny computer would never catch on, others saw the writing on the wall and began to dream up new applications for the microprocessor.

The concept of a microprocessor-based personal computer appeared around this time. The precedents set by existing computers were still a powerful influence and early designs looked just like their larger cousins. They used separate teletypewriter terminals, alongside paper-tape readers and square CPU cabinets containing rows of individual plug-in circuit boards. It was not the sort of thing for the average living room or office.

Seeing the success of the 8080A, many other semiconductor manufacturers were hard at work to do better, and Motorola had some early success with its 6800, which needed less peripheral circuitry than the Intel device. The two microprocessors which had the greatest effect were the Zilog Z-80 and the MOS Technology 6502.

The Z-80 caused quite a stir when it was introduced in 1977. Its advanced features included a very powerful instruction set, extra registers and a sophisticated interrupt structure. Its compatibility with the 8080A provided it with a ready-made market as a replacement for the Intel device. The CP/M disc-operating system software, designed originally for the 8080A, could be used unmodified with the Zilog processor. Z-80 sales took off like a rocket.

In the same way that the Z-80 was designed as an improved 8080A, the 6502 was produced as a competitor to the 6800. It is to this processor that the honour must go of sparking off the concept of personal computers as we now know them. The simple but powerful architecture of the 6502, optimised for use with high-level languages such as Basic, proved to be just the thing for Commodore Business Machines to use in its now famous Pet.

The separate functional units typical of the big computers were replaced by an integrated system with built-in keyboard, VDU screen and cassette-tape unit. Instead

CPU chips

INTEL 8080A, page 106
Used in: S-100 micros

ZILOG Z-80, page 107
Used in: Computers Lynx, Cifer Club, Gemini, Galaxy, Osborne, Rair Black Box, Research Machines 380Z, Sinclair ZX-80/81 and Spectrum, Sord M-23, Superbrain, Tandy Models I, II, III and IV, Video Genie

MOS TECHNOLOGY 6502, page 108
Used in: Acorn Atom, Acorn Electron, Aim 65, Apple models I, II and III, Atari, BBC Micro, Commodore Pet, Commodore Vic-20, Oric

MOTOROLA 6809, page 109
Used in: Dragon, Tandy Color Computer

TEXAS 9900, page 110
Texas Home Computer

INTEL 8088, page 111
Used in: ACT Sirius, DEC Rainbow, IBM Personal Computer, Sharp PC 5000, Texas Professional

MOTOROLA 68000, page 112
Apple Lisa, Bleasdale BDC 680, Britannia Baby, Torch 700, Hewlett-Packard 9826 and 9836

ZILOG Z-8000, page 113
Used in: forthcoming Commodore system

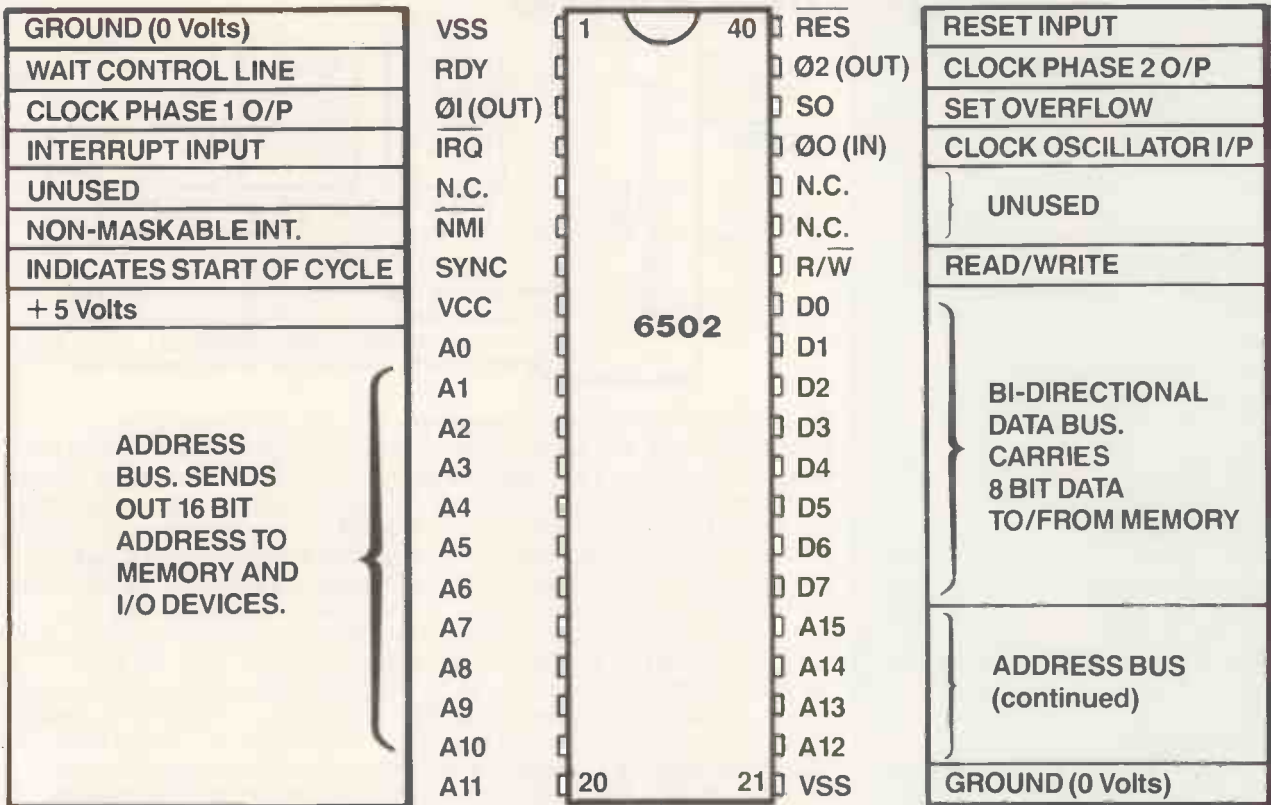

The 6502, like many other microprocessors, is housed in a 40-pin plastic dual-in-line package measuring 2in. by 0.6in. The semiconductor chip itself is in the centre of the package and measures typically 0.3in. square; most of the package volume consists of just plastic or metal frame. Much smaller packages are therefore possible, and are available for high-density applications. Some 16-bit microprocessors may need more than 40 pins, and this has triggered the development of much larger packages. One trick commonly employed to reduce the number of pins is to multiplex or time-share the data- and address-bus pins. This demands additional circuitry to de-multiplex the information outside the microprocessor package.

of loading the Basic interpreter into RAM from a paper tape or cassette the operating system and a Basic were inside the machine, stored in permanent ROM. Best of all, the concept of separate plug-in circuit boards for CPU, memory and I/O functions had gone. Although this reduced flexibility it cut costs dramatically. For the first time, the smallest business budget could withstand a computer, and schools and some lucky households could afford them too. Alongside the Pet, Tandy's TRS-80 with its Z-80 processor and the 6502-based Apple led an American personal-computer boom.

Home users

In Britain Sinclair Research introduced a computer aimed for the first time at High Street stores and the ordinary consumer. The educationally sophisticated but relatively impecunious British home market helped Sinclair create a brand-new low-cost computer formula, turning the tables on the Americans and the Japanese. Where Sinclair led, other British brand names in the computer stores, like Oric, Dragon and Lynx, have followed into the burgeoning computer departments of the country's chain stores.

Meanwhile there was brisk business back at the semiconductor manufacturers, and the resulting profits led to massive investment in the development of new and more exotic microprocessor chips. Eight-bit designs like the Z-80 and the 6502 are now cheap and easy to make, and semiconductor technology has moved on to provide smaller geometries and more transistors per chip. The 8080A and its contemporaries had from 5,000 to 10,000 transistors on a chip. Today 50,000 to 100,000 is routine, and by the end of the decade, microprocessors with 1,000,000 transistors will be commonplace.

There is always a time lag before a new device appears inside a commercially available microcomputer, but 16-bit microprocessors have already provided another quantum jump in processing power since the advent of the first personal computers.

Eight-bit data words can represent a single ASCII character or provide a numeric resolution of one in 256. They are about the smallest units that can usefully be employed in a practical data processor. But eight-bit resolution is not adequate for most numeric applications, so even in eight-bit machines multiple operations are

necessary to achieve the more usable arithmetic precision of 16 or 32 bits. So for every simple calculation made by the Basic interpreter, several eight-bit operations have to be performed one after the other, which slows things up considerably.

Extra goodies

Though improved computational performance is the main driving force behind the move to 16- or 32-bit microprocessor chips, many other benefits are provided too. With 16 bits to play with, more instruction codes become possible and lots of new features can be added to the instruction set. As the data bus becomes wider so does the address bus, and the 64K maximum memory map expands to a megabyte or more.

The technology which manages to squeeze a 16-bit processor on to a chip also allows features such as extra registers and hardware multiply/divide units to be incorporated. As a result, the 16-bit microprocessor is much more than twice as powerful as its eight-bit predecessor.

The first 16-bit processor to see wide use was the Texas 9900. It appeared early

(continued on next page)

Many-legged beasties

(continued from previous page)

because Texas decided to miss the eight-bit evolutionary step altogether. This proved popular in embedded computers for avionics and the like, and was built into a home computer by Texas itself. It never really caught on, perhaps because of its unusual architecture based on the Texas 990 family of minicomputers.

The first 16-bit device to achieve real prominence was the 8088/8086 family from Intel. This company is still a market leader, after the success of the 8080A and its successor the 8085. The 8086 provides the power of a mid-range minicomputer from a single 40-pin plastic package with a 16-bit time-multiplexed data and address bus. Though the 8086 package is no bigger than that used for earlier eight-bit devices, 20 address bits are available to provide access to 1Mbyte of memory. Its only major limitation is that its internal addressing techniques restrict access to four 64K segments at a time.

The cost-sensitive personal-computer market was not really ready for the 8086 when it first appeared, so Intel launched the cut-down 8088 at almost the same time. The 8088 is cut-down in only one sense: it uses an eight-bit data bus in place of the 16 bits of the basic 8086. Inside the 8088 is a complete 8086 16-bit processor with a full-

How it works

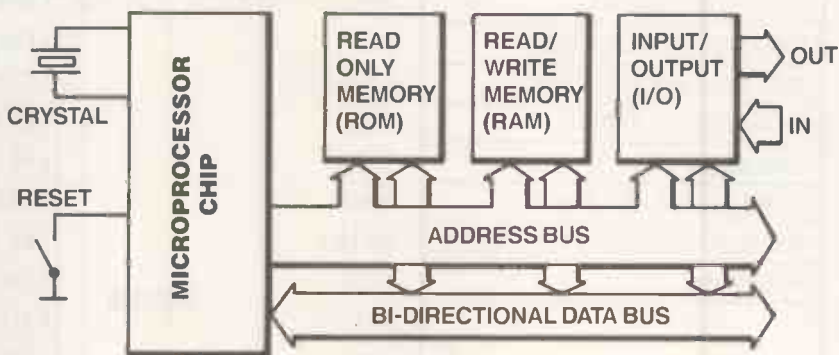

When the microprocessor is powered-up or reset it wakes up in a predefined state and begins to fetch instructions from memory and to execute them. The rate at which it does this is determined by the crystal-controlled clock oscillator which is used to synchronise all activity. The processor fetches an instruction from ROM or RAM memory by issuing an address on the address bus and then reading the instruction it has addressed into its internal instruction register via the data bus. What the processor does next depends on the instruction to be executed, but instructions may involve internal arithmetic and logical operations, or further external bus activity in transferring data to or from the RAM memory or input/output ports. Since the address bus is always driven by the processor it is uni-directional, but data may be transferred in either direction on the bi-directional data bus. The amount of memory which can be accessed by the processor is determined by the address-bus width, which is usually 16 bits for eight-bit processors. The "eight-bit" label actually refers to the width of the data bus which determines the precision of the data which can be handled in one transaction. The main reason that the newer 16-bit machines are more powerful is that they can transfer data twice as fast. In most cases they also have an address bus which is more than 16 bits wide, so that they can reach more than 64K.

Memory and peripheral chips

For every processor sold, at least eight memory devices are sold too. Not surprisingly, therefore, this market is even more important to the manufacturers than that for microprocessor chips. Advances in technology have been very rapid. The 4Kbit chips which were available in the heyday of the 8080A became 16Kbit devices for the Z-80; now 64Kbits is the norm for new machines. Just around the corner are the 256Kbit chips able to exploit the addressing range of 16-bit processors like the 68000. Costs per bit are dropping dramatically to make large memory arrays an affordable proposition.

As the density of RAM memory chips increases, personal-computer manufacturers are able to offer higher-resolution graphics and more advanced software. In some cases the software need not be read in from floppy discs but can be resident in the machine, stored in ROM. The density of ROM devices is even higher than that of RAM. Even now 256Kbit chips are the norm, with 1Mbit not far off. Just think what you could do with 128K of software available as soon as you hit the On switch. As well as a fancy operating system like Unix, there would be room for a word-processing program, a spreadsheet and no doubt a few games too. It's quite an improvement over the 4K Basics of just a few years ago.

Also needed to build a complete system are the specialised peripheral devices. They are often just as dense and sophisticated as the microprocessors they serve. One of the most commonly used peripheral chips is the universal asynchronous receiver transmitter or Uart, which interfaces with RS-232 serial links for VDUs,

modems and other external facilities. Devices of this type are available from the various manufacturers.

Graphics-controller chips are widely used to unload the tedious chore of screen refresh from the processor. Devices are now available which offer not only high-resolution bit-mapped colour graphics but the ability to draw lines and shapes without processor intervention. Add to these the extensive array of parallel interfaces, floppy-disc controllers, text processors, floating-point arithmetic units and memory managers, and you can see why there are often so many little black rectangles inside your office computer.

Each of these specialist chips is likely to cost as much as the CPU itself. At the lower end of the market lots of peripheral chips like these would soon have the price rocketing out of control. The designers of high-volume personal computers therefore turn to custom logic arrays. They are programmed at the manufacturing stage to form a peripheral chip tailored specifically for a particular machine and its needs.

These cost-cutting devices provide only a subset of the general-purpose facilities offered by the conventional peripheral chips. But by clever design and compromise customised arrays can often be made to provide multiple functions such as dynamic-RAM refresh, graphics control and printer interface all from one package at a fraction of the cost of three separate chips. The use of these custom logic arrays means that there are relatively few components in mass-market home micros like the Sinclair Spectrum or Oric.

width internal bus. The memory addressing range is still 1Mbyte, but instructions and data are fetched from memory eight bits at a time. This slows down the processor of course, but it also allows it to be used with external memory and peripheral devices organised on a byte-wide basis, which in turn reduces the overall system costs.

The success of this ploy is plain to see. More 8088 processors have been sold than 8086s, and nearly all the first-generation 16-bit machines like the IBM PC and the ACT Sirius have used it. Better still, 8088 software is absolutely identical to 8086 software. System builders have a no-hassle upgrade path when they need it, which Intel has extended further to the 80186 and 80286 processors now available. In contrast, the more powerful Zilog Z-8000 processor family does not include an eight-bit bus version, which is one of the reasons why this otherwise attractive device has not caught on so well.

For the ultimate in 16-bit power, though, take a look at the Motorola 68000. This beautiful processor is designed with 32-bit architecture on the inside but uses a 16 bit bus to the outside world. It offers an elegant, regular instruction set and a 16Mbyte address range. The 68000 looks a natural for the second generation of 16-bit personal computers and has already been employed in advanced new machines like the Apple Lisa and others. An eight-bit bus version, the 68008, is available and the 68020 with a full 32-bit bus will be along soon.

On the following eight pages you will find details of the eight major families of CPU chip. They range from Intel's pioneering 8080A to the Motorola 68000 whose intricacies are giving the designers something to work on for micros that will be appearing in the second half of the decade. 



Preparing silicon wafers at Ferranti for ULA chips, key elements in cheap home micros.

Does it matter?

A few years ago, when personal computers were a brand-new phenomenon, any prospective buyer was made immediately aware of which microprocessor had been used to animate his or her new-found friend. Today the picture is changing, and in some cases one can comb the glowing text of the advertisements without finding so much as a hint of what the microprocessor chip is among the "128K" and "16-bit" superlatives. So should it really matter to today's prospective buyer what lurks within the oh-so-sexy box? The answer, as so often, is yes and no.

Any particular microprocessor chip can be compared with its contemporaries and a judgment made about its relative power or performance. Regrettably, the potential of that device may not be fully realised in the personal computers in which it is used, so it is better to compare personal computers on the basis of memory, word size, graphics capabilities, available software, and similar overall system parameters than to choose on the basis of the CPU chip used. Regular readers of this magazine have heard often enough about proud owners of new 16-bit machines who discover to their horror that programs actually run faster on their old eight-bit systems. Software is the great leveller, and bad 16-bit software is worse than good eight-bit code, no matter how big the price tag on the system.

But the choice of processor does matter because, by and large, different processor chips cannot run each other's software. If you choose a machine which uses an obscure processor you will find that software is difficult to come by, and expensive too. Happiness is definitely more assured if you go for the Ford Escort processor, rather than for that alluring Porsche with such great potential but so little support.

It also matters if the potential user intends to write any assembly-language software, since in this case the power and instruction set of the processor itself will be more important and more easily exploited. Finally, even if some of today's available software for 16-bit machines is mediocre, it is a fair bet that the situation will improve dramatically. The 16-bit machines do have much more untapped potential in terms of memory expansion and raw processor power, which will ensure that they remain useful for many years to come.



Zilog's super-fast Z-80H eight-bit chips run at 8MHz.

8080A The one that started it all

In 1972, when Intel introduced the first microprocessors, the 4004 and the 8008, the world had little idea of the revolution it was about to witness. They were puny devices with limited capabilities and instruction sets, and were fabricated in the difficult PMOS technology. These newcomers gave no hint of posing any threat to real computers, so most system designers looked briefly at the data sheets and passed on.

Within Intel itself, however, the possibilities opened up by a complete central processor on a single chip of silicon were soon recognised. Development of a more powerful successor using the new NMOS technology was vigorously pursued. The result was the 8080A, launched only 10 years ago as the leader of a revolution which was soon to affect us all.

The 8080A was a real computer in miniature, with a 64K addressing range, a useful set of 78 instructions, plenty of registers, and binary or BCD arithmetic capability. Initially produced in small numbers and with a high price tag, the 8080A went on to sales exceeding two million units per year and made Intel almost a household name.

Right from the start visionaries foresaw its potential for use in small personal computers. The first real example, the Altair 880B, became so successful that its S-100 back-plane bus went on to become an industry standard. CP/M too, was designed for the 8080A, and is still the most popular operating system, offering access to a vast range of software. Intel's chosen successor to the 8080A, the 8085, was a damp squib by comparison, and attention soon switched to the Z-80 device from the competing Zilog corporation.

8080A

Manufacturers: Intel, NEC, AMD, National, Siemens, Signetics, Hitachi
Used on: Altair 880 and numerous other S-100 bus microcomputers
Technology: NMOS
Memory address range: 64K
Clock frequency: 2MHz
Power supply: +5V, +12V, -5V

BUS CONFIGURATION

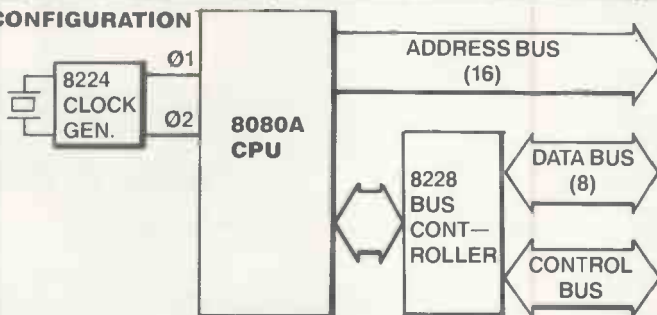

ACCUM	8	Flags	8	PSW
B	8	C	8	BC
D	8	E	8	DE
H	8	L	8	HL
STACK POINTER			16	SP
PROGRAM COUNTER			16	PC

Register set

The 8080 has a single accumulator which acts as the implied focus of most instructions. In addition there are six eight-bit general-purpose registers which can be used as three 16-bit pairs, a stack pointer, a program counter, and a flag register. There are no true index registers.

Family members

Basic 8080A also needs 8224 clock generator or 8228 bus controller. Very wide range of peripheral circuits including serial Uart, parallel I/O, DMA, interrupt controller, keyboard encoder, etc. The 8085 CPU has same instruction set but improved bus and I/O.

Software and instruction set

The 8080A looks rather primitive today, but any system using CP/M runs code written for this processor since CP/M was originally developed for the 8080A. Thus a huge software base is available, including all popular languages and a host of special application programs. The instruction set is register orientated and contains 78 basic instructions including some BCD and 16-bit arithmetic types. A separate I/O address space is available using in and out instructions.

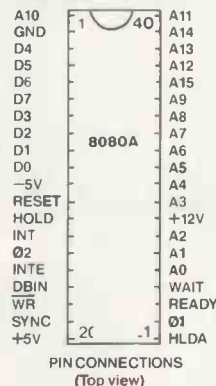

Data types
 Byte, eight bits
 Word, 16 bits

Addressing modes
 Implied
 Immediate
 Register
 Register indirect
 Direct

Z-80 Zilog's challenge

Shortly after the introduction of the 8080A, a group of engineers who had worked for Intel on that project broke away and formed the competing Zilog corporation. They had ambitious plans for a more powerful processor, and it was launched in 1977 as the Z-80.

The Z-80 is impressive even by today's enlightened standards; in 1977 it was a blockbuster. With two complete sets of 8080A-style general registers, two new index registers, on-chip dynamic-RAM refresh logic, three interrupt modes, and no less than 158 instructions including block operations, bit addressing, and BCD shifts, the Zilog Z-80 posed a real and sustained challenge to Intel.

To cash in on the blooming 8080A market, Zilog made its processor upwards compatible at the object-code level. This endowed the Z-80 with a messy and confusing instruction set, but also ensured ready industry acceptance and access to the gigantic CP/M software base. To provide room for all the new instructions, Zilog took advantage of the 12 unused op codes in the 8080A set. Some were used directly, and others were trap doors to additional op-code tables, each with 256 new op code possibilities. This technique made it necessary to use two op code bytes to reach the new tables, and resulted in instructions up to four bytes long, but the wisdom of the Zilog approach to compatibility has been amply demonstrated by the sales figures.

Also introduced were a family of very powerful peripheral devices which used the sophisticated Z-80 interrupt structure; they are still considered the best devices of their type available. Used in many personal computers including all the Sinclair family, the Z-80 will be with us for many years to come.

Z-80

Manufacturers: Zilog, Mostek, NEC, Sharo, SGS
Used on: Sinclair ZX-80, 81 and Spectrum; Lynx; Tandy; Video Genie; Nascom; etc.
Technology: NMOS
Memory address range: 64K
Clock frequency: 2.5MHz or 4MHz
Power supply: +5V

BUS CONFIGURATION

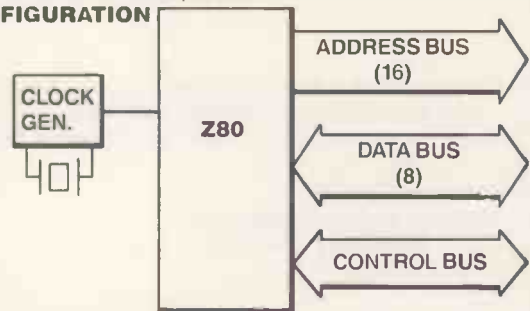

A	8	F	8	A'	8	F'	8
B		C		B'		C'	
D		E		D'		E'	
H		L		H'		L'	
I		R					
INDEX REG		IX		16			
INDEX REG		IY		16			
STACK POINTER		SP		16			
PROGRAM CNTR.		PC		16			

Alternative register set
 Either main set or alternative set can be used. Bank switch is achieved with EX and EXX instructions.

Register set

The Z-80 register set is very generous and has two banks of 8080-style general registers plus two 16-bit index registers. Also included is an Interrupt page address register I and a dynamic-RAM refresh counter register R.

Family members

The Z-80 requires an external clock generator but does not need a bus controller. Zilog has a powerful family of peripheral chips including a PIO, CTC and dual Uart/SIO, each of which includes vectored interrupt logic; 8080 peripherals can also be used.

Software and instruction set

This processor is probably better endowed with available software than any other, thanks to upward 8080 compatibility and the CP/M operating system — and Clive Sinclair. The instruction set is much improved over that of the 8080 and includes extended 16-bit compatibility, relative jumps, indexed addressing, bit set, test, and reset, block operations, and BCD shift operations. There are 158 basic instructions.

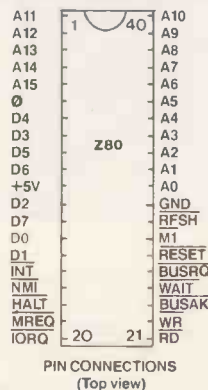

Data types

- Bit
- Nibble, four bits
- Byte, eight bits
- Word, 16 bits
- Block, up to 64K bytes

Addressing modes

- Implied
- Immediate
- Register
- Register indirect
- Extended, Direct
- Relative
- Indexed
- Bit

6502 Commodore's Pet chip

Shortly after the introduction of the 8080A, Motorola introduced the MC-6800, a pretty chip with some nice features like single-supply 5V operation and an easy-to-use instruction set. Due in part to a lack of on-chip registers, the 6800 was never as popular as the 8080A and was not very good at running high-level languages like Basic.

Once again, a small competing firm, in this case MOS Technology, decided it could do better, and the 6502 was born. It was optimised for data-processing applications and had the advantage of two index registers and a comprehensive set of addressing modes which, rather surprisingly, allowed it to run certain benchmarks even faster than the Z-80. The chip was simple and cheap, and right from the start it attracted the attention of budding personal-computer manufacturers.

The very first single-box personal computer, the Commodore Pet, was designed around the 6502. It was hotly pursued by the Apple, and when MOS Technology ran into trouble Commodore took over and is now a fully fledged semiconductor manufacturer in its own right. Two aggressive second sources, Rockwell and Synertek, back up the field. The 6502 is actually only one device in a whole family of processors with the same basic architecture, including single-chip processors with RAM, ROM and I/O all in the same package.

6502

Manufacturers: MOS Technology, now Commodore Semicon Group; Rockwell, Sybertek
Used on: Atom, Apple, BBC, Commodore Pet, Vic-20, Oric, etc.
Technology: NMOS
Memory address range: 64K
Clock frequency: 1MHz or 2MHz
Power supply: +5V

BUS CONFIGURATION

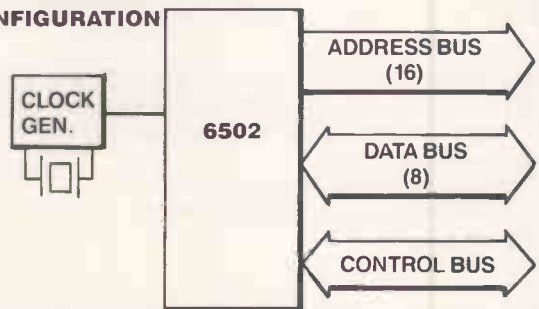

ACCUM	8	A
FLAGS	8	P
INDEX REG X	8	X
INDEX REG Y	8	Y
PROGRAM COUNTER	16	PC
'1' STACK POINTER	8	S

Register set

The 6502 register set appears odd but it has been designed to provide maximum facilities from the minimum of silicon. Apart from the single accumulator there are no general-purpose data registers, but the whole of memory page 0 can be used for this purpose. The short index registers are enlarged by clever addressing modes but the short stack pointer mandates the use of page 1 for the stack.

Family members

The 6502 is just one member of a large family of closely related microprocessors which offer various features and address ranges. There is a large family of 6502 peripheral devices including Uarts, PIOs, CRT controllers and combination chips.

Software and instruction set

The 6502 has been chosen for many personal computers, which guarantees a broad software base. The Achilles heel of the 6502 is its incompatibility with CP/M and the lack of a universal 6502 orientated alternative OS. The instruction set is well thought-out and squeezes a lot of performance from a short set of 56 basic types, thanks to a large repertoire of addressing modes. The 6502 performs very well when running high-level languages — often better, than the Z-80.

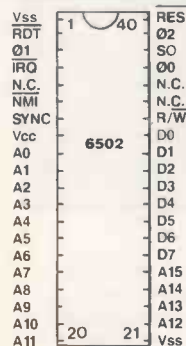

PIN CONNECTIONS
(Top view)

Data types
 Byte, eight bits
 Word, 16 bits

Addressing modes

Implied
 Immediate
 Zero page, eight-bit direct
 Absolute, 16-bit direct
 Relative
 Indexed absolute
 Indexed page 0
 Indexed indirect
 Indirect indexed

6809 Best of the eight-bitters

When the 6502 stole most of the Motorola 6800 thunder, there was only one thing for Motorola to do and that was to build a new processor that was better in every respect. So dedicated were the Motorola designers to building the very best eight-bit device, that the resulting 6809 chip has just about everything that anyone could want from an eight-bit processor, except one thing: it was not around when it was really needed.

This elegant paragon of a microprocessor arrived on the scene too late to grab much of a share of the thriving eight-bit personal-computer market, and most designers had already opted for the Z-80 or the 6502 for their shiny new machines. The classic lines of the 6809 were enough, however, to ensure that some manufacturers would adopt it, and it has appeared in the Dragon, the Tandy Color Computer and a few others you may be lucky enough to own.

Like the 6502, the 6809 does not enjoy the undoubted benefits of CP/M compatibility, and so software availability is a problem. What software there is runs very fast on the sleek architecture of this powerful processor. With two accumulators, two index registers, two stack pointers, a host of addressing modes and a hardware multiplier, the 6809 does well in high-level language applications. It can be expected to Benchmark ahead of the Z-80 or the 6502 on most data-processing tasks. It will be interesting to see whether this chip manages to carve out its own niche in the microprocessor hall of fame before the coming deluge of 16-bit machines swamps the market.

6809

Manufacturers: Motorola, AMI, Fairchild, Hitachi
Used on: Dragon, Tandy Color Computer
Technology: NMOS
Memory address range: 64K
Clock frequency: 1.0MHz, 1.5MHz, 2MHz
Power supply: +5V

BUS CONFIGURATION

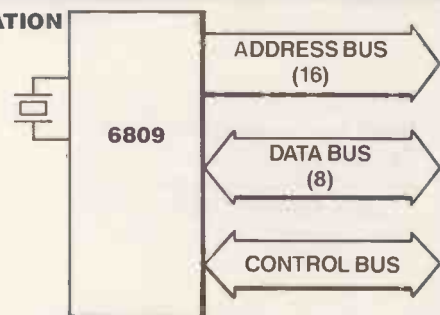

ACCUM A 8	ACCUM B 8	D
DIRECT PAGE	FLAGS	
INDEX REGISTER X	16	X
INDEX REGISTER Y	16	Y
USER STACK POINTER	16	LL
SYSTEM STACK POINTER	16	S
PROGRAM COUNTER	16	PC

Register set

The 6809 puts right the shortcomings of the 6800 and 6502 register set and is optimised for data-processing and high-level language applications. There are two stack points, two index registers and two eight-bit accumulators which can be concentrated to form the 16-bit D register. The direct page register allows the register page to be positioned anywhere in memory.

Family members

The 6809 has a companion device, the 6809E, which is optimised for multi-processor tasks. Since the 6809 bus structure is compatible with the 6800 and 6502, peripheral chips from those families are used for expansion: the special 6829 memory-management unit is also available.

Software and instruction set

The 6809 is ideal for personal-computer applications since it is optimised for data-processing tables. Unfortunately it has not been widely used due to its late arrival on the market, and the available software base is consequently restricted. The instruction set is regular, elegant, and powerful with lots of nice features such as the eight-by-eight multiply and extensive 16-bit operations. The additional stack pointer is useful for RPN maths and high-level language interpreters.

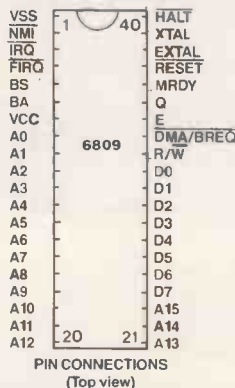

Data types

Byte, eight bits
 Word, 16 bits

Addressing modes

Inherent, implied
 Immediate
 Register
 Direct, eight-bit
 Extended, 16-bit
 Indexed, five sub-modes
 Indexed indirect
 Relative
 Program counter relative

9900 First to 16-bits

The 9900 represented a bold move by Texas Instruments, one of the largest of the semiconductor manufacturers. In 1976, Texas announced that the 16-bit 9900 represented the "end of the two-bit eight-bit", but things are never that clear cut or predictable in the fickle microprocessor market. Despite plenty of early interest from scientific and military designers who needed the high throughput and 16-bit precision the 9900 offered, this unique device was too costly and too different to be used in the volume applications so essential for success. With separate 16-bit data and address buses, the Texas chip needed an expensive 64-pin package, but could only address 32K.

The architecture is based on that of the Texas 990 family of minicomputers and has many novel features, including the use of blocks of workspace registers in RAM memory rather than the more usual on-chip register sets of conventional processors. I/O arrangements are unusual too in using a serial communications register unit which can address up to 4,096 individual bit I/O lines. It is therefore possible for Texas to produce a family of peripheral devices using smaller packages than those used by the competition. But programming the 9900 requires a special approach since there are no stack operations and no JSR instruction.

To the initiated, however, the 9900 chip is powerful and flexible. To show what could be done, Texas introduced its own personal computer which used it, the TI-99/4. Unfortunately it has not proved a great success in the market place and is now being discontinued in favour of an 8088-based machine. More up-to-date versions of the 9900 are now available, including the 9995 with a multiplexed bus, and the 99000 which is intended to compete with the 8086 and 68000.

9900

Manufacturers: Texas Instruments, AMI, ITT
Used on: Texas home computer
Technology: NMOS
Memory address range: 32K
Clock frequency: 3MHz or 4MHz
Power supply: +5V, +12V, -5V

BUS CONFIGURATION

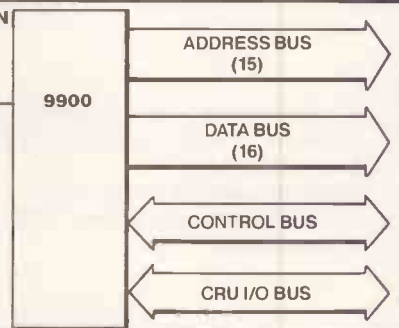

PROGRAM COUNTER	16	PC
WORKSPACE POINTER	16	WP
STATUS (FLAG) REGISTER	16	ST

Register set

The 9900 has a unique architecture which relies on multiple banks of workspace registers in RAM and therefore has few on-chip registers. The only on-chip registers are the program-counter flag register and the register which points to the current workspace. Multiple accumulators and index registers can be provided in the workspace, but there is no true stack pointer on the chip or in the workspace.

Family members

Several more recent variations of the basic 9900 architecture have been produced, including the 9940 single-chip device and the 9995 with a 40-pin package and multiplexed data bus. There is a useful family of dedicated peripheral devices.

Software and instruction set

The 9900 is compatible with the Texas 990 family of minicomputers and can solve software with them, but there is no popular user base and no access to the huge variety of software offered by CP/M. The Texas home computer does, however, have a reasonable following and reasonable software. The instruction set is quite unique and does not include stack operations or subroutine jumps. I/O operations are also different from other CPUs and use the special serial CRU bus.

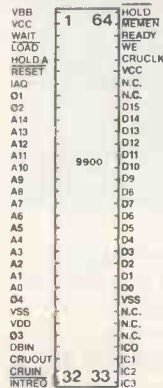

Data types

Bit
 Byte, eight bits
 Word, 16 bits

Addressing modes

Immediate
 Workspace register addressing
 Workspace register indirect
 Workspace register, indirect auto inc.
 Symbolic, direct
 Indexed
 PC relative
 CRU relative

8088 Minicomputer on a desk

Intel waited until large cheap memories were available and the market was ready before launching its own 16-bit processor, the 8086. Once again its timing was excellent. Designers liked the 1Mbyte address range and the powerful new instruction set. A memory system organised for a 16-bit data bus can be expensive however — too expensive for the personal-computer market to begin with — so Intel also produced the companion 8088 which uses an eight-bit data bus.

The 8088 is identical to the 8086 on the inside, and can run the same software; the only difference is the width of the external data bus. This slows things down, but has the more important effect of lowering system costs. The 8088 has been a big success in the personal-computer field, being used in the IBM PC and several other machines where it gives minicomputer performance in a low-cost desk-top system.

In a repeat of its earlier success with the 8080A, Intel has managed to gain a firm foothold in the 16-bit market with the 8088. Manufacturers are therefore likely to choose another Intel device, such as the 8086 or the newer 80186 or 80286, when the time comes to add increased performance to their products. The 8088/8086 family also has the two popular disc-operating systems CP/M-86 and MS-DOS to its credit.

Despite its success, the 8088 is not a very elegant chip. It has an untidy architecture and instruction set, and needs three separate chips for the CPU group alone. It is only the economics of its early popularity which keeps it ahead.

8088

Manufacturers: Intel, AMD, NEC, Siemens, Fujitsu
Used on: IBM PC, Sirius, DEC Rainbow, Texas Professional
Technology: HMOS
Memory address range: 1Mbyte
Clock frequency: 5MHz, 8MHz and 10MHz
Power supply: + 5V

BUS CONFIGURATION

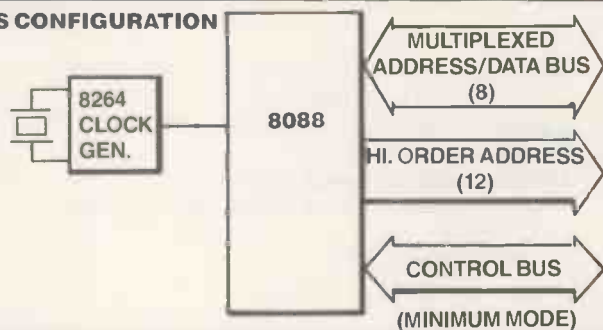

POINTER & INDEX REGS		GENERAL REGS	
STACK POINTER	16 SP	AH	AX
BASE POINTER	16 BP	BH	BX
SOURCE INDEX	16 SI	CH	CX
DEST. INDEX	16 DI	DH	DX

SEGMENT REGS		PROGRAM COUNTER/FLAGS	
CODE SEGT.	16 CS	INSTRUCTION POINTER	IP
DATA SEG.	16 DS	FLAGS	16
STACK SEG	16 SS		
EXTRA SEG.	16 ES		

Register set

The 8088 registers and architecture are identical to that of the 8086 and contain as a subset a group of 8080 types. A 20-bit address is generated by combining a pointer and a segment register, four segments being simultaneously available. There are eight eight-bit general registers which can be used as four 16-bit pairs.

Family members

In Min mode 8088 just needs an 8264 clock generator, but in Max mode an 8288 bus controller is also required. The 8088 is an eight-bit bus version of the 8086 16-bit processor. Few-chip versions 80188 and 80186 are now available as is the 80286 virtual-memory version.

Software and instruction set

Its selection for the popular IBM PC and Sirius machines has meant there is more software available for the 8088/86 than for any other 16-bit CPU. Operating systems include CP/M-80, MS-DOS and Unix. There are no software differences between the 8088 and 8086, and both are upwards compatible with the 8080 at the object-code level. The instruction set is aimed at minicomputer-style applications in high-level languages and contains multiply/divide, bit operations and Z-80 style block operations.

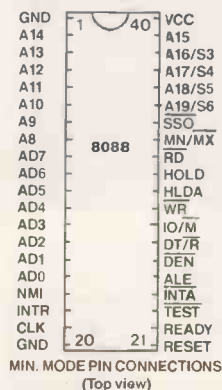

Data types

Bit
 Byte, eight bits
 Word, 16 bits
 Double word, 32 bits
 Bytestring, N bytes
 Wordstring, N words

Addressing modes

Implied
 Immediate
 Register
 Register indirect
 Direct
 Based
 Indexed
 Based indexed
 String

68000 Beauty . . .

Motorola has always produced elegant processors. Its 6800, despite coming second to the 8080A, was much easier to understand and to program, and the 6809 is the best of all the eight-bit chips. With the 68000, though, Motorola has surpassed itself with a processor that is not only prettier to look at than the competition but is also a lot more powerful into the bargain.

While others use fancy extras and clever tricks to squeeze extra performance out of their chips, the secret of the 68000 lies in the sheer scale of its internal 32-bit architecture. With 17 32-bit registers, a 16-bit data bus and a 24-bit address bus, the 68000 does not need tricks to get performance. The programmer is faced with a simple set of only 56 basic instructions which can be expanded by data-type and address-mode options to provide over 1,000 combinations.

The 68000 is powerful enough to take advantage of the much favoured Unix operating system from Bell Labs, which is fast becoming a standard for 68000 users. Unix offers the same advantages that were ultimately achieved by CP/M on the 8080 and its derivatives — a common software base.

While the 8086 needs lots of awkward add-ons to squeeze more performance from it, as in the new 80286, the 68000 is really a more powerful machine struggling to escape, and so upgrades are simple. Next to appear will be the 68010, still with a 16-bit data bus but offering virtual-memory support. After that we are promised the 68020, which reveals for the first time the full glory of that 32-bit architecture.

68000

Manufacturers: Motorola, Mostek, Rockwell, Signetics, Thompson CSF
Used on: Apple Lisa, Torch 700, HP 9826
Technology: HMOS
Memory address range: 16Mbyte
Clock frequency: 4MHz, 6MHz, 8MHz, 10MHz, 12.5MHz
Power supply: +5V

BUS CONFIGURATION

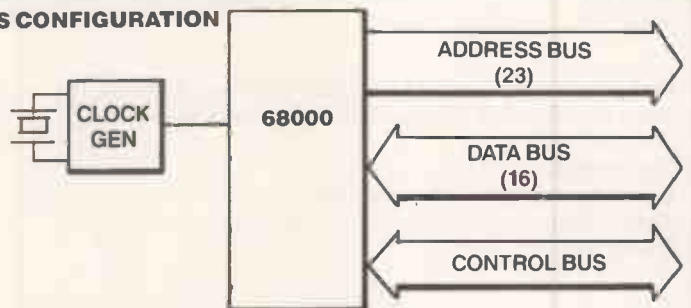

Register set

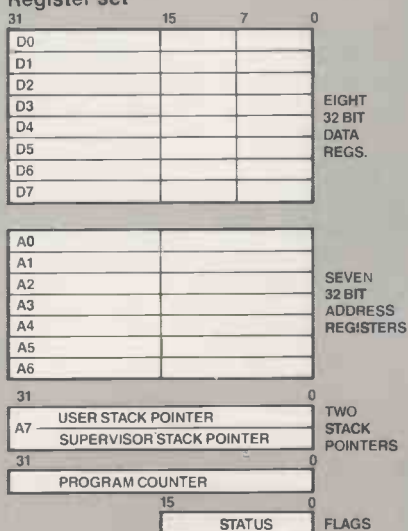

Family members

At the moment there is a shortage of 68000 peripheral devices and no maths processor but 6800/6502 peripherals can be used. Other processors available or planned are the 68008 eight-bit data bus, the 68010 with virtual-memory support and the 68020 with full 32-bit data bus.

Software and instruction set

The 68000 is a very powerful processor and will probably become very popular as new systems are introduced. The most popular operating system at the moment is Unix in several versions. Available software is fairly limited at the moment but the situation will quickly change as support grows. The instruction set is powerful, simple and elegant, being based on just 56 basic mnemonics. Surprisingly, the 68000 can perform floating-point arithmetic almost as fast as the 8086 with 8087 co-processor.

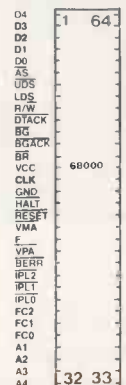

Data types

Bit
 Nibble, four bits
 Byte, eight bits
 Word, 16 bits
 Long word, 32 bits

Addressing modes

Implied
 Immediate
 Register
 Register indirect
 Absolute, direct
 Relative
 — plus many more sub-modes, including indexing

Z-8000 . . . and the beast

The Z-8000 appeared after the 8086 and before the 68000 and has unfortunately turned out to be neither first nor best. A processor very much from the Zilog mould, the architecture is designed for raw processing power with no concessions to the seekers of elegance or simplicity. The Zilog motto seems to be: if it's any use, stick it in. As a result, this admittedly powerful device is the most complex 16-bit processor around, having 110 basic instruction mnemonics and an extensive but tangled register set. But despite the complexity, it actually uses fewer transistors on the chip than the 8086 because it uses logic for instruction decoding rather than the simpler but more wasteful microcode of its competitors.

One of the Z-8000's features, inherited and expanded from the similar Z-80 facility, is an extensive set of 20 block or string macro instructions able to move, compare and translate whole blocks of memory in one go. One of its biggest disadvantages, on the other hand, is the fact that no eight-bit bus version has been produced, effectively keeping the door firmly closed to use in pioneering 16-bit personal computers. Up to now, the Z-8000 has been most successful in military applications, but Commodore has recently announced its intention of using it in a new machine, so perhaps it is not too late. The label Z-8000 is a family name for the Z-8001, with 8Mbyte addressing, and the Z-8002 which addresses 64K. There is no Z-8000 chip as such.

Zilog itself seems to be having second thoughts, because it has launched an entirely separate 16-bit processor, the Z-800. It has the great advantage of being upwards compatible with the Z-80, which the Z-8000 is not.

Z-8000

Manufacturers: Zilog, AMD, SGS, Sharp, Toshiba
Used on: Zilog System 8000, newly announced Commodore system
Technology: NMOS
Memory address range: 8Mbyte
Clock frequency: 4MHz, 6MHz, 10MHz
Power supply: +5V

BUS CONFIGURATION

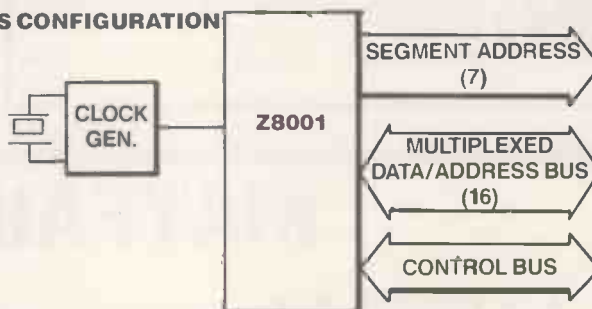

GENERAL REGISTERS

7	RH0	0	7	RL0	0	R0	R80
	RH1			RL1		R1	RQ0
	RH2			RL2		R2	R82
	RH3			RL3		R3	
	RH4			RL4		R4	R84
	RH5			RL5		R5	RQ4
	RH6			RL6		R6	R86
	RH7			RL7		R7	

SPECIAL REGISTERS

RESERVED WORD
FLAGS
PC SEGMENT
PROG. COUNTER
SP SEGMENT
STATUS POINTER
REFRESH COUNTER

15		0	R8	R88
			R9	RQ8
			R10	R810
			R11	
			R12	R812
			R13	

NORMAL STACK SEG	R14
SYS. STACK SEG.	R14

NORMAL SP	R15
SYSTEM SP	R15

Register set
 The Z-8000 has plenty of general and special-purpose registers, but the programmer has a lot to remember. Register combinations of eight, 16, 32 and 64 bits are available.

Family members

The Z-8000 family includes: the Z-8001, 48-pin, 8Mbyte; Z-8002, 40-pin; 64K; and the Z-8003 and Z-8004 with virtual-memory support. There is an extensive family of peripheral chips including a maths unit, memory manager, and a universal peripheral controller.

Software and instruction set

The Z-8000 has not caught on in the personal-computer market despite its power and availability so software support is limited. A version of CP/M called CP/M-8000 is available; as yet there is little software to run under it but this may change when Commodore introduces its promised machine using the Zilog chip. The instruction set has 110 basic mnemonics and many advanced features, including comprehensive string and block functions. Unfortunately, it is also rather messy.

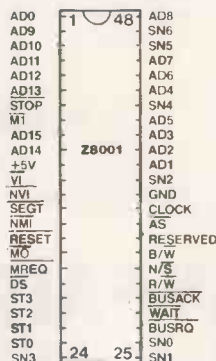

Data types	Addressing modes
Bit	Implied
Nibble	Immediate
Byte	Register
Word	Indirect register
Double word	Direct
Byte strings	Relative
Word strings	Index
	Base
	Base index

PROJECT PLANNING

ON YOUR
DESKTOP COMPUTER
IBC PROJECT PLANNER
GIVES YOU:

Network Analysis
Resource Analysis
Resource Scheduling
Resource Costing
Subnet Library

User Defined Reports
User Defined Bar Charts
Histograms
Critical Path Reports
Special Sort Feature

DEALER ENQUIRIES WELCOME

IBC Computer Systems Ltd,
Belgreen House, Green St,
Macclesfield, Cheshire (0625) 616399

• Circle No. 154

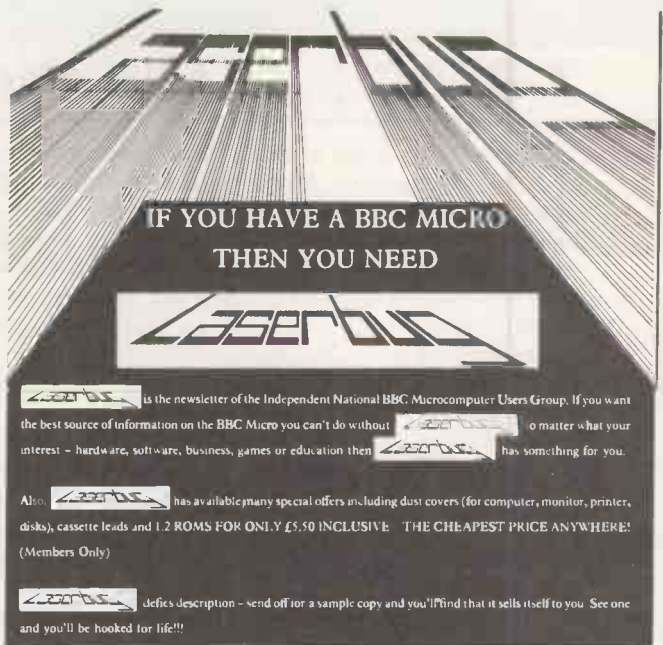

IF YOU HAVE A BBC MICRO THEN YOU NEED

LASERBUG

is the newsletter of the Independent National BBC Microcomputer Users Group. If you want the best source of information on the BBC Micro you can't do without **LASERBUG** no matter what your interest - hardware, software, business, games or education then **LASERBUG** has something for you.

Also, **LASERBUG** has available many special offers including dust covers (for computer, monitor, printer, disks), cassette leads and 1.2 ROMS FOR ONLY £5.50 INCLUSIVE - THE CHEAPEST PRICE ANYWHERE! (Members Only)

LASERBUG defies description - send off for a sample copy and you'll find that it sells itself to you. See one and you'll be hooked for life!!!

Please supply me with more details about **LASERBUG** and your special offers
 a sample copy for £1.00 and an A4 SAE (17p postage)
 1 UK 12 Month Subscription for £12.00
 1 UK 6 Month Subscription for £6.00
 1 Overseas Surface Mail Subscription for £14.00
 (air mail rates on application)

Please send the goods to:

NAME ADDRESS

I enclose a cheque/PO for £ p made payable to LASERBUG.

Please send the form to LASERBUG Dept. P. 10 Dawley Ride, Colnbrook, Slough, Berks., SL3 0QH.

• Circle No. 155

MAYFAIR MICROS

★ ★ PRINTERS ★ ★

	PRICE EX VAT
EPSON	
RX 80T	£229.00
RX 80F/T	£256.00
FX 80	£335.00
MX 100F/T III	£376.00
FX 100F/T	£430.00
SEIKOSHA	
GP100A	£175.00
GP250K	£219.00
GP700A Colour	£349.00
OKI MICROLINE	
OKI 80A	£180.00
OKI 82A	£289.00
OKI 83A	£435.00
OKI 84A (P)	£855.00
OKI 84A (S)	£730.00
OKI 92P	£395.00
OKI 93P	£545.00
OKI 92S	£480.00
OKI 93S	£612.00
MANNESMANN TALLY	
MT80	£265.00
MT180	£495.00
MT180	£800.00
PIXY PLOTTER	£505.00
QUME	
9/45 RO	£1500.00
9/55 RO	£1780.00
11/40 RO	£1120.00
11/55 RO	£1250.00
SHEET FEEDER	£490.00
TEC	
STARWRITER F1040	£959.00
STARWRITER F1055	£1235.00
SHEET FEEDER	£459.00

DIABLO	
630 RO	
SHEET FEEDER	
RICOH	
RP 1300S	£945.00
RP 1600S	£1185.00
RP 1600S SHEET FEEDER	£459.00
RP 1600S TRACTOR	£138.00
FLOWRITER	£1249.00

PRINTERS — OTHER

ANADEx DP6500 500cps	£1719.00
BROTHER HP1	£525.00
CANNON AP400KSR	£780.00
DRE 8925 240cps	£1495.00
JUKI 6100	£350.00
OLIVETTI ET121 + INTERFACE	£830.00
OLIVETTI INK-JET	£299.00
OLYMPIA ESW102	£875.00
PRINTRONIX P300 3001pm	£3683.70
SHINWA CP80	£240.00
SMITH CORONA TP1	£299.00
STAR DP510	£235.00
STAR DP515	£299.00

★ ★ MONITORS ★ ★

NEC JB1201ME	£185.00
NEC JC1201DE	£325.00
NEC JC1202DHE	£545.00
PHOENIX P12	£84.50
SANYO 14in Colour Hi-Res	£280.00
SANYO 14in Hi-Res	£84.50

★ ★ COMPUTERS ★ ★

	PRICE EX VAT
APRICOT	
256K 0.315MB	£1275.00
256K 0.315MB MONITOR	£1440.00
256K 315Kx2	£1445.00
256K 315Kx2 MONITOR	£1575.00
SIRIUS	
128K 1.2MB	£1675.00
128K 2.4MB	£2025.00
256K 2.4MB	£2165.00
256K 10MB	£2995.00
128K MEMORY EXPANSION	£225.00
256K MEMORY EXPANSION	£335.00
512 MEMORY EXPANSION	£473.00
WASP 40MB STREAM/HARDDISK	£4495.00
OLIVETTI	
160KB 2x320KB Disk Drives	£1995.00
160KB 2x640KB Disk Drives	£2395.00
160KB 10MB Hard Disk	£3995.00
SPECTRUM	
SPECTRUM 48K	£108.70
COMMODORE	
COMMODORE 84	£156.51
COMMODORE DISK 1541	£165.21
COMMODORE C2N CASSETTE	£36.51
COMMODORE 1525 PRINTER	£175.00
COMMODORE 64 INTERFACE	£28.69
IBEK 64/Parallel INTERFACE	£59.95
COMMODORE 1311 JOYSTICK	£8.09
COMMODORE 1312 PADDLES	£11.30
COMMODORE 8096	£735.00
EPSON	
HX20 EXECUTIVE	£575.00
HX20	£375.00
QX10	£1600.00

MAYFAIR MICROS

5TH FLOOR 65 DUKE STREET LONDON W1 TEL 01-629 2487

• Circle No. 156

Success Breeds Success

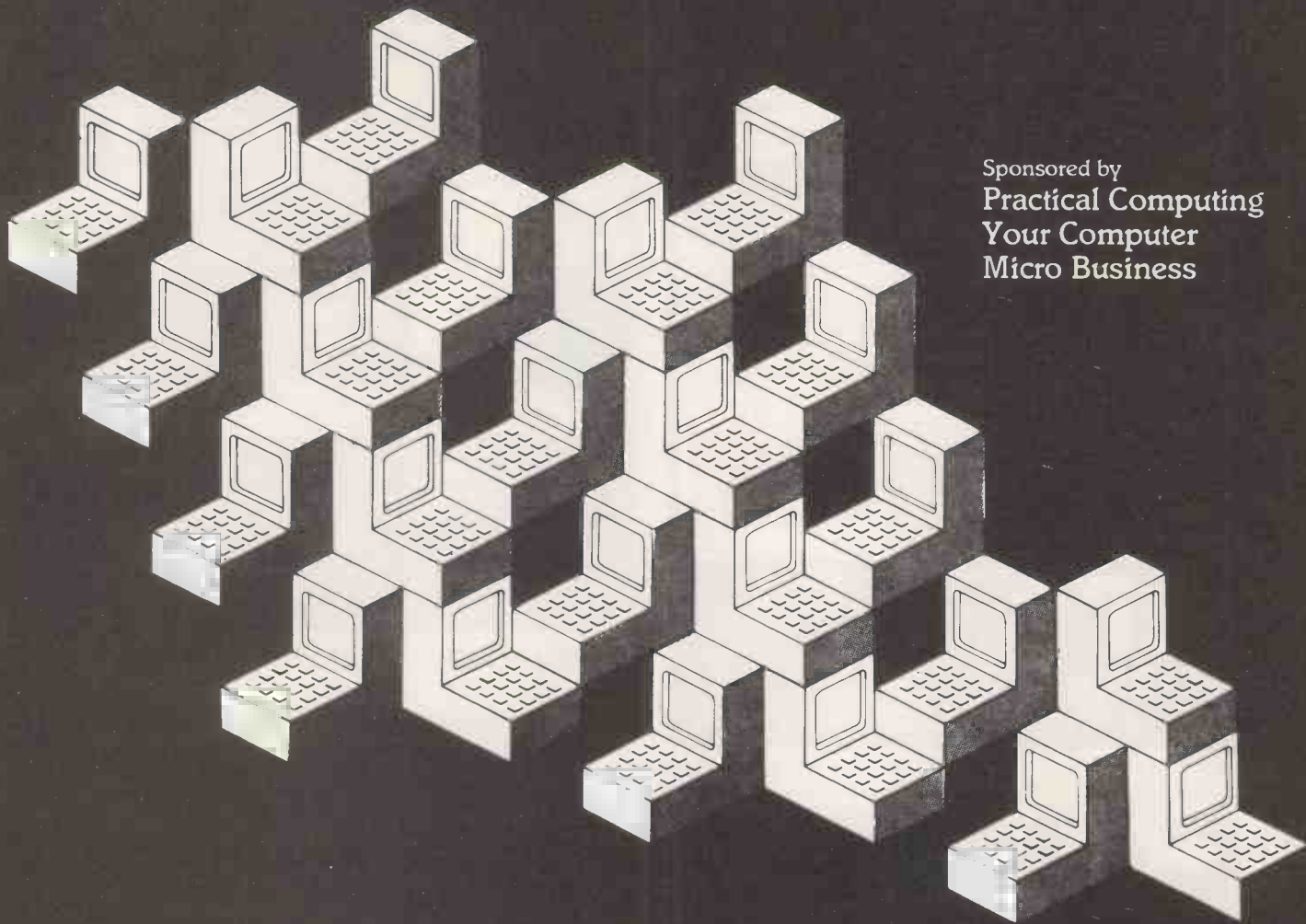

Sponsored by
Practical Computing
Your Computer
Micro Business

National Exhibition Centre, Birmingham. May 4-7, 1984.

After one show the Midland Computer Fair has already established itself as an outright winner. Not only is it the leading exhibition in the Midlands for microcomputers and related products, but it stands in its own right as a major national event.

In recognition of this, and the need to accommodate thousands of expected visitors the venue for the 1984 Midland Computer Fair is to be Britain's premier showcase – the National Exhibition Centre, Birmingham. The NEC with its superb facilities for exhibitors and visitors alike will

be the fitting site for this major event which attracted over 17,000 people for the first show.

Whether you are interested in microcomputer enthusiasts or would prefer to take space in the Business Section to meet small business micro-users, the Midland Computer Fair is definitely for you.

So why not let a little of the Midland Computer Fair's success rub off on your company by reserving a stand at the next show.

The road to success starts by filling in the coupon below:

THE Midland
Computer
Fair *Personal computers*
Home computing
Small business systems

Return to the: Exhibition Manager, Reed Exhibitions,
Surrey House, 1 Throwley Way, Sutton, Surrey SM1 4QQ
Tel: 01 643 8040 Telex: 946564 BISPRS.G

Name _____
Position _____
Company _____
Address _____

EPROM-ERASER
erases 4 EPROMS simultaneously

Low price
Only
£ 26.50

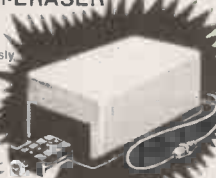

MACH 3

PRINTER BUFFER

Why wait for your printer?...
With the MACH 3 you can use your computer, while the printer is working.

	16 k	32 k	48 k
par. input	£ 86	£ 98	£ 109
serial input - par. output	£ 94	£ 109	£ 123

VIC 20 EXPANSION UNITS

with 2 slots **£ 15.50**

If ordered together with the 40/80 Column card and the 64 k card **£ 5.95**

With 5 slots, fully buffered, switches for deselecting slots, and on-board power supply **£ 29.95**



40/80 COLUMN CARD **£ 59.95**

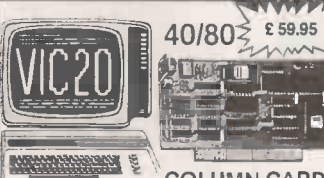

Turn your VIC 20 into a professional computer...
40 or 80 columns instead of 22, very sharp and stable picture.
Try it out without obligation!

VIC 20 64 k RAM + 2 k EPROM EXPANSION
£ 59.95

With software for RAM files. Easily connected. Needs no extra power supply.

Universal EPROM PROGRAMMER
for 2716, 2732, 2516 and 2532
(Already over 1000 satisfied users) **£ 31**

- Assembled and tested
- With extended manual (21 pag.)

This programmer can be very easily connected to almost any microcomputer, e.g.:

OSI xP, PET, CBM, TRS 80, EXIDY, SWTPC, EXORCISER, NASCOM, MAXBOARD, AMICOS, ACORN ATOM, VIC 20, APPLE JUNIOR, SYM, DAI, AIM, EXPLORER, HEATHKIT, ZX 81, ABC and CBM 64.

Convince yourself, that this programmer also can be very easily connected to your computer, ask for a free brochure.

Control software in EPROM **£ 6.50**

VIC 20 EPROM CARD
£ 11.95

Expand your VIC 20 with two 4 k EPROM sockets.
Addresses are changeable.

for all our products: **Dealer inquiries invited.**

zero ELECTRONICS

149 KINGSTREET + GT. YARMOUTH NR30 2PA + TEL: (0493) - 2023
(NASH HOUSE)

● Circle No. 157

Cyber 3 Robot

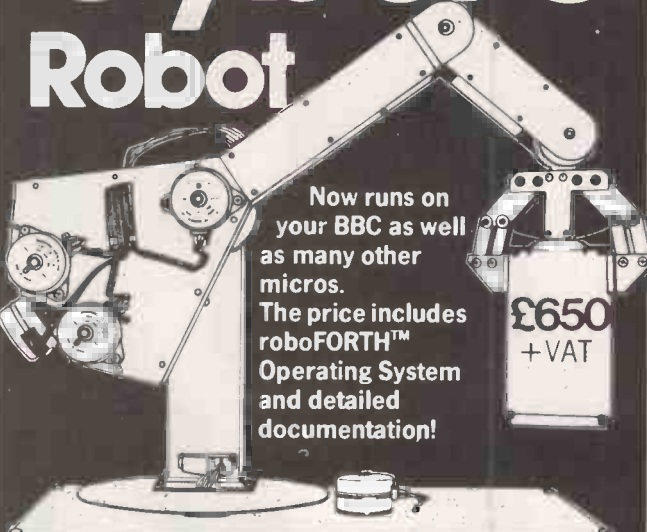

Now runs on your BBC as well as many other micros.
The price includes roboFORTH™ Operating System and detailed documentation!

£650 + VAT

Superbly constructed in black satin anodised aluminium, the CYBER 3 robot is ideal for the educational and light industrial user. It emulates, in behaviour and capabilities, larger industrial robots – the arm can access 350 degrees, with a reach of 50 cm and lift up to 400 gm. It also uses RoboFORTH™, the acknowledged language for robotics applications.

For further information on the CYBER 3 robot and all other products, including speech synthesis units please contact:

CYBER ROBOTICS LTD.
61 Ditton Walk, Cambridge
Tel: Cambridge (0223) 210675



● Circle No. 158

CAMDEN

THE COMPUTER PEOPLE

COMPUTER SYSTEMS LIMITED

462 COVENTRY ROAD, SMALL HEATH
BIRMINGHAM B10 0UG
Telephone: 021-771 3636 (10 lines) Telex: 335909 (Camden G)

5MB WINCHESTER





	RRP	CAMDEN PRICE
APPLE IIE	845	645
80 COL CARD	80	70
80 COL + 64K	180	150
DISK WITH CON	345	270
DISK W/OUT	245	220
TRIDENT 5 MEG	1450	1150
TRIDENT 5 MEG PLUS FLOPPY	1700	1465

SPECIAL OFFER

APPLE IIE PLUS GREEN SCREEN MONITOR
5 MEG WINCHESTER WITH BUILT-IN FLOPPY.

RECOMMENDED PRICE **£2810**
OUR PRICE **£1995**

10 MEG VERSION **£2275**

ALL PRICES EXCLUDING VAT



12 MONTHS PARTS AND LABOUR ON ALL APPLE AND TRIDENT PRODUCTS

● Circle No. 159

ATA

The market leaders!...

APRICOT 256K + 315K s/s 3 1/2" disk
ONLY— £1399

ring 01 833 0044 for latest PRICES

Attention Dealers!

As a result of demand ATA UK has been established to supply dealers, computer products at attractive prices.

Ring now (dealers only)
 (0727) 37327
 (0742) 700802

Export specialists — ring or telex for details

...with recognised professional support



Apricot	£
Apricot Computer 256K RAM + 315K s/s 3 1/2" disk	1399.00
Apricot Computer 256K RAM + 3/5 s/s 3 1/2" disk + monitor	1595.00
Apricot Computer 256K RAM + 315K s/s 3 1/2" disks + monitor (inc. basic, utilities, comms, SuperCalc)	1795.00

Sirius Hardware	£
Sirius 1 128K 1.2mb disk drives	1795.00
Sirius 1 256K 2.4Mb disk drives	2395.00
Sirius 1 256K 1.2mb disk drive & 10Mb internal Winchester	3295.00
128K RAM Boards	264.00
256K RAM Boards	399.00
384 RAM Boards	499.00
512K RAM Boards	575.00

Z80 CP/M 80 System	
SSE Z80 CP/M 80 system	395.00

Sirius Software Languages	
CBasic 86	179.00
Level 2 Cobol with forms 2	595.00
Microsoft Basic compiler	269.00
Microsoft Pascal compiler	335.00
Microsoft Fortran compiler	335.00

Word Processing	
WordStar	269.00
SpellStar	120.00
MailMerge	120.00
Word Mailer	80.00

PRICES EXCLUSIVE OF VAT AND CURRENT AT TIME OF PRINTING

Databases

dBase II	365.00
Autocode	180.00
DataStar	135.00

Spreadsheet

Multiplan	180.00
CalcStar	80.00

System Utilities

	£
Diagnostic package	69.00
CP/M configuration package	119.00
MS DOS programmers toolkit	169.00
Sirius 1 hardware reference manual	45.00
IEEE 488 package	169.00
Graphics toolkit	169.00
Asynchronous communications	169.00
remote batch	285.00
3270 emulator	340.00

I.C.E. Winchester Sub-Systems

5 Megabyte	1395.00
10 Megabyte	1599.00
20 Megabyte	2099.00
40 Megabyte	3399.00

Colour Monitors

Luxor high resolution	
25Mhz linear & TTL	499.00
Kaga Denshi medium resolution TTL	325.00
Kaga Denshi low resolution	265.00

We also stock the Hantarex RGB monitors, as recommended by Apple in Europe.

Kaypro II

KAYPRO II 2 x 200K disc drives	£ 1395.00
--------------------------------	-----------

IBM Peripherals

64K installed	190.00
Smorgasboard 64K 1 serial & parallel etc.	1280.00
Baby Talk — Local 3270 emulation	625.00
IRMA 3270 emulation — Local	925.00
Baby Blue Z80 + 64K	399.00
Big Blue Z80	450.00

Hyperion

Hyperion 256 x 2 MSDOC, Basic	2950.00
-------------------------------	---------

Printers & Plotters

Epson

Epson RX80 120 CPS	245.00
Epson FX80 160CPS	349.00
Epson RX80FT	265.00
Epson FX100 160cps	480.00

Apple

APPLE Dot Matrix 120 CPS	349.00
APPLE Letter Quality Printer	1199.00

Ricoh

Ricoh 1300 Flowriter	1155.00
Ricoh RP1600 Flowriter	1499.00
Mannesmann Tally MT160L	449.00
Mannesmann Tally MT180L	649.00

Plus full Range of Centronics Printers Available

Plotters

Hewlett Packard HP747Q	750.00
Hewlett Packard HP7475(A3) TBA	1399.00
Calcomp B PEN (A3)	2999.00

WE ALSO STOCK APPLE AND HEWLETT PACKARD

TERMS AND CONDITIONS

For delivery please add
 £0-£199 · £5, £200-£1499 · £13,
 £1500 + 1 1/2%.

CHEQUES WITH ORDERS

Please allow 10 days for clearance.
 PLC's, public sector etc 30 days
 credit available on official orders,
 subject to 5%
 credit charge.



ATA — LONDON 4 Albion Hse,
 1 Back Hill, London EC1. 01-833 0044
 Telex 25102 CHACOM G
 ATA — POTTERS BAR 197, High
 Street, Potters Bar, Herts EN6 5DA
 (0707) 57113

ATA — SHEFFIELD 72 Eldon Street,
 Sheffield, S1 4GT. (0742) 700802
 FREEPOST SHEFFIELDS1 1AY



ACT
Sirius 1 128K 1.2MB S/S DISKS
ONLY— £1795



ATA

How to score with the 64

Games on the Commodore 64 are noisy and colourful, but its capabilities are only just beginning to be exploited, as Paul Bond discovered.



Outstanding graphics are a feature of Commodore's forthcoming Soccer.

WITH ITS elephantine 64K of memory, nearly 38K of which is available for Basic programs, and a choice of 16 colours, together with the impressive sound capability of the Sid chip, the Commodore 64 is ideal for home use. On the minus side, its Basic is slow. The machine's potential may be further extended by the addition of the new Simons Basic, but this may be a pricey privilege.



Radar Rat — Pacman with windows.



Mirrorsoft's Caesar aims to keep the larder mouse-free.

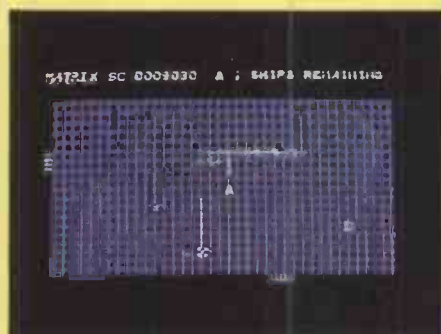

Jeff Minter's Matrix from Llamasoft.

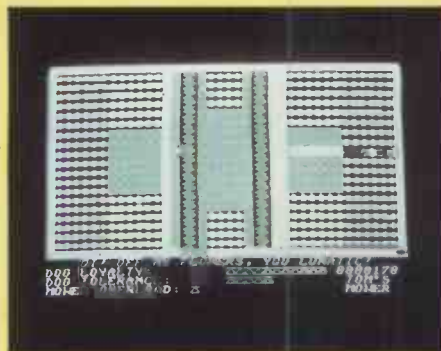

Garden aggro in Hover Bover.

Blue Moon

Like the song *Blue Moon*, the Merlin Software game of the same name is an old standard: you shoot at things coming down the screen. Nevertheless, the game has some originality in its interpretation.

You take the part of the pilot of an intergalactic spacecraft, and have to rescue another spacecraft then return to the safety of the Blue Moon. But before you can get any ground elapsed time under your belt you have to dock with the other half of your ship. There is nothing so infuriating as having to carry out this kind of delicate operation before you can get down to laying waste vast regions of the cosmos. But it is intensely satisfying, seconds later and docking achieved, when you are catapulted straight into a comet storm. You have to dodge them if you want to have any future in the Space Corps, and it won't do your score any harm if you put a few ergs into these irritating ice blocks.

Presently the blue bouncers appear and bounce around the screen firing plasma bombs. They can mutate into pods and fall to the bottom of the screen. Occasionally the Tecom Man drifts across the screen dropping droids and large yellow eggs containing bell birds. They are pretty handy with the old plasma bombs too.

You have to zap the whole sorry crew before you delta-vee down to the lunar surface, where you have a choice of difficult and easy landing sites.

Blue Moon is a good example of how traditional games are implemented on the 64 — not original in concept but visually appealing and addictive if you like shoot-em-up games. It is certainly fast.

Matrix

Still in space, and travelling faster than before, we approach the fine-mesh tracery of the Power Grid surrounding planet Earth. Llamasoft's Matrix, implemented by Jeff Minter for the Commodore 64, is the true son of Gridrunner. Minter's original game is claimed to be number 7 in the American popularity stakes. The follow-up is set 10 years after the infamous Grid Wars when space pilots with nerves of steel battled to free the Power Grid of alien infestation.

In Gridrunner the evil droids traversed the grid horizontally; now they come in diagonal waves too. In the original game the X,Y zappers running along two sides of the grid formed pods at the nodes of their crossfire. If you were not caught in the crossfire, the pods would probably obliterate you by hurling a bolt of energy down the grid. It's the same in Matrix, but there is a treacherous humanoid, the Snitch, who runs along the top of the grid pointing you out to the enemy. Camels appear and run down the grid, reducing

your score, and force fields hurl your fire back at you. On the plus side, ship control — achieved by joystick — no longer limits you to the lower regions of the grid; you can move anywhere other than the top four lines.

There are 20 skill levels. The first six are selectable before play and after that you must fight. Action is incredibly fast and furious throughout, and the interminable sounds of cosmic weaponry are well reproduced by the Sid chip. This is essential, if only to drown out the demented screams which people playing this game inevitably emit.

Hover Bover

Back to the green hills of Earth. Since most surviving grid pilots are good for little other than mowing the lawn, it is fitting that we should move on to another Minter extravaganza, Llamasoft's Hover Bover.

It is summer-time in England. Gordon Bennet presumes too much and borrows his neighbour Jim's Air-Mo. But Jim decides he wants his mower back.

The scene is set for a horticultural holocaust in which, using the joystick to manoeuvre Gordon and his mower, you run away from Jim at the same time as your dog Rover fights a rearguard action, snapping at Jim's heels. However, Rover is frightened of the Air-Mo, so monitor Dog Tolerance and Dog Loyalty readouts carefully. If you slice through a flower bed, an angry gardener will join in the chase. The game has 16 different lawns, including one shaped like a llama. As with Matrix, the graphics are good but the sound-track is particularly telling. Mowing, screaming, snapping and barking are well reproduced and a non-stop rendition of *In an English Country Garden* churns on and on.

Caesar the Cat

From Rover the dog to Caesar the Cat, Mirrorsoft's cute game for the Commodore 64. Mirrorsoft is part of Mirror Group Newspapers and you can buy the software via MGN publications or from newsagents, plus the usual commercial outlets. If Caesar is anything to go by, MGN has avoided the mistakes made by some other big companies seeking to break into the home-computing software market.

Caesar is a cheeky young cat on duty in a well stocked larder. There is a joystick/keyboard control option, which you use to guide the furry feline along crowded shelves to pounce on the mice and take them away from the larder through a door which appears at random.

With its Disneyesque graphics and

(continued on page 121)



Grandmaster — the strongest yet?

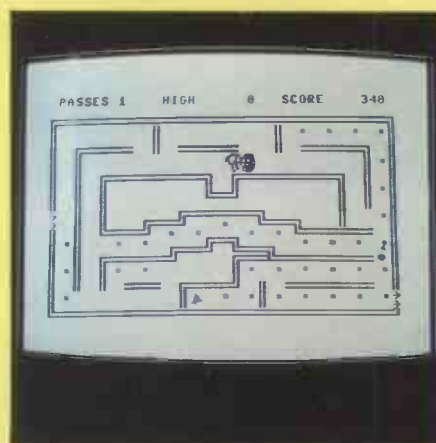

Hungry Horace — for the traditionalist.

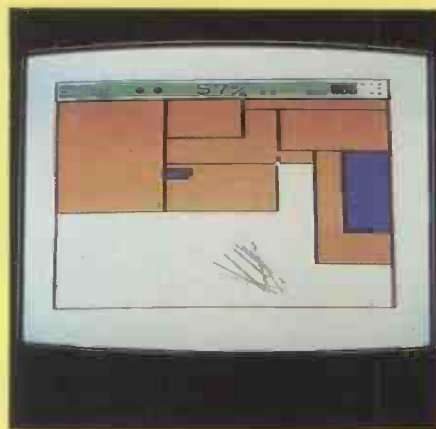

Supersoft's innovative Stix.



You are Bilbo Baggins in Melbourne House's flexible adaptation of J R R Tolkien's tale *The Hobbit*.

A new printer from Epson for letter quality and speed. LQ-1500.



Epson have now launched the LQ-1500 that gives you the best of both worlds, the speed to get the information on paper fast and high quality print you'll be proud of.

The LQ-1500 is a totally new breed of printer. A dot matrix machine capable of 200 CPS in draft mode, which can also be set to produce letter quality at 66 CPS by simply flicking a switch.

Like all Epson products, versatility has been a primary consideration of the LQ-1500, incorporating friction feed as standard with optional tractor and hopper feed, and carriage width of a full 15".

You now have at your fingertips all the advantages of a daisy-wheel machine, in terms of quality, together with the added benefits of condensed or enlarged characters and proportional

spacing, plus a very high speed when set to operate in draft mode.

Having superb graphics capabilities and optional 8 bit parallel (centronics) RS-232 and IEEE interfaces, the LQ-1500 has joined the Epson family of very fine printers.



EPSON

**Extraordinary product.
Exceptional quality.**

Epson (UK) Limited, Freepost,
Wembley, Middlesex HA9 6BR.
Sales Enquiries: Freefone EPSON.
General Enquiries: 01-902 8892.
Telex: 8814169.

- I would like a demonstration of the LQ-1500 printer.
- Please send me details of my local stockist.
- Please send me details of the range of Epson printers.

Name _____

Position _____

Company _____

Address _____

Tel: _____

PC2/P

● Circle No. 161

(continued from page 119)

catchy backing music, the game should appeal to youngsters, but it is also challenging for high-scoring arcade adepts. The concept of keeping the larder free of mice, especially when portrayed so well, seems healthier than murdering encroaching hordes of presumably sentient alien beings. The game is a really excellent use of the Commodore's graphic facilities.

Radar Rat Race

Now from cats to rats. This cartridge-based program seemed the most promising of the bunch. Cartridges cost more than cassettes, and a lot of the games tested did not seem to merit the extra expenditure for the sake of quick loading.

Radar Rat Race, from Commodore, is like a speedy Pacman with windows. As a rat, you race through a continually scrolling maze, pursued by red rats and trying not to bump into cats sitting about in the passageways. If a rat is hot on your trail you can create a false scent by pressing the S key. On the right-hand side of the screen is a small plan of the entire maze, from which you glean where the cheese is hidden. There are 10 cheeses placed throughout the maze. The first is worth 100 points, the second 200 and so on.

There is a joystick/keyboard option and scoring more than 20,000 gives you an extra life. Radar Rat Race was not one of my all-time personal favourites, but it will appeal to maze addicts.

Hungry Horace

Remaining with mazes, we find the voracious Horace — Melbourne House's variation on an Atari theme — still in the park eating flowers and stealing the guards' lunch. The game also scrolls: the park is divided into four sections, each with an exit. Horace exits when he likes, and doesn't have to clear the screen. Each area of the park is tougher than the last. On leaving the last section, you re-enter the first with the action becoming faster and the guards meaner.

This implementation is fine if you are a traditionalist, but hopes remain high that games like this will have more life injected into them in future. Most software houses have so far failed to utilise the extra memory of the 64 to its full extent.

Stix

Atari-like insofar as it bears a passing resemblance to a game called Qix, Stix

from Supersoft has a scenario in which a bundle of energy roams the universe, destroying all in its path. It becomes trapped in a cosmic storm, giving you the chance to harness its evil power for the good of mankind. To control the energy you must restrict its movement by constructing force fields.

This you do by moving four field synthesisers around the screen using your joystick plugged into control port 1. A field can be completed by joining to the boundary of the screen or to another completed force field. If you keep the Fire button depressed, it takes longer to finish a border, but you do score more. When more than 75 percent of the hyperspace has been surrounded by force fields you move into a new dimension and each percent scored above 75 percent scores more points.

A game of strategy, Stix is one of the more original computer games around and its implementation for the 64 has not done it any harm. Mondrian would have loved it.

The Hobbit

Originally implemented by Melbourne House for the Spectrum, this is a computerised Adventure game. It is based on Professor Tolkien's famous yarn about a hairy-footed little creature in conflict with a nasty dragon. Your role is that of the feisty Bilbo Baggins — to discover the evil dragon Smaug and recover the treasure. The delinquent orcs and poor Smeagol cause as much trouble as possible. Help is sometimes available from Gandalf Greyhame, but don't rely on it.

Each different scene in the adventure is colourfully depicted on the screen. Commands can be entered with a great deal of flexibility since the program has a large vocabulary. It recognises over 500 words, and can perform over 50 different actions made up by over 30 verbs, combined with about a dozen prepositions.

Flexibility combined with excellent graphics account for the success of the Spectrum Hobbit. It should be as popular in the Commodore 64 version.

Grand Master

Supposedly the world's strongest chess program yet for home computers, Grand Master was developed by Kingsoft and is distributed by Audiogenic. To begin with you see a chess board with your white pieces, nearer the bottom of the screen. Moves are entered by locating the square from which you wish to move, followed by the square you want to move to, then pressing Return.

The Grand Master displays its thoughts in the form of plys. A ply is one move for one side. If you look to the letter P, you can see how many plys deep the analysis is. So P3 means that the program has analysed one move from itself, one from you, and its own again.

If you key in an illegal move, the computer will not accept it, so the program is a useful chess tutor too. You can have response times from five seconds up to several days, the latter for postal chess. Since the original version of this game will run happily on a Vic-20, perhaps we can look forward to an even stronger program in the future.

Soccer

Leaving the rarified intellectual atmosphere of the chess competition I donned my Pierre Cardin football-terrace-chic pullover and had a quick kick around with the Commodore three-dimensional football game.

The game stands alone as an example of what can be done with the 64. Brilliant graphics show the players from a BBC camera angle. You can select the colours you wish to play in. Two people can play using a pair of joysticks. At any time the man nearest the ball is under joystick control. There is an option enabling you to play against the computer but, as usual, it cheats.

There are some nice touches, such as the way the players troop off at half-time. The ball even casts a shadow, and makes a realistic boinking noise as it bounces around. But as any footballer will tell you, it's the roar of the crowd that makes it all worthwhile. 

Game	Publisher	Price	Rating
Blue Moon	Merlin Software	£6.50	14/20
Matrix	Llamosoft	£7.50	15/20
Hovver Bover	Llamosoft	£7.50	16/20
Caesar the Cat	Mirrorsoft	£8.95	17/20
Radar Rat Race*	Commodore	£9.99	12/20
Grand Master	Kingsoft/Audiogenics	£17.95	16/20
Soccer	Commodore	TBA	18/20
Hobbit	Melbourne House	£14.95	16/20
Hungry Horace	Melbourne House	£5.95	13/20
Stix	Supersoft	£7.78	14/20

*Radar Rat Race is supplied on cartridge

Why all other spread

In the early days of micros, the first spreadsheets appeared, using complicated cell co-ordinate references to define plans.

This made the most of limited computing power but plans were tricky to write, and difficult to read later.

Today's micros are much more sophisticated but all the spreadsheets are more or less the same as they always were. All that is, except PlannerCalc and MasterPlanner. Described in a recent university report as "... the best spreadsheet package currently on the Market," PlannerCalc and MasterPlanner are true business aids.

Dyed in the wool calc freaks won't like them but businessmen will.

NEW USERS START HERE

PlannerCalc at £85.00* is now accepted as the first choice for people new to financial planning.

Designed for 8-bit micros, it boasts the kind of features that you'd expect to pay twice as much for. (Buy PlannerCalc's nearest rival and you'll have to.)

Unlike all other 'calc' products it allows you to enter calculations in a language you understand. Plain English.

For example:

LINE 1 SALES=100,150,175,210
 LINE 2 EXPENSES=GROW 70 BY 15% FOR 4
 LINE 3 NET=SALES-EXPENSES
 LINE 4 CSALES=CUM SALES
 COLUMN 5 YEAR=SUM OF COL 1 THRU COL 4

So it's much easier to use.

It uses the popular "spreadsheet" approach with a window that can be rolled in all directions.

Which means you can enter new figures and rules and

immediately see their effect on everything else in the model.

It comes with the best manual on the market and it's suitable for most micros with a TMCP/M 2.2 operating system, 64K of memory, giving at least 900 cells, minimum screen width of 80 characters and 2 floppy disc drives.



MUCH MORE POWER, NOT MUCH MORE MONEY

MasterPlanner is the most powerful spreadsheet system currently available with its increased matrix size, 2000-3000 cells on most 64K micros. (But at £245* it certainly isn't the most expensive.)

Consolidation of models, allows you to create separate plans for each department and then combine them into an overall company

COMSHARE DEALERS

Aberdeen Aberdeen Ltd (0272) 717442	Translec Ltd (0272) 717442	Gosport Tandberg Ltd (0239) 235846	Datameer Ltd 01 343 0273	Sheep Terminal Ltd 01 343 0273	Richmond French Computer Services 01 548 4213
Aldershot EMS (UK) Ltd (0251) 719551	Bury St Edmunds S.I.R.C. Ltd (0284) 62022	Graintham The Soft Option (0476) 860179	Demio Computer Systems Ltd 01 670 4202	Stanton Ltd 01 661 2766	Rutland Microscopic Ltd (0577) 2528
Aldershot Associated Computer Services (0251) 941 4225	CPS (Data Systems) Ltd (021) 707 3866	Hampstead 01803 118	Corporate Modelling Consultants 01 678 4107	Summit Bondair Ltd 01 250 0925	Slough KGA Micros Ltd (75) 38561
Aylesbury Intrac Systems Ltd (0296) 630368	Cambridge Alexander Systems Ltd (0216) 789771	Haslemere 885 Computer Services Ltd (0424) 439130	Dartford Ltd 01 519 1004	Sunbeam Computers Ltd 01 802 6132	Southampton Kean Systems Ltd (0703) 30746
Barnsley Brook Office Supplies Ltd (01256) 88916	Cambridge Business Computers (0223) 50200	Hemel Hempstead Homesoft Computers Ltd (0432) 739804	DNR Computer Systems Ltd 01 839 8358	Whelan Ltd 01 566 9151	St Albans St Albans Computer Services Ltd (0277) 37708
Bedford MSC Midland Ltd (0234) 502760	Canterbury Kemi Micro Systems (0223) 50200	Hereford Merrill Lynch Business Systems Ltd (0432) 50386	Equinox Computers Ltd 01 739 2387	Malvern Malvern Micro Systems (0549) 68500	St Helier The Processor Centre (0534) 77070
Bentley Computers Computer Sales Ltd (0234) 59961	Cardiff Business Computer Services Ltd (0222) 90876	High Wycombe Mulligh Business Systems Ltd (0494) 47450	Ferran Software Ltd 01 751 5791	Marlborough Celer Systems Ltd (0753) 70636	Thames & Company Ltd 01 81723
Birmingham Computec (UK) (021) 336 3455	Chesham Medway Computers Ltd (0634) 676000	Huddersfield Micrologics Systems (0484) 47450	Interlec 01 683 0268	ICB Ltd (0275) 702113	West Byfleet Ferguson Computers Ltd (91) 41810
Birmingham B.C. Systems Services Ltd (0254) 677215	Chesham Medway Computers Ltd (0634) 676000	Ilminster Anglo Microsystems (0449) 740046	Jarvis Ltd 01 671 6321	ICB Ltd 01 679 4321	West Drayton Fraser Ltd 01 81723
Bristol Aron Micros enter Systems Ltd (0274) 668890	Chesham Medway Computers Ltd (0634) 676000	Leamington Spa Words Ltd (0526) 32029	Marlar Business Systems Ltd 01 688 3836	Mains Electronics Ltd 01 373 6607	Weston Super Mare Expens Ltd (0934) 418346
Bristol E.C.E. (Europe) Ltd (0454) 371088	Chesham Medway Computers Ltd (0634) 676000	Leicester Leicester Micro Centre (0533) 551869	MCI Systems Ltd 01 439 9637	Mannings Automation Ltd (0203) 6641	Weybridge Kean Systems Ltd (91) 50346
Bristol Meridian Computer Systems Ltd (0272) 71079	Chesham Medway Computers Ltd (0634) 676000	Leicester Leicester Micro Centre (0533) 551869	Micros International Ltd 01 263 6026	Milton Keynes Practical Data Systems Ltd (0528) 614242	Wick Wick Computer Systems Ltd (0962) 52559
	Chesham Medway Computers Ltd (0634) 676000	Leicester Leicester Micro Centre (0533) 551869	Modular Business Systems Ltd 01 504 0403	Quaker Choice Business Systems (0951) 2697	Yafford Globe Business Machines 0934 835277
	Chesham Medway Computers Ltd (0634) 676000	Leicester Leicester Micro Centre (0533) 551869	P.W. Hare & Associates 01 551 0888	Raploch V. J. Partners Associates 0266 74 9978	Thorn Data Computer Systems Ltd (0955) 7000
	Chesham Medway Computers Ltd (0634) 676000	Leicester Leicester Micro Centre (0533) 551869	Archives D.B. Ltd. 01 223 1688	Redcar Applesoft (0642) 474707	
	Chesham Medway Computers Ltd (0634) 676000	Leicester Leicester Micro Centre (0533) 551869	Software Ltd 01 307 9927		

...sheets are out of date.

plan. Data transfer to word processing and other systems lets you incorporate figures in reports and output to a data base. It also has extensive formatting facilities which means you can produce reports that wouldn't look out of place in the board room.

It can store up to 25 standard reports to run when you need them. It's got full WHAT IF? analysis and direct editing of both spreadsheet and logic display.

JUST AS EASY TO USE

All this increased power doesn't mean you'll need a degree in advanced computing to understand MasterPlanner.

It works on exactly the same system as PlannerCalc and models written on PlannerCalc run without modification on MasterPlanner.

16 BIT VERSION

A new version of MasterPlanner has been specifically designed for the 16 bit micros like the Sirius 1 under TMCP/M-86 or the IBM personal using either CP/M-86 or TMMS DOS 1.1. With a vast matrix size of over 7000 cells on 128K and even more with larger memory, you'll at last be able to make the most of your micro.

ULTIMATE POWER

Fastplan is the top Comshare micro planning system.

It's file-based, allowing development of large scale models; with a staggering 18,000 cell matrix; full financial functions plus backwards iteration, file input and output; and much more. Yet, because it can be menu driven it is easy to use. For the full story, tick the Fastplan box when you return the coupon.

OVER 10 YEARS EXPERIENCE

When you invest in MasterPlanner or PlannerCalc you're not just getting the best software money can buy.



You're also getting the kind of back up and after-sales service that only a company of Comshare's track-record can guarantee.

If you'd like to know more about any product, call in at your local dealer or fill in the coupon and send it to us.

*Plus VAT and post & package.

COMSHARE

Making the computer make sense.

*CP/M and TMCP/M-86 are the registered trade marks of Digital Research Inc. Comshare Ltd., 32-34 Great Peter Street, London SW1P 2DB. Telephone: 01-222 5665.

To: Department 10 PC, Comshare Ltd., 32-34 Gt. Peter Street, London SW1P 2DB
Please send me:

Qty	Product	Micro	Op System	Disc Size	K	Amount £ p.
	PlannerCalc @ £99.50 (8 bit only)		CP/M 2.2	8"5/4"		
	MasterPlanner @ £282.95		CP/M 2.2	8"5/4"		
	MasterPlanner	IBM PC	MS DOS 1.1	8"5/4"		
	MasterPlanner		CP/M-86	8"5/4"		

All prices include VAT and postage & packing TOTAL

Please send me information about Fastplan

I enclose a cheque/postal order for £ _____ made payable to Comshare Ltd.

Please debit my Access Card No. _____ for £ _____

 Barclaycard No. _____ for £ _____

Signature _____

Name _____

Address _____

Tel. No. _____

Please allow 28 days for delivery. VAT No. 238418649. Registered No. 980406.

Comshare reserve the right not to accept any orders. Any acceptance will be subject to Comshare's terms and conditions.

● Circle No. 142

LONDON COMPUTER CENTRE

8/16 bit SOFTWARE

The comprehensive range includes

WORDSTAR £235	D BASE II £349
SUPERCALC II/III £190	SPELLING CHECKER £80
WORD PROCESSING £	LANGUAGES £
Spellbinder 290	MBasic 215
Peach Pack* 332	MBasic Compiler 235
Spellstar 134	C Compiler 330
Mailist 50	Fortran 80 86 325
Grammatik 85	Cis Cobol/Forms2 399/105
FINANCIAL PLANNING	Pascal MT+ 240
Plannercalc 85	Pascal MT+*SSP 350
Supercalc I 130	ACCOUNTING
Multiplan 170	Pegasus from 250
Lotus 1-2-3 357	Peachtree from 325
D BASE CORNER	Tabs from 199
FastBase 150	Exact 500
Autocode 195	Pulsar from 195
Quickcode 205	COMMUNICATIONS
Dgraph 190	Bstam 130
Friday 185	Crosstalk 135
Infostar 266	Moveit 80/86 90/105
UTILITIES	*Incl. PeachSpell/Mailist
Sid £60, ZSid £76.	Please telephone for the
Mac £133	LCC Software Catalogue

FORMATS: Superbrain, Televideo, Sirius, Sanyo, Osborne Northstar, 8" SD, DEC, Epson QX-10, IBM ICL, H-P, XEROX, ALTOS, Apricot, NEC-APC & many more
All prices are exclusive of VAT

New! The fast and easy way to generate your own dBase 11 Applications programs – use fastBase. £150.

- * only fastBase allows 7 index files per data base, all others allow 1 index file
- * only fastBase allows report generation on 3 files others 1 file
- * fastBase Structures Command files with indentations allowing maximum speed in execution
- * fastBase uses a series of on-screen prompts and Help Menus to lead you through the process of generating your own dBase 11 Command files.

Demonstrations on all software daily – call in or order by mail.

43 Grafton Way, London W1P 5LA (Opposite Maples)

Opening Hours: 10-7 Mon-Fri. 12-4 Sat.

01-387 4455 (4 lines) Telephone Answering Service After Office Hours

Telex: 8953742

● Circle No. 165

ELBUG — ELBUG — ELBUG — ELBUG — ELBUG — ELBUG — ELBUG — ELBUG — ELBUG — ELBUG

ORBIT FOR THE ACORN ELECTRON

IF YOU HAVE AN ACORN ELECTRON OR ARE THINKING OF BUYING ONE THEN YOU SHOULD JOIN THE ELECTRON USER GROUP.

Members receive 10 copies of the magazine ELBUG each year. ELBUG is devoted EXCLUSIVELY to the ELECTRON MICRO. It is packed with news, Reviews, Hints, Tips, Programming ideas, Major articles, plus Regular program features including games and useful utilities.

ELBUG is produced by BEEBUG Publications Ltd., publishers of BEEBUG, the magazine of the National User Group for the BBC Micro. BEEBUG now has some 20,000 members, and has achieved a high reputation both in this country and abroad. Acorn and the BBC have both taken out multiple memberships, for example, and our articles are now syndicated in Australia. (For further details of BEEBUG, see separate advertisement elsewhere in this issue.)

The formula which makes BEEBUG an invaluable companion for users of the BBC micro will be applied to ELBUG.

By subscribing to ORBIT you gain all the advantages of a single-micro magazine, with no space wasted on programs and articles for other computers.

Further benefits of membership:

Members' discount scheme with national retailers of software, hardware and books, with savings of up to 25%.

Members' software library with a growing range of titles at special prices for members.

SPECIAL OFFER

SUBSCRIBE NOW, AND GET A FREE INTRODUCTORY CASSETTE CONTAINING 8 TESTED PROGRAMS FOR THE ELECTRON.

1. **SPACE CITY** Defeat the invading Aliens with your laser, and save the city.
2. **3D NOUGHTS AND CROSSES** Pit your wits against the ELECTRON on a 4x4x4 board.
3. **RACER** Guide your racing car to victory, avoiding other cars and obstacles on the track.
4. **3D MAZE** In this challenging game, you must escape from the maze — The screen displays a 3D view from inside the maze.
5. **PATCHWORK** A multicoloured display of continuously changing patterns.
6. **KEY SET ROUTINE** A program to set up the user function keys.
7. **MEMORY DISPLAY** An efficiently written utility to display the contents of memory (ROM and RAM).
8. **CHARACTER DEFINER** Define individual graphics characters with this useful utility for use in your own programs.

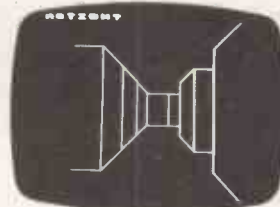

BEEBMAZE



RACER



SPACE CITY

HOW TO JOIN

To subscribe for one year, and get your free cassette, send £9.90 (payable to Orbit) plus a strong stamped addressed envelope (for the cassette) to:

ORBIT, PO BOX 109, High Wycombe, Bucks HP11 2TD

SIX MONTH TRIAL SUBSCRIPTION (5 ISSUES) UK ONLY £5.90 — FREE CASSETTE OFFER STILL STANDS.

Membership outside UK (one year only): Fire and Europe £16, Middle East £19, America & Africa £21, other countries £23.

Editorial address BEEBUG Publications, PO Box 50, St Albans, Herts, AL1 2AR

● Circle No. 166

GRAFPAD

THE AFFORDABLE TABLET

**£125
+ VAT**



**FOR
YOUR BBC
MICRO**

ADAPTORS FOR OTHER HOME COMPUTERS TO FOLLOW ...

BRITISH MICRO

A HEGOTRON GROUP COMPANY

British Micro, Penfold Works, Imperial Way, Watford, Herts. WD2 4YY Tel: Watford (0923) 48222/43956

Qty	Item	Item Price	Item Price inc VAT	Totals
	Grafpad complete	£125.00	£143.75	
	C.A.D. Program	£18.00	£20.70	
	IMPORTANT!!! Tick Below	Postage & Packing		£5.00
	BBC MODEL 2 SINCLAIR SPECTRUM COMMODORE 64		Total	

To: British Micro, Unit Q2, Penfold Works, Imperial Way, Watford, Herts WD2 4YY

I enclose cheque/PO Order £ ● Circle No. 263

Please charge my ACCESS/BARCLAYCARD/AMERICAN EXPRESS/DINERS CLUB

Card No.

Signature

Name

Address

Tel. No.

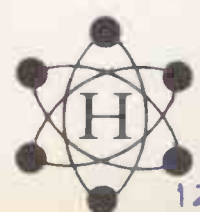

The new Argus Above all, a true



Pro-personal. 16-bit computer.

On performance alone, the new Argus Pro-personal computer is way above the rest.

It's a true 8086-based 16-bit machine. And it's fast—8MHz.

Our Argus Pro-personal also gives you a choice of backing store from floppy right up to big Winchester, and memory up to 896K.

So you've got the capacity and speed for professional-sized programs, and that means savings in expensive professional time.

A NEW WORLD OF SOFTWARE

Running industry-standard CP/M-86[†], the Argus Pro-personal opens your door wide to a vast array of 16-bit application software.

Ferranti also supplies software packages for major applications such as word processing and spreadsheet calculations. Of course the Argus Pro-personal can also run your existing 8-bit software.

It adds up to all the power and capacity you need. Benchmark tests have proved it outperforms its competitors.

A COMPLETE PACKAGE PUTS YOU ONE UP

Right from the start the Argus Pro-personal gives you what you want. CP/M-86[†] and BASIC are included. So is 128K of memory—and it's all available to you because the VDU has its own memory for both alphanumerics and high resolution graphics.

Check this out against the competition.

A COMPUTER WITH THE HUMAN TOUCH

For all its professionalism, the Argus Pro-personal computer is easy to live with. It's user-friendly in every way. Compact and good

looking, with clear characters on an anti-reflective screen. The VDU tilts and swivels, and the keyboard, VDU and processor box can be placed to suit the operator.

CP/M-86[†] is menu-driven so it's easier to use.

IF YOU'RE LAUNCHING AN AUTOMATED OFFICE

The Argus Pro-personal with the rest of the Ferranti office product range allows access to mainframe computers, so if you want it to be part of a general office automation scheme, there's no problem.

YOU'RE ON FIRM GROUND WITH FERRANTI

Behind the Argus Pro-personal computer, a product at the leading edge of a fast moving technology, is a company with over 20 years in the computer business.

Ferranti has an unsurpassed reputation for quality assurance and reliability.

So, your investment is protected for the longest possible time. And you get a first-class maintenance service to back it up.

For a high-flying computer the Argus Pro-personal price tag is remarkably low level. It starts at just £2,800.

Ferranti Computer Systems Limited,
Simonsway, Wythenshawe,
Manchester M22 5LA.
Telephone: 061-499 3355, Telex: 668084

FERRANTI

Computer Systems

Please show me how the Ferranti Argus Pro-personal computer can serve my computing needs.

Name _____

Position _____

Company _____

Address _____

Telephone _____ Telex _____

Ferranti Computer Systems Limited,
Simonsway, Wythenshawe
Manchester M22 5LA.

127



CLEARLY A BETTER WAY TO VIEW THE FACTS IN BUSINESS

GET BREAKDOWN OF BOILER CONTROL EQUIPMENT MANUFACTURERS

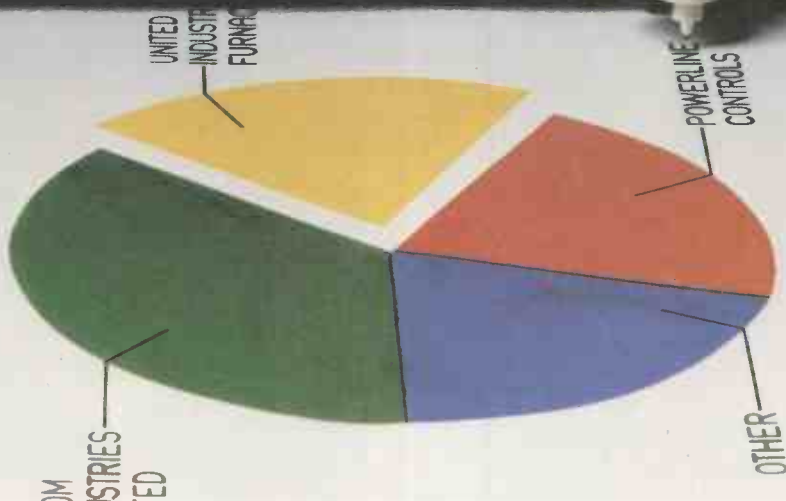

Now you can transform even the most obscure facts into high-quality, multi-colour A4 sheets or overhead projection transparencies, making the Pixy Plotter the ideal aid for all kinds of business presentation.

With the new 3-pen Pixy Plotter you can turn your facts and figures into meaningful pie charts, flow charts, bar graphs, even circles, arcs and spirals easily and quickly.

And with the automatic pen change you can achieve up to 8 brilliant colours to create an extra dimension for reports and presentations.

With its sleek, compact design, it's the ideal companion for any popular

desktop micro, only requiring standard available software to drive the plotter.

Its low cost now puts professional quality plotting within the reach of even the smallest of businesses.

There's never been a better way to put colourful pen to paper (or film).

Why not get a fuller picture of what the new Pixy Plotter can do, from your nearest distributor or send for our free colour brochure.

Mannemann Tally Limited,
Molly Millars Lane, Wokingham,
Berkshire RG11 2QT. Tel: (0734) 788711.
Telex: 847028.

● Circle No. 169

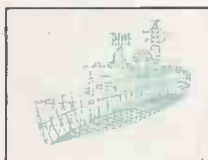
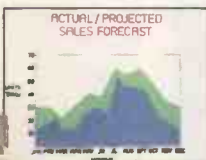

MANNESMANN TALLY

PIXY PLOTTER

CREATING THE RIGHT IMAGE FOR BUSINESS

>OPEN FILE

PRACTICAL COMPUTING FEBRUARY 1984

Open File monitors

Apple John Harris
Atari Jack Schofield
BBC Nicholas McCutcheon
Commodore Mike Todd
Dragon Ian Stobie
Epson HX-20 John Wellsman
IBM PC Jack Schofield
Newbrain David Watt
Tandy John Wellsman
Research Machines Ian Stobie
Sharp John Hooper
Sinclair John Wellsman

Open File is the part of the magazine written by the readers of *Practical Computing*. All aspects of microcomputing are covered, from games to serious business software and utilities. Fully-debugged programs can be submitted for any micro, and for standard CP/M machines such as the Osborne and Superbrain. Programs can be in machine code or any language, including Forth and Pascal.

Submissions should include a brief description which explains what your program does, and how it does it. If possible it should be typed, with lines double-spaced. We need a printed program listing. Hand-written listings cannot be accepted. A tape or disc of the program helps if it is in a standard format.

When printing listings, please remember to use a new ribbon or double-intensity printing — faint listings reproduce badly. Use plain paper only, and try to list the program across either a 35-character or a 70-character width. Also, make sure all special graphics or inverse-video characters are either listed correctly or else include Rem statements to explain them fully.

Each program listing, tape or disc must have your name and address on it, or we cannot promise its safe return. A stamped addressed envelope is appreciated.

If you write in with a comment, correction or enquiry please remember to state the machine and the program title.

We pay at least £10 for any programs used, or £35 per page and pro rata for part pages.

>BBC

130 SENSATIONAL SIMON
An implementation of the well known memory game.

130 CALCULATOR
In John Humphreys' arithmetical puzzle the computer provides the numbers while you guess which operators link them together.

>COMMODORE

137 TRANSFERRING PROGRAMS
Mike Todd's programming guidelines and Basic patches will help you convert Pet software for use on the Commodore 64.

137 CATALOGUING DISCS
L V Turner's compact utilities, suitable for both Basic 4 and Basic 2, catalogue your disc files.

138 BOMBING MONSTER
This arcade game illustrates Vic-20 graphics-programming techniques which help add that touch of excitement.

>NEWBRAIN

139 SCREEN DUMP
A Atkins' routine demonstrates how to address memory for the currently open screen.

139 CARD INDEX
Search through a set of electronic record cards and print the result.

139 RENUMBER
The absence of this useful function can be remedied with A R Armitstead's routine.

140 BRAIN-MAN
A fast and furious combination of maze, monster and power pills.

>SHARP

145 HIDDEN LINES
How program lines may disappear from a listed program, but be implemented by the interpreter when the program is run.

145 THE NULL-INPUT PROBLEM
Pressing Return in response to the Input prompt can make a nasty mess of carefully formatted screen output; this routine keeps things tidy.

>TANDY

146 GRAPH PLOTTER
This Basic program will plot from Data statements or tape or disc files.

146 CODE BREAKER
A logic puzzle after the classic Mastermind game.

>APPLE

149 SHOOT-OUT
Dodge the approaching invaders in D Turnbull's game.

150 SCREEN FORMATTER
Save instructions or text as binary files to be formatted for display.

>ATARI

152 DISC SAVER
With H M Hoffman's routine you can recover a deleted file.

152 PAINTER
Chris Simon's maze game requires 16K of RAM and a joystick.

>SINCLAIR

155 SCRUBBER
How to reserve space and load machine code.

155 VOCABULARY
Test your knowledge of a foreign language.

Send your contribution to:

Open File, Practical Computing,
Quadrant House, The Quadrant,
Sutton, Surrey SM2 5AS

Sensational Simon

```

10 REM @@@@@@@@@@@@@@@@@@
20 REM @@@@@@ SIMON @@@@@@
30 REM @ by D.Whitworth @
40 REM @ 23rd JULY 1983 @
50 REM @@@@@@@@@@@@@@@@@@
60
70 high%=0
80 DIM A%(100)
90 DIM B%(4)
100 FOR L=1 TO 4
110 B%(L)=L*20
120 NEXT L
130 ON ERROR GOTO 9000
140 *FX4,1
150 *TV255
160 MODE 7
170 PROCCOFF
180 PROCINSTR
190 MODE 2
200 PROCCOFF
210 PROCDRAWSCRN
220 REPEAT
230 PROCDLY(30)
240 PROCGAME
250 UNTIL again$="n" OR again$="N"
260 MODE 7
270 *FX4
280 END
290
300
1000 DEF PROCINSTR
1010 FS=CHR$(141)+CHR$(131)+CHR$(157)+CHR$
132
1020 TT$=FS+"SIMON "+CHR$(156)
1030 PRINT TAB(13,0);TT$;TAB(13,1);T
TS
1040 PRINT TAB(5,4);"Simon is a game
of memory.";"The computer repeats a
sequence by""playing notes and flash
ing boxes on the""screen and you mus
t try to copy this by""pressing the
cursor keys in the correct""order."
1050 PRINT""Each time you get it rig
ht the computer""will add one more n
ote and repeat the""sequence. 600
D LUCK"
1060 PRINT""TAB(6)"PRESS THE SPACE B
AR TO START"
1070 REPEAT UNTIL GET=32
1080 ENDPROC
1090
1100
2000 DEF PROCDRAWSCRN
2010 CLS
2020 PROCSQUARE(7,50,50,850)
2030 PROCSQUARE(4,100,100,350)
2040 PROCSQUARE(3,500,100,350)
2050 PROCSQUARE(1,100,500,350)
2060 PROCSQUARE(2,500,500,350)
2070 PRINT TAB(15,5)"SCORE"
2080 PRINT TAB(16,14)"HIGH"
2090 PRINT TAB(15,15)"SCORE"
2100 ENDPROC
2110
2120
3000 DEF PROCGAME
3010 PRINT TAB(0,31);STRING$(19," ")
;
3020 PRINT TAB(17,7);"0 "
3030 PRINT TAB(17,17);high%
3040 CX=0
3050 CX=CX+1
3060 A%(CX)=RND(4)
3070 FOR G=1 TO CX
3080 PROCSOUNDS(A%(G))
3090 NEXT G
3100 *FX15,1
3110 pplayer%=0
3120 REPEAT pplayer%=pplayer%+1
3130 REPEAT
3140 A=GET
3150 UNTIL A>135 AND A<140
3160 PROCSOUNDS(A-135)
3170 UNTIL pplayer%=CX OR A-135<>A%(p
layer%)
3180 IF A-135<>A%(pplayer%) THEN PROC
ERROR:ENDPROC
3190 PRINT TAB(17,7);CX;" "
3200 IF CX>high% THEN COLOUR 9:PRINT
TAB(17,17);CX;high%=CX:COLOUR 7
3210 PROCDLY(10)
3220 GOTO 3050
3230
3240
4000 DEF PROCSOUNDS(FX)
4010 VDU 19,FX,0,0,0,0
4020 SOUND 1,-10,BX(FX),2
4030 PROCDLY(3)
4040 VDU 19,FX,FX,0,0,0
4050 PROCDLY(5)
4060 ENDPROC
4070
4080
5000 DEF PROCERROR
5010 SOUND 1,-15,0,30
5020 SOUND 2,-15,0,30
5030 SOUND 3,-15,0,30
5040 PRINT TAB(0,31);"ANOTHER GAME (
Y/N)?";
5050 REPEAT
5060 again$=GET$
5070 UNTIL again$="n" OR again$="y"
OR again$="N" OR again$="Y"
5080 ENDPROC
5090
5100
6000 DEF PROCDLY(dy)
6010 FOR wait%=1 TO dy*100
6020 NEXT wait%
6030 ENDPROC
6040
6050
7000 DEF PROCCOFF
7010 VDU 23,11,0,0,0,0
7020 ENDPROC
7030
7040
8000 DEF PROCSQUARE(col%,xstart%,yst
art%,side%)
8010 GCOL 0,col%
8020 MOVE xstart%,ystart%
8030 PLOT 80,side%,0
8040 PLOT 81,-side%,side%
8050 PLOT 81,side%,0
8060 ENDPROC
8070
8080
9000 *FX4
9010 IF ERR=17 THEN 140
9020 MODE7
9030 REPORT
9040 PRINT" at Line ";ERL

```

THE COMMERCIAL memory game Simon has been capturing young people's attention. The idea is to repeat a sequence in which the computer plays a series of notes while lights flash in four coloured boxes, each of which corresponds to a particular note. The player uses the cursor keys to simulate the pattern.

Each time the sequence is completed correctly one note is added to the length. If you can get as far as 20 notes then you are

doing pretty well — though I do know someone who has got as far as 33 notes.

Calculator

So-called calculator programs can either be calculator simulators or fun programs where you have to guess the correct answer to a number of questions. J Humphreys' program is of the latter type.

The only restriction on how many questions you may be asked is the number that will fit on a screen, in this case 20. You have all the usual options of addition, subtraction, multiplication and division. When you have guessed all that you feel able to, you are presented with a score as a percentage, and a congratulatory word.

On the whole this is quite an enjoyable little program. Its screen presentation is let down only by the white on yellow prompts.

```

10 REM *****
20 REM *** CALCULATOR ***
30 REM ** By J.Humphreys **
35 REM *** (C) 5/7/83 ***
40 REM *****
50 REM INTRODUCTION PAGE
55 ON ERROR RUN
60 MODE 7
70 VDU 23,11,0,0,0,0
80 FOR A=1 TO 25
90 PRINTCHR$(134);CHR$(157)
100 NEXT A
110 PRINT TAB(14,4);CHR$(129);CHR$(1
41);"CALCULATOR"
120 PRINT TAB(14,5);CHR$(129);CHR$(1
41);"CALCULATOR"
130 PRINT TAB(13,6);CHR$(132);"====
====="
140 PRINT TAB(11,8);CHR$(133);"THIS
PROGRAM ASKS"
150 PRINT TAB(10,11);CHR$(133);"YOU
WHICH SUMS YOU"
160 PRINT TAB(12,14);CHR$(133);"REQU
IRE AND HOW"
170 PRINT TAB(13,17);CHR$(133);"MANY
OF EACH"
180 PRINT TAB(2,2);CHR$(130);"*****
*****"
190 PRINT TAB(2,22);CHR$(130);"***
*****"
200 PRINT TAB(6,23);CHR$(135);"PR
ESS"
210 PRINT TAB(12,23);CHR$(132);"SPA
CE"
220 PRINT TAB(18,23);CHR$(135);"BAR
TO CONTINUE"
230 B=GET
240 IF B<>820 THEN 230 ELSE 260
250 REM SELECTION PAGE
260 MODE 7
270 VDU 23;8202;0;0;0;
280 FOR c=1 TO 25
290 PRINTCHR$(131);CHR$(157)
300 NEXT C
310 PRINT TAB(12,7);CHR$(132);"WHICH
SUMS DO"
320 PRINT TAB(8,8);CHR$(132);"YOU WA
NT (1,2,3 or 4) ?"
330 PRINT TAB(32,9);CHR$(134);CHR$(1
36);" "
340 PRINT TAB(2,2);CHR$(129);"*****
*****"
350 PRINT TAB(2,22);CHR$(129);"****
*****"
360 FOR T=1 TO 1000:NEXT T
370 PRINT TAB(12,12);CHR$(129);"1"
380 PRINT TAB(14,12);CHR$(130);"ADDI
TION"
390 FOR T=1 TO 1000:NEXT T
400 PRINT TAB(12,14);CHR$(129);"2"
410 PRINT TAB(14,14);CHR$(133);"SUBT
RACTION"
420 FOR T=1 TO 1000:NEXT T
430 PRINT TAB(12,16);CHR$(129);"3"
440 PRINT TAB(14,16);CHR$(134);"DIVI

```

```

SION"
450 FOR T=1 TO 1000:NEXT T
460 PRINT TAB(12,18);CHR$(129);"4"
470 PRINT TAB(14,18);CHR$(135);"MULT
PLICATION"
480 VDU 31,34,8
490 VDU 23;8202;0;0;0
500 INPUT D
510 IF D=1 THEN 830
520 IF D=2 THEN 1610
530 IF D=3 THEN 2410
540 IF D=4 THEN 3230
550 GOTO 260

1000 PRINTTAB(14,18);CHR$(133);CHR$(1
36);"MORE THAN"
1010 PRINTTAB(15,20);CHR$(133);CHR$(1
36);"20 SUMS"
1020 VDU 31,29,14
1030 VDU 23;8202;0;0;0
1040 INPUT F
1050 IF F<1 OR F>20 THEN 570 ELSE 107
0

1060 REM ADDITION SUMS

1070 MODE 7
1080 VDU 23;8202;0;0;0;
1090 FOR I=1 TO 25
1100 PRINTCHR$(131);CHR$(157)
1110 NEXT I
1120 PRINTTAB(2,2);CHR$(129);"*****
*****"
1130 PRINTTAB(2,22);CHR$(129);"*****
*****"
1140 PRINTTAB(15,4);CHR$(130);CHR$(14
1);"ADDITION"
1150 PRINTTAB(15,5);CHR$(130);CHR$(14
1);"ADDITION"
1160 PRINTTAB(14,6);CHR$(134);"=====
=====
1170 LET J=-1
1180 LET K=0
1190 LET J=J+1
1200 IF J=10 THEN 1390
1210 IF J=F THEN 4010
1220 LET L=RND(99)
1230 LET M=RND(99)
1240 LET N=L+M
1250 PRINTTAB(3,J+9);CHR$(133);L
1260 PRINTTAB(6,J+9);CHR$(133);"+
1270 PRINTTAB(8,J+9);CHR$(133);M
1280 PRINTTAB(11,J+9);CHR$(133);"="
1290 VDU 31,14,J+9
1300 VDU 23;8202;0;0;0
1310 INPUT 0
1320 IF 0=N THEN 1360
1330 PRINTTAB(17,J+9);CHR$(129);"X"
1340 SOUND 1,-15,0,10
1350 GOTO 1190
1360 LET K=K+1
1370 SOUND 1,-15,150,10
1380 GOTO 1190
1390 LET J=-1
1400 LET F=F-10
1410 LET J=J+1
1420 IF J=F THEN LET F=F+10:GOTO 4010
1430 LET P=RND(99)
1440 LET Q=RND(99)
1450 LET R=P+Q
1460 PRINTTAB(21,J+9);CHR$(132);P
1470 PRINTTAB(24,J+9);CHR$(132);"+
1480 PRINTTAB(26,J+9);CHR$(132);Q
1490 PRINTTAB(29,J+9);CHR$(132);"="
1500 VDU 31,32,J+9
1510 VDU 23;8202;0;0;0
1520 INPUT S
1530 IF S=R THEN 1570
1540 PRINTTAB(35,J+9);CHR$(129);"X"
1550 SOUND 1,-15,0,10
1560 GOTO 1410
1570 LET K=K+1
1580 SOUND 1,-15,150,10
1590 GOTO 1410

1600 REM NUMBER OF SUBTRACTION SUMS

1610 MODE 7
1620 VDU 23;8202;0;0;0;
1630 FOR E=1 TO 25
1640 PRINTCHR$(134);CHR$(157)
1650 NEXT E
1660 PRINTTAB(13,4);CHR$(132);CHR$(14
1);"SUBTRACTION"
1670 PRINTTAB(13,5);CHR$(132);CHR$(14
1);"SUBTRACTION"
1680 PRINTTAB(12,6);CHR$(135);"=====
=====
1690 PRINTTAB(16,8);CHR$(129);"HOW MA
NY"
1700 PRINTTAB(14,10);CHR$(129);"SUBTR
ACTION"

1710 PRINTTAB(16,12);CHR$(129);"SUMS
DO"
1720 PRINTTAB(14,14);CHR$(129);"YOU R
EQUIRE ?"
1730 PRINTTAB(27,15);CHR$(131);CHR$(1
36);"
1740 PRINTTAB(2,2);CHR$(130);"*****
*****"
1750 PRINTTAB(2,22);CHR$(130);"*****
*****"
1760 FOR T=1 TO 1000:NEXT T
1770 PRINTTAB(13,16);CHR$(133);CHR$(1
36);"REMEMBER NO"
1780 PRINTTAB(14,18);CHR$(133);CHR$(1
36);"MORE THAN"
1790 PRINTTAB(15,20);CHR$(133);CHR$(1
36);"20 SUMS"
1800 VDU 31,29,14
1810 VDU 23;8202;0;0;0;
1820 INPUT F
1830 IF F<1 OR F>20 THEN 570 ELSE 18
50

1840 REM SUBTRACTION SUMS

1850 MODE 7
1860 VDU 23;8202;0;0;0;
1870 FOR I=1 TO 25
1880 PRINTCHR$(131);CHR$(157)
1890 NEXT I
1900 PRINTTAB(2,2);CHR$(129);"*****
*****"
1910 PRINTTAB(2,22);CHR$(129);"*****
*****"
1920 PRINTTAB(13,4);CHR$(130);CHR$(14
1);"SUBTRACTION"
1930 PRINTTAB(13,5);CHR$(130);CHR$(14
1);"SUBTRACTION"
1940 PRINTTAB(12,6);CHR$(134);"=====
=====
1950 LET J=-1
1960 LET K=0
1970 LET J=J+1
1980 IF J=10 THEN 2180
1990 IF J=F THEN 4010
2000 LET L=RND(99)
2010 LET M=RND(99)
2020 IF M>L THEN 2000
2030 LET N=L-M
2040 PRINTTAB(3,J+9);CHR$(133);L
2050 PRINTTAB(6,J+9);CHR$(133);"-
2060 PRINTTAB(8,J+9);CHR$(133);M
2070 PRINTTAB(11,J+9);CHR$(133);"="
2080 VDU 31,14,J+9
2090 VDU 23;8202;0;0;0
2100 INPUT 0
2110 IF 0=N THEN 2150
2120 PRINTTAB(17,J+9);CHR$(129);"X"
2130 SOUND 1,-15,0,10
2140 GOTO 1970
2150 LET K=K+1
2160 SOUND 1,-15,150,10
2170 GOTO 1970
2180 LET J=-1
2190 LET F=F-10
2200 LET J=J+1
2210 IF J=F THEN LET F=F+10:GOTO 4010

2220 LET P=RND(99)
2230 LET Q=RND(99)
2240 IF Q>P THEN 2220
2250 LET R=P-Q
2260 PRINTTAB(21,J+9);CHR$(132);P
2270 PRINTTAB(24,J+9);CHR$(132);"-
2280 PRINTTAB(26,J+9);CHR$(132);Q
2290 PRINTTAB(29,J+9);CHR$(132);"="
2300 VDU 31,32,J+9
2310 VDU 23;8202;0;0;0
2320 INPUT S
2330 IF S=R THEN 2370
2340 PRINTTAB(35,J+9);CHR$(129);"X"
2350 SOUND 1,-15,0,10
2360 GOTO 2200
2370 LET K=K+1
2380 SOUND 1,-15,150,10
2390 GOTO 2200

2400 REM NUMBER OF DIVISION SUMS

```

(continued on next page)

(continued from previous page)

```

2410 MODE 7
2420 VDU 23;8202;0;0;0;
2430 FOR E=1 TO 25
2440 PRINT CHR$(134);CHR$(157)
2450 NEXT E
2460 PRINT TAB(15,4);CHR$(132);CHR$(1
41);"DIVISION"
2470 PRINT TAB(15,5);CHR$(132);CHR$(1
41);"DIVISION"
2480 PRINT TAB(14,6);CHR$(135);"====
=====
2490 PRINT TAB(16,8);CHR$(129);"HOW M
ANY"
2500 PRINT TAB(16,10);CHR$(129);"DIVI
SION"
2510 PRINT TAB(16,12);CHR$(129);"SUMS
DO"
2520 PRINT TAB(14,14);CHR$(129);"YOU
REQUIRE ?"
2530 PRINT TAB(27,15);CHR$(131);CHR$(
136);" "
2540 PRINT TAB(2,2);CHR$(130);"*****
*****"
2550 PRINT TAB(2,22);CHR$(130);"*****
*****"
2560 FOR T=1 TO 1000: NEXT T
2570 PRINT TAB(13,16);CHR$(133);CHR$(
136);"REMEMBER NO"
2580 PRINT TAB(14,18);CHR$(133);CHR$(
136);"MORE THAN"
2590 PRINT TAB(15,20);CHR$(133);CHR$(
136);"20 SUMS"
2600 VDU 31,29,14
2610 VDU 23;8202;0;0;0;
2620 INPUT F
2630 IF F<1 OR F>20 THEN 570 ELSE 265
0

```

2640 REM DIVISION SUMS

```

2650 MODE 7
2660 VDU 23;8202;0;0;0;
2670 FOR I=1 TO 25
2680 PRINT CHR$(131);CHR$(157)
2690 NEXT I
2700 PRINT TAB(2,2);CHR$(129);"*****
*****"
2710 PRINT TAB(2,22);CHR$(129);"*****
*****"
2720 PRINT TAB(15,4);CHR$(130);CHR$(1
41);"DIVISION"
2730 PRINT TAB(15,5);CHR$(130);CHR$(1
41);"DIVISION"
2740 PRINT TAB(14,6);CHR$(134);"====
=====
2750 LET J=-1
2760 LET K=0
2770 LET J=J+1
2780 IF J=10 THEN 2990
2790 IF J=F THEN 4010
2800 LET L=RND(500)
2810 LET M=RND(500)
2820 LET N=L/M
2830 IF L<M THEN 2800
2840 IF N<>INT(N) THEN 2800
2850 PRINT TAB(3,J+9);CHR$(133);L
2860 PRINT TAB(7,J+9);CHR$(133);CHR$(
254)
2870 PRINT TAB(9,J+9);CHR$(133);M
2880 PRINT TAB(13,J+9);CHR$(133);"="
2890 VDU 31,15,J+9
2900 VDU 23;8202;0;0;0;
2910 INPUT 0
2920 IF 0=N THEN 2960
2930 PRINT TAB(18,J+9);CHR$(129);"X"
2940 SOUND 1,-15,0,10
2950 GOTO 2770
2960 LET K=K+1
2970 SOUND 1,-15,150,10
2980 GOTO 2770
2990 LET J=-1
3000 LET F=F+10
3010 LET J=J+1
3020 IF J=F THEN LET F=F+10;GOTO 4010

3030 LET L=RND(500)
3040 LET M=RND(500)
3050 LET N=L/M
3060 IF L<M THEN 3030
3070 IF N<>INT(N) THEN 3030
3080 PRINT TAB(21,J+9);CHR$(132);L
3090 PRINT TAB(25,J+9);CHR$(132);CHR$(
254)
3100 PRINT TAB(27,J+9);CHR$(132);M

```

```

3110 PRINT TAB(31,J+9);CHR$(132);"="
3120 VDU 31,34,J+9
3130 VDU 23;8202;0;0;0;
3140 INPUT S
3150 IF S=N THEN 3190
3160 PRINT TAB(37,J+9);CHR$(129);"X"
3170 SOUND 1,-15,0,10
3180 GOTO 3010
3190 LET K=K+1
3200 SOUND 1,-15,150,10
3210 GOTO 3010

```

3220 REM NUMBER OF MULTIPLICATION SUMS

```

3230 MODE 7
3240 VDU 23;8202;0;0;0;
3250 FOR E=1 TO 25
3260 PRINT CHR$(134);CHR$(157)
3270 NEXT E
3280 PRINT TAB(12,4);CHR$(132);CHR$(1
41);"MULTIPLICATION"
3290 PRINT TAB(12,5);CHR$(132);CHR$(1
41);"MULTIPLICATION"
3300 PRINT TAB(11,6);CHR$(135);"====
=====
3310 PRINT TAB(16,8);CHR$(129);"HOW M
ANY"
3320 PRINT TAB(12,10);CHR$(129);"MULT
IPLICATION"
3330 PRINT TAB(16,12);CHR$(129);"SUMS
DO"
3340 PRINT TAB(14,14);CHR$(129);"YOU
REQUIRE ?"
3350 PRINT TAB(27,15);CHR$(131);CHR$(
136);" "
3360 PRINT TAB(2,2);CHR$(130);"*****
*****"
3370 PRINT TAB(2,22);CHR$(130);"*****
*****"
3380 FOR T=1 TO 1000:NEXT T
3390 PRINT TAB(13,16);CHR$(133);CHR$(
136);"REMEMBER NO"
3400 PRINT TAB(14,18);CHR$(133);CHR$(
136);"MORE THAN"
3410 PRINT TAB(15,20);CHR$(133);CHR$(
136);"20 SUMS"
3420 VDU 31,29,14
3430 VDU 23;8202;0;0;0;
3440 INPUT F
3450 IF F<1 OR F>20 THEN 570 ELSE 347
0

```

3460 REM MULTIPLICATION SUMS

```

3470 MODE 7
3480 VDU 23;8202;0;0;0;
3490 FOR I=1 TO 25
3500 PRINT CHR$(131);CHR$(157)
3510 NEXT I
3520 PRINT TAB(2,2);CHR$(129);"*****
*****"
3530 PRINT TAB(2,22);CHR$(129);"*****
*****"
3540 PRINT TAB(12,4);CHR$(130);CHR$(1
41);"MULTIPLICATION"
3550 PRINT TAB(12,5);CHR$(130);CHR$(1
41);"MULTIPLICATION"
3560 PRINT TAB(11,6);CHR$(134);"====
=====
3570 LET J=-1
3580 LET K=0
3590 LET J=J+1
3600 IF J=10 THEN 3790
3610 IF J=F THEN 4010
3620 LET L=RND(12)
3630 LET M=RND(12)
3640 LET N=L*M
3650 PRINT TAB(3,J+9);CHR$(133);L
3660 PRINT TAB(6,J+9);CHR$(133);"X"
3670 PRINT TAB(8,J+9);CHR$(133);M
3680 PRINT TAB(11,J+9);CHR$(133);"="
3690 VDU 31,14,J+9
3700 VDU 23;8202;0;0;0;
3710 INPUT 0
3720 IF 0=N THEN 3760
3730 PRINT TAB(17,J+9);CHR$(129);"X"
3740 SOUND 1,-15,0,10
3750 GOTO 3590
3760 LET K=K+1

```

```

3770 SOUND 1,-15,150,10
3780 GOTO 3590
3790 LET J=-1
3800 LET F=F+10
3810 LET J=J+1
3820 IF J=F THEN LET F=F+10;GOTO 4010

```

```

3830 LET P=RND(12)
3840 LET Q=RND(12)
3850 LET R=P*Q
3860 PRINT TAB(21,J+9);CHR$(132);P
3870 PRINT TAB(24,J+9);CHR$(132);"X"
3880 PRINT TAB(26,J+9);CHR$(132);Q
3890 PRINT TAB(29,J+9);CHR$(132);"="
3900 VDU 31,32,J+9
3910 VDU 23;8202;0;0;0;
3920 INPUT S
3930 IF S=R THEN 3970
3940 PRINT TAB(35,J+9);CHR$(129);"X"
3950 SOUND 1,-15,0,10
3960 GOTO 3810
3970 LET K=K+1
3980 SOUND 1,-15,150,10
3990 GOTO 3810

```

4000 REM SCORE AND PERCENTAGE MARK

```

4010 MODE 7
4020 VDU 23;8202;0;0;0;
4030 FOR X=1 TO 25
4040 PRINT CHR$(134);CHR$(157)
4050 NEXT X
4060 PRINT TAB(2,2);CHR$(130);"*****
*****"
4070 PRINT TAB(2,22);CHR$(130);"*****
*****"
4080 IF F=1 THEN 4140 ELSE 4100
4090 IF K=1 THEN 4180 ELSE 4210
4100 PRINT TAB(8,4);CHR$(133);"YOU AT
TEMPTED"
4110 PRINT TAB(22,4);CHR$(129);F
4120 PRINT TAB(25,4);CHR$(133);"SUMS
"
4130 GOTO 4090
4140 PRINT TAB(9,4);CHR$(133);"YOU AT
TEMPTED"
4150 PRINT TAB(23,4);CHR$(129);"1"
4160 PRINT TAB(25,4);CHR$(133);"SUM
"
4170 GOTO 4090
4180 PRINT TAB(12,6);CHR$(129);"1"
4190 PRINT TAB(14,6);CHR$(133);"WAS C
ORRECT ."
4200 GOTO 4240
4210 PRINT TAB(11,6);CHR$(129);K
4220 PRINT TAB(14,6);CHR$(133);"WERE
CORRECT ."
4230 GOTO 4240
4240 LET Z=INT(K*(100/F))
4250 PRINT TAB(7,10);CHR$(133);"YOUR
PERCENTAGE SCORE IS"
4260 FOR Y=-15 TO 0 STEP 2
4270 SOUND 1,Y,50,5
4280 SOUND 1,Y,120,2
4290 SOUND 1,Y,150,2
4300 SOUND 1,Y,100,5
4310 SOUND 1,Y,150,10
4320 PRINT TAB(16,12);CHR$(132);CHR$(
141);CHR$(136);Z%"
4330 PRINT TAB(16,13);CHR$(132);CHR$(
141);CHR$(136);Z%"
4340 IF Z>=80 THEN PRINT TAB(15,15);
CHR$(129);CHR$(136);"EXCELLENT"
4350 IF Z<80 AND Z>=60 THEN PRINT TAB
(15,15);CHR$(129);CHR$(136);"VERY GOOD
"
4360 IF Z<60 AND Z>=40 THEN PRINT TAB
(17,15);CHR$(129);CHR$(136);"GOOD"
4370 IF Z<40 AND Z>=20 THEN PRINT TAB
(14,15);CHR$(129);CHR$(136);"QUITE GOO
D"
4380 IF Z<20 THEN PRINT TAB(17,15);C
HR$(129);CHR$(136);"POOR"
4390 NEXT Y
4400 PRINT TAB(2,20);CHR$(132);"Do yo
u want another go(Y or N) ?"
4410 VDU 31,35,20
4420 VDU 23;8202;0;0;0;
4430 INPUT US
4440 IF US="Y" THEN 60
4450 CLS
4460 END

```

DATA MASTER

AT LAST – a database designed to let you organise your business the way you want it!

So easy to use you'll start using it in minutes

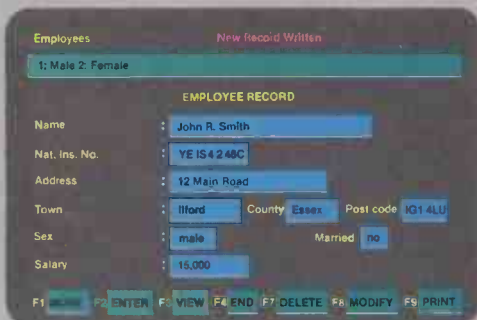

- Fully menu driven to remove the guesswork.
- Full use of function keys with the assignments always displayed. All cursor movement and editing functions on the keyboard are supported.
- Provides full colour support and screen style customisation.

System Features:

- A list of users can be kept, with passwords and security levels.
- The print style is customisable.
- Data can be interchanged with mainframe computers, other databases or spreadsheet programs.
- Database back-up and restore functions are integrated to reduce errors.

System Requirements:

- Available on IBM-PC, SIRIUS, NCR, TEXAS, WANG-PC, DEC and other 16 bit computers. Requires a minimum of 128K memory and 2 disk drives (on some micros a minimum of 192K memory is required).
- Supports floppy or hard disk drives.
- Supports all popular printers.

SOME OF THE DATAMASTER APPLICATIONS:

Inventory Control, Personnel Management, Job Accounting, Mailing List, Accounting, Order Processing, Market Analysis, Financial Portfolio, Medical Office Systems, Real Estate, Agriculture, Distribution Management, Social Sciences, Bibliography, Library Management, School Records.

So powerful you'll have a complete application within hours

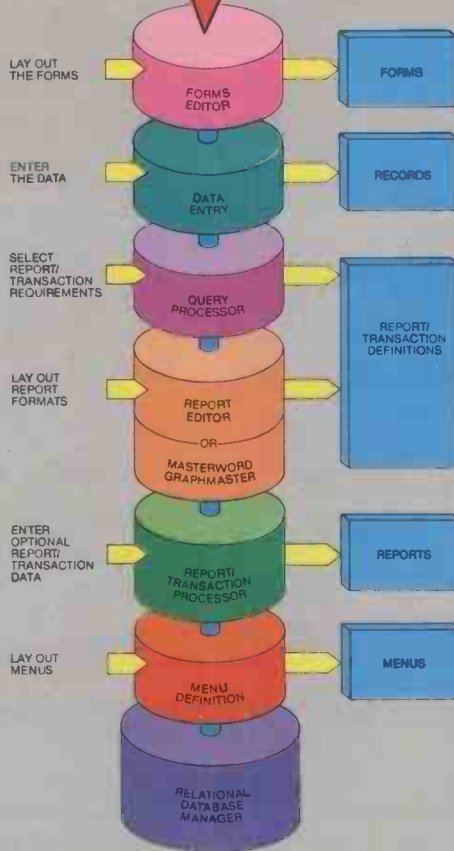

- Lay out your forms on the screen. Define data entry fields anywhere by answering simple questions. Revise the forms any time without losing data.
- Easy, fast and accurate way to fill-in the forms and enter, view or revise records.
- The reports or transactions requirements are defined in the English-like query language by answering simple questions. Select records any number of ways, combine up to 5 forms per report, perform calculations, get totals, sub-totals, or statistical summary. For complete transaction processing, delete, modify or enter records.
- Reports are automatically formatted in several ways, or specify your own format using the Report Editor.
- To format a report complete with text, data, and graphs; use the optional MASTERWORD word-processor or the GRAPHMASTER graphics facility.
- Display or print the report output, or take it to your spreadsheet, word processing, or graphics programs.
- Organise the access to your forms and reports by setting up your own menus.
- The underlying Relational Database Manager provides efficient storage and retrieval of records. It uses B-tree indices for efficient accessing of records, and cache memory to retain the most recently used disk sectors to reduce disk access by 50 percent.

ANOTHER NEW PRODUCT FROM



SAPPHIRE SYSTEMS LTD. 1-3 PARK AVENUE ILFORD ESSEX IG1 4LU TELEPHONE: 01-554 0582

DATAMASTER is available **NOW** to let YOU organise your business the way you want it. So clip the coupon to see a demonstration of DATAMASTER on your own micro or at your local Sapphire dealer.

To: Sapphire Systems Ltd., 1-3 Park Avenue, Ilford, Essex IG1 4LU. Telephone: 01-554 0582.

Please send mecopies of the DATAMASTER DEMONSTRATION SYSTEM @ £5.50 inc. VAT & p.p. per copy for my: –
 IBM-PC Sirius NCR Texas Wang-PC DEC

Please debit my:

Access Card No: for £

Barclaycard No: for £

I understand that £5.00 will be refunded on the return of the demonstration system or on the subsequent purchase of the DATAMASTER full system.

Please arrange for a demonstration of DATAMASTER.

Please send me further details of DATAMASTER and the SAPPHIRE SYSTEMS MASTER RANGE of business software.

Signature

Name

Position

Company

Address 133

..... Tel No:

Computer type

Please allow 28 days for delivery Reg. No. 1467831 VAT No. 250078973

• Circle No. 170



You'll need professional help

DRG Dealers are fully qualified to guide you safely through the process. Firstly we'll discuss your business and analyse your requirements, then we'll recommend a package

of microcomputer, software and peripherals at a price that suits your pocket.

Hardware, software and printers

The hardware in the system will come from the range of best selling DRG Sirius and DRG Apricot micro-computers. It doesn't matter what your applications may be;



Buying a too important a

DRG

Microsystems Division
13/14 Lynx Crescent, Winterstoke Road,
Weston-super-Mare, Avon BS24 9DN
Telephone: (0934) 32525/415398



AVON

Forbes Bus. Systems
6 Alexander Road
Clevedon 0272 879331

A.C. Barratt & Co. Ltd
Bristol & South West
0272 514777

Cotswold Computer Svs
Yate, Bristol
0454 322440

MOS Computers Ltd
11 Portland Square
Bristol 421486

BEDFORDSHIRE

Mertech Systems
Adelaide St., Luton
0582 37931

BIRMINGHAM

B'ham Computer Centre
Alcester Rd, Moseley
021 449 3686

BUCKINGHAMSHIRE

Aylesbury Micros Ltd
Gatehouse Close
0296 32591/2

Kingsley Computers
High Wycombe
0494 449749/37172

CAMBRIDGESHIRE

Herald Computers Ltd
Cambridge
0223 315662

CORNWALL

JM Computer Svs Ltd
Truro
0872 70071

DEVON

Bits & Bytes
Ilfracombe
0271 62801

CBS Business Systems
30 Southernhay East
Exeter 0392 217631

Micros South West
Coxside, Plymouth
0752 671990

I'd like to know more about how my local DRG Dealer can help my business.

Name _____ Position _____

Company _____

Address _____

Tel _____

PC2/84

om accounting, wages and invoicing,
o stock control, word processing and
design, your local dealer has a suite
of software that fits the bill. And when
comes to printers and peripherals,
ve think you'll be pleasantly surprised
at the range and quality
of units we have available
o complete your system.

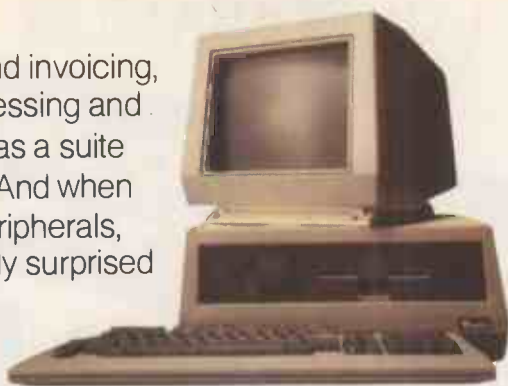

This saves you any worries about local
availability and time wasting;
we're never more than minutes away.



Extensive local training

ow you have a business system that not only matches your
requirements exactly, but also has the in-built flexibility to grow
with your company. In order to get the very best from your
system, DRG Dealers provide extensive local training
programmes that leave nothing to chance.

Don't forget maintenance

Our nationwide on-the-spot service
a maintenance contract taken out direct with DRG.

£600m of support

Unlike any others, the DRG Dealer chain
(and more importantly their customers)
benefit from the strength and stability of
the £600m DRG parent company.

Like the computer, we're here to stay.

computer is step to take alone

DORSET

Brook Computers
Bournemouth
0202 526008/533051

EAST MIDLANDS

A.C. Barratt & Co Ltd
Derby, Notts, Lincs
033 17 3921

ESSEX

C & L Computers Ltd
Basildon
0375 675656/675677

HAMPSHIRE

Gosport Computers
Stoke Road, Gosport
0705 587862

Omega Computers
Hampshire Ltd. Alton
0420 87815 and 86031

HERTFORDSHIRE

Alpha Business Ltd
Church Street, Ware
0920 68926

HUMBERSIDE

Commercial Systems
Hull, Scarborough
0723 351469

KENT

Barratt Computer Grp
Vale Road, Tonbridge
0732 366661

LONDON (CENTRAL)

Data Systems
33 Gt James St, WC1
01 242 9218/405 4006

LONDON (EAST)

Aspirin Computers
Ilford, Essex
01 594 4597 (5 Lines)

Cowlard Computer Svcs
Barking, Essex
01 594 4597

LONDON (NORTH)

Chromasonic Systems
48 Junction Road N19
01 263 7341

LONDON (SOUTH)

Kensington Computers
Philbeach Gdns, SW5
01 370 3882

LONDON (WEST)

Computaline Ltd
Oxford Circus, W1
01 434 4017

MANCHESTER (GREATER)

Eclipse Computers
Swinton, Manchester
061 793 5622

MIDDLESEX

Advanced Micro Tech.
Nr. Heathrow Airport
01 890 1738

Avante Systems Ltd
9 Bridge St, Pinner
01 868 1144

MIDLANDS

A.C. Barratt & Co Ltd
Northampton & Leics
0604 46331

A.C. Barratt & Co Ltd
136 Lawley Street
B'ham - 021 359 0161

NEWCASTLE UPON TYNE

Solenco Info Sys Ltd
19 Portland Terrace
0632 817783

NORFOLK

Sumlock Bondain
Norwich
0603 617083

NORTH EAST ENGLAND

Key Computer Serv
Newcastle upon Tyne
061 793 5622

SCOTLAND

Black Isle Systems
Inverness 0383 20276
Aberdeen 0224 20737

C.B. Business Systems
Fife 0592 202958
Glasgow 041 339 2237

Contralatel Ltd
Forres St, Edinburgh
031 225 5975

STAFFORDSHIRE

Micro Applications
Greyfriars, Stafford
0785 43414/5

SUFFOLK

Ipswich Comp. Centre
27 Old Foundry Road
Ipswich. Tel: 214456

SURREY

A.P. Systems Ltd
90/100 Brighton Road
Surbiton 01 399 1257

Data International
231 High St, Croydon
01 686 0265

Microfacilities
7 Church Road, Egham
0784 31333

J. Phillips Bus. Systems
Weybridge
09323 51051

SUSSEX

Amplicon Micro Sys
Richmond Rd, Brighton
0273 608331

WARWICKSHIRE

A.C. Barratt & Co Ltd
Leamington Spa
0926 34371

WILTSHIRE

Ridgeway Bus. Systems
Swindon
0793 615666

YORKSHIRE

New World Micro
Horsforth, Leeds
0532 582018

YORKSHIRE (WEST)

Yes Computers
Fountain Street
Morley
0532 522181

YORKSHIRE (SOUTH)

Holbrook Bus Sys Ltd
High St, Mosborough
Sheffield 484466

The world's leading micro database package can now give you even more.

QUICKCODE™

Gets the most out of dBASE II fast.

QUICKCODE – FOR PROFESSIONALS

With QUICKCODE professionals can concentrate on using their creativity for the interesting parts of the job and not get bogged down in repetitive detail.

QUICKCODE produces dBASE II command files to carry out many of the routine data handling tasks that come up again and again in every application. QUICKCODE does it automatically – you design the screen layout and QUICKCODE produces the code – an error-free foundation on which you can build your system. QUICKCODE gives you more valuable time.

To give their clients fast and accurate results professionals choose QUICKCODE.

QUICKCODE – FOR NEW USERS

Imagine – you've just bought the market leader – dBASE II. Probably one of the most powerful packages you'll ever buy for your micro. You know it is flexible and very comprehensive. You can't wait to get started. With QUICKCODE you can get started fast.

QUICKCODE creates a complete database from your simple screen layout. In addition QUICKCODE automatically generates 12 dBASE II programs to manage your data. Programs to Add data, Edit data and verify it. Programs to produce labels and even to link your database to WordStar. Automatically.

QUICKCODE gets the most out of dBASE II fast.

DEALERS – Contact Fox & Geller or one of these distributors for more details

Softsel	01-844 2040	Midlectron	(077382) 6811
Tamsys	(Windsor) 56747	Software Ltd	01-833 1173
Pete & Pam	01-769 1022	Xitan	(0703) 871211
MPI	01-591 6511	Tradesoft	01-627 1800
Soft Option	(0476) 860171	Ferrari	01-751 5791

QUICKCODE is a trademark of Fox & Geller.
dBASE II is a trademark of Ashton-Tate.



FOX & GELLER

Fox & Geller (UK) Ltd, 17 Wigmore Street, London W1. Tel: 01-580 5816.

● Circle No. 172

Transferring programs

SINCE THE Commodore 64 has 40 characters on a line, and uses the same character set as the Pet and the same Basic, there should be ample scope for using Pet programs directly on the Commodore with little or no modification. As long as the programs contain no Peek, Poke, Sys or Wait commands, they should be completely portable.

In reality few programs are that simple. The commonest Peeks and Pokes are to the screen; on the Commodore 64 screen memory starts at location 1024 whereas on the Pet it starts at 32768. Fortunately, the 64 is flexible enough to move things around so that the screen memory can be moved to start at 32768.

The sequence of commands in listing 1 sets up the necessary parameters to make the Commodore 64 look like a Pet. The first line moves the screen itself, the second tells the Basic interpreter what has happened and the last two simply clear out any rubbish that is left over.

Any Pet program can now be loaded and examined, although it is possible that when the program is listed the first line may be badly corrupted. This is a result of the way some Basic programs are saved, especially on older-model Pets. If this does occur, it is very simple to recover the situation by the sequence of Pokes in listing 2.

Once the program has been converted to your satisfaction, the necessary reconfiguration can be achieved by adding the three lines of listing 3 to the start of the program and saving it again. In the future,

loading the program will not put it at the same place in the 64 as it was in the Pet, but this should not be a problem unless the program is extremely long.

Despite all this, straight Pokes to the screen will still not work. Whenever the 64 screen is cleared, the colour memory is reset to the same colour as the background, which means that any characters Poked on to the screen will not be seen.

One way of solving the problem is to Poke a colour into colour memory whenever a screen Poke occurs. This can most easily be done by simply adding 22528 to the screen Poke location and putting the correct colour code there. Another way is to fill the colour memory with a different colour every time the screen is cleared. A simple For-Next loop would do the trick, but would be unbearably slow.

A neater solution is provided in the subroutine of listing 4, which actually makes use of the fact that the colour memory is set to the background colour. The first line changes the background colour to the same colour as the current character printing colour, in location 646, first preserving the background colour.

The screen is then cleared, so setting the colour memory, and then the background colour is restored. By removing all Clear Screen characters in the program, and inserting Gosub 63400 just before each Print statement containing a Clear Screen character, the Poke problems on the screen will be solved. It is, of course, possible that there are other Peeks and Pokes in the

Listing 1.

```
POKE 53272,4: POKE 56576,5: POKE 648,128
POKE 56,128: POKE 44,4: POKE 1024,0
clear the screen
NEW
```

Listing 2.

```
POKE 1027,PEEK(1026): POKE 1026,PEEK(1025)
POKE 1025,0: POKE 43,2
```

Listing 3.

```
1 POKE 648,128: POKE 56576,5: POKE 53272,4
2 PRINT "ICLEAR!"
3 POKE 56,128: CLR
```

Listing 4.

```
63400 ZZ=PEEK(53281): POKE 53281,PEEK(646)
63401 PRINT "ICLEAR!";
63402 POKE 53281,ZZ
63403 RETURN
```

program which are rather trickier to deal with, but they will have to wait until a later date.

Finally, there is a bug on the Commodore 64 which affects the Input command when the prompt continues over the end of a line. The Pet is quite happy with this, but the 64 will not read the input correctly, so some Input statements and their associated Prints may have to be changed to avoid printing beyond the end of a line.

I must thank Bob Merry of Stockport for providing many of the ideas for using Pet programs on the Commodore 64.

Cataloguing discs

There are many ways of getting at the file names on a disc, all of which involve opening special files and a lot of Get# commands. These methods certainly work, but they require careful counting of the characters received. The result is often a complicated and rather inelegant program.

Now L V Turner of Colchester has produced an extremely simple and rather elegant approach to the problem. It involves reading the directory and generating a sequential disc file containing all the directory information. His program relies on the Directory command in Basic 4, which normally prints the directory on to the screen, and the method is simple.

Listing 1 shows the program which, first of all, opens a suitable sequential file on the disc in line 200. There is no reason why this should not be an Append command so that a complete file of all disc directories is built up. Just before the Directory command is issued, the output which would normally

(continued on next page)

Cataloguing discs.

Listing 1.

```
100 REM *****
110 REM *
120 REM * DISK CATALOGER - *
130 REM *
140 REM * BASIC 4 + DOS 2 *
150 REM *
160 REM * L V TURNER *
170 REM *
180 REM *****
```

```
200 DOPEN#2,"CATALOG",D0,W
210 CMD2
220 DIRECTORY
230 PRINT#2
240 DCLOSE#2
```

```
300 REM *****
310 REM *
320 REM * READ CATALOGUE *
330 REM *
340 REM *****
```

```
400 DOPEN#2,"CATALOG",D0
410 INPUT#2,A$
420 PRINT A$

430 INPUT#2,A$
440 IF ST=64 OR A$="" THEN 470
450 PRINT A$
460 GOTO 430
```

```
470 DCLOSE#2
```

Listing 2.

```
*****
*
* DISK CATALOGER - *
*
* BASIC 2 + DOS 2 *
*
* L V TURNER *
*
*****
```

```
LOAD "$",B

OPEN 2,B,2,"0:CATALOG,S,W"
CMD2 : LIST
PRINT#2
CLOSE2
```

```
300 REM *****
310 REM *
320 REM * READ CATALOGUE *
330 REM *
340 REM *****
```

```
400 OPEN 2,B,2,"0:CATALOG,S,R"
410 INPUT#2,A$
420 PRINT A$

430 INPUT#2,A$
440 IF ST=64 OR A$="" THEN 470
450 PRINT A$
460 GOTO 430
```

```
470 CLOSE2
```

(continued from previous page)

go to the screen is redirected to the disc file with the CMD2 in line 220.

As the directory is read, it is no longer printed on the screen but is redirected to the disc file. Lines 230 and 240 do the necessary closing out routine when the directory is complete. Now the file exists as a series of individual sequential file entries, each separated by a Carriage Return. They can be read back again using the Input# command.

An example of how this could be done is also included in the program. Line 410 reads the directory heading, and then lines 430 to 460 read the rest of the directory and print it to the screen. Of course, there is no reason why line 450 should not be replaced with a routine to put the file information into an array or to extract any information required simply using the Mid\$ command.

Those who have worked with computers for more than a few weeks will not be surprised to learn that there are problems with the technique. The file Catalog will be shown as though it has not been closed. This is to be expected, as the file was open while the directory was being read.

The disc drive handles directories rather differently to normal files, and there are problems when it comes to do the Blocks Free total at the end of the directory. In fact it will not make much sense, so it should not be used to work out how much space is left. The final problem is that, for some reason, trying to read the directory of only one of the drives does not work. This again is probably a quirk of the way that the disc operating system generates the directory listing.

A version for Basic 2 users is given in listing 2. The main problem is that Basic 2 has no facility for listing the directory directly on to the screen. You have to execute a few commands directly from the keyboard; they are given at the start of the listing. The principle is exactly the same, but the directory must first be loaded into the computer, and then listed to the disc drive.

With this technique, the problems of having files open while reading the directory no longer exist, and the directory loading can be for one or both drives and can follow the usual conventions of a selective directory listing. For instance, to read only the program files from drive 1, replace the Load command with:

```
LOAD "$1:* = P",8
```

The number of blocks free should be correct.

So, where is the problem? The last line to be listed will actually be the "Ready." message that would normally have been printed on the screen. However, as long as you know it is there it should not cause any difficulties.

The read-back operation is almost identical to the Basic 4 version, except that the file is opened in the Basic 2 way, as in line 400. There is no doubt that this is a case of "Why didn't I think of it before?"

Bombing Monster.

```
10 POKE 5184,0
30 GOSUB 5000
```

```
98 POKE 36879,24
99 PRINT "[CLEAR]"
100 POKE 56,26:POKE 52,26:CLR
105 AA=RND(-TI):M=4
107 A(1)=5:A(2)=4:A(3)=2:A(4)=7
110 POKE 36866,23
115 POKE 36878,10
120 POKE 36867,58
130 POKE 36864,11
140 POKE 36865,27
150 POKE 36869,253
```

```
160 FOR I=0 TO 7:POKE 5120+I,0:NEXT
170 FOR I=0 TO 7:READ A:POKE 5128+I,A
:NEXT
180 DATA 60,118,231,247,247,247,126,60
190 FOR I=0 TO 7:READ A:POKE 5136+I,A
:NEXT
200 DATA 60,102,219,247,239,195,126,60
210 FOR I=0 TO 7:READ A:POKE 5144+I,A
:NEXT
220 DATA 60,102,219,247,219,102,126,60
230 FOR I=0 TO 7:READ A:POKE 5152+I,A
:NEXT
240 DATA 60,110,235,227,251,251,126,60
250 FOR I=0 TO 7:READ A:POKE 5160+I,A
:NEXT
260 DATA 24,60,126,90,126,231,255,219
270 FOR I=0 TO 7:READ A:POKE 5168+I,A
:NEXT
280 DATA 127,62,62,62,62,62,28,8
290 FOR I=0 TO 7:POKE 5176+I,255:NEXT
```

```
490 FOR I=37888 TO 38554:POKE I,6:NEXT
495 FOR I=7168 TO 7834:POKE I,0:NEXT
```

```
500 FOR I=1 TO 7:READ A,B
510 FOR J=A TO B:POKE J+7168,7
:POKE J+37888,0:NEXT:NEXT
520 DATA 506,508,526,532,548,556,570,
580,592,604,614,628,636,666
530 POKE 7294,4
550 FOR I=509 TO 635 STEP 2
560 J=INT(RND(TI)*4+1)
570 IF PEEK(7168+I)<7 THEN POKE 3788
8+I,A(J):POKE 7168+I,J:S2=S2+J
580 NEXT
600 A=INT(RND(TI)*10)+11:B=0
```

```
610 POKE 7168+A*23+B,5
:POKE 7167+A*23+B,0
620 B=B+1:IF B=23 THEN POKE 7167+A*23
+B,0:GOTO 600
630 IF PEEK(197)<>64 AND C<>1 THEN C=1
:D=B:E=A:POKE 36877,128
:POKE 36876,250:POKE 36877,0
:POKE 36876,0
640 IF C<>1 THEN 770
650 FOR F=1 TO 2
660 D1=D:E1=E:D=D+.5:E=E+1
670 IF PEEK(7168+E*23+D)=7 THEN GOSUB
2000:GOTO 750
680 IF PEEK(7168+E*23+D)<>0 THEN GOSU
B 1000:GOTO 750
```

```
690 POKE 7168+E*23+D,6
:POKE 7168+E1*23+D1,0
750 NEXT F:GOTO 800
770 FOR F=1 TO 50:NEXT F
800 GOTO 610
```

```
1000 POKE 36877,200
1010 S=S+PEEK(7168+E*23+D)
1020 POKE 7168+E*23+D,0
:POKE 7168+E1*23+D1,0
1030 C=0:E=0:D=0:F=2
1040 POKE 36877,0
1050 IF S=52 THEN GOTO 3000
```

```
1060 RETURN
2000 POKE 7168+E1*23+D1,0
2010 FOR I=230 TO 200 STEP-1
:POKE 36876,1:NEXT:POKE 36876,0
2020 M=M-1:POKE 7294,M
:IF M=0 THEN 3000
2030 C=0:D=0:E=0:F=2
2040 RETURN
```

```
3000 POKE 36864,12:POKE 36865,38
:POKE 36866,150:POKE 36867,174
:POKE 36869,240
```

```
3010 PRINT "[CLEAR, BLUE]"
3015 IF WE=1 THEN 3025
3020 PRINT "THAT WAS YOUR LAST ~~~ MIS
S !!!"
3025 PRINT "[DOWN] YOUR SCORE WAS S
3027 PRINT "THAT IS INT (S/S2*1000+.5)
/10 "[LEFT]X"OF MAX!"
3031 IF S>PEEK(5184) THEN PRINT "WOW,
YOU VE BEATEN THE HI SCORE"
:POKE 5184,S:GOTO 3035
3032 PRINT "[DOWN] HI SCORE: "PEEK(5184)
3035 POKE 198,0:REM CLEAR INPUT BUFFER
3040 PRINT "[DOWN] DO YOU WANT ANOTHER"
3050 INPUT "GO":A$
3060 IF LEN(A$)=0 OR LEFT$(A$,
1)="Y" THEN RUN 50
3070 PRINT "[DOWN] OKAY, CHICKEN!!"
3080 END
```

```
5000 POKE 36879,25
5010 PRINT "[CLEAR, BLUE]
~~ BOMBING MONSTER ~~~ [CYAN]
-----"
5020 PRINT "[BLACK, DOWN]
YOU RELEASE THE BOMBS BY HITTING
ANY KEY."
5030 PRINT "[RED, DOWN] THE TARGETS ARE
WORTH THE AMOUNT THAT IS PRIN
TED ON THEM."
5040 PRINT "[BLACK, DOWN]
IF YOU MISS YOU WILL LOSE ONE M
ONSTER."
5050 PRINT "[RED, DOWN] THE AMOUNT OF MO
NSTERS LEFT, IS THE NUMBER IN T
HE MIDDLE OF THE SCREEN."
5060 PRINT "[GREEN, DOWN, RIGHT 4]
LET S START:"
5070 PRINT "[RVS, RIGHT 4 HIT ANY KEY!
[RVOFF]"
5080 GET A$:IF A$="" THEN 5080
5090 RETURN
```

Bombing Monster

Games are often a useful way of learning programming techniques, especially when they include the complexities of high-resolution graphics or user-defined characters. Thomas and Kim Gustafsson have written a fairly simple bombing game for the Vic-20, in which a craft flies across the screen and drops a bomb when a key is pressed. The object is to destroy as many of the round objects at the bottom of the screen as possible.

Each target object is actually a user-defined character containing a number which represents the score achieved when it is hit. Only four misses are allowed before the game stops and you are given the score.

The distinguishing feature of this game is that the bomb does not drop straight down.

Instead, it continues travelling from left to right with an element of inertia, which makes the task of targeting that much more difficult.

The program is in several distinct sections. Initial setting up, including the setting of the Vic control registers, is done in lines 98 to 150, and the character definitions are set up in lines 160 to 290. Each character is set up individually, with the first being a space, all 0s, and the last a solid block, 1s. Lines 490 to 580 set up the screen itself. The game proper continues from line 600 onwards, the instructions being held in a subroutine at line 5000.

The techniques used show how straightforward it can be to set up a simple sequence of user-defined characters to make a simple game look just that bit more exciting.

Screen dump

ONE of the first responses to my request last July for a text-editing program to complement Letter Writer came from Mr A Atkins of Coventry. Although not quite what I had in mind, it is interesting in itself and demonstrates how to address the memory for the currently open screen. The program will work with either 40 or 80 character lines, and you can select the lines you wish to print.

Bytes 92 and 93 hold the address of the current screen's data area, calculated at line 60030. Line 60070 calculates the location of the first byte of the display buffer; the first byte of the screen data area contains an

offset from which it can be worked out. The questions appear on the VF display of a model AD. If you have a model A delete line 60010 and remove all references to stream £3 for the prompts to be displayed on the video screen.

To use the program, open stream 0 with a suitable line width and number of lines. To print a letter, just type it in using the cursor-control keys to go to a new line. To print a portion of a program, or a display created by a program, load the program using Merge; the program must not use line numbers above 60000. Then run Screen Dump by typing Goto 60005.

```
60005 REM "SCREEN DUMP" BY A.A.ATKINS
60010 CLOSE£3:OPEN£3,3
60020 CLOSE£B:OPEN£B,8,"1200"
60030 TV=PEEK(92)+256*PEEK(93): REM ADD
RESS OF CURRENT VIDEO OWN MEMORY
60040 ML=PEEK(TV+4): REM NO. OF DISPLAY
LINES HELD IN BUFFER
60050 CH=PEEK(TV+5): REM NO. OF DISPLAY
CHARACTERS PER LINE
60060 GL=PEEK(TV+6): REM TOTAL BYTES PE
R LINE
60070 TV=TV+PEEK(TV)+5: REM DISPLAY BUF
FER FIRST LOCATION
60080 PRINT£3,"FIRST.LINE NO.?"
60090 INPUT£3,FL
60100 FL=INT(FL)
60110 IF FL<0 OR FL>ML THEN PRINT£3,"WRON
G ENTRY":GOTO 90
60120 PRINT£3,"LAST LINE NO.?"
60130 INPUT £3,EN
60140 EN=INT(EN)
60150 IF EN<FL OR EN>ML THEN PRINT£3,"WR
ONG ENTRY":GOTO 130
60170 FOR I=FL TO EN
60180 FOR J=0 TO CH-1
60190 PRINT £B,CHR$(PEEK(TV+GL*(I-
1)+J));
60200 NEXT J
60210 PRINT£B
60220 NEXT I
60230 CLOSE£3:CLOSE£B:END
```

Card Index.

```
10 FOR I=1 TO 255:CLOSE#1:NEXT I:OPEN#0,0:OPEN#1,0:1:OPEN#6,6
20 OPTION BASE#1:DIM#V(100):DIM#P(30,5):DIM#K(30)
100 PUT 22,5,10:"DO YOU WISH TO LOAD INDEX CARDS?" PUT 22,11,12:"FROM CASSETTE"
110 PUT 22,24,12:"Y/N?" GET#6,P:IF P<110 AND P>121 THEN 110
120 PUT 31,IF P=110 THEN GOSUB 1100:GOTO 200
130 GET#6,0:PUT 22,6,10:"PRESS PLAY ON THE TAPE RECORDER"
140 PUT 22,7,12:"THEN ANY KEY ON THE KEYBOARD"
150 GET#6,0:IF P<9 THEN 150
160 PUT 31,22,11,12:"LOADING " TAB(25) "CARDS" PUT 22,19,12
170 OPEN IN#99,1,"INDEX" FOR#1 TO 100:LI INPUT#99,AB$(8):NEXT A:FOR#1 TO 30
180 LI INPUT#99,TA$(A) FOR#1 TO 5:INPUT#99,PA$(A):NEXT A:NEXT A:CLOSE#99:GOTO 300
200 PUT#1,22,4,6:"Y/N?" GET#6,0:GOSUB 1200:PUT 31,22,9,11:"IS THIS CORRECT (Y/N)?"
210 GET#6,0:IF P<110 AND P>121 THEN 210
220 IF P=110 THEN 190
230 LI#1:GOSUB 2700:FOR C=1 TO 100
240 GOSUB 1600:GOSUB 1300:PUT 31,22,6,11:"IS THIS CARD CORRECT (Y/N)?"
250 PUT 22,2,13:"PRESS ESCAPE TO FINISH MAKING ENTRIES"
260 GET#6,0:IF P<110 AND P>121 AND P<27 THEN 260
270 IF P=110 THEN 240
280 IF P=27 THEN 300
290 NEXT C
300 REM READING AND INDEXING CARDS
310 PUT#1,31:GOSUB 1400:GOSUB 1100
340 PUT 31:PUT 22,4,6:"PAGE 1 SPECIFIC TITLES REQUIRED":LI#1
350 PUT 22,4,8:"PAGE 2 SPECIFIC CARD NUMBERS"
360 PUT 22,4,10:"PAGE 3 SEQUENTIAL CARD PAGING"
400 PUT 22,4,20:"PAGE REQUIRED ?":GET#6,0:IF P<510 OR P<49 THEN 400
420 IF P=49 THEN GOSUB 2100
430 IF P=50 THEN GOSUB 2200
440 IF P=51 THEN GOSUB 2400
500 GOTO 340
1000 REM USER INPUT
1010 PUT#1,22,X,Y,20:GET#1,A:PUT#1,22,X,Y,CHR$(127)
1020 GET#6,B:IF B=27 AND I=0 THEN 1900
1030 IF B<26 AND B>37 AND B<27 AND B<32 THEN GOSUB 1700
1040 IF B>96 AND B<123 THEN B=B-32
1050 IF B=26 THEN B=A
1060 IF B=17 THEN B=95
1070 PUT#1,22,X,Y,CHR$(B)
1080 IF B=0 THEN B=32
1090 RETURN
1100 REM CARD BORDER
1110 FOR#3 TO 38:PUT#1,22,X,5,129,22,X,20,129:NEXT#
1120 FOR#6 TO 19:PUT#1,22,2,Y,130,22,39,Y,130:NEXT Y
1130 PUT#1,22,2,5,139,22,39,5,130,22,2,20,137,22,39,20,136
1140 RETURN
1200 REM STANDARD CARD INDEX
1210 PUT#1,22,3,21:"I",CHR$(197):" INSERT for reply space, "CHR$(197):" to leave"
1211 PUT#1,22,22,22:"I",CHR$(197):" ESCAPE alone or ESCAPE to start again."
1220 I=0:GOSUB 1600:FOR Y=6 TO 19:FOR X=4 TO 38:IF Y=38 THEN 0=60101290
1230 GOSUB 1000:FOR I=1 AND B=GET#6,A
1240 IF B=26 AND B<32 THEN 0
1250 IF B<35 AND B=0 THEN I=I+1:PC(1,4)=X:PC(1,5)=Y:0=1
1260 IF B=95 AND B=0 THEN I=I+1:PC(1,4)=X:PC(1,2)=Y:0=2
1270 IF B=1 THEN I=I+1:PC(1,4)=X:PC(1,2)=Y:0=2
1280 IF B=2 THEN I=I+1:PC(1,3)=X:PC(1,3)=Y+1
1290 NEXT X:NEXT Y:RETURN
1300 REM INDIVIDUAL CARD INPUT
1310 PUT#1,22,3,21:"I",CHR$(95):" "" will not be printed."
1320 PUT#1,22,3,22:"I",CHR$(197):" to leave the text alone."
1329 IF PEEK(1900) THEN 2500
1330 AB$(C)="":FOR#1 TO 30:Z=PC(R,1):Y=PC(R,2):L=PC(R,3)
1340 IF R=30 THEN:IF PC(R,1,3)=0 THEN RETURN
1350 FOR#X=Z TO Z+L-1:GOSUB 1000:IF B=95 THEN B=32
1360 AB$(C)=AB$(C)+CHR$(B):NEXT X:NEXT R:RETURN
1400 REM PRINTS STANDARD CARD
1410 FOR#1 TO 30:IF PC(R,4)<30 OR PC(R,4)>37 THEN RETURN
1420 PUT#1,22,PC(R,4),PC(R,5):?#1,76(R):NEXT R:RETURN
1500 REM SAVE INDEX CARDS
1510 PUT 31,22,2,10:"PRESS RECORDER ON THE TAPE RECORDER THEN":PUT 22,9,12
1520:"ANY KEY ON THE KEYBOARD"
1530 GET#6,0:IF P<9 THEN 1530
```

```
1540 PUT 31,22,12,12:"SAVING INDEX CARDS"
1550 CLOSE#9:OPENOUT#99,1,"INDEX" FOR#1 TO 100:?"#99,PA$(A)
1560 NEXT A:FOR#1 TO 30:?"#99,TA$(A):FOR#1 TO 5:?"#99,PC(A,B):NEXT B:NEXT A:CLOSE#99
1570 RETURN
1600 REM PRINTS INDIVIDUAL CARD
1610 PUT#1,22,9,6:"I",CHR$(197):" PUT#1,22,8,6:"I",CHR$(197):"
1620 IF AB$(C)="":THEN GOSUB 1800
1630 P=1:FOR#1 TO 30:?"#PC(R,1):Y=PC(R,2):L=PC(R,3)
1640 IF X=30 OR Y=37 THEN RETURN
1650 PUT#1,22,X,Y:?"#1,MID$(AB$(C),P,L)
1660 P=P+L:NEXT R:RETURN
1700 REM DEL
1710 PUT#1,22,X,Y,CHR$(C)
1720 FOR#1 TO 30:GET#6,B:IF B=31 OR B=26 OR B=17 THEN RETURN
1730 IF B=27 AND L=0 THEN 1900
1740 NEXT R:PUT#1,22,X,Y,CHR$(127)
1750 FOR#1 TO 30:GET#6,B:IF B=31 OR B=26 OR B=17 THEN RETURN
1760 IF B=27 AND L=0 THEN 1900
1770 NEXT R:GOTO 1700
1800 REM PRINTS EMPTY CARD
1810 P=1:FOR#1 TO 30:?"#PC(R,1):Y=PC(R,2):L=PC(R,3)
1820 IF X=30 OR Y=37 THEN RETURN
1830 FOR#X=Z TO Z+L-1
1840 PUT#1,22,X,Y:?"#1,CHR$(95):NEXT X:NEXT R:RETURN
1900 REM LEAVES TEXT ON STREAM ONE
1910 CLEAR:OPTION BASE#1:DIM#K(100)
1920 DIM#P(30,5):DIM#K(30):GOTO 200
2100 REM TITLE REQUIRED
2110 PUT 31,22,10,11:"WHAT TITLE IS REQUIRED?" PUT 22,15,13:LI INPUT("YES: B=")
2120 FOR#A=1 TO LEN(ES):T=ASC(MID$(ES,A,1)):R=ASC(ES,A,1)
2130 IF T=96 AND R=123 THEN R=CHR$(ASC(ASC(ES,A,1))-32)
2140 B=CHR$(R):NEXT R:0=0:FOR C=1 TO 100:IF B=CHR$(C):0=0 THEN 2160
2150 IF INSTR(AB$(C),B)=0 THEN GOSUB 1600:GOSUB 2600:GOSUB 2800
2160 NEXT C
2170 GOTO 2100
2200 REM CARD NUMBER
2210 PUT 31,22,10,10:INPUT("CARD NUMBER REQUIRED") X:IF X=1000 OR C=1 THEN 2210
2220 GOSUB 1600:GOSUB 2600:GOSUB 2800:GOSUB 2700:GOTO 2200
2300 CLOSE#B:REM PRINTS CARD ON GP-250X
2310 OPEN#B,"2400" LFS=CHR$(10)
2320 FOR#6 TO 1020:?"#6:" FOR#4 TO 37:PUT#1,22,H,M,20:GET#1,0:IF P<32 THEN 0=32
2330 K=CHR$(CHR$(0)):NEXT R:FOR#1 TO KLEN(K):?"#6,MID$(K,H,1):NEXT H
2340 ?#B:LFS:NEXT R:RETURN
2400 REM SEQUENTIAL CARDS
2410 PUT 31,22,12,12:INPUT("STARTING CARD?" X:0=0:IF X=96 OR C=1 THEN 2410
2420 FOR#K TO 100:IF ASC(AB$(C))=0 THEN 2440
2430 GOSUB 1600:GOSUB 2600:GOSUB 2800
2440 NEXT C:IF 0 THEN GOSUB 2700
2450 RETURN
2500 PUT 31,22,3,10:"SORRY INSUFFICIENT MEMORY AVAILABLE" PUT 22,2,12
2510 FOR#1 TO 999:?"#1:GOTO 340
2600 REM ONLY IF TITLE PRESENT
2610 PUT#1,22,3,21:"I",CHR$(197):" S to save, P to print, A to alter,"
2620 PUT#1,22,3,22:"I",CHR$(197):" ESCAPE for options or SPACE BAR." RETURN
2700 PUT#1,22,11,21:"I",CHR$(197):" PUT#1,22,12,30:RETURN
2800 REM OPTIONS
2810 GET#6,0:IF P<9 THEN 2810
2820 IF P=27 THEN GOSUB 2700:GOTO 340
2830 IF P=37 THEN GOSUB 2700:GOSUB 1300
2840 IF P=112 THEN GOSUB 2300
2850 IF P=115 THEN GOSUB 1500
2860 RETURN
```

Screen Dump program for listing of main program.

```
60000 FOR I=1 TO 255:CLOSE#1:NEXT I:OPEN#0,0,"L170" LIST=59999:OPEN#8,8,"2400" LFS=C
HRS$(10):FOR#1 TO 170:FOR#1 TO 30:PUT 22,X,1,20:GET#X:JD=JD+CHR$(X):NEXT X:FOR#1
TO 80:?"#8,MID$(JD,X,1):NEXT X:?"#8,76(L):FOR#1 TO 20:?"#8:?"#8:NEXT Y:END
```

Card index

This program by Stephen Hall of Hordean, Hampshire allows users with no programming experience to format their own index cards. You can search through them for any word or value, and print the results of the search on a Seikosha GP-250X printer, if available.

Amendments are easily made by pressing A when the card to be altered is shown on the screen. The cursor then appears and can be moved to the area to be altered by using

the Right Cursor control. Any card shown can be printed by pressing P, and the 100 index cards can be saved on cassette by pressing S. Concise instructions are given on the screen.

Renumber

This useful routine to renumber the lines of your Basic programs has been sent in by Mr A R Armitstead of Blackpool. It will not alter your Gotos and Gosubs, so you will have to trace them yourself. Programs

to be renumbered should not contain any lines numbered 60000 or greater.

To use the routine merge it into the program to be renumbered, set the starting line number and step size at lines 60140 and 60150, then type Goto 60000. The routine does not renumber itself, so it can be used again.

The Newbrain stores program lines in an unusual way, using three distinct areas of memory to hold all the information needed to execute a statement. The line-number

(continued on next page)

(continued from previous page)

table, LNT, contains an entry for each Basic statement, consisting of:

- The statement line number as two bytes, low then high.
- A pointer to the compressed Basic statements as two bytes; this is the second area, the source code area.
- A pointer to the compiled version as two bytes. If the statement has not been compiled, it contains 0. This is the object code area.

The LNT is pointed to by locations IY + 30 and IY + 31, where the address of IY is stored at locations 22 and 23.

Lines 60260 to 60360 contain a routine to display the first 18 entries of the line-number table. They are not part of the renumber program and may be deleted if not required.

Renumber.

```

60000 REM Renumbers the line numbers ONL
Y- not the goto's etc.
60010 DEF FNln(n)=PEEK(n)+256*PEEK(n+1)
60020 REM iy:=IY Z80 register.
60030 iy=FNln(22)
60040 REM bs gives the base of the line-
number table.
60050 bs=FNln(iy+30)
60060 REM find end of user program:-it e
nds when this renumber program is found
at line no. 60000.
60070 i=bs+6
60080 j=0
60090 IF FNln(i)=60000 THEN GOTO 60140
60100 j=j+1
60110 REM j holds number of lines.
60120 i=i+6
60130 GOTO 60090
60140 s=100 :REM s:=starting line no
.
60150 st=10 :REM st:=stepsize
60160 REM renumber table
60170 FOR k=1 TO j
60180 sa=FALSE :REM sa:=samelinenumber
60190 i=bs+6*k
60200 IF FNln(i)=FNln(i+6) THEN sa=TRUE
:REM catch multiple statement
lines.
60210 POKE i,s-256*INT(s/256)
60220 POKE i+1,INT(s/256)
60230 IF NOT(sa) THEN s=s+st :REM Only a
dd st if different line number.
60240 NEXT k
60250 END
60260 REM prints out some table entries
to show structure.
60270 bs=FNln(FNln(22)+30)
60280 PRINT " line no. source code o
bject code"
60290 PRINT TAB(16);"pointer" "pointe
r"
60295 FOR i=1 TO 40:PRINT CHR$(129);:NEX
T i: PRINT
60300 FOR i=bs TO bs+18*6 STEP 6
60310 FOR j=1 TO i+5
60320 PRINT PEEK(j)[4];
60330 NEXT j
60340 PRINT
60350 NEXT i
60360 END
    
```

Brain Man.

```

1 REM **
2 REM **
3 REM ** BY RORY STAFFORD
4 REM ** 7,1983
5 REM **
14 REM ** SET UP FOR GAME
15 PUT 31,23,72,22,3,15: PRINT "DO YOU WA
NT INSTRUCTIONS?":CLOSE £10: OPEN £10,
6
16 GET £10,A$: IF A$="y" GOSUB 2000:GOTO
20
17 IF ASC(A$)=0 OR A$<>"n" GOTO 16
18 GOSUB 2210
20 PUT 31: SC=0: SF=10: E(1)=1106: E(2)=
1496
30 E(3)=1112: E(4)=1490: FR=1:CH=98: RAN
DOMIZE
49 REM ** START GAME
50 GOSUB 600
56 IF R<>2 THEN PUT 22,6,19: PRINT SC+SF
60 GOSUB 100
80 GOTO 56
99 REM ** PLAYER MOVEMENT GET
100 GET £10,M$: IF ASC(M$)=0 THEN 160
120 IF M$="n" THEN D=-1
130 IF M$="m" THEN D=1
140 IF M$="a" THEN D=-64
150 IF M$="z" THEN D=64
159 REM ** PLAYER MOVEMENT CONTROL
160 FG=PP+D: IF PEEK(FG)=128 THEN D=0
170 IF PEEK(FG)=109 THEN SF=SF+10
180 IF PEEK(FG)=110 THEN SF=SF+10: CALL
62383
190 IF PEEK(FG)=115 THEN 1000
195 IF CH=98 THEN CH=106: GOTO 200
196 CH=98
200 IF PEEK(PP+D)=243 GOSUB 760: GOTO 10
0
210 POKE PP,32: PP=PP+D: POKE PP,CH
220 IF PP=1295 THEN POKE PP,32: PP=1306:
IF PEEK(PP)=109 THEN SF=SF+10: GOTO 23
0
225 IF PP=1307 THEN POKE PP,32: PP=1296:
IF PEEK(PP)=109 THEN SF=SF+10
230 IF SF=800 AND PP=1296 OR SF=800 AN
D PP=1306 THEN FR=FR+1: SC=SC+SF: SF=10
:GOSUB 600
239 REM ** MONSTER MOVEMENT
240 CALL 62399,M: IF MK*50 THEN 369
249 REM ** NOT ENERGIZED
250 PC=115: MM=DM
260 IF PP<PM-8 THEN DM=-64: GOTO 300
270 IF PP>PM+8 THEN DM=64: GOTO 300
280 IF PP<PM THEN DM=-1
290 IF PP>PM THEN DM=1
300 IF PEEK(DM+PM)<>128 THEN 350
310 IF PEEK(MM+PM)<>128 THEN DM=MM: GOTO
350
320 IF ABS(DM)=64 THEN DM=SGN(RND-.5): G
OTO 340
330 IF ABS(DM)=1 THEN DM=SGN(RND-.5)*64
340 MM=DM: GOTO 300
349 REM ** MOVE MONSTER
350 IF PEEK(PM+DM)=CH THEN 1000
360 GOTO 580
369 REM ** ENERGIZED
370 PC=243: IF GB<>1 THEN MM=DM*-1: GB=1
375 MM=DM
380 IF PP<PM-8 THEN DM=-64: GOTO 420
390 IF PP>PM+8 THEN DM=64: GOTO 420
400 IF PP<PM THEN DM=-1
410 IF PP>PM THEN DM=1
420 IF PEEK(DM+PM)<>128 THEN 450
430 IF PEEK(MM+PM)<>128 THEN DM=MM: GOTO
450
440 IF ABS(DM)=64 THEN DM=SGN(RND-.5): G
OTO 446
445 IF ABS(DM)=1 THEN DM=SGN(RND-.5)*64
446 MM=DM: GOTO 420
449 REM ** MOVE MONSTER
450 IF PEEK(PM+DM)=CH GOSUB 750: GOTO 10
0
580 IF PM+DM=1295 THEN POKE PM,DW: GOTO
590
585 IF PM+DM=1307 THEN POKE PM,DW:PM=129
5
590 POKE PM,DW: PM=PM+DM: DW=PEEK(PM): P
OKE PM,PC
595 RETURN
597 REM ** DRAW MAZE ROUTINE
598 REM ** WHEN TYPING IN USE AN INVERSE
599 REM ** SPACE INSTEAD OF EACH S.
600 IF FR>1 THEN GOSUB 2300
603 IF FR=5 THEN 800
605 PUT 31,22,1,5
610 PRINT TAB(14); "SSSSSSSSSSSSSS"
620 PRINT TAB(14); "Smmmmmmmmmmmms"
630 PRINT TAB(14); "SmSSSSmSSSSmS"
640 PRINT TAB(14); "SmSmmmmmmmSmS"
650 PRINT TAB(14); "SmSmSSmSSmSmS"
660 PRINT TAB(14); "SmSmSmmmSmSmS"
670 PRINT TAB(14); "mmmmmmSmmmmm"
675 PRINT TAB(14); "SmSmSmmmSmSmS"
680 PRINT TAB(14); "SmSmSSmSSmSmS"
685 PRINT TAB(14); "SmSmmmmmmmSmS"
690 PRINT TAB(14); "SmSSSSmSSSSmS"
693 PRINT TAB(14); "Smmmmmmmmmmmms"
695 PRINT TAB(14); "SSSSSSSSSSSSSS"
700 D=0: PP=1621: PM=1301: DW=128: POKE
PM,115: POKE PP,CH: MK=0
710 FOR T=0 TO 5-FR
720 POKE T(1),110
730 NEXT T
735 PUT 22,1,19: PRINT "SCORE";SC+SF:TAB
(12);"FRAME";FR;"HI-SCORE";HS:PRINT "PR
ESS ANY KEY"
736 GET £10,L: IF L=0 THEN 736
740 PUT 22,1,20: PRINT " "
RETURN
749 REM ** CATCH MONSTER
750 POKE PM,DW: H=PM+DM: IF DW=109 THEN
SF=SF+10
755 POKE H,170: GOTO 770
760 H=PP+D: POKE PP,32: IF PEEK(H)=109 T
HEN SF=SF+10
765 POKE H,170
770 FOR T=1 TO 75: NEXT T: POKE H,32
775 SC=SC+100
780 PP=PP+D: PW=128: PM=1301: MK=MK+1: D
M=64: RETURN
799 REM ** WIN
800 FOR T=1 TO 200: NEXT T
810 PUT 31,22,1,14
820 PRINT "YOU HAVE CLEARED ALL THE FRAM
ES"
830 PRINT "YOU SCORED ";SC
840 GOTO 1040
1000 POKE PM,32: FOR T=136 TO 141: POKE
PP,T: FOR TT=1 TO 70: NEXT TT: NEXT T:
POKE PP,32: FOR T=1 TO 200: NEXT T
1010 PUT 31,22,1,14
1020 PRINT "YOU HAVE BEEN KILLED,"
1030 PRINT "YOU SCORED ";SC+SF
1040 IF SC+SF>HS THEN PRINT: PRINT "YOU
GOT THE HIGH SCORE!": HS=SC+SF
1050 PRINT: PRINT "PLAY AGAIN?": GET £10
,U
1055 GET £10,A$: IF ASC(A$)=0 THEN 1055
1060 IF A$="n" THEN 1070
1065 IF A$="y" THEN 20
1066 GOTO 1055
1070 PUT 31,22,1,14: PRINT " GOOD-
BYE"
1080 CLOSE £10: END
    
```

Brain-Man

A version of the popular Pacman game is provided by Rory Stafford. The maze has been simplified, and only one monster is used, but the game is very fast.

The program uses character set 3. Line 15 sets it with the statement

PUT 31,23,72

The Call at line 180 resets the system clock to zero if a power pill is eaten, and line 240 reads the value of the clock so the monster runs away during the following five seconds. This line could be changed to make the game easier to play. Lines 610 to 695 print the maze. The character listed as S should be typed as an inverse space, ASCII 128, by pressing Graphics- = .

```

1999 REM ** INSTRUCTIONS
2000 PUT 31
2010 PRINT " NEWBRAIN PAC-MAN"
2020 PRINT " BY RORY STAFFORD"
2030 PRINT
2040 PRINT "YOU MUST MOVE THROUGH THE MA
ZE EATING"
2050 PRINT "THEM 'm'S WHILE AVOIDING THE
MAN-EATING"
2060 PRINT "MONSTER.HE IS REPRESENTED BY
AN 's' WHEN"
2070 PRINT "YOU EAT AN 'n' YOU HAVE THE
POWER TO EAT"
2080 PRINT "THE MONSTER FOR A SHORT WHIL
E."
2100 PRINT "YOUR CHARACTER IS A FOUR-LEG
GED BEING"
2110 PRINT "WHO YOU CONTROL BY THE FOLLO
WING KEYS,"
2120 PRINT: PRINT "N" "FOR LEFT,"
2130 PRINT "M" "FOR RIGHT,"
2140 PRINT "Z" "FOR DOWN,"
2150 PRINT "A" "FOR UP."
2160 PRINT
2170 PRINT "YOU HAVE A CHOICE OF TWO LEV
ELS OF PLAY."
2180 PRINT "2 BEING VERY HECTIC"
2190 PRINT "WHEN YOU HAVE EATEN ALL THE
DOUGHNUTS"
2200 PRINT "YOU MUST GET TO AN EXIT. YOU
THEN GET A"
2201 PRINT "BONUS FOR EVERY MONSTER YOU
CAUGHT."
2210 PRINT: PRINT "NOW CHOOSE YOUR LEVEL
1/2 "
2220 GET £10,R$: IF R$<>"1" AND R$<>"2
" GOTO 2220
2230 R = VAL(R$): RETURN
2299 REM ** CLEAR FRAME BONUS
2300 PUT 31,22,1,16: PRINT "
": CB=1602
2350 FOR T=CB TO CB+10:MK: POKE T,CH:FOR
TT=1 TO 70: NEXT TT
2360 IF CH=98 THEN CH=106: GOTO 2380
2370 CH=98
2380 POKE T,32: NEXT T
2390 PUT 22,1,17: PRINT "BONUS";MK*100:
SC=SC+MK*100
2400 FOR T=1 TO 300: NEXT T: RETURN
    
```

trendtext

Bringing word processing out of the Stone Age



Trendtext is a complete word processing environment designed for today's microcomputers. Hundreds of WP users have told us Trendtext is easy to learn and easy to use. And now we've included superb features missing from other WP packages.

You get extensive document creation, editing and printing facilities, mail merge, word count, table of contents and index generation as standard features, not expensive extras.

Trendtext has been specially tailored to run on most major business microcomputers and is stocked by dealers all over the country. Microtrend has companies in Britain, Germany and Holland, supplying Trendtext in nine European languages. For more details write or ring us on 0423 711878

microtrend uk
council chambers
king street
pateley bridge
harrogate
north yorkshire
tel: 0423 711878
telex: 57558 micruk g



Trendtext. Software trends in the making.

Meet the fa

Minstrel + TurboDOS

the marriage of reliability and versatility



Minstrel

The Minstrel is an exciting new British micro-computer and offers Winchester-based systems at fantastically low prices. The range extends from single-floppy single-user CP/M systems right up to a 68000-based model and includes an 8086-based range.

The Minstrel is compatible with the North Star Horizon and offers a superior alternative at a much better price.

There is a network of Minstrel dealers in the UK and Europe. Contact us for the name of your local dealer. Dealer enquiries invited.

S100 bus

The amazing versatility of the Minstrel is due to the bus used: the S100 bus. This bus system is not only future-proof – the future is created on the S100 bus. Every major micro-computer development appears first on the S100 bus. Now over 150 manufacturers make S100 products and their combined range approaches 1000 boards.

HMSystems
Hotel MicroSystems

69 Loudoun Road, London NW8 0DQ

national 01 328 8737

international +441 328 8737

telex 266828

mily



One machine – eight computers

Yes! Inside the Minstrel micro-computer illustrated there are actually 8 Z80A single-board computers. One is dedicated to each user of the system resulting in astonishing performance. A ninth processor controls central disk storage and printers.

TurboDOS provides sophisticated spooling for multiple printers, supports 1000Mb disk drives and 128Mb files, and employs powerful disk buffering techniques.

• Circle No. 174

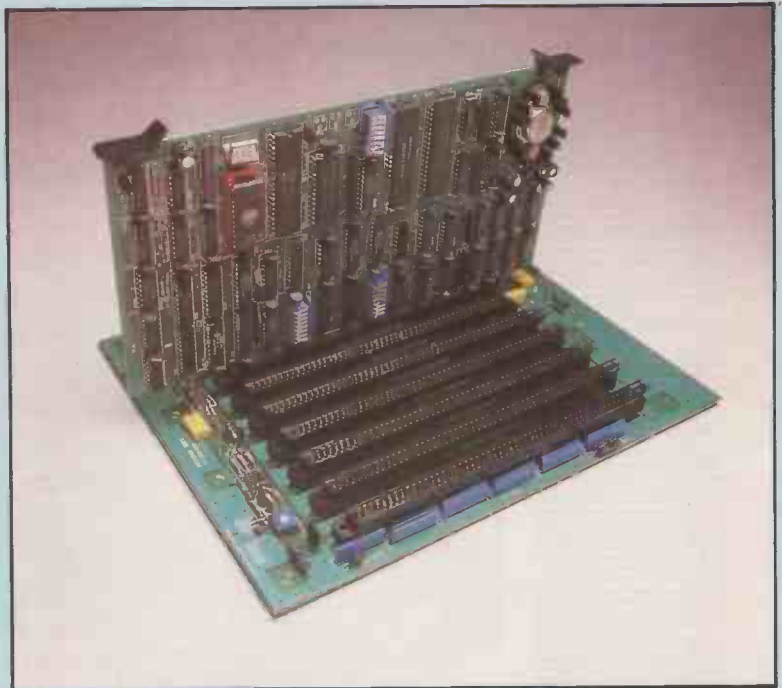

TurboDOS[®] CP/M COMPATIBLE MULTI-USER OPERATING SYSTEM

TurboDOS is a popular high-performance multi-processor operating system. Each user has their own slave processor board (illustrated above). TurboDOS systems have been shown to out-perform mini-computers in the DEC PDP11/34 class at a fraction of the hardware cost.

TurboDOS is compatible with CP/M, the industry standard operating system, which means you have access to a vast range of off-the-shelf software.

The next development to TurboDOS on the Minstrel allows you to connect systems together via a Local Area Network.

ASTONISHING PRICES!

Minstrel with two 400Kb floppy drives £1790.
With 1 400Kb drive and 5Mb Winchester £2615.

A sample 2-user
TurboDOS system
including:

Minstrel
1 800Kb floppy
1 5Mb Winchester
2 slave processor
cards
2 KDS7362 VDU's
(Illus)
1 Epson printer

ONLY

£5420

A sample 5-user
TurboDOS system
including:

Minstrel
1 800Kb floppy
1 20Mb Winchester
5 slave processor cards
5 KDS7362 VDUs (Illus)
1 Epson printer
1 OKI 84 printer

ONLY

£9850

TurboDOS is a registered Trade Mark of Software 2000, Inc.

BRAND NEW FROM THE USA

FOR THE MICRO ON THE MOVE

Computer Carrying Cases provide the protection that you need. Padded with high density foam to cushion your computer during transit. Finished in tough, steel grey Cordura nylon these cases are available for most micros including:-
IBM P.C., Apple, Atari, Commodore, Sinclair and Osborne.



Price for case specifically designed for Atari/Commodore Vic 20 or Vic 64 is £28.95 inc VAT & carriage. Contact us **NOW** for full information and details of this exciting new product.

TRADE ENQUIRIES INVITED

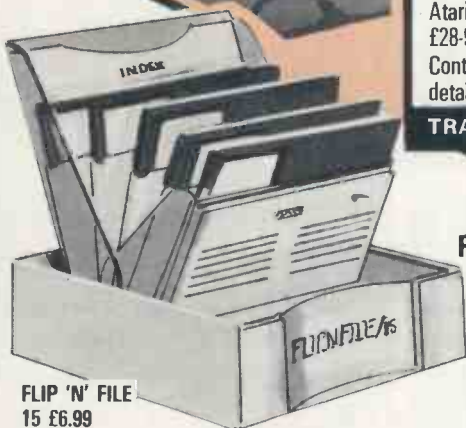

FLIP 'N' FILE
15 £6.99

FLIP 'N' FILE DISK SAFES

- 10 Disk £4.99
- 15 Disk £6.99
- 25 Disk £26.99
- 50 Disk £35.40

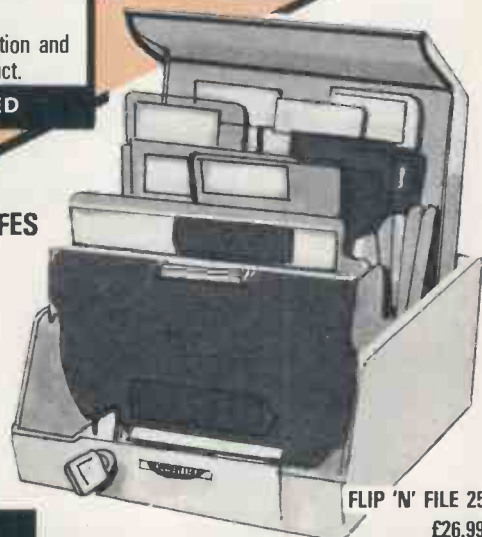

FLIP 'N' FILE 25
£26.99

Ideal for the home or office. Store up to 50 5 1/4" disks FLAT for EXTENDED LIFE. Imaginatively designed with its unique 'pop-up' feature.

Ribbons DIRECT from stock

PRINTER	Min order	Price ea.
Microline 80/Anadex 8000, Sharp, Trend, Commodore 4022	12	£1.10
Juki 6100/Brother HR1 150,000 characters (Pink Hub)	12	£1.25
Juki 6100/Brother HR1 580,000 characters (Blue Hub)	12	£3.95
Centronics 150/Commodore 8023	3	£5.40
Epson MX 80	3	£4.99
Epson MX 100	3	£12.50
Oki Microline 83A/84	3	£3.49
TEC F 10	3	£2.95
Qume for Sprint 3, 5, 7 multi strike	3	£2.40
Qume multi strike for Sprint 9, 11	3	£3.95
Diablo multi strike for Diablo Hytype II 630	3	£2.95

wabash No. 1 DISK

Prices/Box 10		10	50	100
5 1/4"				
SS SD 48TPI	M11	16.10	15.20	14.20
SS DD 48TPI	M13	19.00	17.80	16.70
DS DD 48TPI	M14	21.20	19.90	18.70
SS DD 96TPI	M15	24.20	22.80	21.40
DS DD 96TPI	M16	27.50	25.90	24.30
8"				
SS SD 26S	F11	16.10	15.20	14.20
DS DD 26S	F14	27.50	25.90	24.30

DISK



**04862
26626**

IT'S SO SIMPLE TO ORDER

BY PHONE Call us with your credit card number (Access or Barclaycard) and your order will be despatched directly to you.



Fill in the coupon and enclose a cheque or postal order for the total amount of your order which will be despatched immediately your payment has been processed.



**NO
HIDDEN
EXTRAS**

**DISK DIRECT
FREEPOST
WOKING, GU22 9BR**

Quantity Description & Part Number Price

Quantity	Description & Part Number	Price

Our prices include V.A.T. and carriage.

Name:— _____

Address:— _____

Daytime telephone no.:— _____

Hidden lines

Short and Sharp

For too long the Sharps seem to have existed in the shadow of other machines. First it was the Pets, Apples and Tandys; now it is the BBC and Sinclair machines. But perhaps the blame lies with us, the owners and users. Rather than pester the computer press with queries, articles, hints, tips and programs we have resigned ourselves to a second-rate existence in which we tell each other what wonderful micros the Sharps are, and how foolish the rest of the world is not to realise what it is missing. So now is your chance — let the contributions roll.

I have just one plea to make, and that is for brevity. Each Open File section will be at most two magazine pages long. It is very difficult to accept any contribution of more than three pages of double-spaced A4 typescript or 120 lines of listing. Material for Open File should be short and snappy. For tips and hints listings can be open and easy to follow, but for games and other programs where the result is more important than the ideas and techniques illustrated they should be as densely packed as possible.

The null-input problem

It is perhaps best to employ input routines using the Get command, and best of all to do it in machine code. There is still a place for the humble Input, the trouble is that it is difficult to cope with a null input. If some careless and heavy-fingered user presses Return without entering anything else first, Basic kindly starts a new line with a question mark and waits for a fresh input, which makes an awful mess of a neatly formatted screen.

What is required is something the Input routine will pick up even if nothing but Return has been pressed. Moreover, if that something is unusual and distinctive, then the rest of the program can check for its existence and take whatever remedial action may be necessary.

How is this to be done? The first idea that comes to mind is to Print a special character immediately after the input prompt, then cursor left, and then to use Input "" to suppress the question mark and leave the cursor sitting on the character. For example:

```
PRINT "PROMPT:~*(cursor-left)";
:INPUT"";A$
```

but unfortunately this does not work; the Input routine is not fooled.

IN MOST MICROS, including the MZ-80 series, each line is stored in memory in a four-part format. It begins with a link identifying the next line's start, and is followed by the line number, the content of the line itself and the end-of-line marker, which is 0Dhex for the Sharps.

For the Sharp PC-1500 hand-held computer the format is slightly different. Each line starts with the line number, which occupies two bytes, followed by a single-byte relative link giving the length of the line's content, including the end-of-line marker. Then there is the line content and the end-of-line marker itself.

During editing the relative link tells the editor how many of the next few bytes belong to the current line, and should be prepared for display. During operation it tells the interpreter where to jump to find the next line when executing a Goto or Gosub if the current line has the wrong label or line number.

What is of interest about this is that the editor and interpreter work in rather different ways when actually reading a line. The interpreter scans and executes each line up to the end-of-line marker, Gotos, and so on excepted, and then automatically carries on, assuming the next byte is the start of the next line.

The editor, however, displays the line up to the end-of-line marker, beyond which the cursor cannot be moved, and uses the link to find the start of the subsequent line. One or more lines can be hidden from the editor, and thus from anyone Listing the program, even though it will run quite happily. This can be arranged by the simple expedient of Poking into memory a value for the previous line's link that points not to the line's own end-of-line marker but to that of the line to be hidden.

The listing shows a simple look-at-memory program before it has been nobbled in this way. Assuming no other program is in memory, line 10 starts at locations 16581/2 with the high/low byte of the line number, and 16583 holds 31, the number of bytes up to and including the end-of-line marker, which is at 16614. Line 15 begins at 16615, and 16617 holds 15, the number of bytes up to its end-of-line marker at 16632. The total number of bytes from the line 10 link at 16583 up to the line 15 end-of-line marker at 16632 is 49. If 49 is Poked into 15583, line 15 apparently disappears. If some unscrupulous person deletes line 10, then line 15 actually disappears and the program does not run properly any more.

"Look-at-memory" program.

```
10:REM MYPROG <C          PEEK ML
   > FRED BLOGGS         30:PRINT P:"  ":M
   1983                  L:"  ":CHR# P:
15:MS=16851:WAIT        "  ":CURSOR 0
   :TEXT                 40:NEXT A
20:FOR A=0TO 1000       50:PRINT "THE END
   :ML=MS+A:P=           ":END
```

The next idea involves Printing a new line of cursor-rights over the input prompt, ending up on the character:

```
PRINT "PROMPT:~*":PRINT"(cursor-up;
nine cursor-rights)"; INPUT "";A$
```

which does work, but is rather laborious in a general input routine designed to handle any input anywhere on the screen. And maybe the user will not want confusing characters at the start of each input field.

But these two objections can be dealt with. First, the X,Y co-ordinates of the position on the screen of the beginning of the input field can be found by Peeking 4465 and 4466 just before the Input statement. The top line and the left-most column are zero. These co-ordinates enable the special character to be Printed — or, preferably, Poked — into that position. Rather oddly the character with

the display code 240, which appears to be a space, is not a space at all so far as the input routine is concerned. Instead, it is ASCII character 197 — the left-most line character with the display code 113. So, if it is Poked into place at the start of the input field, and not overwritten by any key press, it is picked up as the input. The form is:

```
PRINT "PROMPT:~*":POKE
53248 + PEEK(4465) + 40 * PEEK(4466),
240:INPUT "";A$
```

where 53248 is the start of the screen memory. This provides both a user-invisible first line of defence against the careless key presser and the means, via a check for the input having the ASCII Code 197, to initiate remedial action. Do not forget to Poke 10167,1 to remove the Peek protect. 

Graph plotter

```

1 'THIS IS JONGRAF/001 V4 STARTED
17.12.81 AS A MOBILE GRAPH, I.E. TO
SHOW GRAPH OF UNLIMITED NUMBERS OF
DATA
4
DATA1,2,3,4,5,6,8,9,12,15,19,23,20,19,2
0,21,22,23,26,28,30,35,36,37,37,36,3
5,34,32,30,28,27,26,25,24,23,21,19,17,1
5,14,14,15,16,17,19,21,24,27,31,35,40,4
4
5
DATA43,43,42,42,42,41,41,41,41,40,40,39
,39,38,38,37,36,35,35,34,34,34,33,33
,33,33,32,31,30,31,32,33,35,37,40,41,42
,44,43,42,40,41,39,40,41
6
DATA41,42,41,43,42,41,40,39,39,38,37,37
,37,37,36,35,35,34,33,32,32,31,31,30
,29,29,28,27,26,25,24,23,22,22,23,22
,22,23,24,24,26,25,24
7
DATA24,23,22,21,19,18,17,16,15,14,13,12
,11,11,10,10,10,9,9,9,8,8,8,8,7,7,7
,7,7,6,6,6,6,6,6,5,5,5,5,5,5,5,5,5,5,5
,7,8,9,10,11,12,13,14,12,13,11,11,11,11
,11,11,11,12,13,14,15,16,16,17,17,17,17
,17,17,18,18,18,19
8
DATA19,19,18,18,18,17,17,17,16,17,17,17
,18,18,19,19,20,20,20,20,21,21,21,21
,21,21,22,22,22,22,22,22,22,22,22,22
,23,23,23,0
10 CLS: CLEAR 500: DIM D(500)
30
GR%=CHR$(176):G2%=CHR$(184):G3%=GR%+GR%
+GR%+G2%:
50
G4%=GR%+GR%+GR%+GR%+G2%:G5%=G4%+G4%+G4%
+G4%+G4%:
70 '***** LINES 50 TO 90 DRAW
THE VERTICAL AXIS
90
PRINT@960,CHR$(181):PRINT@896,CHR$(149
):PRINT@832,CHR$(149):PRINT@768,CHR$(
157):PRINT@704,CHR$(149):PRINT@640,CH
R$(149):PRINT@576,CHR$(151):
110
PRINT@512,CHR$(149):PRINT@448,CHR$(149
):PRINT@384,CHR$(149):PRINT@320,CHR$(
181):PRINT@256,CHR$(149):PRINT@192,CH
R$(149):PRINT@128,CHR$(157):
130
PRINT@64,CHR$(149):PRINT@0,CHR$(149):
150 '***** LINES 130 TO 170"
PRINT "THE NUMBERS ON VERTICAL AND
HORIZONTAL AXES
170
PRINT@769,"10":PRINT@577,"20":PRINT@3
85,"30":PRINT@129,"40":
190
PRINT@900,"10":PRINT@905,"20":PRINT@9
10,"30":PRINT@915,"40":PRINT@920,"50"
:PRINT@925,"60":PRINT@930,"70":PRINT
@935,"80":
210
PRINT@940,"90":PRINT@944,"100":PRINT@
949,"110":PRINT@954,"120":
230 '***** LINES 50 TO 52
PRINT THE HORIZONTAL AXIS
250 PRINT@961,G3%+G5%+G5%+G3%:
270 READ D(X):IF D(X)=0 THEN 290 ELSE
D(X)=D(X)+3*X+1:GOTO 270"
d(x)-d(x)+3 - this is to get the 'dot'
into the correct position on the graph
290 X=0:Z=0
310 IF X=128 THEN X1=X+1:GOTO 370
330 SET(X,(51-D(Z)))
350 X=X+1:Z=Z+1:IF D(Z)=0 THEN 510
ELSE 310
370 I=INKEY$:IF I="" THEN 370:
390 X=0
430 RESET (X,51-D(Z-128)):IF D(Z)=0
THEN 530 ELSE SET(X,51-D(Z)):Z=Z+1
470 X=X+1:IF X)127 THEN 490 ELSE 430
490 X1=X+1:GOTO 370
530 Z=Z-1:FOR A=X-1 TO
127:RESET (A,51-D(Z-128)):Z=Z+1:NEXT
550 FOR X=1 TO 4:FOR Y=1 TO 100
570 PRINT@31,"End":
590 NEXT Y
610 PRINT@31,STRING$(3,32):NEXT X
630 PRINT@31,"End":
650 GOTO 650
60023 CLOSE:CLS:PRINT@470,"G O D D B
Y E ":SAVE"JONGRAF/001.1":END

```

AN ALMOST unlimited number of points can be plotted as a simple line graph using this program. The data can be filed on either tape or disc or in Data program lines, and the number of items of data can be almost unlimited. When the program is run it first draws the X and Y axes with appropriate markers followed by the first 128 items of data. When you press the space bar, the next 128 items of data are drawn and the previous line is erased.

Successive sections of the graph will thus be drawn until all the items of data are exhausted. The end of the data in the program is indicated by a zero.

Lines 4 to 8 contain a specimen set of data and have no other significance. Your own data is entered here or elsewhere if you are using Data program lines. The data is actually read in line 270 as a variable D(X). If necessary you could insert a file opening and reading routine.

Code Breaker

Keith Blount of Northampton has sent in a program which he calls Code Breaker. It is a logical puzzle very much after the style of the well known Mastermind game. Mr Blount tells us very little about the rules as instructions are included in the program. Part of the puzzle is to decide how the rules work: don't be put off, just use your head to work it out.

```

1 '*****. CODE BREAKER BY KEITH
BLOUNT 15/08/83
2 '*****. INITIALIZE
3
CLS: CLEAR 100: RANDOM DEF STRA=F: DEF INTG=Z
:V=207
4 '
5 '*****. ...., SET UP SCREEN
6 '
7
PRINTSTRING$(64,143):PRINTTAB(45)"CODE
BREAKER":PRINTTAB(6)"ROUND
":FORX=0TOD3:PRINTCHR$(143)"
":NEXT:PRINT"
RESULT"CHR$(201)"Select 4
digits":PRINTTAB(42)CHR$(34)CHR$(93)"
"CHR$(94)CHR$(34)"Moves cursor
8 PRINTTAB(42)CHR$(34)"ENTER"CHR$(34)"
for result":PRINT@429,"RESULT
CODE":PRINTTAB(42)"* = Correct
digit":PRINTTAB(46)"Correct
position":PRINTTAB(42)"& = Correct
digit":PRINTTAB(46)"Wrong
position":PRINTTAB(42)". = Wrong digit
9
PRINTSTRING$(64,143):PRINTSTRING$(64,18
8):Y=199:FORX=1TOD9:PRINT@Y,X:Y=Y+64:
NEXT:FORY=0TOD42:SET(O,Y):SET(127,Y):IFY
(36:SET(80,Y)
10 '
11 '*****. SELECT 4 RANDOM NOS.
12 '
13
NEXT:FORX=0TOD3:F(X)=RIGHT$(STR$(RAND(10
)-1)),1):NEXT
14 '
15 '*****. SET VARS. FOR MAIN ROUTINE
16 '
17 FORX=0TOD3:E(X)=F(X):D(X)="
":U(X)=V:V=V+2:NEXT:Z=0:V=V+4
18 '
19 '*****. SCAN KEYS AND FLASH CURSOR
20 '
21
A=INKEY$:IFA="" :Y=Y+1:IFY(8)THEN21ELSEPR
INT@U(Z),D(Z):
22
IFA="" :A=INKEY$:Y=Y+1:IFY(32)THEN22ELSEPR
INT@U(Z),CHR$(140):
23 '
24 '*****. SET PROMPT MESSAGE AND
TEST FOR "ENTER"
25 '
26 Y=0:FORX=0TOD3:Y=Y-(D(X)="
"):NEXT:IFY=0:PRINT@842,"Press
"CHR$(34)"ENTER"CHR$(34)" to have this
round
decoded":IFA=CHR$(13)GOSUB44:GOTO35
27 '
28 '*****. TEST FOR AND ACTION INPUT
29 '
30
IFA="" THEN21ELSEIFASC(A)=9ANDZ=(2:GOSUB
44:Z=Z+1ELSEIFASC(A)=8ANDZ)=1THENGOSUB4
4:Z=Z-1ELSEIFA"O"ORA"9"THEN21ELSEIF(Z)
=A:PRINT@U(Z),A:IFZ=(2)THENZ=Z+1
31 GOTO21
32 '
33 '*****. DECIDE AND TEST FOR SUCCESS
OR FAILURE
34 '
35
F="" :FORX=0TOD3:IFD(X)=E(X)THENF=F+*
":D(X)=" :E(X)="
36
NEXTX:FORY=0TOD3:FORX=0TOD3:IFD(Y)=E(X)TH
ENF=F+*& ":D(Y)=" :E(X)="
37 NEXTX:NEXTY:PRINT@V,LEFT$(F+* . . .
. ,8):V=V+52:PRINT@842,STRING$(40,32):
:T=T+1:IFMID$(F$,7,1)="*":THEN41ELSEIFT=
9THEN43ELSE17
38 '
39 '*****. DISPLAY SUCCESS OR FAILURE
- WAIT TO RESTART GAME
40 '
41 PRINT@834,"*** YOU WIN WELL DONE
*** * Press any key to start again
*":
42 A=INKEY$:IFA="" THEN42ELSE1
43 PRINT@834,"The code was "F(0)"
"F(1)" "F(2)" "F(3)" ** (Press any
key to restart)":GOTO42
44 PRINT@U(Z),D(Z):RETURN

```

OKI MICROLINE

Microline 82A and 83A

High quality and performance as well as an attractive price are key features of these printers. Built on a moulded aluminium plate and driven by 2 motors.

These printers can work almost without limitation, as the printhead's design allows for over 200 million characters to be printed. The short line logic seeking printing speed is rated at 120 cps. The carriage width allows for the printing of 80 characters (model 82A) and 136 characters (model 83A).

Character sets for several languages and graphics printing are standard features of these printers as well as the processing of various paper types.

The interfaces provided allow for parallel or serial data transfer - buffered or unbuffered - from most popular desktop computers and widely-used PCs.



**MICROLINE - more than
150.000 printers in Europe in use.**

OKI OKI ELECTRIC EUROPE GmbH
Emanuel-Leutze-Str. 8 · D-4000 Düsseldorf 11
Telefon 02 11/59 20 31 · Telex 8 587 218

U.K. X-Data Ltd.
F-705/751 Deal Avenue
Trading Estate, Slough
Berkshire SL1 4SH
Tel.: 0044-753-72331
Tlx: 051-847728

COUPON

Please send me/us more information to:

- MICROLINE 82 A
 MICROLINE 83 A
 The whole MICROLINE program

PC2

Name: _____

Street: _____

City: _____

Phone: _____

Ultra-fast BeeBASE -



**A machine code
database in EPROM
(for the BBC Micro)
for £45.94***

- Up to 25 user-defined fields
- Up to 250 characters in each field
- More than 16K of RAM available for storage (unlimited capacity when used with disk or tape). Extremely fast SEARCH, EDIT, and SORT facilities.
- SEARCH commands include: FIND and EXCLUDE - can be used on up to ten consecutive searches. Enables data to be extracted which meets ALL of the given FIND and EXCLUDE commands. Provides extremely selective data extraction.
- Extracted data can be SORTed on any field.
- EDIT enables records to be deleted or amended (shortened or lengthened).
- An ASCII file of extracted and sorted data can output to disk or tape for storage or further editing by a word processing package (such as Wordwise).
- Includes demonstration cassette which also contains a selective printing program.

Order today - Access and Visa welcomed.

*(Price includes VAT - p&p £1)

Trade and local authority enquiries welcome.

Price correct at time of going to press.



GCC (Cambridge) Limited
66 High Street, Sawston, Cambridge CB2 4BG
Telephone: Cambridge (0223) 835330



● Circle No. 203

THE PROFESSIONAL DATABASE

**For:
CP/M-80
MS DOS
PC DOS2
PCOS**

RESOLVE!

**INCLUDING:
IBM PC, APRICOT, WANG, DEC
SIRIUS, ICL PC, OLIVETTI.**

- EASY TO USE
- MANY APPLICATIONS
- MULTI KEY ACCESS
- LINKS TO WORDSTAR™
- SUPERFAST SORT
- FANTASTIC VALUE AT £295 + VAT
- SPECIAL TERMS FOR DEALERS

NEW:
TRAINING GUIDE
WITH DEMO:
£35 + VAT

**RING NOW FOR MORE
DETAILS AND FREE FULL SPEC**

**QUDOS
SYSTEMS LTD**

01-253-3998 TELEX
261729

5 CHARTERHOUSE BLDGS,
27A GOSWELL ROAD, LONDON EC1M 7AN

● Circle No. 147

(continued from previous page)

```

1
116 IF PDL (1) > 235 THEN X = X
    + 1
117 HTAB 1: VTAB 0X: PRINT " "
118 IF SCRN( 0,2 * (X - 1) ) + 1
    6 * SCRN( 0,2 * (X - 1) + 1
    ) < > 160 AND SCRN( 0,2 *
    (X - 1) ) + 16 * SCRN( 0,2 *
    (X - 1) + 1) < > 190 THEN 6
    9
119 VTAB X: HTAB 1: PRINT ">"
120 0X = X
121 IF PEEK ( - 16287) > 127 THEN
    GOSUB 55
122 RETURN
123 REM
124 REM ****
125 REM * HOOT
126 REM ***
127 REM ***
128 REM **** * UT
129 REM * *
130 REM * *
131 REM ***
    
```

Low-resolution screen formatter

Basic programs frequently carry screen-loads of instructions about with them as embedded code, using up memory while the program is resident and requiring effort to code up in the first place. A screen formatter from John Cayley of Durham lets you prepare and amend binary files containing the text in a format suitable for display when brought into memory through a corresponding assembler module. The assembler is prepared through a small Basic program which Pokes the routine into memory and BSaves it. Text is saved in a condensed

rather than display format, which saves some disc space.

When running the formatting program, Encode.Obj must be on disc. When running the user program, Decode.Obj must be in memory; it is put there by entering:

```
PRINT CHR$(4); "BLOAD DECODE.OBJ"
```

When you want to load the screen itself, put its name into a string variable and Gosub to a routine with the following lines:

```

PUT = PEEK (110) + 1
POKE 8, 0 : POKE 9, PUT
PUT = PUT * 256
PRINT CHR$(4); "BLOAD" SCREEN$
"A" PUT
CALL 768
    
```

Screen formatter.

```

100 REM ** LD-RES SCREEN FORMAT
    TER **
110 REM ** AND BINARY SAVER
    **
120 REM ** BY JOHN CAYLEY, 1983
    **
130 REM
140 HOME :A1 = 1:Z = 0:V = A1:H =
    A1:D$ = CHR$(13) + CHR$(
    4)
150 HTAB 3: PRINT "SCREEN FORMAT
    TER & BINARY SAVER": HTAB 3:
    PRINT "-----"
160 HTAB 20: VTAB 4: PRINT "BY J
    OHN CAYLEY, 1983"
170 PRINT : PRINT " THIS PROGRA
    M WILL HELP YOU SET UP D
    ISPLAY SCREENS AND SAVE THEM
    IN AN"
180 PRINT "ECONOMICAL BINARY FOR
    M. THE SCREENS ARE ACCESSIBL
    E TO YOUR BASIC PROGRAMS BUT
    "
190 PRINT "DON'T USE UP VALUABLE
    PROGRAM SPACE."
200 PRINT : PRINT " PRESSING 'E
    SC' ALLOWS THE FOLLOWING
    COMMANDS:"
210 PRINT : PRINT TAB(5)"I,J,K
    ,M - MOVE THE CURSOR"
220 PRINT TAB(7)"V,F,N - INVER
    SE, FLASH, NORMAL"
230 PRINT TAB(9)"C,D - CLEAR S
    CREEN OR LINE"
240 PRINT TAB(11)"/ - FINISH &
    SAVE"
250 PRINT " SPACE BAR - RETURN
    TO TYPING"
260 VTAB 23: HTAB 1: INPUT "DO Y
    OU WANT TO LOAD A PREVIOUSLY
    CREATEDSCREEN? ";A$: GOSUB
    710
270 HOME : IF Y THEN GOSUB 740
280 GOSUB 800
290 GET A$:A = ASC (A$)
300 IF A = 8 THEN GOSUB 370
310 IF A = 13 THEN GOSUB 410
320 IF A = 27 THEN GOSUB 450
330 IF A < 32 THEN 290
340 PRINT A$;
350 H = H + A1: IF H > 40 THEN H =
    A1:V = V + A1: IF V > 20 THEN
    H = A1:V = 20: HTAB H: VTAB
    V
360 GOTO 290
370 REM ** BACKSPACE **
380 PRINT A$;
390 H = H - A1: IF H < A1 THEN H =
    40:V = V - A1: IF V < A1 THEN
    H = A1:V = A1
400 HTAB H: VTAB V: RETURN
410 REM ** RETURNS **
420 PRINT A$;
430 H = A1:V = V + A1: IF V > 20 THEN
    V = 20
440 HTAB H: VTAB V: RETURN
450 REM ** ESC MODE **
460 GOSUB 860
470 GET A$:A = ASC (A$)
480 IF A = 32 THEN GOSUB 800: RETURN
490 IF A = 73 THEN V = V - A1: IF
    V < A1 THEN V = A1
500 IF A = 74 THEN H = H - A1: IF
    H < A1 THEN H = A1
510 IF A = 75 THEN H = H + A1: IF
    
```

```

H > 40 THEN H = 40
520 IF A = 77 THEN V = V + A1: IF
    V > 20 THEN V = 20
530 IF A = 67 THEN HOME :V = A1
    :H = A1: GOTO 460
540 IF A = 68 THEN HTAB A1: PRINT
    SPC(40)
550 IF A = 78 THEN NORMAL :F =
    Z:1 = Z: GOSUB 880
560 IF A = 86 THEN INVERSE :I =
    A1: GOSUB 890
570 IF A = 70 THEN FLASH :F = A
    1: GOSUB 900
580 IF A = 47 THEN POP : GOTO 6
    00
590 VTAB V: HTAB H: GOTO 470
600 REM ** SAVE SCREEN **
610 HTAB A1: VTAB 23: INPUT "DO
    YOU WANT TO SAVE THIS SCREEN
    ? ";A$: GOSUB 910
620 GOSUB 710: IF NOT Y THEN 68
    0
630 HTAB A1: VTAB 23: INPUT "UND
    ER WHAT NAME? ";S$: GOSUB 91
    0
640 HTAB A1: VTAB 23: INPUT "DRI
    VE NUMBER? ";DR$: GOSUB 910
650 HTAB A1: VTAB 22: PRINT D$"B
    LOAD ENCODE.OBJ,D1"
660 POKE 10,76: POKE 11,Z: POKE
    12,3:L =USR (Z)
670 HTAB A1: VTAB 22: PRINT D$"B
    SAVE "S$",A$4000,L"L",D"DR$
680 HTAB A1: VTAB 23: INPUT "DO
    YOU WISH TO CONTINUE? ";A$
690 GOSUB 710: IF Y THEN GOTO 1
    40
700 END
710 REM ** YES/NO **
720 IF LEFT$(A$,A1) = "Y" THEN
    Y = A1: RETURN
730 Y = Z: RETURN
740 REM ** LOAD SCREEN **
750 PRINT D$"BLOAD DECODE.OBJ"
760 PRINT "WHAT IS THE NAME OF T
    HE SCREEN?": PRINT : INPUT "
    > ";S$
770 PRINT : INPUT "DRIVE NUMBER?
    ";DR$
780 PUT = PEEK (110) + A1: POKE
    B,Z: POKE 9,PUT:PUT = PUT *
    256
790 PRINT D$"BLOAD "S$",D"DR$",A
    "PUT: CALL 768: RETURN
800 REM ** TYPING MODE **
810 NORMAL : HTAB 14: VTAB 23: PRINT
    "TYPING MODE";
820 HTAB H: VTAB V
830 IF F THEN FLASH
840 IF I THEN INVERSE
850 RETURN
860 REM ** ENTER ESC MODE **
870 NORMAL : HTAB 14: VTAB 23: PRINT
    "ESC MODE ";: GOTO 820
880 VTAB 23: HTAB 2: PRINT "
    ";: VTAB 23: HTAB 35: PRINT
    " ";: VTAB V: HTAB H: RETURN
890 VTAB 23: HTAB 2: PRINT "INVE
    RSE";: VTAB V: HTAB H: RETURN
900 VTAB 23: HTAB 35: PRINT "FLA
    SH";: VTAB V: HTAB H: RETURN
910 REM ** CLEAR LOWER LINES **
920 HTAB A1: VTAB 23: PRINT SPC(
    79): RETURN
    
```

Basic loader.

```

100 REM ** PROGRAM TO CREATE AN
    D SAVE OBJECT FILES FOR SCRE
    EN MAKER **
110 D$ = CHR$(4): HOME
120 GOSUB 1000
130 PRINT D$"BSAVE ENCODE.OBJ,A$
    300,L188"
140 PRINT "SCREEN ENCODER CREATE
    D AS "; INVERSE : PRINT "EN
    CODE.OBJ": NORMAL
150 GOSUB 2000
160 PRINT D$"BSAVE DECODE.OBJ,A$
    300,L112"
170 PRINT : PRINT "SCREEN DECODE
    R (AS USED IN PROGRAMS) S
    AVED AS "; INVERSE : PRINT
    "DECODE.OBJ": NORMAL
180 END
1000 REM ** MACHINE CODE FOR SC
    REEN COMPRESSOR **
1010 DATA 169,0,133,6,133,8,141
    ,185,3,141,186,3,141,187,3,1
    69,4,133,7,169,64,133,9,160,
    0,162,0,177,6,201,160,208,74
    ,32,145,3,165,7,201,8,208
1020 DATA 5,169,160,76,85,3,177
    ,6,201,160,240,8,32,165,3,17
    7,6,76,107,3,169,153,32,122,
    3,232,240,29,177,6,201,160,2
    08,23,32,145,3,165,7,201,8
1030 DATA 208,238,138,32,122,3,
    173,187,3,172,186,3,32,242,2
    26,96,138,32,122,3,162,0,76,
    27,3,32,122,3,32,145,3,165,7
    ,201,8,208,164,76,85,3,140
1040 DATA 185,3,172,186,3,145,8
    ,200,208,5,230,9,238,187,3,1
    40,186,3,172,185,3,96,200,19
    2,248,208,5,230,7,76,159,3,1
    92,120,208,5,152,24,105,8,16
    8
1050 DATA 96,136,192,255,208,5,
    198,7,76,179,3,192,127,208,5
    ,152,24,233,8,168,96,0,0,0,0
1060 FOR X = 0 TO 188: READ CD: POKE
    768 + X,CD: NEXT
1070 RETURN
2000 REM ** MACHINE CODE TO LOA
    D COMPRESSED SCREEN INTO LOW
    RES AREA **
2010 DATA 169,0,133,6,141,110,3
    ,141,111,3,169,4,133,7,162,0
    ,160,0,177,8,201,153,208,24,
    32,104,3,177,8,32,104,3,170,
    169,160,32,64,3,201,255,240
2020 DATA 16,202,208,244,76,18,
    3,32,64,3,32,104,3,201,255,2
    08,216,169,160,141,247,7,96,
    140,111,3,172,110,3,145,6,20
    0,192,248,208,11,230,7,165,7
    ,201
2030 DATA 8,208,7,169,255,96,19
    2,120,208,5,152,24,105,8,168
    ,140,110,3,172,111,3,96,200,
    208,2,230,9,96,0,0,0
2040 FOR X = 0 TO 112: READ CD: POKE
    768 + X,CD: NEXT
2050 RETURN
    
```

CodeWriter

makes
data-base and
related programming
as simple as

abc

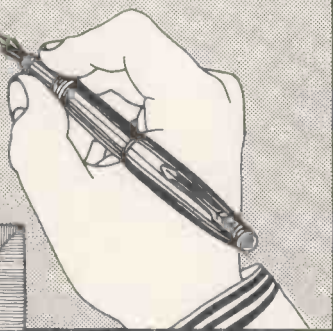

"WHY BUY ANY
OTHER DATA-BASE
PROGRAM WHEN
YOU HAVE
CODEWRITER?"
- recent satisfied user.

Forget about the expense of hiring a professional programmer or the restrictions of 'off-the-shelf' programs. Become your own program designer producing microsoftware to suit your specific requirements. Codewriter enables you to do this, you type commands in your own everyday language, just as you would write them on paper... it's as simple as ABC!

When you've completed your design, Codewriter will write the program code and store it on your own disk whilst you sit back and watch. At anytime, you can of course modify the programs you've designed.

Your programs may include data bases printed reports, calculations and comparisons between fields of data, development of menus, forms, letters, memos, cheques, invoices, statements, mailing labels... the possibilities for design are endless. Codewriter operates with most popular micros and will be demonstrated fully at your local dealer.

For details on Codewriter, complete and return the coupon to:
DYNATECH MICROSOFTWARE LTD.

Rue du Commerce, Bouet, St. Peter Port,
Guernsey, Channel Islands.
Telephone 0481 26081 Telex 4191130

name _____
address _____
_____ tel. _____

PC

C/WP COMPUTERS

£159

inc VAT



ALPS DISK DRIVE FOR APPLE II*

Slimline half height disk drive for the Apple II. Use with Apple disk controller card.

Box of disks **£13**. Disk storage boxes (35) **£14** (80) **£19**

*Apple is a registered trade mark of Apple Computers.

£79

inc VAT



PHOENIX 12" PLASTIC MONITOR

24 MHz monitor for the best possible resolution for 80 columns.
80 column card for Apple II Plus **£109**

£399

inc VAT

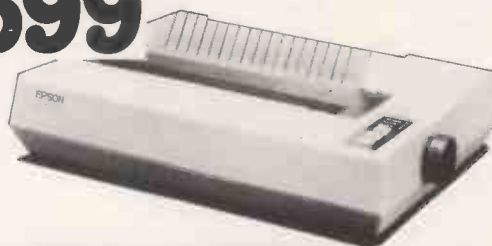

EPSON FX 80 PRINTER

160 cps, user definable fonts and graphics.
Parallel interface card **£72**. 16k buffer **£79**. 32k buffer **£109**.
Ribbons **£4**

C/WP Computers
Willow House Willow Place
London SW1P 1JH
Telephone 01-828 9000

Please send me details of/I enclose cheque/Access/
Barclaycard (No.) _____

for £ _____ and am ordering*

Alps disk drive Phoenix monitor

Epson FX80 Other _____

Name _____

Address _____

Telephone _____

*Delete where applicable

Delivery charge **£3.00**

● Circle No. 177

● Circle No. 178

MicroSight

Use your BBC Model B as an image analyser with MicroSight I



Available on BBC, Apple, Commodore, Research Machine, Sirius, etc, Includes Camera cables, interface, software and documentation.

£495.00 + VAT

MicroScale.



Image processing software to calculate area and perimeter of objects within a specified window also to dimension features. Disk and printer dumps of binary and grey scale data.

£295.00 + VAT

MicroEye Vision Interface.

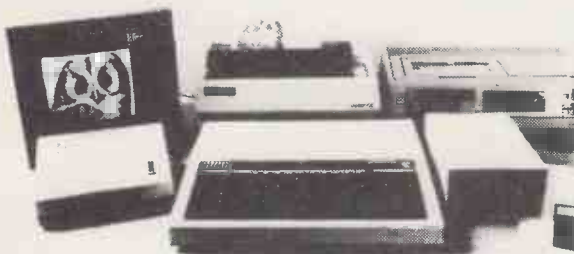

256 x 256 pixel resolution with 255 grey levels per pixel comes complete with software and documentation. Can be used for video tape digitising Satellite picture analysis etc. Available for BBC, Apple, Commodore, Research Machine, Sirius etc.

£295.00 + VAT

DIGITHURST

Digithurst Ltd.
Leaden Hill, Orwell, Royston,
Herts. SG8 5QH
Tel: (0223) 208926

● Circle No. 179

C/WP COMPUTERS



QUALITY 5¼" FLOPPY DISKS

Take our choice of three top quality brands – BASF, Wabashi or Xidex. C/WP has tested most available disks and offers these as the best value for money, combining reliability, with low prices.

Single-sided, single-density (100k) **£13**

Single-sided, double-density (200k) **£17**

Double-sided, double-density (400k) **£22**

Double-sided, quad-density (800k) **£29**

Includes VAT per box of 10.

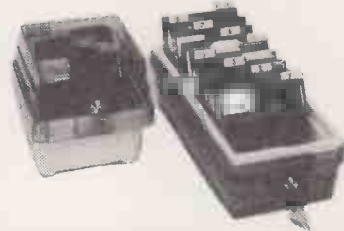

FLOPPY DISKS STORAGE BOXES

A neat box with transparent lockable cover to hold up to 35 disks. With the top off the disks are presented as in a card index. A larger version will hold up to 80 disks.

Small size **£14** Large size **£19** inc VAT

LISTING PAPER

2000 sheets fanfold listing paper 9 inch or 14 inch. **£12** inc VAT

SELF ADHESIVE LABELS

1, 2 or 3 across. Per thousand. **£5** inc VAT

C/WP Computers
Willow House Willow Place
London SW1P 1JH
Telephone 01-828 9000

Please send me details of/I enclose cheque/Access/
Barclaycard (No.) _____

_____ for £ _____ and am ordering*

Floppy Disks (size) _____ Listing Paper/Labels

Storage Boxes (size) _____ Ribbons _____

Name _____

Address _____

Telephone _____

*Delete where applicable Delivery charge £3.00

● Circle No. 180

1984 On Course For Record Computer Sales

Sponsored by:

**Practical
Computing**
&
**YOUR
COMPUTER**

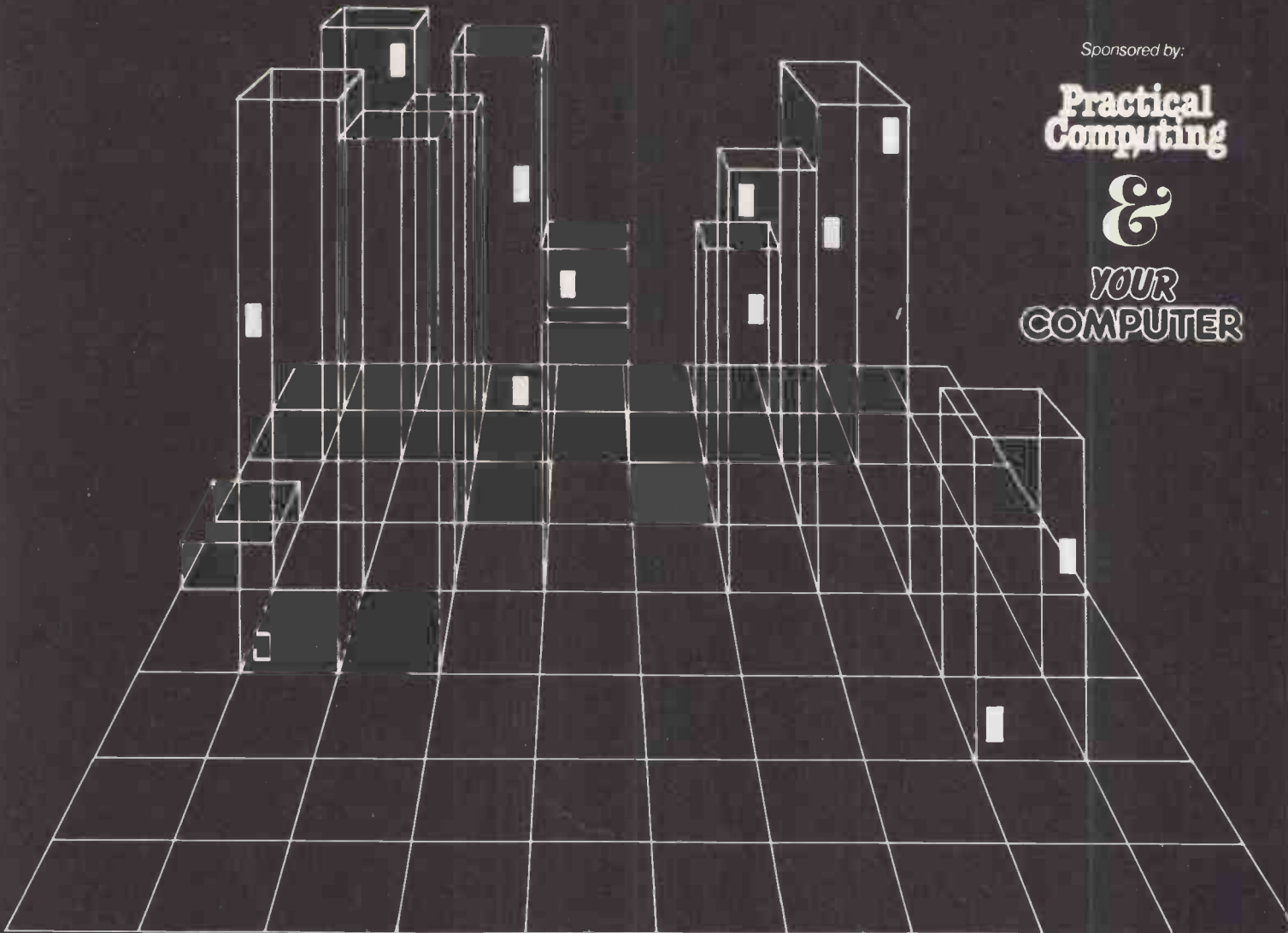

There can be few – if any – comparable exhibitions capable of generating such intense public interest as The Computer Fair series.

As expected, the 1983 Computer Fair, held at Earls Court, has consolidated its position as the major showcase for home and small business computers, to the extent that it became necessary for the original exhibition area to be doubled to a record 2,300 square metres. And all the signs are emerging to support our belief that 1984 will see further growth in an exhibition which provides an unrivalled opportunity for promoting personal computer systems of all kinds.

Sponsored by 'Practical Computing' and 'Your Computer' and organised by Reed Exhibitions, the 1984 London Computer Fair will again be backed by a massive publicity campaign using radio, television and press media. Advance stand reservations are understandably already well up on 1983. If you want to ensure that you do not miss out on a preferential site, you really must fill in the coupon below NOW, and return to the

Exhibitions Manager, The Computer Fair,
Reed Exhibitions, Surrey House, Throwley Way,
Sutton, Surrey. SM1 4QQ

THE
**Computer
Fair** *Personal computers
Home computing
Small business systems*

154

Earls Court, London. June 14–17 1984

I am interested in exhibiting at The Computer Fair, Earls Court,
London. June 14–17 1984.

Please send full information to

Name _____

Position in Company _____

Company _____

Address _____

Telephone No. _____ Telex _____

(continued from previous page)

```

LET h=24: FOR f=1 TO 3: PRINT AT
f,9;"□";AT f,h;"□": LET g=g-1:
LET h=h+1: NEXT f
52 GO SUB 9500
55 INK 0
58 GO SUB 2000
60 PRINT AT 6,2; INK 2;"PLEASE
SELECT:"
70 PRINT AT 9,2;"Press A to en
ter words.";AT 11,2;"Press B to
start test.";AT 13,2;"Press C to
save the program";AT 15,10;"and
the vocabulary.";AT 17,2;"Press
X to exit."
80 PRINT AT 9,8; PAPER 2; INK
6; FLASH 1;"A";AT 11,8;"B";AT 13
,8;"C";AT 17,8;"X"
85 LET i$=INKEY$: IF i$="A" OR
i$="B" OR i$="C" OR i$="X" THEN
BEEP .1,10: GO SUB 2000
90 IF i$="A" THEN GO TO 9000
100 IF i$="B" THEN GO SUB 500
110 IF i$="C" THEN GO TO 6000
120 IF i$="X" THEN PRINT AT 12
,6; INK 2;"THANK YOU FOR USING";A
T 13,7;"LANGUAGE TUTOR!": BEEP
2,10: NEW
130 GO TO 85
510 LET sc=0
520 GO SUB 2000: PRINT AT 12,3;
INK 2;"HERE ARE YOUR QUESTIONS.
...": FOR f=0 TO 20: BEEP .01,f:
BEEP .01,f+3: NEXT f
530 FOR q=1 TO 10: GO SUB 2000
540 PRINT AT 6,2; INK 1;"QUESTI
ON NUMBER:"; PAPER 6; FLASH 1;q:
FOR f=1 TO 60: NEXT f: PRINT AT
6,18; INK 2;q
550 LET a=INT (RAND*100): IF a<5
0 THEN GO TO 800
560 GO TO 900
630 INPUT LINE s$: BEEP .1,10
632 IF a<50 THEN LET m$=a$(h) (1
TO m(h))
634 IF a>49 THEN LET m$=b$(h) (1
TO n(h))
650 IF s$<>m$ THEN GO TO 700
655 LET sc=sc+1: GO SUB 2000: P
RINT AT 8,2; INK 2; FLASH 1;"WEL
L DONE!";AT 10,2; FLASH 0; INK 1
;"That is correct"
657 FOR f=1 TO 30 STEP 3: BEEP
.03,f: BEEP .03,f+10: BEEP .03,f
: NEXT f: PRINT AT 13,2; BRIGHT
1;"SCORE SO FAR:";sc;" out of ";
q: FOR f=1 TO 5: BEEP .05,30: BE
EP .05,20: NEXT f: FOR f=1 TO 30
: NEXT f
660 GO TO 750
700 GO SUB 2000: PRINT AT 8,2;
PAPER 2; INK 7; BRIGHT 1; FLASH
1;"NO!": FOR f=0 TO -20 STEP -1:
BEEP .1,f: NEXT f: PRINT AT 10
,2; INK 2;"That is incorrect.": B
EEP 2,-20: PRINT AT 12,2; INK 1;
"The correct answer was";AT 13,2
;m$: " "
710 PRINT AT 16,2; BRIGHT 1;"SC
ORE SO FAR:";sc;" out of ";q: FO
R f=1 TO 50: NEXT f
720 FOR f=1 TO 200: NEXT f
750 NEXT q
760 GO TO 1000
800 LET h=((RAND*(w-1)+1))
805 LET z#=b$(h) (1 TO n(h))
810 PRINT AT 11,2; INK 1;"What
is the English word";AT 12,2;"fo
r ";z$;"?"
820 GO TO 630
900 LET h=((RAND*(w-1)+1))
905 LET z#=a$(h) (1 TO m(h))
910 PRINT AT 11,2; INK 1;"What
is the ";x$;AT 12,2;"word for ";
z$;"?"
920 GO TO 630
1020 GO SUB 2000

```

```

1030 PRINT AT 6,2; INK 1; PAPER
5;"THAT IS THE END OF THE TEST":
FOR f=1 TO 4 STEP .1: BEEP .01,
10: BEEP .01,20: BEEP .01,30: NE
XT f
1040 PRINT AT 8,5; INK 1;"YOUR F
INAL SCORE WAS ";sc: IF sc<=hs T
HEN GO TO 3000
1050 LET hs=sc: PRINT AT 12,1; P
APER 2; INK 7; BRIGHT 1; FLASH 1
;"*****"
;AT 18,1; INVERSE 1;"*****"
*****"
1060 PRINT AT 14,11; INK 1;"WELL
DONE!";AT 15,5; INK 2;"YOU HAVE
REACHED A NEW";AT 16,11;"HIGH S
CORE"
1070 FOR f=1 TO 30: BEEP .01,f:
NEXT f: FOR g=1 TO 20: BEEP .01,
f-5: BEEP .01,f: NEXT g
1080 INPUT INK 1; PAPER 6;" PL
EASE ENTER YOUR NAME... "; PAP
ER 7;" "; LINE n$
1090 FOR f=1 TO 10: BEEP .01,f:
BEEP .01,f+4: NEXT f: GO TO 57
2010 FOR f=5 TO 19: PRINT AT f,1
:" "; NEXT f
2020 RETURN
3000 PRINT AT 11,1; INK 1;"The h
ighest score so far is ";hs;AT 1
3,1; INK 2;"This score was reach
ed by";AT 14,1;n$;" "
3010 FOR f=10 TO 7 STEP -1: BEEP
.1,f: BEEP .1,f+3: NEXT f
3020 FOR f=1 TO 300: NEXT f: GO
TO 57
6010 GO SUB 2000: SAVE "LANGUAGE
" LINE 20
6020 GO TO 57
9010 PRINT AT 12,1; INK 2;"WHAT
IS THE FOREIGN LANGUAGE?": INPU
T "█"; LINE x$: BEEP .3,20
9030 PRINT AT 12,1; INK 2;"
HOW MANY WORDS?": INPU
T "█";w: BEEP .3,20
9035 DIM a$(w,10): DIM b$(w,10):
DIM m(w): DIM n(w)
9040 PRINT AT 12,1;"PLEASE ENTER
THE VOCABULARY..."
9045 FOR f=1 TO w
9050 INPUT "English word?" "█";
LINE e$: BEEP .3,20
9055 PRINT AT 14,2;" ";
AT 16,2;" "
9060 IF LEN e$>10 OR e$="" THEN
BEEP .4,-20: GO TO 9050
9070 LET m(f)=LEN e$: LET a$(f)=
e$
9075 PRINT AT 14,2; INK 0;e$:
9080 INPUT (x$);" translation?"
"█"; LINE e$: BEEP .3,20
9090 IF LEN e$>10 OR e$="" THEN
BEEP .4,-20: GO TO 9080
9100 LET n(f)=LEN e$: LET b$(f)=
e$
9110 PRINT AT 16,2;e$
9120 NEXT f
9130 GO SUB 2000
9140 PRINT AT 12,8; INK 2; FLASH
1;"ALL DATA ENTERED"
9150 BEEP 2,20
9160 GO TO 57
9510 PRINT AT 6,2; INK 1;"The ai
m of this program is";AT 7,2;"to
help you to learn the";AT 8,2;"
vocabulary of a foreign";AT 9,2;
"language."
9520 PRINT AT 11,2; INK 2;"You c
an enter words of up";AT 12,2;"t
o ten letters in length";AT 13,2
;"and the computer will then";AT
14,2;"test you on your knowledg
e";AT 15,2;"of that vocabulary."
9530 PRINT AT 17,10; PAPER 6; IN
K 2; FLASH 1;"PRESS ANY KEY": PA
USE 1: PAUSE 1: PAUSE 0: RETURN

```

□

FREE WITH ORDERS OF MINIMUM 10 BOXES ANY DISK TYPE EITHER

1. 3 PLASTIC LIBRARY CASES TO HOLD 10 DISKS EACH OR

2. PRESTIGIOUS LAMBS NAVY RUM CLASSIC GLAMOUR CALENDAR WITH SUPERB COLOUR PHOTOS BY DAVID BAILEY

STRICTLY LIMITED SUPPLY OF CALENDARS SO ORDER EARLY IF THIS IS YOUR CHOICE

DISKOTEK

FOR VERBATIM DATALIFE
5 1/4" DISKETTES
SUPPLIED IN BOXES OF 10

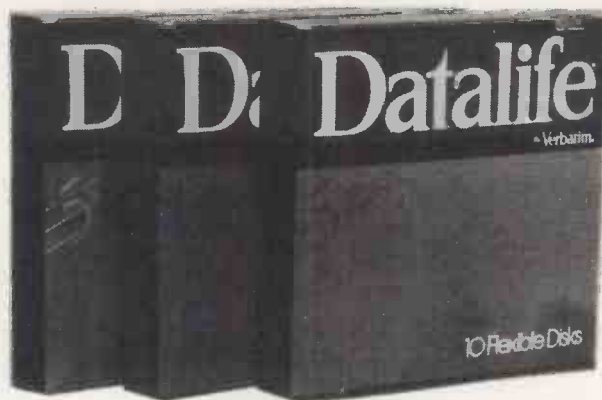

WE SELL ONLY DATALIFE BECAUSE OF THEIR HIGH QUALITY AND RELIABILITY

- 5-YEAR WARRANTY
- LIFE UP TO 5 TIMES LONGER THAN OTHER DISKETTES
- ALL INTERNATIONAL STANDARDS MET OR EXCEEDED
- ALL TRACKS CERTIFIED 100% ERROR FREE

PRICES BELOW EXCLUDE VAT BUT INCLUDE FIRST CLASS POST (FOR SPEED) AND PACKING

DISKOTEK
P.O. BOX 18
WORSLEY
MANCHESTER
M28 5HA
TELEPHONE:
(061) 799-1427

EVENING INCLUDING WEEKEND ANSWERPHONE

HAVE YOU A HIGH QUALITY CALENDAR IN YOUR OFFICE? IF NOT ACT ON OUR FREE OFFER QUICKLY

All disks are suitable for both single density and double density use

MD 525 single sided 48tpi/40 track
MD 550 double sided 48tpi/40 track
MD 577 single sided 96tpi/80 track
MD 557 double sided 96tpi/80 track

Price per box of 10

No. of Boxes

Cost

19.80
25.80
25.80
33.80

Total Excluding VAT

15% VAT

Total Payable

Strictly cash with orders to:

Name

Address

..... Post Code

I enclose cheque/P.O. Payable to Diskotek for the sum of £ _____

For orders of 10 boxes minimum of any disk type tick one of the boxes below for preference:

- Please send me free of charge 3 plastic library cases
or Please send me free of charge Lambs Navy Rum 1984 Calendar

DISKOTEK
PO. BOX 18
WORSLEY
MANCHESTER
M28 5HA

● Circle No. 250

LVL COMPUTERTOWN

Whether its your first computer or whether you're already an enthusiast, LVL COMPUTERTOWN offers you the quality of service you expect from experts. If you invest money, you go to a bank or a broker - a specialist who can guide and advise you on the best return for your capital. At LVL COMPUTERTOWN we're specialists too. We're there to help guide you through the micro maze, keep you up to date on innovations, help you get the best value for money, whether your computer is for you, your children or your business. Your computer can change your life - make sure you change it for the better: Come and talk to the experts and move into micros with LVL COMPUTERTOWN



A REFLECTION OF SUPERIORITY

(WHICH EVER WAY YOU LOOK AT IT).

£39.95

The Bell & Howell/LVL Computer Compatible Data Recorder.

- Automatic Level Control
- Automatic Tape Stop
- Tape Counter
- Remote Motor Control.



MONITORS



SABA 14" COLOUR MONITOR/
COLOUR TV.

£274.45

MICROVITEC 14" Colour Monitor
£247.25

BBC MICROCOMPUTER

- MODEL A £299
- MODEL B £399
- MODEL B with ECONET £446
- MODEL B with DOS £469
- Model B with DOS & ECONET
..... £516



DECCACOLOUR

14" Colour Monitor
£247.25

SANYO

12" Green Screen
£102.35

PRINTERS



£503.70



£734.85

EPSON

FX-80

An astonishing 160 characters per second, proportional spacing, quick forms tear-off, superscripts, subscripts, dot addressable graphics and down loadable character set.

TRI-WRITER

- * IT'S A PORTABLE COMPUTER TERMINAL!
- * IT'S A LETTER QUALITY COMPUTER PRINTER
- * IT'S A FULL FEATURE ELECTRONIC TYPEWRITER

SOFTWARE

DESIGNED FOR THE BBC MICROCOMPUTER

ADVENTURES	
Philosophers Quest	£9.95
Castle of Riddles	£9.95
Countdown to Doom	£9.95
Sphinx Adventure	£9.95

GENERAL	
Desk Diary	£9.95
Creative Graphics	£9.95
Graphs & Charts	£9.95
Tool Box	£21.00
Record Keeper	£13.80
Magic Garden	£9.95

EDUCATIONAL	
Business Games	£9.95
Tree of Knowledge	£9.95
Peeko Computer	£9.95
Algebraic Manipulation	£9.95
Word Sequencing	£11.90
Missing Signs	£11.90
Number Balance	£11.90
Word Hunt	£11.90
Density Circuit	£11.90
Chemical Analysis	£13.80
Chemical Structures	£13.80
Jars	£11.90
Vu-Type	£16.10

BBC	
The Computer Book	£6.75
The Book of Listings	£3.75
30hr. Basic	£5.95
Beyond Basic	£7.25
The Friendly Computer	£4.50
Sound & Graphics	£7.95

GENERAL

Programing for the BBC	£8.95
Advanced User Guide	£12.95

ACORN

Creative Graphics	£7.50
Graphs and Charts	£7.50
Forth Book	£7.50
Lisp Book	£7.50
View Guide	£2.50
Into View	£2.50
BCPL User Manual	£15.00

The items featured represent a very small selection from our vast product range.

Further information of both product and services available can be obtained by telephoning or visiting your nearest LVL Computertown Dealer.



CHESHIRE

C-TECH SOFTWARE
184, Market St.
HYDE
Cheshire
061 366 8223
* COMPUTER CITY
78, Victoria Rd.
WIDNES
Cheshire
051 420 3333
* OAKLEAF COMPUTERS
100, Boughton
CHESTER
0244 310099

CUMBRIA

* THE COMPUTER SHOP
56/58 Lowther St.
CARLISLE
Cumbria
0228 27710

ESSEX

A.C.L.
1, Northmall
GRAYS, ESSEX
0375 79834
BROADWAY MUSIC
AND VISION
Woodford Green
ESSEX
01 504 7500

GREAT MANCHESTER

* LOMAX
8, Exchange St.,
St. Annes Square,
MANCHESTER
061 832 6167
WORC'S
SPURTREE COMPUTING
LTD.
Council Buildings,
Teme Street,
TENBURY WELLS,
Worcestershire
0584 811353/811304

MERSEYSIDE

* THORNGUARD
46, Pensby Rd,
HESWALL
The Wirral,
Merseyside
051 342 7512

NOTTS'

* BASIC BUS. SYS.
Trent Boulevard
WEST BRIDGFORD
Nottingham
0602 819713
S P ELECTRONICS
48, Linby Rd.
HUCKNALL
Notts.
0602 640377

LEASALINK VIEWDATA Ltd
230, Derby Rd.

STAPLEFORD

Notts.
0602 399484

OXFORD

ABSOLUTE SOUND
AND VIDEO (Oxford) Ltd.
19, Old High St. Headington

OXFORD

0865 65861

AVON

K & K COMPUTERS
32, Alfred Street,
WESTON

SUPERMARE

Avon
0934 419324

COLSTON COMPUTER

CENTRE LTD.,

The Colston Centre,

11, Colston Ave.,

BRISTOL

0272 276619

WARWICKSHIRE

CARVELL
9, Bank St.
RUGBY
Warwickshire
0788 65275

WEST MIDLANDS

RICHARD MORRIS
523, Bearswood Rd.
Smethwick
WARLEY
021 429 1161
JBC MICRO SERVICES
200 Earlsdon Ave.,
Nth. Earlsdon
COVENTRY
0203 73813

WILTSHIRE

WILTSHIRE MICRO
CENTRE
Unit 6,
Central Trading Estate,
Signal Way,
Old Town.
SWINDON
0793 612299

BUCKS'

HI-VU ELECTRONICS
38, Church St. Wolverton
MILTON KEYNES
Bedford
0908 312808

SUSSEX

C.J.E. MICROS
78, Brighton Rd.
WORTHING
West Sussex
0903 213900

ISLE OF WIGHT

EXCELL
4, Foreland Rd.
BEMBRIDGE
Isle of Wight
098 387 2878

YOUR LOCAL



DEALER

HEREFORD

KEMPSONS
26, St. Owen St.,
HEREFORD
0432 273480

KENT

KENT MICRO
57, Union St
MAIDSTONE
Kent.
0622 52784
GRAVESEND
COMPUTERS
39, The Terrace,
GRAVESEND
0474 50677

NORTHANTS'

M A ELECTRICAL
7, High St.
IRLINGBORO
N'Hants
0933 650133

LEICESTER

FENY LORD & SON
63, Blaby Rd.
WIGSTON
Leicester.
0533 785033

LINCOLNSHIRE

* OAKLEAF COMPUTERS
121, Dudley Rd.
GRANTHAM
0476 70281

LONDON

CANNONBURY RADIO
185 Upper St.
ISLINGTON N1
London
01 226 9392
PAUL ELECTRICAL
250/2, Grand Drive,
Raynes Park,
LONDON SW20
01 542 6546
WOODS RADIO
257, Lavender Hill
Battersea,
LONDON
01 228 1768

SALOP

MEDLICOTT BROS
53, Mardol
SHREWSBURY
Shropshire
0743 3060

SUFFOLK

S J EMERY & CO.
10, Market Place
BUNGAY,
Suffolk
0986 2141

IRELAND

EVERYMAN COMPUTER
SERVICES
BALLYMONEY

Co-Antrim
N. Ireland
026 56 62658
NEWBURN
ELECTRONICS
BALLYCARRY
Co.-Antrim,
09603 78330

STAFFS

J W BAGNALL
18, Salter St.,
STAFFORD
0785 3420

KIRKLANDS

City Rd., Penton.

STOKE ON TRENT

0782 415787

* COMPUTERAMA

59, Foregate St.

STAFFORD

0785 41899

SURREY

* HASLEMERE COMPS
25, Junction Place,
HASLEMERE
Surrey
0428 53850

P & H ELECTRONICS

5, The Parade,

Reading Road,

YATELEY
Surrey.
0252 - 877 222

* Spectrum Members

LANCASHIRE

* P V MICROS
38A Water St.
ACCINGTON
Lancs.
0254 36521

* Home & Business
Computers Ltd.
54, Yorkshire Street,
OLDHAM

061 633 1608

Home & Business

Computers (RCH) Ltd.

73, Yorkshire Street.

ROCHDALE

0706 344654

WALES

BUCON
18, Mansel St.
SWANSEA
0792 467980

S.I.R.
91, Whitchurch Rd.
Cyncoed
CARDIFF
Wales
0222 621813

THE COMPUTER SHOP
41, The Hayes,
CARDIFF,
Wales,
0222 26666

SCOTLAND

COMMSCOT
30 Gordon St.
GLASGOW
041 226 4878

NORTH LAND

NEWTONS
Main St.
SEAHOUSES 159
0665 720307

NORTH LAND

NEWTONS
Main St.
SEAHOUSES 159
0665 720307

NORTH LAND

NEWTONS
Main St.
SEAHOUSES 159
0665 720307

NORTH LAND

NEWTONS
Main St.
SEAHOUSES 159
0665 720307

Revolutionize the way you think about computers.

The new OM8064



The 8064 packs all the power you will ever need. Sleek and trim, yet fully expandable with eight slot expansion unit.

The newly designed compact keyboard is a piece of art in itself. The OM8064 features ultrasensitive key and single key programming commands, you will get much more including a powerful 64K dynamic RAM up to 14K of ROM, 24 line x 40 character text display with high resolution graphics a 6502 and Z80 microprocessor.

12 month on site maintenance

CP/M Wordstar Super Calc II and Friday

CP/M Wordstar Calstar and Infostar

CP/M Basic Trainer BBC Personal, Data Base & Planner Calc

Complete systems plus maintenance on the software package
£1600 plus VAT.

Dealer Enquiries welcome

TASHKL COMPUTER SYSTEMS LTD
24 LOGAN ROAD, WEMBLEY, MIDDLESEX HA9 8PX
TEL No. 01-904 4467. TELEX No. 296708

CP/M is a registered trade mark of Digital Research Inc.

THE PRICE OF THE COMPLETE SYSTEM COMPRISING OF:

- OM8064 MICROCOMPUTER WITH
- * STANDARD 64K RAM
- * 8 SLOT EXPANSION UNIT & COVER
- * STANDARD 2K ROM FOR CP/M®
- * MAXIMUM 14K ROM FOR BASIC
- * STANDARD 6502 CPU
- * STANDARD Z-80 CARD
- * STANDARD CENTRONIC I/F CARD & I/F CABLE

- * STANDARD 80 COLUMN CARD
- * STANDARD FLOPPY DISK DRIVE CONTROLLER
- * TWO 5¼in SSSD SLIMLINE DISK DRIVES & I/F CABLES EACH 163 KBYTE
- * 12in GREEN MONITOR & CABLE
- * JOYSTICK ADAPTOR CABLE
- * TV ADAPTOR
- * TAPE RECORDER CABLES

● Circle No. 184

Assembler for the IBM PC

Paul Myerscough looks at the guides available for those preparing to delve below the surface of the PC's operating software.

AT THE HEART of the IBM PC is an Intel 8088 microprocessor. It is this chip that provides the instruction set and hence lays the ground rules for assembler programming. The 8086/88 family of processors has been available for five years now, and several books have been published that describe their programming and hardware features. Two new books are specific to the IBM PC and more are on the way, no doubt inspired by the news that the PC started outselling Apple in the U.S. last summer.

The iAPX-88 Book is produced by Intel, the company that designed the 8088. Not surprisingly, it provides an excellent and readable description of the chip architecture and instruction set. This book has been available for some time and is presented as a publication designed to sell the 8088 as well as inform potential users. The initials iAPX stand for Intel Advanced Processor System, and the iAPX-88 is a real or hypothetical computer based on the Intel 8088 CPU.

In their introduction the authors outline the architecture of the 8088 and describe what makes it superior to eight-bit microprocessors. This clear and concise discussion is comprehensible to anyone with a little basic knowledge on the subject. For those without it there is a supplement towards the back entitled "What is a Microcomputer?"

Intel assembler

For the programmer, the chapter "Architecture and Instructions" describes the concepts of segmented memory, the register structure, addressing modes, and the 8088 instructions grouped by function. A further 24 pages are devoted to assembly-language programming. Although the information is applicable to all 8088 assemblers, specific reference is made to ASM-86 which is Intel's own assembler. The text in this section is largely reproduced from *The 8086 Primer* by Stephen Morse, published by Hayden Book Co.

A short program is given by way of introduction to many of the concepts and terms employed in 8088 programming. The style is at once authoritative and concise, and the authors define their terms carefully



and analytically as they are introduced. An assembler statement is built from different kinds of tokens, a token being an identifier, a reserved word, a constant, an operator, and so on.

Each category of token is discussed before the authors deal with statements, which they divide into instructions and directives. Instructions have their equivalent 8088 function; directives control the way the assembler generates the 8088 program from the instructions.

The directives described correspond with a subset of the pseudo-ops available with the IBM Macro Assembler and allow the definition of symbols, data storage, segments and procedures. The discussion that follows is clear but very condensed, covering general and 8088-specific programming techniques in a few pages with four short example programs to provide an idea of how real routines might look.

Some 110 pages, over one-third of the book, are devoted to an alphabetic table of instructions with one or two pages per instruction. Here you will find a description, details of the operation in pseudo-code format, the flags affected, the binary encoding, the required operands, clock times, instruction length and a coding example. This information is complete but lacks the illuminating explanations provided by Rector and Alexy in their book.

Osborne/McGraw-Hill books seem to be becoming the standard texts for assembler

programming on microcomputers. *The 8086 Book* by Russell Rector and George Alexy was published in 1980 and is on the shelves once more after being unavailable for some months. Whereas Intel's book provides a readable and concise introduction to the 8088 microprocessor and 8088 programming, this one is much more of a reference work. The scope here is slightly more comprehensive.

Stock text

It is always a little strange when such specialised books should take the time to answer the question "What is programming?" One suspects that this publisher's word-processing software automatically pulls in the standard paragraphs on these subjects, which are admittedly concise and well presented. After this short general introduction two programming problems are presented and the reader is walked through the design process.

By page 20 the 8086 is introduced; from a programming point of view the 8086 and 8088 are identical, the only noticeable difference being run times. The description begins with the registers and the flags, and reference is made to the equivalent 8080 implementation. A discussion of the 8086 address modes follows. About 150 pages are used to describe the instruction set.

The concepts surrounding Intel's Multibus system are introduced, and some

(continued on next page)

(continued from previous page)

notes are provided on multi-processor configurations. The book ends with a set of appendices. They give a table summarising all the 8086 instruction in alphabetic mnemonic sequence and in object code numeric sequence; electrical and timing data sheets for the 8086/88 and related series of clock and bus controller; and notes on the differences between the 8086 and the 8088. These hardware differences effect some of the pin signals and the bus timing for the data/address cycles.

The two remaining books, as their titles indicate, are IBM PC oriented and give themselves a wider brief. They refer not only to the 8088 and its programming, but also to the PC-DOS operating system, the ROM BIOS and some of the additional hardware that is found in the PC. Both refer specifically to the IBM Macro Assembler, though it cannot function very differently from any other assembler for the 8088 CPU.

New breed

Scanlon's *IBM PC Assembler Language* is one of the new breed. A floppy disc prepared for use in conjunction with the book contains the example programs referred to in the text. It cannot be denied that this is a good idea. However, in this instance the publisher seems to be motivated by dollars: the programs cannot be described as useful outside of the context of this already expensive book, yet you have to pay an extra \$34 for the diskette. By adding its real cost of two or three dollars on to the book and packaging them together successful sales would be assured.

The approach taken by Scanlon is that of a cataloguer. He brings together fairly comprehensively relevant information from all the IBM PC manuals, lists it, tabulates it, describes it, and provides some useful if unexciting example programs. By contrast, David Willen and Jeffrey Krantz in their *8088 Assembly Language Programming: the IBM PC* provide a clearer and more readable discussion of much the same subject matter, with original programming examples and excellent diagrams. They also manage to cover more topics more thoroughly in fewer pages. While Willen and Krantz have a style that is easy and authoritative, Scanlon's is more uneven and in places awkwardly verbose.

Both books launch into binary arithmetic and numbering systems and in a few pages seek to embrace bytes, nybbles, twos-complement form, and some discussion of the 8088 architecture. Such a short and general introduction is difficult to organise in a few pages and Scanlon is less successful here.

Under the label of "8088 Architecture" Willen and Krantz provide a well organised summary of the internal functions of the CPU and its instruction set by functional group, again with good explanatory diagrams. Then they quickly add all that is

necessary to create a simple program: describing how it sits in memory, how it relates to DOS, and the BIOS. Some specifics about the IBM Macro Assembler are supplied, particularly the essential pseudo-op instructions to the assembler for reserving storage and defining procedures and segments. They take about 60 pages to describe this material.

Scanlon requires 120 pages to cover less ground — he does not even mention DOS and BIOS. Some of the more esoteric pseudo-ops provided by the IBM Macro Assembler are rather difficult to understand from the manual and here. Scanlon's detailed explanation provides a welcome insight. However, even he is stumped when it comes to Record and Struc.

After these introductory chapters the two books diverge on to different paths. Scanlon takes a couple of chapters to cover higher-precision mathematics and data structure operations. Though the material he provides is useful for orienting the inexperienced programmer, it can be found in virtually any text on the subject. He approaches the keyboard, video display, cassette and the like from the point of view of a program looking outwards. The interrupts are catalogued and described, and a few simple programming examples are given.

Willen and Krantz follow their introduction to the CPU and the Macro Assembler with a thorough and interesting breakdown of the IBM PC hardware and its control. Starting with the system board they provide descriptions of the 8259 interrupt controller, the 8253 timer, and the 8255 programmable peripheral interface, which are all configured in the PC as I/O devices. They go on to discuss the other devices that are not on the system board. The chapter referring to the display and printer adaptors describes their operation at length and provides programs for both monochrome and colour/graphics use.

A typical application where Basic programming is often just not fast or versatile enough is that involving communications. For this reason, although it is an optional extra, the RS-232-C serial communication adaptor is of particular interest to the assembler programmer. The authors provide a good chapter on this device, describing asynchronous protocol, how a Uart functions, and how it interfaces through an RS-232 interface to a

modem. Programming of the Intel 8250 used by the IBM PC for controlling asynchronous communication is described, and a simple terminal-emulation program is provided as an example.

Unlike Scanlon, Willen and Krantz do not shy away from disc I/O. Their chapter on the subject starts at basics with the anatomy of a diskette and takes you through file access using DOS to access at the track/sector level using BIOS routines.

The books discussed so far fall into one or more of the categories 8088 reference work, assembler programming text and IBM PC assembler-level guide. *Programming the 8086/8088* by James W Coffron falls between all three stools. He covers the 8086/88 in sufficient depth to provide a good introduction but the book is not comprehensive enough to be considered as a reference work.

On assembler programming Coffron discusses some important topics but others are omitted, and his program examples could be more frequent and more illuminating. A 20-page chapter on the IBM PC is dropped in almost as an afterthought and deals with only a few of the machine's features.

Numbers

Following the mould of the two PC-oriented books, Coffron starts by introducing number representation, binary arithmetic and associated processor-flag usage, and follows up with a summary review of the CPU architecture and a detailed discussion of the 8086/88 address modes and their encoding.

Next comes a substantial chapter of 105 pages cataloguing the 8088 instruction-set mnemonics. Unlike Rector and Alexy, Coffron does not choose to expand on the information provided by Intel and leaves out some of the details available.

Programming techniques are introduced with some very basic arithmetic and a discussion of subroutines. This is followed by a useful review of external and internal CPU interrupts and a chapter on I/O ports and instructions In and Out. His program examples here are short and curious — to generate a delay, and to scan a four-by-four keyboard. Although the 8255 PIO and the 8253 timer chips are mentioned he does not convey their functions and uses as clearly as Willen and Krantz do. □

The iAPX 88 Book, by the Intel Corporation. Published by Reston Publishing Company, Inc., 315 pages, £11

The 8086 Book by Russell Rector and George Alexy. Published by Osborne/McGraw-Hill, 595 pages, £13.95

IBM PC Assembly Language — A Guide for Programmers by Leo J Scanlon. Published by R J Brady/Prentice-Hall Publishing. 311 pages, £16.95

8088 Assembler Language Programming: The IBM PC by David C Willen and Jeffrey I Krantz. Published by Howard W Sams & Co. Inc., 235 pages, £13.55

Programming the 8086/8088, by James W Coffron. Published by Sybex Inc., 309 pages, \$14.95

DISKPOST

* BETTER VALUE MAIL ORDER SUPPLIES FOR YOUR MICRO *

TDK DISKS



High grade flexible disks from one of the world's most famous suppliers. 5 1/4" and 8" disks, in boxes of 10.

5.25" DISKETTES

M10-S	S/S, D/D, 48 TPI	£24.30
M2D-S	D/S, D/D, 48 TPI	£34.80
M2DX-S	D/S, D/D, 96 TPI	£45.50

48 TPI suitable for 35 or 40 track operation.
96 TPI suitable for 77 or 80 track operation.

8" DISKETTES

F1-S128	S/S, S/D	£27.60
F1-H32	S/S, S/D	£27.60
F2D-S1024	D/S, D/D	£40.10

DATALIFE DISKS



From Verbatim, the world's leading diskette manufacturer. Full 5 year warranty. All minidisks are certified for double density recording, and are fitted with hub ring reinforcement as standard.
Prices per box of 10 disks.

5.25" DISKETTES

MD525	S/S, D/D, 48 TPI	£18.25
MD550	D/S, D/D, 48 TPI	£27.15
MD577	S/S, D/D, 96 TPI	£25.55
MD557	D/S, D/D, 96 TPI	£34.20

48 TPI suitable for 35 or 40 track operation.
96 TPI suitable for 77 or 80 track operation.
10 and 16 hard sectored versions available at same prices.

8" DISKETTES

FD34-8000	S/S, S/D	£26.10
FD34-8000	S/S, D/D	£26.60
DD34-4001	D/S, D/D	£30.95

32 hard sectored versions available at same prices.

XIDEX DISKS



The new premier quality standard, against which all other manufacturers will have to be judged. All products certified for double density recording. Now with a lifetime warranty. Unreservedly recommended.
Prices per box of 10 disks.

5.25" DISKETTES

5012-1000	S/S, D/D, 48 TPI	£19.55
5022-1000	D/S, D/D, 48 TPI	£27.55
5012-2000	S/S, D/D, 96 TPI	£27.75
5022-2000	D/S, D/D, 96 TPI	£35.80

48 TPI suitable for 35 or 40 track operation.
96 TPI suitable for 77 or 80 track operation.
10 and 16 hard sectored versions available at same prices.

8" DISKETTES

8012-1000	S/S, D/D	£26.40
8022-1000	D/S, D/D	£31.90

32 hard sectored versions available at same prices.

TDK CASSETTES



You know the name and the quality's the same. 15-minute computer grade cassettes for optimum performance in all standard microcomputer cassette drives. In boxes of 10.

TDK PC15 £5.90

DISK DRIVE HEAD CLEANING KITS



Helps to protect your valuable data, and minimise expensive downtime and repair costs. Consists of a flexible jacket, which receives a pre-saturated cleaning disk. Each disk is sealed within a foil sachet to ensure that it contains the right quantity of cleaning fluid when used. After use the disk is disposed of, and the jacket is kept for future use.
Suitable for single or dual head drives. Please specify 8" or 5.25" disks.

STARTER KIT £7.70
(contains jacket and two cleaning disks)

REPLACEMENT CLEANING KITS £14.80
(pack of 10)

DISKETTE STORAGE BOXES



Protect your diskettes and valuable data from external contamination. Lockable, portable and secure. Two part box made from anti-static ABS plastic. Price includes dividers and index labels. Capacity 80 disks.

A5 Storage box (for 8" disks) £32.00
A6 Storage box (for 5.25" disks) £22.00

CTI - CP80 PRINTER



Features:—

- Friction and tractor feed as standard
- 90 c.p.s
- Bi-directional logic seeking.
- 13 x 9 dot matrix giving true descenders.
- Sub and superscripts.
- Italic printing and auto underlining.
- Condensed, emphasised, expanded and double strike printing (can be mixed in a line).
- Parallel interface fitted as standard.
- 12 month warranty.

Print sample available on request.

CP-80 PRINTER £249.00
Optional RS-232 interface £40.00
Special VIC20/VIC 64 interface £46.00

PRINTER STAND

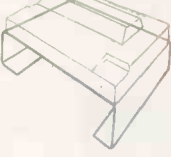

Suitable for use with dot matrix printers. Lifts printer sufficiently to enable continuous stationery to self-stack. Painted steel unit.
Dimensions: 39cm wide x 28cm deep x 10cm high

Comes as package which also contains:—

- 200 sheets continuous stationery.
- 1 x 9 1/2" binder.
- 1 x highlighter pen.
- choice of rubber feet/sticky pads.

PRINTER STAND £19.95

COMPUTER FURNITURE



Suitable for use with all leading personal computers. Features a top shelf for monitor/printer, lower shelf for books, paper and general storage; large desk top surface at keyboard height; attractive teak finish, and castors for mobility.





U.K. Manufacture. Comes in flat pack for self assembly - full instructions provided.

A further range of more sophisticated units is available - please ask for details.

THE ORGANISER £55.00

To: DISKPOST, FREEPOST, WEST MOLESEY, SURREY, KT8 0QF. Tel: 01-941 4066

All prices inclusive of delivery and insurance on British mainland.

Qty	Product	Price	YOUR NAME
.....	£	ADDRESS
.....	£
.....	£
.....	£	Tel. No.:
Sub Total		£	Please charge to my Visa/Mastercharge/American Express/Diners Club account.
Delivery/Insurance		£ FREE	
V.A.T.		£	My card number is
TOTAL VALUE OF CHEQUE PAYABLE TO DISKPOST		£	   

Company Orders

If you are unable to raise cheques without an invoice, please post or telephone your order to us. We will then forward a pro-forma invoice, for your accounts department to pay against.

* NEW 1984 PRICES * DISKPOST

DISKPOST* is the mail order division of the BFI Electronics Group Europe's largest independent diskette supplier. FREEPOST West Molesey Surrey KT8 0QF. Tel: 01-941-4066

EUROPEAN DISTRIBUTOR

SATURN SYSTEMS

Have changed their name to

The name may have changed but the product is still the best available!



SATURN RAM

Perfect for Apple II, II+, IIe and their compatibles. In 1981, we introduced our famous Saturn multi-bank RAM card to boost the Apple's memory by 32K. Now, we also offer 64K and 128K versions for even greater power.

Big on benefits. Each Saturn RAM board performs all the functions of a language card. More important, its extra banks of RAM give you loads of memory space for BASIC, VisiCalc, Multiplan and much more. You can even use your RAM boards like a speedy disk drive. Save time accessing data, and save wear and tear on your floppy drives! Saturn boards are a super aid for advanced word processing, data base management, spreadsheet, and accounting applications. They're ideal with PASCAL, CPM and BASIC too.

32K £129 128K £299

Now you can write Applesoft Programs bigger than 64K!

EMBER is written for Titan RAM Boards or Neptune extended 80 col. card. You can use as much memory as you can possibly plug into your Apple! Ember automatically puts variables and strings in expansion RAM leaving full lower 48K for program text. All bank switching is done for you. Each array can use up to 64K of RAM. Ember runs slower than Applesoft—but you can always use an Accelerator!

£34.95 + VAT

Titan TECHNOLOGIES, INC.

Make your Apple run 3 1/2 times faster



NEPTUNE

The two most popular expansion features, on a single card.

Titan's exclusive Neptune Extended 80-Column Card gives you increased video display and up to 192K of extra memory by using just the auxiliary slot of your Apple IIe. And you can select from three versions - 64K, 128K or a full 192K of RAM. Dramatic increases in speed and productivity. Software included with Neptune lets you use the additional memory as a super-fast RAM disk—a big plus with many programs. You also get Titan's special VIC-EXPAND/80 software to expand VisiCalc up to 220K of workspace memory and to provide many more VisiCalc enhancements. PASCAL and CPM PSEUDO-DISK patches and a DOS relocation program are included with each Neptune card.

64K £179 + VAT each additional 64K (up to max 192K) - £109 + VAT

Imagine running VisiCalc, DB Master, Applesoft, Apple Fortran or Pascal without long delays. With the Titan Accelerator II, Your Apple II or II Plus runs these programs a true 3 1/2 times faster. This faster computer response time means less waiting for you and an increase in your productivity.

This Titan exclusive has its own fast 6502 processor, 64K of high-speed memory, and built-in fast language card. It is transparent to your software and is hardware compatible with most standard peripherals. And you can turn it off from the keyboard to run your Apple at regular speed.

£299 + VAT

EUROPEAN DISTRIBUTOR

MAGICALC

Both the Apple II (minimum 48K) and the new IIe are supported, as well as expanded memory cards up to a total memory of 512K (four 128K cards). There are 254 rows and 63 columns of work space on the spreadsheet. The program works in 40 or 80 columns (most of the 80-column cards are supported). A 70-column format is provided using Hi-Res graphics. Both uppercase and lowercase entry/display are allowed. The program can be used with multiple drives including hard disks.

Q. What advanced spreadsheet features does MAGICALC have?

A.1. Columns may be different widths to fit your data and formats.



2. Columns may be made invisible to hide data or to operate as a third-window on the data (bring first and last quarter figures together, for example, while leaving the title and other windows unchanged).

3. Individual cells may be made invisible to hide sensitive data.

4. Cells may be protected to prevent inadvertent erasure.

5. Cells may be protected to allow only numbers or labels to aid in the setup of templates.

6. A "tab" to the next unprotected cell is provided for fast data entry into templates.

7. On-screen indication of Global Computation Order is provided, as well as Manual or Automatic Computations mode.

£99 + VAT

Grappler +



The Original Apple graphic printer interface. Since its introduction three years ago, the Grappler has been initiated by many, but never matched. Now with Dual Hi-Res Graphics for side by side reproductions and Mixed Mode screen dumping the Grappler+ remains the most intelligent interface available. Over two dozen commands give Apple users full control over any graphic or text on the Apple screen including a new 80 column text dump.

£109 + VAT

Bufferboard

For Apples and Printers



The economical way to add printer buffering. The Bufferboard easily adds memory to your current Apple interface system, freeing your computer for additional input. Easily upgradable from 16K, the Bufferboard can store up to 20 pages of text. It fits neatly inside your Apple, "docking" onto your existing printer interface. No clumsy boxes or cables, no external power supplies... just convenience and economy.

£109 + VAT

Bufferboard + Grappler +



The most sophisticated bufferboard Apple printer interface available. The New Buffered Grappler combines the industry leading features of the Grappler + with the time saving economies of the Bufferboard. £179 + VAT. With this much interface power you'll never need anything else. Over 90,000 Apple computers are using Orange Micro products. Innovation and excellence has made us the No. 1 manufacturer of intelligent printer interfaces. The top selling Grappler + has become an industry standard recommended by more software houses and Apple dealers. Recent innovations include the Grappler + for IDS colour printers and the new Orange interface, with text screen dumps and formatting at a low price.

A

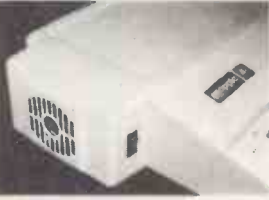

HELLO FAN!

The P & P fan is here! This neat fan with power surge suppression and neon lit front facing switch will help to keep your Apple cool and avoid possible data errors by smoothing current flow and keeping the Apple's power supply and circuitry at a lower temperature. The fan is a high-quality unit at £39.95 + VAT (Dealer and Distributor enquiries welcome.)

WORDHANDLER NOW ONLY £39.95 + VAT SUPERB VALUE

GLANMIRE 64K EXTENDED 80 COLUMN CARDS FOR THE APPLE IIe

— at a price you'll find hard to believe — just £89 + VAT! This card works in the same way as Apple's own 80 column extended memory card and is covered by Pete & Pam's own 12 months warranty.

A

THE APPLE PROFESSIONAL HOME COMPUTER



YOU GET:

- An Apple IIe
- Disk Drive with Controller
- TV Modulator (Colour and Sound)
- Exclusive Apple Bag
- Plus MONEY OFF VOUCHERS FOR

£25 off Apple IIe Monitor (£149 + VAT)

£25 off 1 of the Apple discovery games

or Apple Logo or Appewriter IIe or Quickfile IIe

46% off Micronet 800 Service a saving of £79.95 which includes:

- Modem
- Communications Card
- British Telecom Jack Plug Installation

• Postage/Packing/Insurance

1 days FREE training at an Apple Training Centre Value £100

Various Vouchers for money off Pete & Pam distributed software.

£999 including VAT

Get into Personal computing in a big way!

A



Sweet.P™
AN INCOMPARABLE GRAPHIC PLOTTER AT ONLY £495+VAT Works on all micros with a suitable parallel interface for all your Graph Processing, Chart Processing, Engineering Graphics and Overhead Transparencies.

ONE MORE WAY TO GET THE BEST OUT OF YOUR APPLE.

Fast Dos

SPEED UP DISK ACCESS ON DOS 3.3 BY UP TO 20 TIMES! (Depending on the program)

£19.95 + VAT

A

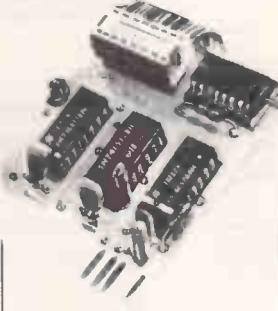

SNAPSHOT TWO

An accidentally erased disk can cost you weeks of time waiting for an expensive replacement. Making backup copies of all your important programs is an essential element of sensible computer use. SNAPSHOT TWO is the powerful, fast, and easy-to-use hardware/software system that gives you the power to copy your valuable software. Just boot your disk, and press the trigger. SNAPSHOT TWO removes copy protection, and copies most programs in 30 seconds, even programs that baffle other copiers. Backups are ordinary DOS 3.3 disks that will immediately boot and run on any 64K Apple (and, often, on any 48K Apple) without SNAPSHOT TWO Present.

£99.00 +VAT

A

APPLE BLOSSOM!

Sea Dragon	22.95	Apple Joystick	36.00
Magicalc	99.00	Apple Controller	22.00
d Base II	375.00	Master type	25.95
Andromeda Conquest	14.95	BASF S/S S/D	17.90
Apple Mechanic	19.95	Olympic Decathlon	19.95
Bank Street Writer	44.95	Dollars & Sense	64.95
Murder by the Dozen	23.95	Castle Wolfenstein	19.95
Kids + the Apple (no VAT)	13.95	Chess	45.95
Zaxxon	26.95	Perfect Writer	179.00
Speed Reader II	45.95	DB Master	154.95
Rondezvous	25.95	DB Master Vers. 4.0	239.95
Jumpman	26.95	Shamus	23.95
Sargon II	22.95	Stickbear Bop	24.95
Zork I	26.95	Pre School IQ Builder	14.95
Zork II	26.95	Golf	26.95
Zork III	26.95	Frogger	22.95
Professional Easywriter	119.95	Type Attack	25.95
Apple Cooling Fan	39.95	Wizardry	34.95
Koala Pad Touch Tablet	99.00	Snooper Troops 1	22.95
Kraft Joystick	37.95	Snooper Troops 2	22.95

164

RENTAL

Want to rent an Apple? Or an IBM PC . . . a QX10. a Printer or anything else you can think of? Call either of our offices for a quote from one machine to fifty from one day to a thousand years.

JACK REPORT

THE INCREDIBLE JACK OF ALL TRADES

WHAT IS JACKreport?
 JACKreport is a Report Generator designed for use with the incredible JACK-Of-All-Trades. JACKreport uses information from your JACK files to create customized reports.

WHY SHOULD YOU BUY JACKreport?
 People who are considering JACK (or already using JACK) for personal filing. If you need to calculate the total value of your inventory, or count the number of labels in your mailing lists, or summarize data from your JACK files, JACKreport lets you turn this information into clear and useful reports.

JACK REPORT
£75 + VAT

FINGER PRINT FOR EPSON MX PRINTERS
£39.95 + VAT



SPECIAL OFFER BASF DISKS

10 Disks for the price of 9! Single Sided Single Density suitable for Apple.
 10 for **£16.11 + VAT**
 100 for **£148.50 + VAT**
 Double Sided Double Density suitable for IBM PC
 10 for **£24.75 + VAT**
 100 for **£225.00 + VAT**
 Double Sided 96 tpi suitable for Sirius/Victor
 10 for **£30.60 + VAT**
 100 for **£279.00 + VAT**
 A whole range of other disks available - ring for details.
 Disk Boxes **£1.95 + VAT**
 5 1/4" Head Cleaning Kits **£15.95 + VAT**

P & P DUSTCOVERS	
Apple II	6.95
Apple 2 Disks	8.95
Apple 8 1/2" Monitor	8.95
Apple 2 DK & 12" Monitor	9.95
Apple 2 DK & 9" Monitor	8.95
Single Disk	3.45
Stacked Disks	4.45
Tris Keyboard	5.95
Tris Proc & Mon.	10.95
BC Computer	6.95
et 4023/8023/8096	9.45
et 4040/8050 Disk	6.95
et 9060 Hard Disk	6.95
X10 and Monitor	9.95
IX10 Keyboard	4.95
pson MX80/70	5.95
aper Tiger 445/60	7.45
IX100	9.95
ume 5 W/Tractor	1.95
rism Printer 560	8.45
nadex 9000 Series	6.95
pple Dot and NEC	6.45
et 4022P Printer	5.95
et 8023P Printer	7.45
et 8300P Printer	9.45
X 80	5.95
ilentype Printer	5.95
icroline 80	5.95
icroline 82	6.50
icroline 83	6.75
icroline 84	9.95
lt. Monitor	5.95
ec 12" Monitor	7.45
itachi 12" Mon	7.45
Deca RGB Monitor	9.95
BM PC Mon and Bas.	9.95
BM PC Keyboard	4.95
Apple III Inc. Mon	12.45
Apple III Mon & pro	13.95



What is the incredible JACK of All Trades?
 JACK is an integrated applications software package for Apple II computers. "Integrated" means that JACK can do Word Processing, Data Base Storage and Retrieval, and Calc Analysis all at the same time. Because it is Integrated JACK lets you do all these things with just one simple set of commands.

Who should buy JACK?
 JACK is perfect for the first-time computer buyer who works with information, be it words, numbers, or lists with words and numbers in them. You can learn JACK just once and do three times as much with your computer as with any single-function software. And JACK costs far less than buying three different programs! Experienced computer-users who need to integrate their applications should also consider JACK. If you've ever wished you could integrate a document and a calc model without scissors and glue, or 'printing to disk', JACK is for you.

What kinds of work can I do with JACK?
 If your work consists of words, lists, or numbers, JACK can probably handle it. If you work with words and numbers at the same time, or lists with numbers, or even lists with words, JACK will make that work easier than any other software you can buy. Things you can't do with most software are easy with JACK: write a memo with calculations and do those calculations at the same time; or create form letters from a mailing list with a single command, or make a list of 'what-if' options and select the best one by simply telling the computer what you want.

What else makes JACK special?
 Convenience. Most people use computers to prepare documents, to handle information, and to answer "what-if"-type questions. Without JACK, it takes a separate program to do each task. But most people don't work that way. We work on tasks that involve words, numbers, and record-keeping all together. And those tasks don't conveniently sort themselves into "word processing tasks", "calc tasks", and "data base tasks". By allowing you to work on one task in all three ways, at the same time, JACK offers greater convenience than single-function software packages. JACK is THE software that lets your personal computer work the way YOU do, instead of the other way around.

How long will it take me to get going with JACK?
 Experienced computer-users have picked up JACK in as little as half an hour. First-timers may take a day or two. JACK comes with a step-by-step tutorial of seven lessons, so you can go at your own pace.

INCREDIBLE JACK
£129.50 + VAT

BECOME A PETE & PAM DEALER
 We're looking to expand our fast growing dealer network.
 Call now for details



THE APPLE-IBM CONNECTION

This might sound like heresy, but we're sure that some of you are going to want to transfer any kind of file to and from the IBM-PC. The ability to upgrade files from the 8 bit Apple to the 16 bit IBM-PC must be of use to someone?

Can also be used to send electronic mail messages in mixed Apple / IBM-PC network. Comes with a disk for the IBM-PC. **£139 + VAT**



NEC GREEN MONITORS

12" diagonal & 90° deflection video band width 30 Hz-20 MHz. An excellent high quality video display monitor.
£135 + VAT

SPECIAL OFFER OKI MICROLINE PRINTERS

- Dual mode printing Mode 1 - 9 x 9 matrix, 160 cps bi-directional logic seeking Mode 2 - dual pass, near-letter-quality (NLQ) printing
 - Pin-addressable graphics 72 x 72 dot resolution
 - Superscript, subscript and underline
 - Proportional spacing in NLQ mode
 - Downline loadable character set
 - No routine maintenance
- The Microline 92 (360 x 328 x 130mm)
 Parallel **£399** Serial **£419**
 The Microline 93 (512 x 328 x 130mm)
 Parallel **£599** Serial **£629**

1-2-3™

Meet 1-2-3 - the remarkable new software package that puts more raw power at your fingertips than anything yet created for the IBM PC. 1-2-3 actually combines information management, spreadsheet, and graphing in one program that can perform all three functions interchangeably and instantly at the touch of a key. That's Power.

To explain: since 1-2-3's information management, spreadsheet and graphing functions reside in memory simultaneously, you can go from retrieval to spreadsheet calculation to graphing instantly, just by pressing a few keys. So now you can experiment and recalculate and look at data in an endless variety of ways. As fast as your mind can think up new possibilities. There's no lag between you and the computer. And that's a new kind of power - power that's greater than the sum of its programs.
£375.00 + VAT

MULTIMATE™

Complete Function Key Orientation

Multimate™ is the fastest, easiest to use and most powerful word processor available on microcomputers today. Multimate™ offers a complete function key driven system for efficient document creation and modification. Most functions are performed while in the document (rather than from menus or utilities) with a minimum number of keystrokes.

Cursor Positioning Functions

Multimate™ has the most complete set of cursor positioning capabilities available today.

Editing Functions

The standard functions such as Insert, Delete, and Move, as well as the more complex functions, are self-prompting and are performed with a minimum number of keystrokes.

Formatting Functions

Full control over tab settings, line spacing and line length are provided by Multimate™'s format line feature. An unlimited number of format lines may be included in your document. Format line modification results in automatic text readjustment from the modified format line to the next format line or the end of the page.

Printing Functions

Multimate™'s complete printer control capabilities allow full utilization of the features available on your printer. Multimate™'s Header and Footer facility is unsurpassed in flexibility and ease of use. Alternate Headers and Footers are supported as well as the ability to change Header or Footer text as often as needed within a document.

Printer Control Codes provide special printing functions, unique to your printer.

Document printing is performed in a "background" mode so that while a document is being printed, you may create or revise another document. Foreground printing is also provided.

The Printer Queue Control allows you to control the documents to be printed by: deleting a document from the queue, placing a document on hold or releasing it from hold, moving a document to the top of the queue, and restarting a document currently printing.

Advanced Functions

Multimate™'s Library function allows you to store an unlimited number of boilerplate phrases, paragraphs, or forms (up to one page each) on a diskette. These Library entries may be recalled for insertion into your document whenever specified.

Merge, Repagnate, Column Manipulation and the other advanced functions are also available and equally easy to use.

With the Column Manipulation function, you may Move, Copy, Delete, or Insert columns of text or numerical data in a page of your document with a few keystrokes.

Column Calculation functions provide you with the following math capabilities: Vertical and Horizontal Addition to sum columns or lines of numerical data; Subtraction, which is accomplished by designating a number as negative, and thereby is equivalent to adding a negative number. Combined, these column-oriented functions yield you considerable flexibility and versatility when creating or editing documents with numerical data.

Mylar Key Labels

See-through, color-coded, adhesive labels are provided for quick and easy identification of the function keys. Both a Help screen and a Function Location Chart are provided for use when you are working on an unmarked keyboard.

£339.00 + VAT

COPY II PC
 Allows you to make backup copies of your valuable software. **£39.95 + VAT**

SEE US AT THE WHICH COMPUTER SHOW ON STAND 2301

MULTI-TASKING PC DOS



AND MAKE ONE IBM PC WORTH NINE

TASCMaster SOFTWARE does that by converting PC-DOS to CONCURRENT PC-DOS thus enabling you to create up to 9 tasks and run up to 9 programs simultaneously. **TASCMaster DOES THE WORK OF NINE.** While you are working with a task on the screen other tasks are working for you. To give you every board you may need for your IBM PC we include with **TASCMaster SOFTWARE** a powerful **MULTIFUNCTION board FREE!!**

Take your choice of:
ADDRAM ELITE FEATURES or **ADDRAM PLUS FEATURES** with **RAMDISK** and **RAMPOOL** SOFTWARE TOO.

£345.00 + VAT

SIDEWAYS™

FOR EASY-READING HARD COPY

Now you can print all the columns of your spreadsheet, all at one time, all on one continuous page. Sideways, the ingeniously simple software program, causes your hard copy to print out - you guessed it - sideways. So your spreadsheet columns need never fall off the edge of your printer paper again.

£49.49 + VAT

INFOTORY

Stock Control System
 Infotory and its special data management feature. ANY-REPORT, Provide you with a Stock Control System that is:
 • Easy to understand and use.
 • Comprehensive enough to solve your inventory management problems.
 • Flexible enough to offer alternatives that satisfy the needs of your particular business.
 • State of the art - fully utilising the power and potential of your computer.
 • Capable of handling 5000 to 65,000 stock items depending upon your floppy or hard disc drive configuration.

£350 + VAT

Pete & Pam Computers

Mail Order & Distribution: New Hall Hey Road, Rossendale, Lancs. BB4 6JG
 Norwegian Agent: The Norwegian Software House, Okerweien 145 Oslo 5
 Phones: (0706) 212321 & 227011 Address Oslo 5
 Telex: 635740 Petpam G Telephone 47 2 64 55 77

London Retail: 1, Gleneagles Road, London SW16 6AY Phone: 01-677 7631
 London Office Open Saturdays

Prices do not include VAT please add 15% to your remittance
 Postage and Packing FREE

Opening Hours 8 - 6 Mon. to Fri. 9.30 - 5 Sat.

AT LAST!



Someone has computerised the 'back of an envelope'

CALCMASTER — a breakthrough in micro software technology from **SAPPHIRE SYSTEMS** for only **£49.00**.

The unique design concept of **CALCMASTER** means that the 'back of an envelope' system — the tried and trusted favourite that generations of businessmen have reached for to provide instant analysis and control — has now been brought well and truly into the micro age.

We've retained all the virtues of the old system — extreme low cost, ease of use, convenience and flexibility but added **POWER, SPEED AND ACCURACY** to make **CALCMASTER** the low cost, easy to use, basic utility for business planning and control.

By entering your calculations in English and using the power of the 1,000 cell matrix you can now use your micro to get to grips with all those 'everyday' managerial situations and events where your decisions count. Yet have enough power in reserve to handle larger functions, even including the consolidation of small to medium size models by using the unique 'Read' 'Write' and 'Nested Run' facilities.

CALCMASTER comes with a superb pocket size manual and is suitable for most 8 and 16 bit micros with CP/M, CP/M86, PC-DOS or MS-DOS operating systems and an 80 character screen width with at least 64K of memory and a single floppy disk drive.

So almost at the flick of a switch, you can now ensure that you and your company, like **CALCMASTER**, stay one step ahead of the competition.

Of course, when you need to move up to a more powerful system, **CALCMASTER** leads you naturally to the outstandingly successful **SAPPHIRE MARS** — the easiest to use full structured modelling systems available. Because it's totally integrated to **CALCMASTER** both your experience and data are not

wasted and you have the complete business planning system for **ALL** your needs.

But first things first. To order **CALCMASTER** please clip the coupon and enclose your cheque or credit card details and we will send you **CALCMASTER** plus details of the extensive **SAPPHIRE MASTER RANGE** of business software.

To: Sapphire Systems Ltd., 1-3 Park Avenue, Ilford, Essex IG1 4LU.
Telephone: 01-554 0582.

Please send me.....copies of **CALCMASTER** @ £58.35 including VAT and p&p per copy, I enclose a cheque/postal order for £.....made payable to Sapphire Systems Ltd.

Please debit my:



Access Card No:..... for £.....



Barclaycard No:..... for £.....

Signature.....

Name.....

Position.....

Company.....

Address.....

Tel No.....

VERY IMPORTANT. Please provide the following particulars: —

Type of micro..... memory size.....k

Operating system CP/M CP/M86 PC-DOS MS-DOS

Floppy disk size: 5 1/4" 8"

Single sided Double sided Single density Double density

Please allow 28 days for delivery

Reg No 1467831

VAT No 250078973

• Circle No. 187

COMPILERS

If you have any experience of writing Compilers or Interpreters and are familiar with 6502, 6809 or Z80 Assembler then we would like to hear from you.

We provide machines for the duration of the work and offer cash, royalties or a combination of the two.

If you are interested, please send relevant details to:-



COMPILERS
OASIS SOFTWARE
9A ALEXANDRA PARADE
WESTON-SUPER-MARE
AVON.

● Circle No. 188

Superbase 64

TRANSFORMS THE COMMODORE 64 INTO A FULL-FEATURED AND PROFESSIONAL DATABASE SYSTEM! WITH UP TO 1000 CHARACTERS PER RECORD ON UP TO 4 SCREENS... AND UP TO 128 ITEMS PER RECORD, DEFINABLE AS KEY, TEXT,

NUMERIC, CONSTANT, RESULT OR DATE... IN FILES OF UP TO 164 CHARACTERS! SUPERBASE EVEN HAS SPREADSHEET AND CALCULATOR CAPABILITY, CALENDAR FUNCTIONS, EASY INPUT FROM WORDPROCESSOR/DATA FILES, BOTH MENU-DRIVEN AND PROGRAM OPTIONS, SORTING/SEARCHING, FULLY DEFINABLE OUTPUTS... SUPERBASE 64 IS ESSENTIAL IF YOU WANT THE MOST FROM YOUR 64! SUPPLIED ON CBM 1541 DISK WITH EXCELLENT TUTORIAL/REFERENCE MANUAL. EX-STOCK NOW!

● OUR PRICE ONLY ~~199.95~~ £88!

VIZAWRITE 64

NOW AVAILABLE ON CARTRIDGE. VIZAWRITE 64 IS A HIGH-PERFORMANCE, LOW-COST WORD PROCESSOR, WITH ON-SCREEN

FORMATTING, THAT TAKES FULL ADVANTAGE OF THE 64'S COLOUR, GRAPHICS AND MEMORY FEATURES... AND SUPPORTS VIRTUALLY ANY PRINTER! WITH A COMPREHENSIVE AND EASY-TO-FOLLOW USER MANUAL, VIZAWRITE OFFERS THE ULTIMATE IN PERSONAL COMPUTER WORD PROCESSING! ALSO AVAILABLE ON DISK (OUR PRICE ~~199.95~~ £68!), OR COMBINED WITH VIZASPELL (OUR PRICE ~~199.95~~ £85!).

● OUR PRICE ONLY ~~189.95~~ £75!

Master 64

MASTER 64 IS A TOTALLY NEW CONCEPT... A COMPLETE PROGRAM DEVELOPMENT PACKAGE, THAT'S AVAILABLE NOW FOR THE CBM 64.

MASTER HAS 85 NEW COMMANDS... AND BASIC IV TOO! PLUS PROGRAMMER'S TOOLKIT, MACHINE CODE MONITOR, BUSINESS BASIC, KEVED DISK ACCESS, SCREEN MANAGEMENT, USER-DEFINABLE INPUT ZONES, REPORT GENERATOR, 22-PLACE ARITHMETIC, DATE CONTROL, STRING FUNCTIONS, DISK DATA COMPRESSION, SCREEN PLOTTING, SCREEN DUMP, AND MORE... IN FACT EVERYTHING YOU NEED TO PROGRAM YOUR 64 TO TOP PROFESSIONAL STANDARDS! (SCREEN MANAGEMENT, TOOLKIT, HI-RES GRAPHICS AND DOS SUPPORT ARE AVAILABLE SEPARATELY ON CARTRIDGE - £49.50). MASTER IS ALSO AVAILABLE FOR CBM 700 (£339.25) AND CBM 4032/8032/8096 (~~399.95~~ £225!).

● SPECIAL OFFER PRICE ~~143.95~~ £115!

THESE ARE JUST SOME OF OUR FINE SOFTWARE PRODUCTS FOR COMMODORE COMPUTERS... PLEASE TELEPHONE OR WRITE FOR FREE DATA SHEETS! PRICES SHOWN INCLUDE 15% VAT AND ARE CORRECT AT TIME OF GOING TO PRESS. ORDER BY POST/TELEPHONE/PRESTEL, USING CHEQUE, ACCESS, BARCLAY CARD OR OFFICIAL ORDER. TELEPHONE 01-546-7256 FOR SAME-DAY DESPATCH! POST FREE EXCEPT ON CREDIT/OVERSEAS ORDERS. (REF A25)

Calco Software

LAKESIDE HOUSE, KINGSTON HILL, SURREY KT2 7QT TEL 01-546-7256

● Circle No. 189

uninterruptible power supply

THE POWER BANK

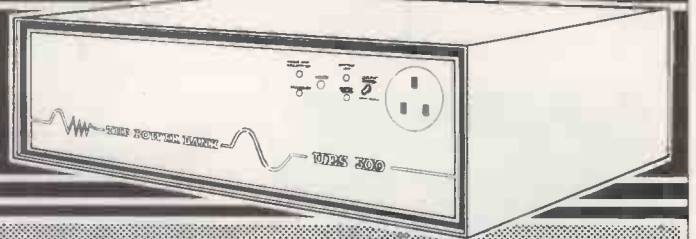

The COMPLETE solution to your POWER SUPPLY problems with the POWER BANK ... "BLACK OUTS" will not affect the operation of your computer system.

Micro Systems

- * Output derived constantly from self contained sealed for life batteries.
- * Sine wave shaped output — voltage and frequency closely regulated.
- * Genuine "NO-BREAK" unit with continuous output rating of 500-250 & 120VA.
- * Much more than a "spike and surge" suppressor.

Networks

Hard Disks

Printers

Data Transmission etc.

- * For superior to a voltage stabilizer.
- * Overload and short circuit (output) indication and protection.
- * Bench or rack mounting (500VA).
- * Battery level monitored — mains on — mains off indication.

Manufactured by:- POWER TESTING (SALES) LTD 65a Shenfield Road, Brentwood, Essex CM15 8HA.

Tel: 0277 233188 Telex: D24224MON Ref. 586

● Circle No. 190

VAT INCLUDED



FREE DELIVERY

Expand your
ELECTRON
with
MRL'S ELECTRON-CLOUD®



A NEAT "BLACK BOX" CONTAINING:

- EC1 Centronics Printer Interface (with Cable)
- EC2 A/D Converter and Joystick Ports
- EC3 Double User I/O Ports

Complete only £79

SEPARATE:

- EC1 Printer Interface (Base Unit) £39
- EC2 A/D Converter and Joystick Ports £29
- EC3 Double User I/O Ports £29

Available Mail Order (10 Days), soon to be on sale in many High Street Outlets.

Coming soon:

- ECDI Disk Interface approx £99
- ECSP Speech Synthesiser approx £39

Also Available: Spectrum Printer Interface (Fully compatible, e.g. with TASWORD 2) £39
and ATARI PRINTER DRIVER £45
Plus lots more.

Micro Research Ltd, FREEPOST 0506-31605
Industrial Unit 6, Knightsbridge East,
LIVINGSTON, West Lothian, Scotland. EH54 5BR.

● Circle No. 191

DISKS DISKS DISKS

★ ★ ★ LOWEST PRICES - FAST DELIVERY ★ ★ ★

PRICE PROMISE

We will Better any lower delivered price advertised in the current issue of PC
Please Telephone

5.25" DISKS - BOXES OF 10

	Prices per Box (£)	QTY	AMOUNT
DYSAN	1-4 5-9 10-49		
104/1 S/size S Dens 48tpi 40Tr	21.00 20.00 19.00		
104/1D S/size D Dens 48tpi 40Tr	23.00 22.00 21.00		
104/2D S/size D Dens 48tpi 40Tr	31.00 30.00 29.00		
204/1D S/size Q Dens 96tpi 40Tr	33.00 32.00 31.00		
204/2D S/size Q Dens 96tpi 40Tr	39.00 38.00 37.00		
VERBATIM DATALIFE (Five year warranty)			
MD525-01-HR S/size S or D Dens 48tpi 40Tr	15.25 15.00 14.50		
MD560-01-HR D/size S or D Dens 48tpi 40Tr	21.50 20.75 19.50		
MD577-01-HR S/size D or Q Dens 96tpi 77/80Tr	22.00 21.25 20.00		
MD587-01-HR D/size D or Q Dens 96tpi 77/80Tr	28.00 27.50 26.00		
10 or 16 hard sectors at same price.			
Free plastic case for limited period only.			
VERBATIM VEREX (One year warranty)			
MD200-01 Soft Sector unformatted	14.25 13.75 13.25		
MD200-AS Apple Systems Only	14.00 13.50 13.00		
MEMOREX			
3431-HR S/size S Dens 48tpi 40Tr	14.50 14.25 13.75		
3481-HR S/size D Dens 48tpi 40Tr	14.80 14.50 14.00		
3491-HR D/size D Dens 48tpi 40Tr	20.50 19.75 19.00		
3504-HR S/size Q Dens 96tpi 40Tr	23.00 22.25 21.50		
3501-HR D/size Q Dens 96tpi 40Tr	26.00 24.25 23.25		
BASF (Qualimetric) - Special Offer			
1X S/size S Dens 48tpi 40Tr	13.25 13.00 12.50		
1D S/size D Dens 48tpi 40Tr	16.50 16.00 15.50		
2D D/size D Dens 48tpi 40Tr	20.00 19.25 18.50		
ACCESSORIES			
HCK5 head Clean Kit with Fluid	15.90 15.50 15.00		
LC5 5.25 Library cases EGLY	1.90 1.80 1.70		
LB40-5 Lockable Box 40 Cap inc Disk Pen	13.50 13.00 12.50		
LB85-5 Lockable Box 85 Cap inc Disk Pen	17.50 16.50 15.50		
VCK-5 Verbatim 5 in Head clean kit	6.40 6.20 6.00		
VCD-5 Verbatim 5 in H/c disks (per 10)	12.50 12.30 12.10		

8" DISKS - BOXES OF 10

Phone for most Competitive Prices for Verbatim, Basf, Memorex and Accessories.

POSTAGE/PACKING (UK)

- 5.25 Disks/Clean Kit £1/Box * (75p/Box 5 +, 50p/Box 10 +)
- Library Case 50p/Box (35p/Box 5 +, 25p/Box 10 +)
- Lockable Box £2.50/Box (£2/Box 5 +, £1/Box 10 +)

*Add 30p/Box for 1st Class

Please contact us for Quantity Discounts (10 + Boxes) and Trade Accounts. Official orders accepted from Government and Educational Establishments.

Name Tel. No.

Address

Access/Barclaycard/Cheque No.
If you do not wish to cut out form send order separately

34 Cannonbury Avenue, Pinner, Middx HA5 1TS
Telephone orders any time - we do the rest - 01-868 9548



Pinner Wordpro



● Circle No. 192

COMMUNICATIONS

Tandata

SMART MODEMS

Auto dial, direct connect, with 8 telephone & 8 ID store on modem, 1200/75bps or full multirate (1200/75, 75/1200, 300/300 full duplex, 1200/1200 half duplex). Many advanced features. From £99. Also special terminal, Prestel and downloader software for BBC APPLE COMMODORES with more following

- ELECTRONIC MAIL
- PRESTEL
- BULLETIN BOARD
- TELECOM GOLD
- COMPANY DATA BASES
- MICRONET 800
- TELESOFTWARE
- MICRO-TO-MICRO "CHAT"

Tandata Marketing Limited,
Albert Road North, Malvern, Wotcs. WR14 2TL
Telex: 337617 Prestel * 799 # Telecom Gold: TAN 001

Please send me Smart Modem literature and Order Form

NAME

COMPANY

ADDRESS

PC2/84

● Circle No. 193



CDP Consultants Limited

CONSULTANTS
IN COMPUTER
SYSTEMS
Green Gables, Wicken Road
Clavering, Essex CB11 4GT.
Tel: Clavering 617

THE FUTURE IS YOURS WITH THE FX20 AT ONLY £1875.00



- FX20 — 16 Bit/8Bit Formulation, 128K — 1mbyte ram, Integral LAN, choice of 4 OPERATING SYSTEMS and SPELLBINDER, the total wordprocessing software supplied FREE

SOFTWARE APPLICATIONS AVAILABLE

- Product Pricing/Enquiry
- Video Library
- Printers Estimating/Job Control
- Accounts (Integrated)
- Estate Agents
- Special (Bespoke) Software written ● Circle No. 261

ZORBA THE SERIOUS PERSONS PORTABLE

- Software writers/Developers/Engineers
- College and University Dept.
- Business Executives who want to work at home

This is the computer for you. It has

- 8 Bit, 800K Disc, 5 R/W Formats and coms for up and down loading to Minis and Mainframes.
- FREE Software is CBASIC, WORDSTAR/MAILMERGE AND CALCSTAR £159.00

ORDER BEFORE END 1983 and we will give you 20 DYSAN DISCS FREE

Phone 0992-445700

AND PLACE YOUR ORDERS NOW ● Circle No. 262

VAT No. 219 561877 Directors: C.A. Pearce, D.K. Pearce Registered in England No. 1448753
Registered Office: Price Bailey & Partners Aviner House, The High, Harlow, Essex

EPROM PROGRAMMERS

NEW

BBC PET VIC APPLE ACORN

MODEL A 2716, 2516, 2532, 2732, 2732A, 2764, 2564, 25128, 27128 £110.00

MODEL B 2716, 2516, 2532 £53.50

MODEL C 2716, 2516, 2732 £53.50

PET, VIC, ACORN MODEL A, B, or C. ALL PROGRAMMERS CAN

READ/PROGRAMME/VERIFY/COPY

BBC, Apple Model A only.

Full Software Tape supplied for your Computer

PET OWNERS:- Free Programme for making your own Character Sets.

PET SUPERBOARD 40 or 80 COLUMN £52.50

● Select up to 8 ROM/Eprom, RAM/ROMS from any available ROM Socket.

● No Wires, Switches or Soldering Required.

● Will accept any combination of 2K or 4K ROM/EPROMS, RAM/ROMS.

● Select upto 8 of your own Character Sets

APPLE VIA BOARDS ● The Via Board contains 1 or 2 6522 Via's Single £27.90

Each 6522 Via's contains: 2 x 8 bit Programmable I/O Ports. 1 x 8 Bit Shift Register Double £36.60

● Four Handshaking Lines CA1 CB1, CA2, CB2. Two Programmable Timers.

● Full 6522 Data Sheets supplied

ACORN MONITOR CHIP (2K) £10.50

● 10 Commands to simplify Machine Code Programming

● Full Screen Editor, Repeat Key, Auto Entry Flashing Cursor, Tape Verify.

● Slow Scroll, Memory Fill, and many more.

PET IEEE PRINTER BUFFER Available soon

IEEE-Centronics — RS232

● Free Your Pet from Printing

● The Printer Buffer receives all your Printer Data in seconds (5 sheets) Then outputs your Data while you type your next letter.

● 14K printer Buffer.

● Full IEEE to IEEE or IEEE to Centronics output.

● IEEE to RS-232 optional extra. S.A.E. for details

CONNECTORS CHIPS

PET IEEE User Port 2716 EPROM (2K) £4.00 C10 Cassettes (10) £5.00

VIC User Port £5.65 2532 EPROM (4K) £6.50 Eprom Eraser £40.00

VIC Games Port £5.65 2764 EPROM (8K) £8.00 Eprom Eraser Timer £10.00

Acorn Expansion Port £7.00

PET Cassette Port (Crimp) 6116 P.3 (2K) Static £4.50 ALL THESE PRICES INCLUDE VAT AND P&P

Orders over 100 £1.00 6522 VIA'S £6.50

Please Add 15% VAT Plus £2.50 P&P to your orders.

OFFICIAL ORDERS

CID COMPUTER INTERFACE DESIGNS
4 ALBERT RD. MARGATE. KENT. (0843) 294648

● Circle No. 194

>NEXT MONTH

>WORD PROCESSING

Almost everyone can benefit from word processing, and almost every micro now offers a word processor, so in the March issue Special Section we offer a guide to the field. We will be examining a range of packages, from the easiest to use, like the Bank Street Writer, to the famous WordStar.

>COMPETITION

The Research Machines 480Z system is on the test bench for next month, along with its disc drives and a bundle of software including WordStar. An outfit worth £1,000 will be offered as a prize in an accompanying competition that anyone can enter.

>REVIEWS

One of the world's leading micro companies, named after a fruit, will be launching a user-friendly computer, named after a raincoat . . . but we aren't allowed to mention it. Full details in the next issue. We will also be looking at battery-powered portable computers, including hands-on experience with the new Sharp PC-5000. Software under investigation includes Oz, Expert-Ease and Atari games.

>AND MUCH MORE!

Features for March include a visit to Xerox's Parc where Smalltalk and Lisa-like environments originated. Commodore 64 owners should order their copy now: Boris Allan will be helping out with colour-graphics routines for this machine. Mike Lewis presents the second of his columns for programmers; plus there will be all the regulars, including News, Chip-Chat, and pages and pages of free software in Open File.

Make sure you don't miss the March issue of

Practical Computing

On sale at W H Smith and all leading newsagents after February 18.

169

WHY LOOK FOR ANYTHING ELSE WHEN YOU COULD AFFORD YOUR OWN IBM PERSONAL COMPUTER



Look.

It's easy to get to know. Even the brochures are written in plain English.

It is undemanding in terms of space. It will sit comfortably on a desk top or, if you're pushed, a filing cabinet.

And in its attitude to book-keeping, estimates, and information, it is very accommodating.

Call us today and we'll show you the IBM Personal Computer. Tel: 01-675 5325/6/7

For further information please write:

IBM Sales
Interam Computer Systems Ltd
Freepost, London SW11 4BR
Tel: 01-622 9373 Telex: 925859

INTEDAM
COMPUTER STORE
46 BALHAM HIGH ROAD, LONDON SW12 9AQ TELEX:925859



IBM Authorised Dealer

● Circle No. 196

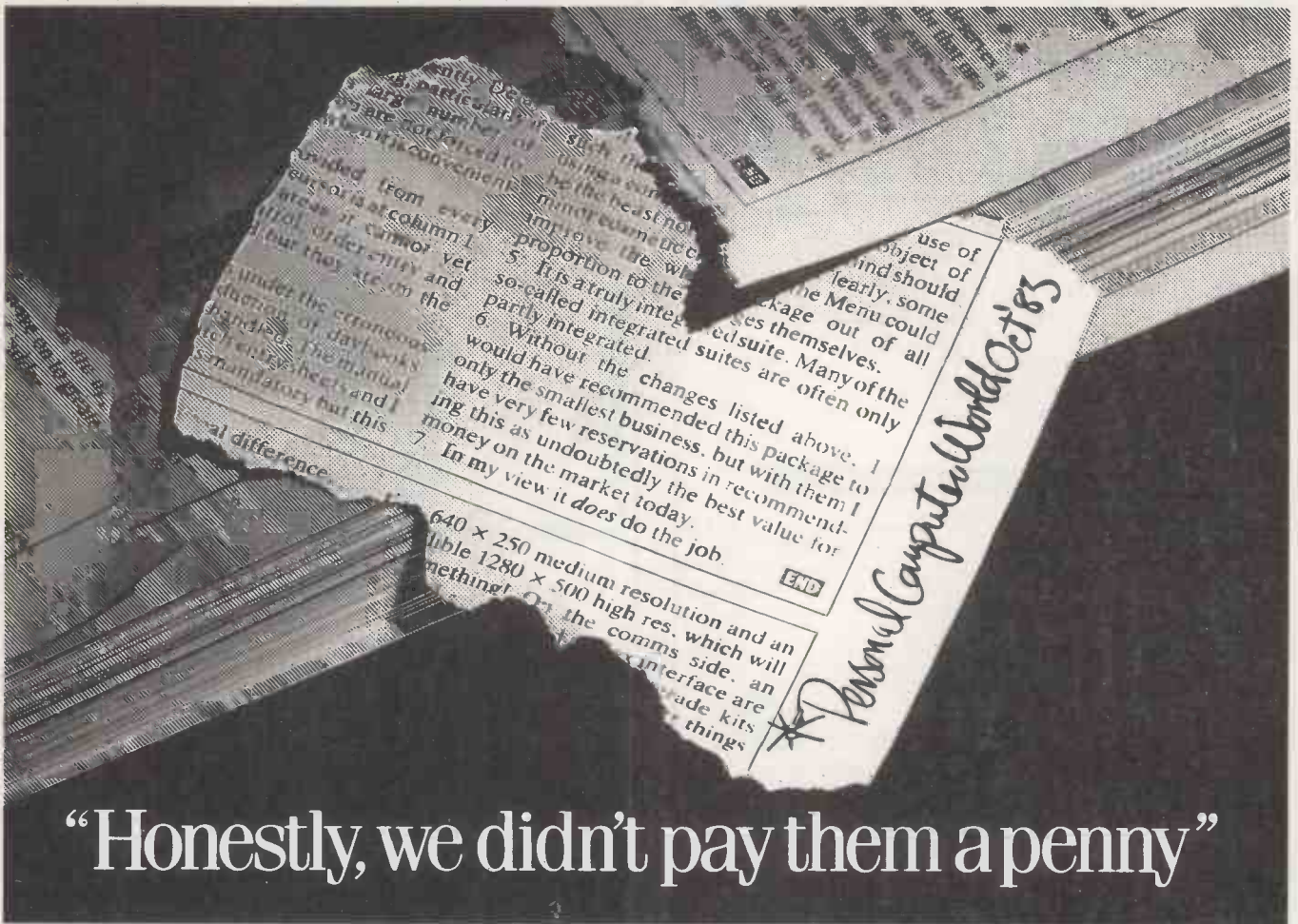

“Honestly, we didn't pay them a penny”

Read between the lines and you'll see that Personal Computer World's high praise for the Sage accounting program is bad news for our competitors.

Until now, you might have felt justified in paying out £1,000 or more for the complicated 4-7 disk programs which they offer. You might indeed have felt that, at only £375, the Sage program couldn't possibly do the job properly.

After reading PCW's verdict there's no longer any room for doubt!

The Sage book-keeping/accounting program is truly integrated and uses one diskette.

● Sales and Purchase Ledgers,
● Nominal Ledger, ● Trial Balance,
● VAT Analysis ● Monthly and Annual Accounts ● Age Analysis ● Statements
● Audit Trail - every accounting function in one compact package. Its efficiency is built on simplicity - and its simplicity accounts for the price.

Sage is self-installing, easy-to-learn and easy-to-use, comes with a short, clear manual and a tutorial cassette.

Sage is available on most CP/M, MS-DOS and PC-DOS computers and has so far been implemented on over forty machines including Apple, Apricot, Epson, IBM-PC, Sirius and Zenith. It's as effective in a one-man business as in a

multi-million pound corporation.

We've told you all this before. But now you've seen Personal Computer World's verdict.

It's a death sentence for our competitors!

Return the coupon and we will send you more information on Sage Software systems and the name of your nearest dealer - there are over 400 of them in the UK!



NEW PRODUCT - SAGE PLUS

The same brilliant features as SAGE, plus ● Invoicing, with Stock Control. ● 9999 Ledger Accounts. ● Budget Reports. ● Credit Control Features. Still only one program disk. £695.

NEW PRODUCT - SAGE PAYROLL

● Monthly and/or weekly. ● Automatic SSP. ● 999 Employees. ● Full feature system. £195.

- Please send me your explanatory brochure.
 Please arrange for me to have a demonstration.
 *I do not yet own a computer/have a _____ computer. *Delete as appropriate

Name _____

Position _____

Company _____

Address _____

Tel: _____

 British Software for British Business
 SAGE SYSTEMS LTD, Hawick Crescent Industrial Estate, Newcastle upon Tyne, NE6 1AS.
 Tel: 0632 761669 Telex: 53623 SAGESL G.

PCI

Innovation not imitation

● Circle No. 197

If you want it tomorrow . . .
call us today
01-455 9823

COMPUTER/CALCULATORS

HEWLETT PACKARD			
HP 41C (Comp/Cal)	£126.00	HP 16C (Hex Con)	£81.00
HP 41C C/R	£126.00	HP 15C (Adv Sci)	£81.00
HP 41CV (Comp/Cal)	£176.00	HP 75C (Portable)	£650.00
HP II-Module	£78.00	Apple IIe	£645.00
Printer 82143A	£230.00	Sirius 1128K with 1.2Mb S/S Disks	160.00
Printer 82162A	£300.00	HP Plotter 747A RS232 or HP1B	£832
SHARP		M Z-8080AEU Exp Unit	£86.00
PC 1500 Pocket Computer	£130.00	MZ-80FB Dual Floppy Disc Drives	
CE 148 RS232 and Cent I/F	£130.00	for MZ-80AB complete with I/F card,	
CE 158 printer/cassette I/F	£115.00	cables, and	
CE 151 4K Add on mem	£43.00	Sharp Disc BASIC & Manual	£650.00
CE 152 Cassette	£69.00		
CE 155 8K Add on mem	£380.00		
MZ-80A 48K Computer			

WORD PROCESSING PRINTERS

NEC SPINWRITER*		BROTHER*	
(RS232 or Centronics)		HR1 *Highly Recommended*	368.00
7710 RS232/7730 Centronics		Serial or Centronics	—
Tractors, Sheet Feeders and Paper Guides		HR15	£420.00
for NEC, Ex-Stock		DIABLO 630*	
Smith Corona*		620(RO)	£550.00
The most exciting thing to happen to		630(RO)	
Daisywheel Printers this year.		630 API—RO	£1200.00
TP1	£290.00	630(KSR)	
(RS232 or Centronics — please specify		Tractor (Bi-Di)	£136.00
EL-2000		Sheet Feeder	
(The TPI/Typewriter Combo-Centronics		FUJITSU SP 830*	
only)		THE FASTEST DAISY	
TEC STARWRITER*		RO (S)	
F10—40cps (Serial/Parallel)	£999.00	Front Panel	
An enhanced F10—40cps with a 2K buffer		Tractor	
Tractor (Bi-Di)		Sheet Feeder	
Mechanical Sheet Feeder			
Mechanical Sheet Feeder		HERMES 612-B	
OLYMPIA*		Centronics	£1550.00
ESW 103 KSR		Tractor	£138.00
ESW 102(RO)		RICOH*	
TOSHIBA*		Model RP 1300 (S) (4K Buffer)	£990.00
The all new high speed:— Word		Flowriter (8K) PR 1600	£1290
Processing/Draft/Data Processing printer		Mechanical Sheet Feeder	£475.00
using a — 24 wire printhead to give			
exceptionally high letter quality output			

PHONE US FOR BEST DEAL

DOT MATRIX PRINTERS

OKI*		SEIKOSHA GP700A	
M80A	£198	Colour	£378.00
M82A	£295	GP-100A	£210
(120cps Pin, Friction with RS232 &		(RS232 Option)	£63
Centronics Parallel I/F)		GP-100 (VIC 20)	£175.00
Tractor	£55	GP-250X	£220.00
M83A	£465.00	EPSON	
(120cps Friction, removable Tractor and		Epson RX80 (100cps)	£245.00
RS232 and Centronics Parallel as		Epson FX80 (160cps)	£350.00
standard)		Epson RX80FT	£260.00
M84A	£695	Epson MX100 Type III	£380.00
ANADIX*		Epson FX100FT (160cps)	£487.00
DP-9001(A)	£777		
DP-9500(L)	£777		
DP-9500(A)	£810		
DP-9501	£810		
DP-9501(A)	£810		

STOP PRESS NOW IN STOCK IBM/PC

IBM/PC SUPPLIED ON VERY COMPETITIVE TERMS. ALSO
AVAILABLE EXTENSIVE RANGE OF SUPPORT
HARDWARE/SOFTWARE

EPSON HX20 Briefcase computer. Weighs less than 4 lbs. 16K expandable.
64K Rom. 32K Ram. Full size ascii keyboard. Runs on own power for 50 hours.
Complete Serial and RS232 interface. £350.
Accessories & Software for Epson HX20 available from stock.

SOFTWARE

Word Processing APPLE		Word Processing IBM	
Applewriter 1.1	£55.00	Wordstar	£285.00
Applewriter 2	£85.00	Easywriter II	£230.00
Wordstar	£245.00	Volkwriter	£149.00
Applewriter IIe	£105.00	Mallmerge	£140.00
Word Processing SIRIUS		Easyspeller	£115.00
Supr Calc	£140.00	Superwriter	£230.00
Multiplan	£149.00		
Wordstar	£289.00		
Select	£285.00		
Mall Merge	£85.00		

Other Software Including Microsoft/Comsoft/BOS etc. also in stock

**GOODS FULLY GUARANTEED
PRICES EXCLUDING VAT AND P + P.**

Company and Government orders accepted by phone.
Barclaycard/Access/Visa accepted by phone.

Tel.: 01-455 9823

MOUNTAINDENE

22 Cowper Street London EC2

● Circle No. 198

**TOP VALUE AND LOWER PRICES AT
LOMAX NEW
COMPUTER
CENTRE**
(Est 1927)

The BBC Microcomputer
System MODEL B **£399**
(cassette lead £4.50) (cover £4.95)

COMMODORE
64 **£199.00**

MICROVITEC
Colour Monitor **£287**

SINCLAIR
SPECTRUM 48K **£129.95**

ACORN AP
100A Printer **£212.00**
LVL Dual Disk
Drive 100K **£389.00**
200K **£573.00**
Disk Interface
(fitted free) **£79.95**
Speech Interface
(fitted free) **£55.00**
View Word
Processor (fitted free) **£59.00**

TEXAS
T199/4A **£89.95**

SHARP
MZ80A **£389.00**

SORD
M5 **£149.00**

**PLUS MUCH, MUCH MORE
IT PAYS TO LOOK IN BEFORE
GOING ANYWHERE ELSE!**

SOFTWARE AVAILABLE FOR ACORN (BBC)
ATARI, DRAGON, BUG-BYTE, RABBIT,
COMMODORE, UK.

Send S.A.E. for our Computer News Sheet
For Insurance & Postal charges
ADD £5 for Hardware £1 for Software

For MAIL ORDER
Phone your ACCESS / VISA on our
HOT LINE 061-832 6345
or send cheque P.O. Payable to
LOMAX LTD for IMMEDIATE ATTENTION
NO EXTRA CHARGE ON CREDIT CARDS.

Cassette
Recorders from **£29.95**

Monitors
from **£79.95**

ORIC
48K **£128.00**

DRAGON
32 **£159.95**

LOMAX (Computer Division)
8 EXCHANGE ST (St Anns Sq) MANCHESTER M2 7HL

● Circle No. 199

MICROPACS

Simulation, training and control packages available

TUTSIM, a powerful digital dynamic simulation tool. **£250**

This unique and very popular package can be used
for all types of simulations, socio economic,
physiological, electronic, servo mechanism, chemical plant,
aero-space Etc.

CONTROL, Comprehensive control design and advanced
training tool. **£850**

FILTER, Digital filtering tutorial **£850**

PID, A PID control loop tutorial **£850**

LEVEL, A level control tutorial **£850**

All these packages run on the Apple 2/2e system are very
interactive, easy to use and make full use of graphics. IBM PC
versions are becoming available (Tutsim now). Substantial
discounts on the software are available for bonafide educational
establishments.

For the INSTRUMENT OR CONTROL ENGINEER, we supply a
complete "toolkit" comprising the above packages integrated
with micro, dual floppy and hard cop printout at a **BUNDLED
PRICE OF £4190, A SAVING OF OVER £1000**, extras include;

Applescope 2 channel fast digital storage scope **£695**

Control loop draughting system with A3 size plotter
and instrument/control symbols **£1950**

Total bundled price **£6450**

**THINK OF DESIGNING, TESTING, DEBUGGING, TRAINING FOR
AND DOCUMENTING ALL YOUR CONTROL SYSTEMS FROM
ONE INTEGRATED DESK TOP PACKAGE.!!**

SEND FOR DETAILS TO MICROPACS, GRAPHICS HOUSE,
50 GOSPORT STREET, LYMINGTON SO 9BE Tel: 0590 73503.

(Micropacs is a division of Process Automaton And Control Systems Ltd.)

● Circle No. 200

Return of the electronic brain

Chris Naylor sets his grey matter working on itself and comes up with some unexpected predictions of what can be done with a few hundred megabytes.

"OF COURSE," the man is saying, "you can do anything you want with a computer." He smiles and waves an expansive hand over his shelves of shiny machines while, before him, an uncertain customer nervously fingers a cheque book. "Anything," continues the salesman. "Absolutely anything at all. It's entirely up to you what you make it do."

And, at this point, one ceases to eavesdrop and shuffles away out of earshot so that this particular naive end-user may be fleeced in private. Too much, one thinks to oneself, to be both fleeced and to have an audience at the said fleecing.

Pausing to think for a moment about what the salesman said: is it actually incorrect. Can a computer, actually and really, do anything? To us experts, of course, the answer is No. So what, actually, would a do-anything machine look like?

Rough workings

Now the human brain is, surely the most do-anything machine in the entire known world. While admitting that there are certain difficulties in explaining exactly how it works, it is still possible to give a rough idea. The many thousands of neurons that make up our thinking engine are sufficiently similar for an idealised neuron to be taken as a pretty accurate representation of the whole lot.

Each neuron consists of a cell body out of which appear lots of little branches called dendrites and one big branch called an axon. At the end of the axon there are a lot more branches sticking out which are called terminals. These terminals come very close to the little dendrites sticking out of the cell bodies of other neurons, and sometimes come close to the actual cell bodies themselves. The junction between a terminal and a dendrite is called a synapse.

What happens is this. For some reason one of the cell bodies acquires an electrical charge. When it does so it sends a signal down the long axon to all the terminals at its end. When the signal reaches the terminals they fire the synapses and induce a corresponding signal in the nearby dendrites of other cells. As the cell potential passes a certain threshold it too sends its own signal down its own axon to other neurons. And so the process goes on. Once

started it turns into an avalanche of signals until the whole brain is humming away nicely.

You can get a computer to do the same sort of thing. One bit can represent each cell body firing or not firing according to whether it is 0 or 1. A simple address takes the place of an axon with terminals out to the dendrites on other cells. Allow six terminals to each axon and give one-byte addressing for each terminal. So, connected with the bit for the cell body are six bytes for the terminal address, for other bits representing other cell bodies.

Pass it on

Now write a short piece of code to allow for the fact that the electronic neurons are not self-acting in the same way that real neurons are. All you need is a loop which scans through each of the cell-body bits, reads it, and if it is set to 1 goes on to read the terminal addresses associated with it and sets the cell bits in those addresses to 1 before passing on to read the next cell body in line.

So far the end result will be that the system jams solid with every bit set to 1 and staying there. This is because all of the electronic synapses are excitatory synapses — that is, they trigger a cell into action. Real brains also have inhibitory synapses which inhibit a cell from triggering. What your electronic analogue needs is another bit to go with each of the terminal addresses to show whether or not it is excitatory or inhibitory. Now the level of firing varies, but the whole thing should neither jam solid nor switch off altogether.

Time slice

Real axons are surrounded by something called myelin, which insulates it but also alters the speed of transmission of each nerve impulse. In a real brain, the cells can fire or stop firing as soon as they receive the appropriate signals. In the computer they have to be read and fired by a scanning process, which rather upsets the time picture by introducing an order into the events which really should not be there. Each scan should produce an instant slice of time, and if some synapses are triggered at different times due to transmission

delays then you want to be able to represent this somehow or everything will get out of step. So introduce another bit to go with each cell bit, which can be either 0 or 1 depending on whether or not transmission down the axon to the terminals is to be fast or slow.

For the sake of yet more verisimilitude, add in another bit for each cell to represent the threshold level which must be provided to start each cell firing down its axon. As a final touch of accuracy the threshold bit and transmission time bit can be changed to bytes to give more variability.

Each neuron then takes up about $2n + 3$ bytes, where n is the number of terminals addressed. That assumes one byte is enough to hold the terminal address — in practice two bytes per address might be better — and with, say, six terminals that gives us 21 bytes per neuron. The control program will not take up much room, so 48K of memory will give you around 2,340 neurons in the machine.

Now the human brain contains around 10^9 neurons, so machine memory size is going to be a problem. Even adding a 200K floppy gives you not much more than 10,000 neurons.

Clever snail

Still, all is not lost. A snail or a locust has between 10,000 and 100,000 in its little head and, say what you like, but the locust can fly and even the snail can get about.

So there you have the makings of an intelligent computer which can do anything that, say, a snail can do. The real problem as always, lies in the software — in particular specifying all those terminal addresses and whether they should be excitatory or inhibitory. Somehow the human brain already has it all built-in, and it can alter its own threshold values over a period so that different connections come into play at appropriate times.

If you worked out one address for each of those 10^9 neurons every five seconds and put it in the machine you'd be through the lot in less than 160 years. Or maybe you could write a program to do it all for you. It is an attractive thought certainly, and there do not seem to be any theoretical problems. Maybe if 160 programmers worked for a year without sleep . . .

COMPUTER REFERENCE BOOKS

COMPUTER GRAPHICS MARKETPLACE, 1983-84

John Cosentino — Editor

c102pp paper c£25.95 Dec 1983 0 89774 086 6
Reviews of the first edition included: "The directory lists, classifies, and describes (US) manufacturers, consultants and services, professional organisations, educational programs, conferences and conventions, and publications related to the computer graphics area. The section on manufacturers includes vital information on each company plus product description, services, and product area....Names and addresses with telephone numbers of key people in the computer graphics industry complete the book." *ARBA 83*

MICROCOMPUTERS: A Planning and Implementation Guide for Librarians and Information Professionals

Robert A. Walton

c104pp paper c£14.80 Jan 1984 0 89774 097 1
Part I covers hardware, Part II is devoted to software and focuses on library applications such as administration, etc. Part III provides detailed information on procurement and management of microcomputer systems.

To order, or request further information contact:

Clio Distribution Services, 55 St Thomas' Street, Oxford OX1 1JG, U.K.

THE COMPUTER GRAPHICS GLOSSARY

Stuart W. Hubbard

c104pp case c£19.60 Feb 1984 0 89774 072 6
Helps every CAD/CAM professional by providing convenient access to the special language that has emerged. The terms fall into one of two categories. CAD/CAM technology, or CAD/CAM business. The definitions are complemented by illustrations, photographs, and charts.

COMPUTERS AND INFORMATION PROCESSING WORLD INDEX

c600pp case c£38.40 March 1984 0 89774 116 1
This reference work locates and analyses the key sources throughout the world for information on computers, computing, and information processing.

DEVELOPING COMPUTER-BASED LIBRARY SYSTEMS

John Corbin

240pp casebound £23.95 1981 0 912700 10 6
"... a useful, detailed guide for librarians responsible for developing automated systems. Following a clearly-presented overview of the systems approach, the author introduces definitions and topics in a precise and readable manner." *Journal of Academic Librarianship*

● Circle No. 207

VER-WORD

THE ULTIMATE WORD PROCESSOR

For your CP/M™ Microcomputer

Write now for a full specification brochure.



VERWOOD SYSTEMS
Verwood House
High Street,
West Haddon,
Northants NN6 7AP.

CP/M™ is a registered trade mark of Digital Research, Inc.

● Circle No. 205



SOFTWARE PROFESSIONALS

THORN EMI is looking for innovative, top-quality software to incorporate into a best-selling range of home computer products.

If you are an experienced software author, and you've come up with an interesting, professionally produced piece of entertainment, educational or home management software, we'd like to hear from you.

Your talents lie in programming and design. Ours are in marketing and distribution. Together, we could put your program into homes all over the world.

So don't waste time.

Call Patricia Mitchell on 01 437 3453

or write to us:

Acquisitions Dept, THORN EMI Software,
5th Floor, Film House, 142 Wardour Street
London W1V 4PT

● Circle No. 253

Anglia Computer Centre

88 ST BENEDICTS STREET NORWICH NR2 4AB
TELEX 975201 ACOMP G

SPECIALISTS IN BUSINESS COMPUTERS

BUSINESS COMPUTERS
Phone (0603) 667032/3 or 21117
APPLE, SIRIUS,
OSBORNE, ANADIX,
IBM*, DEC, EPSON.
★ Complete with professional
back-up service ★

HOME COMPUTERS
Phone (0603) 26002/667031
BBC, DRAGON,
COMMODORE 64,
SINCLAIR, ORIC, LYNX.
★ On special offer ★
Call for Price £££

**BOOKS AND
STATIONERY CENTRE**
Phone (0603) 29652
PROBABLY THE
LARGEST SELECTION
OF COMPUTER BOOKS
IN EAST ANGLIA

ACCESS AND BARCLAYCARD WELCOME
*IBM authorised dealer — IBM Personal Computer

● Circle No. 201

FOR SALE

EX-RENTAL RAIR MICROS

WE HAVE A NUMBER OF EX-RENTAL MACHINES AVAILABLE FOR SALE WITH ON-SITE MAINTENANCE AVAILABLE.

PRICES FROM:

3/20A 64K	£750
8MB HARD DISK	£600
3/30A 64K	£1750
3/30S 64K	£2250
3/50 256K	£3000

CONTACT:

JULIE HEWITT ON:- (01)-897 3071

ADP innsite

HEATHROW HOUSE
BATH RD,
CRANFORD
HOUNSLOW
MIDDLESEX TW5 9QP

● Circle No. 202

Micro Computer Disks Ltd

Computer supplies for the end-user

LOWEST PRICES FOR HIGHEST QUALITY PRODUCTS

MAXELL FLOPPY DISKS
DYSAN FLOPPY DISKS
MEMOREX FLOPPY DISKS

prices from **£20.50** per box
prices from **£22.50** per box
prices from **£13.50** per box

Ribbons (over 50 varieties in stock)

Multistrike High Capacity Ribbons
Diablo/Qume Daisywheels

£1.95!!
only £3.95 each!!

NO MIDDLE MEN! NO FRILLS! STRAIGHT FROM THE WAREHOUSE!

0990 23002/3

M.C.D. LTD 8 DOWER HOUSE, TRUSSHIL, SOUTH ASCOT, BERKSHIRE SL5 9AN

● Circle No. 183

MicroValue 80-BUS MULTIBOARDS

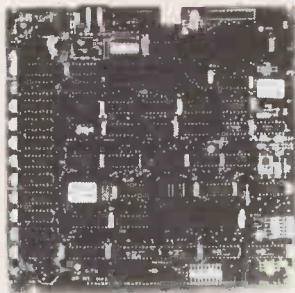

GM813—CPU/64K RAM Board

- * 4MHz Z80A C.P.U. * 64K Dynamic RAM
- * RS232 Interface * Two 8-Bit I/O Ports
- * Cassette Interface
- * Extended & Page Addressing Modes
- * CP/M Compatible Monitor

£225



GM812—Video Controller Board

- * 80 Characters x 25 Line Display Format
- * On-board Z80A Microprocessor
- * Buffered Keyboard Input
- * Programmable Character Generator
- * 160x75 Pixel Graphics
- * Light Pen Input

£125

GM811—CPU Board

- * 4MHz Z80A CPU
- * 4 'Byte-wide' Memory Sockets
- * 2x8-Bit Input/Output Ports
- * 8 Bit Input Port
- * RS232 Serial Interface
- * Cassette Recorder Interface

£125

GM803—EPROM/ROM Board

- * Up to 40K of Firmware
- * 2708 or 2716 EPROMS
- * Page Mode Operations

£65

GM802—64K RAM Board

- * 64K Dynamic RAM
- * 4MHz Operation
- * RAM Disable Function
- * Page Mode Operation

£125

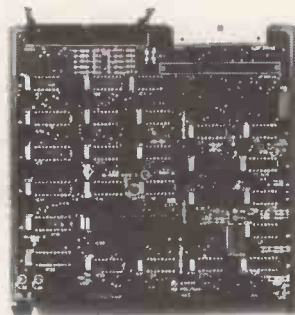

GM829—Disk Controller Board

- * Up To 4 Mixed 5.25 & 8" Drives
- * SASI Hard Disk Interface
- * Single & Double Density Operation
- * Single & Double Sided Drive Support
- * Supports 48 and 96 TPI Drives

£145

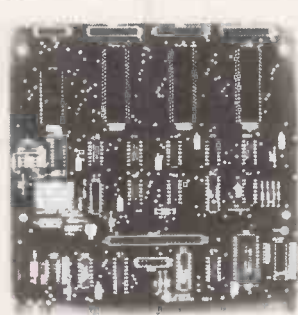

GM816—Multi I/O Board

- * 6 I/O Ports
- * 4 Counter/Timer Channels
- * On-Board Real Time Clock
- * Battery Backup
- * Further Expansion Capability

£125

MP826—Static RAM Board

- * 32K Static RAM
- * Battery Backup
- * Page Mode Operation

£225

EV814—IEEE488 (GPIB) Controller

- * Cost Effective Controller
- * Comprehensive Software Supplied
- * Full Implementation
- * Easy To Use

£140

GM827—87 Key Keyboard

- * User Definable Function Keys
- * Numeric Keypad
- * Cursor Control Keys

£85

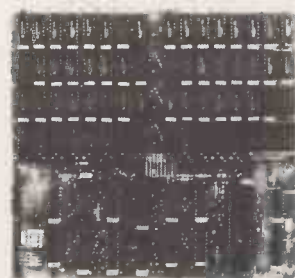

GM833—RAM-DISK Board

- * Virtual Disk Operation * 512K Dynamic RAM
- * Port Mapped For Easy Interface Software
- * Over 10 Times Faster Than a Floppy Disk

£450

Please note: This board cannot be used as a conventional RAM board

PLUTO—Colour Graphics Board

- * On-Board 16 Bit Microprocessor
- * 640x576 Bit Mapped Display
- * 192K Of Dual Ported RAM
- * Comprehensive On-Board Software

£499

CLIMAX—Colour Graphics Board

- * 256x256 Pixel Display
- * 16 Colours
- * Ultra-fast Vector & Character Generation
- * Light Pen Input
- * UHF or RGB Outputs

UHF Version
£199

UHF & RGB Version
£220

GM839—Prototyping Board

- * Fibreglass P.C.B.
- * 80-BUS Signal Identification
- * High Density IC Capability

£12.50



Gemini Microcomputers

All the boards and components in the 80-BUS range are fully compatible and offer a very flexible and cost effective solution to your computer needs. For further information about the 80-BUS range contact your nearest MICROVALUE dealer.

MicroValue - MicroValue

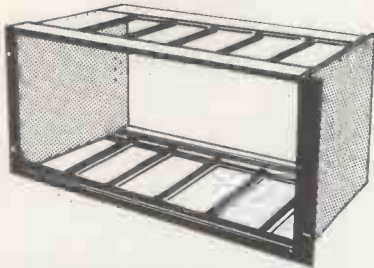

Power Supplies, Mother Boards & Frames

* GM807 3A Power Supply	£40.00
* GM817 6A Switch Mode P.S.U.	£75.00
* GM843 10A Switch Mode P.S.U.	£95.00
* GM656 3 Slot Motherboard	£5.00
* GM654 5 Slot Motherboard	£6.00
* GM655 8 Slot Motherboard	£10.00
* MP840 14 Slot Motherboard	£47.00
* GM662 5 Board Frame	£50.00
* GM610 19" Frame	£37.50



Gemini Galaxy 2

"I would place the Galaxy at the top of my list"
(Computing Today, April 1983)

- * Twin Z80A Processors
- * CP/M 2.2 Operating System
- * 80x25 Video Display
- * 64K Dynamic Ram
- * Light Pen Interface
- * Up to 1.6Mhz Disk Capacity
- * Serial RS232 Interface
- * Parallel Interface
- * Numeric Keypad
- * Definable Function Keys
- * Cassette Interface
- * 12" Monitor Included

from **£1495**

Quantum System 2000

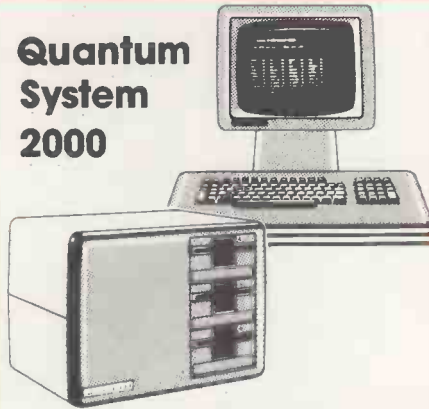

Computerise Without Compromise

- * 80-BUS Construction
- * Serial & Parallel Interface
- * Stylish Design
- * Up To 2.4Mhz Disk Capacity
- * Up To Three 5.25" Drives
- * Fully Expandable
- * Twin Z80A Processors
- * CP/M Operating System
- * 64K Dynamic Ram
- * Definable Function Keys

Two-Drive Quantum £1910

Gemini Multinet

The Gemini Multinet enables as many people as possible to have access to their own microcomputer with mass storage and printer facilities for the lowest possible cost. This is achieved by providing a central 'fileserver' fitted with a Winchester hard disk unit and printer interfaces, in conjunction with a method of interconnecting up to thirty-one workstations to the fileserver. The fileserver and each station are fitted with the Gemini GM836 network interface board. A Micropolis 800K floppy disk drive is incorporated in the fileserver providing backup for the hard disk.

GM910 Galaxy 4 Multinet 5.4 M/byte fileserver **£2600**

GM912 Galaxy 4 Multinet 10.8 M/byte fileserver **£2850**

GM909 Galaxy 4 Multinet workstation **£650**

Both fileservers and workstations are supplied complete with VDU's; the operating software is supplied with the fileserver.

Phoenix P12 Monitor

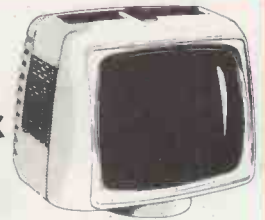

A high quality 12" data display monitor, ideal for Gemini systems. The P12 is available in both green and amber phosphor versions and has a resolution of 20Mhz.

£95

BUY FROM THE COMPUTER PROFESSIONALS

MICROVALUE DEALERS:

AMERSHAM, BUCKS
Amersham Computer Centre,
18 Woodside Road,
Tel: (02403) 22307

BRISTOL
Target Electronics Ltd., 16 Cherry Lane.
Tel: (0272) 421196

EGHAM, SURREY
Electrovalue Ltd.,
28 St. Judes Road, Englefield Green.
Tel: (07843) 3603

LEEDS
Leeds Computer Centre,
55 Wade Lane, Merrion Centre.
Tel: (0532) 458877

LONDON W2
Henry's Radio, 404 Edgware Road.
Tel: 01-402 6822

LONDON SW11
OFF Records,
Computer House, 58 Battersea Rise,
Clapham Junction.
Tel: 01-223 7730

MANCHESTER M19
EV Computing, 700 Burnage Lane.
Tel: 061-431 4866

NOTTINGHAM
Computerama, (Skytronics Ltd.)
357 Derby Road.
Tel: (0602) 781742

Telephone orders welcome



All prices are exclusive of VAT

MicroValue

REAL value - from the Professionals

● Circle No. 182

DISKING

FLOPPY
DISKS
FAST

FREE with EVERY TEN-PACK of diskettes from DISKING at these prices.

The complete DISKING DATA PROCESSING package

1 - SEE 10 LIBRARY BOX



Value £2.50

**** PLUS ****

2. DISKWRITER

Value 20p

You may purchase these separately at £9.90 for 50 (specify blue or black ink)



**** PLUS ****

3 - DISK DIRECTORY

Value 99p

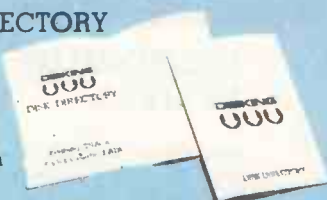

You may purchase these at 9.90 for ten

MEMOREX



MEMORY EXCELLENT

With their NEW FIVE YEAR WARRANTY MEMOREX prove once again their reputation for high quality media. Specify MEMOREX diskettes and you can be sure of reliable products with specifications far exceeding those stated on the label.

***** FREE *****

***** MEMOREX C-90 CASSETTE *****

A FREE MEMOREX C-90 CASSETTE TAPE will be packed with every ten-pack of any MEMOREX diskettes purchased at these prices. This offer does not affect any other promotions and is in addition to them. Offer ends June 30th 1984.

5.25" DISKETTES

PRICES EXC VAT	10-40	50-90	100+
3481 S/S 48 tpi Soft Sect	21.90	20.90	19.90
3491 D/S 48 tpi Soft Sect	27.90	26.90	25.90
3504 S/S 96 tpi Soft Sect	27.90	26.90	25.90
3501 D/S 96 tpi Soft Sect	35.90	34.90	33.90

48 tpi suitable for 35 or 40 track operation
96 tpi suitable for 77 or 80 track operation
10 & 16 Hard Sector available at same prices

DISKING stock around 80,000 of the world's finest diskettes and normally ship within FOUR working hours! Whether you want 1 or 100 ten-packs we are waiting.

Call Joan or Roger on 0428 722563 any-time. ACCESS, VISA or DINERS cards welcome.

Verbatim®



Datalife by Verbatim - With Five Year Warranty

VERBATIM have not become the World's favourite floppy disks by accident. Perfect magnetic media is their stock in trade, and to prove it they now offer an unconditional FIVE YEAR warranty on all DATALIFE products.

5 1/4" DISKETTES

Certified for single OR double density and with hub ring reinforcement.

PRICES EXC VAT	10-40	50-90	100+
MD525 S/S 48 tpi Soft Sect	22.90	21.90	20.90
MD550 D/S 48 tpi Soft Sect	29.90	28.90	27.90
MD577 S/S 96 tpi Soft Sect	28.90	27.90	26.90
MD557 D/S 96 tpi Soft Sect	36.90	35.90	34.90

48 tpi suitable for 35 or 40 track operation
96 tpi suitable for 77 or 80 track operation
10 & 16 Hard Sector available at same prices

8" DISKETTES

PRICES EXC VAT	10-40	50-90	100+
FD34-9000 S/S S/Dens Soft Sect	31.90	30.90	29.90
FD34-8000 S/S D/Dens Soft Sect	31.90	30.90	29.90
DD34-4001 D/S D/Dens Soft Sect	36.90	35.90	34.90

32 Hard Sector available at same prices

Verex



THE VERBATIM PROMISE AT POPULAR PRICES

5 1/4" DISKETTES

PRICES EXC VAT	10-40	50-90	100+
MD200-01 S/S S/Dens. Soft Sect	19.90	18.90	17.90
MD200-AS S/S S/Dens. Apple only	19.90	18.90	17.90

8" DISKETTES

PRICES EXC VAT	10-40	50-90	100+
FD34-1500 S/S S/Dens. Soft Sect	22.90	21.90	20.90
FD32-1500 S/S S/Dens. 32 Hard Sect	22.90	21.90	20.90
DD34-1501 D/S D/Dens. Soft Sect	29.90	28.90	27.90

FREE LORUS GOLD PLATED QUARTZ WATCH WITH GENUINE SOLID LEATHER STRAP

LORUS are part of the SEIKO group of companies



Order FOUR Ten-packs of any brand of diskettes (5 1/4" or 8") using the coupon opposite, or if telephoning credit card orders mention this ad. At these prices you will receive a FREE Quartz Watch. Order EIGHT Ten-packs and you will receive TWO Quartz Watches and so on. Please specify when ordering whether you require Gents or Ladies models. Offer ends 28th February 1984.

All free gift offered at any time by DISKING are subject to availability. Disking reserves the right to substitute any similar alternative item or withdraw the offer without notice.

DISKETTE CARE AND MAILING

The NEW DISKING 'SUPERMAILER'



NEW LOW PRICES
DISK DRIVE HEAD CLEANING KITS

We're fed up with being asked whether our disk drive head cleaning kit actually works. So here's the proof:



Can you really risk that breakdown?

CK5 for 5 1/4" disk drives	14.90
CK8 for 8" disk drives	14.90

(5 1/4" only)

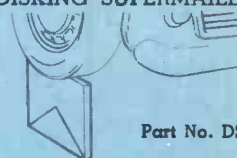

Part No. DSM

* COPYRIGHT DESIGN - Unlike the rest, this ingenious mailer has a flute crossing action when folded, resulting in a virtually unbendable mailer.

* CAVERNOUS CAPACITY - will take, one, two, three or even four diskettes WITH envelopes.

* FULL INSTRUCTIONS - Each DISKING 'SUPERMAILER' is printed with full instructions

*PACKED IN 100'S - For convenience

1 PACK	2 PACKS	3+ PACKS
24.90	22.90	19.90

DISKING INTERNATIONAL

FREPOST, LIPHOOK, HANTS GU30 7BR, UK
 TELEPHONE (0428) 722563
 TELEX 858623 Telbur G or FAX (0252) 721521

ATTENTION ALL PRESTEL USERS, SEE US
 ON PAGE 2477310 & ORDER DIRECT FROM
 YOUR TERMINAL BY CREDIT CARD

UK SHIPPING RATES EXC VAT

5 1/4" DISKETTES	8" DISKETTES
1-2 Packs each pack @ 95p	1-2 Packs each pack @ £1 60
3-5 Packs each pack @ 75p	3-5 Packs each pack @ £1 20
6-9 Packs each pack @ 60p	6-9 Packs each pack @ 90p
10+ Packs @ POST FREE*	10+ Packs @ POST FREE*
5 1/4" CLEANING KITS	8" CLEANING KITS
Same postal rate as packs of 5 1/4" diskettes, 10+ POST FREE	Same postal rate as packs of 8" diskettes, 10+ POST FREE
5 1/4" NEW SEE 10 LIBRARY BOXES	8" LIBRARY BOXES
SEE 10 1-4 off @ 40p	LBB 1 4 off @ 60p
SEE 10 5-9 off @ 30p	LBB 5 9 off @ 45p
SEE 10 10+ @ 20p	LBR 10+ off @ 30p

DISKING SUPERLUXE DISK LIBRARY (5 1/4" ONLY)	DISKING DISK DIRECTORIES
Same postal rate as 5 1/4" diskettes 10+ POST FREE	10-Pack 2.00
DISKING SUPERMAILERS (5 1/4" ONLY)	DISKING DISKWRITERS
100 Pack Complete with sealing labels 3.00	50 Pack £1.00

LOCKABLE DISKETTE STORAGE
 All versions £2.00 each for one, £1.30 each for 2-7, 8+ postage.

NORMAL ORDERS - We now welcome any official Government orders
 We are now happy to accept any official orders with a minimum value of £30.00 from Government Departments, Ministries and Local Authorities. We do this on the understanding that invoices will be settled within thirty days or preferably less please.
 Alternately, you may send your remittance with your order if you so wish.
 All other non Government bodies, cheques with order please payable to DISKING. If you are a large establishment, and cannot raise cheques without an invoice please post or telephone us your order, and we will send a pro-forma invoice by return, for your accounts department to pay against.
 Also bear in mind, that you do have to pay VAT, which will be added to these prices. If you are in any doubt, please see the order form on this brochure to help you with your calculations, or telephone us for assistance.

CREDIT CARD ORDERS
 We welcome Access (Mastercharge), Barclaycard (VISA) & Diners Club International, & there is NO credit card surcharge. You may write your card No. on your order or telephone the order day or night, 365 days a year. You may speak for as long as you like, (but don't leave long gaps otherwise our machine thinks you've gone home) and don't forget to give the following details:
 1 The Cardholder's Name, Address and day time telephone number
 2 Delivery Address if different
 3 First Class, ordinary or special post
 4 Your Credit Card Number
 5 What you wish to Order.
 You may leave the rest to US!

URGENT ORDERS
 If you're posting your order, omit the word FREEPOST from our address, and use our normal postcode GU30 7BJ and do not forget to stamp it FIRST CLASS. If you are a Government body as defined under NORMAL ORDERS and are telephoning your official order OR are an individual or company using your credit card No., please make it clear that you wish to pay for your goods to be sent to you by FIRST CLASS POST.

FIRST CLASS RATES EXC VAT	MINIDISKS	8" DISKETTES
First TEN-PACK	2.00	2.50
Second and subsequent TEN-PACK	1.50	2.00

DESPERATE ORDERS U.K.
 Your options are: DATAPOST which will deliver the goods within the United Kingdom over night (usually before 10 am the next day) provided they are ordered and paid for from DISKING by 3.00 pm or EXPRESSPOST which will deliver the goods the SAME DAY provided they are ordered and paid for from DISKING by 10.30 am, and provided you are no further north than Manchester.
 These services put great stress on our sales order processing and packaging departments.
 * Please therefore, spare a thought for our girls, and make sure that:
 -) The required goods are in stock and
 -) A full complement of manpower and vehicles are available at DISKING

TRADE CORNER

Write or call for our 1984 Trade pack, including our FREE sample unlabelled diskette.

A Seasonal Message to all our Customers

You'll find our prices good, and our service even better. Cheaper products you may find, but anyone can advertise anything at a silly price. Just try buying it — it's always next week! Like car salesman with the new £1000.00 cars, he had plenty of orders, but he just couldn't get the stock! surprise surprise.

Our thanks this month go to Alistair who always leaves his order for 1000 diskettes until 6.15pm and then wants delivery in London next morning — A Happy New Year to him from DISKING, and from our local taxi driver who's getting to know the route quite well. To ALL our customers both Trade AND End User, without whom we wouldn't be here:-

***** A HAPPY AND PROSPEROUS NEW YEAR *****
STOP PRESS * STOP PRESS * STOP PRESS *

400 Brand New, Unlabelled Grey Superluxe Disk Libraries (20 minidisk capacity) at half price to Clear. Minimum order quantity 10 pieces.
 Only ... 4.90 each. (3.00 P&P per 10, 30+ FREE)
 This offer is open to the trade OR end users. First come, first served.

DISKETTE STORAGE



LOCKABLE DISKETTE STORAGE

These anti-static, ABS plastic diskette storage boxes come in four sizes, two for mini disks and two for 8" disks. They have a white base with a transparent smoked lockable lid, and hold 40 or 80 diskettes. They come complete with keys and dividers.

PRICES EXC VAT	
M35 40 minidisk capacity	14.90
M85 80 minidisk capacity	18.90
F40 40 8" diskette capacity	18.90
F90 80 8" diskette capacity	27.90

LIBRARY BOXES



PRICES EXC VAT	1-49	50+
SEE 10 for minidisks only	2.50	2.20
	1-47	48+
	2.50	2.20

8" LIBRARY BOX (NOT SEE 10 Design)
 The new SEE 10 us probably the best 5 1/4" library box around.
 (FREE with every ten disks ordered).

5, 10, 15 & 20MB Hard Disks for YOUR Micro.



We just bought a 20MB sub-system for our micro., to service the ever increasing number of you lovely people who keep ordering diskettes, and were so impressed with the performance, service and price, that we decided you'd all like one of these magic boxes. So we now sell them.

They come in four sizes, and there's one for YOUR machine:-

Part No:	5MB	10MB	15MB	20MB
APPLE II	DS505	DS510	DS515	DS520
IBM-PC	1290.00	1390.00	1490.00	1590.00
SIRIUS/VICT.	1190.00	1290.00	1390.00	1490.00
EPSON QX10	1190.00	1290.00	1390.00	1490.00
DEC LSI 11	1390.00	1490.00	1590.00	1690.00
Z80 System	1190.00	1290.00	1390.00	1490.00
S100 System	1290.00	1390.00	1490.00	1590.00

ONE slave may be added at these lower prices
 Slaves 990.00 1090.00 1190.00 1290.00
 Complete with intelligent controller, host adaptor power supply unit, fan, cabling, software and User Manual.
 Free delivery in the UK.

Order any 4 Ten-packs of diskettes use this coupon and you will receive a FREE Quartz watch, specify

Gents Qty
 or
 Ladies Qty



QTY	PART NO.	DESCRIPTION	PRICE EXC VAT
			£
			£
			£
		TOTAL GOODS VALUE EXC VAT	£
		TOTAL DELIVERY AND INSURANCE	£
		SUB TOTAL EXC VAT	£
		VAT	£
		VALUE OF CHEQUE PAYABLE TO DISKING	£

Name: _____ Tel No: _____

Address _____

Please charge my credit card No. _____
 ACCESS, VISA AND DINERS cards welcome.

179



DYSAN - For The Decisive

When you think of disks you often think of DYSAN. DYSAN have the reputation for TOTAL dependability whatever the application. They may cost a little more but data is irreplaceable.

5 1/4" DISKETTES

Certified for Single OR Double Density, and all with Hub Ring reinforcement

PRICES EXC VAT	10-40	50-90	100+
104/1D S/S 48 tpi Soft Sect	25.90	24.90	23.90
104/2D D/S 48 tpi Soft Sect	37.90	36.90	35.90
204/1D S/S 96 tpi Soft Sect	36.90	35.90	34.90
204/2D D/S 96 tpi Soft Sect	46.90	45.90	44.90

48 tpi suitable for 35 or 40 track operation
 96 tpi suitable for 77 or 80 track operation
 10 & 16 Hard Sector available at same prices

8" DISKETTES

PRICES EXC VAT	10-40	50-90	100+
3740/1 S/S S/Dens Soft Sect	30.90	29.90	28.90
3740/1D S/S D/Dens Soft Sect	37.90	36.90	35.90
3740/2D D/S D/Dens Soft Sect	41.90	40.90	39.90

32 Hard Sector available at same prices

SONY

3 1/2" MICRODISK

	10-40	50-90	100+
OM-D3320 S/Sided Auto Shutter	42.90	41.90	40.90

(There is no free library box with these yet)

ZORBA Portable Microcomputer



Whether Businessman, Programmer or beginner THIS Portable Business Micro is for YOU. We defy ANYBODY to match it's value ANYWHERE!

For ONLY ... £1395.00 EXC VAT (UK dly free) you can baffle your Bank Manager and impress your Secretary.

MORE STORAGE - 800 KBytes on twin 5.25" floppy disks plus 64 KBytes User Memory.

MORE SCREEN - Compact 7" Green screen with full 80 columns by 25 lines means

MORE KEYBOARD - Professional/detachable Qwerty format, caps & shift lock & 19 programmable

MORE EXPANDABILITY - Serial/Parallel & IEEE

MORE SOFTWARE - CP/M 2.2, M 80, L 80, LIB 80 & CREF 80.

Plus the incredible:- CBASIC, WORDSTAR, MAILMERGE & CALCSTAR Plus COMPATABILITY SOFTWARE for reading, writing and formatting ACCESS, IBM-PC, KAYPRO, MAX 80, MORROW, NEC-PC, OSBORNE, SUPERBRAIN, SYSTEL or OLYMPIA, DEC VT-180, XEROX, ZENITH 290 or Z100 or Double Sided - AVATAR, CASIO, COLUMBIA, EPSON, HP 125 or 87, IBM-PC, OTRONO, PMC, SANYO, SUPERBRAIN, SYSTEL, TELEVIDEO, ZENITH Z100, ZORBA.

More handbooks including:- CP/M, Zorba, WordStar, Mailmerge, Calcstar AND Beginners Manuals.

This man can use...

**46 Microcomputers 6 Word Processors
16 Printers 2 Mini Computers**



...all without leaving his seat!

Clearway

is a low cost Networking device allowing ALL minis, micros, printers, mainframes etc. to communicate with each other.



- From £150 per connection (node)
- No controller needed.
- Easy installation
- Connects any hardware device through an RS232 interface
- Up to 99 nodes on the same ring
- File sharing software available
- Enables printer sharing
- Has special hunting feature
- Other models available
- Over 3000 nodes currently installed
- Manufactured and supported in UK

Mail the coupon now for full information

Real Time Developments Limited, Lynchford House, Lynchford Lane, Farnborough, Hampshire GU14 6JA. Telephone: Farnborough (0252) 546213 Telex: 858893 Fletel G

I am interested in Clearway – the low cost Networking device, please send me details

Name

Position

Address

Telephone

Send to: Real Time Developments
Lynchford House, Lynchford Lane, Farnborough, Hampshire GU14 6JA
Telephone: Farnborough (0252) 546213 Telex: 858893 Fletel G

● Circle No. 256

MAILING FLOPPY DISKS?

The Swan Disc Pack combines great strength with simplicity of use. Made from rigid white corrugated, it is a self assembly package providing high postal security at economical rates.

Free sample ring us on
01-607 9938



NOW AVAILABLE: 5 1/4" Floppy Disc Holders to fit A5 Ring Binders.

sizes:
6 x 6;
8.75 x 8.75

● Circle No. 254

reprints

If you are interested in a particular article/special feature or advertisement in this journal **HAVE A GOOD LOOK AT OUR REPRINT SERVICE!**

We offer an excellent, reasonably priced service working to your own specifications to produce a valuable and prestigious addition to your promotional material. (Minimum order 250 copies).

Telephone Michael Rogers on 01-661 3457 or complete and return the form below.

To: Michael Rogers, Practical Computing, Reprint Department, Quadrant House, Sutton, Surrey SM2 5AS.

I am interested in copies of article/advert. headed featured in this journal on pages, issue dated Please send me full details of your reprint service by return of post.

Name

Company

Address

..... Tel No

EuroBEEB – basically the best controller

How to make small control systems easy:-

1. Plug the EuroBEEB ROM and the EuroBEEB power lead into the BBC
2. Connect the BBC serial port the EuroBEEB serial port
3. Switch on, and type *TERM. and press return
4. You now have control of the EuroBEEB through the BBC
5. You can now write BASIC programs directly into the battery-backed memory of the EuroBEEB, and upload or down from it to the BBC disk or cassette
6. You can program an EPROM, and use it to replace the CMOS RAM on the EuroBEEB (using CU-PROM)
7. You can program a "turnkey" line in the EuroBEEB's operating system EPROM so that it runs its program as soon as it is powered up
8. You can add an enormous range of CUBE modules through a backplane, including hi-res colour video, analog, digital and serial i/o, industrial i/o, printers, liquid crystal display, etc.,
9. You can use any RS-423 terminal instead of the BBC
10. EuroBEEB, complete with sideways ROM and cables, costs only £249. ex. VAT (order code CUU6592)

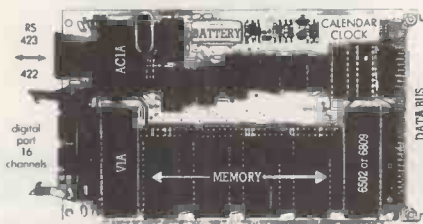
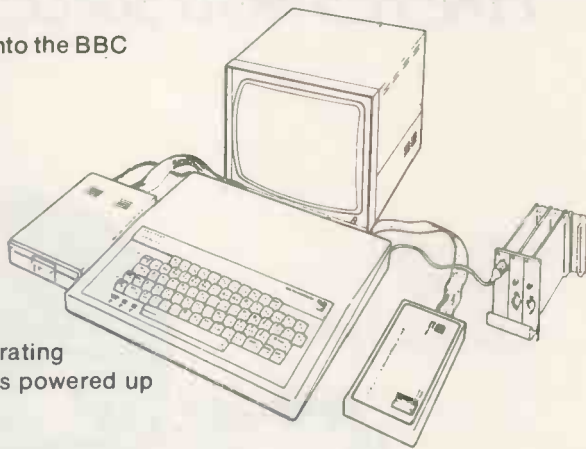

Send for free
150 page
Catalogue to:-

Control Universal Ltd
Anderson's Court
Newnham Road,
Cambridge CB3 9EZ
Tel 0223 358757 Telex 995801

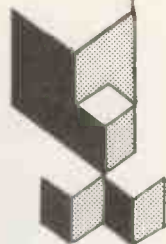

● Circle No. 209

PANASONIC 12" MONITORS

£95

- monochrome green screen
- high quality and reliability
- genuine 80 character and high resolution display

RING NOW ON OUR
HOTLINE
0865 726639

● Circle No. 208

A MULTI-USER BUSINESS SYSTEM FOR UNDER £2,000 PER USER

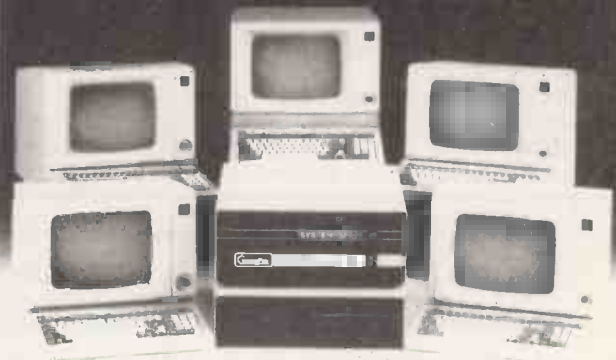

If 21 megabytes of fast storage with five users and two printers sounds useful and £2000 per user seems unbelievable—give us a call and ask us to prove it!

We will explain how your sales clerk, accounts clerk, secretary and you can access your business files at the same time! And there's still that other terminal for expansion!

At COMCEN we make our own computers—Ask our advice—your alternative may be learning the hard way!



COMCEN
TECHNOLOGY LTD

A COMPUPRO
SYSTEMS
CENTRE



Comcen Technology Ltd.
45/46 Wychtree Street,
Morrilton,
Swansea, SA6 8EX.
Tel: (0792) 796000
(0792) 796337 (24 hours)
Telex 48297 Joytel.

London sales office,
2nd Floor,
Avon House,
360-366 Oxford St,
London W1N 9HA
Tel: 01-491-4636
Telex 28800 London

● Circle No. 210

(THE KEY * TO SUCCESSFUL SOFTWARE SALES)

Earls Court,
London.

June 5-7, 1984

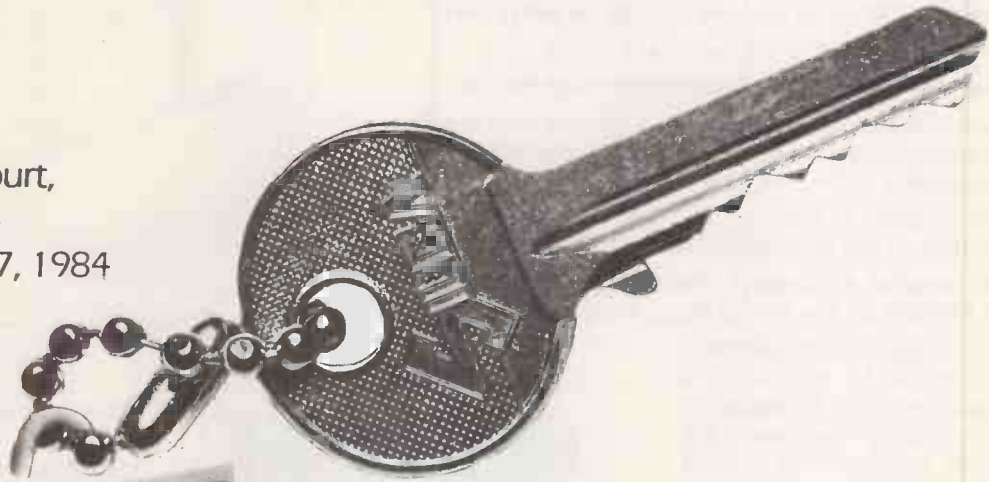

software '84

EXHIBITION AND CONFERENCE

Certainly the major software event of 1984 will be **Software '84**, to be held for the first time in Central London. **Software '84** will be totally dedicated to professional software sales and will be held from June 5-7, 1984 at Earls Court in the centre of London, the Nation's biggest commercial market place.

Such a show could only come from a company that understands the computer market. Reed Exhibitions, the country's largest exhibition organisers, will be staging **Software '84** with all the skill the company has already brought to the highly successful Compec shows.

Computer Weekly, Software and the National Computing Centre (NCC) will be sponsoring both the exhibition and the prestigious conference, running at the same time, guaranteeing a high level of interest in both events. The event has the full support of the Computer Services Association (CSA) and The Institute of Data Processing Management (IDPM) and are co-sponsored by 'Systems International', 'Practical Computing', 'Micro Business' and 'Computer Talk'.

Inevitably, top quality business visitors will be drawn to such a show, with DP professionals, dealers, OEM's and serious business and professional end-users all visiting the exhibition with nothing but software purchase at the forefront of their minds.

With that kind of captive audience you can't afford not to be a part of this important event. So turn the key to the booming software market and make **Software '84** the key to successful software sales. The first step is to fill in the coupon below:

Return to: The Exhibition Manager, **Software '84**, Reed Exhibitions, Surrey House, 1 Throwley Way, Sutton, Surrey SM1 4QQ

I am interested in exhibiting at '**Software '84**'. Please send me full details.

I am interested in visiting '**Software '84**'. Please send me a visitor registration form.

I am interested in attending '**Software '84**' Conference. Please send details.

Name _____ Position _____

Company _____

Address _____

Telephone No. _____ Telex _____

software '84

EXHIBITION AND CONFERENCE

Practical Computing

SHOPWINDOW

Telephone 01-661 3612 to reserve your space

ADVERTISEMENT RATES

£15.00 per single column centimetre (minimum 5 cms x 1 col.)
Series discounts available, details on request.

COPY DATES

4 weeks preceding Publication date.

: GO FORTH & * ;

Laboratory Microsystems FORTHS - the professional FORTHS complete with editors, assemblers, turn-key compiler, many system utilities, multi-tasking, and extensive documentation. These FORTHS are available for 8080, Z80, 8086/88, and 68000 processors using CPM-80; CPM-86, MSDOS/PCDOS, or CPM-68K.

CPM-80 £60 CPM-86 £105
MSDOS/PCDOS £105 CPM-68K £190

NEW - FORTH+ packages have 32-bit stacks and can access the processor's full address space for both program and data.

CPM-86/MSDOS/PCDOS £190 CPM-68K £290

Nautilus Systems Cross-compilers - transport FORTH to different processors, generate ROMmable code, these compilers will run on any of the FORTHS above. The complete development system - a real time saver. Choose targets from - 8080, 8086/88, Z80, 6800, 6301/6801, 6809, 68000, 1802, Z8, 9900/99000, Z8000, LSI-11. First compiler from £230, additional targets from £95.

NEWBRAIN FORTH in PROM - includes screen editor, full integration to NEWBRAIN i/o handlers, a complete Z80 assembler, decompiler, utilities and manual - £55 + VAT. EPROM/RS232 card and comms software also available.

DRAGON FORTH cartridge - full fig-FORTH with editor, colour management, sound facilities, and manual - £45 + VAT

777 III JUPITER ACE DISC CONTROLLER III 777 Well ain't that magic - just add 12 volts and a disc drive - 3", 5", or 8". Includes full FORTH DOS software. A snip at £98 + VAT. Additional disc utilities £15.

DIY FORTH Kits Installation manual - How to do it, model, definitions, editor £7

Source code listing for one processor - choose from 6502, 6800, 6809, 8080, Z80, 8086/8088, 9900, 1802, 68000, Z8000, VAX, Apple II, LSI-11, Eclipse £7

Comprehensive range of FORTH books includes -
'Starting FORTH' by Brodie - the classic £16
'Systems Guide to fig-FORTH' by Ting £26



MicroProcessor Engineering Ltd
21 Hantley Road Shirley
Southampton SO1 5AP
Tel: 0703 776492



● Circle No. 215

MJ MICRO SUPPLIERS

Disks Wabash - Box of Ten			
SSDD 5.25"	15.10	SSDD 8"	17.90
SSDD	19.16	SSDD	22.33
DSDD	21.80	DSDD	26.30
Samsom Data Binder			
9.5" x 12" ea.	1.15	Disk Storage Box 5"	16.00
14.5" x 11" ea.	1.22	ABA 30/40	22.00
Listing Paper 9.5" x 11"		ABA 60/80	
500	2.84	A4 Clean Edge	
1000	5.43	500	6.82
2000	10.36	1000	13.02
Listing Paper 14.5" x 11"		2000	24.80
500	3.61	Labels 3.5" x 1.5"	
1000	6.91	1000 1up	5.35
2000	13.18	4000 1up	20.45
		8000	38.97

All sizes of stationery available.

Prices excl. P&P and VAT.

Ribbons-Apple Peripheral Cards-Disk Drives

Pre-printed Stationery-Cassettes-Printers

For all your supplies, write for full prices to

MJ MICRO SUPPLIES, FREEPOST (BS3661).

NAILSEA,

BRISTOL BS19 2BR.

No stamp required

Tel: Nailsea (0272) 857354

● Circle No. 217

FULL COLOUR Inlay Cards



Sell your programs with colour inlay cards and add that professional sales appeal from as little as £28 per 1,000. A.W.P. are the specialist trade colour printers for both Audio and Computer cassette inlay cards. They are produced in two types the deluxe finish (min. 1,000) and the standard finish (min. 8,000).

Details and samples from A.W.P. Ltd. 5 Bexley Sq., Salford, Manchester. 061 832 4533.

The Trade Colour Printers

● Circle No. 218

northern computers
THE COMPUTER CENTRE OF THE NORTH



THE showroom for all the leading micros

easy parking off the M56 (junc 12) VIC 20 VIC 64
BBC micros Newbrain Acorn Atom Books
Apple 11e, 111 Dragon Electron Games
Sinclair Spectrum

Secondhand computers EASY PAYMENTS
ALL ACCESSORIES SALES AND SERVICE

northern computers Churchfield Road,
computers FRODSHAM
Cheshire WA6 6RD

TEL: FRODSHAM (0928) 35110

WE WILL PURCHASE AND PUBLISH YOUR PROGRAMS Call Steve Rhodes for details

● Circle No. 216

● Circle No. 219

HAVE YOU CONSIDERED BAR CODES



Bar-codes give a speedy and error free means of data entry and provide a foolproof method of identification for any item or document. Typical uses include stock control, libraries, filing systems, security & checkpoint verification, point of sale terminals, spare parts identification, etc. etc. Already most grocery products are bar-coded at source and many other areas of industry and commerce are following. Bar-codes will soon be commonplace.

APPLE 2 PET BBC micro

A complete low cost bar-code identification system is available for these micros. It contains all the hardware, software and documentation needed to read and print bar-codes (using an Epson dot matrix printer). Most bar-code formats may be read and the system may easily be patched into an existing applications program.

£199.00 + VAT

*** NEW *** RS232 bar-code reader

This new stand-alone unit decodes the bar-code and converts it into ASCII for transmission to the host computer via a RS232 port. Complete with scanning wand, power supply & cables. Works with virtually any computer.

£385.00 + VAT

More information on these products is available on request. Please state your micro & area of interest. The decoder board is available separately to OEMs.

DOT MATRIX & DAISYWHEEL PRINTERS

LOWEST PRICES GUARANTEED! FX80

EPSON FX80 RX80

NEC 8023 STAR

SHINWA CP80

BROTHER TEC

etc. etc. etc.

Our pricing policy is to match or better any other advertiser. In addition enthusiastic and knowledgeable technical advice and backup is available to all our customers. Delivery is from stock to your door, often within 24 hours. Phone for a quote or write for full lists.

ALTEK (PC) 1 GREEN LANE
WALTON ON THAMES SURREY

please phone before calling
(0932) 244110

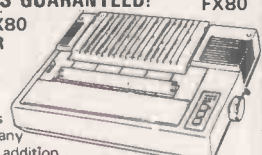

APPLE CARDS AT INCREDIBLE PRICES!

RAM Card 16k	£34.50
RAM Card 128k	£151.95
80-Column Card	£46.95
Z-80 Card	£37.95
PAL Colour Card	£29.95
EPROM Writer	£41.50
Talking Card	£25.95
Drive Controller Card	£25.95

Prices include air postage to U.K.
COMMUNICATIONS ASSOCIATES
Dept. PC, GPO Box 7779, Hong Kong

● Circle No. 220

POOLS PREDICTION "POOLSWINNERS"

The most sophisticated Pools Prediction Aid available. Gives probabilities of score draws, draws, homes or aways, based on two databases holding over 20,000 matches (included).

The databases are automatically updated as results are entered. Can be used in simple mode, or with parameter adjustments to develop your own unique forecast method.

Fully documented, available now for Apple, Spectrum (48K), Dragon, ZX81 (16K), BBC Model B, Commodore 64 (others - please enquire). £15.00 (discs/tapes)

"POOLSDATA"

Complete record of all English Football League matches 1978-83. Teams, scores and dates of 10,000 matches held in simple format, ready for your analysis. Starter analysis programs and full documentation included. Available for Apple, Spectrum, ZX81, BBC, Dragon, Commodore series.

Discs (5 year) £15.00
Tapes (5 year) £12.50 all prices
Tapes (2 year) £7.70 (p&p included)

SELEC SOFTWARE (PC)

37 Councillor Lane,
Chaddle, Cheshire
061-428 7425



● Circle No. 216

SHOP WINDOW

Every computer needs
CHATTERBOX II
"Listen creep, I am the leader...."

For ZX81 SPECTRUM BBC TRS 80 APPLE NASCOM VIC/PET/64 (Please state)

TAKE US TO YOUR LEADER

NEW! EXCLUSIVE! PITCH CONTROL

£49 COMPLETE OR £39 (OVN KIT)

WILLIAM STUART SYSTEMS

CHATTERBOX II can say anything!
Genuine phoneme synthesis - not just recorded speech - hence unlimited vocabulary. Programmable pitch for more natural intonation (exclusive to Wm Stuart Systems) - solid tone cabinet for quality sound - integral beep/music amplifier. PLUS expansion socket for BIG EARS voice recognition system. Full instructions technical notes and software supplied with this outstanding educational unit.
DEALER ENQUIRIES WELCOME

As seen on BBC TV "Computer Programme"

BIG EARS STOP GO LEFT! RIGHT!

SPEECH INPUT FOR ANY COMPUTER

Hugely successful Speech Recognition System, complete with microphone, software and full instructions

BUILT TESTED & GUARANTEED
PLEASE STATE COMPUTER: UK101, SPECTRUM, ATOM, NASCOM2, Vic 20, Micron, ZX80/81, PET, TRS80, MZ80K, APPLE II, BBC MICRO

ONLY £49

ZX81/SPECTRUM NEW!

MUSIC SYNTHESIZER (Stereo) +16 LINE CONTROL PORT

Play 3-part music, sound effects, drums etc. Full control of attack, decay and frequency. Input/Output lines provide control and monitor facility for Home Security, Robot Control, Model Railway etc. etc. Works with or without 16K RAM.

Full instructions/software included. Add keyboard to make a live performance polyphonic synthesiser

Note: up to 3 units can be used simultaneously, giving 9 music channels & 48 I/O lines

AMAZING VALUE AT ONLY **£19.50 (KIT)** £25.50 (BUILT)

SOFTWARE

THE COMPOSER Synthesiser Music Programme. Enter & play 3 part harmony. Includes demonstrations (Spectrum ZX81) recommended £7

TALKING HANGMAN For Chatterbox! The classic game claims its victims with a dry vocal accompaniment (Spectrum) £6

ZX ARP/DRUMSEQ Fascinating synthesiser demonstrations. Generates automatic sequences and plays from keyboard. Some weird effects (Spectrum) £6

CHROMACODE??????? Can you defuse the bomb by cracking the secret combination before time runs out? With Chatterbox voice output (Spectrum) £6

COLOUR MODULATOR RGB in, PAL/UFH out (not for ZX)

Request add VAT at 15% to prices. Barclay/Access orders accepted by telephone

WILLIAM STUART SYSTEMS Ltd

Quarley Down House Chiddingfold Nr. Salisbury Wiltshire, SP4 0DZ Tel: 098 004 235

WILLIAM STUART SYSTEMS Ltd

Quarley Down House Chiddingfold Nr. Salisbury Wiltshire, SP4 0DZ Tel: 098 004 235

KINGSLEY ENTERPRISES

Mail Order Discs
Prices are for boxes of 10 discs

Soft Sector	Nashua	Xidex	Dysan	GenTech
5.25" Diskettes				
SS/SD 48	15.00	22.00	-	-
SS/DD 48	17.00	23.00	25.00	25.00
DS/DD 48	19.00	24.00	31.00	31.00
SS/DD 96	24.00	25.00	32.00	35.00
DS/DD 96	25.00	31.00	40.00	40.00
8" Diskettes				
SS/SD 48	20.00	26.00	-	-
SS/DD 48	21.00	23.00	30.00	30.00
DS/DD 48	22.00	27.00	35.00	37.00

Sony 3.5" (Apricot) Diskettes £40.00

Add carriage (£1 per box) and V.A.T. (15%)
Prices correct at time of going to press
Please write for full-range price list

KINGSLEY ENTERPRISES
87 Whitefield Road
Stockton Heath
Warrington
WA4 6NB

Organise your files on
CentTech Colour discs

Snail Software

INCOMPLETE RECORDS/ NOMINAL LEDGER PLUS (IRNLP)
Finished accounts from incomplete records. Full nominal ledger, running totals of all debtors, creditors, stock and capital assets. Weekly and quarterly cash, bank, VAT and nominal accounts summaries. Detailed profit and loss and balance sheet. Comprehensive manual.

IRNLP Single Disc Sanyo MBC 1000/1150 57.50
IRNLP Single Disc BBC B 27.50
IRNLP Single Disc TRS 80 27.50
IRNLP Cassette 48K TRS 80/GENIE 27.50

* SPECIAL OFFERS *
SCRIPT 32 with manual Dragon 32 9.50
MAILBAG with manual Dragon 32/BBC B 8.00
DRAWER with manual Video Genie 9.95
POKER BBC B 4.99

Dealer enquiries welcome. **SNAIL SOFTWARE**, 21 Bell Lane, Ludlow, Shropshire. SY8 1BN. Telephone (0584) 4303.

• Circle No. 223

SCIENTIFIC SUBROUTINE LIBRARY

VOLUME 1 — STATISTICS AND FITTING FUNCTIONS
Mean, SD, normal distribution, partial expectation, Chauvenet's criterion, least squares fit to polynomial and arbitrary function, repetitive least squares fits, covariance matrix, chi-squared statistic, matrix inversion, solution of simultaneous equations.

VOLUME 2 — LINEAR PROGRAMMING
Reduction of a Simplex tableau, integer programming, partial integer programming, conversational linear programming system, least cost mix problem.

VOLUME 3 — FURTHER STATISTICS
Ranking, quantiles, frequency, 2-way table, correlation coefficient, T, chi-squared and F distributions and their inverses, T test, chi-squared test, Wilcoxon test, linear and multiple regression, ANOVA 1-way and 2-way.

VOLUME 4 — TRANSFORMATIONS & SORTING ALGORITHMS
Fourier, FFT, Laplace, numerical integration and differentiation. Exchange sort, Quicksort, Shell sort, Tree sort.

Manuals including full source listings with implementation notes and documentation —
BASIC £25 per volume
PASCAL £30 per volume

Software in CP/M (8" SSSD) or DEC RT-11 (RX01) formats — £75 + VAT per volume.
CP/M TO DEC FILE TRANSFER
Software to read and write RT11 format RX01 diskettes under CP/M. Supplied on 8" SSSD diskette — £25 + VAT.

MICRO LOGIC CONSULTANTS LTD.
57, Station Rd., Southwater, Horsham, W. Sussex.
Telephone: 0403 731818

• Circle No. 224

DBASE II

ON SITE TRAINING

Phone Mike Gardner on
01-421 0266

cats software

96 Grimsdyke Road, Hatch End Pinner Middx HA5 4PW

• Circle No. 225

NEWBURY DATA PRINTERS

8510 from £480.00
1550 from £600.00
are, what other printers want to be

Continuous Stationary 1000 SHTS

11 x 9 1/2 plain £5.25
11 x 9 1/2 plain (zip margins) £6.00
11 x 14 1/2 plain/lined £7.00

Min. Quantity = 1 Box (2,000 sheets)

Contact **Chris Pearce**
CDP Consultants Ltd.
Wicken Rd., Clavering, Essex CB11 4QT.
(079985 617)

• Circle No. 226

SOFTWARE

For simple bookkeeping & VAT record: Designed for small business & the self employed. A simple to use program combining sales cash book and purchase day book, included VAT calculation and analysis can be printed if required

For Apple II 48K Disc £9.99 inc.
For Spectrum 48K Tape £7.99 inc.

JADE TRADING
409 ILFORD LANE, ILFORD, ESSEX

• Circle No. 227

MICROCOMPUTER INSURANCE

Comprehensive cover at a reasonable premium:

- All Risks Cover (incl. Transit) — up to £8,000 for £20
- Increased Cost of Working — to reinstate lost data
- Breakdown & Derangement — alternative to maintenance agreement

Write with details of equipment to:

Geoffrey Hoodless & Associates
Freepost (no stamp required)
Woking
Surrey GU21 3BR
Tel: Woking (04862) 61082 (24 hrs)

• Circle No. 228

ZORBA
THE SERIOUS PERSONS PORTABLE PLUS
LUCAS LOGIC LX80
The Low Cost 80cps Printer
(A Great Partnership)
ADD

DBASE II
The Most Powerful Micro Database (Now the system is complete) And you can take it anywhere Deliveries are immediate

Contact **Chris Pearce**
CDP Consultants Ltds
Wicken Rd., Clavering, Essex. CB11 4QT
(0799 85) 617

• Circle No. 229

POSEIDON COMPUTER SERVICES LTD.

Of Hampton S.W. London Dealer
FOR SIRIUS 1 APRICOT & PULSAR

COMPETITIVE PRICES — FULL UK DELIVERY

Bespoke Software and Consultancy

01 941 1447/5986 TELEEX 8954665 GITS

CIF I/O FOR EXPORT/IMPORT SPECIALISTS FOR COMPUTER EQUIPMENT AND SOFTWARE

POSEIDON COMPUTER SERVICES LTD
01 941 1447/5986 TELEEX 8954665 GITS

• Circle No. 230

DATA DISK LTD.

Data Disk Ltd.
67, Swan Street
Boxford
Suffolk 0787 210091

COMPARE OUR PRICES

PRINTERS

The New "JUKI" 610 Daisywheel
(RRP £399 + VAT)

The small Company
with the big name
in consumables

OUR PRICE
ONLY £375 + VAT
"Free Delivery" No Extras

JUST ARRIVED

Our own brand of covers
for the Commodore 20, 64 &
the B.B.C./V computer £3.95
+ VAT Colours black or beige.

Our own brand of disk binders
with a capacity of 20 £3.95
+ VAT Colours black or beige.

ALL CARRIAGE FREE

Floppy Disks by BASF

5 1/4" Single Sided/Single Density = £15.00 for 10 + VAT
Single Sided/Double Density = £22.00 for 10 + VAT
Double Sided/Double Density = £24.00 for 10 + VAT
8" Disks and Quad Density also available
5 1/4" Plastic Library Cases £2.75 + VAT each

NEW FROM FRANCE!

LIBRARY CASES IN BROWN/CREAM.

5 1/4" 20 - Capacity = £2.80 + VAT
8" 25 - Capacity = £5.75 + VAT
Lockable Filing Cases with carrying handle Brown/Cream
for 5 1/4" disks x 100 capacity ONLY £18.50 + VAT

Other lockable filing cases;

5 1/4" 40 - Capacity = £15.50 + VAT
5 1/4" 90 - Capacity = £21.95 + VAT
8" 40 - Capacity = £22.95 + VAT
8" 90 - Capacity = £31.95 + VAT

Contact us for all your computer needs. Anything from
ribbons, listing paper, labels, disks, printers etc. etc.

Everything on mail order, enquire for our comprehensive
price lists.

* Free delivery on all printers and disks *

Nominal charge for all other ranges.

EPSON FX80 **OUR PRICE**
(RRP £438.00 + VAT) ONLY £425.00 including VAT.
"Free Delivery" No Extras.

EPSON RX-80 **OUR PRICE**
(RRP £298.00 + VAT) ONLY £285.00 including VAT
"Free Delivery" No Extras

EPSON RX-80 FP **OUR PRICE**
ONLY £315.00 including VAT
"Free Delivery" No Extras.

OKI MICROLINE 83a = £525.00 including VAT
OKI MICROLINE 80a = £225.00 including VAT

LISTING PAPER

11" x 9 1/2" Single pt = £9.60 + VAT per box of 2000
11" x 14 1/2" Single pt = £12.40 + VAT per box of 2000
All other sizes available. Either plain or green lined.

To Data Disk.

Please Supply

Please Supply

Please Supply

Please Supply

Enclosed my cheque/money order Total

Delivery to:- (Name)

Address

Telephone No

Trade and Dealer Enquiries Welcomed. More Agents Urgently
Needed Nationwide.

● Circle No. 245

Advertisement Index

A		D		K		Q	
A&G Computerware	60	DRG Business Systems	134,135	Keele Codes Ltd	32	Qubie	53
A-Line Computer Systems	98	Data Disk	186			Qudos Systems Ltd	148
ACT Pulsar	62,63	Dennison Kybe Corp	IFC				
ADP	175	Digital Equip Co.	38,39,40	L		R	
ATA	117	Digithurst Ltd	153	LSI Computers Ltd	10,11	Real Time Developments	180
AWS Computer Supplies	58	Direct Disk Supplies	93	Lantech	69	Research Machines	181
Act Hardware	46,47	Disk Direct	144	Laserbug	114		
AcuLab Ltd	69	Disking International	178,179	Lomax	172	S	
Akhter Instruments	76	Diskotek	157	London Computer Centre	44,124	SM Software	26
Anglia Computer Centre	175	Dynotech Microsoftware	151	London Computer Fair	154	Sage Systems	171
Asco Business	60					Sanyo Marubeni	18,19
						Sanyo Marubeni	BC
B		E		M		Sapphire Systems	133,166
BFI/Diskpost	163	Epson HX20	12	Mannesman Tally	128	Sirtan Computer Systems	16
Barley Mow Workspace	58	Epson Printer	120	Mayfair Micros	114	Soft Option	59
Beebug	97,124	Epson QX10	48	Memotech	26,27,28	Software84	182
British Data Capture	6			Micro Peripherals	IBC	Software Ltd	73
British Micro	125	F		Micro Research Ltd	168	Swan Packaging	98,180
Bromcom	54,55	Ferranti	126,127	Microcomputer Products	14		
		Fox & Geller	136	Microcomputer Disks	175	T	
C		Fraser Assoc.	98	Micropacs	172	Tandata	168
C/WP Services	151,153			Microsoft	20	Tandy Corp	9
CAE Teleprinter	56	G		Microtrend	141	Tashki Computers	160
CDP Consultants	169	GCC Cambridge Ltd	148	Microvalue	176,177	Teledigital Computers	36
CLIO Press	174	GW Computers	30,31	Microware Ltd	57	Thorn EMI	174
Calco Software	167			Midland Computer Fair	115		
Cambridge Comp Consults	79	H		Mountandene	172	U	
Cambridge Micro Electric	60	Hal Computers	97	3m Data	42,43	UMicro	69
Camden Computers	116	Hotel Micro Systems	142,143				
Chiltern Electronics	22			O		V	
Comcen Technology	181	I		OKI Electric	147	Verelco Ltd	97
Compsoft Ltd	17	IBC Computer Systems	114	Oasis Software	167	Verwood Systems	174
Computech Systems	45	ITL Kathmill Ltd	33	Opus Supplies	41		
Computer Fair	125	Icarus Computer Systems	85	Oxford Computer Systems	58	W	
Computer Interface Design	169	Intec	61			Wordflow Elec Office	32
Computer Trade Show	180	Interam	170	P			
Computer Town	158,159			Page Plus	24	X	
Comshare	122,123			Pete & Pam Computers	164,165	X-Data	37
Control Universal	181			Pinner Wordpro	168		
Crowther Cosine	32			Power Testing (sales)	167	Z	
Cyber Robotics Ltd	116			Precision Software	34	Zero Electronics	116

Look to the **stair**^{sk} for the best in printing

120 CPS
£219
+ VAT



160 CPS
£359
+ VAT

GEMINI and DELTA, a new range of Star Performers —the ideal complement to any computer system. At prices starting from £219 + VAT, the GEMINI and DELTA open up a new world of printing power — quiet, fast printing in a range of different character types, print pitches and print densities and ultra high resolution graphics and programmable downloadable characters for good measure.

GEMINI and DELTA — professional solutions to the printer problem.

KEY FEATURES:

- ★ 120 CPS (Gemini), 160 CPS + 8K buffer (Delta)
- ★ Friction, tractor and roll feed
- ★ Ultra high resolution graphics
- ★ Normal, expanded and condensed print
- ★ Emphasized and double strike print
- ★ Superscripts and subscripts
- ★ True underlining
- ★ Italics and international characters
- ★ Downloadable character set
- ★ Interface — Gemini (parallel), Delta (parallel & RS232)
- ★ Full one year parts and labour warranty



Micro Peripherals Ltd

'THE POWER BEHIND THE PRINTED WORD'

69 The Street, Basing, Basingstoke, Hants. RG24 0BY
Tel: 0256 3232 (12 lines) Telex: 859669 MICROP G

Call your local dealer now for full information on the GEMINI and DELTA printers or clip this coupon and we'll send you brochures and print samples.

Name.....

Address.....

187

..... Tel. No.

THIS YEAR WILL BE AS IMPORTANT TO THE COMPUTER INDUSTRY AS 1959 WAS TO THE MOTOR INDUSTRY.



1959 saw a revolutionary development in the evolution of the motor car that shook the industry. The launch of the Mini.

Twenty five years later, Sanyo are set to cause a similar stir in the world of computers with the launch of the first ever Small Business Micro. The Sanyo MBC 550. The first machine of its kind to offer the performance, compatibility and range of software of a true business micro for just £699*. Which is considerably less than the cheapest business micro.

So if your business requirements are too great for a personal computer and you can't justify the expense of a business micro, phone Logitek on 0257-426644, or STC on 0279-26777 or ICARUS on 01-485 5574 or clip the coupon and we'll show you the Sanyo MBC 550 or the more powerful twin drive Sanyo 555, two revolutionary new micros that mean business.

See Sanyo's new small business computer at the "Which Computer? Show," N.E.C. 17th - 20th Jan. 1984.

*Single drive excluding monitor.

SEE SANYO, THEN DECIDE



188 Name _____
 Company _____
 Position in Company _____

Address _____
 PC1 _____ Tel. no _____

Return to: Marketing Dept., Sanyo Marubeni (UK) Ltd, Sanyo House, 8 Greycaine Road, Watford, Herts.

● Circle No. 247