

# Practical Computing

An ECC Publication. Volume 2 Issue 3

March 1979

**Ready-made computer systems for stock control**

**We review single-board computers**

**Tandy Forum & Pet Corner**

**School computer project**

**Build your own frequency meter**



# After you've been chased by rhinos and have met the hangman, it's time to learn a thing or two...

One lesson you'll have to learn on your own - how to tear yourself away from your computer in the early hours. Infoguide provides you with a new concept in recreational, educational and business software.

## You'll probably start in the Playgroup.

Insert your Compusette, and there's the Hangman to challenge.



Or Rhino - a progressively harder chase through the jungle, where you're never sure what's going to happen next.

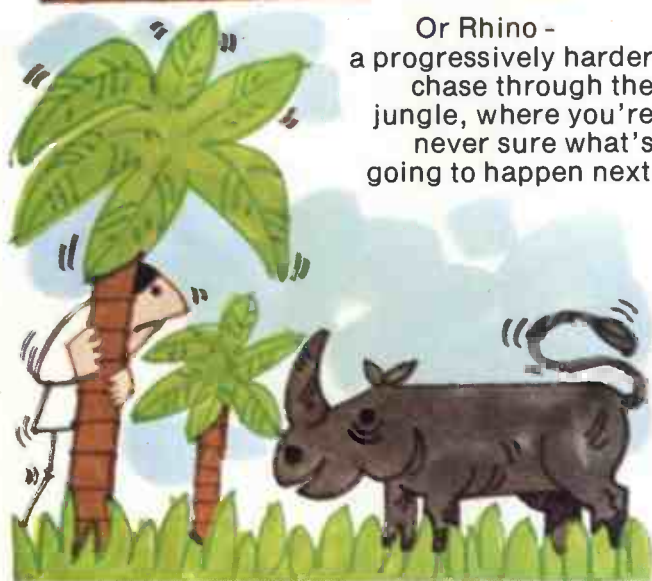

Insert other Compusettes, and ...

### Middle School

could see you taking your computer on at Mastermind. Or Go!



### High School

sees you and your computer working on statistical programmes. Conversion. Financial management. Forecasting. These - and many other functional programs - are on Compusette.

### At Degree Level,

why not simulate an enzyme reaction? Change any one (or more) of six parameters and see what happens? Maybe discover, when playing chess, that your computer is a Grand Master? A Compusette will supply each of the necessary programs.

An interesting variety of Compusettes are being made available for PET, Apple II and TRS 80. Each is accompanied by a fully detailed booklet with listings of the programs - there are up to three on each tape.

You will find that most dealers handling personal computers will be stocking the Compusette range. Ask your dealer now.

For as little as £2.70 per program\* - that's value!

## COMPUSSETTES

Compusettes are produced by Infoguide Ltd, 142 Wardour Street, London W1. 120 El Camino Drive, Suite 108, Beverley Hills, Cal 90212 USA

\* Based on three programs on an £8.00 Compusette.



Managing Editor  
**Dennis Jarrett**

Computabits Editor  
**Nick Hampshire**

Staff Writer  
**Kay Floyd**

Production Editor  
**Harold Mayes**

Advertisement Manager  
**Erica Gibson**

Advertisement Representatives  
**Tom Moloney**  
**Tina Roberts**

Subscription Manager  
**Annabel Hunt**

Publisher  
**Wim Hoeksma**

Company Secretary  
**Carole Fancourt**

Managing Director  
**Richard Hease**

Editorial: 01-278 3111  
Advertising: 01-278 3143  
Production  
and Subscriptions: 01-278 9517

Practical Computing is published by ECC as a subsidiary of WHICH COMPUTER? Ltd at its registered office, 2 Duncan Terrace, London, N1, and printed by Bournehall Press Ltd, Welwyn Garden City. Distributed by Moore Harness Ltd, 31 Corsica Street, London, N5.

© Practical Computing 1979  
ISSN 0141-5433.

Subscription rates: Single copy: 50p. Subscriptions: U.K., £6 per annum (including postage); overseas, £12 (including airmail postage).

Every effort has been made to ensure accuracy of articles and program listing. Practical Computing cannot, however, accept any responsibility whatsoever for any errors.

## COMPUTERS FOR STOCK CONTROL

We review some of the low-cost, ready-made systems for handling a company's stock control problems.

Page: 42

## SINGLE-BOARD COMPUTERS

One of the best and possibly cheapest ways of starting in computing is to use a single-board computer. We look at these computers, which range in price from £50 to more than £1,000.

Page: 27

## TANDY FORUM & PET CORNER

Tandy Forum joins Pet Corner presenting news, views and ideas on how to use Tandy and Pet computers.

Pages: 52 & 55

## SCHOOL COMPUTER PROJECT

Fearnhill School started its computer project on £250 with no experience. Now it is using the system to teach physics in a novel way.

Page: 38

## PLAY NIM

Nim is one of the ancient games. We list a Practical Computing-tested program in Basic. It's great fun.

Page: 36

## ALL THIS AND MORE

Comment, page 19; Feedback, page 19; Print-out, page 22; Interview goes to a Scottish outpost, page 41; Buyers' Guide, page 47; IBM typewriter conversion, part III, page 57; Illustrating Basic, page 59; Book reviews, page 65; Computabits, page 67; Competition news, page 79; Glossary, page 81; Advertisement Index, page 79.

APRIL ISSUE ON SALE MARCH 14  
ORDER NOW

# Britain is a nation of PET lovers

THE No. 1  
Personal  
Computer  
in the  
U.K.

Hobbyist  
Commercial  
Scientist  
Education

Affordable  
**£695**  
inc. VAT

for the first time  
user and the professional  
check out the PET, the world's  
most popular personal computer

- \* **CAPABLE** - just like a traditional computer.
- \* **UNDERSTANDABLE** - fast, comprehensive and powerful - BASIC is one of the easiest computer languages to learn, understand and use. Machine language accessibility for the professionals.
- \* **PERSONAL** - easily portable and operated - just "plug in" and go. Unique graphics make fascinating displays.
- \* **EXPANDABLE** - built in IEEE-488 output, 8K RAM expandable to 32K, parallel user port 2nd. Cassette interface.
- \* **SERVICEABLE** - easily serviced - only 3p.c. boards all readily accessible.

#### Features of PETS extended BASIC include

Integer, floating point and string variables; A full set of scientific functions, Logical operators, Multi-statement lines. String functions, Left \$, Right \$, Mid \$, Chr \$, Val, Str \$, Peek, Poke, Usr, Sys, to interface to memory and machine language subroutines. Time of day variable.

Future Commodore developments \* FLOPPY DISC \* PRINTER  
\* MEMORY EXPANSION \* MODEM

Extensive software readily available.

Contact your nearest PET dealer, call today for a demonstration

In case of difficulty call **COMMODORE SYSTEMS DIVISION**  
360 Euston Road, London. Tel. 01-388-5702

## AUTHORISED PET COMMODORE DEALERS

**Bristol**  
Sumlock Tabdown Ltd  
0272-26685

**Derby**  
Davidson-Richards (Int) Ltd  
0332-366803

**Durham**  
Dyson Instruments  
0385-66937

**Grimsby**  
Allen Computers  
0472-40568

**Guildford**  
P.P.M.  
0483-37337

**Hemel Hempstead**  
Data Efficiency Ltd  
0442-57137

**Liverpool**  
Dams Office Equipment Ltd  
051-227-3301

**London W.C.2**  
TLC World Trading Ltd  
01-839-3893

**Manchester**  
Cytek (UK) Ltd  
061-832-7604

Sumlock Electronic  
Services  
061-228-3507

**Newport**  
G.R. Electronics Ltd  
0633-67426

**Northern Ireland**  
Medical & Scientific  
08462-77533

**Nottingham**  
Betos (Systems) Ltd  
0602-48108

**Reading**  
C.S.E. (Computers)  
0734-61492

**Southampton**  
Business Electronics  
0703-738248

**Southampton**  
Symtec Systems Ltd  
0703-37731

**Thame, Oxon**  
Memec Systems Ltd  
084-421-2149

**Woking**  
Petalect Ltd  
048-62-69032

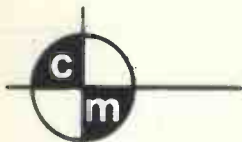

# comart



Comart's Cromemco systems represent probably the widest range of micro computing power available today. Systems are in use in control, research, educational and commercial applications: the S100 standard adds the dimension of future compatibility and expandability.

- \* Single Card Computer
- \* Z80A Z2 Computer
- \* Mini & Standard Floppy Disks
- \* PROM & 4MHz RAM cards
- \* Analogue, Digital, VDU & Printer interface cards
- \* BASIC, FORTRAN IV, COBOL & Macro-Assembler languages
- \* Cromemco System Three

Contact us direct or call your nearest dealer.

The Byte Shop, 426/428 Cranbrook Road, Ilford, Essex ((01-554-2177)  
Cambridge Computer Store, 1 Emanuel Street, Cambridge (0223-68155)  
Holdene Ltd., 10 Blenheim Terrace, Woodhouse Lane, Leeds 2 (0532-459459)  
Isher-Woods, 110 Leagrave Road, Luton, Beds (0582-424851)  
Microcomputermart Ltd., 29 Hanging Ditch, Manchester (061-832-2269)  
NewBear Computing Store, Bone Lane, Newbury, Berks (0635-49223)  
Xitan Systems Ltd., 23 Cumberland Place, Southampton (0703-38740)

COMART LTD., PO BOX 2, ST NEOTS, CAMBS PE19 4NY. (0480-215005)



# Heathkit systems. Right from the start.

At Heathkit, we do our homework properly. And the result is an exceptional range of computer equipment.

Processors, video terminals, cassette units and floppy disk drives.

A paper tape reader/punch and a printer. You can make up a system that suits your

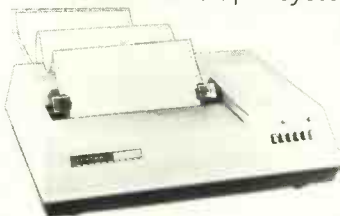

H14 Line printer.

application and your pocket, and then you can extend it whenever you want to.

Everything is fully compatible.

And the quality is superb throughout.

Choose from assembled units or kits – all accompanied by some of the world's best documentation.

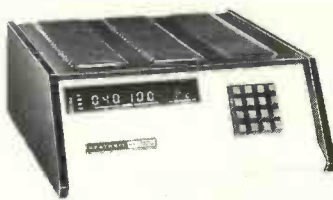

H8 computer, extendable from 8K to 64K.

The details are in our colour brochure. Send for your copy now.



To: Heath (Gloucester) Limited, Dept. PC3  
Bristol Road, Gloucester, GL2 6EE.

Name \_\_\_\_\_

Address \_\_\_\_\_

Please tick the item(s) you want.

Colour brochure of computer equipment. (Enclose 20p in stamps.)

Catalogue of other electronics kits and courses. (Enclose 20p in stamps.)

Registered in England number 606177.

Heathkit self-instructional computer courses, probably the finest available.

**THERE ARE HEATHKIT SHOWROOMS AT**  
233 Tottenham Court Road, London (01-636 7349)  
and Bristol Road, Gloucester (0452-29451)

● Circle No. 104

**D.A.M.S.**  
Computer Division

## PET 24k EXPANSION £ 3 2 0

### PET PERIPHERALS

#### 24K Expansion

Internal expansion is here, now at £320 + VAT for 24K (to give 32K). Easily fitted with full instructions.

FLOPPY DISK for Pet. Twin 80K mini drive £840 (complete with dual density prom to give 320K, when available). Adds 16 extra commands to Pet.

INTERNAL RS232 INTERFACE for Pet (upper and lower case) £59

EXTERNAL RS232 INTERFACE with power supply and 'print using' function. £89

JOYSTICK (including software) £25

PAGE PRINTER INTERFACE (for 20m.a. loop) £25

625 VIDEO ADAPTOR (for TV or Monitor) £25

PET 2001 8K—£643-52p

PET PRINTER 2020—£425

PET 2nd CASSETTE—£55

We also supply:

APPLE II, & DISK, KIM, OHIO, and T.E.I.

Also Petsoft, CBM and DAMS Software.

e.g. DAMS RENUMBER (m/c code routine renumbers GOTOS & GOSUBS etc, very fast) £6

TIM 1-5 (vastly improved Terminal Interface Monitor) £4

DOUBLE DENSITY (4000pt. plot, 80 X 50 on Pet) £4

Send for our comprehensive software and hardware catalogues.

Add 8% VAT to all prices.

P & P 50p per order.

5% discount for orders over £400 (exclusive VAT) C.W.O.

Computer Division D.A.M.S. (Office Equip) Ltd.  
30/36 Dale Street, Liverpool, L2 5SF  
Sales: 051-227-3301 10 lines

● Circle No. 105

# ELECTROVALUE

APPOINTED NATIONAL DISTRIBUTORS

## NASCOM 1 MICROPROCESSOR KITS

- ★ For Delivery from Stock
- ★ Full supporting Programme of NASCOM Equipment
- ★ Quantity Discounts
- ★ Service you will Appreciate

### PRICE LIST AND INFORMATION

Gladly sent on request. Your name will be fed to our computer for use immediately our new catalogue is ready.

### ELECTROVALUE LTD

Dept. PC 12, 28 St Judes Rd, Englefield Green, Egham, Surrey TW10 0HB.  
Phone Egham [389 from London: STD 0784-3] 3603; Telex 264475.

Northern Branch [Personal shoppers only] 680 Burnage Lane, Burnage, Manchester M19 1NA  
Phone [061] 432 4945.

Franchised  
Distributors for  
**SIEMENS**  
**MOTOROLA**  
**MICROPROCESSORS**  
**ISKRA**  
**RADIOHM**  
and other brand names  
famous for reliability

● Circle No. 106

# THE EXPANDABLE GENERAL-PURPOSE MICROCOMPUTER



## THE RESEARCH MACHINES 380Z

### A UNIQUE TOOL FOR RESEARCH AND EDUCATION

Microcomputers are extremely good value. The outright purchase price of a 380Z installation with dual mini floppy disk drives, digital I/O and a real-time clock, is about the same as the annual maintenance cost of a typical laboratory minicomputer. It is worth thinking about!

The RESEARCH MACHINES 380Z is an excellent microcomputer for on-line data logging and control. In university departments in general, it is also a very attractive alternative to a central mainframe. Having your own 380Z means an end to fighting the central operating system, immediate feedback of program bugs, no more queuing and a virtually unlimited computing budget. You can program in interactive BASIC or run very large programs using your unique Text Editor with a 380Z FORTRAN Compiler. If you already have a minicomputer, you can use your 380Z with a floppy disk system for data capture.

What about Schools and Colleges? You can purchase a 380Z for your Computer Science or Computer Studies department at about the same cost as a terminal. A 380Z has a performance equal to many minicomputers and is ideal for teaching BASIC and Cesium. For A Level machine language instruction, the 380Z has the best software front panel of any computer. This enables a teacher to single-step through programs and observe the effects on registers and memory, using a single keystroke.

#### WHAT OTHER FEATURES SET THE 380Z APART?

The 380Z with its professional keyboard is robust, hardwearing equipment that will endure continual handling for years. It has an integral VDU interface—just plug a black and white television into the system in order to provide a display unit—you do not need to buy a separate terminal. The integral VDU interface gives you upper and lower case characters and low resolution graphics. Text and graphics can be mixed *anywhere* on the screen. The 380Z also has an integral cassette interface, software and hardware, which uses *named* cassette

files for both program and data storage. This means that it is easy to store more than one program per cassette.

Owners of a 380Z microcomputer can upgrade their system to include floppy (standard or mini) disk storage and take full advantage of a unique occurrence in the history of computing—the CP/MTM\* industry standard disk operating system. The 380Z uses an 8080 family microprocessor—the Z80—and this has enabled us to use CP/M. This means that the 380Z user has access to a growing body of CP/M base-software, supplied from any independent sources.

380Z mini floppy disk systems are available with the drives mounted in the computer case itself, presenting a compact and tidy installation. The FDS-2 standard floppy disk system uses double-sided disk drives, providing 1 Megabyte of on-line storage.

Versions of BASIC are available with the 380Z which automatically provide controlled cassette data files, allow programs to be loaded from paper tape, mark sense card readers or from a mainframe. A disk BASIC is also available with serial and random access to disk files. Most BASICs are available in erasable ROM which will allow for periodic updating.

If you already have a teletype, the 380Z can use this for hard copy or for paper tape input. Alternatively, you can purchase a low cost 380Z compatible printer for under £300, or choose from a range of higher performance printers.

\*CP/MTM Registered trademark Digital Research.

**380Z/16K System with Keyboard £965.00**

**380Z/56K complete with DUAL FULL FLOPPY DISK SYSTEM FDS-Z £3,266.00**

380Z Computer Systems are distributed by RESEARCH MACHINES, P.O. Box 75, Chapel Street, Oxford. Telephone: OXFORD (0865) 49792. Please send for the 380Z information Leaflet. Prices do not include VAT @ 8% or Carriage.

# EQUINOX 300

A powerful multi-user  
multi-tasking  
multi-language

16-bit microcomputer time-sharing system

supporting

- \* BASIC
- \* LISP
- \* PASCAL
- \* Floppy discs
- \* Hard discs

including a powerful Text Formatter,  
Assembly Language Development System  
and disc-based Sort utilities.

Priced from under **£5,000**

Write or phone for further information.

**EQUINOX COMPUTER SYSTEMS LTD**

32-35 Featherstone Street,  
London EC1Y 8QX.  
(Tel: 01-253 3781/9837)

● Circle No. 108



**COMPACT 1**  
**Acoustic Coupler** — the simple,  
economic way to connect a VDU or hardcopy  
terminal into your computer via the telephone  
network. **COMPACT 1** only £180, less for  
multiple orders.

To find out more ring —  
**COMPUTRADE** on (03723) 77374 or  
write to — **Computrade Ltd.**,  
Silverwood House, Oxshott Road,  
Leatherhead, Surrey.

**COMPUTRADE**



North: 061-477 4960  
Midlands: 0533-536077  
South-East: 01-658 5906

● Circle No. 109

## ANNOUNCING THE **MICROS**

JOIN THE MICRO REVOLUTION



£399 for a Z80 based microcomputer, built and tested

Designed for educational establishments, personal  
computing and small business users

- \* Includes 1K monitor Eprom, 47 key solid state keyboard, video, TV, cassette and teletypewriter interfaces, serial i/o, 2 parallel i/o ports, 2K bytes RAM, power supplies and instrument housing.
- \* Connect to domestic TV or video monitor to complete the system
- \* 48 x 16 character video matrix
- \* 47 key contactless ASC11 keyboard
- \* Hard copy on teletypewriter
- \* 2 TTL compatible parallel i/o ports
- \* RS232 serial i/o port

**THE MICRONICS COMPANY**

1, STATION ROAD TWICKENHAM MIDDLESEX



- \* Load and dump programmes on unmodified cassette recorder
- \* Up to 16K byte mixed RAM and Eprom in table top housing
- \* Expandable up to 64K bytes
- \* Security locked power switch
- \* British designed and built
- \* Available in kit form for £360
- \* Credit terms available

**PART OF THE MICRO REVOLUTION**

Prices exclusive of VAT and carriage

● Circle No. 110



**ORDER BY POST  
FROM THE WIDEST  
RANGE OF  
MICRO-COMPUTERS  
IN BRITAIN...  
OR VISIT OUR  
STORES**

# the **BYTE** SHOP Ltd

**IT'S  
APPLE  
EX-STOCK** 

## SOUTHWEST TECHNICAL PRODUCTS — FOR 6800 USERS



- MP-68CPU, 4K RAM ..... £355
- 8K additional RAM ..... £140
- 560KB twin disk system ..... £1,400
- 160KB twin mini floppy system ..... £860
- CT-64 V.D.U. upper/lower case, monitor ..... £455
- PR-40 40-column printer ..... £250
- Cassette interface ..... £100
- GT-61 Graphics Terminal ..... £105

A favourite with schools and colleges —  
low priced system that can grow.

Attractive low-priced software!

## FOR THE PROFESSIONAL — CROMEMCO



- Z-2 system:  
fully assembled ..... £575
- Z-2 system: Kit ..... £395
- Disk system from ..... £1,425
- CS-3 System 3, 32K, dual disk,  
expandable ..... £4,175
- 4 MHz Single card computer ..... £345
- Bytesaver board with PROM  
Programmer ..... £135
- 16K PROM card ..... £135
- Analogue Interface ..... £135
- Disk — BASIC, FORTRAN,  
ASSEMBLER, COBOL, ..... each — £85  
etc. etc.

A rugged well-engineered system designed for  
hard use. Expandable to 512K, 21 Boards.  
Excellent software support CP/M AVAILABLE

## PROCESSOR TECHNOLOGY SOL 20/16



- Computer system, 16K, V.D.U. etc. .... £1,785
- Additional memory, 16K dynamic ..... £275
- Mini-floppy disk (first) ..... £635
- High quality word processing  
printer from ..... £1,800

A quality 8080 based system.  
Over 7,000 sold! Excellent word processing  
software available.

Also ... Printers for all the above systems ...  
extra software ... diskettes ... cassettes ...  
Chess Challenger 10 ... games ... etc. ....

Branches in Nottingham, Tottenham Court Road — London, Birmingham, Manchester & Glasgow.

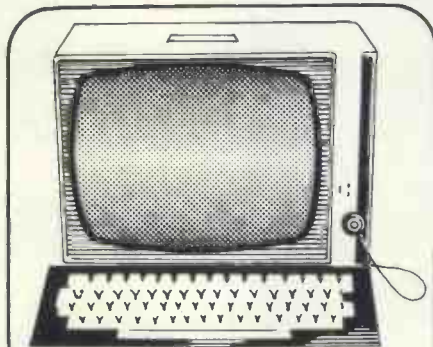

## THE BYTE SHOP V.D.U.

- 16 x 64 Display
- Upper/Lower Case
- Separate Keyboard
- Clear 7 x 9 Dot Matrix
- British Design & Manufacture
- CC1TTV24 or Current  
loop interface ..... £359
- VDU without keyboard ..... £299

## BOOKS GALORE!

- Introduction to Microcomputers
- Vol. 0 ..... £5.95
- Vol. 1. Basic Concepts ..... £5.95
- Vol. 2. Some Real products ..... £11.95
- Some Common BASIC Programs ..... £5.95
- Instant BASIC ..... £7.50
- Understanding microcomputers ..... £7.95
- Your Home computer ..... £4.95
- 6800 Assembly language programming ..... £6.95
- 808A Assembly language programming ..... £6.95
- Z-80 programming for logic design ..... £5.95
- etc. etc.

Also most U.S. magazines available. ...  
Personal Computing, BYTE, Interface Age,  
Dr. Dobbs etc. ....

## NORTH STAR COMPUTER PRODUCTS



- Horizon-1 system, 16K, 1 mini floppy ..... £1,265
- Additional mini floppy ..... £325
- Additional 16K static memory 4MHZ ..... £315
- Printer interface ..... £70
- Extended BASIC and DOS included in above

- Release 4 BASIC & DOS ..... £25
- CP/M Horizon ..... £130

A value-for-money system  
using the advanced  
Z-80 clip and S100 Bus.

## COMMODORE SYSTEMS

Pet personal computer, including V.D.U.  
BASIC interpreter + 8K user memory  
Built-in cassette, ready-to-go ..... £643.52  
Pet 2nd cassette deck ..... £55.00  
Pet software, large selection, from ..... £3.00  
Joystick, video monitor attachment,  
now available!  
Expander printer, Pet Interface and  
power supply ..... £414.00  
A very popular and adaptable system,  
excellent value!

- KIM-1 system 2K ROM, 1K RAM etc. .... £149.00
- KIM-3 additional 8K RAM ..... £179.00
- KIM-4 Motherboard ..... £89.00
- KIM-5 Assembler and Editor ..... £129.00



Send for  
FREE catalogue



## MAIL ORDER

Please send me .....

(if preferred, attach order on separate  
sheet to coupon)

Name .....

Address .....

- I enclose cheque for £ .....
- Please debit my Diners Club/  
American Express/Access/Barclaycard  
Account no. ....

Please add 8% VAT to all items except books

The Byte Shop Ltd  
426-428 Cranbrook Road, Gants Hill,  
Ilford Essex. Tel: (01) 518 1414.

All prices correct at time of going to Press

● Circle No. III

# MICRO COMPUTER COURSES

Seminars on microcomputers.  
Applications for the computer  
lay man

Learn how to use a micro on our three-day practical course for small groups in London; includes an introduction to Basic.

Learn what a micro can do for you and how to choose one; suitable for management as well as users.

Beyts Logic Ltd.  
Windmill Road, Sunbury,  
Middx. U.K.  
Telephone (09327) 86262  
Telex 928185

# BEYTS LOGIC

● Circle No. 112

## BRINDIWELL LTD.

Telephone (0454) 774564

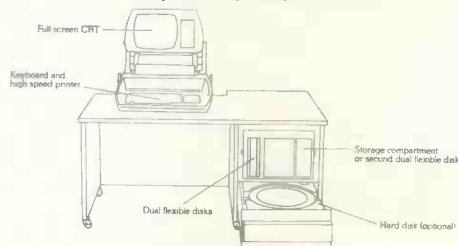

D.T.C. MKX Microcomputer—64K Memory Multi User  
Dual Floppies—315K each Multi Task  
Up to 4 general I/O Ports Asyn/sync  
Up to 150 Megabyte Hard Disk  
System Software. Etc. Etc.

VDUs Hazeltine  
Micro Informer (Pollable) Discount prices

PRINTERS DECwriters	Discount Prices
Tally 1612	£950
D.T.C. Diablo Hitype	£1,800
	£1,908

### LIMITED STOCKS ONLY:

TERMINALS—Refurbished with IBM Golf Ball Printer,  
RS232 interface, IBM 2740/41 compatible,  
BCD or Selectric Keyboards. FROM £495

TERMINALS—With Reader/Punch FROM £625

SALES

SERVICE

SUPPLIES

● Circle No. 113



A complete Disc File System for your Micro Computer System Connects through RS232 Serial Interface and includes as hardware functions:

- |          |             |
|----------|-------------|
| * Read   | * Write     |
| * Delete | * Rename    |
| * Copy   | * Directory |
| * Format |             |

The Disc File will support a complete disc operating system and many other functions.  
Contact:

**Data Design Techniques Ltd.,**  
12, Leeming Road,  
Borehamwood, Herts.  
Tel: 01-207 1717

● Circle No. 114



# This Is The Famous

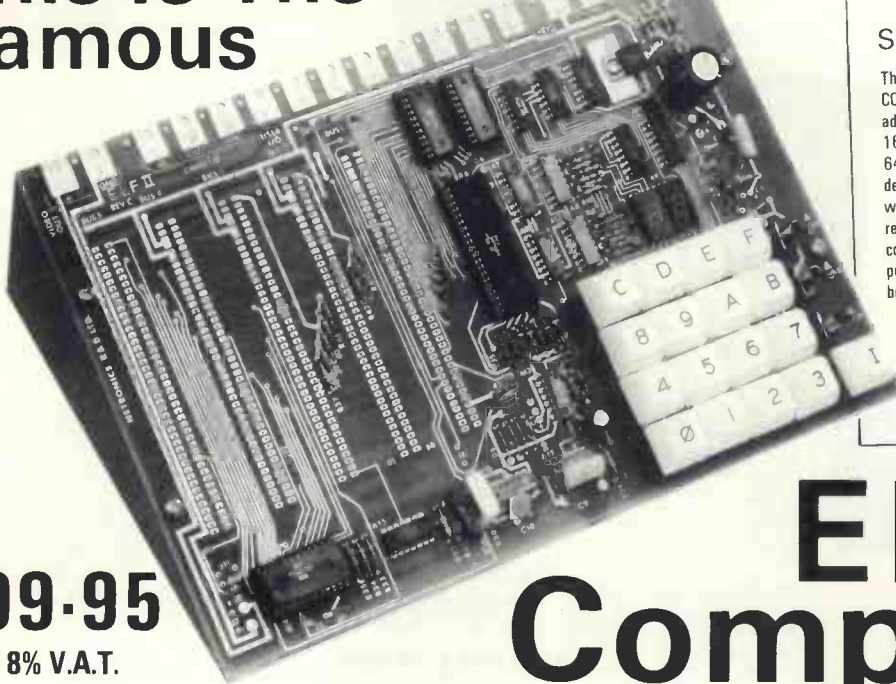

**£99.95**  
PLUS 8% V.A.T.

# ELF II Computer

## SPECIFICATIONS

The £99.95 ELF II computer features an RCA COSMAC COS/MOS 1802 8-bit microprocessor addressable to 64K bytes with DMA, interrupt, 16 registers, ALU, 256 byte RAM expandable to 64K bytes, professional hex keyboard fully decoded so there's no need to waste memory with keyboard scanning circuits, built-in power regulator, 5 slot plug-in expansion bus (less connectors), stable crystal clock for timing purposes and a double-sided, plated-through pc board plus RCA 1861 video IC to display any segment of memory on a video monitor or TV screen along with all the logic and support circuitry you need to learn every one of the RCA 1802's capabilities.

Stop reading about computers and get your hands on one! With ELF II and our new *Short Course* by Tom Pittman, you can master computers in no time at all! ELF II demonstrates all 91 commands an RCA 1802 can execute and the *Short Course* quickly teaches you how to use each of the 1802's capabilities.

ELF II's video output lets you display an alphanumeric readout or graphics on any TV screen or video monitor and enjoy the latest video games.

But that's not all. Once you've mastered computer fundamentals, ELF II can give you POWER with add-ons that are among the most advanced found anywhere. American IEEE chapters plus hundreds of universities and major corporations have chosen the ELF II to introduce their students and personnel to microprocessor computing!

### Learn The Skill That May Soon Be Far More Important Than Your College Degree!

The ability to use a computer may soon be more important to your earning power than a college degree. Without a knowledge of computers, you are always at the mercy of others when it comes to solving highly complex business, engineering, industrial and scientific problems. People who understand computers can command MONEY and to get in on the action, you must learn computers. Otherwise you'll be left behind.

### ELF II Is The F-A-S-T Way to Learn Computer Fundamentals!

Regardless of how minimal your computer background is now, you can learn to programme a computer in almost no time at all. That's because Netronics has developed a special *Short Course on Microprocessor And Computer Programming* in non-technical language that leads you through every one of the RCA COSMAC 1802's capabilities so you'll understand everything ELF II can do... and how to get ELF II to do it!

All 91 commands that an 1802 can execute are explained to you, step-by-step. The text, written for Netronics by Tom Pittman, is a tremendous advance over every other programming book in print.

Keyed specifically to the ELF II, it's loaded with "hands on" illustrations. When you're finished, ELF II and the 1802 will no longer hold any mysteries for you.

In fact, not only will you be able to use a personal computer creatively, you'll also be able to understand computing articles in the technical press.

If you work with large computers, ELF II and our *short Course* will help you to understand what makes them tick.

### A Dynamite Package For Just £99.95 Plus 8% V.A.T.!

With ELF II, you learn to use machine language - the fundamental language of all computers. Higher level languages such as FORTRAN and BASIC must be translated into machine language before a computer can understand them. With ELF II you build a solid foundation in computers so you'll really know what you're doing, no matter how complicated things get.

Video output also makes ELF II unique among computers selling such a low price. Attached to your TV set, ELF II becomes a fabulous home entertainment centre. It's capable of providing endless hours of fun for both adults and children of all ages! ELF II can create graphics, alphanumeric displays and fantastic video games.

Only a low cost RF modulator is required to connect ELF II to your TV's aerial socket! (To order see below.)

ELF II's 5-card expansion bus (connectors not included) allows you to expand ELF II as your needs for power grows. If you're an engineer or hobbyist, you can also use ELF II as a counter, alarm, lock, thermostat, timer, or for countless other applications.

### ELF II Explodes Into A Giant!

Thanks to ongoing work by RCA and Netronics, ELF II add-ons are among the most advanced anywhere. Plug in the GIANT BOARD and you can record and play back programmes, edit and debug programmes, communicate with remote devices and make things happen in the outside world. Add Kluge Board to get ELF II to solve special problems such as operating a more complex alarm system or controlling a printing press. Add 4k RAM board and you can write longer programmes, store more information and solve more sophisticated problems.

Expanded, ELF II is perfect for engineering, business, industrial, scientific and personal finance and tax applications. No other small computer anywhere near ELF II's low price is backed by such an extensive research and development programme.

The ELF-BUG Monitor is an extremely recent breakthrough that lets you debug programmes with lightning speed because the key to debugging is to know what's inside the registers of the microprocessor and, instead of single stepping through your programme, the ELF-BUG Monitor, utilising break points, lets you display the entire contents of the registers on your TV screen at any point in your programme. You find out immediately what's going on and can make any necessary changes. Programming is further simplified by displaying 24 bytes of RAM with full address, blinking cursor and auto scrolling. A must for serious programmers!

Netronics will soon be introducing the ELF II Colour Graphics & Music System - more breakthroughs that ELF II owners will be the first to enjoy!

### Now BASIC Makes Programming ELF II Even Easier!

Like all computers, ELF II understands only "machine language" - the language computers use to talk to each other. But, to make life easier for you, we've developed an ELF II Tiny BASIC. It talks to ELF II in machine language for you so that you can programme ELF II with simple words that can be typed out on a keyboard such as PRINT, RUN and LOAD.

### "Ask Not What Your Computer Can Do... But What Can It Do For YOU!"

Don't be trapped into buying a dinosaur simply because you can afford it and it's big. ELF II is more useful and more fun than "big name" computers that cost a lot more money.

With ELF II, you learn to write and run your own programmes. You're never reduced to being a mere keypunch operator, working blindly with someone else's predeveloped software.

No matter what your speciality is, owning a computer which you really know how to use is sure to make you a leader. ELF II is the fastest way there is to get into computers. Order from the coupon below!

**H.L. AUDIO LTD., Dept. P.C., 138 Kingsland Road, London E2 8DY**

**— SEND TODAY! —**

### NOW AVAILABLE FOR ELF II -

- Tom Pittman's *Short Course On Microprocessor & Computer Programming* teaches you just about everything there is to know about ELF II or any RCA 1802 computer. Written in non-technical language - it's a learning breakthrough for engineers and laymen alike. **£5.00\*** post paid!
- Deluxe metal cabinet with plexiglas dust cover for ELF II. **£29.95\*** plus £1.50 p&p.
- RF Modulator for use with TV set. **£3.00\*** post paid.
- GIANT BOARD kit with cassette I/O, RS 232-C/TTY I/O, 8-bit P I/O, decoders for 14 separate I/O instructions and a system monitor/editor. **£39.95\*** plus £1.00 p&p.
- Kluge (Prototype) Board accepts up to 36 IC's. **£17.00** plus 50p. p&p.
- 4k Static RAM kit. Addressable to any 4k page to 64k. **£89.95\*** plus 50p. p&p.
- Gold plated 86-pin connectors (one required for each plug-in board). **£5.70\*** post paid.
- Professional ASCII Keyboard kit with 128 ASCII upper/lower case set, 96 printable characters, onboard regulator, parity, logic selection and choice of 4 handshaking signals to mate with almost any computer. **£64.95\*** post paid.
- Deluxe metal cabinet for ASCII Keyboard. **£19.95\*** plus £1.50 p&p.
- ELF II Tiny BASIC on cassette tape. Commands include SAVE, LOAD, ±, x, +, (-), 26 variables A-Z, LET, IF/THEN, INPUT,

- PRINT, GO TO, GO SUB, RETURN, END, REM, CLEAR, LIST, RUN, PLOT, PEEK, POKE. Comes fully documented and includes alphanumeric generator required to display alphanumeric characters directly on your TV screen without additional hardware. Also plays tick-tack-toe plus a drawing game that uses ELF II's hex keyboard as a joystick, 4k memory required. **£14.95\*** post paid.
  - Tom Pittman's *Short Course on Tiny BASIC* for ELF II. **£5.00\*** post paid.
  - Expansion Power Supply (required when adding 4k RAM). **£19.95\*** plus £2.00 p&p.
  - ELF-BUG Deluxe System Monitor on cassette tape. Allows displaying the contents of all registers on your TV at any point in your programme. Also displays 24 bytes of memory with full address, blinking cursor and auto scrolling. A must for the serious programmer! **£14.95\*** post paid.
  - Coming Soon: A-D, D-A Converter, Light Pen, Controller Board, Colour Graphics & Music System... and more!
- Call or write for wired prices!**

H. L. AUDIO LTD., Dept. P.C.  
138 Kingsland Road, London E2 8DY  
(Tel 01-739 1582)

Sole European Distributors for Netronics R & D Ltd., U.S.A.

Yes! I want to run programmes at home and have enclosed  £109.56 including postage and V.A.T. for RCA COSMAC ELF II kit,  £6.94 including postage and V.A.T. for power

- supply (required),  £5.95 for RCA 1802 User's Manual,  £5.95 including postage and V.A.T. for *Short Course on Microprocessor Computer Programming*.
- I want mine wired and tested with power supply, RCA 1802 User's Manual and *Short Course* included for just **£164.10** including postage and V.A.T.
- I am also enclosing payment (including postage and V.A.T.) for the items checked at the left.

Total Enclosed £ \_\_\_\_\_

USE YOUR  ACCESS  BARCLAYCARD

Account No. \_\_\_\_\_

Signature \_\_\_\_\_ Exp. Date \_\_\_\_\_

CREDIT CARD PHONE ORDERS ACCEPTED 01-739 1582

Print Name \_\_\_\_\_

Address \_\_\_\_\_

DEALER INQUIRIES INVITED



**NEW LOW PRICES**

# 56-STATION ASCII KEYBOARD

NOW IN STOCK — ASCII KEYBOARD MODEL KB756

KB756 mounted on PCB  
**ONLY £49.50**  
(mail order total £55.08)

KB756MF including metal mounting frame for extra rigidity,  
**ONLY £55.00** (mail order total £61.02)



**SELF-SCAN ALPHANUMERIC PANEL DISPLAY**  
16/18 position display with 64 character repertoire, 5 x 7 dot matrix. Input 6-bit BCD-code, power requirements +5v, -12v. Character size 0.40" x 0.28" Overall dimensions 8 1/4" x 2 1/4" x 1 1/4". Supplied with full technical data. Price £55.00 + 75p P&P + 8% VAT (Mail order total £60.21).

Optional Extras:		Mail Order Total
KB15P Edge Connector	£ 3.25	£ 4.05
KB701 Plastic Enclosure	£12.50	£14.31
KB702 Steel Enclosure	£25.00	£28.62
KB710 Numeric Pad	£ 8.00	£ 9.18
KB2376 Spare ROM Encoder	£12.50	£14.04

## SEAELECTRO PATCH BOARDS

Programme boards for switching and interconnecting input/output circuits. 11 x 20 XY matrix. Interconnection is by means of shorting, skip and component holding pins (not supplied). Dimensions: 7 1/2" x 5 3/4" x 1"



**PRICE: £12.50**  
(mail order total £14.58)

## NEW KEYTOP/KEYSWITCH KITS

Pack of 56 keyswitches plus 56 keytops comprising standard ASCII character set. Ideal as basis for self-build keyboard projects.

**BRAND NEW SURPLUS PRICE: £15.00**  
(mail order total £17.28)

## Reconditioned HAZELTINE VISUAL DISPLAY UNIT

- \* Teletype Compatible
- \* 12" Diagonal Screen
- \* TTY Format Keyboard
- \* 12 lines of 80 characters
- \* 64 ASCII Character Set
- \* 5 x 7 Dot Matrix
- \* Switch-selectable Transmission Speeds up to 9600 baud
- \* Switch-selectable Parity
- \* Standard CCITT V.24 Interface



**MODEL H-1000 PRICE £350** + carriage and VAT

Also available: —  
**Model H-2000:** Buffered/Editing model with direct cursor addressing, dual intensity video, and detachable keyboard with separate numeric and edit clusters. 27 lines of 74 characters. Price £495.00 + carriage + VAT.

A copy of trading conditions supplied on request

We also specialise in: DEC minis—PDP8 and PDP11 processors, add-on memory, peripherals and spares. Hard copy terminals—ASR 33 and KSR 33 Teletypes, Data Dynamics 390, Texas Silent 700. Send for complete lists.

**ELECTRONIC BROKERS LTD.**  
49-53 Pancras Road, London NW1 2QB.  
Tel: 01-837 7781. Telex: 298694.

● Circle No. 116

# SMALL SYSTEMS ENGINEERING LTD.

(Incorporating R. BAILEY ASSOCIATES)

62 New Cavendish Street, London W1M 7LD, Tel: 01-637 0777, Telex: 8813085 Abacus

### THE LARGEST SUPPLIER OF PET MEMORY BOARDS AND INTERFACES IN EUROPE

**PET MEMORY BOARDS**  
Sole official U.K. Agent for PME memory boards. We provide approved technical back-up, up-grade and service facilities for these boards in the U.K.

Internally mounting memory boards available in 2 configurations:  
—24K . . . £412.50 —32K . . . £475

#### IEEE-488/RS232C SERIAL INTERFACE

—Full IEEE address decoding, RS232C or 20mA loop output,  
—Switch selectable Baud Rate, Crystal controlled Baud Rate timing,  
—Boxed units complete with connectors, full operating instructions and sample programs supplied

—Serial Interface B, input and output . . . £186  
—Serial Interface A, output only . . . £106  
—Lower Case Printing option . . . £10

#### IEEE-488/CENTRONICS TYPE PARALLEL INTERFACE

Low cost unit without IEEE address decoding. Also suitable for Anadex DP-8000 Printer . . . £45

#### ANALOG INPUT/OUTPUT

—IEEE-488, 16 Channel, 8BIT A-D . . . Price to be announced  
—IEEE-488, 16 Channel, 8BIT D-1 . . . Price to be announced

#### CUSTOM INTERFACE DESIGN

Interfaces designed for special applications. Interfaces supplied so far include Analog Input/output, XY plotter, stepper motor control.

#### PET INTELLIGENT TERMINAL SOFTWARE PACKAGE

A software package which, in conjunction with an Interface B enables the PET to operate as an intelligent terminal. The software implements full IBM or DEC protocols . . . £100

#### TV/VIDEO MONITOR INTERFACES

—Video Monitor output only . . . £29.50  
—Video and UHF output (plugs into aerial socket of domestic TV) . . . £35

#### IEEE-488 TELEX PUNCH AND INTERFACE

—50 chars/sec. Telex punch . . . Price to be announced

### OHIO SCIENTIFIC

Small Systems Engineering is an official distributor for OHIO SCIENTIFIC products including:

**CHALLENGER I** (available March 79)  
—Superboard II 4K computer on a board . . . £298  
—CIP 4K Superboard in case and power supply . . . £415  
—CIP MF 16K CIP with mini-floppy and OS-65D V3.0 . . . £1,235

#### CHALLENGER II

—C2-4P 4K "professional portable" computer . . . £620  
—C2-4P MF 20K C2-4P with mini-floppy and OS-65D V3.0 . . . £1,595  
—C2-8P 4K mainframe class personal computer . . . £825  
—C2-8P DF 32K dual 8" floppy personal/business system . . . £2,670

The **SUPERBOARD II** includes 8K BASIC in ROM up to 8K of RAM on board, full keyboard, cassette interface and video display interface. The **CHALLENGER C2-4P M4** includes 20K of RAM, 1 mini-floppy drive, full keyboard and TV monitor, software supplied. Includes:

- Business disk,
- Education disk,
- Personal disk,
- Games disk,
- OS-65D V3.0 program development disk

BASIC and assembler run under the OS-65D V3.0 disk operating system. All systems supplied with full documentation.

#### Also available:

#### COMPULOUR II MODEL 3

- 13" 8-colour CRT, 8080 Microprocessor.
- 16K extended disk BASIC in ROM.
- 71-Key detached keyboard.
- 8K RAM memory for user programs.
- 64 characters perline by 32 lines per page.
- Special graphics package with 128 x 128 point plotting.
- Built-in mini-floppy disk drive.
- 50 pin bus.
- RS-232 I/O port for serial printers, etc. . . . £1,248.70

TERMS: All prices EX. VAT. All orders C.W.O. Cheques should be made payable to SMALL SYSTEMS ENGINEERING LTD. Orders should include £2.50 P&P per unit. All goods supplied under 90 days warranty.

● Circle No. 117

# JADE Computer Products

## MEM-2

### 16K Static RAM Board

S-100, fully buffered, with PHANTOM and bank addressing capabilities, can be addressed at 4K boundaries.

250ns Kit	\$356.25
450ns Kit	\$312.50
250ns A&T	\$47.50
450ns A&T	\$406.25

## EPROM BOARD KITS

EPM-1 (uses up to 4K or 1702)	\$74.94
JG8/16 (uses 2708 or 2716)	\$87.44

## "IMSAI"-TYPE CARD GUIDE SPECIAL:

Regular Price 38¢ each

**SPECIAL: 10 for \$1.25**

## MICROPROCESSORS

F8	\$21.19
Z80 (2MHz)	\$25.00
Z80A (4MHz)	\$31.25
CDP1802CD	\$22.44
6502	\$14.94
6800	\$21.19
6802	\$31.25
8008-1	\$16.19
8035	\$25.00
8035-8	\$26.25
8080A	\$12.50
8085	\$28.75
TMS9900TL	\$62.44

## 8080A SUPPORT DEVICES

8212	\$ 3.63
8214	\$ 5.81
8216	\$ 3.44
8224 (2MHz)	\$ 5.38
8224-4 (4MHz)	\$12.44
8226	\$ 3.44
8228	\$ 8.00
8238	\$ 8.00

## USRT

52350	\$13.69
-------	---------

## UARTS

AY5-1013A	\$ 6.56
AYJ-1014A	\$10.31
TR1602B	\$ 6.56
TMS5011	\$ 7.44
IM6403	\$11.25

## BAUD RATE GENERATORS

MC14411	\$12.50
14411 Crystal	\$ 6.19

## 6800 PRODUCT

6810P	\$ 5.00
6820P	\$ 8.25
6821P	\$ 8.25
6828P	\$14.06
6834P	\$21.19
6850P	\$10.81
6852P	\$13.75
6860P	\$11.56
6862P	\$15.00
6871P	\$35.94
6875P	\$10.94
6880P	\$ 3.13

## KIM SUPPORT DEVICES

6502	\$14.94
6520	\$12.50
6522	\$11.56
6530	\$19.94
6530-002	\$19.94
6530-003	\$19.94
6530-004	\$19.94
6530-005	\$19.94

## CHARACTER GENERATORS

2513 Upper (-12+5)	\$ 8.44
2513 Lower (-12+5)	\$ 8.44
2513 Upper (5 volt)	\$12.19
2513 Lower (5 volt)	\$13.69
MCM6571 up scan	\$13.69
MCM6571A down scan	\$13.69

## PROMS

1702A	\$10.00
2708	\$12.44
2716 (5+12) TI	\$31.25
2716 (5v) INTEL	\$75.00
2758 (5v)	\$29.25

## DYNAMIC RAMS

416D/4116 (250ns)	\$15.63
2104/4096	\$ 5.00
2107B-4	\$ 4.94
TMS4027/4096 (300ns)	\$ 5.00

## STATIC RAMS

1-15	16-100
21L02 (450ns)	\$ 1.88
21L02 (250ns)	\$ 2.19
2101-1	\$ 3.69
2111-1	\$ 4.06
2112-1	\$ 3.69

## FLOPPY DISK CONTROLLERS

1771B01	\$49.94
---------	---------

## KEYBOARD CHIPS

AY5-2376	\$17.19
AY5-3600	\$17.19
MM5740	\$22.50

## Rockwell AIM-65: The Head-Start in Microcomputers

A KIM-1 compatible machine with on-board printer and a real keyboard!

\$468.75 w/1K RAM  
\$562.50 w/4K RAM

4K assembler/editor in ROM:	\$100.00
8K BASIC in ROM:	\$125.00
Power supply:	\$ 74.93
Case for AIM-65:	\$ 62.43

**Special Package Price: \$748.75**

AIM-65 (4K), Power Supply, Case, and 8K BASIC ROM



## EXPANDOR'S BLACK BOX PRINTER

This 64-character ASCII impact printer with 80-column capability is portable and uses standard 8 1/2" paper and regular typewriter ribbon. Base, cover and parallel interface are included. Assembled and complete with manual and documentation.

**only \$599.00**

(90 day manufacturer's warranty)



TRS-80 Interface Cable for Black Box Printer with mating connectors: \$60.00 (must be used with expansion module, +8v/1 amp power supply required.)

Power Supply for TRS-80/Black Box Printer \$61.25

## Sale!

### DYNAMIC RAM BOARDS

#### EXPANDABLE TO 64K

#### 32K VERSION • KITS

Uses 4115 (8Kx1, 250ns)

Dynamic RAM's, can be expanded in 8K increments up to 32K.

8K	\$198.75	24K	\$311.25
16K	\$248.75	32K	\$373.75

#### 64K VERSION • KITS

Uses 4116 (16Kx1, 250ns)

Dynamic RAM's, can be expanded in 16K increments up to 64K.

16K	\$311.25	48K	\$593.75
32K	\$461.25	64K	\$718.75

## S-100 MOTHER BOARDS

### 9-SLOT "LITTLE MOTHER"

Kit	\$107.00
Assembled & Tested	\$123.75
Bare Board	\$ 43.75

### 13-SLOT "QUIET MOTHER"

Kit	\$118.75
Assembled & Tested	\$137.50
Bare Board	\$ 50.00

### 22-SLOT "STREAKER"

Assembled & Tested	\$186.25
--------------------	----------

## JADE 8080A

with full documentation

Kit	\$125.00
Assembled & Tested	\$186.25
Bare Board	\$ 37.50

# JADE Computer Products

4901 W. ROSECRANS AVENUE  
Department "U"  
HAWTHORNE, CALIF. 90250  
U.S.A.



Discounts available at OEM quantities. All prices above are quoted in U.S. \$ F.O.B. Hawthorne, Calif., U.S.A. To expedite shipments please include International money order or bankers check payable against any U.S. bank in U.S. \$, or use your Barclay, Access or American Express credit card (include card number, expiration date, and signature). Add 20% of total order for shipping & handling.

**WRITE FOR OUR FREE CATALOG**

All prices subject to change without notice.

Telephone:  
(213) 679-3313

Telex:  
18-1823

## TRS-80 MEMORY EXPANSION KITS

### 4116's

8 for \$106.25  
(16K x 1, 200ns)  
includes dip plugs and instructions

### ★ TRS-80 Kit ★

(16K x 1, 300ns)  
includes connectors and instructions  
**\$112.50**

## JADE Z80

with provisions for ONBOARD 2708 and POWER ON JUMP

### 2MHz

Kit \$168.75

Assembled & Tested \$231.25

### 4 MHz

Kit \$187.44

Assembled & Tested \$249.94

Bare Board \$ 43.75

## STATIC RAM BOARDS

### JADE 8K

Kits:	450ns	\$157.44
	250ns	\$187.19

Assembled & Tested:

	450ns	\$174.69
	250ns	\$212.19

Bare Board: \$ 31.25

16K - Uses 2114's (low power)

Assembled & Tested:

RAM 16 (250ns)	\$168.75
RAM 16B (450ns)	\$231.25

16K with memory management

Assembled and Tested:

RAM 65 (250ns)	\$468.75
RAM 65B (450ns)	\$406.25

### 32K Static

Assembled & Tested:

250ns	\$993.75
450ns	\$906.25
250ns Kit	\$718.75

## ★ STATIC RAM SPECIALS ★

2114's, low power (1024x4)

	1-15	16-99	100+
450ns	10.00	8.69	6.88
250ns	11.25	10.00	8.13

TMS4044/MM5257, low power

450ns	10.00	9.38	8.13
250ns	12.44	10.94	10.00

4200A (4Kx1, 200ns)

	12.44	10.63	10.00
--	-------	-------	-------

## DISK DRIVES

MINI DISK DRIVE \$368.75  
Model B51 by Micro Peripherals, Inc. will operate in either single density (125KB, unformatted) or double density (250KB, unformatted) modes, up to 40 tracks, with a track-to-track access time of only 5ms.

SA801R \$618.75  
Shugart single-sided 8 in. floppy disk drive.

DM 2700-S \$937.50  
Includes SA801R disk drive, 10 in. x 10 in. x 10 in. cabinet, power supply, data cable, fan AC line filter.

## VERBATIM FLOPPY DISKS

5 1/4 in. Minidiskettes  
Soft sector, 10 sector, or 16 sector  
\$5.50 each or  
box of 10 for \$50.00

8 in. Standard Floppy Disks

Soft Sector

\$5.94 each—10 for \$53.13



# PET SOFTWARE

Of all the microcomputer systems now available, the Commodore PET is the one best supported by software.

The widest range of programs is offered by one company—**PETSOFT**.

You will find a hundred programs in the new 12-page catalogue, covering Business applications, Programming Aids, and some superb Games. Here are just a few examples:

**VAT** £17.50 A package for small businesses. Consultancy Service available.

**PAYROLL** £25 A four program package providing an easy method of pay computation and access to month-end and year end data. Update service available.

**STOCK CONTROL 4** £12 Stores data on up to 150 items per tape file of rapid recall and amendment.

**PERCENTAGE COSTING** £49.50 A powerful method of handling cost information, facilitating the study of percentage changes in total due to individual changes.

**MICROCHESS** £14 Play against the latest version of our famous chess program. Excellent graphics..

**ASSEMBLER/EDITOR** £25 Translates assembly language programs into machine code for direct execution.

**DATA FILE HANDLER** £12 Provides a working file handling structure to be used when writing your own programs.

**MICRO TEXT EDITOR** £15 Line oriented text editor for word processing applications etc.

**BRIDGE CHALLENGER** £10 You and dummy play four person Contract Bridge against the computer.

**PET BASIC TUTORIAL** £15 Let your PET teach you to program in Basic with our best-selling tutorial suite.

**PET WORKBOOKS** £15 Set of five professionally written workbooks covering all aspects of the PET.

For further details of these and the other ninety programs in our free catalogue, call or write to us today.

We also accept credit card orders over the telephone.

## Petsoft

MICROCOMPUTER SOFTWARE

Tel. 0635-201131 01-752 0814  
Telex: 8951672

PET is the trademark of Commodore

● Circle No. 119

## millhouse designs limited

now DISPLAYING and DEMONSTRATING

the PET 2001-8 computer

in our new Camberley showrooms

All Commodore and Petsoft programmes available for instant running and evaluation

Engineering and Programming experts at hand to discuss your precise requirements

Centronics line-printers in stock with PET interfaces

for full details

**MILLHOUSE DESIGNS Ltd.**  
185 LONDON ROAD, CAMBERLEY.  
Telephone Camberley 23581

● Circle No. 120

**Confused by the Microprocessor Jungle ?  
Looking for a learning aid and a tool to design your  
own Microprocessor applications ?  
Then all you need is**

**SOFTY** the all in one Development And Training Aid with Software-Firmware Copier and Programmer

- ★ Execute programmes on TV screen by resident micro-processor programme will halt and display contents of all internal registers at set break points.
- ★ Develop your firmware on TV screen with true memory mapped hex' display with block shift, displacement calculations, insertion and deletion, byte matching and other assembler functions.
- ★ Produce your firmware with high speed on board EPROM programmer, approx 2 mins for 2708. Also handles 2704 and 2716.
- ★ Replaces monitor or debug programme.
- ★ Plus many other standard features including high speed cassette interface and user programmable function keys.
- \* Universal Monitor which can be directly connected to
- \*\* ANY external microprocessor in system situ for firmware development (written by resident micro and executed by external micro).

**SOFTY** is equivalent to Development Systems costing thousands of pounds. Yet **SOFTY** only costs you for kit and full instructions—**£125 plus VAT**, built and tested—**£145 plus VAT** full details available on request or send cheque or PO to

**VIDEOTIME PRODUCTS**

**56 Queens Road, Basingstoke, Hants RG21 1REA  
Tel: (0256) 56417. Telex: 858747.**

We welcome Barclay & Access Orders by telephone. (Trade and Export enquiries welcome).

● Circle No. 121



# L.P. ENTERPRISES

Room PC  
313 Kingston Road, Ilford  
Essex IG1 1PJ, England

From the representatives in Europe... for America's leading Micro-computer magazines and books for the hobbyist, educationist and professional alike, we bring you a little light browsing! Reading maketh a full man... Francis Bacon (1561-1626)

Introduction to Microcomputers	
Volume 0 The Beginners Book	£5.95
Volume 1 Basic Concepts	£6.30
Volume 2 Some Real Microprocessors (without binder)	£18.95
Volume 2 Some Real Microprocessors (with binder)	£24.70
Volume 3 Some Real Support Devices (without binder)	£11.95
Volume 3 Some Real Support Devices (with binder)	£17.70
6 Updating supplements for Vol. 2 (for 1 year)	£18.95
6 Updating supplements for Vol. 3 (for 1 year)	£18.95
6 Updating supplements for Vol. 2 } (for 1 year)	£30.0
6 Updating supplements for Vol. 3 }	
Binder (specify for Vol.2 or Vol. 3)	£5.75
1 Updating supplement for Vol. 2	£4.00
1 Updating supplement for Vol. 3	£4.00

6800 Programming for Logic Design	£6.30
8080 Programming for Logic Design	£6.30
Z80 Programming for Logic Design	£6.30

Basic Computer Games	£5.50
What To Do After You Hit Return	T.B.A.
<b>8080 Galaxy Game</b>	£7.95
The Colossal Computer Cartoon Book	£3.95
Computer Rage (A Board Game)	£6.95
Artist and Computer	£3.95
Games with a Pocket Calculator	£1.75
Games, Tricks and Puzzles for a Hand Calculator	£2.49

<b>Z80 Instruction Handbook</b>	£3.50
8080 Programmers Pocket Guide	£1.95
8080 Hex Code Card	£1.95
8080 Octal Code Card	£1.95

Dr. Dobbs Journal: Vol. 1	£10.00
Best of Byte	£8.95
Scelbi Byte Primer	£9.95
Best of Creative Computing: Vol. 1	£6.95
Best of Creative Computing: Vol. 2	£6.95
Best of Micro	£5.50

8080A/8085 Assembly Language Programming	£6.45
6800 Assembler Language Programming	£6.45
8080 Software Gourmet Guide and Cookbook	£7.95
6800 Software Gourmet Guide and Cookbook	£7.95

## MAGAZINE SUBSCRIPTIONS

	U.K.	Overseas
Subscriptions start within 3 weeks	price	price
Personal Computing (12 per year)	£16.00	£17.00
Interface Age (12 per year)	£20.00	£20.50
Dr. Dobbs Journal (10 per year)	£13.00	£13.50
Computer Music Journal (4 per year)	£8.50	£9.00
Peoples Computers (6 per year)	£8.00	£8.50
BYTE (12 per year)	£21.00	£21.00
Creative Computing (12 per year)	£16.00	£16.50
Calculators and Computers (7 per year)	£10.00	£10.50
Kilobaud (12 per year)	£20.00	£21.00
73 (12 per year)	£20.00	£21.00
<b>MICRO-6502 Journal</b> (12 per year)	£11.50	£12.50

First Book of Kim	£6.50
Microprocessors from Chips to Systems	£7.95
Microprocessor Interfacing Techniques	£7.95
Z80 Microcomputer Handbook	£7.50
T.V. Typewriter Cookbook	£7.50
T.T.L. Cookbook	£7.50
CMOS Cookbook	£7.95
IC OP Cookbook	£9.50
RTL Cookbook	£4.25

Some Common BASIC Programs	£6.30
Computer Programs that Work (in BASIC)	£2.55

<b>Introduction to Personal and Business Computing</b>	£4.95
Getting involved with Your Own Computer	£4.75
Your Home Computer	£7.95
<b>How to Profit from your Personal Computer</b>	£5.50
Reference Book of Personal & Home Computing	£4.95
Hobby Computers are Here	£3.95
New Hobby Computers	£3.95
Understanding Microcomputers and small Computer Systems	£7.95

Instant BASIC	£7.50
My Computer Likes Me... When I speak in BASIC	£2.75
<b>Basic BASIC</b>	£6.50
<b>Advanced BASIC</b>	£6.00
<b>Introduction to PASCAL</b>	£4.00

Accounts Payable & Account Receivable	£10.95
Payroll with Cost Accounting	£10.95
General Ledger	£10.95

BASIC Software Library	
Vol. 1: Business and Games Programs	£17.50
Vol. 2: Maths, Engineering, Statistical Programs	£17.50
Vol. 3: Advanced Business Programs	£26.95
Vol. 4: General Purpose Programs	£7.95
Vol. 5: Experiments Programs	£7.95
Vol. 6: Miniature Business System	£32.50
Vol. 7: Chess/Medbil/Wdpros Programs	£29.95

8080 Standard Monitor	£9.95
8080 Standard Editor	£9.95
8080 Standard Assembler	£9.95
Special Package: 8080 Assembler, Editor, Monitor	£20.00
Tiny Assembler for 6800 systems	£5.75

## MAGAZINE BACK ISSUES

Personal Computing	£1.75
Interface Age	£2.25
Dr Dobbs Journal	£1.75
ROM	£1.75
Computer Music Journal	£2.50
Peoples Computers	£1.75
BYTE	£2.25
Creative Computing	£1.75
Calculators & Computers	£1.75
Kilobaud	£2.25
73	£2.25
Micro-6502 Journal	£1.50
Magazine Storage Box (Holds 12)	£1.25

## HOW TO ORDER

Tick required items or write letter.  
Please note our prices include postage and packing, but not insurance, if wanted add 12p for every £10 of books ordered. Make cheques PO's etc payable to:—

**L.P. Enterprises.**

CREDIT CARDS accepted  
BARCLAYCARD/VISA/ACCESS  
DINERS CLUB/AMERICAN EXPRESS

Phone 01-553 1001 for Credit Card order (24-hr service).

Send to address above  
Indicate Payment Method: All Orders must be Prepaid  
Total Enclosure £.....

..... My cheque, P.O., I.M.O. is enclosed in **Sterling on U.K. Bank**

..... Charge to Barclaycard/Visa/Access/Diners/American Express

Credit Card No ..... Expiry Date .....

Name .....

Address .....

..... POSTCODE .....

Signature .....

All publications are published in U.S.A. and shipped air-freight by **L.P. Enterprises**. In unusual cases, processing may exceed 30 days. Trade enquiries welcome.

## The world's best-selling personal computer



# APPLE II

- \* New powerful basic and new graphics on Rom. £110 card.
  - \* Talk to Apple with voice recognition, speaker trained, 32 word vocabulary. £165 card.
  - \* Colour Graphics. High resolution 280h x 192v, 6 colours, easy-to-use. 16 colours, very powerful. Low resolution 40h x 48v.
  - \* Apple's disks. Powerful DOS. 116K bytes capacity, multiple drives, fast access. £425.
  - \* Use Apple as a computer terminal 110 or 300 BAUD. Full or half duplex or use with a Dec-writer. £110 card.
  - \* Use any 8 bit parallel printer with Apple 11.
- Print up to 3,700 lines per minute. 255 character lines, upper and lower case. £110 card.

Personal  
Computers  
Limited

194-200 Bishopsgate, London E.C.2. 01-283 3391

● Circle No. 123

## SMALL

# Business Systems

FREE £250 worth of application software with your microcomputer system.

(This special offer is available for a limited period only.)

We provide a complete consultancy service for business applications of microcomputers.

Insurance brokers' package on Cromemco or Modata DSC-2.

Complete systems from £7,000.

other applications: stock control, sales ledger, purchase ledger, incomplete records, letter writer, mailing lists, etc.

ADM-3A £575      DECwriter 2 LA36 £840  
6 mth. old TRS 80 16K level 2 £580  
(prices exclude package and VAT)

## Microdata

051-426 7271

71 Deepdale Drive

Rain Hill

(callers by appointment only)

Merseyside, Liverpool L35 4NN

● Circle No. 124

## computer centre

	Kit	Ass.
8K bytes ECONORAM II (450 n.s.)	£79	£89
8K bytes SSM 250 (250 n.s.)	£95	—
16K bytes ECONORAM IV	—	£199
8080A CPU with vector interrupt	£69	—
SBC 100 Z80A, serial + parallel, ROM/RAM	£199	—
104 2 Serial/Parallel	£89	—
VBI-B VIDEO	£79	—
MOTHERBOARD MT3 11-Slot Board	—	£19
PIS 100 Edge Connectors	—	£3.50
S100 Prototype Board	—	£19
TARBELL Disc Controller	£125	—
VERSAFLOPPY Disc Controller	£95	—
SA400 MINIFLOPPY Disc Drive	—	£195
DRI 7100 8in. Disc Drive	—	£290
Z80 Starter kit	£145	—

Ring 02514 29607 for full catalogue.

Mail Order Address: 20 Durnsford Avenue,  
Fleet, Hants, GU13 9TB.

## THE DISCOUNT MICRO STORE

### S100 Hardware CP/M Software

#### Computer Centre Mini Disc Kit £786

S100, Z80 micro, 16K bytes memory, MINIFLOPPY drive, programmable baud rate serial I/O, parallel, PROM monitor and boot, CP/M operating system, cables, connectors, 10 manuals.

Add your power supply and terminal.

#### Computer Centre Maxi Disc Kit £886

As Mini Disc Kit above but with DRI 7100 8 inch Disc Drive.

CP/M Disc Operating System	£52
+BASIC-E	
CP/M Manuals (6)	£22
CP/M U.S. User Group library (8in. floppy disc, 25 volumes)	FREE with media £4.50 ea.

Also available for CP/M: Microsoft BASIC  
FORTRAN and COBOL

All items currently in stock.

Add 2% postage (min. 25p), Add 8% VAT.

● Circle No. 125

PRACTICAL COMPUTING March 1979

# IF YOU CAN'T BEAT THEM:-

## VECTOR GRAPHIC INC



VECTOR V18A slot Motherchassis accepts the wide range of Vector S100 cards and makes an ideal base to build a microcomputer system. Computing power is available to perform a wide range of tasks from industrial control to small business.

PR2 12K PROM/RAM card holds a comprehensive monitor program for system testing and configuration. Normal operation is in conjunction with a serial terminal via I/O card. £350

FLASHWRITER, memory mapped VDU with graphics, allows a system to be built without a terminal or I/O card. Specify version EV of monitor program. £160

I/O, Switchable 110 to 9600 baud serial interface plus two 8-bit parallel I/O ports. £150

High resolution graphics interface bit-maps 8K of RAM to 256 x 256 points, or 128 x 128 with 16 level grey-scale. £125

Z80 Processor card	£140	8080 Processor card	£120
8K Static RAM 4MHZ	£140	16K Static RAM 4MHZ	£300
Analogue Interface	£70	Precision analogue interface	£250
Rackmount 18 slot motherboard	£150	Rackmount power supply	£90

8K Computer System £895

## MICROPOLIS

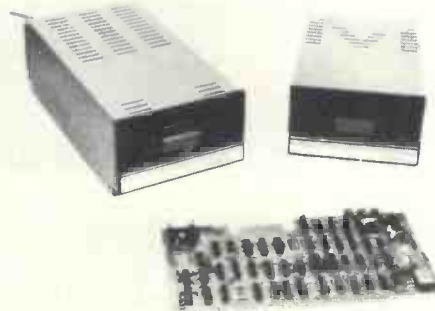

Micropolis disk drives employ higher standards of engineering to pack either 143K or 315K bytes per diskette, formatted. Supplied complete with controller card, cables, manual and software they plug directly into the S100 bus; 8080 or Z80.

Extended disc BASIC, mnemonic editor and assembler are provided, to run under the powerful MDOS operating system.

Add-on units are supplied to extend the system to four drives and one drive per system may be powered from the S100 bus.

143K System S100 powered	£439	143K Add-on S100 powered	£279
143K System Mains powered	£499	143K Add-on Mains powered	£339
315K System S100 powered	£649	315K Add-on S100 powered	£349
315K System Mains powered	£699	315K Add-on S100 powered	£399
Twin drive System 630K	£1159	Twin drive Add-on 630K	£859
S100 bus regulator	£14	Diskettes per five	£24

Unmounted drives available from £225

# JOIN THEM!

## VECTOR MZ



# £2300

Combining the best features of the VECTOR GRAPHIC computer and twin MICROPOLIS 315K byte drives. The Vector MZ produces, in one package a powerhouse of Microcomputer ability.

The VECTOR PROM monitor bootstraps directly to either MDOS, for housekeeping and Assembly language operation, or to BASIC to run high-level user programs. Provision is made to immediately attach a printer, for example one of the extensive range from Centronics sold by Sintrom; enabling use of the powerful printer-related features in the MICROPOLIS Software.

Applications Software for the VECTOR MZ now in preparation will perform a wide variety of business functions; stock control, invoicing, ledger and mailing lists. Further applications exist as a microcomputer development system, and low cost replacement for minicomputer control and instrumentation.

VECTOR MZ configuration includes:

Twin disk 630K minifloppy.  
Full Micropolis disk software.  
Z80 4MHZ 32K processor.  
1 Serial port, 2 Parallel ports.  
12K PROM RAM card with extended monitor.

And will support:

Flashwriter, Graphics interface, Analogue interface  
Additional RAM, additional minifloppy drives.

Centronics Microprinter	£398
Centronics 779	£780
ADM3A VDU	£620



SINTROM GROUP

PRICES EXCLUDE VAT  
ALL EQUIPMENT FULLY ASSEMBLED AND TESTED  
OEM AND DEALER ENQUIRIES WELCOME

DEMONSTRATIONS IN OUR SHOWROOM

## Sintrom Microshop

14, Arkwright Road,  
Reading, Berks. RG2 0LS.  
Tel: Reading (0734) 84322  
TELEX: 847395  
CABLES: SINTROM READING



# OHIO SCIENTIFIC

Microcomputers from the world's largest  
full-line manufacturer



## The C2-4P Mini Floppy

20K RAM  
Basic + Assembler  
Personal, Games, Small  
Business & Educational Disks  
90K Mini Floppy Storage  
Printer Interface  
OS 65D V.30 Operating System  
Only £1595.00 Complete + VAT.

Economic expandable  
systems with good disk  
based software, available  
now.

See your nearest  
dealer for full price  
list and catalogue.

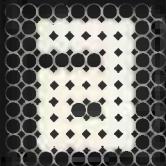

**Abacus  
Computers  
Limited**

62 New Cavendish Street  
London W1 Tel: 01-580 8841

**Mutek**  
Quarry Hill, Box Corsham  
Wiltshire SN14 9HT  
Tel: 0225-743289

**Thames Personal  
Computers**  
13 Wilmot Way Camberley  
Surrey Tel: 0276-27860

**Linn Products**  
235 Drakemire Drive  
Castlemilk Glasgow

G45 95Z Scotland  
Tel: 041-634 3860  
**U Microcomputers**  
PO Box 24 Northwich  
Cheshire CW8 1RS  
Tel: 0606-75627

Other systems available include the  
C3 OEM with 32K RAM, 512K of disk storage and  
BASIC as standard, £2950.00 + VAT. (FORTRAN and  
COBOL available as extras.) All dealer enquiries  
direct to Abacus Computers Limited.

## Publisher's Letter

THE micro revolution will give Britain's entrepreneurs the same tremendous opportunity the industrial revolution did in the past. It appears that the Government has recognised the opportunity and is ready to encourage free enterprise to grasp it to the full. Over recent months very large amounts of taxpayers' money have been committed in that direction.

The announcements to date already total nearly £250 million—yes, £250,000,000. That includes an initial £55 million for the Microprocessor Application Project (MAP), and £60 million for schemes to make Britain more aware of the possibilities, and for education and training.

The money will be spent over three years at the most and industry is expected at least to match the Government contribution; thus the very lowest estimate of the sums available over the coming years averages in excess of £15 million per month.

The Government is busily commissioning studies on what to spend the money. We know there are many readers of *Practical Computing* who have really *practical* ideas on applications which would be well worthwhile funding.

Well, the money is there and the right time is now. Has your company yet taken the trouble to find out the details of MAP? The Secretary of State for Industry has stated that under MAP: "Assistance will be available both for application of microprocessors in end-products and for their use in production processes". Why not invest 7p in a stamp and write to:

Miss M. S. Rae  
Room 309  
Department of Industry  
Dean Bradley House  
52 Horseferry Road  
London SW1P 2HE

Good luck.

*The Publisher*

Our Feedback columns offer readers the opportunity of bringing their computing experience and problems to the attention of others, as well as to seek our advice or to make suggestions, which we are always happy to receive. Make sure you use Feedback—it is your chance to keep in touch.

### Extender boards

I WOULD like to point out a possible source of confusion in your glossary definition of Extender Board.

In my limited hardware experience, 'Extender Board' is a hardware diagnostic tool and is a simple board comprising a PC plug on one edge and a mating PC socket on the opposite edge. Plug and socket are connected, pin to equivalent pin, by straight PC tracks.

The purpose of the board is to extend a PC socket inside a framework to the outside of the framework so that the original PC board the extender replaces may then be plugged into the outer socket of the extender. The original PC board is then in an accessible position for scoping or whatever.

Extender Board would appear to be the more standard definition of the hardware you describe.

If Extender Boards to my definition were advertised and purchased by someone using your definition, then that purchaser will not be very pleased nor any more able to expand.

N. D. Canton  
St. Albans, Herts.

### Fascination

HAVING just purchased a copy of *Practical Computing* may I say it has greatly increased my fascination with computers?

I have for some time toyed with the idea of buying a personal computer but must confess to knowing next to nothing about them. Your magazine obviously must aim at a section of the community whose minimum knowledge must be a smattering of jargon and an ability to press the right key somewhere along the line. Therein lies the dilemma for myself. To get to the point, it would be infinitely easier if I had a computer, but how do I choose a computer without this basic knowledge?

My interest in computers is purely games. Even the most advanced TV computer games tend to need special skill and quick reactions at the expense of intellect. I am looking for a cheap—perhaps second-hand?—computer programmable for a wide number of games where tactics and strategies depend on forethought rather than wrist agility.

If you could advise, or put me in touch with any group which could advise me on such a choice so I may become one of the enviable bunch of home computer operators, I would be extremely grateful, and am sure *Practical Computing* would be-

come a necessity rather than a present curio.

Philip A. Rylett  
Brighton.

● Yes, there is a problem in bridging the gap between ignorant interest and positive enthusiasm; and it is true that personal computers offer some really excellent programmable games, so it seems a pity you should miss out on any of it.

One starting-point might be to contact a local computer club. We know of several, and here is the address of one relatively near you—P. Guile/N Latcham, 23 Silverdale Road, Hove, Sussex.

### Help offered

I BOUGHT your first issue at the DIY Exhibition in Summer, 1978 and took a year's subscription shortly afterwards.

In June, 1978 I also purchased a Synertek Vim-1, probably among the first to be released. I had no previous experience of computers or microprocessors, other than the general knowledge acquired as a physics teacher over the last 27 years.

During the last three months I have put in several hundred hours on the Vim-1, working solely from the two printed handbooks supplied with it. They consist of 370 pages of text, 50 pages of component data sheets, and 55 pages of listing. Unfortunately most of the intermediate and all of the advanced material is contained in about 10 pages of (important) tables and flowcharts, with only six pages of explanation.

This has to cover vector points, monitor calls, interrupts, trace routines, monitor extensions, user-defined functions, mixed I/O configurations, and so on.

There is a rich library of Kim-1 programs, with more than one in *Practical Computing* recently. But the compatibility of Vim's 4K monitor with Kim's 2K equivalent is only superficially dealt with in a brief one-page appendix to my documentation, making it almost impossible for me to utilise all these Kim programs.

This is most frustrating. The Vim-1 performs excellently and I am sure with only a few more clues I could obtain considerably more versatility.

I would be grateful for the opportunity to exchange information, assistance or ideas with any other Vim-1 (or Sym-1) owner.

In return, I can offer correction of

(continued on page 21)



The exciting new  
**TRITON**  
 Personal Computer  
 exclusively from:

# TRANSAM



**Complete kit of parts available only £286 (+ VAT)**

**Basic in Rom:** a powerful 2k Tiny basic resident on board, makes Triton unique, easy to use and versatile.

**Graphics:** 64 Graphic characters as well as full alpha numerics.

**Single Board:** Holds up to 8k of memory, 4k RAM and 4k ROM, supplied with 3k ROM and 2k RAM.

**Memory Mapping:** 2 mode VDU I/O or memory mapped for animated graphics.

**Cassette Interface:** crystal controlled Modern tape I/O with auto start/stop + "named" file search.

**UHF TV Interface:** On board uhf modulator, plugs into TV aerial socket.

**Comes Complete** with KEYBOARD, CASE, POWER SUPPLY, THRO-HOLE PLATED QUALITY P.C.B. FULL DOCUMENTATION POWERFUL 1k MONITOR & 2k TINY BASIC PLUS ALL COMPONENTS INCL. IC SOCKETS. NOTE TV SET & CASSETTE NOT INCLUDED.

**Expansion:** Expand your Triton simply and easily with our new 8-slot motherboard complete with its own P.S.U. takes 8 plug-in Euro cards. Plug-in 8k RAM card now available.

**All components can be bought separately and eleven packs can be purchased on an easy-to-buy scheme. See catalogue.**

**The P.C.B. alone is £50 + VAT plus £1 for packing and postage.**

**VAT rate is 8% on all kit components.**

## TRANSAM

**TRANSAM COMPONENTS LTD.**  
 12 CHAPEL STREET, LONDON, NW1  
 TEL: 402 8137

Next to Edgware Road Tube Station (Met. Line)  
 Triton Computer is the Trade Mark of  
 TRANSAM COMPONENTS LTD.

**EXPANSION MOTHERBOARD . . . £50**  
**8K STATIC RAM BOARD . . . . . £97**

Full details available in our brand new 1979 computer products catalogue, so order your copy right now!

I am interested in the Triton

Name \_\_\_\_\_

Address (please print) \_\_\_\_\_

\_\_\_\_\_

\_\_\_\_\_

\_\_\_\_\_

BARCLAYCARD, ACCESS, VISA & MASTER CHARGE ARE WELCOME. SEND YOUR CARD NUMBER WITH ORDER

To: TRANSAM COMPONENTS LTD., 12 CHAPEL STREET, NW1

Please send me the following

1 A copy of your latest catalogue I enclose 30p + S.A.E. 9 x 7

2 A copy of the Triton Manual I enclose £5 + 70p P & P

3 A complete kit of parts for Triton Computer, £286 + VAT + £4 P & P

4 A Printed Circuit Board £50 + VAT & £1 P & P

TOTAL ENCLOSED £ . . . . .

Cheque, Money Order, etc.

● Circle No. 128

PRACTICAL COMPUTING March 1979



(continued from page 19)

several errors and misconceptions in the handbook texts and personal experience about the most suitable, and cheapest, cassette recorder, and the most reliable tapes. I have much to say on the general reliability of the keypad and the transfer of the oscilloscope routine and character generator—it works very well on my very cheap and rudimentary 'scope'. I also have a few display, delay and clocking gimmicks.

Finally, I am very interested in the November article *How to play Mastermind*. I am particularly keen to get it into my Vim monitor and would welcome any advice, especially on how to produce an 'aesthetic' display with the minimum pressing of keys and Hex codes between moves, segment patterns, and so on.

The Vim manual lists the equivalents of GETKEY & AK but not the other monitor calls; and there are various other functional differences.

Len Green,  
15 Jotan Street,  
Achuga, Haifa,  
Israel.

## Malaysia bound

I AM hoping to buy a computer in England, perhaps next year, and to take it to Malaysia with me in the summer. In my mind now I have three computers to choose from—Pet, Exidy Sorcerer and the new contender Superboard II. Can you please give a review about the second and the latter?

From the above three computers, can you please help me to choose which one suits me best from the following guides:

To use it as a personal computer; to teach my sisters and brothers more about Basic; to play some games for the family; ability to add other manufacturers' plug-in memory; low power consumption; portable.

I am also most concerned about the servicing of the computer as there are no service facilities near me. If you have any extra advice, please reply and I would be grateful. In particular, if you know of any company with some link with a company in Malaysia, I would be most interested.

Lastly, can you please give me the address of Ohio Scientific because I want to give some extra ideas to the Superboard II.

A. G. Adam,  
Worksop, Notts.

● We have discussed both the Exidy and the Ohio microcomputers, though we have not done a full-scale review on either. You may, however, be aware that delivery on the Ohio Superboard is delayed. Contact Abacus Computers (tel. no. 01-637 0777) for the latest news.

In any case, from your list of requirements only the Pet looks an obvious

choice. In particular, there is now a very wide range of add-on hardware options, including floppy discs and printers, and ready-to-go software from independent suppliers and from Commodore. Pet has a fine Basic, it is portable, it seems reliable, and it has built a good body of knowledge around it.

We asked Commodore about your nearest Pet agent and the only address produced is: Commodore Japan Ltd, Paisei-Benshi Building, 8-14 Ikue 1-choee Asahy-Ku, Osaka 535.

## Buss exchange

THE REVIEW of "Heath's Kit" in your November issue was most interesting. I edit *Buss: The Independent Newsletter of Heath Co. Computers*, to which the article referred. One of the four pages of the September issue of *Buss* was devoted to a letter from a fellow who took an H11 into England by rather unconventional means.

I would be willing to offer *Buss* to anyone mentioning *Practical Computing* at the modest discount of \$10 for 14 issues by airmail. At the subscriber's option this could start with either the current issue or available back issues.

Charles Floto,  
*Buss*,  
325 Pennsylvania Ave, S.E.  
Washington DC 20003

## Users' club

WE ARE in the process of forming a National Association for all those working with the 6502 microprocessor (Kim-1, Sym-1, Aim-65, Superboard II, Pet, Apple II, and the like).

We see the objectives of the association as providing a medium for the sharing of information which will benefit both the new user and people with more experience in this field. If you are interested, please contact me.

W. R. Wallenborn,  
21, Argyle Avenue,  
Luton, Beds LU3 1EG.

● 6502 enthusiasts, including Pet and Apple owners, should also note the existence of the 6502 Program Exchange, an excellent organisation in the States whose stated aim is "to provide a means of exchanging tested software for 6502 systems at reasonable prices".

Much of it is from user groups and is charged at a bargain price, equivalent to 50 cents per page of assembly code, \$3.50 per page for code in Tiny Basic, or a Focal implementation is also available from the exchange. The Tiny Basic, incidentally, costs \$7.50, as a hex dump, hex format buff tape, or on Kim hypertape.

Other goodies from the Exchange newsletter are a Kim-to-S100 bus adapter for \$165. The address is 2920 Moana, Reno, NV 89509, U.S.

## Prize offer

AFTER READING your excellent article in the November issue of *Practical Computing* concerning the future of personal computing in schools, I noticed a footnote concerning your willingness to correspond with people either developing subject courseware or with those requiring more information about microcomputers and education.

I am a newcomer to the field of computers and computing and I have been trying to absorb the largest possible amount of information concerning microprocessors, programming and other related subjects.

I have recently been practicing on the local university computer terminal Basic and Fortran and with these two languages I have taught myself Cobol, all with the aid of books only. I am still a member of the country's education system and I have been writing, and I might add enthusiastically, programs for my maths and physics. I have found that by dissolving the mathematical principles and re-constructing them stage by stage into a computer program, it makes clear to me the more fundamental principles concerned.

I have also recently been to a lecture about microelectronics and data transmission systems. Since this lecture and your article concerning the use of Pets in the classroom, I have researched more deeply into job possibilities in this field and have decided that with my love of maths and physics and electronics computers are to be my career.

I wondered if you could possibly increase my knowledge upon the subject of how education might differ in about 20 years, from what it is like at present.

R. J. R. Morris,  
Caerphilly  
Glam.

● We could write pages on what computers will be like in five years, let alone 20. Anyone with an idea on how a computer will perform in five years' time, however, can write to us and we will give a prize for the most original thoughts.

## Tandy printers

I OWN a Tandy TRS-80 system and I am interested in including a printer. I note that a printer is made by Anadex Ltd. and perhaps you will kindly let me know if this will couple and work from a TRS-80 expansion interface.

T. R. Martin,  
London SW9

● As far as we know the Anadex printer will not work directly from Tandy TRS-80 interface, but for about \$80 Tandy will sell you an RS-232 interface conversion. This will allow you to attach the Anadex, and indeed other printers.

## Nascom club is formed

THE INTERNATIONAL Nascom Microcomputer Club is not least a formal recognition of the impressive success of the Nascom-1 micro. The club is organised by Nascom. The supplier says its prime objective is "the exchange of programs and ideas for developing the Nascom-1" and that must be entirely commendable.

Membership is open to anyone for £5 a year. The principal benefit is *INMC News*, issue one of which appeared in December. It consists largely of messages from Nascom, a few apologies for unsatisfactory hardware items and delivery delays, tips for tweaking systems and getting around operational inefficiencies and a handful of job advertisements. Nascom obviously expects more user feedback in successive issues.

Incidentally, if there's any demand from *Practical Computing* readers, we will be pleased to start a Nascom-1 page along the lines of the Pet and TRS-80 pages. Let us know what you think—much of the input will have to come from you. □

## Zilog package for MCZ and ZDS

ZILOG MCZ and ZDS users will be glad to learn that the company is now marketing a Z8 Software Development Package, an assembler and simulator, which allows you to write and debug Z8 software without having Z8 hardware.

The package will run on any MCZ or ZDS system with 60K bytes of memory. The two major components of the package are the assembler for the Z8 PLZ/ASM structured assembly language and the Z8 Simulator.

### Special features

The assembler lets you generate re-locatable and absolute object code and special features include conditional statements, CASE statements, a DO...OD looping construct and procedures. Data structures include bytes, words, arrays and records. Data and instructions can be mapped into any of the three Z8 address spaces—register, data and program.

The simulator enables you to set and display simulated memory, set breakpoints, and

access simulated external memory. A special shadow memory feature permits you to know whether a particular memory location has been read, written or executed.

The Software Development Package is a diskette with software and documentation including a technical manual, a Z8 assembler users' guide, a PLZ/ASM programming manual, a simulator manual, sample programs and sample simulator sessions.

Detailed pricing and ordering information is available from your local Zilog dealer. The package is available with 30 days' delivery. □

## Micro course at Reading

CELDIS MICROSYSTEMS of Reading runs a three-day micro course which looks comprehensive.

It presumes a certain amount of knowledge on your part, so if you are a beginner, it is not for you. Celdis expects you to know about binary, octal, BCD and hexadecimal numbering systems, signed and unsigned arithmetic, Boolean logic and TTL family.

The workshops are run once every month and will cost £140 per person, plus VAT. That includes lunches and full documentation but not accommodation.

More information from Julie Lea on Reading (0734) 598848. □

## Impressive guide

IF YOU have £5 to spare, you could do worse than to spend it on "the most comprehensive sources of microcomputer software ever published". That modest title is claimed by *The SSI Microcomputer Software Guide* and though we don't really like subscribing to such

over-enthusiasm, we are forced to concede that the 2,000 or so programs referenced in this 124-page paperback constitute an impressive list.

They are all American, of course, but all authors and suppliers are noted. For each program entry the Guide may or may not give enough information to specify exactly the system on which it can run; some programs are named without any further explanation—that usually means they are in a Basic—while others include notes on exactly which implementation of which language on which particular micro, the medium on which the code is supplied, and the host operating system required.

There are 236 separate classifications, including 20 pages under Games. Pet and TRS-80 are separate categories, two pages for the Tandy, three for Pet.

It's a good guide, especially if you're looking for software. Why doesn't someone sell it here? In the meantime, you can order it (cash with order, we're told) from SSI at 4327 E Grove St, Phoenix, AZ 85040, U.S. If you have any difficulty, we will probably be able to obtain it for you. □

**ACTRESS** Joanna Lumley, who played 'Purdie' in *The New Avengers* TV series, presenting the robot prize to Fiona Mackay (12), of Rickmansworth, who won first prize in the Altergo painting competition. The presentation was made at the British Computer Society Young Computing Funfair.





# PCNET is method to link personal computers

SOMEONE told us about PCNET, so we sought more information. It sounded interesting—people looking at ways to hook together personal computers.

Eventually we reached Dave Caulkins, who is 'co-ordinator' of the PCNET Committee. He says that PCNET is a loosely-organised group of volunteers in California, plus a mailing list of about 500 names—"but we are starting to make progress". That consists of some experiments to try the PCNET software in practice.

The goal of the PCNET organisation is the provision of "a reliable, low-cost means of transferring messages or files between personal computers", using ordinary voice-grade dial-up telephone lines.

PCNET is aiming at unattended operation—with one computer transmitting automatically and initiating receive mode automatically at another—to take advantage of cheap late-night connections.

## Great potential

The prospect of this is obvious and its potential is enormous—instant communication between enthusiasts; instant transfer of programs and data; instant updates to existing software.

It could even be the start of a small but important social change, with increased dissemination of ideas and information which could lead eventually—here comes the starry-eyed visionary bit—to a reduced need for urban conglomerations.

Returning briefly to earth, you can't create an interlinked network of Pets and TRS-80s and Nascoms like that. You have to develop standardised forms of communication all participating computers will understand, and which they will all be able to use. That is what a communications protocol is, and developing protocols is the principal activity of the PCNET Committee.

From here it becomes a trifle esoteric, so we'll be brief. The PCNET 'protocol work-



group' has produced a five-level protocol which covers everything from the way a computer plugs into a telephone line—in the States they use modems—right to the kind of electronic mail programs you'll need to switch around messages between participating computers.

The first problem is the fact that the telephone line works on analogue signals and your computer works with digital information. A modem is a black box which converts digital to analogue, so you can transfer computer data to the phone line and send it, and

vice versa, so that it can be re-converted at the other end.

In the States the telephone companies are fairly sanguine about what you attach to their lines; they have to approve the modems, but several modems are available and approved—PCNET has found three it regards as particularly suitable. Two are S100-compatible, one likes the Pet, and prices range from \$280 to \$395.

In Britain, the Post Office is much less accommodating. You take either its modems for your dial-up link, and pay the price, which isn't anything like \$395; or you rent your own line,

which is clearly out of the question.

There is, of course, the acoustic coupler. This is a kind of modem—it does the analogue-digital conversion—and it doesn't have to be cable-connected to the telephone lines. It is connected to your computer and it has a padded receptacle on it into which you place the handset of an ordinary telephone receiver. So you disconnect nothing and you don't tamper with the Post Office lines.

## Distortion

Because you are employing the telephone handset the chances for electrical noise are much increased, and this can distort the data you are trying to send or receive. The Post Office might not like it very much, and even an acoustic coupler will cost £300 or more.

Still, the chances are there. We would be most interested to hear any news and views on the interconnection of personal computers in Britain.

Meanwhile, we'll keep you posted with PCNET. Last year it demonstrated several inter-computer connections successfully. Two PCNET members have set up an interesting Community Bulletin Board System in California which can be called to read or leave a message. How about that for a U.K. project?

## Selling Triton in parts

IF YOU can't afford to pay hundreds of pounds to buy your own computer, Transam Components may have just what you're looking for.

It has decided to sell its Triton single-board computer in individual component parts as well as in kit form, so that instead of buying everything at once, you can take your time about it, without upsetting your bank manager.

The Triton has resident Basic in EPROM, graphics, memory mapping, and a

modem-controlled data-handling feature. The single board holds 8K of memory, full power supply, and will interface to standard audio cassette and domestic TV. It is complete with 56-key ASCII keyboard, a custom-designed case and a fully-comprehensive manual.

Transam says that it is easy to construct and versatile to use. It has fully-buffered outputs for up to 64K memory, 256 input/output ports, and eight levels of interrupt.

Programs run in Basic and

machine code, and the total price of the model is £286 plus VAT. All resident hardware is in EPROM and Transam offers an EPROM programming service for Triton users who want to "burn-in" their own resident hardware.

Transam is developing an expansion motherboard and 8K RAM, 8K ROM and serial interface boards. They are expected to be released shortly.

The Triton is available from Transam Components at 12, Chapel Street, London, NW1. Telephone 01-402 8137. 



# NASCOM I AT MICRODIGITAL



The Microcomputer only shop providing a complete service from a single chip to a commercial data processing installation. Well worth a visit for a look around and a chat.

**nm**

**NASCOM I.....£178.20**  
From 10th February 1979.  
Includes VAT and carriage.

The Nascom I was exceptional value for money at the old price, now it is unbeatable. The Nascom I is the best possible introduction to the world of personal computing, yet it has the power and flexibility to be expanded into a full data processing system. The specification includes powerful Z80 processor, parallel I/O controller with two 8 bit ports. UART driving cassette interface or most serial peripherals, video output to plug in the ariel socket of your T.V., 2K bytes of RAM (1K user and 1K video), proven 1K byte monitor program in EPROM and a spare EPROM socket. The kit is complete, all that is required is a power supply a domestic T.V. and a domestic cassette recorder.

**POWER SUPPLIES**

There are two power supplies available, a 3 amp supply which will power the basic kit and some expansion and an 8 amp supply with toroidal transformer which will power a very large system. Both supplies can be mounted in the vero frame.

3 amp P.S.U. kit.....**£26.46**  
8 amp P.S.U. kit.....**£64.80**

**EXPANSION**

Nascom I is expanded by connection to a buffer board which creates a 77 way bus structure "NASBUS" into which expansion boards plug directly. The bus structure is carried along a motherboard which allows future boards to be added and to keep your computer neat the Nascom I, power supply, buffer board, mother board and expansion boards can all be mounted in a vero frame.

Buffer Board.....**£27.00**  
Mother board.....**£10.26**  
Mini Motherboard.....**£3.13**  
Vero frame.....**£31.86**

**NASBUS**

The 77 way Nasbus has the following advantages:-

1. Uses standard Veroboard as a motherboard and Standard 0.1" single sided edge connectors for expansion cards. These components are readily and cheaply available.
2. The bus structure leaves 8 spare data lines and 4 spare address lines for future use of 16 bit processors.
3. The power lines are regulated, on board regulators are therefore not needed which obviates the necessity for fan assisted cooling.

All prices include VAT and Carriage.

4. All cards use lower power, low noise shottky buffering which means the bus is quiet and does not need sophistications like active termination or interleaved ground planes.
5. Expansion boards are standard 8" x 8" vero DIP boards which are economic and give a good useable area.

**MEMORY**

The memory expansion board can carry 16 dynamic RAM chips, these can be either 4K bit or 16K bit chips and the board is offered with 8, 16 or 32K bytes of RAM. The 16K board can be expanded to 32K by plugging in 8 more 4116 chips.

The memory expansion board also has room for 4 2708 UVEPROMS each of 1K bytes and a lot of pre-programmed systems software is available to fit these sockets.

8K RAM board kit.....**£91.80**  
16K RAM board kit.....**£151.20**  
32K RAM board kit.....**£216.00**  
Set  
8 x 4116.....**£75.60**  
Additional 2708.....**11.34**

**INPUT/OUTPUT**

For people wanting to use more peripherals than the standard kit allows for, Nascom are producing an I/O board which can carry a counter timer chip and a number of PIO's and UARTS. This will be available in March.

I/O board.....**£37.80**  
CTC.....**£8.64**  
UART.....**£5.94**  
PIO.....**£8.64**

**BASIC**

To allow high level language programming Nascom have produced a 2K Tiny basic and a 3K Super Tiny Basic in 2 or 3 2708 EPROMS respectively. Also available is an 8K Microsoft precision floating point basic in 8 2708's which will be available in April on a single 64K bit ROM to fit the EPROM board.

Tiny Basic.....**£27.00**  
Super Tiny Basic.....**£37.80**  
8K Basic (8 x 2708).....**£108.00**  
8K Basic (ROM).....**£43.20**

**EPROM BOARD**

Available in March this board will carry 8 x 2708 UVEPROMS and the 64K bit ROM containing basic. The board can also be used for burning in 2708 UVEPROMS.

EPROM BOARD.....**£43.20**

**GRAPHIC BOARD**

Allows high resolution graphics on your Nascom I. Contains 4K of RAM.

Graphics board.....**£102.60**

**MONITOR**

Nascom have written a new monitor, T4 the most powerful yet available for this machine it contains many desirable features not found on any other monitor. T4 comes in 2 x 2708 to plug into the main Nascom I board.

Nasbug T4.....**£27.00**

**FIRMWARE**

A powerful editor assembler zeap 15 available to run under Nasbug in 3 x 2708 or on tape. ICL Datskill have produced a letter Editor available in 2 x 2708.

Zeap (tape).....**£32.40**  
Zeap (Eeprom).....**£48.60**  
Letter Editor.....**£75.60**

**THE FUTURE**

In the near future a mini-floppy disk system will be available with either single or double drive. These will probably offer in excess of 1/2 a megabyte and 1 megabyte respectively at prices that will allow even the hobbyist to have a large data base. To take full advantage of the business and scientific uses opened up by disks Nascom intend to release several high level languages. Looking further forwards Nascom is a developing product, and the fact that many thousands are now in use will ensure that the latest in computer technology will be available at a competitive price.

OPENING HOURS: 9.5.30 Monday to Saturday.  
Friendly, expert staff always on hand!

Phone in your Access/Barclaycard Number on 051-236-0707

or complete this order form

PLEASE SEND ME:



**I ENCLOSE:**

CHEQUE/POSTAL ORDER NO.....  
BARCLAYCARD NO.....  
ACCESS CARD NO.....  
NAME.....  
ADDRESS.....

**COMPLETE AND POST TO**



**MICRODIGITAL LTD.** 25 BRUNSWICK STREET LIVERPOOL L2 0BJ Tel: 051-236 0707

## Sailing along with your programming skills

IF YOU want to combine your programming with your sailing skills, then Texas Instruments latest product is for you. It is a complete electronic navigation package, tailored specifically to the needs of small boat users, especially those who are all at sea when it comes to finding their way home.

The system is called Navigatronic, and is made up of a TI-58 programmable calculator with up to 480 program steps, a marine navigation solid-state software program library and a 12-24V dc adapter/charger. This is mounted in a luxurious brass-handled, mahogany case which would give a touch of class to even the humblest vessel.

The case houses a label cards holder, marine navigation quick-reference guide, and a block notepad and pencil. There is also a 220V ac adapter charger for shore use.

Texas says the package is designed to meet all navigational needs, from racing to cruising or ocean-crossing navigation. There is a comprehensive library of 30 programs, includ-

ing coastal navigation to compute relative or absolute position; speed made good and true course; time, speed and distance equations; distance to horizons; even star identification and planet location—in fact, everything you could need

to reach your destination.

The dc adapter/charger includes automatic voltage selection, is protected against radio frequency interference, and operates with either polarity. The package retails at £149.95, including VAT. □

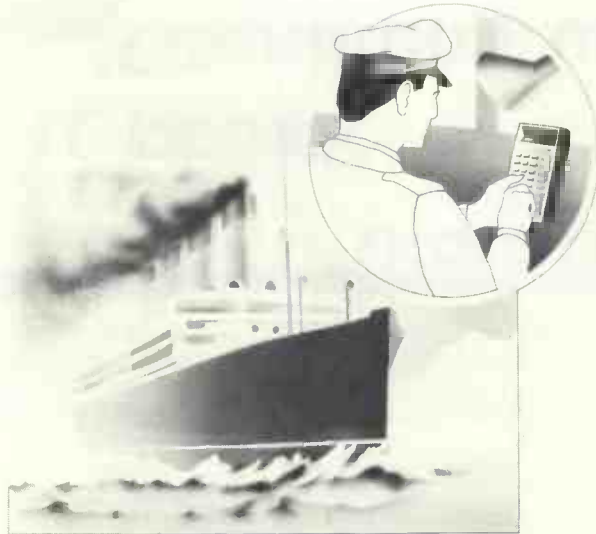

## Better support for Kim

THE recent fall in price of the Commodore Kim 1 has allowed GR Electronics to put together a package which includes the Kim, a power supply, and an 8K RAM and 8K erasable PROM extension board for less than £300.

The Kim 1 was reduced to £99 plus VAT in December and its increasing popularity has led to better support for the machine. GR Electronics of Newport has been appointed sole U.K. distributor for the range of hardware and software produced by Computerist, of Chelmsford, Massachusetts, for the Kim and other 6502-based systems. GR has appointed other dealers in several areas over the last few weeks.

The available software offers several business applications, including editor, mailing list and information retrieval packages, as well as chess and other games programs. □

## Assembler for calculators

HELPING you build a bridge between assembler and calculator operation is SIA Computer Services, with its new technical language, ASSIST.

The language was designed specifically for Motorola 6800s for those who find difficulty with software but can operate programmable calculators successfully. It has straightforward

verbs such as load, store, add and subtract, and more complicated ones like log, sin, cos, tan and square root.

The package can be controlled via an executive/operating system block which can handle up to 16 programs running at the same time.

You can provide up to 256 external routines which inter-

face directly to ASSIST programs, which means that functions best performed in assembler can be controlled by you. The system designer.

Subroutines can be stored to any depth, and the subroutine address library is a LIFO stack. Real-time functions include programs being able to run any other programs, calling for any other to be revived, and dropping itself from the system—becoming idle or suspended pending a transaction completion. A time-slice version of the package is available but it makes more extravagant use of memory than the normal multiprogramming ASSIST.

There are 256 storage areas available to the user but they need not all be put to work. Many ASSIST solutions use only a few areas, thus saving on RAM space. The package is available in ROM form or as an Exorcizer-compatible card with RAM and I/O ports.

As yet, there is no price on the system as SIA says it is still adding enhancements. □

## Micros in kitchen

PRESTIGE, the household equipment firm, is organising a competition for suggestions on the use of microprocessors in the kitchen.

All you have to do is design a piece of kitchen equipment which uses a micro. If Prestige thinks it's good enough to sell commercially, it will give you the option of selling it the design at the end of the competition.

The rules are very simple. The product should be designed to sell at £100 or less and the design must be something to do with food or recipes. No washing-machine applications—it's all been done before.

Two first prizes of £1,250 will be offered. If you're interested, we have the address to which your entries should be sent. □

## Roadrunner board aid

ROADRUNNER may sound like something from a Warner Brothers cartoon, but it is, in fact, the latest prototype wiring system for circuit boards from TJB Associates.

It is a cost-effective device, giving a fast, accurate means of producing pre-production circuit boards of any type, size or integrated circuit packing density.

The key to the system is a new "pencil", a wiring instrument which feeds the quick-soldering enamelled wire from interchangeable bobbins. Special features include the simple threading system which allows fast change of the bobbin

and the device provided for adjusting the wire tension.

The distribution strips used in the system are low-profile, press- or glue-fix and have the capacity for retaining a large number of wires securely in position without affecting the low profile of finished boards.

TJB will supply Roadrunner in kits which include a circuit board, wiring instrument, distribution strips and spare bobbins of wire in four colours. A typical kit costs £8.50, and individual components are available separately.

More information from TJB, Haslemere (0428) 52511. □





# Keen Computers, Spread Their Wings

## Hardware

---

You've heard about the new **attache**—we stock it. We are the Midlands distributors of the sophisticated **attache** business computer from America: This is a purpose designed business computer supplied complete with monitor, dual 8" floppy disks and printer. We also stock the **Apple II**—the best micro for its price available in the U.K.

Attache	£5,895	Disk & controller	£425	Decwriter II	£1,050
Apple II 16K	£ 985	Applesoft ROM	£110	Centronics 779	£ 850
16K Memory	£ 160	Printer card	£110	Axiom micro printer	£ 350
		Communications card	£110	Axiom printer/plotter	£ 699

## Software

---

We have a full range of software for the Apple II, available on disk or cassette:

Incomplete Records Accounting	Matrix Inversion
Addressing & Mailing program	Information Retrieval
Word Processor	Co-resident assembler
Chequebook	Regression
Shape-create	Standard deviation
Variance	Correlation
Data Testing	Distribution

Personal Software MICROCHESS for the Apple II computer, Tandy, and the Pet.

**Keen Computers Ltd,**  
**5 The Poultry,** (off Market Sq)  
**Nottingham**  
**Tele: Nottm**  
**583254/5/6**

● Circle No. 130



# Wide choice available but no accepted standard

This month *Practical Computing* looks at single-board computers. Starting at £50, they are ideal for training, developing systems or just for playing around.

As a descriptive definition, the term single-board computers is somewhat restrictive, because there is no universally-accepted board size, and no accepted standard as to what components ought to be included on the board to constitute a computer.

Therefore on the one extreme, the Rockwell AIM 65 is an all-singing, all-dancing board complete with dedicated QWERTY keyboard, 20-character LED display, 20-character hard-copy, roll

printer and single-chip CPU.

At the other extreme is the 'half-card' LSI-11/2 from Digital Equipment Corporation with multi-chip CPU and no memory or interfaces. For all but bottom-end applications, though, one will need additional boards for almost any single-board computers.

Single-board computers are essentially designed as replacement modules for discrete logic and even for discrete component

electronics. Many have little by way of real software other than elementary firmware monitors to control LEDs, set breakpoints, debug and edit hex programs.

That is particularly true of training systems/courses which are not really applications-orientated. They are more orientated to the component level and their manuals determine whether they are good or bad.

For applications-orientated systems, software is essential. This may be in a variety of forms, such as an extra-cost Basic interpreter and/or operating system burned into ROM, or loaded to RAM from cassette or floppy disc storage.

Alternatively, applications may be developed on special-purpose development systems, or even off-board on a minicomputer for compatible boards such as the Digital LSI-11, Data General MicroNOVA or General Automation GA-16/110 & 220.

Every board has its strengths and weaknesses; a really cheap one will have limited use and the very expensive one will probably be under-utilised. One may have better computational capability than another, but poor video graphics facilities. You would be well advised to define your requirements as accurately as possible before dipping into your pocket.

Some boards may be more easily obtainable than others and suppliers to the wholesale (known as OEM) market may feel some self-righteous revulsion to hobbyists.

Manufacturer	Model	Price
Advanced Microcomputer	AMC 95/4000	Not available
American Microsystems Inc	EVK Series	Not available
Brutech Electronics	BEM-CPU I	£116
Commodore	Kim I	£99-95
Computer Automation	LSI 4/10	£387
Data General	MicroNOVA	£505
Digital Equipment Corp	LSI-11	£650
EMM SESCO	SECS 80/10A	Not available
General Automation	GA-16/110 & 220	Not available
Heathkit	Training Course	£248-70
Intel	iSBC 80/10A	£303
Intel	iSBC 86/12	£1,399
Integrated Computer Systems	Training System	£349
Mostek	OEM 80E	Not available
Mostek	MD Series	Not available
Nasco Sales	Nascom	£167
National Semiconductor	BLC 80/10	Not available
Newbear	7768	£50 approx.
Ohio Scientific	Superboard II	£284-95
Plessey Microsystems	Miproc	£500
Pronto Electronics	Z80 Eurocard (3 off)	£265
RCA Service Div.	Cosmac Eurocard	Not available
Real Time Controls	RTC 5100	Not available
Rockwell	AIM 65	£249-50
Texas Instruments	"Micro 99"	£350 approx.
Zilog	Z80 MCB	£329

## Advanced Microcomputers

THE AMC 95/4000 MonoBoard Computer (MBC) from Advanced Microcomputers, an affiliate of Siemens in Europe, is fully bus-compatible with Intel SBC 80 products.

AMC popularity, however, stems from its AMD Am 9511 Arithmetic Processor Unit. Arithmetic computations are performed by this special-purpose processor to realise a throughput up to 100 times faster than comparable software approaches.

This unit is contained on the AMC 95/6011 board to provide 32-bit floating point arithmetic, 16- and 32-bit fixed-point arithmetic, and data format operators for fixed-point and floating-point conversions.

There are 4K bytes of RAM and sockets for up to 12K bytes ROM on the

AMC 95/4000 board. By replacing a single address decoder PROM, the entire 16K bytes of address space can be reorganised, thereby permitting memory selection to external boards.

The communications port is fully-programmable and supports synchronous or asynchronous communications with full duplex capability.

An auto-initialisation feature allows repetitive DMA operations such as VDU refresh or memory buffer transfers without the need for re-programming of the DMA channel. Four DMA channels are incorporated on the board.

**Memec Ltd.**  
**Thame Park Industrial Estate,**  
**Thame, Oxon**  
**Tel: (084421) 3146**

## Memec

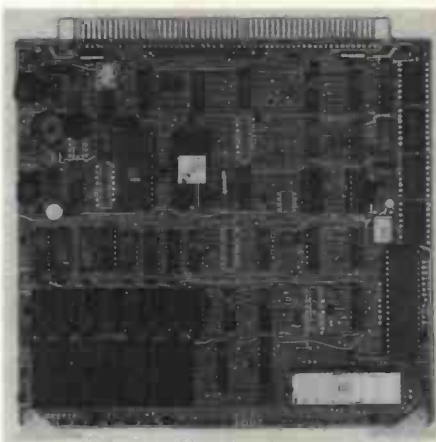

(continued on next page)

(continued from previous page)

## American Microsystems Inc.

AMERICAN Microsystems Inc (AMI) has based its EVK Series Board on the Motorola 6800 MPU. The EVK 300 is a fully-assembled and tested board, while the EVK 200, and EVK 100 and EVK 99 are in kit form. All kits are fully-expandable to EVK 300 capabilities.

One of its main features is the ability to program S6834 EPROMs (512 bytes) on-board from any memory location, RAM, ROM or EPROM.

The standard system clock is adjustable

from 300kHz to 1MHz and an on-board interval timer gives 1ms and 100ns timing marks for EPROM programming and general use. Three types of DMA operation are possible—halt processor, cycle steal or multiplexing.

All memory and I/O on board may be disabled externally by an edge connector line called 'memory disable', leaving the MPU free to operate a totally external memory.

A prototype Operating Library (Proto)

and a ROM Subroutine Library (Rs) comprising the system monitor are contained in S6830 ROMs and require 256 bytes of RAM. An optional assembler/disassembler (M/AD) S6831 ROM is available to operate with Proto.

A 20 mA current loop and an RS232C interface are both available on the board. Three S6820 PIAs allow up to 58 I/O lines.

American Microsystems Inc.  
108A Commercial Rd.,  
Swindon, Wilts  
Tel: (0793) 31345

## Brutech BEM-CPU 1

BRUTECH Electronics is a Dutch company and a relative newcomer on the scene with its BEM CPU 1 central processor card.

The card is based on the 6502 CPU and except for a small 32-byte PROM is not supplied with memory or other addressable devices. The PROM may be switched

off, enabling the user to have full access to any memory location under DMA control.

Therefore it has to be used in combination with other cards to create a working system and these are offered, too, including 2, 4, and 8K RAM, EPROMs and Interfaces.

No manuals are provided and for a

detailed description of the 6502 CPU, Brutech recommends the hardware and applications manuals of MOS Technology, Rockwell and Synertek.

Data Precision Equipment Ltd.  
81 Goldsworth Road, Woking,  
Surrey GU21 1LJ.  
Tel: Woking (04862) 64444

## Kim 1

WHEN Commodore decided to buy its own semiconductor manufacturing company, MOS Technology, it inherited the Kim 1 microprocessor system based on the 6502 CPU, the MOS Technology version of what the Motorola 6800 should look like.

Kim 1 is assembled on a PC board with 2K bytes of ROM, 1K bytes of RAM, hex keyboard and six-digit LED display. Three manuals accompany the system—user, hardware and software.

Memory may be expanded by 4K and 8K RAM using Kim 2 & 3 boards, and a cassette and Teletype interface is already on-board.

Software available includes an assembler/disassembler/editor package, an in-

formation retrieval package and a mailing list program, according to Commodore claims. They are loaded from cassette and prices start at £12. A chess game is also available.

Kim is marketed in the U.K. by an electronics chain, Marshalls, and by GR Electronics of Newport, Gwent. The latter offers a pocket terminal for £240 for the input of ASCII characters from 40 keys, and a video board for attachment to a domestic TV set for £150.

If the prices are disconcerting, the price of the Kim should help you change your mind—£99.95.

Commodore, 360 Euston Rd.,  
London W1  
Tel: (01) 388 1358

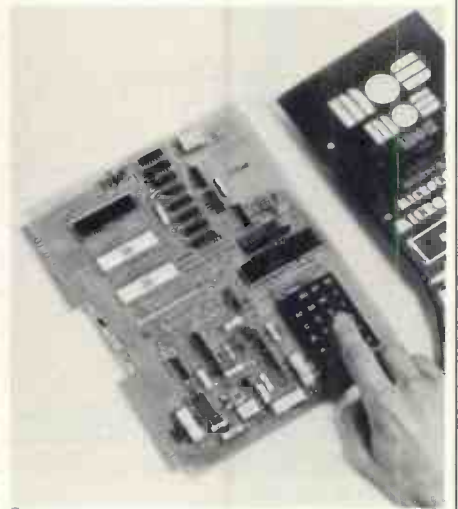

Kim 1

## Computer Automation

THE Computer Automation LSI 4/10 features a high-speed processor with a powerful instruction set, up to 4K RAM and four distributed I/O channels.

An optional configuration includes a processor and I/O-only version, plus various RAM PROM combinations. The distributed channel technique utilises the CA microcoded, Picoprocessor-controlled intelligent cables.

Each I/O distributor accommodates

up to four or eight intelligent cables. For high data-rate applications, a four-channel DMA version is available. Also available are I/O controllers for floppy medium- and high-capacity disc drives, and a full range of peripheral devices.

Core memories are offered in 4K- to 16K-word cards, semiconductor RAMs up to 32K words with cycle times as fast as 550ns, and RAM/ROM/PROM combinations up to 2K-word RAM and 8K-word ROM. All semiconductor memor-

ies have provision for battery back-up.

The Naked Mini 4 Operating System supports a macro-assembler, Fortran IV, Basic and Pascal, and editors, file and data management routines, utilities and handlers for I/O and communications.

Computer Automation  
Hertford House,  
Denham Way,  
Maple Cross, Rickmansworth, Herts.  
Tel: (87) 71211

(continued on next page)



(continued from previous page)

## Data General

DATA GENERAL's MBC/I is bound to become a serious challenger to the Digital LSI-11 single-board computer. The MBC/I comprises a 16-bit MicroNOVA CPU, 2K bytes static RAM, sockets for 4K bytes of PROM, an asynchronous communications interface, and a 32-line digital I/O port on a single  $7\frac{1}{2} \times 9\frac{1}{2}$  in. board.

This type of board is at the top of the league as far as hobbyists are concerned. A multi-tasking software support package (MBC/M) provides an emulator for other Data General systems which allows MBC/I users to develop programs under the Data General Advanced Operating System (AOS), Disc Operating System (DOS), and Real-time Disc Operating System (RDOS) and a monitor for program execution on the board.

An optional on-board ROM console debug and self-test diagnostic chip is also available. The MBC/I is compatible electrically and mechanically with the entire MicroNOVA family.

Applications may be developed using Fortran IV, single- or multi-user basic, in addition to the standard utilities in DOS

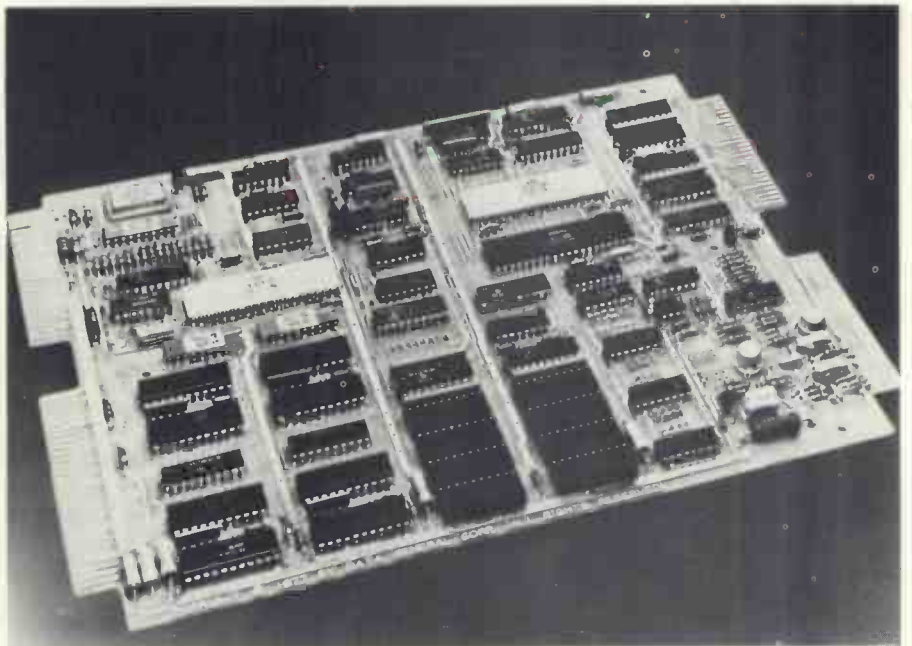

Data General MBC/I

which include a macro-assembler, command line interpreter, library file editor, text editor, re-locatable loader and Symbolic debugger.

The end-user distributor is Celdis.

Data General,  
Hounslow House,  
London Rd.,  
Hounslow, Middx.  
Tel: (01) 572 7455

## Digital Equipment Corporation

DIGITAL Equipment Corporation's LSI-11 was reviewed in depth in our sister magazine, WHICH COMPUTER? in July, 1978 and we reproduce the following extracts:

"The LSI-11 chip set was developed originally to Digital specifications by a West Coast semiconductor company, Western Digital, for a 16-bit microprocessor which would relate to the best-selling PDP-11 line.

"Many of its U.K. sales have been made through distributors like Dicoll, Rapid Recall and Midlectron. The LSI-11 is a single-card PCB which includes the CPU—basically four NMOS chips, two of which implement the PDP-11 instruction set and an on-line diagnostic routine, with a fifth chip supplied optionally at extra cost for extended arithmetic, including

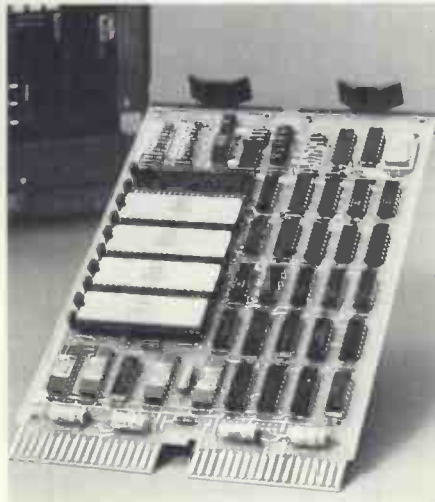

LSI 11/2

floating-point instructions.

"Also on-board are the input/output control, real-time clock, power fail/auto re-start, and a basic 4K words of semiconductor RAM.

"System software includes RT-11, a small real-time disc operating system in single- or multi-user versions, but not time-sharing. RT-11 is designed for on-line program development and interactive applications.

"RSX-11S is an execute-only version of a more powerful operating system. Up to four Basic programs can run in foreground, with background batch work on the multi-user RT-11".

Digital Equipment Corporation  
Fountain House,  
The Butts Centre,  
Reading, Berks.  
Tel: (0734) 583 555

## EMM Sesco

secs 80/10A is a severe environment equivalent of the Intel iSBC 80/10A supplied by EMM Sesco with 8080 CPU, 1K bytes of RAM and sockets for 8K bytes of ROM.

As it is designed for airborne, ship-board or land-based applications primarily for the military market; it might be

of little value to the hobbyist and difficult to obtain.

The SECS 80/10A contains 48 programmable parallel I/O lines implemented with the use of two Intel 8255 Programmable Peripheral Interfaces, and a programmable communications interface using the Intel 8251 Universal Synchronous/Asynchronous Receiver/Transmitter (USART).

The USART may be programmed by the system software to select the desired serial data transmission technique including IBM Binary Synchronous Control (BSC).

EMM Sesco  
12 Redford Way,  
Uxbridge, Middx.  
Tel: (89) 38421

(continued on page 31)



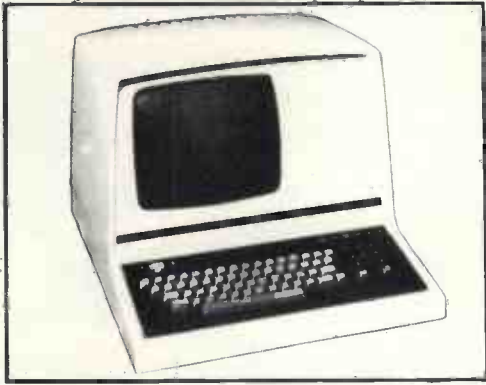

Introducing the Lyme 4000 family of visual display computer terminals, the British-designed and built Terminal exploiting all the very latest Microprocessor and N-MOS circuits. Only 32 Chips provide a VDU giving the highest performance and flexibility at low cost.

- \* 4,000 character page with 1,920 characters viewable at any one time
- \* 64/96 character set
- \* Switchable transmission speeds 75-9,600 bps (split speeds optional)
- \* HDX FDX (Model 4002) Block Mode (Model 4004)
- \* Dual interface—RS232C and 20 ma current loop
- \* Protected areas (defined by reduced intensity)
- \* XY Cursor addressing, 12" diagonal screen
- \* 12 × 7 dot matrix upper and lower case
- \* Character delete and insert
- \* Up to 16 dedicated function keys. Printer Port RS232 optional
- \* One off end user price £645

**Lyme Peripherals** Limited, 2 Avenue Court, Farm Avenue, London NW2 2PT.  
Tel: 01-4520490.

● Circle No. 131

# Euro-Calc Ltd

224 TOTTENHAM COURT ROAD, LONDON W1. TEL: 01-636 8161  
New Shop: 55-56 High Holborn, London WC1 Tel 01-405 3113

**For electronic calculators and watches.**

We have the largest range in London at the most competitive prices.

Export and Personal Export Tax, free facilities arranged.



**HEWLETT PACKARD \* CASIO  
\* SHARP \* TEXAS  
INSTRUMENTS \* OLIVETTI \*  
SEIKO \* SINCLAIR \*  
COMMODORE \* SANYO \*  
NATIONAL PANASONIC, ETC.**

We stock the

**COMMODORE  
PET 2001-8**

**APPLE II**

**NORTH STAR  
HORIZON**

and

**TEXAS SR60a**

microcomputers with a full range of hardware and software options.

● Circle No. 132

PRACTICAL COMPUTING March 1979

(continued from page 29)

## General Automation

THE General Automation GA-16/110 and 220 microcomputers are configured around a microprogrammed 16-bit CPU emulating the instruction set of the larger GA minis.

The GA-16/110 is designed as a 'load-and-go' computer for dedicated applications, without software development or sophisticated disc-based operating system.

The GA-16/220, on the other hand, has the full hardware configuration needed for program generation and for running all GA operating systems and software, except the Control IV memory management operating system for large GA-16/440

minis. In fact, it comprises two GA-16/110s attached back-to-back.

Small GA-16/110 and GA-16/220 systems are configured with one of two types of 'piggyback' memory modules; static RAM with 1K or 2K words, plus positions for 64 words of initial program load (IPL) PROM for simple applications, or 3K words of EPROM, plus 1K words of RAM working storage.

For larger systems, memory is expanded with plug-in, automatically-refreshed dynamic RAM modules of 4K or 8K words, available in 16-bit or 18-bit byte parity versions.

Programmed I/O takes place under CPU control for 16-bit parallel transfers at rates up to 120K words per second.

Interleaved DMA and serial I/O is available only on the GA-16/220.

All programs are re-entrant and recursive, I/O device-independent and relocatable. Fortran, Commercial Fortran, and Cobol modules may be linked with assembly language subroutines to form a single program if required.

Other program generation tools include CAP-16 Macro assembler, Basic, Core Load Overlay Builder, Dynamic debug, Text editor, Utilities, and hardware diagnostics.

**General Automation,**  
Victoria Road,  
Burgess Hill, Sussex.  
Tel: (04446)-43421.

## Heathkit

IN our November issue we looked at what Heathkit has to offer in terms of packaged systems. Also available is a microprocessor course and trainer based on the Motorola 6800 MPU.

The hardware comprises a microprocessor board with six-digit LEDs, hex keypad, 1K ROM monitor, and 256 bytes of RAM which is assembled from a kit of 62 components. The course covers

microprocessor basics, computer arithmetic, programming and interfacing.

This kit however, is not for the beginner, a fact which few suppliers of training kits care to admit. Heath can afford to because it has a beginners' course called Digital Techniques, a lower-level course more orientated towards electronics and logic design.

There is, however, a catch. Heath recommends the use of its IM-5284 multi-

meter (£40.18) and an oscilloscope such as its IO-4541 (£164.32) with this course.

The manuals must be the best-selling point for Heathkit and are among the best we have seen. Microprocessor training course costs £248.70 and Digital Techniques course £63.46.

**Heath (Goucester) Ltd,**  
Gloucester GL2 6EE.  
Tel: (0452)-29451

## Intel

INTEL is almost synonymous with single-board computers. The iSBC is second-sourced by numerous semiconductor manufacturers and is a *de facto* standard in industry.

Intel also makes single-board computers based in its 8085 and 8086 microprocessors. The new iSBC 86/12 is claimed as 'the most powerful microcomputer board to be announced to date'.

It comprises 16-bit CPU, up to 48K bytes memory, parallel I/O and serial communication ports on-board. Intel claims that with a 5MHz 8086 CPU it exceeds the Digital PDP-11/34 in performance. The 8MHz version will be available 'shortly'.

The iSBC 86/12 plugs into the standard Intel Multibus for expansion, using cards available from Intel and more than 100 other manufacturers supporting Multibus.

With its announcement Intel revealed the purpose of several lines on the Multibus which were not needed by 8-bit microcomputer systems; eight additional data lines, four more address lines, increasing the number to 20 to cater for the iSBC 86/12 one-megabyte addressing capacity, and a byte-control line which allows 8- and 16-bit CPUs to be used on the same Multibus in a multi-processor system.

The 8086 instruction set includes multiply and divide in binary, BCD or ASCII. On-board memory on the 86/12 includes 32K bytes of RAM and sockets for up

to 16K bytes of ROM. A dual-port feature allows the RAM to be accessed by both the 8086 CPU and any other bus master sharing the Multibus.

There is no shortage of software support for iSBC products, particularly the 80/10A, which, in addition to Intel development systems, may have applications developed on independently-supplied cross-assemblers and intermediate-code Cobol compilers such as those offered by CAP microSoft and MicroFocus.

**Intel Corporation (U.K.) Ltd.,**  
4 Between Towns Road,  
Cowley, Oxford OX4 3NB.  
Tel: (0865)-771431

## Mostek

THE Mostek OEM-80E is a single-board microcomputer designed around the Z-80 microprocessor with 4K bytes of RAM expandable on board to 16K bytes, sockets for up to 10K bytes of ROM, serial port and 40 buffered I/O lines.

It is full-expandable with a wide range of Mostek SD Series boards. RAM-80E provides up to 64K bytes of MK 4116 dynamic RAM. FLP-80E will interface the board with up to four single- or double-sided floppy disc drives.

For connection to a video display, the VDI-S/P provides the interface for 80 ×

24 upper- and lower-case characters and ASCII keyboard.

The SD Series also includes backplane cards, extender cards, and wire-wrap cards for easy systems construction.

Software support includes an operating system; FLP-80DOS, Basic, Fortran, Macro, and cross-assemblers.

Also available from Mostek are two other single-board computers. The MDX-CPU1 comprises Z-80 CPU, 4K bytes PROM and 256 bytes RAM on a compact 4.5 × 6.5 in. card. The MD-SBC1 has the same measurements but contains CPU, 8K bytes EPROM, 2K bytes RAM,

two 8-bit input ports, and three 8-bit output ports.

The Mostek SYS-80F dual floppy disc development system features 32K bytes memory, Z80 CPU card with 3K bytes dedicated PROM, serial I/O port, four parallel I/O ports, with additional memory up to 56K bytes.

**Mostek U.K. Ltd.,**  
Masons House,  
1 Valley Drive,  
Kingsbury Rd.,  
London NW9  
Tel: (01) 204 9322

(continued on page 33)



Unleash your Pet\* to its full capability. Add a Plessey Petite.



# The easy way to 32K.

- Self-contained peripheral for any Commodore Pet.
- Plugs into mains and Pet.
- No modifications required.
- No demands on Pet power supply.
- No extra heat dissipation within Pet cabinet.
- No warranty problems.

Available now from Europe's leading memory manufacturer, an add-on 24K module to make your Pet more like a powerful business computer.

On sale now through authorised distributors of Plessey Pet peripherals:

\* Trademark of Commodore Business Systems.

Business Electronics Limited  
Rownhams House  
Rownhams  
Southampton  
(0703) 738248

C.S.S. (Business Equipment)  
Limited  
502 Kingsland Road  
London E8 4AE  
01-254 3293

Dams Office Equipment Limited  
30-36 Dale Street  
Liverpool L2 5SF  
(051) 227 3301

H.B. Computers Limited  
22 Newland Street  
Kettering  
Northants  
(0536) 83922/520910

Holdene Limited  
10 Blenheim Terrace  
Leeds LS2 9HX  
(0532) 459459

Medical & Scientific Computer  
Services Limited  
Altona Road  
Lisburn, County Down  
Northern Ireland  
(084) 62 77533

Rockcliffe Brothers Limited  
2 Derby House  
Rumford Street  
Liverpool L2 8SZ  
(051) 236 6773

Sigma Systems Limited  
54 Park Place  
Cardiff  
(0222) 21515

Torbus Business Systems  
Limited  
500 Chesham House  
150 Regent Street  
London W1R 5PA  
01-734 5351

(continued from page 31)

## Newbear

THE Newbear 7768 was designed as a rudimentary CPU board which could be bought at around £50 and expanded upon as time and pocket permitted.

The board is based on the Motorola 6800 MPU, 256 bytes of RAM, miscellaneous control logic and 'halt', 're-set', and 'load' switches, and is constructed from a kit.

Once this kit is assembled it will not be long for the 'expandability' bug to set in. A 4K byte RAM is available with straps which allow it to be set to any 4K block within the 64K-byte address block.

A monitor allows for the attachment of a cassette or paper tape drive and terminal comprising two UARTs with output buffers to interface with TTL or 20mA current loop or RS232C terminals, 1K byte of memory and provision for a

32- or 64-byte bootstrap loader in PROM to load a monitor from cassette or paper tape into the 1K RAM via one of the serial input ports.

(With acknowledgment to the Amateur Computer Club)

**Newbear Computing Store**  
7 Bone Lane,  
Newbury, Berks.  
Tel: (0635) 49223

## Nascom

THE Nascom 1 will need little introduction to most U.K. hobbyists because it has been promoted very aggressively.

Sold through Lynx Electronics of London, the Nascom is based on the Z-80 CPU and supplied in kit form complete with full QWERTY keyboard.

The kit comprises a 12 x 8 in. card, five LSI MOS chips (six with second EPROM option), 16 1K MOS chips (2K bytes) and 33 TTL chips, all packaged, of course.

Some of the so-called options are clearly necessary to get a going system, such as an extra 2K bytes of RAM, cassette modem or Teletype, CPU clock and video modulator.

A monitor allows for setting break-points, single-stepping and tabulating on screen.

**Nascom Sales Ltd.,**  
92 Broad Street,  
Chesham, Bucks.  
Tel: (02405) 75151



**Nascom 1**

## National Semiconductor

NATIONAL SEMICONDUCTOR has four single-board computer in its Series/80 micro-computer systems.

The BLC-80/10 is a self-contained board-level computer based on second-source 8080A CPU with 1K RAM and sockets for 4K RLM, 48 programmable I/O lines, and RS232C or 20mA current loop interfaces.

The BLC-80/11, 80/12 and 80/14 micro-computers provide greater on-board

RAM capacity up to 4K bytes and jumper-selectable transmit/receive reverse for RS232C interface.

Software may be developed on the Starplex SPX-80/40 development system, a general-purpose, user-orientated hardware and software system based on the 8080 family processor with 64K bytes of RAM.

The Starplex system comprises keyboard/VDU, floppy disc storage up to one megabyte, 50 cps thermal printer, and PROM programming option.

System software includes operating

system, macro-assembler, text editor, linker, debugger, Basic interpreter/compiler, and Fortran compiler.

Most of these products are plug-for-plug, second-source replacements for existing Intel SBC products but National claims to offer significant improvements, such as greater reliability, more convenient user options and cleaner design.

**National Semiconductor U.K. Ltd.,**  
301 Harper Lane, Bedford  
Tel: (0234) 211262

## Ohio Scientific

THE Superboard II from Ohio Scientific provides a 6502 microprocessor, 8K Microsoft Basic in ROM, 4K bytes RAM, and full QWERTY keyboard with upper- and lower-case characters.

An optional expander board adds 24K

bytes of extra RAM and interfaces for printer and mini-floppies. Otherwise the board supports Kansas City standard audio cassette interface.

Features include I/O utilities in ROM and direct-access video display with 1K of dedicated memory (beside user 4K memory), and upper- and lower-case characters, graphics, and gaming

characters from a normal TV set.

An optional assembler/editor and extended machine code monitor is available.

**Lotus Sound,**  
4 Morgan Street,  
London E3 55B.  
Tel: (01)-981 3993

## Plessey Micro Systems

PLESSEY Micro Systems offers a wide range of semiconductor memory systems com-

patible with all the popular micro-processors. They are designed to provide low-cost, versatile modules for both OEM and end-user. In addition, it offers the

System 80 range of single-board computer products based on the 8080A and 8085. These modules enable powerful micro-

(continued on page 35)



# 1979 MICRO-COMPUTER SHOW

INCORPORATING THE  
DIY COMPUTER FAIR

## At the Bloomsbury Centre Hotel, London 5-7 July '79

A three day exhibition, with seminars, developed from the highly successful 1978 DIY Computer Show. This year greater emphasis will be given to the rapidly expanding area of Personal Computers in Business.

Exhibitors will be able to sell their goods direct from the stands; creating an ideal market place for the ever growing number of personal computer retail outlets.

### **BOOK NOW - SAVE 20%**

A discount of 20% is offered on all exhibition space for which full payment is received before 28 February 1979.

### **Seminars**

Thursday, 5 JULY Microprocessors in Light Industry

Friday, 6 JULY Personal Computers in Business

Saturday, 7 JULY Personal Computers in the Home

### **Speakers will include:**

Portia Isaacson (USA), Adam Osborne (USA), Howard Kornstein (Intel), Keith Baker (University of Sussex), John Coll (Oundle School), Mike Gurr (BOC), Guy Kewney (Computing).



Online Conferences Limited  
Cleveland Road, Uxbridge, England UB8 2DD  
Telex: 261173. Cables: Online Uxbridge  
Phone: Uxbridge (0895) 39262

For full details complete the coupon and return to Online Conferences Ltd. or telephone (0895) 39262.

Name \_\_\_\_\_ Position \_\_\_\_\_

Company \_\_\_\_\_

Address \_\_\_\_\_

Phone \_\_\_\_\_ PC \_\_\_\_\_

(continued from page 33)

computers to be built at competitive costs.

The key products in the range are the PMS 80/10, a self-contained, single-board computer including the 8080A CPU, system clock, RAM and ROM I/O lines, serial communications interface, bus

logic and drivers. The PMS 8201 single-board disc controller supports two standard or mini-sized floppy disc drives and has on-card error-checking and logic for soft-sectored formatting.

The PSM 4463I memory boards with up to 64K-bytes capacity use dynamic RAMs to provide low cost and contain the board,

the control and timing logic to provide transparent refresh.

**Plessey Micro Systems**  
Water Lane,  
Towcester,  
Northants.  
Tel: (0327) 50312

## Pronto

AT Compec '78, a newcomer, Pronto Electronic Systems, launched a range of Z-80-based Eurocards and a graphics package consisting of four single Eurocards complete with software.

A three-card set provides a complete microprocessor system with Z80 CPU, 1K byte of RAM, sockets for 8K bytes of PROM, and PIO (programmable I/O) card for £265.

Pronto Electronics is a U.K. OEM supplier and consultancy and will write

applications programs for users. Otherwise there is no user software support.

**Pronto Electronic Systems Ltd.,**  
645-647 High Road,  
Seven Kings, Essex IG3 8RA  
Tel: (01) 599 3041.

## RCA Cosmac

A SWEDISH firm, Bhiab Electronics, has developed a single-board personal computer system based on the RCA Cosmac CDP 1802 with powerful video graphics facilities.

SPC 1800, has a simple 64-character 'light touch' keyboard as well as a ready-to-use cassette with some 40 programs. The board comprises the CPU, 4K bytes of RAM expandable externally to 32KB,

graphic video display interface, sound circuits, 512 bytes ROM operating system, and documentation.

It features CHIP-8, an interpretative programming language consisting of 31 instructions. By the use of single instruction, one may generate a random byte, read-in a hex keyboard digit, display a pattern on the video screen, sound a tone, increment a variable, or set a real-time clock.

Sixteen one-byte variables are provided

and subroutine nesting and machine language inserts are permitted.

The optional CRT screen is probably advisable for the system. With it, RAM may be extended by another 8K, and it provides 16 lines × 64 characters per line.

**RCA Service Division,**  
Lincoln Way,  
Sunbury-on-Thames,  
Middlesex TW16 7HW  
Tel: (09327) 85511

## Real Time Controls

REAL TIME Controls Ltd offers a Z-80-based microprocessor incorporating a fully-buffered busbar channel for memory, I/O and peripheral controller expansion called the RTC 5100.

It incorporates a Z80 CPU, 4K bytes of RAM expandable to 16K bytes and two parallel I/O ports. A printed circuit backplane is available for mounting the board with five extra slots for expansion.

The company claims that the RTC 5100 is supported with an extensive range of

software including a real-time operating system.

**Real Time Controls Ltd,**  
Kebbell House, Carpenders Park,  
Watford, Herts WD1 5BE  
Tel: (01) 428 0088

## AIM 65

IT TOOK Rockwell long enough to get a product on the market but those who waited will not be disappointed with the AIM 65.

The AIM 65 is fully-built and tested with full QWERTY keyboard, 20-character display, and 20-column printer configured around a 6502 CPU second-

sourced from MOS Technology.

The printer uses thermal roll paper and produces characters formed in a 5 × 7 dot matrix operating at 120 lines per minute. On the display, the characters are formed by 16-segment-font monolithic LEDs.

AIM 65 has a 4K ROM monitor and spare sockets for additional ROMs, including those containing Rockwell's

assembler, text editor, and Basic interpreter plug-in options.

RAM may be expanded off-board, and a cassette and Teletype may be attached directly via on board interfaces.

**Pelco Electronics Ltd,**  
Enterprise House, 83-85 Western Road,  
Hove, Sussex BN3 1JB.  
Tel: Brighton (0273) 722155.

## Texas Instruments

THE TMS9900 must be one of the most powerful commercially-available microprocessors on the market. It is unconventional in that the CPU has no accumulators but instead uses 16 consecutive 16-bit words of memory, known as a 'workspace', which are addressed via a pointer in the CPU, which may be software driven—the only restriction on the

number of workspaces is memory size.

A ready-built 'Micro-99' board may be bought comprising CPU, 256 words of RAM, 16 I/O lines (parallel) and a 20mA current loop and RS232C interface, along with the 1K Tibug ROM monitor.

The CPU has 69 instructions compatible with the upper range of TI minis and including 16-bit multiply and divide. There are 16 external and 16 software interrupts, all separately vectored.

For software development, Texas supplies an Advanced Microprocessor Prototyping Library, a floppy-disc-based minicomputer for generating software or debugging hardware. High-level languages include a Fortran IV and Coral-66 compiler.

**Texas Instruments Ltd.,**  
Manton Lane  
Bedford MK41 7PA  
Tel: (0234) 67466

## Zilog

IN DESIGNING its Z-80 microprocessor, Zilog made it completely compatible with the Intel 8080 instruction set but used an enhanced second-generation MOS fabrication process to add a few instructions of its own and to put the instruction set on a mirror image, thereby providing more than double the amount of instructions of the 8080.

In spite of this, the majority of applications utilising the Z-80 treat it as an emulation of the 8080. Nevertheless, it will provide a fascinating device with which the hobbyist can experiment.

The Z-80 microcomputer board comprises the Z-80 CPU, up to 16K bytes of dynamic RAM, provision for up to 4K bytes of ROM, and parallel and serial ports. The parallel port is implemented with the Z-80-P10, and the serial port

with an 8251 USART.

Two versions of monitor software (1K and 3K bytes) are available in bi-polar PROMs for insertion into four 24-pin PROM sockets, allowing for software debugging and terminal interface.

**Memec Systems Ltd,**  
Thame Park Industrial Estate,  
Thame, Oxon OX9 3RS.  
Tel: Thame (084421) 5471.



# New slant on an ancient game

OUR GAME this month is Nim, an ancient game in which two players take turns to remove matches from a pile in a group of piles. there are in each pile. If you do not wish to do this, the computer will do it randomly. The winner is the player who forces his opponent to remove the last match.

Only one pile may be accessed at any one time but any amount (at least one) can be removed from that pile.

You will be given the option of setting the piles, and how many

*The program was written by 15-year-old schoolboy David Hartnell from Birmingham, and has been tested by Practical Computing.*

```
Ready

LIST
NIM      02:00 PM      16-Jan-79
10 PRINT "A GAME OF NIM IS READY.DO YOU WANT INSTRUCTIONS?";
20 INPUT Z$
30 IF Z$="N" THEN 120
40 PRINT "THE GAME OF NIM IS AN OLD GAME IN WHICH TWO PLAYERS TAKE"
50 PRINT "TURNS TO REMOVE MATCHES FROM A PILE IN A GROUP OF PILES."
60 PRINT "ONLY ONE PILE MAY BE ACCESSED AT ANY ONE TIME BUT ANY"
70 PRINT "AMOUNT CAN BE REMOVED FROM THAT PILE. (AT LEAST ONE)"
80 PRINT "YOU WILL BE GIVEN THE OPTION OF SETTING THE PILES,AND HOW"
90 PRINT "MANY THERE IN EACH PILE.IF YOU DO NOT WISH TO DO THIS THE"
100 PRINT "COMPUTER WILL DO IT RANDOMLY.THE WINNER IS THE PLAYER WHO"
110 PRINT "FORCES HIS OPPONENT TO REMOVE THE LAST MATCH."
120 PRINT
130 PRINT "WHO WILL SET THE PILES?TYPE 1 FOR PLAYER OR 0 FOR COMPUTER;"
140 INPUT M
150 IF M=0 THEN 220
160 IF M=1 THEN 270
170 GOTO 120
200 REM:COMPUTER SETS PILES
220 LET A=INT(RND(-1)*8)+1
230 IF A<3 THEN 220
240 GOTO 360

270 REM:PLAYER SETS PILES
280 PRINT
300 PRINT "HOW MANY PILES ARE THERE?(AT LEAST 3,NO MORE THAN 8).";
310 INPUT B
320 IF B=INT(B) AND B>2 AND B<9 THEN 350
330 PRINT "ERROR:PLEASE TYPE AN INTEGER BETWEEN 2 AND 9".
340 GOTO 300
350 LET A=B
380 DIM P(25)
390 IF M=1 THEN 530
420 REM:COMPUTER CHOOSES HOW MANY IN EACH PILE
440 FOR C=1 TO A
450 LET P(C)=INT(RND(-1)*7)+1
470 NEXT C
480GOTO 650
510 REM PLAYER CHOOSES HOW MANY IN EACH PILE
530 FOR C=1 TO A
540 PRINT "HOW MANY MATCHES IN PILE";C;"?(AT LEAST 1,NO MORE THAN7)".
550 INPUT K
560 IF K=INT(K) AND K>0 AND K<8 THEN 590
570 PRINT "ERROR:PLEASE TYPE AN INTEGER BETWEEN 0 AND 8."
580 GOTO 540
590 LET P(C)=K
600 NEXT C
650 DIM D(3),F(3)
700 GOSUB 1240
730 REM:DECIDE WHO STARTS
750 PRINT "WHO WILL START?TYPE 0 FOR COMPUTER,1 FOR PLAYER";
760 INPUT N
770 IF N=1 THEN 840
780 IF N=0 THEN 1440
790 GOTO 750
820 REM:PLAYER'S TURN
840 PRINT
850 PRINT "WHICH PILE WILL YOU ALTER?";
860 INPUT G
870 IF G=INT(G) AND G<=A AND G>0 THEN 900
880 PRINT "ERROR:PLEASE TYPE AN INTEGER BETWEEN 0 AND";A+1
890 GOTO 840
900 IF P(G)>0 THEN 930
910 PRINT "SORRY,THIS PILE HAS NO MATCHES IN IT-TRY AGAIN!!!"
920 GOTO 840
930 PRINT "HOW MANY MATCHES WILL YOU TAKE FROM THIS PILE?";
940 INPUT H
950 IF H=INT(H) AND P(G)-H>=0 AND H>0 THEN 960
960 PRINT "SORRY,THAT NUMBER CAN'T BE ACCEPTED-TRY AGAIN!!!"
970 GOTO 930
980 LET P(G)=P(G)-H
```

```

1010 REM:PRINT GAME SO FAR AND TEST FOR A WIN
1030 GOSUB 1240
1040 GOSUB 1350
1050 IF Y=0 THEN 1120
1060 IF Y=1 THEN 1120
1070 GOTO 1440
1100 REM:A WIN FOR PLAYER-PLAY AGAIN?;
1150INPUT AS
1160 IF AS="YES" THEN 120
1170 PRINT
1180 PRINT "OK THEN,GOODBYE."
1190 STOP
1220 REM:SUBROUTINE TO PRINT GAME SO FAR.
1240 PRINT
1250 PRINT "PILE", "MATCHES"
1260 FOR C=1 TO A
1270 PRINT C,P(C)
1280 NEXT C
1290 PRINT
1300 RETURN
1330 REM:SUBROUTINE TO TEST FOR A WIN.
1350 LET Y=P(1)
1360 FOR C=2 TO A
1370 LET Y=Y+P(C)
1380 NEXT C
1390 RETURN
1420 REM:COMPUTER'S TURN
1440 PRINT
1450 PRINT "MY TURN"
1460 LET E=1
1470 LET D(E)=0
1480 IF E=3 THEN 1510
1490 LET E=E+1
1500 GOTO 1470
1510 FOR C=1 TO A
1520 IF P(C)>=4 THEN 1560
1530 IF P(C)>=2 THEN 1600
1540 IF P(C)>0 THEN 1650
1550 GOTO 1660
1560 LET D(3)=D(3)+1
1570 LET X=P(C)-4
1580 IF X>2 THEN 1610
1581 IF X=2 THEN 1610
1600 LET X=P(C)
1610 LET D(2)=D(2)+1
1620 LET X=X-2
1630 IF X>0 THEN 1650
1640 GOTO 1660
1650 LET D(1)=D(1)+1
1660 NEXT C
1710 IF D(5)<2 THEN 1730
1720 GOTO 2020
1730 IF D(2)<2 THEN 1750
1740 GOTO 2020
1750 LET J=0
1760 IF D(1)-J=0 THEN 1800
1770 IF D(1)-J=1 THEN 1820
1780 LET J=J+2
1790 GOTO 1760
1800 LET V=0
1810 GOTO 1830
1820 LET V=1
1830 IF D(3)=1 THEN 1880
1840 IF D(3)=1 THEN 1860
1850 GOTO 2210
1860 IF V=0 THEN 2420
1900 GOTO 2360
1910 FOR C=1 TO A
1920 IF P(C)<>7 THEN 1950
1930 IF V=0 THEN 3170
1940 GOTO 3200
1950 IF P(C)<>6 THEN 1980
1960 IF V=0 THEN 3170
1970 GOTO 3200
1980 NEXT C
2020 LET E=1
2030 LET J=0
2040 LET W=D(E)
2050 IF W-J<>0 THEN 2100
2060 LET F(E)=0
2070 IF E=3 THEN 2150
2080 LET E=E+1
2090 GOTO 2030
2100 IF W-J<>1 THEN 2130
2110 LET F(E) =1
2120 GOTO 2070
2130 LET J=J+2
2140 GOTO 2040
2150 IF F(3)<>0 THEN 2250
2160 IF F(2)=0 THEN 2190
2170 IF F(1)=0 THEN 2680
2180 GOTO 2740
2190 IF F(1)=0 THEN 2210
2200 GOTO 2490
2210 LET C=1
2220 IF P(C)>0 THEN 3050
2230 LET C=C+1
2240 GOTO 2220
2250 IF F(2) <0 THEN 2280
2251 IF F(2) >0 THEN 2280
2270 GOTO 2810
2280 IF F(1)=0 THEN 2970
2290 GOTO 2880
2360 LET C=1
2370 IF P(C)=4 THEN 3140
2371 IF P(C)>4 THEN 3140
2390 GOTO 2370
2420 LET C=1
2430 IF P(C)=5 THEN 3170
2440 IF P(C)=4 THEN 3110
2450 LET C=C+1
2460 GOTO 2430
2490 LET C=1
2500 IF P(C)=7 OR P(C)=5 OR P(C)=3 OR P(C)=1 THEN 3050
2510 LET C=C+1
2560 IF P(C)=3 OR P(C)=2 THEN 3080
2570 LET C=C+1
2580 GOTO 2560
2610 LET C=1
2620 IF P(C)=5 THEN 3110
2630 IF P(C)=2 THEN 3050
2640 LET C=C+1
2650 GOTO 2620
2680 LET C=1
2690 IF P(C)=6 OR P(C)=3 OR P(C)=2 THEN 3080
2700 LET C=C+1
2710 GOTO 2690
2740 LET C=1
2750 IF P(C)=7 OR P(C)=3 THEN 3110
2760 IF P(C)=6 OR P(C)=2 THEN 3050
2770 LET C=C+1
2780 GOTO 2750
2810 LET C=1
2820 IF P(C)=7 OR P(C)=5 THEN 3170
2830 IF P(C)=6 OR P(C)=4 THEN 3110
2840 LET C=C+1
2850 GOTO 2820
2880 LET C=1
2890 IF P(C)=7 THEN 3230
2900 IF P(C)=6 THEN 3170
2910 IF P(C)=5 THEN 3110
2920 IF P(C)=4 THEN 3050
2930 LET C=C+1
2940 GOTO 2890
2970 LET C=1
2980 IF P(C)>=6 THEN 3200
2990 IF P(C)>=4 THEN 3080
3000 LET C=C+1
3010 GOTO 2980
3050 LET K=1
3060 GOTO 3270
3080 LET K=2
3090 GOTO 3270
3110 LET K=3
3120 GOTO 3170
3140 LET K=4
3150 GOTO 3270
3170 LET K=5
3180 GOTO 3270
3200 LET K=6
3210 GOTO 3270
3230 LET K=7
3250 REM:REMOVE MATCHES FROM PILE.
3270 LET P(C)=P(C)-K
3280 PRINT
3290 PRINT "I AM TAKING";K;"MATCHES FROM PILE";C
3300 PRINT
3330 REM:PRINT GAME SO FAR AND TEST FOR A WIN.
3350 GOSUB 1240
3360 GOSUB 1350
3370 IF Y<>1 THEN 840
3400 REM:COMPUTER WINS
3420 PRINT
3430 PRINT "HARD LUCK, I HAVE BEATEN YOU."
3440 PRINT
3470 REM: ANOTHER GAME?
3490 GOTO 1130
3500 END

```



Setting-up an entire school computer department can be a headache. Doing it successfully on £250 is little short of a miracle. "We haven't had to sell matches, but it's almost been like that", says Tony Compton, the brain behind the project at Fearnhill School, Letchworth, Herts.

Compton is head of the physics department. Starting with nothing—no experience, no equipment and very little money—he built FREACK, the Fearnhill Resource and Educational Applications Computer Kit.

The system comprises a Nascom 1 kit, a Ferguson black and white portable television set, and an ordinary cassette tape recorder. The system is already proving an invaluable aid to teaching in physics, biology and astronomy.

The idea of a school computer began in the Autumn of 1977, after Compton read articles in an electronics constructors' magazine. He realised that a computer was no longer an impossible luxury; one could be built on a very limited budget.

### Training ground

"I felt the need for a computer in the school, in the first place mainly because I think a school should be a model of the outside world," he says, "It's the outside

# School's miracle effort for £250 with FREACK

world they'll be going into, and there is so much computing going on out there that I really felt there ought to be something in the school. Now the pupils can get an idea of a computer, what it can do and what it can't, as well as being a training

by

KAY FLOYD

ground for those people who might enter into computing, or at least, might do a lot of computing".

It soon became apparent that the school was not convinced of the educational advantages of having a computer, compared to all the other items on which it wished to spend its meagre resources.

So finance was one of the major factors which influenced Compton's choice of machinery. "The alternatives were either to get a terminal in the school, which would have cost around £800, or we could have had what the county council wanted us to

buy—that would have cost around £1,000."

In spite of opposition from his colleagues, Compton took a chance. He "mortgaged" the physics department and ordered one of the then unproven Nascom 1 kits. It arrived last June and in the next three to four weeks Compton built the system. The case which houses it was obtained separately, the power supply was designed at the school and built from components supplied through the years by local firms which have used the school as a "dustbin" for obsolete equipment. The television set was given by one of the school cleaners.

### No experience

Plans were made at the time of ordering the kit for sixth-year pupils to begin a course and help develop programming methods for the system. All programs were written in Z-80 machine code, about which Compton and his pupils knew nothing.

"We learned together", he says. "We simply had to learn the principles of

(continued on next page)

Pupils with their system.





### Tony Compton using FREACK.

(continued from previous page)

machine-code programming. I was learning from scratch. It was a case of sitting down together, swapping ideas and telling each other what we'd learned".

In addition to having no programming experience, Compton had no technical computing experience. "I was very interested in the idea of computing at university, and I just missed it since it was two years before they began using computers in university courses and I've always felt the lack of it in myself.

"I felt if I didn't do something about it, not only was I going to be missing-out but I was missing an opportunity for the school".

The great switch-on day for FREACK was four weeks after the kit was delivered. It almost worked, except for two faults which were soon corrected by Compton's group of "experts".

### Ecology programs

The computer has by now attracted a sizeable following. Almost every day Compton finds a new pupil using the 'teach-yourself' worksheet which he devised. All sorts and conditions of pupils have been seen during lunch-times trying the games the senior students have developed.

So far, a library of 16 programs has been written, ranging from games like Mastermind to ecology programs and a stars program for the astrology class. The programs have been conceived during the one-hour-a-week programming

lessons. The games programs, apart from being fun to play, were developed for the school fair and parents and visitors were asked to pay a nominal fee to play them.

At present, the system has only 1K of memory and it takes about two minutes to call-up each program. Long programs have to be dumped on to an audio-cassette, as FREACK forgets everything when it is switched off, apart from its built-in monitor program.

For educational use in the classroom there are statistics programs, graph plotting, oscillations, and a small-scale model of a 'bad business computer', complete with faults like sending out invoices for £0.00.

### Sparking

Plans include a moving night sky, chemical equilibrium and an illustration of how sparks occur. Some help to the school timetablers is not outside the realm of possibility, although it would be limited. Compton reckons that the system will have benefitted about half of the 760 students by the time it has been installed for a year.

Now that he has the system working, he will not sit back and rest. He is hoping for an extra £240 from "various sources" shortly, so that he can implement a 2K version of Tiny Basic on to the system. An expansion to 8K memory is scheduled for next year.

"The advantage of doing it this way is that you can do it gradually and you don't have to spend all the money at

once", he says. He also hopes to improve the graphics facilities.

"The other big problem is that you have 48 characters in a line, and you have 16 lines, so to try to make molecules go flying across the screen is not very easy. We hope to have better graphics by the end of the school year". Hard-copy facilities are expected in two or three years.

### Fun to build

Compton is also developing an interface of his own design, with two analogue-to-digital converters which allow bit inputs and analogue input and output. It will mean that he can extract TV signals to synchronise television video recorders. He hopes that will lead to stage lighting control and a system for teaching people how to use a telephone switchboard without disconnecting callers.

The system has limited capabilities as it stands but Compton maintains that it has been "fun building it". "Obviously I would have been happier with a larger thing, to be able to use Basic at once. It would also be better from the point of view of teaching.

"At the moment this looks like an expert's machine, and to a large extent it is. In fact, the only way it's not an expert's machine, is if we, the small group of experts, can develop programs which the staff can use, just as an audio-visual aid like a television. That is the only way non-experts can use it, because machine-code programming is fairly sophisticated. It's tedious, but it's good training".





## THERE'S MORE TO LUTON THAN CAMPARI AND THE AIRPORT

There's the Commodore PET, the APPLE II, the North Star Horizon, Processor Technology's Sol, Cromemco's Z2, Z2D and System 3. Together with disc drives and terminals and printers and VDUs and all manner of accessories and books and magazines. Almost everything the Personal Computer lover could wish for. So put away the holiday brochures and come along to—

**i**sher-woods

PERSONAL COMPUTER SYSTEMS

110 Legrave Road - Luton - Tel (0582) 424851 - Just off the M1.

With acknowledgements to David Campari and Luton Airport.

● Circle No. 135

# MATROX FROM SHELTON

### TV GRAPHIC AND ALPHANUMERIC VIDEO RAMS

Intel SBC-80, LSI-11, S100 and general purpose cards, modules and LSI ICS. Some can be operated together for colour or TV picture + Alphanumeric or graphics + alphanumeric.

Eg:	£ 1-off
MTX 1632 16 rows 32 chars module	£162.00
ALT 250 × 256 graphics (S100)	£284.00
MSBC—2480 SBC—80 24 row 80 char	£356.00
MDC—512 (PDP-11) 512 × 512 graphics	£995.00
MTX—A1 uPC controller—KBD + LEDs	£ 28.00



**SHELTON INSTRUMENTS LTD.,**

22/24 Copenhagen Street, London N1 0JD Tel: 01-278 6273

● Circle No. 136

PRACTICAL COMPUTING March 1979

# Hunt-and-find service cuts time and distance

THERE are days when you can look across the Firth of Clyde from the Ayrshire coast to the Isle of Arran and appreciate quickly that the 14-miles sea crossing will be either a feat of endurance or an impossibility. So how, then, is it possible for Ardrossan, mainland base for the ferry boats, sometimes to appear closer to far-off California—strictly in computer terms?

The man who can provide the answer is 30-year-old Mike Parry. Joint director of Airamco Ltd., along with 34-year-old Malcolm Cardill, Parry, as one of the sidelines to the business of selling computer equipment, operates a Hunt-and-find service for equipment which is in short supply and urgently needed.

From his base in appropriately-named Witches Linn, Parry might be expected to use a besom but instead employs the simple expedient of the telephone, contacting all the possible known sources of supply—provided that the customer is prepared to pay for the cost of the calls.

Yet how is it easier to get goods to this Scottish outpost quicker than it might be to obtain them, say, in London?

## Same-day clearance

"Easy", says Parry. "Prestwick is just down the road and whereas equipment might lie at London Airport for a week or two, I can always get clearance at Prestwick in a day.

"It certainly doesn't make it any more difficult when I tell you that the head of Customs at the airport lives at the end of my road."

Parry and Cardill started the company in 1976. Parry, after service in the Royal Navy, worked for four and a half years as an instrument commissioning engineer for Honeywell and, like his fellow director, first made his acquaintance with Scotland's west coast at Hunterston B Power Station, down the road from Ardrossan towards Largs.

"After being on 24-hour call, I decided it might be better to go freelance", he says, "and then decided the next step was to form a company."

"Since then, from watching micros scratching the surface, I have seen them come on in a big way. I certainly never thought when we started that it would go so well, or that the biggest problem would not be selling equipment, but getting deliveries.

"Our business has expanded so much that that is probably our biggest problem. The large pending order file is what we are continually trying to reduce.

"We have a policy of making sure that no customers' cheques are cashed until they get delivery. The cheques just lie

there with the orders until the equipment is available. There is no way we are ever going to trade with other people's money.

"Because of that, we are always anxious to move things as quickly as possible, and so the customer must benefit in the long run. After all, we are anxious to use that money, because we've reached the stage, after looking on £500

by

**HAROLD MAYES**

to £600 as a big order six months ago, where we are often thinking instead now of £5,000-£6,000.

"We don't set ourselves up as being able to provide all the answers. People ask for equipment and we provide it. Of course, if someone is trying to put together something which is not likely to work we should tell him right away. But we don't say what we don't know, and we don't make false promises.

"The biggest criticisms we have had have been from people who have suggested we are slow in delivery on occasions, but there are times when people

have to wait to buy at our prices.

"I think some of our prices are the cheapest in the U.K. I try to give a fair pricing, an economic pricing, and in those circumstances the play-off is sometimes extended delivery. From our point of view it means finding out who are the ropey suppliers and staying away from them.

"If people want super-fast deliveries, they can always go to people who charge twice as much as we do", he adds.

Scottish clannishness, Parry agrees, helps in obtaining orders from people who wish to shop with suppliers in their own country—even though he's a Welshman from Colwyn Bay, he's sufficiently integrated to be chairman of the Glasgow group of the Scottish Amateur Computer Society, which has some 25 members after an existence of only four months.

## Home buyers

"Orders come from universities, schools and teaching colleges", he says, "but a lot of local enthusiasts like to buy in Scotland, which helps".

Parry has one other observation to make pertinent to the industry. He regards *Practical Computing* as the best magazine available. "And that", he says, "is not just because it produces more orders for me". So there.

**MIKE PARRY doesn't often have his eyes closed to possibilities but that is how the camera caught him when Princess Margaret visited the Airamco stand at the TV and Microelectronics exhibition at Birmingham.**





ONE MICRO manufacturer bemusedly said that his company, when enquiring in the marketplace for application software houses to write software for its new machine, had replies from more than 500 "companies"—he reckons there are thousands of them.

The vast majority are the ubiquitous "man-boy-dog-garage" and not a few are sizeable—10 or more programming staff.

The situation reflects conditions in the micro marketplace—a very wide range of equipment both U.K.-manufactured and imported, mostly from the U.S., at a wide range of prices.

The micros being pushed at the hobbyist and very small businessmen are easy to set-up and to program. Still, there is a big slice of that group which wants pre-programmed games, home applications, and business applications. So, scenting fair game, the entrepreneurial software genius is setting-up to provide them, either "one-offs", like a software consultancy, or packaged to sell by the thousand, they hope.

In this series we shall concentrate on applications for the small businessman, starting with stock recording and stock control—later on, we'll look at ledgers (sales, purchase, nominal), order processing and invoicing, financial and management accounting.

## Functions

We start with what stock recording and stock control ought to be, and what we can find calling itself "stock ordering/stock control".

Let us look at the functions of stock recording and stock control. To start, stock control is impossible without good stock recording. Stock recording tracks the movement of goods in and out of the stock room and shows what stock is on

# Applications for the small businessman

hand. Stock recording should do five things:

1. Receive the goods into store and match the items and quantities shown on the incoming invoice;
2. See that the goods are identified properly and located easily;
3. Issue the goods;
4. Maintain records of receipts, issues, shortages and adjustments;
5. Make the stock room safe from pilferage.

At point 4, a properly-designed records system aids the businessman. This "records" system can either be manual, as many are, or computerised. How can it be computerised? First, the number of items to be tracked limits the design. If cassette, then about 200 items per cassette, depending on how much information about each item is kept; if floppy discs, then perhaps a factor of 20 and higher improvement in number of items recorded but also an increase of five to 10 times the cost.

## Information

The kind of information a businessman in retail/wholesale and distribution trades may want to retain on a monthly basis includes:

1. The item description (and code number);
2. The month-to-date issues, receipts,

and adjustments (this for damaged goods, returns, and the like);

3. a, Balance on hand;
  - b, On order next month;
  - c, Allocated (forward delivery dates) and back ordered;
  - d, Balance available.

Those items are sometimes called "perpetual" stock (or inventory) recording. In addition, some businesses want values of stock and status by supplier.

The recorded data, updated daily, weekly or monthly, is then available for printed management reports on a periodic basis or, better still and in addition, as enquiry answers from a display screen.

So then the businessman knows what and how much is in stock. He can then proceed to stock control, i.e., how much should be ordered, when, and at what frequency? When a businessman can satisfy customer demand while keeping his level of stock of each item to a minimum, he increases his profit margins enormously. Here we come to a jungle of definitions and terminology about stock control. We will try to keep it simple, at the expense of completeness and clarity.

What more does a businessman have to know before he places an order on a supplier?

- Customer Service Level—there are two definitions: a, ratio of demand

(continued on next page)

	When Available	Machine	Supplier	Cost (hardware and software; not incl. VAT)
<b>PETSOFT</b> Stock Control	Now	Pet	Petsoft, Newbury, Berks.	£712
<b>COMPELEC</b> Stock Control	Mar 79	Series I	Compelec, London	about £5,500
<b>VIDEO-STOCK</b>	early 79	Machine Independent	Video Software, Worcester	£1,000 to £5,000 (software only)
<b>MICROINV</b>	Now	Sorcerer	Comp Computer, Components, New Barnet, Herts.	about £2,300
<b>COMPUCORP</b> Stock Control and Invoicing	Now	Compucorp 625	Compucorp, Wembley	about £4,500
<b>COMPUTER MART</b> Stock Control System	Now	VDP-80	Computer Mart Ltd, Norwich	about £8,000
<b>EQUINOX</b> Inventory-I	Now	Horizon	Equinox Computer Systems Ltd, London	about £4,000

(continued from previous page)

- quantity met from stock to total demand; b, ratio of value of orders filled to total order value received. "Normal" service levels are between 95 and 98 percent.
- **Lead Time**—this is the time between the businessman placing an order on his supplier and the actual delivery of the goods to his warehouse/shop.
- **Safety Stock**—stock required to minimise "stock-outs"—over and above stock required to cover what is forecast in demand for the period. It is calculated using statistical techniques (frequency distribution error).
- **ABC Analysis**—80 percent of stock value comes from 20 percent of the items.

- **Economic Order Quantity (EOQ)**. This is determined by two factors—the cost of carrying the inventory and the cost of the order.
- **Order Point**—when stock issues bring down the level to this pre-determined point, an order is placed on the supplier.

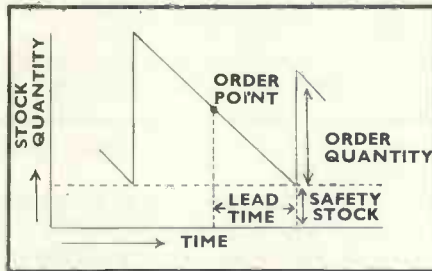

Graphically, what the stock control system should do for the businessman is shown thus:

No businessman runs an orderly and precise inventory system as our graph shows; what we are trying to indicate is that there is some logic behind inventory systems which can be handled easily by a computer.

Can you program a stock recording/stock control system on your micro by yourself? Most assuredly you can—if you are prepared to put in the effort. If you are a small businessman, you probably are not. To your rescue there are pre-programmed applications programs. We were given the specifications, or manuals, or demonstrations for seven systems which we now examine.

## Petsoft Stock Control

Supplied by Petsoft, PO Box 9, Newbury, Berkshire.

To be run on the Pet computer, this is a very basic system which essentially does two things:

1. It builds and stores on cassette tape your stock items—by code, description, and supplier and address;
2. It allows instant access to the stock

data on a tape (once properly recorded).

Other options include a "corrections" sequence (you use this option to update your tapes), a re-settable "low stock" warning on every item, and an item counter (important in this package because it is needed when updating your records).

You can store up to 150 items (and their data) on one tape—customers with extra memory can increase this to 255

items but without extra memory as many data tapes as you need can be built up with 150 items on each.

The system is aimed at the very small business; we believe that more than, say, 400 items (about three data tapes), the system will start to creak from slowness and inaccessibility of data. For the price of the software (£12) and the price of the PET (about £700), the system is good value,

## Compelec Stock Control

Supplied by Compelec, 14-15 Berners Street, London W1.

The concept in this system is another level entirely from the Petsoft application. For one thing, the hardware is Compelec Series 1 with floppy disc input/output. The software costs about £1,000 and the hardware £4,000-£5,000. Although the stock ordering/stock control function can be implemented on its own, this application is part of a larger order processing/invoicing/stock control/accounting system. Because of the use of floppies, two

advantages are gained in the stock control application:

1. More items can be recorded—no estimate is given but possibly 5,000 items per diskette;
2. Quicker access and display of the data.

In addition, the fact that this is one component of a larger application system means less difficulty when the additional modules are added.

The stock recording/stock control has these features:

1. Stock status enquiries;
2. Stock valuation on one of three

costs—selling, replacement, or standard;

3. Calculation of recommended re-order quantities;
4. Incoming stock, issues, returned goods, damaged goods, transfers, automatically reduce or increment the files "On-order" and "In-stock".
5. Price list and suppliers' list.

Purchase orders are matched against incoming stock and maintain chains with the stock files.

The system is sophisticated and is for the small businessman with a turnover of £0.5 to £1 million a year.

## Video-stock

Supplied by Video Software Ltd, Stone Lane, Kinver, Stourbridge, Worcester DY7 6EQ.

This software house is not concentrating on any particular machine but on the "executive" (or operating system) called VIDEO (Virtual Computer Using Decision Tables for On-line Processing). Designed initially for minis but being converted to

micros, VIDEO supports a complete range of standard on-line application packages which are machine-independent. One of these applications is called VIDEO-STOCK. This application supports a stock control system for finished goods, raw materials, or work in progress stocks. Like the Compelec stock control package, VIDEO-STOCK can be part of a larger information system, embracing Invoicing and Ledgers.

VIDEO-STOCK is a further refinement of the stock control systems already mentioned. More options and functions are available. This is reflected in the price of the software alone, which can range from £1,000 to £5,000.

This is a very powerful and complicated system for controlling inventory and worth a look by the businessman whose annual turnover is in the range of £0.75 to £2 million.

## Microinv

Supplied by COMP Computer Components, 14 Station Road, New Barnet, Hertfordshire.

Of all the packages we have reviewed, this one is closest to the ideal. MICROINV provides a simplified sequence of steps, telling the user what is required at every step. Running on an Exidy Sorcerer with two

floppy diskettes from Micropolis—each floppy with 630K bytes—the hardware costs about £2,000. The applications package is not yet priced but may be between £200 and £500.

The running of the program is simplicity itself. First, you choose which of six programs you want to enter:

1. Inventory data entry;
2. Inventory

transactions;

3. File listing;
4. Inventory reports;
5. Job cost report - materials;
6. Economic order quantities.

The Master File holds 25 pieces of data on each item and about 5,000 items can be put on one diskette.

Because of its simplicity and relatively low cost, this looks like a super-buy for the small businessman. (continued on next page)



(continued from previous page)

## Compucorp Stock Control and Invoicing

Supplied by Compucorp Ltd., 65-67 Wembley Hill Road, Wembley, Middlesex.

The stock control package we examined has a semi-automatic invoicing procedure which, although an integral part, will be investigated later. The stock package is designed to run on a Compucorp 625—prices start at about £4,000. The software is in the region of £500.

The 625 has a built-in floppy disc unit, so the number of items which can be held on one disc is about 5,000. Included in the functions are:

- stock listing (either detailed or by supplier);
- stock ordering which allows you to put items on order but does not physically update the stock;
- sales across the counter, i.e. in a shop situation, automatically update the

stock file. This routine also prints-out a stock reminder when stock falls below a pre-determined stock level.

Of course, adding, deleting, and amending of stock files are included.

Although the total system price is in excess of £4,500, the limited functions of the stock control software appear inadequate for the price; bear in mind, however, that an invoicing routine is included which none of the others we have reviewed possessed.

## Stock Control System

Supplied by Computer Mart Ltd, 38 St. Faiths Lane, Norwich.

The stock control system runs on the VDP-80 Computer Mart distributes. With the software costing about £1,000 and the hardware and operating system

about £6,900, the total system costs around £8,000.

In hardware there is a 32K RAM and standard dual floppies with 1.2MB disc storage and video monitor/keyboard. The stock control package handles about 6,000 items per disc. Its facilities are comprehensive, featuring a "menu" from

which you choose your option.

The price of the total system almost takes it out of the micro market, (by *Practical Computing* definitions) and into the mini area where it appears to be good value in that arena.

## Inventory-1

Supplied by Equinox Computer Systems Ltd, 32-35 Featherstone St, London EC1.

Inventory-1 runs on the Horizon where a minimum configuration of 32K and the software will cost around £4,000. Inventory-1 is part of the Horizon Business System which includes sales, purchase, and general ledgers and payroll—all, presumably, priced separately. The North Star minifloppy disc will

hold up to 940 inventory items.

This is the only software we have encountered so far with upwards-compatible "brothers"—Inventory-2 and Inventory-3—which provide control of larger inventories and the added features of order entry and bill-of-materials processing. Inventory-1 features include:

- On-line status enquiries.
- Add, update, and edit of files.
- Listing of all stock items (bought, sold, on-hand, sale value, stock

value, suggested re-order).

4. Produces a form for stock-taking with a price list).

5. Individual item update by article name or record number (added on purchase or deleted or sale).

We think this system with its upwards-compatibility and modularity represents the first trembling awakening of the business applications potentially inherent in the micros.



## Introducing the personal computer you've waited for.

### The Exidy Sorcerer.

# LOOK AT THESE FEATURES

16K £760

32K £859

add 8%  
VAT

- \* WORD PROCESSING, COBAL, FORTRAN etc
- \* PLUG IN ROM CARTRIDGES
- \* WORKS WITH NORMAL TV
- \* \$100 EXPANSION UNIT
- \* CASSETTE INTERFACE
- \* Z80 CPU
- \* 32K RAM ON BOARD
- \* A REAL BUSINESS MACHINE

The Sorcerer Computer is a completely assembled and tested computer system ready to plug in and use. The standard configuration includes 63 key typewriter-style keyboard and 16 key numeric pad dual cassette I/O, with remote computer control at 300 and 1200 baud data rates, RS232 serial I/O for communication, parallel port for direct Centronics printer attachment, Z80 processor, 4K ROM operating system, 8K Microsoft BASIC in separate plug-in Rom Pac™ cartridge, composite video of 64 chars x 30 lines, 128 upper/lower case ASCII character set and a 128 user-defined graphic symbols, up to 32K on-board RAM memory, operators manual, BASIC programming manual and cassette/video cables, connection for \$100 bus expansion unit giving access to the spectrum of exciting and useful peripheral devices, such as Floppy disk drives, voice recognition/synthesis battery back-up board in case of power failure, additional memory boards, E-PROM cards give you the facility to program and re-program your own ROM memories etc. etc. This is the most useable and flexible system that's now available to the home and business user at such a low price.

please make cheques and postal orders payable to JADE  
phone your order quoting ACCESS or VISA number  
for technical information or advice phone 0736 66565

Supplied by - Factor One Computers

# JADE

17 Market Place, Penzance, Cornwall.

● Circle No. 137

PRACTICAL COMPUTING March 1979

# COMPUCORP ANNOUNCES THE 610

THE NEW ADDITION TO ITS 'ALL IN ONE'  
MICROCOMPUTER FAMILY



- \* Why have a separate Microprocessor + VDU + Discs + Interfaces when you can have a complete system, beautifully packaged and ready to use by simply turning on only one switch.
- \* The 610 and the 625 are already being used in practical environments for applications such as Payroll (with up to 3,000 employees); Incomplete Records (3,700 transactions per client and almost 450 Nominal Accounts); Stock Control/Invoicing; Estate Agents (2,000 properties, 500 clients held on disc at one time); Accounting; Dealing on the Foreign Exchange Markets in order to provide daily and monthly reports as required by the Bank of England.
- \* Complete back-up service available.

The 600 Series uses

- \* Z80 Microprocessor
- \* Extended Basic and Assembler with one of the most complete File Management Systems available enabling identical packages to work on the 610 and 625.
- \* Up to 60K internal memory.

The 600 Series has complete range of Interfaces and peripherals available to include:-

- \* 160 cps dot matrix printer
- \* 1k Cmos and Real-time clock
- \* RS232/V24 Interface
- \* IBM-compatible tape
- \* 220 Volt uninterruptable Power Supply
- \* A/D and D/A Convertor for process control
- \* Up to 4 min. floppy drives at 315k bytes each, totalling 1.2 MEG(625)
- \* 10 and 20 meg. cartridge disc
- \* 32 bit parallel interface
- \* IEEE interface for instrumentation
- \* S-100 Bus

- \* Price of the 600 Series starts from £3,890 and includes
- \* 48k RAM Memory; 150k Floppy Disc; VDU; Full Operating Software to include Basic; Assembler; File Management; Disc Operation System and Text Editor
- \* DEALERS REQUIRED
- \* SUBSTANTIAL OEM AND DEALER DISCOUNTS AVAILABLE

COMPUCORP LTD., CIRCLE HOUSE SOUTH, 65-67 WEMBLEY HILL ROAD, WEMBLEY,  
MIDDLESEX. Telephone: 01-903 5444



**SOFTWARE ARCHITECTS LTD**  
34/35 DEAN STREET, LONDON W1

**THE ZILOG COURSE SPECIALISTS**

PRESENT

**SYSTEMS DESIGN WITH  
MICROPROCESSORS**

23rd APRIL 1979-4th MAY 1979  
COST £430 LONDON

**INTRODUCTION TO  
MICROPROCESSORS**

12th SEPTEMBER 1979-  
14th SEPTEMBER 1979  
COST £150 LONDON

THESE COURSES PLUS PL/2 AND  
COBOL WORKSHOPS CAN ALL BE  
HELD IN-HOUSE

FOR FURTHER DETAILS CONTACT  
JULIA SYMONDS OR STEPHEN KIRK  
01-734 9402

● Circle No. 139

## The great RAM sale

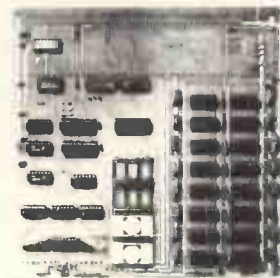

The Nascom system offers major expansion at sale prices. To give you as much choice as possible we offer RAM boards in three configurations to accommodate up to 16 memory ICs of either MK4027 or MK4116, all socketed.

The memory board kit options are:

8K £85.00  
16K £140.00  
32K £200.00

Boards will also accommodate up to four EPROMS of type 2708 at £10.50 plus VAT each. And if you wish to upgrade 16K to 32K it will only cost you an additional £70.

Memory boards plug straight into a NASBUS and an edge connector is included for this. All boards must be used in conjunction with the buffer board which, like the memory boards, is available in kit form ex-stock from approved Nascom distributors.



Nascom Microcomputers

121 High Street,  
Berkhamsted,  
Herts.  
Tel: (04427) 74343

● Circle No. 140

The microcomputer for those who need more than the minimum. The right processor for business, scientific and educational use. Proven applications include Games • Educational • Word Processing • Invoicing • Stock Control • Sales Ledger • Purchase Ledger • Mailing • Scientific.

**The Horizon computer includes:-**

### Specification

Zilog Z80A MPU • S-100 bus (12 slots) • Solid well-built case • Up to four Shugart mini-floppy disc drives, 180KB each • Serial port for CRT or Teletype • Real-time clock on motherboard

Optional additional serial port and parallel port • Powerful operating system and monitor • Access to wide range of S-100 special application boards.

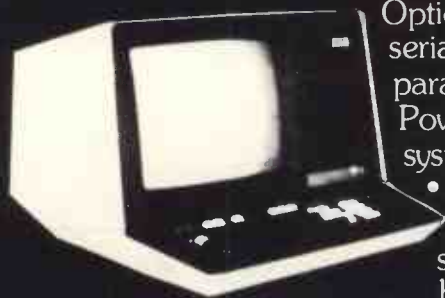

# THE NEW HORIZON

### Languages

Powerful Basic including sequential and random access disc files • formatted output • strings • line editor • machine language CALL • many other facilities. Optional additional software (under CP/M operating system) includes BASIC

compiler, FORTRAN and COBOL.

Horizon Z80A computer with 2 double-density disc drives and 24K RAM £1,823 (exclusive of VAT and carriage).



Equinox Computer  
Systems Ltd,  
32-35 Featherstone Street,  
London EC1Y 8QX.  
Tel: 01-253 3781/9837.

● Circle No. 141

COMPANY	SYSTEM	APPLICATION	PRICE RANGE
<b>AIRAMCO LTD</b> 30 Witches Linn, Ardrossan, Ayrshire KA22 8BR 0294 65530	<b>SDS 100.</b> Single unit containing 32K memory (expandable to 64K); up to 8K PROM; twin double-sided floppy disc drives of 500K bytes each; serial and parallel RS232C interfacing; keyboard; 12 in. video display; power supplies; SD monitor program; line printer available.	Software: CP/M, 8080 assembler, E Basic, Editor supplied with system; M Basic, Fortran, Cobol available for business use, Industrial process monitoring and control (with additional hardware). All CP/M games and business packages available.	From £3,750 (basic machine) £890 (printer) £4,500 combined
<b>CALDERBROOK TECHNICAL SERVICES (CTS)</b> 1 Higher Calderbrook Littleborough, Lancs 0706 79332	<b>Ohio Superboard II</b> (computer on a board), Min. size: 6502 processor. 8K BASIC in ROM; 2K monitor in ROM; 4K RAM; Cassette I/F; full keyboard; 32 x 32 video I/F; controller for two floppies.	8K BASIC in ROM; Assembler/Editor; Games, personal, maths tutors, and business programs. American system aimed at hobbyist/small business.	£275-1,100
	<b>Challenger II 4P</b> (professional portable), similar to Superboard but supplied as two separate boards with open slots for expansion.	Similar to Superboard. Aimed at small business, education, research.	£595-1,500
	<b>Challenger II 8P</b> (personal computer), similar to 4P but expandable to include 2 x 8 floppies, multiple line printers, 74 MB hard disc, multiple terminals.	Similar to 4P but larger business/commercial programs. Aimed at small business with requirement for large storage and multiple users. Also education and research.	£800-7,500
<b>COMART</b> PO Box 2, St Neots, Cambridgeshire 0480 215005	<b>Microbox</b> , Min. size: Chassis with three sockets. Max. size: Chassis with six sockets.	Aimed mainly at OEM industrial users and perhaps the serious hobbyist. Manufactured in Britain by Comart, it will take Cromemco, North Star and other processors and software.	£70-£195
	<b>Cromemco System Two</b> , Min size: Processor alone with six sockets in kit form. Max size: 21 sockets; 512K of memory; up to three mini-diskettes of 90K bytes each.	Software: Extended Basic; Fortran IV; Cobol; Macro-assembler; Word-processing, DBMS. American system suggested for systems development.	£395 to around £5,000
	<b>Dynabyte</b> , Memory board for any S100 bus system. Available in 16-32K units.		£275-695
	<b>Cromemco System Three</b> , Min size: 32K memory; terminal and printer interface; dual 250K-byte IBM-compatible floppy discs. Max size: 128K memory; two-three terminals.	Software: Same as System Two. Suitable for a wide range of commercial and scientific applications. Theoretical maximum of 512K of memory.	£4,174- £10,000-plus
	<b>Horizon</b> , Min size: 16K memory; serial interface; one mini-diskette drive with 90K bytes; power supply. Max size: 48K memory; three diskettes; hardware floating point board.	Software: Extended Basic; disc operating system; monitor; access to CP/M range. Manufactured by North Star Computers of the U.S. Aimed at educational and small business users.	£995-£3,500
	<b>SOL 20/16</b> , Min size: 16K memory; integral keyboard and monitor; serial and parallel interface; cassette unit. Max size: 64K memory; up to 1MB disc capacity.	Software: Extended Basic; Fortran; Focal; Assembler; Editor; Games. Another American system from Processor Technology Corp aimed at the small business and education markets.	£1,785-£5,000-plus
	<b>COMMODORE SYSTEMS DIVISION</b> London NW1 01-388 5702	<b>PET</b> , Single unit containing screen, tape cassette and keyboard. Memory is expandable from 8-32K.	Software: Basic; Games; Business packages. The British subsidiary of Commodore Systems of the U.S. sells Pet for home, educational and small business applications.
	<b>Kim I</b> , Min size: Processor (6502 chip); small calculator-type keyboard; LED six-digit display; built-in interfaces for audio-cassette and Teletype; 1K RAM; 2K ROM. Max size: Can add: Kim 4 motherboard; Kim 3B 8K RAM (up to 64K); Kim 5 resident assembler.	Software: None available yet, but it has three good manuals. An American import which gives Pet-type capabilities with a maximum configuration. For the hobbyist but used mainly as an evaluation board for the 6502 chip. There are two dealers, GR Electronics and J Marshall, which offer further facilities.	£129-£600 (+VAT)
<b>COMP Computer Components</b> 14 Station Road, New Barnet, Herts. 01-441 2922	<b>EXIDY Sorcerer</b> based on Z-80. Typical size: 12K ROM, 32K RAM; cartridge and cassette I/F; 79-key keyboard; 256 character set (128 graphics symbols); 12 in video monitor; expandable with Micropolis floppy discs.	Software: standard Basic Assembler and Editor Fortran and Cobol; word processor; games and other pre-packaged programs.	From £950
<b>COMPELEC</b> 14/15 Berners Street, London W1 01-580 6296	<b>Altair System 1300</b> , Min size: 32K memory; dual minifloppy discs, 71K bytes each formatted; serial interface. Max size: 64K memory; 4 serial ports.	Software: Basic (single and multi-user); Fortran; Cobol. The hardware for the Altair systems is from Perotec in the States, but the software is Anglo-Dutch.	£3,000-£5,500

(continued on page 49)



# Scotland's first computer shop

● PROUDLY PRESENTS ●

## Pet computers ... £695

● PLUS FULL SUPPORTING CAST ●

Dual floppy disc (525k)	£795
Choice of 3 printers	£365-£499
Memory expansion (to 32k)	£185
Extra keyboard	£65
Modem with acoustic coupler	£75
VDU + keyboard	£395

## All Pet compatible!

● ALSO STARRING ●

**Cromemco System Three - £3,750**  
**Cromemco System Two - £2,500**

● WITH ●

Full range of Cromemco peripherals  
Fortran IV, ANSI, Cobol, Extended Basic  
Word processing, DBMS, etc.

● AND FEATURING ●

Full warranty and maintenance  
Tailored software supplied

● ALL PRICES INCLUDE VAT ●

# MicroCentre

132 St. Stephen Street  
Edinburgh 3  
(5 mins. walk Princes St.)

Tel: 031-225 2022

COMPARE OUR PRICES . . .  
—THEN DROP IN FOR A DEMO

● Circle No. 142

## Computer standard

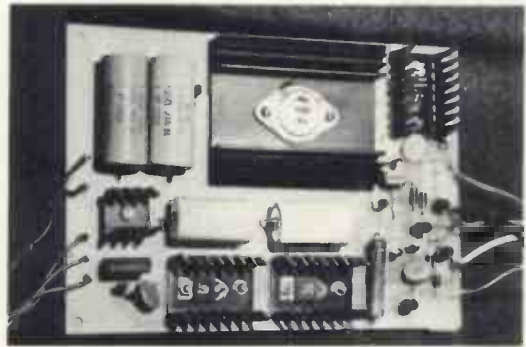

3A PSU

Computers require a reliable and even power supply. The redesigned and uprated Nascom 3A PSU meets these requirements. Its output voltages are +5V 3A; +12V 1A; -12V 1A; -5V 1A. And are sufficient to drive the Nascom-1, buffer board and up to 32K of RAM. It has LED displays on all the outputs and will fit into the Nascom frame to be announced soon. Price of PSU kit—£24.50 plus VAT.

A buffer board kit with edge connectors suitable for the NASBUS and with edge connectors and inter-connectors to attach directly to the Nascom-1 is available at £25.00 plus VAT.



Nascom Microcomputers

121 High Street,  
Berkhamsted,  
Herts.  
Tel: (04427) 74343

● Circle No. 143

# AIM 65

£249.50 + VAT

- FEATURES INCLUDE:**
- \* 20 COLUMN PRINTOUT
  - \* 20 CHARACTER ALPHANUMERIC DISPLAY
  - \* FULL 54 KEY TERMINAL-STYLE KEYBOARD
  - \* TTY INTERFACE
  - \* TWIN CASSETTE INTERFACE
  - \* RAM — 1K TO 4K OPTIONS
- OPTIONS INCLUDE:**
- 8K BASIC INTERPRETER ROM
  - 4K ASSEMBLER/EDITOR ROM

AIM 65 comes to you fully built and tested with a full alphanumeric keyboard, 20 character display and a 20 column printer — for keeping a permanent record of all your work. Available in 1K- and 4K-byte RAM versions, AIM 65 is designed around the 6502 CPU, which has 64K address capability with 13 addressing modes. This is the microprocessor at the heart of many other, more costly, systems such as PET and APPLE. AIM 65 has a 4K ROM-resident monitor program for all peripheral control and user programming functions. Spare sockets are included for expanding on-board program memory via user PROM-based programs and/or Rockwell assembler, text editor and BASIC interpreter plug-in options. AIM 65 has a connector for external access to system bus for memory and I/O expansion, a separate connector

for interfacing a teletype and two cassette recorders. There is a user-dedicated Versatile Interface Adaptor, featuring three 8-bit, bidirectional ports (two parallel, one serial) and two 16-bit interval timer/event counters — thus allowing the user to interface his own system, without extra interface devices in many cases. AIM 65 is probably the most effective, low-cost microcomputer development system available — an invaluable educational aid to first time users and an ideal general purpose micro-computer for the engineer. AIM 65 is available in the UK only from PELCO ELECTRONICS LTD at £249.50 + VAT, complete with User's Manual and Schematic, R6500 Programming and Hardware Manuals and a handy pocket reference card.



## Pelco (Electronics) Ltd

Enterprise House,  
83-85 Western Road, Hove, Sussex BN3 1JB  
Telephone: Brighton (0273) 722155

Buy it with your Access or Barclaycard.

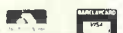

● Circle No. 144

PRACTICAL COMPUTING March 1979

(continued from page 47)

COMPANY	SYSTEM	APPLICATIONS	PRICE RANGE
<b>COMPELEC</b> (continued)	<b>Altair System 70</b> , Min size: 33K memory; dual floppy discs, 300K bytes each. Max size: 64K memory; provision for up to 8 VDUs.	Software: Single and multi-user Basic; Fortran; Cobol; APL. Aimed exclusively at business applications; packages are available for general and sales and purchase ledger, payroll, word processing, stock control, estate agency, hotel or small airline reservations, transport management and freight costing. A point-of-sale package will soon be ready.	£4,500 to £10,000-plus
	<b>Altair System 300</b> , Typical size: 64K memory; 10MB disc drive; turnkey processor; VDU; Qume daisywheel printer and disc unit.	Software: Single-user Basic; Fortran; Cobol. The same packages as for the System 70 are available for this top-end-of-the-market, business-orientated system. Compelec has its own office in Birmingham, but a full distributor network is being set up.	£10,000-plus
<b>COMPUTERBITS LTD</b> 40 Vincent Street, Yeovil, Somerset 0935 26522	<b>System 8</b> , Typical size: 64K memory; 1MB disc storage; serial I/O port for VDU; parallel port to printer; CP/M operating system.	Software: Basic; Pascal; Fortran. This British-manufactured microcomputer system is almost exclusively for business applications.	£3,000-£5,000
<b>COMPUTER MART LTD</b> 38 St Faiths Lane, Norwich. 0603 615089	<b>VDP-80</b> , Typical size: Single desk-top unit housing a 12 in. display, dual standard floppy disc drive, processor, power units, cooling system and fully-programmable keyboard containing 62 alphanumeric, 12 numeric and 12 cursor controls in separate keypads. Normally sold with 32K memory and 1.2M bytes of disc storage but may be expanded.	Software: Included in the price is a sophisticated operating system with Commercial Basic. A range of commercial application packages is available, including word processing if required.	£9,500
<b>COMPUTER WORKSHOP</b> 38 Dover Street, London W1 01-491 7507	<b>System 1</b> , Typical size: 40K memory; dual 8 in. floppy discs, total storage capacity 1.2MB; Ricoh daisywheel printer. <b>System 2</b> , Typical size: 24K memory; dual minifloppy discs of 80K bytes each; Centronics 779 dot matrix printer; VDU. <b>System 3</b> , 12K memory; cassette interface; 40-column dot matrix printer.	Software: Range of Editors, Assemblers, Basics and Games; Information retrieval package. These systems were designed and built in Peterborough and are suitable for educational, small business users and perhaps the more serious hobbyist. There is a large number of dealers around the country.	System 1—£5,000-plus; System 2—around £3,000; System 3—from £1,350
<b>EQUINOX COMPUTER SYSTEMS LTD</b> 32-35 Featherstone Street, London EC1Y 8QX 01-253 3781/9837	<b>Horizon</b> , Min size: 16K memory; Z80A processor; single minifloppy disc drive (180KB). Max size: 56K memory, four minifloppy disc drives (180KB), any acceptable S100 peripheral boards.	Software: Standard—Basic Interpreter (includes random and sequential access), disc operating system and monitor; Options—Basic Compiler, Fortran, Cobol, and Pilot. The system is suitable for commercial, educational and scientific applications. Application software for general commercial users.	£1,000—around £2,500
	<b>Equinox 300</b> , Min size: 48K memory; dual floppy discs giving 600K bytes of storage; 16-bit Western Digital m.p.u. Max size: Up to 256K memory; up to four 10MB hard discs.	Software: Basic, Lisp, Pascal, Macro Assembler, Text Editor and Processor. All software is bundled. The system is a multi-user, multi-tasking, time-sharing system for 2-12 users. Application software is available for general commercial users.	£5,000-£40,000-plus
<b>MICRONICS</b> 1 Station Road, Twickenham, Middlesex 01-892 7044	<b>Micros</b> , Typical size: 1K monitor; 47-key solid state keyboard; interfaces for video, cassette, printer and UHF TV; serial I/Os; dual parallel I/O ports; 2K RAM; power supply.	Software: Extended Basic; Pascal. A British-designed and manufactured system which is being enhanced rapidly. Already available are a 40-column impact printer using plain paper, at £360; what is claimed to be the cheapest data terminal around—a system with an acoustic coupler and VDU for £1,020. Prospective applications: small businesses, process controllers and hobbyists.	From £400, assembled
<b>NASCOM MICROCOMPUTERS</b> 92 Broad Street, Chesham, Buckinghamshire 02405 75151	<b>Nascom 1</b> , Min size: CPU; 2K memory parallel I/O; serial data interface; 1K monitor in EPROM. Max size: CPU; 64K memory; up to 16 parallel I/O ports.	Software: Mostly games, but a maths package is on its way. The British-manufactured system started as a hobbyists' package but has found an increasing number of industrial users. Printer and minifloppy interfaces are in preparation. There are about two dozen dealers around the country.	From £197-50
<b>NEWBEAR COMPUTING STORE</b> 7 Bone Lane, Newbury, Berkshire and 2 Gatley Road, Cheadle, Cheshire 0635 49223	<b>Sym 1</b> , Size: 6502 chip and keypad, with memory available in 4K blocks to 64K.	Software: Any Kim software. An American system meant to be the foundation for very small business and hobbyist users.	From £200
	<b>7768</b> , Size: CPU board; 4K memory; cassette and VDU interfaces.	Software: Range of Basics and Games. A British-manufactured system for hobbyists. Expandable to 64K memory, it is available only in kit form.	
	<b>Cromemco Z2</b> , Min size: Z2 chassis: power supply; motherboard; CPU; fan; sockets; byte saver board; 16K memory. Max size: 48-64K memory; dual 8 in. floppy discs.	Software: Basic, Fortran; Assembler; macro assembler. For small business and educational applications. These systems are also supplied to more than a dozen dealers. Same basic system as Comart.	£1,375 to £4,000

(continued on page 51)



## AIRAMCO LTD — MICROCOMPUTER PRODUCTS

Distributors for JADE, S. D. SALES, MATROX  
All products brand new with full industrial specification

### SDS-100 SYSTEM

Complete business computer system, comprising 12in. VDU, keyboard with numeric pad, two 8in. disc drives (1MByte on-line storage). 32K RAM, serial/parallel I/O. Four separate S-100 slots for expansion. Included in price integral data systems printer type IP-225. Introductory price, complete with printer, **£4,250**.

### SD STARTER KIT

Single-card development system based on Z-80, Hex keyboard/display, 2K RAM, 8K PROM, PROM programmer, four-channel counter-timer, PIO, cassette interface. Provision for two S-100 sockets for expansion. Price **£415** kit, **£249** assembled and tested.

### SD System Expander RAM

Note new low prices. 64K dynamic RAM board, **£399** kit, **£499** assembled and tested.

### SBC-100 Single Card Computer

S-100 single-card computer with one serial RS-232/20mA I/O, one parallel I/O, four-channel hardware counter-timer, 8K EPROM sockets, 1K RAM. Price **£155** kit, **£245** assembled and tested.

Shugart SA-400 disc drive **£190** 4116 Dynamic RAMs, eight for Shugart SA-801 disc drive **£350** **£69**, usable for Apple and TRS-80 computers.

We continue to carry all our existing lines.

All Prices EXCLUDE VAT @ 8%.  
Trade discounts on Quantity  
Please add £1.00 P&P for S100 items  
then add VAT @ 8%.

24-hr Ansaphone order service with  
ACCESS or BARCLAYCARD.  
MAIL ORDER ONLY



For components please add 40 P&P,  
then add VAT @ 8%.  
AIRAMCO LTD  
30 WITCHES LINN  
ARDROSSAN  
AYRSHIRE  
KA22 8BR  
TEL. 0294 65530  
TELEX 779808

Semiconductor prices are always  
changing and the trend is generally  
downwards. So ring for latest up-to-  
date details.

● Circle No. 145

## Written for the Nascom

Among the programs written to run on the Nascom-1 and available now are:

### ICL Dataskii Letter Editor

This software provides a comprehensive set of data operations. Text can be input, displayed, edited, stored on tape, retrieved and further amended. Control functions include cursor, character, word, line, scrolling, tabbing, tape store and retrieve, text printing. All in less than 2K byte plus workspace for up to almost two full screens. Price on 2 x 2708 EPROM £70 plus VAT.

### TINY BASIC

A 2K BASIC Interpreter in 2x2708 EPROM. Normal commands: 1-32767 MSL/single array/arithmetic constant/ <>≠≠≠ /strings valid in PRINT/supplied with user manual/additional three level keyboard control/compatible with NASBUG and B.Bug Price £25 Plus VAT.

An extended version of the above is our SUPER TINY BASIC which has all the TINY BASIC functions plus full editing features and additional operator command. Price in 3x2708 EPROM £35 plus VAT.

### ZEAP

An editor assembler which runs under NASBUG and provides the powerful advantages of writing programs in Z80 assembly language instead of directly in machine code. Uses less than 3K bytes of memory and is supplied on cassette priced £30 plus VAT.



Nascom Microcomputers

121 High Street,  
Berkhamsted,  
Herts.

Tel: (04427) 74343

● Circle No. 146

# A more interesting way to learn



## what is a microprocessor?

If you are considering buying a Microcomputer, Development System, or just want to learn more about this exciting technology, then this short introduction to Microprocessors is for you. Comprising a 72 page book keyed to over two hours of cassette tapes, the many aspects of Microprocessors are explained, including Binary and Hexadecimal counting, Internal structure, Operation, Programming Techniques, Devising a program, etc. . . Learn at your own pace with this valuable addition to your reference library.

To Technical Book Services  
P.O. Box 79  
Maidenhead, Berks SL6 2EG

### ORDER FORM

Please send me.....copy/copies of What is a microprocessor?  
@ £10.75 each inclusive. I enclose remittance £.....

Name  
(Print Please)

Address

Registered office 21, Mincing Lane, London EC1 Registered No 12225

● Circle No. 147

(continued from page 49)

COMPANY	SYSTEM	APPLICATIONS	PRICE RANGE
<b>PERSONAL COMPUTERS LTD</b> 194 Bishopsgate, London EC2 01-283 3391	<b>Apple II</b> , Min size: 16K memory; 8K ROM; keyboard; monitors; mini-assembler; colourgraphics; Powell card; RF modulator; Games; paddles and speaker; 4 demo cassettes. Max size: Expandable to 48K memory, and floppy discs and printers are now available.	Software: Basic; Assembler; Games; Business packages. An American system regarded as suitable for any kind of applications. There are 15 dealers throughout the country and maintenance contracts are offered.	£1,000-£2,000
<b>RAIR</b> 30-32 Neal Street, London WC2 01-836 4663	<b>RAIR Black Box</b> , Min size: 32K memory; dual minifloppy discs, 80K bytes each; two programmable serial I/O Interfaces. Max size: 64K memory; 8 serial interfaces; 1MB disc storage (or 10MB hard disc); range of peripherals.	Software: Advanced Basic interpreter, Fortran IV compiler; Cobol compiler. Described by the makers as the only 'sensible' British-designed and manufactured microcomputer, its uses are small business and educational applications and in distributed processing networks. Hardware distributors are being signed and agreements made with software houses to add software. It is not for the hobbyists. A warranty and U.K.-wide on-site maintenance is given.	£2,300-£8,000
<b>RESEARCH MACHINES LTD</b> PO Box 75, 209 Cowley Road, Oxford 0865 49793	<b>Research Machines 380Z</b> , Min size: 4K memory; 380Z processor; keyboard. Max size: 48K memory. <b>280Z</b> , 4K board plus connecting cables, £398. 32K board—identical in performance to the 380Z: £722.	Software: Basic interpreter; 12K Basic; Assembler. A British system using CP/M software; delivery times are about 6 weeks at the moment. A minifloppy disc system is on trial. Sintel is the sole distributor.	From £830
<b>SCIENCE OF CAMBRIDGE</b> 6 Kings Parade, Cambridge 0223 312919	<b>MK 14</b> , Min size: 8060 SC/MP; ¼K user memory; ¼K PROM with monitor program; Hex keyboard and 8-digit, seven-segment display; interface circuitry; 5v regulator on board. To this can be added: ¼K RAM (£3-60); 16 I/O chip (£7-80); cassette interface kit (£5-95); cassette interface and replacement monitor (£7-95); PROM programmer (£9-95).	Software: None provided, but a 100-page manual includes a number which will fit into 256 bytes covering monitors, maths, electronics systems, music and miscellaneous. Based on American National Semiconductor chips. Science will soon have a VDU interface and large manual on user programming. Half of sales are to hobbyists, half to engineers.	Basic price is £39-95. All prices are exclusive of VAT
<b>STRUMECH ENGINEERING ELECTRONICS DIVISION (SEED)</b> Portland Place, Coppice Side, Brownhills, Walsall, Staffordshire 05433 4321	<b>MSI 6800</b> , Min size: 6K memory; Act I terminal (keyboard); cassette interface. Max size: Three disc systems are offered: Minifloppy disc system with triple drives of 80 bytes each and 32K memory. Large floppy system with dual 312K-byte capacity disc and 32K of memory. Hard disc system with 10MB, five fixed, five removable, and 56K.	Software: Basic interpreter and compiler; super editor assembler; text processor on small disc system. This is an American-designed system which is being manufactured increasingly in U.K. A SEED survey of its sales showed 60% of the customers were educational establishments, a further 10% research institutes, 10% hobbyists and the rest commercial companies. A distributor network is being set up.	Basic system is £1,100 (£815 as kit); Minidisc—£2,500; large floppy disc £3,200; hard disc £8,000-plus
<b>TANDY CORPORATION</b> Bilston Road, Wednesbury, West Midlands 021-556 6101	<b>TRS-80</b> , Min size: Level 1 4K memory; video monitor; cassette; power supply. Max size: Level 2 16K memory; line printer, floppy disc system.	Software: Basic; some business packages. An American system from the 200-outlet Tandy chain—The Level 1 is aimed at the hobbyist and education market and Level 2 at small business applications.	Level 1—£499; Level 2—£2,434
<b>U-MICROCOMPUTERS</b> PO Box, 24, Northwich, Cheshire 0606 75627	<b>Challenger 1</b> . Min. size: 4K RAM, 8K Basic in ROM, keyboard, video and cassette I/F. Max size: 32K memory, printers, voice I/O, dual mini floppies, modem. Based on Ohio Superboard II. <b>Challenger 2</b> . Min-size: (C2-4P) 4K RAM, 8K Basic in ROM, two slots for expansion (C2-8P has six slots for expansion). Max size: 36K RAM, mini-floppies, full-size floppies, hard disc (74MB), printers. <b>Challenger 3</b> , Min. size: 32K RAM, dual mini-floppies, triple processor architecture (6502A, Z-80, 6800). Max size: 768K RAM, 74MB hard disc, multiple terminals, printers.	Fast Basic in ROM with wide range of business, personal, games and educational software on cassette or mini-disc. Similar to Challenger 1. Can run virtually all 6502, 6800, 8080 and Z-80 code. With CP/M, languages Basic, Fortran, Cobol can be run. Full business software packages available including word processing and database management. Multi-programming available.	From £300. Single mini-floppy system about £1,400. From £700. From £3,550 (C3 OEM) to £10,000 plus (C3 B with 74MB disc).





These pages represent an independent collection of news and views for owners of the Commodore Pet.

The principal focus is Mike Lake, of the Independent Pet Users' Group (IPUG).

If you wish to contact *Pet Corner*, write to him or send articles or ideas to us directly.

This month's offerings include information on new catalogues of interest to Pet users' independent American newsletters for Pet owners, some useful tips to avoid problems and program proposals on which your views are invited.

## Catalogues

WE HAVE received the new catalogue from the London bookseller and program distributor MINI-MICRO. It features some Pet games we hadn't encountered, including a "very sophisticated" space game called *Galactic I*. Contact 01-889 7615 for more details.

Another interesting catalogue to come through the post arrived from Lotus Sound (01-981 3993). It includes a dual-drive minifloppy system for £916; it has a disc operating system—the well-respected DISKMON—which also supports Centronics printers and Axiom's clever, cheap printers but we don't know of a U.K. outlet for them yet.

Other DISKMON attractions include support for Fortran (about £60) and Intel's PL/M language (£40).

To run the floppy discs you will also need to spend at least £276 on an ExpandaPet expansion memory board. This is easy to install—it slots in above the main Pet circuit board—and it claims to have little adverse effect in terms of heat generation or power consumption. ExpandaPet is in 16KB or 32KB chunks; the biggest board costs £394.

Lotus Sound says it will despatch boards by registered mail, so you should have more memory a couple of weeks after your order.

Also in the Lotus catalogue is a £37.50 music synthesiser. It comprises the necessary software plus an integrated loudspeaker and amp which plugs into the I/O port; you can compose up to 90 'pages' of music, with up to 16 notes per page. Obviously you can store and edit music just like any other data. The Music Box also enables you to add sound effects to existing programs.

The third, and best, catalogue to arrive is the latest from Petsoft, 12 packed pages of programs. It is especially strong on business packages, including a new VAT system for £17.50, but is also good on other software. Programming aids in the catalogue include a data file handler for £12, which Petsoft claims "overcomes the problems often associated with

Pet file handling capabilities".

Also new from Petsoft is the TIS series of *PET Workbooks*. They have been available previously only in the States but they have a fine reputation. Petsoft is charging £15 for the file and we have asked for review copies.

Petsoft has also tackled the problem of residual magnetisation of the heads on the cassette deck, to which Pets are prone. It is offering a battery-powered, solid-state de-magnetiser for £10.75; it emits a powerful pulse which instantly de-magnetises the heads without affecting other program cassettes, as mains-powered de-magnetisers are liable to do.

All prices in the new catalogue have been reduced by at least eight percent and are now inclusive of VAT. Copies are available free of charge; telephone 0635-201131.

## Spanish problem

WE HAD a letter from a reader interested in buying a Pet for use in Spain. He was worried about voltage variations there, so we checked this.

It seems Pet is quite tolerant to voltage fluctuations within reason, but Iberian readers who are still uneasy might look for a small constant voltage transformer—a supplier in Madrid, Cierva Electro Optical, was recommended to us.

## Petite

HB COMPUTERS of Kettering has contacted us to counter the claim of Torbus Ltd as the first distributor for the Plessey Petite add-on memory. HB says: "To our certain knowledge we are the only officially-appointed distributor for the Petite". More information from 0536 83922.

## PET Gazette

THERE are three good independent American newsletters for Pet owners, and the one we're homing-in on is the *PET Gazette*. It is cyclo-styled, home-made, cheerful, friendly, packed, excellent, scruffy, and free—but more of that later.

It's a "news and resources handbook for Pet users". The first issue we saw is Volume 1 No. 5 for August-September, 1978. It is an A5 publication of 64 pages and a variety of typewriters. It is jam-packed with items for the U.S. user, much of which could also apply to British owners.

It had three pages of editor's ramblings and rumours, including some personal remarks about cassettes—Agfa he likes, Scotch and Microsette he'd heard bad things about; any U.K. experience to contribute? The booklet also contains some aggressive readers' letters, an excellent piece on Pet standards which we want to re-print, several tips and many programs, reviews of proprietary cassettes and hardware add-ons, and many lists about what you can get where. That last category includes the newsletter's own *PET Cassette Exchange*, for which you pay a \$1 copying and handling fee.

The quality of the information is good, and we would like to re-print some of it from time to time.

We can recommend this publication. Which brings us to the fact that it's free but the publisher, Len Lindsey, asks for contributions. U.S. postage by air to Britain costs \$1.02, so we reckon it wouldn't be unreasonable to send him £1 or so if you want a copy. We'll act as a clearing house; send us £1 and we'll pass it on, along with your name.

## PET tips

- Many of you will be familiar with this message—PRESS PLAY & RECORD ON TAPE 1. If you want to avoid it, you can—simply press STOP then type in CONT (from *PET Gazette*).
- It probably goes without saying but when you turn it on the Pet is always in graphics mode. To get into lower-case you can type POKE 59468, 14. To return to graphics without switching off, type POKE 59468, 12.
- Here are a couple of line-remembering programs for you to try. In the second, 'NS' is the next line number.

(continued on next page)

(continued from previous page)

```

****RENUMBER***
59900 REM LIST THIS PROGRAM, LOAD
TARGET PROGRAM, "RETURN"
60000 INPUT "RENUMBER OLD LINE
NUMBERS FROM ";L1: INPUT
"THROUGH";L2
60010 INPUT "AS NEW LINE NUMBERS
FROM";L: INPUT "IN STEPS OF";D
60020 K=1025: B=256
60030 N=PEEK(K+2) + G*PEEK(K+3)
60040 IF N=O OR M>L2 GOTO 60000
60050 IF N>L1 THEN PRINT N,L: POKE
K+2, L-INT(L/G)=G: POKE K+3,
INT(L/G): L=L+D
60060 K=PEEK(K)+G*PEEK(K+1): GOTO
60030
READY
***AUTO LINE NUMBERER***
3 NS= 100
4 PRINT"3";NS;
5 GET K$:IF K$="" GOTO 5
6 PRINTK$:IF ASC(K$)<13 GOTO 5
7 NS=NS+10:PRINT"3NS=";NS:PRINT"
RUN 3"
8 POKE 525, 4:FOR 1=1TO 4:POKE525+1,
13:NEXT:END
READY
    
```

- Another from *The PET Paper*. From time to time you may get the message.

PRESS PLAY AND RECORD ON TAPE 1

You can avoid this if you wish. Press STOP, then type in "CONT".

This we also took from *The PET Paper*.

- Replacing input statements.

It's a chore to teach a newcomer always to press the RETURN key after entering something. We might realise that the RETURN key signifies the end of input to the Pet. But that's not natural to the layman.

Many times the naive user will press RETURN by mistake, causing the program to end. Then you have to step in and type "CONT". That mystifies and alienates the newcomer.

Wouldn't it be better if the computer wouldn't quit when we just typed RETURN? And wouldn't it be pleasant if we could control what happens when the user makes a mistake, like enter a letter in a numeric INPUT—instead of the cryptic "?REDO FROM START" error message? But how can we put these things under program control?

- The form of the GET statement is:

GET V\$ (V\$ is any string variable)

You've all seen lines in programs like this:

```

10 PRINT"PRESS ANY KEY TO CONTINUE"
20 GET A$:IF A$="" GOTO 20
    
```

The GET A\$ statement will place the character being pressed on the keyboard into variable A\$. If no key is being pressed, A\$ will be set to a null string (""). Thus, line 20 GETs A\$. If A\$="" (no key pressed) then line 20 will GOTO line 20. If a key is pressed, the program continues. A\$ will equal the character you pressed. Add the following line:

```

30 PRINT A$:GOTO 10
    
```

Then run the program. Note that if you press the A key, A\$ will equal "A". But how do we stop the program? Press the STOP key.

- Many times a program will ask a yes or no question (such as "DO YOU WANT INSTRUCTIONS?"). These are sometimes asked via INPUT statements. But then you have to type "YES" (or "Y") followed by the RETURN key for instructions.

But can't we use a GET statement instead? Try this program:

```

10 PRINT" IS YOUR NAME JON"
20 GET A$: IF A$="" GOTO 20
30 IF A$="N" GOTO 100
40 IF A$="Y" GOTO *00
50 PRINT" PLEASE ANSWER Y OR N"
60 GOTO 10
100 PRINT" YOUR NAME ISN'T JON!!!"
110 END
120 PRINT" HELLO JON"
130 END
    
```

Notice that if the user accidentally presses just RETURN, the program won't die. Even the layperson can understand the error message.

### PET standards

THERE's an argument against standards—they enforce rigidity, sometimes for its own sake—but if you want to be able to exchange programs and listings which are fully-compatible and easily-understood, you do need to follow some conventions and guidelines.

*The PET Paper* offers the following proposals for programs. We would like your opinion of them.

- Start your program with line 100.

Starting with line 100 serves two purposes. It allows 100 free lines for identification and useful routines: it will also allow a user provide an easy way to return in case you jump out of the program accidentally. If you hit RETURN with no data for an input statement, for example, you could simply type in GOTO 100 to get back into the program.

- Identify the program

Use lines 10–19 for identification purposes. A suggested format is:

```

10 PRINT "PROGRAM NAME"
12 PRINT "AUTHOR - DATE"
14 PRINT "LIST THE BOOK OR MAGAZINE
TAKEN FROM, IF ANY/OR COPYRIGHT
INFO"
16 PRINT "MEMORY NEEDED OK"
    
```

- Include instructions as part of the program.

Instructions on paper are fine, but you may lose your way. Best to have both but make sure enough instructions are part of the program so that it will be useful without the written instructions.

- Allow the user to read your identification/instructions.

Include a routine like the following:

```

40 PRINT "HIT ANY KEY TO CONTINUE"
42 GET A$:IF A$="" THEN GOTO 42
    
```

As soon as any key is pressed the program will continue.

- Clear the screen before starting. Use a line such as:

```

60 PRINT"(CLR) " : REM CLEAR SCREEN
    
```

- Include documentation within your program.

Include plenty of REMarks in your program. It will help the next person understand what is going on—and you will be surprised how much it will help you with your own programs.

- Use lower-case whenever you have much text to display.
- Label each subroutine or main section of the program.

To make it easy to spot the beginning of each section of your program begin with a line with a lot of asterisks—for instance:

```

430 REM *****PRINT THE HUGE
LETTER*****
    
```

- Use line numbers increasing by 10 each new line.

By leaving nine lines between two program lines you obviously allow for future additions.

- Indent each FOR,NEXT loop.

This is a good programming technique. Remember that the Pet erases extra spaces between the line number and the beginning of your statement. To be able to indent simply use colons. For example:

```

560 REM*****SHOW ADDITION WITH
THE SUM*****
570 FOR A=1 TO 4:REM Loop for the first
number
580 :FOR B=1 TO 6:REM Loop for the second
number
590 : :PRINT A; "PLUS";B; "EQUALS" ; A+B
600 : :PRINT : REM print one blank line
610 :NEXT B:REM Next second number
620 NEXT A:REM Next first number
    
```

By indenting, you can see if you end every loop, and in the correct order.

The awkward part, of course, is coping with control and graphics keys. *Practical Computing* and *The PET Paper* both like the conventions proposed a year or so ago for key identification in a U.S. magazine, *Peoples' Computing*, which, incidentally, is about to turn into *Recreational Computing*.

- Use key cap identifiers if possible. By using the letter/letters printed on the key there is nothing to memorise.

- Use capital letters and enclose them in square brackets.

This method allows each to be typed/with any typewriter or printer. Use ordinary parentheses if square brackets are not available.

- Use a number before an item to tell how many times it should be repeated.

This saves a good deal of typing. Keep the number inside the brackets also.

- Enclose consecutive special keys within the same brackets separated by commas.

This is much easier to read and eliminates the need to type brackets all the time.

- For graphics use the letter on the key enclosed in brackets.

If you see a letter inside brackets it means shift and hit that key. (S) means 'shift and hit s' which gives you a heart.



# NEW FROM SEED

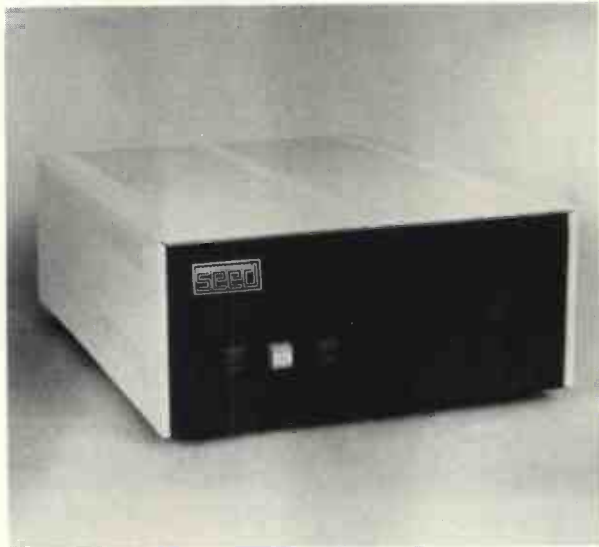

## The 'System One':

A complete system based upon the highly successful MSI 6800 processor and including single or dual Shugart SA400 minifloppy drives all assembled in a single chassis.

'System One' is expandable to 56K bytes of memory and will support up to eight I/O devices of serial or parallel types. The system is supplied with a disk operating system. The system includes a basic interpreter.

Further information from Strumech Engineering.

**Strumech Engineering  
Electronics Division Ltd.  
Portland House  
Coppice Side  
Brownhills**

**Tel: Brownhills 4321**

# TANGERINE

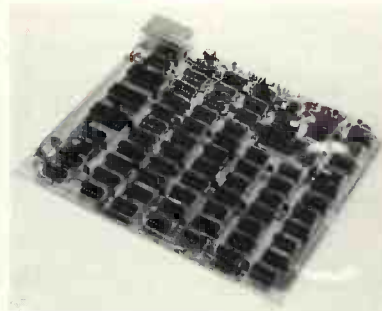

**NEW!**  
Ready built  
modules now  
available in 7 days  
Kits from  
**STOCK!**

A fully-compatible terminal when used with any keyboard and domestic TV (or monitor) that can replace any serial terminal for a fraction of the cost.

Apart from the regular features that most VDUs have, the 1648 can perform the following:

- 1) Fully-controllable cursor.
- 2) Generates 16 lines of 44/48 characters (selectable) in both upper- and lower-case with any keyboard, even those without an 'alpha' facility.
- 3) Break and Repeat also provided.
- 4) RS232 and full current loop I/O provided.
- 5) Full control character decoding—selectable by the user to perform cursor movements, bell, page clear, and for switching any other peripherals with suitable interfacing.
- 6) 10 switchable Baud rates.

All VDUs are supplied with an A4-sized ring-binder containing 50 pages of comprehensive manual with large A3 fold-out Circuit Diagram and Component Layout. Details of graphics, and other applications are also included.

### COMING SOON!

We shall be announcing soon the details of our Professional keyboard available in both kit and ready-built versions, with a numeric pad option.

Reed-keys are used exclusively, and it is therefore exceptionally reliable and robust!

Other products to be announced are:

- Z80 based single-board  $\mu$ computer.
- 6800 based single-board  $\mu$ computer.
- CRT Controller, an economy VDU module using software to control its functions. Also Teletext-compatible, with full graphics.
- Add-on Graphics Module for the 1648.
- Add-on Hex Keypad, for machine coding.
- Add-on  $\mu$ modem for cassette interfacing.
- Prom Programmer.
- Complete monitor-less Terminal.

### TANGERINE COMPUTER SYSTEMS LIMITED

RIVERMILL LODGE, LONDON ROAD,  
St. Ives, Huntingdon PE22 4BR 0480 65666

Please send the following:

- ( ) Further information.
- ( ) 1648 VDU KIT @ £129.50 inc. pp + VAT £10.36
- ( ) 1648 VDU Built and tested @ £154.50 inc. pp + VAT £12.36

NAME: .....

ADDRESS: .....

Business telephone: ..... Home telephone: .....

DATE: / /79

I enclose a cheque no: ..... for,

£..... INCLUDING VAT.

Signature: .....

Overseas customers should send a bank draft drawn on a London Bank, and include sufficient postage for surface/air mail for 1,3 kg.

Tandy users, like any other micro enthusiasts, have their difficulties as well as their successes—information they would clearly like to share with others. Now *Practical Computing* offers them their own monthly forum to share their news and air their views.

## Troubles

WE HAD a letter from Nigel Dibben wondering whether the other 199,999 TRS-80 users have had as much trouble as he has.

Nigel has had a collection of hardware faults on his 16K Level II machine. His first system arrived with some, was returned to Tandy, was repaired and failed completely within half an hour of being re-started. The replacement refuses intermittently to LIST or CLOAD, the cassette relay is jammed, and is unable to compute some mathematical functions correctly.

He reckons that the faults on the second system are caused by over-heating. He reports that "a blast of cold air into the back reduced errors and overflows from 50 percent probability to zero within about five minutes. Switching-off the cooling causes errors within one minute, deteriorating to 50 percent again after about 10 minutes.

He also suggests that buyers should be warned that the video is sensitive to any operating TV within about two metres; the effect is a severe horizontal wobble on the picture. This could be what our reviewer suffered.

There is another problem he found. The Editor/Assembler software works well enough but the documentation is below standard, apparently being assembled hastily from poorly-edited material. For example, there are references to sections of text which do not exist; and the Opcode listings are re-printed computer output with two out of four columns irrelevant. Incidentally, they were run off at 10:20:50 am and 10:22:47 am on July 9, 1976—it's all there.

More seriously, there is a dearth of information about subroutines already available in the resident ROM and there is not even a reference in the contents list to the few (such as *keyboard scan*) which are listed.

## All about the TRS-80

WE HEARD pleasant things about the *Guide to TRS-80 Information* and recently tracked down a copy. We saw the second edition, which appeared in mid-1978.

Modestly subtitled 'All about the world's fastest-selling microcomputer', the guide declares that it "permanentises in one place a large number of exciting references to or about the TRS-80 and the broad field of hard/software designed for it."

It appears that permanentises in one place means 'contains'; and you can be your own judge of what constitutes an 'exciting' reference.

So what is it? For a start, it's an A5

booklet of 36 pages organised into seven sections, plus an introduction:

- *General TRS-80 Information.* Articles, letters, editorials, advertisements, newsletters of interest to users and potential users. Mostly culled from U.S. magazines.
- *TRS-80 Software Articles and Information.* Articles, reviews and sources.
- *A special TRS-80 Software List.* Annotated entries and location of authors of selected software, many people wanting a SAE.
- *Other TRS-80 Software Sources.* Authors and addresses, mostly small companies.
- *TRS-80 Hardware Articles and Information.* References to hardware articles and reviews.
- *A special TRS-80 Hardware List.* Annotated references to some hardware sources.
- *TRS-80 and General Programming Information.* Selected references to articles and books on programming; not many, but good quality.
- *TRS-80 User and Special Interest Group Information.* Who and where they are—there are 13 of them and, of course, they are all in the U.S.
- *Bugs, Ideas and Tips.* Brief but helpful information reported by or prepared for users, including some things about which you might ask your TRS-80 supplier.

What did we think of the guide? It's excellent value if you have access to U.S. magazines, and perhaps U.S. people. The 'tape tips' alone are worth several pence of anyone's computer budget, in any case.

There are some 400 references. Since it costs only \$2.80 (plus \$1.50 shipping plus 20 percent for air mail, which we work out at a total of \$5.16) you should be able to get something from it.

The address is PO Box 37206, Oak Park, Mi 48237, U.S. If you have any difficulty obtaining it, contact us.

## Colour blindness

EVERY TIME the editor assembles his TRS-80, he has to refer to the *Handbook* to make sure which jack plug goes into which socket—he's funny that way. The instant solution, as now practised by many TRS-80 owners, is to colour-code the jacks and sockets; he is using coloured insulating tape.

## Cursor curse

HERE'S a thought from a U.S. seminar participant—don't leave your cursor for too long in the middle of the screen. It may get 'locked' in that position.

## Square cut

WRITING programs to draw squares and rectangles can be tricky. This effort is from Freddie Nicholls of Optronics in Twickenham.

```
1 CLS
5 PRINT"ENTER START & FINISH OF
  HORIZONTAL LINES (0 TO 127):INPUT A,B
6 PRINT"ENTER START & FINISH OF VERTICAL
  LINES (0 TO 47):INPUT C,D
8 Y=C
10 FOR X= A TO B:SET (X,Y):NEXT X:Z=Z+1:
  IF X=B GOTO 20:GOTO 10
20 Y=D:IF Z=2 GOTO 40
30 GOTO 10
40 X=A
50 FOR Y= C TO D:SET (X,Y):NEXT Y:IF Y=D
  GOTO 60:GOTO 50
60 X=B:GOTO 50
70 END
```

Does anyone have a routine to draw circles?

## Optronics options

INCIDENTALLY, Optronics will be marketing three American goodies in this country. Pride of place must go to Michael Shroyer's Electronic Pencil software, available on several \$100 micros already but now implemented on Tandy's little giant, as we mentioned in our U.S. report in the January issue. We'll be asking for a review copy of the software.

Optronics is also fixing a distributorship for *The BASIC Handbook*. This we have reviewed enthusiastically; we like it so much we might even sell it ourselves.

Optronics is also arranging to sell *TRS Computing* here. This is the best of the TRS-80 specialist magazines, even if it is only a few months old. Optronics let us see a copy but insisted we return it, so the continuity of supply might be in some doubt. Still, if you have a chance it is worth subscribing to—we get ours direct from the States for \$18. Goodies from issue one—much the best so far—include:

- A \$6 kit to get Level I and Level II on the same machine.
- How to get at the lower-case characters every TRS-80 has within it.

## Getting taped

J & J Electronics is a new name to us, but it's keen to become better known. We've just received the company's mailing sheet and there are some real goodies on it, including a do-it-yourself 16K upgrade kit for \$149. J & J promises that this takes only half an hour to install and it certainly beats the Tandy price.

This supplier also has good-quality Racial tapes at discount prices—10 for £4.50. The bulk of the lists comprise programs, 23 of them ranging from a £5.95 submarine chase game to £19.95 for an accounts-receivable package. More programs are promised, especially for business.

J & J is on 0424 220391.



# INTRODUCING DUAL DRIVE MINIFLOPPY FOR PET!



- DUAL MINI FLOPPY DRIVE WITH 100K PER DISK SIDE FOR TOTAL 200K ON LINE
- DESIGNED FOR COMMERCIAL SPEED REQUIREMENTS
- FAST LOADING SPEED
- DISKMONTM (DOS) AUTOMATICALLY REORGANIZES FREE DISK SPACE AFTER SAVE OR ERASE
- DISKMON IS RESIDENT IN ROM VIA DISK CONTROLLER BOARD PLUGGED INTO EXPANDAPET\*
- DISKMON ADDS 14 COMMANDS TO BASIC INCLUDING DISK DATA FILES
- DISKMON COMMANDS SUPPORT COMMERCIAL PRINTER OFF PARALLEL PORT SUCH AS CENTRONICS 779
- FULL DISK SOFTWARE SUPPORT
- FORTRAN & PLM COMPILERS THIS JANUARY
- 90 DAY MANUFACTURER'S WARRANTY ON HARDWARE
- READY TO USE ON DELIVERY, WITH FULL INSTRUCTIONS AND UTILITY DISKETTE
- CALL OR WRITE FOR ADDITIONAL INFORMATION
- INITIAL QUANTITIES LIMITED
- THIS SYSTEM IS FULLY SUPPORTED BY SOFTWARE FROM THE MANUFACTURER
- ORDERS ARE NOW BEING ACCEPTED FOR DECEMBER & JANUARY DELIVERY

DKH641	—DUAL DRIVE SYSTEM, COMPLETE WITH DISKMON	.....£916 + VAT
DKL067	—DISKMON ASSEMBLER LISTING/DOS	.....P.O.A.
ASM789T	—PET-ASSEMBLER ON CASSETTE	.....P.O.A.
ASM789D	—PET ASSEMBLER ON DISKETTE (5.5 inch)	.....P.O.A.
LNK456	—AUTOLINK LINKING LOADER ON DISKETTE	.....P.O.A.
FOR300	—FORTRAN COMPILER ON DISKETTE	.....P.O.A.
PLM400	—PLM COMPILER ON DISKETTE	.....P.O.A.

★★ BUSINESS PACKAGES STARTING IN 1st QUARTER 1979 ★★  
\*THIS SYSTEM REQUIRES EXPANDAPET MEMORY (MINIMUM 16K—SEE BELOW)

## INTERNAL MEMORY EXPANSION FOR PET!

### EXPANDAPET™

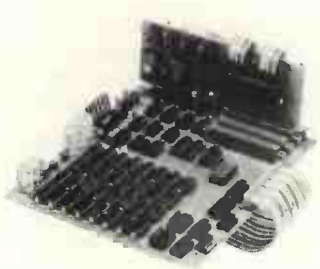

- INTERNAL MEMORY  
EXPANSION UNIT*
- MOUNTS EASILY INSIDE YOUR PET
  - EASY TO INSTALL (15 MINUTES)
  - NO DEGRADATION OF PET SYSTEM
  - USES LOW POWER DYNAMIC RAMS
  - 90 DAY PART & LABOUR 1 YR-RAMS
  - 30 DAY MONEY BACK GUARANTEE
  - MOUNTING SLOTS FOR 4 BOARDS
  - CALL/WRITE FOR ADDITIONAL INFO
  - DEALER INQUIRIES INVITED

32K UNIT ALLOWS 8K OF ASSEMBLY LANGUAGE SUBROUTINES ACCESSED VIA THE USR COMMAND

OPTIONAL PLUG-IN BOARDS

SERIAL I/O BOARD	P.O.A.
S-100 I/O BOARD	P.O.A.
4K EPROM BOARD	P.O.A.

**EXPANDAPET PRICES**

16K (+ 8K PET = 24K)	£298 + VAT
24K (+ 8K PET = 32K)	£364 + VAT
32K (+ 8K PET = 40K)	£425 + VAT

### MUSIC BOX

Turns your PET into a programmable musical instrument. You can record and ply up to 90 pages, 16 notes per page, change tempo, key, etc.

**£37.50 inc. VAT & P&P**

### T.I.S. WORKBOOKS

A set of 5 workbooks to give you a full understanding of all the ins and outs of your PET more fully than any previous manuals.

**£15.95 per set, inc. P&P**

Lots of software and other goodies.  
Send large SAE

## OHIO SCIENTIFIC SUPERBOARD II

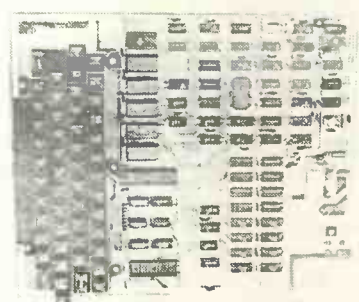

**£263 plus VAT**

### Standard Features

- Uses the ultra powerful 6502 microprocessor
- 8K Microsoft BASIC-in-ROM
- Full feature BASIC runs faster than currently available personal computers and all 8080-based business computers
- 4K static RAM on board expandable to 8K
- Full 53-key keyboard with upper-lower case and user programmability
- Kansas City standard audio cassette interface for high reliability
- Full machine code monitor and I/O utilities in ROM
- Direct access video display has 1K of dedicated memory (besides 4K user memory), features upper case, lower case, graphics and gaming characters for an effective screen resolution of up to 256 by 256 points. Normal TV's with overscan display about 24 rows of 24 characters, without overscan up to 30 x 30 characters.

### Extras

- Available expander board features 24K static RAM (additional mini-floppy interface, port adapter for printer and modem and OSI 48 line expansion interface).
  - Assembler editor and extended machine code monitor available.
- Fully built and tested. Requires only +5V at 3 amps and a videomonitor or TV and RF converter to be up and running. Phone or write for delivery dates. Full one year warranty.

**LOTUS SOUND, 4 MORGAN ST., LONDON E3 5AB**

Tel: 01-981-3993      Telex: 261426 Attn: Lotus Sound

# Similar considerations for input conversion

by ROLAND PERRY

In two previous articles we discussed the use of an IBM Selectric I/O writer as a printer, describing a hardware interface and giving suitable software routines to drive it. The IBM machine is capable of input; indeed the output can even be verified as it proceeds.

SIMILAR considerations apply to the input conversions as were detailed for output conversion. For example, it is easier to re-wire the contacts than to trace the existing wiring. Again, the input may be derived from an operational cycle or from a golf-ball character. Some of the circuitry of the original output conversion, and the look-up table of the software, are used, with the addition of a little extra electronics and a driver program.

The C1 contact, as yet unused, signals that the character selection contacts are ready to be sampled, and the combination C2 and the like signals that the operational contacts are ready to be sampled.

In fact, for character inputs both C2 and C1 are used and it is this combination which will allow the computer to differentiate between operations and characters.

Sampling takes place when the Normally Open (N/O) contact closes, which for the C2 and the like combination is already detected in the interface as one of the constituent parts of the BUSY signal. To detect the N/O closure of C1, an extra pair of NAND gates are used to form a bi-stable, de-bouncing the switching action.

A new set of seven wires connects the contacts to the computer. The contacts are wired in pairs, one character and one opera-

Figure 3. Electronics.

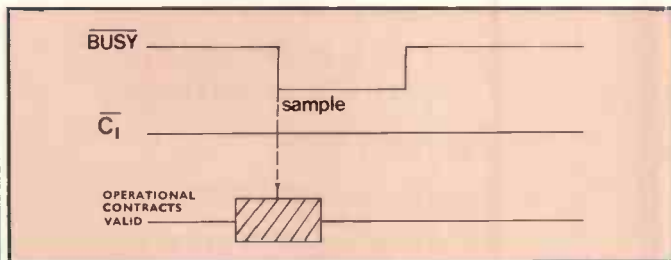
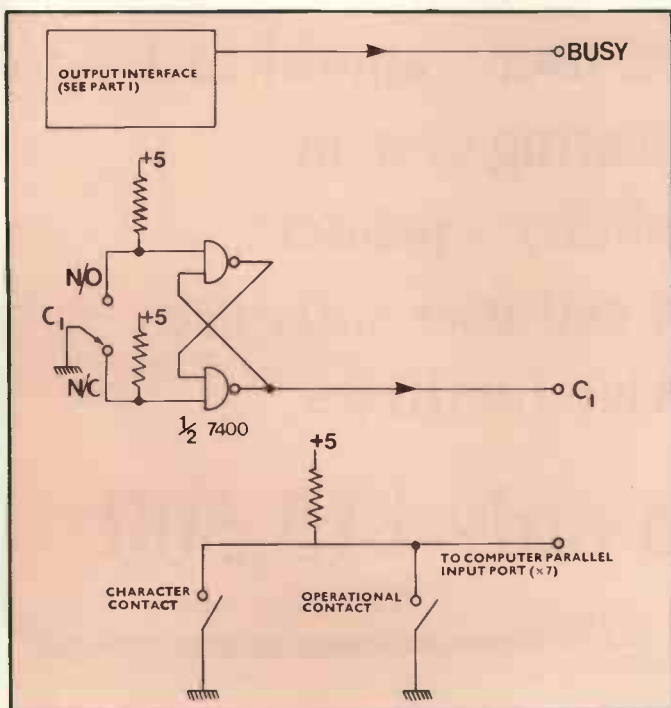

Figure 1. Operational Input.

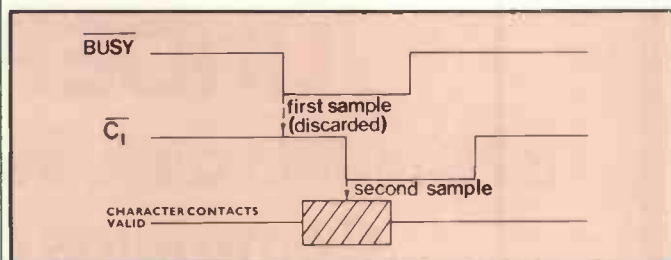

Figure 2. Character Input.

tional, using the same relationship as for the paired output magnets—note the inverted sense of R-5 and wire accordingly. It is unlikely that the terminal will have spare contacts for the shift operations and they are dealt with as a special case.

The software should be arranged to act as follows:

When expecting an input, the BUSY line is polled until it goes low. At that point the contacts are sampled in case it was an operational cycle. The result is stored. If, while the BUSY line is still low, the C1 line goes low, then the cycle is a character input and the contacts are once again sampled on the falling edge of C1. This sample replaces the previous result.

For an operational cycle the look-up table already existing for outputs is scanned between ASCII 00 and 20 inclusive, to determine the code for the input to be returned to the system.

If no contacts were detected as closed when the BUSY line fell, then the cycle was a shift and all that needs to be done is to examine the shift status-line for use when decoding the next character input.

For character cycles, the look-up table is scanned from ASCII 21 upwards, comparing the contents to a combination of the input IBM code and the shift status, to determine the ASCII for the input character.

Finally, when interfacing with the system software, be careful to program the routines for half-duplex operation, otherwise the system may echo all the input characters on to the printer, causing double-printing. Some care may also be required in the treatment of back-space characters.



# TWO POWERFUL LOW COST MICROCOMPUTER SYSTEMS

## **1** compelec SERIES I

- Fast 4MHz Z80 CPU.
- Selectable Disk Capacity (½M, 1M, 2M, or 4M Bytes.)
- 2 Parallel Ports
- 2 Serial RS 232 Ports
- 1 Kilobyte of 2708 EPROM
- Floating Point Processor
- 64 Kilobytes of 16K Dynamic RAM
- Programmable Real Time Clock

### SOFTWARE

- CP/M
- BASIC
- COBOL
- FORTRAN IV
- PASCAL

## UNDER £5,000

32K, ½MB disk, serial I/O, parallel I/O.

Centronics printer and vdu

---

## **2** ALTAIR 300 WORDFLOW BUSINESS SYSTEM

- word processing
- multi-user
- multi-tasking
- re-entrant operating system
- 4 + V.D.U. capability + printers
- extensive library of end-user software
- full field service facilities

INVITATION  
NEXT PAGE

## from only £15,500

Tel: 01-636 1392/4



**compelec**  
LONDON BIRMINGHAM STOCKHOLM LOS ANGELES  
14-15 BERNERS STREET, LONDON W1P 3DE

# ILLUSTRATING BASIC

## ( A SIMPLE PROGRAMMING LANGUAGE )

WE CONTINUE our series of articles on how to program in Basic, probably the most widely-used programming language for small computers. For the series, we have obtained the serialisation rights for one of the best books on the subject, *Illustrating Basic* by Donald Alcock.

★

Each month, we are publishing a part of the book, so by the end of the series you will have the complete book. It is written with a distinct informality and has a rather unusual presentation; but it is this style, we believe, which makes it one of the most easy to read tutorials.

★

Alcock *Illustrating Basic*. Chapter 2. © Cambridge University Press. Reprinted by permission.

★

Copies of *Illustrating Basic* can be obtained from *Practical Computing*.

PREFACE	
1. COMPONENTS OF THE LANGUAGE	2
2. INPUT & OUTPUT, EXPRESSIONS AND FUNCTIONS	15
3. CONTROL	39
4. ARRAYS	59
ARRAYS ≈ INTRODUCING SUBSCRIPTED VARIABLES	60
DIM ≈ DECLARING THE DIMENSIONS OF ARRAYS	62
SUBSCRIPTS ≈ MANIPULATING SUBSCRIPTS AS EXPRESSIONS	64
RIPPLE SORT ≈ AN EXAMPLE TO ILLUSTRATE SUBSCRIPTS	66
CONTINUED NEXT MONTH	
5. MATRICES	75
6. COMPLETE EXAMPLE PROGRAMS	101
7. COMMANDS AND SIGNING ON	111
8. FILES OF DATA	119
9. SYNTAX	127
INDEX	132



# ARRAYS

IN ADDITION TO THE SIMPLE NUMERICAL & TEXTUAL VARIABLES YOU MAY USE THOUSANDS OF OTHER VARIABLES ARRANGED IN ARRAYS.

BELOW IS AN EXAMPLE OF A ONE-DIMENSIONAL NUMERICAL ARRAY CALLED A( ).

A(1)	3.56
A(2)	7.12
A(3)	10.68
A(4)	

A( ) HAS ELEMENTS, EACH OF WHICH CAN STORE A NUMBER IN THE SAME WAY AS ANY SIMPLE NUMERICAL VARIABLE :

```
100 LET A(1) = 3.56
110 LET A(2) = 7.12
120 LET A(3) = A(1) + A(2)
```

ANOTHER NAME FOR ELEMENT IS SINGLY-SUBSCRIPTED VARIABLE (OR JUST SUBSCRIPTED VARIABLE IF THE CONTEXT ALLOWS).

OTHER NAMES FOR A ONE-DIMENSIONAL ARRAY ARE: VECTOR, COLUMN VECTOR, & COLUMN MATRIX. YOU CAN ALSO THINK OF A( ) AS A ROW :

A(1)	A(2)	A(3)	A(4)
3.56	7.12	10.68	

AND CALL IT A ROW VECTOR OR ROW MATRIX.

BELOW IS AN EXAMPLE OF A TWO-DIMENSIONAL NUMERICAL ARRAY CALLED B( , ). IT HAS 4 ROWS AND 3 COLUMNS.

	1)	2)	3)
B(1,	8.92		
B(2,		17.84	-8.92
B(3,			
B(4,			

JUST AS WITH A( ), B( , ) HAS ELEMENTS EACH OF WHICH CAN STORE A NUMBER IN THE SAME WAY AS A SIMPLE NUMERICAL VARIABLE :

```
130 LET B(1,1) = 8.92
140 LET B(2,2) = 2 * B(1,1)
150 LET B(2,3) = -B(1,1)
```

ANOTHER NAME FOR AN ELEMENT OF A TWO-DIMENSIONAL ARRAY IS DOUBLY-SUBSCRIPTED VARIABLE (OR JUST SUBSCRIPTED VARIABLE WHEN THE CONTEXT ALLOWS).

OTHER NAMES FOR A TWO-DIMENSIONAL ARRAY ARE RECTANGULAR ARRAY AND RECTANGULAR MATRIX. (IF THE NUMBER OF ROWS IS THE SAME AS THE NUMBER OF COLUMNS THEN SQUARE MAY BE SAID IN PLACE OF RECTANGULAR.)

A FEW BASICS ALLOW THREE-DIMENSIONAL ARRAYS.

**B**ELOW IS AN EXAMPLE OF A *TEXTUAL* ARRAY CALLED  $T\$( )$ . IT IS *ONE-DIMENSIONAL* (SEVERAL *BASIC*S DON'T ALLOW TWO-DIMENSIONAL TEXTUAL ARRAYS SO FOR THE SAKE OF "PORTABILITY" IT IS BEST TO DO WITHOUT THEM ).

$T\$(1)$	HO
$T\$(2)$	
$T\$(3)$	KEGRAPHA
$T\$(4)$	
$T\$(5)$	KEGRAPHA

$T\$( )$  HAS ELEMENTS EACH OF WHICH CAN STORE A TEXT IN THE SAME WAY (AND USUALLY TO THE SAME LENGTH) AS ANY SIMPLE TEXTUAL VARIABLE.

```
160 LET T$(1) = "HO"
170 LET T$(3) = "KEGRAPHA"
180 LET T$(5) = T$(3)
```

**Y**OUR PROGRAM MAY HAVE UP TO 26 NUMERICAL ARRAYS:

$A( )$ ,  $B( )$ ,  $C( )$ , ...,  $Z( )$

OF WHICH SOME MAY BE *ONE-DIMENSIONAL* AND SOME *TWO-DIMENSIONAL*: ONE LETTER CAN'T BE MADE TO SERVE FOR BOTH KINDS AT ONCE.

YOUR PROGRAM MAY ALSO HAVE UP TO 26 TEXTUAL ARRAYS:

$A\$( )$ ,  $B\$( )$ ,  $C\$( )$ , ...,  $Z\$( )$

AND YOUR PROGRAM MAY USE ALL 286 SIMPLE NUMERICAL VARIABLES AND ALL 26 SIMPLE TEXTUAL VARIABLES WHICH ARE COMPLETELY DISTINCT FROM ELEMENTS OF ARRAYS:  $B(2,2)$  HAS NOTHING TO DO WITH  $B$ ;  $T\$(5)$  HAS NOTHING TO DO WITH  $T\$\$ .

**S**PECIFY THE SIZES AND SHAPES OF THE ARRAYS YOU WANT TO USE BY THE "DIM" STATEMENT (SHORT FOR *DIMENSION*) AS EXPLAINED OVERLEAF. THE ARRAYS ON THIS DOUBLE PAGE WOULD BE SPECIFIED LIKE THIS:

```
10 REM A PROGRAM WITH ARRAYS
20 DIM A(4), B(4,3), T$(5)
```



# DIM

DIM IS SHORT FOR *DIMENSION*  
 USE THIS STATEMENT TO SPECIFY THE  
 DIMENSIONS OF ALL ARRAYS IN YOUR PROGRAM.

THE FOLLOWING SELECTION OF ARRAYS :

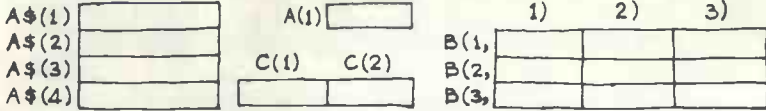

MAY BE SPECIFIED IN ONE "DIM" STATEMENT :

```
10 REM PROGRAM WITH ONE DIM
20 DIM A$(4), A(1), C(2), B(3,3)
```

OR IN MORE THAN ONE "DIM" STATEMENT :

```
10 REM PROGRAM WITH SEVERAL DIMS
20 DIM C(2), A(1)
30 DIM B(3,3)
40 DIM A$(4)
```

INTEGERS ONLY!  
 EXPRESSIONS  
 NOT ALLOWED

MANY *BASICs* ALLOW YOU TO OMIT "DIM" STATEMENTS WHEN DIMENSIONS ARE 10 OR LESS, BUT DON'T TAKE ADVANTAGE OF THIS. IF YOU GO BACK TO A PROGRAM WRITTEN LONG AGO OR HAVE TO SORT OUT SOMEONE ELSE'S PROGRAM IT IS HELPFUL TO KNOW STRAIGHT AWAY WHAT ARRAYS ARE BEING USED. IN ANY CASE THERE ARE SOME *BASICs* THAT DEMAND DECLARATION OF ALL ARRAYS HOWEVER SMALL.

**A**LL "DIM" STATEMENTS SHOULD BE NEAR THE BEGINNING OF THE PROGRAM BEFORE THE FIRST USE OF ANY SUBSCRIPTED VARIABLES AFFECTED AND YOU SHOULD ENSURE THAT "DIM" STATEMENTS ( LIKE "DEF" STATEMENTS ON PAGE 26 ) ARE ACTUALLY ENCOUNTERED DURING EXECUTION.

```
50 LET P(1) = 4*5
60 DIM P(16)
```

```
10 GO TO 30
20 DIM A(40,40), B(1000)
30
```

IN MANY *BASICs* THESE THINGS DON'T MATTER BUT IN SOME THEY DO SO FOR THE SAKE OF "PORTABILITY" ACCEPT SUCH LITTLE RESTRICTIONS.

IT IS ALWAYS A MISTAKE TO DECLARE AN ARRAY MORE THAN ONCE.

```
10 DIM A(100,20), B(60)
20 DIM B(60), C(500)
```

**H**ISTORICALLY THE ROWS & COLUMNS OF ARRAYS IN BASIC WERE COUNTED FROM ZERO RATHER THAN UNITY.

	0)	1)	2)	3)
P(0,				
P(1,				
P(2,				

Q(0)	
Q(1)	
Q(2)	

AND THE "DIM" STATEMENT REFERRED TO *BIGGEST SUBSCRIPTS* RATHER THAN QUANTITIES OF ROWS AND COLUMNS:

```
10 REM HISTORICAL BASIC
20 DIM P(2,3), Q(2)
```

BUT THERE ARE VERSIONS OF BASIC TODAY THAT COUNT FROM UNITY (AS IN THE ILLUSTRATIONS OPPOSITE) SO IT IS SAFEST TO IMAGINE YOUR VERSION COUNTS FROM 1. IF, IN FACT, IT COUNTS FROM ZERO IT MEANS YOU ARE WASTING SOME SPACE IN THE COMPUTER'S STORE BUT AT LEAST YOUR PROGRAM SHOULD BE "PORTABLE".

SOME BASICS CATER FOR BOTH METHODS WITH THE STATEMENT:

OR:

```
10 BASE 0
```

```
10 BASE 1
```

TO DECLARE WHETHER YOU WISH TO COUNT FROM ZERO OR UNITY RESPECTIVELY.

**T**HE "DIM" STATEMENT MAKES BASIC RESERVE SPACE IN THE COMPUTER'S STORE FOR ALL YOUR ARRAYS, BUT THIS DOESN'T IMPLY THAT BASIC CLEARS THEM OF INFORMATION LEFT OVER FROM A PREVIOUS COMPUTER RUN. SOME BASICS DO SET SUBSCRIPTED VARIABLES TO ZERO (BLANKS IN THE CASE OF TEXTS), OTHERS "FLAG" THEM AS UNSET (AS DISCUSSED FOR SIMPLE VARIABLES ON PAGE 11), AND OTHERS LEAVE THEM FULL OF "GARBAGE". SO IF YOUR PROGRAM READS FROM AN ARRAY:

```
100 LET A = B(2,2)
```

EXPECTING TO FIND ZERO WHEN NOTHING HAS YET BEEN PUT THERE, MAKE SURE YOUR PROGRAM CLEARS THE ARRAY FIRST. THE SIMPLEST WAY TO DO THIS IS EXPLAINED ON PAGE 86 WHICH WE ANTICIPATE WITH THIS EXAMPLE:

```
70 MAT B = ZER
```

SETS ALL ELEMENTS  
OF ARRAY B(,) TO ZERO





# SUBSCRIPTS

THE FOLLOWING ARRAY :

```
10 DIM B(4,3)
```

	1)	2)	3)
B(1,			
B(2,			
B(3,			
B(4,			

IS AN ARRAY OF 12 SUBSCRIPTED VARIABLES EACH OF WHICH CAN BE USED AS THOUGH IT WERE A SIMPLE NUMERICAL VARIABLE :

```
100 LET B(1,2) = B(2,2)*2 + 6*B
110 LET B(3,3) = FNC(B(1,1)/B(2,2))
120 PRINT B(1,2); B(3,3)
130 FOR I = B(1,1) TO B(1,2) STEP B(1,3)
140 IF B(3,3) >= B(2,3) THEN 600
```

EXAMPLES  
OF SYNTAX:  
THE CONTENT  
IS MEANINGLESS

THIS APPLIES TO TEXTUAL VARIABLES TOO :

```
150 LET T$(6) = "PONZIO"
160 IF T$(7) <> "PILATO" THEN 200
170 PRINT T$(6); T$(7)
```

IN ANY EXPRESSION WHERE A SIMPLE VARIABLE IS ALLOWED A SUBSCRIPTED VARIABLE IS ALSO ALLOWED.

BUT THERE ARE PLACES OUTSIDE EXPRESSIONS WHERE YOU CAN'T HAVE A SUBSCRIPTED VARIABLE :

NOT AS A LOOPING  
VARIABLE :

```
180 FOR B(1,1) = 1 TO 3
```

```
190 DEF FNC(B(1,1)) = SQR(A+2 + B+2)
```

NOT AS THE  
DUMMY ARGUMENT  
OF A FUNCTION.

THE REAL ADVANTAGE OF SUBSCRIPTED VARIABLES, HOWEVER, IS NOT AS A SUBSTITUTE FOR SIMPLE VARIABLES BUT BECAUSE THEIR

## SUBSCRIPTS MAY BE VARIABLES + EXPRESSIONS

EVEN COMPLICATED EXPRESSIONS,  
THEMSELVES CONTAINING SUBSCRIPTED VARIABLES.

**T**HUS IT IS SIMPLE TO READ A ROW OR COLUMN VECTOR:

```
240 FOR R = 1 TO 4
250 FOR C = 1 TO 3
260 LET B(R,C) = 0
270 NEXT C
280 NEXT R
```

```
200 DATA "A","B","C","D"
210 FOR I = 1 TO 4
220 READ T$(I)
230 NEXT I
```

OR CLEAR A RECTANGULAR ARRAY:

OR PRINT A VECTOR (IN THIS CASE AS A ROW):

```
290 FOR I = 1 TO 4
300 PRINT T$(I);
310 NEXT I
320 PRINT
```

```
330 FOR R = 1 TO 4
340 FOR C = 1 TO 4
350 PRINT B(R,C);
360 NEXT C
370 PRINT
380 NEXT R
```

OR PRINT A RECTANGULAR ARRAY (IN THIS CASE BY ROWS):

OR SCAN A LIST OF ITEMS TO FIND THE LOCATION OF A PARTICULAR ITEM.

```
390 FOR I = 1 TO 4
400 IF T$(I) = "C" THEN 430
410 NEXT I
420 LET I = 0
430 PRINT "LOCATION IS"; I
```

**B**UT **B**EWARE OF USING COMPLICATED EXPRESSIONS AS SUBSCRIPTS:

```
440 LET X = B(A↑2/2, 3)
```

WHAT WOULD HAPPEN IF  $A↑2/2$  TURNED OUT TO BE 3.99999?

★ SOME *BASIC*S WOULD TAKE THE *INTEGRAL PART* OF THE RESULT AND LET  $X = B(3, 3)$

★ OTHER *BASIC*S WOULD TAKE THE *NEAREST INTEGER* TO THE RESULT AND LET  $X = B(4, 3)$

YOU CAN EASILY TEST WHAT YOUR OWN VERSION OF *BASIC* DOES BY RUNNING THE LITTLE PROGRAM BELOW. BUT YOU SHOULD NOT

```
10 DIM A(2)
20 LET A(1) = 100
30 LET A(2) = 200
40 LET I = 1.99
50 PRINT A(I)
60 END
```

WRITE PROGRAMS THAT RELY ON ONE PARTICULAR INTERPRETATION. KEEP SUBSCRIPTS SIMPLE AND USE "INT()" IF THEIR VALUES COULD HAVE FRACTIONAL PARTS.



# RIPPLE SORT

AN EXAMPLE TO ILLUSTRATE SUBSCRIPTED VARIABLES

SORTING NUMBERS INTO ASCENDING ORDER IS SIMPLE IN CONCEPT BUT SURPRISINGLY DIFFICULT TO ORGANISE WHEN THERE ARE LARGE VOLUMES OF DATA. THE EXAMPLE BELOW USES THE SIMPLEST TECHNIQUE OF ALL - THE RIPPLE SORT - WHICH IS ADEQUATE FOR SMALL VOLUMES OF DATA (( 100 OR SO NUMBERS)) STORED AS ARRAYS IN BASIC.

A(1)	6.5
A(2)	13.9
A(3)	4.6
A(4)	10.2
A(5)	3.5

ARRAY A(), A COLUMN VECTOR, IS TO BE SORTED INTO ASCENDING ORDER - HEAVIEST NUMBERS SINKING TO THE BOTTOM. YOU CAN REVERSE THIS ORDER BY REVERSING THE CONDITION IN THE "IF" STATEMENT.

WE START WITH AN "INDEX" I POINTING TO ROW 1; THEN WE ADVANCE I ROW BY ROW. AT EVERY ADVANCE WE LOOK AT THE NUMBER I IS POINTING TO AND ALSO AT THE NUMBER ONE ROW AHEAD OF I. IF THE FORMER IS GREATER THAN THE LATTER WE SWOP THE TWO NUMBERS.

HAVING FINISHED ONE "SWEEP" OF I WE SWEEP AGAIN BUT STOP ONE ROW SHORT OF THE PREVIOUS SWEEP BECAUSE THE HEAVIEST NUMBER MUST ALREADY HAVE SUNK TO THE BOTTOM.

WE CONTINUE SWEEPING EACH SWEEP A ROW SHORTER THAN THE PREVIOUS ONE UNTIL THERE IS A WHOLE SWEEP WITHOUT A SINGLE SWOP IN IT OR THE LENGTH OF SWEEP IS REDUCED TO NOTHING.

HERE IS THE WHOLE PROCESS: )) SHOWS WHERE A SWOP HAS JUST OCCURRED

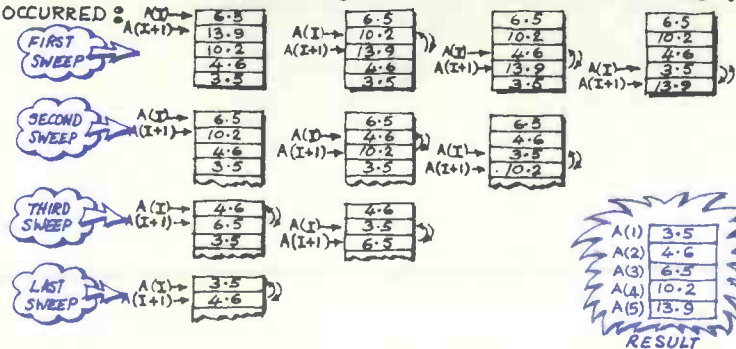

THE PROGRAM BELOW IS DESIGNED TO SORT A COLUMN VECTOR, A(), HAVING N ROWS. THE VECTOR IS FILLED FROM "DATA" STATEMENTS. THE FIRST NUMBER IN THE FIRST "DATA" STATEMENT TELLING THE NUMBER OF NUMBERS TO BE SORTED. THE LOGIC ILLUSTRATED HERE IS USED AGAIN IN A MORE USEFUL WAY ON PAGE 71 WHERE WE AVOID ACTUALLY HAVING TO MOVE THE NUMBERS BEING SORTED.

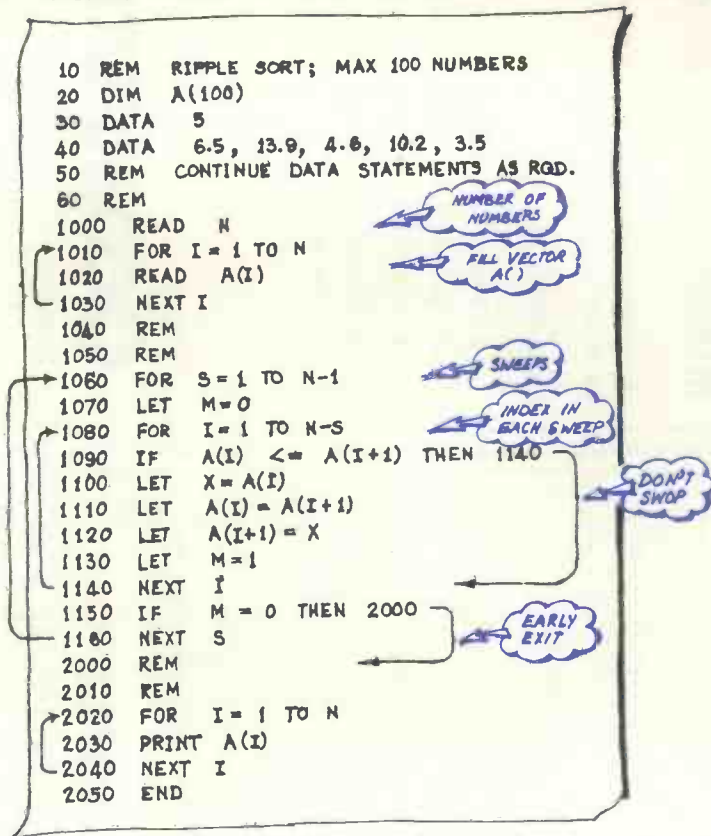

VARIABLE M IS A "MARK" SET ZERO BEFORE EACH SWEEP BUT SET NON-ZERO EVERY TIME THERE IS A SWOP. M IS TESTED AT THE END OF EACH SWEEP AND IF IT SHOWS THERE WERE NO SWOPS THEN CONTROL JUMPS TO AN EARLY EXIT.

THIS TECHNIQUE AND OTHERS USED IN THE LONGER EXAMPLES IN THIS BOOK ARE EXPLAINED VERY CLEARLY BY A. COLIN DAY IN "FORTRAN TECHNIQUES" 2 CAMBRIDGE UNIVERSITY PRESS (1972).

## GAMES GAMES

### GAME CASSETTES IN BASIC

(suitable for PET etc.)

**TORPEDO RUN**—Solo simulation of the destruction of the Death Star. Out-maneuvre and battle, tie fighters until the vent comes into range. Drop your Photon torpedo and the Death Star explodes. Full graphics. . . .£8.00

**FINAL FRONTIER**—Solo Star Trek adventure combining functions on most other Star Trek games. Multiple-choice command including built-in range-finding computer. Nice graphics. Can be replayed instantly. . . .£8.00

**YAM**—(Yahtzee) Classic dice game using 5 dice. 2 versions on one tape: 1 for up to 6 players; one for up to 4 players with 4 columns each. . . .£6.00

**PONTOON**—Solo version of the well-known card game. Good graphics; betting facility; Splitting and Burning possible. . . .£5.00

**MAN-EATER**—Surround and capture the shark before he chomps your swimmers. Skilful game of deduction, with graphics. . . .£4.00

### COMPUTER GAMES & BOOKS

**BASIC COMPUTER GAMES**—101 games in Basic. Microcomputer edition. . . .£5.50

**CREATIVE COMPUTING MAGAZINE**—Games, puzzles, projects, fiction, articles, humour, cybernetics, building info and more. Sample copy. . . .£1.50

**BEST OF CREATIVE COMPUTING Vo. 1**—328pp compendium. . . .£6.95

**BEST OF CREATIVE COMPUTING Vo. 2**—328pp compendium. . . .£6.95

**BEST OF BYTE**—Taken from first 12 issues of 'Byte' mag. Theory, applications, speculations, projects, software systems etc. 384pp. . . .£8.95

### SCIENCE FICTION & FANTASY BOARD & TABLE GAMES

We are specialists in the rapidly-expanding Science Fiction Games hobby. For our illustrated games catalogue, introductory literature and illustrated miniature figures lists send 30p in stamps + a large SSAE.

All prices include postage and packing (UK only)  
TRADE ENQUIRIES WELCOME

Games Workshop, 1 Dalling Rd, London W6 01-741 3445

## GAMES GAMES

● Circle No. 151

## INTRODUCING THE SLAVE

*A truly commercial computer printer at a personal computing price.*

*Some of the features:*

- ★ 80 columns, 112 cps
- ★ 84 lines per minute, bi-directional
- ★ 100 million characters printhead life
- ★ Sprocket feed, multi-copy
- ★ V24 interface

## COMPUTRADE

Silverwood House, Oxshott Road, Leatherhead, Surrey  
Tel. No. 03723 77374

North: 061-477 4960

Midlands: 0533-536077

South-East: 01-658 5906

● Circle No. 152

## KIM 1 New Low Price

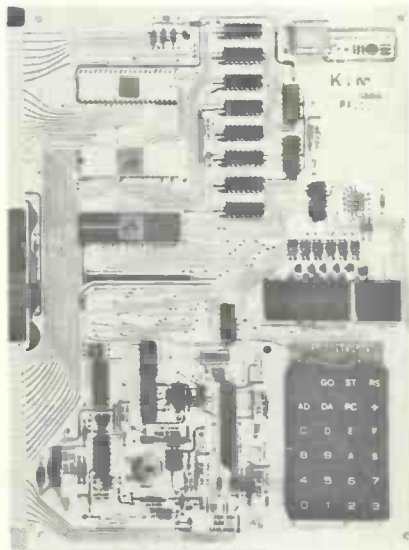

# Marshall's for Microprocessors and associated components

We distribute the fabulous KIM System – the ready to use microprocessor system – a new concept in microcomputers. Not a kit but supplied fully tested, wired and guaranteed. Expandable memory that grows with your system – not just an evaluation kit. Starting with KIM 1 at £108.00 VAT incl. you get immediate capability which can be expanded to a complete system capable of addressing up to 65K bytes of memory.

We also stock PET and a comprehensive range of ROMs, RAMs, PROMs, EPROMs, 74LS series, 74C series, microprocessor support components, the National SC/MP Microprocessor and the MEK 6800 DII kit. In addition to these we stock an extensive range of discrete semiconductors, passive components and DIL switches, etc.

Send for details to: MARSHALL'S ELECTRONICS Kingsgate House, Kingsgate Place, London NW6 4TA Tel: 01-624 0805  
Retail Sales London: 40 Cricklewood Broadway, NW2 3ET. Tel: 01-452 0161/2. Telex: 21492  
London: 325 Edgware Road, W2. Tel: 01-723 4242. Glasgow: 85 West Regent Street, G2 2QD.  
Tel: 041-332 4133. Bristol: 1 Straits Parade, Fishponds Road, BS16 2LX. Tel: 0272 654201.

**NEW 1979 CATALOGUE NOW AVAILABLE** 50p post paid or 40p to callers.

● Circle No. 153



This month we review two more books which have been published with the beginner in computing in mind.

# This calls for patience

## BASIC—A Self-teaching Guide

by Robert Albrecht, LeRoy Finkel and Jerald Brown (published by John Wiley & Sons, 1978; limp cover, 325 pages, £3.25)

PUBLISHED as a second edition in 1978, the authors claim that "tens of thousands of people of all ages have used the first edition for a fast and thorough introduction to programming in Basic". We would not dispute the total for the number of people who may have achieved a thorough introduction to Basic by using this book but to claim it would be a speedy process is outrageous.

The book is of 325 pages, albeit with much use of space on the pages, a giant Teletype



for most of the printout examples, and a large type-face for the text—it is also written in a style reminiscent of a children's primer.

Even so, it does no more than cover the elementary structure of the Basic language. The discerning reader might well feel some insult to the intelligence by the level at which some of the questions in the text are posed.

An example of this approach is on page 2—"this first section starts off slowly and simply to kind of ease you into things". There the reader will find a photograph of a teletypewriter—a Teletype 33, in fact—and what is described as

a CRT is a Commodore Pet microcomputer.

The reader is asked to identify which of three characteristics these devices have in common—a television screen, a typewriter-like keyboard, or a steering wheel. We are not saying this is a *bad* approach to teaching a language—we do have doubts about the content.

As a more pointed example, the book will teach the reader how to write and run a simple Basic program but it will not tell you how to store a program as anything other than a source library.

The concept of storage space for files is introduced in the final chapter, with the explanation that a numeric variable occupies two "words" of file space while a single character of a string variable occupies *approximately* half a "word" of file space. That is not good enough.

## Simplistic

Simple error correction is explained but almost no mention is made of the syntactical checking facilities available with the majority of Basic systems today. In fact, the authors do not acknowledge the existence of or difference between interpreters or compilers—their examples are produced, however, from an (un-named) interpretative time-sharing system.

Some of the differences in language implementation are pointed out but with insufficient attention for our taste—there is no standard Basic. The chapter on files adopts a most simplistic approach; this is probably the area of concern for the user of a small business system.

## Conclusions

● True to its title, this book is indeed a self-teaching guide but only for readers endowed with a large amount of patience and only for those who will be satisfied with learning no more than an

elementary usage of the Basic language.

## Beginner's Guide to Computers

by T F Fry (Butterworths, 1978; paperback, 182 pages, £2.95)

WE LIKED this book. In it Fry has revealed the technicalities and complexities of the computer with lucidity and simplicity.

The book is very much an elementary and commendably light *technical* introduction, using basic mathematics and electronics. It is recommended



for the technically-inclined layman and as background reading for students of computer technology beginning their studies. Consequently, the author, who has already established something of a reputation as a clear expositor of electronics and computer techniques, takes few short cuts.

He starts by introducing three basic terms—data, process and information. Data he defines as consisting of "facts and figures relating to a situation which in isolation may not be meaningful"—a trifle heavy for our tastes, but accurate.

Processing is the business of relating and interpreting data in such a way as to provide information as a useful and meaningful statement upon which action can be taken.

The distinction between data

and information is critical to an appreciation of computers—data is disorganised, information is elegant—and it is proper that it should be introduced even before computers are discussed.

Fry gives three numbers as an example—7, 78, 8. In the right context, for instance, the top right-hand corner of a cheque, this becomes a meaningful statement of information: the date 8-7-78.

Number systems, logic and the central processing unit, together with storing and retrieving information, are explained with the aid of small diagrams. They and the printing could have been larger for clarity.

## Not dated

There is a reasonable introduction to the intricacies of programming, an overview of hardware systems, including small computers. Fry's terminology is by no means dated, so one may suppose that he keeps on top of his subject but the way he glosses-over small business computers is depressing.

Minis are given a paragraph, microcomputers three; floppy discs do not even warrant a mention. Visible record computers, curiously enough, are given a couple of pages and a photograph. Fry winds up with some ideas on "the computer and society" which comprises a neat enough overview of applications.

An index is included but, sadly, no glossary. On the whole, though, we were inclined to forgive this omission because of Fry's diligent care for explanatory detail.

## Conclusions

- Excellent value at less than £3 for the student as a broad outline to a deeper technical study. Not recommended for the businessman, who will probably find it too technical, and perhaps a trifle boring.
- The computer hobbyist might find it a good introduction. □

# POCKET TERMINAL

Midget duplex unit with man-sized facilities

Until you've tried it, you won't believe how much capability we've packed into the Pocket Terminal. We've gone all-out to make it the most practical and useful hand-held data communications device available.



Here's just a few of the facilities:

- Transmits 128 ASCII codes.
- Displays full 64 character ASCII set clearly.
- 30 character memory accessible through display.
- Single 5V supply required at 400mA max.
- 110 or 300 baud transmission, selectable.
- 20mA loop or V24/RS232 level versions available.
- Parity codes and stop bits settable to your standard.
- Reacts to bell, cursor and formatting control codes.

Pocket Terminal is a convenient, versatile, totally portable tool for anyone who needs to communicate with computers or their peripherals. Send for details now from:



**JGR ELECTRONICS LTD.**

Fairoak House, Church Road, Newport, Gwent NPT7EJ. UK.  
Telephone: Newport (0633) 67426 Telex: 28604 Ref.1796

● Circle No. 154



## THE TOTAL SOLUTION FROM ALMARC

OF COURSE!

Now Almarc & Vector Graphic offer the complete solution to your computing needs for £2300.00\* . . . The Vector MZ needs only the addition of a V.D.U. and it's ready to go. Completely assembled and fully tested the Vector MZ Offers the following features as standard:-

- \* S-100 bus
- \* 4 MHz Z80A processor
- \* 158 instructions
- \* two quad density Micropolis floppies—over 630k bytes on line
- \* serial port
- \* two parallel ports
- \* 32K static ram
- \* 12K prom/ram board with extended monitor
- \* Extended disc Basic

Simply connect your peripherals (Elbit V.D.Us & Centronics printers are available from Almarc) and your up and running and, because the MZ uses the S-100 bus, you can plug in a massive range of add on units.

Ring or Write for a demonstration to:-

Almarc Data Systems Ltd.,  
29 Chesterfield Drive,  
Burton Joyce,  
Nottingham. Tel: 0602 248565.

- \* Discount terms available.

CPN now available  
on the Vector MZ

● Circle No. 155



### MICROSTAR 45

If you need advice on which Micro-computer to buy **we can help you**. We are specialist's in writing packages and tailor-made software. **Test our medical and sales ledger packages.**

Come and have a demonstration on the APPLE II (from £985) and the new multi-user, multi-task MICROSTAR 45 (from £4,950).

We promise a personal service (H.P. or leasing terms available).

## MICROSOLVE

Microsolve Computer Services Limited, 2nd floor  
125-129 High St, Edgware.  
Telephone: 01-951 0218/9.

● Circle No. 156

## MICRO TRADE-IN

### Does Your Micro Meet Your Needs?

If it does not or you simply want to change it, drop us a line.

We buy or allow trade-in on good factory-built microcomputers.

Write to:

**Micro Trade-in,  
FREEPOST,  
WELWYN GARDEN CITY,  
HERTS.**

32K Systems; 140-200Kb Disc £1,970

Apple/ITT 2020; Exidy Sorcerer; PET 2001, SEED System One.

64K System with VDU, fully keyboard 16 special functions, numeric keypad 350Kb Disc £3,500; 700Kb Disc £3,850.

64K System:

1.2 megabyte Disc, 4-partition multi-tasking BASIC (no VDU) £4,950

also available from: COMPLETE COMPUTER SYSTEMS, 22 Westside, 68 Fortis Green, London N2

● Circle No. 157



# Moving software from one micro to another

This is the second part of the article by Mark Witowski on how to overcome the difficulty of moving software written for one make of computer to another. The first part appeared in the February issue.

PART 1 showed how the operator and operand fields of an object-coded program can be displayed in a pseudo-assembly listing format. More information, however, can be gleaned from the code. Looking at the disassembly listing produced by the simple program, and then comparing it to any piece of assembly language text, it can be seen that only certain statements have labels. For the others this field is left blank. A label is required on a statement only if it is the destination of a program branch, jump or subroutine call.

Data statements, ones which reserve memory storage for use by the program, are also labelled. So they can be accessed by direct and extended mode instructions. The first pass of a two-pass assembler is concerned mainly to assign a numeric value to each label. It does this by keeping a hypothetical "program counter", which is updated by the correct amount for each statement.

The current value of this variable is assigned to the label. This will then be substituted for the label whenever it is used as part of an instruction operand. Conversely, the operand of an instruction statement can be used to determine which disassembled statements should have labels, and of what type, data, instruction, subroutine or fixed.

Fixed labels are ones in which the programmer makes a label directly equal to some constant, with "EQU", and not to the current program counter. This disassembler is a direct extension of the one given in part one.

## Label operator (mnemonic) operand comment

A typical assembly language statement will be typed on one line, and will have up to four fields. The first is the label field. This gives an effective name to the instruction. "Labels" in Basic are the line numbers. In assembly language statements, labels are optional; they are required only if the instruction is the destination of some branch or jump command. Statements are assembled in order down the page.

Because each line is unnumbered and therefore anonymous, different tech-

niques for editing have to be employed. The rules in M6800 assembly language state that a label may be up to six characters long; that the first character must be a letter "A" to "Z", and that the remaining five may be a letter or a digit "0" to "9". Therefore, "START", "PART 1" and "Q12345" are all valid label names. Since the label is symbolic it need in no way be related to the machine location of the instruction. Even if it is related, that fact is ignored totally by the assembly program. If all the labels in a program were the numeric address of the instruction, each preceded by a letter, they are still valid as labels, even if the program is then re-located to some completely different part of the memory space.

## Powerful feature

It is this that gives the upgraded disassembler its most powerful feature. Every time an instruction or data location is mentioned in the operand field of any instruction statement, a label is generated. The last five characters of the label produced will be the actual numeric value of the operand. Whenever the label is used in the disassembled code, this number will be preceded by a single letter. The letter tells us what kind of operand generated the label.

If the operand was associated with a branch or jump instruction, the label will be that of an ordinary instruction statement. Any label so produced will be preceded by the letter "I"—for instruction. If the mnemonic was JSR or BSR, first letter "S", a subroutine call, the label is at the start of a subroutine, and will have a matching RTS.

Immediate mode operands are treated as literal constants and consequently generate no label. This reflects the usage of this mode on the M6800. Extended Immediate mode can refer to either an instruction or data statement, as well as a genuine constant. It is assumed to refer to a data statement. Direct and extended mode instructions are also assumed to point to data, first letter "D".

A fourth type of label, denoted by a "Q" in the first letter position, is used if the generated label points to a location outside the specified program limits. Such

(continued on next page)



You can advertise your shops, products and services in our Shop Window columns for only £6 per single column centimetre (minimum 5cm). For details, contact: Tom Moloney or Tina Roberts, Practical Computing, 2 Duncan Terrace, London, N.1. Tel: 01-278 9517

## Harley-Thomson Ltd

31 Southway Lane, Plymouth

We specialise in the supply of ribbons and cassettes for all types of printer and terminal. Whether you use one ribbon a year or hundreds, we feel that our competitive prices and technical know-how will appeal to you.

Send now for our catalogue or ring

Plymouth (0752) 778096

N.B. Trade Enquiries welcome.

● Circle No. 158

## CAMBRIDGE COMPUTER STORE

East Anglia's leading computer and electronics store offers you:

TRS-80  
APPLE II  
N-S HORIZON  
CROMEMCO  
NASCOM-1

Our stock includes a vast range of components as well as computer books and magazines.

Our store is open 6 days a week from 9-5-30 with demo. systems always in operation — We offer a professional standard of advice and after-sales support and we're ready to discuss your application any time.

CAMBRIDGE COMPUTER STORE  
1 EMMANUEL STREET  
CAMBRIDGE (0223) 68155

● Circle No. 159

NASCOM 1 : Kit £197.50 + VAT  
: fully-built and tested  
£247.50 + VAT

SUPERBOARD II : fully-built and tested  
£284.95 inc VAT  
Ohio Scientific.

8K basic, 4K Static RAM 1K dedicated video memory, 53-key keyboard, upper and lower-case, graphics and gaming characters.  
for details: NIC Models, 27 Sidney Road, London N22 4LP Tel. 01-889-9736

● Circle No. 160



## One Day Courses on the Business and Professional Use of Micro-computers

Held in a pleasant rural setting less than 2 hours from London. Course fee of £18 includes lunch and full documentation. Full range of equipment demonstrated. Also SWTPc equipment, with full software support available. (for TRS-80 software service, SAE please.)

**PROTECHNIC**  
Yarwell, Peterborough  
Tel: (0780) 782746

● Circle No. 161

## Hard Copy



**THE KIMBERLEY AZ-3 PRINTER**  
88 character set, ASCII coded  
8cps; 11" carriage  
Correspondence quality output  
Price £182.86  
plus £3.50 carriage + VAT  
Purpose built interfaces now  
available for PET and TRS-80  
Also text editing software

Send for full details

**KIMBERLEY**  
Business Records  
2, Hartington Road  
Gosport  
Hants, PO12 3AG

07017 86642

● Circle No. 162

## TERMINALS IN STOCK

USED OLIVETTI TE 300 Series e.g. Upper/Lower-case, high-quality printout, RS232 serial interface, from £300.

TC 380 intelligent terminal for connection to modem as new, only £400.

IBM 735 I/O writers from £175.

## J & A COMPUTERS

15 Fleetwood Gardens  
Market Harborough  
Leicestershire LE16 9LX  
Tel: (0858) 7620

● Circle No. 163

(continued from previous page)

labels will be used for fixed locations, ACIA and PIA ports, monitor routines and the like.

As with the assembly phase, the disassembler works in two "passes". During the first pass a symbol table is built from all the memory locations referred to explicitly in the operand fields of all the instructions in the program. This symbol table mimics the original produced by the first pass of the assembler. Additions are made to the symbol table by subroutine 4000. Each direct, extended, relative or extended immediate mode instruction will call subroutine 4000.

The symbol table is searched to see if the label is already defined (st.4190-4210). If it is, the types are compared, (st.4290) and if the new type is higher than the last the type number is upgraded (st.4300). Thus a label assumed previously to be data becomes an instruction, and an instruction a subroutine.

This is based on the assumption, mostly valid, that a labelled statement to which a program jumps is an instruction. A label is built from a character which shows the label type.

## Hash functions

Subroutine 7500 converts the type digit, stored with the actual label value, to its corresponding character format, and loads this into D\$ (st.4330). This is then ready to be printed as the operand of the instruction. If the location was not found in the symbol table it is added, along with the current guess at its type (st.4150). Here D\$ contains the numeric value of the label preceded with an "X", to show it has been newly defined (st.4150).

Because the SWTPBasic is very slow, it is impossible to store the symbol table as a linear list. In such a scheme a label would be found by starting at the top of the symbol table and then matching each entry to the one being searched for, until it is found, or an empty entry signals the end of the list. New entries would be placed at the end of the list.

This takes a prohibitively long time, particularly since it must be done twice for each instruction. Instead, a technique known as "hash coding" is employed. A "hash" function is applied to the symbol. This returns a value which is essentially random and connected to the original symbol only insofar as each time you apply the same hash function to the same symbol you get the same result. The ideal hash function returns values for each symbol—there are about  $1.5 \times 10^9$  possible combinations for a valid M6800 symbol—evenly distributed throughout the hashed symbol table, which is somewhat smaller—typically 250 to 1,000 entries.

Because of their value in compiler writing, hash tables and hash functions have been subjected to a great deal of scrutiny. The hash technique used here is

probably the simplest possible. As the label is already numeric, there is no need to convert the symbol from characters to digits. A possible technique to do this would be to regard each character as an octal number, concatenate these to form a string, and then regard that as a decimal number. In either case, these numbers will be larger than the size of the symbol table.

At first sight, a division by the size of the table would appear to solve the problem. Unfortunately, this would lead to considerable "clumping", where many symbols equate to a few locations, leaving most unused. Division by a prime number always leaves a non-zero remainder.

The hash function, subroutine 7000, multiplies the label by a constant, adds a constant, divides by the prime 727 and finally extracts the remainder, which is always less than one. This remainder is then multiplied by somewhat less than the overall size of the symbol table, leaving room at the end of the table for expansion. The program tests during a search to see if the next location is, in fact, beyond the end of the table. Instead of causing an "array out of bounds" failure, it wraps the search around to the beginning of the table (st.4400-4410). If it wraps round twice while looking for the same symbol, the table is completely full and the program must stop (st.4420-4440).

Because the symbol table is made up of a number of segments, each 255 long, X1 has to be split into two variables, one for each of the two dimensions of S(,) (st. 4070-4095).

## Label values

This hash technique has the effect of breaking the symbol table into many smaller fragments. Whether we wish to find if a label is already stored, or if we wish to add a new label, the hash function tells the program where to start the search. Optimally each label would go to a special place in the symbol table. With a less-than-perfect hash function it is possible for two labels to fall on the same location. This presents no problem. We are concerned to know only if a label has been used or not, and if it has, what its type is.

Label value and type are stored as a single integer value, to save space. The label is an integer in the range zero to 65536. Added to this is the type digit (data=1, instruction=2, subroutine=3, fixed=4), multiplied by 100000 (st.4160). So a data type label of 2020 is stored as 102020, an instruction as 200000 plus the label value, a subroutine as 300000 plus the label value and a fixed label as 400000 plus its numeric value.

When searching for a label the program starts looking at the location given by X1, the hash result, and stops if the stored value is equal to the one required. Finding an unused location (70000) in the symbol table shows that the label is undefined.

(continued on next page)

(continued from previous page)

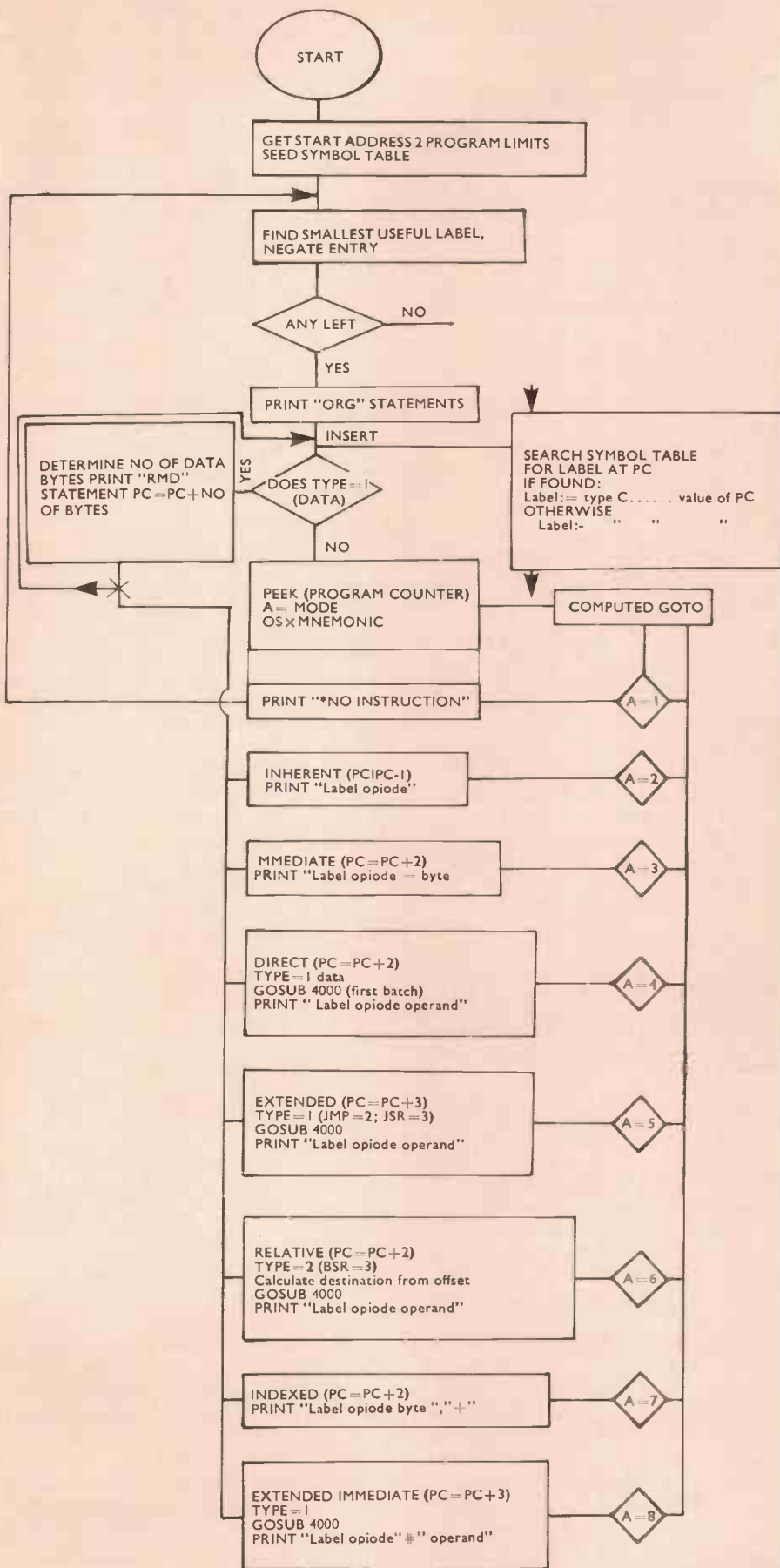
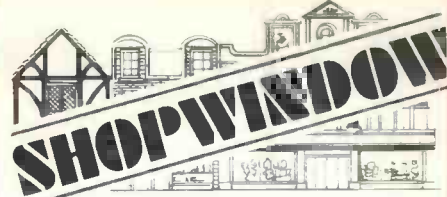

Figure 1. Algorithm flowchart.

(continued on next page)



## TRS-80 Software

Business, hobbyist, games and general software including inventory-control file-handling and mailing-list. Level 1 and 2. Mostly imported from America S.A.E. for list.

**A. J. Harding**

28 Collington Avenue,  
Bexhill-on-Sea, E. Sussex.

Tel: 0424 220391

● Circle No. 164

## EXIDY SORCERER

32K Micro Computer

£850.00 + VAT

Dealer for

### Bristol and South West

ELECTROPRINT (Mr. Tasker)

5 Kingsdown Parade • Bristol 6 • 292375

● Circle No. 165

## U-Microcomputers

FROM LESS THAN £300 TO OVER £15,000 WE GOT SYSTEMS!

U-Microcomputers are the factory appointed distributor in the north and midlands for the Ohio Scientific range of micros—from Superboard II to the C3B. Mini discs, full-size floppies or hard discs all available so that we can offer a system to suit *your* needs including software.

*This month's offer: C1P-MD C1P 20K with single mini disc*  
..... £1,200 + VAT

Drop us a line outlining your requirements:

**U-Microcomputers,  
PO Box 24,  
Northwich, Cheshire**

**U-Microcomputers**

● Circle No. 166



## PET PROGRAMS

Microchess	£8.00
Backgammon	£14.00
Blackjack	£4.00
Othello	£8.00
Lem Landing	£8.00
Starwars	£6.00
Payroll	£25.00
Stock Control	£15.00

These are just a small selection.

Why not send for our free catalogue of hardware and software for PET.

PET 2001-8 £695.00 inc VAT and carriage.

PET dustcover £4.50.

Please add 50p post and packing on programs and dustcovers.

Floppy disc units and memory expansion boards now available.

### Intex Datalog Ltd,

Eaglescliffe Industrial Estate,

Eaglescliffe,

Cleveland TS16 0PN

Tel. 0642 781193 Telex 58252

● Circle No. 167

HAVE A NIBBLE OF THE TANDY TRS-8, TAKE A PEEK AT THE PET, OR TRY A BYTE OF THE APPLE II at:

### RADIO SUPPLIES (SWANSEA) LTD

80 GOWER ROAD

SKETTY

SWANSEA

Tel: (0792) 24140

● Circle No. 168

## TOPMARK Computers

dedicated to

### APPLE II

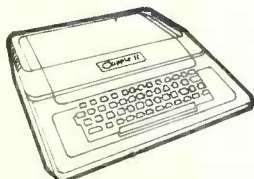

Simply the best!

Full details from Tom Piercy on Huntingdon (0480) 212563 or circle enquiry card.

● Circle No. 169

(continued from previous page)

If a previously-undefined symbol is to be added, it is stored in the first free (70000) location, starting from the entry pointed to by X1.

Figure 2 shows a portion of a partially-filled symbol table after a program run. Ideally there is never any searching of a hash-coded symbol table, in practice there is always a little to be done. Even when the table is almost full, and there are very few undefined locations to act as stops, it is still better than the sequential search algorithm.

113	70000	113	70000
114	70000	114	70000
115	70000	115	70000
116	357546	116	70000
117	70000	117	257977
118	70000	118	70000
119	70000	119	70000
120	70000	120	70000
121	461446	121	70000
122	157745	122	70000
123	70000	123	70000
124	357481	124	70000
125	357415	125	70000
126	70000	126	257780
127	70000	127	157714
128	70000	128	70000
129	70000	129	70000
130	70000	130	70000
131	357548	131	70000
132	258143	132	70000
133	358077	133	257847
134	70000	134	70000
135	257879	135	70000
136	461448	136	258244
137	0000	137	257451
138	70000	138	70000
139	70000	139	70000

Figure 2. Part I of symbol table for 5(225,2). Notice small clump around (131,1) and how generally even distribution of entries is. Label value is stored in last five digits, type in the first.

Figure 1 is a flowchart of the program. The only thing you should need to know to run a program on the M6800 is its start address. In most cases, this is all that is required to disassemble the whole program. Even if the second instruction is of the "No Instruction" mode, then the first one must have been a control branch or jump, and disassembly can continue from there.

To start the program the symbol table is "seeded" with the start address (st.310-350). Disassembly will begin at this address. Every time the disassembler gets stuck it searches the symbol table, sequentially, for the smallest, still undisassembled label and re-starts disassembly from that point, using subroutine 6000 (st.400-430). For each instruction it checks, using the current program counter (P1) to see if a label has been defined for this location, and if it has it loads L\$ with the type character and

value (st.4330). If it has not defined it loads L\$ with eight spaces (st.4130).

One space is sufficient for the assembler but it would leave the listing with a very rugged appearance. Whenever it finds a label in the operand position—it negates the value stored in the table (st.4270). Whenever it finds a negative entry (st.4230) it re-starts disassembly from the smallest positive label, which is within the user-specified program limits (subroutine 6000). If no label meets this criterion then the whole program has been disassembled.

The first byte pointed to by the program counter is the operator for the instruction (st.640). This is extracted and converted to the mnemonic form, as described in part 1 (st.660-670), using the mnemonic table (st.99-126) stored in Q\$. The use of the computed GOTO (st.680) and the mode digit (st.660) were both described fully in part one.

For all modes except inherent, which has none, the operand is extracted from the next one or two bytes. With the exception of immediate mode the operand is treated as a label. Variable M3 is loaded with a guess at the operand type. The symbol table is again searched for this operand value by subroutine 4000. If the operand value was stored the types are compared, and changed if necessary. An operand symbol is generated from the symbol table and loaded into D\$. If the value was not found it is stored, along with its type number, in the next free symbol table location.

### Saving time

Decimal, not hexadecimal as in part one, is used in this program, saving the conversion time. Any constant not preceded by a "\$" for hex, "G" for octal or "%" for binary is treated as a decimal number by the assembler. It is immaterial to what number base the body of the label is printed, so long as it starts with a letter. Hexidecimal could be used by incorporating the decimal-to-hex routines given in part one.

For each instruction statement a line of text is produced. The label from L\$, the operator mnemonic from O\$ and the operand from D\$, along with any assembler directives ("+", ",", "x" etc). Items may be placed in the comment field. A programmable switch, F6, is used to determine whether subroutine 4000 will search the symbol table to see if a label should be placed at the current location (st.440, F6=1). With F6 set to zero, subroutine 4000 searches the symbol table to find the operand type, and to add it as a new label if it is not found (st.630).

This algorithm leads to some apparently silly things happening on the first pass. Whenever the disassembler is forced to re-start, it does so at the smallest label in the symbol table at the time. Since new labels are being added continually by the

(continued on next page)





(continued from previous page)

disassembly process, these will invariably be smaller than the current location. Disassembly will re-start until a negated label is found, and so on.

Each branch or jump backwards introduces a new, smaller label. So the next re-start will tend to split the listing into smaller and smaller fractions, all in the wrong order. If a data location is found then some data bytes must be reserved (st.420-620). The decision as to the number of bytes is taken to be the next smallest label from the symbol table, minus the current location (st.490). In the first pass code of the form:

D342 RMB -246

is not uncommon, and should be ignored. During the second pass, when the symbol table is complete, the algorithm works well. The next smallest symbol value is always larger than the current location.

When all the operands have been looked at, and all the labels so generated printed and negated, then the symbol table is complete. The first pass is finished and the second pass may begin. Program control jumps to statement 9000. The value of this algorithm is that it is thorough. Any location referred to,

whether as data, instruction, subroutine or fixed, is found and exhaustively disassembled.

Before the second pass we can print the symbol table; the code is at 9500. This produces a complete list of all labels and their types. The first digit is the type (in the hundred thousands), the remainder is the label value. (Figure 2).

The second pass begins by making all the labels in the symbol table positive again (st.9050-9140). It also prints all the fixed labels, those outside the specified program limits, in the form:

Q62720 EQU 62720

Once defined by "EQU" they will resist attempts at re-location. Figure 5 is a header generated by this program, showing all the fixed locations, even though the rest of the code will re-locate by changing any of the "ORG" statements produced at the beginning of the disassembly (st.430). (Figure 5).

Any "ORG"s which appear in the body of the code may be due to "No instruction" breaks, or because of a genuine re-location. In the former case it would be best to work out what the invalid code locations did, and then edit the listing, before reassembly, to do the same.

Throughout the second pass the symbol

(continued on next page)

E0E1	01		NOP	
E0E2	01		NOP	
E0E3	86 11	I57571	LDAA	#17
E0E5	B7 F500		STAA	Q62720
E0E8	7F F01A		CLR	Q61466
E0EB	BE F008		LDS	Q61448
E0EE	CE E172		LDX	#D57714
E0F1	8D 92		BSR	S57477
E0F3	BD E1A4		JSR	S57772
E0F6	16		TAB	
E0F7	8D D3		BSR	S57548
E0F9	C1 4C		CMPB	#76
E0FB	27 69		BEQ	I57702
E0FD	C1 4D		CMPB	#77
E0FF	27 68		BEQ	I57705
E101	C1 50		CMPB	#80
E103	27 61		BEQ	I57702
E105	C1 52		CMPB	#82
E107	27 36		BEQ	I57663
E109	C1 43		CMPB	#67
E10B	27 5F		BEQ	I57708
E10D	C1 54		CMPB	#84
E10F	27 5E		BEQ	I57711
E111	C1 47		CMPB	#71
E113	27 0A		BEQ	I57631
E115	B6 E3F8		LDAA	I58368
E118	81 7E		CMPA	#126
E11A	26 C7		BNE	I57571
E11C	7E E3F8		JMP	I58368
E11F	BD E310	I57631	JSR	S58136
E122	30		TSX	
E123	B6 F01E		LDAA	Q61470
E126	A7 05		STAA	S,X
E128	B6 F01F		LDAA	Q61471
E12B	A7 06		STAA	6,X
E12D	3B		RTI	

Figure 3. Portion of disassembled code re-assembled at the same locations.

## CAPITAL COMPUTER SYSTEMS

invite you to call in or phone to discuss your personal computer requirements

### CAPITAL HOUSE

29/30 Windmill Street  
London W1 (off Tottenham Court Road). 01-637 5551

● Circle No. 170

## SOUTH WALES

PET

and

## PETSOFT PROGRAMS

sales and service

SIGMA SYSTEMS Ltd  
54 Park Place, Cardiff

CARDIFF 21515

● Circle No. 171



NewBear Computing Store



### SYM-1 (Formerly VIM-1)

The new 6502 based Micro from Synertek ● Fully assembled and tested ● 1K byte storage, expandable on board to 4K byte ● 4K byte ROM monitor ● £199 plus 8% VAT £1 carriage ● Send for data  
For further details: Visit Newbear Computing Store, 2 Gatley Road, Cheadle, Cheshire, 061-491-2290. Or visit, or write to: Newbear Computing Store, 7 Bone Lane, Newbury, Berks. 0635-49223. Send for catalogues of Hardware Components, Literature and Software.

● Circle No. 172

## Dateline

Psychologically accurate introductions lead to:-

- Pleasant friendships
  - Spontaneous affairs
  - firm & lasting relationships
  - including marriage
- all ages, all areas.

free details:

Dateline Computer Dating  
Dept (PCI)  
23 Abingdon Road  
London W8  
Tel: 01-937 6503.

● Circle No. 173

### EAST MIDLANDS

**Microcomputer systems** hardware for small businesses etc. from £3,000. Custom-built software also available. Phone now for our catalogue (078887) 629

**Verwood Systems,**  
West Haddon, Northants.

● Circle No. 174

## P. I. P. S.

### COMPUTER SERVICES

North-East England distributors for the best selling micro, the

### APPLE II

Full range of accessories and software can be supplied.

Telephone John or Jane Page on (0632) 482359 to discuss your requirements.

## NEWCASTLE UPON TYNE

● Circle No. 175

### HUMBERSIDE MICROPROCESSOR SERVICES THE COMPLETE INDEPENDENT SERVICE

*Application areas:-*  
Business, process control, education,

*Personal Computing*

We can provide for you:-  
Consultancy, training, supply, maintenance and software to suit your individual requirements

*Including*

Commodore P.E.T.  
M6800  
Compec 202  
and full ancillary equipment.  
Microprocessor Services,  
139 Beverley Road,  
Hull  
Humberside.

For further details ring (0482) 23146

● Circle No. 176

(continued from previous page)

table is complete and fixed. Because of this exactly the same program can be used for both the first and second pass. The first operation is to call subroutine 6000 to find the smallest useful label, an "ORG" statement is produced and disassembly continues. If this was a data statement the next smallest label is found and the difference between the two shows how many bytes to reserve with an "RMB", for instance:

```
D176 RMB 47 71'G,79'O,84'T,79'O,32',54'4,
D223 RMB 17 48'O,48'O,44',49'1,56'8,48'O,
```

shows two disassembled data labels, the first reserves 47, and the second 17 data bytes. As an aid to indicate whether the data should be pre-determined, with "FCB", "FDB" or "FCC" etc., the actual contents of the data locations are printed, up to the first six.

If it is decided that the data was present at the start of the program, then these statements must be edited before re-assembly. If the contents of a byte correspond to an ASCII character, this is printed, too (st.550-570). The letters "GOTO" should give a clue in the first example. During the second pass, the disassembler will happily mix data and code instructions, modelling the way they

were laid out in the original assembly language listing.

The program is easy to use. Only three decisions have to be made before leaving the program to disassemble. Statement 192 determines the size of the symbol table. Variable U is the second dimension of the two-dimensional array S; the first dimension is fixed at 255. The size of the symbol table is 255 x U. The larger the program to be tackled, the larger the symbol table required.

Since the symbol table can be increased only in steps of 255, some rules-of-thumb are required for choosing a suitable value for U. As a very rough guide, each 1K of program requires space for about 100 labels. If the final number of labels is close to the symbol table size, the program will operate more slowly than it might as the table fills up. If the symbol table is too generously dimensioned, however, the code will slow down due to the sequential search at each re-start to find the next smallest label.

Subroutine 6000, the code for this, takes about 30 seconds for each of 255 label sections. At the end of each section a delete character (127, all ones) is sent out, as a precaution against a Teletype device "falling asleep" and therefore missing the

(continued on next page)

04C9	01		NOP	
04CA	01		NOP	
04CB	86 11	157571	LDAA	#17
04CD	B7 F500		STAA	Q62720
04D0	7F F01A		CLR	Q61466
04D3	BE F008		LDS	Q61448
04D6	CE 055A		LDX	#D57714
04D9	8D 92		BSR	S57477
04DB	BD 058C		JSR	S57772
04DE	16		TAB	
04DF	8D D3		BSR	S57548
04E1	C1 4C		CMPB	#76
04E3	27 69		BEQ	157702
04E5	C1 4D		CMPB	#77
04E7	27 68		BEQ	157705
04E9	C1 50		CMPB	#80
04EB	27 61		BEQ	157702
04ED	C1 52		CMPB	#82
04EF	27 36		BEQ	157663
04F1	C1 43		CMPB	#67
04F3	27 5F		BEQ	157708
04F5	C1 54		CMPB	#84
04F7	27 5E		BEQ	157711
04F9	C1 47		CMPB	#71
04FB	27 0A		BEQ	157631
04FD	B6 07E0		LDAA	158368
0500	81 7E		CMPS	#126
0502	26 C7		BNE	157571
0504	7E 07E0		JMP	158368
0507	BD 06F8	157631	JSR	S58136
050A	30		TSX	
050B	B6 F01E		LDAA	Q61470
050E	A7 05		STAA	5,X
0510	B6 F01F		LDAA	Q61471
0513	A7 06		STAA	6,X
0515	3E		RTI	

Figure 4. Disassembled code, re-located and then re-assembled; compare this to Figure 3.





(continued from previous page)

first few characters of the next statement, while the motor starts up (st.6120).

Remember that data storage is not particularly compact in SWTP Basic; each 255 dimension of S(.) uses 1,536 bytes. Add this to the interpreter (about 7K), the program itself and the stored mnemonic table (4,596 bytes) and random access memory is soon used up. A run with a symbol table of 1020 labels runs comfortably in a 24K system.

The second decision involves the limits of the memory to be disassembled. The program requests two (decimal) numbers with:

**\*LOWER AND UPPER PROGRAM LIMITS?**

Any label generated outside these limits will be defined with an "EQU" statement at the beginning of the second pass. Without this facility the program would disassemble all code in the machine accessed by the code being tackled, almost certainly including all of the monitor. These limits will often be set to the extent of the random access memory in the microprocessor system.

Lastly, the program asks for the start address, in decimal, of the code to be disassembled. If hexadecimal input is preferred, the hex-to-decimal routine of part 1 could be added. The same applies to the user program limit requests. Type these and off it goes—slowly. Expect longish waits—about 30 seconds to three minutes—at random intervals, par-

ticularly before an "ORG" or "RMB" statement.

Of the two large programs on which the disassembler has been tested, the MSI monitor (U=2), and the Basic interpreter (U=4), the former took about 90 minutes, the latter a staggering 30 hours for both passes.

Fortunately, the code has been improved since the latter case and it should be much better. Figure 3 shows a portion of disassembled program, re-assembled at its original location of \$E000. Figure 4 shows it re-assembled at a different origin, decimal 1000. Notice how "Q" labels keep their original value, and how "D", "I" and "S" have changed.

### Modifications

All programs should have a "bugs and modifications" section. This program is no exception. There are a number of snags to this approach to disassembly, which becomes rather apparent when re-location to a new part memory is attempted. While it is not affected by interspersed code and data, which may occur in any assembly language program, it is upset by the use of indexed "JMP" and "JSR". In these cases no explicit mention is made of the original label in any operand.

Most usually, it will have been set-up by "LDX +CODE", and so will be assumed to be data, possibly incorrectly. When checking the final listing, be on your guard for this type of instruction. They

(continued on next page)

### MAILING SERVICES

Computer held files, Selected outputs on labels, letters, envelopes, Sorted for Mailing Rebate, Complete Mailing Shots Assembled & Posted, Coupon Responses, Order Files, Media Analyses etc.  
 NLDS, ROTHWELL, LINCOLN  
 0472-89346/7

● Circle No. 177

### NEED PROGRAMS?

Then you need  
**COMPUTER PROGRAMS THAT WORK (BASIC)**  
 2nd edition. Contains 24 games and simulations. Book £2.40. Book + ASCII papertape £6, post paid.

### NEED MONEY?

Contribute your best programs to our new multi-author book. We pay £25 for each program published.

**SIGMA TECHNICAL PRESS**  
 23 DIPPONS MILL CLOSE,  
 TETTENHALL,  
 WOLVERHAMPTON  
 Telephone: (0902)-763152

● Circle No. 178

### WEST COUNTRY DEVON

## Crystal Electronics

**FOR THE BEST IN SMALL COMPUTERS**  
 advice and full back up on  
**APPLE II NASCOM I ATARI NEW BEAR**  
 books (over 150 titles), components, add ons, etc.  
 SOFTWARE FOR  
 Apple 2 stock control (disk and printer) for 10,000 items plus £100 + full update for six months exc VAT  
 Nascom tape containing 6 games etc £6.00 + VAT.  
 All products are stocked on advice from our engineers as to quality value for money and reliability.  
 Shop open 0930-1800 except Wed/Sun

**40 MAGDALENE ROAD,  
 TORQUAY, DEVON  
 Tel. 0803 22699**

● Circle No. 179

		*	DISSASSEMBLED LISTING	
		*	FIXED LOCATIONS	
F500		Q62720	EQU	62720
F01A		Q61466	EQU	61466
F01B		Q61467	EQU	61467
F01C		Q61468	EQU	61468
F01D		Q61469	EQU	61469
F01E		Q61470	EQU	61470
F01F		Q61471	EQU	61471
F508		Q62728	EQU	62728
F00		Q61440	EQU	61440
F006		Q61446	EQU	61446
F008		Q61448	EQU	61448
F00A		Q61450	EQU	61450
F00B		Q61451	EQU	61451
F00C		Q61452	EQU	61452
F00D		Q61453	EQU	61453
F072		Q61554	EQU	61554
F00E		Q61454	EQU	61454
F00F		Q61455	EQU	61455
F010		Q61456	EQU	61456
F011		Q61457	EQU	61457
F012		Q61458	EQU	61458
F014		Q61460	EQU	61460
F016		Q61462	EQU	61462
F018		Q61464	EQU	61464
		*	RELOCATABLE LOCATIONS AND CODE	
E000			DRG	57344
E000	FE F000	I57344	LDX	Q61440
E003	6E 00		JMP	0,X I1DXD JMP

Figure 5. Header of fixed locations printed at beginning of second disassembly pass. After re-assembly.

SCOTLAND Distributors in Scotland for SCOTLAND

## NASCOM 1

Nascom 1 can be seen in action  
 9-5 Mon.-Fri.  
 Buffer boards and memory now in stock  
 Callers welcome

### STRATHAND

44 St. Andrew's Sq. BARCLAYCARD  
 Glasgow G1 5PL 4/54

Enquiries invited from prospective Dealers throughout Scotland.  
**GLASGOW (041) 552 6731**  
 Tel. order welcome with Access and Barclaycard.

● Circle No. 180





## HB COMPUTERS

Home of sophisticated  
Computer peripherals  
East Midlands Area  
distributor for  
PET 2001/Apple II

### PET PERIPHERALS

**TV Interface**, no cables, plugs directly into the PET userport, displays PET's superb graphics on standard TV monitor, £45.99 inclusive.

Expansion memory for PET from Europe's largest memory-board supplier.

Make your PET audible with our **SOUND BOX**. Plugs directly into second cassette-port, no cables. Complete with demo-software. £12.99 inclusive.

**DUST COVERS** to protect your PET available in 4 colours (rust, beige, dark-blue, black.)

Only £9.50 inclusive. Please specify colour when ordering.

Visit our showrooms for personal service with expert technical back-up PET and APPLE II both normally available for hands-on experience.

For details of all products listed, plus many more stock-lines of interest to home-computing buffs. (For circle number see below.) (Barclaycard and Access accepted for orders placed by telephone or post.) All prices include post and packing (insured post extra).

22 Newland Street, Kettering, Northants.  
KETTERING (0536) 83922/520910 2 lines

● Circle No. 181

### MICROCOMPUTER BARGAINS

We have a stock of untested microcomputer PCBs which are surplus to our requirement. Each board contains an Intel 4040 (CPU), 4201 (clock), 4289 (standard memory interface), 5MHz2 crystal, zero crossover detector cct, power on reset cct, slots for 6 x 1702A PROM and on-board power supply containing transformer, rectifier, regulator, heatsink and reservoir capacitor.

These PCBs are sold with data on all chips and cct diagram, as untested units, at the bargain price of £19 each.

Race Electronics, 54-64 Marfa Road, Strand, Swansea. Tel (0792) 41241/462684

● Circle No. 182

## Dyna-Byte

fully assembled  
burned in S100

16K Dynamic	RAM	£198
16K Static	RAM	250ns £271
16K Static	RAM	450ns £266
32K Static	RAM	250ns £506
32K Static	RAM	450ns £470

80 x 24 video terminal, just add keyboard and monitor £177.

Cable set for video terminal £7.20

Post free. Add 8% VAT to all prices.

S.W.C. Electronic distributors, P.O. Box 30, London E.4.

● Circle No. 183

(continued from previous page)

are specially warned in the comment field by either "!! IDXD JMP" or "!! IDXD JSR" last statement on Figure 5. The missing code can often be detected by a data statement following directly an instruction which is NOT an unconditional program counter change (RTS, RTI, JMP, BRA, or some combination of relative branches).

Any instruction which follows directly such a statement and is not labelled should also be treated with the utmost suspicion. These cases may require a little careful "hand-disassembly", using the package presented in part 1.

Extended immediate mode provides the real teaser—should the operand be re-located or not? "LDX +CODE" and "LDX +DATA" probably should; something like "CPX +100" will almost certainly be indicative of something more subtle, probably requiring to be left un-re-located. This depends entirely on the nature of the program and is unresolvable by the disassembler. You may finish having to understand how a program you re-locate works if it doesn't run first time.

On the other hand, if you write programs you don't want disassembled, think of these points fondly. If you want to be really sure nobody disassembles code, try making it self-modifying. That should really upset the program. It probably won't improve your temper, much as you try and de-bug it, or anybody else's when they try to use it.

```

LIST 99,290
0099 DATA "2NOP",2NOP,1,1,"!"
0100 DATA "2TAP",2TPA,2INX,2DEX,2CLV
      ,2SEV,"2CLC"
0101 DATA "2SEC",2CLI,2SEI,2SBA,2CBA,1,1,1,1,
      "2TAB"
0102 DATA "2TBA",1,2DAA,1,2ABA,1,1,1,1,
      6BRA,1,6BHI,6BLS,"6BCC"
0103 DATA "6BCS",6BNE,6BEQ,6BVC,6BVS,6BPL
      ,6BMI,6BGE,"6BLT"
0104 DATA "6BGT",6BLE,2TXX,2INS,2PULA,
      2PULB,2DES,2TXS,"2PSHA"
0105 DATA "2PSHB",1,2RTS,1,2RTI,1,1,2WAI
      "2SWI"
0106 DATA "2NEGA",1,1,2COMA,2LSRA,1,2RORA,
      2ASRA,2ASLA,2ROLA,"2DECA"
0107 DATA "1",2INCA,2TSTA,1,2CLRA,2NEGB,1,1,
      2COMB,"2LSRB"
0108 DATA "1",2RORB,2ASRB,2ASLB,2ROLB,2DECB,
      1,2INCB,2TSTB,"!"
0109 DATA "2CLRB",7NEG,1,1,7COM,7LSR,1,
      7ROR,7ASR,7ASL,"7ROL"
0110 DATA "7DEC",1,7INC,7TST,7JMP,7CLR,
      5NEG,1,1,5COM,"5LSR"
0111 DATA "1",5ROR,5ASR,5ASL,5ROL,5DEC
      ,1,5INC,5TST,"5JMP"
0112 DATA "5CLR",3SUBA,3CMPA,3SBCA,1,
      3ANDA,3BITA,3LDA,!"
0113 DATA "3EORA",3ADCA,3ORAA,3ADDA,
      8CPX,6BSR,8LDS,1,"4SUBA"
0114 DATA "4CMPA",4SBCA,1,4ANDA,4BITA,
      4LDA,4STAA,4EORA,"4ADCA"
0115 DATA "4ORAA",4ADDA,4CPX,1,4LDS
      ,4STS,7SUBA,7CMPA,"7SBCA"
0116 DATA "1",7ANDA,7BITA,7LDA,7STAA,
      7EORA,7ADCA,7ORAA,"7ADDA"
0117 DATA "7CPX",7JSR,7LDS,7STS,5SUBA,
      5CMPA,5SBCA,!"
0118 DATA "5ANDA",5BITA,5LDA,5STAA,
      5EORA,5ADCA,5ORAA,"5ADDA"
0119 DATA "5CPX",5JSR,5LDS,5STS,3SUBB,
      3CMPB,3SBCB,!"
0120 DATA "3ANDB",3BITB,3LDAB,1,3EORB,
      3ADCB,3ORAB,"3ADDB"
0121 DATA "1",1,8LDX,1,4SUBB,4CMPB,4SBCB,
      1,4ANDB,4BITB,"4LDAB"
0122 DATA "4STAB",4EORB,4ADCB,4ORAB,
      4ADDB,1,1,4LDX,"4STX"
0123 DATA "7SUBB",7CMPB,7SBCB,1,7ANDB,
      7BITB,7LDAB,"7STAB"
0124 DATA "7EORB",7ADCB,7ORAB,7ADDB,1,1,
      7LDX,7STX,"7SUBB"
0125 DATA "5CMPB",5SBCB,1,5ANDB,5BITB,
      5LDAB,5STAB,5EORB,"5ADCB"
0126 DATA "5ORAB",5ADDB,1,1,5LDX,"5STX"
0190 RESTORE
0191 C=100000

```

```

0192 U=2
0200 DIM Q(255)
0210 DIM S(255,U)
0220 FOR M9=1 TO 255
0230 READ Q(M9)
0240 NEXT M9
0250 FOR M9=1 TO 255
0260 FOR M8=1 TO U
0270 S(M9,M8)=70000
0280 NEXT M8
0290 NEXT M9

```

READY

LIST 300,680

```

0300 INPUT "*" LOWER AND UPPER PROGRAM
      LIMITS",U1,U2
0310 INPUT "*" START ADDRESS" P1
0320 F6=0
0330 P6=P1
0340 M3=2
0350 GOSUB 4000
0400 GOSUB 6000
0410 P1=P4
0420 IF P4<0 THEN 9000
0430 PRINT "      ORG ";STR(PI)
0440 F6=1
0448 M2=2
0449 P6=P1
0450 GOSUB 4000
0460 IF F7<0 THEN 400
0470 IF M2<1 THEN 630
0480 GOSUB 6000
0485 IF P4<0 THEN 9000
0490 T1=P4-P6
0500 PRINT L;"RMB";STR(T1);" ";
0510 IF T1>6 THEN T1=6
0520 FOR M9=P1TO (P1+T1)-1
0530 T2=PEEK(M9)
0540 PRINT STR(T2);
0550 IF T2<32 THEN 580
0560 IF T2>127 THEN 580
0570 PRINT " ";CHR(T2);
0580 PRINT " ";
0590 NEXT M9
0600 PRINT " "
0610 P1=P4
0620 GOTO 440
0630 F6=0
0640 I1=PEEK(P1)
0650 IF I1=0 THEN 1100
0660 A=VAL(LEFT(Q(I1),1))
0670 O2=RIGHT(Q(I1),4)
0680 ON A GOTO 1100,1200,1300,1400,1500,1600,
      1700,1800

```

READY

LIST 1100,1835

```

1100 PRINT "*" NO INSTRUCTION"
1110 GOTO 400
1200 REM INHERENT MODE
1205 PRINT L;"O2";
1210 P1=P1+1
1215 GOTO 440
1300 REM IMMEDIATE MODE
1305 I2=PEEK(P1+1)
1310 P1=P1+2
1330 PRINT L;"O2";" *";STR(I2);
1335 IF I2<32 THEN 1350
1340 IF I2>127 THEN 1350
1345 PRINT " *";CHR(I2);
1350 PRINT " "
1355 GOTO 440
1400 REM DIRECT MODE
1405 I2=PEEK(P1+1)
1410 P1=P1+2
1415 M3=1
1420 P6=12
1425 GOSUB 4000
1430 PRINT L;"O2";" *";D2
1435 GOTO 440
1500 REM EXTENDED MODE
1505 I2=(PEEK(P1+1)*256)+PEEK(P1+2)
1510 P1=P1+3
1511 M3=1
1515 IF I1=126 M3=2
1520 IF I1=189 M3=3
1525 P6=12
1530 GOSUB 4000
1535 PRINT L;"O2";" *";D2
1540 GOTO 440
1600 REM RELATIVE MODE
1605 I2=PEEK(P1+1)
1610 IF I2<128 P6=I2+2+P1
1615 IF I2>128 P6=P1-254+I2
1620 M3=2
1625 IF I1=141 M3=3
1630 GOSUB 4000
1635 PRINT L;"O2";" *";D2
1640 P1=P1+2
1645 GOTO 440
1700 REM INDEXED MODE
1705 I2=PEEK(P1+1)
1710 PRINT L;"O2";" *";STR(I2);"X";
1715 IF I1=110 PRINT "!!DXD JMP";
1720 IF I1=173 PRINT "!!DXD JSR";
1725 PRINT " "
1730 P1=P1+2
1735 GOTO 440
1800 REM EXTENDED IMMEDIATE MODE
1805 I2=(PEEK(P1+1)*256)+PEEK(P1+2)
1810 M3=1
1815 P6=12

```

(continued on next page)

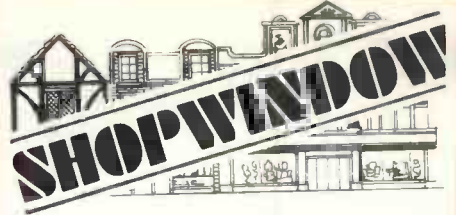

(continued from previous page)

```

1820 GOSUB 4000
1825 PRINT L$;O$;" # ";D$
1830 P1=P1+3
1835 GOTO 440

READY
#
LIST 4000, 4490

4000 REM HASH SYMBOL TABLE LOOK-UP ROUTINE
4001 REM IF F6=0 ADD SYMBOL IN NEXT FREE
LOCATION
4002 REM IF F6=1 THEN GENERATE LABEL FROM
TABLE
4005 F7=1
4006 F8=0
4010 IF P6<U1 THEN 4040
4020 IF P6>U2 THEN 4040
4030 GOTO 4050
4040 M3=4
4050 P9=P6
4060 GOSUB 7000
4060 Y=INT(X1/255)
4080 X=X1-(Y*255)
4090 Y=Y+1
4095 IF X=0 X=1
4100 FOR M9=X TO 255
4105 T6=S(M9,Y)
4110 IF ABS(T6<>70000) THEN 4180
4120 IF F6=0 THEN 4150
4130 L$=""
4140 GOTO 4480
4150 D$="X"+STR$(P6)
4160 S(M9,Y)=(M3*Y)+P6
4170 GOTO 4480
4180 M4=M2
4190 M2=INT(ABS(TC)/C)
4200 P3=(ABS(T6))-(M2*C)
4210 IF P3<>P6 THEN 4360
4220 IF F6=0 THEN 4290
4230 IF T6<0 F7=-1
4240 GOSUB 7500
4250 L$=R$+STR$(P6)
4260 GOSUB 7700
4270 S(M9,Y)=(ABS(T6))
4280 GOTO 4480
4290 IF M2=M3 THEN 4320
4300 S(M9,Y)=((M3*C)+P6)*SGN(T6)
4310 M2=M3
4320 GOSUB 7500
4330 D$=R$+STR$(P6)
4340 M2=M4
4350 GOTO 4480
4360 M2=M4
4370 NEXT M9
4380 X=1
4390 Y=Y+1
4400 IF Y<(U+1) THEN 4100
4410 PRINT "★! SYMBOL TABLE OVERFLOW"
4420 IF F8=0 THEN 4450
4430 PRINT "★! SYMBOL TABLE FULL"
4440 STOP
4450 F8=1
4460 Y=1
4470 GOTO 4100
4480 RETURN
4490 END

READY
#
LIST 6000, 7750

6000 REM REACHES HASH TABLE FOR SMALLEST
POSITIVE
6001 REM LABEL WITH-IN THE PROGRAM LIMITS.
    
```

```

6002 REM IF NONE FOUND P4=1
6010 P4=70000
6020 FOR M9=1 TO U
6030 FOR M8=1 TO 255
6040 T6=S(M8,M9)
6050 IF T6=70000 THEN 6110
6060 IF T6<0 THEN 6110
6070 M3=INT(T6/C)
6080 P3=T6-(M3*C)
6090 IF P3<U1 THEN 6110
6100 IF P3<P4 THEN P4=P3
6110 NEXT M8
6120 PRINT CHR$(127);
6131 NEXT M9
6140 IF P4=70000 P4=-1
6150 IF P4>U2 P4=-1
6160 RETURN
6170 END
7000 REM HASH FUNCTION, FROM P9 TO X1.

7010 X9=((P9*11)+1111)/727
7020 X1=INT((X9-INT(X9))*245*U)
7030 IF X1=0 X1=1
7040 RETURN
7050 END
7500 REM TURNS LABEL MODE INTO CHARACTER.
7510 R$=""
7520 IF M2=1 R$="D"
7530 IF M2=2 R$="I"
7540 IF M2=3 R$="S"
7550 IF M2=4 R$="Q"
7560 RETURN
7570 END
7700 REM PADS L$ TO EIGHT CHARACTERS WITH
SPACES.
7710 FOR M7=1 TO 8-LEN(L$)
7720 L$=L$+" "
7730 NEXT M7
7740 RETURN
7750 END

READY
#
LIST 9000, 9590

9000 PRINT "★ GOTO 9500 TO PRINT SYMBOL
TABLE"
9010 PRINT "★ CONT FOR NEXT PASS"
9020 STOP
9030 PRINT "★ DISASSEMBLED LISTING"
9040 PRINT "★ FIXED LOCATIONS"
9050 FOR M9=1 TO 255
9060 FOR M8=1 TO U
9070 T6=ABS(S(M9,M8))
9080 IF T6<400000 THEN 9120
9090 L$="Q"+STR$(T6-400000)
9100 GOSUB 7700
9110 PRINT L$;" EQU ";STR$(T6-400000)
9120 S(M9,M8)=T6
9130 NEXT M8
9140 NEXT M9
9150 PRINT "★ RELOCATABLE LOCATIONS AND
CODE"
9160 GOTO 400
9500 REM PRINT SYMBOL TABLE
9510 LINE=100
9520 FOR M9=1 TO 255
9530 FOR M8=1 TO U
9540 RPRINT M9;
9550 PRINT ABS(S(M9,M8));
9560 NEXT M8
9570 PRINT ""
9580 NEXT M9
9590 GOTO 9000

READY
#
    
```

## Tandy 10 latest addition

TANDY was slightly unprepared for the instant take-off in the U.K. of the TRS-80 but things are now ticking along well in that area. Whether the company follows by bringing the Tandy 10 to these shores is still debatable, though.

This is an interesting small business system, released at less than \$10,000 in the States. The interest does not lie in its design, which is conventional enough. Packaged as a desk unit with integral screen and two single-density, single-sided floppies, it looks positively conservative, in fact. The printer is a separately-attached Centronics 700, programming is in Basic or Fortran IV (or Assembler).

The interest lies in Tandy intentions. The 10 apparently owes nothing to the

TRS-80 in styling, design or marketing.

## On Target

NASCOM Microcomputers has appointed Target Electronics as distributor for the Nascom-1 system in the Bristol area.

Target was established 20 years ago as the Radio Shop but changed its name this year to reflect its growing business outside the radio industry.

One of the largest suppliers of semi-conductors and other electronic components in Bristol, Target is managed by David Britton.

Full address is Target Electronics, 16 Cherry Lane, Bristol BS1 3NG. Telephone (0272) 421196

## OHIO SUPERBOARD

Computer on a board. 8K basic in ROM keyboard, graphics, cassettes interface, 2K monitor, British TV interface, expandable.

**4K RAM £275 8K RAM £315 C.T.S.**

**1 Higher Calderbrook, Littleborough Lancs OL15 9NL Tel. Littleborough (0706) 79332 anytime**

● Circle No. 184

Agents in  
**SCOTLAND**  
for the  
**COMMODORE PET**



**Robox (Office Equipment Systems) Ltd.**  
84 Townhead  
Kirkintilloch  
Glasgow, Scotland

**SALES SERVICES SOFTWARE**

Telephone: 041-776-4388

● Circle No. 185

Hybrid systems DAC-371-8, D/A converter, plugs into single IC skt, ttl, dtl compatible 8 bits binary or 2 decades bcd, with data, £22,708 (450ns) £6,85p, 2102 (500ns) 98p, 21L02 (250ns) £1,35p, 2513 (Upp case) £5, 75S108 (ttl to moss level converter) 40p, 2512V (dual 128 bit static shift reg (128 x 2)) £1, TMS3128NC (shift reg) £1, N8293A (presettable 1/power binary counter) 50p, vero edge connector 2245/2 (22 x 22) key at 7/h 35p, LM711CH (voltage com) 30p, SN76477 £2.50. p/p 20p.

**LB Electronics**  
43, Westacott,  
Hayes,  
Middx. UB4 8AH  
England

Mail  
Order  
only

● Circle No. 186





## GRAFFCOM PROFESSIONAL BUSINESS SYSTEM

We can offer a complete Turnkey installation with everything including evaluation, system design, installation and training.

Our range of systems handles payroll, accounts, inventory, invoicing, financial planning, plus any specialised applications you require.

Why not contact us Today?

### GRAFFCOM

52 Shaftesbury Av., London W1  
01-734 8862



● Circle No. 187

## MICROCOMPUTERS ETC

PET 2001 8K RAM		£595
TRS80 Level I 4K RAM		£425
TRS80 Level II 16K RAM		£685
APPLE II 12K RAM		£895
SORCERER 32K RAM		£950
Mini Floppy Disk Drives		£350
RS232C/S100 Interfaces	From	£90
Mini Floppy Disks (min 10)	Each	£3
Expander Black Box Printer		£350
SCI Screen Printer (for RTS80)		£425
National Panasonic Video Recorder		£690

TV JOHNSON GROUP  
78 Park St, Camberley,  
Surrey. GU15 3PF  
(callers by appointment)

Telephone 0276 28333  
(plus answering machine evenings/weekends)

Evenings 0252 721094

● Circle No. 188

You can ADVERTISE your shops, products and services in our SHOP WINDOW columns for only £6 per single column centimetre (minimum 5cm). for details, contact TOM MOLONEY or TINA ROBERTS, *Practical Computing*, 2, Duncan Terrace, London N1, Tel: 01-278 3143

# Business games with commercial connotations

MARTIN MITCHELL is justifiably proud of having written one of the longest and fastest programs for the Tandy TRS-80. He works for Understanding, a firm which runs computer training courses and first published his business game program in 1974, with little success.

It "reared its ugly head again" when the micro revolution took off. It is being run as a game and a financial planning package, the object of which is to run a firm successfully against market competition.

"If you want to learn about business, this is a marvellous way of simulation", says Mitchell. As a game, the program has certain financial parameters written into it but if you want to use it for a real situation, all you have to do is re-write a line of the Basic program.

## Menu form

The game begins in menu form, with 14 items to call up, including a double-entry accounting system and a forecast for the next five years of your firm, based on current policy.

The heart of the game is the decision-making, in which you decide how the firm is going to be run. You have to spend certain amounts of money on items such as new factories, issuing shares, promotion of your product, whether to hire or fire staff, take on more salesmen, and at what price you will sell each unit.

Once you have done this, the computer will work out the results of your efforts. As a beginner with the system, you will probably find yourself going bankrupt more often than not but once you have become used to the way in which a business is run, you will, no doubt, be a much-sought-after commodity.

It is certainly an enjoyable game to play but the practical implications of the program are immediately apparent. It is being used seriously by only two firms at the moment and they are certainly not treating it as a toy. In fact, it has become the basis of their financial planning.

## New version

Mitchell has written the program on a 48K system, with two discs—an expensive addition to the TRS-80. At the moment, it is being run on the normal tape cassette, taking 300 cycles of tape. This, Mitchell admits, is ridiculous, so he is now in the process of writing it for a 16K version. It is that version which he is now marketing commercially. He expects to generate plenty of interest, especially in the management development programme area.

Mitchell's other program, which he

claims to be the fastest for a Tandy system, is a graphics package. An example of its speed is its ability to select any predetermined variable within the program in a matter of seconds. □

## Pet printer

A COMPANY called Peripheral Hardware, from West Molesey, Surrey, has decided to cash in on the popularity of the Pet personal computer, and has brought out a printer for use with the system.

It has, in fact, taken a standard Teletype 43 table-top keyboard printer, and modified it so that it can be plugged straight into Pet. This provides Pet with full 64-character upper case character set.

Up to 132 characters can be printed per line using 12-inch wide continuous stationery.

Further information: Peripheral Hardware Ltd, Link House, Pool Close, West Molesey, Surrey KT8 0HW. 01-941 4806. □

## Handy guide

RAPID RECALL, the company which specialises in supplying bits and pieces of microprocessor systems, has produced a handy reference card for users of the Digital LSI-11 microcomputer.

The guide, designed to slip into the pocket, lists the whole instruction set and system commands for the LSI-11/2. It should prove a valuable aid, especially to the winner of the latest *Practical Computing* competition—first prize, a Digital LSI-11.

Rapid recall says it can supply from stock a wide range of memory expansion boards for LSI-11/2 and PDI-11/03 systems. Delivery normally can be made within 48 hours of receipt of order. □

## More power

RESEARCH MACHINES of Oxford are adding power to its 380Z microcomputer system with the introduction of standard and minifloppy discs.

This follows a deal the company has signed with peripheral supplier BASF to provide about 500 floppy disc subsystems over the next two years.

The general-purpose 380Z system, based on the Zilog Z80A microprocessor, could previously support only a tape cassette for back-up storage. The system is marketed by Sintel. □

# The complete supplier

\*RANGE\*PRICE\*DELIVERY\*

## TELETYPE

43KSR

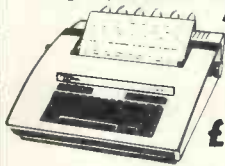

From  
**£869**

Also ASR and RO Models

## LEAR SIEGLER

ADM-3A

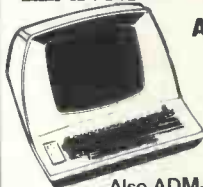

From  
**£595**

Also ADM-31 ADM-42

## digital

LS120



120 cps terminal **£1995**

## A J 211 Acoustic Coupler

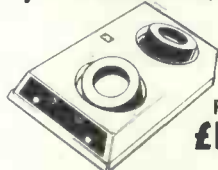

From  
**£197**

Rugged and reliable coupler

## Anadex DP 8000

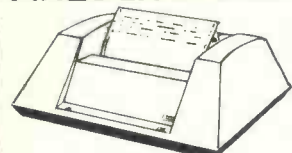

84 lpm printer From **£575**

## Lear Siegler 200 Series



**£1685**

Heavy duty 180 cps printer



South  
01-941 4806

North

Wetherby 61885

Ireland

Dublin 971854

PERIPHERAL HARDWARE LIMITED  
Link House, Pool Close, West Molesey  
Surrey England KT8 0HW Telex: 922175

● Circle No. 189

## BUILD THE NASCOM I COMPUTER

12,000 ALREADY SOLD



KITS IN STOCKS

New Low Price **£165** + 8% VAT POST FREE

★ British Design ★ UK Best Selling Kits FULL AFTER SALES SERVICE & GUARANTEE

We are the Sole Approved London Stockist and National Distributor

### FEATURES

FREE B-BUG WITH EVERY KIT

- ★ Supplied in kit form for self-assembly
- ★ Full documentation supplied
- ★ Fully screened double-sided plated through hole printed circuit board
- ★ Full 48 key keyboard included
- ★ 2K × 8 Ram
- ★ 1K × 8 monitor program in Epr/rom
- ★ Powerful Mostek Z80 CPU
- ★ 16 × 48 character display interface to std un-modified T.V.
- ★ T.V. display memory mapped for high speed access
- ★ On board expansion to 2K × 8 Eprom



- ★ On board expansion for additional 16 I/O lines
- ★ Memory may be expanded to full 60K

### EXPANSION

- ★ Expansion buffer board . . . £25
- MEMORY KITS (inclusive all hardware)
- 8K . . . . . £85
- 16K . . . . . £140
- 32K . . . . . £200
- ★ I/O board with decoders and all hardware except ICS will accept up to 3 PIOs, 1 CTV and 1 UART . . . . . £35

### OTHER HARDWARE

- ★ 3A power supply for up to 4K expansion . . . . . £19.90
- ★ 3A power supply for up to 4K expansion Mk II . . . . . £24.50
- ★ 8A power supply for larger than 32K expansion . . . . . £50.00
- ★ Expansion card frame . . . . . £29.50
- ★ E PROM programmer . . . . . £40.00
- ★ E PROM Eraser . . . . . £25.00
- ★ Keyboard cabinet . . . . . £35.00
- ★ Programming manual . . . . . £4.00

### SOFTWARE

- ★ 1K × 8 monitor program providing
- ★ 8 operating commands; supporting Mem examine/modify, tabulate, copy, break, single step execute tape, load, tape dump
- ★ Reflective monitor addressing for flexible monitor expansion through user programs
- ★ Monitor sub-routines include—delay ASCII coding, binary to hex convers/rn, clr screen, scroll up, string print, cursor shift and many others

- NEW T-4 operating system in (2) 2708 EPROMS upwards compatible from T2 and B-BUG . . . . . £25.00
- Tiny Basic . . . . . £25.00
- Super Tiny Basic (with editor and machine utility routines) . . . . . £35.00
- Zeap assembler editor . . . . . £32.00

★ VAT 8% ALL ITEMS EXCEPT BOOKS ★ DEMONSTRATIONS CONTINUOUS DAILY ★ WE WELCOME EXPORT—EDUCATIONAL AND INDUSTRIAL ENQUIRIES ★ FREE BROCHURE—SEND SAE 9½ × 6½ STAMP 12p.



**HENRY'S**  
RADIO

All mail to:  
Henry's Radio  
404 Edgware Rd  
London W12  
Phone (01) 723-1008



● Circle No. 190

# WHEN IT COMES TO EDUCATION TANDBERG IS WAY AHEAD.

Which means a lot can be learned from the EC10 Educational Computer.

Education Division  
Tandberg (UK) Ltd  
81 Kirkstall Road  
Leeds LS3 1HR



Learning laboratories  
Tape and cassette recorders for schools  
Colour TV  
Computer trainers

To: Tandberg (UK) Limited  
81 Kirkstall Road, Leeds LS3 1HR. Tel: (0532) 35111

- Please send me details of Tandberg educational equipment (Tick where applicable)
- I would like your specialist Representative to contact me

NAME \_\_\_\_\_ POSITION \_\_\_\_\_

ADDRESS \_\_\_\_\_

TEL: \_\_\_\_\_

# TANDBERG

EDUCATION DIVISION

PC3-79

● Circle No. 191



# PETALECT

ELECTRONIC SERVICING LTD.

## WANTED

Good Homes for Intelligent Pets

THE

## PET 2001 Computer

£643.52 plus VAT



Illustrated: PET plus optional sound cassette deck and printer (prices on application)

**This unbelievably versatile, compact, portable and self-contained unit has many varied applications and offers tremendous benefits in the worlds of**

● **BUSINESS and COMMERCE:**

Can be used efficiently for Trend Analysis · Stock Control · Payroll · Invoicing · Inventory Control, etc.

● **SCIENCE and INDUSTRY:**

The 'PET' has a comprehensive set of scientific functions useful to scientists, engineers and industry.

● **EDUCATION:** An ideal tool for teaching and it can be used to keep records, exam results, attendance figures, etc.

● **ENTERTAINMENT:**

Games including Backgammon, Noughts and Crosses, Pontoon, Black Jack and Moon Landing

**Possesses all usual alphanumeric PLUS 64 graphic characters for plots, artwork, etc., a printer, 2nd cassette deck and software available AND IN THE NEAR FUTURE 'Floppy Disc' data and programme storage system.**

We have six years' experience in servicing electronic calculators, mini-computers in S.E. England. 24-hour service contract available at £69.50 per annum. Credit and leasing terms available.

**For full details and demonstration contact Peter Watts . . . Now!**

### STOP PRESS

See the full Tandy range at our new shop in Chertsey Road, WOKING

ELECTRONIC SERVICING LTD

(Authorised Commodore Pet and Tandy Dealer) Specialists in Electronic Servicing, Programming, Electronic Design and Prototype Manufacture

33 PORTUGAL ROAD, WOKING, SURREY GU21 5JE

Tel: Woking (04862) 69032/68497/20727

● Circle No. 192

# HAPPY MEMORIES

21L02 450ns 80p	2114 450ns £5.25
21L02 250ns 95p	2114 300ns £6.00
4116 250ns £9.25	2708 450ns £6.75

TRS-80 16K Memory Upgrade Kit £75  
Full instructions included

S100 16K Static RAM Kit 450ns £195  
Bank select, 4K boundaries, all sockets, components and instructions included

ASCII Keyboards from the USA £48.50  
59 keys, 128 characters, alpha-lock, repeat, pos and neg strobe, send SAE for data sheet

Science of Cambridge Mk 14 set of 18  
Texas low-profile sockets £2.80

Texas low-profile DIL sockets:  
pins 8 14 16 18 20 22 24 28 40  
pence 10 11 12 17 18 20 22 28 38

Antex Imm bits CCN or CX17 45p

Call or write for 74LS price list

VAT included. 20p p+p under £10 order

5 Cranbury Terrace, Southampton  
Hants SO2 0LH Tel. (0703) 39267

● Circle No. 193

## MINE OF INFORMATION LTD

1 FRANCIS AVENUE, ST. ALBANS AL3 6BL TELEPHONE 0727 52801

### BOOKS \* PROGRAMS

AUTHORISED MAPCON MICROCOMPUTER CONSULTANCY 79/1

Your Own Computer, by Waite & Pardee (80 pages)	£ 1.50
Osborne Vol. 0 - The Beginner's Book (300 pages)	5.40
Osborne Vol. 1 - Basic Concepts + MoI corrections list	5.90
C201 From Chips to Systems by Rodney Zaks (420 pages)	7.50
Illustrating BASIC by Donald Alcock (134 pages)	1.90
24 BASIC Computer Programs that Work! Lee/Beech (100 pages)	2.40
BASIC Computer Games - Microcomputer edition (185 pages)	5.40
Pascal User Manual and Report by Jensen & Wirth (167 pages)	5.20
Structured Programming . . . with Pascal, by Kieburz (365 pages)	9.50
Cheap Video Cookbook by Don Lancaster (256 pages)	4.30
CMOS Cookbook by Don Lancaster (414 pages)	7.50
C207 Interfacing Techniques by Zaks (420 pages)	7.50
Microprocessor Systems Design by Klingman (480 pages)	16.40
Osborne Vol 2 - Some Real Microprocessors (1373 pages)	17.50
Osborne Vol 3 - Some Real Support Devices (652 pages)	11.50
[These two volumes are looseleaf - suitable binders, each	5.00]
1978-79 updates (6 issues) with either Vol 2 or Vol 3	19.00
!! Package deal! Vol 2 + Vol 3 + binders + updates (12 issues)	69.00
8080A/8085 Assembly Language Programming (400 pages)	7.50
8080A Bugbook Interfacing & Programming (416 pages)	5.90
Z80 Programming for Logic Design by Osborne (372 pages)	5.90
Z80 Microcomputer Handbook by Barden (304 pages)	7.20
MoI Z80 Othello - game for 2 players on NASCOM 1 cassette	2.00
MoI Z80 Minipilot - Text Editor & Interpreter in ¼KB!	
NASCOM 1 Machine Code on cassette	5.00
RML 380Z Machine code on cassette	5.00
Using the 6800 Microprocessor by Poe (176 pages)	5.00
6800 Assembly Language Programming (400 pages)	5.90
How to Program Microcomputers: 8080/6800/6502, by Barden	6.50
C202 Microcomputer Programming: 6502 by Zaks (250 pages)	7.50

All prices include postage, VAT. Pay by ACCESS, cheque, bank draft. For delivery outside the UK add £1 per order for any quantity.

**SPECIAL OFFERS!** The MoI booklist above is under continual review for relevance, accuracy and plain old value for money. The books below have been dropped from the list and are available at reduced prices, as shown, while stocks last. Your payment will be returned immediately if the book you requested is sold out.

Introduction to Personal & Business Computing (245 pages)	4.50
Best of Creative Computing Vol. 1 (325 pages)	5.90
Best of Creative Computing Vol 2 (325 pages)	5.90

Scelbi 8080 Software Gourmet Guide & Cookbook (210 pages)	7.50
Scelbi 6800 Software Gourmet Guide & Cookbook (210 pages)	7.50

● Circle No. 194



# Nine finalists

FINDING nine finalists for our £5,000 Win-a-Computer Competition from the hundreds of entries was no easy task.

## COMMERCIAL CATEGORY

In the commercial category our first pruning session reduced the 150-plus entries to 25. Most entrants offered solutions for stock control, payroll, general accounting and information retrieval—applications for which software has already been developed or is at least near completion.

Among the 25, special mention must go to J. Addison, who suggested a veterinary surgeons' system; T. Taylor, for a TV contacts information retrieval system; J. Hall, for a micro business game; and C. Boreham, for the computerised milkman.

The 25 were pruned to six. The three who "almost made it and we hope you will stand by in reserve" are I. Carbars, who wants to automate hearing tests; J. McCullough for computers in baby care; and D. Byford, who suggests an automated league management system.

The three finalists are M. STANLEY, to automate taxi reservations; G. BLIGH, for sea search planning; and D. GREEN, with a cargo management system.

## EDUCATION CATEGORY

In the education category we received 122 qualifying entries and between them they represented individual and group efforts of more than 200 people. We were pleasantly surprised by the diversity of projects and producing the short-list was not easy.

The three who go through to the final are J. R. ENNALS, of Essex, who proposes to use the computer for history simulation games; MARY RUSSELL, from Hull, who wants to use the computer to teach English in the remedial department; and ELIZABETH MOORE, whose application is to monitor the progress and development of children.

## PERSONAL CATEGORY

The personal category produced 107 qualifiers. Inevitably the bulk of them were for home computers which did everything but brush your teeth. At the end we felt somewhat wary about living in a computerised home.

The three who go to the final are N. GREENWOOD, with his guidelines for an integrated domestic computer; CLAIRE GAETH, with a home diet management system for diabetics; and JANET HILL, who wants to computerise a survey she is carrying-out on facilities for the disabled in Stratford-upon-Avon.

The next step is for the nine finalists to produce a working flowchart of their systems. The three most practical, detailing how the system could be implemented, will be the winners.

Prizes are a complete Digital Equipment LSI-11 system from Dicoll; a Research Machines 380-Z; and a Nascom 1.

## Advertisement Index

Airamco	50	Jade Computer Products	13
Almarc Data Systems	66	Keen Computers	26
American Data and Office Computer	18	Lotus Sound	56
Beyts Logic	10	LP Enterprises	15
Boer, De Elektronika	80	Lyme Peripherals	30
Brindiwell	10	Marshalls	64
Byte Shop	9	Microdata	16
CCS Microhire	66	Microdigital	24
Clustan	48	Micronics	8
Comart	5	Microsolve Computer Services	66
Commodore Systems Division	4	Millhouse Designs	14
Comp Computer Components	82, 83	Mine of Information	78
Compelec Electronics	58	Nasco Sales	46, 48, 50
Compucorp	45	Online	34
Computer Centre	16	Peripheral Hardware	77
Computrade	8, 64	Pelco	48
Computer Workshop	84	Personal Computers	16
DAMS	6	Petalect	78
Data Design Techniques	10	Petsoft	14
Electronic Brokers	12	Plessey	32
Electrovalue	6	Research Machines	7
Equinox	8, 46, 80	Robin Bailey	12
Euro-Calc	30	SEED	54
Factor-One	44	Shelton Instruments	40
Games Workshop	64	Sintrom Microshop	17
GR Electronics	66	Software Architects	46
Happy Memories	78	Tandberg	77
Heathkit	6	Tangerine	54
Henry's Radio	77	Technical Book Services	50
HL Audio	11	Transam	20
Infoguides	2	Video Software	80
Isherwoods	40	Video Time Products	14

**6080 Assembler programmers** needed for U.K. and European contracts.

**£150 to £300 per week.**

We also have a constant demand for analyst/programmers and software support staff to work in Scotland, England, Europe and Saudi Arabia. E.g. COBOL/GCOS/TDS: PDP-11 RSX and RSTS: DG Assembler: PL1/IMS/CICS op. systems designers: 2900 VME/B: 2903: System/34: System/3: Finger 1500-Assembler.

For local interview, contact Neil Phillips:

**Office: 041 226 4721**

**Home: Crossford (055 586) 319**

**MAL-N Associates Ltd.,  
Consultants**

## SHOP MANAGER

for expanding games retailer in West End.

Excellent salary plus commission.

Telephone 636 8278

for an appointment.

**CAPITAL APPOINTMENTS Ltd.** are specialists in computer recruitment for engineering and scientific applications.

We also have many vacancies for programmers with micro experience.

Contact Ray Darker now to discuss situations available throughout the U.K.

**29-30 WINDMILL STREET,  
LONDON W.1.**

Telephone: (01) 637 5551



## Business Men in the Midlands

Thinking of buying a Computer ?

Bewildered by the Choice ?

Let us help you through the Maze !

**During 1979 we shall be holding a series of one-day seminars on the use of microcomputers in business.**

- Attendance at each seminar limited to 20 people.
- Individual attention to your problems.
- Talks by experienced business Consultants.
- Demonstrations of a full range of *working* business software packages.
- Demonstrations of microcomputers in action.
- No prior knowledge of computers necessary.
- Lunch and refreshments available.

To date we have been involved in the installation of more than 40 small business systems. Why not gain the benefit of our experience ? Attendance fee £50.

For further details contact: Mrs D. G. Smith  
Video Software  
Stone Lane  
Kinver  
Stourbridge  
West Midlands.



Tel: Kinver (038483) 2462 or Stourport (02993) 77498.

● Circle No. 195

# EQUINOX 300

A powerful multi-user  
multi-tasking  
multi-language

16-bit microcomputer time-sharing system

supporting

- \* BASIC
- \* LISP
- \* PASCAL
- \* Floppy discs
- \* Hard discs

including a powerful Text Formatter,  
Assembly Language Development System  
and disc-based Sort utilities.

Priced from **under £5,000**

Write or phone for further information.

**EQUINOX COMPUTER SYSTEMS LTD**

**32-35 Featherstone Street,  
London EC1Y 8QX.  
(Tel: 01-253 3781/9837)**

● Circle No. 196

# DE BOER ELECTRONICS

Our program contains a large assortment of kits. Specially interesting is a microprocessor kit designed by Elektor magazine. This SC/MP  $\mu$ P (National Semiconductors) consist of:

- RAM I.O (9846-1), digital in- and output. With binary switches-displaying the databus £32.35
- SC/MP board (9846-2), a simple mainboard. With the  $\mu$ P- and timing circuits £26.75

With these two kits you can start your own " $\mu$ P-ing"

- CPU-card (9851) extension card for the SC/MP. This card contains the SC/MP (you don't need the SC/MP board anymore) E-prom for monitor, some RAM etc. £90.50
- Bus-board (9857): Handy card to connect to SC/MP unit in an easy way £3.00



- Memory card (9863): This card completes the heart of the kit. With some memory and monitor E-proms £57.00
- Hex I.O (9893): Now you can load your program in hex-code and on the card there are hex displays £67.25
- 4-K RAM (9885): memory extension £112.05
- SC/MP power supply (9906) with transformers £23.05
- Cassette interface (9905): This kit makes it possible to store programs in an easy way. You can use an ordinary cassette-recorder £16.05
- 3 Elburg-programmed Eproms £68.85  
Complete system, consists of 9851-9863-9885-9906-9905 and Elburg Eproms £349.00
- Keyboard complete with encoder £46.50
- Video display terminal (accepts information of keyboard and SC/MP  $\mu$ P) £69.00

### Ordering details:

By letter to: Mike Hutchinson, 2 Lynn Road, Grimston, Kings Lynn, Norfolk PE32 1AD. Phone: Monday to Friday 1 pm to 6 pm. Saturday 10 am to 1pm. At Hillingdon (04856) 553 cheques and postal orders only in the name of De Boer Electronics. All prices are VAT-inclusive. Add 50p for post and packing. No callers, please.



**de boer  
elektronika**

Kleine Berg 39-41 Eindhoven.  
Nederland, tel 040-448229

● Circle No. 197

# A PRACTICAL GLOSSARY

Continuing the terminological gamut from F to G

## Floating point

Floating point representation is a clever way of manipulating numbers so that no matter how big or small the number is, it always takes up the same amount of storage space.

Frankly, most micros do not have the ability to handle floating point, and unless you're a scientist or a numbers nut you probably don't need it. There are some plug-in \$100 boards which give you floating point arithmetic commands, implemented as microcode in PROM.

Floating point extends a computer's calculation abilities and simplifies the programming of complicated arithmetic operations.

You still want more? Your ordinary decimal number is turned into a mantissa and an exponent. We're not going to tell you what a mantissa is, but the result looks like this:

The bit in front of the E is a mantissa, the bit after is an exponent. The mantissa is always less than 1.0 and multiplying it by the exponent gives you the decimal number you first thought of (4.8 in this case).

## FP/2

The opposite of floating point is, would you believe, fixed point, which are ordinary, familiar decimal numbers with a point in the same position all the time—after the whole number, before the fraction—remember?

## Foreground

Where the foreplay takes place? No, it's just a way of indicating what's happening in the computer when two (or more) tasks, programs, jobs, or whatever are competing for resources. It applies only to multiprogramming systems, and denotes the program with the highest priority.

The converse is *background*, naturally enough, and what happens is typically something like this. Your printer program is happily trundling away, printing. Then in comes something from you on the VDU. The computer knows that the VDU doesn't want to wait for the printer program to complete, not in view of the fact that it's printing the whole London telephone directory and has reached only AAA Car Hire; so it suspends the print job automatically, gives its full resources to this piece of VDU activity, and returns to the printing when the VDU interaction is finished. Servicing the VDU is the foreground job, the printing is going on in the background.

## Format

The logical organisation of programs or data. In practice, this

formatting will cover all kinds of preambles, postambles, check digits, stop and start indicators, beginning and end marks, and so on.

## FORTRAN

FORmular TRANslator. It's another IBM invention (c. 1957) though it's travelled a long way since then; it is still the single most widely-used scientific programming language. It's not much good for anything else (though a company called General Automation has a business version called Commerical FORTRAN). Basic owes some of its parentage to FORTRAN.

## Front-end

All-purpose buzzword meaning 'at the front', though often used as a verb, meaning 'to put on to or at the front'.

It's not all nonsense though. A front-end processor is a separate mini or micro which does something to input (pre-processes it, in fact) to help optimise the work of the main processor. This might be unscrambling a coded message of some sort, figuring what files will have to be accessed, and so on.

## Full duplex

This describes a simultaneous but independent two-way transmission of data. It is distinguished from *simplex* (one-way transmission only) and *half-duplex* (two-way transmission, but alternatively rather than simultaneously). More about this when we get to H.

## Function

In practical terms, a function is essentially a subroutine—either literally (a bunch of program statements) or figuratively (a set of operations and events which can be repeated as required when they are called on). The classic functions are the four basic arithmetic operations. In a pocket calculator, for instance, pressing the ADD key initiates a (quick) set of programmed operations which produces the desired result for the data presented to it.

## Function key

Obviously, a key which calls up a function. Your keyboard may not have any (there are two other types of key on it, alphanumeric and control). You can activate functions in other ways, though, typically by a code key sequence, like pressing CONTROL and another key at the same time.

On the other hand, your keyboard may have a row of keys with no labels, perhaps, or cryptic messages like 'PFO'. In that case

you'll have a manual which shows you how to set up functions (typically as conventional program codes) and assign them to particular function keys. Subsequently you can call up function with a single keystroke.

Nearly all keyboards will have some function keys, in any case—like NEWLINE, CR, RETURN, LF, ENTER. They're just not very complicated functions.

## Games

You don't really need a definition of a game, do you? It is, however, worth spending a few words on the subject, because it is far from trivial. On the one hand, games represent an excellent use of computers; they involve rules and alternative decision paths, both of which are highly appropriate to the computer. So games actually make good use of the computer.

They also make good use of you, not least because you can plumb your potential and exercise your mind in a situation where you are calling the shots. If you don't like the game or if you don't want to play, that is up to you: if you win, it's you who did it; if you lose, it doesn't matter; and if you don't like losing, that's your business, too.

There are more serious games, too, of course—'serious' in this context referring to social repercussions. You might be playing in a team—the family which plays together stays together?; and there isn't really much difference between *Star Trek* and the kind of what-if business planning programs widely available.

## Gas-discharge display

Also called a plasma display. This is an alternative to the TV-type cathode ray tube as a way of displaying man-machine communication. The CRT works by firing electrons at a phosphor-coated surface, which lights up at the point where the electrons hit. The gas discharge display consists of many tiny, gas-filled cells, the gas in which lights up when a small electrical current is passed through it. The character which results depends exactly on which cells in the matrix are illuminated, of course, since the illumination produces a pattern of dots like the glowing dots build up a character on a CRT screen.

There are good and bad points to gas-discharge displays. In particular, you do not have to fit in an electron gun; so this kind of display can be very flat, and that means a VDU using it doesn't occupy as much space on the table as one with a CRT screen. Also the electrical stimulation can be constant, so you don't have the flickering which sometimes

occurs with a CRT; the phosphor glow starts to fade when the electron gun has moved on to illuminate the next dot, and the flickering is caused when the electron beam re-stimulates the point.

The cells have to be reasonably large, and the dots can't be defined as clearly as the small CRT dots. So you don't have many characters on the screen and they certainly do not resemble 'joined-up' writing in the way CRT characters sometimes do.

The killer is that gas-discharge displays are more expensive than CRTs on a per-character basis, if you have many characters to display, and LEDs are cheaper if you want to display only a few. So you probably won't see many gas-discharge displays.

## Gate

A single logic function. Formerly, electronic systems used electromagnetic relays which opened and closed electrical paths in different directions; that's where the term originated, for the way a path was routed is analogous to a gate opening or remaining closed. A gate is thus a point at which a logic decision has to be made; more about this under *Logic*.

## Gigo

Acronym for garbage in—garbage out. The sense is obvious; if you use duff input you can't expect elegant output. It's not much use these days, but oldsters of the computer business go into paroxysms of knowing chuckles whenever they meet the term.

## Golfball

The resemblance gave the name to the type element on IBM typewriters and this genre of electric typewriter. It's properly called a *typesphere*, in fact. The key point as far as the personal computer user is concerned are two. The typesphere rather than the paper moves, and the printing produced is of excellent quality. A moving type element involves much less mechanical effort than an ordinary type-bar typewriter, so it is reliable enough and fast enough to be used by a computer. If you want to do word processing—like write form letters to your bank managers, lovers, or wine suppliers—the print impression cannot be bettered.

On the other hand, the design of the golf-ball type mechanism is such that you'll never achieve much faster than about 15 characters per second. If you use it for long jobs, it is likely to fall apart; wonderful though it is, the typesphere printer is still delicate by comparison with other printer mechanisms, notably the *matrix* printer.



## INTERESTED IN HOME COMPUTING?

Start now and don't get left behind THE NASCOM 1 is here Ex-stock with full technical services

Plus the opportunity to join the fastest moving club of personal computer users enabling you to get the most out of your computer. You can OBTAIN and EXCHANGE programs and other software — many now available.

- The Powerful Z80 Microprocessor
- Professional Keyboard
- 1 Kbyte Monitor in EPROM
- 2 Kbyte RAM (expandable)
- Audio Cassette interface
- Plugs into your domestic TV
- Easy construction from straightforward instructions
  - no drilling or special tools
  - Just neat soldering required.



**SAVE £30**

Only **£197.50 + 8% VAT** (includes p & p + insurance)

Manuals separately	<b>2.95</b>	
Z80 programming Manual	<b>6.90</b>	
Z80 Technical Manual	<b>2.95</b>	
PIO Technical Manual	<b>2.95</b>	Power supply suitable for NASCOM <b>19.90</b>

(All prices add 8% VAT)

**NASCOM AD ONS** — Nascom improved monitor B Bug (2K) featuring — \*Four times tape speed \*Direct text entry without ASCII \*Extended keyboard facility \*Additional useful subroutines **£23.00**

Nascom Vero Case <b>£22.50</b>	Nascom Music Box Kit <b>£9.90</b> <i>(write your own tunes and play them on your Nascom. Complete with full documentation).</i>
Nascom Joy Stick Kit <b>£14.90</b>	

**FREE B BUG** valued at £23.00 plus 10 x C12 cassettes valued at £4.00 plus Standard Modulator valued at £2.25 **WITH EVERY NASCOM**

## PET COSTS LESS AT COMP and it's a pedigree RRP £695

The No. 1 Personal Computer in the U.K. Affordable **£590** **SAVE £100** for the first time user and the professional check out the PET, the world's most popular personal computer.



## THE ATARI video computer system



Atari's Video Computer System now offers more than 1300 different game variations and options in twenty great Game Program™ cartridges!

Have fun while you sharpen your mental and physical coordination. You can play rousing, challenging, sophisticated video games, the games that made Atari famous.

You'll have thrill after thrill, whether you're in the thick of a dogfight, screeching around a racetrack, or dodging asteroids in an alien galaxy. With crisp bright color (on color TV) and incredible, true-to-life sound effects. With special circuits to protect your TV.

**Cartridges now available**  
Basic Maths, Airsea Battle, Black Jack, Breakout, Surround, Spacewar, Video Olympics, Outlaw, Basketball, All at **£13.90 each.**

Years and years of fun and satisfaction are assured

**SAVE £30**

~~£169~~ **£139.00**

## NASCOM IMMEDIATE EXPANSION S100 from COMP —strongly recommended

The only available S100 motherboard kit (fully buffered) that plugs directly into your Nascom. Designed for the insertion of S100 boards (e.g. Static RAM, EPROM and discs etc.).

S100 Motherboard/Buffer (Complete kit + documentation)	<b>£47.50</b>	} Buy both and get 2K Tiny Basic On cassette FREE.
Suitable 8K Static RAM Memory (fully assembled tested and guaranteed)	<del>£125</del> <b>£110</b>	

## NASCOM LOW COST EXPANSION

Uses dynamic RAM and NASBUS (please note this expansion does not support S100 memory)

Tiny Basic in EPROM	<b>£25.00</b>	} All plus VAT
8K Dynamic RAM board (in kit only)	<b>£85.00</b>	
Motherboard (in kit only)	<b>£12.50</b>	
Buffer board (in kit only)	<b>£25.00</b>	

## ATTENTION! TRS 80 USERS

**SAVE £90**

*Simple to fit—only a screwdriver is required.*

<b>16K UP GRADE KIT</b>	Half Radio Shack Price <b>£99</b> + VAT	<b>LIFETIME GUARANTEE</b>
-------------------------	---	---------------------------

**TRS 80 SOFTWARE NEW**  
100 MIXED PROGRAMMES on cassette **£49.00**

## OHIO SUPERBOARD II NEW

For electronic buffs. Fully assembled and tested. Requires +5V at 3 Amps and a video monitor or TV with RF converter to be up and running.



**STANDARD FEATURES**  
Uses the ultra powerful 6502 microprocessor  
8K Microsoft BASIC-in-ROM  
Full feature BASIC runs faster than currently available personal computers and all 8080-based business computers.  
4K static RAM on board expandable to 8K  
Full 53-keyboard with upper/lower case and user programmability  
Kansas City standard audio cassette interface for high reliability  
Full machine code monitor and I/O utilities in ROM

Direct access video display has 1K of dedicated memory (besides 4K user memory), features upper case, lower case, graphics and gaming characters for an effective screen resolution of up to 256 by 256 points. Normal TV's with overscan display about 24 rows of 24 characters; without overscan up to 30 x 30 characters.

**EXTRAS**  
Available expander board features 24K static RAM (additional), dual mini-floppy interface, port adapter for printer and modem and an OSI 48 line expansion interface.

Assembler/editor and extended machine code monitor available.  
~~£289.00~~ **£249.00** + VAT *Send £10 to reserve one—pay balance on delivery.*

## MODULATORS UHF Channel 36

Standard 6 meg band width **£2.25**  
High Quality 8 meg band width **£4.90**

**BULK PURCHASE VDU MONITORS** ~~£99~~ **£69** + VAT  
CASED AND GUARANTEED **12"**



SPRING SUPER SALES OFFERS

# Teleplay presents the PROGRAMAGAME of all time!

TELEPLAY have produced a new product of easy to assemble cartridge games, for you and all your family, that will not go out of date. Just ADD each new cartridge, as it becomes available, and your colour video centre will be up to date the Teleplay way. You will save pounds in the long run. Works OK on Black and White TV.

The Teleplay Kit consists of a Professional Finished Inject Moulded Box Joystick Hand Controls one cartridge which consists of 10 games: Football, Tennis, Solo Squash (1 & 2 Football), Hockey, Basketball (1 & 2 players), Shoot etc. Mains Adaptor. All notes are pre drilled! - No Special holes are required. You'll be surprised how easy it is to assemble this professional kit! Instruction Manual supplied separately at 0.45p. TELEPLAY GIVES YOU TWICE THE FUN BUILDING AND PLAYING THE MOST PROFESSIONAL TV GAME KIT EVER OFFERED

**Special Show Price £28.90** + £2.31 VAT Fully Assembled! £35.90

Every 3 months a NEW game will become available to you and those already under production include Submarines, Snake War, Wipe Out and many more. The price of these will vary from £12 to £19 depending upon the complexity of the game.

Additional cartridges NOW available include:

4 games	Cartridges and Hand Controls	£14.90	£1.14 VAT	Fully assembled
4 games	Cartridge and Hand Controls	£18.90	£1.51 VAT	and
2 games	Cartridge Controls already with basic kit	£12.90	£1.00 VAT	£13.90

NEW - Wipe Out cartridge - 6 games £13.90 + £1.11 VAT

Cartridges come complete with printed case and easy to follow assembly instructions.

All parts fully guaranteed.

Electrical knowledge is not a necessity to assemble this project. Just simple soldering.

## OHIO C2-4P MINI FLOPPY

**SAVE £100**

20K RAM Basic + Assembler  
Personal, Games, Small Business & Educational Disks  
90K Mini Floppy Storage  
Printer Interface  
OS 65D V.30 Operating System  
RRP £1595.00

**Only £1,495.00 Complete + VAT.**  
Complete with monitor + disc drive  
**Economic expandable systems with good disk based software, available now.**

## THE EXIDY SORCERER.

**SAVE £100**

### SORCERER COMPUTER SYSTEM

**CPM NOW**

The Sorcerer Computer is a completely assembled and tested computer system. Standard configuration includes 63-key typewriter-style keyboard and 16-key numeric pad, Z80 processor, dual cassette I/O with remote computer control at 300 and 1200 baud rates, RS232 serial I/O for communications, parallel port for direct Centronics printer attachment. 4K ROM operating system, 8K ROM Microsoft BASIC in Rom Pac™ cartridge, composite video of 64 char/line 30 line/screen, 128 upper/lower case ASCII set and 128 user-defined graphic symbols, operation manual, BASIC programming manual and cassette/video cables, connection for S-100 bus expansion.

**LOOK!**

- \*32K RAM on board
- \*RS232 interface
- \*8K BASIC ROM
- \*CUTS interface
- \*4K MONITOR
- \*KANSAS CITY interface
- \*S100 BUS
- \*User defined graphic symbols
- \*Z80 cpu

16K ~~£860~~ £751 \* 32K ~~£950~~ £850 \* Credit facilities available. + VAT

## COMPUTER COMPONENTS

Send for our Spring 1979 catalogue. 0.60p Full of Computer Components, Peripherals and systems.

4116 —	£9.90	6800 —	£11.90	6852 —	£9.90
Z80 P10 —	£9.90	6820 —	£5.00	6502 —	£9.90
Z80 CPU —	£14.90	8T26 —	£2.90	1702A —	£4.90
Z80 CTC —	£9.90	6810P —	£4.95	2102 —	£1.00
2350 —	£4.90	6852P —	£11.25	2708 —	£9.90
6828 —	£6.90				

## KEY BOARD

756 GEORGE RISK **SAVE £10**

Brand new professional ASCII keyboards (USA)  
Full technical details included. RRP £60.00  
Ready built, tested and guaranteed.

Only **£49.90** + VAT

## INDUSTRIAL POWER SUPPLY

+5v 10 amps — £63.25 +5v 5 amps + 12v-12v-5v £89.00  
DC switched Both housed and fully guaranteed. Lightweight

## SHORT C12 CASSETTES

FOR COMPUTER PROGRAMMES  
10 for £4.00

## VIDEO GAME COMPONENTS

8603 — Video Road Race Chip	£3.90	8710 — Tank Chip (with no upwards firing, otherwise OK)	£3.50	ETI PCB-£1.50
8500 — 6 Game Chip	£3.90			
8610 — 10 Game Chip	£4.90			

## BOOK SHELF

Vol 0 The Beginner's Book	£5.40	8080 Software Guide & Cookbook from Scelbi	£7.90
Vol 1 Basic Concepts + 1977	£5.90	8080 Software Guide & Cookbook from Scelbi	£7.90
Vol 2 Some Real Products (June 1977)	£9.90	8080 A/8085 Assembly Language Programming	£6.50
Microprocessor series, by Rodney Zaks C201 From Chips to Systems	£7.50	8080A Bugbook Interfacing & Programming by Rony, Larsen & Titus (1977) 416 pages	£6.90
C207 Interfacing Techniques	£7.50	Z80 Programming for Logic Design by Adam Osborne	£5.90
Microprocessor Systems Design by Edwin Klingman ISBN 0-135-81413-8 (1977) 480 pages hard cover	16.40	Z80 Microcomputer Handbook by William Barden	£7.20
CMOS Cookbook by Don Lancaster	£6.90	Structured Programming & Problem Solving with Pascal ISBN 0-138-54869-2 (1978) 365 pages by Kiebertz "When will your microcomputer speak Pascal"	£9.50
6800 Assembly Language Programming	£6.50	BASIC Computer Games — Microcomputer edition	£5.40
6800 Software Guide & Cookbook from Scelbi	£7.90	Best of BYTE Vol 1 (1977) 376 pages	£8.90
8080 Software Guide & Cookbook from Scelbi	£7.90	Best of CREATIVE COMPUTING Vol 1 (1977) 326 pages	£6.90
8080 A/8085 Assembly Language Programming	£6.50	Vol 2 (1977) 323 pages	£6.90
8080A Bugbook Interfacing & Programming by Rony, Larsen & Titus (1977) 416 pages	£6.90	MOI OTHELLO Game for 2 players on NASCOM 1 cassette	£2.00
Z80 Programming for Logic Design by Adam Osborne	£5.90	MOI MINO PILOT powerful text editor and interpreter in 1/2 KBI!	£5.00
Z80 Microcomputer Handbook by William Barden	£7.20		

## MAGS.

BYTE — £2.00

INTERFACE AGE — £2.00

KILO BAUD £2.00

**MANY RECENT BACK ISSUES**

WE CAN SUPPLY YOUR SHOP

All prices include VAT except where shown. Orders over £5 post and packing free otherwise add 20p. Please make cheques and postal orders payable to COMP, or phone your order quoting BARCLAYCARD or ACCESS number.

## COMP COMPUTER COMPONENTS

14 STATION ROAD, NEW BARNET, HERTFORDSHIRE TEL: 01-441 2922 (Sales) 01-449 6596  
CLOSE TO NEW BARNET BR STATION — MOORGATE LINE TELEX: 298755  
OPEN — 10am to 7pm — Monday to Saturday CONTINUOUS DEMONSTRATIONS  
£6 EXTRA FOR SECURICOR DELIVERY



# We're getting bigger to give you a better service

**We've opened a Sales and Customer Service Centre in London. And our new factory is fully operational. Southwest Technical Products provide a range of superb computer systems with technical backing second to none.**



#### **Systems**

To suit all types of user – OEM, process control, data handling, small business systems, and all accounting functions.

#### **Software**

Low cost packages for word processing, selective mailing, progress control and invoicing. Our Software Development Unit available to prepare programmes to customer specification.

#### **Training**

Inexpensive courses (at Dover Street): **BASIC** – programming for the businessman; microcomputers in **EDUCATION**; **WORD PROCESSING** made easy; **SOFTWARE DEVELOPMENT** – make your microprocessor work.

#### **Maintenance**

Comprehensive national service by Computer Field Maintenance Ltd.

**Sales Office: 38 Dover Street, London W1.**

**Tel: 01-491 7507 Telex: 268913.**

**Factory: 12 Tresham Road, Orton Southgate, Peterborough.**

**Tel: 0733-234433 Telex: 32600.**



**the symbol of reliability**