

POPULAR WIRELESS, May 1st, 1937.

REGISTERED AT THE G.P.O. AS A NEWSPAPER.

SHORT-WAVE CONTEST! GRAND PRIZES

Popular Wireless

EVERY
WEDNESDAY
PRICE

3D

№ 778. VOL. XX XI
MAY 1st. 1937

AND TELEVISION TIMES

★ Special
SHORT-WAVE NUMBER



**W.L.S. SET • D.X. INFORMATION • LATEST
APPARATUS • USING ADAPTORS & CONVERTERS**

YOU CAN HEAR ALL THESE STATIONS

The stations in this list are ones which anybody with a good short-wave receiver can expect to hear. You may not hear them first time because conditions may not be right, or the station might not be working. The most likely times to get the various stations are when conditions are best for reception on the particular wave from the particular part of the world concerned. A rough guide to these times is included in this list. The logging of some of these easier-to-receive stations will help you to know where to look for the more distant and tricky ones

Wave-length	Station and Country	Call Sign	When to Listen	Wave-length	Station and Country	Call Sign	When to Listen
13-93	Pittsburg (U.S.A.)	W 8 X K	Afternoon	25-6	Radio-Colonial (France)	TPA 4	Whenever working
13-93	Daventry	G S J	Whenever working	27-25	Bandoeng (Java)	PLP	Evening
13-94	Wayne (U.S.A.)	W 2 X E	Afternoon	27-93	Tokio (Japan)	JVM	Morning
13-97	Daventry	G S H	Whenever working	28-99	Buenos Aires (Argentina)	LSX	Evening
15-93	Bandoeng (Java)	PLE	Morning and afternoon	29-04	Ruyselede (Belgium)	ORK	Whenever working
16-86	Daventry	G S G	Whenever working	29-24	Bandoeng (Java)	PMN	Evening
16-87	Boundbrook (U.S.A.)	W 3 X A L	Afternoon	30-43	Madrid (Spain)	EAQ	Evening
16-89	Zeesen (Germany)	D J E	Whenever working	31-06	Buenos Aires (Argentina)	LRX	Evening
19-52	Budapest (Hungary)	H A S 3	Whenever working	31-09	Lisbon (Portugal)	CT 1 A A	Late evening
19-56	Zeesen (Germany)	D J R	Whenever working	31-13	Rome (Italy)	I 2 R O	Evening
19-57	Schenectady (U.S.A.)	W 2 X A D	Evening	31-25	Moscow (U.S.S.R.)	R A N	Evening
19-60	Daventry	G S P	Whenever working	31-28	Huizen (Holland)	P C J	Whenever working
19-62	Buenos Aires (Argentina)	LRU	Whenever working	31-28	Sydney (Australia)	V K 2 M E	Whenever working
19-63	Zeesen (Germany)	D J Q	Whenever working	31-28	Philadelphia (U.S.A.)	W 3 X A U	Evening
19-66	Daventry	G S I	Whenever working	31-32	Lyndhurst (Australia)	V K 3 L R	Early morning
19-68	Radio Colonial (France)	TPA 2	Whenever working	31-32	Daventry	G S C	Whenever working
19-70	Podebrady (Czechoslovakia)	O L R	Evening	31-35	Millis (U.S.A.)	W 1 X K	Evening
19-71	Huizen (Holland)	P C J	Afternoon and evening	31-38	Zeesen (Germany)	D J A	Whenever working
19-72	Pittsburg (U.S.A.)	W 8 X K	Early evening	31-45	Zeesen (Germany)	D J N	Whenever working
19-74	Zeesen (Germany)	D J B	Whenever working	31-48	Schenectady (U.S.A.)	W 2 X A F	Late evening
19-76	Daventry	G S O	Whenever working	31-55	Meibourne (Australia)	V K 3 M E	Morning
19-8	Bandoeng (Java)	Y D C	Evening	31-55	Daventry	G S B	Whenever working
19-82	Daventry	G S F	Whenever working	31-58	Rio de Janeiro (Brazil)	P R F 5	Evening
19-85	Zeesen (Germany)	D J L	Whenever working	31-8	Havana (Cuba)	COCH	Late evening
22.0	Warsaw (Poland)	SPW	Evening	32-09	Bangkok (Siam)	HS 8 P J	Evening
22-95	Suva (Fiji Islands)	V P D	Early morning	32-88	Budapest (Hungary)	H A T 4	Whenever working
25-0	Moscow (U.S.S.R.)	R N E	Evening	38-89	Moscow (U.S.S.R.)	R V 9 6	Whenever working
25-23	Radio-Colonial (France)	TPA 3	Whenever working	48-78	Caracas (Venezuela)	Y V 5 R D	Late evening
25-27	Pittsburg (U.S.A.)	W 8 X K	Evening	48-86	Pittsburg (U.S.A.)	W 8 X K	Late night
25-29	Daventry	G S E	Whenever working	49-02	Wayne (U.S.A.)	W 2 X E	Late night
25-31	Zeesen (Germany)	D J P	Whenever working	49-1	Daventry	G S L	Whenever working
25-34	Podebrady (Czechoslovakia)	O L R	Evening	49-18	Chicago (U.S.A.)	W 9 X F	Late night
25-36	Lisbon (Portugal)	CT 1 A A	Evening	49-18	Boundbrook (U.S.A.)	W 3 X A L	Late night
25-38	Daventry	G S N	Whenever working	49-31	Nairobi (Kenya)	V Q 7 L O	Early evening
25-4	Rome (Italy)	I 2 R O	Evening	49-5	Philadelphia (U.S.A.)	W 3 X A U	Late night
25-42	Tokio (Japan)	J Z J	Morning	49-5	Cincinnati (U.S.A.)	W 8 X A L	Late night
25-45	Boston (U.S.A.)	W 1 X A L	Evening	49-59	Daventry	G S A	Whenever working
25-49	Zeesen (Germany)	D J D	Whenever working	49-67	Boston (U.S.A.)	W 1 X A L	Late night
25-51	Podebrady (Czechoslovakia)	O L R	Evening	49-83	Zeesen (Germany)	D J C	Whenever working
25-53	Daventry	G S D	Whenever working	49-92	Podebrady (Czechoslovakia)	O L R	Whenever working
				50	Mexico City (Mexico)	X E B T	Late night and early morning
				50	Moscow (U.S.S.R.)	R W 5 9	Evening



Editor: G. V. Dowding

Asst. Editors: A. Johnson-Randall, A. S. Clark

AN OLD-HAND
STATION NOTE
MEDICAL RADIO

RADIO NOTES & NEWS

SET SOS
SPEECH TEST
DAVENTRY DEEDS

The Dodging Diggers

A RECENT census shows that 73 per cent. of the houses in Australian towns now have wireless sets. Unfortunately, some of the Australian set-owners are so busily engaged in collecting Ashes, emitting "Cooecs," and kangarooing, that about 13,000 of them have omitted the formality of taking out a radio licence since the licensing system came into force.

Their careless rapture cost them about £24,000 in fines alone; and the magistrates thoughtfully added on another £7,000-odd, in costs. Altogether the delinquents appear to have had something to "Cooec" about.

NEXT WEEK ANOTHER "HOW IT WORKS" ARTICLE

Where Honour is Due

UNKIND Fate, in the form of hearty sneezes denoting a touch of influenza, kept me a bed-room prisoner on Wednesday, April 14th, when I would fain have hied me to ye fair city of Southampton. For it was the occasion of the opening of the Wireless College at Calmore, by Sir Ambrose Fleming, F.R.S.—and Sir Ambrose is on my list of Not-to-be-Misseds! It was nearly fifty years ago that he was appointed the first Professor of Engineering, University College, London, and he has been acquiring honours for distinguished work ever since.

Inventor of the Fleming valve, the daddy of every valve in the world, Sir Ambrose Fleming is so firmly associated with radio pioneering that wireless listeners are apt to forget his extensive contributions to the epoch-making inventions of the telephone and electric lamp. Since most of us were prevented from cheering him at Calmore, let me assure him of the loud huzzas, the plaudits, and the high regard of "P.W." readers.

A Nice Distinction

WHEN I say "A Nice Distinction," I mean you to pronounce it mentally as "A Niece Distinction," for I refer to the Mediterranean rather than to the adjectival Nice.

Nice, as you probably know, has one

SIMPLE SHORT-WAVE CONTEST

Grand Prizes for "P.W." Readers

Here is a competition open to all readers of "Popular Wireless," in which the following grand prizes are to be won:

FIRST PRIZE.—A B.T.S. battery Adaband, with which a set can be converted into a highly efficient superhet short-wave receiver.

SECOND PRIZE.—Peto-Scott "Band-Spread" 3 Kit. A magnificent battery short-waver with a first-class performance.

THIRD PRIZE.—New Times Sales Combined Adaptor, Converter and Single-Valve Short-Wave Set. The newest and most versatile S.W. unit of the year.

All you have to do is to describe on a postcard the most interesting half an hour of listening on the short waves which you experience between May 1st and June 1st.

Perhaps you will hear part of an attractive programme from America and some war news from Spain. For example, you might record something like this:

"At 9.30 p.m. on the 8th May I tuned in W 2 X A D and heard" (then you would give in a few words just what it was you listened to).

"At 9.45 p.m. I went over to Madrid E A Q . . ." (and you would give details of this item).

There are no restrictions. You can include amateur transmissions as well as broadcasters. And, remember, this is not a literary contest. It's what you will hear as much as how you describe it which will form the basis of adjudication in this contest.

The above prizes must be won, and a few words on a postcard may bring one of them to your door, carriage paid.

A selection of the entries will appear in "Popular Wireless" and each one published will be paid for, so that even if you don't win one of the prizes you may still receive a fee for your effort.

You have a whole month in which to find your most interesting half an hour on the short waves.

Happy listening!

Note These Rules:

1. The prizes will be given in order of merit to those entries which the Editor considers to be the best and most interesting.
2. Entries should be on postcards only, which should bear the entrant's name and address, and be sent to: "Short Wave Contest," Popular Wireless, 1, Tallis House, London, E.C.4 (Comp). All cards must reach that address by Tuesday, June 1st, 1937, the closing date.
3. Give the date and time and the names or call signs of the stations to which you listen.
4. It must be half an hour of consecutive listening, not half an hour made up of periods of time selected from different days or even hours!
5. Competitors may send in as many entries as they like.
6. The Editor's decision will be final and binding, and no correspondence is allowable. No one connected with "Popular Wireless" may compete.

station on 253.2 metres, and another on 235.1 metres. The latter is a privately-owned station, and it used to style itself "Côte-d'Azur." But the authorities now say that the State-owned station, on 253.2 metres, holds full baptismal rights to the name, Nice-Côte-d'Azur, so the other fellow must stick to the title Radio-Méditerranée.

Inter-Service Interference

RADIO'S adaptability, and its habit of spreading into more and more fields of action, are making it imperative to solve problems of interference.

The needs of television and the increasing use of ultra-short waves by the Services

NEXT WEEK PRACTICAL POINTERS AGAIN

have caused the Postmaster General to consider the control of any electro-medical equipment which might interfere with these services. But hint of such action acts on the medical profession like a night bell, and turns out the doctors, asking that the needs of their patients should be borne in mind.

The benefits conferred by X-ray equipment, ultra-short-wave radio, and diathermy (electrical heating) should not be restricted because of the interference they may cause. The technicians will have to see what screening and special wavelength allocation will do.

Ups and Downs

IF Warsaw No. 2, on 216.8 metres, seems to be unusually temperamental, blame nobody but the engineers there. They are engaged in the thankless task of testing.

* * *

Collectors of qucer stations who would like to add Banska-Bystrica to their bag should not waste time on attempted afternoon reception, for the Czecho-Slovak does not use his full 30 kilowatts until 5 p.m.

* * *

Both the Hilversums have this trick of changing power in the evenings, on 1,875 and 301.5 metres, but the changes in power are made at 5.40 p.m.

(Please turn to page 189.)

THE DIAL REVOLVES

SOME AMATEURS YOU CAN HEAR

20-METRE "STARS" :: EXPLORING THE LESSER KNOWN WAVE-BANDS :: A LOW-POWER SOUTH AMERICAN

RADIO was given a fine recommendation when Mr. Masaki Iinuma, wireless operator of the Japanese plane Divine Wind, told a Press representative that "we were encouraged by the cheers of well-wishers over our radio." A cynic remarked that if they had tuned-in to the B.B.C. they would have made a record return flight.

Amateurs

Before me are a number of requests for information regarding the owners (not of their stations, you will observe!) of transmitters, operated by members of the fair sex, to which I made reference in a recent issue. W2IXY is owned by Mrs. (isn't that a shame?) Dorothy Hall who, rumour

SHORT-WAVERS IN THE EAST INDIES

MANILA	MACASSOR
K T O—18.47 m.	P N I—34.14 m.
K A Y—20.03 m.	JAVA
SAIGON	P L E—15.93 m.
F Z S—16.35 m.	P M K—26.09 m.
F Z R 3—18.48 m.	Y D C—19.8 m.
SINGAPORE	P M A—15.51 m.
Z H I—49.85 m.	P M C—16.54 m.
PENANG	Y D A—98.64 m.
Z H J—49.34 m.	Y D B—31.11 m.

has it, is considering a scheme for cooking by high-frequency waves so that she can spend more time at her transmitter!

Reception of amateur stations on all bands is particularly good at the present time. The "star" stations on 20 metres are V P 9 R, Bermuda, V E 3 J V, V E 1 K S, W 2 V P, W 2 B A, W 2 M B J, and W 2 C R.

Conditions have been even better on 10 metres, whilst the 5-metre band has provided many thrills. Those of you who live in the London area should try for G 5 R D, Watford, G 2 M V, G 2 H G, G 2 A W, G 2 N K, G 5 W W, G 6 N F, G 8 F D and G 5 L B.

All short-wave enthusiasts are optimists, so why not search for W 2 H E J, Jersey City, and W 2 I A G, Bronx—you never know—you *might* be extra lucky.

Exploration

One of our parliamentary members, deploring the lack of adventure in the younger generation, made me really enthusiastic the other day. And so, as soon as I reached home I pulled out my receiver and set about searching the lesser known wave-bands. And, boys, the experience was well worth while!

First I turned to approximately 32 metres where I heard, so faintly that I almost kinked my ear-drums listening,

music from what may have been Z B W 3 in Hong Kong. My next port of call was more to my liking. Eastern music (there is no mistaking it) greeted me, followed by the unmistakable voice of a Japanese announcer, from a station (presumably J Y R, Kemikawa-cho) on approximately 38 metres.

Next came a real mystery. Yes, boys, a French-speaking station on approximately 31.36 metres (have you heard him?). Before I could get my wits about me in an endeavour to recognise some of the French phrases, he closed down—the rascal.

Disappointed, but not defeated, I carried on. P L M on approximately 28 metres was my last stop—ending a short, but nevertheless exciting flip over the wave-bands.

5-watt Station Received

Forgive my excitement, please, but, you see, I logged a 5-watt South American

SHORT-WAVE STATION IDENTIFICATION

By F. A. BEANE

HOW TO RECOGNISE THE CUBANS

AT the time of writing, Cuba—"Land of the Evergreen: the Land of the Ladies and the finest Tobacco in the World"—predominates the transmissions emanating from the West Indies, notably from C O C Q, C O C H, C O C D and C O C X, while C O C O, former "star" of Havana, seems to have lost much of its old vitality, undoubtedly due to the terrific QRM existing around its frequency.

C O C Q, (30.77 m.) employing 4 kw.—soon to be increased to 26—uses a miscellany of signals, including a baby's cry, a man's raucous laughter, the sound of a motor-car engine, bugle call, and usually a two-chime signal, and the Spanish announcement "C M Q (Say-emma-y-koo) La Casa de las Medias y los Cigarros Gaditana y C O C Q (say-o-say-koo), La Voz de la Victor, en Habana, Cuba," are heard at fifteen-minute intervals. Incidentally, C O C Q may make a change shortly, so do not be very surprised if you hear additional signals or a new slogan. At 06.00 (G.M.T.) they usually close with an organ recording.

C O C H (31.8 m.) occasionally favours its English-speaking audience with English announcements, although one usually has to rely on its multiplicity of signals for quick identification. In English the call is generally given as "This is the General Electric Station C O C H in Havana, Cuba" and either followed or preceded by one, or more, of its signals, which include a bugle call, church organ recording, cock-crow, roar of the seashore, chimes (usually three and a recording of "Big Ben" to strike certain hours.

C O C D (49.92 m.) perhaps most popular of Cubans due to its numerous English announcements, is usually very strong, although severely heterodyned, and may be best logged by listening between 05.00 and 08.00 (G.M.T.) on Sundays when it is free from all interference and the programme is announced in

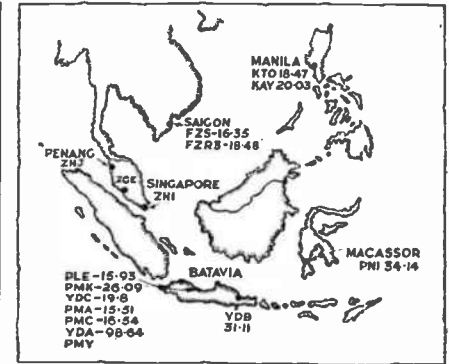

Some East Indies stations worth listening for.

station the other day, and I haven't got over it yet. Like to hear about it? Yes? All right, here goes: Searching the 20-metre amateur band the other day I tuned-in a South American station, 2 B C, which was working L U 7 V D in Argentina. According to the operator, he was using a power of 5 watts. Not bad going, is it? Unfortunately, I don't know in what part of South America the station is, and consequently, unless some of you DX-hounds can help me, I cannot verify reception. Wretched luck, isn't it?

WHEN YOU SEE A STAR LIKE THIS AT THE END OF AN ARTICLE YOU WILL KNOW THAT IT IS A REGULAR "P.W." WEEKLY SHORT-WAVE FEATURE.



English at regular intervals. A four-chime signal is employed, together with the English call "Short-Wave Station C O C D, and Long-Wave C M C D, The Voice of the Air, in Havana, Cuba." A recording of Ted Lewis's "Good-Night Song" terminates their programmes on week-days at 06.00. Reports are welcomed and verified by a beautiful card.

C O C X (26.5 m. approx.) is at present the strongest station operating at the low-frequency end of the 25-metre band using Spanish, and may be identified by the use of a single chime between announcements, and four chimes every fifteen minutes preceding the announcement "C M X (say-emma-y-kis) La Casa Savin y C O C X (say-o-say-y-kis) La Voz del Radio Philco." Occasionally we hear mention of "La Corona" (cigars).

Sending the Same Programme

C O C O (49.92 m.) English announcements are heard frequently, usually as "Short-Wave Station C O C O, Post Office Box 98, in Havana, Cuba," and other characteristics are its three chimes and mention of "R.C.A. Victor," and occasionally a bugle call. Incidentally, I should have mentioned that C O C Q, C O C H and C O C X occasionally broadcast the same programme simultaneously, and the bugle call and "Big Ben" recording have been heard from the last named.

The only other Cuban of note is C O K G (48.4 m.) situated in Santiago, and which may easily be recognised by its employment of male and female announcers. C O 9 J Q (34.62 m.) of Camaguey, like other Cubans, sometimes employs a bugle call, but the single chime interspersed between announcements is more familiar. English announcements are given occasionally as "This is Short-Wave Station C O 9 J Q in C-a-m-a-g-u-e-y, Cuba," and its programmes originate from C M J A.



SHORT-WAVE ADAPTORS AND CONVERTERS

A PRACTICAL ARTICLE DESCRIBING HOW AN ORDINARY BROADCAST RECEIVER MAY BE USED FOR SHORT-WAVE RECEPTION

THE short-wave listener can be divided into two distinct classes: the enthusiast to whom short-wave reception is the very salt of life, and the keen radio man who is interested both in broadcasting and short-wave listening.

Generally, the man who is interested mainly in the short-wave side of radio builds himself a special short-wave receiver. For his ordinary broadcast listening, or perhaps I should say for the benefit of the family, he will buy or construct a two-band set which will be used entirely separately from the short-wave receiver. Probably he will use two different aerials, his short-wave set being joined up to a carefully erected aerial system designed to give him the maximum pick-up on the frequencies with which he is specially concerned.

The other type of listener chooses either an all-wave set, or a short-wave unit which, when added to his existing broadcast receiver, converts it into an all-waver.

There are a large number of constructors in this country who have perfectly satisfactory

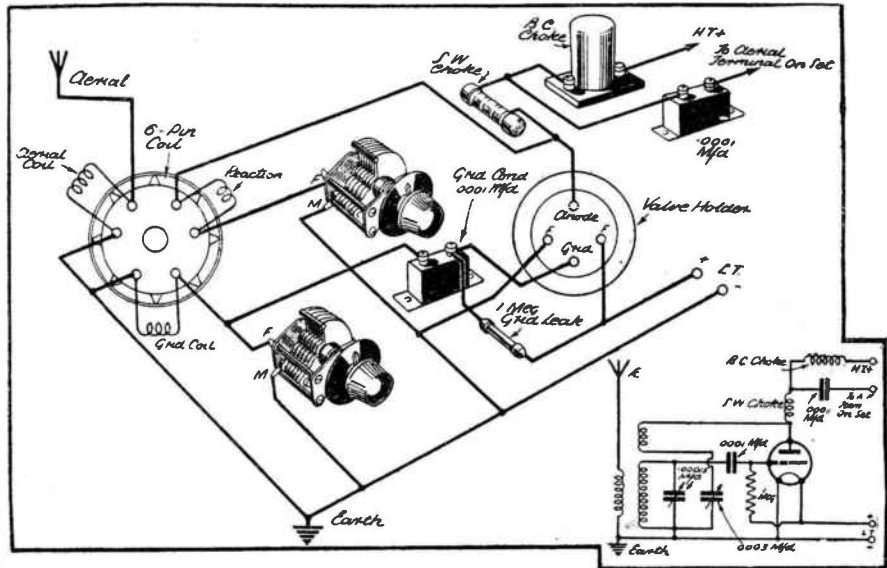

Fig. 1. A simple form of short-wave converter—the autodyne. In these two diagrams the L.T. switch has been omitted for simplicity, but can be an ordinary on-off switch connected in the L.T.+ lead. The 6-pin coil connections are as seen looking at the base of the former.

valve short-wave set fitted with a plug which is inserted in the detector valve holder of the existing set, the detector valve first being removed. This valve is plugged into the valve holder of the adaptor and the arrangement now becomes a detector followed by one or two L.F. stages, depending upon the number employed in the set.

Any single valve short-wave set can be used in this way if it is provided with an adaptor plug. L.T. for the adaptor is taken via the plug from the existing set, and so also is the H.T. supply.

It is usual to supply these special plugs with a dummy grid pin so that the grid circuit of the existing set is disconnected at the plug, this not being necessary for the operation of the adaptor. The aerial and earth leads are joined to the adaptor.

A short-wave converter is a different proposition. No alteration is made to the existing set, and the converter unit is simply connected up to the aerial terminal on the set, the aerial lead being removed and joined to the converter. H.T. can be supplied either from the batteries used for the existing set or from separate ones.

Fig. 1 shows the theoretical and practical arrangements for the simplest form of short-wave converter. This particular type is known as the Autodyne.

Briefly, it converts an existing broadcast receiver into a short-wave superhet. Actually the Autodyne is merely a straightforward short-wave one-valve set, the only departure from the conventional one-valver being the use of two H.F. chokes and a small coupling condenser.

The Autodyne is operated in a state of continual oscillation, the reaction condenser not requiring any very delicate adjustment, and for this reason a condenser

of the pre-set type can be employed if desired.

In the circuit and practical diagram I have shown an ordinary variable 0003-mfd. condenser because the arrangement can also be used as a single-valve receiver by inserting a pair of telephones in place of the broadcast choke and ignoring the coupling condenser of 0001 mfd. and the lead which is marked "to aerial terminal on set." The valve can be one of the H.L. type and the coil is a standard Eddystone or B.T.S. six-pin. The coil connections (looking at the base of the coil former) are given in the practical diagram.

In practice the Autodyne is connected up as follows: Aerial and earth to aerial and earth terminals on converter. The lead marked "to aerial terminal on set" is joined to the aerial terminal on the existing set.

The H.T.+ is inserted at about 70 volts on the H.T. battery. L.T.+ and - go to the existing L.T.+ and - terminals on the set.

The reaction control is turned about half or two-thirds of the way round towards its (Continued overleaf.)

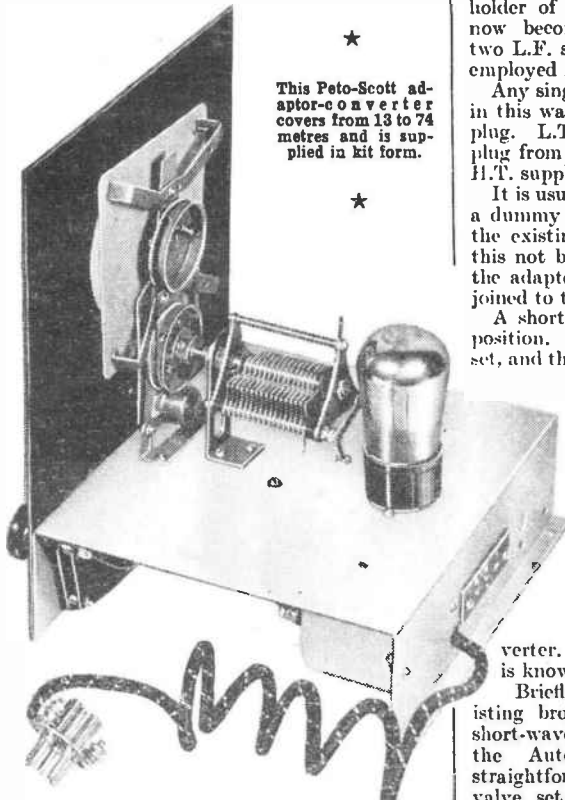

This Peto-Scott adaptor-converter covers from 13 to 74 metres and is supplied in kit form.

broadcast sets and who would very much like to listen on the short waves if they could do so without scrapping their existing sets and without having to face the additional expense of building a separate set specially for short waves.

To these a short-wave converter or adaptor is a happy solution. The adaptor is a single-

USING A HEPTODE

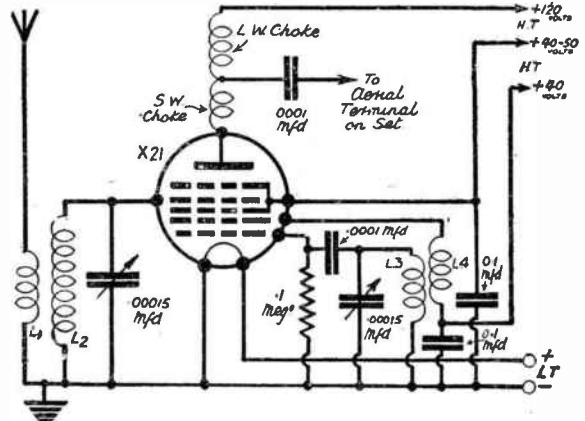

Fig. 2. Here you see the circuit of a heptode converter in which the oscillator circuit is separate from the aerial circuit. The oscillator is coupled to the aerial circuit by the electron stream in the valve.

SHORT-WAVE ADAPTORS AND CONVERTERS

(Continued from previous page.)

maximum—that is clockwise—so that the converter is gently oscillating and the '00015 tuning condenser is used for tuning-in the programmes on the desired short waves in the usual way.

I would mention that before doing this the existing broadcast set should be switched over to its long waveband and the tuning control adjusted and left at about 1,800 metres—or at any point on the waveband where there is likely to be no interference.

Although attractive on account of its simplicity the Autodyne converter has one drawback, and that is the '00015 tuning condenser is never quite tuned to the wavelength of the desired short-wave station; it is always operated slightly off tune, although the constructor will not realise this when operating the set.

The reason is that it has to be adjusted so that it beats with the carrier of the desired station, otherwise there would be no superheterodyne action and the converter wouldn't work as such. This fact produces a slight loss of efficiency, especially in selectivity, and for that reason the more elaborate type of converter shown in Fig. 2 gives improved results. But, for all this, the Autodyne can give very good results, and it is inexpensive.

Using the Heptode

In Fig. 2 you have a battery heptode of the Osram X21 type, working as a straightforward frequency changer with a separate oscillator circuit.

L_1 and L_2 are the primary and secondary respectively of a standard Eddystone or B.T.S. four-pin coil. This coil is tuned by a '00015 tuning condenser, and it is tuned dead on to the wavelength of the desired station.

The oscillator circuit consists of the coils L_3 and L_4 , these two windings being the grid and reaction winding respectively of a standard four-pin coil similar to that used for L_1 and L_2 . The grid winding, which is the same as the secondary L_2 , is tuned by a '00015 condenser, and L_4 merely serves to keep this part of the circuit in constant oscillation.

Coupling between the oscillator and aerial-grid circuit is provided by the electron stream within the valve itself. Two H.F. chokes are needed as in the Autodyne, the first choke being of the short-wave type and the second a normal broadcast choke, a lead being taken at the junction of these two chokes and joined to a '0001 coupling condenser, the other side of the coupling condenser going to the aerial terminal on the existing set.

This circuit works quite well down to about 16 metres and like the Autodyne arrangement,

it can be used with any existing receiver having one or more H.F. stages.

The connections to the existing set are precisely the same as in the case of the Autodyne, and as before the broadcast set is adjusted to a long wavelength of 1,800 metres or so and left at that adjustment. The existing receiver is, of course, merely acting as the intermediate, detector, and L.F. amplifier of a superhet and therefore needs no adjustment after it has been once set.

Gang Control

The Heptode converter lends itself to the use of gang control, but for the less experienced constructor it is perhaps better to use two separate '00015-mfd. condensers for the tuning and oscillator circuits respectively.

Turning now to commercial converters and adaptors, in the B.T.S. range there is a compact adaptor having a waverange of 13-47 metres.

A B.T.S. DESIGN

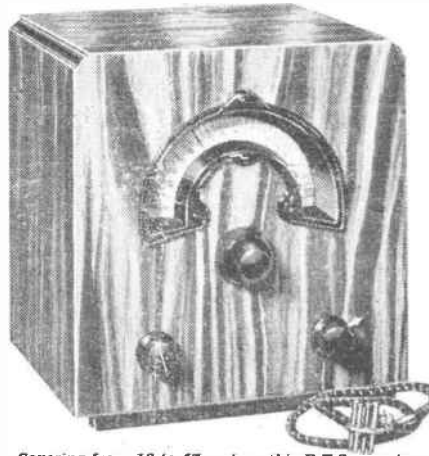

Covering from 13 to 47 metres, this B.T.S. adaptor plugs in to the existing set. It can also be employed as a converter.

The unit is provided with slow motion control on the aerial tuning and reaction condensers, and uses the well-known B.T.S. plug-in coils. Its price is £2 12s. 6d., and with additional coils the waverange can be extended to 170 metres.

CONVERTER AND H.F. AMPLIFIER

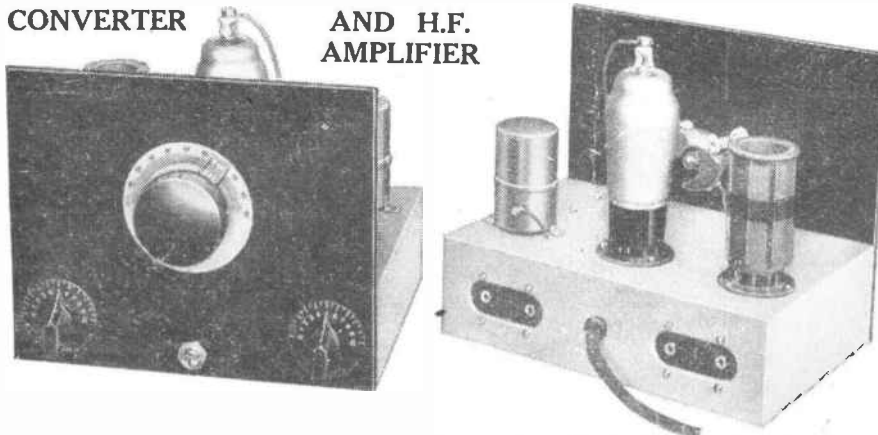

This Eddystone converter can also be used as an H.F. amplifier. It has bandsread tuning and works from batteries.

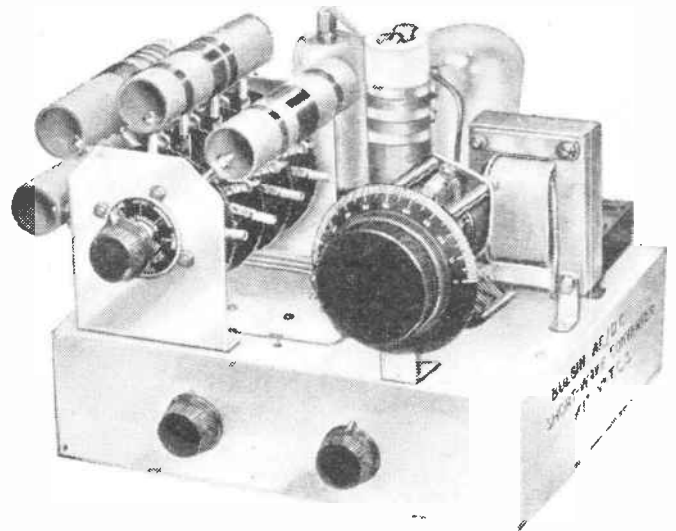

The Bulgina A.C./D.C. converter. Note the method of mounting the coils. Wavechanging is carried out by direct switching.

Peto-Scott supply an adaptor-converter covering from 13-74 metres, and the kit, which comprises the chassis and panel ready drilled, together with all drawings and instructions, less cabinet and valve, is priced at £1 9s. 6d. This unit is employed as an adaptor in sets which have no H.F. stage, in which case the adaptor plug is inserted into the detector valve holder of the set. As a converter used in front of a set with H.F. amplification it converts the existing set into a superhet.

Another unit of which a photograph appears in this article is the Eddystone Short-Wave Converter, which, incidentally, can also be used equally well as a high-frequency amplifier.

This Eddystone unit is available as a constructor's kit, and a full description of it is given in the Eddystone Short-Wave Manual. It is supplied in two models, one for A.C. mains and the other for the battery user. Our photograph shows the battery model.

Electron-Coupled Oscillator

This employs a screened pentode, and when used as a converter the circuit becomes an electron-coupled oscillator, oscillation being controlled by a 50,000-ohms potentiometer, connected in the H.T. feed to the screening grid of the valve. Bandsread tuning is provided, and the waverange is 13.75 to 99 metres in three ranges, interchangeable coils being used.

Those who require an A.C./D.C. converter are catered for by the Bulgina unit, which is described in the firm's "Radio Progress No. 1" wherein full wiring details appear.

In this unit an interesting system of wave-changing is employed, the various coils being plugged into a special coil chassis and the actual wavechanging being carried out by direct switching. The wavelength coverage is from 10-170 metres, four coils being needed.

For those who require a battery converter on these lines there is one fully described in the same issue of Radio Progress. This is likewise available as a constructor kit.

New Times Sales are marketing a combination adaptor-converter and one-valve kit, covering from 12-94 metres. With its three plug-in coils, it can be used as a straightforward adaptor, superhet converter, or single valve short-wave set.

It has bandsread tuning, and the price of the kit is only 25s.

The Rideo short-wave unit is now available as a universal mains design, and further details appear in our Radio Bulletin this week.

A. J. R.

TOKIO ON ONE VALVE

One afternoon Mr. Chester arrived at Tallis House full of ideas. But, as it happened, our stock of MS. on hand was particularly large, and we did not want to add to its general contents even with good articles from the pen of this skilled writer. "Do you know anything about short waves?" I asked. "Not a thing, I'm afraid," he replied. "Right," I said. "Go away, buy some bits and pieces and get acquainted with them. You'll find it mighty interesting, and I think you should be able to describe your experiences so that our readers will enjoy reading about them and benefit both by your mistakes and your successes." Mr. Chester enthusiastically welcomed the suggestion, and here is his first article. You will see that he was quickly off the mark in his practical exploration of short-wave experimenting, and he, at any rate, is thoroughly enjoying it.—EDITOR.

I SUPPOSE none of us starts absolutely at zero. In my case, I have been studying the pages of POPULAR WIRELESS for many weeks past, as well as poring over technical tomes of all kinds. I felt I must at least be able to draw out a theoretical diagram before I could consider myself "in the swim."

I bought a set of B.T.S. four- and six-pin plug-in short-wave coils, finding inside a diagram of connections. To my confusion I found that, for reasons best known to the makers, the pin connections were shown as viewed from upside down! You have no idea how this Alice in Wonderlandish joke upset my calculations.

Sorting Out the Connections

There I was trying to fix a coil base in position, turning it upside down every few seconds to see which was reaction, which tuning, and which aerial winding. I should have thought that it would have been simpler to follow if the diagram had been drawn looking down on the coil base—as in actual baseboard set construction.

Anyway, I concocted what I imagine must be the most elementary of all one-valve short-wave set circuits, making use of the six-pin coil base, tuning condenser, reaction condenser, valve holder, grid leak and condenser and short-wave choke.

I noted from the coil data that a .00016 microfarad tuning condenser was needed to give the wavelength ranges specified, so I got a Polar type E for the job—and a very beautiful piece of work it is, complete with an extension spindle. I also thought I might as well go the whole hog with a Polar Micro Drive—which gives a fast motion of 7 to 1 and a very slow motion of 100 to 1.

I did not know quite what to do about the reaction condenser, so purely on guesswork I bought a Polar .0002-mfd. reaction condenser, which the carton says is a type QJ slow motion. My other purchases were quite inexpensive—B.T.S. valve holders, Bulgin short-wave chokes, Dubilier grid leaks, and T.C.C. fixed condensers.

Arranging the Components

I expect when you look at my Fig. 1 circuit diagram you will begin to pick holes in it at once. All I ask you to believe is that I thought it just about the "bee's knees" when I had finally drawn it up after many false starts.

But from drawing out a pretty nifty looking diagram to its translation into an actual set was quite a big step in my young life. I began with a virginal looking slab of Metaplex board, which I gather is ordinary five-ply wood sprayed with some kind of metal solution to make it electrically like a metal baseplate.

Ever tried juggling with bits and pieces on a baseboard? Of course, most of you must have done, I suppose. Phew! I kept looking at the theoretical to see how

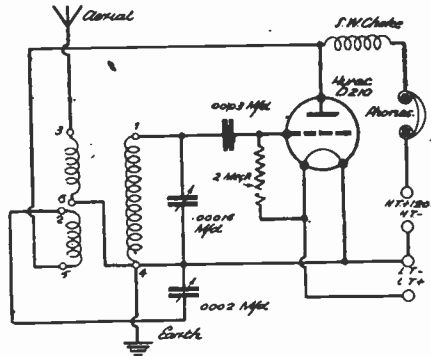

Fig. 1.—This is the simple circuit on which the first station Mr. Chester identified was Tokio in Japan.

the wires would go, trying all the time to evolve a layout of parts that would give me short leads, which I understand are essential for short waves.

In the end I settled down to the disposition you see drawn up as Fig. 2. Needless to say, when I came to wire up the parts I found more than one wire had to be stretched right across the board. But before I did any wiring I had to fix the parts firmly down. And it was then that the coil base numbers began to worry me. I wish they would mark the numbers on the base itself for "mutts" like me.

As it was, I first tied bits of paper on each of the six terminals to identify them with the diagram, and then when the coil base was on the board I marked the numbers in ink against each terminal. Very long and very narrow gauge screws seem to be

THE LAYOUT USED

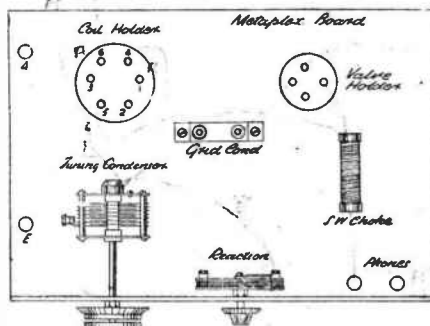

Fig. 2.—There was nothing special about the set, the parts were just screwed down to a baseboard in convenient positions and then wired up.

needed for the base fixing—my 3/4-in. screws were useless.

Some of the holes for the other components, such as the valve holder and the grid condenser, also seemed very small. My 3/4-in. screws would not go through until I had enlarged all the holes with the end of a file.

Still, that part of the job was done in the end and then I joined up as many of the components as possible with short

lengths of tinned copper wire, tightening down the looped ends under the terminals provided. I left one or two to be soldered—as I wished to try my hand with a new electric bit I had been loaned.

I must say that from what I had read I imagined soldering was the very deuce of a business. Yet I found it absurdly easy—the easiest thing in the whole construction. I used ordinary solder bought from an ironmonger's and little dabs of "Fluxite" where needed. Perhaps the electric bit makes things easy? It did for me, anyway.

My four battery leads, H.T.+, H.T.—, L.T.+ and L.T.—, I made as soldered flexes, not bothering with terminals. But I did use terminal blocks for my aerial and earth and phones connections.

Conducting the First Test

I was getting near the great moment then. And the urgent question kept intruding: "Would it work?" I felt it would be a latter-day miracle if it did—but I went on checking up my wires to make sure they were correct. I brought out my brand-new Siemen's Full-O-Power 120-volt high tension battery and my Exide 30-ampere hour accumulator, my Hivac D210 valve, and my delightfully lightweight pair of B.T.H. headphones.

Soon they were all in place, all connected up. I plugged in one of my six-pin coils—and listened. Plop! I heard the reaction working right away. Why no signals, though? Obvious reason—no aerial connected up!

I quickly had my little outdoor aerial tied on to the set, and the lead from an 18-in. earth tube connected to the earth terminal. Then I did hear things—all round the dial! Morse signals, mostly, but sweet music to me, showing that my first short-wave set was really working.

I was using the S3 coil at the time, tuning, according to the makers, from 22 to 47 metres. It was around 8 p.m. I looked up my list of short-wave stations and saw that Tokio ought to be coming in on 25 and 27 metres. Was I asking too much?

The Great Moment Arrives

I slowly turned my tuning condenser from minimum, and at 31 degrees precisely on the scale I heard weird singing, all out of tune. No, this was not possible, I thought. But then, to my utter delight, a man's voice informed me I had just been listening to a Geisha girl, and that I was about to hear another song from—Tokio!

I rushed the tuning knob round a bit, and at 60 degrees I heard the same song again, only much louder. No doubt about it, my little one-valver had won its spurs for me. I still can't believe it is possible to span so many thousands of miles with just one valve—but it must be, I've heard it.

Well, well, I thought, if Tokio comes in like this, the States ought to be even

(Please turn to cover iii.)

THE "HIEROGLYPHICS" OF S.W. LISTENING

Facts, Figures, Abbreviations, Symbols, Etc.

SOME AMATEUR PREFIXES

The stations of a country are distinguishable by the first, or first two, letters of each station's call sign. Some of the more frequently heard countries, with their distinguishing letters, are given below. Sometimes colonies or possessions of the countries use the same letters, and listeners should avoid being misled in this way.

- | | |
|------------------------|--------------------------|
| Chile—C E | U.S.S.R.—U |
| Cuba—C M (for C W) | Poland—S P |
| Cuba—C O (telephony) | Egypt—S U |
| Portugal—C T I | Greece—S V |
| Germany—D | Turkey—T A |
| Spain—E A 1-2-3-1-5-7 | Iceland—T F |
| France—F 3, F 8 | Guatemala—T G |
| United Kingdom—G | Costa Rica—T I |
| Hungary—H A | Canada—V E |
| Switzerland—H B | Australia—V K |
| Ecuador—H C | Newfoundland—V O |
| Haiti—H H | British India—V U |
| Dominican Republic—H I | Bermuda—V P 9 |
| Kenya—V Q 4 | |
| Colombia—H J—H K | U.S.A.—W |
| Italy—I | China—X T—X U |
| Japan—J | Latvia—Y L |
| Norway—L A | Rumania—Y R |
| Argentina—L U | Venezuela—Y V |
| Austria—O E | Albania—Z A |
| Czechoslovakia—O K | New Zealand—Z L |
| Belgium—O N | Paraguay—Z P |
| Netherlands—P A | South Africa—Z S—Z T—Z U |
| Brazil—P Y | |

COMMON ABBREVIATIONS

A few of the common abbreviations used by amateurs are given in this list. Many other abbreviations used are quite ordinary and will be understood by anyone.

- XS—Atmospherics
- RPT—Repeat
- BCJ—Broadcast listener
- BUG—Vibroplex key
- CANS—Phones
- CUL—See you later
- CW—Continuous wave
- DX—Distance
- FONES—Telephones
- GB—Good-bye
- HI—Laughter
- ICW—Interrupted continuous wave
- OM—Old man
- URS—Yours
- 73—Best regards
- WKG—Working
- WX—Weather

THE RST CODE

This is an abbreviated method of reporting on Readability (R), Signal Strength (S), and Tone (T) of a Morse transmission. An example is RST 465. The 4 refers to R, the 6 to S, and the 5 to T, and the degrees referred to by the numbers are as follows:

- Readability**
- 1—Unreadable
 - 2—Barely readable
 - 3—Readable with some difficulty
 - 4—Readable with little difficulty
 - 5—Perfectly readable

- Signal Strength**
- 1—Barely perceptible
 - 2—Very weak
 - 3—Weak

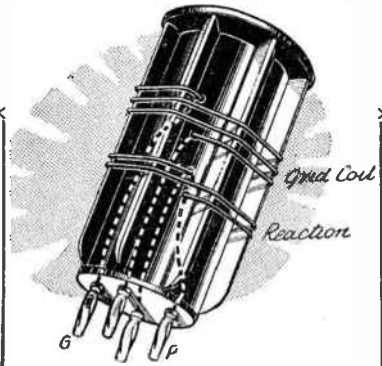

The following details for a set of 4-pin plug-in short-wave coils incorporate the normal connections for such coils with a 4-pin valve base. In all cases the connections from windings to pins should be made in the manner shown above, namely, top of grid coil to grid pin, bottom of grid coil to one filament pin (you can see which by the perspective sketch), top of reaction coil to other filament pin and bottom of reaction coil to anode pin. The two coils are always wound in the same direction.

The formers are quite standard ones and readily obtainable. They have six or eight ribs and are 1/2 in. in diameter to the outside of the ribs. Ribs with serrations to hold the turns are best. If your formers have no serrations, space the turns about 1/4 to the inch.

The two windings are separated by one serration or its equivalent and 22 or 24 S.W.G. wire is suitable. The following waveranges are given with a '00015-mfd. tuning condenser:

- 12-25 metres—4 turns grid—2 turns reaction.
- 21-45 metres—9 turns grid—5 turns reaction.
- 40-90 metres—24 turns grid—12 turns reaction.

In the case of the last coil, the grid winding of 24 turns will occupy nearly the whole length of the former, so you will have to wind the reaction with thin D.C.C. wire in a little pile at the bottom end, as near as possible to the bottom of the grid coil.

- 4—Fair
- 5—Fairly good
- 6—Good
- 7—Moderately strong
- 8—Strong
- 9—Extremely strong

Tone

- 1—Extremely rough hissing note
- 2—Very rough A.C. note
- 3—Rough, low-pitched A.C. note slightly musical
- 4—Roughish A.C. note moderately musical
- 5—Musically modulated note
- 6—Modulated note, slight trace of whistle
- 7—Near D.C. note, smooth ripple
- 8—Good D.C. note, slight ripple
- 9—Pure D.C. note.

The R (readability) of the RST code must not be confused with the R scale of signal strengths, which more or less corresponds with the S of the RST code. It will be met frequently in connection with telephony transmissions. The scale is as follows:

- R 1—Faint signals
- R 2—Weak signals
- R 3—Weak signals, but all words clear
- R 4—Fair signals easily understood
- R 5—Moderately strong signals
- R 6—Strong signals
- R 7—Good strong signals (understandable through interference)
- R 8—Very strong signals (heard several feet from phones)
- R 9—Extremely strong signals

THE "Q" CODE

The statements to which the various letter groups in the "Q" code refer are given in the second column of this table. If followed by a question mark they are taken to be asking for the information required. Thus, QRA means "The name of my station is —"; followed by a question mark it becomes "What is the name of your station?" The symbols are also used as abbreviations due to their long and familiar use. Thus QRA can stand for "location." The most commonly used signs of the "Q" code are as follows:

Letter Group	Meaning	Abbreviation
QRA	The name of my station is —	Location
QRB	The approximate distance between our stations is —	Distance
QRG	Your exact frequency (or wave-length) is —	Frequency or Wave-length
QRM	I am being interfered with	Interference
QRT	Stop sending	Silence
QSB	The strength of your signals varies	Fading
QSL	I give you acknowledgment of receipt	Verification
QTR	The exact time is —	Time

THE INTERNATIONALLY USED MORSE CODE

A . - -	N - . -	1 - . - - - -	6 -	Wait
B -	O - - - -	2	7 -	End of Message
C - . - . -	P - - - -	3	8 -	End of Transmission
D - . - .	Q - - - -	4	9 -	Received (O.K.)
E . - - -	R	5	0 - - - - -	Invitation to transmit (go ahead) - - -
F -	S			Exclamation
G - . - .	T - - -			Bar indicating Fraction
H	U			(oblique stroke)
I . - -	V			Comma
J - . - -	W - - - -			Colon
K - . - .	X - - - -	Period		Semicolon
L	Y	Interrogation		Quotes
M - - - -	Z - - - -	Break (double dash) - -		Parenthesis

ON THE

SHORT WAVES



THE SINGLE-SIGNAL SUPER

A high-selectivity set for S.W. work.
By W. L. S.

It has often been said that the "Single-Signal" superhet receiver is the outstanding example of a good set haunted by a bad name. It certainly is a queer name, apart from being a bit of a tongue-twister; but the chief fault about it is that it is liable to be misunderstood.

Let's begin at the beginning of the story of C.W. reception. Every reader is familiar with the ordinary "beat" method of receiving C.W. by generating a local oscillation to heterodyne the incoming signal. The ordinary reacting detector does the job itself; some sets use a separate oscillator to beat with the detector; and the superhet uses an oscillator beating with the intermediate frequency.

In all these cases, when the C.W. signal is correctly tuned-in, i.e. to "zero beat," no audible note is heard. But on either side of the correct setting, an audible beat-note of varying frequency can be received. In other words, every transmission tuned-in produces two separate "signals."

Interference Halved

The "single-signal" receiver cuts out, or very much diminishes one of these "signals"—hence its name. With a single-signal super, nicely lined up, and with the beat-oscillator switched on for C.W. reception, only one "tweet" can be heard: on the other side is silence, or comparative silence. This, naturally, reduces the interference on a crowded amateur band by exactly 50 per cent.

Readers will doubtless remember Dr. Robinson's "Stenode" receiver, which was of revolutionary design, and used a quartz crystal "gate" at its intermediate frequency. The enormous selectivity obtained by forcing a signal, so to speak, through this narrow gate, opened up a new era of selectivity, and started the fashion of high-selectivity superhets with "compensated" I.F. stages to put the low-frequency reproduction back more or less into the right proportions. We need not go into an argument about side-bands here!

The single-signal super is, in a sense, a Stenode; but the crystal may be used in two ways. It may be used for giving a very narrow band-width for the reception of telephony through bad interference; and it can be used for cutting out C.W. interference and producing the single-sided effect.

The sketch on this page shows the basic layout of one of these receivers. It is quite a straight superhet except for the crystal gate, which is interposed between the I.F. and the second detector. In some of these receivers it is used at the "entry" to the I.F. instead of the "exit"—but the principle is the same.

The crystal is connected in a bridge circuit with a switching arrangement that makes it possible to connect it either in series or in parallel. The series position gives an extremely sharp resonance curve and gives the condition necessary for receiving on a very narrow band-width.

The parallel position gives a converse effect—that of a fairly broad resonance curve with an extremely sharp "dip" in it. This dip can be dropped, so to speak, on top of

it on the high-frequency side of the resonance curve, you will obtain a good strong audible beat on that side; but on the other side the beat will be very weak. If the signal was weak to start with, and the curve is sharp enough, you may not hear anything at all on the wrong side.

Even with the quartz crystal cut out, the single-signal superhets give this effect, on account of the high selectivity of the I.F. stages. Some types don't use a crystal at all, but use regeneration on the I.F. stages to give the required selectivity. These types have no variable selectivity control as a rule, but are sufficiently good under all conditions to score heavily over the ordinary "medium-selectivity" superhet.

The reason for the supremacy of the crystal models over all others is their flexibility. You are listening to a phone station, and someone on C.W. lands right on top. Switch in the crystal, rotate the phasing control, and out goes that beat-note. If the frequency of the beat varies, you can still chase it—cut it out again.

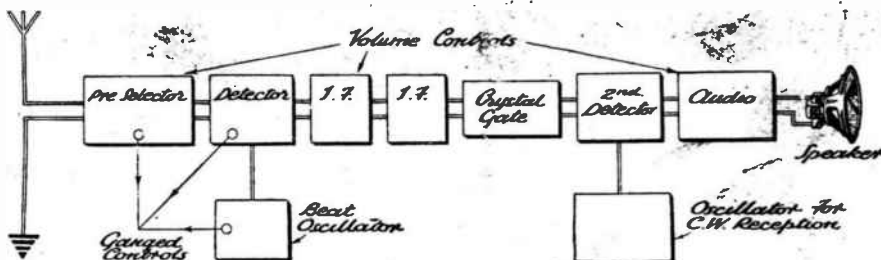

CUTS OUT ALL SHORT-WAVE INTERFERENCE
The stage-by-stage arrangement of a single-signal super. It is a straightforward superhet except for the crystal-gate, which is inserted between the second I.F. stage and the second detector. Razor-edged tuning is a feature of these receivers.

an interfering signal so as to cut it out, partly or completely.

A balancing condenser is provided, and this gives a variable control of selectivity, whichever of the two conditions is in use at the time.

The ability of being able to cut out an interfering signal by adjustment of the balance circuit is quite separate from the "single-signal" effect, which takes place automatically and without the necessity of making adjustments.

High Selectivity I.F.'s

This takes place simply by virtue of high selectivity in the I.F. circuits, which should be obvious from consideration of the beat method of reception. Your signal is correctly tuned-in—you have a very sharp resonance curve. You want to produce a beat of, say, 2,000 cycles with that signal so that you can listen to it in the phones or loudspeaker.

Very well, you must dump your local beat oscillator on one side or other of your sharp resonance curve. And, whichever side you put it, it's obvious that the effect you get can't be symmetrical. If you put

receiving a C.W. signal and a phone station suddenly sits on it. You now use the crystal in the other position, adjust it to peak the C.W. tremendously at whatever beat-note you like to listen to, turn down the volume control, and the phone interference to all intents and purposes just isn't there any more.

Two phone stations are interfering with one another, perhaps—you can still do the trick, just by sharpening up the selectivity. The readability goes down, owing to the cutting of side-bands; but you can understand the other fellow, which you wouldn't be able to do without the help of the crystal.

Further, the average crystal-gate model scores heavily in the matter of man-made static. The "door" by which the static gets in is so much narrower than it is with an insensitive receiver that there is a huge reduction in the amount of interference caused by it.

Unfortunately a crystal-gate super is rather beyond the scope of the home- constructor—but if readers would like to have more detailed data on it I will deal with it in a later article. ★

Separation

On the other hand,

suppose you are

ON THE SHORT WAVES—Page 2.

POINTS from the POST-BAG

W.L.S. Replies to Correspondents

W. A. B. (Liverpool) reports that he and a friend have both converted their short-wavers to the use of screened-grid detectors. Both now have sets that seem to work normally except for the fact that they are giving vent to a high-pitched whistle all the time.

I should say at once that they are using too high a screen voltage and have their sets "supering." Screened-grid detectors don't want anything like the 60 volts that one uses on the screen of an H.F. stage. Something of the order of 24 volts usually gives the best results, and I imagine that W. A. B. and his companion in distress will find things come right if they go right down with their screen volts until the whistle disappears.

H. J. B. (Manchester) reports complete loveliness in the garden, with good conditions and a set that does its stuff. His QSL's keep flocking in, nearly all being concerned with 10-metre reports. He does not send out reports on 20-metre stuff unless they are definitely asked for, and because of this he gets a very high percentage of replies.

He is now talking of putting up new aërials—a subject which touches me to the heart, as I have just spent the best part of a day trying to throw a rope over the roof. Succeeded finally at the cost of a couple of nice transmitting insulators and one tile.

Ploppy-Reaction Cure.

A. K. S. (Louth) reports that my suggestion of taking the grid leak to a potentiometer instead of to L.T. positive, on the "Simplex" Two, completely cured ploppy reaction. Other sufferers, please note.

G. B. (Angus) reports hearing V 2 C Q, giving his location as Bombay. This must have been V U 2 C Q, a well-known phone station on the 20-metre band.

Several readers report reception of Q M 8 Q U (alluded to in these notes a few weeks ago), but no one knows who he is. Among this crowd is L. T. (Bishop's Stortford), who also is puzzled by V I 6 T on 40 metres. Short of suggesting that this might be the Irish Free State station E I 6 T, I don't know what to make of this one.

H. W. (Bristol) has built a "Simplex" Two that isn't much use to him because it is completely minus reaction. First suggestion—coils wired up wrongly. Failing that, dud valve, insufficient L.T. or H.T. After that, goodness knows without seeing the set!

J. E. B. (Paignton) sends in a nice selection of stations heard, and asks me to contradict the statement (not made in these columns, by the way) that E A Q has packed up. At the time of writing E A Q is going strong and still promising QSL's to anyone sending a reply coupon.

J. E. B. brings up some more points on this awful subject of QSL's, which the

Editor has asked me to deal with once more. In an early issue I shall have to thrash the whole matter out all over again.

E. W. J. (W.9) gives me the call-signs of several British amateurs and asks for their addresses. If I were to comply with all these requests, "P. W." would become a long list of QRA's. If you want to QSL to British amateurs, anyone, send your cards to the R. S. G. B., QSL Section, 53, Victoria Street, S.W.1. But *don't* send reports for foreign stations to R. S. G. B.

A. W. L. (Birmingham) passes on a tip for getting rid of hum when an eliminator is used on short waves. He has a mains unit in a metal case, which is earthed. His set has a metal-covered baseboard, also earthed. He gets a hum when the mains unit is beneath the detector end of the set, but if it is moved along towards the output end the hum disappears. I think direct pick-up of this kind is responsible for no end of the trouble that mains users seem to get on short waves.

THE HALL-MARK OF GOOD LISTENING



Here is a small reproduction of our new certificate which will be awarded to those who qualify as members of The "18" Club. The certificate itself is produced on glossy, super-fine art paper, and details of the conditions under which it is awarded will be found elsewhere in this number.

A. P. T. (Barry) sends in a list of amateur stations heard on "40" on a Sunday morning. He always tries to get both ends of a contact, which takes time and patience but makes listening far more interesting. He built the "Simplex" Two when it came out in 1935 and has never had a moment's trouble. I doubt whether even the "Simplex" Three will induce him to part with it!

G. B. (Newcastle) wants a "hot" three- or four-valver capable of pulling in everything worth hearing, on the speaker. I am inclined to suggest that the "Simplex" Three, plus another stage of amplification, perhaps, would do all that he wants. As it stands I don't claim that it is a real loudspeaker receiver for *everything*.

The New "18" Club

The new "18" Club is explained elsewhere in this issue, but our pretty, new certificate is illustrated on this page, and I hope to have in a batch of claims very quickly. It is a certificate that's not too easy to get, but it is proportionately worth having, and we shall all be interested to see how many claims we receive in the first week or so.

Short-Wave NEWS

CONDITIONS are simply marvellous at the time of writing. There isn't an hour of the day or night when you can't do real DX work. I have heard all continents on phone—in the amateur bands only—several times over in twelve hours; and I heard all continents on 10-metre phone in less than two hours.

Some of the U.S.A. stations on 10 metres have been reaching new levels of strength. Among the real "R99" stations I must mention W 2 H F S, W 1 D Q K, W 1 T W and W 9 H Y Q. Those putting over R9's and R8's can only be mentioned in scores, if not in hundreds.

An interesting thing a few afternoons ago was the way the South African phones were coming across on 10. Z S 6 Q and Z S 6 A J were the best two—the former was R7-8 for some hours.

Incidentally, what would British short-wave listeners do without the Egyptian station S U 1 S G? Not only does he put in a consistently good signal, but he QSL's! During the time the Verified All-Continents Certificate (now out of date!) has been running, I rarely had a bunch of twelve cards which didn't include S U 1 S G as one of the Africans. Very few listeners seem to have heard South Africa on phone, but Egypt has been a good old stand-by.

20-Metre Activity

Twenty metres is now active in the early mornings, and a little early rising is rewarded by marvellous reception from the West Coast of America and from Australia and New Zealand. I am not dealing so much with broadcast reception now; but the amateurs are attracting a lot of attention and account for 95 per cent. of the short-wave phone stations.

Forty metres is the usual local jam, but quite interesting if you have the patience for it—which I haven't. Some of those "networks" that you hear operating on Sunday mornings are a serious attempt to get over the interference problem. They rope into one "gang" twelve or fifteen stations who might all be working separately. As a "gang" working in rotation with one another, they don't cause so much bother.

I want to get a good check on the best Californian stations putting 10-metre phone into this country. Will readers who do a lot of listening on "10" please note the call-signs of all the W6 stations they hear in the next fortnight or so and send it along? I am co-operating with someone on the other side in this matter, and have promised to get a score or more of receivers working; this strikes me as an easy way.

I hope to give more news of National Field Day and the 5-metre Field Day next week. These two events are the next big national tests, although they are as yet some way ahead.—W. L. S. ★

WHAT ABOUT THE AERIAL?

The significance of various factors in short-wave aerial design are explained in this article, which will help readers to erect the most useful pick-up system which their conditions permit

A SPECIAL aerial is not a necessity for short-wave working, in fact any old aerial will give results. Now just a minute, you super enthusiasts with your "Yes, buts." I'm going to qualify that statement.

If, however, you want to get real DX and to make the most of your short-wave receiver, whatever it may be, you need an efficient aerial. But mark this—by efficient I do not mean freak or special type. The latter, of course, have advantages and I shall refer to them later.

So long as the aerial you use for ordinary broadcast reception is reasonably well erected, it will prove satisfactory on the short-waves as well. When I say reasonably well erected, I refer to the taking of the usual sort of precautions such as keeping the wire well away from walls and metal gutters, having a nice direct down-lead and no badly made joins in the wire.

Height Is Beneficial

Actually you do not need such a big aerial for short-wave work as for normal broadcast reception. Sometimes, if the amount of wire in an aerial, including the lead-in, is more than

45 to 50 feet it may prove advantageous for short-waves if the horizontal part is reduced.

Next to the usual precautions of good insulation, clearness from surrounding objects and so on, height is the most beneficial quality in a short-wave aerial. But don't misunderstand me, it is not a necessity by any means for really good results.

Some of the most amazing logs have been obtained with aerials that are shocking from a theoretical point of view. But we want to make the most of our possibilities for erecting a good aerial.

The bottom sketch on this page is given as a guide to the minimum at which to aim when putting up your short-wave aerial. It is not frightfully high, and not by any means long, and is one that probably most of you can manage. But go one better if you can.

The Di-Pole Arrangement

Note the distance of six feet for the insulator at the house end. It keeps the aerial and lead-in away from the guttering and also avoids a sudden angle in the run of the aerial. I don't think I need advise you to put the set as near to the lead-in point as you can, and not to have the wire running around walls before reaching the set. This direct lead effect is also good advice for those who are forced to use an indoor aerial.

And now for a few words about the type of aerial usually called a dipole. The general scheme of one of these is given at the top of the page. Some people seem to think there is something magical about these and that the use of one erected any old how will guarantee results from the worst "bitser" set.

Get that out of your head right away. Actually, such an aerial is only at its maximum efficiency on the wavelength to which it is tuned, and this is governed by the length of the wires. It originally came into pro-

minence as a transmitting aerial where only one wavelength had to be considered, but practice has proved that it can be very efficient on a band of wavelengths around its fundamental wave, and will also work on wavelengths a long way off tune.

Television Reception

For these reasons it is well worth a trial by those experimentally inclined. It is best to cut it to the wavelength on which you expect to be working most or hope to get best results. The length of the wire in each arm should be exactly that of a quarter of the length of a wave on the frequency to which you wish to tune the aerial.

If the wavelength is such that you are unable to get the aerial in one straight line, you may try the scheme shown in the sketch to the left, or some other arrangement that suggests itself to you.

It must be appreciated that my remarks so far about this type of aerial have no application to its use for television reception. Here it comes entirely into its own for reception since we need only consider the main wavelength, that of

the vision signal.

It is usual in the case of television to arrange the two halves in a straight line vertically. Sometimes a similar arrangement behind the main aerial, but unconnected, is used to increase pick-up by acting as a reflector.

Commercial Types

Television aerials of this type, more correctly called, perhaps, centre-fed half-wave aerials, are supplied by Messrs. Belling and Lee. Two enamelled brass tubes are used fixed to a specially designed porcelain insulator which is fixed to a bracket arm running at right angles to the tubes and arranged for screwing to the side of a building.

A similar arrangement may be used as reflector, which makes the aerial directional. A mast head fitting, also with or without reflector, is also provided.

The price of the wall fitting aerial is 35s., the reflector costing the same. The mast type is 45s. or 65s., with reflector. These prices do not include the feeder wire.

It should be noted that in some cases the use of the reflector helps to reduce the amount of interference picked up. Interference due to man-made static can be quite bad

on other short-wave bands as well as on television wavelengths, and where trouble of this nature is experienced one of the special anti-noise aerials should be employed.

An inexpensive aerial of this type, which is designed for all-wave working, is the B.T.S. Noise Suppressing All-Wave Aerial.

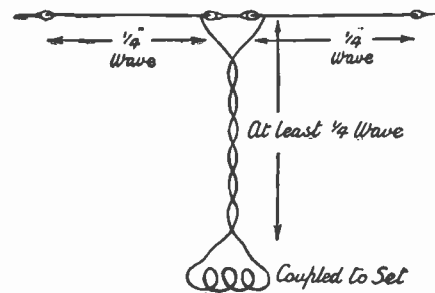

The essential considerations of a "dipole," or centre-fed half-wave aerial, are given in this diagram.

This is priced at 25s. complete with feeder. In order that it shall be efficient for all wavelengths, and therefore, incidentally, ideal for the modern commercially made all-waver, matching devices are provided at each end of the downlead or feeder. A switch on the transformer between feeder and set changes the aerial from medium and long-wave reception to short waves.

Erected Clear of Earthed Objects

The aerial is 60 feet long from insulator to insulator, the downlead being taken from a point 17 feet from one end. The aerial should be arranged at least 35 feet from the nearest earthed object.

The reason for this is to ensure that the active pick-up part of the aerial is well away from interfering fields. The transmission line, or down-lead is de-sensitised to interference. That is the principle on which anti-noise aerials work.

AERIAL POINTERS

Height is more important than length.

Keep aerial clear of surrounding objects.

Avoid joints in the wire.

Have set near lead-in tube.

A screened down-lead system suitable for all-wave working, and for fitting to existing aerials is the Belling-Lee "Eliminoise" aerial. Transformers are provided at either end, and the price per pair is 35s. Suitable down-lead costs 10d. per yard. The down-lead or feeder may be almost any length which greatly assists in situating the aerial itself outside of interfering electrical fields.

From the foregoing it will be appreciated that the best type of aerial to use is largely governed by local considerations, particularly in regard to the presence and position of a source of interference.

If space is not too restricted, and if interference is not bad, all sorts of aerial schemes, freak and otherwise, may be tried. Aerials provide interesting experimental work

which is not expensive and which may well reward you because it is impossible to predict to any great degree the performance of a particular aerial on short waves.

The most unlikely looking schemes on paper may prove to give in practice greatly improved results on certain bands.

A. S. C.

FOR SMALL SPACES

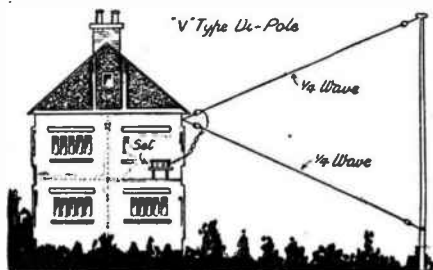

One way of accommodating a "dipole" aerial when space is somewhat restricted.

QUITE GOOD ENOUGH

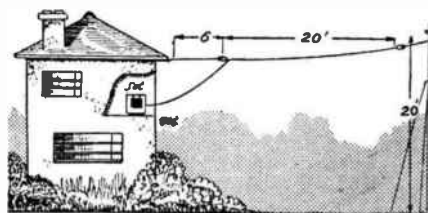

The dimensions that you should aim at as the minimum when erecting a good short-wave aerial.

MOVING DX

With the approach of summer, the time for hiking, cycling, boating and motoring, we decided that this article from the pen of our popular contributor of "The Dial Revolves" would be welcome. Mr. Leslie Orton has had considerable experience with short-wave sets in vehicles and on the move.

DURING holidays one is very inclined to forsake a radio set for a tennis racket, or some similar symbol of sunny weather; and yet a wireless set, particularly a short-wave one, is a wonderful companion, particularly when it rains, as seems to always happen when I am on holiday!

If you possess a car, you can readily take your existing receiver on holiday with you, receiving en route. Of course, this is assuming that your receiver works from batteries. Incidentally, the S.T.800 is an excellent receiver for such work, being particularly immune from ignition noises.

When testing the S.T.800 in a moving car some time ago, I received numerous medium-, long- and short-wave stations at good strength on the loudspeaker. My aerial comprised a wire taken from the top of the car to the spare tyre at the back.

Old Man River

There is something particularly attractive in sitting back in a boat and letting it drift down-river—assuming that there isn't a weir near at hand!—listening to America on the loudspeaker at the same time.

I have conducted many experiments on moving boats (both of the rowing and steamship class), and I have discovered that the secret of good reception is to employ no earth. You see, the swaying of the boat changes the capacity between the aerial and water (earth) if you have an earth. This, as you can imagine, renders tuning extremely difficult.

For an aerial, I consider the best method is to run a wire from a short mast erected at the end or in the middle of the boat. With such an arrangement I have tuned-in three Javanese and a great number of North and South American stations on the loudspeaker.

Walking Tours

If you are going for a walking or cycling tour, it is a good idea to take a receiver with you. Besides supplying you with the latest news, it also provides much entertainment. Can you imagine hiking with the S.T.800 over your back? No? Nor could I, so I set about designing a midget receiver which would use a minimum of H.T. and yet give good results. The result was the "Lovolt Portable," as I named it.

The receiver, when complete, need not be much bigger than a box of cigars. Results are rather astonishing and, with a slung-up aerial, I have heard W2XAF, 1XK, 3XA U, 8XK (49 m.), 3XAL (49 m.), PRF5, DJA (and the other D's), 2RO and numerous other stations at excellent

volume on headphones. The 49-metre stations were tuned-in in the early morning.

The diagram shows the circuit of the "Lovolt." Don't waste time looking for the reaction condenser, for the condenser C_1 in the aerial circuit controls reaction.

The "Lovolt"

The idea of this unconventional arrangement is simple. Have you ever experimented to discover how little H.T. is required by a single-valve receiver to oscillate and work satisfactorily? If so, you will have found that with directly coupled aerial the lowest working voltage

FOR CARRYING AROUND

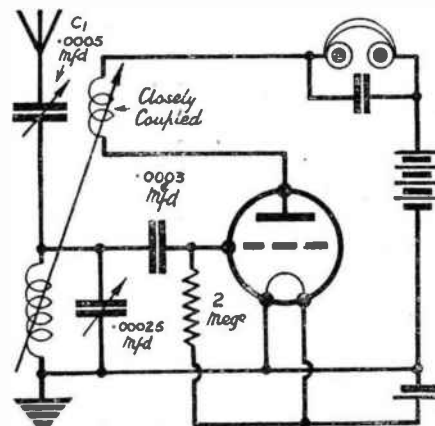

This is the simple circuit used by Mr. L. Orton for a very compact portable set.

is around 20. But—and it is an important "but"—if you place a variable condenser in the aerial lead, you will find that the receiver works satisfactorily (assuming you have a good detector valve) with astonishingly little H.T. A decent valve will give quite good results with a flash-lamp battery for H.T., but for short-wave work I recommend a minimum of 9 volts.

Variation of the condenser C_1 controls reaction. When it is "meshed" the receiver stops oscillating—this being the secret of the affair.

The "Lovolt" will be found to work satisfactorily down to about 30 metres, but as the reaction control varies tuning difficulty may be experienced in tuning below that wavelength.

Under Canvas

If you propose to spend a holiday "under canvas"—and, in my opinion, such a holiday is one of the most enjoyable types imaginable—a wireless set again makes an excellent companion. But beware, friends! If you choose a sandy

place to camp, make sure that your wireless pole (I suggest a telescopic portable affair) and tent "guy" pegs are well-anchored, otherwise they are liable to slip out of the sand.

In the Air

To me, at least, there is nothing so exciting as to receive a station when in an aeroplane. But if this is to be done successfully, you will need to arrange your aerial carefully and also to have a well-padded and tight-fitting helmet placed over the headphones to keep out the sound of the aeroplane's engines. Even so, you cannot expect to pick up more than the powerful stations, as the noise level is decidedly high. But take my tip: if you want a really unforgettable experience, take your receiver in the air with you. The excitement is great. Imagine hearing a station when travelling at 144 miles an hour, as I have done.

Whatever you do, I certainly advise you to take a wireless set with you when on holiday this year. You will never regret it.

THE CLUB CORNER

Will secretaries of short-wave clubs note that we are always pleased to publish reports, such as these, on the activities of societies and clubs.

TOTTENHAM SHORT-WAVE CLUB

The club has held a series of very interesting meetings during the winter months and recently celebrated its second anniversary, at which the newly elected president, Mr. Batt, was presented with the first prize for the DX phone competition, held on the two middle week-ends in March, in which he succeeded in logging 52 countries.

After this, the members awarded a vote of thanks for the services rendered by the secretary and the treasurer (Mr. Cave), and a complete majority was obtained that they should continue office for the coming year.

The club has arranged a programme of field days for the summer months, at which visitors will be welcome. It is being arranged for a special 5-metre section to be active at these, and transmitting members in the locality will be looked out for if they care to let me know if they will be on the air on these various field days we shall be having.

The club meetings are well attended, and lectures, together with practical experiments in transmitting, are being given by the secretary. Morse practice is progressing very well, and members are proving quite good at speed tests. The log department, which has been mentioned in our previous reports, has now been collecting valuable data for the last 18 months, and a very comprehensive list of stations and conditions over this period has been obtained.

I wish to thank POPULAR WIRELESS for all the help it has given us since the club's beginning, and for the way in which it has encouraged the club spirit among its readers. Also, I wish to thank the various clubs at home and abroad that have written to me, and to those that have not yet received any reply, that they will do so in the very near future.

Finally, full particulars of membership, fees, meeting nights, etc. can be obtained by writing to me at 57, Pembury Road, Bruce Grove, Tottenham, N.17.—L. Woodhouse, Hon. Sec.

SOUTHEND & DISTRICT RADIO AND SCIENTIFIC SOCIETY

I have pleasure in enclosing a copy of the "Guide" to our tenth radio exhibition (a particularly interesting publication.—Ed.).

This exhibition was a great success, the total attendance being over 6,000. The opening was performed by the mayor and mayoress of the borough. The amateur section was well supported and the judges had a difficult task. In this connection, a significant sign of the times was the fact that in the "broadest receiving apparatus" class there were only two entries, and we were only justified in awarding one prize, although there was a good selection of exhibits in each of the other classes, which were as follows: Short-wave transmitters; short-wave receivers; ultra short-wave apparatus; auxiliary apparatus; receivers and transmitters constructed by members of the R.N.W.A.R. The society's silver challenge cup for the most meritorious exhibit in any class was awarded to Dr. A. C. Gee (G2UK), for a short-wave transmitter.—F. S. Adams, Hon. Sec.

THE MODERN ALL-WAVE RECEIVER

While there are advantages in a separate receiver for short-wave listening, there are also advantages in the commercial all-waver, a type of set dealt with in this article

By A. S. CLARK

THE advent of the modern all-wave receiver has done much to popularise short-wave listening. It has been the means of starting off many present-day enthusiasts, who now have special short-wave sets and whose wallpaper is rapidly vanishing from sight behind an ever-increasing number of QSL cards.

It is also giving many, who otherwise would never have considered the short waves, a chance of sampling the thrills—and the disappointments—of short-wave listening. I feel it necessary to mention the disappointments, because many who have not studied the theory of short waves often take on a very "disillusioned" attitude when they find that conditions play such a big part.

Two Typical Sets

Personally, I think that people who buy an all-wave commercial set and then after a week or so never turn the wavechange switch off medium or long waves, do so because either they have never troubled to learn to make the most of what the manufacturer has given them, or else they have been unfortunate in their choice of a receiver.

For the benefit of those who read this article who may be contemplating the purchase of an all-waver, let me draw their attention to the two makes of sets illustrated on this page. They are two of the makes that will ensure satisfaction in a new realm of listening, and the two receivers are typical of the types that are available on the market to-day.

The Peto-Scott model 7034 is a battery screened-grid three. The first valve is a multi-mu H.F. pentode, and a Harries output valve is employed.

There are four wavebands covering 14-31 metres, 28-62 metres, medium waves, and long waves. It should be noted that 14 to 62 metres includes all the more interesting of the short-wave broadcasters.

To help the inexperienced user of the receiver, a colour code waveband-indicating system is employed. On the dial there are four scales representing the four bands covered. Each is in a different colour.

Simplifying Tuning

On the wavechange switch knob are four dots in the same four colours. By noting which dot is uppermost on the dial, it is easy to tell on which scale tuning is being carried out. This is a good illustration of the pains to which manufacturers are going to make short-wave tuning as simple to the ordinary listener as tuning on the medium and long waves.

Another point illustrative of the same feature of modern all-wave design is the use on this Peto-Scott receiver of two-speed tuning. Two drives with ratios of 8-1 and 100-1 are provided.

The price of this receiver is £8 15s.

The Marconiphone model illustrated costs 12 guineas and is for operation on A.C. mains. It has six valves used in a superhet circuit.

In the case of this set there are three wavebands, the one short-wave band covering from 16.5 to 52 metres. Here again a two-speed tuning knob is provided, and tuning-in stations on the short waves with it is absolutely child's play. It is the only control that needs manipulating to bring in stations from all parts of the world. The other three controls are simply for volume, wavechange and tone control.

A Further Instance

On the dial of this set we have another instance of the way in which short-wave tuning is being simplified for the non-technical. The short-wave scale is first of all calibrated in wavelengths, so that with the aid of a station list the operator knows just where to look for any particular station.

But even a list is unnecessary, for the small sections of the short-wave range where broadcasting and other interesting telephony stations are grouped together

ENSURES GOOD RESULTS

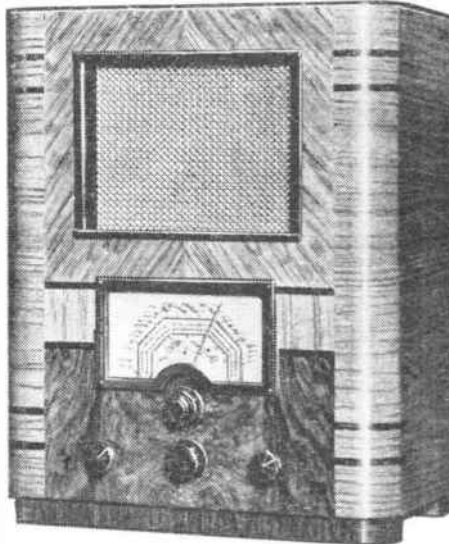

The Peto-Scott 1937 Super All-wave Battery Screened-Grid 3, a good example of the straight circuit all-waver.

are marked by thick red lines. Anybody can thus be sure of tuning over just the right part of the dial to obtain interesting stations, and time is not wasted in searching among Morse for non-existent broadcasters.

To the uninitiated the biggest disappointments in short waves are due to listening on the wrong bands at the wrong times. It is partly for this reason that in the list of principal short-wave stations this week we have provided a column which indicates



This is the Marconiphone model 557, an all-mains short-wave receiver.

a good time to listen for the particular station concerned. Of course, it is only possible to give a very rough guide, but that is all that is required, for once regular reception of a few stations is achieved the listener soon gets to know for himself just where to tune at any time of the day.

The modern all-waver shows up to best advantage on the more powerful broadcast stations. This is all to the good, for those who require loudspeaker results on the short waves are mainly interested in the stations that give the best programme value.

For the logging of weak stations a pair of earphones can seldom be beaten, and then one naturally requires a smaller set, preferably of the straight variety, because the background is usually quieter. Also the more critical tuning needed to bring in the stations that are mere whispers calls for a specially designed short-wave set.

But many will consider this aspect simply a matter of opinion, and certain it is that many a good log has been achieved working entirely on the loudspeaker. So in closing we must take off our hats to the set manufacturer for producing such a miracle of compact all-wave reception as the modern all-wave receiver.

ROBED BRILLIANCE OF BRITISH HISTORY

Cavalcade of Coronation Splendours

THE glamour of British State Pageantry is reflected in an admirable and dignified work of reference which Messrs. John Player & Sons have just prepared, in the form of an album specially planned to take the new Coronation series of 50 cards issued with Player's "Medium" Navy Cut Cigarettes. It is a portfolio of pageantry which is obtainable for 3d. from most tobacconists.

The aim has been to make this series of permanent value to the collector and due attention has been given therefore to ensure accuracy of text and detail.

So well selected are the series that a complete album constitutes a really handsome souvenir and an attractively useful addition to the home library. Do you know the work for which an Elder Brother of the Trinity House shares responsibility and how he dresses? What shape is the distinctive hat of a High Constable of Holyroodhouse? The interesting answers to these and many more ceremonial dress questions are recorded by building up this unusual album. [Adv.]

JOIN THE "18" CLUB!

How to Qualify for Our New Short-Wave Certificate

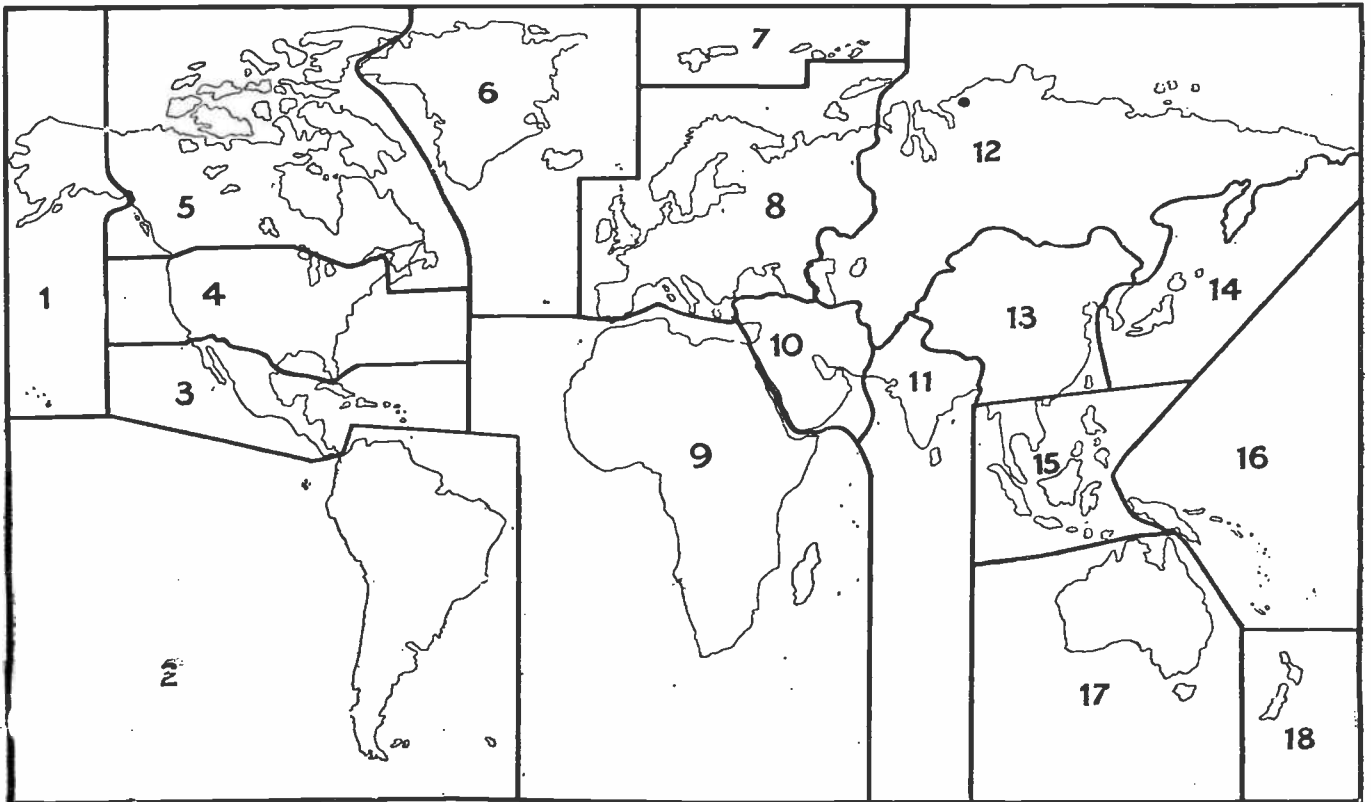

This map shows how the world has been divided into eighteen areas for the purpose of our new short-wave listening certificate.

THE "P.W." International DX Certificate is being "withdrawn from circulation" on April 30th. It has been running for just about a year, and has attracted a lot of attention from readers. Many have cast envious eyes at it, but relatively few have been able to produce the necessary verifications—two from each of the six continents of the world.

From May 1st we are starting again. The scheme is quite different; whether it is more difficult or not I cannot say. But here it is.

A Certificate Worth Having

You will see from the map above that the world has been divided into eighteen areas. Some are big, some small. Some contain many thousands of transmitters, and some one or two. I doubt whether number seven contains one at the present time, but it has done at some time or other.

We are awarding a fine certificate, printed on the finest quality art paper, to every reader who can supply proof of having heard a telephony transmission from twelve or more of those areas. If you have heard your twelve, you get the certificate. If you have heard more, you will get a gold seal on the certificate

for each additional area. If you have heard all the eighteen, you will be a nine days' wonder!

The certificate, which has been specially drawn up for us and is a beautiful-looking job, is shown in reduced form

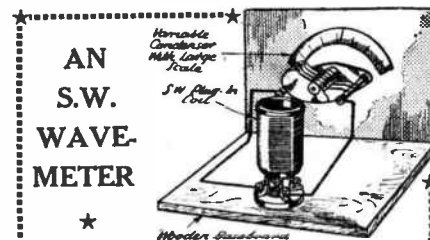

The simplest type of wavemeter for short-wave work is that working on the absorption principle. It consists, as shown in the diagram, of a coil wired across a variable condenser. The variable condenser should have a large, clear scale for accurate reading and a value about the same as that in the normal S.W. receiver. Plug-in coils may be used to cover different wavebands.

To use the wavemeter the coil in it is brought into proximity with the set's coil, the set being put into oscillation. When the wavemeter is in tune with the set the latter will stop oscillating. The wavelength to which the set is set can then be read on the wavemeter.

on the second page of "On the Short Waves" in this issue. Just turn to page 176 and see what you think of it.

The areas are self-explanatory from the above map, but one or two points may need clearing up. "1" contains Alaska and Hawaii; "3" takes in Mexico and the West Indies; "6" includes Greenland, Iceland, the Faroes and the Azores.

Telephony Transmissions Only

"10" takes in Iran, Transjordan, Palestine, and the rest. "15" means receiving the Dutch East Indies, Singapore, North Borneo or some of those parts. China is in "13," Japan in "14," and New Guinea and Fiji in "16." The rest are clear enough from the map.

The veri's sent in must be for telephony transmissions, whether amateur or broadcast, and we are, of course, only asking for one from each area.

Go ahead, turn up your veri's, and see what you can do! If you are one or two areas short, that gives you something to do during the next few months. We don't anticipate a terrific rush—but we can cope with it if it comes.

W. L. S.

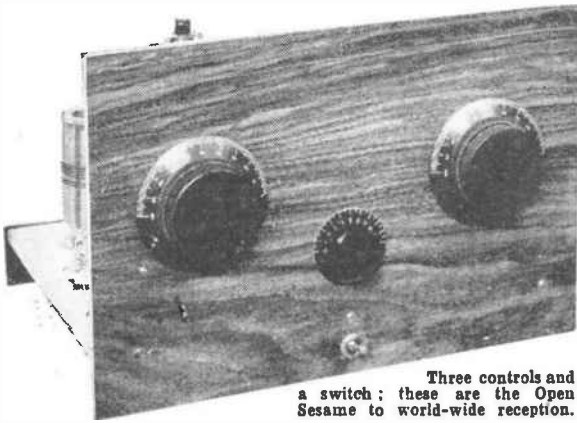

Three controls and a switch; these are the Open Sesame to world-wide reception.

THE "SIMPLEX" THREE

By W.L.S.

A simple set to build but quite capable of dealing with modern crowded conditions on the short waves—~~but~~ the set short-wave enthusiasts have been waiting for—Designed by a leading expert—Ideal for the newcomer to S.W. reception

IN introducing the "Simplex" Three to readers of POPULAR WIRELESS I feel that it is necessary to explain its title and the reason for its existence before I do anything else.

In 1935 I described a set called the "Simplex" Two. It was a very straightforward and cheap two-valver, designed chiefly for the man who wanted to make his first short-wave set and to be quite certain that he was going to get results.

The Most Popular Type

For various reasons which none of us anticipated, the "Simplex" Two caught on in a most amazing way. We are still being asked for back numbers of the issue in which it was described—but, naturally, that issue was out of print fairly soon after its publication.

A few weeks ago I reprinted the wiring and circuit diagrams of the "Simplex" Two in "P.W." and thousands more readers have built it. But many of the original users of the set feel that the time is ripe for a rebuild, and, in accordance with modern requirements and the general trend of design, they want to use a stage of H.F. in front of it.

Added to this, we have the evidence

provided by the ballot which I ran last year, when the most popular type of short-wave receiver turned out to be one with a tuned H.F. stage, detector and resistance-coupled L.F.

Many readers have been demanding such a set: and in the "Simplex" Three I feel that I have killed two birds with one stone. The three-valver demand has been settled; and, at the same time, the "Simplex" Three is just the set for users of the "Simplex" Two who want to rebuild and improve.

It is *not* a rehashed "Simplex" Two with a stage of H.F. stuck in front. It is a brand-new set; but the circuit arrangement of the detector and the L.F. stage is rather similar to that of the old "Simplex" Two. And with this little preamble, let us get to business.

This set is an all-purpose receiver. Candidly, I have designed it chiefly for the headphone user who wants real, reliable DX reception; but it will, and does, give loudspeaker results on the more powerful short-wave stations. (And by that I don't mean Zeesen, Moscow and Rome only; several of the Americans have been received at good speaker strength.)

If I were asked to name the best feature of the "Simplex" Three, I should, without hesitation, say "quiet background." It really is a joy to handle, from that point of view. It is difficult to tell whether the detector is oscillating or not, so quiet is the mush level. It sounds, in fact, like a thoroughly "dud" set until one finds signals loud enough to make one remove the phones on to the cheek-bones!

A Compact Set

It is a compact little set, but the layout has worked out exceedingly well. The tuned circuits have very short wiring, and the components are placed just where I like them to be, but without undue crowding. Furthermore, although there is a tuned H.F. stage and there are two sets of coils, there is not a trace of interaction between the two tuned circuits.

The H.F. circuit tunes quite independently of the detector circuit, with the very minimum of "pulling" effect, and the reaction control is *not* a third control on which one has to have a hand all the time.

But I will deal with the question of operation later on. First let us look at the circuit. The first valve is an H.F. pentode, into the grid circuit of which the aerial is inductively coupled. Much of the quietness and selectivity of the set is due to this arrangement.

There is a choke in its anode circuit, and

THE CIRCUIT GUARANTEES SUCCESS

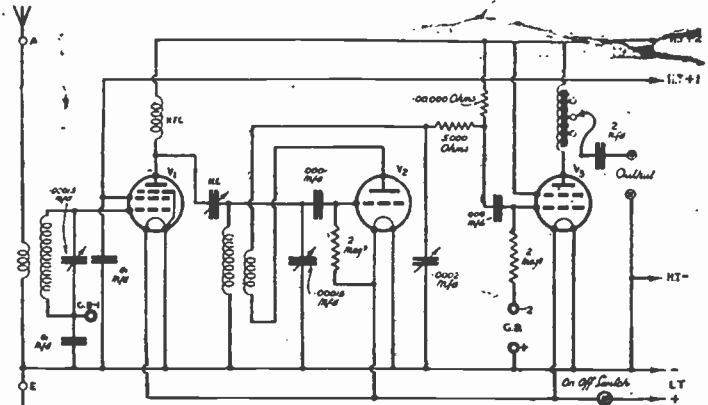

The circuit is reminiscent of the "Simplex" Two, apart from the H.F. stage. The "Simplex" Two has proved the most popular short-waver ever described.

coupling to the grid circuit of the detector is effected by a neutralising condenser, which is always operated at as small a capacity value as possible.

The detector uses the conventional series-fed reaction circuit, with a 5,000-ohm resistance taking the place of an H.F. choke. It is resistance-capacity coupled to the output valve, which is of the Harries type, with a pentode output choke in its anode circuit. This choke output is always well worth while, since it usually improves stability, and, in any event, it keeps the direct current out of the headphones.

The translation of this circuit to a base-board layout is not difficult. To save space, however, the three valves have not been laid out in the usual straight line, but the output valve "doubles back," so to speak, from the detector.

Note that the first valve, its coils and their condenser form a compact group, as do the detector, its coils and their condenser. And these two groups are well separated from one another—on the panel by the

(Continued overleaf.)

WHAT YOU NEED

- 2 Polar .00015-mfd. variable condensers, type C.
- 1 Eddystone .0002-mfd. reaction condenser, type 957.
- 4 Eddystone 4-pin valve holders, type 949.
- 1 Eddystone 5-pin valve holder, type 950.
- 1 J.B. neutralising condenser.
- 1 B.T.S. short-wave H.F. choke, type U.H.F.1.
- 1 Varley pentode "Nichoke."
- 1 T.C.C. 2-mfd. fixed condenser, type 50.
- 1 T.C.C. .01-mfd. fixed condenser, type 34.
- 1 T.C.C. .01-mfd. fixed condenser, type 250.
- 1 T.C.C. .004-mfd. fixed condenser, type 34.
- 1 T.C.C. .0001-mfd. fixed condenser, type 34.
- 2 Dubilier 2-meg. grid leaks, 1-watt type.
- 1 Dubilier 100,000-ohm. resistance, 1-watt type.
- 1 Dubilier 5,000-ohm, resistance, 1-watt type.
- 1 Bulgin toggle switch, type S 80.
- 2 Sets Eddystone 4-pin short-wave coils, types LB, Y and R.
- 4 Belling-Lee terminals, type R, marked A, E, L.S., L.S.
- 1 Peto-Scott polished wood panel with "Metalex" back, 12 ins. x 8 ins. x 1/2 in.
- 1 Peto-Scott baseboard with "Metalex" both sides, 12 ins. x 8 ins. x 1/2 in.
- 1 Peto-Scott ebonite terminal strip, 12 ins. x 1/2 ins. x 1/8 in.
- 18-gauge tinned copper wire, 1/2 mm. Systoflex, flex, screws, etc. (Peto-Scott.)
- 6 wander plugs (Cliz).
- 2 accumulator spades (Cliz).

BATTERIES

- L.T.—2-volt accu.
- H.T.—120 volts.
- G.B.—4½ volts.

VALVES

- V₁—Tungram H.P.210.
- V₂—Tungram H.R.210.
- V₃—Hivac Y.220.

(Continued from previous page.)

reaction condenser, and on the baseboard by the neutralising condenser, which provides the coupling between the first and second valves.

In point of fact, this set is smaller than the old "Simplex" Two—but no one can say that this has been achieved by overcrowding. The panel layout proves excellent for easy handling, the two tuning controls being symmetrically placed. They are generally set at about the same reading, and, much as some people dislike "twodial tuning," it is certainly an extraordinarily simple matter to keep these two dials revolving in step with each other, an occasional touch on the central reaction condenser being necessary as one goes up and down the wavelength range of each set of coils.

Covering the Different Wavelengths

Three pairs of Eddystone coils give the set a wavelength range of 12-94 metres. The Blue-Spot covers 12-26 metres (including the 16-, 19-, and 25-metre broadcast bands and the 20-metre amateur band); the Yellow-Spot covers 22-47 metres, with the 25- and 31-metre broadcast bands and

the 40-metre amateur band; and the Red-Spot covers 41-94 metres, with the 49-metre broadcast band and all the "odds and ends" that inhabit the space above 50 metres. The 80-metre amateur band is becoming very interesting these days, and that comes near the top limit of the tuning range.

The bottom limit of the set, however, is not 12 metres, for a special coil in the detector circuit will take it down to 7 metres or lower. I don't advocate the use of tuned H.F. on these frequencies, since the amplification gained is very small indeed, and does not justify the introduction of a second tuning control.

For the television wavelengths, ultra-short-wave broadcasting, American police stations and the 10-metre amateur band,

HOW TO DRILL YOUR PANEL

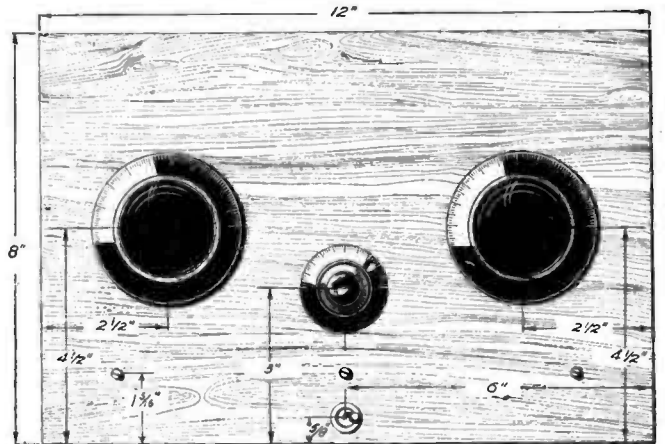

Panel Layout
Details of panel : size and hole positions.

a suitable coil has two turns of reaction winding and one and a half turns of grid winding. It may either be made up on a blank former or be "cut down" from an Eddystone Blue-Spot coil, which has a suitable reaction winding, but four turns

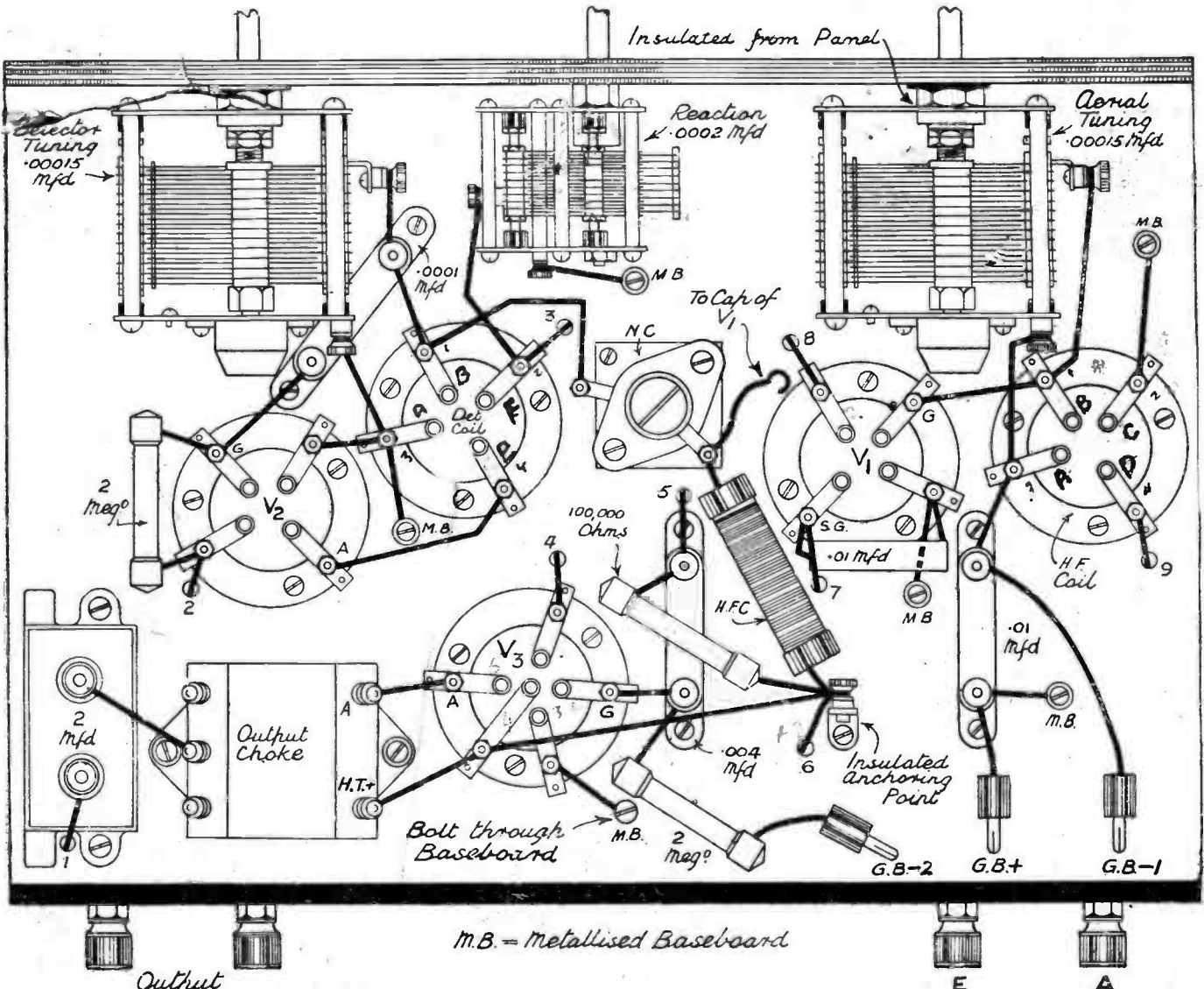

Most of the wiring is above the baseboard, although there looks little enough in this diagram because all the leads have been kept as short as possible.

in the grid circuit. A two-turn grid coil will cover the 10-metre amateur band and the police cars, etc., but will not quite get down to the Alexandra Palace transmission. A one-and-a-half turn coil brings in the "sound" signal at about 10 divisions on the dial — incidentally at tremendous strength at my locality in the southern part of London.

Little need be said about the construction of the set, except to remark that if you follow the photographs and the diagrams carefully you can't go wrong. A few small points, however, are worthy of mention.

Points to Note

First, the back of the panel must be chipped away slightly for the reaction condenser, or else it will not be possible to screw the nut on to its bush. (In other words, the panel is too thick for it.) Two layers of panel were chipped away in the original. This means, of course, that the Metaplex covering goes; but the moving plates are earthed on to the baseboard by a short lead.

Next, the H.F. tuning condenser (at the aerial-terminal end of the set) has to be insulated from the panel, since its moving plates go to negative grid-bias and not to earth. This insulation is easily done by drilling a countersunk hole from the rear of the panel and mounting an ebonite washer on the bush of the condenser. Just see that no part of the condenser touches the metallising, and all is well.

All leads through the baseboard are insulated with systoflex, but the others are bare. The systoflex insulation, of course, is important in view of the metallised baseboard.

Next, the L.T. switch is mounted on its side under the baseboard. There isn't much space there, and the wire to one side of the switch must be screwed into position before the switch is mounted.

The neutralising condenser is mounted just off the baseboard by means of small ebonite washers. This reduces its capacity to earth and obviates any risk of a short between its assembly bolts and the metallised baseboard.

A Convenient Anchorage

Finally, a point of junction between two wires—one of them from the detector's anode resistance—is made by using a small ebonite grid-leak clip. This can be seen in the diagram. A proper small stand-off insulator may be used for this, or some other improvisation may come to mind. It is just a question of providing a convenient anchorage for the ends of the two leads.

So much, then, for the circuit and the construction. The list of components will answer most other questions that crop up; and what you are keen on hearing, by now, is something about operation and results.

All that I can say about operation is that it completely satisfies the severest

handling the dials for a bit, remarked "This is something like!" And it was, for it pulled in American amateurs on 20 metres at good strength, one after the other, at a time when the performance of my big super indicated that conditions were really anything but good.

The pulling between the two circuits is just sufficient to enable one to use the H.F. tuning as a reaction control. When it comes dead in tune it just stops the detector from oscillating. An occasional touch on the reaction condenser, to ensure that the detector is oscillating just hard enough to be pulled in this way, is all the attention that one has to pay to this component.

It's not much use going into a long description of the method of operating; as soon as you sit down to the set you will get the hang of it, and it's an extraordinarily comfortable set to handle. As far as hand-capacity, threshold howl, ploppy reaction and all those atrocities are concerned, it is sufficient to remark that none of them is present.

H.F. Pentode H.T. Voltage

There are few adjustments that one can make on the set. The screen voltage on the pentode is looked after by a separate H.T. lead, and this should be plugged into something like 60 volts on the battery. The neutralising condenser, for normal operation, should be about half-way in, but for the reception of ultra-short waves it should be reduced still further in capacity.

Incidentally, when you have in the ultra-short-wave coil for the detector, plug in the 41-0.4-metre coil in the H.F. stage and set its tuning condenser at zero. It then behaves as a normal buffer stage with the additional advantage of a loose-coupled aerial. If you like to try your hand at using tuned H.F. down there, however, make a duplicate of your detector coil and plug that in, tuning the two circuits in the usual way.

(To be concluded next week.)

WHAT YOU HAVE "UNDERNEATH"

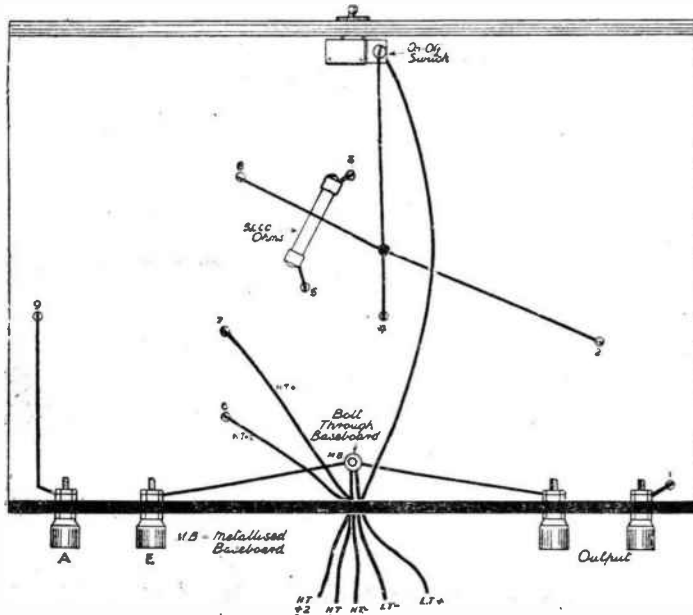

The numbers against the holes through which wires pass, correspond in this diagram and the wiring diagram on the opposite page.

critic I know—namely, myself. I simply can't stand a set that doesn't handle nicely, and I really am tremendously particular about it. As soon as I started looking round the bands on the "Simplex" Three, I said to myself, "This is the goods!" And a colleague arrived the same evening—before the set had really got into its stride, so to speak, and he, after

COMPACT LAYOUT FOR EFFICIENCY

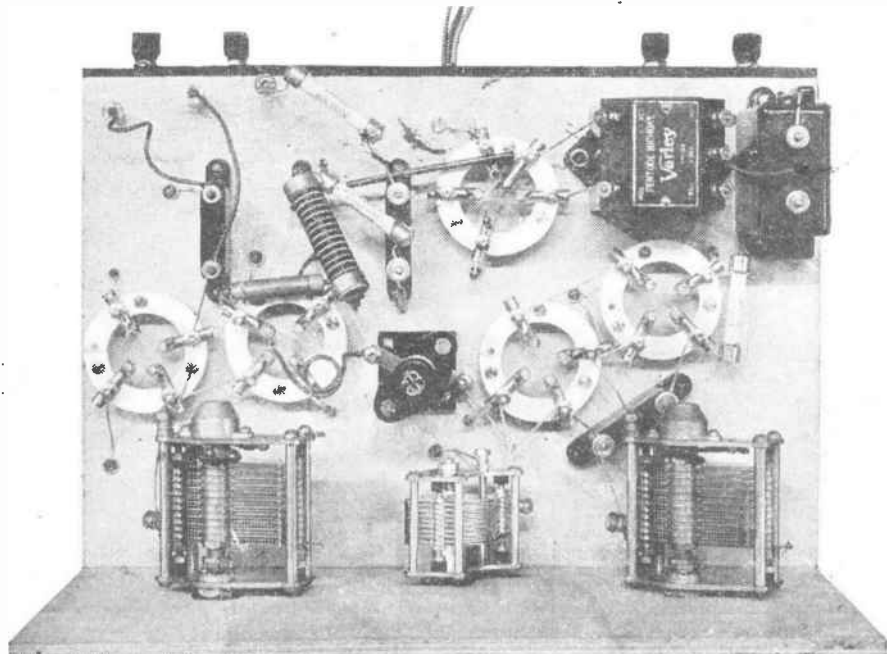

No space is wasted, but careful arrangement of the parts ensures complete stability and aids short wiring.

TELEVISION TOPICS—Collected by A. S. Clark

LIGHT ENLIGHTENMENT

A MOST interesting paper was given recently before the Illuminating Engineering Society, by Mr. G. T. Winch and Mr. L. Jesty, of the research laboratories of the G.E.C. It was entitled: Television Images, an Analysis of Their Essential Qualities, and dealt with the light and illumination side of television pictures on the cathode-ray tube of the receiver.

It was truly amazing to realise the depth to which the detail of just this one aspect of television reception has received. Much of the subject matter was very advanced, from a technical point of view, but at the same time a number of points were brought forward—and demonstrated—which will be of interest to all readers of POPULAR WIRELESS.

Perhaps most outstanding of these is the research into the use of an illuminated surround for the television picture. At first this may sound rather surprising, but demonstrations soon show up the possibility.

For instance, a sepia picture of a girl, to which the background was very dark, was enhanced by the addition of a white surround. It was like framing a picture.

The Question of Contrast

Then again, a rather greeny cathode-ray tube working on actual television was made to look almost true black and white by a deep bluey-green surround. It should be pointed out, of course, that the surround light does not fall on the end of the tube and upset contrast like diffused illumination in the room.

As a matter of fact, it was illustrated how light falling direct on to the tube upsets considerably the possible range of contrast

between light and dark parts of the picture. The whole matter of contrast was dealt with in great detail, and it was suggested that the contrast might well be a fixed factor in future designs instead of variable at the receiver. The engineers and producers could then vary it at the transmitter.

In the discussion which followed the paper it was suggested that restricted contrast range at the transmitter and contrast expansion at the receiver might be found in future television, just as with volume expansion in present sound broadcasting.

An Ingenious Instrument

Another point brought up in the discussion was that lookers (like listeners and tone) might prefer an unnatural contrast effect to the exact contrast as seen in the studio. In this connection an ingenious mechanical optical instrument was demonstrated which provides a variation of contrast and brightness in a projected picture, by moving one knob backwards and forwards and from side to side.

When the most pleasing effect is achieved, pushing the knob down records on paper the ratios of contrast and brightness chosen. It is the intention of the engineers to try this device on a large number of people to endeavour to assess the popular taste in picture balance.

Other demonstrations showed how increased brightness can cause distortion of detail, and how at high levels of brightness true focus is not so important, how if interlacing is not accurately achieved lines tend to fuse together in pairs, and how accurate measurements of screen colours can be made.

In this latter connection it is worth recording in closing that one of the demonstration television receivers had a tube with a screen half blue and half sepia toned. The blue seemed far better from a detail point of view, the sepia giving things a dull and dirty look. But, perhaps, without the blue alongside to act as "a colour surround," the sepia would have appealed more!

"TELEFRAMES"

Items of general interest

THE television demonstrations at the Science Museum, Kensington, we learn, were closed down on Saturday, April 10th, in order for preparations for the forthcoming television exhibition there to go ahead.

Since last November, when the demonstrations were commenced, 60,000 people have been present to see them.

NEW H.M.V. TELEVISION INSTRUMENT

"His Master's Voice" announce the introduction of a new television model. It is an autoradiogram model 902, and priced at 120 guineas.

The technical specification is very similar to the model 900 combined television and all-wave receiver, with the addition of an automatic record changer unit. The unit is of the standard H.M.V. type, playing eight 10- or 12-in. records.

Deliveries of the new instrument are now available.

TYPICAL OF AMERICA

Fundamental Baptists of the Pacific Coast recently appointed a committee to investigate television progress for the purpose of establishing, as quickly as possible, the world's first television church in Los Angeles. No comment needed!

THERE'S NOTHING NEW

On May 10, in the television studio, Pearl Birder, with the aid of her pencil and lightning sketches, will set out to prove—taking the latest model in frocks as a start—that there is no such thing as modern fashion.

TELEVISION FOR BEGINNERS

Electrostatic focusing of the electron beam is described this week by G. Stevens

LAST week we saw that the velocity of the electron in the tube depended on the positive potential which was applied to the anode. As a matter of fact, the velocity is proportional to the square root of the potential, which means that if we double the potential, say from 500 v. to 1,000 v., the velocity is only increased to 1.4 times its original value. But it increases, and this is the basic principle on which the electrostatic focusing of the beam is designed.

Increasing Velocity

Suppose we have an electron emitted from the cathode in a direction along the axis of the tube (see sketch). It passes through an electrostatic field E and its velocity is proportional to E. If it goes on through another field E', which is higher in potential than E, its velocity increases, and if we represent the velocity by a line of definite length in the figure, the increase in velocity will be shown by the longer line after the field has been passed.

This is comparatively simple. Now take a case of an electron which

is emitted at an angle to the axis, such as is shown by the arrow pointing upwards. There will be a number of electrons which do not travel parallel with the axis—some will be very divergent, some will hardly diverge at all. If they all travelled parallel with the axis as they left the cathode system there would be no need for all this bother about focusing them!

Now, there was a little proposition about the "resolution of velocities" which went something like this: The velocity of any moving body (they were always moving bodies in mechanics!) in a direction at an angle to the horizontal plane can be resolved into two components at right angles, one in the horizontal and one in the vertical direction.

A Simple Analogy

This isn't quite scientific, but may be a bit clearer. As an illustration we can take the old analogy of a man in a railway coach which is travelling at 60 m.p.h. If he walks across the coach at right angles to the direction in which he is going his velocity is compounded of his

rate of travel across the coach and the rate with which he is being carried along, and his movement is actually in a direction at an angle to the rail on which he is running.

So the movement of the electron in a direction at an angle to the axis of the tube can be split up into two movements or two velocities—one along the axis (shown in the figure as V_h) and the other at right angles to the axis, shown as V_v .

Now we have just seen that if

ELECTRONIC FOCUSING

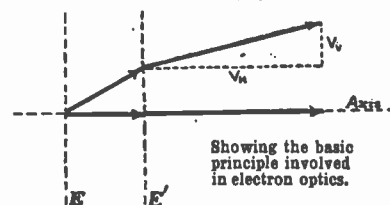

Showing the basic principle involved in electron optics.

an electron enters an electric field at a higher potential, its horizontal velocity is increased; that is, V_h will get longer as we go through E_1 . On the other hand, V_v will be the same, because there is no force tending to alter it. As a result the velocity of the electron leaving the field will be changed and the direction will be changed to suit. The electron is then travelling at an angle to the axis, which is less than the original angle. (This should be clear from the figure.)

In other words, we have changed the direction of the electron by passing it through a field at high potential, and if the increase in potential is high the change in direction is correspondingly abrupt. This effect of electric fields on the direction and velocity of the electron has been the subject of a lot of research lately, and it has been called "electron optics" because the behaviour of the electron has been shown to be almost exactly similar to that of a light ray entering a lens.

We can do almost anything with electrons that we can do with light rays—bend them, reflect them, focus them. The reason for the similarity is that the light ray consists, as we know, of waves travelling at a certain velocity in a straight line. If we can change the velocity by passing the light through a different substance such as glass, we change the direction of the ray; that is, *refract* it.

Refracting The Electron

Now, this is exactly what we have just done with the electron. We have refracted it by passing it through a field at a higher potential. Next time we can see that the similarity between electrons and light is even more close, and we can deal with electron lenses in the same way as light lenses.

FITTING A SUPPRESSOR TO CUT OUT MAINS HUM

W. J. McL. (Heswall).—With regard to interference suppressors, what sizes of H.F. choke and condensers should be used? I have a mains set which hums and I think it is due to the mains. A suppressor should stop it.

That depends, W. J. McL. If the hum is ordinary constant A.C. hum, which occurs no matter whether you are tuned to a station or not, I am afraid a suppressor will be of no use. On the other hand, if the hum is one that comes on only when a station is tuned, and is louder than the station, then possibly to fit a suppressor would help. The difference between the hums is that the first is the ordinary 100-cycle or 50-cycle hum, caused by insufficient smoothing in the H.T. supply of the set, or by miscreened wires, while the other case is what is known as modulation hum, and is caused by H.F. on the mains getting into the set.

In the former case the better remedy is to use more H.T. smoothing in the power-pack section of the receiver, or to find what grid leads are long and exposed and should be screened.

If the latter case is apparently the one which you are experiencing, try an H.F. stopper circuit, consisting of a large mains type H.F. choke (Bulgin make a suitable one), and a couple of condensers joined in series with the common point taken to earth. The "outside" terminals should be joined in one case to the terminal of the choke farthest from the mains supply (nearer the set) and the other condenser terminal should be joined to the remaining mains lead. See diagram.

The upper sketch shows a unit with one choke, and the lower one a unit with two chokes. Note the fuses, which should be of the 2-amp type enclosed in a small bakelite case. Bulgin or Belling-Lee make these. The condenser values should be as shown.

The whole unit should be fitted into a metal box, with the box earthed. That is important for safety reasons.

with every set on which we tested it. Well-known manufactured sets as well as home-made ones were used, but the whistle came with every one. The speaker manufacturers replaced it with another of the same type, and the whistle has not been heard again.

This suggestion is offered to L. W. for what it is worth, and I hope he is successful in eliminating the whistle."

MAINS OR BATTERY?

H. W. (Eynsham).—I have the battery S.T.800 with Milnes H.T. The A.C. mains are coming shortly; would it be better to build the A.C. model or to get a charger for my Milnes unit? The power of the battery model is quite sufficient for me. What is the advantage of mains over battery sets?

I should get a charger and keep your Milnes unit up to scratch and not go in for the expense of building a mains set if the battery model is quite powerful enough for you. You can charge the L.T. and the Milnes unit from the same

charger without any complications. The advantage of mains over battery sets is, first, they are usually cheaper to run and, secondly, they are certainly more efficient, valve for valve, while the output power is very much greater. In all normal circumstances I would go for the mains set every time, but in your case, as you have the Milnes unit and the set is giving you all you want, it would not be economical to change. In addition, there is one thing. With the Milnes unit you are sure of hum-free reception. With a mains receiver you might

It should really be spaced and crossed over, but many people do use twisted flex with good results. If you have the patience to do the crossing over scheme I should do it and so make sure you have a low-loss aerial. It is the proper way.

PORTABLE AERIAL

J. L. (South Bank, Yorks.).—I have a two-valve set which I use with a mains aerial through a 2-mfd. condenser. Is that O.K.? How can I make a portable aerial for it, as the set is in a small case for portable work?

The mains aerial is O.K., but why the 2-mfd.? That is too large, and will pass quite a considerable amount of current, which may or may not be wasteful. I should use a .001 mica condenser.

As regards the portable aerial, all you want is a length of wire which can be wound on a convenient carrier and slung up on a tree when in use. You will not find a frame aerial much good with a set of that size I am afraid, if you have that kind of aerial in mind. You need one stage of H.F. amplification at least for satisfactory work with a frame aerial unless you are going to use the set for local station reception, and by local I really mean "local"—a matter of very few miles away.

You can use the set without an earth if you like, but unless you are near the station you will get better results by using an earth.

H.F. ON SHORT WAVES

R. H. S. (Cricklewood).—I am going to build a short-wave set with H.F. detector, and two L.F. Can I use ganged tuning with matched coils, or is it better to use separate tuning controls?

As you will be using reaction on one of the coils I would prefer to use separate tuning condensers. You will no doubt find the H.F. tuning (aerial) somewhat flatter than the other, but though you could gang it I think you will get more sensitivity with the separate arrangement than you would with the ganged arrangement. With the latter you would need a separate trimmer so that you could trim up the tuning when required. I know one is supposed to get perfect results with ganged tuning on short waves, but where there is reaction I don't like it—I prefer separate tuning—it is quite easy to handle, especially as the aerial tuning will be fairly flat.

But it does make a difference to be able to tune exactly and for each setting of the reaction control.

MODULATION HUM

L. H. (Lapset) writes: "With regard to the query of S. A. (Newcastle) concerning modulation hum, I should like to make a suggestion. As a service engineer I have come across quite a few cases with battery receivers using mains units and have found that reversing the secondary connections of the mains transformer in the power unit has completely cured the trouble. This has been effective with both half wave and voltage doubler circuits."

Thanks very much, L. H. I am putting your remarks in our columns in the hope that they will prove of assistance to others besides S. A., who are troubled with mains hum.

L.T. FROM THE MAINS

G. S. (Golders Green).—I am buying one of the popular 2-v. 1/2-amp. chargers. Could this be used for lighting the filaments of the two-battery valves? They take .4 amp. between them.

Possibly, but you would certainly have to insert smoothing, for the supply from the charger will be pretty rough rectified A.C. You will have to bear in mind the fact that the output from the charger is probably something over 2 volts, for it is designed to charge a 2-volt accumulator—i.e. against a back pressure of 2 volts or more when the battery is fully charged. You would have to get in touch with the makers and find out what sort of resistance (if any) would have to be inserted when the unit was used to run the filaments.

(Please turn to page 191.)

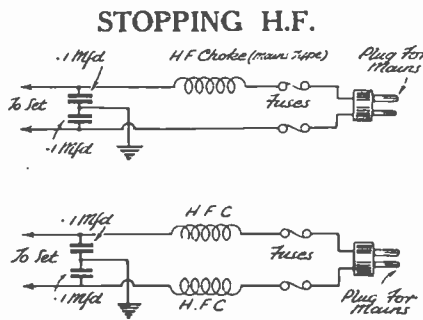

Two commonly used types of suppressors for stopping H.F. from getting into the set from the mains (see reply to W. J. McL.). The H.F. chokes should be wound with thick, well-insulated wire, since they have to carry the full mains current to the set.

"PENNIES FROM HEAVEN"

W. B. W. (Rotherham) has been watching his short-wave set. He has discovered that he gets a severe crackling in the phones when it hails. On taking the coil out he found sparks jumped across the vanes of the tuning condenser, yet on disconnecting the aerial he got no shock. He wants to know what is happening.

In the first place, W. B. W., you are right about the hail being charged. Each stone holds a charge of electricity which it gives up to the aerial on striking it. You were lucky not to get a shock. I should not advise you to touch the aerial next time. You might get one, though it would not necessarily be dangerous. But hailstorms are often accompanied by thunderstorms, so don't risk anything.

While the coil was in position it shorted the electrical charges to earth. When it was withdrawn they built up on the aerial until they reached sufficient voltage to spark across the tuning condenser, which acted in just the same way as an aerial lightning arrester.

TRY THIS

E. J. B. (Bristol) writes in answer to the query of L. W. (Tooting) in "P.W." March 27th, concerning an S.T.800 that whistled.

I suggest he tests his S.T.800 with another speaker. During the S.T.800 rage I had a similar experience of whistle in a set. The whistle could not be eliminated, and in desperation I carried the set (it belonged to a friend) to my home. On hooking up to my speaker it behaved perfectly, with no trace of whistle.

Further tests with the whistling speaker were carried out, and to my surprise the speaker whistled

THE "SIMPLEX" THREE

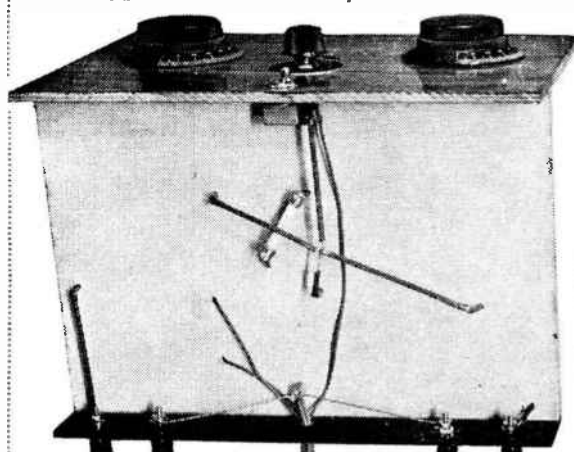

This photograph shows how baseboard of the "Simplex" Three is arranged. It will be found helpful if used in conjunction with the diagram of the under-base-board wiring on page 183.

get a little hum—it is sometimes very difficult to get rid of the last trace.

THAT DOUBLET

W. H. (Southampton).—I am going to erect a doublet aerial. Should the down lead be spaced and crossed over every few inches, or will twisted flex do?

Now about your aerial!

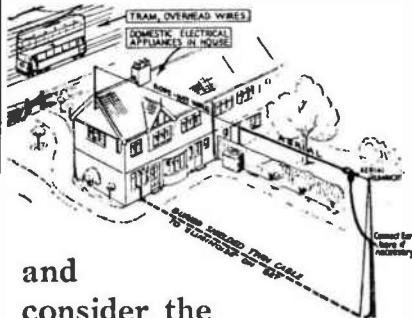

and consider the "ELIMINOISE" Trade Mark

Anti-Interference Aerial

Short, Medium and Long broadcast bands.

As easy to erect as an ordinary aerial, to which it is similar in appearance.

"Eliminoise" for one aerial - 35/-
Down lead cable, extra, per yard 10d.
Additional parts for extra receivers each 17/6

TELEVISION AERIAL SYSTEM

Simple centre-fed half-wave aerial, to be terminated by balanced input system at the receiver. Consists of two enamelled brass tubings of correct proportions to give maximum reception of the vision channel at 45 mc. Full details in "Suppression" catalogue (see coupon).

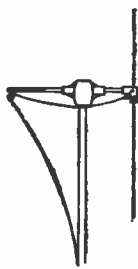

No. 334.—Masthead half-wave aerial, 45/-; No. 323, Masthead half-wave aerial, complete with Reflector, 65/-; No. 321, Wall-mounting half-wave aerial, 35/-; No. 322, Reflector for No. 321, 35/-.



H.F. LOW IMPEDANCE FEEDER

Surge Impedance, 80 ohms.
Four times better than ordinary flex.

To convey H.F. currents to or from half-wave dipole aerials in which feed is taken at aerial centre. For transmission purposes, current carrying capacity, 1.5 amps. H.F. Full details in "Suppression" catalogue (see coupon). 65 feet on bobbin in carton with technical information. No. 344, 10/6.

BELLING-LEE SUPPRESSION SERVICE

Strike out items not required.
Belling & Lee, Ltd., Cambridge Arterial Road, Enfield, Middlesex.
FREE: "Suppression Devices" catalogue.
FREE: "Eliminoise" folder.
"Interference Suppression" manual, 1/2, remittance enclosed.

Name.....

Address.....

Pop. W. 1-5-37.....

WITH THE AMATEURS

All about the short-wave bands used by amateur transmitters.

IT is safe to say that there are more stations crammed together within the narrow limits of the amateur wavebands than there are in the whole of the radio spectrum. Most owners of short-wavers know all about the fascination of the amateur bands by now. Those that don't will soon find out for themselves if they listen on the right wavelength at the right time.

The actual limits of the bands are as follows: 150-175 metres, 75-85.7 metres, 41.1-42.86 metres, 20.83-21.43 metres, 10-10.71 metres, and 5-5.36 metres. These six bands are generally known as 160, 80, 40, 20, 10 and 5 metres, or among the amateurs themselves as 1.7, 3.5, 7, 14, 28 and 56 megacycles.

The Real DX Wave

The 160-metre band is not much used except late at nights and during week-ends. It does not carry much long-distance traffic, but is used chiefly for local work. The 80-metre band is better for DX work, and U.S.A. and Australia may be heard at times. The 40-metre band, though full of European signals tightly crammed together, comes out with a real burst of DX at times.

"Twenty" is the real DX wave, and at this time of the year it is live at nearly all hours of day and night. America may be heard in the early mornings with Australasia. Asia and America come through, sometimes with Africa, in the afternoons, and Africa and America are good in the evenings.

Just at present 10 metres is as good for DX as 20, and the strength of some of the distant stations is even better on 10. The band is "open" from about mid-day till 8 p.m., and you may hear anything if you're lucky. Most 10-metre work is done on telephony nowadays.

The Cinderella of the amateur bands is 5 metres, used mostly for local work, although it has been proved that long-distance work is possible at the right times and when good conditions are in force.

The bands above 10 metres are so narrow, and carry so much traffic, that considerable jamming is bound to be experienced. A selective receiver, however, will give you endless hours of amusement, and amateur-band listening is a hobby in itself.

THE SHIPPING BANDS

Transmissions that are full of interest

ANY owner of a short-wave receiver may amuse himself, if he knows the ropes, by listening to ship-to-shore traffic

between some of the larger liners and the shore stations which are responsible for handling their messages. The shipping bands are located between 17 and 18 metres, between 22.5 and 24.3 metres, between 34 and 36.6 metres, and between 68 and 73 metres.

Ship-to-shore radio-telephony is not an everyday occurrence, but one may often hear tests carried out between shore stations and the liners, and if one picks the most suitable wavelength a little patience will generally be rewarded.

The 17- and 24-metre bands are in use mostly during the early part of the day, the 36-metre band during the evening and the 68-metre band later. The band chosen will also naturally depend upon the distance of the ship from the shore station.

Rugby (G B C) handles the bulk of the British traffic, and may be heard working with the Queen Mary (G B T T), Empress of Britain (G M B J), Monarch of Bermuda (V Q J M) and other large liners. The Normandie (F N S K) may be heard working with French stations; and the Italian liners Rex (I C E J) and Conte di Savoia (I B L I) are also frequently heard working with Coltano (I A C).

Most of the ships are not equipped with "scrambling" devices for making their transmissions unintelligible; but it should be remembered that one is not allowed to divulge the nature of any messages picked up by chance. The liners make an interesting test of the sensitivity of one's receiver, since there is usually no trouble in finding out roughly where they are at the time of reception; but they should not be looked upon as "entertainment." Trawlers and lightships use various wavelengths between 130 and 200 metres, but most of them seem to be found on about 150-170 metres—in the 160-metre amateur band. They are sometimes amusing but seldom intelligible.

ON LAND AND SEA, WITH THE W.L.S. ADAPTOR

ALTHOUGH summer is regarded as the time for outdoor reception, entertainment can be obtained by the use of a short-wave receiver (or an adaptor coupled to a broadcast set) on a car journey during the winter months.

To the experimenter a journey with short-wave apparatus is particularly interesting during the winter months whilst, to the

(Continued on next page.)

ADDING AN H.F. STAGE

The advantages of an H.F. valve, apart from any amplification that may be obtained, are to simplify tuning by isolating aerial effects, and to increase selectivity. The unit illustrated here can be made up entirely independently of the set, but can use the same batteries, in which case no H.T.—connection should be made. (It can also be run from its own batteries and used with a mains receiver.) The same sizes of coils should be used in the H.F. unit as in the set, and the same precautions about short wiring observed.

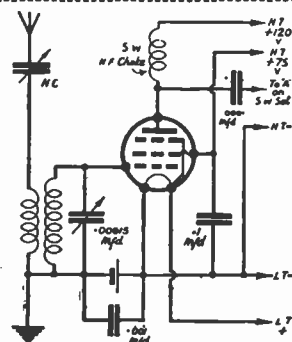

(Continued from previous page.)

listener the number of stations audible is greater and the chance of hearing worth while broadcasts consequently greater.

Not long ago I gave you a description of a trip I took to Wales with the W.L.S. adaptor. Since then I have again been to Wales and, once again, the W.L.S. adaptor and my broadcast set have been my companions—and very good companions, too.

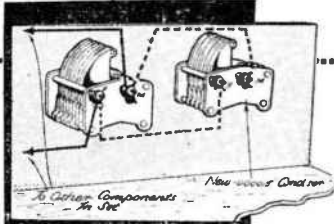

BAND-SPREADERS

Band-spreaders are simply small-capacity variable condensers wired in parallel with normal tuning condensers. The main tuning condenser is then used roughly to set the receiver to the desired wavelengths and stations are selected on the band-spreader. The dotted lines in the sketch show the new connections required to add a band-spreader to an existing tuning circuit.

Between Uxbridge and Portsmouth reception was good both as regards volume and consistency. I heard DJA and DJN at Zeesen and the Empire stations during this part of the journey. At Portsmouth I found that numerous French amateur stations came in well upon the 40-metre band—surprisingly well, when one considers that my aerial comprised a wire taken from the top of my car to the spare tyre at the back.

At Bristol I heard my first American station on the trip. It was our old friend W 2 X A F in Schenectady.

On the way to Aust I tuned-in Sydney telephone station. Incidentally, I heard this station and several other telephone stations whilst crossing the Bristol Channel by ferry. As the stations were coming in on the loud-speaker the reception decidedly surprised other passengers.

Consistent German Stations

Whilst on the water I tuned-in the Zeesen transmitters, DJA and DJN, and a French station which was broadcasting a musical programme on approximately 40 metres.

On the Welsh side of the ferry Zeesen provided the only reliable signal until I reached Barry (slightly south-west of Cardiff). There Jelöy joined in a contest with Zeesen, so it appeared, to discover which could put over the more powerful signal.

Reception in Porthcawl was not particularly good although I picked up P R F 5, Rio de Janeiro; W 2 X A F, Schenectady; W 1 X K, Millis; and W 8 X K, Pittsburg, to say nothing of European stations.

Reviewing the trip the most outstanding point that struck me was the consistency with which the German transmissions came over. There was little to choose between their volume in Uxbridge, Portsmouth, or Porthcawl.

I was also convinced that good though a straight auto-radio may be a short-wave receiver is a far better companion on a long trip for, besides its capacity of reaching out and bringing in stations from hundreds of miles away, it has no "closing down" time—there is always some station audible—day or night.

L. W. O.

PETO-SCOTT PILOT AUTHOR KITS
Exact to Specification
W.L.S. SIMPLEX 3 KIT "A" £4:10:0

These are the Parts in Pilot Author Kit "A"

2 Polar .00015-mfd. variable condensers, type "C"	17 0
1 Eddystone .0002-mfd. reaction condenser, type 957	6 0
4 Eddystone 4-pin valve holders, type 949	5 8
1 Eddystone 5-pin valve holder, type 950	3 6
1 J.B. neutralising condenser	1 6
1 B.T.S. short-wave H.F. choke, type UHF.1	11 6
1 Varley Pentode Nichoke	10 3
5 T.C.C. specified condensers	4 0
4 Dubilier 1-watt resistors, 2 2-meg. grid leaks, 5,000, 100,000 ohms	1 9
1 Bulgin toggle switch, type S.80	16 6
2 Sets Eddystone 4-pin short-wave coils (types, 1.B. 1H)	6 9
1 Peto-Scott ready drilled and polished wood panel, with Metaplex back, 12" x 8" x 1/2"; Metaplex (both sides) base-board, 12" x 8" x 1/2"; 2" x 1/2" Ebonite ready drilled terminal strip, 12" x 1 1/2" x 3/8"; 1 1/2" x 1 1/2" x 1/2" total 18 gauge tinned copper wire, 1 1/2 mm Syntoflex, flex, screws, etc.; 6 Clix wander plugs, 2 Clix accumulator spades, 4 Belling Lee terminals, all as specified	4 9

KIT "A," CASH OR C.O.D. Carr. Pd. £4 10 0

Comprise complete Kit of components exactly as specified by W.L.S., including ready drilled Metaplex panel and set of 6 specified S.W. coils with all necessary screws, wire, etc. Cash or C.O.D. £4 10 0. Paid £4/10/0, or 7/6 down and 11 monthly payments of 8/4.

7/6 DOWN

KIT B "1" As for Kit "A," but including 3 specified valves. Cash or C.O.D. Carr. Pd. £5/15/3, or 10/6 down and 11 monthly payments 12/6.

KIT B "2" As for Kit "A," but including 3 specified valves and Ericsson headphones. Cash or C.O.D. £6 10 3, or 12/- down and 11 monthly payments 12/-.

FINISHED INSTRUMENT

Built up by Peto-Scott technicians exactly to W.L.S.'s specification and tested on actual S.W. broadcast, complete with valves, Ericsson headphones and 6 coils. Cash or C.O.D. Carr. Pd. £7/7/0, or 15/- down and 11 monthly payments of 13/4.

15/- DOWN

IMMEDIATE DELIVERY-CASH-COD. or H.P.

S.T. 800 KIT "A" CASH or 70/- YOURS 7/- and 11 monthly payments of 6/4

BATTERY VERSION
Complete Kit of Components exactly as FIRST specified and used by Mr. J. Scott-Faggart, with Konekkit (Gratis with Complete Kit) but less wander plugs, accumulator connectors, valves, Extractor Kit, Cabinet and Speaker.

KIT "B"	KIT "CT"	KIT "CC"	KIT "CLL"
Cash or C.O.D. Carr. Paid £4/16/6, or 9/- down and 11 monthly payments of 9/10.	Cash or C.O.D. Carr. Paid £5/14/0, or 12/- down and 11 monthly payments of 10/6.	Cash or C.O.D. Carr. Paid £6/11/6, or 12/3 down and 11 monthly payments of 10/6.	Cash or C.O.D. Carr. Paid £6/14/0, or 12/3 down and 11 monthly payments of 10/6.

* S.T. 800 KIT "A" CASH OR C.O.D. Carr. Pd. £21/10/0. Cash or C.O.D., or add 2/3 to deposit and each monthly payment. Please state which is required when ordering.

Peto-Scott 1937 ALL-WAVE

★ **SUPER S.G. BATTERY 3** ★

- 14-31, 28-82, 200-550, 900-2100 metres ● Variable Mu H.F. Pentode High Efficiency Detector, Harries Distortionless Output Pentode Valves
- Double-Ratio 8 to 1 and 100 to 1 Slow-Motion Drive ● Air-plane Colour-Coded Dial ● Beautiful Walnut-Veneered Cabinet Illustrated.



Cash or C.O.D. £8:15:0
Carrage Paid.
Or 8/6 down and 18 monthly payments of 10/8.

8/6 DOWN

CHASSIS ONLY complete with 3 British coded 4-way pointer dial and all knobs, less speaker, cabinet and batteries. Over all dimensions: 9" high, 11 1/2" wide, 9" deep. Fully tested on all wavebands before despatch. 12 months' guarantee. Cash or C.O.D. Carr. Pd. £3/19/6, or 5/- down and 11 monthly payments 7/6.

5/- DOWN

B.T.S. ANTI-NOISE ALL-WAVE AERIAL

(As Reviewed on Page 177.)
Cuts out noise and increases efficiency on every waveband. Improves every all-wave set. 90% of the trouble experienced in all-wave reception is STATIC NOISE which the B.T.S. Anti-Noise Aerial efficiently suppresses. Outfit includes special set transformer with switch for reception on ALL WAVEBANDS, improving both sensitivity and selectivity. Suitable for all sets, A.C. battery and D.C. and ALL WAVEBANDS. Complete Outfit, ready for instant erection. 25/-. Cash or C.O.D., or 2/6 down and 8 monthly payments of 3/3.



2/6 DOWN

Ready to Erect

PETO-SCOTT 1937 SHORT WAVE ADAPTOR CONVERTER KIT

(As Reviewed on Page 171.)



Convert your existing Battery or A.C. set for operation on the short waves with this up-to-the-minute unit. No alterations to your set whatever. Two hours to build—a lifetime of world-wide entertainment.

- No coil changing.
- Drilled steel chassis.
- Drilled steel panel.

KIT "A" Cash or C.O.D. 29/6
Carrage Paid.
or 2/6 down and 10 monthly payments of 3/-. Comprises all parts for building, with diagram, assembly, and operating instructions, less cabinet.

2/6 DOWN

B.T.S. 1937 SHORT-WAVE ADAPTOR

(As Reviewed on Page 172.)



HEAR AMERICA DIRECT with this famous unit. Simply plug in your battery or A.C. Mains set. 100:1 ratio aerial tuning and slow-motion reaction; for use either as plug-in or a superb H.F. adaptor. Walnut finished cabinet, 22 plug-in coils 12-26, 22-47 metres. Ready assembled and tested on short waves before despatch. Cash or C.O.D. Carrage Paid £2/12/6, or 2/6 down and 11 monthly payments of 5/-. Extra coils, 41-94 metres 3/6; 76-170 metres 3/6

2/6 DOWN

CHARGE your L.T. for 1/2d. A WEEK!

Peto-Scott TRICKLE CHARGER

- 12 months' guarantee.
- Nothing to wear out or go wrong.
- Modern metal rectifier.
- Air-cooled mains transformer.
- Charges your 2-volt accumulator at 1 amp.
- 7 days' approval against cash.
- End outlay for accumulator recharging. Never be "left without your Radio" because your L.T.'s run down. The new Peto-Scott 1/2 amp. Trickle Charger will charge your 2-volt accumulator at 1 amp. while you sleep. Wonderfully efficient and simple to use. A.O. Mains, 200/240 volts, 40/100 cycles. Cash or C.O.D. 12/6. Overall dimensions: 3 1/2" high, 2 1/2" diam.

CASH **12/6 PRICE**



SOMETHING new for the short-wave enthusiast has been produced by New Times Sales, and it takes the form of a kit of parts which when built may be used either as a single-valve short-wave set, or an adaptor-converter.

In the kit are all the necessary components right down to the last screw and piece of wire, and also included are three plug-in short-wave coils covering from 12-94 metres. Band-spread tuning is incorporated, both the band-spread and tank condensers being equipped with ceramic compound insulation, a feature which ensures low losses.

The necessary adaptor plug is provided with the kit, so that those who want to use the unit as an adaptor can do so by inserting the plug in the detector valve holder of the present set and transferring the detector valve to the unit.

The price is 25s. for kit "A," which is remarkable value, as the total value in the components amounts to 37s. 6d.

BRITISH INSULATED CABLES

Mr. James McKay, of Liverpool, has been elected a director of British Insulated Cables, Ltd., to fill the vacancy caused by the resignation of the Hon. Sir Arthur Stanley, G.B.E.

CORONATION BROADCASTS AND OVER-SEAS LISTENERS

Many thousands of natives in British West Africa will be able to hear the Coronation broadcasts via a relay network installed by the General Electric Company. This service will operate through 5,250 loudspeakers from seven centres.

Installations at Lagos, Accra, Cape Coast, Sekondi and Freetown have already been completed, while those at Koforidua and Kumasi, as well as other towns, are in course of construction.



Up-to-the-minute news concerning the radio industry.

Thousands of short-wave sets have also been despatched to Africa in time for the Coronation, and so as to make quite sure that the natives have every facility for listening to the Coronation broadcasts these and the radio relay service will be supplemented by transportable public address equipment operating through special amplifying gear and loudspeakers.

"There has been an enormous demand from overseas," said a G.E.C. official, "and the rush of last-minute orders for sets to hear the Coronation has been terrific. Large numbers of sets have been sent to South America, India, South Africa and British Malaya during the past few weeks."

UNIVERSAL CONVERTER

The well-known Ridco "Ranger" short-wave superhet converter is now available in a version suitable for both A.C. and D.C. mains.

The new unit is basically the same as the standard battery model, but has, of course, a valve rectifier and the usual smoothing equipment. It is housed in a black cellulose metal cabinet of compact dimensions, the size being 6 ins. by 5 ins. by 6 ins.

The intermediate frequency chosen for the unit is 550 metres, so that it can be used on

American receivers with one waveband only. The price is 52s. 6d., including two valves, and ready for reception. It is suitable for use on mains of 100-110 volts and 200-250 volts, and the wavelength range is 15-85 metres.

NEW W.B. RANGE

W.B. Stentorian loudspeakers are now available without the input transformer for use with such receivers that require an extension value of 2 ohms. Actually the standard speaker with a Microlode transformer is easily adjustable to this value, but there has been a demand from those who are prepared to sacrifice the universal adaptability of the Microlode transformer in order to make a saving in cost which this new instrument shows.

The new speakers are similar to the standard cabinet speaker in every way, except that the terminals on the back are connected straight to the speech coil.

A DE-LUXE TELEVISION RECEIVER

A new Marconiphone television receiver, known as the Model 703, has been released. It is a de luxe television and all-wave radio receiver and automatic record-changing gramophone, and the price is 120 guineas. Thus the one instrument includes every means of entertainment via the ether, plus the advantages of the gramophone. Fuller details of this receiver will be given in Television Topics next week.

LATEST K.-B. RELEASE

Kolster-Brandes announce a new addition to their range, this being an all-wave A.C. superhet listed as the K.B.630. It incorporates five valves (plus rectifier), and on the short waves tunes from 16.5 to 52 metres.

It has the K.B. "Alphadex" three-colour tuning scale in which station names are arranged alphabetically in groups on the glass scale. The price is 12 guineas.

How to make a Silence SPEAK for itself



BRITISH
MADE

EVERY TEST

Current
0-6 m/amps
0-30 m/amps.
0-120 m/amps.

Voltage
0-6 volts
0-12 volts
0-120 volts
0-240 volts
0-300 volts
0-600 volts

Resistance
0-10,000 ohms
0-60,000 ohms
0-1,200,000 ohms.
0-3 megohms

45/.

Deferred
Terms
if desired.

SHOULD your set become obstinately silent and your loudspeaker won't even whisper, it will readily confide the cause of the trouble to the AvoMinor.

Trouble-tracking with the D.C. AvoMinor is fascinatingly simple with the help of the illustrated instruction booklet included with the instrument; and the AvoMinor gives you accurate readings in milliamps, volts and ohms. It enables you to test valves, circuits, components, batteries and power units with the ease and precision of the radio engineer. The AvoMinor is a permanent investment in a trouble-free radio. It's time YOU had an AvoMinor in the house.

Write for descriptive pamphlet and details of
Easy Terms.

THE AUTOMATIC COIL WINDER &
ELECTRICAL EQUIPMENT CO., LTD.
Winder House, Douglas St., London, S.W.1.
Vic. 3404/7

The D.C.
AVOMINOR
REGD TRADE MARK

HIVAC

HARRIES

The range of HIVAC HARRIES output valves were introduced to the public last August. They combine the quality of the triode with the sensitivity of a pentode because the suppressor grid has been removed and the anode set at a "critical distance." The results of this remarkable technical achievement are—

- GREATER VOLUME
- IMPROVED TONAL BALANCE
- INCREASED CLARITY OF REPRODUCTION

The designer of the

"SIMPLEX THREE"

has, because of the special features of these valves, chosen a

Y220. It costs only **9/6.**

Your dealer can supply, at once.

THE HIGH VACUUM VALVE CO., LTD.,
111-117, Farringdon Road, London, E.C.1.

RADIO NOTES AND NEWS

(Continued from page 169.)

The Engineer-in-Charge at Cassel, Germany (251 metres) is now doing to his station what he does to his hat when he goes home to dinner. It is temporarily suspended.

SOS From a Burnt-Out Set

A BLACKBURN radio dealer hit on a novel SOS appeal when he placed in his window a burnt-out and battered radio set, with a notice, "Please help. Young couple have lost a new home. Please help."

This novel appeal called attention to the plight of a young married couple who had got a new home together but lost most of their furniture and effects when the house caught fire. They were not insured.

Awakened by the barking of their dog they escaped unhurt, but they lost practically all the furniture they had got together in their year of married life. Since the B.B.C. cannot send out an SOS in such cases the dealer thought that the burnt-out set might serve instead.

Conversation Piece

THE broadcasting station at Troy, New York, advertised for an announcer. To sort out the possible sheep from the unquestionable goats, all applicants



were required to say the following conversation piece: "As the wretched, ragged robber ran rapidly towards the rugged rock, whither the weary Willow River wound, he saw a Psyche in a niche near a schism in

the chasm."

Only the applicants who could read that little lot aloud, without hesitation, and without the addition of unnecessary "Humms," "Errrrs," and Noises Off were allowed to come next day and try for the job.

Testament of Youth

JUST who was responsible for starting the broadcasting of the Welsh Children's Message I have forgotten; but it is remarkable that in these troublous times it has lived for fifteen years, and that on May 18th next it will be heard by radio listeners all over the world.

After being given in Welsh on the B.B.C. National wavelength on May 18th, translated versions will go out from various capitals in Europe and South America—Moscow, Tokio—in fact, from countries who seem to agree on practically nothing else.

The message is very popular in the U.S.A., and I think that those who work to make it such a success deserve the gratitude of all well-meaning folks and blokes.

Granulated Information

If you buy one of those transceivers now advertised, don't bluff yourself that you don't need a transmitting licence for it. You do. (This means YOU.)

R.A.F. radio men overseas should prick up both ears if they hear G 8 F C on short waves, for this is the call-sign of the Cranwell amateur transmitting station.

Scottish amateur call-signs can now be distinguished from English, by letters G M, instead of plain G. Similarly, Northern Ireland is now G I.

Licences are being granted to U.S. experimenters to work on wavelets as low as 69 centimetres, either radio or television.

African Serenade

THERE is much talk in the bazaars and villages of North-Eastern Africa about a scheme to make radio available to every tribe and settlement. The scheme is



to install in the hut of every village headman a robot radio set, which will switch itself on at certain predetermined times, give loudspeaker addresses in the vernacular, and then wish everybody good-night till

the arranged time next day.

Every month or so the set will be overhauled by a visiting devil-doctor, who will carry on his camel a box of milliammeters, voltmeters, and spares such as the regulation service-man in this country carries in his little black bag.

The African service-man, however, will carry cartridges among his condensers, and a long rifle—he knows that adverse criticism of the programmes may take the form of a disapproving bullet from the sandhills!

Coronation Preparation

AT least two of the new Daventry 50-kw. transmitters, and possibly all three, will be ready for the Coronation. The Daventry station is humming day and night, for twenty-two new aerials are being erected there, over 150 acres of land having been acquired to give them garden-room. Daventry is now the largest B.B.C. station.

Where Honour is Due

TWO robust "hips" and a loud "hurrah" should be accorded to the Research Department of All-India Radio for the work they are doing in popularising radio in the Delhi Province.



As readers of Kipling will know, the Indian native is a controversial conversationalist. His motto is that anything that is worth doing is worth arguing about.

So when it was proposed to generate power for charging radio batteries from the back wheel of a bike, the controversy was many-sided. Some favoured a one-man bike, some a tandem; some wanted foot-pedals, others favoured hand propulsion; some favoured stand-up operation, while others demanded the comfortable sit-me-down method. What did the Research Department do? The wily rascals promptly evolved a generator which may be hand-turned or pedalled, by one man or two, standing or sitting! And that is why I say, with emphasis, two robust "hips" and a loud "hurrah" for the Research Department of All-India Radio.

ARIEL



Stability. n. The quality of being steady or constant, having durability or permanence. —Dictionary

Let the dictionary guide you in the choice of your

CONDENSERS

MANY have been the makes of condensers . . . all good to look at . . . some good performers—for a time. Why aren't they on the market now? Because they lacked the quality of permanence . . . Inadequate experience, doubtful materials or unskilled workers left the job in some way incomplete . . . they failed in the test of time.

T.C.C. Condensers are the product of over 28 years' specialisation in condenser design and manufacture. That experience—that solid foundation is behind every T.C.C. Condenser. The result is a range second-to-none plus a reliability that is pre-eminent. For safety's sake use T.C.C.

T.C.C.

ALL-BRITISH CONDENSERS

The Telegraph Condenser Co. Ltd., Wales Farm Road, N. Acton, W.3.

SEEN ON THE AIR

News and Views on the Television Programmes
by our special radio-screen correspondent

L. MARSLAND GANDER

DURING a recent week-end I watched the afternoon television programme at a distance of more than fifty miles from the Alexandra Palace. The receiver was situated in a house on the outskirts of Brighton, where Dyke Road climbs over the Downs.

Allowing for the height of the site above sea level, I estimate that the summit of the aerial was about 400 feet high. Any deductions made from this feat of reception should therefore be tempered by consideration of the situation. My host, Mr. W. R. Westhead, is an amateur television enthusiast who has demonstrated that consistent reception of the Alexandra Palace transmissions at a distance of fifty miles is practicable.

Pictures seen on his screen are subject to car interference, owing to the weakness of the signal at such a distance. There is, however, not the smallest difficulty in holding the picture, the detail is extremely good and the contrast satisfactory. Passing cars cause "snowfall," which is, at present, practically continuous. Mr. Westhead tells me that he hopes to eliminate this trouble by erecting a higher aerial. He proposes to use an 80-ft. ship's mast.

Why Not More Power?

If Mr. Westhead succeeds in eliminating this interference, as seems quite possible, his reception will be nearly perfect. Behind the "snow" the pictures are as steady and as firmly interlaced as in my London office within ten miles of the transmitter. Besides increasing the height of his aerial, he intends to place a parabolic reflector at the back.

I am privately of opinion that if the B.B.C. could increase the power of the Alexandra Palace transmitter it would

greatly help these viewers on the edge of the service area. This suggestion, I know, is enough to draw an immediate chorus of derision from the television engineers. They will tell me that if they double the power only a slight increase of signal strength would result at a range of 50 miles.

Nevertheless, the fact remains that 30-kilowatt transmitters are being built both in Paris and New York. The peak power of Alexandra Palace is 17 kilowatts; its mean power 10 kilowatts. My engineer friends will tell me that more nonsense is talked about power than any other subject in television. I will contribute a little more nonsense by saying that whatever the ratio of increased signal strength to increased power, there must be some increase in the former.

The B.B.C. thought it worth while to build a 150-kilowatt station on long waves, 100-kilowatt stations on medium waves, and now some 50-75-kilowatt transmitters on short waves. The special problems involved in applying high power to the 6- and 7-metre waves are too well known to need recapitulation here. But the fact remains that two television stations are being constructed to radiate, apparently, twice the power used by the B.B.C.

Unfortunately, it appears that at the moment the B.B.C. has definitely called a halt in television expenditure. The disused Baird studio is exactly as it was when the double standard of transmission was dropped. The change that was to have heralded the programme millennium by giving more studio space has, in fact, had no appreciable effect in that direction.

The old Baird studio is used occasionally with "outside television" technique; that is to say the Emitron cameras are

taken in and connecting cables trailed along the corridor. No progress has been made with the plan to convert the Alexandra Palace Theatre into a super television studio; it is still used as a scenery shop. Stagnation continues. Why? Because the Government cannot be persuaded to devote more money to television until given figures showing that there are a substantial number of viewers.

How many television sets are in use? This is a most difficult question to answer, but I have heard the authoritative and conservative estimate of 3,000.

That Third Hour

If there are four listeners to each radio set, there are probably twice that number of potential viewers to each television set, the reasons being that many of these receivers are in viewing rooms and that each private owner is something of a missionary and invites friends and relatives to see his new possession. Television goes ahead slowly but irresistibly with steam-roller progress.

It is now definite that a third hour of television daily will be broadcast, beginning probably at the end of May and that it will consist of film. Mr. Dallas Bower is working in the Stoll studios at Cricklewood on a B.B.C. film record of some of the high spots of past television programmes.

This will be put out in the mornings for the benefit of manufacturers. The only possible comment on this arrangement is that it is better than nothing.

It has now been discovered that it will be impossible to use the plinth of Apsley Gate, Hyde Park Corner, for the televising of the Coronation Procession, as decorative banners hanging from it are likely to obstruct the cameras. A special platform is therefore being built.

A recent demonstration of Coronation earthenware and pottery largely lost its point because it was impossible to appreciate the colouring or the intricate designs.

And, speaking of colouring, the snooker match between Horace Lindrum and Willie Smith also suffered from being in black and white, though not quite so much as I had expected. There were decided differences in the shades of the various balls.

"I've had no Radio trouble since they fitted EDDYSTONE Components"



EDDYSTONE HIGH GRADE SHORT WAVE COMPONENTS 

For complete Reliability and Outstanding Performance

SEND FOR ILLUSTRATED LIST. STRATTON & CO. LTD., Eddystone Works, Birmingham.
London Service: WEBB'S RADIO, 14, Soho Street, W.1.

QUESTIONS & ANSWERS

(Continued from page 185.)

SOS's

Will readers kindly note that the following gentlemen would appreciate assistance.

S.T.300. Blue prints and details. R. E. Toulinson, 14, Link Lane, Oldham; C. T. Cadwell, Yd. Foreman's Quarters, W.D. Hands Yard, Stanhope Lines, Aldershot; J. Fellowes, 204, Kingsheath Avenue, Rutherglen, Scotland; F. Thompson, 35, Parkside Road, St. Amnes-on-Sea; A. F. Renvoize, 42, Edinburgh Colts, Popham Street, Islington, London, N.1.

S.T.400. J. Stillings, 27, Charnwood Road, Bradford, Yorks. Blue print and details.

S.T.800. N. Wilcock, 521, Stretford Road, Manchester, wants to get in touch with a neighbour who has similar set.
(This is with a view to discussing results and mutual assistance.)

Portable set design. J. E. Pattison, Jr., 4, Rosslyn Avenue, Low Fell, Gateshead, Co. Durham, wants to build the portable set which we described in "Wireless and Television Review," July, 1935. Title was "Midget" Portable. Can anyone help? Copy is out of print.

L. Kirby, 5, Ronald Park Avenue, Westcliff-on-Sea, Essex has a large number of "P.W.'s" and other radio magazines which he is prepared to give away. Anyone dropping him a line will receive the book he requires, provided Mr. Kirby has it "in stock" and that the postage is sent. Thanks, Mr. Kirby, and also thanks for writing to the reader who had trouble with his power transformer. I cannot understand why the letter was returned, we gave you the address given to us.

I end this rather long list of SOS's with a letter from the secretary of a men's club, Mr. Fred Long. It is not our usual practice to insert appeals, but we feel that perhaps in this case we can stretch a point. The appeal is for odd radio parts which our readers may have and which they do not want.

Mr. Long appeals to them not to throw such bits away but to send them to him, at 3, Dellow Buildings, Shadwell, London, E.1, for the use of the St. George's Men's Club. He writes: "Of our members only four are working. Some of the fellows are pretty keen on wireless, but being out of work they have the time but not the means to dabble in it."

THANKS A LOT

H. C. Denison, 42, Princes Avenue, Greenford, Middx. writes to thank readers for assisting him with the "Cosmic" III. He has written to all those who offered blue prints, but I am putting this in to add not only our thanks for kindly aid, but to tell readers Mr. Denison is now "suited," and to prevent other readers writing to him. It often happens that the repercussions of an SOS go on for weeks and weeks after the notice appears.

THIS WEEK'S WORST

L. M. (Southampton).—*I have just built a battery set. It takes too much anode current and runs the battery down too quickly. Why is this?*

Probably (1) Because, as you say, it takes too much anode current. (2) Because the battery is not big enough. (3) Because it— But let me have some details as to what the set consists of, how many valves, what valves, what the batteries are, and I may be able to help you.

ANOTHER FREE COLOUR PLATE FOR GARDEN-LOVERS

TO the many magnificent Natural Colour Flower Studies already presented with POPULAR GARDENING is added, this week, a reproduction of the beautiful Ursinia Sunstar, in the issue out now, price 2d.

This colour plate is superbly reproduced in all the lovely hues of the flower. Instructions for sowing are included on the back of the Plate.

Ensure Summer Beauty in Your Garden

The profusely illustrated articles in this special Flower Beds Number of POPULAR GARDENING will assist you in the intricacies of the gardening work now seasonable.

During Summer the attractiveness of the garden depends largely upon beds filled with brilliantly coloured bedding plants, and these plants are now due to be set out for Summer display. Such is the variety of these flowers that most amateurs feel the need of expert guidance in their choice, and in POPULAR GARDENING this week you will find helpful advice in selection, and on designs for beds that will show the plants to advantage, and on other topical gardening matters.

MORE SHORT WAVE BARGAINS!

New 2-valve BANDSPREAD SHORT WAVE KIT LIST VALUE 59/6 BARGAIN 32/6

12-94 metres

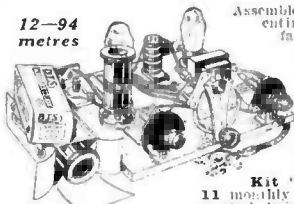

Assembled by even a novice in an evening, this wonderful receiver, of entirely new and unique design, will bring you a lifetime of fascinating short-wave entertainment. Send your order now. Delivery from stock. ● Reacting Detector and Transformer coupled circuit. Power Output. ● Slow-motion bandspread tuning SIMPLIFIES WORLD RECEPTION! ● Low-loss reaction condenser. ● Air-spaced bandspread and tank condensers. ● SPECIAL ANTI-BLIND SPOT CONDENSER. ● 3 scales calibrated in degrees and tenths.

KIT "1" comprises every part for assembly, including 3 4-pin coils, wiring and assembly instructions, less valves only. Cash or C.O.D. Carr. Pd. 32/6, or 2/6 down & 11 monthly payments 3/-.

KIT "2" With 2 British Valves, £21/9, or 4/- down and 11 monthly payments 3/10. If N.T.S. headphones required, add 7/6 to Cash Price, or 8d. to deposit and each monthly payment.

2/6 DOWN

New 3-valve BANDSPREAD SHORT WAVE KIT LIST VALUE £3 BARGAIN 37/6

● Det. and 2 L.F. Resistance and Transformer Pentode Output. ● Slow-motion bandspread tuning SIMPLIFIES WORLD RECEPTION! ● Efficient reaction condenser. ● Air-spaced bandspread and tank condensers. ● SPECIAL ANTI-BLIND SPOT CONDENSER. ● 3 SCALES calibrated in degrees.

12-94 metres

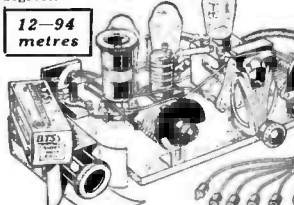

2/6 DOWN

and 11 monthly payments of 3/6. Each kit complete with full drawing and instructions.

NEW DESIGN! WONDERFUL PERFORMANCE! The latest Bandspread world-wide tuning system incorporated into an ultra-modern aperitone aerial short-wave circuit... and this amazing kit is yours at almost half the list value!

KIT "1" comprises every part for assembly, including 3 6-pin coils, wiring and assembly instructions, less valves only. Cash or C.O.D. 37/6, or 2/6 down and 11 monthly payments 3/8.

KIT "2" With 3 British valves, £21/5/0, or 12 monthly payments 5/-.

If N.T.S. headphones required, add 7/6 to Cash Price or 8d. to deposit and each monthly payment.

The above Kits are fully described in the Free Booklet offered below.

Something Entirely NEW! "3-in-1" SHORT WAVE KIT Adaptor — Converter — Receiver

As Reviewed on Page 188 LIST VALUE 37/6 BARGAIN 25/6

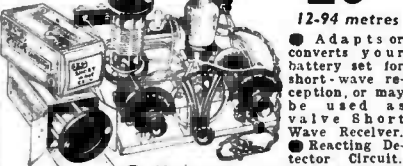

12-94 metres

● Adapts or converts your battery set for short-wave reception, or may be used as valve Short Wave Receiver. ● Reacting Detector Circuit. ● Slow-motion bandspread tuning SIMPLIFIES WORLD RECEPTION! ● Low-loss reaction condenser. ● Air-spaced bandspread and tank condensers. ● SPECIAL ANTI-BLIND SPOT CONDENSER. ● 3 scales calibrated in degrees.

The N.T.S. "3-in-1" Short-Wave Kit is entirely unique in short-wave technique. This amazing combined Adaptor-Converter-Receiver is offered you for the first time... at an astonishingly low price.

KIT "1" comprises every part for assembly, including 3 4-pin coils, wiring and assembly instructions, less valve only. Cash or C.O.D. Carr. Pd. 25/-, or 2/6 down and 10 monthly payments 2/6.

KIT "2" With 2-valve valve, £19/9, or 2/6 down and 11 monthly payments 2/9. If N.T.S. headphones required, add 7/6 to Cash Price, or 8d. to deposit and each monthly payment.

2/6 DOWN

CLASS "B" 4 CHASSIS LIST PRICE £6 : 6 : 0

● WITH 4 BRITISH VALVES BARGAIN 63/6

● Variable-Mu H.F. Pentode, Reacting Detector, Class "B" Driver and Class "B" Output Valves.

● Slow-motion tuning. ● Illuminated circular air-plane dial.

● Wavelengths 200-550 and 900-2,100 metres.

Or 5/- down and 12 monthly payments of 5/8. Another wonderful N.T.S. half-price offer. Battery operated, this splendid band-pass circuit gives amazing purity of tone and mains volume, yet is unusually economical in battery consumption.

HALCYON "AUTODYNE" SHORT WAVE CONVERTER

Instantly attached to your present A.C. Mains set and makes it an efficient All-Wave Receiver.

LIST PRICE £3 : 3 : 0 BARGAIN 29/6



With Mullard 354V Valve. Stand your set on this amazing unit and hear the whole world through your present receiver. Only from N.T.S. is this famous converter obtainable at this astounding bargain price. Secure yours now!

● FOR A.C. MAINS SETS ONLY ● 14-600 metres. ● No alterations to your set. ● Simply attach, and your set is an all-waver, a special switch enabling short-wave or broadcast reception to be enjoyed at will. ● Tuning and Sensitivity controls. ● Dial calibrated degrees. ● Walnut finished cabinet. Complete with plug-in adaptor and instructions. ● For A.C. mains sets only. 2/6 down secure; balance in 10 monthly payments of 3/-. ● **2/6 DOWN**

FREE! Write to-day for free Booklet describing in full, with actual photographs, 5 entirely new N.T.S. Bargain Short-Wave Kits, and range of Bargain Short-Wave Components, including the "3-in-1" Kit and 2 and 3-valve Bandspread Receiver Kits offered above.

All P.O.'s must be crossed and made payable to New Times Sales Co. All currency must be registered.

NEW TIMES SALES CO., 56 (P.W.29), Ludgate Hill, London, E.C.4. 1924

COMPONENT BARGAINS

N.T.S. SHORT-WAVE COILS. Interchangeable plug-in coils. Low-loss material ribbed formers. N.T.S. coils are expertly wound with high-grade copper wire, to ensure accurate distributed self-capacity, 100% efficient. 4-pin: 12-26, 22-47, 41-94, 76-170 metres. List Value 2/9. Bargain Price 1/9. 6-pin wavelengths as for 4-pin types. List Value 3/6. Bargain 2/6.

Coil Bases for above: 4-pin 1/-; 6-pin 1/6. **ANTI-BLIND-SPOT CONDENSER** Type AB. List Value 2/-. Bargain 1/-. Excessively designed to overcome "blind-spots" always present in ordinary aerial systems. Ensures smooth reaction and maximum H.F. gain as "blind-spots" otherwise devoid of short-wave signals.

BANDSPREAD & TUNING CONDENSERS, Type 3/16-00016 and List Value 5/9. Bargain 3/6. Type 4/16-000016. List Value 4/9. Bargain 2/9. For all short 4.5 and ultra-short-wave circuits. Brass cases and spindle and ceramic compound end-plate. Extended spindle for gauging. For infinite accuracy and efficiency on short-wave tuning always use N.T.S. **SLOW-MOTION DIAL**, List Value 2/8. Bargain 1/9. 10:1 slow motion. Illuminated scale, 0-180 degrees. Burnished (selenite). For all 1" spindle condensers. With bracket for single condenser and with knob.

HEADPHONES List Value 15/-. Bargain 7/6. Highly efficient yet extremely light and comfortable in use. Total weight, 4½ ozs. Black crystalline finish. 2,000 ohms resistance.

2/6 DOWN



A wireless constructional chappie,
Was always notoriously snappy!
Until he made bubbles,
Of all of his troubles,
With FLUXITE. . . he's now nick-
named "Happy"!

See that FLUXITE is always by you—in the house—garage—workshop—wherever speedy soldering is needed. Used for 30 years in government works and by leading engineers and manufacturers. Of Ironmongers—in tins, 4d., 8d., 1/4 and 2/8.

Ask to see the FLUXITE SMALL-SPACE SOLDERING SET—compact but substantial—complete with full instructions, 7/6.

Write for Free Book on the art of "soft" soldering and ask for leaflet on CASE-HARDENING STEEL and TEMPERING TOOLS with FLUXITE.

TO CYCLISTS! Your wheels will NOT keep round and true unless the spokes are tied with fine wire at the crossings AND SOLDERED. This makes a much stronger wheel. It's simple—with FLUXITE—but IMPORTANT.

The FLUXITE GUN is always ready to put Fluxite on the soldering job instantly. A little pressure places the right quantity on the right spot, and one charging lasts for ages. Price 1/6.



ALL MECHANICS WILL HAVE

FLUXITE

IT SIMPLIFIES ALL SOLDERING

FLUXITE LTD., DEPT. 324, DRAGON WORKS, BERMONDSEY STREET, S.E.1.

HOME RECORDING!!!

ELECTRADIX RADIOS WONDERFUL BARGAINS

Electradix Home Recording with the all-g geared FEIGH Electric Recorder, Ball Bearing centre gear-box and traverse rod is the lowest-price electric home recorder that will fit any grammo. The set with Tracking Gear, Pickup and tone arm with diamond 37/6 Gear only 21/8.

ACOUSTIC RECORDERS. Great Fun. Lasting Interest. Cost is low. New MIVOICE acoustic sets, complete outfits in carton de luxe, 21/- No. 2 Mivoice, 12/6. Junior, 7/6.

PARCELS of experimental odd coils, magnets, wire, chokes, condensers, switches, terminals, etc., post free, 10 lbs. 7/-; 7 lbs. 5/-; 1,000 other Bargains in New Sale List "P."

ELECTRADIX RADIOS

218, UPPER THAMES ST., LONDON, E.C.4

Telephone: Central 4611

ENGINEERING OPPORTUNITIES



This unique Handbook shows the easy way to secure A.M.I.C.E., A.M.I.Mech.E., A.M.I.E.E., A.M.I.A.B., A.M.I.W.T., A.M.T.E.B. and similar qualifications. WE GUARANTEE "NO PASS—NO FEE." Details are given of over 150 Diploma Courses in all branches of Civil, Mech., Elec., Motor, Aero., Radio and Television Engineering, Building, Government Employment, etc. Write for this enlightening Handbook today FREE and post free.

British Institute of Engineering Technology, 101, Shakespeare House, 17, 18, 19, Stratford Pl., W.1

PLEASE BE SURE TO MENTION "POPULAR WIRELESS" WHEN COMMUNICATING WITH ADVERTISERS. THANKS!

SOME WILL BE RADIO "STARS" ONE DAY

THERE is a meek little man with a drooping moustache that has long lost its pristine freshness.

Next to him a smart rather plump woman with smooth black hair, flashing eyes and a noisy Caucasian tongue is talking with a matronly woman friend.

On the adjoining chair is a well-groomed person, immaculately dressed, an attaché case on his lap, looking as though he were a bank manager or a prosperous stock-broker.

Nearby, nervously wringing her gloves, is a girl—a typical Londoner—neatly clad, like all the teeming thousands of earnest young women who work in the shops and offices of the Metropolis. She rests rather uncomfortably, it seems, on the edge of one of the line of tubular steel seats. And the toes of her shoes are forming an inverted V.

As they sit together in the foyer of St. George's Hall, the little company of strangers have a common purpose in that they are a few of the thousands of seekers after radio fame, waiting for their first B.B.C. Variety audition.

Every post each day brings to Broadcasting House at least two or three applications for auditions—applications from all parts of the country.

There is a man in Room 425 of Broadcasting House who is responsible for these auditions—from the receipt of a "Please-may-I-have-a-chance" letter to the actual microphone test under broadcasting conditions. And it is well that this official has a suave charm and a sense of humour.

Let him tell you about his job.

"Since last September we have actually given between four hundred and five hundred Variety auditions," he says. "There were, of course, many applications that had to be turned down."

"During the first three days of each month about sixty eliminating auditions are held in one or other of about six studios. I keep on my desk a file marked 'P' for promised. In it are letters either from people themselves, or from agents. Let me explain:

"We have first to judge from the applications—it is not always easy—whether they come from amateur or professional artists. Amateurs are told that we cannot grant them an audition as we have so many professionals on our books. If there is a doubt about the writer's status, we ask for more details. We are surfeited with artists of one or two types and any similar applicants have that explained to them. To the others we send the 'P' letters, promising an audition as soon as an opportunity arises, usually in about a month's time. Studios and internal circuits as well

as accompanists have to be arranged, days—perhaps weeks—before each audition.

"Auditionees (it is a bad word, but you know who I mean) are given necessary warning by letter of the date allotted to them, and we allow about ten minutes for each audition. That gives each artist one minute to get into the studio, eight minutes to perform and one minute to get out again. It is a surprising thing that quite a number of people do not bother to acknowledge a letter inviting them to an audition. They just turn up.



The New Times Sales Combination Short-Wave Kit Set. It can be used as a single-valver or an adaptor-converter.

"One or other of the B.B.C. Variety producers attends the audition with me, and, through a loudspeaker in the silence room adjoining the studio, we can hear each artist under conditions closely resembling those of an actual broadcast. As each turn goes on we decide there and then whether it is going to be suitable for booking.

"This is the kind of form we use." From a mass of documents on his desk he produced a foolscap sheet. Down one side were the names of half a dozen artists. Against each, in one column, were the monosyllables "Yes" or "No," and in another remarks such as these:

"An excellent act, amusing, sophisticated, original lyrics."

"I just don't know what this was about. I couldn't understand anything. Incredible."

(Continued on next page.)

THE S.T.800 IS STILL THE BEST BATTERY ALL-WAVE RECEIVER YET DESIGNED.

S.T.800 KITS

AS SPECIFIED BY THE DESIGNER, MR. JOHN SCOTT-TAGGART

For perfect results construct your set from the L.R.S. Designer's Kits—the original kits containing first-choice parts as specified by the designer, Mr. John Scott-Taggart. Sent carefully packed. Satisfaction guaranteed.

KIT "A" WITHOUT VALVES.	KIT "B" WITH VALVES.
Cash Price or C.O.D. £3.10.0.	Cash Price or C.O.D. £4.16.0.
or 6/3 down and 11 monthly payments of 6/8.	or 8/- down and 11 monthly payments of 8/10.
6/3	8/-
DOWN	DOWN

FREE BLUEPRINT and INSTRUCTIONS

AVOMINOR TESTING METER 4/- A most valuable instrument for tracing faults, etc. £2 Cash or C.O.D., or 4/- with order and 10 monthly payments of 4/-.

GARRARD AC4 GRAMO-MOTOR 5/- 42/6 Cash or C.O.D., or 5/- with order and 10 monthly payments of 4/2.

W.B. STENTORIAN SPEAKERS 2/6 3/8. 42/- Cash or C.O.D., or 2/8 with order and 11 monthly payments of 4/-.

CASH OR C.O.D. ORDERS DEALT WITH BY RETURN OF POST.

Established 1925. We pay all C.O.D. charges.

THE LONDON RADIO SUPPLY CO., LTD., 11, Oat Lane, Noble Street, London, E.C.2

**FULL DETAILS
of ENGLISH
PROGRAMMES
from - -
LUXEMBOURG
1,304 metres
PARIS (Poste Parisien)
312.8 metres
NORMANDY
206 metres**

Every week RADIO PICTORIAL devotes seven pages in giving full details of the English-speaking programmes from Continental stations for the coming week. These programmes are exclusive to RADIO PICTORIAL.

RADIO PICTORIAL always contains forty pages revealing in pictures and in words the latest news and gossip about radio stars and well-known personalities of the microphone.

To make sure that you get a copy regularly, place an order with your newsagent to-day.

LISTEN TO THE
"RADIO
PICTORIAL"
CONCERTS FROM
RADIO NORMANDY
and PARIS (POSTE
PARISIEN).
Full details of Pro-
grammes, etc., in the
current issue.

All the latest Broadcasting News and Pictures in ...

RADIO PICTORIAL

Of All Newsagents, every Friday—PRICE THREEPENCE

G.E.C.H.T.

- Stabilised Electrolyte for purity and power
- Super insulation for longer life

YOUR EAR will notice the greater purity of tone

YOUR POCKET will notice the longer life

120 volt, 144,000 milliwatt hours guaranteed
MADE IN ENGLAND



PRICES: 60v: 5/6. 99v: 9/-. 108v: 10/-. 120v: 11/-. 124v: 11/6. 139v: 12/9. 150v: 14/-. Also Triple Capacity, 60v: 8/6. 120v: 17/6.

Sold by all Radio Dealers

A TRIAL MEANS YOU'LL ALWAYS USE G.E.C.H.T.

Advt. of The General Electric Co. Ltd., Magnet House, Kingsway, London, W.C.2.