

MORE ABOUT THE NEW LOFTIN-WHITE CIRCUITS

Popular Wireless

Every Thursday
PRICE
3d.

No. 254. Vol. XI.

INCORPORATING "WIRELESS"

April 16th, 1927.



SPECIAL FEATURES

Secrets of 2LO

Europe's Wave-length Changes

CONSTRUCTION OF THE "50-50" THREE

Where Your Crystals Come From

THE IMPORTANCE OF THE AERIAL

By Sir Oliver Lodge, F.R.S:

This week our cover photograph shows some seamen of an anti-submarine school receiving instruction in radio-reception

A STEP FORWARD IN WIRELESS EFFICIENCY!

The new "LOTUS" Remote Control gives perfect reception and control from any distance and from any number of rooms simultaneously.

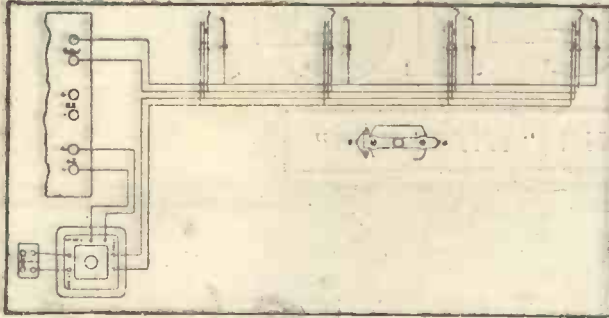

The "LOTUS" Relay is placed on or near to the Receiving Set in accordance with instructions shown on the "LOTUS" REMOTE CONTROL AND JACK CIRCUITS (free on application).



The first Relay Filament Control Wall Jack can be fitted to the wall in any convenient position in the same room as the Receiving Set and wired to the Relay and Set as shown. The Plug for use with the Wall Jack is connected to either the Loud Speaker or Phones. The second Relay Filament Control Wall Jack can be fitted in any room of the house or building in a similar manner, the four wires being continued from the first Wall Jack. There is no limit to the number of Wall Jacks

that can be so fitted in different rooms. All the rooms can listen in simultaneously and it is not possible for one room to interfere with another. The last plug to be withdrawn breaks the Filament Circuit and cuts off the Set. The Receiving Set is actually controlled from any point where a Wall Jack is wired up and by inserting or withdrawing the Plug. This Remote Control makes it entirely unnecessary to go to the Set to switch it on or off.

Complete outfit for wiring up two rooms:—
 1 "Lotus" Radio Relay, 2 "Lotus" Relay Filament Control Wall Jacks, 2 "Lotus" Jack Plugs, 21 Yards of Special 4-Strand Wire. Price **30/-**
 Each additional room:—
 1 "Lotus" Relay Filament Control Wall Jack, 15 Yards of Special 4-Strand Wire. Price **7/6**

THE LOTUS REMOTE CONTROL

GARNETT, WHITELEY & CO., LTD., BROADGREEN ROAD, LIVERPOOL, Makers of the Famous "LOTUS" Coil Holder and "LOTUS" Buoyancy Valve Holder.

FREE COUPON	
Please send free and post free Blue Prints and instructions for the "LOTUS" Remote Control House Wiring System and Jack Circuits.	To ADVT. DEPT., GARNETT, WHITELEY & CO., LTD., LOTUS WORKS, BROADGREEN ROAD, LIVERPOOL.
Name	Name
Address	Address
Date	Date

2770 C

COUPON

The British Thomson-Houston Co., Ltd.,
Publication Department, Rugby.

Dear Sirs,
Please send me a free copy of your "RESISTOR"
Book of Resistance-Coupled Receivers.

Name

Address

PLEASE WRITE IN BLOCK LETTERS



Build a "Resistor" Set for £2-2-0 (or less)

Here is an opportunity to build a highly efficient 2-valve receiver for the ridiculous! small sum of two guineas or even less. This receiver will give excellent loud speaker reception from Daventry and the local station, and, under normal conditions, all main B.B.C. stations and many continental ones can be received on headphones.

The extreme simplicity of this receiver and the small number of components required will be noted from the diagram. The Resistance-Capacity method of amplification is employed giving perfect purity in reproduction. In the past this system involved a considerable loss of volume. The B.T.H. B.8 valve, however with its extraordinary high amplification factor of 50 (unsurpassed by that of any other valve) gives as great a sound magnification per stage as the best L.F. transformer. By its use you may now have all the volume of transformer coupling with the purity of resistance coupling.

Fill in the coupon and post to-day. You will receive in return a free copy of the "Resistor" Book giving all necessary details for the construction of 2, 3, 4, or 5 valve receivers and a 2-stage L.F. amplifier.

Price given for the B.8 valve is applicable in Great Britain and Northern Ireland only.

Characteristics of the B.8 Valve.

Fil. Volts	Fil. Amps.	Anode Volts	Amplification Factor	Impedance
1.8 to 2.8	0.1 at 1.8v.	90 to 120	50	180,000 ohms.

It will be noted that the filament is rated at 1.8 to 2.8 v. The B.8 will function perfectly through out this range. It can be used directly from a 2-volt accumulator or from a 4 or 6 volt accumulator with suitable resistance.

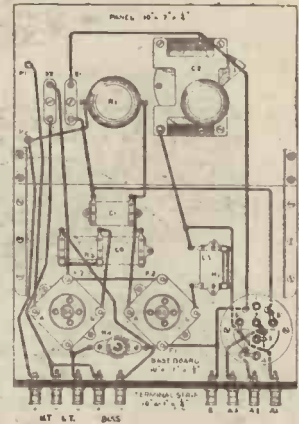

The



FOR RESISTANCE CAPACITY COUPLING

B 8 VALVE

AMPLIFICATION FACTOR 50

THE MAY ISSUE OF
“THE WIRELESS CONSTRUCTOR”
 NOW ON SALE

ANOTHER fine issue of “The Wireless Constructor” is now on sale, and the contents are of interest to every amateur and constructor. Among the many excellent features in this May number may be mentioned

“THE SIGNAL BOX”

By PERCY W. HARRIS, M.I.R.E.

A Three-Valve Set which gives Five-Valve Results.
 Notes on Neutralisation. The “As You Like It” Crystal Set.
 The Note Magniplex. New Lamps for Old.
 The “Selector” Two. Choosing Your Accessories.

Order Your Copy Now!

“THE WIRELESS CONSTRUCTOR”

Edited by PERCY W. HARRIS, M.I.R.E.

PRICE

6d.



PLAYER'S MEDIUM NAVY CUT CIGARETTES, WITH OR WITHOUT CORK TIPS.

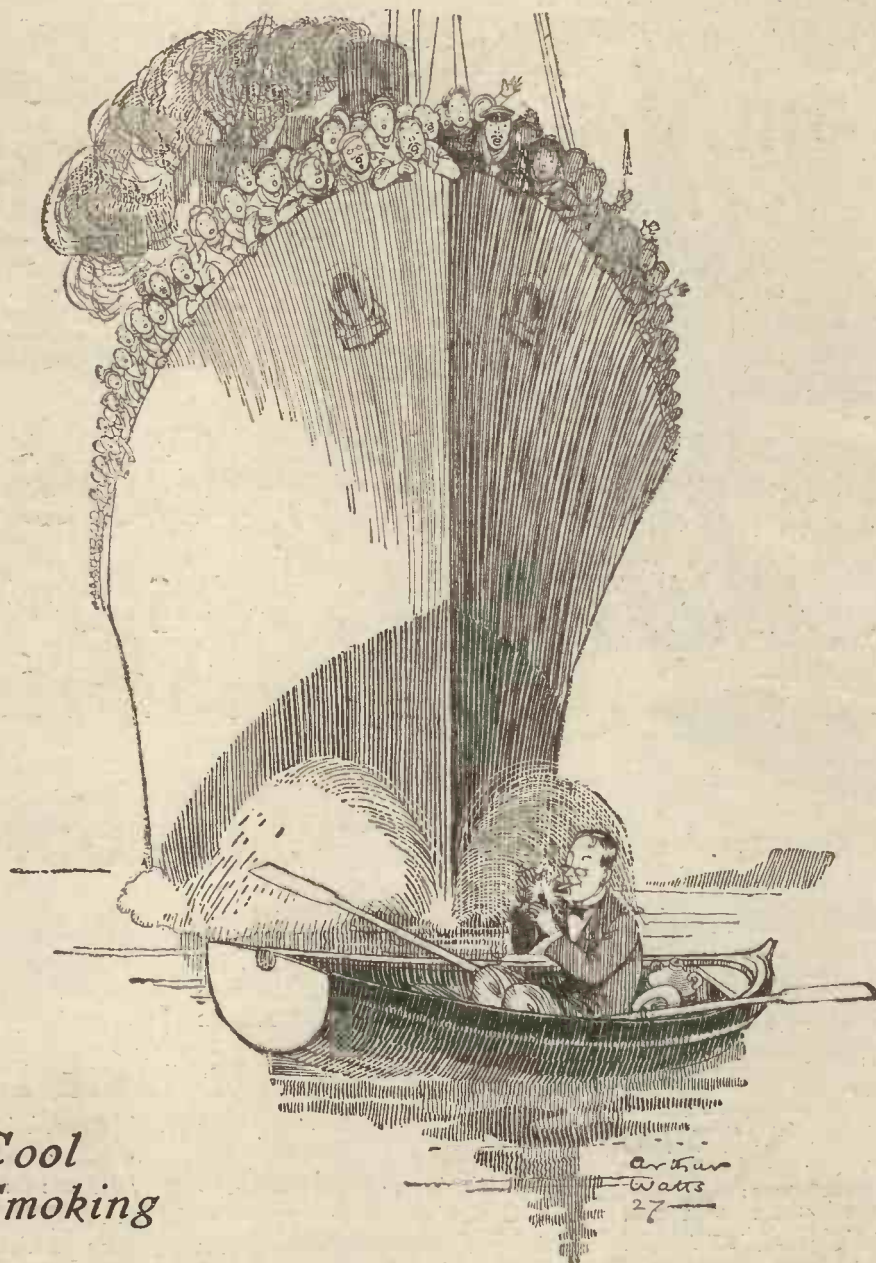

for Cool
Smoking



PLAYER'S

Navy Cut

CIGARETTES



10 for 6d. 20 for 11½d.

50 for 2/5 100 for 4/8

British Valves are supreme



3

reasons why
Cossor
enjoys such
wonderful sales

1. Because it has better tone

COSSOR has repeatedly led the way to better reproduction. When Cossor Valves are used the music is as real as if the artistes themselves were in the room. All the subtle low notes are recorded with marvellous fidelity. Every instrument

pours forth its mellow tones unspoiled by any microphonic or other noises. There is a complete absence of distortion, and the increased volume, due to the terrific emission from the Kalenised filament, has surprised even the most critical experimenter.

A full range for 2, 4 and 6-volts.

For 2-volt Accumulators:

210 H.F. (Red Band) for H.F. use. 1 amp. 14/-
210 R.C. (Blue Band) Resistance or Choke Coupling 1 amp. 14/-

210 Det. and L.F. (Black Band) 1 amp. 14/-
215P (Green Band) Stentor Two Power Valve 15 amp. 18/6

For 4-volt Accumulators:

410 H.F. and Det. (Red Band) 1 amp. 14/-
410 L.F. (Black Band) for 1st L.F. stage 1 amp. 14/-

410 R.C. (Blue Band) Choke or Resistance Coupling. 1 amp. 14/-
410P. (Green Band) Stentor Four Power Valve 1 amp. 18/6

For 6-volt Accumulators:

610R.C. (Blue Band) for Resistance or Choke Coupling 1 amp. 14/-
610H.F. and Det. (Red Band) 1 amp. 14/-

610L.F. (Black Band) 1st L.F. stage 1 amp. 14/-
610 P. Stentor Six Super Power Valve 1 amp. 22/6

2. Because it lasts longer

NO valve equals the Cossor for length of service. The Kalenised filament—an exclusive Cossor invention—operates at such a low temperature that it never

becomes brittle. You cannot see it working. Heat—the destructive influence responsible for the untimely end of most valves—has been practically eliminated.

3. Because it is 100% British

BRITISH Valves are the best in the world—and Cossor is British throughout; Labour, Capital and Materials. We are proud of their performance and nothing is left undone to maintain

their high standard of quality. Every one has to pass the most stringent laboratory tests that can be devised. You take no chance when you buy a Cossor Valve. You are assured of satisfaction.

Cossor

—the Valve which serves you longest

Popular Wireless

Scientific Adviser:
Sir OLIVER LODGE, F.R.S.
 Technical Editor:
G. V. DOWDING,
 Grad. I.E.E.,
 Assistant Technical
 Editors:
K. D. ROGERS
P. R. BIRD
G. P. KENDALL, B.Sc.



Incorporating "Wireless."

Consultants:
Dr. J. H. T. ROBERTS,
 F. Inst. P.
J. F. CORRIGAN, M.Sc.,
 A. I. C.
O. E. FIELD, B.Sc.
E. J. SIMMONDS,
 M. I. R. E., F. R. S. A.

Editor: **NORMAN EDWARDS, M. Inst. R. E., M. R. S. L., F. R. G. S.**

RADIO NOTES AND NEWS.

Radio Ten Miles Up—The Trapper Trapped—An Ideal Set—Eavesdropping Incredible— The Eclipse—A Belle Lettre.

Easter Holidays.

HERE we are, then, in the middle of the year's first holiday. Get into the open air as much as possible and hear the birds oscillating. Has anyone seen an Easter egg containing a crystal set? I was hoping it would arrive this year. Cheerio! Where's my racket?

Those Leaden Sets.

A FORMER Deputy Inspector of Factories is reported to have announced the prevalence of lead-poisoning in the wireless trade. Solder, certain crystals, and accumulator plates are the only items in a wireless set containing lead, so far as I know; unless you count paint, and there is not much of that on mine. The chief disease of the wireless trade is scantiness of orders, and in that it is not alone.

Radio Ten Miles Up.

IN an attempt to study the effect of the atmosphere on wireless waves French scientists are planning to send a transmitter ten miles up into the air by means of a balloon. The apparatus will automatically send out signals. More signals from a similar set will be sent out from ground level, and will be compared with those emanating from the upper regions. American papers will, no doubt, describe these experiments as "Aerial Attack on Old Man Heaviside."

The Trapper Trapped.

A FUNNY yarn from a Harpenden reader. His friend, the owner of a one-valve set, decided to make a wave-trap, took good advice and plenty of it, added coils and condensers, kept on

doing it till he ran out of parts; but all on the best advice. Then he took his aerial off, and found that he had added so much wire that it didn't matter. I wish I could publish the diagram; it reminds me of a shilling flash-lamp-lost in a power station.

The Super-Enthusiast.

WRITING from Irkutsk, Siberia, Mr. E. M. Osterhammel tells me he has read "P.W." regularly for nearly two years, although he has no receiver. A red-hot "fan," if you like, eh? He is, however, hoping to bring a four-valve set into action shortly; if he does, I am sure I shall have news of him before long, and I shall be glad to know how B.B.C. stations behave towards Siberia. "P.W." as a missionary of peace and good will is "doing its bit."

Club Note.

THE Huddersfield New Radio Society, the birth of which I announced with pleasure last week, has cut its teeth, held its first general meeting, slapped its nurse—no! my error—and now wants more members. Entrance fee, 1s.; annual subscription, 2s. 6d. Hon. Sec.: Mr. F. Simpson, 39, Victory Avenue, Paddock, Huddersfield.

Just Like Mushrooms.

BROADCASTING stations are coming up all over the world at an amazing rate, and it is a mixture of dread and delight to speculate on the prospects of a man with a four-valve set in

(Continued on next page.)

Multum in Parvo.

THE latest studio to be fitted up at 2 L.O.—they now have eight there—is the most interesting. It specialises in noises, and most of the sounds emitted by the elements can be reproduced there with ease. Pipes, taps, baths, etc., are included; whereby the roar of the ocean or the musical tinkle of the brook may be counterfeited.

H.M. the King at Cardiff.

DON'T forget that when their Majesties visit Cardiff on April 21st to open the National Museum of Wales, the proceedings will be broadcast and relayed to Daventry.



A close-up of the new broadcasting transmitter at WARS, Coney Island, New York.

NOTES AND NEWS.

(Continued from previous page.)

1937 Asuncion (Paraguay) is to have a station. Now, Paraguay boasts an area of some 200,000 square miles and a population of about one million, of whom 80,000 are Indians. That, including the Indians, means five people per square mile. Plenty of fresh air per person, no oscillation trouble, and re-radiation doubtful, to say the least of it.

Statistics Continued.

THEN we have Bolivia—what an aid to the study of geography is broadcasting!—which is going to have a station at Magdalena (Province of Iténez). Bolivia's back-to-the-land problem is clearly shown by the fact that it has only half a person per square mile. By the way, most of the square miles in Bolivia stand up on end, instead of lying down to be trodden on. Another country where the radio amateur will be at peace for a long time to come.

Nearer Home.

TURNING back the pages of the atlas we find Ireland, sometimes known as "Erin." There they propose to have a high-power station, probably situated in Athlone. The new Cork station is due to be opened on April 25th. It will radiate on 400 metres. For the benefit of experimenters, I will mention that it is rated at 1.5 kw. (Geneva rating), which works out at 1.0 kw., unmodulated power delivered to the aerial. Expected crystal range, 20 miles. Built on the site of a prison—a fair exchange.

Two Into One Will Go.

I AM advised that an inventor has discovered how to work two receivers from one aerial. He can receive two programmes simultaneously on waves not very different from each other in length. I confess I have never tried this, as my ears work "in series," and therefore I have not felt the need of two doses of chamber music at once; but I cannot see much technical difficulty in the feat, given selectivity and sufficient amplification. But I am always open to instruction, and perhaps my readers may be moved to try the matter out and report.

The Ideal Set.

A MONTH or two back, I gave my definition of the ideal set—too ideal ever to approach reality, I am afraid. Capt. H. J. Round, M.C., the chief of Marconi's



Senator Marconi leaving the recent momentous Marconi Co. meeting.

research laboratory, gives as his favourite basic combination three valves, the first a detector, followed by two stages of resistance-capacity coupled amplifiers. The detector should operate on "plate-bend rectification." Add reaction to this, properly used, and I agree that the results obtainable will be excellent in quality and reasonable as regards volume.

The Radio Doctor.

CAN I, without fear of letters demanding apology, crack a mild second-hand joke? I can, and I will. I simply want to repeat the story of the Scotsman (not Scotchman) who suffered from stammering and was cured by having to telephone to New York at £5 per minute! Bless 'em! the Scots just love this kind of yarn.

Mr. Dan Godfrey.

READERS will, no doubt, be interested to learn that Mr. Dan Godfrey, late the genial conductor of 2 L.O.'s orchestra, has been appointed director of music to the Tower Ballroom, Blackpool. Our good wishes go with Mr. Godfrey, the rap of whose baton we have often heard with such pleasant anticipations.

Eavesdropping Incredible.

IT is difficult to understand the mind of the man who will go to the trouble of building a set specially designed to

SHORT WAVES.

Another meanest-man-in-the-world candidate is the individual who telephones an urgent request for "Valencia" to his local broadcasting station, and then shuts off his radio.—"Stanford Chaparral."

The microphone by which the Grand National was broadcast was placed within a yard of where his Majesty stood. Well, a cat's-whisker may... mayn't it?—"Birmingham Gazette and Express."

Friend (who has just called in): "Can you tell me what's been broadcast on the radio this evening?"

"Yes. Why do you want to know?"
"Just want to prove to my wife where I've been."

"Since Mr. Eckersley was made the wavelength... we get nothing but foreign music." Given a queer cause like that, anything may result.—"Tit-Bits."

A well-known critic remarked, re a broadcast concert: "With regard to the singing, the soloists were rather thin."

Some critics are never satisfied. We should call this a welcome and very unusual asset.

"The B.B.C. gets less." The Post Office are not "broadcasting" so much.—"The Star."

In the Country.—A preliminary peep at the pale perfection of the primrose is now possible, and the alert naturalist may spy a young specimen of the wild coltsfoot making for its native rock. In the thickets the "chip-ship" of the jhamiar, blending with the "wish-wash" of the tea-tipler, is taken up, beaten, and relayed from Daventry to all stations.—"Sunday Pictorial."

"When I heard 'Abide with Me,'" remarked a listener, passing judgment on his friend's new loud speaker, "I thought I was in Paradise. The low notes are fine. With the bass I was quite intoxicated!"—"News of the World."

It is now suggested that the reason why Mars has not yet communicated with us is that she has been listening-in for the past few years.—"Evening Standard."

Wireless licences issued in the Manchester district during 1926 numbered 10,700 more than in 1925.—"Daily Paper."

We are interested, but not surprised.

eavesdrop on Rugby's telephonic transmission. Yet in America constructional details for such nose-poking are being made available to the public. I am confident that I shall have one hundred per cent. of "P.W." readers—aye, and of the general public—with me when I say that "it's not done." Moreover, I don't believe the average American "fan" would stoop to do it. It's—er—piffing and the mark of a mean mind.

"More Loud Clicks."

IN reply to a recent letter from "D. C. Mains" on the subject of clicks, "Railclix" is good enough to write suggesting that if "D. C. Mains" is near railway telegraph lines the cause of the trouble may be the electric "block" system used to signal the approach and departure of trains. The clicks from this system can be deafening on a two-valve set at 80 yards. I may add from personal experience that a "ticker" such as is used in clubs and newspaper offices gives horrible clicks to nearby aeriars.



Mr. McCarthy, chief radio-engineer of the world's largest motor liner, the S.S. "Aicantara."

The Eclipse.

ASTRONOMERS tell us that a solar eclipse will take place on June 29th. Radio experts say that the eclipse will be likely to cause abnormal long-distance reception. I hope my friends will report any unusual DX effects they may observe on that day—if any of them should be at liberty. Personally speaking, no insignificant affair like a mere eclipse of the sun is considered sufficient excuse for me to be absent from the daily treadmill.

My Letter Bag.

MY postbag is a source of perennial delight to me—and to the youngsters who collect stamps—but sometimes I get a letter which makes me wonder whether my notes portray me falsely. To some I appear to be a snarling old groucher—as, for instance, to the Welsh gentleman who didn't like my jocular note the other day about the much-sought-for all-Welsh station. (The joke is that I am as much Welsh as I am Kentish.) But when I get a letter such as that reproduced below, I feel that I must brisk up these pages and not appear quite so gullible in future.

A Belle Lettre.

FROM a certain British Protectorate, where the education is apparently a combination of culture and commerce, I have received the following appeal: "Sir, dear friend and amiable paragonist, I apprehend that you are receptive of propositions relative to development of overseas colonial interest." (So far, so good.) "Without to beat bushes, humble subscriber hereto offers deliver consignment of dried yams against receipt of latest marvelous invention Signor Marconi for radio, pound for pound sterling value, less your side fullest trade discount." Ought I to throw the valves in? ARIEL.

SECRETS OF 2LO

By E. A. ANSON.

IT is very easy to get the impression that 2 L O is merely switched on by the Chief Engineer at the commencement of a transmission, and turned off by the last man to leave at the end. In fact we are accustomed to turn on our wireless set with the flick of a switch or two every evening, and, after all, a broadcasting station is merely an overgrown receiver! But sometimes when we switch on, just to show our friends what a good set it is, nothing happens at all, or worse still, peculiar crackles and tickings drown a well-intentioned effort on the part of somebody in London.

Careful Tests.

Well, of course, it is obvious that there is something wrong with your set. There must never be anything wrong with 2 L O! If it is humanly possible to avoid such a disaster. Instead of a small party of friends, as in your case, there may be two or three million people awaiting the opening item! Yet a tiny little thing—a loose connection—a frayed flex—or a run down battery, might result in the most astounding crackles coming to you through the ether. For the most microscopic scratch is magnified 1,000,000 times before it gets turned into wireless vibrations.

Each morning alert engineers test every inch of wire at 2 L O and pay especial attention to spots likely to develop faults.

Engineers testing a microphone before an important outside broadcast.



Each microphone is tested, there are something like 20 microphones altogether. An engineer goes into each studio and tests the microphone to make sure that the feed current of 10 milliamps is passing from the batteries through the instruments. He shakes every flexible connection, the microphones plug into the floor through flex leads, whilst another engineer listens with headphones in the control room. Any loose connections or broken flex will give crackles in the control room, just the same as partly broken 'phone leads crackle on your own receiver. He then speaks into the microphone whilst the engineer in the control room watches a delicate galvanometer that measures the output on the "slide back" principle.

The amplifier that magnifies the feeble electric vibrations from the microphone is tested very carefully. The slightest thing wrong here would be fatal for it is the very first link after the microphone.

All these careful tests are normal routine every morning carried out in order to prevent trouble. However, to make doubly sure that nothing can possibly go wrong, that it is humanly possible to foresee, tests are again carried out half an hour before a transmission commences.

Meanwhile, in the control room another engineer is busy testing between Savoy Hill and the Oxford Street transmitter. There are nine lines in all, seven of them being spare. Every

morning these nine lines are carefully tested for insulation by a very sensitive galvanometer. There is bound to be slight leakage to earth, and this is shown by a deflection in the instrument—it looks like a voltmeter. The important point is to make the leakage exactly similar in the two lines in use. The engineer does this artificially at Savoy.

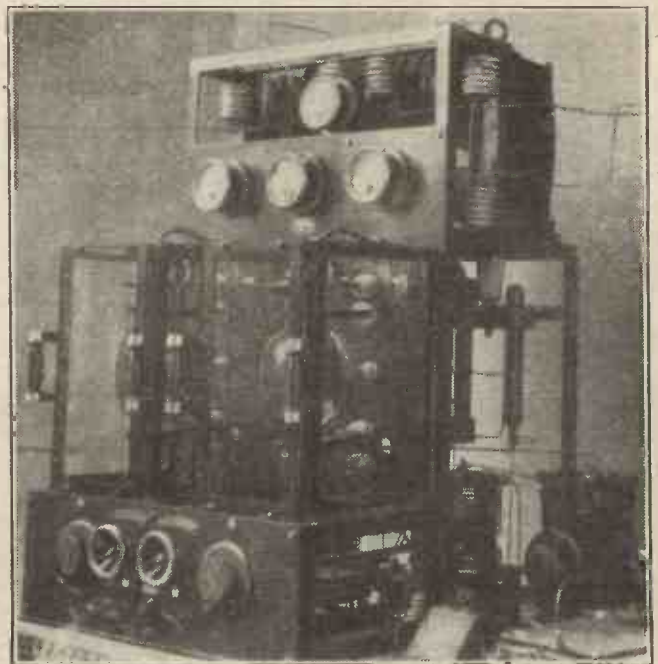

The main oscillator panel at the 2 L O station.

Hill and thus ensures clear results. Every line between the B.B.C. and the Post Office is tested like this. Between five and six o'clock all the S.B. lines are tested in addition. In all there are some 250 lines entering Savoy Hill—each one is tested.

Furthermore each pair of lines have little idiosyncrasies of their own that require correction. For instance, if left to themselves, one particular pair of lines might pass the low notes more than the high notes.

This requires attention. By the judicious insertion of balancing circuits across the two lines the desired condition for perfect

(Continued on next page.)

SECRETS OF 2 L O.

(Continued from previous page.)

results is obtained. But from time to time the state of the lines must be checked in this respect. Engineers "squeak" the lines. They send different notes along the



Fixing the microphone in a church tower, for broadcasting the bells.

line—low squeaks and high squeaks—and the strength of the squeak is measured at the other end.

At the transmitter yet more men are on the alert. At 9.30 each morning everything is thoroughly overhauled—absolutely nothing is left to chance. Whilst one man is making overhauls and testing the generators and alternators, another is busy testing the grid batteries. These batteries consist of dry cells, like you have on your set, but they are very much larger than yours and your receiver would scarcely require 600 volts grid bias. Yet that is what 2 L O's transmitter demands. These cells last about eight months. Each one is tested. The transmitter is started up.

Meters show that the valves are receiving their correct current and a note is made of the aerial current, which is generally about 10 amps. After a few minutes the transmitter is stopped and the grid bias cells tested with a voltmeter. A fall of 10 per cent. from the correct voltage is permitted—all cells below that are ruthlessly scrapped.

The modulation is tested by a buzzer when the station is running. A special electro-static voltmeter across the speech choke measures the modulation.

An electro-static voltmeter takes absolutely no current and will measure all speech frequencies accurately. It is really nothing but a delicately-poised moving vane condenser.

Of course, if the Oxford Street transmitter should break down Marconi House comes into use within a few minutes. Two or three times daily this transmitter is carefully tested just the same as the Oxford Street transmitter.

During transmission when broadcasting is actually in progress every precaution is taken to guard against bad quality and noises.

When the engineer in the control-room is ready he flickers a red light that warns the announcer. When all is ready in the studio the announcer presses a push button. This rings a buzzer in the control-room and lights an indicator showing studio number. The supervisory engineer can listen on a loud speaker or headphones either by radio reception or straight off the studio amplifier

—not by wireless. Thus he can roughly localise a fault.

The control engineer listens for quality and parasitical noises. He wears headphones. Any scratch or bad quality he hears must come from some fault between the control-room and the studio microphone. In addition the control engineer keeps his eyes glued to a microammeter connected in the grid circuit of an instru-



The London switchboard and indicator for simultaneous broadcasting.

ment which shows a deflection when a grid current flows in the transmitter modulating valves. By turning two knobs he can so adjust his amplifier that the needle of this grid-bias meter just trembles. We all know that for perfect reception no grid current should flow. This is just as true for the transmitting side.

A Model Station.

A replica of the electro-static voltmeter that reads the modulation at the actual transmitter is set up in the control-room. As a matter of fact, the control-room instrument is not connected across the speech choke at all. It really measures the strength of received signals from the transmitter and is calibrated to indicate exactly the same as the electro-static voltmeter. For instance, the voltage across the speech choke for the tuning note is 3,500, whilst for a soprano it flickers up to 2,500, and for speech it is flickering in the neighbourhood of 1,500. The whole point is that this voltage, which is a measure of the modulation, must never be allowed to rise above a certain value, otherwise overloading and blasting will occur.

Seated in another room is a musician. He is listening by wireless to the quality of the music. He moves the various musical instruments nearer or farther from the microphone. Bad quality may escape the engineer, but it certainly cannot escape the musician, seated in a sound-proof room with his ears glued to the 'phones.

It is this wonderful attention to details that makes 2 L O the model station of Europe.

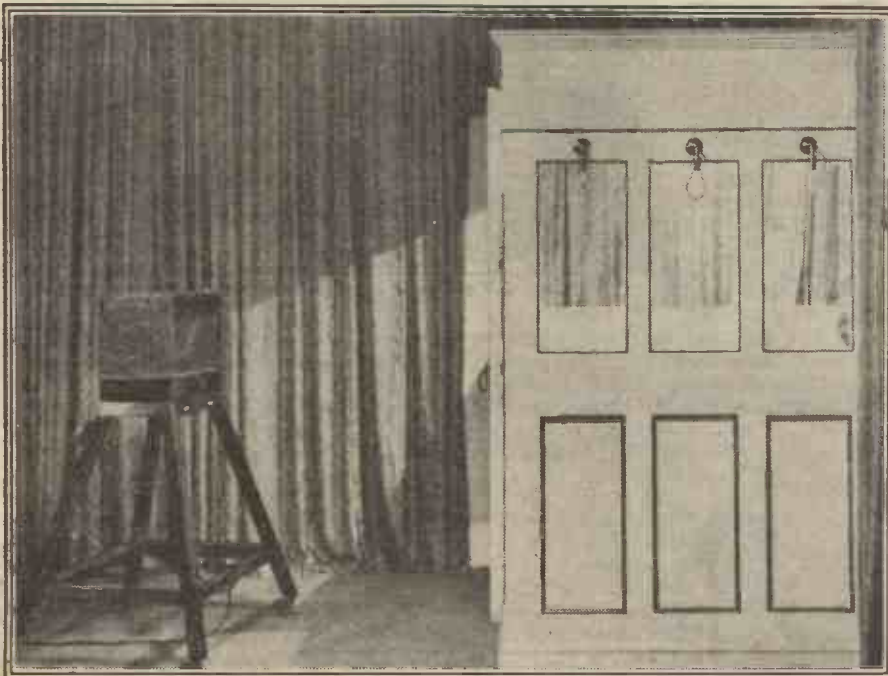

The microphone and control box in the No. 4 studio at 2 L O.

The "50-50" THREE

A three-valve designed for pure reception of the "local" with good volume. It employs one stage each of resistance and transformer L.F. coupling.

Constructed and described by J. ENGLISH.



The Cabinet with centre panel in position.

WIRELESS receivers for short distance reception have now progressed well beyond the immature experimental stage, and modern sets, besides giving high quality reproduction, can be foolproof in operation and handsome in appearance. The three-valve receiver I am going to

lid and pressing down or pulling up the knob of switch A.

This switch is mounted on a sub-panel on

The circuit of the receiver is quite straightforward, and, as shown in Fig. 1, consists of a detector valve followed by two L.F. stages, the last valve being capable of handling some considerable power without distortion.

The intervalve couplings and valves recommended for this set have been chosen for high amplification and distortionless reproduction. On test, the original receiver proved capable of very powerful loud-speaker reproduction at six miles from 2 L.O., quality being exceptionally good. Even on a 4-foot frame aerial this station is received at full loud-speaker strength, a few foreign stations also coming in strongly on the 'phones, one or two at fair loud-speaker volume.

Good Results Obtained.

No excuse is proffered for the use of a direct-coupled reaction circuit, although the efficiency of the detector stage as constituted here is quite high without any reaction at all. However, reaction, controlled by the condenser C_3 , is of great use in bringing the receiver to a high degree of sensitivity for long-distance reception. In this direction some very good results have been obtained with the original set, although it was not specially designed

(Continued on next page.)

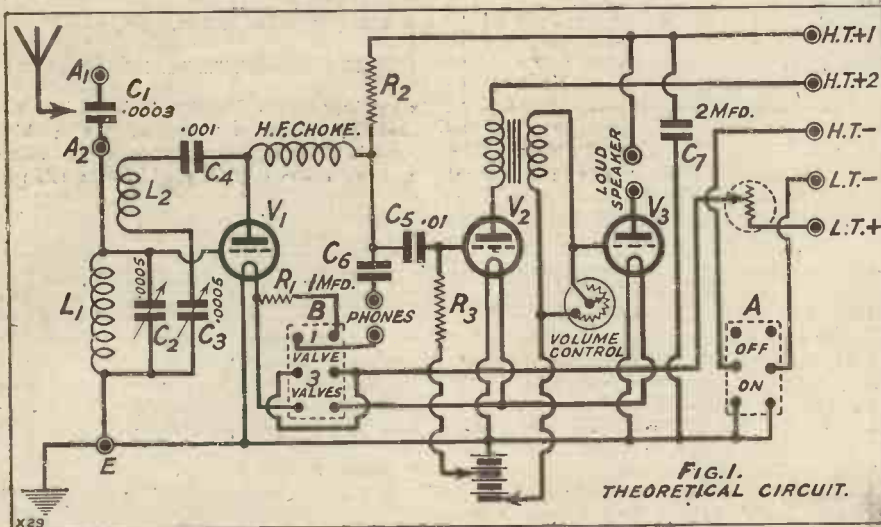

FIG. 1. THEORETICAL CIRCUIT.

describe in this article has been designed primarily for faithful loud-speaker reproduction of the programmes of a nearby station, not overlooking the provision for loud-speaker reception under favourable conditions from Continental stations. Simplicity of control has been the keynote of design, and its dignified exterior will add to the appearance of any living room.

Simple Control.

The receiver itself incorporates several refinements making for high quality reception and the controls are so simple that it can be successfully operated without a detailed technical knowledge. The containing cabinet betrays nothing in the way of a wireless set, but the middle panel in front can be removed by lifting the lid and pressing from the inside. When removed this false panel reveals the tuning controls just inside as you will see in one of the photographs. Actually, when once the set has been tuned to the local station, the false panel can be left in place and the set turned on and off simply by lifting the

the right hand side, together with a switch B, which when pulled up throws into circuit only the first valve for 'phone reception when the loud speaker is not required. Depressing this switch brings all three valves into operation, and switches on the loud speaker. The knob between these two switches is a volume control. All leads are connected at the rear of the cabinet, thus preserving the plain appearance of the set.



The complete receiver with the centre wooden panel removed to show the controls.

THE "50-50" THREE.

(Continued from previous page.)

for this purpose. On several evenings over a dozen foreign stations have been tuned in at excellent loud-speaker strength, a number of others being comfortably

resistance compensates for the rise in filament voltage and retains the filament current at its normal value.

On switching over to three valves this resistance is out of circuit. After the main rheostat has been adjusted to give the correct current for all three valves it can be left on indefinitely. It is only incorporated to provide a means of compensating for any drop in the voltage of the L.T. supply.

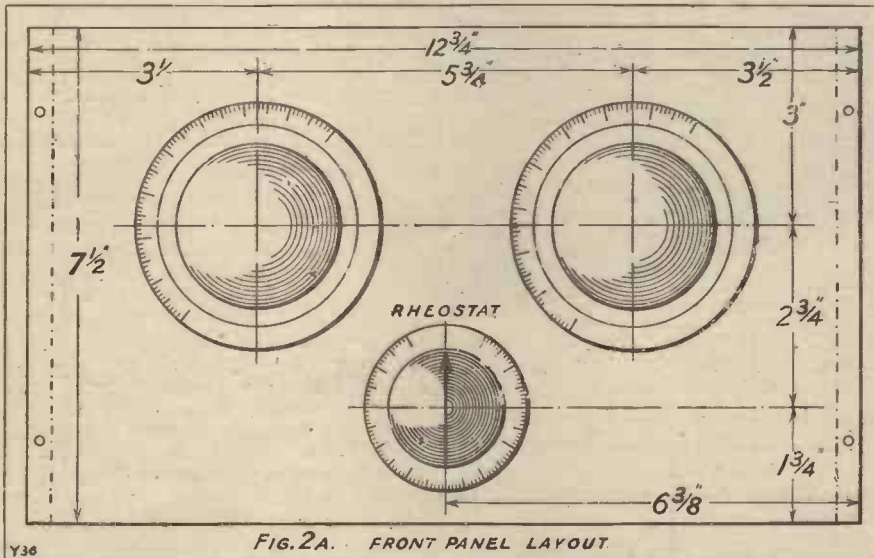

audible on the 'phones. The switch B comes in useful here, for in the one-valve position a station can be tuned in on the 'phones, and then switched on to the loud speaker by pushing down this switch to the 3-valve position.

Automatic Filament Adjustment.

In connection with this valve switch there is a refinement of some interest to experimenters. This consists of a device for preventing a sudden jump in the filament current of the first valve when the last two are switched off.

Without this device the filament of the first valve will be overheated and eventually ruined if the rheostat is not adjusted when changing from 3 to 1 valves, while another adjustment is necessary when switching back again. The switch B makes this rheostat adjustment automatically, by introducing in the one valve position an auxiliary resistance R1 in series with the positive lead of the first valve. This

The battery switch A also introduces additional refinements eliminating the risk of burnt out transformer or loud-speaker

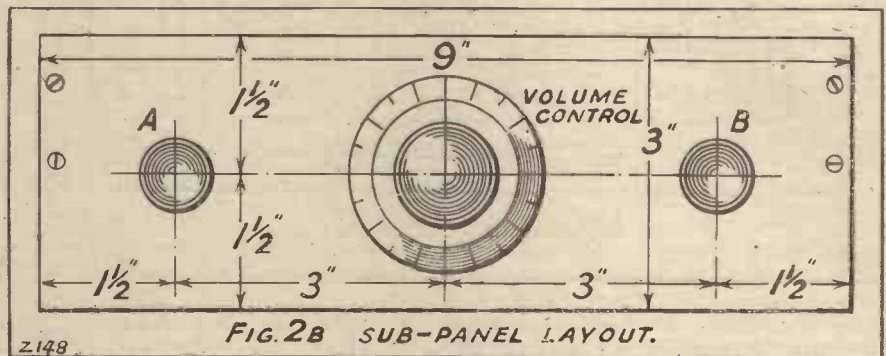

windings through heavy current surges in the anode circuits. This risk is obviated by breaking and making the L.T. circuit

before the H.T. circuit, the springs of the switch being arranged to give this order of contact.

Some further notes on the valve stages may be of interest to those constructors who like to know all about the workings of

COMPONENTS REQUIRED.

- 2 .0005 mfd. variable condensers (Polar Cam Vernier).
- 1 .0003 mfd. fixed condenser (Dubilier).
- 1 .001-mfd. fixed condenser (Dubilier).
- 1 .01-mfd. fixed condenser.
- 1 1/2-mfd. fixed condenser.
- 1 2-mfd. fixed condenser.
- 1 .5 meg. grid leak Dumetohm.
- 1 2 meg. grid leak Dumetohm.
- 2 holders for grid leak Dumetohm.
- 1 Rheostat.
- 1 Transformer (Ferranti A.F.3).
- 1 Variable resistance 0/500,000 ohms (Mareoniphone).
- 1 H.F. choke (Cosmos).
- 2 Switches D.P.D.T. (Utility push pull).
- 2 Coil holders.
- 3 Valve holders.
- 3 Terminals.
- 9 Sockets.
- 9 Plugs.
- Ebonite, 12 1/2 x 7 1/2, 3 x 9, 2 x 12.
- Sundry wire and screws.

a receiver before deciding to build it. The detector stage is designed for a high magnification high impedance type of valve, and with the coupling resistance (R2) of .5 megohm, high amplification is obtainable without distortion. One .5 megohm leak

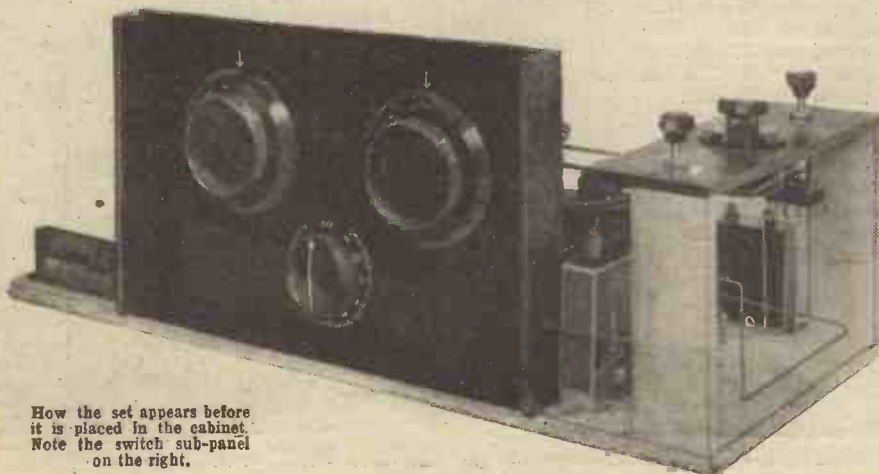

How the set appears before it is placed in the cabinet. Note the switch sub-panel on the right.

of the type used here appears to be quite capable of carrying the very small anode current without introducing any noisiness.

If a .25 megohm resistance is used, amplification is slightly reduced, but it is much easier to get the full degree of reaction required with a smaller reaction coil. The valve operates as an anode-bend rectifier and with the special high impedance valves used, no additional negative grid-bias is necessary for efficient rectification.

The first L.F. stage is designed for a valve of moderately low impedance with a magnification factor of 5 to 8. With the transformer used here, amplification is high and comparatively even over the whole audible frequency range.

The second L.F. stage requires a type of power valve capable of handling considerable input power without distortion. Where the receiver is used on a good aerial in close proximity to a broadcasting station, say

(Continued on next page.)

THE "50-50" THREE.

(Continued from previous page.)

up to ten miles, it becomes necessary to use a super-valve of the type indicated in Table A, if full advantage is to be taken of the high amplification possible without sacrificing quality. A smaller type of valve can be used successfully by detuning the receiver so that the last valve is not overloaded. However, it really pays to use a super power valve, properly adjusted, especially in connection with a cone loud speaker, as the very excellent and realistic results obtainable will amply repay you for the extra initial outlay and cost of upkeep. In conjunction with a good loud speaker,

of uprights is truly at right angles with the baseboard and to prevent trouble in the future through warping of this board, I have found it advisable to use a piece of six-ply. This will always remain perfectly flat so that the front panel will not be twisted away from the cabinet front.

Drilling Dimensions.

A piece of $\frac{1}{4}$ -in. plywood, or even metal, can be used quite well for this front panel. The parts of all components mounted on it are at earth potential so that there is no question of leakage or necessity for insulation. The terminal panel, however, must be a piece of good quality ebonite. The drilling points for front panel and terminal panel are indicated in Fig. 2 (A) and (C) respectively.

The sub-panel and its supports can next be prepared and fitted, the wooden supports

When mounting the components on the baseboard, it is a good plan to leave out the transformer and bias battery until last, thus making it easier to get at certain wiring points. The original layout should be followed as closely as possible since the disposition of components has been carefully considered in order to secure short and direct wiring. If the wiring diagram of Fig 3 is carefully followed, connecting up the various wiring points should be quite a straightforward job.

In Fig. 3 the wiring tags of the two switches are shown in their actual positions as one would see them if the sub-panel were transparent, and not turned upside down as would appear at first glance.

The series resistance R_1 is adjusted when the set is ready for operation and may consist of a length of No. 30 resistance wire or a semi-variable resistance of the base-

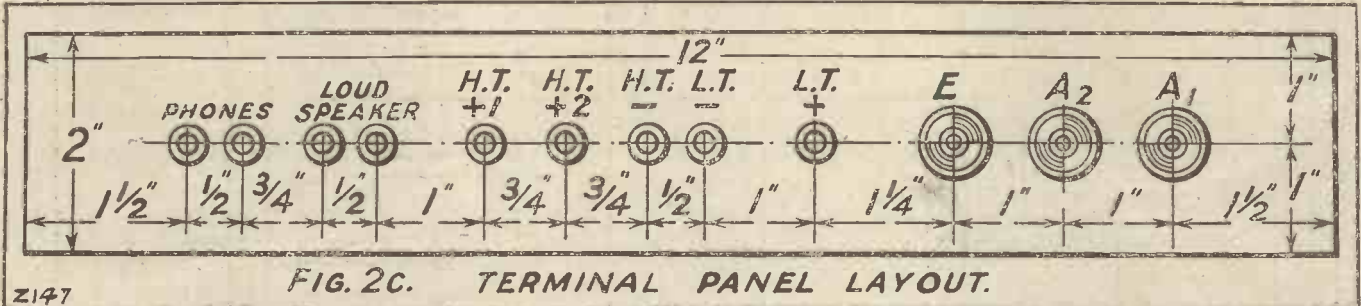

even the music lover can listen to and enjoy the ultimate product of the receiver without experiencing any of the pangs caused by some wireless installations.

To return to practical details, the receiver proper has not a full length panel. A small centre panel is mounted against two wooden uprights and set back from the front edge of the baseboard. When the set is lowered into the cabinet this panel comes immediately behind the opening in the cabinet front, revealed when the false panel is slipped out. The interior of this space is shut off from the rest of the receiver by the uprights and the panel on which are mounted the two tuning condensers and the rheostat. The terminal panel at the back of the baseboard is mounted in the same way, and access to the terminals is obtained through a slot cut in the back of the cabinet.

Constructional Details.

The sub-panel on the right hand side of the baseboard is raised on two wooden supports. On it are mounted the switches A and B, and between them the volume control. This consists of a variable resistance, having a maximum value of 500,000 ohms, shunted across the transformer secondary. This gives a very pleasing control of volume without in any way impairing the quality of reproduction, rather the reverse.

Coming now to actual constructional details, the two wooden uprights for the front panel are $7\frac{1}{2}$ in. long and 1 in. wide cut from $\frac{3}{8}$ in. thick wood. The two uprights for the terminal panel are also 1 in. wide and 2 in. long. These pieces should be stained and polished before being mounted, the position of each pair being shown in Fig. 3. These uprights can be screwed down to the baseboard from underneath or, better still, let into $\frac{1}{8}$ in. deep grooves cut into the baseboard and then screwed from underneath. It is necessary to see that each pair

measuring 5 in. by $1\frac{1}{2}$ in. The sub-panel itself can very well be a piece of $\frac{1}{4}$ -in. mahogany, as in the original receiver, since there is no need for insulation all the working parts of the switches used here being insulated from the fixing bushes. Dimensions and drilling points are shown in Fig. 2 (B).

A list is given of components used in the original set, but equally reliable ones may be substituted, provided that they do not differ appreciably in dimensions or electrical values.

Before mounting the two condensers it is necessary to cut out the earth screen. This screen, either a piece of copper foil or perforated zinc sheet, effectively eliminates all hand-capacity effects when tuning in with the receiver in a sensitive condition. See that only the fixing bushes of the condensers touch this screen, which must be clear of the fixed vanes.

board mounting type, the latter being, of course, easier to adjust. Details of adjustment are given below.

The battery switch A which I have used here requires a slight adjustment in order to give the desired sequence of contact-making mentioned above. To do this the contact spring at X (see Fig. 3) is bent outward slightly so that the moving brass arm makes contact with it after the other moving arm has touched the contact spring at Y.

Connection between the batteries and the receiver is made by means of a multiple flex lead terminating in a five-point plug, which fits into the five sockets on the terminal panel. Five terminals can be substituted, of course, but I can recommend the plug system as being very convenient, safe and efficient. Notice that the five sockets are irregularly spaced to prevent incorrect insertion.

(Continued on next page.)

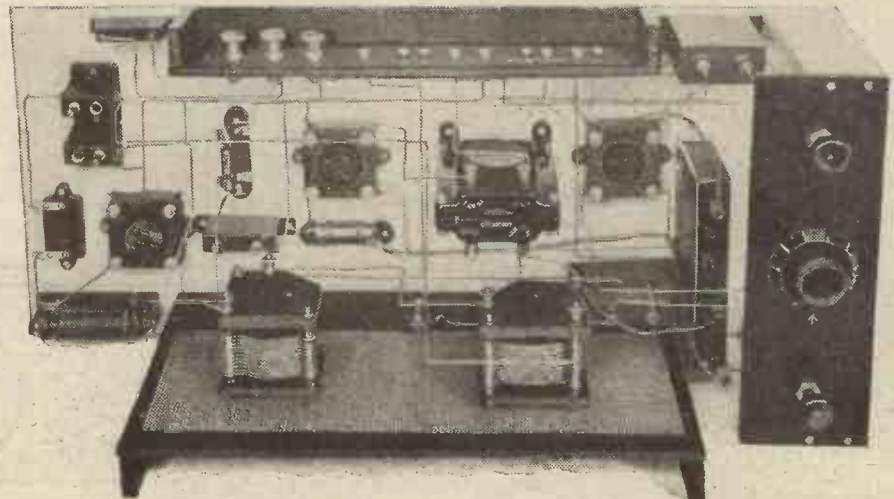

The layout of components can be clearly seen in the above illustration.

THE "50-50" THREE—(Continued from previous page.)

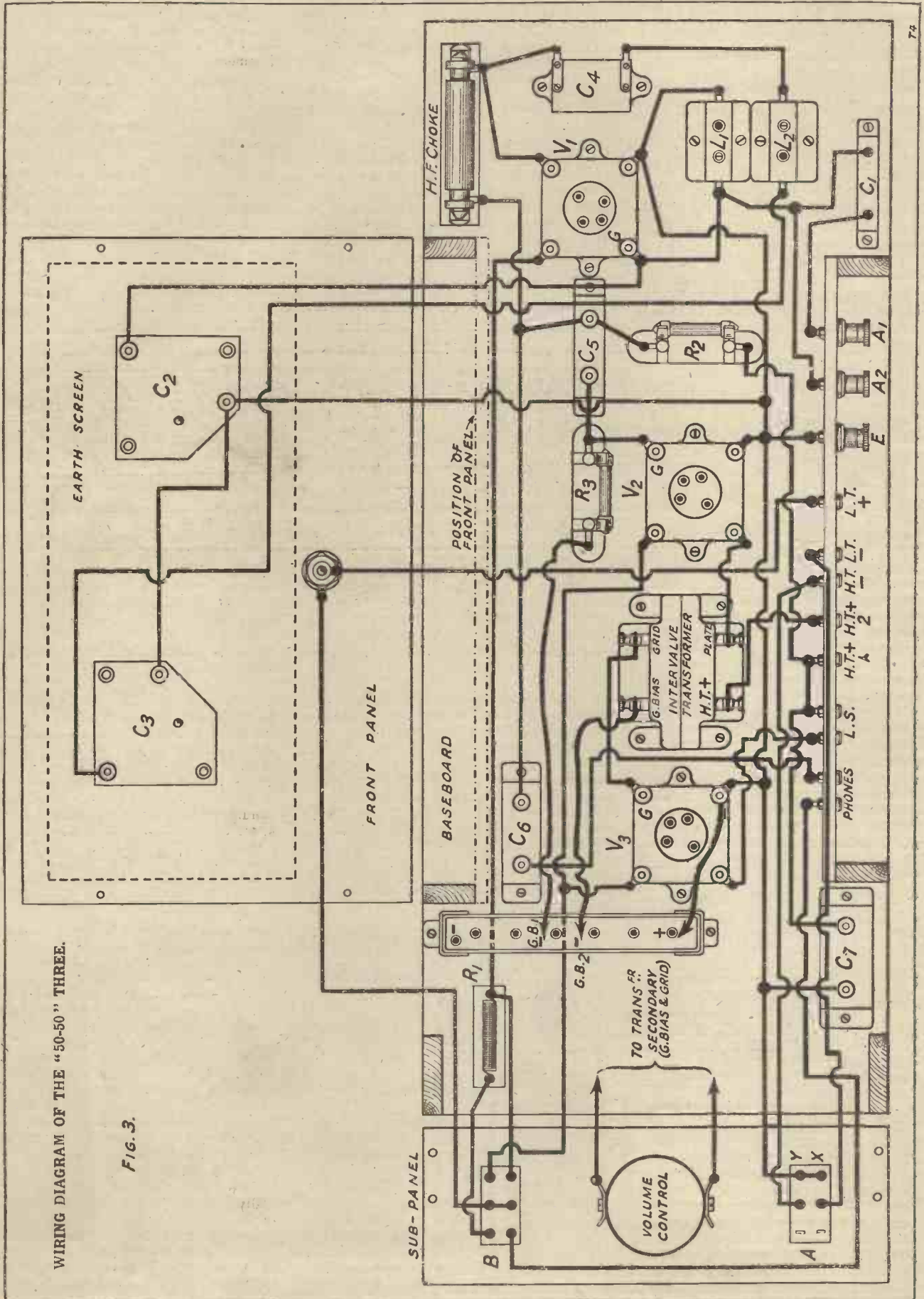

WIRING DIAGRAM OF THE "50-50" THREE.

FIG. 3.

(Continued on next page.)

THE "50-50" THREE.

(Continued from previous page.)

The plug is constructed from a piece of $\frac{1}{2}$ -in. ebonite, 5 in. by 1 in., in which are bored five $\frac{1}{4}$ -in. holes spaced to correspond with the five sockets. Wander plugs are inserted in these holes and connected to suitable lengths of single flex, the free end of each length terminating in a different coloured plug to indicate the correct connections to the batteries. The L.T. leads should terminate in stout spade terminals, marked positive and negative.

The loud-speaker and 'phone leads are also fitted with double plugs fitting into corresponding sockets on the terminal panel. The plug system makes it easier to change over if it is desired to use the 'phones on three valves.

TABLE A.

Type	L.T. Supply Voltage	Anode Volts	Grid Volts
S.P. 18 Blue Spot	2	120	—
D.E. 2 L.F.		80	3
S.P. 18 Red Spot		120	6
Cossor 4 volt Point 1 R.C.	4	110	—
Cossor Stentor Four		75	3 to 4 $\frac{1}{2}$
Cossor ditto		110	6
P.M. 5B	6	100	—
P.M. 5X		75	3 to 4 $\frac{1}{2}$
P.M. 6		100	6
Or 256 super Power		100	12

When the wiring has been checked and passed, the receiver can be set up without its cabinet for testing. First of all, make sure that the filament wiring is correct by connecting the accumulator to the H.T. leads, the battery plug being in position, and

if the valves do not light all is well. Now the adjustment of the series resistance must be made. The best way to do this is to plug an ordinary cell testing volt-meter into the filament sockets of the first valve holder, turn on the rheostat and switch A, pull up switch B and then adjust the variable resistance R_1 until the volt-meter gives the same reading with switch B either up or down.

Operating Details.

If you intend using a length of resistance wire, cut off a foot or so and then gradually decrease the length until the volt-meter gives the required reading. The wire can then be wound on a matchstick and the free ends soldered in place. This adjustment only holds good for one particular set of

volume with the reaction control at zero, switches A and B both being down.

With the loud speaker going full blast, the final adjustment of grid bias can be made for the best quality. A means of adjustment more reliable than the ear test is to observe a milliammeter connected in series with the H.T. positive lead of first, the second and then the third valve. Grid bias should then be adjusted until the milliammeter needle ceases to give sudden jerks when a loud sound comes through. A slight quivering of the needle is of good moment. If a super-power valve is used in the last stage more than 9 volts grid bias will generally be required, and there is room beside the present bias battery for another 9-volt unit.

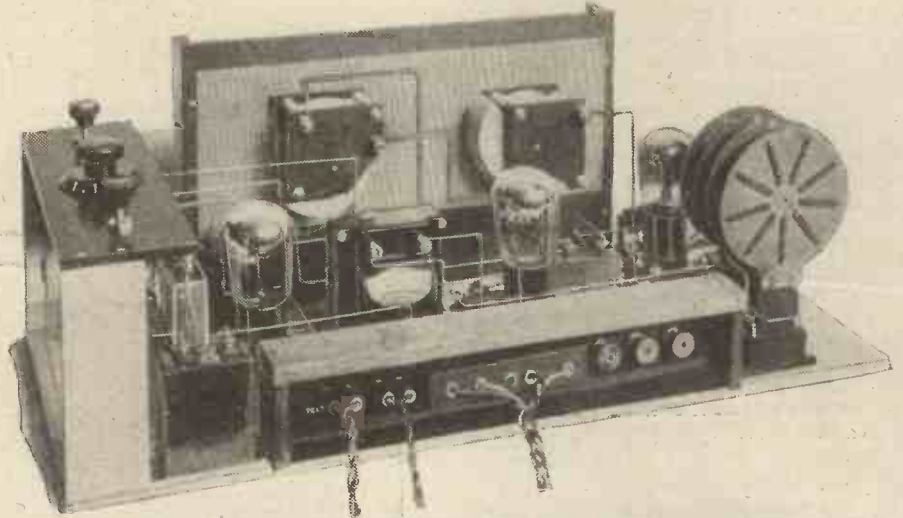

The terminal sub-panel is seen in the foreground of this photograph, which shows the receiver with valves and coils in position.

three valves, and if any other set having a different filament rating are substituted later the resistance R_1 will have to be readjusted.

Types of valves that will give good results and the recommended values of anode and grid voltages are set out in Table A. For convenience one make only of each range is shown, other makes having similar characteristics being equally suitable.

Having inserted the valves and applied the anode and bias voltages recommended by the makers, the tuning arrangements can be attended to. Two aerial terminals are provided, A_1 for an aerial of large capacity, and A_2 for a small one. The reaction coil should not be too large, but of sufficient number of turns to give full reaction with C_3 at maximum for any setting of C_2 . This coil will usually be the same as, or one size smaller than, the aerial coil. The set can now be turned on and tuned to the nearest station, which should come in at full loud-speaker

The sensitivity of the set can be increased for the reception of weak signals by manipulating the reaction control C_3 , keeping off the oscillation point. I noticed with the original receiver that the setting of C_3 did not vary appreciably over the major portion of the tuning range of C_2 , thus making tuning very easy. With a little practice the knack of long distance tuning can be readily acquired, but for the best results do not forget that an efficient aerial is of paramount importance.

Cabinet Dimensions.

So much for the works of the receiver, but before I conclude you will probably want to know more about the cabinet. Leading dimensions are given in Fig. 4, and if you do not care to undertake the job of making it up yourself any reliable firm will undertake the work for a reasonable sum.

A cabinet of this description looks best made in oak and finished in the Jacobean style. Note that the false panel is retained in position by two pins at the bottom and a ball-catch at the top. The panelling is done by letting pieces of $\frac{1}{4}$ -inch oak board into the framing of the cabinet, the panels being finished off along the edges with a moulding glued on afterwards. A good receiver deserves a good cabinet, so that it really pays to spend a bit more on this part of the set.

Finally, I may say that anyone who constructs this receiver and takes care to get all the details correct will be well repaid for the time and trouble spent over it.

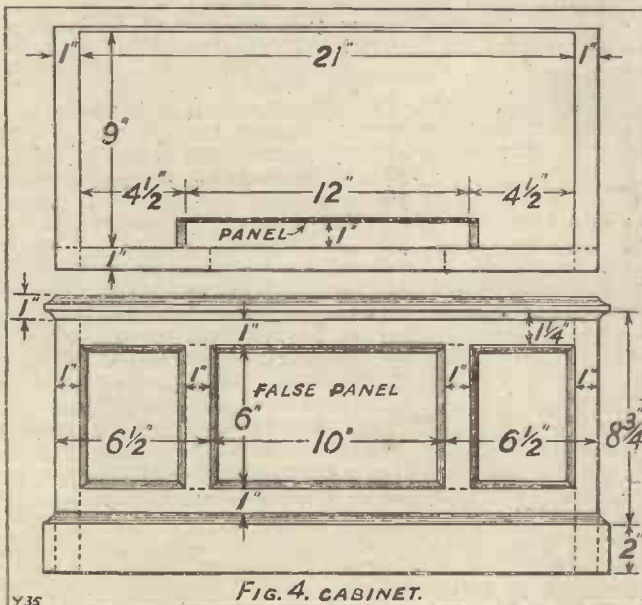

FIG. 4. CABINET.

BROADCAST NOTES.

FROM OUR BROADCASTING CORRESPONDENTS.

Mr. Wells on Wireless—Mr. Arnold Bennett Succumbs—The First Listener—The Musical Avolos—Essex v. New Zealand at Cricket—"Daily Mail" Week—"R. U. R." by Broadcast—Shakespeare's Birthday—A Good Mixture—Adult Education by Broadcast—Edinburgh en Fête—"Dick" Sheppard and the B.B.C.

Mr. Wells on Wireless.

MR. WELLS recently expressed some interesting opinions on broadcasting in a Sunday newspaper—opinions which have aroused considerable interest and comment; but broadcasting critics point out that there are two considerations which stand in the way of the unreserved acceptance of his views. One is that Mr. Wells is not a very keen listener-in, and the second is that on the day before his criticism of the B.B.C. was published in a Sunday newspaper, the B.B.C. broadcast of the Boat Race thrilled the whole country in a way never before experienced.

Mr. Wells, however, is very interested in gramophones, and he compares them with broadcasting in a way not likely to give the impression that he thinks broadcasting reproduction better than gramophone reproduction. Mr. Wells seems to have great faith in the future of the Automatic Ticker, which he thinks will give better service for the dissemination of news than the broadcasting service.

Mr. Arnold Bennett Succumbs.

It is not so very long ago since Mr. Arnold Bennett was also criticising the B.B.C. rather severely. H. M. Tomlinson's rejoinder to Mr. Arnold Bennett appears, however, to have had some effect, for it is now stated that Mr. Bennett has undertaken to do a "My Programme" in about two months' time. It is also to be hoped that the B.B.C. will have equal luck with Mr. H. G. Wells, for it would be undoubtedly interesting for listeners to hear a programme devised by one of the most outstanding thinkers of this century.

We have no definite information that Mr. Wells has in any way promised to accept an invitation from the B.B.C. in this respect, but we feel sure readers will join us in hoping that the B.B.C. will succeed in persuading him to broadcast one day. Mr. Bernard Shaw refused invitations to broadcast many times, but at last he agreed. Let us hope the same will be the case with Mr. H. G. Wells.

The First Listener.

The B.B.C. have been making some enquiries with a view to determining the earliest listeners. Mr. Charles Pratt, of Parkeston, in Essex, is a strong claimant in this connection. He is an operator at the London & North Eastern Railway Co.'s wireless station, one of the very few privately owned semi-commercial stations in this country. It began in 1910. Sir Oliver Lodge was personally interested in the initial equipment of this station. Mr. Pratt has been the chief operator from the start. Mr. Pratt has been a listener to broadcasting since Captain Eckersley's first Writtle programmes.

The Musical Avolos.

This trio of xylophone performers will be heard from Birmingham on Thursday, April 21st. They are unique in several ways. They have composed practically all the items they play, and they have constructed their own instruments. One of the instruments—the largest of the kind in the world—is played with hammers weighing two-and-a-half pounds each. This instrument itself weighs 260 pounds, and took 15 years to build!

Essex v. New Zealand at Cricket.

This match will be relayed in a running commentary from Leyton on Saturday, May 14th.

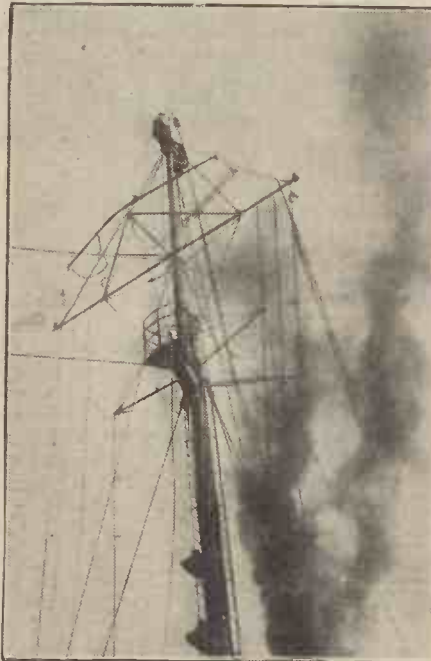

Repairing an aerial damaged by a storm at sea.

"Daily Mail" Week.

There are nearly six hours of variety in the programmes of the week beginning April 24th—the week in which the results of the "Daily Mail" Ballot are being interpreted. A good chunk of talk time vanishes, but there are no sweeping differences in other programme items. The variety periods are so considerable that the B.B.C. are having no little difficulty in getting enough talent. Their effort will be composite, Birmingham, Manchester and Glasgow contributing to the common pool for this purpose.

"R. U. R." by Broadcast.

"R. U. R." the fantastic Robot melodrama by Carel Kapek, adapted by Nigel

Playfair, and produced at St. Martin's Theatre in 1923, is to be broadcast from London on May 3rd. The radio version is being prepared by Cecil Lewis.

Shakespeare's Birthday.

April 22nd, the anniversary of Shakespeare's birthday, will be celebrated by a special radio version of "The Merchant of Venice," to be broadcast from London and most other stations. The cast will include Raymond Trafford (Shylock), Phyllis Neilson Terry (Portia), Austin Travers (Bassanio), and Hilda Bruce Potter (Nerissa).

A Good Mixture.

Excerpts from the speeches at the Royal Academy dinner, a variety entertainment, and items by the Railway Clearing House Choir are included in Saturday evening's programme from London on April 30th.

Adult Education by Broadcast.

The B.B.C. are launching a special campaign to develop the co-operation of adult education authorities and bodies. It is hoped soon to make broadcasting a normal part of all the plans of study of the numerous organisations engaged in stimulating adult education. As in other branches of educational work, Scotland is well ahead of the rest of the U.K. The man behind the scenes in Scotland is Mr. J. S. M. Thomson, the brother of Mr. Cleghorn Thomson, the brilliant young Controller of B.B.C. activities north of the Tweed. Mr. John Thomson is in charge of the Y.M.C.A. in Scotland. This gives him an interesting and useful background of knowledge to guide his keen young brother in broadcasting.

Edinburgh en Fête.

Edinburgh will put on a special Scottish national programme on April 20th. Mr. Donald Shaw, President of the Highland Pipers' Society, will introduce the main programme items. The Edinburgh Highland Reel and Strathspey Society's Band will give a special representative selection of strathspeys and reels. Mr. Neil Orr's Edinburgh Gaelic Choir will also be heard. The soloists of this choir are Miss Helen Whitelaw and Mrs. Neil Orr. The evening will be S.B. for Scotland.

"Dick" Sheppard and the B.B.C.

Last October POPULAR WIRELESS discussed the possibility of the Rev. H. R. L. Sheppard going to Savoy Hill to take over the Sunday work. "The Times" has raised the matter afresh, and it is understood that conversations on the subject have been resumed between Mr. Sheppard and the B.B.C. headquarters officials concerned. It is impossible to forecast with accuracy the outcome of the negotiations, but this much seems certain, that Mr. Sheppard will retain some kind of connection, official or unofficial, with the B.B.C. That very large body of listeners who like Mr. Sheppard are anxious that he should have a staff job at Savoy Hill; but this outcome is doubtful. Mr. Sheppard's independence of judgment and belief commend him to the "man-in-the-street," but the same qualities are not as popular with hierarchies and authorities. Not that the B.B.C. would mind, but a Royal Chartered organisation must pay some attention to orthodoxy. Moreover, Dick Sheppard's amazing popularity as a preacher invokes a certain jealousy, and perhaps a little apprehension in the breasts of other preachers. But it is good to know that his voice will not be barred from the microphone.

THE IMPORTANCE OF THE AERIAL SYSTEM.

An article which should be read by all constructors.
 By SIR OLIVER LODGE, F.R.S.
 (P.W.'s Scientific Adviser.)

I SOMETIMES think that amateurs (I don't mean listeners-in, but those who take an interest in the working of their sets), though they pay great attention to the coils and condensers, and connections, might do well to pay more attention to the aerial. For, after all, the aerial has to collect all the energy with which they deal.

It is true that almost any aerial will serve, and that sets are made with none at all; or with a frame aerial in the lid of the box, though the amount of energy collected by this method must be very small. By a series of valves the least trace of energy can, by good arrangements, be worked up to any desired amount without much distortion; just as a high-power microscope may make visible things of incredibly small size. But with every increase in the power of a microscope the difficulties of manipulation increase, and optical imperfections become more pronounced. A high-power microscope has to be very perfectly made in order to be efficient; whereas, when working on objects of reasonable size a low-power microscope or a single lens can be used with great ease and convenience.

Importance of Height.

Similarly in a wireless set: a series of good valves, properly arranged, can work up an almost infinitesimal amount of energy. But surely it would be easier to collect more energy and magnify it less.

Moreover, the valve part of the apparatus means battery expenditure and running cost; whereas, a good aerial, as part of the original equipment, is of the nature of capital, and involves no current expenditure. In many places a good aerial is impracticable, and people are content with an indoor arrangement, or with something quite inconspicuous. But in the big

sending stations great attention is paid to the aerial, and it is by far the most conspicuous part of the installation.

The Eiffel Tower is so effective because it has such a lofty aerial. Similarly a lofty receiving aerial would pick up a considerable amount of energy, and ought to make reception easy. An over long aerial may be unsuited to short waves, though its wave-length can always be shortened, if desired, by a condenser in series. But many people now listen to long-wave stations such as Daventry, for which an aerial up a hillside or tall mast or chimney would seem to be appropriate.

There may be many practical difficulties

and some legislative ones, and I do not dogmatise on the subject; but I think that some experimenters in out-of-the-way districts might put up a good aerial, that is, one that rises to a considerable height above the earth (for height after all is the most valuable feature, receptivity depending on the square of the height, other things being equal), and see whether he could not get good results even on a crystal set, without any magnification. Perhaps a single valve would be necessary; it depends upon circumstances. One cannot tell without making the experiment.

Advantage of Stranded Wire.

I have seen it stated that conductivity in an aerial does not matter. It does not if you are ready to employ plenty of magnification. It is also said that a thick wire is not better than a thin one. As a matter of fact a thick wire is rather better; but a stranded wire, that is many thin insulated wires in parallel, stranded or packed together into a small cable, will be better still. The effective conductance of a wire depends on the surface it exposes to the ether. The ether penetrates into the interstices of a stranded wire as it cannot penetrate to the interior of a solid wire, and all the wires of the strand assist in conveying the current. It is the insulator between the wires that enables the ether to penetrate, and this insulator must be dry; for anything like conductivity in the insulator makes penetration more difficult.

Wave energy only reaches a conductor through the insulator round it; but it is remarkable through what narrow crevices and into what small interstices the ether effectively penetrates; thus enabling the waves to reach the conductor, which taps the ether, and transmits the high frequency oscillations down to the rectifying and receiving mechanism.



Sir Oliver Lodge, F.R.S.

MANY of the single headphones which can be purchased so cheaply nowadays give an excellent quality of reproduction, and therefore there is no reason why they should not be more generally employed for listening-in purposes.

Of course, the one disadvantage of these single headphones is that they are most difficult to wear, and usually they have to be held in the hand against the ear.

However, by a very simple procedure this great fault may be to a certain extent eliminated.

Procure a foot or two of No. 14 D.C.C. wire, or wire even thicker than that if it is readily obtainable. Double the wire, and then shape it roughly in the form of a head-band, as shown in the illustration. Two small holes are then drilled in opposite sides of the 'phone earpiece, and the ends

ADAPTING SINGLE HEADPHONES.

By "AMEC."

of the wire are pushed through these. Finally, the wire ends are flattened out gently inside the earpiece, thus making the latter loosely but safely attached to the wire headband.

The above is a very convenient method of utilising a single headphone earpiece, and if the wire headband is made with but reasonable care, it will remain, after a preliminary adjustment, on the head of the wearer without showing any signs of slipping off.

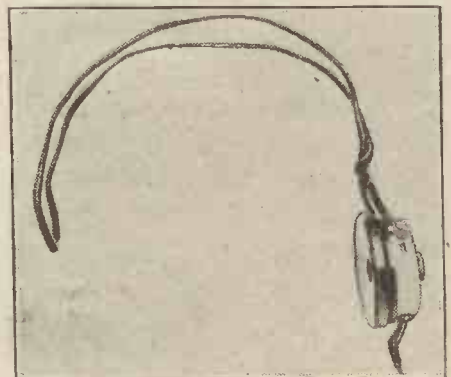

The single 'phone described in the foregoing article.

CONE AMPLION SPEAKER



"OPEN TYPE"
Model AC3

An exposed cone of exceptionally well-balanced and neat appearance. In performance, fully up to standard; in price, most attractive.

£3 : 15 : 0

Dimensions: Height, $16\frac{3}{4}$ "
Overall diameter of cone, $14\frac{5}{8}$ "

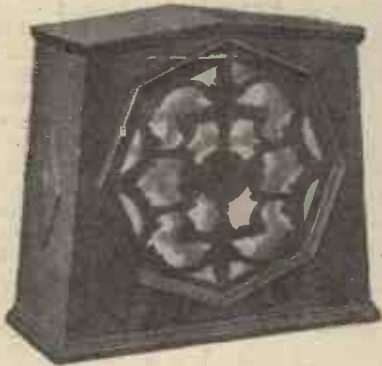

"DARK OAK"
Model AC5

An original and compact cabinet of plain but good design, moderate in price.

£6 : 0 : 0

Dimensions: Base, $15\frac{1}{2}$ " x $6\frac{1}{2}$ "
Overall height, 14"

The Advent of a Masterpiece

EVER since the inception of Broadcasting the AMPLION Loud Speaker—in its varied horn and cabinet types—has been looked upon as the World's Standard. This was the outcome of over 30 years' experience in the construction of Loud Speaking telephones, and now, after further extensive research and experiments, AMPLION Engineers have evolved an entire new range of instruments. These afford remarkable progress in the art of Radio Reproduction, and every model is, without doubt, a masterpiece. The new AMPLION Cone Speaker has the following outstanding features:—

- ☞ An adjustable unit of improved type, remarkably sensitive and efficient, yet robust.
- ☞ A cone diaphragm made, *not of paper*, but of *strong seamless material*, acoustically correct and entirely impervious to changes in temperature and climate—a vital point.
- ☞ A system of construction which possesses all the qualities inherent to cone speakers without any of the common defects, thus affording extraordinarily life-like and natural results.
- ☞ A carefully considered and well-balanced design such as to eliminate the necessity for a special amplifier; in effect, the AMPLION CONE gives—on any ordinary receiving set—remarkable fidelity in reproduction.

Amplion still leads

The Natural Tone Loud Speaker

IN the new AMPLION the better features of the Cone type have been preserved and developed, while certain undesirable features have been eliminated.

The lack of sensitivity, combined with a need for frequent adjustment and a tendency to "drumminess"—popularly supposed to be inherent to the cone speaker—is entirely absent in the AMPLION Cone.

No longer is there need to suffer from the well-known "phonograph effect" so commonly associated with Wireless Loud Speaker reproduction, even of the best obtainable quality. Nor must the other extreme, an "artificially mellowed" tone, be adopted as a poor remedy.

The AMPLION Cone Speaker has been designed—by giving the right pitch and proper balance—to afford fidelity in reproduction, following a close practical study of the average characteristics of British Radio sets and ordinary conditions of reception.

The net result is a quality of reproduction quite unlike anything hitherto attainable—a reproduction which may be truly described as a remarkably close approximation to, and practically indistinguishable from, the real thing.

Send for Descriptive Booklet W.L.5.

GRAHAM AMPLION LIMITED,
25, Savile Row, London, W.1

**CONE
AMPLION
SPEAKER**



"JACOBEOAN OAK"

Model AC7

A particularly handsome and stylish piece of furniture in period design

£6 : 10 : 0

Dimensions : Base, 15" x 7¼".
Overall Height, 15½".



"CHIPPENDALE"

Mahogany Model AC9

A striking cabinet design of beautiful lines and finish, worthy of association with furniture of the highest class.

£7 : 0 : 0

Dimensions : Base, 17¼" x 7½".
Overall Height, 16½".

For Better Radio Reproduction

EUROPE'S WAVE-LENGTH CHANGES.

BY THE EDITOR.

THE experimental transmissions by Daventry Junior on 400 metres have made it quite clear that this is an unsuitable wave-length, for, within a radius of 50 or 60 miles of that station, it is extremely difficult to tune out Daventry Junior in order to receive a local station. The 400 metres wave-length, however, is not definite, and we do not know as yet exactly what wave-length will be allocated to this new station.

It is also becoming clearer and clearer that the Geneva wave-length plan has only proved partly successful, for the constant listener will agree that there still exists a considerable amount of interference between broadcasting stations in Europe, and that of late the trouble has grown even more pronounced.

An analysis of this interference shows that the station at Toulouse is badly interfered with, while Bernc, Gotenberg and Glasgow have been interfering with each other. Langenberg and Paris also interfere with each other, while within a radius of a few miles of London it is extremely difficult to tune in Stuttgart and other German broadcasting stations near to 2 L O's wave-length.

When these stations are tuned in, London can also be heard at a strength sufficient to spoil one's enjoyment of the foreign programmes. The trouble is that the stations concerned under the finds of the Geneva Wave Plan Committee are not all carrying out the recommendations of that committee, and so far the Spanish stations have entirely ignored the plan. They have had wave-lengths allotted to them, but they have not yet adopted them; and it seems quite likely they do not intend to adopt them.

Co-operation Wanted.

This is extremely disappointing, as no doubt listeners will agree; that a few Spanish stations should upset the apple-cart of what was, after all, a very meritorious attempt on behalf of the Geneva Wave Plan Committee to reduce interference among broadcasting stations.

We understand that a Committee of Enquiry has been appointed by the Spanish Government to deal with the question of the adoption of the wave-lengths by Spanish stations. But Spain is not entirely to blame. There are other offenders. And, again, since the plan was brought into operation officially, a good number of new broadcasting stations have started transmissions without any reference to the Geneva rulings or to the Union Internationale de Radiophonie.

If, of course, European Broadcasting Companies are going to ignore the International Radiophone Bureau at Geneva and the rulings of the wave-length plan committee, then the work of that committee will be completely nullified, and holding conferences for the benefit of European listeners and for British listeners will simply be a waste of time.

The trouble is the International Radiophone Bureau has not the international

support of the Governments of the various countries; its findings are more or less unofficial. It merely makes recommendations which the Governments of the countries concerned are invited to consider and to adopt. But there is no international law to enforce its rulings, as is the case with the Berne Wireless Telegraph Convention of 1911.

The Forthcoming Conference.

Another big conference is to be held in Washington in October. It is "billed" as the first International Wireless Conference since the War, and we understand that its deliberations will last at least two months. Its main object will be to revise the conventions as laid down fifteen years ago. The Radiophone Bureau of Geneva is to send delegates, and no doubt representatives of the B.B.C. will also attend.

A good deal of the business will be in connection with European broadcasting problems, and we understand that it will be urged that the wave-band of 200 to 570 metres should be reserved exclusively for broadcasting and kept clear of Morse. How Morse is to be kept clear of wave-lengths near 570 metres, which, of course, is very near 600 metres—the ship's wave-length—we do not know, for so many

ships these days still retain obsolete spark apparatus, and to cut out transmissions of this nature, even with the most selective apparatus, is—as our readers know—extremely difficult, especially on the south and east coasts.

There is no doubt that a considerable tightening-up of the regulations governing broadcasting stations in Europe and Great Britain is required. America does not affect broadcasting this side of the Atlantic, but from what we know of the conditions over there, we should think that America also should seize this opportunity of drastically dealing with the broadcasting situation in the States.

There are two main sources of trouble—in Europe, at any rate:

(1.) The increasing number of broadcasting stations which spring up like mushrooms in the night and start transmitting irrespective of the findings of the Geneva Wave Plan Committee, and

(2.) The failure of certain stations to keep their promise and change their wave-lengths in accordance with the plan.

Until these two problems are dealt with effectively, the real pleasures of DX listening and the international effects of broadcasting as a means of propaganda and amusement will never become really satisfactory.

It seems that the solution is to give executive power to the International Radiophone Bureau. At present it is a sort of milk-and-water League of Nations Committee, but if it can only make recommendations which are to be carried out, if the various Governments concerned think fit, then unity of purpose and unity of organisation will never result. Instead, chaos, and the retardation of European broadcasting.



The new No. 7 studio at B.B.C. headquarters, Savoy Hill, W.C.2.

Where Your Crystals Come From

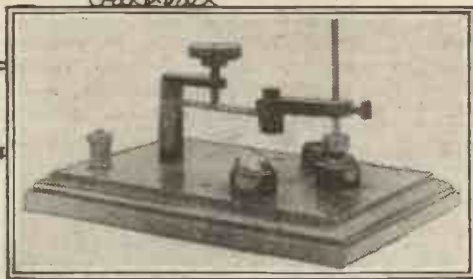

It would be difficult to find a commoner article than a wireless rectifying crystal among the apparatus and equipment of the average radio user. Yet, despite this fact, the origin of the radio-sensitive crystal is, to many people, quite a matter of mystery. I remember once conversing with an old gentleman who, although he was really frantically interested in wireless, held many peculiar and entirely original

An extremely interesting and informative article by our Staff Consultant, who is an authority on radio sensitive crystals.
By J. F. CORRIGAN, M.Sc., A.I.C.

another, is a very abundant mineral. It is found in all parts of the world. There are great natural stores of the mineral in America, Germany, France, Spain, and even in the vast and almost unexplored (and certainly unexploited) regions of Australia galena occurs in immense quantities. Even in England we are not without galena mines, although the amount of ore yielded by these mines is not great.

Radio-Sensitive Ore.

Unfortunately, most of the galena which is mined for the purpose of manufacturing metallic lead is of very little use in the radio industry, owing to its comparative insensitivity. The majority of the sensitive galena which we use in this country comes from special mines situated in the south of France and in Spain. In these mines the mineral occurs in a peculiarly crystallised form. The crystal lumps are fine-grained (comparatively speaking), and it is from this material that the natural galena of radio science is obtained.

The mineral is found, in common with

many other minerals, in quarries in the sides of hills. Here it is mined, as the photograph Fig. 1 will show, and the crude ore is then conveyed to large breaking and pulverising machines. One of these machines is illustrated at Fig. 2. The raw mineral is tipped into these machines, and it is separated from dirt, rock, and other impurities, and finally obtained in any desired grade of fineness, from a mere powder to lumps weighing several pounds each.

It is from these latter mines that our radio-sensitive galena comes. A crystal



Fig. 1. Bringing the ore from one of the quarries.

notions on the subject. One of his hectic beliefs was to the effect that the ordinary galena crystal consisted of a number of very fine lead and silver turnings which had all been cemented together with some metallic cement!

Galena Mines.

Well, although it is quite certain that none of my present readers will be labouring under any such delusion regarding the nature of the crystals they use, there will be, perhaps, many individuals to whom a little information concerning the origin of the average radio-sensitive crystal will be of interest. After all, the radio crystal is always full of interest, and, as we shall see, the facts concerning its production are hardly less interesting.

Let us begin by considering the commonest of all radio-sensitive crystals nowadays—the crystal galena. That is to say, the brightly glittering crystal which makes its appearance in so many different proprietary guises on the modern radio market.

Galena, as the reader will be aware, is a naturally occurring mineral consisting, for the most part, of a compound of lead and sulphur. Hence the mineral galena is technically said to be composed of lead sulphide. Now, galena, in one form or



Fig. 3. A natural lump of galena before it is broken up for radio purposes.

dealer or manufacturer trading in his own proprietary brand of natural galena will have regular consignments of small galena lumps sent over to him. Such lumps may weigh anything from an ounce to a pound or more. The illustration, Fig. 3, shows a typical lump of this naturally sensitive galena before it has been broken up, tested, and graded by the crystal dealer.

Testing Crystals.

The process of breaking up and testing galena for the radio market is a tedious one, but nevertheless, it is a task which must be undertaken with great care if the final marketed products are to possess a high and a uniform sensitivity. The actual breaking up of the lump galena, too, is not so simple a job as it might seem. Generally, it is a very wasteful operation, as much as 40 per cent. of the material being rendered useless during this process. The cheaper grades of crystals are usually tested out *en masse* or in large batches, but the best varieties are each tested singly on actual broadcast reception. It is in many respects this careful process of testing good quality crystals which sends their prices up.

(Continued on next page.)

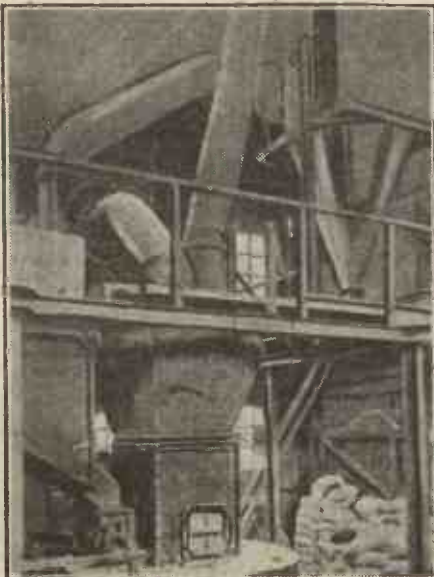

Fig. 2. One of the giant pulverising machines used to crush the ore.

WHERE YOUR CRYSTALS COME FROM.

(Continued from previous page.)

Of course, quite a considerable amount of radio-sensitive galena is now manufactured entirely artificially. The process consists in heating up raw galena or lead sulphide until it fuses, and then allowing it to cool down slowly in order to effect a fine crystallisation of the molten mass. Such a process has to be performed in a high-temperature electric furnace, because the ore does not begin to melt until a temperature approaching a thousand degrees centigrade has been attained.

Carborundum.

Another artificial crystal is the well-known carborundum, which consists of a compound of silicon and carbon. In the manufacture of this crystal, which is chiefly carried on at the Niagara Falls, in Canada, on account of the cheap electric power in that locality, a mixture of purified sand and granulated coke is packed into an

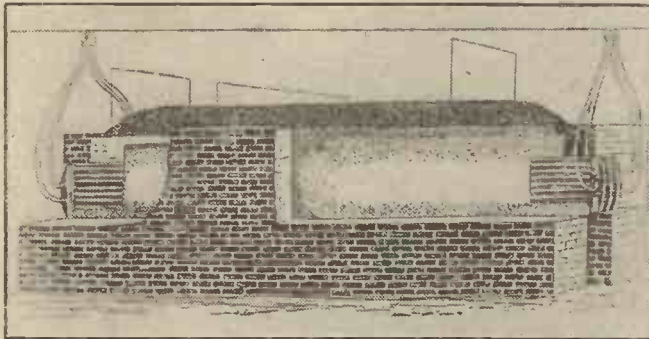

Fig. 4. The preparation of carborundum is carried out in electric furnaces similar to the one illustrated above.

electric furnace, similar to the one illustrated at Fig. 4. A heavy current is turned on, and the furnace is heated up for about eight hours. After this time, the furnace is allowed to cool down, and the crude carborundum is dug out. The product is crushed and treated with mineral acids to remove impurities.

Silicon is another radio crystal which is artificially manufactured. In this case, however, the crystal is not composed of any chemical compound. It is an element, that is to say, it consists through and through of silicon, and nothing else. The manufacture of commercial silicon is not unlike the electric process for the manufacture of carborundum. In the preparation of silicon, fine purified sand and coke are heated in an electric furnace, but the proportion of sand is kept in excess of the amount of coke used. In this manner, silicon occurs as the final product of the electrical fusion.

A Scarce Rectifier.

Turning now to other crystals which are used for wireless rectifying purposes we have the highly satisfactory, but considerably scarce, iron pyrites. Iron pyrites is really an extremely common mineral. It is found in many parts of the world, and in this country we can find masses of it occurring in rock quarries, in the sides of hills, and even on the seashore. Unfortunately, however, not much of the mineral so found

is sensitive. The sensitive specimens of iron pyrites have generally a very smooth and polished lemon-yellow appearance, and they have the peculiar surface formation shown at Fig. 5. A small amount of sensitive iron pyrites comes into this country from Italy, but it is not much. Germany seems to be favourably situated for good supplies of this mineral, for in many parts of that country iron pyrites detectors are as common as galena ones are over here.

Copper Pyrites and Bornite.

Next we have two very similar ores (or similar ones so far as their radio-sensitive properties go), to wit, copper pyrites and bornite. Copper pyrites is the commoner ore of the two. Here again we have two minerals which occur naturally in rock veins and mineral quarries in many widely differing regions of the world. Copper pyrites is mined in Cornwall, in Derbyshire, and also in regions such as Siberia, the Ural mountains, Australia, South America, and so on. Bornite occurs, also, in the same regions.

Both bornite and copper pyrites are sulphides of copper, but they contain iron also, and other impurities, and it is very likely that the nature and proportion of these natural impurities have a great bearing on the rectifying properties of these minerals.

The minerals, bornite and copper pyrites, in common with most of the other radio-sensitive minerals, are mined in very much the same manner as galena. They are separated from dirt

and other earthy impurities, mechanically washed and broken up, and finally specially selected masses of the mineral are sent in small sacks to the radio dealer in crystals for his own treatment and grading.

Two Rare Minerals.

Tellurium, a rectifying element which is of very great value to the crystal set owner and experimenter, is found in certain rare minerals, such as tellurite, which is an oxide of tellurium, and also *tetradymite*, the latter being a combination of tellurium and bismuth. The element also is found in some parts of the world in its free state. Most of the radio-sensitive tellurium sold nowadays, however, is extracted along with selenium, from the sludge which is formed as a by-product in the settling tanks of sulphuric acid works, the metal originally coming from the pyrites which is employed in the manufacture of the acid. The tellurium so obtained is then generally purified by chemical means, and finally cast into sticks or crystallised. Tellurium is a rare element, and owing to its excellent rectifying properties when used in conjunction with zincite or copper pyrites in a detector of the perikon type, is in con-

tinual demand. Amateurs, therefore, who hold supplies of this crystalline metal would be well advised to conserve their stock of it to the utmost degree, for, owing to the demand which is made upon the metal, it is certainly not getting more plentiful or cheaper.

A rectifying mineral which is seldom used nowadays, except by the enthusiastic experimenter, is molybdenite, a sulphide of the metal molybdenum. Molybdenum

is a very useful metal indeed, and thus there is a constant demand for its ore, molybdenite. In appearance molybdenite is not unlike galena, except that it has a greenish cast



Fig. 5. Sensitive specimens of iron pyrites have a definite surface formation, as shown in the illustration.

about it, and that it usually takes the form of flattish plates of mineral, the surfaces of which can be peeled off in a manner similar to mica. The ore molybdenite has been found in small quantities in this country, but the chief source of present day supplies is South America.

Finally, we come to an extremely interesting rectifying mineral, zincite. Now zincite is really a naturally occurring oxide of zinc, its red colour being due to the presence of slight amounts of manganese compounds. The curious fact concerning zincite is that although there are many zinc ores very much akin to it in physical properties, almost the whole of the supply of this red zinc ore which is of any use for wireless purposes comes from a group of mines situated in the New Jersey district of North America.

It is on account of the above facts that zincite possessing good rectifying properties is fairly scarce. Naturally, efforts have been made to manufacture rectifying zincite crystals artificially. The exact process by which these artificial zincite crystals are prepared is kept secret, but, nevertheless, the synthetic zincite consists of nothing more than fused zinc oxide, the fusion being carried out in a high temperature electric furnace.



Fig. 6. Testing samples of radio crystal before placing them on the marks.

Constant Coupling

LAST week I briefly explained the general principles of the new Loftin-White system of combined constant-coupling with an ingenious method of preventing self-oscillation. I also gave photographs of an experimental board by means of which the circuit can be tested by the reader himself. This week I want to give you some actual details of how to wire up this board, and what you can do with it.

Let me say at once that it should not be the aim of the experimenter actually to

Some interesting and practical details concerning the wiring up of an experimental receiver on the Loftin-White principle.
By
PERCY W. HARRIS, M.I.R.E.
(Editor of "The Wireless Constructor.")

principles, it is better to consider the inter-valve coupling alone in the first tests.

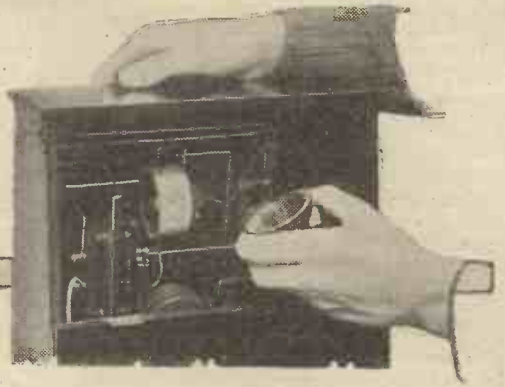

capacitative and inductive methods, and the practical wiring diagram of the set made up for this week's experiments shows the moving coil in the coil holder as the inductive winding, and the McMichael clip-in condenser as the capacity for the purpose.

The Intermediate Condenser.

The grid circuit, consisting of another plug-in coil tuned with a variable condenser, is quite conventional, a fixed condenser being shunted across the telephone terminals in the plate circuit in the usual manner. The very important intermediate condenser which serves to shift the phase is made variable for this experimental work, although once the correct value has been found it can be fixed in a finished receiver. The centre condenser of the three is used for this purpose, and, as previously explained, has a value of .0005 mfd.

For general experimental work on the ordinary broadcast band, a No. 60 plug-in coil should be placed in the fixed socket (i.e. the grid-coil socket for the detector valve), and, as a first trial, a No. 35 as the inductive coupling (moving coil).

Connecting Up.

The centre condenser should first be placed at its maximum capacity, and a .002 mfd. or .003 mfd. condenser clipped

(Continued on next page.)

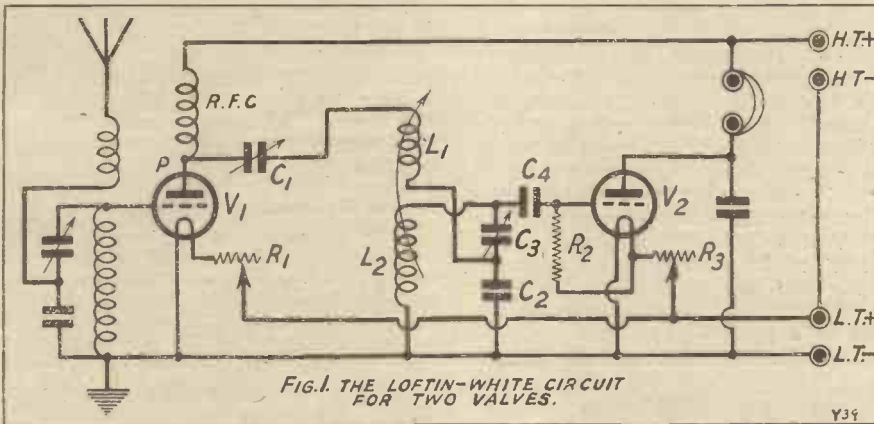

FIG. 1. THE LOFTIN-WHITE CIRCUIT FOR TWO VALVES.

duplicate this board assembly in detail; any similar apparatus will do. For example, I always keep a few odd strips of ebonite with slots in them, into which I can quickly slip "one-hole-fixing variable condensers." These strips can then be screwed along the front of a baseboard in any convenient position without the need of using a special ebonite panel. If you have an odd piece of ebonite sufficiently large to carry all three condensers, by all means use it; the whole scheme is to utilise any existing apparatus you have in the most economical fashion.

Conventional Aerial Coupling.

In addition to this you will require one standard six-pin split-primary aerial coil, a few plug-in coils of values up to 75, and several McMichael clip-in condensers of values which you will choose after reading this article.

If you will refer to Fig. 1 in my last week's article (reproduced again this week) you will see that the first valve is not coupled to the aerial in the conventional way. There are several methods of joining the aerial to the present set, but I have chosen the tapped aerial method, using a standard six-pin coil. It would, of course, be better to couple the aerial by the Loftin-White system, but in experimental work of this kind we do not want too many variables; and, in order to get a good grasp of the

We thus use an H.F. valve joined to the aerial in the conventional manner, the point of interest in the set being the method of coupling this valve to the detector. As will be seen from the theoretical diagram, the coupling is a combination of

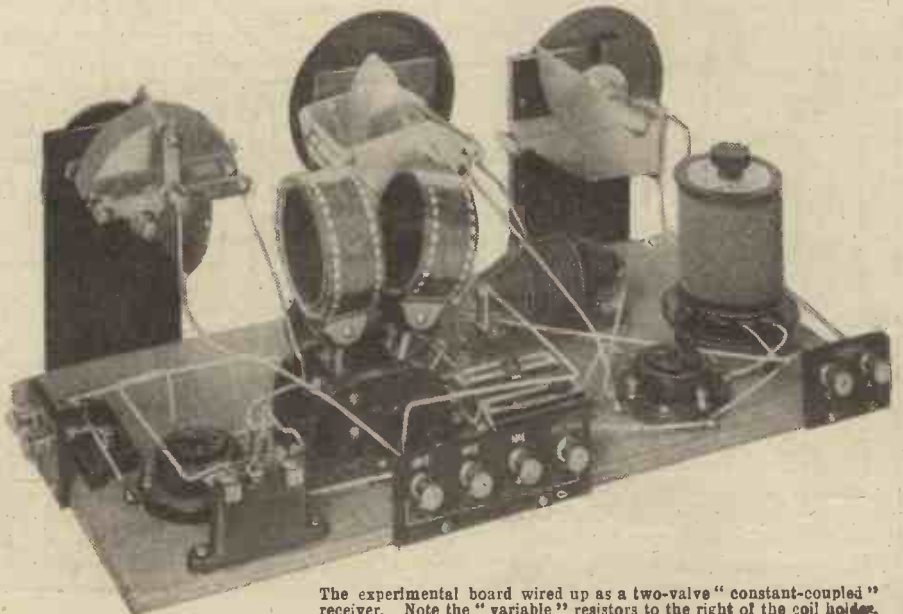

The experimental board wired up as a two-valve "constant-coupled" receiver. Note the "variable" resistors to the right of the coil holder.

CONSTANT COUPLING.

(Continued from previous page.)

in for the capacitive coupling. The coupling between the moving and fixed coils should be made fairly tight. Any suitable H.F. valve should be plugged in the first socket and a suitable detector valve in the second. Aerial and earth should not be connected yet.

Preliminary Adjustments.

Connect your batteries, a pair of telephones, and tune on the first and third dials until the first and second grid circuits come into resonance. Vary the coupling between coils and experiment generally, and you should soon find that the set can be made to oscillate over the whole range of the tuning condensers. If this does not happen, you will get one of two effects: either the set will tend to oscillate at the top of the condenser scale, and not at the bottom (quite the reverse of the usual state of affairs!), or you will get the reverse effect of a tendency to oscillate more at the bottom of the scale than at the top. If the former phenomenon occurs it shows that your clip-in condenser is of too small a value, while if the latter this condenser is too large. Between .002 and .004 you will find the correct value, when you have arranged your coupling between the moving and fixed coils to the correct value.

It is worth while experimenting with various sizes of coils in the moving coil socket. The fixed coil should not be altered once you have found a coil to suit your wave-length range. The actual

degree of coupling is best found by experiment, for the mechanical separation between the coils will differ for different makes of coils.

The actual components needed for this experimental board are given below.

COMPONENTS REQUIRED

- 3 Variable condensers, each of .0005 mfd. preferably. (Note: The middle condenser can be a .0003 mfd., but this is barely large enough for all the experiments.)
- 2 Baseboard-mounting sockets.
- 1 Six-pin coil base.
- 1 Radio-frequency choke.
- 2 Baseboard-mounting resistors (one, at least, variable).
- 1 Base for McMichael clip-in condensers.
- 1 Two-coil holder.
- 1 Fixed condenser, .001 mfd.
- One .0003 mfd. fixed condenser with clips for leak (it should be possible with this condenser to connect the grid leak from the grid to positive filament, and not across the condenser).
- Terminal strip for aerial, earth, L.T. neg., L.T. pos., H.T. neg., H.T. pos., and telephones.

You will notice on my baseboard layout that I am using what have sometimes been humorously called "variable fixed resistors"; that is to say, baseboard resistors which are variable and calibrated. It is a great help to have the resistor for the H.F. valve variable, so that you can dull the filament down to a point where it just stops oscillating. This adjustment is most helpful when the set is oscillating at, say, the top end of the scale. You can then dull the filament of the H.F. valve to a point where it will just stop

oscillating. Having found this point, increase the brightness just slightly until the set begins to oscillate once more. Now turn to the other end of the scale and find whether the set will oscillate there or not. You have to aim in these experiments at an adjustment of values so that the set will oscillate uniformly, and at an equal strength over the whole scale. Once you have found this position the H.F. valve can be brightened up until it is working at a maximum efficiency.

Preventing Oscillation.

The next step to take is to stop the set oscillating without losing efficiency, and to adjust it until you find a point where the set is just below oscillation-point over the whole range of the condenser scale. To do this it is merely necessary to reduce the value of the centre variable condenser. You will then find the set is in that desirable state which we have all so frequently sought—highly sensitive over the whole tuning range, without any need to touch a reaction control. When you have found this state of affairs, you can connect your aerial and earth, and you will find that the set is surprisingly sensitive. There are two reasons for this sensitivity, one being that the coupling is constant over the whole range, and the other that you can get a really efficient coupling between primary and secondary of your H.F. transformer (in this case the moving and fixed coils in your coil holder) without self-oscillation taking place.

Possible Modifications.

Several modifications of this experimental modification of lay-out are possible. For example, you can, if you desire, use the ordinary type of plug-in coil instead of

(Continued on page 309.)

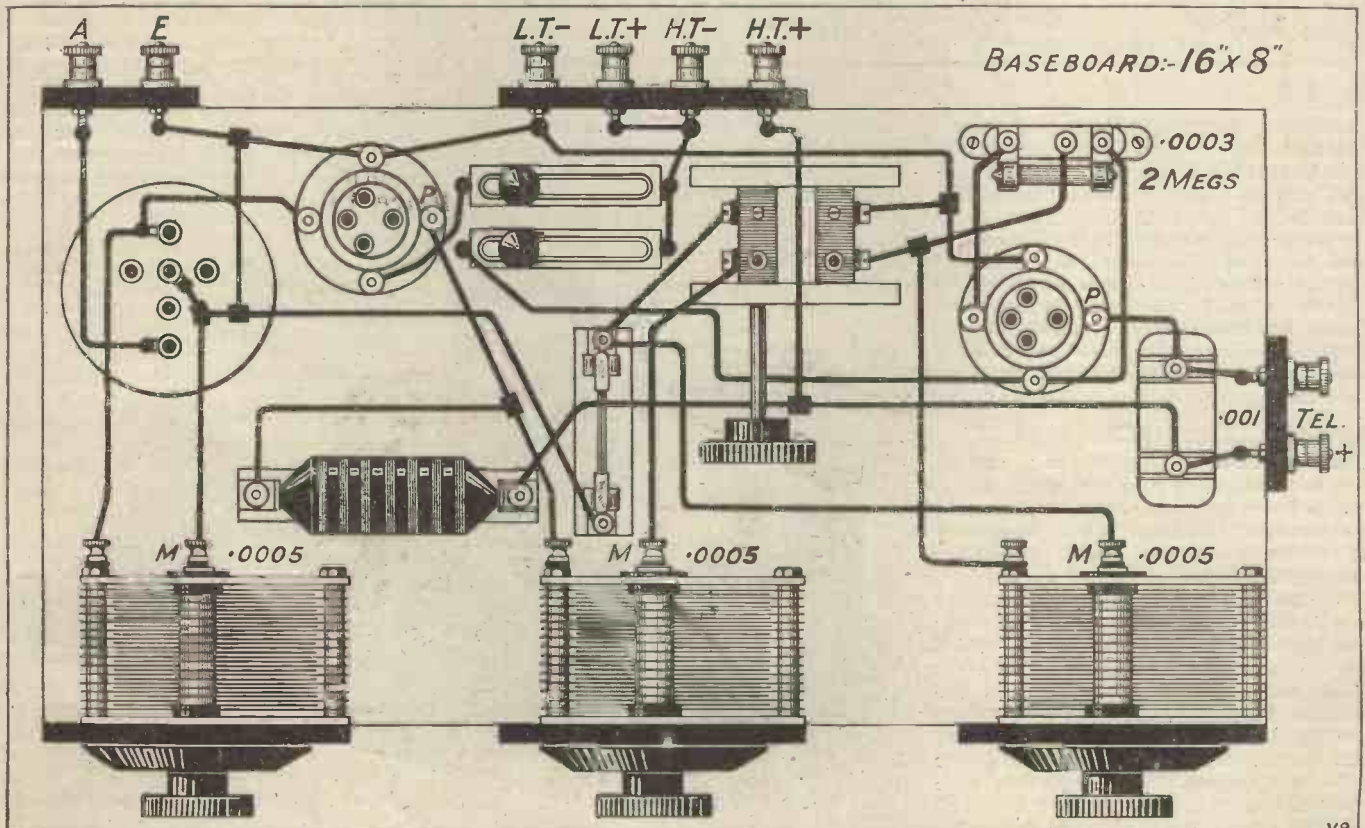

"STEEP SLOPE"! MEANS STRONGER SIGNALS



"The steeper the slope of the characteristic curve the stronger is the reception of weak signals, the better the reception of good signals, and the greater the purity of reproduction," said "TONE" to "POWER."

"That's 'Steep-Slope' efficiency in a nutshell," replied "POWER," "added to which 'Steep-Slope' Valves use less current, and have great mechanical strength."



The New Valves for 4 Volt Users

D.E.H. 410. A remarkable valve for the popular Resistance-Capacity Amplifiers. "Amplification Factor" 40 H.F. Price 14/-

D.E.L. 410. For sensitive H.F. Amplification and Detection, or L.F. Amplification in Transformer coupled sets Price 14/-

D.E.P. 410. You need this valve for the last stage in your set to get the utmost volume and purity from your Loud Speaker. Price 18/6

These valves consume less than 1/10 amperes and are designed to operate from a 4-volt accumulator.

Osram STEEP SLOPE Valves for TONE & POWER

THE BEST AMPLIFIER AND THE CHEAPEST IS THE NEW NON-VALVE BAR AMPLIFIER

ABSOLUTE QUIET NEEDED WHEN USING CRYSTAL SET ONLY.

"SHI"

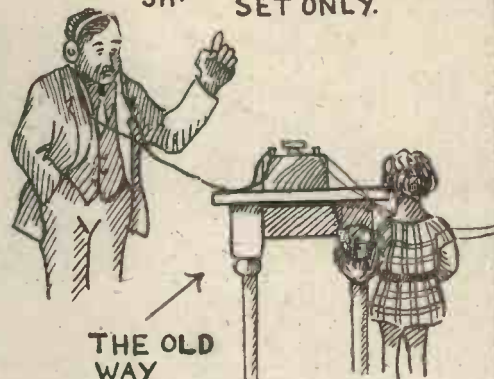

THE OLD WAY

NO NEED FOR THAT TOMB-LIKE SILENCE WHEN LISTENING-IN NOW

Complete Amplifier

Price 38/-

THE NEW WAY



GIVES REALLY GOOD LOUD PHONE RECEPTION FROM WEAK SIGNALS AND GOOD LOUD-SPEAKER RESULTS FROM SIGNALS OF AVERAGE STRENGTH

FULLY ILLUSTRATED LISTS FREE.

Order from your Dealer or Direct from:

THE NEW WILSON ELECTRICAL MFG. CO., LTD. 18 FITZROY STREET W.I. FITZROY SQUARE, LONDON.

50 WONDERFUL OFFERS.

60 volt M.A.L. Batteries .. each 4/11	Rheostats .. 1/-	Hydrometers (Unbreakable) .. 2/6	Headphones Valves—	FRELAT .. 4/-	Anti-Micro Valve Holders "DUNDAS" Loud Speaker (Full size) .. 25/-	Coil Plugs .. 4d.	Grid Bias Batteries, 0 volts .. 1/-	Knife Switches Variable Grid Leaks .. 1/-	Screw Drivers .. 3d.	Banana Plugs & Sockets .. 2d.	Earpads .. pair 3d.	Coil Plugs on Base each 9d.	Croix ..	Transformers .. 3/6	Celluloid Strips strip 3d.	TRIOTRON Valves .. each 5/-	2 mfd. Condensers .. 2/3	Accumulator Carriers .. 1/-	"FLUXITE" tin 6d.	Adhesive Tape Variometers .. 3d.	"NELSON-MULTI-Valves Basket Coil .. 7/6	Holders .. 9d.	Transfers packet 4d.	"MICRO-RADIO" Potentiometers each 4/-	"MURRAY" Valve Holders .. 1/-	2-way R.D. Coil Holders .. 4/-	Pulleys .. 2d.	Insulators .. 2 for 1d.	Valve Holders each 8d.	Crystal (NEUTRON) .. 1/-	Flash Lamp Cases .. 6d.	1-lb. 16 Gauge Wire .. 1/-	2 B.A. & 4 B.A. Rod.. foot 21	Name Plates per set 1d.	Aerial Wire Coil 1/6	Red & Black Flex yd. 1 1/2d	Panel Switch—Ebonite 1/-	Baseboard Coil Plugs each 9d.	.0003 Variable Condensers .. 3/8	Earth Tubes .. 2/-	Cone Loud Speakers .. 20/-	Voltmeters .. 2/6	Ebonite Panels 24 x 8 ins. .. 4/6	24 x 9 ins. .. 5/-	24 x 10 ins. .. 5/6	24 x 11 ins. .. 6/-	24 x 12 ins. .. 6/6	Headphone Cords .. 1/2	Electric Lamps. Metal Filament Lamps doz. 9/-	100 watt 1/2 watt type .. 17/6	100 watt Opal Lamps .. 24/-	Beaded Shades each 1/-	Nickel Spade Tags .. gross 1/-
---------------------------------------	------------------	----------------------------------	--------------------	---------------	--	-------------------	-------------------------------------	---	----------------------	-------------------------------	---------------------	-----------------------------	----------	---------------------	----------------------------	-----------------------------	--------------------------	-----------------------------	-------------------	----------------------------------	---	----------------	----------------------	---------------------------------------	-------------------------------	--------------------------------	----------------	-------------------------	------------------------	--------------------------	-------------------------	----------------------------	-------------------------------	-------------------------	----------------------	-----------------------------	--------------------------	-------------------------------	----------------------------------	--------------------	----------------------------	-------------------	-----------------------------------	--------------------	---------------------	---------------------	---------------------	------------------------	---	--------------------------------	-----------------------------	------------------------	--------------------------------

POST ORDERS. Carriage paid on orders of £1 and over. Terms: Cash with order, on money-back guarantee.

CECIL RIDLEY

'RADIO HOUSE,' MIDDLESBROUGH Phone 1366, MIDDLESBROUGH

Save One and Sixpence per Valve

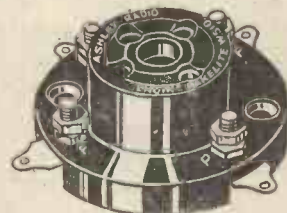

PRICE 1/3 each

Beyond the Detector stage, to pay more than 1/3 for the valve holders is extravagance. The belief that "shock absorbing" devices are necessary in every stage is a definitely exploded fallacy. For H.F. and L.F. stages there is nothing better than the new Ashley Valve Holder. Constructed throughout of genuine bakelite and non-oxidising metal, the valve sockets are surrounded by air throughout 90% of their length. Sockets and connections are stamped complete out of one piece, provision being made for wiring to terminals or soldering to tags. Moreover, a special safety groove is provided to ensure the valve legs engaging with the corresponding sockets.

STANDARD VALUE RESISTANCES



PRICE 2/6 each (with clips)

50,000 ohms to 1 megohm.

Exhaustive tests by the National Physical and other world famous laboratories have produced highly satisfactory reports. Each Resistance on completion is subjected to a prolonged ordeal during which it is under pressure at a minimum of 230 volts. Guaranteed accurate within ten per cent. Superior to wire wound. Differs in construction from all others.

Ashley Radio

If your dealer cannot supply we send post free.

Ashley Wireless Telephone Co. (1925) Ltd. Finch Place, London Road, Liverpool

FINISHING OFF FLEX.

A short article which will prove of value to the tidy amateurs.
By HUMPHREY PURCELL.

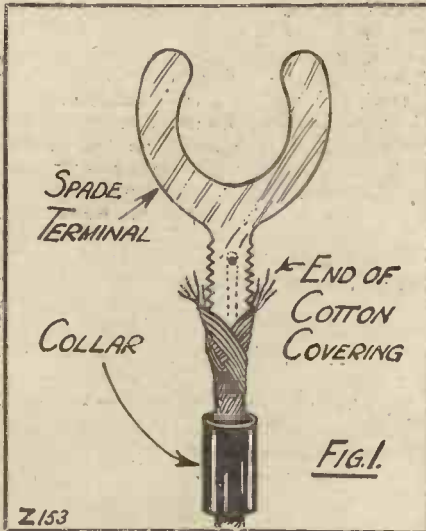

ONE of the least tidy and least efficient features of the home-made set is usually the condition of the flexible leads to the batteries, the loud speaker,

and to aerial and earth. Often the ends of the flex are merely twisted so that the seven or nine thin strands of wire are squeezed beneath a terminal until, one by one, they break away and another inch of flex has to be bared. Meanwhile, there is quite a good chance that one of the broken off bits of wire may fall where it is not needed, or that a stray strand may touch a connecting wire that ought not to be touched. Further, the experimenter in a hurry gives himself every opportunity of connecting wires to the wrong terminals.

Fixing Spade Tags.

Coloured flexible wire is very cheap, and it is a pity not to take the simple precaution of providing a lead of a different colour for each H.T. tapping. Double flex should be knotted about four inches from the end to prevent it from unwinding. The best terminals for the wires are probably those consisting of a spade or pin with a screw-on collar of red or black composition. If the ends of the cotton covering of the wire are pushed through the collar so that they are caught in the thread of the tag when the collar is screwed home, there will be no fraying (Fig. 1).

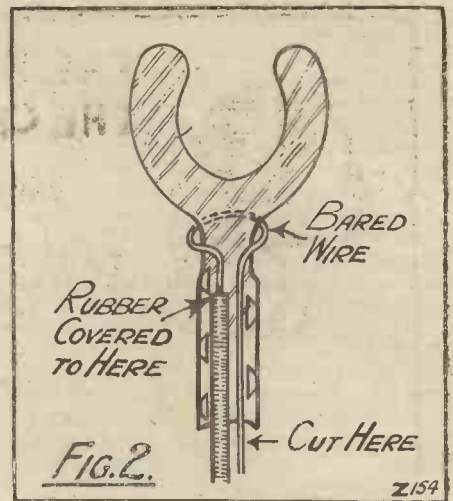

If clip-on tags are used, the bared wire should not be merely held by the turned-down teeth of the clip. A sufficient length should be bared and cleaned to allow it to be taken first up the groove between the teeth, then underneath the tag, and finally down the groove again. When the teeth are pressed down to grip the wire, the two teeth farthest from the spade should also be made to bite into the insulating cover of the wire (see Fig. 2). Even with this precaution it will probably be necessary to bind the joint to make a good job of it. Black or red cotton, or silk, should be used for binding to distinguish positive and negative leads.

CONSTANT COUPLING.

(Continued from page 306.)

the newer six-pin coil; but if you do so, you must be careful to arrange the various coils in such a way that there is a minimum of interaction between the two grid circuits. By using the six-pin aerial coil the windings of this and the plug-in coils in the coil holder are approximately at right angles.

Constant Reaction Coupling.

If you care to carry your experiments to a still further point of nicety, a .001 variable condenser could be connected in parallel with the McMichael clip-in condenser, so that you can easily obtain intermediate values between those of the various fixed condensers you may clip in. A .002, a .003, and a .004 mfd., however, will be enough for you to carry out some interesting experiments, particularly if, in addition to these, you have a small value like .0002 mfd. to show you what happens when this condenser is too small.

When you have carried out the experiments described, and have obtained a good idea of the Loftin-White method, it is quite simple to proceed with experiments in aerial coupling, thus enabling you to get a greater efficiency of coupling over the whole range than is possible by the usual methods.

In many aerial coupling methods we either use tapings on the aerial coil, as is the case with the standard six-pin

or the Lissen X coil, or we change a coil coupled to the first grid coil. In the Loftin-White method it is possible to arrange a coupling which serves from, say, 200 to 600 metres with equal efficiency without making any change.

The Loftin-White method is also applicable to reaction coupling, so as to give you a constancy of reaction in a single-valve set over the whole range of your condenser. This, too, can be combined, if necessary, with the methods I have already described. Details of experiments on this line will be given next week.

Meanwhile, I think I have shown sufficient to indicate the great importance of Messrs. Loftin and White's contribution to the radio art.

They have obviously gone into the theory and practice very thoroughly, and in their first published papers they gave particulars, not only of constant coupling between aerial and first grid, together with constant coupling between valves, but also of constant reaction coupling and the very important method of obtaining stability while retaining a really efficient degree of coupling between valves.

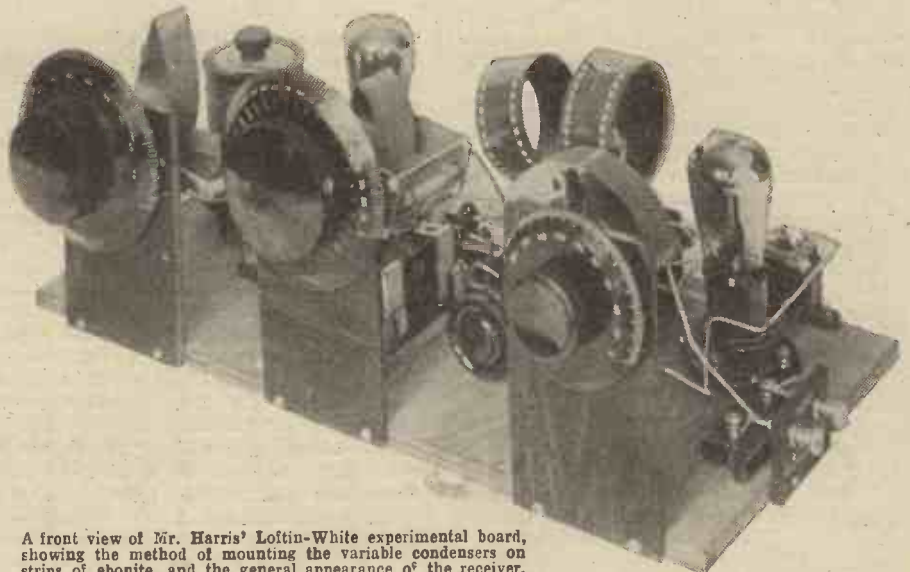

A front view of Mr. Harris' Loftin-White experimental board, showing the method of mounting the variable condensers on strips of ebonite, and the general appearance of the receiver.

Wireless Services.

I NOTICE that many wireless dealers in suburban and provincial parts are establishing excellent systems of wireless accumulator hire, exchange and maintenance services. Services of this kind have, of course, been in existence for a considerable time, but they have not been made as much use of as I think they deserve. In spite of the great variety of battery-charging and battery-eliminating devices available, there must still be a very large section of wireless users who really know nothing about the battery, beyond the fact that it is some unfortunate necessity and something which has an annoying habit of "giving out" at inconvenient times. By availing himself (or, more likely, herself) of an accumulator exchange or maintenance service, the battery can practically be forgotten and almost the only feature of the "Home Radio Receiver" which requires attention thereby ceases to be a source of trouble. The rates charged are usually very reasonable: I have before me a leaflet of a well-known service in North London, which charges only 18s. per quarter of 13 weeks for the weekly exchange of a 6-volt 30-ampere-hour accumulator; 18s. for the weekly exchange of a 4-volt 40-ampere; and 13s. for the weekly exchange of a 2-volt 40-ampere. This latter item, which works out at exactly 1s. per week, gives some 40 ampere hours (actual) for 2-volt valves, which should surely be ample for any ordinary set.

Maintaining the Set.

In addition, the wireless service, being in regular touch with the client, is able to carry out repairs and generally keep the set in perfect working order, and in the leaflet before me I see that for complete maintenance (except battery charging) a fee of 10s. per quarter is quoted. I should recommend all those who are purely listeners (and not experimenters or "fans") to look into the question as to whether the local wireless maintenance service might not be worth making use of, especially at the very low rates now prevailing.

Of Interest to the Deaf.

I have received a small booklet from Messrs. John Bale, Sons, & Danielsson, Limited, 83, Gt. Titchfield Street, W.1., entitled "Deafness Explained," with a foreword by Lord Charnwood. The book is by C. N. R. Balbi, A.C.G.I., A.M.I.E.E., Hon. Consulting Electrical Adviser to the National Institute for the Deaf. Apart from its interest to deaf persons, or to those who are concerned with the design or manufacture of devices for aiding the deaf, the little book contains a large amount of useful and interesting information on the science of audition and also deals, amongst other things, with wireless loud speakers. By means of some of the apparatus described in the book it has been possible for persons normally deaf to hear and enjoy wireless programmes. Those who are interested in this matter should get into touch with Mr. J. L. Calvard, 1, Ferens Avenue, Newland, Hull.

Detection of Small Signals.

In the "Proceedings of Radio Engineers" for February is an interesting paper entitled "A Theoretical and Experimental Investigation of Detection for Small Signals," which should be read carefully by all serious experimenters. The paper is, of course,

TECHNICAL NOTES.

A Weekly Feature
Conducted by

Dr. J. H. T. ROBERTS, F.Inst.P.
(Staff Consultant.)

rather "advanced" and requires for its proper reading rather more than an elementary knowledge of mathematics, but it is a singularly clear and concise examination of the principles of detection and the *modus operandi* of some of the devices used for the purpose. The first chapter deals with the theory of the two-terminal detector (such as the 2-electrode valve, the crystal detector or the electrolytic detector). The second chapter deals with the theory of detection in a 3-electrode valve, including, of course, simple grid-circuit rectification, anode rectification, and many other important matters. Amongst the conclusions reached, it is stated that the ordinary grid leak and condenser is not the best form of grid impedance, because of its variation with frequency and its large value at low-frequencies. The ideal impedance is one having negligible resistance to steady currents, a high impedance for frequencies from 100 to 10,000 and low impedance for radio frequencies.

Alkali Vapour Valves.

In the issue of the "Institute of Radio Engineers Proceedings" for January are several interesting papers, one by Crossley on "Piezo Electric Crystal Controlled Transmitters," another on the "Behaviour of Alkali Vapour Detector Valves," by Brown and Knipp. This latter paper is particularly interesting, and it is shown that since the original investigation of alkali vapour tubes used as detectors, new and more sensitive types of tube have been developed. In the original tubes a potassium-sodium alloy was used which, by its vapour, aided in the discharge in the tube. Means have now been found for preparing the postassium-sodium alloy in a special way, so that very much improved results are obtained and the new tubes containing the "molecular alloy" of the two metals are claimed to be ideal for durability, true tone reproduction and non-critical adjustment of anode and filament voltages.

A Talking Book.

I suppose loud speakers, more than any other radio component, and perhaps almost more than any other kitown object, have been incorporated with other devices and disguised in a hundred and one different ways. We have them as lamp-shades, flower bowls, artistic figures, and even pictures to hang on the wall.

One of the newest disguises is what appears to be an open book. This particular camouflaged loud speaker comes from America, and is described as the "talking book." It is manufactured by the Utah Radio Products Company. The open pages of the book are hand-tinted in sepia, and the whole device is finished in gold and brown morocco leatherette. It may be held in an upright position on an easel furnished with the speaker, or may be hung on the wall like a picture.

Apart from the artistic features of this loud speaker, it has certain rather novel technical features. The electro-magnetic unit is applied tangentially to the edge of a



Aerial system of the Witzleben broadcasting station. This is situated near Berlin.

specially-curved membrane. This mode of application of the vibrations of the driving unit is in contrast to that conventionally employed in which, of course, the oscillatory motion is in general normal, or at right-angles to the plane of the diaphragm.

Globe Aerial.

A new type of aerial has been produced in Germany which is really a large hollow metal sphere 10 in. in diameter. It is formed from sheet copper, and it is claimed to have practically equal pick-up receptivity for all different wave-lengths, although this claim seems difficult to support on theoretical grounds. The spherical ball is supported at the top of the mast, and is connected to a large fixed condenser.

"BEST WAY"

GUIDES FOR WIRELESS CONSTRUCTORS

Three Splendid Numbers—
Now on Sale Everywhere

PORTABLE SETS

The book is amply illustrated with photographs and diagrams, and constructors will find the wiring directions most lucid and straightforward. The sets described are: The All-Station Loud Speaker Portable. A remarkably compact six-valve Super-Het. Three-Valve Portable. Several stations on the loud speaker and many more on Telephones can be obtained with this receiver.

Baby Portable. A two-valve receiver contained in a very small attaché case.

THREE FAMOUS VALVE SETS

This book describes and illustrates in photographic detail three absolutely reliable circuits. All have been tested under normal-broadcasting conditions. The sets are "A Trinadyne Two-Valver," "The 'Chitos' One-Valve Set," and "The One-Valve Unidyne Receiver." The directions given make the assembling of each set exceedingly straightforward.

THIS YEAR'S CRYSTAL SETS

This "Best Way" Guide for the Wireless Constructor contains the latest and most authentic information for building five first-class Crystal Sets. A special feature of the book is the clear constructional photographs. All the receivers described have been carefully tested. The sets are as follow: A One-Control All-Range Set; Building a "D" Coil Receiver; The Universal Crystal Set; A Quick-Change 2 L O—5 X X Receiver; A Main Stations Ultra and The Half-Crown Crystal Set.

Price **6d.** Each

At all Newsagents and Bookstalls

Constructors Using These Books Cannot Go Wrong

ANOTHER TRIBUTE

JUST ONE AMONG MANY.... BUT....
BEING WELL EARNED.... IS JUSTLY
TREASURED... ADDING TO THE FAME
OF THE.... ALREADY FAMOUS....

LOW FREQUENCY TRANSFORMER

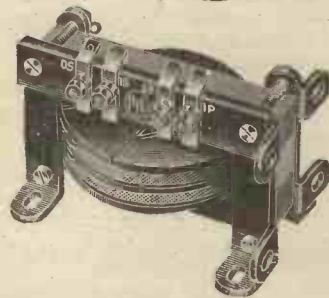

25:1 17/6
4:1 17/6
6:1 20/-

ALSO WITH
TAPPED
SECONDARY.

UNSOLICITED TESTIMONIAL

received by Mr. H. T. Knight,
Wireless Retailer, Westcliff-on-Sea.

Feb. 8, 1927.

Dear Sir,

I am very glad I took your advice on Saturday last, when I purchased a Pye L.F. transformer.

After having trouble with my set due to faulty resistance coupling and indifferent transformers, it is now quite refreshing to listen to a broadcast which is free from any distortion coupled with a silent background.

At the reduced price of 17/6 I consider this transformer excels in quality any 25/- or 30/- transformer on the market.

Again thanking you,

I am, Yours Faithfully,
(Sgd.) G. Borcham.

223, Leigh Road,
Leigh-on-Sea.

MAKE CHOKES TOO.... BOTH GUARANTEED 1 YEAR

32, 110, 150 HENRIES 12/6
200 or 300 HENRIES 17/6
With two tappings 2/6 extra.

Illustrated descriptive literature sent post free on application to Dept. P.

W. G. PYE & CO.,
CAMBRIDGE, ENGLAND

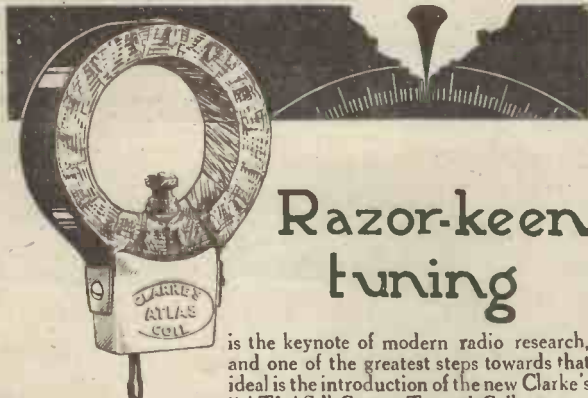

Razor-keen tuning

is the keynote of modern radio research, and one of the greatest steps towards that ideal is the introduction of the new Clarke's "ATLAS" Centre-Tapped Coils.

Think of it! No alteration to the set; no special mounting or re-arrangement of components. Just a plug-in coil, to the centre terminal of which is attached the aerial wire—and there you are. The station you want comes in loudly and clearly, without a whisper from the station you don't want.

Coil No. 40, recommended for 200/400 metres; Coil No. 60 for 350/600 metres.

Price - - - - 4/3 each.

Special Coil for Daventry, etc. - - - - 6/6 each.



Completely change the 'listening look'

No more groping for the distant stations or grumbling at poor reception from the local one. Clarke's "ATLAS" Low-Loss Coils bring in more stations—easier and louder! The patent twin-wire winding is the chief secret of a coil which meets every demand of the keenest critic. For Distance, Selectivity and Volume, Clarke's "ATLAS" Low-Loss Coils are the recognised leaders.

CLARKE'S "ATLAS" RADIO SPECIALITIES

PRICES

No.	Each	No.	Each
25-50 ..	2/6	600 ..	9/6
65 ..	3/-	750 ..	10/6
75-150 ..	3/6	1,000 ..	12/6
175/300 ..	4/6	1,250 ..	14/-
400 ..	5/6	1,500 ..	15/6
500 ..	7/6		

We have vacancies in various districts for first-class Service Agents. Replies should be addressed to us, stating full qualifications.

H. CLARKE & CO. [Mcr.] Ltd., Radio Engineers, "Atlas" Works, Old Trafford, MANCHESTER
 Telephones: 683 and 793 Trafford Park. Telegrams: "Pirtoid, Manchester."

"MODERN WIRELESS"

HAVE YOU PURCHASED YOUR COPY OF "MODERN WIRELESS"?

Mr. PERCY W. HARRIS, M.I.R.E., contributes "THE BLACK PRINCE"—a wonderful Four-Valve set for long distance loud-speaker reception.

For crystal users there is the "No-Code" Crystal Set, designed to cut out the jamming that so often prevents programme enjoyment.

Other first-class features include:

- "The Overseas Three"
- "Are Portable Sets Worth While?"
- "The Four-Coil Two"
- "The 'Combine Five' On Test"
- "Resistance-Capacity Problems"
- "Design of Small Power Transformers"
- "More About Your Valves," etc.,

and an authoritative article

"THE SEARCH FOR QUALITY"

By CAPT. P. P. ECKERSLEY, M.I.E.E.

In this helpful and essentially practical article—the first of a special series—the B.B.C.'s Chief Engineer tells listeners how to solve the problem of perfect reproduction of the programmes.

"MODERN WIRELESS" - - - - - Now On Sale, 1/-

TRANSFORMER V. RESISTANCE COUPLING.

The Editor, POPULAR WIRELESS.

Dear Sir,—I have read with interest the letter from "Maltese Cross," published in your March 12th issue. This gentleman is certainly talking through his hat when he says that there is not a horn loud speaker on the market which will reproduce a pure note of less than 250 cycles. For some time now I have used my H.M.V. gramophone (an early type with large oak horn) in conjunction with a loud speaker attachment of foreign manufacture. So far as pure reproduction is concerned I think it would be a revelation to "Maltese Cross" had he an opportunity of hearing its performance. I recently had the pleasure of hearing Mr. Jetsam of "Flotsam and Jetsam" fame, singing his famous "Drinking" song, and the reproduction on the lowest notes was practically perfect. Again, the Fifth Symphony of Tchaikowsky, relayed from the Albert Hall last week, "came through" with remarkable fidelity, and I submit that this latter piece is a severe enough test for any loud speaker, so far as the lower tones are concerned.

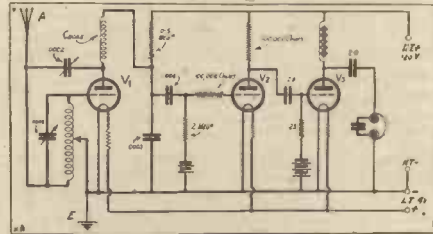

For the benefit of "Maltese Cross," I am enclosing the theoretical circuit of my wireless set, which I have built after carefully studying the various wireless periodicals. For the sake of simplicity, I have omitted the two high-frequency stages, and I think it might interest your readers. I can recommend this circuit for both volume and natural tone.

Yours, etc.,
A. C. R.

Wallasey.

P.S.—For V₁ I use Cosmos Blue Spot; V₂, D.E.3B, or similar type; V₃, super power valve.

The Editor, POPULAR WIRELESS.

Dear Sir,—Following the publication of my letter in POPULAR WIRELESS, when I asked the favour of your assistance in getting the ideas of your correspondent, "Maltese Cross," with regard to a 3-valve R.C. receiver with crystal detector, it may be of interest to you and readers of "P.W." if I may be permitted to relate the outcome.

"Maltese Cross" promptly sent me full details and diagrams, and also kindly invited me to visit him and hear the set working. This invitation I very gratefully accepted, with the result that I came away an ardent enthusiast of R.C. coupling. The receiver was in no way laid out for appearance, and I am sure "Maltese Cross" will pardon me when I say that it looked a most haphazard arrangement.

Results, however, were splendid, the quality being very far in advance of anything I have yet ever heard, and another point, there was absolutely no loss of volume, in my opinion, to be detected, compared with transformer coupling. On two valves London was received at sufficient strength to suit anybody, and I personally like good strength that can be heard over the house.

On switching in the third valve the volume was far too loud; in fact, it was difficult to make yourself heard. The test was carried out on speech and piano, and on both the results obtained were absolutely first class. As a seeker of the best quality obtainable from the local station, I have always been pleased to hear other people's results; these have always been of the transformer coupled variety. Many were very good and many otherwise. "Maltese Cross" has evolved a receiver which none that I have heard could approach for purity coupled with very great volume. I do not give particulars of the components used. If any of your readers are interested I am sure he would be pleased to give details through the correspondence columns of "P.W."

May I be permitted to thank all those who so kindly wrote me enclosing circuits, etc. It is impossible, however, for me to try them all, on the question of expense.

Thanking you for your kind assistance,

Yours faithfully,

C. HARDINGHAM.

75, Shallmar Gardens, Acton, W.3.

THE COST OF HIGH TENSION.

The Editor, POPULAR WIRELESS.

Sir,—It would be interesting to know the experiences of your readers in regard to the cost of high tension power for their wireless receiving sets, for I myself find that the cost is much higher than I had been led to suppose from the articles I read in wireless magazines and books.

Two years ago I constructed a one-valve and crystal reflex set, according to the Best Way Series specifications. The set worked excellently, but a 60-volt H.T. battery, costing about eight shillings, lasted me only two months, with an average use of twelve hours a week. I used a .06 G.P. valve.

CORRESPONDENCE.

Letters from readers discussing interesting and topical wireless events, or recording unusual experiences, are always welcomed; but it must be clearly understood that the publication of such does in no way indicate that we associate ourselves with the views expressed by our correspondents, and we cannot accept any responsibility for information given.—Editor.

Thus, H.T. for one valve and a crystal cost me a penny per hour. This was not dear, but I had heard of similarly priced batteries lasting nine months. I tried several different makes: but with the same result. There was no possibility of leakage when the set was not used.

After that I constructed a two-valve and crystal set (H.F. Crystal D. and L.F.), and now I find that a similar battery lasts barely a month at ten hours' use per week. This means a cost of over twopence per hour for H.T. at thirty-three volts on an average.

Are these figures fairly normal? If so, it might save disappointment if the facts were made known to beginners who expect a battery to last a year.

How is it that manufacturers do not state how many hours an H.T. battery will function effectively at a certain voltage? Recently, I bought a battery (British make) guaranteed to supply a single valve, in average use from 9 to 12 months, provided it is not misused. It was a 60-volt battery, and at a voltage of 33 worked my two-valve set for less than forty hours before perishing!

Yours truly,

A LANCASHIRE READER.

(The experiences related above are not "normal" and except where super-power valves were being used with H.T. batteries of insufficient capacity we have not heard of any similar cases. Surely there is a leak in the set somewhere or else our correspondent has been unfortunate in obtaining batteries that have been in stock for some time, or perhaps one of inferior manufacture.—TECH. ED.)

THOSE "SINGING SETS."

The Editor, POPULAR WIRELESS.

Dear Sir,—Regarding the recent letters which have appeared in your periodical regarding the "Singing Set," I feel sure that your correspondents will find that the sound emanates from the transformer.

It is a well-known fact that a bar of iron alters its length when subjected to magnetisation. Thus a direct current electro-magnet will give a very distinct "click" on being switched on. With alternating current, a hum—i.e. a series of clicks—will be audible, and with currents varying at speech frequencies then a reproduction of the speech will be audible. It was on this principle that the early (1860) Reiss telephone was based. The receiver of this apparatus may be imitated by using 'phones without diaphragms—the music received being produced by the variations in length (and so a variation in the "clicks") of the iron composing the magnets. It may often be noticed that a distinct hum is audible in the vicinity of a power transformer in a lighting or other system due to a similar reason.

The music may also be heard if the ear is placed on or near a fixed condenser in the L.F. portion of the set due to the varying electrostatic strain moving (very very slightly) the tinfoil sheets. With a 1 mfd. condenser, made of tinfoil sheets merely clamped between oiled paper, music was pleasantly audible when the condenser was connected across the 'phone terminals of a fairly powerful receiver.

As a further "stunt" for those possessing powerful sets perhaps the following may not be well-known.

Let two persons (call them A and B) each grasp firmly one 'phone terminal. Now let A place a piece of paper over his other hand and firmly press this paper against B's ear. B will find that the music received is quite pure although faint.

Yours faithfully,

LEON B. NEWHAM, B.Sc.
Radio G O N Z.

14, Silchester Road,
Copnor, Portsmouth.

The Editor, POPULAR WIRELESS.

Dear Sir,—In reply to your correspondent, F. Griffiths, writing on the "Singing Set" in "P.W." No. 250, my set can be heard singing at a distance of nine feet when 'phones and L.S. are disconnected. This comes from the choke in the filter circuit, connected directly across the output terminals of the set. It does not appear adversely to affect reproduction.

Yours faithfully,

K. S. KELWAY.

St. Peter's School,
Seaford, Sussex.

NEXT DOOR'S BROADCAST.

The Editor, POPULAR WIRELESS.

Sir,—Referring to your correspondent "Canal," in March 20th issue, re "Next Door's Broadcast."

I also have had the unique experience of listening on a "Chitos" one-valve set to the conversation,

etc., of people in the same house, two floors below, who have a crystal set and an indoor aerial. Also the people next door have their aerial running along the passage inside the house. Children can be distinctly heard running up and down the passage and their remarks. Although this can be tuned in or cut out at will, the effect is more noticeable when 2 I.O. is "off." Of course, eavesdropping is not to be considered, but the phenomena is worth noting.

"RELAY."

P.S.—For obvious reasons, viz., the disclosure of my "broadcasters," I must remain anonymous.

The Editor, POPULAR WIRELESS.

Sir,—Re "Canal's" letter about "Next Door's Broadcast." I am experiencing a similar interference. When 5 N.O. is not working I can "tune in" my next door neighbour, who has a crystal set, and who leaves the 'phones hanging on the wall, on the same wave-length as 5 N.O. My set is a "Reinartz" three-valve. Both my neighbour and I have indoor aeriels. Conversation can be easily followed on loud speaker. I am a regular reader of your interesting paper.

Yours faithfully,

P. EVERETT.

31, Croydon Road,
Newcastle-on-Tyne.

A STRAIGHTFORWARD CRYSTAL SET.

The Editor, POPULAR WIRELESS.

Dear Sir,—I herewith enclose sketch of a circuit which I am using with excellent results.

I am approximately three miles from 5 W A Cardiff and can cut them out completely and listen to 5 X X (Daventry). I can also tune in 2 I.O. and sometimes 5 I.T. (Birmingham), Bournemouth, and three continental stations (two German and one French) without the addition of any other coils (except for 3 X X, when I use a 150 coil).

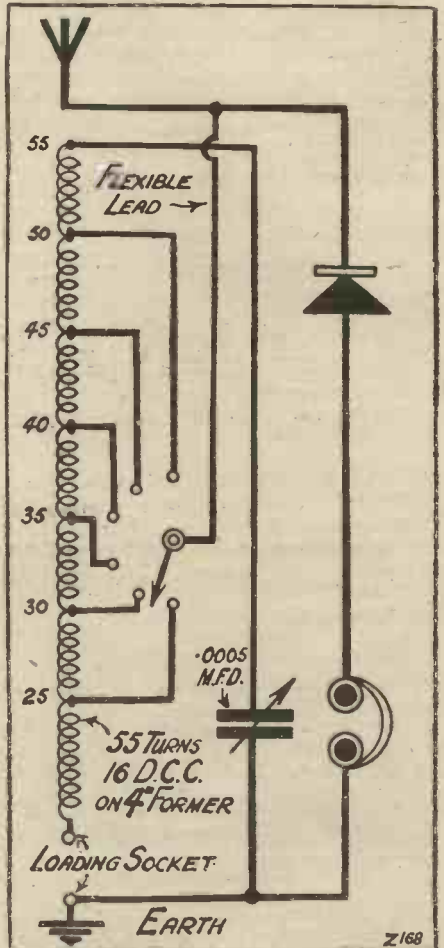

The volume on 'phones from my local station is audible in any part of the room, which is about 12 ft. square. I have not properly tested out with a loud speaker, but I have understood a programme from my local station at a distance of about 5 ft.

The set is constructed as follows:

An upright ebonite panel and a wood baseboard, fitted at right angles, upon which is mounted on end a 4-in. diameter cardboard coil former wound with 55 turns of 16 S.W.G. D.C.C. wire, which is tapped at the 25th, 30th, 35th, 40th, 45th, and 50th turns.

(Continued on page 318.)

Radio Uses for Paper Clips

[By J. F. CORRIGAN, M.Sc., A.I.C.
(Staff Consultant, "Popular Wireless.")]

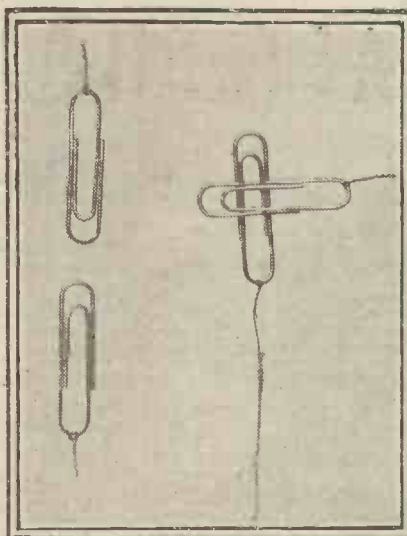

Fig. 1. Paper clips used as temporary connectors.

ON this page are illustrated some of the many uses to which the ordinary conventional type of paper clip, selling at about fourpence a box, can be put by the wireless amateur. Consider the illustration Fig. 1, for instance. Here it will be seen that paper clips when attached to the ends of wire leads can make useful temporary connectors. Naturally, the electrical connection so made is not what one would term of the utmost efficiency, but, nevertheless, for purely temporary purposes such paper clip connectors are extremely useful articles for the busy wireless man to have in mind.

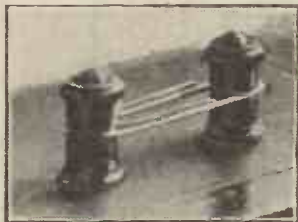

Fig. 2. A terminal shorting link.

connectors are extremely useful articles for the busy wireless man to have in mind.

Solving Minor Problems.

Next, Fig. 2 illustrates a method of shorting two neighbouring panel terminals by means of a paper clip. If the terminals are too far apart to be bridged by a single paper clip, a chain of clips may be formed, as in the illustration, Fig. 3, and may be used for connecting the terminals together. In this case, however, care should be taken to see that the chain of clips is stretched



Fig. 3. For temporarily shorting widely separated terminals.

tightly between the terminals, for a sagging clip would cause a loose connection, and a consequent loss, or very probably total cessation of current.

Illustration Fig. 4 depicts a very well-known use to which a paper clip may be placed, *to wit*, that of connecting two or more flash-lamp batteries together. As a crystal holder, however, the paper clip serves quite a novel purpose. Fig. 5 brings this latter use out in a clear manner. The paper clip is attached either to the

crystal cup by one means or another, or to the terminal of the crystal set which is directly connected to the crystal cup. The crystal is held by the paper clip, and the cat's-whisker contact effected in the usual manner. This serves as an excellent means for using up fragments of crystals which are too small to be conveniently inserted in the crystal cup itself. It is also a very effective mode of providing a quick change of crystals for experimental purposes.

We have all at one time or another experienced the really heartrending task of trying to attach 'phone leads of the "push through" type and those of the "spade-end" variety to the same pair of 'phone terminals. By the use of the inevitable paper clip, however, this task becomes almost a pleasure.

First of all, secure the spade-end 'phone leads to the screw-down 'phone terminals in the usual manner. Afterwards insert a paper clip in each terminal, and then screw down the terminals tightly. Finally, one or more pairs of 'phones possessing leads whose tags are of the push-through type may be connected to the paper clips in the manner shown in the illustration, Fig. 6. These latter tags are simply pushed through the paper clips, and the electrical contact so set up is amply sufficient to give strong and clear signals with any ordinary set.



Fig. 4. For connecting up "flash-lamp" batteries.

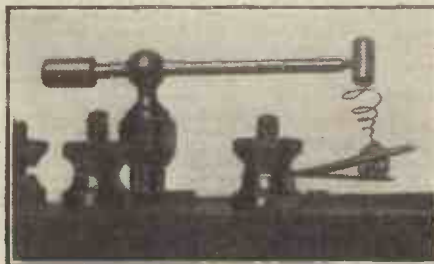

Fig. 5. A novel crystal mounting.

If the shorting plug for a radio coil holder happens to get mislaid in a busy moment, the amateur need not despair. Insert one of the largest coils into the holder, but while doing so place a paper clip across the con-

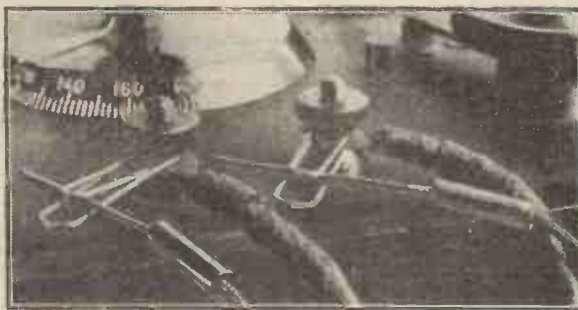

Fig. 6. For attaching to 'phone terminals.

necting plugs in the manner indicated at Fig. 7. A direct "short" will thus be effected between the coil leads, with the result that the coil itself will be out of action, the current flowing across the coil plug via the paper clip.

Many Other Uses.

There are many other uses to which paper clips may be placed in radio work, and apparently their number is limited only by the ingenuity of the individual amateur. For instance, paper clips may be utilised for the purpose of temporarily holding small

fixed condensers in position. As grid-leak holders they will also serve a purpose. A loosely-held chain of the clips will form a rough—perhaps I had better say a very rough—form of variable resistance.

Paper clips can also be made into serviceable flat springy contacts for certain types of crystals.

For gripping sheets of thin metal together they will often prove most effective. Layers of tinfoil may also be conveniently held together for any length of time by this method.



Fig. 7. "Shorting" a coil holder.

To Introduce TWO NEW BATTERIES

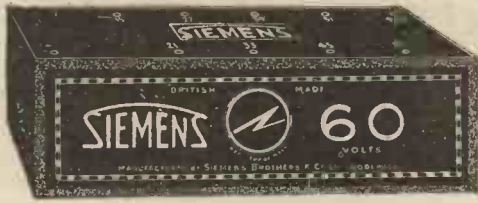

SIEMENS BROTHERS & CO., LTD.
WOOLWICH, S.E.18

with 50 YEARS' experience of BATTERY MANUFACTURE are now placing on the market

TWO SPECIAL RADIO BATTERIES

to compete with the cheap batteries now being imported

SIEMENS 60 at 9/6
volts

SIEMENS 100 at 15/6
volts

Give BRITISH MAKE the PREFERENCE and help to RELIEVE UNEMPLOYMENT

Obtainable from all Dealers.

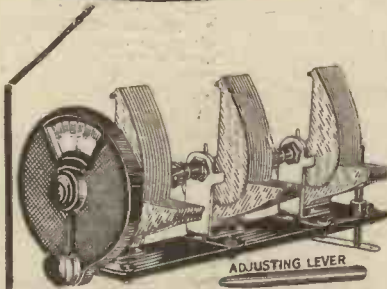

ONLY FORMO USERS KNOW
Quality and Efficiency with Economy

Single Condensers 7/6
Twin Gang ... 24/6
Triple Gang ... 33/6
Vernier Dials... 6/-

Crown Works,
Cricklewood Lane,
N.W.2
Telephone: 1787 HAMP.



10/6
"FORMO"
Shrouded Transformer

Screens complete with 6 pin base 9/-
Split Primary Aerial Coil 250/550 5/6
H.F. Transformer .. 7/6
Reinartz Coil 250/550 .. 7/6
Mullard Rodney 250/550 9/-
Mullard Nelson 250/550 9/-
All types of coils in stock.

Manchester :
J. B. LEVEE,
23, Hartley Street,
Levenshulme,
475 Heaton Moor.



ETHERPLUS + RADIO SPEAKER

This original and artistic "Etherplus" Speaker is British made and combines crystal purity of tone with ample volume.

Fixed retail price
£3 : 10 : 0

From your agent or from
M. & A. WOLFF,
9-15, Whitecross St., London, E.C.1



Reg.
Deg.

Prov.
Pat.

Don't throw away your old valve

Whether it is merely burnt out, broken, or has lost its efficiency from much use, we can make it as good as new for exactly one-half of its original cost. Think of the saving. Look over your old valves and send them to us for "repairs."

ALL TYPES OF VALVES REPAIRED AT HALF LIST PRICES. (Minimum charge 5/-).
Weco, S.P.'s and low capacity types not repairable. Minimum D.E. current 0.15 amp. when repaired.

Satisfaction Guaranteed or Money Refunded.
VALCO LTD., Dept. P.W., Tabor Grove, WIMBLEDON, S.W.19.

Simply pack it up and send it to us together with your name and address and remittance.





Traders and manufacturers are invited to submit wireless sets and components to the "P.W." Technical Dept. for test. All tests are carried out with strict impartiality in the "P.W." test-room under the supervision of the Technical Editor, and the general reader is asked to note that this weekly article is also intended to provide a reliable and unbiased guide as to what to buy and what to avoid.—EDITOR.

"ATLAS" DOUBLE-TAPPED COILS.

MESSRS. CLARKE, of Manchester, have followed up their centre-tapped coils with two double-tapped coils. One is a 60-turn with taps at the 7th and 12th turns, and the other a 250, with taps at 28 and 50. The prices of these are 5s. 6d. and 7s. 6d. respectively.

The design of these double-tapped coils is identical to that of the centre-tapped coils, with the exception that two terminals are situated on the inner diameter of the former of each coil. Plug-in coils having taps of this nature are very useful indeed. They can be employed as straightforward aerial tuning coils, the taps being used to introduce selectivity, or they can operate as aerial-reaction inductances in Reinartz reaction circuits. There are other special circuits in which they can be used.

The "Atlas" double-tapped coils were tested in a receiver employing a Reinartz-

reaction in which they gave results fully up to standard. We will probably find these new "Atlas" coils quite useful in some of our future sets.

A VERY NOVEL CONDENSER DIAL.

Tuning your stations by colours is the latest radio novelty. You slip over a little switch on the top of the variable condenser dial and turn the control knob of this latter until a tiny shaft of red or blue or green light shines forth. Blue can be Bouinemouth, so you can remember it because it is alliterative and because it reminds you of the sea; green can be Belfast, "Erin," etc., etc.—you choose your own colours. All this can be accomplished with the "Astra" fine tuning illuminated dial. Additionally a segment of condenser scale is also lighted up in order to provide the more conventional means of identification for those who require it.

Several colours are available and the method of bringing these into use is very ingenious. There is a tiny puncture in the metal cover of the dial, and when a station is tuned in nicely, a small piercing instrument is passed through this hole and for ever after that station can be tuned in again by means of the colour that immediately shines forth. The colours can, of course, be re-arranged if necessary.

Purely as a condenser dial the "Astra" is an excellent piece of work and operates smoothly and with a gear ratio of about 36 to 1. It is well made, and should be able to stand up to any amount of hard work. It costs 12s. 6d., and is supplied by Mr. P. Sherman, of 12, River Street, London, E.C.1.

CHEAP BRITISH H.T. BATTERY.

In order to compete with the large numbers of cheap H.T. batteries which are tending to flood the home market, Messrs. Siemens are producing an excellent little 60-volter at 9s. 6d., and a 100-volter at 15s. 6d. Although these prices are by no means down to those of many foreigners these new Siemens batteries should be accorded a hearty welcome, inasmuch as they are British and carry behind them the reputation of a very great firm.

We have had a 60-volter sent along to us, and while we have not yet had time to test it fully—the only satisfactory test for such an article is naturally a life test under average working conditions—it would appear to us that the battery is a good proposition. We are particularly glad to note

(Continued on page 318.)

3 NEW MARCONI VALVES
ECONOMY
 D.E.H.410 · D.E.P.410 & D.E.L.410

FOR
 4 VOLT
 ACCUMULATORS

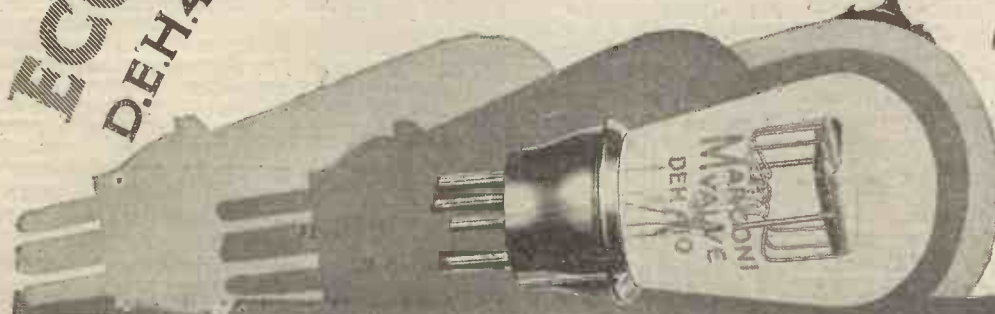

Each one consumes but 1 ampere—upkeep costs are cut down to a minimum.

D.E.H. 410
 14/-

A high magnification valve for radio frequency circuits where some method of stabilising is used; for resistance capacity amplifiers; also an excellent detector.

D.E.L. 410
 14/-

A general purpose valve for radio frequency circuits, for grid rectification and in the first audio frequency stage with choke or transformer coupling.

D.E.P. 410
 18/6

A power valve for last stages of receivers operating loud speakers. Will handle enough power to fill a large room.

Full particulars from your dealer or
The Marconiphone Company, Limited,
 Head Office:
 210-212, Tottenham Court Road, W.1
 Registered Office:
 Marconi House, Strand, W.C.2.



Note the Difference!

Long life, steady discharge and ample reserve of power are the first essentials of a low tension accumulator for wireless use.

"HART" Batteries possess all these features in a marked degree. Years of research and manufacturing experience have imparted an individuality to "HART" Batteries which is reflected in the wonderful service they give.

Use "HART" Batteries on your own set and notice the great improvement in power and tone.

HART BATTERIES

FOR ALL WIRELESS CIRCUITS

PORTABLE L.T. BATTERIES.

Ref.	Voltage	Capacity (A.H.)	Price
Ref. 502.	2 volt	30/60	£12 2
Ref. 513.	4 volt	40/80	£19 0
Ref. 515.	6 volt	60/120	£33 3 9

(Carrying Crate 4/2, 4/9, 6/- extra respectively).

Write to Dept. "P.W." 15 for full particulars and FREE illustrated booklet, "The Right Way to Use Your Wireless Batteries."

HART ACCUMULATOR CO., LTD.,
STRATFORD, LONDON, E.15.

Two Polar Units for better reception

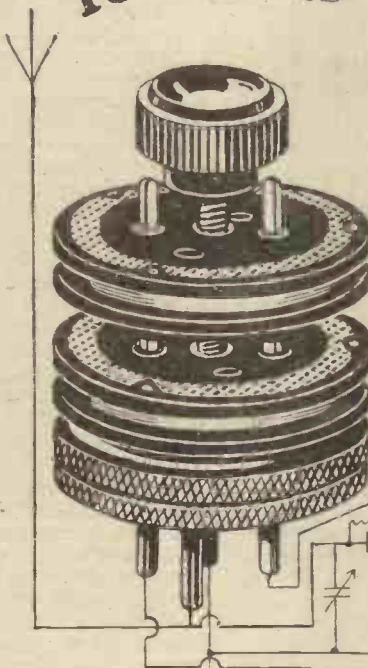

THE POLAR COIL UNIT — the smallest, most efficient and adaptable COIL UNIT on the market. Two coils can be mounted on the carrier, and by means of a screwed spindle one can be moved to and from the other. Eleven coils of uniform size are available, giving wavelengths between 170 and 4,720 metres. Fits any standard 4-pin valve socket. Admits of extreme delicacy of tuning, and is an efficient guard against OSCILLATION.

PRICES:
 Carriers only, 3/- Coils, 3/-
 Coil unit, consisting of carrier and two coils, complete, 9/-

POLAR R.C.C. UNIT.

Use the Polar Resistance Capacity Coupling for quality of reproduction, compactness, low cost and economy of H.T.

The POLAR Resistance Capacity Coupling Unit consists of a non-inductively wire wound Anode Resistance, Coupling Condenser and Grid Leak, all mounted in a strong bakelite moulding. Being wire wound it ensures a silent background, entirely void of crackling and hissing noises. See the letters R.C.C. on every unit.

PRICES:
 Green Seal (40,000 ohms) 10.6
 Red Seal (80,000 ohms) 12.6

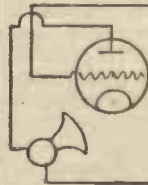
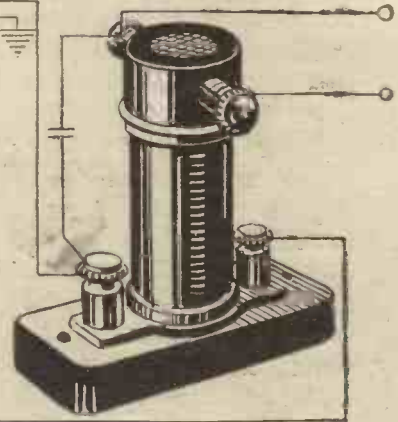

POLAR PRODUCTS ARE GUARANTEED.

Ask to see these two POLAR triumphs at any high-class radio dealer, handle them, and you are certain to want them.

Radio Communication Co., Ltd.
 BARNES, LONDON, S.W.13. MANCHESTER. GLASGOW

APPARATUS TESTED.

(Continued from page 316.)

that a "pitch" filling material is used. This makes a much cleaner job of a battery than paraffin wax.

A USEFUL MILLIAMPMETER.

Messrs. A. H. Hunt, Ltd., of Croydon, among many other useful meters, are marketing a treble scale milliampmeter. A milliampmeter is one of radio's necessities and no amateur should be without one, but the difficulty of choosing one which will adequately fulfil all requirements is a difficult task especially if the instrument is to be mounted on a panel. Close readings cannot be taken if the scale is too crowded, whilst if the scale is well spread out then the range will be limited. Messrs. Hunt's treble scale system solves the problem. By means of shunts their instrument is made to give three ranges over the one dial. These are 0-5, 0-10, and 0-25 milliamps, all very useful ranges indeed from a radio point of view. The change-overs are effected by means of a small switch fitted to the top of the meter, this latter being of quite a normal overall size. Tested up against our standard meter we found the Treble Scale to be closely calibrated. It operates on the moving coil system and provides "dead beat" readings. It would appear to us that the meter represents rather unusual value for money at 42/-.

By the way, we recently received a sample of Messrs. A. H. Hunt's "Clutch" brand insulating tape. This is sold in rolls at 3d., 6d. and 9d. each. Insulating tape is excellent stuff for tidying up battery leads and for affecting all sorts of temporary repairs in the home. The "Clutch" brand appears to have excellent adhesive qualities and is stated to retain these for very long periods.

THE "R.C. TWOSOME."

The new Ediswan circuit for home constructors, the "R.C. Twosome," is an eminently practical proposition for the average man. It is a two-valve resistance-coupled amplifier for use with a crystal set. The design is perfectly straightforward. The input is via an ordinary L.F. transformer, whose secondary is in the grid circuit of the first valve. This is an R.C.2, and this valve passes on the amplified energy through a resistance-capacity coupling to the last stage for which that efficient little power valve, the P.V.2, is recommended. It will be observed that there is very little danger of overloading occurring in this amplifier, and the difficulties sometimes experienced because of this when two or more high amplification factor valves are linked together do not have to be faced.

Messrs. Edison Swan Electric supply free a well-produced folder describing the construction of the "R.C. Twosome," which can be constructed for about 25s. Recently we were sent a built-up model for test. It was submitted complete with the specified valves. The layout is excellent and the designers are to be congratulated on their achievement in this respect, for it

is difficult to arrange components so that they look neat and at the same time are efficiently placed from an electrical point of view. The wiring should be most easy to carry out and should be well within the scope of the average constructor.

On test the amplifier was coupled to a crystal receiver which was delivering good 'phone signals some eight miles from 2 L.O. Up to 120 volts H.T. was employed. The signals were brought up to full loud-speaker strength and the tone of reproduction was excellent. A small "cone" type loud speaker was operated very pleasingly and the amplifier also worked well in conjunction with medium-sized horn types. Actually, of course, although two valves are used, only one resistance-capacity coupling is employed in this circuit, the coupling between the first transformer and the input being in the form of an L.F. transformer. This enables a fairly high degree of amplification to be obtained together with reasonable purity. From the average listener's point of view such a compromise has everything in its favour, and carried out in the manner of the "R.C. Twosome" produces a practical amplifier for coupling to the "household" crystal set. Moreover, as previously mentioned,

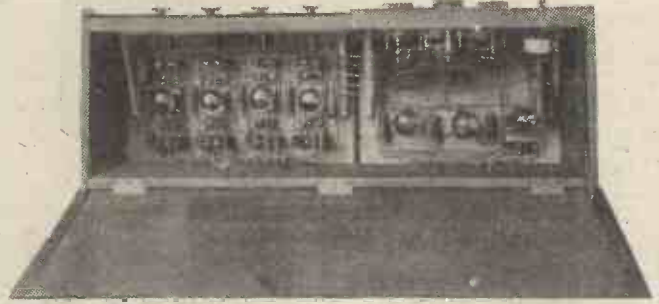

The set built by the General Electric Co., Ltd., for the Cambridge Hospital at Aldershot, to operate about 400 telephone receivers.

there is little danger of serious "overloading" occurring—a fault which so frequently evinces itself in R.C. work, and which is tending to increase the adherents to the transformer method!

CORRESPONDENCE.

(Continued from page 313.)

Mounted on the panel is the '0005 variable condenser, switch-arm and studs, an ordinary glass-enclosed cat's-whisker and crystal detector, and 'phones, aerial, and earth terminals.

The enclosed diagram will explain the circuit used.

My aerial is a twin wire (wires 6 ft. apart) 7-22's copper, from chimney stock to a 35-ft. pole at the bottom of the garden. The horizontal wires are about 40 ft. long with a single download of about 32 ft. The earth is connected to a water-pipe, and is 4 ft. long.

Hoping this will interest you.

Yours faithfully,
A. H. MOUNTAIN,

P.S.—I am a continuous reader of "P.W."
70, Coleridge Avenue
Penarth, Glam.

A READER WHO HAS!

The Editor, POPULAR WIRELESS.

Sir,—Re your correspondent's letter in "P.W." March 26th, 1927, under the heading "Has Any Other Reader Heard This Station?" I also heard W 1 O D. Miami Beach, Florida, about 4.40 a.m., Wednesday, March 9th. Scraps of the talk were about hydroplanes competing on the 4th and 5th for gold cup, and something about free tickets to be issued. He closed down with W 1 O D how wonderful they be.

I used a four-valve set, 1 H.F., 1 Det., 2 L.F. Reception good, but periodical fading.

Yours truly,
CHAS. H. MILLS.

8, Cumberland Road, Oxford.



The **'PEERLESS'**
Junior
RHEOSTAT

Sales
now over
 $\frac{1}{2}$
MILLION

Study the life of your valves and fit only the components that will function properly. In the "Peerless" Junior Rheostat are found features which make it exceedingly popular—its sales figures are now well over the half million. This Rheostat has an OFF position provided, while definite stops make short circuit impossible. The resistance element is immune from damage. Will safely carry current of two valves.

Complete with
nickelled dial and one
hole fixing. Three
types. Size, 1½" dia. ½"
high, 6, 15 or 30ohms.

2/6

From all dealers or direct

The Bedford
Electrical & Radio Co Ltd
22, Campbell Road, Bedford.



Who's your singing pal?

HIS taste in furnishing may differ from yours. His dress is probably not what you would call 'smart.' There is one matter, however, in which you must admit he 'takes the prize.' Wireless. He *does* know something about Wireless. When you first enter his house, and hear the stirring sounds of a tenor's voice, you're inclined to exclaim, "Hallo! Who's your singing pal?" For, although you know he's something of an expert in Wireless matters, you'd never think it was possible for a loud speaker to be so realistic. Until you hear his **Brown H.Q. Loud Speaker.**

This Wireless expert knows that with a good set, the **Brown H.Q. Loud Speaker** is so realistic in its reproduction, that it is almost uncanny. It tells the truth—as no other Loud Speaker of this type can. But to realise its superiority of tone and volume you must hear it. Your Dealer will be pleased to give you a demonstration. Ask him! In 2000 and 4000 ohms resistance, £6.

Brown

S. G. BROWN, LTD., Western Ave., N. Acton, W.3
 Retail Showrooms: 19, Mortimer St., W.1; 15, Moorfields, Liverpool; 67, High St., Southampton. Wholesale Depots: 2, Landsdown Place West, Bath; 120, Wellington St., Glasgow; 5-7, Godwin St., Bradford; Gibb Chbrs., Westgate Road, Newcastle; Howard S. Cooke & Co., 59, Caroline St., Birmingham; Robert Garmany, Union Chambers, 1, Union St., Belfast, N. Ireland. G.A. 8691.

WEAK JOINTS NEED FLUXITE!

7/6

Fluxite Soldering Set—complete **7/6**

All Hardware and Ironmongery Stores sell **FLUXITE** in Tins, price 8d., 1/4 and 2/8. Another use for Fluxite—Hardening Tools and Case Hardening. Ask for leaflet on improved methods.

FLUXITE Ltd., (Dept. 324), Rotherhithe, S.E.16.

NEW VALVES FOR OLD

To further popularise our celebrated **GUARANTEED BRITISH-MADE VALVES** we make the following exceptional offer for a limited period. Send us your old valve, no matter what make and condition, and we will replace with a **BRAND-NEW GUARANTEED VALVE AT HALF PRICE.**

	Special List Price.	Offer Price.
BRIGHT EMITTER. L.F. or H.F. 3-4 v. '6 a.	7/6	3/9
DULL EMITTER. L.F. or H.F. 3 v. '25 a.	10/6	5/3
Do. L.F. or H.F. 3-4 v. '2 a.	12/-	6/-
POWER VALVE. 2 or 4 v.	17/-	8/6
Do. 2 or 6 v.	22/-	11/-

Above offer for **CASH WITH ORDER** only. Please include Sixpence per valve for postage and packing.

Full Particulars, Curves, etc., on receipt of P.C. Satisfaction Guaranteed.

HANDLEY & JORDAN (Dept. P.W.), **Radio Experts,** 31, CANNON STREET, BIRMINGHAM.

CUT THIS OUT FOR CABINETS

and post to us for **FREE** list illustrating Cabinets as shown in "Popular Wireless," etc., etc., and for our additional Bulletin No. 2

NAME.....

ADDRESS.....

(Write in block letters, please!)

CARRINGTON Mfg. Co., Ltd.
CANCO WORKS, SANDERSTEAD ROAD, SOUTH CROYDON.
 Telephone: Croydon 0623 (2 lines).
 Trade enquiries especially invited.

NOTICE WE ARE OPEN

**11-1 GOOD FRIDAY
ALL DAY SATURDAY
11-1 EASTER SUNDAY
11-1 EASTER MONDAY**

SO DON'T WORRY IF YOUR VALVES BREAK or your Batteries give out, WE HAVE PLENTY MORE

WE SELL EVERYTHING YOU ARE IN NEED OF IN WIRELESS

For full lists see "Popular Wireless" March 26th, April 2nd, April 9th (also for four years previous) or send a postcard for one.



THIS MAGNIFICENT 2-VALVE SET

(D. and L.F.) as shown, in Handsome American Type Cabinet, 12 by 8 Panel. ALL PARTS ENCLOSED. Complete with 2 Dull Emitter Valves, Tandoo latest Coils, L.T. and H.T. Batteries, Aerial Equipment, 4-way Leads, 4,000 ohm Phones, OR Lissencola, OR Loud Speaker **£4 19 6**

Marconi Tax Paid. Carriage and Packing, 5/- **SET ONLY 45/- TAX PAID**

With Power and D.E. Valves, 2 Coils Carriage and packing, 5/-

FORMO or FINSTON S.L.F. CONDENSERS



With handsome 4" TRIOLITE dial and knob... By Post 7/11.

ANOTHER GOOD MODEL S.L.F., with 4-inch Dial. '0093 & '0005, each 5/11. By post, 6/5.

LOW LOSS SQUARE LAW

'0003 and '3005 4/11 each. By Post 5/11. With Vernier 1/- extra.

RADIO MICRO. (Guaranteed genuine.) 3.5-v. '96-a., G.P. 5/11 1.8-v. '2-a. G.P. 5/11 3.5-v. '1-a. Power 9/6 1.8-v. '2-a., 10/6 Post 1/- each per valve.

ACCUMULATORS. 2-v. 40, 7/11; 2-v. 60, 9/6; 2-v. 80, 12/6; 2-v. 100, 14/6; 4-v. 40, 13/11; 4-v. 60, 17/11; 4-v. 80, 23/6; 6-v. 60, 26/6; 6-v. 80, 35/6. ALSO another good make, 1/6 extra on each of above. Post 1/- each.

GAMBRELL COILS. a2 4/10, a 4/10, A 5/-, B1 5/3, B 5/6, C 5/9, D 6/3, H1 6/9, E 7/9, F 8/6, G 10/-. Centre-tapped coils, 6d. extra.

GAMBRELL CENTRE-TAPPED COILS. B.B.C., 6"- 5X, 8/3. 60X, 6/9; 250X, 8/9.

K. RAYMOND 27 & 28a, LISLE ST., LEICESTER SQ., W.C.2

Hours: 9.15 to 7.45 Back of Daily's Theatre Saturday: 9 to 8.45 Nearest Tube: Leicester Square Sunday: 11 to 1 Phone: Gerard 4637

RADIOTORIAL.

All Editorial Communications to be addressed to the Editor, POPULAR WIRELESS, The Fleetway House, Farringdon Street, London, E.C.4.

Editor: NORMAN EDWARDS, M.Inst.R.E., M.R.S.L., F.R.G.S.

Technical Editor: G. V. DOWDING, Grad.I.E.E.

Assistant Technical Editors: K. D. ROGERS. P. R. BIRD. G. P. KENDALL, B.Sc.

Scientific Adviser: Sir OLIVER LODGE, F.R.S.

Staff Consultants:

Dr. J. H. T. ROBERTS, F.Inst.P.; J. F. CORRIGAN, M.Sc., A.I.C.; C. E. FIELD, B.Sc.; E. J. SIMMONDS, M.I.R.E., F.R.S.A.

Foreign Correspondents:

F. M. DELANO, Paris; Dr. ALFRED GRADENWITZ, Berlin; L. W. CORBETT, New York; P. F. MARTIN, Italy; W. PEETERS, Holland.

The Editor will be pleased to consider articles and photographs dealing with all subjects appertaining to wireless work. The Editor cannot accept responsibility for manuscripts and photos. Every care will be taken to return MSS. not accepted for publication. A stamped and addressed envelope must be sent with every article. All enquiries concerning advertising rates, etc., to be addressed to the Sole Agents, Messrs. John H. Lile, Ltd., 4, Ludgate Circus, London, E.C.4.

As much of the information given in the columns of this paper concerns the most recent developments in the Radio world, some of the arrangements and specialities described may be the subject of Letters Patent, and the amateur and the trader would be well advised to obtain permission of the patentees to use the patents before doing so.

Readers' letters dealing with patent questions, if sent to the Editor, will be forwarded to our own patent advisers, where every facility and help will be afforded to readers. The envelopes should be clearly marked: "Patent advice."



MEASURING PLATE CURRENT.

P. T. R. (Dunmow, Essex).—"How should a milliammeter be connected in circuit, and what prevents it being burnt out when high-tension is used?"

The accompanying diagram shows a milliammeter connected in the plate circuit of an L.F. amplifying valve. It will be seen that it is "in series"—i.e., all the current in the circuit flows through the instrument.

Protection from burn-out lies in the circuit conditions, which is to say that it should not be connected

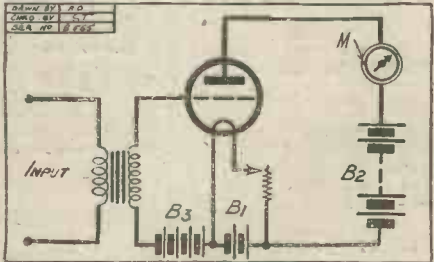

in a circuit where the current flowing exceeds the full-scale deflection of the milliammeter. In the case shown there is a high-tension battery in the circuit, but the high-resistance of the valve itself keeps the current flow down to a low value, so that the milliammeter is quite able to record the current passing, and is in no danger of burning out.

(Continued on page 322.)

STANDARD WET H.T. BATTERIES (LECLANCHE TYPE)

Recommended by Wireless Press. The following is an example of the many testimonials received daily.

Dear Sirs, April 5th. Just a line to thank you for evolving such an efficient H.T. Battery. Last December I purchased from you four dozen cells and they have given splendid service—have been using headphones till lately—now we are using loud speaker and need extra H.T. for same.

Wishing you every success. C.R. Originals can be inspected.

NO CHARGE! G. PERMANENT. ECONOMICAL. SILENT.



90-volt, 60-cell Battery. Complete Sets of Components, 21/-

Jars	Price Per doz.	Rubber bands for insulating 12 No. 1
Sacs No. 1 - - -	1/3	Sacs - - 6d. box
Sacs No. 1 (with terminals) - - -	2/3	Do. No. 2 Sacs 6d. box
Sacs No. 2 - - -	3/-	Electrolyte sufficient for 20 cells - 9d.
Sacs No. 2 (with terminals) - - -	3/9	Shellac Varnish - 6d.
Zincs (new model) 1/-		Oil for 60 cells - 9d.

Carriage forward. Send 1d. stamp for new illustrated list giving full details, price of batteries for various voltages, maintenance hints, and useful information.

Special Note—The NEW ZINC is designed so that Standard winder-plugs can be inserted in every cell.

WET H.T. BATTERY CO., 12, Brownlow St., HIGH HOLBORN, W.C.1. Phone: Chancery 7846. By First Avenue Hotel.

CABINETS!

Write for Illustrated Price List of Cabinets. Let us quote you for your own designs and sizes.

F. DIGBY, 9, BANBURY ROAD, SOUTH HACKNEY, E.9.

BANKRUPT STOCK

VARIABLE CONDENSERS. Genuine "DEVICON" single hole fixing, all nickel finish. Square Law Condensers. Best quality knob and dial, 20 S.W.G. vanes, entirely rigid construction.

PRICE: With vernier, 5/-; Postage, 6d. ea. Without vernier, 4/6; Postage, 5d. ea.

DOUGLAS WALKER, Radio Dealer, CHEW MAGNA, BRISTOL.

AMPLIFIERS: 1-VALVE, 19/-; 2-VALVE, 30/-

2-Valve All-Station Set, £4. Approval willingly Wet H.T. Batteries—Jars, Zincs and Sacs complete, 3/6 per doz. (18 volts). Post 9d. extra. Sample 6d. 5 doz. upwards post free, in divided cartons.

Baron's List Press. P. Taylor, 57, Studley Rd., Stockwell, London

ADVERTISEMENTS

As far as possible all advertisements appearing in "P.W." are subjected to careful scrutiny before publication, but should any reader experience delay or difficulty in getting orders fulfilled, or should the goods supplied not be as advertised, information should be sent to the Advertisement Manager, "Popular Wireless," 4, Ludgate Circus, London, E.C.4.

BUILD A LOUDSPEAKER

WITH OUR SEAMLESS MOULDED CONE (Patent 25699) and BALANCED ARMATURE UNIT, or a LISSENCOLA, or BROWN A, you can successfully construct an ultra-efficient Loudspeaker. Specialities separately or complete. Illustrated lists and full particulars for stamp GOODMAN'S 27 FARRINGTON ST. E.C.4. Also Spencer's Stores, 4-5, Mason's Ave., N.C.2.

The
"Resistor 2"

HAVE YOU BUILT THIS FAMOUS



RESISTANCE-CAPACITY SET?

A complete set of Dubilier Condensers and Resistances for this set costs only 20/6. It comprises:—

- 1, 0.00025 mfd. Condenser, Type 610 with clips.
- 1, 0.001 mfd. Fixed Condenser, Type 610 with series clips.*
- 2, 5M Ω Grid Leaks.
- 1, Duvarileak 0 to 5M Ω
- 1, Fixed Condenser 0.00025 mfd. Type 610.

* For those who already possess a Type 610 condenser of this capacity, this series clip can be obtained for 6d.

Ask your Dealer for these parts or, in case of difficulty write direct to us.



Advt. of the Dubilier Condenser Co. (1925), Ltd., Ducon Works, Victoria Road, North Acton, W.3.

M.C. 273

Invaluable to
EVERY Amateur
 and Constructor.

The "POPULAR WIRELESS"

BLUE PRINTS
 of TESTED CIRCUITS

The following is a complete list of the "P.W." 6d. Blue Prints for Constructors, showing the different circuits available.

P.W. BLUE PRINT

- Number
1. DETECTOR VALVE WITH REACTION.
 2. UNIDYNE DETECTOR VALVE WITH REACTION.
 3. 1-VALVE L.F. AMPLIFIER.
 4. CRYSTAL DETECTOR WITH L.F. AMPLIFIER.
 5. H.F. (Tuned Anode) AND CRYSTAL, WITH REACTION.
 6. H.F. AND CRYSTAL. (Transformer Coupled, without Reaction).
 7. 1-VALVE REFLEX WITH CRYSTAL DETECTOR (Tuned Anode).
 8. 1-VALVE REFLEX AND CRYSTAL DETECTOR (Employing H.F. Transformer, without Reaction).
 9. H.F. AND DETECTOR (Tuned Anode Coupling, with Reaction on Anode).
 10. H.F. AND DETECTOR. (Transformer Coupled, with Reaction).
 11. DETECTOR AND L.F. (with Switch to Cut Out L.F. Valve).
 12. DETECTOR AND L.F. UNIDYNE (with Switch to Cut Out L.F. Valve).
 13. 2-VALVE REFLEX (Employing Valve Detector).
 14. 2-VALVE L.F. AMPLIFIER (Transformer Coupled, with Switch to Cut Out Last Valve).
 15. 2-VALVE L.F. AMPLIFIER (Transformer-Resistance Coupled, with Switch for Cutting Out Last Valve).
 16. H.F. (Tuned Anode), CRYSTAL DETECTOR AND L.F. (with Switch for Last Valve).
 17. CRYSTAL DETECTOR WITH TWO L.F. AMPLIFIERS (with Switching).
 18. 1-VALVE REFLEX AND CRYSTAL DETECTOR, with 1-VALVE L.F. AMPLIFIER, Controlled by Switch.
 19. H.F. DETECTOR AND L.F. (with Switch to Cut Out the Last Valve).
 20. DETECTOR AND 2 L.F. AMPLIFIERS (with Switches for 1, 2, or 3 Valves).
 21. THE 2-VALVE LODGE "N."
 22. "THE GUARANTEED REFLEX."
 23. THE 1-VALVE "CHITOS."
 24. THE "SPANSACE THREE." Three-Valve Receiver employing 1 Neutralised H.F. Valve, Detector with Non-Radiating Reaction Control, and 1 L.F. Valve.
 25. 2-VALVE REINARTZ (Det. and L.F.).
 26. A "STRAIGHT" 4-VALVER (H.F., Det., and 2 L.F. with Switching).
 27. A "MODERN WIRELESS" 4-VALVER (2 H.F., Det., and L.F.).
 28. A "MODERN WIRELESS" 5-VALVER (H.F., Det., and 3 L.F.).

ALL "POPULAR WIRELESS"
 BLUE PRINTS—6d. EACH

All orders for these Blue Prints should be sent direct to the "Popular Wireless" Queries Department, Fleetway House, Farringdon Street, London, E.C.4, enclosing a stamped addressed envelope and a postal order for 6d. for each Blue Print Ordered.

PRICE
7/-

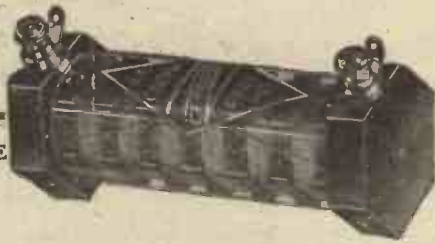

PRICE
7/-

—and now, the **C.E. PRECISION H.F. CHOKE**

The special method of manufacture ensures a maximum efficiency over a wide range of wave-length, with a minimum self-capacity and a small external field.

C. EDE & Co., Ltd., BYFLEET, SURREY.

There are also the C.E. Precision Rheostats, Dual Rheostats, Potentiometers and Grid Leaks. The C.E. Precision Floating Valve Holder, anti-capacity and non-microphon.c. is illustrated here; price 2/3 each.



Telephone:
Byfleet 226.

Telegrams:
Ceprecise, Byfleet.

RADVACO VALVES

—Best of all foreign valves

ASK YOUR FRIENDS! THEY KNOW. Radvaco guarantees to return your money if not entirely satisfied.

Type No.	Des.	Amps. Fil. Ct.	Heating Voltage	Imp. ohms.	Price each
1	D.E.	.06	3	25000	7/8
2	P.	.25	4.5	9000	10/6
3	B.E.	.5	3.5	40000	3/8
4	B.E.	.7	4	25000	3/6
5	cl.	.4	3.5	—	9/-
8	D.E.	.06	1-1.3	22500	10/-
9	P.	.1	1-1.3	8250	12/8
10	P.	.15	1-8	7000	11/8
11	D.E.	.06	1.5-1.8	18000	7/9

Accurate filament adjustment prolongs the life of your valves.



Nos. 1 to 5, for use with 4 v. accumulator.
" 8 and 9, for use with 1.5 v. dry cell.
" 10 and 11, for use with 2 v. accumulator.
If your dealer cannot supply you send P/O direct to the Sole Agents:

RADVACO LTD., 3, LYNTON RD., LONDON, W.3 Phone: Chiswick 2922

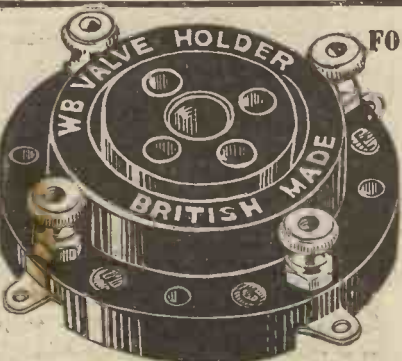

FOR BEST RESULTS

USE **W.B. ANTI-PHONIC LOW LOSS VALVE HOLDERS**

PRICE With Terminals **2/3**

With Tinned Soldering Tags **2/-**

If unable to obtain from your dealer write direct. Manufactured by **WHITELEY, BONEHAM & CO., LTD., Duke Street, MANSFIELD, NOTTS.**

CENTROID

Wireless Components

Screened Coils



Model	Description	Price	Each
C5BA	250-550 Split Primary Aerial Coil	8/6	
C5DA	1000-2500 " " " "	8/6	
C5BT	250-550 " " Transformer	10/-	
C5DT	1000-2500 " " " "	12/-	
C6B	250-550 " Secondary	10/-	
C6D	1000-2500 " " " "	12/-	
C3B	250-550 Reinartz Coils	10/-	
C3D	1000-2500 " " " "	12/-	

Prices include complete screened coil and base.

An entirely new and original method of using screened coils.

CENTROID lead-in and earthing switch - 4/- each
CENTROID slow-motion dial - - - - - 3/- "

CONDENSERS

Die Cast.	Low Loss.	Square Law	Price
SINGLE	- - -	10/-	each
DUAL	- - -	21/-	"
TWO GANG	- - -	22/-	"
THREE	- - -	33/-	"

Two and three gang are fitted with additional balancing condensers.

Obtainable through dealers or direct from manufacturers

The Camden Engineering Co., Ltd.
Bayham Place, Camden Town, N.W.1

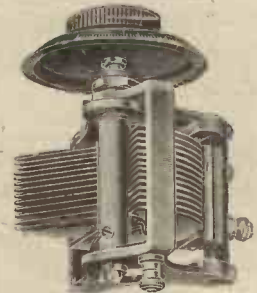

RADVACO VALVES

—Best of all foreign valves

ASK YOUR FRIENDS! THEY KNOW. Radvaco guarantees to return your money if not entirely satisfied.

Type No.	Des.	Amps. Fil. Ct.	Heating Voltage	Imp. ohms.	Price each
1	D.E.	.06	3	25000	7/8
2	P.	.25	4.5	9000	10/6
3	B.E.	.5	3.5	40000	3/8
4	B.E.	.7	4	25000	3/6
5	cl.	.4	3.5	—	9/-
8	D.E.	.06	1-1.3	22500	10/-
9	P.	.1	1-1.3	8250	12/8
10	P.	.15	1-8	7000	11/8
11	D.E.	.06	1.5-1.8	18000	7/9

Accurate filament adjustment prolongs the life of your valves.



Nos. 1 to 5, for use with 4 v. accumulator.
" 8 and 9, for use with 1.5 v. dry cell.
" 10 and 11, for use with 2 v. accumulator.
If your dealer cannot supply you send P/O direct to the Sole Agents:

RADVACO LTD., 3, LYNTON RD., LONDON, W.3 Phone: Chiswick 2922

When you make your Frame Aerial—
be sure to use LEWCOS Frame Aerial Wire. Guaranteed by the manufacturers of GLAZITE.
In cartons in the following colours: Bright Red, Bright Blue, Bright Green, Marone, Old Gold and Golden Brown. 3/8 per 100 ft. coil, from all Radio dealers.
THE LONDON ELECTRIC WIRE COMPANY & SMITHS, LTD.

LEWCOS Frame Aerial Wire

The DIX-ONEMETER

is a beautifully finished Moving Coil instrument of wonderful precision and delicacy. Measures microamps to 20 amps, millivolts to 2,000 volts, and 50 ohms to 50 megs. INSTRUMENT ONLY 50/-.

"VIOLINA" LOUD SPEAKERS are elegant furniture, as delightful as a violin. Model-de-luxe hornless mahogany cabinet type for lid of set or on wall. Liquidation stock of brand-new original 6-guinea Violinas, fitted 2,000 ohm Viola reed reproducer, 25/-, packing and carriage, 5/-.

HEAR-EASY 'PHONE EARPADS, List Price, 2/- pr. Sale, 6d. pr. Free to Blind. Half-price to Hospitals.

SALE OF RECEIVERS by MARGONI CO. and other Leading Makers. M. Crystal Cabinets, with phones, 15/6. The Bargain of the Year. The R.B.10 1-Valve and Crystal Reflex Sets, with Osram Valve. As new, in cabinet, with phones, 30/-. Usual price, 25. A number of 2, 3, 4, 5 and 6 Valve Sets at Bargain Prices.

TEXAS GONE LOUD SPEAKER with the Golden Voice, 3-guinea Model, bronze, for 30/-, complete with cord.

Weston Relays, 30/-; Wheatstone Bridge, 45/-; Micro-Galvos, 60/-; Uni-Shunts, 35/-; Res. Boxes, Thermal and Electro-static Meters, Cell Testers, Capacity Meters, all at low prices.

NOW READY—OUR NEW CATALOGUE
68 Pages, Novel Apparatus, Profusely Illustrated, Numerous New Lines. Over 1,000 Splendid Bargains. Send 4d. Stamp and Save Pounds.

ELECTRADIX RADIOS, 218, Upper Thames St., London, E.C.4.



THE FINEST VALVE CONTROL
Can be adjusted by using only the

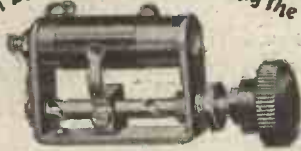

NEW T.C.B. GUARANTEED RESISTANCE

(Illustration is three-fifths actual size.)
Perfect contact; smooth and dead silent; stops for "off" and "full on"; total travel two turns of the knob; panel or baseboard mounting; easy to fit. British throughout. Send postcard for descriptive folder.

CAUTION: See that guarantee is filled in when purchasing.

Resistance, 6, 13 or 30 ohms, 2/6; 50 ohms, 3/-
Potentiometer, 300 ohms, 3/6
Of all dealers, or direct, post free, from sole makers, State whether one- or two-hole panel fixing or base-board mounting desired.

Wavio Ltd

Dept. P, QUEEN STREET, HITCHIN.

EXPERT REPAIRS

To all kinds of Radio Instruments by experienced workmen. Phones and Transformers, 5/- Speakers, 4/6. All work guaranteed as new.

PROVINCIAL READERS—Have you any difficulty in obtaining components for "P.W." sets? We can supply all parts for sets described in this paper, at usual advertised prices, within 48 hours.

KNIGHT, 6, Chapel St., London, E.C.2.
Phone: Clerkenwell 4715.



You do not know the possibilities of your set until you have fitted Voltron Valves.

Voltron high efficiency valves stand supreme and cost you less.

2 V. 2a 5/6
2 V. 06a 7/6
4 V. 06a 7/6
H.F. DET OR L.F.
2 V. POWER 9/-
AT YOUR DEALER OR DIRECT
TECHNICAL FOLDER FREE

VOLTRON

169, CITY ROAD, LONDON, E.C.1.

HEADPHONES REPAIRED.

Re-wound and re-magnetised 5/- per pair. Loud Speakers repaired 5/-. Transformers re-wound 5/- each. All work guaranteed and tested before delivery. Write for Trade Prices. Phone: Clerk 1795. MASON & CO., 44, East Rd., City Rd., N.1

To All Advertisers

PLEASE note that communications concerning advertising in POPULAR WIRELESS MODERN WIRELESS WIRELESS CONSTRUCTOR must be made to

JOHN H. LILE, LTD.,
4, Ludgate Circus, London, E.C.4

(Phone: City 7261.)
and NOT to the Editorial or Publishing Offices.

RADIOTORIAL QUESTIONS AND ANSWERS

(Continued from page 322.)

lately it is very unreliable, signals fading away suddenly in the most erratic and annoying manner."

This fluctuation of signals that is troubling you is not really "fading," but is caused by a fault in your set. ("Fading" proper is a phenomenon that is only noticeable on long-distance signals, and the cause does not lie at the receiving end, but is due to peculiar reflection effects experienced by the electro-magnetic waves during their journey through space.)

A likely cause of your fluctuating results is an intermittent or loose contact, especially in coils, valve holders, terminals on 'phone leads.

Any wire that is partially broken may occasionally be mended momentarily by chance, thus restoring results for a moment. Other likely places for such a fault to occur are at the accumulator's connecting bar (terminals not screwed down tightly), or in the aerial or earth circuit.

When dry batteries deteriorate they occasionally cause these fluctuations, and an aerial swinging against a water-pipe or other earthed object may have the same effect.

THE FILADYNE ONE-VALVER.

M. S. (Tarporley).—"What are the connections for the Filadyne one-valver, using capacity controlled reaction for long distance reception?"

The connections for this circuit are given in the diagram reproduced herewith.

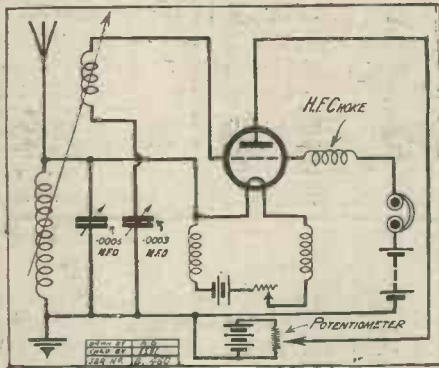

LOADING A VARIOMETER FOR 5 X X.

P. L. (Silloth, Cumberland).—"Why is it that 5 X X cannot be received when a 5 X X loading coil is connected to a variometer-crystal set?"

Probably the loading coil has not been inserted in the right place. It is not sufficient to connect it between the aerial and earth, but it must be placed so that 'phones and crystal are connected across it. The connections for such a set are as follows. Aerial terminal to crystal and to one side of loading plug. Other side of loading plug to variometer. Other side of variometer to earth terminal and to 'phones. And finally, remaining side of 'phones to remaining side of crystal detector.

MEASURING CRYSTAL SET CURRENTS.

"CURIOSITY" (Cheltenham).—"What sort of an instalment is required to measure the currents flowing in a crystal set, and where should it be connected up?"

A micro-ammeter is required—i.e. an instrument capable of measuring millionths of an ampere. It is connected between the 'phones and the earth terminal—that is, in series with crystal and 'phones, across the aerial coil.

THE "MAY" CIRCUIT.

L. H. (Manchester).—"What are the point-to-point connections of the famous "May" circuit?"

The connections are as follows. Aerial to plate socket of valve holder and to variometer. Remaining side of variometer to H.T. +, to grid leak and grid condenser, and to a .001 variable condenser. Remaining side of grid leak and grid condenser to grid of valve socket.

Remaining side of .001 variable condenser to earth, to 'phones, to rheostat, and to L.T. +. Remaining side of 'phones to H.T. neg.

Other side of rheostat to filament socket of valve holder. Filament socket of valve holder to L.T. negative.

GRAVES
2-VALVE LOUD SPEAKER BARGAIN.

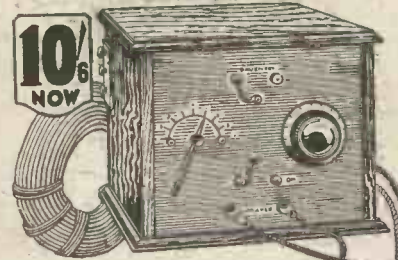

This highly efficient 2-Valve Loud-Speaker Set is the finest wireless value ever offered.

It gives a volume and quality of tone unattained by any instrument of a similar price and is the essence of simplicity. Fitted with coils covering all the British wave-lengths, including Daventry.

THE CABINET is of beautifully polished Oak, & all components are of the highest quality. Dual Emitter Valves with patent valve holders, &c.; H.T. Battery, 2-volt accumulator and complete Aerial Outfit. **LOUD SPEAKER** of exclusive design with unique magnetic system and £7:17:6 improved mica diaphragm. Price

TERMS: Our Bargain Price is for deferred payments. Send 10/6 now, & complete purchase in 14 monthly payments of 10/6. If you wish to pay cash, 5 per cent discount is allowed. Catalogue Post Free. Up-to-date Crystal & Valve sets at lowest prices. J. G. Graves Ltd. Sheffield



TRANSFORMERS REWOUND—Transformers, Phones, Loudspeakers, Rewound and Repaired to Maximum Efficiency. All One Price 4/- each. Don't discard if burnt out. All work guaranteed for 12 months. Write for trade terms TRANSFORM CO., 115, LINKS RD., TOOTING, LONDON, S.W. 17.

WET H.T. POROUS POTS

Genuine miniature porous pots for Wet H.T. to fit 2 1/2 x 1 1/2 Jar, registering 1-4 volts; 3/- per doz. Non-conductive Glass jars, 1/- doz. Waxed, 1/3 per doz. Sacs, 1/8 doz. Zincs, 1/- doz. Send 1/6 stamp for Price List and Instructions. Carriage and Packing extra.

Trade Inquiries: **THE ETON GLASS BATTERY CO.,** (Dept. P), 46, St. Mary's Road, E.10.

THE EXACT AERIAL TUNER. Panel mounting. No Galls or Coil-holders required. Maximum results guaranteed. Wave lengths 250 to 2,000 metres. Best all in one yet! 1/- Money refunded if not satisfied. Price only 14/- postage 6d. extra. Write: Sales Department of **THE EXACT MANUFACTURING CO.,** Priory Street, COVENTRY.

CATWHISKERS & CRYSTALS ABOLISHED

for 1d. per year. Guaranteed indefinitely. Pat. No. 265,469. Fixed Permanent Detector and Stabilising Unit. No Batteries required with Crystal Circuits. Indispensable for Reflex and Hiale Circuits. From all dealers, or post free from Patentees, 2/2. **A. W. GRIFFIN & CO.,** Manufacturers, REDDITCH

When replying to advertisements please mention "Popular Wireless" to ensure prompt attention. THANKS!

4-ELECTRODE VALVES

We are the suppliers of the genuine U.O. and Thorpe valves, as specially tested and recommended by the "Undyque" inventors and "Popular Wireless." U.C.5 and Thorpe K.4. (both 4-electrode 5-pin valves), each, post free..... 8/11
Order direct from— Cash with Order
LUDGATE RADIO CO.,
56, LUDGATE HILL, LONDON, E.C.4

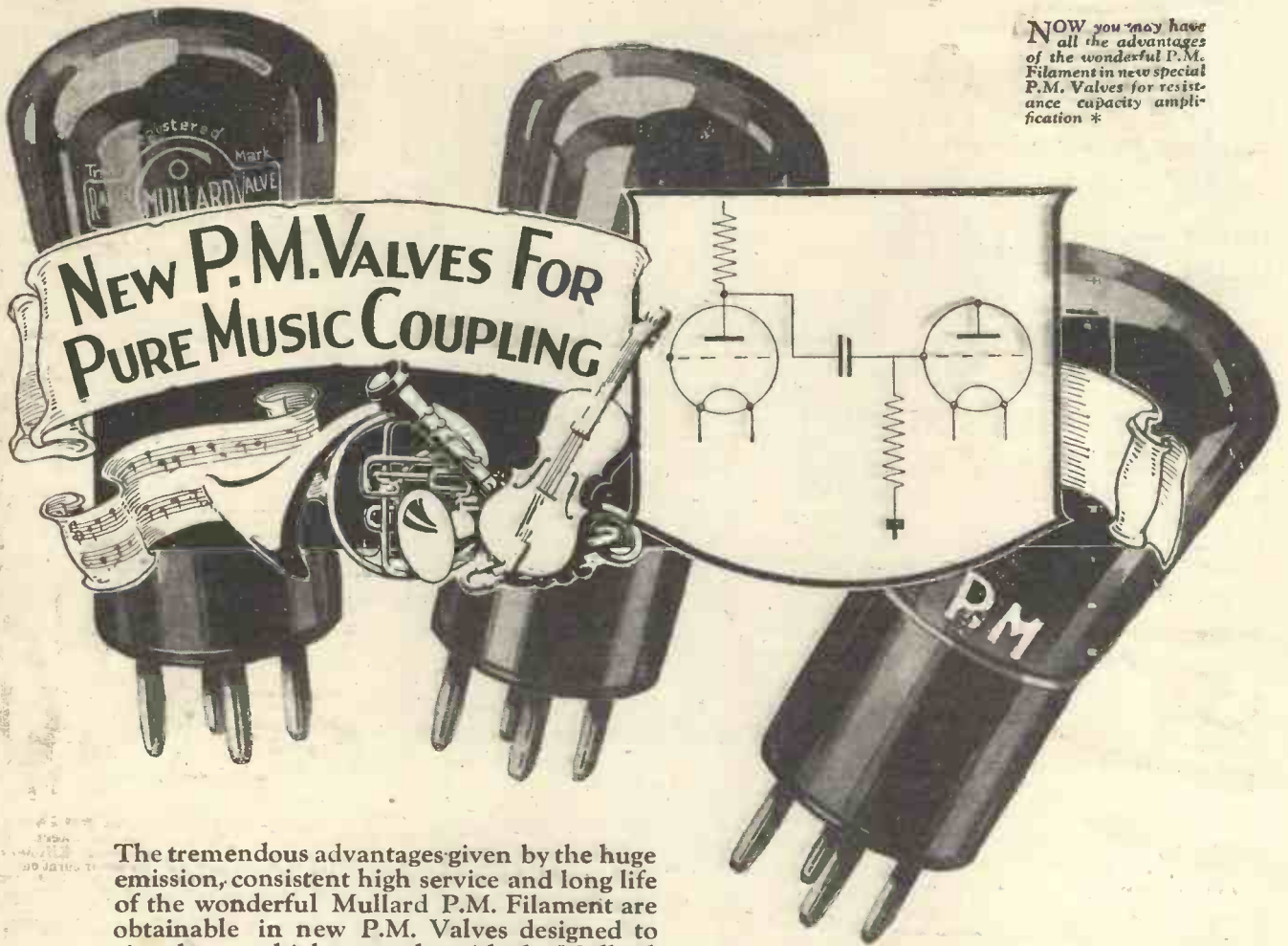

NOW you may have all the advantages of the wonderful P.M. Filament in new special P.M. Valves for resistance capacity amplification *

The tremendous advantages given by the huge emission, consistent high service and long life of the wonderful Mullard P.M. Filament are obtainable in new P.M. Valves designed to give the very highest results with the Mullard Pure Music Coupling (the ideal method of low frequency amplification approved by the Mullard Engineers and employed so successfully in Mullard P.M. Receivers described in "Radio for the Million.")

These new P.M. Valves are available for 2 volt, 4 volt and 6 volt accumulators. Apart from absolute purity in music and speech reproduction, abundant volume is obtained and H.T. Battery consumption is considerably reduced.

Let these new Mullard P.M. Valves bring you unequalled results in the resistance coupled stages of your receiver, and give you the master service and long life universally associated with the valves with the wonderful Mullard P.M. Filament.

Obtainable from all Radio Dealers

Mullard

THE MASTER VALVE

British Made
in a
British Factory,

For 2-volt accumulator

- P.M.1 H.F. 0.1 amp. 14/-
- P.M.1 L.F. 0.1 amp. 14/-
- * P.M.1A (Resist. Capacity) 0.1 amp. 14/-
- P.M.2 (Power) 0.15 amp. 18/6

For 4-volt accumulator or 3 dry cells

- P.M.3 (General Purpose) 0.1 amp. 14/-
- * P.M.3A (Resist. Capacity) 0.1 amp. 14/-
- P.M.4 (Power) 0.1 amp. 18/6

For 6-volt accumulator or 4 dry cells

- P.M.5X (General Purpose) 0.1 amp. 14/-
- * P.M.5B (Resist. Capacity) 0.1 amp. 14/-
- P.M.6 (Power) 0.1 amp. 18/6

Super power valves for last L.F. Stage

- P.M.254 (4 volts, 0.25 amp.) 22/6
- P.M.256 (6 volts, 0.25 amp.) 22/6



Right, First Turn

THERE is no quicker or easier way of finding any station between 200 and 4,000 metres than with the R.I. Retroactive Tuner. Right, first turn, is the rule with this time- and money-saving instrument.

All bother with coils is eliminated and a greater efficiency is gained, for the R.I. Retroactive Tuner secures the correct aerial reaction over the whole range of wave-lengths covered. In addition this tuner costs appreciably less than a set of coils with coil holder to cover the same range.

The R.I. Retroactive Tuner provides the easiest, most efficient and most economical method of tuning which you can incorporate in your set. Follow the lead of all the famous set designers and constructors and improve your tuning arrangements from to-day with the R.I. Retroactive Tuner.

PRICE 39/6

Write for the R.I. Green and Gold Catalogue.



Advt. R.I. Ltd., 12, Hyde St., New Oxford St., London, W.C.1.