

# THE "P.W." SAVOY THREE

7

# Popular Wireless

Every Thursday  
—PRICE  
3d.

No. 239. Vol. X.

INCORPORATING "WIRELESS"

January 1st, 1927.

### *Special Features :*

Recent Advances in  
Radio Science

The Right and The  
Wrong Way

Do You Know "Mu"  
and "I"?

Wiring Your Set

A Triumph of Broad-  
casting

Half An Hour With  
"P.W."

Our cover photograph this  
week shows the W R N Y station  
studio as arranged at a New  
York Exhibition.



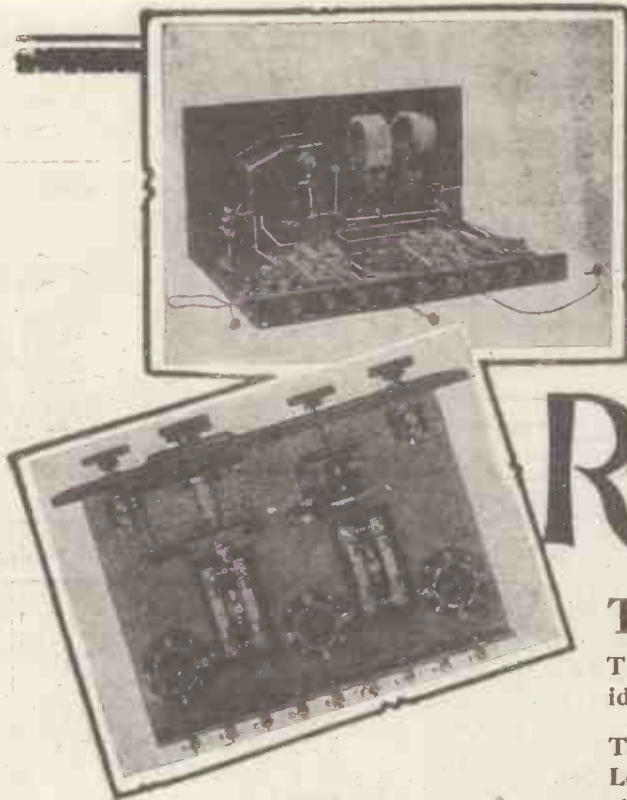

# Are you making the famous R.C. Threesome?

**T**O get the wonderful results obtained with the original R.C. Threesome Set, you should use identical components.

The Coil Holder used is a "Lotus" Left-Hand Two-Way Coil Holder; the three Valve Holders are "Lotus" Buoyancy Valve Holders, with Terminals.

Wireless experts decided that these were best for a very important experiment; that they would get most out of the set on which depended the very high reputation of the famous Ediswan Valves.

They were not disappointed. YOU will be more than pleased with the R.C. Threesome's performance if you fit "Lotus" Valve Holders and Coil Holder.

*From all Radio Dealers*

## LOTUS COMPONENTS



Lotus Two-way Coil Holder. Inside mounting. Left-hand. **7/-**  
Patent No. 244251.

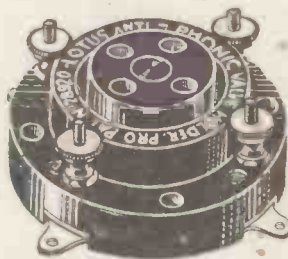

Lotus Buoyancy Valve Holder with Terminals. **2/6**  
Patent No. 256833.

# An Efficient Four Valve Long Range Receiver for Loud Speaker Reception

Comprising an H.F. valve with tuned anode, a detector valve with reaction on anode of preceding valve, and two L.F. valves coupled by means of two Ideal Transformers to ensure purity and volume. Two, three or four valves may be used as desired.

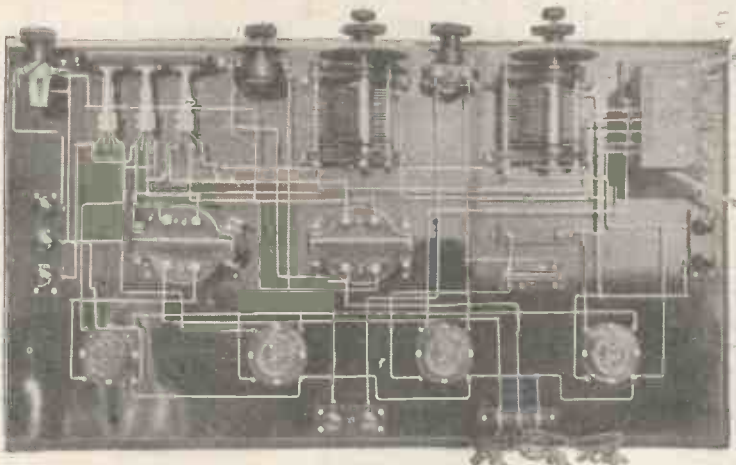

The most satisfactory results are ensured by using the following

## Marconiphone and STERLING Radio Components

2 Sterling Sq. Law Variable Condensers '0005 mfd., with Vernier. 1 Sterling Triple Coil-holder. 3 Sterling Low Loss Coils. 1 Marconiphone Tubular Condenser '00025 mfd. 1 Marconiphone Gridleak (mounted). 2 megohms. 4 Sterling Non-Pong Valveholders. 4 Marconi Valves. 2 Marconiphone Ideal Transformers, ratios 2.7-1 and 4-1. 1 Sterling Fixed Condenser '0005 mfd. 1 Marconiphone Tubular Condenser, '0005 mfd. 1 Sterling Rotary Filament Resistance. 1 Marconiphone Variable Resistance 500,000 ohms. 3 Sterling Telephone Jacks. 2 60-volt H.T. Batteries. 1 Accumulator (according to Valves used). 1 9-volt Grid Bias Battery. 1 Marconiphone H.T. and L.T. Switch. 10 Terminals and 1 Ebonite Panel.

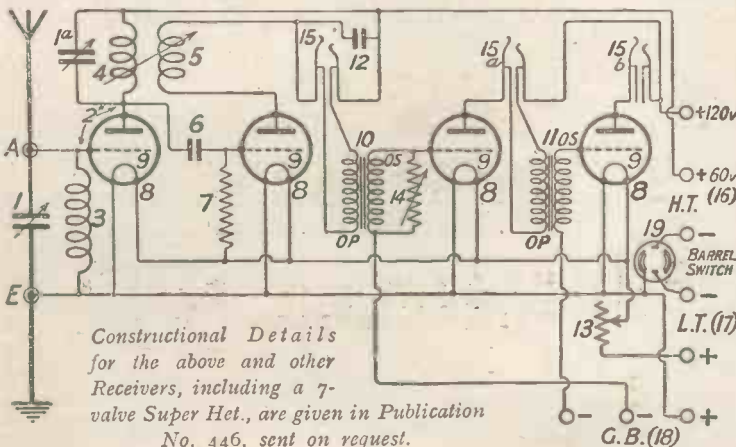

Constructional Details for the above and other Receivers, including a 7-valve Super Het., are given in Publication No. 446, sent on request.

### Marconiphone "IDEAL" Transformer

Guaranteed Distortionless Ratio:  
2.7-1  
4-1  
6-1  
8-1  
25/- each

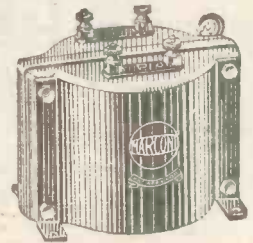

### Sterling Variable Air Condenser

(Square Law Type, with Vernier.)  
'00025 mfd. - 8/6  
'0005 " - 9/6  
'001 " - 10/6

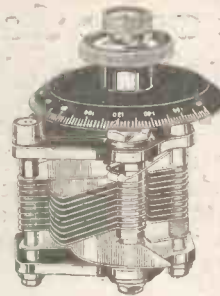

2/3 each (Mounted.)

### Marconiphone GRID LEAKS

1, 2.5, 5, 10, 20, 30, 50, 105 Capacity.



### Sterling COIL HOLDERS



Double 16/6  
Triple, for mounting on either side of a panel... 20/-

### Sterling FIXED CONDENSERS

All Capacities. 1/6 each



### Sterling "NON-PONG" Shock Absorbing VALVE HOLDER

2/9 ADAPTER, 3/6

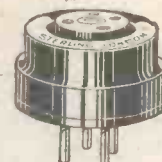

Marconiphone VARIABLE RESISTANCE  
H.F. 40,000 ohms.  
L.F. 500,000 ohms.  
8/6 each



## THE MARCONIPHONE COMPANY LIMITED

Head Office: 210-212, Tottenham Court Road, London, W.1.

(Sole Agents for Sterling Telephone & Electric Co., Ltd.)

Registered Office: Marconi House, Strand, London, W.C.2.



Things  
are not  
always  
what they  
seem

## 2. The case does not make the Watch

**T**HE most exquisite case imaginable will not make an accurate timekeeper. Unless the delicate mechanism is assembled and adjusted by experienced hands with the same care as those which fashion the case, the watch will not fulfil its purpose.

As in timekeeping, so in Wireless. Take the fixed Condenser. In outward appearances two of different makes may be identical. As with the watch, however, the correct functioning does not rely upon the case alone. How, then, are you to judge a Condenser? You buy this, more than any other component in your set, in the dark.

Do not prejudice the success of your Receiver for the sake of a few pence; pin your faith to T.C.C.—the proved Condenser. One embodying the experience of over twenty years Condenser making. One which is the choice of the foremost radio technicians of the country. One whose sale extends to several millions. With a T.C.C. Condenser in your Set, you are freed from condenser trouble—*for ever*.

**Q** T.C.C. Mica Condensers come in capacities from '0009 to '001, price 2s. 4d. The Mansbridge type ranges from '0009 at 2s. 0d. to 2 mfd. price 4s. 8d.

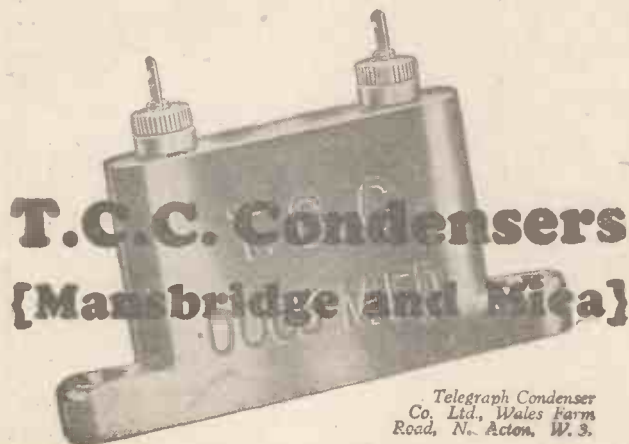

Telegraph Condenser  
Co. Ltd., Wales Farm  
Road, N. Acton, W. 3.

G.A. 6867

## Invaluable to EVERY Amateur and Constructor.

The "POPULAR WIRELESS"

## BLUE PRINTS of TESTED CIRCUITS

Every wireless amateur and every wireless constructor will find these "POPULAR WIRELESS" Blue Prints absolutely reliable. They have been most accurately drawn, and every circuit has been tested under normal broadcasting conditions by the technical staff of "Popular Wireless." It will be seen from the complete list given below that the series covers a very wide field. The veriest tyro will find each print most straightforward to follow and the receivers most easy to construct.

### P.W. BLUE PRINT

- Number
1. DETECTOR VALVE WITH REACTION.
  2. UNIDYNE DETECTOR VALVE WITH REACTION.
  3. 1-VALVE L.F. AMPLIFIER.
  4. CRYSTAL DETECTOR WITH L.F. AMPLIFIER.
  5. H.F. (Tuned Anode) AND CRYSTAL, WITH REACTION.
  6. H.F. AND CRYSTAL. (Transformer Coupled, without Reaction).
  7. 1-VALVE REFLEX WITH CRYSTAL DETECTOR (Tuned Anode).
  8. 1-VALVE REFLEX AND CRYSTAL DETECTOR (Employing H.F. Transformer, without Reaction).
  9. H.F. AND DETECTOR (Tuned Anode Coupling, with Reaction on Anode).
  10. H.F. AND DETECTOR. (Transformer Coupled, with Reaction).
  11. DETECTOR AND L.F. (With Switch to Cut Out L.F. Valve).
  12. DETECTOR AND L.F. UNIDYNE (With Switch to Cut Out L.F. Valve).
  13. 2-VALVE REFLEX (Employing Valve Detector).
  14. 2-VALVE L.F. AMPLIFIER (Transformer Coupled with Switch to Cut Out Last Valve).
  15. 2-VALVE L.F. AMPLIFIER (Transformer-Resistance Coupled with Switch for Cutting Out Last Valve).
  16. H.F. (Tuned Anode), CRYSTAL DETECTOR AND L.F. (with Switch for Last Valve).
  17. CRYSTAL DETECTOR WITH TWO L.F. AMPLIFIERS (with Switching)
  18. 1-VALVE REFLEX AND CRYSTAL DETECTOR, with 1-VALVE L.F. AMPLIFIER, Controlled by Switch.
  19. H.F. DETECTOR AND L.F. (with Switch to Cut Out the Last Valve).
  20. DETECTOR AND 2 L.F. AMPLIFIERS (with Switches for 1, 2, or 3 Valves).

ALL "POPULAR WIRELESS"  
BLUE PRINTS——6d. EACH

All orders for these Blue Prints should be sent direct to the "Popular Wireless" Queries Department, Fleetway House, Farringdon Street, London, E.C.4, enclosing a stamped addressed envelope and a postal order for 6d. for each Blue Print Ordered.

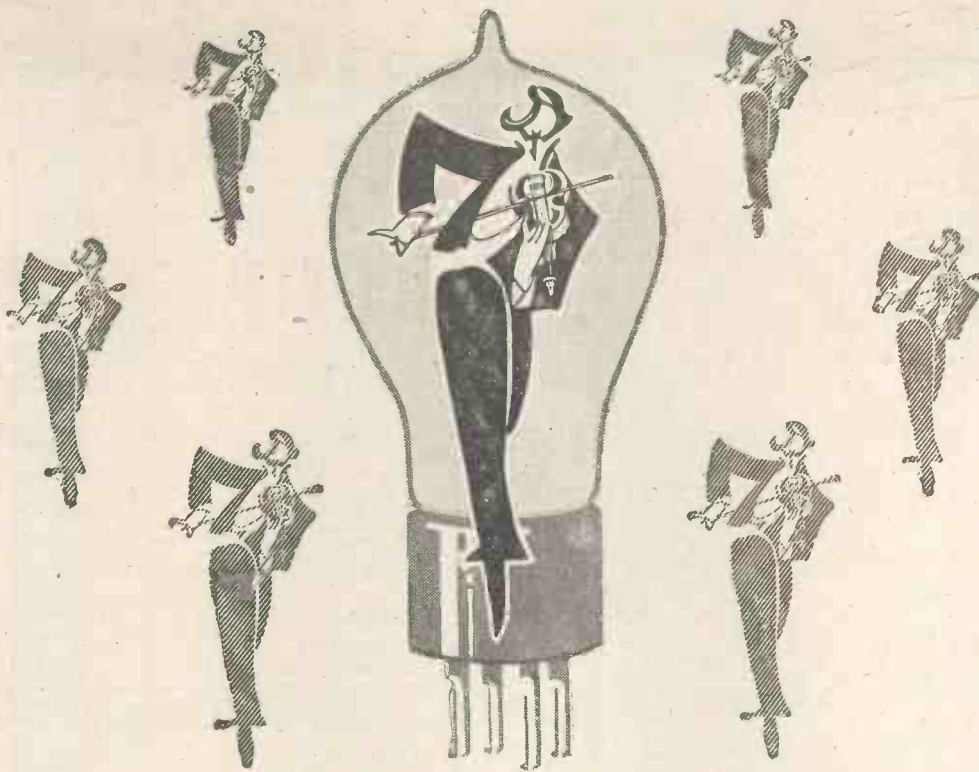

THEY BRING THE MUSIC NEARER

*They make the Music Clearer*

*and yet they are no dearer than any other valves.*

Cosmos Valves are valves of sheer musical virtuosity. Sure, exquisitely sensitive and sympathetic, they give your set a new soul. They are wonderful musicians, the Cosmos Valves, and keep their youth, knowing no fatigue!

**Cosmos**  
SHORT PATH  
**RADIO VALVES**  
*for all circuits*

FROM WIRELESS DEALERS EVERYWHERE Wholesale only: METRO-VICK SUPPLIES LTD.  
Metro-Vick House, 155 Charing Cross Rd., W.C.2. Proprietors: Metropolitan-Vickers Electrical Company Ltd.

# EDISON BELL RADIO

THE BEST FOR 1927

THE E.B. "KING" 3-VALVER

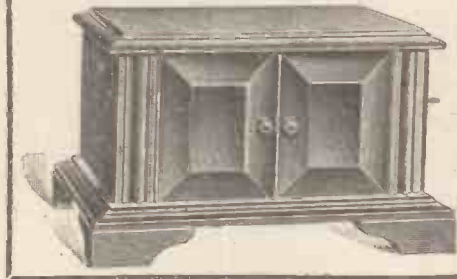

**WHY**  
not ask your  
dealer for  
Illustrated  
Catalogues,  
or apply to  
Edison Bell,  
Limited.

**WHY**  
pay more  
when the  
best is so  
cheap and  
so efficient.

This magnificent Edison-Bell 3-Valve set represents the finest value for money ever offered to the public. Beautifully constructed and highly receptive, this instrument is unsurpassed by any on the market. It is constructed by skilled British workmen and scientifically tested by experts before it leaves our factory.

Price £6 : 7 : 6

(Valves, Batteries and Marconi Licence extra.)

EDISON BELL, LIMITED, LONDON, S.E.15.

TESTED 500 VOLTS  
FLAT TYPE



TESTED 500 VOLTS  
UPRIGHT TYPE



## INSIST ON EDISON BELL CONDENSERS

THEY ARE BRITISH MADE AND GUARANTEED BY A NAME WITH 30 YEARS REPUTATION BEHIND IT

WHY PAY MORE THAN DOUBLE for other amplifiers  
or for a valve set, when you can get as good results with THE

# MAGNETIC MICROPHONE BAR AMPLIFIER

(Patent No. 248551/25.)

"NO CRYSTAL SET IS COMPLETE WITHOUT THIS WONDERFUL ATTACHMENT."

Not only will this marvellous device give really good LOUD-SPEAKER RESULTS from CRYSTAL RECEPTION of average strength, but it is absolutely the ONLY means of increasing the strength of weak signals in HEADPHONES without using valves.

Works perfectly on one or two dry cells.

A BOON TO DEAF PERSONS

EQUALLY EFFICIENT ON VALVE SETS

IF YOUR DEALER CANNOT SUPPLY ORDER DIRECT FROM SOLE MANUFACTURERS AND PATENTEES:



(Two-thirds actual size.)

NOT a Microphone Button.

**NO** Valves, Accumulators or H.T. Batteries. Fragile parts. Distortion.

Simple as ABC.

MICROPHONE AND OTHER PARTS OF AMPLIFIER SUPPLIED SEPARATELY

FULLY ILLUSTRATED LISTS FREE

COMPLETE AMPLIFIER as shown PRICE post free 38/-  
3-volt DRY BATTERY lasting over three months 4/- extra.  
No other accessories required.

DELIVERY BY RETURN FROM STOCK. EVERY AMPLIFIER GUARANTEED.

NEW WILSON ELECTRICAL MANUFACTURING CO., LTD., 18, FITZROY STREET, EUSTON ROAD, LONDON. W.1. Phone: Museum 8974.

# 1927

## A New Year's resolution.

### Use



always

**IGRANIC "INDIGRAPH" Vernier Knob and Dial**



The Igranic Indigraph Vernier Knob and Dial is a handsome slow motion dial which greatly facilitates fine adjustment. Two scales of 0 to 100 each are provided reading in opposite directions making the Indigraph suitable for different types of condensers. Space is provided opposite the scale for recording station settings. The metal dial acts as a shield against hand capacity effects. **Price 7/6 each.**

**IGRANIC PACENT "PRE SET" Resistors**

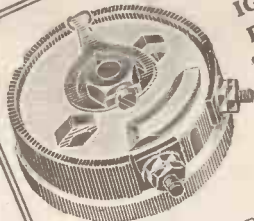

Igranic-Pacent "Pre Set" Resistors have all the uses of fixed resistors and yet are almost as easily variable as rheostats. Their use instead of rheostats lessens the cost of the receiver and prevents over-running the valves. Igranic-Pacent "Pre Set" Resistors are suitable for all types of valves and the position of the contact finger is easily altered. Made with resistances of 6, 10, 20, 30 and 50 ohms. **Price 1/8 each.**

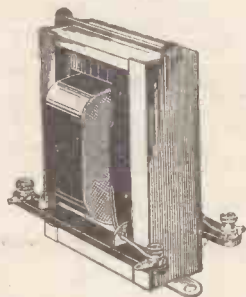

**IGRANIC-PACENT SUPER AUDIOFORMER**

The Igranic-Pacent Super "Audioformer" has a remarkable amplification curve making it quite different from all other transformers and giving uniformity of amplification which results in superlative tone qualities. The Igranic-Pacent Super "Audioformer" has a ratio of 1:3 and is suitable for all stages. **Price 2/1s. 6d.**

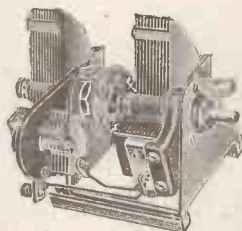

**IGRANIC GANG CONDENSERS**

Igranic Gang Condensers are fitted with special equalising devices which enable the sections to be accurately matched without altering the relative settings. The square law characteristic is thus preserved and the full tuning range is maintained. Igranic Gang Condensers are built up from Igranic-Pacent 0005 mfd. Square Law Condensers. **Twin Gang £2:10:0 Triple Gang £3:15:0**

WRITE FOR THE NEW IGRANIC CATALOGUE LIST NO. R.41.

**IGRANIC ELECTRIC CO. LTD**

149 QUEEN VICTORIA STREET, LONDON

Works: BEDFORD



**IGRANIC CENTRE TAPPED "XLLOS" (Extra Low Loss) COILS**

Igranic Centre Tapped "XLLOS" Coils possess special windings of very high efficiency, enclosed in a sealed Bakelite shell which excludes dust and moisture and prevents the coils being damaged, thus preserving absolute constancy in operation. Igranic Centre Tapped Coils actually contain two separate inductances which may be used singly or may be joined in series to form a single coil to which a centre tapping can be taken. Made in five sizes for wavelengths from approximately 110 to 3,350 metres. **Prices: from 7/- each. Mounting Base ... 4/6.**

**PROTECT YOUR VALVES**

BY USING W.B. ANTI-PHONIC

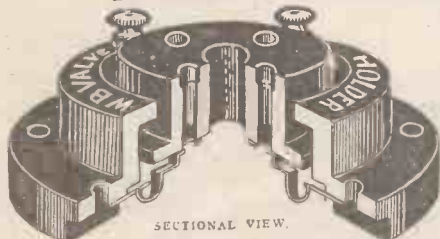

**LOW LOSS VALVE HOLDERS**

PRICE Complete with Terminals

**2/3**

If unable to obtain from your dealer write direct.

Manufactured by **WHITELEY, BONEHAM & CO., LTD.,** Duke Street, MANSFIELD, NOTTS.

**BECOL**

Makers of the **ORIGINAL world-famous BECOL LOW LOSS FORMER**

Registered Trade Mark.



As used, in sets that took the first four prizes at the 1926 "Manchester Evening Chronicle" Wireless Exhibition and the set that won the Gold Medal at the 1926 Amsterdam Exhibition.

Size: 3 inches diameter to outside of wings. Prices:  
6 inch lengths, -3/- (Postage 9d.);  
4 inch lengths, 2/- (Postage 6d.);  
3 inch lengths, 1/6 (Postage 6d.);  
Up to 36 in. lengths.

**NOTICE:—Do not be put off with an imitation. Ask for BECOL and use the Former with a reputation.**

Write for List "C."

Ebonite Rods, Tubes and Sheets. Panels guaranteed free from surface leakage.

**THE BRITISH EBONITE Co., Ltd.,** Hanwell, London, W.7.

# Announcing the new Stentor Four

—a valve which  
easily shatters  
all records for  
volume & purity

## 18'6

4 volts  
·1 amp.

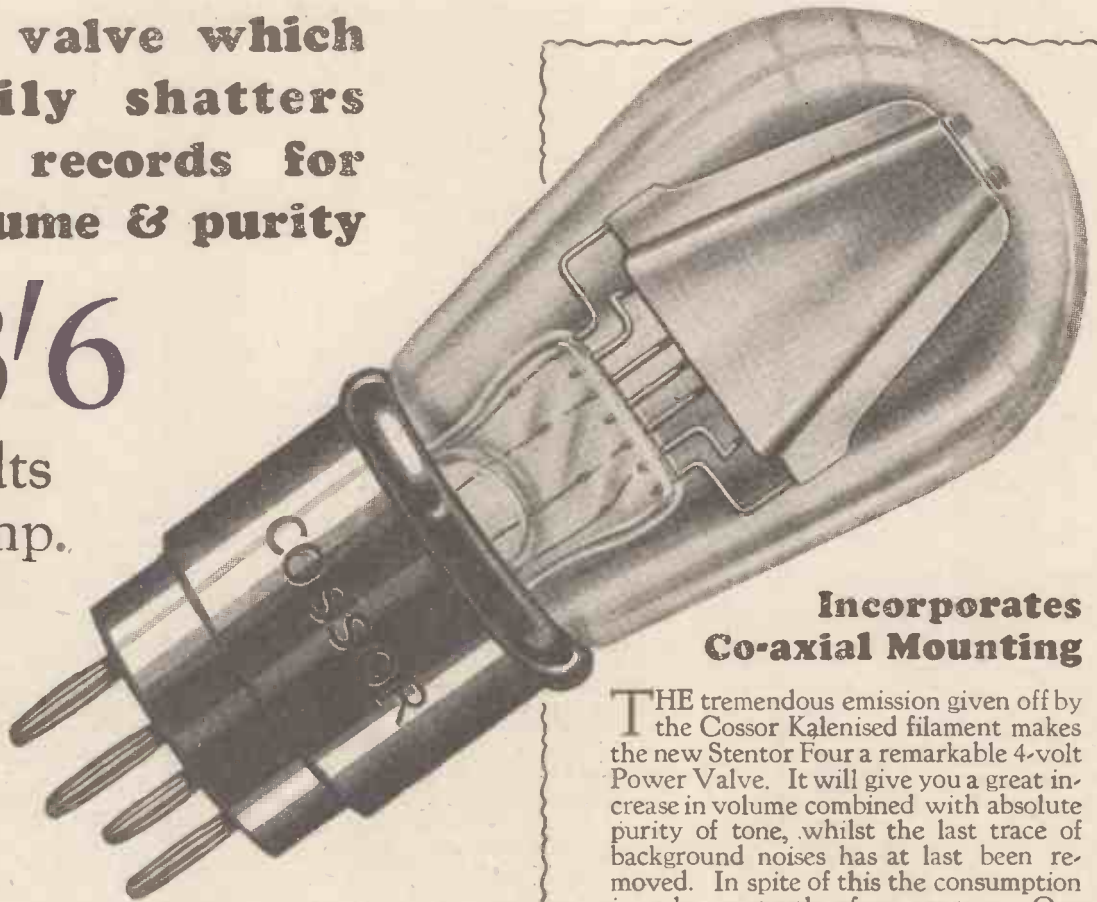

### Incorporates Co-axial Mounting

THE tremendous emission given off by the Cossor Kalenised filament makes the new Stentor Four a remarkable 4-volt Power Valve. It will give you a great increase in volume combined with absolute purity of tone, whilst the last trace of background noises has at last been removed. In spite of this the consumption is only one-tenth of an ampere. One power stage with a Stentor Four gives greater volume than two ordinary valves. This is an economy you most appreciate.

The Kalenised filament is of exceptional length. Its emission surface is enormous. Under the system of Co-axial Mounting (exclusive to Cossor) the twin filament, the grid and the anode are securely held in life-long alignment. Individual movement is absolutely impossible. The characteristics of the valve cannot change and absolute uniformity is automatically guaranteed.

See your Dealer without delay. The demand is already very large—if he is out of stock further supplies will reach him within the next few days.

With the new  
Kalenised  
Filament

# Cossor

—the Valve which  
serves you longest



# Popular Wireless

Scientific Adviser:  
**Sir OLIVER LODGE, F.R.S.**  
 Technical Editor:  
**G. V. DOWDING,**  
 Grad. I.E.E.  
 Assistant Technical  
 Editors:  
**K. D. ROGERS**  
**P. R. BIRD**  
**G. P. KENDALL, B.Sc.**



Incorporating "Wireless."

Consultants:  
**Dr. J. H. T. ROBERTS,**  
 F. Inst. P.  
**J. F. CORRIGAN, M.Sc.,**  
 A.I.C.  
**C. E. FIELD, B.Sc.**  
**E. J. SIMMONDS,**  
 M.I.R.E., F.R.S.A.

Editor: **NORMAN EDWARDS, M.Inst.R.E., M.R.S.L., F.R.G.S.**

## RADIO NOTES AND NEWS.

"All the Best"—A Wonder Year—New Irish "Ham"—An Italian Exposition—More Crystal Reports—Madrid Again—Super Station for France

"All the Best!"

**O**YEZ! Oyez! Here we are again! Years may come and years may go, but we keep on like billy-oh. "All the best" to all of you. I can't say fairer than that. And I say! What luck we've had with the dates lately! A "P.W." dated Christmas Day, and another dated New Year's Day. A jolly good omen, oh—readers!

Past and Future.

**E**VEN that cheery slogan, "All the best," has its significance for us, because that's what "P.W." tries to give you, and between you and me and the binding-post, I have a strong suspicion that we deliver, too. Figures talk!

What I was going to say, before this fit of modesty came on, was that if "P.W." has during the past year "said a mouthful," it's nothing to what it will do in 1927. I'm tellin' ye!

A Wonder Year.

**A**ND what a year it's likely to be! A mixed bag for most of us, because life is like that. But for radio it is pretty sure to be a year of steady progress. Thousands of A1 brains on the job. Tons of ebonite and brass. Forests of wood. A huge hole in the atmosphere, where vacua have been dug out for valves. Miles of blue-prints. Unlimited ether. "Beams" shooting all over the Empire, and television bringing the broadcasters' faces bang into the parlour, perhaps. Well, you'll see! "All the best." (This seems rather a contradiction in terms.—Ed.)

Inns and Outs of English.

**O**N New Year's Eve, instead of going out and going in and out of inns I shall stay in and "listen-in" the Old Year out, out of intense interest in

outside indications of the outgoing year, till the announcer gives out that the sands have run out. Then I shall give in and go out. (About time, too.—Ed.)

Wanted—Selectivity.

**R**ATHER a good one from Amurca! A man was asked by his wife to take down a broadcast cookery recipe. He did his best, but got two stations at once. The station he ought to have tuned out was broadcasting the morning exercises. This is what he copied: "Hands on hip,

with a fine comb. I am afraid I like it better, in the lump, than the B.B.C.'s efforts. Much more music is given, for one thing; music of a good no-brow level. Moreover, the pudding is better mixed, so that the listener does not have to wait through a lengthy "group" of songs by one artiste before the orchestra plays again. But the most remarkable fact which emerges from my analysis is that the ten stations between them put over only thirteen "talks" during the month! Anyone heard CN R lately?

New Irish "Ham."

**M**R. EDWARD BEAT asks me to announce that he has been licensed to transmit with 10 watts on 23 and 45 metres. Call sign, 2BB. As his set is to be used mostly as a portable station, we may conclude that Mr. Beat is going to beat about the bush with it. Other stations had therefore better rig up D.F. receivers. Reports are welcomed by 2BB, who rightly reckons his sigs. are hard to beat—!



Curious effect of a broadcast talk to children on the Delights o. Studying Mathematics.

place one cup of flour on the shoulders, raise knees and depress toes and mix thoroughly in a cup of milk. Repeat six times. Lower the legs and wash two hardboiled eggs. Lie on the floor, roll the white of an egg back and forth till it comes to a boil. Dress in warm flannels and serve with fish soup."

A Lesson from Canada.

**T**HE Canadian National Railways have sent me the programmes of their ten broadcasting stations for December, and having no 2LO or Daventry programmes to listen to, owing to the greater part of the evening being filled with one play, I went through the Canuck stuff

Underfoot Aerials.

**T**HE very latest radio thought-wallop from the U.S.A. is the underfoot aerial, which is a wire contraction sandwiched between two sheets of waterproof parchment, mat size, and laid under a rug. I have not divined why it has to be so concealed or why, being waterproof, it cannot be secreted in the old oaken bucket or used to cover hen-houses. But imagine the joy of the sportive puppy when he digs up this treasure from underneath the mat!

New Wireless Service.

**O**N Dec. 15th there was opened the first wireless service between this country and its oldest ally, Portugal. (Continued on next page.)

## NOTES AND NEWS.

(Continued from previous page.)

It is conducted between the Marconi Station at Ongar and Lisbon, with extensions to Madeira and the Azores. Later, there will be "Beam" services opened between Lisbon, Cape Verde Islands, the Portuguese African colonies and Brazil.

## An Italian Exposition.

IN 1927 there is to be held at Como an International Telegraph and Telephone Exposition and Congress in celebration of the centenary of Alessandro Volta, who was born there. Alec knew a lot about "juice" for those times, but not much about cat's-whiskers. His discoveries were, however, "the snake's eyebrows," and because of this he has been immortalised by the name given to the unit of electromotive force, the volt, sometimes profanely referred to in electrical circles as "the doings."

## A Japanese Fan.

THE fan I wish to introduce to you is not made of bamboo and paper, but flesh and blood. His name is Mr. Takee Kimizuka, and I think he is a jolly good fellow. He has sent to me—and therefore to all of you—a long printed letter in English and I am at a loss to know which I admire most, his eloquent communication or his benevolent heart.

## The Road to Peace.

MR. KIMIZUKA, whose address is Asahi Co., Kazusa, Chibaken, Japan, says: "The lack of friendly relations leads to misunderstanding between nations, and, in turn, this sometimes results in terrible destruction of peace. War is really the most barbarous act done by mankind. As we have no doubt been born to live in peace and with happiness on earth, I hope radio will be of great service for dispelling the misunderstanding between nations and worldly everlasting peace will come." He has got to the root of the matter, and that's a fact. But read on, I prithee.

## The Definite Object.

OUR Oriental friend adds: "This conception has driven me to the compilation of a list of world-wide radio broadcasting stations. It was April last I happened to enjoy beautiful foreign musics through a speaker." He promptly wrote for details and after long waiting secured them. They are "happended" to his letter in the form of a printed schedule, which he is distributing far and wide and proposes to issue monthly.

He begs earnestly for lists of stations, giving the name of the owner, call-letter, wave-length, power in watts and hours of operation. As his first list contains only twenty-four stations, collected with great patience and printed with great labour, shall not some of us inundate him with further lists? Yes, I think so. Our far-off colleague and fellow fan is "only a humble Japanese yonug man. And I swear I am not a man who takes advantage of radio as stock-in-trade." He deserves encouragement. May no earthquake ponk his aerial.

## More Crystal Reports.

WHEN in the Christmas number I threw down the glove to the Knights of the Cat's-whisker I had a shrewd suspicion that I was starting something. Well, so I was, for the Knights have attacked in squadrons and I am left wondering whether the valve has not been over-rated. What emerges crystal (*ahem!*) clear from the letters received from these Galena Giants, Carborundum Captains and other stalwarts is the fact that not all long-distance crystal reception can be magnificently swept aside as the offspring of re-radiation from valve receivers.

## A Good Example.

A SOUTH Norwood reader states that on November 21st, between 7 p.m. and 8 p.m., he heard Hamburg, Frankfurt, Radio-Paris, and several other German stations unidentifiable at the time, one of them probably Leipzig. He can hear Hamburg almost any night even when 2 L O is transmitting. Radio-Paris is also a nightly "cert," though it is faint, and Daventry cannot be tuned out. He suggests that as he could tune these stations in and out at will he was not getting re-radiated signals. I do not think that is a conclusive proof, but, speaking as "Ariel," I should be inclined to bank on it.

## Long Distance for Ten Shillings.

MR. D. MCCARTHY of Co. Cork, made his crystal receiver at a cost of six shillings, begorra, and gets Daventry, which he thinks is pretty good. So it is—unless re-radiation come into the business, and on this point he says nothing.

## Evidence by the "P.W." Ultra.

KNIGHT WILL H. RANDLE, Nuneaton, springs into the fray with a "P.W." Ultra set and produces results which he says have been verified by others. He can pull in Daventry with sufficient strength

## SHORT WAVES

"The wireless 'uncle' who had to read out birthday congratulations to a child living in Ystradgynlais scarcely made a pronounced success of it."—"The Star."

"The gaol in Cork is to be converted into a 'bread-casting' station."—Provincial Paper.  
A matter of habit, we suppose.

"A scientist has discovered how to distribute heat by radio. It is expected that the day is not far distant when ladies will be able to dry their hair in the hot air broadcast from Parliament."—"Passing Show."

A choir of Swiss yodellers recently broadcast a concert in London. Many people remarked on the lateness of the milk round the next morning—owing to the number of milkmeu who listened in.

"Contented—the man who stays at home in the evenings and just listens to the wireless or his wife, whichever happens to be broadcasting."—"Sunday Pictorial."

"Wireless is not merely a commodity in itself but a kind of megaphone for the sale of other goods."—"Daily Telegraph."  
This, of course, is a misprint and should read: "other goods."

Another Impending Apology.  
From a broadcasting programme:  
"7.40.—Professor J.—: The Mind of the Lower Animals (from Aberdeen)."—"Punch."

"The most important question of the moment is: 'What can the B.B.C. in television?'"—Daily Paper.

to make a loud-speaker speak under its breath; Birmingham, Nottingham and Frankfort equal in strength to Nottingham. He has also logged a Birmingham amateur (6 BY?). I should like to hear more reports on Frankfort; it seems to have either a hefty punch or a slick wave-length.

## Madrid Again!

ONE more bit of testimony, this time from Swansea, by a reader (Mr. L.), who writes cautiously and whose letter reveals the truth-seeker's nice discrimination. Madrid, he says, can be heard more often than not; Stuttgart and Hamburg have been heard several times recently, occasionally almost as strongly as Daventry; Frankfort identified once; Radio-Paris, faint; Daventry comes in loudly enough for real "listening-in" purposes. Now, Mr. L. says: "There are no other aerials within 100 yards of the house," and I think we come, now, to the question as to how far a given valve set tuned to a given station can affect a given crystal receiver by re-radiation, and to what extent, calculated in signal-strength. There is a pretty line of research for you, Knights, and I pause for a reply. Thank you, kindly.

## New Wireless Section of I.E.E.

THE South Midland centre of the Institution of Electrical Engineers has formed a wireless section, forty strong. New members will be welcomed. Sec., Mr. A. T. Thurman, Electric Supply Station, Soho Road, Handsworth, Birmingham.

## Super Station for France.

IF the proposal of the Union of Radio-Electric Industries to erect a 60 kw. broadcasting station near Paris is realised the crystal enthusiasts will have a new pond to fish in, for the station will be heard as far distant as the U.S.A. Students of French drama and French language and learning will also be in luck's way, because it is proposed to transmit performances at the Opéra, the Opéra Comique and the Comédie Française as well as lectures at the Sorbonne. But I feel inclined to sing, "What will the wave-length be?"

## The Bell(e) of Philadelphia.

CAST in Croydon, the tenth largest bell in the world has been sent to Philadelphia for the roof of the Wannamaker store. Evidently they Wannamaker noise there. If all has gone well this little rattle will have struck the hour of midnight on New Year's Eve. They say it is going to broadcast once a day, but as it weighs 18 tons I think that must be a slight exaggeration. A well-groomed cat's-whisker to the first "P.W."-er to log Big Phil.

## A Happy Afterthought.

HA! I have just thought of some more New Year's greetings. May 1927 be X-less, talk-less (or at any rate, less talk). May we be able to buy "cold" valves at 5s. each, with a rebate on returned empties. Then "P.W." will promptly publish the design of "The Ten-pound Ten" receiver. What hopes? Lots! (Perhaps.—Tech. Ed.)



A FEW years ago comparatively little importance was attached to the characteristics of valves even by really enthusiastic amateurs. And perhaps it was just as well, for in those days valves were much more inconsistent than they are to-day. Standardisation was attempted, of course, but the processes and the machinery involved in their production were both insufficiently advanced to render the attempts at all successful. Therefore, the

A simple explanation of two terms which directly affect every user of a valve set.  
By G. V. DOWDING, Grad.I.E.E.  
(Technical Editor).

amateur buys a valve of a certain type bearing the name of a reputable manufacturer he can safely depend upon it having those characteristics ascribed to the type in question. And what are the special characteristics which have a direct bearing upon the work it will be called upon to do?

First of all there are "Fil. volts" and "Fil. amps." And everybody knows all about these for the simple reason that until a certain number of volts are applied across the filament of a valve by means of an accumulator or a dry battery, and until the specified amount of current is flowing through the filament and bringing it to the required temperature, the thing just will not work at all. Therefore, people have been forced to learn about these characteristics; but the same cannot be said about "impedance" and "amplification factor," for the misapplication or an ignorance of

will be able to leave the least technical reader with a clear idea of the general principles involved.

**Concerning Impedance.**

First of all, let us take impedance. Impedance indicates the resistance of a valve and for that reason it is always expressed in ohms. Thus, a valve having an impedance of 20,000 ohms should be no more frightening to the amateur than a pair of telephone receivers stated to have a resistance of say 4,000 ohms. It is called impedance in the case of a valve because it is presumed to be the resistance of the valve to fluctuating currents, and capacity and inductance have to be taken into account as well as plain straightforward ohmic resistance. And impedances calculated from statically prepared characteristic curves do not take these into account simply because such curves are prepared under static conditions with currents and

these, may only mean the difference between bad and good results or between good and very good results!

**What Do They Mean?**

A great deal has been written about the suitability of valves of certain impedances, and with certain amplification factors for certain specific purposes, and the two terms have been explained briefly many times; but we wonder how many of our readers even now know exactly what they mean. Anyway, what we are going to do on this occasion is to treat the subject from a slightly different viewpoint to those usually taken, hoping by doing this that we

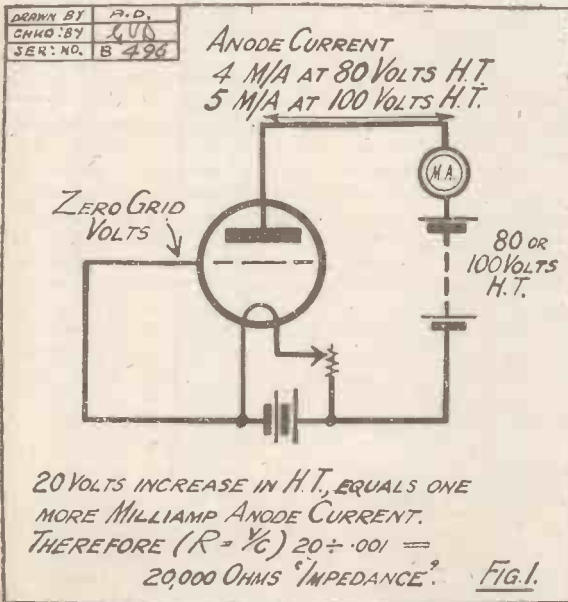

result was that individual valves of similar types varied quite considerably. Even now perfection in this respect has not been attained. As a matter of absolute fact it never could be, for no two or more manufactured articles ever can be absolutely identical, whether they be made by hand or machinery.

**Consistency of Modern Valves.**

And in a valve the discrepancy of a microscopical nature can affect its electrical characteristics. But such a wealth of scientific research and endeavour has been directed towards the problem that for all practical purposes standardisation has been achieved. Therefore, if the present-day

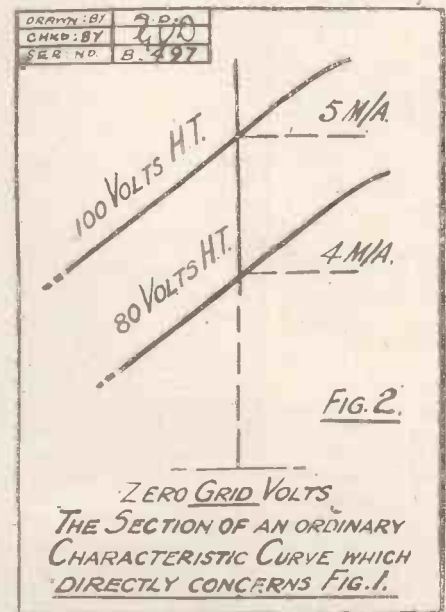

potentials that do not fluctuate. And when it is added that the frequencies of current, and potential fluctuations also

(Continued on next page.)

# A SIMPLE ELECTROSCOPE.

This instrument is extremely easy to make and will prove of interest and use to all wireless experimenters.

By J. F. CORRIGAN, M.Sc., A.I.C.  
(Staff Consultant.)

A USEFUL piece of apparatus which is not always to be seen among the experimental outfit of the genuine radio enthusiast is an electroscope, or static charge measurer. Nevertheless, an efficiently working instrument of this nature is not difficult to construct, and, with

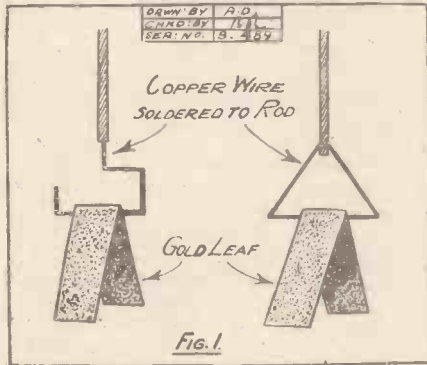

the exception of the cost of the necessary small piece of gold leaf, the instrument described in this column may be constructed almost for nothing.

An electroscope of this type is very useful for obtaining an estimate of static charges

on the aerial, and it is, indeed, primarily for this purpose that the use of the instrument is suggested. A host of further uses for the instrument will readily occur to the mind of the more general experimenter, however.

To make the electroscope, take a wide-mouthed bottle about four to six inches in height, and about an inch and a half wide. The bottle must be provided with a tightly-fitting cork, and the latter should preferably have been well impregnated with paraffin wax or shellac before use.

### Constructional Details.

Procure a length of brass rod, and to one end of it solder a circular metal plate of about three inches diameter.

A hole is now bored in the centre of the cork, and the free end of the rod is pushed through it. A support or stirrup for the gold leaf must now be provided. This is most conveniently constructed by soldering a short piece of No. 22 copper wire on to the end of the rod, in the manner shown in the illustration, Fig. 1. Two separate methods of constructing this stirrup are shown in that illustration.

A strip of gold leaf, measuring about three inches by half an inch, is now taken and very carefully folded loosely over the

stirrup. This is, perhaps, inclined to be a tricky operation because the gold leaf is so light and fragile that the merest breath will blow it away. However, with reasonable care, the operation can readily be completed.

### How to Use It.

The appearance of the completed electroscope will be seen from a glance at the photograph, Fig. 2. Care must be

taken to have the whole of the apparatus thoroughly dry, and to prevent the leakage of atmospheric moisture into the bottle, the cork, when finally in position, may be thickly covered with wax.

The instrument so constructed will be found to be very sensitive to static charges, and upon making contact between the circular plate and a body containing the slightest static charge, the gold leaves will diverge, the amount of their divergence indicating the strength of the charge. In order to bring the leaves together again, merely touch the circular disc with the finger, and the desired result will be attained, the charge on the leaves instantly flowing to earth through the body.

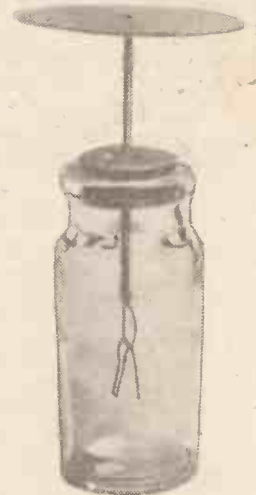

Fig. 2. The instrument described.

## DO YOU KNOW "MU" AND "I"?

(Continued from previous page.)

should be taken into account, it is easy to see where the amateur can be confused.

But a characteristic curve can be a very good guide and impedances and amplification factors worked out from this will give very close approximations of the capabilities or purposes of valves. But we cannot regard the "impedance" as anything but plain, straightforward resistance in this case.

### The "Amplification Factor."

And Ohm's Law says that Resistance equals Voltage divided by Current. The current will be the Anode Current which is expressed in milliamperes. Our Voltage will be the voltage of the H.T. battery which will be connected directly across the plate and the filament of the valve with a milliamperemeter in series for measuring purposes. We do not want the grid to affect our readings so we will leave it connected to the negative pole of the filament lighting battery. Thus, the mystical condition of "Zero Grid Volts" is obtained.

Now, supposing, with an H.T. voltage of 80 volts, 4 milliamperes of current is flowing through the anode circuit, and when the H.T. voltage is increased to 100 volts

the anode current jumps up to 5 milliamperes. An increase of 20 volts H.T. has increased the anode current by 1 milliampere. Remembering that "Resistance" equals Voltage divided by Current, all that we have got to do is to reduce our milliamperes to amperes, and to divide this figure into the 20 volts to obtain that mysterious "Impedance" figure. One ampere equals one thousand milliamperes, so we must divide the 20 by .001, which gives us 20,000. Very simple, is it not?

Now the amplification factor is nothing more or less than an expression indicating the amplifying power of a valve. A valve amplifies because variations on its grid cause greater variations in its anode circuit, which includes the H.T. battery and telephone receivers or the primary of a transformer. Signals arrive in the form of voltage fluctuations on the grid and evince themselves in the form of variations in the current flowing in the anode circuit.

A variation of the H.T. battery voltage would also cause a variation in the strength of the anode current. Increase the H.T. by 20 volts and perhaps 1 more milliampere of anode current will flow; reduce the H.T. by 20

volts and, perhaps, the anode current will drop 1 milliampere. Supposing a two-volt variation on the grid caused as much variation of anode current as the above 20 volt variation of the H.T. battery voltage — i.e. 1 milliampere more or less, then it has taken ten times the amount of anode voltage to do what a certain grid voltage did, and so 10 is the amplification factor. (See Fig. 3). Very easy, after all, isn't it?

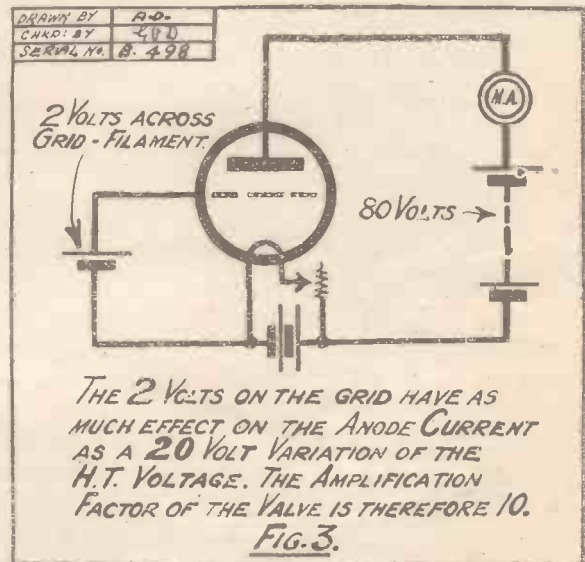

THE 2 VOLTS ON THE GRID HAVE AS MUCH EFFECT ON THE ANODE CURRENT AS A 20 VOLT VARIATION OF THE H.T. VOLTAGE. THE AMPLIFICATION FACTOR OF THE VALVE IS THEREFORE 10.

FIG. 3.

# WIRING YOUR SET



Many an otherwise well-built receiver is spoiled by the poor arrangement of the wiring. Constructors who doubt their capabilities in the direction of making a really satisfactory job "behind the panel" will find a number of useful hints in this article.

By K. D. ROGERS.  
(Assistant Technical Editor.)

IT is difficult when discussing the wiring of a receiver, and the methods that should be employed in making the connections, not to refer to the *lay-out* of the components, for these two subjects are very closely connected and, in fact, are interdependent. Readers must forgive me, then, if I refer at some length to the lay-out portion of the construction of wireless receivers, as well as talking about the actual making of the connections.

No matter what type of set is being built, nor who is constructing it, the two main factors to be taken into consideration when *designing* the set are the lay-out of components, both from the point of view of facilitating the operating of the set, and from that of possible interaction between the parts, and the actual position of the various wires which are to connect the components together.

It may appear that all this care is unnecessary when dealing with a fairly simple receiver, but it is best for the constructor to get into the habit of thoroughly thinking out these points, no matter what type of receiver he is building. It may save no end of trouble and time in the long run, besides making for the more efficient operation of the set.

## Lay-out Important.

I remarked once before in an article in this paper that the final lay-out chosen for any one receiver would be a compromise between that giving the best operating facilities and the one giving the best back-of-panel arrangement. It will be realised, of course, that preponderance must be given to the back-of-panel arrangement if true efficiency is to be obtained, because the relative positions, not only of the components but of the connections themselves, will play a very large part in the results of which the set will be capable.

In building a set the first thing to consider is the type of circuit you are dealing with, the actual components you will use, and then the minimum size of panel and base-board that will suit your requirements. I say minimum because no one wishes to use an unnecessarily large panel or cabinet, but that minimum does not mean the smallest space into which the components can be crowded.

By judicious spacing and the careful arrangement of valves and some of the smaller components, it is often surprising into what a small area quite a complicated receiver can be built without impairing its efficiency. But it is better to err on the large side than to cram the receiver and spoil the results.

When arranging the components the constructor must not only bear in mind the possible interaction between them, but also the fact that wherever possible the leads connecting the various parts must be short and direct. This is especially so where H.F. circuits are involved, and in the majority of cases where *large* receivers are concerned, it is far better not to worry too much about the symmetrical appearance of the inside of the receiver, but to devote one's attention more to the efficient arrangement of the components and the future positions of the leads.

## A Typical Example.

No one building a short-wave receiver, where the importance of careful lay-out is

out by a variable condenser placed right up at the other end of the set simply because it made the panel look nice and gave the owner the idea (quite erroneous, by the way) that he would obtain more efficient results because the handling of the set would be easier.

As a matter of fact, on test the set gave perfectly hopeless results, and on close examination it was further found that the aerial coil upon which reaction effects were to take place by means of the usual reaction coil was situated in the *middle* of the receiver about seven inches away from its tuning condenser. I need not enlarge any further upon these points, as the hopelessness of building a set under such conditions will be obvious to my readers, and yet I can assure them that similar instances come to my notice nearly every day.

The only way in which to obtain the maximum from the receiver is to wire it up properly, and to do this it must be decently laid out. Remember that a golden rule is to have leads going to the grids and plates of the valves as short and as direct as possible, especially on the H.F. side, though this does not mean that *anything* may be done with those following the detector valve. Furthermore, bunching of connections such as is illustrated in the photo, must be avoided as far as possible even though it is taking place at the output end of the receiver.

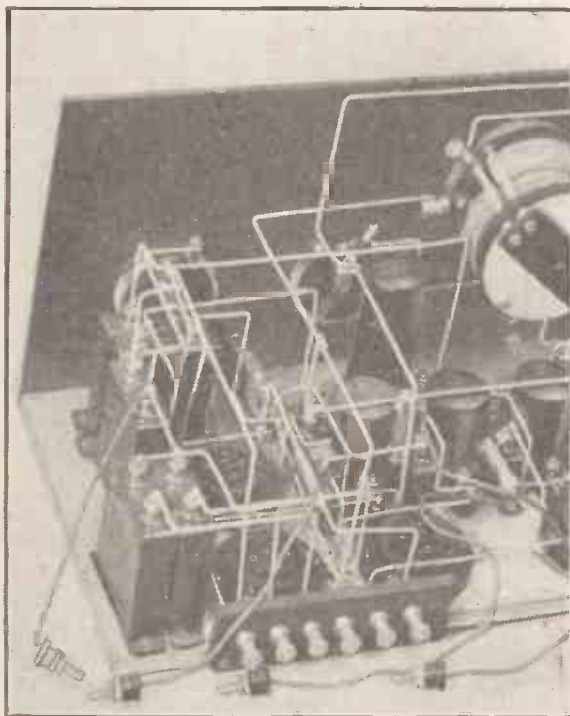

An example of badly spaced wiring. Even at the output end overcrowding should be rigorously avoided.

## Direct Leads.

In order more or less to guarantee that a set should be wired up in the most efficient way possible, it is a good plan to wire all the interval filament leads and those from valves to rheostats first, then the grid leads, including the grid bias connections, and all the plates, but leaving those connecting the various components to the H.T. terminals and the long L.T. leads to the rheostats from the terminals. By this means direct wiring will be made easily possible between the components, and what may be called the

(Continued on next page.)

naturally emphasised rather more than is the case with sets designed to deal with lower frequencies, would ever dream of having the grid and plate leads wandering about all over the baseboard. But I have seen many four-valvers embodying quite complicated circuits with the tuning of the plate circuit of the H.F. valve being carried

## A HOME-MADE ELECTRIC FURNACE.

A simple device that will be of interest and value to the crystal experimenter.

By J. F. CORRIGAN, M.Sc., A.I.C.  
(Staff Consultant)

THE electric furnace described in this article is a miniature copy of the well-known Moissan type of furnace, and although the very simplest materials are used in its construction, it will nevertheless be found of exceedingly great use to the amateur whose line of experiment involves the fusing of various materials for the production of synthetic crystals.

The furnace, carefully worked, is a great advance on the gas, fire, or blowpipe type of fusing apparatus, and temperatures which are attainable only with the very greatest difficulty with the latter types of apparatus can be obtained with the utmost ease with the furnace described below.

Thus the furnace is just the thing for fusing up bits of galena (melting-point about 950 degrees C.), and for fusing zinc oxide (m.p. about 1,200 degrees C.) in the preparation of artificial zincite.

### Preparing the Furnace.

First of all procure two limestone blocks. These can usually readily be obtained from hardware firms or paint stores. The size of the blocks should be approximately 5 in. by 5 in. by 9 in. They should be smoothed all round, and on their upper surface there should be made a small depression in order to admit the placing of the mixture to be fused. Two grooves must also be provided in the surface of the limestone blocks to take the electrodes.

The other block should then be similarly prepared and then rested on the surface of

satisfactory for all practical purposes, although, of course, it is of the rough-and-ready variety.

The furnace is worked on an alternating supply of current of about 212 volts. A resistance and fuse must be provided in the circuit. It is also a good plan to cover the whole of the furnace up with thin sheets of asbestos in order to retain the heat.

A further practical tip is this. Both of the limestone blocks must be perfectly dry and free from even the slightest trace of moisture before they are put into use. Otherwise, when they become heated up, they will begin to crack and splinter. The best way of providing for the drying of the limestone blocks is to put them away in a hot oven for 24 hours before use. It should also be noted that the limestone, being composed of calcium carbonate, gives off carbonic acid gas under the influence of heat, thereby being converted into ordinary lime. This change will be evident around the sides of the inner cavity of the furnace, and thus every time the furnace is used, the cavity will subsequently be enlarged.

For most purposes, the inner cavity should be kept fairly small in size, a cavity half the volume of an eggcup being quite sufficient for average use. The smaller the cavity the greater the temperature attained by the furnace, and, *vice versa*, the larger the cavity the lesser the degree of heat obtained.

### Cool Slowly.

When fusing up galena in such a furnace for the purpose of preparing artificial radio-sensitive crystals, it should be noted that after the fusion is complete the cooling process should be very gradual. This can be brought about by heavily wrapping the furnace with sheets of asbestos, and, after the current has been switched off, it will be found, under these conditions, that a slow cooling of anything from 4 to 12 hours' duration can be effected. The slow cooling is necessary, of course, in order to permit the solidifying galena to crystallise to its most favourable extent.

For the purpose of making galena, the actual heating should be continued for 6 to 10 minutes. In order to prepare zincite artificially, pack the inner cavity about three-quarters full with ordinary zinc oxide (to which may be added the merest trace of black manganese dioxide) and allow the heating process to carry on for about 10 minutes to a quarter of an hour.

In this case, slow cooling of the furnace is not necessary, for the resulting product will not be crystalline. It is only when well-crystallised products are required that the slow cooling of the fused product is absolutely essential.

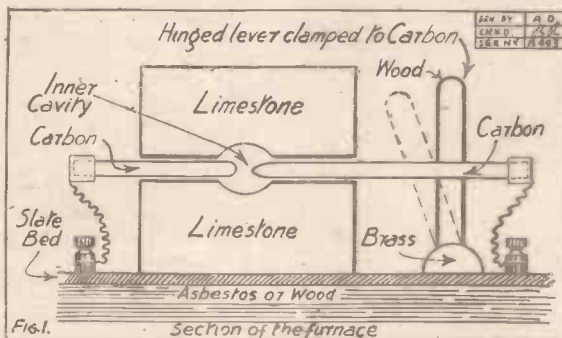
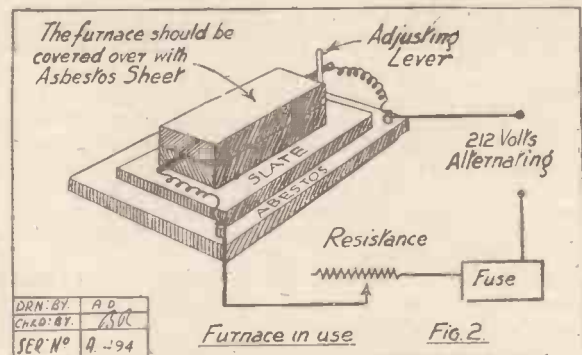

the former block. It is necessary to observe the precaution that the grooves for the carbons must be a little wider than the diameter of the rods themselves in order to admit of an air channel being made to the interior of the furnace. This will serve to allow any gases formed during the heating operations to be led away.

As a base for the furnace, a good thick piece of slate should be used, and this should also rest upon asbestos.

An adjustment for one of the carbons is provided by means of a vertical wooden lever which is fastened or screwed down at one end to the slate bed of the furnace. A suitable clamp for the carbon electrode is furnished on this lever, and by this means the adjustment of the carbons is obtained. This type of adjustment will be found to be

variable condensers, tuning coils, etc., and these should be done next.

Then should be considered the H.T. leads to the various components, and if it is found that a very long H.T. lead is required from either the H.F. or the detector valves, it is often a good plan to connect a .001 fixed condenser (a smaller one will operate quite well if this size is not available) between that point on the tuned-anode coil, reaction coil, or whatever it is, connected to the lead from the H.T. terminal and the nearest point on the L.T. wiring. This will neutralise any deleterious effects that a long H.T. lead might have.

Finally, the long L.T. wiring (from the terminals to the rheostats, etc.) should be carried out, and providing they do not short against anything, it doesn't matter where these wires run, so they can be tucked away as desired.

### Use Good Solder.

A word should be said here about the actual method of making connections. If really short leads are to be obtained, it is almost essential that the joints should be soldered, and the leads taken direct to one another rather than to terminals or soldering tags on the components. By this means also it is easier to avoid parallel wires and their attendant disadvantages.

In multi-valve receivers, and especially on the H.F. side, it is advisable to take the wires direct and not go in for right-angle bends where mere appearance is likely to upset efficiency. Where appearance and efficiency do not clash, these bends can be used as much as you like, because they certainly do make for a better-looking interior.

A last word: When soldering, for goodness' sake use a clean iron, clean flux and thoroughly clean the places where the joints have to be made. Have the iron properly heated (although not too hot); and, above all, use solder (tinman's solder); and not some of the stuff masquerading on the market as that substance.

## WIRING YOUR SET

(Continued from previous page.)

live portions of the set will be properly connected. Included among the connections to be made will, of course, be those to the

# The Right and the Wrong Way

**M**ANY hundreds or even thousands of pounds' worth of wireless apparatus has been thrown on the scrap heap each year through mis-handling.

Most of us have extracted a certain amount of humour out of the beginner's dismay when he has found that he has connected the H.T. wires to the L.T. terminals, and burnt out his valves in one pretty flash. Generally it is quite a good joke until you do it yourself, whereupon it takes upon itself quite a different aspect.

## Inserting Valves.

There is a right and a wrong way of performing dozens of tasks in radio, and the wrong way is generally expensive. Many valves are burnt out through fumbling when placing valves in the sockets, particularly when these sockets are of the exposed variety consisting of four little brass tubes. Remember that the socket for the plate end of the valve is connected to the positive



This hint will help you to fit your valves quickly. Place your finger on the grid pin as a guide.

By PERCY W. HARRIS, M.I.R.E.

battery, a complete absence of signals, and with the L.T. accumulator, a certain amount of distortion. In any case, you can rest assured that you

cannot burn out your valves or do any other injuries to the set by reversing these connections.

There are many right and wrong ways of handling and using an accumulator. If you charge your own accumulators, you will find that in time the level of the liquid steadily falls and you may be tempted to fill up again with acid. If you do so you will probably injure the battery, for the loss has not been of acid but of water alone, the acid remaining in the liquid and increasing its concentration as the level falls. "Topping up" of accumulators should be carried out with pure distilled water only, and it is a good plan to change the acid once a year.

## Accumulator Voltage.

To do this, see that your battery is fully charged and then empty out all acid, rinse the cell with distilled water and fill

the energy of the H.T. battery will pass through the filament, resulting in a bright blue flash in the bulb, and one of the most expensive moments in your wireless history.

Fortunately the use of exposed valve sockets is passing out, and the majority of listeners are now using the anti-vibratory type of holder, in which it is practically impossible, even intentionally, to burn out the valve in this fashion. In any case, quite apart from any danger of burning out the valve, it is very annoying when we cannot fit the pins into the socket.

Above is shown how to pick up a valve and place it in its holder with the certainty that you will get the pins in their right positions practically at once.

Although many of the modern plug-in coils are encased in insulating containers, thus protecting them from mechanical injury and adding considerably to their strength, there are still many coils of fairly fragile construction which can easily be injured by rough handling.

On respective sides are shown the right and wrong ways of getting hold of such a coil. Remember that by pulling in the wrong way you will not only distort the shape of the coil, but possibly injure the windings and even disconnect them from the pins and socket.

## Battery Leads.

I have referred to the dangers of wrong connection of battery leads. You will obviate all risks in this connection if you keep leads permanently attached to your set for both high and low tension. The H.T. lead should terminate in the conventional wander plug, and the L.T. in spade terminals. If by any chance you should attempt to join the L.T. wires to the H.T. battery, the absence of the wander plug and any means of connecting these leads will be immediately apparent. While it is true that you may connect the positive to negative and negative to positive, the only result will be, in the case of the H.T.

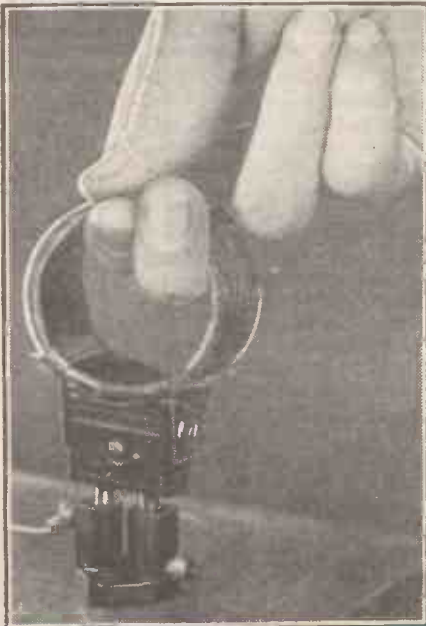

Never pull out a coil by the top.



This method is safer and easier.

of the high tension battery, the negative of which is connected through the accumulator to the two filament sockets. If then, by chance, the two filament legs come in contact one with the plate socket and the other with either of the filament sockets,

with fresh acid of the correct specific gravity, as indicated on the label of the accumulator itself. I cannot give you a figure for this, as it varies with different makes, but if you have any doubts, a post-

(Continued on next page.)

## THE RIGHT AND THE WRONG WAY.

(Continued from previous page.)

card addressed to the manufacturer will bring you the right information.

In case you should think me unduly fussy in pointing out the necessity of using pure distilled water, it is necessary to point out that ordinary tap water contains



Press your thumb on the valve holder and stop that dangerous jerk when removing a valve.

a number of mineral salts—lime, etc.—which may seriously injure the delicate plates of the accumulator. In some parts of the country the impurities present will do no harm, but such cases are relatively few.

### Safety First for Valves.

One of the reasons why I have so steadfastly advocated the use of fixed resistors in place of the older variable resistances for controlling current through valve filaments is that the variable type tempts the user to discharge his accumulator below the safe limit. When you take your accumulator to be charged, or when you charge it yourself, you restore the ability of the cell to give out current.

With the ordinary type of lead accumulator, the voltage on the full charge is just above 2 per cell, and in use rapidly falls to 2, maintaining this voltage for useful duration of its discharge. After a time the voltage will begin to drop and as the filament resistance is used to reduce the effective voltage of the accum-

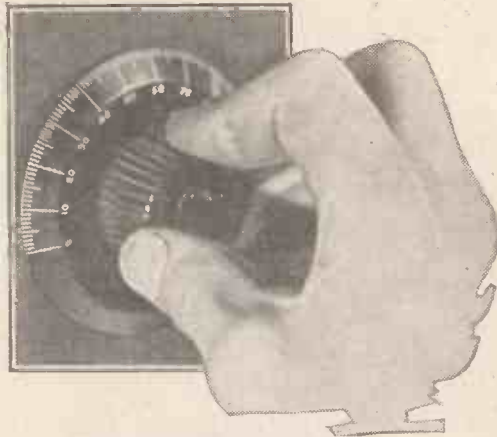

If your dial is small, do not tune this way—

ulator to that required for the valve filament, one can easily compensate for the drop in voltage of the accumulator itself by cutting out a certain amount of the resistance.

### Abusing the Rheostat.

If, for example, we are working a valve requiring 4 volts on the filament from a 6-volt accumulator, there is what is called a drop in voltage in the filament resistance of 2 volts. Let us now imagine that the voltage of the accumulator falls to 5. By readjusting the filament resistance so that there is a drop of only 1 volt, we can maintain the voltage on the valve itself at 4, and signals will be just as good, but, and this is a very important but, as soon as the voltage of a 6-volt accumulator drops to 5.4 we have reached the limit of safe discharge, and if we take any more current from the cell after this it will be damaged.

You will thus see that running an accumulator below 1.8 volts per cell is very false economy. We may be able

to run our set for a few more hours for the price of one charge, but the small saving is very dearly paid for in another direction—i.e. by causing disintegration of the active material of the accumulator and thus shortening its life.

By using fixed resistors, we are compelled to get our accumulator recharged as soon as the voltage drops below 2 per cell, and while we could run on for a little longer until the voltage fell to 1.8 per cell, if we were using a variable resistance, the additional hour or two is not worth while, and I do not recommend the practice.

### A Futile Test.

The trick adopted by some wireless enthusiasts of "flashing" an accumulator or an H.T. battery to "see if there is any current in it" is a very dangerous and futile proceeding.

In what are sometimes referred to as "the good old days" of England, if a

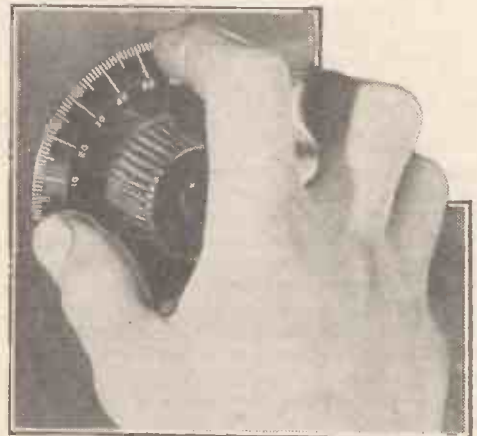

—using the edge of the dial will give you a finer control.

woman were suspected of being a witch they threw her into the nearest pond, whereupon, if she sank it was proved that she was not a witch, but if she floated they proclaimed her guilty.

### The Price You Pay.

Similarly, when we quickly flash an accumulator or H.T. battery, we gain a certain amount of information. If there is no flash there is probably no current in the accumulator, and if there is a flash we lose a very useful part of the available current in the flash itself. Flashing an H.T. battery in this way may cause cell containers to burst, and in every case will do damage, quite apart from several hours of useful life in each flash.

There is only one safe and satisfactory way of testing the "liveliness" of an H.T. battery, and that is by means of a voltmeter, which, if all is well, will show a voltage of 1.5 volts per cell. Even then, a high resistance voltmeter must be used, or the current taken by the meter itself will be greater than the safe discharge rate of the battery, causing a big drop in voltage and possibly damage to the cells.

A last word about high-tension batteries. Do not forget the limitations of the small size cells. Never try to supply a set using power valves from the small size flashlamp batteries. They won't stand it!



Sealing wax will stop the fraying of insulation on your leads, and not only improve the appearance of the connections, but will prevent all sorts of annoying troubles.



# RECENT ADVANCES IN RADIO

**B**ROADLY speaking, progress of late appears to have been more pronounced on the transmitting than the receiving side of wireless, although, of course, both aspects of the question are so closely related that improvements in the one necessarily lead to better conditions in the other.

### Beam Signalling.

The new system of beam transmission, recently established between this country and Canada must, for instance, be regarded as an event of outstanding importance in the history of wireless development. Similar lines of communication are shortly to be opened up with South Africa and Australia, and before long we shall no doubt see a world-wide network of directive channels.

Senatore Marconi stated some three years ago that short-wave transmission would revolutionise existing practice, and it seems that this prophecy is about to be fulfilled. Suggestions have, in fact, already been made for utilising beam methods of transmission for the selective distribution of broadcast programmes.

Some of the advantages of the beam system as compared with non-directional transmission are (a) low power input and consequent saving in capital and upkeep charges; (b) increased selectivity owing to the radiated energy being confined to a relatively narrow channel instead of spreading outwards in all directions; and (c) comparative freedom from the effect of static and similar atmospheric disturbances.

### Constant Modulation.

A problem peculiar to telephony transmission is that of insuring a constant percentage modulation of the carrier wave. When a transmitting station is in operation, its full power is utilised only for a small fraction of its active periods. Actually, it modulates on an average only one-third of its output, so that it may have sufficient margin to carry the modulation of a really large sound volume when necessary.

For instance, during a whispered conversation or a soft passage of piano music, the carrier wave is only slightly modulated. In its passage through the ether, this weak

\*-----\*

A review of the progress made in  
the science of wireless during the  
past few months.

By **SEXTON O'CONNOR.**

\*-----\*

signal must contend with atmospheric and other disturbances, and its reception may be largely masked by such extraneous "noises." On the other hand, a strong, fully modulated signal is better able to withstand and maintain its supremacy over atmospheric disturbances.

A method has recently been devised whereby the weak signals are differentially amplified before reaching the modulating valve, with the object of bringing all the signal sounds to a standard strength before transmission into the ether. This is ensured by passing the microphone currents through a valve, the amplification ratio of which is automatically varied in accord-

chronising current of supersonic frequency. In this way a perfect reproduction of the original tonal qualities is given by the receiving apparatus, whilst at the same time the heavy handicap normally placed on the passage of the pianissimo modulations across the ether is removed.

### Piezo Crystal Control.

The use of the piezo-electric effect of quartz and certain other crystals as a means of stabilising or keeping constant the operating wave-length of broadcast stations is another development of notable interest. A suggestion has recently been made to replace the present B.B.C. system of distribution by two or more super-power stations, similar to that at Daventry, in combination with a large number of low-powered centres graded to give crystal reception over a restricted range of ten or twelve miles radius.

According to the International Bureau at Geneva, a similar scheme is being considered in connection with Continental broadcasting. Any such system must necessarily involve a considerable duplication of existing broadcast wave-lengths, all stations using identical wave-lengths being, of course, separated into distinct zones.

Piezo-electric control at present affords the only practical means of bringing such a plan into operation. Unless the duplicated wave-lengths can be maintained with absolute constancy and faithfulness, the system will be made unworkable owing to widespread heterodyne trouble.

### The Problem of Fading.

Fading remains one of the most baffling problems in wireless science. It is generally attributed to reflection or refraction effects occurring at the Heaviside layer.

During the last twelve months various attempts have been made to devise a method of transmission which will be free from this defect. One solution is based upon the observed fact that at moments when a signal on one particular wave-length has faded almost to zero, a signal sent on an adjacent wave-length will come through with normal strength.

*(Continued on next page.)*



An example of modern receiver design—a popular three-valve set of German manufacture.

ance with the initial strength of the applied signals.

If such signals were received on an ordinary set, a uniform volume of sound would, of course, result, pianissimo and fortissimo passages being heard with equal intensity. In order to adjust matters, the incoming signals are first passed through a valve in which the amplification ratio is automatically varied in the opposite sense to the valve used at the transmitting station. The simultaneous control of the valve at the sending station and that at the receiving end is ensured by a special syn-

## THREE CONFUSING TERMS

To the newcomer to wireless there must be many points in theory as well as practice that are not too clearly understood. In this brief article our contributor discusses three important and frequently used terms which are apt to be confused.

BY A CORRESPONDENT.

**T**HERE are three terms constantly employed in books and articles dealing with wireless work which are apt to be very confusing to the beginner. These are *resistance*, *reactance*, and *impedance*.

We will consider briefly each of these in turn.

The *resistance* of any part of an electric circuit, such as a length of wire, a transformer winding, a soldered joint, a valve filament, and so on, is the opposition offered by that part of the circuit to the flow of an electric current.

Thus, if a battery is connected to the two ends of a length of wire, the resistance of the wire limits the amount of the current which will be driven through it. If it is necessary to change the value of the current, then either the resistance of the wire, or the voltage of the battery, or both, must be altered.

### A Definite Property.

If we double the resistance of the wire, the current will be halved, whereas doubling the battery voltage will double the current.

Resistance is measured in *ohms*, the number of ohms equalling the number of volts required to drive a current of one ampere through the resistance. For example, if 6 volts send a current of 2 amperes through a rheostat, the number of *volts required per ampere* is  $\frac{6}{2} = 3$ . Hence the resistance of the rheostat is 3 ohms. Thus, we can say that the resistance of an electric circuit is obtained by dividing the voltage by the current.

The same rule applies if the voltage and current are *alternating*, as, for instance, in a house-lighting system supplied from A.C. mains. The resistance of the circuit is

obtained by dividing the alternating voltage by the alternating current.

It must not be thought, however, that resistance depends in any way upon whether the current is direct or alternating. It is a definite property of the circuit or apparatus, just as is weight, length, or colour.

*Reactance* (not to be confused with *reaction*) is the opposition to an electric current offered by an inductance or a capacity, usually introduced by means of a coil or condenser respectively. (Inductance is that property of a circuit which tends to prevent any change in the value of the current flowing, and is analogous to mechanical *momentum* or *inertia*.)

If we were to wind several turns of thick copper wire on an iron core, and join the ends up to an accumulator, a very large current would flow, for the thick wire would possess hardly any resistance. The same coil, however, would very strongly oppose the flow of an alternating current, for, being wound in the form of a coil upon an iron core, it would possess a high inductance which would tend to prevent the current

from changing. In other words, the current would encounter a high *reactance*.

Comparing the property of inductance with mechanical inertia, we may imagine the difficulty that would be encountered if we tried to push a heavy truck rapidly backwards and forwards, whereas, providing that the *resistance* (of the bearings, etc.) was low, we could easily push it steadily in one direction.

The reactance of a coil depends upon its inductance and upon the frequency of the current. A high inductance offers a greater reactance than does a low one, and the opposition offered by a given inductance varies directly with the frequency of the alternations of current. Thus, doubling either the frequency of the current or the inductance of the coil will double the reactance, while doubling both frequency and inductance will make the reactance four times as great.

The same reactance is also given to the opposition offered to a current by a condenser. In this case the conditions are exactly opposite to those obtaining in the case of an inductance.

### Impedance.

A condenser completely prevents a steady flow of current, but offers very little opposition to H.F. alternations, and in order to obtain a *small* reactance, the capacity of a condenser must be *large*.

All electric circuits offer both resistance and reactance to the flow of an alternating current. Very often either one or the other is negligible, and direct current (as from a dry battery or accumulator) encounters no reactance. In alternating current circuits,

however, the two may be of equal importance, and the name *impedance* is employed to denote the *total* opposition offered to the current by resistance and reactance (whether due to inductance or capacity).

*Impedance*, therefore, is influenced by frequency, as is reactance, and concerns direct as well as alternating currents, as does resistance.

For example, the resistance of a pair of headphones is very often 4,000 ohms. The *impedance* of such a pair, to a current at a frequency of 800 cycles per second, may be about 30,000 ohms, whereas to a current at 400 cycles it would be a little more than half that amount.



A totally enclosed neutrodyne receiver of German manufacture.

## RECENT ADVANCES IN RADIO.

(Continued from previous page.)

Accordingly, a carrier wave of periodically varying frequency is used for transmission, the wave being made to rise above and fall below the standard frequency value by a comparatively small amount, say in the neighbourhood of one or two per cent. The over-all variation is extremely rapid, taking place twenty thousand times per second.

A supersonic receiver is used at the receiving station, and the frequency of the local oscillator is made to vary synchronously with the transmitter variation by means of a special control wave. For commercial stations using long-wave radiation

this synchronisation is found to be quite feasible, although it would be an extremely difficult matter in the case of short-wave broadcast telephony.

Luckily, it is found, in the latter case, that a broadly-tuned receiver responds evenly to the small frequency changes imparted at the transmitting end, so that no special synchronising means are required. At the same time, the signals are received continuously, and at full normal strength, these components which fade on one wave-length coming through without any perceptible interval on the adjacent wave-length.

### Polarised Radiation.

The use of polarised waves constitutes another possible remedy for fading. Since most of the energy loss is assumed to take place at the Heaviside layer, it must occur as a consequence of reflection or refraction. A polarised wave with a horizontal electric

field is reflected without loss of energy on a horizontal conducting plane such as that existing in the upper reaches of the atmosphere. On the other hand, a wave vertically polarised is found to be subject to considerable loss.

Accordingly, special aerial systems have been devised to radiate a type of wave in which the electric component is polarised horizontally, so that it meets the layer in its own plane, and is completely reflected without absorption.

Alternatively, the radiated energy may be arranged to leave the transmitting aerial as a circularly or elliptically polarised wave. In such a case only a definite proportion of any wave striking the Heaviside layer will be absorbed, the remaining energy being reflected downwards to earth. This prevents "total" fading, a certain proportion of the signal energy winning through at all times to the distant receiving station.

## EQUAL TO A £20 LOUD SPEAKER

The success of any loud speaker depends primarily upon the sound reproducing base. In the LISSENOLA Loud Speaking Unit you have a base which will repeat everything it hears—no hidden tones—no indistinct whispers—no wooden notes. The introduction of the LISSENOLA Loud Speaking Unit marked an epoch in loud-speaking devices. You can do everything with it—attach it to any gramophone tone arm in place of the sound box, and you have a cabinet loud speaker, which can be turned back to a gramophone just as easily. Fit any horn to it, build it into a cabinet, attach it to a cone diaphragm by means of the unique LISSENOLA Reed. So sensitive is it you can use it on small-powered sets, so powerful is it you can put it on to a big power amplifier without the slightest chance of distortion. It will do everything you want it to.

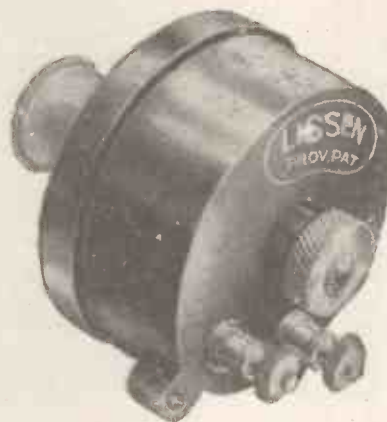

### SEVEN DAYS' TEST

Buy a LISSENOLA and put it to the most exacting tests you can think of. Compare it against any expensive loud speaker a friend may have. If at the end of seven days you do not definitely prefer the LISSENOLA for tone purity and power to any loud speaker you have tested it against, take it back to the shop and your money will be refunded in full.

### MANY WORTHLESS IMITATIONS

Success always attracts imitators. But you do not want a unit which will lose its magnetism—which will easily overload—which becomes noisy and loses tone—which is made heavy to give the impression of weight. You can avoid all these risks by asking for and insisting upon being given the LISSENOLA Loud-Speaking Unit.



### AN APOLOGY:

*We are sorry so many people have been unable to obtain the LISSENOLA Horn in time for Christmas. Orders for this horn should be placed with nearest LISSEN Dealer, who will obtain and supply as quickly as possible after the holidays.*

### IN ADDITION TO THE LISSENOLA

We have produced an ingenious stand which takes the LISSENOLA Unit and an upright horn. Those who have built a horn from the full size diagrams and instructions given with each LISSENOLA Unit will appreciate this new addition. It has been made inexpensive to give LISSENOLA users the opportunity of possessing it. Price 3/-.

### ANOTHER HORN

An upright type of LISSENOLA Unit will make its appearance within the next few days—14 in. flare, price 17/6. Your dealer should be asked to get one for you.

The LISSENOLA Unit with upright horn and new stand complete is now the only British made full sized loud speaker selling for 34/-.

**LISSENOLA - 13/6**

*made golden toned for your enjoyment.*

Sold by all good radio dealers.

**LISSEN LIMITED, 8-16, FRIARS LANE, RICHMOND, SURREY**

Managing Director: THOMAS N. COLE.



*"Sou-west by West —  
a Quarter West!"*

**S**ETTING the course of a ship so that she takes the most economic route to port calls for great skill and long experience.

Making up for errors in navigation is costly in fuel, and a missed tide may cost thousands.

Wherefore the navigator makes every possible allowance for stray currents, varying magnetic fields, and any factor which may affect his calculations and send the ship off her course.

The design and manufacture of condensers for wireless sets also calls for great skill and long experience. Condensers which are faulty in design or construction are constantly drawing upon your valves and batteries to make up for their deficiencies, even if they do not cause you to miss the programme.

Wherefore we make every possible allowance to ensure that Dubilier Condensers, under the conditions of high frequency and high voltage obtaining in wireless circuits, shall be as efficient as our 16 years' specialised experience can make them.

Your wise course is to specify "Dubilier."

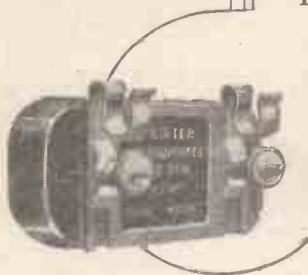

ADVT. OF THE DUBILIER CONDENSER CO. (1925), LTD.,  
DUCON WORKS, VICTORIA ROAD, NORTH ACTON, W.3

**T**HE completion of the Gloucester Station marks a step forward in the B.B.C.'s plans to improve the technical system of transmission. The station at Gloucester is similar to the installation already working at Leeds, and it is designed to give better quality and greater reliability to the transmissions which principally affect the Bournemouth, Cardiff, Swansea, Birmingham and Stoke stations.

The Gloucester station is really a Distributing Point; for example, when a News Bulletin is being read out from London, it is transmitted by Post Office lines direct to Gloucester, where the quality of the speech is improved by correcting circuits. After re-amplification (in order to make up for the losses in line transmission) it is re-distributed to Plymouth, Swansea, Cardiff, etc.

**Improving Quality.**

The B.B.C.'s aim in selecting Gloucester as the distributing point was a wise one, as they have secured main Post Office lines serving the broadcasting stations in the south and west, while at the same time they can in an emergency serve the northern stations via Stoke, Manchester and Leeds, should the direct route to Leeds be put out of action.

The Gloucester station marks a definite attempt to improve the quality of land-line transmission. The trouble heretofore has been that the use of land lines has resulted in distortion and other deleterious factors which it has not been possible to avoid owing to the lack of apparatus for correcting such faults, but it is hoped that the Gloucester Station will now prove its worth by considerably improving the quality of land-line transmissions in the district it serves.

**The Geneva Scheme.**

It is hard to say definitely at the moment whether the Geneva broadcasting wave-length scheme, even in its revised form, has proved a success or not. Certainly we hear a good deal of comment of an unfavourable nature, and on the whole, as far as the reports of the DX listener in England are concerned, the new scheme does not seem to have been a very great success.

The DX amateur had hoped that towards the middle of this month he would be able to tune in foreign stations without undue European interference. It must be admitted that the interference has been lessened, but it does not seem to have been lessened enough. The greatest amount of interference originates in Spain, where there are fifteen stations working which have ignored the Geneva plan. All these stations are still operating on their old wave-lengths; for example, Radio-Barcelona, which has always been received clearly in this country, is still transmitting on a wave-length of 324 metres instead of its allotted 280 metres, or, at any rate, it is as these words are being written! Consequently interference with Belfast and Breslau is considerable.

All plans to regulate wave-lengths are perfectly futile in the long run unless discipline among the stations abroad is maintained.

# CURRENT TOPICS.

By THE EDITOR.

If Spain is going to remain on its old wave-lengths then the Spanish stations will be responsible for the maintenance of a degree of interference which renders any improvements in other directions of small value. We can only hope that very shortly these other stations will come into line and help clear the ether and reduce interference generally.

When a discussion concerning the rights and wrongs of a B.B.C. programme crops up, we often hear it stated that: "If you don't

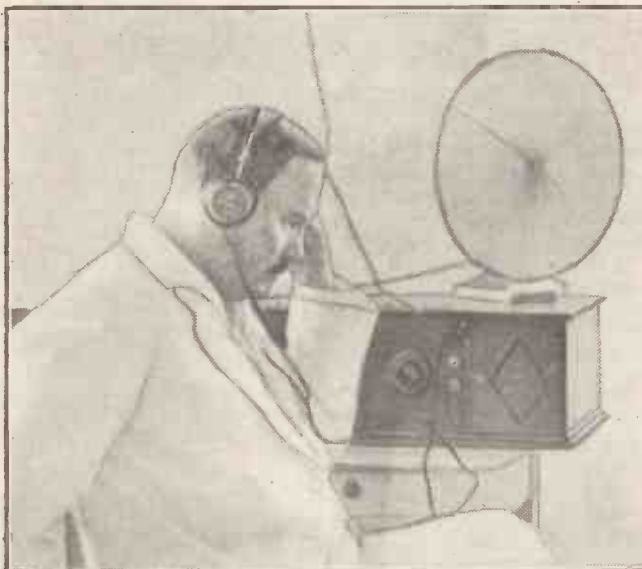

A hitherto unpublished photo of the President of Finland "listening-in"

want to listen, you needn't, as there is nothing compulsory about having a wireless set or listening in to a wireless programme."

This argument is all right if applied to a public meeting. For example, if a certain gentleman is speaking on a subject which one does not like or agree with, one need not go to the meeting, and therefore need not be offended by the speaker's views and remarks. But with wireless it is different. It is perfectly true that one needn't listen if one doesn't want to, but the public served by the B.B.C. is such a large one, and so many young people listen in, that the question of free speech by wireless cannot be argued on the same lines as free speech at a public meeting. Furthermore, a public meeting will only deal with a small section of the public, while broadcasting is not only national these days, but international.

Recently Professor Julian S. Huxley introduced the subject of Birth Control into one of his talks, and a great deal of protest was received at the B.B.C. Arguments were advanced by Sir G. Marchant and Sir Arthur Newsholme to the effect that persons of both sexes and all ages were probably

listening on the wireless that night and therefore anything which would affect their susceptibilities must be avoided.

Professor Huxley points out, however, that if all discussions on controversial subjects were always allotted to one of the alternative programmes, one would know what to expect.

**Alternative Programmes.**

It has been suggested that the provision of alternative programmes should largely abolish the difficulty of having to please everybody and offend nobody, but we doubt whether this would completely solve the moral and social problem involved, for there would still be a large number of well-meaning people who would persist in arguing that talks and debates on controversial subjects should not be allowed to be broadcast at all, even in any one particular programme.

But this, we think, is advancing the argument too far, and seriously approaches the borderline where censorship of free speech becomes intolerable. There is no reason why broadcasting should be muzzled any more than newspapers, although it would probably be better to allow propaganda to be broadcast in favour of some object or idea concerning which there is considerable diversity of moral argument; but we agree with Professor Huxley that it cannot be right to refuse to allow controversial subjects to be mentioned or to be discussed in the scientific spirit.

That can only be done if we definitely adopt the theories of Fascism or Bolshevism, and if we do that the privilege of free speech is killed.

In these days we have to admit hard facts, and broadcasting is an invaluable instrument whereby we can appreciate the logic of facts more calmly and more reasonably. Personally, we hope that when the new B.B.C. takes over there will be no dogmatic censorship of talks on subjects which may be thought controversial. As long as vulgarity is

kept out of the programmes, and as long as subjects are dealt with in a serious and commonsense way, there is no reason why authorities on various subjects, however controversial, should not be invited to express their views by wireless.

**Need For Tolerance.**

If all parties holding entirely different views on a matter are allowed to express those views in clear and reasonable language, it would at least help listeners to cultivate powers of tolerance, and especially the gift of listening to an argument without going into violent hysterics because the subject dealt with happens to offend their own particular susceptibilities. They may offend yours, remember, but they may not offend the susceptibilities of other people, and partisanship, when carried to extremes, very often breeds fanaticism.

It is to be hoped, therefore, that when the British Broadcasting Corporation begins its duties in January it will cultivate a breadth of outlook and a tolerance in connection with free speech by wireless.

It is common to divide electric batteries into two classes, which in the textbooks of one's schooldays were known as "primary" and "secondary" batteries. There is, to some extent, good reason for so dividing electric batteries into two main classes, but, on the other hand, the division is apt to give rise to misapprehensions; it is apt to create the impression, for instance, that the *modus operandi* of a so-called secondary battery (of which the ordinary lead accumulator is the most familiar type) is essentially different from that of the primary battery (of which the Leclanché is probably the most familiar type). It should be understood clearly that in both a Leclanché cell and a lead accumulator cell the action, when the cell is working, is a chemical action and a better way to classify these two types would be into "reversible" and "irreversible" cells or batteries. (I know that some of my more scientific readers—of whom I have many—will write to me and point out exceptions to this classification. I am, of course, fully aware of this, but at the moment, for the sake of simplicity, I am concentrating on the two types of cell most commonly used by the wireless amateur.)

#### Chief Difference.

The main difference, from our present point of view, between the lead accumulator and the Leclanché cell is that in the case of the latter the chemical condition resulting from the working of the cell is one which cannot (at any rate, easily or conveniently) be reversed; the cell cannot, for example, be put back into its original condition by passing electric current through it in the opposite direction to that in which the current came out of it. The outstanding feature of the lead accumulator is that the chemical compounds formed during discharge can be decomposed and, in fact, the chemical condition of the cell generally can be restored to its original form by nothing more than the passage of a sufficient quantity of electricity through it in the reverse direction to the operating direction. Thus the reactions of the cell are reversible and the cell may be described as a reversible cell. But the point I am seeking to emphasise is that a charged accumulator is to be regarded simply as an ordinary chemical cell; it produces electricity, just as a Leclanché cell does, by the chemical reactions between its elements, and until we come to the question of recharging there is no fundamental difference between a so-called secondary cell and a primary cell.

#### Semi-rechargeable Type.

There are, however, cells in which the reactions, although partly reversible, are not entirely so, and cells of this type might be said to occupy a position somewhere intermediate between that of the primary and that of the secondary types. A lead accumulator, provided it is properly taken care of so that other actions, such as sulphating, do not set in, may be said to be dischargeable and rechargeable almost indefinitely. In the intermediate or semi-rechargeable type of cell, however, there are reactions which cannot be avoided, and the effect of which is cumulative, so that the cell is rechargeable and dischargeable a certain number of times but with gradually increasing deterioration. Nevertheless, such cells may have important advantages. For one thing, they may be made with a

## TECHNICAL NOTES

A Weekly Feature  
Conducted by

Dr. J. H. T. ROBERTS, F.Inst.P.  
(Staff Consultant.)

comparatively innocuous electrolyte, and they may be sealed up in the same convenient form as the ordinary H.T. dry batteries.

#### New Valve Process.

Provided their limitations as well as their advantages are properly appreciated, there is a good deal to be said in their favour, and I personally have no doubt that they will come into much greater favour in the near future.

I see from one of the foreign journals that a new process has been developed for



A two valve recently built by a North London reader. It is unique in that it was entirely constructed from locally made components.

the exhausting of valves during manufacture; this process is intended to replace the present method of using a "getter," which, as you know, causes the deposit of a silvery coating upon the interior of the bulb. In dull-emitter valves this coating is often a source of inconvenience in that it prevents a proper view of the filament, or, if the filament can be seen, the partial opacity of the coating makes it impossible to judge correctly the temperature (or, rather, the degree of brightness) of the filament. It is, therefore, desirable from this point of view that the bulb should be left clear, notwithstanding that, in deference to fashion, many manufacturers would consider that an unsilvered bulb was a less attractive article than a heavily silvered one. The "silvering" is, of course, due to magnesium.

In the new process, full details of which are not yet to hand, I understand that a special gas is introduced into the bulb in the last stages of exhaustion, this gas having the same effect as the "getter," but the gas being subsequently got rid of by an ingenious method which avoids any deposition on the interior of the bulb.

#### The Power Valve Fallacy.

Amateurs often seem to be under a misapprehension with regard to power valves and their uses; some are great believers in power valves and, in their enthusiasm make impossible claims for them, whilst others are sceptical and prefer to use a valve in the last L.F. stage of the ordinary type. The fact is that the term "power valve" is rather misleading. It suggests that the other kinds of valve are *not* power valves. The distinction is quite arbitrary, and the description "power" in this case merely means that the type of valve referred to is capable of handling more power than the usual type of valve used for reception purposes in other positions, for example, in the H.F. amplifying and L.F. amplifying stages.

Another misapprehension which is really very common, is that the mere substitution of a power valve for an ordinary valve is necessarily going to increase the volume obtained from the loud speaker. Everyone who has tried power valves knows that they frequently *do* increase the volume, but such increase is not necessarily to be obtained. In other words, the power valve does not make any more power—it simply lets it through in the proper way, if it is there.

#### Less Distortion.

Perhaps I ought not to be so definite and to say that the power valve does not help to produce more power. I have so many well-informed readers of these Notes, nowadays, that I have to be extremely careful

what I say; if I generalise for the sake of simplicity, I have numerous kind correspondents who write at once to point out the exceptions.

The point I want to make clear is that the principal function of the power valve, as distinct from the ordinary valve, is to enable more power, when it is available, to be handled without distortion.

If an ordinary valve be used to handle heavy output, the filament emission of the valve and its other characteristics being unsuitable, the inevitable result will be that the valve will be badly overloaded and distortion will be produced.

But if the filament emission (and the other characteristics) are suitable, the valve will be operating on the appropriate part of its curve and distortion will be avoided.

# De Groot — Wonderful Testimony to

## the **GECOPHONE**

4 VALVE RECEIVING SET AND

# CONE

## LOUD SPEAKER

**T**HIS striking testimony from De Groot, the eminent violinist and musical director, emphasises the extraordinary purity of reproduction given by the "GECOPHONE" Receiver and "CONE" Loud Speaker.

Discriminating listeners appreciate the tremendous advance which this new "CONE" Loud Speaker represents.

For speech and for music it marks a new era of better reception.

TELEPHONE  
MAYFAIR 1501.

3A, MONTAGU MANSIONS,  
PORTMAN SQUARE,  
W. 1.

Messrs. The General Electric Co. Ltd.  
Magnet House,  
Kingsway,  
London. W.C. 2.

1926,  
November.  
20th.

Dear Sirs,

At last I can enjoy listening to "wireless", thanks to the wonderful "GECOPHONE" receiving set which you have just installed in my flat.

Not only am I astonished at the purity and quality of the reception, but it is difficult to realise that this marvellous transmission should come through what appears to be just a mahogany cabinet.

The only indication to the contents of the cabinet is the "Cone" loud-speaker; and while on this subject, I should like to add that the realistic reproduction obtained on this loud-speaker is amazing. When an orchestra is playing, one can detect every individual instrument.

I would also like to add that the "Hart" Accumulators I am using for both my High and Low Tension supply continue to be in every way most satisfactory.

I can now truthfully say that "listening-in" is a great pleasure.

Yours sincerely,



The Installation supplied to De Groot was a "GECOPHONE" 4-Valve Cabinet Model, complete with four D.E.5 OSRAM VALVES and "GECOPHONE" "CONE" Loud Speaker.

BROADCASTS BY 'TONE' & 'POWER'  
*The Boon' Companions of Osram Valves*

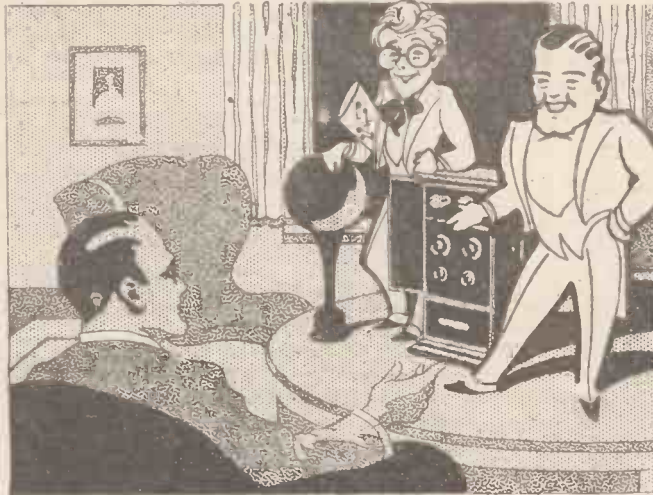

**'TONE' & 'POWER'**  
 visit an Amateur

"Good evening, POWER—Good evening TONE—glad to see you. You're just the fellows I need. Can't get anything much this evening, all the foreign stations seem most elusive!" And in a jiffy our two friends were in the amateur's set and the foreign stations started coming in as clear as a bell. "There you are!" said POWER proudly.

"Amazing!" replied the amateur. "I've never had them so strongly. So pure too!" (*Tone bows.*)

"You two fellows must accept the hospitality of my set indefinitely!"

"Only too pleased," replied TONE and POWER in chorus. "You'll always have us if you stick to OSRAM VALVES."

**Osram**  
**Valves**  
*for TONE & POWER*

*The G. E. C. - your guarantee*



**BRITISH  
 MADE**

For  
 2-v., 4-v. & 6-v.  
 Accumulators  
 and Dry Cells



# BROADCAST NOTES.

FROM OUR BROADCASTING CORRESPONDENTS.

The New B.B.C.—The Glasgow Trouble—Sport Broadcasts—Changes at Bournemouth—"The Dream of Gerontius"—All-Star Matinées.

THE old régime of broadcasting in this country is now, virtually a thing of the past. The new régime will have to submit to much more exacting criticism, if for no other reason than that it is supposed to have greater power, freedom, and resources. The listening public will be impatient to recognise concrete results. They have been reluctant to witness the passing of the Company, and they will only be reconciled to the Corporation if there is an immediate and general improvement in programmes. If the change is simply to add to red-tape, and confer "dignity," then the Corporation is in for a very bad time with the public as a whole.

## A Glasgow Trouble.

The fuss about the change in the 10 p.m. Greenwich time-signal was concentrated entirely in Glasgow. There was hardly a murmur of protest from any other part of the United Kingdom. On the contrary, there were signs that most English listeners were in hearty agreement with the change. Yet the agitation in Glasgow was worked up to a tremendous pitch of excitement and resentment. There were crowded public meetings, street processions, and petitions signed by thousands; and it now eventuates that the whole agitation was artificial and owed its being to a small group of malcontents who are perpetually trying to undermine the B.B.C. in Glasgow. In fact, so unpleasant is the Glasgow atmosphere so far as the B.B.C. is concerned that the new Corporation may well move the centre of its work in Scotland from Glasgow to Edinburgh. It is unlikely that the Glasgow Station will be closed down, but it may well become quite a minor organisation. This would be the first case of disciplinary measures being applied by the Broadcasting Authority in this country. A final decision on the point is not yet taken.

## Sport Broadcasts.

Now that the B.B.C. has secured authority to broadcast all the chief sporting events of 1927, eager preparations are under way at Savoy Hill to carry these out efficiently. The broadcasting of narratives from the scene of the event has evolved a highly specialised branch of broadcasting art in the United States. Besides having an intimate knowledge of the game, the sports announcer must have also a keen journalistic judgment and a ready wit. It is understood that before long the new Corporation will appoint an eminent journalist to control this new branch of its work. Incidentally, some of the bodies in control of sport are not showing the expected eagerness to have their chief events broadcast. If there should be irrational obstruction in that quarter, the public will deal with it drastically.

## A Happy Gesture.

The B.B.C. did well to invite its enemies to the big dinner on December 16th. The

presence of Mr. William Boosey and Mr. C. B. Cochran was the subject of general approval. This may well be the first step in the direction of some new concordat.

## Another Brilliant Broadcaster.

Attention has already been drawn on this page to the discovery in Mr. Cleghorn Thomson of an embryo broadcasting genius. It now emerges that Mr. Thomson's second cousin, Miss Hilda Matheson, who has also joined the staff of the B.B.C., bids fair to

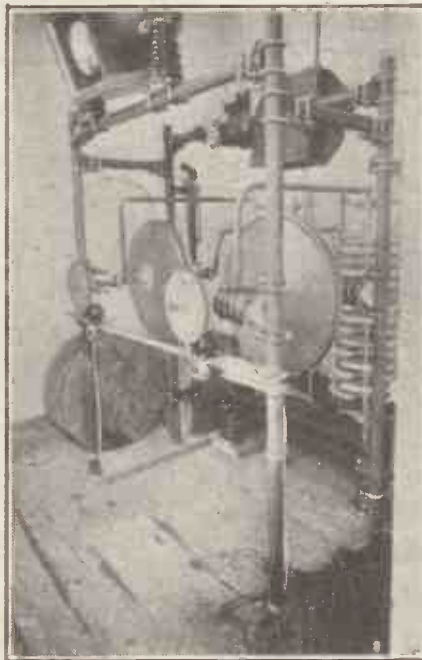

The huge vernier condensers and other aerial tuning equipment of the high power American Station W J Z.

rival her clever kinsman. Miss Matheson, who was formerly political secretary to Viscountess Astor, is Deputy Talks Director at Savoy Hill, and handles the executive side of this important department. She is likely to take over from Mr. Stobart when he retires, which is understood to be happening soon.

## Changes at Bournemouth and Newcastle.

The new policy of greater concentration has involved the cutting down of staff at both Newcastle and Bournemouth. The station orchestras have been demobilised and replaced by octettes. The recent marked improvement in land-line transmission makes it possible to substitute the superior orchestral work of London for the local orchestral work. The maintenance of octettes is sufficient to preserve the necessary local atmosphere. The result will be an all-round improvement of the service to listeners in both Newcastle and Bournemouth. It is gratifying to learn that the

B.B.C. are dealing generously with those members of the orchestras whose services are no longer required through no fault of their own.

## Myra Hess.

It is understood that this talented artiste has been induced to accept an engagement for a London broadcast during the early spring.

## "The Dream of Gerontius."

The choral work "The Dream of Gerontius" will be given in the London studio on Good Friday.

## Musical Pitch.

A joint talk on the vexed question of Musical Pitch is to be given by Sir Walford Davies and Sir William Bragg in February. The B.B.C. engineers are now experimenting with reeds, hoping to be able to improve on the tuning note, and at the same time to standardise pitch.

## Dance Transmissions.

Broadcast dance transmissions from the studio will be more carefully organised in the New Year. Songs are to be interspersed in accordance with the new vogue in the entertainment world.

## Music Societies and Radio.

A meeting of the Music Association, recently went solidly in favour of Broadcasting as an auxiliary to the spread of appreciation of good music. This resolution followed an interesting debate which was ably handled by Mr. Percy Scholes. The Music Society are proposing to hold a similar debate shortly, and while they are likely to give the broadcasters a more severe testing there seems every probability that the new medium will once again be endorsed.

## A Toy Band.

The toy symphony band to be relayed from Dogmersfield on Friday, January 21st, promises to be a novelty of exceptional quality and interest.

## All-Star Matinées.

A pleasing innovation under the Corporation will be the introduction into the programmes of All-Star Matinées at least once a quarter. These are to be run throughout the afternoon and to replace the ordinary programmes for the day. The dates will be chosen so as to fit in with the free dates of the most eminent artistes of the stage and concert world and music-hall.

## Difficulties of Helping Opera.

The new B.B.C. comes into power ready and willing to help opera, and particularly British opera, in a most substantial way. But the early exploration for the best way to put this goodwill to account reveals many complications and difficulties. A special committee is tackling the problem at Savoy Hill, and a tremendous mass of conflicting evidence and conflicting claims has come forth. The British Opera Trust does not see quite eye to eye with the B.N.O.C.; there are differences in other directions as well. It may be that in the end the B.B.C. will have to undertake a new organisation of opera in this country.

I'M TRYING TO CLEAN YOUR DEN OUT AND THERE'S A PILE OF POPULAR WIRELESS MAGAZINES



THEY HAVE BEEN LUMBERING THE PLACE UP FOR YEARS — I WISH YOU WOULD CARRY THEM UP TO THE ATTIC

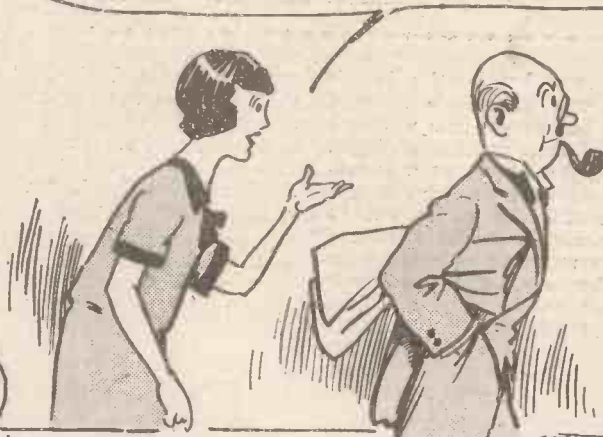

STEADY NOW — THEY'RE SMOTHERED IN DUST!



MAUD'S RIGHT — IT IS TIME THIS LOT WAS SHIFTED

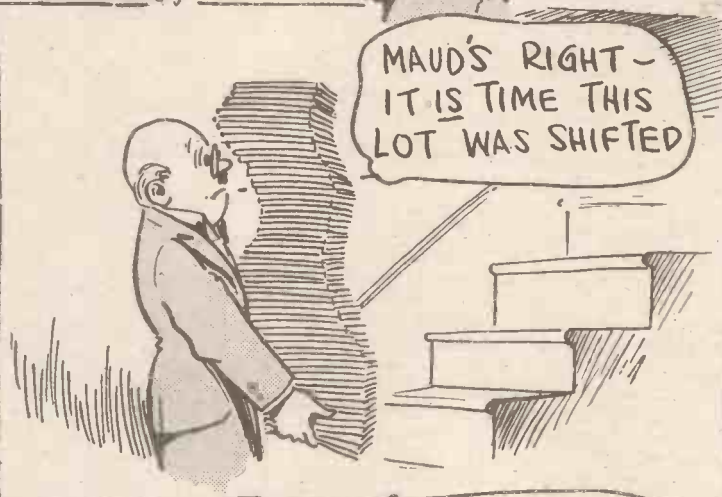

GOOD GRACIOUS! JOHN HAS BEEN IN THE ATTIC FOR AN HOUR — I WONDER WHAT HE'S UP TO?



WHAT THE-?

I'VE BEEN GOING THROUGH THEM DEAR — I'VE FOUND A FEW ARTICLES I WANT TO READ AGAIN !!!

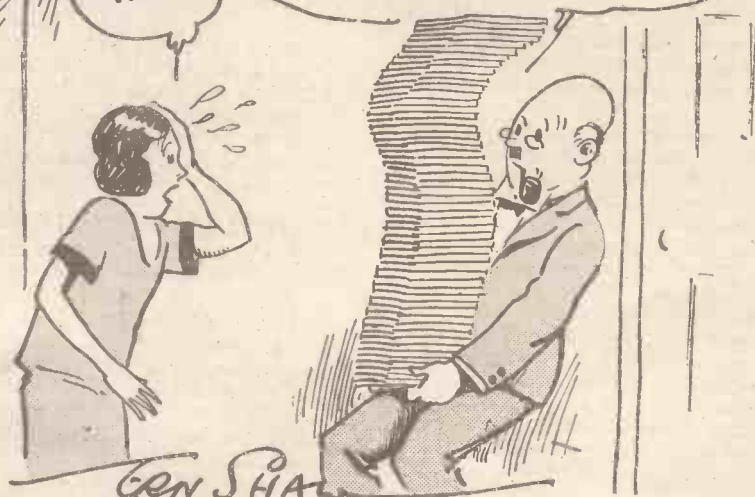

GEN SHAW

# The "PW" Savoy Three

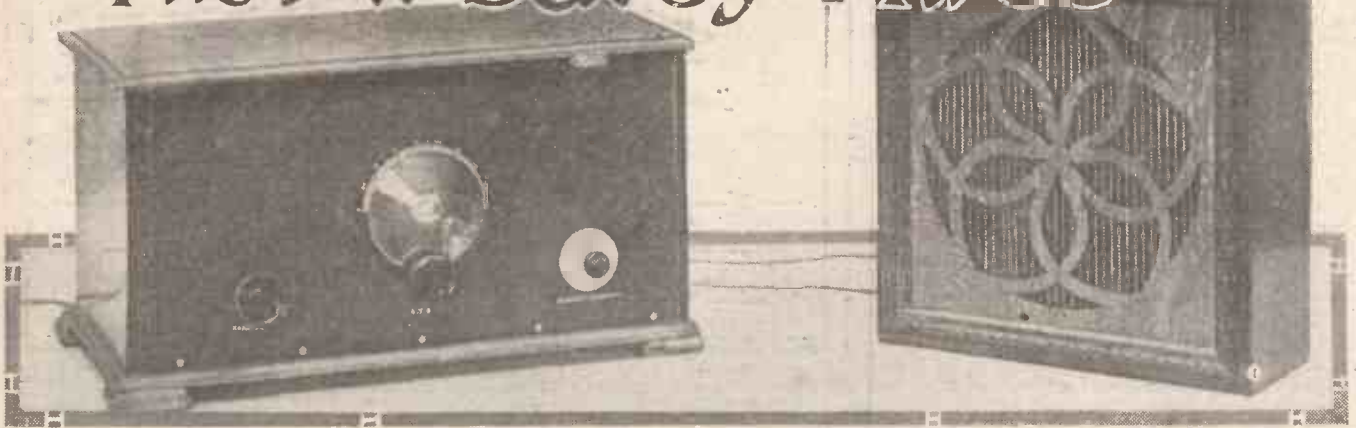

It is a generally recognised fact that to obtain even amplification over all the audio-frequencies is a very difficult task if it is to be done with any degree of efficiency. Resistance-capacity-coupling is of course the method to be employed when absolutely even amplification (as far as is at present possible) is to be obtained, but unfortunately in most methods there is a distinct and unfortunate loss of amplification per stage when this form of coupling is compared with that using a transformer. In spite

\*-----\*  
 Designed and constructed by the  
 Technical Staff.  
 \*-----\*

There is no chance of obtaining a step up in voltage due to a high-ratio transformer.

In practice this amplification is not obtained, only a proportion of it being utilised, this proportion being dependent upon the ratio of the coupling resistance

employed to the anode impedance of the valve. Thus the proportion can be stated

as  $\frac{R}{R+R_a}$  where R is the coupling resistance, and  $R_a$  is the value of the anode impedance. Thus if the resistance is merely equal to the impedance of the valve, then only half the voltage factor can be obtained in the way of amplification. Increasing the resistance gradually brings up the amplification until when the resistance value

is twice that of the valve, the amplification obtainable is two-thirds that of the amplification factor of the valve.

Meanwhile, of course, the H.T. voltage

### LIST OF COMPONENTS.

	£	s.	d.
1 Panel 16" x 8" x 1/4" baseboard and cabinet to fit	1	15	0
24 Cosmos resistance-coupling units, type V	1	1	0
1 Artic valve holder	3	9	
1 7-terminal terminal strip 8" x 2"	4	0	
1 2-terminal terminal strip 3" x 2"			
1 2-way coil-holder (Detex)	6	6	
1 .0005 S.L.F. variable condenser (Peto-Scott)	17	6	
1 Rheostat (precision)	3	0	
1 Vermo-dial 4" (Detex)	5	9	
1 .0002 fixed cond. and 2 meg. leak (Lissén)	2	0	
1 .002 fixed cond. (Lissén)	1	6	
Wires, screws, plugs, etc.	4	0	

has to be increased owing to the increasing resistance, and the set is rapidly becoming less and less a practical proposition. What is required is now obvious, namely a valve (Continued on next page.)

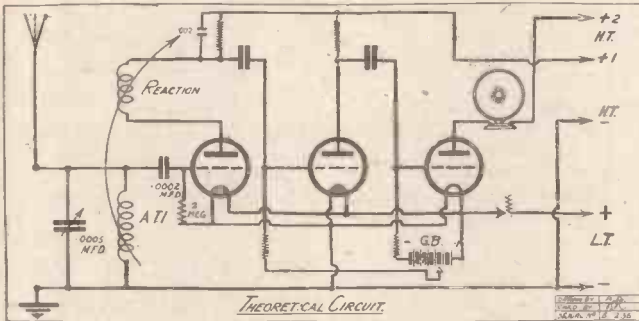

of this drawback, resistance coupling is exceedingly popular, and it is usual to employ three valves to make the volume up to that obtainable with two using the transformer method.

Valve design and the careful matching of components to suit the valves employed has gradually improved matters until the limitation of inefficiency referred to has been removed, and by the means employed in the set to be described the results of two valves resistance capacity coupled are equal to those obtainable with transformer coupling, but at the same time the purity of reception for which resistance-capacity coupling is so rightly noted is retained.

### High Amplification.

How such a high amplification per stage is obtained may be a mystery to many readers, especially as the H.T. voltages required are not by any means excessive. It may be stated, however, that the results are due to a combination of valves and resistances especially designed to operate together. In resistance-coupled amplification the maximum amplification that can be obtained would be equal to the voltage amplification factor of the valve employed.

ing the resistance gradually brings up the amplification until when the resistance value



The Savoy Three with coils and valves in position. All terminals are at the back of the baseboard.

# THE "P.W." SAVOY THREE.

(Continued from previous page.)

with high voltage amplification factor and a comparatively low impedance.

Such valves are now available on the market, and these (namely the S.P. Blue Spot) are the ones used as amplifiers in the operation of the set. In conjunction with them the specially designed L.F. resistance-capacity units made by the makers of the valves are employed so that a surprisingly high proportion of the amplification factor of each valve is utilised. The valves have an amplification factor of 35 with an impedance as low as 70,000 ohms at 120 volts on the plate.

With a resistance-coupling of about 500,000 ohms at 120 volts applied H.T., the working impedance of the valve will increase to somewhere about 140,000 ohms. This cannot be helped as in the case of other valves where the impedance is about 30,000 ohms, the working impedance (with resist-

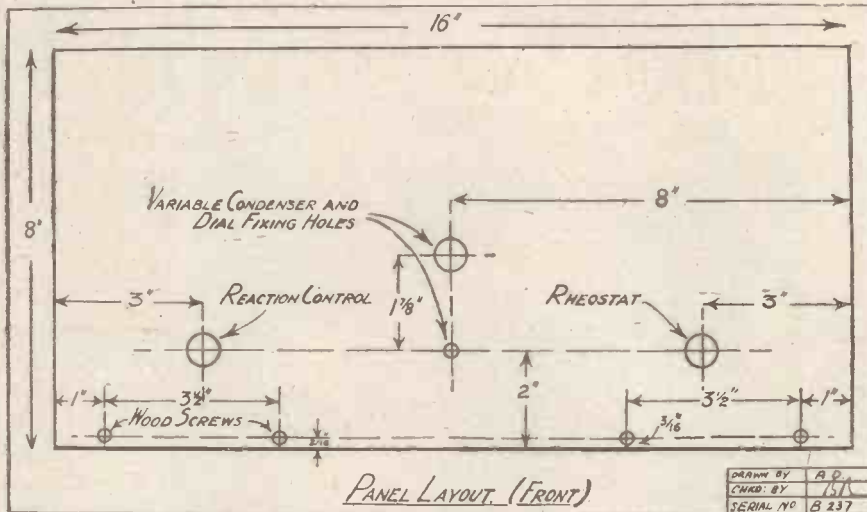

suitable valve is used for the loud speaker stage.

The set, as will be seen from the photographs, is very compact, this being made possible by the fact that there is no magnetic field from the resistance units and they can, therefore, be crowded more together, enabling short leads and thus added efficiency to be obtained.

The components necessary for the construction of this set are given in the list on page 1101, and if best results are to be obtained they should be adhered to, especially as regards the resistance units. Units incorporating valve-holders of anti-microphonic design are employed, and this simplifies the wiring to a considerable extent, besides enabling a

more compact receiver to be built. To obtain still further compactness a Detex coil holder was employed, this being

mountable on the panel, the moving coil moving to and from the other towards and away from the panel. Smooth control is possible, and this type of coil holder constitutes a considerable saving in space.

A Verno-dial also enhances not only the appearance of the set but also its operative value, enabling vernier condenser control to be obtained, and also the names or wavelengths of stations received to be written on the dial so that on a future occasion no time need be lost in searching for them.

### Simple to Operate.

As a household loud-speaker set, the Savoy Three is almost ideal, simplicity of operation being coupled with purity of reproduction and really surprising volume. A single rheostat controls all the valves, so that a single movement either switches the set on or terminates the reception. Nothing is more aggravating on a set that is to be used as a programme getter than to have to manipulate several knobs and then two or three dials before anything comes through. This receiver

(Continued on next page.)



An extremely neat panel appearance characterises the Savoy Three, while the Verno-dial enables very easy tuning to be obtained.

ance in circuit) also goes up to about 60,000 ohms. As against 60,000 ohms and 140,000 ohms we then have an amplification factor of 20 against 35, and working it out we have  $\frac{R}{R + R_a} = \frac{500,000}{500,000 + 140,000} \times 35 = 27.3$  as against  $\frac{500,000}{120,000 + 60,000} \times 20 = 14.3$ .

Thus with the high voltage factor valve of comparatively low impedance with high anode resistance it is possible to obtain a far greater amplification factor valve. The net result is an amplification comparable with that obtained by means of a transformer coupled stage with the added advantage of the purity of reproduction that accompanies a well-designed resistance-coupled amplifier.

### Low Running Costs.

Such an advance has a very obvious merit in the fact that a whole stage, valve and all, only costs 24s. 6d.—an exceedingly cheap method of obtaining good, pure and efficient L.F. amplification. Another advantage is that a very small plate current is required on the intermediate valves. Thus a three-valve set of the kind being described will only take about 5 milliamps at the most from the H.T. battery, and probably considerably less if proper grid bias on the last valve is employed and if a

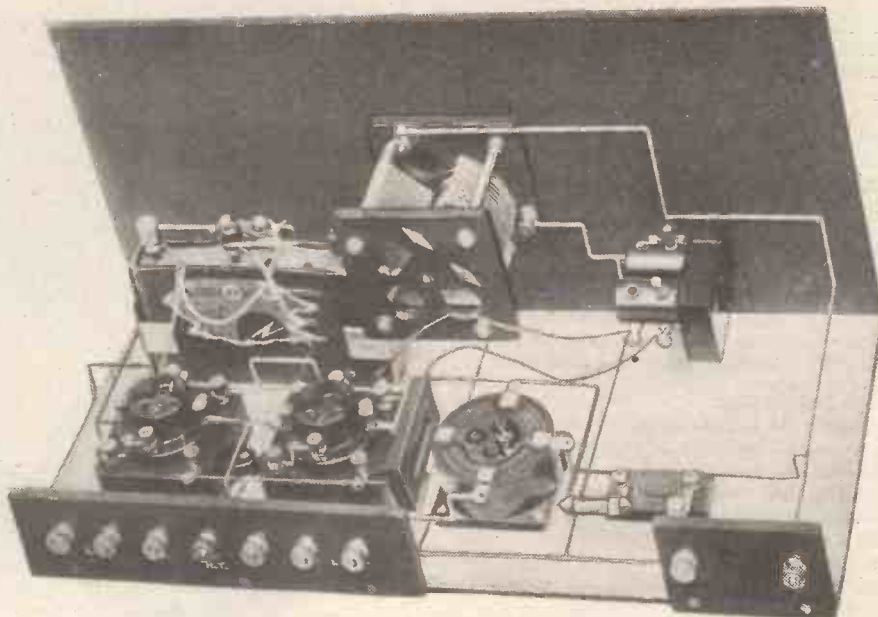

The compact nature of the set can be judged from the above illustration. Note the panel-mounting coil holder on the right of the photograph.

# THE "P.W." SAVOY THREE.

(Continued from previous page.)

can be left "set" and a single turn will switch on the programme.

Owing to its sensitivity, the receiver is not limited to the reception of the local station, it can be used for loud-speaker work up to 25-30 miles from any main B.B.C. station, over 100 from Daventry, and has on test brought in several other transmissions on the loud-speaker at comfortable volume. Among these "outside" broadcasts may be mentioned Bournemouth, Birmingham, Newcastle, Hamburg, Madrid, Frankfort, Radio-Paris, and several others, all collected during one evening when the

## POINT-TO-POINT CONNECTIONS.

Aerial terminal to one side of grid condenser, to plug side of fixed coil holder and to fixed vanes of variable condenser.

Earth terminal to moving vanes of variable condenser, to socket of fixed coil holder, to one filament socket on first valve holder, to one filament on each coupling unit, and to L.T. —

L.T. + to H.T. —, to one side of rheostat and to grid bias +. Grid of first valve holder to remaining side of grid condenser and one side of grid leak. Other side of leak to remaining filament socket of first valve holder, to remaining filament socket on each coupling unit, and to remaining side of rheostat.

Plate of first valve holder to plug of moving coil holder. Other side of coil holder to "A" terminal on first coupling unit and to one side of .002 fixed condenser. Other side of .002 condenser to "H.T." on first unit, to H.T.+1 terminal, and to "H.T." on second unit.

"G" on first unit to grid of valve holder incorporated in that unit. "B" of first unit to a grid bias neg. plug. Plate of valve holder on first unit to "A" of second unit.

"G" of second unit to grid of valve holder on second unit. Plate of holder on the second unit to one loud-speaker terminal. Other loud-speaker terminal to H.T.+2. "B" of second unit to second grid bias neg. plug.

set was being tested at a place about 12 miles N.W. of London.

It is important in wiring up that the connections be perfectly made, as any suspicion of a loose connection or a dry joint will spell disaster in a circuit of this nature. Plate and grid leads also should not be run too close together, or unwanted reaction effects may take place (at H.F.) in the first valve and cause roughness of tone.

## Grid Bias.

We have shown grid bias on both L.F. valves, but it may be found that the 1st L.F. does not need any—in fact, we found that only under exceptionally loud signals was any grid bias needed on this valve. As a general rule this grid bias plug can be placed into the top of the one going to the positive end of the battery. The extra bias tapping is provided merely as a safeguard in case it should be required.

When the wiring has been completed, all the connections should be carefully checked from the point-to-point list given

separately. We do not advise readers to wire up from this list, as it gives the points touched by each wire, and does not necessarily form a true guide to the actual disposition of the wiring. This latter should be taken from the wiring diagram and the point-to-point list used as a final check before the set is put into operation.

With regard to accessories, the constructor will need a 2-volt accumulator of not less than 20 ampere-hour actual capacity—a 30 or 40 would be better, as whether Cosmos, Benjamin, or other suitable valves are used it will be found that they will be of the 2-volt type, and will take from 1 to 25 amp.

## On Test.

On test Cosmos valves were employed, and these can be recommended to our readers without the slightest hesitation. Two blue spot valves and one red spot will be required, the latter going in the last stage and the other two as detector and first L.F. respectively.

An H.T. battery having voltages up to

108 volts should be available, while the grid bias employed should be capable of giving 9 volts, and should be tapped at every 1½ volts.

The tuning coils employed in the Savoy Three are of the usual type—those shown in the photographs being Leweos coils. A 35 or 40 will cover most of the lower wave stations with a 50 taking the set up to 500 metres. A 50 or 75 reaction is sufficient for these wave-lengths. For Daventry and Radio-Paris a 150 or 200 aerial and 200 reaction proved most satisfactory.

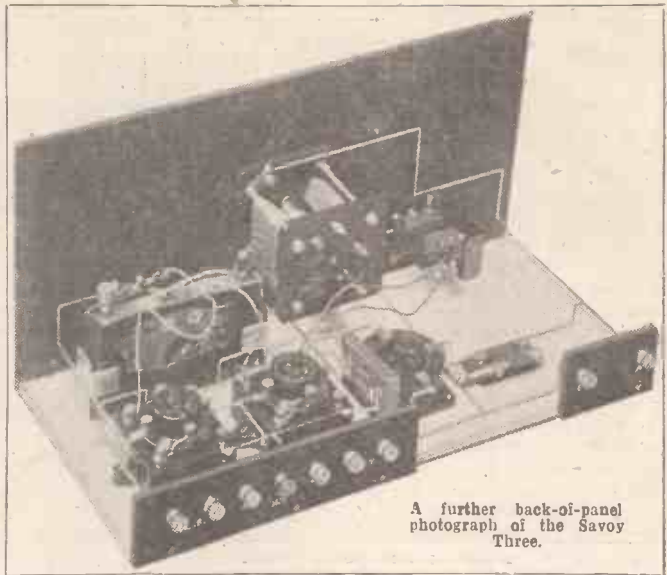

A further back-of-panel photograph of the Savoy Three.

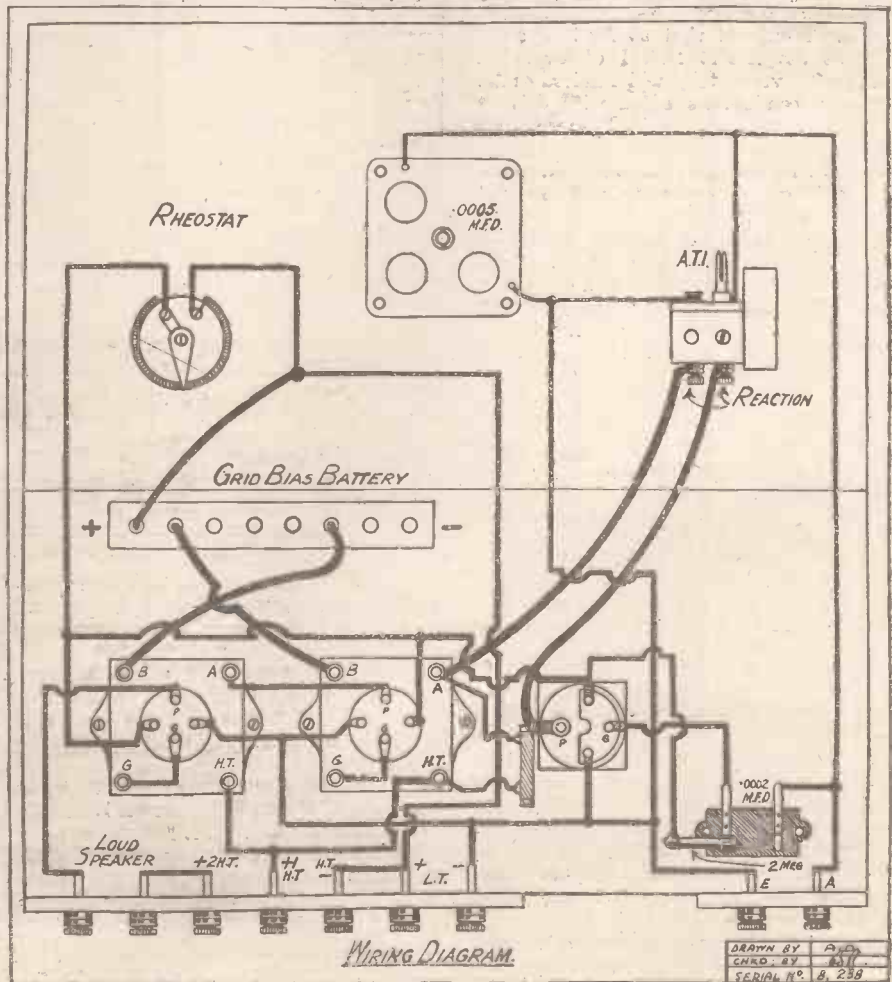

DRAWN BY A.D.  
 ENGR. BY E.H.  
 SERIAL NO. B. 298

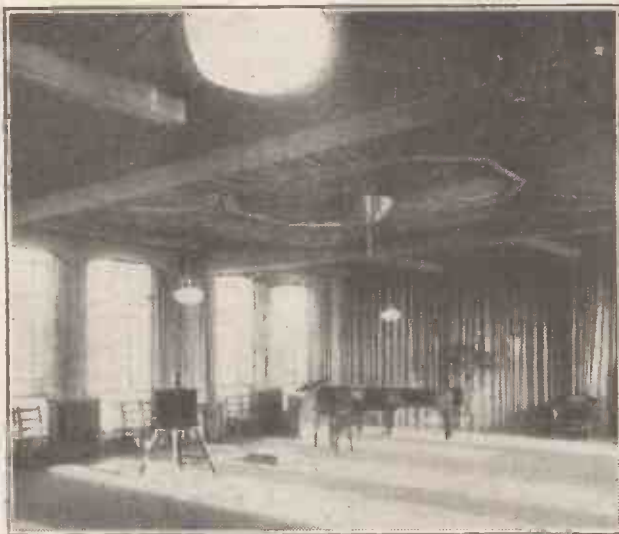

A corner of the Birmingham studio.

"**B**ROADCASTING has taken an important place in the life of the country, and in the same way the National Concerts have taken an extremely interesting and worthy stand in the musical world. They have done more for good British music than any other function of a similar kind for the last three years," is an extract from the conversation I had with Mr. Albert Coates, the famous conductor, after his brilliant personal success at the second of the series of National Concerts organised by the British Broadcasting Company at the Royal Albert Hall.

When I entered that so familiar anteroom at the Albert Hall I discovered a handsome, very tall, white-haired man waving a conductor's baton with evident enjoyment and average intelligence. He fingered the delicate stick almost lovingly, conducted a few bars of an imaginary tune with an imaginary orchestra, and then put it down again. He turned with a jovial laugh, and said that he thought it was not such a difficult profession after all. Then George Bernard Shaw, for it was he, proceeded to compliment Mr. Coates on his concert, saying "he had never enjoyed so much a concert of that kind."

#### A Lover of Broadcasting.

"I have always been a lover of broadcasting," Albert Coates told me later, "and now I am more of an enthusiast than ever."

Mr. Albert Coates told me that he thought the broadcasting of the National Concerts a triumph of organisation.

"I was approached to conduct at all the National Concerts, but unfortunately I was not able to accept as I am hardly ever in England. Most of my time is spent in Russia, and a great deal of that time is spent in listening to the old country. It is so nice to be able to keep in such close touch with England by means of a few valves!"

Mr. Coates was born in Petrograd in 1882 of English parents, and is already associated with at least one memorable occasion so far as British broadcasting is concerned, when under the auspices of the B.B.C. he conducted last March the Rimsky-Korsakov opera "Kitesh," with what success every radio fan knows.

"Modern dance music, or jazz as you call it, has been greatly criticised from so many different points of view that I would like

following weeks of nothing but jazz is lost on a mind that is sodden with jazz. It is absurd to say such a thing. I personally rather like jazz, and I know that after an overdose of this it is a really welcome change to hear pure symphony afterwards.

"Jazz is not new," Mr. Albert Coates went on to remark. "In fact, it is the oldest form of music known, except that in its modern presentation it is given new clothes.

"Even Gershwin's Rhapsody in Blue is not new. In its own peculiar style I suppose it is a classic, but it is a very ancient form of melody. It is, moreover, not music, but just

# A TRIUMPH OF BROADCASTING.

By ALBERT COATES.

In a recent exclusive interview with "Ariel."

to add my opinions. A great many people say that jazz is harmful to good music. This is rank nonsense. I shall go even as far as to say that it is extremely beneficial to good music.

"It has often been said that syncopation stunts the brain and that good music

top line melody is then given to an expert arranger to fill in the harmony, and the result is exactly the same music that is being broadcast.

"The band parts are printed in Russia. Why all this is done is easily understood when it is known that no English or American publisher will send his music to Russia as they will only pay in roubles, and roubles are of no use over here."

Mr. Albert Coates then went on to say that the future of British broadcasting is safe as long as it includes good music in its programmes. The success of broadcasting depends entirely, in his opinion, on its musical selections.

#### More Good Programmes.

"I do not consider it at all difficult to find good musical material for the B.B.C. programmes," he said. "Naturally, it is sometimes not an easy matter to satisfy the public taste, but I do not think there is anyone who is a lover of music who can honestly criticise the policy of the B.B.C. National Concerts.

"I think, moreover, that the radio public

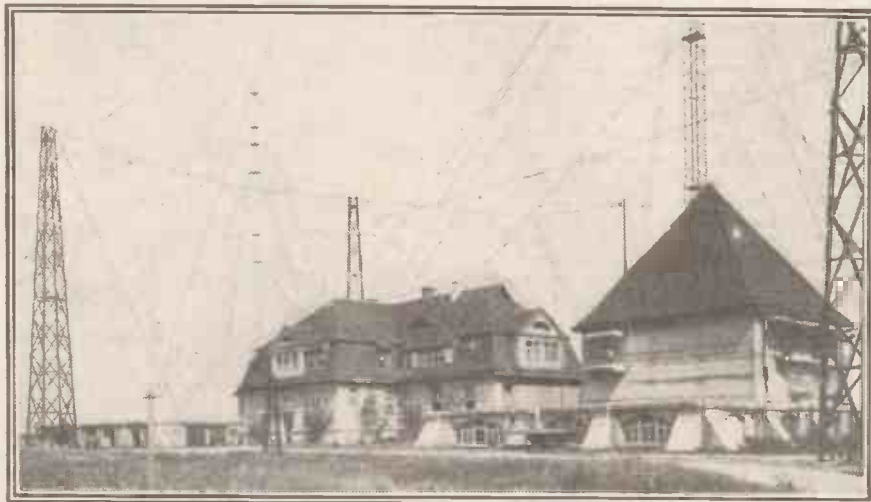

The aerial system of the well-known broadcasting station at Koenigswusterhausen.

the stringing together of various piano exercises which form the rhythmic syncopation."

#### Russian Jazz.

Mr. Coates then told me some very interesting things about Russia and broadcasting. Wireless has played a great part in the Russian entertainment world of to-day.

"It is not generally known that the educating of Russia in jazz music is entirely due to broadcasting. If it had not been for wireless there would be no syncopated music in Russia to-day.

"Whenever the Savoy Bands broadcast, musical arrangers in Petrograd listen to the numbers and set them down, as wireless operators set down Morse messages. The

will have good cause to be extremely pleased with the B.B.C. in the future. It is sparing no pains to get good programmes together, and I for one feel convinced that if it is music the British public require, they will most emphatically have it.

"The National Concerts have opened a new era in British broadcasting. For one thing, it has shown that music is not mutilated over the wireless; it has shown that at Savoy Hill the powers that be have a knowledge of what kind of music to broadcast; and last, but far from least, it has proved that England is a great musical nation who has appreciated the vast organisation that has been the means of bringing, with ridiculous ease, music into every home that requires it."

## A Transformer Without a Precedent—



## A GREAT CHOKE as well as a GREAT TRANSFORMER!

Transformer and Choke coupled amplifiers give greater and better volume per stage than resistance capacity coupled amplifiers (popularly referred to as r.c. sets). Less skill is also required in balancing the circuit to suit the valves used, an important point which requires careful watching in r.c. sets. No special high tension voltage is necessary for transformer and choke couplings, either. Transformers and Chokes are widely used, therefore, for excellent reasons. The advantage of being able to use a Transformer also as a Choke is obvious. **AND NOT ONLY IS THE NEW LISSEN A GREAT TRANSFORMER, but by the simple act of connecting two of its four terminals together, we have found it to be A GREAT CHOKE, ALSO.**

LISSEN has therefore given you a radio part that saves you buying two parts—for a single LISSEN Transformer now enables you to make use of the two most used methods of low frequency amplification.

### FOR USE AS A CHOKE :

All you have to do is to connect together the terminal marked O.P. to the terminal marked L.S. Then take a connection from the remaining two terminals, and you have a **HIGHLY EFFICIENT CHOKE**. Your dealer will show you how easily you can do this if you do not already know. Ask him.

Test this new LISSEN as a transformer against the most expensive transformer you know of—test it as a Choke against the most expensive Choke you know of. If, within seven days, you find a better Transformer or a better Choke, no matter how high its price, then take the new LISSEN back to your dealer. It is significant that LISSEN has unhesitatingly withdrawn in favour of this new LISSEN all the previous expensive LISSEN transformers which have been on the market for several years.

**USE IT AS A TRANSFORMER—USE IT AS A CHOKE**, either way it **AMPLIFIES FULLY EVERY NOTE, EVERY TONE, EVERY HARMONIC, EVERY OVERTONE**. Never again pay a high price for a transformer—this new LISSEN will replace any transformer mentioned or used in any circuit. Choose your own transformer, and your own parts. Remember there are many advertising manufacturers, and that they expect a share of the use and mention of their products in any circuit published in periodicals. You can gain in performance and in economy if you choose your own transformer and other parts, for LISSEN now gives you keen prices as well as LISSEN quality.

**8/6** **GUARANTEED FOR 12 MONTHS**  
 Turns ratio 3 to 1. Resistance ratio 4 to 1.  
 Use it for 1, 2, or 3 stages L.F.  
 It is suitable for all circuits and all valves you will want to use.

LISSEN LIMITED, 8-16, FRIARS LANE, RICHMOND, SURREY  
 (Managing Director : Thos. N. Colc.)

## USE LISSEN FIXED CONDENSERS, TOO Mica & Mansbridge Type LISSEN Mica Type CONDENSERS

Small energy-conserving condensers—note the new case which enables the condenser to be used upright or flat. At present the new case is available only in the most used capacities, but will quickly become a LISSEN standard.



### Capacities—

.0001 to .001 1/- each (much reduced).

.002 to .006 1/6 each (much reduced).

Accurate to 5%—they never leak—they never vary.

## LISSEN Mansbridge Type CONDENSERS

To a fine LISSEN quality condenser is added the specially moulded case—the condenser cannot short circuit on to its case. The new LISSEN case protects you if the condenser is used in any circuit connected straight on to the electric light mains. And due to our new policy of direct-to-dealer distribution this LISSEN Condenser costs no more than the ordinary type.



.01 to .09	2/4
.1	2/6
.2	2/8
.25	3/-
.5	3/4
1.0	3/10
2.0	4/8

## LISSEN FIXED GRID LEAKS

A case of these was left on our factory roof during the summer of 1925, soaked in rain, baked by sun, and the resistance value of these leaks never altered.

All capacities, previously 1/8. Now 1/- each.



Improve every circuit by using LISSEN parts wherever you can—save money, too—for now you get keen prices as well as fine quality. L.177



*"Little brown box,  
I do love thee;  
You make Wireless  
Loud for me!"*

**A** NEW joy has come into Joan's life. Wireless that she can hear without sitting still with Headphones tight over her ears. Time was when she couldn't run about when Daddy was struggling with the Crystal Set. "Ssh! Ssh!" it was everlastingly! Now all that is gone. Since the little brown box was brought home Joan has sat hour after hour listening to the Loud Speaker working from the little Crystal Set. For the "little brown box," is the **Brown Crystal Amplifier**. The instrument which makes Loud Speaker reproduction possible for almost everyone. Not a valve is needed. Nor any other method of Amplification. No accumulators. Just the Crystal Amplifier connected to the Set, an ordinary 4½ volt dry battery and a Loud Speaker. Thus, if you are not more than fifteen miles from a Broadcasting Station (Daventry, 80 miles) your Crystal Receiver will give you the results enjoyed by your friend the valve user. Without any of the expense and trouble which is his!

Let your dealer demonstrate the Crystal Amplifier on one of the nine **Brown Loud Speakers**. It costs £4 4s. and they range from 30/- to £15 15s.

# Brown

**S. G. BROWN, LTD., Western Ave., N. Acton, W.3**

Retail Showrooms: 19, Mortimer Street, W.1.; 15, Moorfields, Liverpool; 67, High Street, Southampton. Wholesale Depots: 2, Landsdown Place West, Bath; 120, Wellington Street, Glasgow; 5-7, Godwin Street, Bradford; Cross House, Westgate Road, Newcastle; Howard S. Cooke & Co., 59, Caroline St., Birmingham; Robert Garmany, Union Chambers, 1, Union Street, Belfast, N. Ireland.



Gilbert Ad. 6856.

## Another Reason why you should use

### BRETWOOD S. L. F. CONDENSERS.

#### The Elimination of Hand and Body Capacities.

THESE are eliminated by setting the thin edge of vanes to face panel, which gives 70 to 90 per cent less surface area exposed to body or hand than any other condenser on the market. Again, no interference is caused by stray field effects with other components in your set, because the vanes move away from the panel instead of across it, as in all other designs of S.L.F. Condensers.



The Bretwood design gives a great saving of back of panel space and enables one to place their inductances immediately behind the condenser, causing a close magnetic field, which produces an increase of selectivity.

PRICES:—.0005 .. 17/6; .0003 .. 14/9; .00025 .. 14/-; .00015 .. 13/3

#### Another Component that will greatly help in securing selectivity and ease in distant station tuning.

### THE BRETWOOD GRID LEAK DE LUXE

Constant—Silent—Efficient

This improved type has a syphon container which prevents all possible leakage of resistance element and guarantees the even distribution of it.



Grid Leak de Luxe 3/6  
Grid Leak (with Condenser) 4/8  
Anode Resistance 3/8

For accuracy of readings (50,000 ohms to 10 megohms) it is on a par with those of our straight-line frequency condenser.

For baseboard mounting a special mount is now available .. Price 3d.

— Obtainable from all dealers or direct from sole manufacturers —

## BRETWOOD LTD.,

16, London Mews, Maple Street, London, W.1.

Parr's Ad.

ARTIC ARTIC ARTIC ARTIC ARTIC ARTIC ARTIC ARTIC ARTIC ARTIC ARTIC ARTIC

## The Master Non-Vibratory Valve Holder

ANTI—  
-MICROPHONIC  
-VIBRATION  
-SHOCK  
-CAPACITY

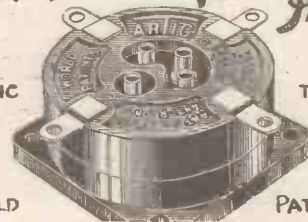

SPRUNG - YET  
THERE ARE NO  
SPRINGS OR  
RUBBER  
SUSPENSION  
PATENTS.

WORLD

## YOU WOULD LAUGH

If you saw a man using a heap of sand as a spring board. WHY, because he would not bounce in sand, his bounce is immediately damped out. You cannot eliminate microphonic noises, distortion, and obtain purer and more distant reception by bouncing your Valves on spring boards. WHY, because springs and rubber accentuate bounce shock and vibration—this is indisputable. The Artic Valve Holder is like the heap of sand, being dead to vibration and shock, a De Luxe Holder which can be obtained at small extra cost. The suspending medium is used by the Admiralty, large Industrial Concerns, etc., for protecting metallic filaments.

HAVE THE BEST AND ORDER NOW!

THE ULTRA  
SENSITIVE  
VALVE  
HOLDER

FROM YOUR DEALER  
OR DIRECT



3/9  
EACH  
POST FREE

ARTIC ARTIC ARTIC ARTIC ARTIC ARTIC ARTIC ARTIC ARTIC ARTIC ARTIC ARTIC



## HALF AN HOUR WITH "P.W."

An interesting and frank article written from an unusual standpoint, giving the impressions of a regular reader of "Popular Wireless" as he runs through the pages of this journal.

By A WELL-KNOWN RADIO MANUFACTURER.

**L**UNCH-TIME on Thursday of each week; a current issue of POPULAR WIRELESS commands a prominent position on my desk, and the next half-hour or so is devoted to intensive research of its pages.

Generally, in the course of this interesting voyage, there is something which causes me to pause, and probably to say to myself, "Ah, yes, that is so; but I remember—". There is no doubt that if the scene of the proceedings were laid in the club-room of a wireless society, instead of an office of which I am often the solitary occupant, many of these points might give rise to considerable discussion, and the members present would probably gain much useful information. However, as there are no members present, and there is no club-room, the discussion is rather one-sided; but some of the points that arose in the issue I have just read, one dated a few weeks back will probably be of interest to many readers of this very adequate journal.

One of the first stumbling-blocks in the voyage occurred in connection with a very admirable and comprehensive article on tone-control units. The slight delay in proceeding forward was caused by the pause necessary to consider as to whether loud-speaker tone-control units were really desirable in these enlightened days.

### Broadcast Reproduction.

Two or three years ago, when wireless receivers were chiefly noted for their magnificent efforts in the way of providing distortion, the shunting of a loud speaker by various sizes of condensers had the admirable effect of apparently remedying some of the harshness and distortion in the equipment. One reason for this was that it reduced the strength of the higher frequencies, and consequently gave one the idea that one was receiving more of the bass. As a matter of hard fact, although a more pleasing balance may be obtained in this manner, you cannot produce bass notes which have already been cut off in the receiver. By reducing the higher frequencies, certain harmonics are reduced or cut off, and this will have the effect of causing many instruments in an orchestra to lose their natural characteristics.

It is rather a case of endeavouring to make two wrongs make a right, and although a unit such as described has very considerable uses, I am sure both the author and the editor of POPULAR WIRELESS will join me in suggesting that, where possible, it is better to use a loud speaker which does not require such a unit, and a complete set which does not require correction in this manner.

Almost immediately following this, one runs up against the topic of Sir Thomas Beecham and his description of wireless reproduction. I only wish I could get him into one of my arm-chairs for half an hour. I would guarantee entirely to convert him. A famous conductor, whom I had the privilege to entertain on one occasion, informed me that the reproduction was

perfect enough for him to make notes, which would enable him to criticise the playing of various individuals in his own orchestra, if he had the opportunity of listening to it. It rather strikes me that Sir Thomas must have been listening to one of those sets and loud speakers which required a tone control as described on the previous page, and it seems to be such a pity that there are people still going about in these enlightened days, who have only heard this unnecessarily horrible side of wireless reception. One wonders how



Tuning the high-speed receiver at the St. Albans station.

much of it is due basically to the craze for distance and volume.

A paragraph in connection with the POPULAR WIRELESS 14-valve receiver, in which it states how distinctly relieved the designers were to find it unnecessary to use screens, gave me an irrepressible desire to rush off to London and shake them by the hand.

### Wireless Fashions.

We are very easily led by popular crazes in wireless construction, and when an easy way out of a difficulty is presented we are very apt to take it without giving any consideration to the method by which the result is obtained. Looking back over the years, it is easy to see that fashions in wireless are almost as changeable as fashions for ladies, as presented by "our Paris correspondent." Certain individuals become to be looked

upon as leaders of fashion, and are very apt to be followed blindly, which cannot be for the good of the science, and I am not sure that it is good for the industry.

In that excellent feature, entitled "Technical Notes," which is so full of useful hints and tips, I rammed my head hard against a paragraph about enclosing the batteries inside the cabinet. In my horrible ignorance, I had not realised that there was any feeling that they should not be so enclosed, and I rush to support the remarks of Dr. Roberts, when he states that no harm can come of it, because for over four years I happen to have been manufacturing receivers in which the batteries were all contained in the cabinets, and not one of which has ever suffered any ill effects thereby. On one occasion a number of receivers were found to be suffering internally, due to apparent oxidation and corrosion of the connecting wire and the switch contacts.

The idea of the batteries immediately jumped into our minds, but it was soon expelled, and after careful research the trouble was found to be due to the presence of a great deal of free sulphur in the ebonite. I wonder if this has been the cause of the fallacy regarding the placing of the batteries inside the receiving set.

### L.F. Howling.

A little farther on Dr. Roberts has much of interest to say regarding coupling between intervalve transformers. In these days, when nearly all transformers are shrouded, it is a blessing to be able to state that one rarely comes up against the trouble, but it is my experience that one frequently comes up against a similar trouble due to coupling in the wiring of this part of the receiver.

I know for a fact, that using some of the super-efficient transformers now available, with suitable valves, one is working so near the danger-point that if the loud-speaker leads are accidentally led over the top of the cabinet containing the set, low-frequency oscillations are often set up. It behoves one, then, to be very careful in the wiring of the L.F. transformer.

A little paragraph in "Broadcast Notes" regarding the appointment of a gentleman of only twenty-five years of age to a very responsible position in the broadcasting world, causes one to pause and think of the many friends one has, holding responsible positions in connection with broadcasting in the wireless industry, who are under forty years of age. I wonder if there is any other industry in existence which is

(Continued on next page.)

## SWITCHING FOR TWO LOUD SPEAKERS.

A useful idea for the listener who runs extension wires from his set to a loud speaker in another room.

By HUMPHREY PURCELL.

THE writer was recently confronted with the problem of working two loud speakers from the same set, one of them at a considerable distance from the set, and of providing a simple switching

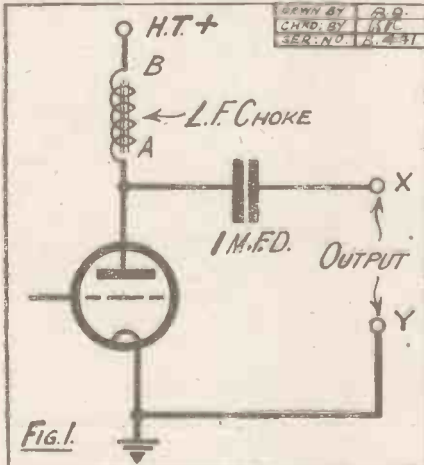

Fig. 1.

arrangement so that either or both loud speakers might be put in or out of action by any member of the household. "Remote control" of the set itself was not required. The method adopted may be of interest to others.

### Only One Wire Required.

First, as one of the loud speakers was to be so far removed from the set, it was decided that a double wire extension would be undesirable, and the set was accordingly altered so as to comprise a choke filter circuit. That is to say, whereas the loud speaker had previously been connected between the points A and B in Fig. 1, an ironcore choke of 32 henries was wired as shown, and a 1 mfd. fixed condenser was connected from A to the negative output terminal of the set (marked X). The other output terminal of the set (Y) was connected to earth.

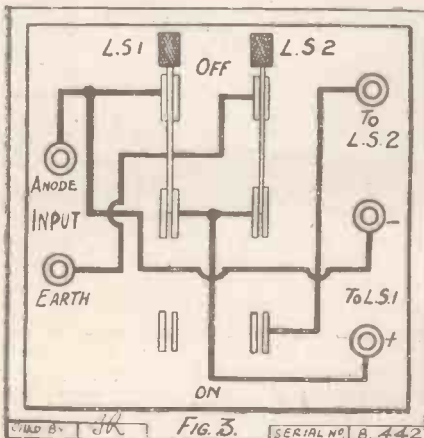

Fig. 3.

This plan of earthing one of the output terminals has the advantage, altogether apart from the question of working a distant loud speaker, that the reproducer is not directly connected to H.T. positive. Not only does no current flow through the windings, but it is impossible to get a shock, as sometimes occurs when using headphones which are not well insulated.

As one end of the loud speaker is earthed, it is possible to extend to a distant loud speaker by means of a single wire, provided an earth connection is made to the loud speaker itself. In the writer's case this was a convenient matter, because it was easy either to run a wire to a main water pipe in the bathroom, or to drop a lead to the ground outside the window.

### Operation of Switchboard.

The circuit (Fig. 2) therefore provides that when both loud speakers are in use, the impulses from the anode of the last valve (terminal X) pass through the windings of the first loud speaker, along the single extension wire to the second loud speaker, and finally to the auxiliary earth. If it is desired to use only the second loud speaker, the first is short-circuited by means of switch No. 1. When the first loud speaker only is required to function, switch No. 2 is thrown

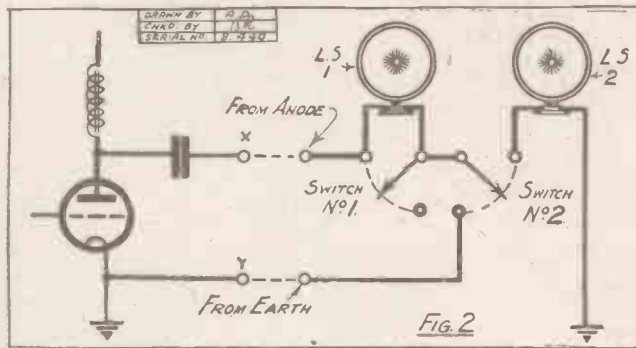

Fig. 2.

over so as to break the connection to the distant loud speaker and, at the same time, connect the output from loud speaker No. 1 to the earth terminal on the set.

These switching arrangements were wired on a separate panel, about 4 1/2 inches square, the only components required being two simple single-pole double-throw switches and five terminals. The lay-out and wiring are indicated by Fig. 3.

## HALF AN HOUR WITH "P.W."

(Continued from previous page.)

so largely controlled by young blood, and how much of this very considerable percentage of young blood in the industry is the cause both of its exceedingly rapid progress, and a certain rather undesirable financial instability, because, after all, so much time

has been spent by the young fellows in concentrating on the advancement in design, that they have scarcely had time to imbibe the necessary methods to insure an equal success in the commercial side of the question.

### "Pure" Reproduction.

Once more over the page, one comes up against the old question of the comparative performances of transformer amplifiers and resistance-coupled amplifiers, and I am left wondering exactly what the author of the article meant when he talked about the "pure" reproduction. I have rather an idea that he used the word as a side exit from the difficulty of setting a standard for reproduction. One can almost divide reproduction into three classes: "The objectionably distorted"; "the pleasing to listen to, but quite inaccurate"; and "accurate and realistic reproduction." If he means by pure reproduction the second of these classes, then I agree with him when he says that pure reproduction is not only possible with resistance-coupled amplifiers, but if he means the last of these classes, then I should be most interested to hear as to whom has evolved a transformer, which will give equal straight-line amplification-frequency curves, with a correctly designed resistance amplifier.

In Mr. Harris's letter-bag, he shows an admirable little picture of resistance shunted across the secondary terminals of a transformer in order to stop howling and improve reception. I wonder if he experiences that guilty feeling, if he ever resorts to this himself. I must admit that in very obstinate cases, in order to save time and trouble, I have utilised this very excellent tip, but in doing so I have felt exceedingly guilty, because it is another of those cases of endeavouring to make two wrongs become a right.

I think, as time goes on, one develops a wireless conscience, and there are certain little popular devices for overcoming troubles which, if utilised, give one a feeling similar to that of the small boy, who having spilt some raspberry jam on the table-cloth, slides his plate over it.

### Question Easily Answered.

I could not help having a chuckle, which I am sure "Ariel" must have shared with me when in his interview with Madame Olczewska, she stated in reply to a query of his regarding B.B.C. talks, "Your talks annoy me tremendously." Apparently they only annoyed Madame Olczewska because she could not understand them, owing to their not being in her own language. I do not think the same reason applies to many of us. So far as I am concerned I hate being transported from a first-class variety show to a talk upon the habits of the wasp.

I am afraid my answer to the heading of the article, "What to do with an inefficient transformer," would only take up half a line instead of half a column, but one cannot help but admire the ingenuity of the contributor, who is out wholeheartedly to make the best of things.

Now my half-hour is over, I must go and spend a few more hours putting theory into practice, but not without grace after meat.

Thank you, Mr. Editor, and also you, Mr. Contributor, for a very pleasant lunch-hour.

# Selectivity?

—instantaneous with an

## ORMOND S.L.F. CONDENSER

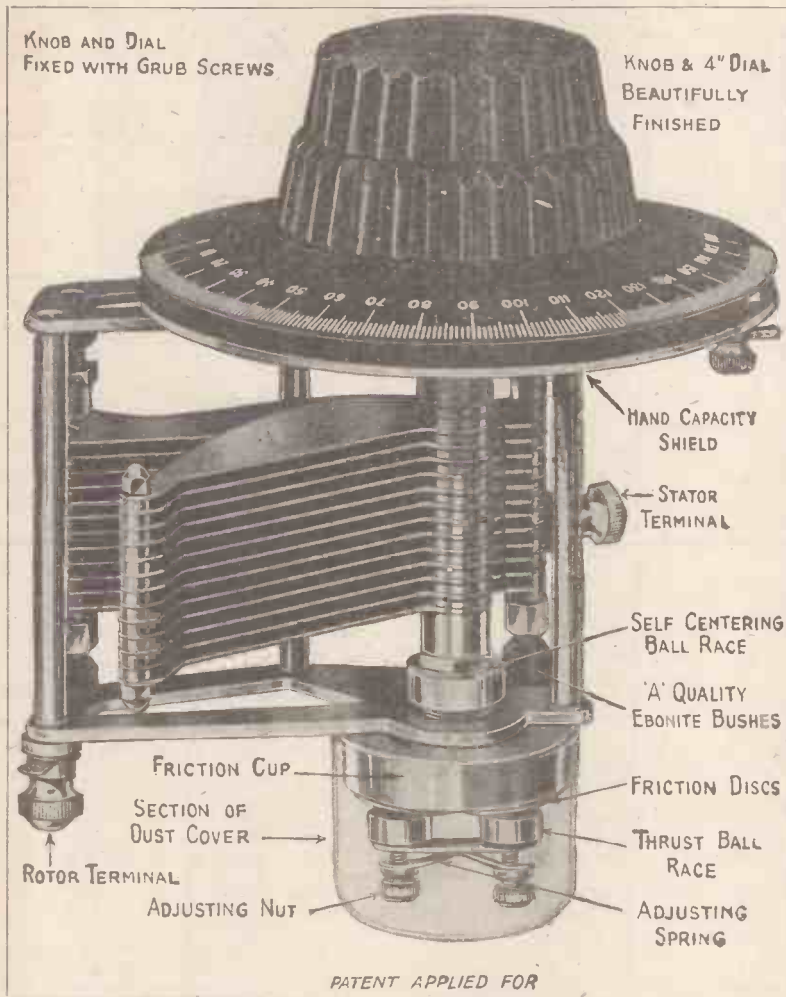

There's no "missing" with an ORMOND—no tiresome twiddling to and fro until you almost get your station. A turn of the famous ORMOND Slow Motion Dial, and you're there—in a twinkling of an eye.

The ORMOND S.L.F. Condenser is all but essential now that the new "Geneva Plan" is in operation. The markings of the dial enable listeners to pick up any station with the minimum of trouble and without any unnecessary calculations. Precise tuning adjustments with noiseless operation are ensured by the general sound construction of this newest ORMOND Product. The famous ORMOND SLOW MOTION FRICTION DRIVE (Ratio 55—1) is incorporated, and special Ball Bearings give liquid-like movement to every turn of the knob. This world-famous ORMOND component is easy to mount, having one and three holes for fixing, with both terminals and soldering tags for connections.

Note the extraordinarily low  
**PRICES**

With 4 in. Bakelite  
Knob.

·0005 mfd. ... 20/-  
·00035 mfd. ... 19/6  
·00025 mfd. ... 19/-

RATIO 55—1

With Dual Indica-  
tor Dial

·0005 mfd. ... 21/6  
·00035 mfd. ... 21/-  
·00025 mfd. ... 20/6

RATIO 55—1



199-205, Pentonville Road,  
King's Cross, London, N.1

Telephone :  
Clerkenwell 9344-5-6.

Telegrams :  
"Ormondengi, Kincross."

Factories :  
Whiskin Street and Hardwick Street, Clerkenwell, E.C.1  
Continental Agents : Messrs. Pettigrew & Merriman,  
Ltd., "Phonos House," 2 & 4, Bucknall Street,  
New Oxford Street, W.C.1

THE ORMOND CONDENSER WILL BE YOUR FINAL CHOICE

THE "POPULAR WIRELESS" VALVE GUIDE—continued.

2-VOLT H.F. VALVES—continued.

Make of Valve	Type	Fill. Volts	Fill. Amp.	Anode Volts	Grid Bias	Impedance	Amp. Fac.	Price	Remarks	Make of Valve	Type	Fill. Volts	Fill. Amp.	Anode Volts	Grid Bias	Impedance	Amp. Fac.	Price	Remarks
"TWO GRID."—Analog Products, Eton Works, E. Dulwich, S.E.22. VITA—Peter Curtis Ltd.,	H.F.	2.0	0.34	20-30	—	—	—	s. d. —	Also det. inner grid, 10-15 volts, 4-electrode	VOLTRON—Volvtron Co., 75, City Rd., E.C.1.	202 202 red * L.C.2	1.8-2.0 1.8-2.0 1.8-2.0	0.22 0.22 0.06	30-100 30-100 30-80	—	13,000 25,000 15,000	— — —	8. d. 7 6 7 6 9 0	General purpose H.F. G.P., also believed obtainable as special H.F. or L.F.

2-VOLT DETECTOR VALVES—(Most power valves O.K. as detectors—see L.F. 2-Volt Valves).

Make of Valve	Type	Fill. Volts	Fill. Amp.	Anode Volts	Grid Bias	Impedance	Amp. Fac.	Price	Remarks	Make of Valve	Type	Fill. Volts	Fill. Amp.	Anode Volts	Grid Bias	Impedance	Amp. Fac.	Price	Remarks
AMPLION—A. Graham & Co., 25, Saville Row, W.1	A.M.G. A.M.R. 2/9	1.6-1.8 1.6-1.8	0.25 0.09	Max. 120 Max. 120	—	18,000 70,000	9 35	14 0	General purpose Det. foll. by res. comp.	LOEWE AUDION—Audion Radio Co., 52, Dorset St., W.1. LOUPE—Fellows Mag. Co., Cumberland Ave., Park Royal, W.	L.A.75 L.E.R.1 L.E.R.2	2.0 2.0 2.0	0.17 0.2 0.2	50-100 40-80 40-100	—	35,000 20,000 40,000	10 6 12	8. d. 8 0 8 0	General purpose Also L.F. Det. when followed by resist. coupling Also L.F.
ARA—Stations & Weill, 55, Gt. Queen St., E.C.2	13	1.8-2.0	0.08	30-90	—	15,000	3	—	General purpose	LUSTRODUX—Lustrodux Ltd., W. Rotherhithe, London, nr. Macclesfield.	L.F.206	1.8-2.0	0.06	40-80	—	25,000	7	9 0	Also L.F.
BEAM & Marquis, 15-16, Benjamin St., E.C.1	D.E.2	1.8-2.0	0.12	20-90	—	—	—	9 0	General purpose	MARCONI—Marconi Co., Marconi Hse., Strand, W.C.2	L.F.212 L.F.234	1.8-2.0 1.8-2.0	0.12 0.34	40-80 40-80	—	20,000 25,000	7 7	9 0 9 0	Also L.F. Also L.F.
BENJAMIN, E.C.1	S.P.18G	1.6-1.8	0.3	30-80	—	17,000	15	14 0	Det. foll. by trans. or choke coupling	METAL—Rae, 60, Blackfriars Rd., S.E.1.	C.L.202 C.L.152 C.L.62	1.8-2.0 1.8-2.0 1.8-2.0	0.2 0.15 0.06	20-100 18-20 20-60	—	25,000 25,000 25,000	7 9 4	8 0 8 0 10 6	General purpose General purpose General purpose
Benjamin Electric Ltd., Broughton Works, Tottenham, N.17	D.E.2	1.8-2.0	0.12	20-90	—	—	—	9 0	General purpose	MULLARD—Mullard Wireless Service Co., Denmark St., W.C.2	P.M.1 P.M.1 H.F.	1.3 1.3	0.1 0.1	50-80 50-80	—	28,000 18,000	13.5 8.9	14 0 11 0	Det. when followed by resist. L.F. Det. when followed by trans. General purpose 4-electrode valve
B.T.H.—The British Thomson-Houston Co., Crown Hse., Aldwych, W.C.2	B.3	1.8	0.35	20-80	—	27,000	7.5	14 0	General purpose	NETELSON—Netelson Electric Ltd., 135, Kingston Rd., S.W.19	P.M.2 D.3L.F.	1.8 1.8	0.15 0.3	50-80 30-100	—	8,750 20,000	5.4 6.5	18 6 14 0	Also H.F. and res. L.F. Det. foll. by trans. coupling L.F. valve
S.S.A.—S.S.A. Radio Ltd., Small Heath, Birmingham.	G.125 G.125A G.225	0.85-1.1 0.85-1.1 1.7-2.2	0.25 0.25 0.28	30-60 30-60 30-60	—	25,000 25,000 15,000	5-6.5 5-6.5 5.5	14 0	G.P. 4-pin base G.P. bayonet fixing General purpose	NEUTRON—Neutron Ltd., Sentinel Hse., Southampton Row, W.C.1	H.220 L.220	1.8-2.0 1.8-2.0	0.2 0.2	20-80 30-100	—	20,000 13,000	7 8	11 0 12 6	General purpose Also H.F. Also L.F. det. followed by trans.
BURNDEPT—Burndept Wireless Ltd., Bedford St., W.C.2	H.L.213	2.0	0.13	30-45	—	19,000	6.5	14 0	General purpose	OSRAM—Osram Ltd., Magnet Hse., Kingsway, W.C.2	D.E.2 D.E.2 D.E.7	1.8 1.8 1.8	0.12 0.12 0.4	40-80 20-40 30-80	—	50,000 25,000 20,000	18 11 12	12 6 12 6 14 0	Det. foll. by res., L.F., also H.F. Det. or stand. H.F. valve, det. foll. by trans. or choke Det. when foll. by resist. L.F. Det. when foll. by trans.
C.A.C.—C.A.C. Valve Distrib. Co., 10, Rangoon St., E.C.3.	D.E.2 H.F.	1.95	0.25	30-80	—	38,000	17	7 6	Also H.F. and res. L.F. Det. foll. by trans. coupling	OSRAM—Osram Ltd., Magnet Hse., Kingsway, W.C.2	D.E.2 D.E.2 D.E.7	1.8 1.8 1.8	0.12 0.12 0.4	40-80 20-40 30-80	—	50,000 25,000 20,000	18 11 12	12 6 12 6 14 0	Det. foll. by res., L.F., also H.F. Det. or stand. H.F. valve, det. foll. by trans. or choke Det. when foll. by resist. L.F. Det. when foll. by trans.
CLEARTRON—Cleartron Radio Co., Charing Cross, W.C.	C.T.15 C.T.2	1.8-2.0 1.8-2.0	0.15 0.13	30-80 30-50	—	18,000	7.5	14 0	General purpose Gas filled Det.	OSRAM—Osram Ltd., Magnet Hse., Kingsway, W.C.2	D.E.2 D.E.2 D.E.7	1.8 1.8 1.8	0.12 0.12 0.4	40-80 20-40 30-80	—	50,000 25,000 20,000	18 11 12	12 6 12 6 14 0	Det. foll. by res., L.F., also H.F. Det. or stand. H.F. valve, det. foll. by trans. or choke Det. when foll. by resist. L.F. Det. when foll. by trans.
MOSBY—MOSBY V. Wick Supplies, 155, Charing Cross Rd., W.C.2	S.P.18G	1.6-1.8	0.3	30-80	—	17,000	15	14 0	Det. foll. by trans. or choke coupling	OSRAM—Osram Ltd., Magnet Hse., Kingsway, W.C.2	D.E.2 D.E.2 D.E.7	1.8 1.8 1.8	0.12 0.12 0.4	40-80 20-40 30-80	—	50,000 25,000 20,000	18 11 12	12 6 12 6 14 0	Det. foll. by res., L.F., also H.F. Det. or stand. H.F. valve, det. foll. by trans. or choke Det. when foll. by resist. L.F. Det. when foll. by trans.
CONSOR—A. C. Connor Ltd., Aberdeen Works, Highbury Grove, N.	W.1 W.R.1 Pt. 1 (black)	1.6-1.8 1.6-6 1.8	0.3 0.3 0.1	30-120 30-120 60-120	—	19,000 19,000 22,000	6.6 6.6 9	14 0	Also L.F. Also L.F. Also L.F.	OSRAM—Osram Ltd., Magnet Hse., Kingsway, W.C.2	D.E.2 D.E.2 D.E.7	1.8 1.8 1.8	0.12 0.12 0.4	40-80 20-40 30-80	—	50,000 25,000 20,000	18 11 12	12 6 12 6 14 0	Det. foll. by res., L.F., also H.F. Det. or stand. H.F. valve, det. foll. by trans. or choke Det. when foll. by resist. L.F. Det. when foll. by trans.
CUNNINGHAM U.S.A.—Rothermel Corp. Ltd., 24/26, Maddox St., W.	C.X.12	1.1 1.1	0.25 0.25	—	—	—	10 0	10 0	G.P. special base G.P. stand. CX base	OSRAM—Osram Ltd., Magnet Hse., Kingsway, W.C.2	D.E.2 D.E.2 D.E.7	1.8 1.8 1.8	0.12 0.12 0.4	40-80 20-40 30-80	—	50,000 25,000 20,000	18 11 12	12 6 12 6 14 0	Det. foll. by res., L.F., also H.F. Det. or stand. H.F. valve, det. foll. by trans. or choke Det. when foll. by resist. L.F. Det. when foll. by trans.
DEXTRAUDION—W. E.C. Co. Ltd., 10, Fitzroy Sq., W.1.	235	1.8-2.0	0.35	40-75	—	21,000	—	10 0	General purpose	OSRAM—Osram Ltd., Magnet Hse., Kingsway, W.C.2	D.E.2 D.E.2 D.E.7	1.8 1.8 1.8	0.12 0.12 0.4	40-80 20-40 30-80	—	50,000 25,000 20,000	18 11 12	12 6 12 6 14 0	Det. foll. by res., L.F., also H.F. Det. or stand. H.F. valve, det. foll. by trans. or choke Det. when foll. by resist. L.F. Det. when foll. by trans.
FIDISWAN—Lidson Swan Co., Queen Victoria St., E.C.	D.R.2 G.P.2 A.R.D.E. L.F.	1.8-2.0 1.8-2.0 1.8-2.0	0.1 0.1 0.3	40-80 30-80 20-60	—	27,000 16,500 15,000	8 10 5	14 0	Special det. also L.F. General purpose Also L.F.	OSRAM—Osram Ltd., Magnet Hse., Kingsway, W.C.2	D.E.2 D.E.2 D.E.7	1.8 1.8 1.8	0.12 0.12 0.4	40-80 20-40 30-80	—	50,000 25,000 20,000	18 11 12	12 6 12 6 14 0	Det. followed by res. Det. and L.F. Det. and power General purpose
ELKA—L. Krenner, 49a, Shudehill, Manchester.	C	1.5-2.0	0.15	20-100	—	—	—	—	General purpose	OSRAM—Osram Ltd., Magnet Hse., Kingsway, W.C.2	D.E.2 D.E.2 D.E.7	1.8 1.8 1.8	0.12 0.12 0.4	40-80 20-40 30-80	—	50,000 25,000 20,000	18 11 12	12 6 12 6 14 0	Det. followed by res. Det. and L.F. Det. and power General purpose
FRELAT—L. Krenner, 49a, Shudehill, Manchester.	K D.B.	1.8-2.0 1.8-2.0	0.3 0.06	20-30 30-100	—	—	—	4 11 8 6	General purpose	OSRAM—Osram Ltd., Magnet Hse., Kingsway, W.C.2	D.E.2 D.E.2 D.E.7	1.8 1.8 1.8	0.12 0.12 0.4	40-80 20-40 30-80	—	50,000 25,000 20,000	18 11 12	12 6 12 6 14 0	Det. followed by res. Det. and L.F. Det. and power General purpose

To be continued.

# S. T. VALVES

## CAN BE OBTAINED FROM THE FOLLOWING FIRMS.

Certain wireless dealers are from ulterior motives attempting to persuade customers who ask for S.T. valves to buy other makes. There is nothing to equal the S.T. valve and readers of this advertisement should resist any attempt to put them off. The characteristic curves of S.T. valves are unlike those of any other make in this country as comparison will show, and while certain constructional features are embodied under patent licence, the performance and life of S.T. valves are unique. The Wireless Dealers in the following list are not the only ones supplying S.T. valves, but represent the largest buyers of these valves.

LONDON, EAST CENTRAL: Melhuish, Ltd., 50, Fetter Lane; Munday, 45, Eastcheap; Munday, Watling St.; Wood, 2, Copthall Court. NORTH: Ambridge & Son, 281, High Rd.; Tottenham; Bartlett's Wireless Service, 265, Green Lanes, Harringay; Dawson, 227, Balls Pond Rd.; District Light Supply, 43, High Rd.; Wood Green; Hall, 91, Fore St.; Henson Littlewood, Church End Radio Depot, Finchley; Hollands, Queen's Parade, 659, Green Lanes; Jackson Wireless Service, 126, High Rd., S; Tottenham; Morris, 9, Station Rd., Finsbury Park; Palmer's Green Radio Service, Ltd., 15, Melbourne Parade; Reflex Radio Co., 102, High St.; Socks, 130, Kentish Town Rd. NORTH-WEST: Booker's Sports Stores, The Parade, Golder's Green; Coles, 70, Park Rd. SOUTH-EAST: Bacon & Co., 449, London Rd., Thornton Heath; Dulwich Cycle & Carrier Co., 356, Lordship Lane, E. Dulwich; Mitchell's Electric & Wireless, 182, Rye Lane, Peckham; Pastimes, 208, Walworth Rd.; Phoenix Wireless Supplies, 314, High Rd.; Lee; Radio Supply Stores, 574, Old Kent Rd.; Scratchleys, Ltd., 111, High St., Thornton Heath; Woolwich Radio Supplies, 22, New Rd. SOUTH-WEST: Cooper, 18, Royal Arcade, London Rd., W. Croydon; Alpha Mfg. & Electric Co., 26, High Rd., Balham; Arthur's Wireless Stores, 5, The Arcade, Victoria St.; Economic Lighting Stores, 24, Fulham Palace Rd.; Goddens, 298, High Rd., Streatham; Premier Supply Co., 20/24, High St., Clapham; Pritchett's Cycle and Motor Stores, 139/141, Merton Rd., Wimbledon; Ar Sacks, 336, Lillie Rd., Fulham Cross; Shipton, 27, Tothill St.; Wireless & Light Supplies, 155, Balham Hill. WEST: Bailey & Perkins, 138, South Ealing Rd.; Economic Electric, Ltd., 10, Fitzroy Sq.; Foot & Sons, 108, North End Rd.; W. Kensington; Jones & Noyes, 164, Railway Approach, Shepherd's Bush; Raie Mfg. Co., 7, Fulham Palace Rd.; Smith & Co., 289, Edgware Rd. WEST-CENTRAL: Wooldridge, 26, Lisle St. ABERDEEN: Wireless and Electric Eng. Co., 39, Bridge St. ACCRINGTON: Somerville, Ltd., 45, Abbey St. ALTRINCHAM: Brown, 1, Moss Lane. ASHFORD: Hayward & Sons. AYR: Fairburn, Ltd., 181, High St. BATH: Bath Electrics, Ltd., George St.; Stanley Hargrove, Gay St. BELFAST: Moffatt, Ballynafeigh; Patterson, 13/15, Bridge St. BETHESDA: Owen, House Furnisher. BEXLEY HEATH: Bexley Heath Elect. Co., 167, Broadway. BIRMINGHAM: Baldwin & Co., 1, 078, Warwick Rd., Acock's Green; Beeby, 25, Winson Green Rd.; Birmingham Co-operative Society, 129, Gt. Brook St.; Booth, 19, John Bright St.; City Radio Service, 226, Warwick Rd., Greet; County Cycle & Motor Co., 200/1, Broad St.; Dale End Radio Electric Co., 100, Dale End; Hockley Brook Electric Co., 9, Hunters Rd.; Omniaphone Co., 67, George St.; Welrose, 44, Church St. BLACKBURN: Shaws, 49, Larkhill. BLACKPOOL: Moore, Trocadero Bldgs., Central Beach. BLOXWICH: Tomkinson, 222, High St. BOLTON: Grimshaw Radio Co., Market Hall; Thomasson Bros., 298, Chorley Old Rd. BRADFORD: Dobson, 475, Manchester Rd.; Wood, 57, Park Rd. BRAINTREE: Nicholls Bros., 149, High St. BRENTFORD: Biggs & Sons, 38, High St. BRIDLINGTON: Doughtys, Ltd., 8, Manor St. BRIGHTON: Galliers, 32, St. James St.; Newman & Sons, 43, Upper St.; James St.; N. R. Phelps, 54, Queen's Rd. BRISTOL: Brown & Sons, 12, Narrow Wine St. CAMBRIDGE: Carter Bros., Newmarket Rd.; King & Harper, Ltd., 6, Bridge St.; Morley & Duke, 46, King St. CARDIFF: Garelick, 45, Wood St. CHATHAM: Radio Supply Co., 22, Medway St. CLACTON-ON-SEA: Due, 60, Rosemary Avenue. COATBRIDGE: Coatbridge Cycle Depot, 73½, Bank St. CONGLÉTON: C. W. Whitter, 26, High St. COVENTRY: C. Payne, 26, Earls St.; Salmon, Spon End Works. CREWE: Wistonia Motor Garage, Wistonia. DERBY: Derby Co-operative Society, Albert St.; Jolly & Cowlshaw, 61, East St. DOUGLAS, I.O.M.: Express Photographic Service, 44, Athol St. DUBLIN: Irish Radio Stockists, 3, Crow St.

EDINBURGH: Baird, 33, Lothian St. EMSWORTH, Mitchell, Stein Rd., Southbourne. EXETER: Pincott, 91, Queen St. GLASGOW: Blackadder, 107, Union St.; Radio Accessories, 192, Buchanan St.; Robb Bros., 69A, West Nile St.; Electrical Ohms, Ltd., 6, Bridge St.; GOSPORT: Woodford, C.W. Depot, N. Cross St. GLOUCESTER: Radio Electric Co., 3, Commercial Rd.; Williams & Co., 35, Westgate St. GRIMSBY: Turner, 3, Corporation St. HALIFAX: Ambler, 3, Old Market, Woolshops. HARROGATE: Ideal Radio Shop, 8, Lowther Arcade. HITCHIN: Shadbolt, 6, Tilehouse St. HOLYHEAD: Holyhead Motor Co., Kingsland Rd. HUDDERSFIELD: Wood, 37, Westgate; Eastwood, High St.; Taylor & Co., Macaulay St. HULL: King & Co., Electric Dept. IPSWICH: Ipswich Wireless Co., St. Matthew's St.; Boddy, Page & Co., 27, St. Peter's St. JERSEY: Jersey Electric Service Co., 21, Charing Cross. KETTERING: Jessop, Newland St. KIDDERMINSTER: Russell, 106, Blackwell St. KING'S LANGLEY: Sands, High St. LANCASTER: Jones, 7, James St. LEEDS: Direct Wireless Co., 83, Vicker Lane; Ingleby, 1, Albion St.; Riche, 20, Queen's Arcade. LEICESTER: Griffins, Ltd., 51, Tudor St.; Wathes & Co., 86, High St.; Scientific Wireless Stores, 23, Humberstone Rd. LEVENSHULME: Peacock, 169A, Stockport Rd. LEEDS: County Garage Eng. Works, 170, High St. LIVERPOOL: Warbrick Bros., 5, Cook St. Arcade; Hoskins, 45, Whitechapel St.; Kelly, Ranelagh St.; Central Radio, Fenwick St. LANELLY: Thomas, Optician, Lucania Bldgs. LONDON-DERRY: McDowell, Strand Rd. LOWESTOFT: Parish, 82, High St. MACCLESFIELD: Newman, 34, Chestergate. MANCHESTER: Brown & Co., 22, Corporation St.; Lomax, 15, Trafford Rd.; New Radio Service, 47, Grafton St.; Potts, 3, Albert Place, Bridge St.; Lloyd, Audenshaw; Welworth Wireless, 8, Withy Grove; Garnetts, Islington Grove. MARGATE: Kings Wain, 272, Northdown Rd. NEWCASTLE: Owen, 2, Northumberland Rd. NEWPORT: Goldsmith & Co., 8 & 9, Queen St. Place. NEWQUAY: Sowell, Station Rd., Bugle, Newquay. NORTHAMPTON: Cowell & Wyatt, 47, Abingdon St. NORWICH: Bennett, 40, Exchange St. NUNEATON: Parker, 44, Church St. OLDBURY: Sanders' Stores, Market Place. OLD NORMANTON: Dale, Post Office. OXFORD: Gillman & Co., 107, St. Aldate's; King, 87, St. Aldate's. PLYMOUTH: Lazenby, 29, Old Town St. PRESTATYN: Haworth, Kingsway House, Vic. Rd. PRESTON: Billy's Wireless, 19, Friargate; Central Wireless Stores, 115, Lancaster Rd. RHONDDA: Davies, Chemist, Tonypanydy. ROCHDALE: Premier Motors, Ltd., Town Head Garage; Yorkshire St. RUSHDEN: Clipson Bros., 131, High St. SAFFRON WALDEN: Wallis, High St. SALISBURY: Radio Services, 2, Winchester St. SCARBOROUGH: Bell, Seamer. SHEFFIELD: Ashton, Ltd., Norfolk St.; Glossop, 7, Norfolk Market Hall. SLOUGH: General Distribution Co., 22, High St.; Nelson Engineering Co., 87, Wellington St. SOUTH-END: Coyle, 134, London Rd.; Bridge, Warrior Square. SOUTHPORT: Storry's, 144, Eastbank St. STOCKTON: Farriday, Arcade Wireless Shop, High St. STOKE-ONTRENT: Bew, Electrical Engineer. STOWMARKET: Godding & Son, Ipswich St. SUTTON-IN-ASHFIELD: Hanstock, Forest St. SWANSEA: John & Sons, Newton Rd. TAMWORTH: Garbutt, Measham. THORNTON HEATH: Bacon & Co., 449, London Rd.; Scratchleys, Ltd., 111, High St. TORQUAY: Crocker, 40, Reddenhill Rd. WEDNESBURY: Hill & Co., 13/14, Lower High St. WEST HARTLEPOOL: Alton, Picture House, Stockton St. WESTON-SUPER-MARE: Green-slade & Co., High St. WIGTOWN: C. Mair, 23, Victoria St. WINDSOR: Wellman Bros., 59, St. Leonard's Rd.; Atkins & Powell, 48, Thomas St. WORCESTER: Bullock, Premier Bldgs., Barbourne Rd. WORTHING: Wade's Garage, Chapel Rd. YORK: Whitelock, Tholthorpe; Kay & Co., 6, Blake St.



# Apparatus Tested

Traders and manufacturers are invited to submit wireless sets and components to the "P.W." Technical Dept. for test. All tests are carried out with strict impartiality in the "P.W." Test room under the supervision of the Technical Editor, and the general reader is asked to note that this weekly article is also intended to provide a reliable and unbiased guide as to what to buy and what to avoid.—EDITOR.

## WIRE FOR LOW-LOSS COILS.

**M**ESSRS. Ward & Goldstone, Ltd., inform us that they are producing large quantities of their new stranded wires. Several types are manufactured. For instance, we recently had sent us reels of 7/42's enamelled and silk covered, and 10/42's double cotton covered. Both are excellent and, on account of their large surface areas, should appeal strongly to amateurs interested in the construction of short-wave and other low-loss receivers.

## NON-PHONIC VALVE.

It is claimed that the Nelson Non-Phonic Valve allows the use of a cheap valve holder, as its base is flexibly fixed to its bulb, and thus can absorb vibrations after such have reached the pins and before they can pass to the elements. The Nelson sent us for test was type C410, which has the following characteristics: fil. volts, 3·8·4;

fil. amps, .1; anode volts, 60-100; impedance, 20,000 ohms; amplification factor, 7.

It makes a very good detector and, whether it is due to the novel construction or not, the fact remains that it is entirely "non-microphonic" even when employed under adverse conditions. In first L.F. stages, with a volt or two of grid bias, it amplifies well and handles quite respectable inputs with satisfactory freedom from wave distortion.

## NEUTRON VALVES.

Although "·06" valves have lost a considerable amount of their one-time popularity there is still a very great number of amateurs and listeners who use them and find that they answer their requirements. If a valve is to operate successfully with dry batteries it must not consume more than ·06 amperes, but the Neutron, despite this handicap, has quite a large emission,

and the samples we have had on test for a fairly long time (running continuously) show no signs at all of any diminution in this respect.

In fact, the Neutron ·06 is one of the most efficient valves of this class we have ever had pass through our hands. We particularly like the type H406, which has the following characteristics. Filament volts, 3·5-4; filament amps., ·06; impedance, 22,000 ohms; amplification factor, 9. It is a most successful H.F. amplifier and detector, and gives really good results. For the one-valve man there are, in our opinion, few better valves in any class. The H406, an L.F. amplifier, has an impedance of 12,000 ohms and an amplification factor of 6. It handles medium inputs quite satisfactorily.

Both these valves can, of course, be used with 4-volt accumulators, and are certainly cheap at 12s. 6d. each.

## THE "MUSICALPHA" LOUD SPEAKER.

Messrs. E. Joublin and A. R. Kingsley, of 317, High Holborn, London, W.C.1, recently sent us one of their "Musicalpha" loud speakers to test. It is a small but neat little instrument, and is provided with a stretched fabric diaphragm which is apparently quite unaffected by atmospheric conditions. This diaphragm is of an exceptionally novel design, and does not appear to have a natural period in the normal musical scale.

The "Musicalpha" on test gave very good results, and while the tone was mellow there was an entire absence of "drumminess." It appeared to be rather more  
(Continued on page 1114.)

Ring out  
the Old—



1926  
Dry Batteries

Units to suit  
all Sets  
from 42/6  
Illustrated Folder FREE

"EKCO"  
H.T. UNITS

Obtain H.T. Current from Electric Supply  
Mains (D.C. & A.C.) by just attaching  
adaptor to electric light lampholder!

SAFE! SILENT! SOUND!

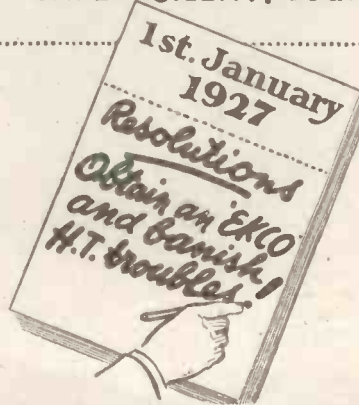

— Ring in  
the New!



1927  
Model 2A "EKCO" H.T. Unit.

GET YOURS NOW!  
But be sure it's an  
"EKCO"

Obtainable from all Radio Dealers.

F. K. COLE LTD

(Dept. A.) 513, LONDON ROAD,  
WESTCLIFF-ON-SEA.

Evening News OCTOBER 7, 1926.

# more **CYLDON** successes

PRONOUNCED (SIL-DON)

1 Mr. Emerson, awarded Internat. Gold Medal by Amsterdam Radio Society for his "Elstree Six" writes: "success due to CYLDON Condensers."

2 2nd prize, Radio World's Fair, New York, awarded to "Mewflex" receiver fitted with CYLDON Condensers.

3 2nd prize at Chicago Exhibition, 1926, also awarded to "Mewflex" Receiver fitted with CYLDON Condensers.

4 Radio World's Fair, New York, 3rd prize to "All British Six" to which CYLDON Condensers and Temprytes were fitted.

There is a complete range of CYLDON Condensers in all capacities—Square Law, S.L.F., Dual, 2 Gang, Triple Gang and 4-Gang. Each is the Premier of its class—exceptionally well designed and finished. Prices:—

SQUARE LAW. .0005 17/6. .0003 16/6. .00025 16/6.  
.0002 15/6. Complete with dials.  
S.L.F. .0005 15/6. .00035 15/6. .00025 14/6.  
Dials 2/- extra.  
DUAL CONDENSER. .0005 mfd. 27/6. .0003 mfd. 25/-.  
Complete with dials.  
2-GANG £2. 10. 0  
TRIPLE GANG (as illustrated) £3. 10. 0  
4-GANG £4. 10. 0

Prices without dials.

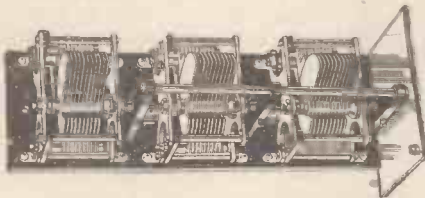

**CYLDON TEMPRYTES.**  
The best means of Valve control. British made and unconditionally guaranteed. Can be supplied in correct resistance for any Valve. State resistance (ohms) required when buying or be sure to give name of Valve and voltage of Accumulator supplying current to the Valve.  
Cylidon Temprytes .. 2/6 each.  
Holder mountings .. 1/6 each.

Get full particulars of the Cylidon WAVEMETER (identifies unknown stations and makes searching and testing simplicity itself) and all the other CYLDON products. If unable to obtain from your dealer send direct to:—

**SYDNEY S. BIRD & SONS,**  
"CYLDON WORKS," SARNESFIELD ROAD, ENFIELD TOWN, MIDDLESEX.  
Telephone: Enfield 0672.

## DANCING AND ALMOST PERFECT WIRELESS.

WITH LONDON DEMONSTRATION NO. ONE SHOULD MISS.

### MUSEUM CONCERT.

From our Wireless Correspondent.  
During the past few months I have been asked almost daily "Where can I go and hear a wireless set that will give me a fair idea of what a first-rate reproduction of music sounds like?"  
Until very recently no such set had been permanently available for public demonstration, as far as I know, but now any London listener may obtain a first hearing of the very best model of Most up-to-date apparatus has been installed in the wireless section of the Science Museum in South Kensington. After 4 P.M. on every afternoon except Mondays and Thursdays, this programme, with a first-class battery, is available by any apparatus I have ever heard.

7-Valve Set.  
The expert in charge of the music section of this museum told me some details which will interest enthusiasts. The set is one of 7 valves. The programme, followed by a first-class battery, is available by any apparatus I have ever heard.

The set referred to in the "Evening News" article is fitted with CYLDON Condensers—which is further testimony to their ability to meet the exacting conditions necessary for such demonstrations.

## Get a 'BELDEN' 16/28 AIR-SPACED BRAIDED AERIAL

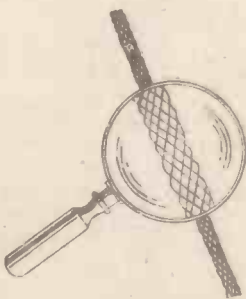

Something entirely new and gives the best results. Each strand is insulated with enamel and then braided so as to offer the maximum signal receiving surface. Extra flexible and suitable for either indoor or outdoor use. Price 3/3 per 100 ft. coil.

## "MIDGET" FRICTION TUNER

This will add 100% to the efficiency of your set. It can be easily fitted to any set; is self-adjusting. All metal parts heavily nickel-plated. Highly polished Bakelite knob and rubber washers. Complete with fixing instructions. 9d. each.



Trade enquiries invited.

**THE STANDARD INSULATOR CO., LTD.**  
Winsley House, Wells St., Oxford St., London, W.1  
Phone: Museum 5978.

## Safety **EEXLEX** First!

BE PREPARED FOR TORMS—WINTER and SUMMER—by

## FIXING THE "EEXLEX" SAFETY SWITCH

Comprising: Switch, Lightning Arrester, Lead-in Tube and Weatherproof Cover.

The Eexlex safety switch, the latest development in Safety First devices, enables the operator to earth the aerial outside the house. By pushing the knob the set is at once connected to the aerial. A pull instantly disconnects the set from the aerial system, automatically earthing the aerial. The spark gap provides ample means of by-passing any electrical discharge which may occur while set is in operation.



6 in. Tube PRICE 5/6

12 in. tube 6/6. 18 in. tube, 7/6.

## KNIFE SWITCHES

D.P.C./o 2/6 each.  
S.P.C./o 1/6 each.

S.P.C./o 1/- each

S.P.S.T. 1/- each.

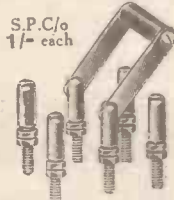
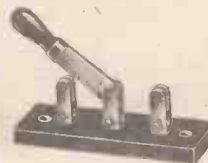

Please Write for Entire List of Switches.

MINIATURE KNIFE SWITCHES for Panel Mounting as illustrated 1/6. S.P.C./o 1/-.

Write for New Eexlex Catalogue P.W. 9



**EEXLEX HOUSE, 118, BUNHILL ROW, E.C.**  
Phone: Clerkenwell 9282/9283.

## APPARATUS TESTED.

(Continued from page 1112.)

sensitive than the average small loud speaker, but it could handle fairly heavy inputs without discomfort.

Its price, 52s. 6d., would appear to be quite reasonable. But it is very "French" in appearance, and from this point of view might not appeal to all listeners, although it might, on the other hand, coincide with the tastes of many.

### HOBBIES' READY-TO-MAKE WIRELESS CABINET.

Messrs. Hobbies, of Dereham, Norfolk, supply complete sets of parts of wireless cabinets of the conventional panel and baseboard "American" type. They recently sent us Set No. 6. This consists of all the necessary wood for a cabinet to take a 16 x 8 in. panel. The timber is of first-class quality, and is accurately cut and nicely finished—all ready for polishing, in fact. A little glue and one or two screws are all that is necessary, and one does not need to be a carpenter to make a handsome cabinet out of a set of Messrs. Hobbies' parts. Amateur constructors should send for the list detailing the range of sets available.

### A USEFUL OUTFIT.

Messrs. S. P. Polishes Co., 5, High Holborn, London, W.C.1, are retailing a complete French Polishing outfit. We recently received a sample for examination, and this was subsequently placed in

commission in our workshop. It has proved most useful, and many cabinets that had become scratched and otherwise badly marked have, with very little work, been furnished up to their pristine elegance. The outfit is most complete, and includes a supply of a very efficient "stopping" material and various stains, polishes, and other essential items. A clearly worded instruction book is provided which should enable even the tyro to obtain professional "finishes." The S.P. outfit costs 4s. 6d.

### THE "SOPRANIST" L.F. TRANSFORMER.

We recently received a sample of the above from Messrs. Kalinsky, Ltd., 75, Aldgate High St., E.1. It is a very neat



The new G.E.C. H.T. battery with interchangeable units.

little component, and has a black, frosted casing with nickelled end plates. With a ratio of 1-5, for its size, it gives good results. Readers who have had experience of small French transformers will agree that the results obtainable from such are somewhat better than one would generally expect in

view of their light construction. In a two-valver (Det., L.F.) the "Sopranist" functioned quite happily except on the very low frequencies, where slight irregularities were noticeable.

### FRELAT AND ELKA VALVES.

We recently received samples of the following valves from Messrs. L. Kremmer. Frelat K. (detector), 1.8-2 volts, .3 amps., price 4s. 11d.; Frelat K. (amplifier L.F.), 1.8-2 volts, .3 amps., price 4s. 11d.; Frelat DPK. (power), 1.8-2 volts, .35 amps., price 8s. 6d.; Elka C. (det. and L.F. amp.), 1.8-2 volts, .15 amps., price 7s. 6d.; Elka D. (det. and L.F. amp.), 3.5-4 volts, .15 amps., price 5s. 6d. The Frelat K. and both Elka operate well as H.F. amplifiers.

The Elkas are very natty little valves; quite the smallest we have seen. Both these and the Frelats are apparently of Dutch origin, and readers will not need to be reminded that both tubes and tubulars of good quality come from Holland.

All the detectors in the above range were found to be very good, the Elka C. especially operating well in all the receivers in which it was tested. The Frelat DPK., however, could not handle an input which a standard two-volt power valve of English design made light work of, although in a first L.F. position the former was quite satisfactory.

The Frelat and Elka valves are very nicely made, and compare well in this respect with anything that is on the market. And, taken all round, their performances call for very little criticism. Certainly proportional to their price they are really excellent.

## Look out for this S.T.61A

—a new resistance-capacity valve



WE are daily being asked for a 6-volt resistance-capacity valve having a specially high amplification factor. We are now able to state that, after months of experiment on numerous models having amplification factors ranging from 20 to 50, we have arrived at the best design—which, moreover, will embody the new torodium filament. It will be non-microphonic, and will not sacrifice life for performance.

Supplies of this valve (S.T.61A) will not be available for some weeks, but meanwhile we only think it fair to notify our friends of our plans. Orders will be carried out in rotation.

Meanwhile, have you tried "the valve with the golden voice"—our S.T.63 (S.T.43 in the 4-volt class)—the prince of super-power valves, which in the last stage gives incomparable quality?

S.T. Ltd., 2, Melbourne Place, London, W.C.2.

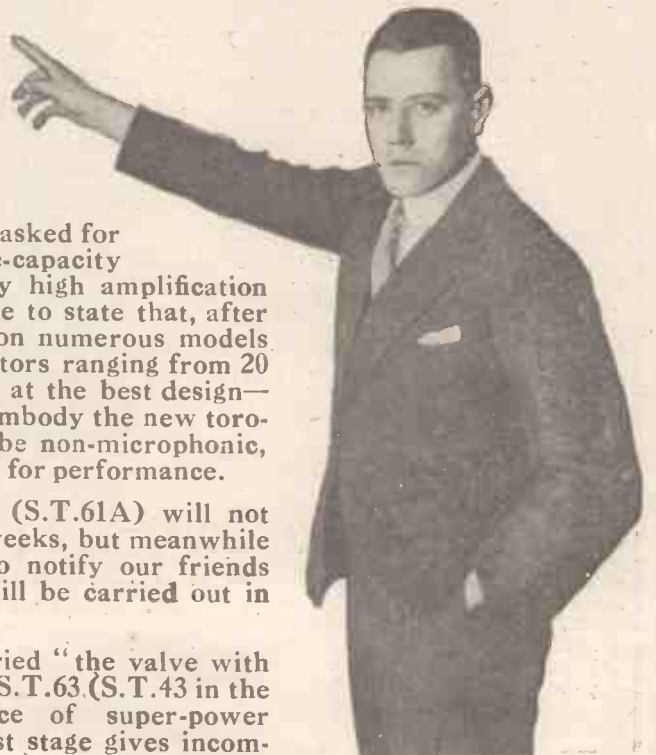



# RESOLUTION THE NEW YEAR - 1927

I will fit Bowyer-Lowe tested Radio Components in my next set because their inclusion will introduce to me a New Year in Radio Reception

LOWYER-LOWE

COMPONENTS

# Bowyer-Lowe

ARE NOT



EXPERIMENTAL

ANNOUNCEMENT BY THE BOWYER-LOWE CO LTD LETCHWORTH HERTS

### Guaranteed Results with Economy

FOUR STATIONS on your Loud Speaker obtainable on THE GUARANTEED "SERVICE" RECEIVER

### A TWO-VALVE LOUD SPEAKER SET

Absolutely complete. Valves, Coils, H.T. and L.T. Batteries, Aerial and Earth Equipment and Loud Speaker.

£13 CASH or a deposit of £2 12 0 (and balance monthly.)

For FREE Demonstration, Installation and Upkeep see our Catalogue. Also 3, and 4-valve receivers and components.

Send for our SPECIAL BARGAIN LIST OF COMPONENTS—FREE!

WIRELESS SPECIALISTS



"SERVICE—OUR NAME AND AIM"

Wireless Dept.:

273-274, HIGH HOLBORN, LONDON, W.C.1

## VALCO MAGIC!

### WILL MAKE YOUR REPAIRED VALVE AS GOOD AS NEW.

ALL TYPES OF VALVES REPAIRED AT HALF LIST PRICES (minimum charge 5/-).

Satisfaction Guaranteed or Money Refunded.

An unsolicited testimonial from one of our many satisfied users will appear each week.

GORLESTON-ON-SEA, 1/12/26.—Having received the valves quite safely, I find them to be equal to all that you advertise. I am sending seven more to be repaired.—F.P.W.

Weco, S.P.'s and low capacity types not repairable. Minimum D.E. current 0.15 amps when repaired.

Dept. "P.W.," TABOR GROVE, VALCO LTD., — WIMBLEDON, S.W.19. —

**HYDRA CONDENSERS**  
The finest Condensers money can buy. Specify "Hydra" and you take a big step towards better reception. Hydra Condensers operate up to 700 Volts D.C. without risk of break down or overheating. Obtainable in capacities: 00011-00117 mfd. 1/6 up to 10 mfd. 15/- on 500 volts D.C. Tested on 500 volts A.C. 2/- to 16/- from your dealer, or write direct to

**Louis Holzman**  
109, KINGSWAY LONDON W.C.2  
PHONE 1 HOLBORN 6202

**THE FINEST CONDENSER MONEY CAN BUY**

## "POPULAR WIRELESS" ADVERTISEMENT RATES

WHOLE PAGE £40 QUARTER PAGE £10  
HALF PAGE - £20 EIGHTH PAGE - £5

Narrow Column Advts. (3 columns to page) per inch 30/-  
Minimum Space accepted - - - - half inch 15/-

NO SERIES DISCOUNTS. ALL ADVERTISEMENT COPY SUBJECT TO EDITORIAL APPROVAL

COPY AND BLOCKS MUST BE IN HAND 11 DAYS BEFORE DATE OF ISSUE TO ENSURE PROOFS

ALL Communications respecting advertising must be made to

JOHN H. LILE LTD., 4, Ludgate Circus, London, E.C.4.

Phone: City 7261.

# RADIOTORIAL

All Editorial Communications to be addressed to The Editor POPULAR WIRELESS, The Fleetway House, Farringdon Street, London, E.C.4.

Editor:  
NORMAN EDWARDS, M.Inst.R.E., M.R.S.L.,  
F.R.G.S.

Technical Editor:  
G. V. DOWDING, Grad.I.E.E.

Assistant Technical Editors:  
K. D. ROGERS. P. R. BIRD.

Scientific Adviser:  
Sir OLIVER LODGE, F.R.S.

Staff Consultants:  
Dr. J. H. T. ROBERTS, F.Inst.P.; J. F. CORRIGAN, M.Sc., A.I.C.; C. E. FIELD, B.Sc.; E. J. SIMMONDS, M.I.R.E., F.R.S.A.

Foreign Correspondents:  
F. M. DELANO, Paris; Dr. ALFRED GRADENWITZ, Berlin; L. W. CORBETT, New York; P. F. MARTIN, Italy; W. PEETERS, Holland.

The Editor will be pleased to consider articles and photographs dealing with all subjects appertaining to wireless work. The Editor cannot accept responsibility for manuscripts and photos. Every care will be taken to return MSS. not accepted for publication. A stamped and addressed envelope must be sent with every article. All inquiries concerning advertising rates, etc., to be addressed to the Sole Agents, Messrs. John H. Lile, Ltd., 4, Ludgate Circus, London, E.C.4.

As much of the information given in the columns of this paper concerns the most recent developments in the Radio world, some of the arrangements and specialities described may be the subject of Letters Patent, and the amateur and the trader would be well advised to obtain permission of the patentees to use the patents before doing so.

Readers' letters dealing with patent questions, if sent to the Editor, will be forwarded to our own patent advisers, where every facility and help will be afforded to readers. The envelope should be clearly marked. "Patent Advice."

### TECHNICAL QUERIES.

Letters should be addressed to: Technical Query Dept., "Popular Wireless," The Fleetway House, Farringdon Street, London, E.C.4.

They should be written on one side of the paper only, and MUST be accompanied by a stamped addressed envelope.

Queries should be asked in the form of the numbered questions: (1), (2), (3), etc., but may be accompanied by a short letter giving any necessary additional particulars as briefly as possible.

For every question asked a fee of 6d. should be enclosed. A copy of the numbered questions should be kept, so that the replies may be given under the numbers. (It is not possible to reproduce the question in the answer.)

BACK OF PANEL DIAGRAMS can be specially drawn up to suit the requirements of individual readers at the following rates: Crystal Sets, 6d.;

One-Valve Sets, 6d.; One-Valve and Crystal (Reflex), 1s.; Two-Valve and Crystal (Reflex), 1s.; Two-Valve Sets, 1s.; Three-Valve Sets, 1s.; Three-Valve and Crystal (Reflex), 1s. 6d.; Four-Valve Sets, 1s. 6d.; Multi-Valve Sets (straight Circuits), 1s. 6d. Except SUPER-HETERODYNE DIAGRAMS, all of which, irrespective of number of Valves used, are 2s. 6d.

If a panel lay-out or list of point-to-point connections is required an additional fee of 1s. must be enclosed. Wiring diagrams of commercial apparatus, such as sets of any particular manufacture, etc., cannot be supplied. (Such particulars can only be obtained from the makers.) Readers may submit their own diagrams, etc., for correction or for criticism. The fee is 1s. per diagram, and these should be large, and as clear as possible.

No questions can be answered by 'phone. Remittances should be in the form of Postal Orders.

Details of the "P.W." BLUEPRINTS will be published fortnightly in the advertisement pages of "P.W."

## Questions and Answers

### BATTERIES OR ELIMINATORS?

B. S. P. (Bloomsbury, London, W.C.2).—I am designing a 6-valve set for use in a large institution, and I am uncertain what to do about battery eliminators. The set will be in use constantly whilst broadcasting is on, and there will be a heavy drain on the batteries. To obviate the expense and difficulty of frequent renewals and re-charging, I have been advised to work the set entirely from the electric light supply. But, on the other hand, friends who have tried this have experienced a loud humming interference, which spoils the programmes.

(Continued on page 1118.)

The children drink food in



# BOURNVILLE COCOA

It has delicious flavour too and is— food below pre-war price

'Keep fit on Cocoa'

See the name 'Cadbury' on every piece of chocolate

**SECTION**

This diagram is a magnified section of the Watmel windings. Spotted area—interwoven cotton. Striped area—enamel insulation. Black area—wire. Expensive new machines have been installed to wind the WATMEL Auto Choke this way.

**Watmel**

**AUTO-CHOKES**

18'6

THE WATMEL WIRELESS CO. LTD., 332a, Goswell Road, London, E.C.1. Telephone: Clrk 1011 7900. Lancs., Yorks., and Cheshire Representative—Mr. J. B. Levee, 23, Hartley Street, Levenshulme, Manchester. Telephone: 475 Heaton Moor.

**FORMO**

**A MONUMENT IN THE MARCH OF PROGRESS**

The Formo Shrouded Transformer is the universal favourite. Made in Ratios 1-1, 1-2, 1-3, 1-4 and 1-5

10/6 1-3 and 1-5 for 1st and 2nd stages

Send for Catalogue and Descriptive Literature of Complete Formo Range



**THE FORMO COMPANY**

Crown Works, Cricklewood, N.W.2

'Phone: Hampstead 1787.

Manchester: Mr. J. B. Levee, 23, Hartley St., Levenshulme.

'Phone: Heaton Moor 475.

<b>JACKS 4-POINT</b>  1-Hole Fixing <b>1/9</b>	<b>S.L.F. CONDENSER</b>  With 4-in. dia. <b>7/-</b> 0005 .. 7/3	<b>RELIABILITY CONDENSERS</b>  Mansbridge Mids. Type. <b>25, 1/6 1 ms., 2/6</b> 5, 1/9 2 ms., 3/6	<b>WIRELESS CABINETS</b> For Panels 7 in. high Width 8 in. Hinged Lid Oak 12 in. 17/-, 14 in., 17/6, 18 in. 18/6, Mahogany 1/- extra.  12-Contact <b>2/6</b>	<b>DEWAR SWITCH</b> 
---	---	---	--	--

**READ THIS LIST AND SAVE MONEY ON COMPONENTS**  
**EBONITE**.—Any size cut; Clayton brand, 1/2 in., id. sq. in.; 9 in. by 6, 2/2; 12 in. by 9, 4/6; 15 in. by 9, 5/6; 3/16 in. 25 per cent. less. Paragon and Radion, id. per sq. in.  
**CONDENSERS**.—Low Loss, Square Law, with knob and dial, '0005, 5/-; '0003, 4/6; with Vernier Blade, 1/- extra. Twin '0005, for Elstree Six, unequalled value, 5/6; Gylidon Twin for ditto, 2/6; Ormond, J.B. Utility, Sterling, Polar, Formo, Icaric, G.E.O., Var. in all capacities. Neutrodyne type, Ormond, 2/-; Colvern 3/6; Gambriel, 5/6.  
**FIXED CONDENSERS**.—Dublier, Edison Bell, Lissen, Watmel, Mullard, McMichael, at advertised prices. Special Reliability Fallon—'0003 mfd. 2 meg. Leak, 1/3; Cases only 1d.  
**INSULATORS**.—Large Shell, 3d.; Reel or Egg, id.; Climax, 6d.; Ditto, with shock absorbers, 3/- pr.; Gal. Pulleys, 4d.; 100 ft. Gal. Straining Wire, 1/6; Strainix Bolts, 6d.  
**BATTERIES**.—Reliability, 90 v., 11/-; 60 v., 7/6; 36 v., 4/6; 15 v., 1/10. Ever Ready, Siemens, Hellen, 100 v., 21/-; 66 v., 12/6; 36 v., 7/6; Flashlight Battery Cases for 19 Batts., 3/6; 41 v. Batts., 4d.; 60 v. Unequalled, 6/6; Wan. Plugs, 14d.; Clix Type, 2d.  
**ACCUMULATORS**.—Exide, D.T.G., 4/6; D.F.G., 8/6; W.J., 20 v., H.T. type, 15/-; Oldham H.T., 10d. per volt. complete; Duros, 20 v., 11/-; 10 v., 5/6; Repairing Outfit, 1/5.  
**L.F. TRANSFORMERS**.—R.I. Multi-Ratio, 25/-; Marconi Ideal, 25/-; Junior, 18/6; Ferranti A.F.3, 25/-; A.F.4, 17/6; Formo, 10/6; H.T.C. Empire, 7/6; Croix 5 to 1, 6/-; Lissen new type, 8/6; Icaric, 15/-; Eureka Concert Grand, 25/-; No. 2, 21/-; Baby Grand, 15/-; Ormond, 15/-; Royal, 20/-; Success, All Black, 21/-; Silvertown, 21/-; G.R.C., 15/-; Brandes, 17/6; Burndep, 16/6; Special Value, 7/6; Modulation, 7/6.  
**VALVES**.—"Radion" all types. Frelat 2 volt. 3 amp., 4/11. All advertised makes stocked.  
**VALVE HOLDERS**.—Anti-Phonic Benjamin, 2/9; Lotus, 2/3; with terminals, 2/6; Burn dept, 2/9; Harle, 1/6; Reliability, unequalled, 2/-; all baseboard types, ord. ditto. 6d.; N.P. Valve Sockets, dust fitting, 1d.; Superior Panel Type, 6d.; All Ebonite, 10d.;  
**HEADPHONES**.—B.T.H., 15/-; Brown "P" type, 20/-; Reliability, 7/6; Adjustable, 8/-; Dr. Nesper, 12/11; T.M.C., 17/6; Western Electric, 20/-; all 4,000 ohms; Sullivan, 120 ohm Double Ex-Govt., New, 4/-; 120 ohm Single Phone, 2/6 Long Phone Cord, 1/-;  
**AERIALS**.—100 ft. 1/4 in. copper tape, 1/6; 7/22's Bright, 2/3; Enamelled, 3/6; Electron, 1/8; Superal, 2/6; Mars, 9/8; Ashton Spreaders, 12/- per pair; O.V. complete, 2/6.  
**RECENT REDUCTIONS**.—Sterling '0005 Square Law Condensers with Vernier, 9/6; Geared 12/-; Miniloss, 15/-; '0025, 8/6; Geared, 10/6; Miniloss, 14/-; Marconi Automatic Detector, 2/6; Series Parallel Variometer, 10/6; Eddystone Absorbos Feet, set of 4, 2/3; Benjamin S.P. Switch, 1/3; N.P. Clix Plug & Insulator, 2d.; Adaptor, 14d.; Socket, 2d.  
**LATEST COMPONENTS**.—6-Way Coil Stand, 2/9; Colvern Low Loss Inductance Former, 5/-; Formo straight Line '0005 Condenser, 10/6; Success, 18/6; Eureka, 15/6; Gylidon, 15/6; Lissen 60 v. H.T. New Process Battery, 10/6; Valve Vibrating Springs, 6d. set of 4.  
**TERMINALS & ACCESSORIES**.—Single W. Office N.P. or Hol. Brass with nut and washer, 14d.; Phone and Castle type, 1d.; Double Mark, 3, 2d.; 4-way Phone Connector, 6d.; Pole-End ng paper, 3d.; Fluxite, 8d.; Black Tape, 6d. per coil; 1/4 in. Empire Tape, 6d. dozen yards; Insulating tube, 3d. yard; Glazite, 1/2, 10 ft. coil; shellac Varnish, 6d.; Mica 2 in. x 1 1/2 in. 4d. dozen; Chatterton's Compound, 9d.; Hand Drill, 3/6; Drill, 1/-.  
**EXPERIMENTERS' PARCELS**.—Accessories of Various Types, worth 20/-, post paid, 5/6.

Send for New RELIABILITY WIRELESS GUIDE No. 9. Free on Request. Trade Supplied.	 <b>J.H. TAYLOR &amp; Co.</b> 4. RADIO HOUSE. MACAULAY ST., HUDDERSFIELD. Tel. 541. Grams: "THOROUGH HUDDERSFIELD."	Orders 5/6 Value Carriage Paid. Under 5/6 2d. per lb. for Packing, etc.
---	--	---

# To All Listeners!



You know those delightful little yarns that

## A. J. ALAN

tells from 2 LO from time to time?

Mr. Alan has at last been persuaded to let his millions of admirers read him in print. These stories will appear exclusively in the LONDON MAGAZINE. The first of them, "My Adventure in Jermyn Street," appears in the issue on sale to-day. Other splendid features in this number of the LONDON include:—

How I Played "Beau Geste,"  
 by **RONALD COLMAN**  
 Speed, by **WOOLF BARNATO**

and other first-class fiction by

**SAX ROHMER**  
**DANA BURNET**  
**VALENTINE WILLIAMS**  
**VICTOR MACCLURE**

etc., etc.

Ask for the January

# LONDON MAGAZINE

Now on Sale. Buy a Copy TO-DAY!

## £5 for a Limerick

### CAN YOU BEAT THIS?

*There was a young man with a set,  
 Poor reception was all he could get,  
 So he re-did the wiring,  
 The result was inspiring,  
 Because he used "JUNIT"—you bet.*

—of course you can—

### BUT YOU CAN'T BEAT "JUNIT"

The Unique Self-Soldering Wire  
 (As used by Leading Radio Manufacturers.)

No. 17 S.W.G. } per coil 1/- Per 2 ft. 2D.  
 (Sq. section) in Carton 1/- straight length 2D.

If unobtainable from your dealer, send P.O. to us for Coils 1/- each, post free.

It's BRITISH throughout.

We are offering £5 for the best Limerick submitted before February 8th, 1927, each attempt to be written on a separate carton of the 1/- coils. Write name and address clearly.

Patentees and Manufacturers:  
**REXO ENG. CO., 2, Ravenscourt Sq., London, W.6**  
 Phone: Riverside 0274.

## RADIOTORIAL QUESTIONS AND ANSWERS

(Continued from page 1116.)

What is the position regarding battery eliminators? Are they really satisfactory, or not?

It is now pretty generally recognised that the elimination of the H.T. battery is a comparatively easy matter, and one which the average constructor can tackle with every confidence. Occasionally, noisy mains are encountered that need extra smoothing units, but generally speaking, the elimination of the H.T. battery can be quite successfully accomplished. The saving of expense for constant renewal of dry cells or dry batteries is very considerable, so this type of eliminator is recommended (either for D.C. or for A.C. mains.)

The elimination of the L.T. battery, by lighting the filaments direct from the mains, has been found to be "a horse of another colour." Very often a troublesome hum arises, that is most difficult to cure, and the cases in which a silent L.T. supply has been successfully obtained from the mains by a constructor who is not an electrician, must be few and far between.

However, the difficulty may be surmounted by taking a middle course—i.e. by using an accumulator to light the filaments, and then using the mains to re-charge the accumulator.

A comparatively small accumulator will give good service in such circumstances. It can be re-charged after broadcasting finishes, and if this is done regularly it will always be in good condition to light the filaments. We think that the solution to your problem lies along these lines—an H.T. battery eliminator, and the charging of the L.T. accumulator from the mains.

### REVERSED REACTION.

"ROMEO" (Whitechurch, Salop).—What is meant by "reversed reaction control"?

Sometimes the accidental couplings in a set cause it to oscillate continuously, without any necessity for a reaction coil. In such a case, if the reaction coil is connected the wrong way round (i.e. to oppose instead of to assist oscillation) it will tend to stabilise the set and stop the self-oscillation.

As might be supposed, such "control" is not to be recommended. Obviously, the set should be overhauled and the cause of the trouble remedied—rather than misuse reaction effects in this way, to overcome the fault.

### INTERFERENCE BY NEIGHBOUR'S SET.

P. L. (Broadway, Worcestershire).—My neighbour had a crystal set, and some months ago he complained that my 1-valver spoilt his reception, every time I switched on. As it was not oscillating I thought he was mistaken, but now I know better! He has lately got a 3-valve set in use, and it wipes out my programmes the minute his loud speaker starts! What can I do about that?

It is certainly no good trying to shout each other down! If you now get a 4-valver he may retaliate with 5, so it is better to "get together," and try to minimise the cause of the trouble.

Probably it is due to your aerials being too close together, so we should try the effect of varying the positions of these. If they are at present parallel, and at approximately the same height, try separating them as widely as possible, keeping one as high as possible at the house-end, and the other as high as possible at the far end.

If one is made to slope up and the other down you may effect a great improvement in both sets, even if narrow gardens compel the aerial to run more or less parallel with one another's length.

In bad cases of this kind it sometimes happens that the only way out to avoid mutual interference is for one set to use an indoor aerial, but frequently a little experimenting with the position of the outdoor aerials will work wonders.

### DUTY ON SETS SENT ABROAD.

B. D. (Boston, Lincs.).—What are the charges, for customs, etc., upon a wireless set with valves? I am sending one out to a friend in Hong Kong, and should like to pre-pay all the charges upon it.

The charge for sets sent abroad varies widely, according to the destination, type of set, etc.

If the set is small enough to go-by post you can probably obtain all the information you require at the post office, before despatch; but if it is too heavy a package for post you had better write for the information to the Secretary, H.M. Customs and Excise, Customs House, London, E.C.1.

### CHARGING FOR NOTHING.

I. R. J. (Seven Kings, Essex).—I wish to charge my small accumulator from the direct-current mains, using house-lighting lamps as a resistance.

If I break one of the constantly used lamp circuits and insert the accumulator in this circuit, keeping the lamp burning continuously, I get just about enough charging current to keep the accumulator in condition.

The extra cost seems to be very small, but I am told that if I put the accumulator in the main circuit, instead of in one branch, I could charge the accumulator absolutely free of cost. Is this correct?

By placing the accumulator in the main lead, all the lamps in use in the house would act as resistances (in parallel with each other and in series with the accumulator), and probably you would not need to burn a lamp specially in order to pass enough current to charge the accumulator.

In this way the charging of the accumulator would be "free of cost," because you would not be using any more current than if the accumulator were not in the circuit.

Actually, of course, the energy supplied to charge the accumulator would be paid for by you. But as it would be extracted from the ordinary lighting circuit, and used only when the lights were required for other purposes, its cost would not affect your electric-light bill. You would, however, pay for the charging, because whilst it was going on the lighting would be slightly dimmed, corresponding with the energy required to charge the accumulator.

### AVOIDING HAND CAPACITY.

"CONSTRUCTOR" (Oulton Broad, near Lowestoft).—I have built several sets of different kinds, mostly with one or more H.F. stages, and I am often up against the hand-capacity trouble.

Generally I can cure the effect by reversing leads to one of the tuning condensers, but this means altering the set after it has been made up. I am wondering if there is any rule I could follow in wiring up, so as to avoid the necessity of changing over after the set has been made?

Yes. A good rough-and-ready method of avoiding hand-capacity effects is to notice whether the various leads in the receiver, as they are being placed in position prior to soldering, are to be connected directly to earth, or are separated from earth by a tuned circuit.

(Continued on page 1120.)

**L** OUD SPEAKERS are legion, their sponsors have been apt to write abundantly of qualities supreme. So-called mellowness, sweetness, clarity, wonderful depth, fidelity, etc., etc., are insufficient to truly describe the reception experienced by users of the Claritone.

*It is sufficient for them to know that they can sit back and enjoy*

*Ashley Radio*

Ashley Wireless Telephone Co. (1925), Ltd., 17, Finch Place, Falkland Street, Liverpool.



# CLARITONE

LOUD SPEAKERS & HEAD PHONES

- W265 £5 00
  - W267 £2 15 0
  - W299 £12 10 0
  - W287 £4 10 0
  - W275 £6 00
  - W277 £4 00
- Described and illustrated in Booklet No. 71 obtainable from all dealers.*



Patented.

## The final Condenser

embodying new and vitally important improvements, and solving for ever the tuning evils of the past.

The J.B., S.L.F. spreads stations so evenly over the dial that all stations on all wavelengths can be quickly and easily tuned in or out, and accurately logged.

Ball bearings ensure a wonderfully smooth control, and the beautiful finish of the complete condenser forms a perfect parallel to its real efficiency in tuning.

**PRICES, Complete with 4-inch Bakelite Dial:**

The J.B., S.L.F.	The J.B. True Tuning S.L.F.
•0005 mid. 11/6.	•0005 mid. 16/6
•00035 mid. 10/8.	•00035 mid. 15/6
•00025 mid. 10/-.	•00025 mid. 15/-

The J.B. •0005 mid. Dual Gang Control Condenser, complete with 4-inch Bakelite Dial ... 33/-

# JACKSON BROS.

8, POLAND ST-OXFORD ST  
LONDON - W.1  
(First Floor)

Telephone -  
GERRARD 7414

# NO. 1 of a GREAT NEW WIRELESS JOURNAL



## HAS ELSTREE DIED?

YOU know what Elstree has done; how its sets have won championships and prizes at Amsterdam, New York, and Chicago. The Radio Press periodicals have now come under new proprietorship, but Elstree remains as it was. You can still read of its activities, because very shortly a new journal is being issued, entitled:

## The "Elstree Radio News"

¶ The Elstree Laboratories, with John Scott-Taggart, F. Inst. P., A.M.I.E.E., once more in charge, will publish star set designs and research articles. But you won't be able to buy the "Elstree News" on the bookstall. You can get free a full year's subscription to this magnificent new journal by simply buying an S.T. valve of any type and sending your name and address, together with the test certificate cut from the cardboard box in which every S.T. valve is packed. Send this coupon (or your name, etc., on a separate sheet) with the test certificate, carefully addressed to: "Elstree Radio News," c/o. S.T., Ltd., 2, Melbourn Place, London, W.C.2.

S.T., LTD.,  
2, MELBOURNE PLACE, LONDON, W.C.2.

Dear Sirs,—

Please put me down for a year's FREE subscription to "Elstree Radio News." I enclose test certificate cut from one of your valve boxes.

Name .....

Address .....

[Write in block capital letters.]

# ELIMINATE RADIO H.T. BATTERIES! USE THE A.C. MAINS



Absolutely silent in operation. Ample anode voltage and current. All component parts can be supplied separately if desired. The output is ample for even a large receiving set—20 milliamps. with a variable detector voltage and amplifier voltage of 160.

Price, complete in metal case with connecting plug **£7 : 15 : 0**

Ask for Leaflet 123A.



LONDON : 25, Victoria Street, S.W.1  
NEWCASTLE/TYNE : Tangent House,  
Blackett Street

**GENT & Co., Ltd.**  
FARADAY WORKS, LEICESTER.

## RADIOTORIAL QUESTIONS AND ANSWERS

(Continued from page 1118.)

In the former case, the wires may be brought near to the panel, and hand-capacity will not be found troublesome; but any lead which is separated from earth by an intervening tuned circuit is liable to give rise to hand-capacity effects, if it is brought too near to the tuning controls.

The reason for this, of course, is that the hand, or indeed any part of the body of the operator, is "earthed." And if brought near to that side of a tuned oscillatory circuit which is also earthed, there is little likelihood of disturbance of tuning, etc.

But, on the contrary, if the earthed hand of the operator is brought too near to any point in the circuit where the signal potential is varying with regard to earth, tuning is very liable to be upset by every movement of the hand.

For instance, in the case of the H.F. wiring in the 2-valve set shown in the accompanying diagram. One

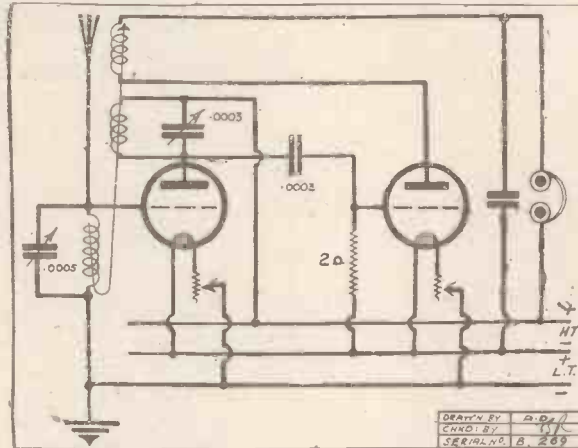

side of the aerial coil and condenser is connected directly to earth, and wires to these points could be brought near to the front of the panel with impunity. Hand-capacity would not affect these wires.

Similarly, the H.T. + side of the tuned anode coil and its condenser are connected to earth (via the H.T. battery), and hand-capacity is not likely to arise with these leads, either.

The aerial side of the aerial coil and condenser (e.g. the grid connection) has a tuned circuit between it and earth. Consequently if the hand is brought near to the grid wiring, hand-capacity effects are marked.

In the same way the plate lead from the first valve to the tuned anode and the grid connections to the second valve are separated from earth by the tuned anode circuit, so all this wiring is likely to give rise to hand capacity effects.

It should be noted that the steady potential of the H.T. battery wiring is relatively unimportant. What matters is not the voltage applied, but the difference in voltage that exists at any moment across the tuned circuits, due to the signal impulses flowing in the circuits.

### DAMPING RESISTANCE FOR H.F. AMPLIFIERS.

J. E. (Newry, Co. Down, Ireland).—What is meant by the expression "H.F. Damping Resistance," which I have seen used in the description of an American receiver in which I am interested?

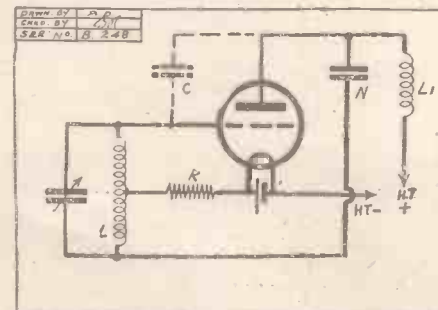

Probably the H.F. damping resistance in question is one which is inserted in the lead between the H.F. valve's filament and its grid input circuit (see diagram above). Such a resistance tends to suppress

undesirable capacity leakage, so increasing the efficiency of the H.F. amplifying stage.

In the diagram it will be seen that one half of the tapped input coil is connected to the plate of the valve via the usual electrodynamic condenser N. Between plate and grid is shown (dotted) a small condenser (c), which represents the inter-electrode capacity of the valve.

The resistance R is an H.F. damping resistance inserted in the common lead to filament, in order to stabilise the H.F. amplifier. (This subject was dealt with in "P.W." 229, under the heading "Parasitic Oscillations.")

### CAPACITY OF ANODE TUNING CONDENSER.

S. F. (Glasgow).—In the directions for a 2-valve (H.F. and Det.) set which I am building, the list of components gives the anode tuning condenser capacity as .00025. I have no condenser of this size, but I have a .0003 on hand. Will this do?

Yes. The small difference in capacity will make very little difference, especially if the number of turns on the anode coil is slightly reduced (five to ten turns) to correspond with the increase in capacity.

### FLAT TUNING.

S. M. P. (Southampton).—My 3-valve set, which has for over a year given excellent results, has lately developed flat tuning. The trouble began when I moved to a different house, so I think there must be something in the "local conditions" legend. Formerly I could cut out 6 B M fairly well, but now he is "all round the dial." What is likely to be causing this annoying fault?

The likeliest cause in your case is an inefficient aerial. Probably the set is still all right, but your former aerial was unscreened and your present one is not. Or else you have now made it too long—for selectivity the aerial, including the lead-in, should not be longer than 80 feet at the very most.

If the lead-in wire hugs the walls, or the earth-lead is too long, this may be the cause of your trouble. Keep the earth-wire as short as possible, and the lead-in as clear of all buildings, etc., as you can.

If your present aerial is low, or overshadowed by neighbouring buildings, trees, etc., the flat tuning should, to a great extent, be cured by raising it clear of the obstructions.

### CHEAP RESISTANCE FOR L.F. COUPLING.

"HARD-UP" (Farnham, Surrey).—If I get a .1 meg. grid leak instead of a 100,000 ohms anode resistance—in an attempt to economise—shall I be likely to get good results with it?

If the leak is a good one it will probably work quite well, though a wire-wound anode resistance is a far more robust component, and is not so liable to give rise to scratchy noises.

### CAPACITIES IN PARALLEL.

B. M. H. (Rotherham).—If I place one .0005 condenser in parallel with another of the same capacity, do I get in effect a .001? If so, can any condenser capacities be added together in this easy way?

Yes. The total value of condensers in parallel is simply the sum of the respective values—i.e. .0005 + .0005 + .001 = .002.

### TOO MUCH REACTION.

"CURIOUS" (Bristol).—Is it true that when a set has too much reaction it becomes a small transmitter? And if so, is it possible to use receiving valves to transmit telephony?

The answer is in the affirmative in both cases. You must remember, however, that when a set is oscillating (due to excessive reaction), and it is interfering with other people's programmes, you are liable to be proceeded against for causing such interference.

And it is illegal to attempt to transmit telephony without the P.M.G.'s licence for telephonic transmitting.

After such a licence had been obtained telephony transmission could be maintained with ordinary receiving valves, though the H.T. used is generally greatly in excess of that required for reception.

(Continued on next page.)

## RADIOTORIAL QUESTIONS AND ANSWERS

(Continued from previous page.)

### H.T. CURRENT FROM A.C. MAINS.

"BATTERY PROBLEM" (London, S.W.).—What are the connections for obtaining H.T. from the A.C. mains? I understand that with a suitable circuit it is possible to utilise old-fashioned bright-emitter valves, and that such a method is very efficient, and inexpensive to run.

The connections are as shown by the accompanying diagram.

At the top are the two leads to the mains, connected across the primary of a special type of transformer.

This has two secondary windings, both of which are tapped at the centre point, as shown, to give full wave rectification.

The secondary on the left has a comparatively low voltage induced across it, and its outer ends are connected so as to light the filaments of the two rectifying valves. (The rheostat regulates the filament current flowing in this circuit). Grid and plate of each rectifying valve are joined together, to form in effect a two-electrode valve. These are joined to opposite ends of the main secondary winding (H.T.), and the rectified high-tension output is taken from the tapped centres of the two secondaries.

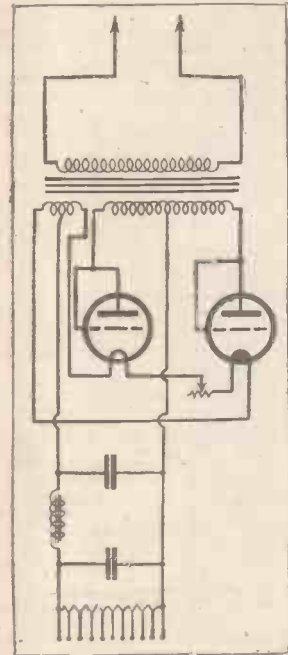

Two smoothing condensers (2 to 4 mfd. each) and a large choke, are connected to these leads for smoothing the H.T. current, and a tapped resistance joined across the smoothed output allows any desired H.T. voltage to be plugged to the set.

The method is generally very satisfactory, the H.T. supply being cheap, perfectly steady, and without any humming noises.

### FITTING SEPARATE H.T.

J. M. P. (Conventry).—In bringing my old set up to date, I wish to add extra terminals. The base-board is rather crowded and I do not wish to alter the panel face. What is the best alternative?

We should mount a short terminal strip on edge (as shown by the accompanying photograph). This takes up practically no base-board space and ensures that it



accidentally strained the new leads do not tug at the wiring.

### A CHEAP RADIO TEXTBOOK.

A. J. M. (London, W.).—Is there any cheap Government publication or book dealing with the technical aspects of wireless?

Yes. The "Admiralty Handbook for Wireless Telegraphists" is an excellent textbook, used as an instruction manual for naval W/T ratings.

It is obtainable from H.M. Stationery Office, Kingsway, London, W.C.2, price 5s.

# Announcing the COPLEX "POPULAR MODEL" COPPER COIL SCREEN AND BASE



Copper Screen and Interchangeable 6 pin base (Patent No. 259,459), Beautifully Finished,

# 9/6

As the originators and patentees of the Interchangeable Coil Screen, we have used our utmost endeavours to make the Copex Copper Coil Screens superior to all imitations now on the market. The salient features of these Screens are as follows:—

- (1) High-grade copper is used for the screen—other metals cannot give the same degree of efficiency.
- (2) Copex Screens are sprung on to the copper base and may be revolved on the base, thus giving perfect electrical and self-cleaning contact.
- (3) The novel arrangement of the terminals entirely prevents accidental 'shorting' when replacing the screen.
- (4) The lacquered finish of the screens prevent tarnishing.

The "De-Luxe" (original) model is still available at 15/-

### Copex O.C. Coils for the above

Copex "O.C."-type Screened Coils embody a special patented feature, which makes them far superior to other types of screened coils.

The chief advantages gained by the use of Copex "O.C." coils are:—

- (1) Oscillation is rendered perfectly under control.
- (2) Higher amplification is obtained.
- (3) All Copex Coils and Transformers are matched within one metre, this accuracy being attained by testing against Quartz-Oscillator.

Type	O.C.	250-550 M. Ordinary	1000-2000 Ordinary
Split Primary	—	—	—
Aerial Coil	—	6/-	6/-
SP type	10/6	10/-	10/-
SS type	10/6	10/-	14/-
Reinartz type coil	—	10/-	14/-

For the "King of the Air." A "Popular" Model, screen and base with a split primary may be used in place of the special HF transformer specified. Price complete 19/6

### Keystone Binocular Coils for the "King of the Air"

Made exactly to Mr. P. W. Harris's specification. Only the highest grade of wire is used and the former and base are cut from best quality ebonite. Stringently tested and guaranteed. Each turn of wire is air-spaced on the threaded formers. Special 5-pin base, 250-500 M, for above 2/-.

# 10/6

### Special Six-pin Base

To replace the more expensive standard screened coil base in sets where the actual screen is not required. Standard spacing with terminals arranged for easy accessibility.

# 2/9



### Keystone Neutralising and Balancing Condensers

For use in the "King of the Air" and many other popular circuits. Beautifully made and fully tested and guaranteed. Board Mounting 5/-; Panel Mounting 6/3; Balancing Condenser, equally well made, price 7/6.

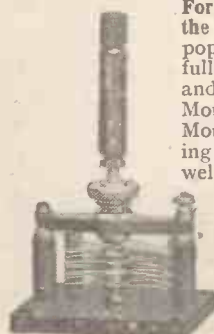

We can supply all the components and panels ready drilled for Mullard Receivers described in "Radio for the Million."

### Keystone Fixed Resistors

No. 4 for 25 amp. valves with 6-volt. accumulator. No. 17 for '06 amp. valves with 4-volt accumulator. Price 2/6



THE PILOT MANUAL contains illustrated details of a number of up-to-date sets which we thoroughly recommend. Much useful information on soldering, assembling, testing, etc., is also included. 6d. Post free . . .



### THE PILOT MANUAL

Branches—LONDON, 62, High Holborn, W.C.1. WALTHAMSTOW—230, Wood St. PLYMOUTH—4, Bank of England Place. LIVERPOOL—4, Manchester St.

PETO-SCOTT Co., Ltd.,  
77, City Rd., London, E.C.1



## With the "PEERLESS" Resicon Condenser

(Reg. Trade Mark 457357)

you can tune over a greater range with a given inductance than with many condensers having double the stated capacity. The plates of the "PEERLESS" RESICON CONDENSER are shaped to give uniform tuning over the whole scale in both aerial and anode circuits—the minimum capacity being very low. A precision instrument. Electrical loss exceedingly low. No side strains. Moving plates revolve freely and without backlash. For Super Heterodyne receivers the "PEERLESS" RESICON CONDENSER is ideal. Operates so finely that vernier is almost unnecessary. One 7/8 inch hole only needed for panel fitting.

Capacity.		
00025	Complete with Dial	15/-
	(With Dial and Vernier)	17 6
0003	Complete with Dial	16 6
	(With Dial and Vernier)	19/-
0005	Complete with Dial	18/-
	(With Dial and Vernier)	20 6



From all Dealers or direct from

**The Bedford Electrical & Radio Co Ltd**  
22, Campbell Road, Bedford

## THE B.B.C. DINNER. A JOLLY EVENING.

THE Prime Minister was the guest of honour at a dinner given at the Hotel Metropole on December 16th by Mr. J. C. W. Reith, managing director of the British Broadcasting Company, and members of the staff to mark the end of four years' effort under one constitution and the transfer to another. Mr. Reith, presided, and the company included present directors, members of the staff, and the governors-designate.

The menu (which had an "Eckersley" touch about it) was described as "First general food bulletin, S.B. to all centres (copyright reserved)," and contained such items as "Soup, headphone strength or loud-speaker strength," and "Fillets of sole monopoly à la P.M.G." It concluded with the words: "That concludes the food bulletin. Coffee will follow in a few moments, please."

In the course of his speech, Mr. Baldwin paid tribute to the work of the B.B.C. during the four years of its existence. It had established itself, he said, in the affections of the British people, and it had set a high standard which it would be the aim of the new directors to continue. Especially had it proved its worth, he said, during the General Strike, when the people realised that the company was keeping itself, as it always had done, free from personal bias and disseminating, as it always did, the bare, uncoloured truth and nothing more.

### Public Service.

In the course of a finely-delivered speech, Mr. Reith said that public dinners were among the exacting duties which modern civilisation seemed to require, and in due course a satisfactory substitute would doubtless be evolved. (Laughter.) He paid a warm tribute to the loyalty and enthusiasm of the staff, and thanked the retiring directors for their confidence and their generosity. Tracing the progress of broadcasting in the directions of education and entertainment, he said there was already a wireless installation in every second or third home. In their relations with the broadcasters of the Dominions and other countries they had endeavoured to encourage concerted action in the direction of world peace and understanding. If their policy succeeded, in due course the world's chief broadcast systems would be so inter-related that barriers of nationality, language, and geography would be overcome, and the human family be conscious of its essential unity.

"We have tried to found a tradition of public service," he said, "and to dedicate the service of broadcasting to the service of humanity in its fullest sense. We venture to believe that a new national asset has been created. That is one reason why, with every respect to his exalted office, we invited the Prime Minister to our gathering to-night; but apart from that, the function would have been incomplete without him, and we take his presence as a high honour, not merely because he is Prime Minister, but because he is himself." (Cheers.)

(Continued on next page.)

Put on a little—  
**FLUSOLDA** (Resd.)  
(Patent Applied For)  
—and Heat it— That's All

**The Secret  
of Simple Soldering**

One clean handy fluid—no tinning, no flux—now enables expert or novice to handle any soldering job with complete confidence.

'Flusolda' has made soldering simple at last. Just apply "Flusolda" and then apply heat and a perfect joint: must result.

In tins at 1/3 from Wireless Dealers and Ironmongers.

Trade Enquiries to the Sole Manufacturers—  
**THE TRANSPORT SUPPLY CO., LTD., WARRINGTON.**  
Telephone: Warrington 459.  
(S.A.S.)

**2-VALVE AMPLIFIER, 35'**  
1 Valve Amplifier, 20/-, as new; Valves, 0 E. -06, 7/-; Headphones, 8/6 pair; new 4-Volt Accumulators, 13/-; new 60-Volt H.T., guaranteed, 7/-; 2-Valve All-Station Set, £4. Approval willingly. Write for free bargain list.  
**P. Taylor, 57, Studley Rd., Stockwell, London.**

**EVERY LOUDSPEAKER  
DESERVES  
MULLARD  
MASTER  
VALVES**

— Ask for —  
**Mullard P. M. Power Valves.**

**RADIO REGISTERED PANELS**

<p>Inches</p> <p>7 x 5 1/2</p> <p>7 x 6 1/3</p> <p>8 x 6 1/4</p> <p>10 x 8 2/1</p> <p>10 x 9 2/4</p> <p>12 x 10 3/4</p> <p>14 x 12 4/8</p>	<p>Inches</p> <p>6 x 6 1/2</p> <p>8 x 5 1/2</p> <p>9 x 6 1/7</p> <p>11 x 8 2/3</p> <p>12 x 8 2/6</p> <p>12 x 9 2/10</p> <p>14 x 10 3/5</p> <p>3/4 in. thick Post Free.</p>
--	--

**CROXSONIA TRADE MARK**

Money back guarantee that each and all Panels are free from surface leakage. Megger test Infinity. Callers cut any size. Quotations by post, or phone Clerkenwell 7853. Samples and prices post free to the Trade.

**CROXSONIA CO., 10, South St., MOORGATE, E.C.2**

**ACCUMULATORS  
ON EASY PAYMENTS**

High-Tension Accumulators built up from 20-volt sections (15/- each) Example: 60-Volt H.T. £51/- CASH or 12/6 DOWN and 6 monthly payments of 6/-. Carriage Paid. Satisfaction or money back. Write for Lists to DEPT. 11, COVENTRY DIRECT SUPPLIES LTD., 23 Warwick Row, COVENTRY. Any Wireless Goods supplied on easy payments.



## THE B.B.C. DINNER.

(Continued from previous page.)

The health of the Prime Minister and Mrs. Baldwin was drunk with great enthusiasm.

### Fewer Restrictions.

Mr. Reith proposed the toast of "The Old Board and the New Board," Sir William Bull and the Earl of Clarendon responding. The Earl of Clarendon (the chairman designate of the new B.B.C.) drew an analogy between the old and the new Corporations. "It seems to me," he said, "that I might refer to the old Corporation as sunset going down with the red glory of past achievements. In so far as the new Corporation is concerned, I venture to hope that we, like the sun, may rise in the morning in a dawn of promise. We are fully aware of the great responsibilities which rest upon our shoulders. I am sure I can say that we have taken the words of the Prime Minister to heart to-night—I refer to the phrase which he used when he said that he hoped the new board would seek to be animated by the spirit of the old, and would go on as it has begun, from strength to strength. I personally have a good many views as to the future. I am sure my colleagues have as many. But I think that this is not an occasion on which to enlarge upon that subject."

Lord Riddell, Mr. Walter Payne, the Bishop of Southwark, Senatore Marconi, and Sir Hugh Allen also replied.

The Postmaster-General, responding, paid a tribute to the organising ability of Mr. Reith and the technical skill of Captain Eckersley. "To the new corporation and their members," he continued, "I should like to say that the Prime Minister and I are both confident that we shall have a jolly good all-round team, with a diversity of interest in special subjects and a common breadth of view. I see the new service sometimes alluded to in the Press as Government broadcasting, which is a complete and absolute illusion, and if I can do anything to dispel it I am glad to do it. So far from the new corporation being more bound by the executive, it will be more free; so far from it being fettered by the Legislature, it will be more independent—apart from the restrictions which for the present we impose upon broadcasting of editorial and the broadcasting of controversial matter of particular types—but the conduct of the business, the technical arrangements, the make-up of the programme, will be in the discretion of the governors of the new corporation, and that discretion I promise you I will uphold and maintain."

Lord Gainford proposed the health of the chairman.

### Among the Guests.

Amongst those who accepted invitations were: Sir Hugh Allen, Mr. Charles G. Ammon, M.P., Mrs. Baldwin, Major Basil Binyon, Air-Commodore L. F. Blandy, Mr. William Boosey, Sir Harry Brittain, M.P., Mr. T. J. Brown, Sir William Bull, M.P., Sir Henry Bunbury, Mr. W. W. Burnham, the Earl and Countess of Clarendon, Mr. Alfred Clark, Mr. S. Carey Clements, Mr. Charles B. Cochran, Mr. R. A. Dalzell, Mr. J. C. C. Davidson, the Earl of Drogheda, Sir Frank Watson Dyson, Sir Laming

(Continued on next page.)

# GAXTON WIRELESS CABINETS

All Polished with new enamel that gives a glass hard surface that cannot be soiled or scratched. Ebonite or Radion Panels Supplied and Perfectly Fitted at low extra cost. SENT FREE.—Catalogue of Standard Wireless Cabinets in various sizes and woods.

## THOUSANDS OF SATISFIED CUSTOMERS.

**ELSTREE SOLODYNE.** Panel 21" x 7" fitted 16" Baseboard, drop down Beaded Front Door. Fumed Oak 61/-, Dark Oak 65/-, Mahogany polished 68/6. Raised Panel 5/- extra. Packing Case 5/- extra.

**ELSTREE SIX.** Panel 42" x 9" fitted 13 1/2" Baseboard. Open Type. Fumed or Dark Oak 80/-. Mahogany polished 90/-. Packing Case 7/6 extra.

**MONODIAL.** Panel 14" x 7" fitted 14" Baseboard. Fumed Oak 33/6, Dark Oak 35/-, Mahogany polished 39/6. Packing Case 6/- extra.

**NIGHT HAWK.** Panel 16" x 8" fitted 14" Baseboard. Open Type. Fumed Oak 33/6, Dark Oak 35/-, Mahogany polished 39/6. Packing Case 7/- extra.

**FIVE FIFTEEN.** Panel 24" x 7" fitted 8 3/4" Baseboard two Front Doors. Fumed Oak 40/-, Dark Oak 42/6, Mahogany polished 48/-. Packing Case 7/6 extra.

**THE 1927 FIVE.** Panel 27 1/2" x 7" Sloping Front, as originally described. Fumed or Dark Oak 38/-, Mahogany polished 48/-. Packing Case 7/6 extra.

**EVERYMAN THREE.** Panel 20" x 8" fitted 8" Baseboard. Fumed Oak 33/6, Dark Oak 35/-, Mahogany polished 39/6. Packing Case 6/- extra.

**EVERYMAN FOUR.** Panel 26" x 8" fitted 8" Baseboard. Fumed Oak 35/6, Dark Oak 37/6, Mahogany polished 41/6. Packing Case 7/- extra.

CASH WITH ORDER. CARRIAGE PAID U.K. PROMPT DELIVERY.

Packing Case Money repaid if Case returned within 14 days Carriage paid to Works.

## GAXTON WOOD TURNERY CO., MARKET HARBOROUGH

### SOMETHING UnUsUal.

When you require Special Apparatus, Transmitting, Receiving or Recording, Precision, Instruments, etc.,

"THOSE HARD-TO-GET THINGS,"

write or call on us.

We stock the famous DIX-ONEMETERS.

Send ad. stamps for our 1,000 Bargains Catalogue.

ELECTRADIX RADIOS

218, UPPER THAMES STREET, LONDON, E.C.4.

**THE FINEST VALVE CONTROL**  
Can be assured by using only the



### NEW TCB GUARANTEED RESISTANCE

(PATENT NO. 225,132)

Perfect contact; smooth and dead silent in operation; perfect insulation; positive stops for "Off" and "Full On" positions; a travel from "Off" to "On" in two turns of the knob; easy to fit; occupies minimum panel space (illustration is three-fifths actual size).

Every one carries our written guarantee to replace free if the slightest defect be found within three months from date of purchase.

Resistance 6, 13, or 30 ohms - - - 2s. 6d.  
Resistance 50 ohms - - - 3s. 0d.  
Potentiometer 300 ohms - - - 3s. 6d.

BRITISH THROUGHOUT.

Of all dealers or direct, post free, from the sole manufacturers. If ordering direct, state whether one or two hole fixing is desired.

Send postcard for descriptive folder.

**Wavio Ltd**

DEPT. P., QUEEN STREET, HITCHIN.

**ALL APPLICATIONS FOR ADVERTISING SPACE IN "POPULAR WIRELESS" MUST BE MADE TO THE SOLE ADVERTISING AGENTS JOHN H. LILE, LTD., 4, LUDGATECIRCUS, LONDON, E.C.4.**

**WET H.T. BATTERIES**  
BUY BRITISH. Complete Units 3/6 per doz. All goods BRITISH MADE BY BRITISH LABOUR. Jars 1/3, Zincs 1/-. Sacs 1/6 per doz. Carriage and Packing extra. Trade inquiries invited.—Demion Battery Co., 59, Baddis Rd., Walthamstow, E.17

### EBONITE BUSHES

FOR MOUNTING ON WOOD

Orders under 1/- send 1/4 postage.

NUMBER 0 1 2 3 4 5 6

Hole in Bush. 6BA, 4BA, 2BA, 1/4" 5/16" 3/8" 7/16"

Price each: 1d. 1d. 1d. 1 1/4d. 2d. 2d. 2d.

DAREX RADIO CO.,

Waldram Road, Forest Hill, London, S.E.23

TRADE SUPPLIED

### LIFE LONG H.T.

Tromba units are constructed of the finest quality sacs, zincs, jars, etc., and creeping of the electrolyte and other troubles usual to Leclanche cells eliminated. In units of any size battery to order in Mahogany Case with glass cover Amalgamated zincs 6d. doz. extra. Sample unit and sample large capacity Sac., post free 1/-.

Send to-day for free descriptive folder, etc.

TROMBA ELECTRICAL CO. 17 WHITE HART LANE, TOTTERHAM, N.17.

OF ALL DEALERS OR DIRECT 6 MONTH

ALL MANUFACTURERS' GOODS ADVERTISED IN THIS PAPER

Can be obtained C.O.D. or Cash with Order, per return, from

**YOUNG'S (GLASGOW) LIMITED,**  
40, STOCKWELL STREET, GLASGOW.  
Write To-day for Big Free Catalogue.

### BUILD A LOUDSPEAKER

WITH OUR NEW SEAMLESS MOULDED CONE

(Prov. Patent 25069/26.) and a BROWN A. or LISSENOLA. You will obtain PERFECT RESULTS. Successful Construction for a minimum outlay is ensured with our Specialities. Illustrated Lists and full particulars for Stamp.

GOODMAN'S, 27, FARRINGTON ST., E.C.4.

Britain's Best **RADIO** in Radio

**LAMPLUGH**  
PRODUCTS

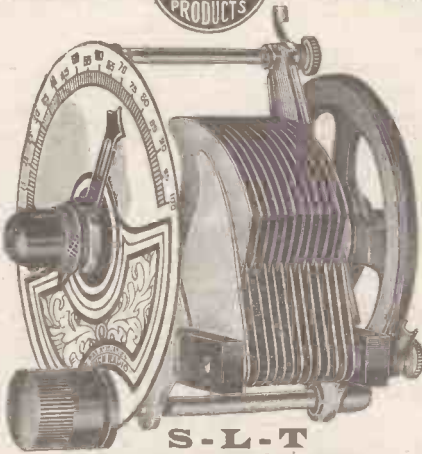

**S-L-T**  
**STRAIGHT LINE TUNING**  
**CONDENSERS**

separate stations on all wavelengths. Lowest minimum capacity and the most positive slow-motion control.

Prices:—'0005 13/- '0003 12/6 '0002 12/-  
Gang of Three '0005 50/-

**S. A. LAMPLUGH LTD.**  
King's Road, Tyseley, BIRMINGHAM.

Our high-grade components are obtainable from all first-class Radio Dealers.

**TRANSFORMERS REWOUND**  
Transformers, Phones, Loudspeakers, Rewound and Repaired to Maximum Efficiency. All One Price 4/- each. Don't discard if burnt out. All work guaranteed for 12 months. Write for trade terms. TRANSFORM CO. 115 LINKS RD. TOTTING, LONDON, S.W.17

**The High Tension System of the Future**  
**WET H.T. BATTERIES**



Due to the silent background and great economy of working, WET H.T. Batteries have almost everything to recommend them. They offer all the advantages of an H.T. accumulator, with none of the disadvantages such as the inconvenience of charging and the liability to sulphate if left run down. The cost is less than 3d. a volt, and up-keep 1ld. per volt per annum. Send 1ld. for full details. Jars 2 1/2" high, 1 1/2" dia., waxed.....dozen 1/3  
Sac Elements..... " 1/6  
Zincs..... " 1/-  
Carriage Extra.

**WET H.T. BATTERY CO., 23, Coldharbour Lane, Camberwell Green, S.E.5. Phone: Brixton 2539.**

**REPAIRS**

Headphones and loudspeakers rewound and remagnetized, H.F. and L.F. Transformers rewound and repaired **EQUAL TO NEW** by skilled mechanics on the latest automatic coil winding machines.

From 2/6

**B. KIMBER, ALLEN & COY.,**  
39, Bargery Rd., Catford, London, S.E.6.  
TRADE ENQUIRIES SOLICITED.

**A HOME FOR YOUR WIRELESS SET**

**OUR STANDARD CABINETS**

are **DUSTPROOF** and house the whole apparatus, leaving no parts to be interfered with. All you do is **UNLOCK & TUNE IN**. Made on mass production lines, hence the low price. Provision is made to take panels from 16 x 7 up to 30 x 13 in.



Carriage paid and packed free England and Wales. Thousands supplied with full satisfaction.

**MAKERIMPORT Co.**

From 24 18 0  
Write to-day for descriptive pamphlet and suggestions for adapting your receiver or panel to our Standard Cabinets. Immediate Delivery.  
Dept. 5, Melville Chambers, 50a, Lord St., LIVERPOOL.

**THE B.B.C. DINNER.**

(Continued from previous page.)

Worthington-Evans, M.P., the Rev. Archibald Fleming, Dr. J. A. Fleming, Mr. T. W. Fletcher, Mr. W. S. Forbes, Sir Johnston Forbes-Robertson, Captain Ian Fraser, Lord and Lady Gainford, Mr. Frank Gaylor, Mr. R. H. Gillespie, Mr. W. Grierson, Sir Edmund Gosse, Sir Benjamin S. Gott, Miss Beatrice Harrison, Mr. F. Hope-Jones, Brig.-General Sir W. T. F. Horwood.

Sir Edward M. Hiffe, M.P., Prof. A. Lloyd James, Mr. J. Hugh Jones, Sir Roderick Jones, Right Hon. F. G. Kellaway, Mr. Wilfred King, Sir Oliver Lodge, Mr. John B. McEwen, Mr. A. McKinstry, Senatore Guglielmo Marconi, Lady Isabel Margesson, Sir William Mitchell-Thompson, M.P., Sir Evelyn Murray, Mr. S. R. Mullard, Sir John Gordon Nairne, Sir George Newman, Sir Frank H. Newnes, Mr. O. W. Nicholson, M.P., the Rev. Thomas Nightingale, Sir James G. Owen, Mr. Walter Payne, Mr. H. M. Pease, Mr. Frank Phillips, Mr. F. W. Phillips, Colonel T. F. Purves, Mrs. J. C. W. Reith, Dr. Montague John Riddell, Lord Riddell, Mr. H. C. Robbins, Sir Landon Ronald, Captain H. J. Round, Mr. Norman Edwards, Mr. Hugh Pocock, Mr. Bernard E. Jones.

Mr. E. H. Shaughnessy, Mr. W. Lints Smith, Lieut.-Colonel Adrian Simpson, Dr. George G. Simpson, the Right Hon. Philip Snowden, M.P., Colonel J. A. C. Somerville, Captain J. F. Somerville, the Bishop of Southwark, Mr. J. C. Squire, the Hon. Sir Arthur Stanley, Mr. Louis Sterling, Major-General Sir Frederick Sykes, Dame Meriel Talbot, Mr. A. H. Thring, Lady Tree, Lieut.-Colonel Sir Ronald Waterhouse, Mr. R. J. Webber, and the Dean of Westminster.

**MODERN WIRELESS**

The January issue of "Modern Wireless" will be on sale on Saturday, January the First.

It will contain full constructional details of four first class receivers.

- The "European" Five.
- The "Bulldog" Four.
- The "Tranode" Two.

(This set embodies a novel, wonderfully efficient method of H.F. intervalve coupling and is a remarkably inexpensive D.X. receiver.)

The Beginner's Crystal Set.  
Among the many other informative and interesting articles in this issue are the following:—

- Curious Crystal Circuits.  
By J. F. Corrigan, M.Sc., A.I.C.
- Those "Super Power" Valves.  
By G. P. Kendall, B.Sc.
- Radio Misfits.  
By G. V. Dowding, Grad., I.E.E.

Radio Notes and News of the Month, Off the Beaten Track, My Broadcasting Diary, World Radio, In Passing, Questions Answered, are regular features in "Modern Wireless." **Order Your Copy Now.**

**SUPREME**  
in the  
**TWO VOLT**  
class

H.F. ST.21(0-1A)-14/-  
L.F. ST.22(0-1A)-14/-  
POWER ST.23(0-15A)-18/6

**POINT ONES WHICH GIVE THE HIGHEST EFFICIENCY ON THE LOWEST H.T. (60 VOLTS AMPLE)**

**BUILT LIKE THE PYRAMIDS—TO LAST**

**WIRELESS.**—Capable, trustworthy men with spare time who wish to substantially increase income, required where we are not fully represented. Applicants must have practical knowledge of installation of Set and Aerial, be a householder or live with parents, and be able to give references: state age and experience. Address: Dept. 10, General Radio Company, Limited, Radio House, Regent Street, London, W.1.

**EASY PAYMENTS**

Finest 2-valve amplifier set, including loud speaker, 120 H.T., D.E. valves, £7 10s.; or 18/9 down and 11' instalments of 15/-.

**CASH BARGAINS.**

Amplifiers, 17/6 and 21/-; Phones, Telefunken type, 7/9; Fr. T. Houston, 11/-; Good H.T., 60v., 5/9; Best 60v., 6/9; or 41v. (laboratory test), 4/-; doz. Famous Metal Valves (French), 2v., 2/5/-; 2v., 06, 8/9; 2v., 5/-; Power, 8/9; 4v., 06, 5/6; Straight line Condensers, 5/9; Ditto, 4" dial, 7/3; Transformers, Habana, 3/6; Radiolya, 3/8; Fr. T. Houston, 8/3; Brunet, 2/9. Also Ferranti Eureka, Forno, etc. Postage extra. Everything in Wireless reliable and cheap. Satisfaction or cash refunded.—Music Roll & Gramophone Records Exchange, 29, High St., Clapham, London, S.W.4.

**Trelleborgs**  
GENUINE EBONITE  
Experts choose it - it's Choice

STOCKED BY ALL THE BEST DEALERS  
TRELLEBORGS EBONITE WORKS Ltd. Audrey House, E.C.1.

**HEADPHONES REPAIRED**

Re-wound and re-magnetised 5/- per pair. Loud Speakers repaired 5/- Transformers re-wound 5/- each. All work guaranteed and tested before delivery. Write for Trade Prices. Phone: Clerk 1795. MASON & CO., 44, East Road, City Road, N.1.

PLEASE be sure to mention "POPULAR WIRELESS" when communicating with Advertisers. THANKS!

**JARS ZINGS SACS**

Waxed, Special, High Capacity,  
1/6 DOZ. 1/- DOZ. 1/6 DOZ.

For making Wet H.T. Batteries, post free on 3 doz. and over. Packed in special carton with division for each cell. This can be used as a container for the battery when made up. Send 6d. for sample complete unit, particulars and instructions. Build a Loud Speaker of the latest type with the Seamless Moulded Cone for the most perfect reception. Easily assembled. All the necessary parts stocked. Call, inspect and hear.

**SPENCER'S STORES, LTD.**  
14-5 Mason's Avenue (Clerkenwell Street), London, E.C.2.  
Phone: London Wall 2292. (Nr. Bank.)

**1/9 DONT PAY MORE AERMONIC**  
VALVE HOLDER  
Anti-capacity. Anti-phonio.  
Don't pay more than 1/9.  
If hard to get, drop us a line.  
James Christie & Sons, Ltd.,  
24 West Street, Sheffield.  
London Agents: A. R. B. HAIN & Co.,  
10, Curstow St., London, E.C.4.

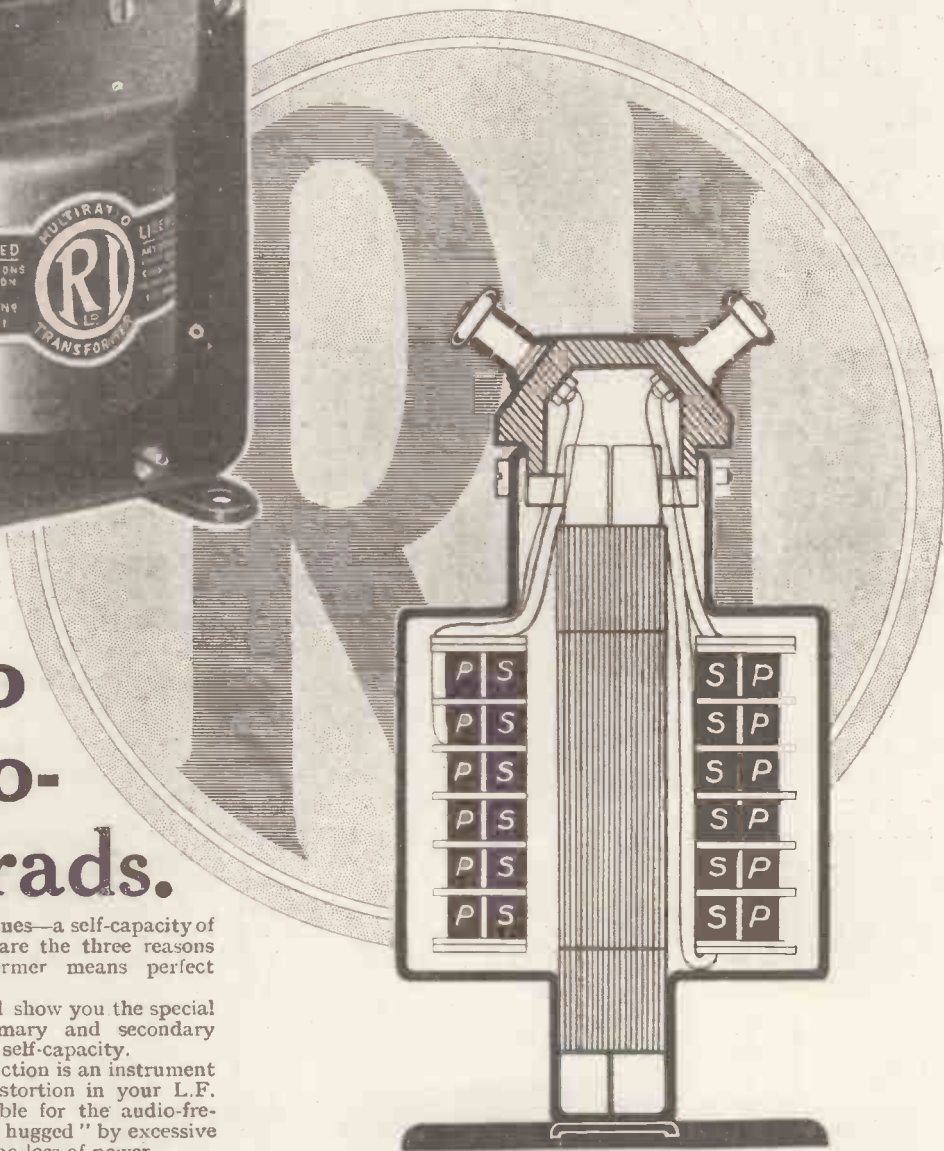

# Down to 18 Micro- Microfarads.

Seven ratios—three impedance values—a self-capacity of only 18 micro-microfarads—these are the three reasons why the R.I. Multi-Ratio Transformer means perfect audio-frequency amplification.

A glance at the diagram here will show you the special method of sectionalising the primary and secondary windings to give this amazingly low self-capacity.

The result of this unique construction is an instrument that minimises the likelihood of distortion in your L.F. stages, for a free passage is available for the audio-frequencies which are not choked or "hugged" by excessive self-capacity. In addition there is no loss of power.

It is only by using a transformer with a range of ratios and impedance values allowing of its use in any circuit and with any valve, plus a minimum self-capacity, that you can hope to obtain the kind of reproduction which will please you.

Fit the R.I. Multi-Ratio Transformer to your set to-day and notice how immediately the reproduction reaches so closely the distinction and quality of tone of the original.

**Price 25/-**

*Write for the R.I. Catalogue.*

**THE MARK OF BETTER RADIO**



*Advt. R.I. Ltd., 12, Hyde St., New Oxford St., London, W.C.1.*

# FREE



Perfect Radio —  
Mullard brings it home to you

## 4 PERFECT CIRCUITS AND 4 BLUE PRINTS

Every wireless amateur will welcome this great opportunity to build quickly and at little expense up-to-date receivers in keeping with the new high standard of modern valve design, made possible by the Mullard P.M. Series of Radio Valves with the wonderful P.M. Filament.

"Give us master circuits for your P.M. master valves," has been the demand from thousands of P.M. Valve users.

Here is your chance. Get this free book, "Radio for the Million." Gives you new radio outlook and endeavours for 1927.

The chapter "The Choice of a Receiver," alone, is a gold mine of lucid information.

Get your copy at once and make your existing components, with a few extras, bring greater zest to your radio pleasure.

Fill in the coupon to-day.

# Mullard

## THE • MASTER • VALVE

THE VALVE WITH A PUBLISHED  
NATIONAL PHYSICAL  
LABORATORY TEST

The  
Mullard Wireless  
Service Co., Ltd.  
Mullard House, Denmark St.  
London, W.C.2

Please let me have, free and at once, a  
copy of "Radio for the Million," price 1/-,  
either direct or through my nearest radio dealer.

(Your Name) M.....  
Address.....

P.W.

ADVT. THE MULLARD WIRELESS SERVICE CO., LTD., MULLARD HOUSE, DENMARK STREET, LONDON, W.C.2.

Printed and published every Thursday by the Proprietors, The Amalgamated Press (1922) Ltd., The Fleetway House, Farringdon Street, London, E.C.4. Advertisement Offices, Messrs. J. H. Lile, Ltd., 4, Ludgate Circus, London, E.C.4. Registered as a newspaper and for transmission by Canadian Magazine Post. Subscription rate: Inland, 17/4 per annum, 8/8 for six months; Abroad, 17/6 per annum, 9/9 for six months. Sole agents for South Africa: Central News Agency, Ltd.; Sole agents for Australia and New Zealand: Messrs. Gordon & Gotch, Ltd.; and for Canada: The Imperial News Co. (Canada) Ltd. Saturday, Jan. 1st, 1927. R/B

JOHN SCOTT-TAGGART WRITES IN THIS ISSUE

7

# Popular Wireless

Every Thursday  
PRICE  
3d.

No. 240. Vol. X.

INCORPORATING "WIRELESS"

January 8th, 1927.

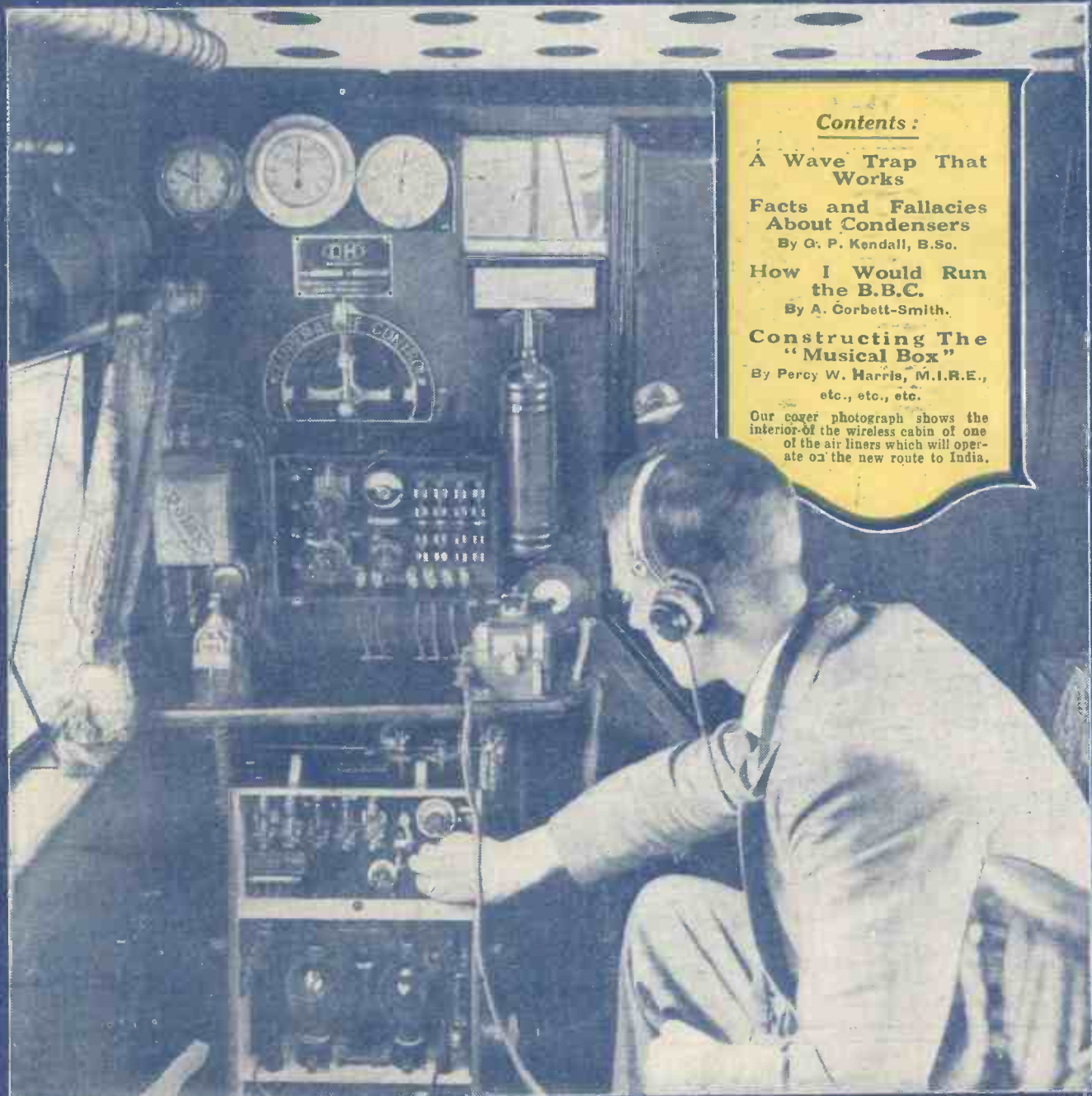

**Contents:**

**A Wave Trap That Works**

**Facts and Fallacies About Condensers**  
By G. P. Kendall, B.Sc.

**How I Would Run the B.B.C.**  
By A. Corbett-Smith.

**Constructing The "Musical Box"**  
By Percy W. Harris, M.I.R.E., etc., etc., etc.

Our cover photograph shows the interior of the wireless cabin of one of the air liners which will operate on the new route to India.

# MARCONI

## NEW 2-VOLT POWER VALVE

TYPE

D.E.P. 215



A POWER amplifying valve for final stages of low frequency work, for use also as a detector with a grid leak and condenser, with 40 volts High Tension. The filament is robust and rigid, with

a great emission surface. The grid is unusually large. Type D.E.P.215 gives a distinctly better volume and a rounder, fuller tone than any other 2-volt power valve.

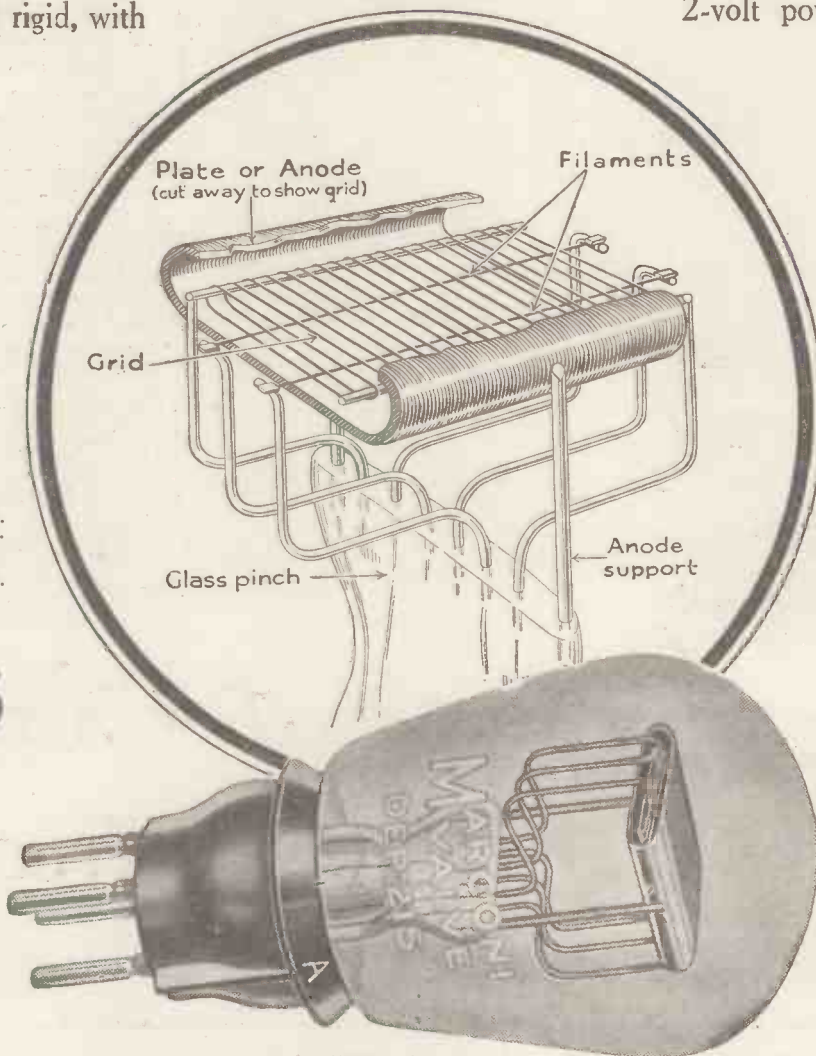

Fil. volts—2.0 max.  
 Fil. current—  
 0.15 amps.  
 Anode volts—120 max.  
 Amp. factor—6.25  
 Impedance—  
 6,250 ohms.

PRICE  
**18/6**

Write for Marconi  
 Valve Literature for  
 full particulars con-  
 cerning the D.E.P.215  
 and other types to—

THE  
 MARCONI PHONE  
 Co., Ltd.,

Regd. Office:  
 Marconi House,  
 Strand, W.C.2.

Head Office:  
 210-212, Tottenham  
 Court Road, W.1.

# The Right Thing in the Right Place

**Y**OU would not take your umbrella to bed—it would be out of place.

In other cases it may not be so obvious. Take radio valves, for instance. There are over 100 different makes—a thousand different varieties—each with a filament, a grid, and an anode. And there is the new AMPLION Valve. The right place for this is in your receiver—that is to say, if you desire

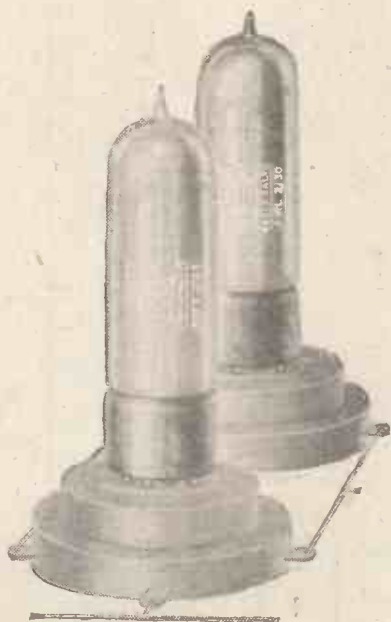

*Better Radio  
Reproduction*

## A Real "Distance Getter"



*The  
European  
Five*

This really efficient receiver, designed by Stanley G. Rattee, M.I.R.E., is fully described and illustrated in the January issue of MODERN WIRELESS (now on sale, 1/-). The home constructor will find "The European Five" quite easy to build with the aid of the diagrams and concise directions given.

Other special features include:—"The Tranode Two," by K. D. Rogers, which describes for the first time a novel two-valver which is sure to become very popular; "Curious Crystal Circuits," by J. F. Corrigan, M.Sc., A.I.C.; and many other articles by well-known radio experts which will appeal to all classes of amateurs.

An announcement is made also concerning a new Queries Service for readers, with a special offer of assistance to inventors by the journal's new Scientific Adviser, Dr. J. H. T. Roberts.

Be sure you ask for

# MODERN WIRELESS

Edited by NORMAN EDWARDS, M.I.R.E., M.R.S.I., F.R.G.S.

Monthly at all Newsagents, etc.

1/-





# Are you making the famous R.C. Threesome?

TO get the wonderful results obtained with the original R.C. Threesome Set, you should use identical components.

The Coil Holder used is a "Lotus" Left-Hand Two-Way Coil Holder; the three Valve Holders are "Lotus" Buoyancy Valve Holders, with Terminals.

Wireless experts decided that these were best for a very important experiment; that they would get most out of the set on which depended the very high reputation of the famous Ediswan Valves.

They were not disappointed. YOU will be more than pleased with the R.C. Threesome's performance if you fit "Lotus" Valve Holders and Coil Holder.

*From all Radio Dealers*

## LOTUS COMPONENTS

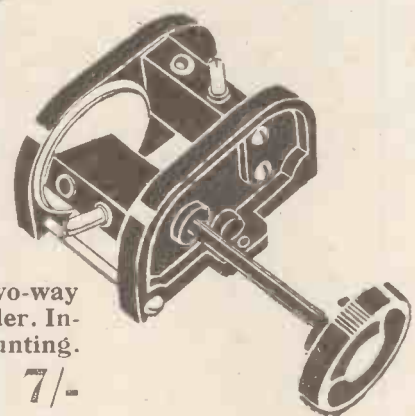

Lotus Two-way Coil Holder. Inside mounting. Left-hand. 7/-  
Patent No. 244251.

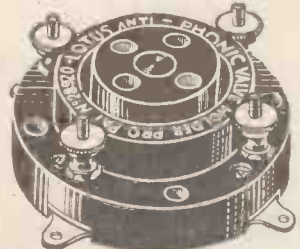

Lotus Buoyancy Valve Holder with Terminals. 2/6  
Patent No. 256833.

PLAYER'S "MEDIUM" NAVY CUT CIGARETTES WITH OR WITHOUT CORK TIPS

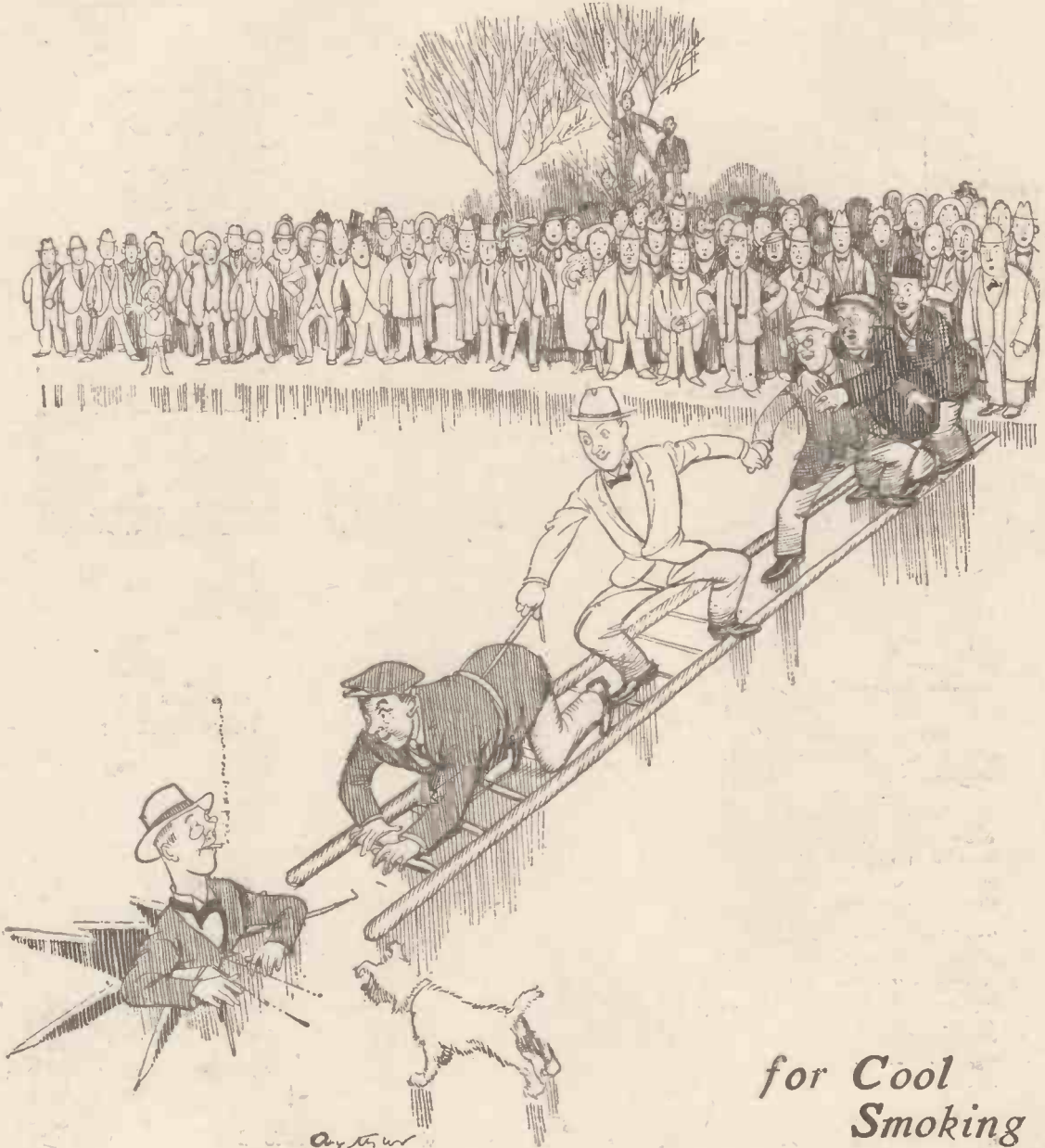

Arthur  
Watts  
26

for Cool  
Smoking



REGD. BY 14902B

PLAYER'S  
Navy Cut  
CIGARETTES

10 for 6d. 20 for 11½d.

50 for 2/5 100 for 4/8



THE  
"UNIVANE"

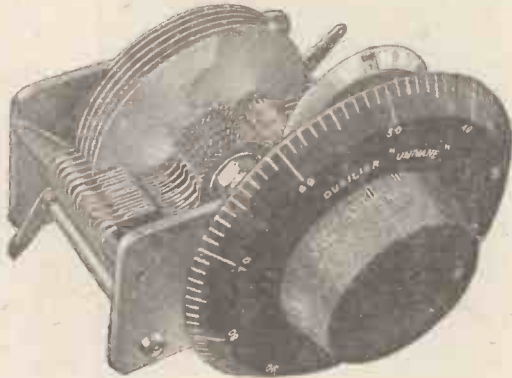

Over 4,600 degrees  
of Vernier Tuning!

The "Univane" gives the equivalent of a continuous Vernier adjustment between minimum capacity and 0.0005 mfd. Rotation of the scale moves one vane at a time, adding it to or subtracting it from those already in opposition.

This enables you to pick up station after station with the greatest accuracy, and the figures on the small dial can be noted to form a permanent log of all stations heard.

The "Univane" is intended for use on every occasion where the ordinary variable condenser is now employed. It is in no sense a condenser for special circuits, and in these days of ultra fine tuning it is a necessity whether you "search the ether" or merely listen to your local station.

It is backed by the full Dubilier guarantee and is further described in our new Catalogue. May we send you a copy?

Price, of all dealers

25/-



ADVT. OF THE DUBILIER CONDENSER CO. (1925) LTD.  
DUCCON WORKS, VICTORIA ROAD, N. ACTON, W.3  
TELEPHONE: CHISWICK 2241-2-3. E.P.S. 259

Now your

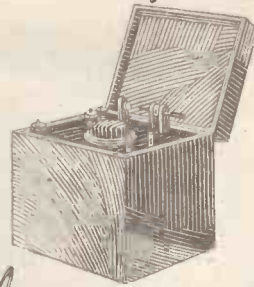

by means of  
the



will work a



without the aid  
of

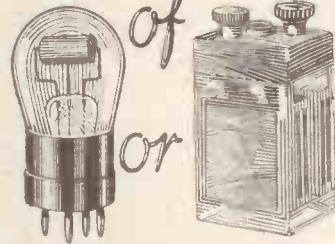

**Brown**

CRYSTAL AMPLIFIER

Price: £4 : 4s.

S. G. BROWN, LTD., Western Ave., N. Acton, W.3

Retail Showrooms: 19, Mortimer Street, W.1. 15, Mootfields, Liverpool; 67, High Street, Southampton. Wholesale Depots: 2, Lansdown Place West, Bath; 120, Wellington Street, Glasgow; 57, Godwin Street, Bradford; Cross House, Westgate Road, Newcastle; Howard S. Cooke & Co., 59, Caroline St., Birmingham; Robert Garmany, Union Chambers, 1, Union Street, Belfast, N. Ireland.



## His clutching, thieving fingers cannot harm this new Cossor Kalenised filament—

**N**ORMALLY the filament of a valve is a slender thread of metal subjected to intense heat. From the time the first valve was made, heat—in the form of an electric current—has been required to produce the necessary electron emission from the filament.

But Heat—although a good servant—is a bad master. His thieving fingers have robbed every filament of many hours of useful life. Through excessive heat metal becomes crystallised. When in this brittle state it is susceptible to the slightest knock. Even expansion and contraction under tension is sufficient to cause a fracture. That is why the ordinary valve has only a comparatively short life.

Now at last Heat has met his match. His services have been dispensed with. The new Cossor Kalenised filament

emits a torrent of electrons practically without heat. The familiar glow is entirely absent. Experts agree that the Kalenised filament is one of the greatest fundamental improvements in wireless.

Even after prolonged use the Cossor Kalenised filament never becomes brittle—it is still pliable. Whilst the electron stream emitted is hundreds of times greater than that to be obtained from an ordinary filament. Obviously the greater the emission, the more efficient the valve and no other valve equals in intensity the emission given off by the Cossor Kalenised Filament. That is why Cossor Valves are setting entirely new standards for volume, for purity and for extreme sensitivity to weak signals.

Let your next valve be a Cossor, therefore, and enjoy anew the pleasures of Radio freed from the continual expense of valve replacement.

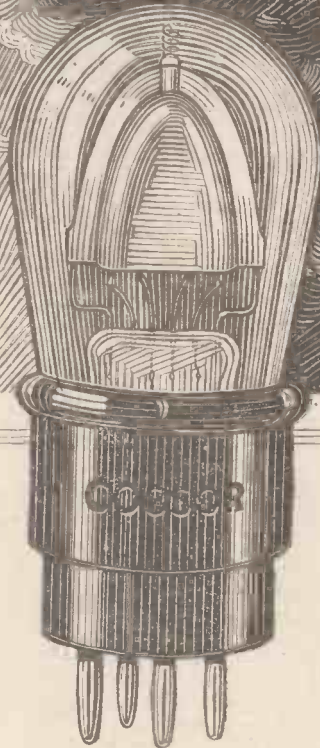

### Cossor 4-volt Power Valve now available

THE new Stentor Four power valve is now available. Co-axial Mounting (exclusive to Cossor) ensures life-long uniformity. Even under the hardest blow it is absolutely impossible for the elements to move independently—they are securely anchored to each other in permanent alignment. The Kalenised filament ensures a terrific electron stream, which in turn means the greatest possible volume with a remarkable purity and freedom from background noises. Filament voltage 3·8 volts. Consumption '1 amp. Impedance 5000 ohms. Amplification Factor 3. **18/6**

### Cossor Point One (2 volts)

210 H (Red Band) H.F. Amplifier. **14/-**  
Consumption '1 amp.

210 D (Black Band) Detector Valve. Consumption '1 amp. **14/-**

215 P (Stentor Two) Power Valve Consumption '1·5 amp. **18/6**

# Cossor —the Valve which serves you longest

# Popular Wireless

Scientific Adviser:  
 Sir OLIVER LODGE, F.R.S.  
 Technical Editor:  
 G. V. DOWDING,  
 Grad. I.E.E.  
 Assistant Technical  
 Editors:  
 K. D. ROGERS  
 P. R. BIRD  
 G. P. KENDALL, B.Sc.



incorporating "Wireless."

Consultants  
 Dr. J. H. T. ROBERTS,  
 F. Inst.P.  
 J. F. CORRIGAN, M.Sc.,  
 A.I.C.  
 C. E. FIELD, B.Sc.,  
 E. J. SIMMONDS,  
 M.I.R.E., F.R.S.A.

Editor: NORMAN EDWARDS, M.Inst.R.E., M.R.S.L., F.R.G.S.

## RADIO NOTES AND NEWS.

Bomb-Dropping by Valve Makers—The Invisible Searchlight—Have You Heard These? A New Telephone Development—Power by Wireless—This Crystal Affair—A Miss-Timed Hurricane—Dame Madge Kendal's Programme.

### The Slacker.

**G**REAT Scott! Here's a whole week of the New Year flown and I have no notes ready on the subject of portable sets for Easter or how to fit the latest type of small car to a super-het receiver as a useful adjunct.

### 'Ear, 'ear!

**W**RITING thus of the modern tendency to make the radio set as much an intimate as the watch and fountain-pen, reminds me that a doctor recently stirred me from my usual calm by saying that the listening-in habit is tending to enlarge the human ear. Well, I expect you will renew your licences in spite of this. By the time we have to cut notches in our collars in order to accommodate our side-receivers perhaps the last-mentioned will have developed a high-frequency sense and all we shall have to do will be to stand at right angles to the transmitting beam and tune in by *thinking* of the wave-length.

### Bomb-dropping by Valve Makers.

**T**HE other day a member of the "P.W." staff was privileged to witness what is the most extraordinary valve-testing display I have heard of. It was nothing less than bomb-dropping practice with Cossor valves for bombs, though the objects of this display of "hate" were not civilians but the valves themselves.

### The Test Magnificent.

**A** DOZEN "Stentor 2" Cossor Valves enclosed in their usual containers were taken aloft from Stag Lane 'drome in a machine piloted by Captain Barnard, and from a height of about 600 feet were dropped, one by one, indiscriminately overboard. One fell on the roof of a hangar and bounced like a tennis ball, while another made contact with a concreted

road. They were all retrieved except one and subjected to examination.

### The Result Stupendous.

**O**NE was found to be broken. One or two had their electrodes bent or displaced, but this was found to be remediable by shaking or knocking the valves. *All ten filaments were intact*, and all ten valves when connected in circuit worked exceedingly well. I think the makers have demonstrated the excellence of the construction of their products. It remains only for some other firm to agitate a valve in a cocktail-shaker and then try it with a steam-roller!

### The Invisible Searchlight.

**O**H, dearie me! What things they do think of nowadays! Mr. Baird, the scientist who is going to give us the home cinema-de-luxe and enable us to see Captain

noiseless guns and shells, odourless gas and invisible, noiseless aircraft? Let's all naturalise in Andorra, eh?

### Air Force DX.

**I** READ in an Australian paper that at Point Cooke, Melbourne, the Royal Australian Air Force has a transmitter and receiver fitted in a roofed aeroplane case, which has been in daily communication with our own R.A.F. Good for the Diggers! Looks to me as though a few "fans" have joined up. The job has their mark on it, right enough.

### Have You Heard These?

**T**HIS Week's Aristocrat. The man who wrote to the B.B.C. saying that he only listened in to the Saturday night time-signal and would be glad if he could have his private announcer for the occasion.

**This Week's DX Champion.** The man who picked up Grease on his crystal.

**This Week's Careful Body.** The man who wrote to the electric light company to ask whether he could have dull-emitter lamps fitted in his house.

### A New Telephone Development.

**T**HE German railway authorities have introduced what I believe is quite a novel idea. (Correct me if I am wrong, please.) On the Berlin-Hamburg section it is now possible for a passenger in a moving train to communicate by means of a combination of wireless and wire telephony with any subscriber to the ordinary wire telephone system, and *vice versa*. I understand that the wireless part of the process is for bridging the gap between the train and the lineside wires, which act as a receiving aerial. The Berlin-Halle-Munich section is now being similarly

(Continued on next page.)

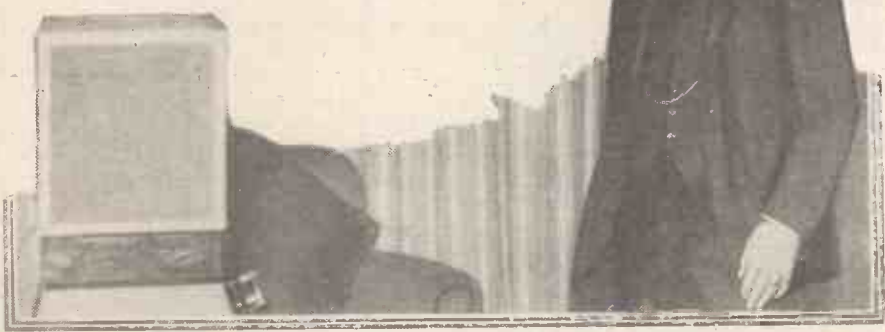

Mr. Ramsay MacDonald, M.P., delivering his recent broadcast talk, describing his holiday in Northern Africa.

Eckersley smoking his pipe while he tells us not to oscillate but use the Lodge "N" circuit, has produced an invisible ray as a sort of an afterthought.

Rather funny, isn't it, that a man who has spent years in dogged research, trying to make things visible, should suddenly bring into prominence something invisible? Invisible light is, as you know, no new discovery, but I cannot recollect any previous suggestion to put these *infra red* waves to a practical use. Will the next war see the Baird searchlight used in connection with

## NOTES AND NEWS.

(Continued from previous page.)

equipped. I hazard the prophecy that it will be long before we get the system over here.

### Power by Wireless.

**SENATORE MARCONI** thinks there is a possibility of conveying power by the wireless "beam" system and draws an admittedly imaginative picture of motor transport gliding along in the path of the beneficent power-rays, like a string of cats on the sunny side of a wall. Ripping! And if a "Busby Seven" or a "Midget Five" went wrong and got melted up like a bit of fuse wire? And if the transmitting aerial blew down on Derby Day? Wouldn't everybody beam then?

### Society Gossip.

**THE** "Charleston" doesn't come into this; it's about a couple of go-ahead wireless societies whose membership can still accommodate some more enthusiasts. First, The Croydon Wireless and Physical Society (Hon. Sec., Mr. H. T. P. Gee, 51-52, Chancery Lane, W.C.2) reports a very successful year, has instruction classes in Morse, "practical" evenings, and visits to interesting establishments. The North London Experimental Radio Society (Hon. Sec., Mr. Wilfred Parker-Ayrès, 61, Carey Street, Lincoln's Inn, W.C.2) will take your subscription, welcome your presence and give you of its best. The hon. secs. of both these societies are denizens of those parts where lawyers most do congregate. A healthy sign, no nonsense, and brisk proceedings!

### B.B.C. Time Signals.

**THE** Executive Council of the Scottish Association of Watchmakers and Jewellers has written to the B.B.C. deploring the fact that the B.B.C. has decided to discontinue superimposing the "six dot" time signal.

### Leningrad Radio.

**LENINGRAD'S** broadcasting station is to be increased in power from 18 kw. to 50 kw., about twice the power of Daventry. I anticipate that my knights will give me news of this. The song of the Volga Boatmen will be heard in the land, "straight from the cow," so to speak.

### New Invention.

**A** FRENCH engineer has devised an earphone which grips the cartilage of the ear and holds it against the telephone. I thank you very much. How is the gardener's wife and the pen of my grandfather's pupil? Who wants to listen-in to a rat-trap?

### The Prize Winners Respond.

**THE** Editor has shown me the letters received from the prize-winners in our last competition, and wishes me to express the pleasure he and his technical staff have derived from those missives, which amply repays the work they expended. The competition has revealed what a high standard of excellence obtains amongst "home constructors" generally, and the task of judging was on this account rendered the more difficult.

### This Crystal Affair.

**IT'S** a thousand pities a crystal hasn't got three electrodes, for then we might devise a reflex circuit for it and work

a loud speaker. Happy thought! Why not invent a three-electrode valve with a bulb made of carborundum, and use the thing in a three-stage reflex set? All this arises from the correspondence hurled at me by the knights of the cat's-whisker, who refuse to be superannuated.

### More Feats.

**HERE** is Mr. T. J. Wadlow, of Shropshire. That provocative "Times" article, to which I referred some weeks ago, so roused the fighting blood that, regardless of consequences, he seized the Shropshire Lad's set—his son's—and raised Cain and six stations in two minutes. He has heard Aberdeen. There is no other aerial within three-quarters of a mile. Whilst I fear that Aberdeen will send him a bill for this, I cannot refrain from making it public. Good! The plot thickens.

A Southampton reader records that he has "picked up" Glasgow—wow!—and Frankfurt. (What is there about Frankfurt?) Also École Supérieure and Petit-Parisien.

Well, there is something to all these results, and I suggest that it would be interesting to know what can be done with one valve.

### A "Knight" of Norway.

**MR. J. H. LUDURGSUR**, Prinsensgate, 8, Larvik, Norway, writes to say that he has succeeded in receiving Daventry on a crystal detector; but there is a drop of gall in his sweet cup—he observes a difficulty in obtaining com-

## SHORT WAVES

There was a man of Camps Bay,  
Who said to his pal, "By the way,  
I'll make you a bet,  
You sit by your set,  
And make it squeak hard, night and day."  
"But look here, my friend, Mr. Gay,  
You're not going to have your own way;  
I've made a great vow  
To stop your fine row  
If I sit here till Michaelmas Day!"  
"S.A. Wireless Weekly."

A Thames bargee is reported to have a vocabulary of only about 300 words. It has been suggested that he should take up golf, or perhaps install a wireless set.

"Broadcasting is improving the national musical taste," says an admirer. "I heard a milkman whistling Bach recently."  
A sort of can-tata, perhaps.—"The Star."

Armchair Worship. Church or Wireless? Why ether?—"Caterham Weekly Press."

Small Boy (listening in): "Father, I've got Hong-kong!"  
Father: "Oh, I expect it's only a motor-car in the street outside."—"Punch."

Of the 9,000 people in possession of wireless sets at J— only 50,000 odd have paid their licence fees.—Foreign Paper.  
Very odd.

A writer suggests that broadcasting will eventually lead to English being accepted as the international tongue. Not, however, without strenuous opposition on behalf of America.—"Eve."

It has been said that broadcasting has a tendency to kill new songs before they are really born. Another factor in favour of broadcasting.

To be pitied—The wireless enthusiast who decorated his aerial with mistletoe and then complained that his set was oscillating.—"Sunday Pictorial."

Loving Wife: "I know you'd like something for your wireless for your birthday, John. What do you say if I buy you a new earth?"

ponents, especially coils. I imagine that Britain, on seeing this note, will attend to the hardy Norseman's requirements at once.

### The Champion.

**I** WAS pleased to see the manner in which Earl Russell threw down the glove in the House of Lords on Dec. 16th last year, in the discussion of the new B.B.C. Certainly none of the surplus derived from licence fees should be engulfed by the Chancellor of the Exchequer, à la Road Fund. Our Winston is, I doubt not, an assiduous steward, but broadcasting ought not at present to be placed on a par with telegrams and postage stamps. When the fee is half a crown per annum and everything in the programme garden is lovely, and when we have a daily alternative programme, perhaps something can be spared.

Earl Russell indicated that the B.B.C. directors' fees were not over generous, and here I do not follow him, for it seems to me that the directors should be remunerated on the scale of the directors of a public company, the salaries being drawn by those of the management who work "whole time."

### Waves Do Not Travel.

**EXTENSIVE** reading of the Press, especially of the notes about wireless, has revealed that there are multitudinous references to the "travelling" of waves. Now, as a matter of fact, may I remind us all that waves do not travel. One uses the phrase as a matter of convenience in writing, and there is perhaps a tendency to overlook the fact that not all "listeners" are versed in physics. It were a pity that the idea should be literally interpreted. I read in a report of a lecture delivered at Hoxton Library that sound waves travel through the ether much more rapidly than through air. Sound waves do not travel at all, and certainly are not propagated in the ether. Nor do ether waves or water waves travel. A wave, in any medium whatever, is created in a given locality and is reproduced and re-reproduced outwards at a certain velocity; in other words, a wave never leaves its birth-place, but exists and dies there. Forgive this sermon and forget it if you like.

### A Mis-timed Hurricane.

**A** BIT of hard luck for the newly-opened Portuguese wireless system. It opened on Dec. 15th, with a through service from England to Lisbon, and thence to Madeira and the Azores. On the next day the mast of the Madeira station was one of the victims of the unprecedented hurricane which swept Madeira, causing loss of life and property. Strangely enough wireless kept the island in communication with the rest of the world, for although the cables went down hopelessly an emergency wireless service was maintained.

### Dame Madge Kendal's Programme.

**ON** Jan. 12th this remarkable lady's selection will be broadcast. It will be interesting to compare it with those of Mr. George Grossmith and others. What's the betting on "Allan Water" and "Just a Song at Twilight"? And very nice, too.

ARIEL.

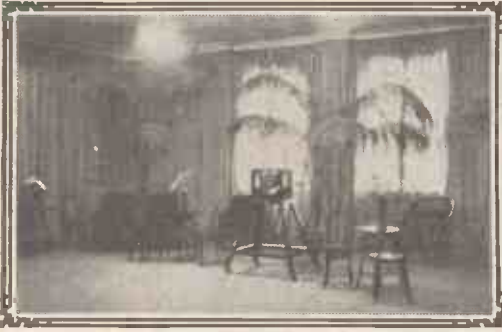

# "How I Would Run the B.B.C."

By A. CORBETT-SMITH.

**B**UT really, my dear Editor, I have never once dreamed of doing such a thing! ("Run" the B.B.C., I mean.) You want a man totally devoid of imagination for that job. Some cheery, stolid individual who, like our Stock Exchange friends, takes every Friday to Tuesday off to play golf, and lunches heavily between whiles. Any queer, temperamental person like myself would be so appalled at the immensity of the task that he would worry himself into Hanwell within a week.

No. My line is just the popular entertainment side. Nothing else. You understand that? "Artistic direction" is what we call it in our more dignified moments. And if I am an artist I cannot describe that work; I can only do it. But just in case the new Board should be struck by any fleeting suggestions of mine as to think of offering me the post, to avoid any misunderstanding I had better state my terms right away. For my price has gone up a good deal since 1924. Besides, it is another of my "queer" ideas that the men who do the work should be paid rather more than those who merely take the credit. And what are a few thousands more or less to the milch-cow of State?

"To Start With—"

So, my lord-president, I must request a completely free hand within the policy laid down. I shall want a three years' agreement, without renewal, at £10,000 a year, free of income tax. And since I shall have to spend the little of life then remaining to me in recuperation upon an island in the Pacific, I shall want a pension of, say, £1,500 a year? Agreed? Very well, then. On to the barricades!

To start with, it is not a bad idea to have a definite plan of campaign and steadily to build towards the end desired. Daily improvisation will not go far. Lord Kitchener, you will remember, took some ten years to build his victory of Omdurman. We must decide what we are out to do. Popular fireside entertainment, the best of its kind in the world, and planned to meet any emergency? Good! But we must not attempt to compete with existing forms of entertainment. We are something rather above and beyond those, are we not? Co-operation with them, by all means. Back them up. But we have such mighty opportunities of getting direct at the great heart of the people and of influencing them for good, that it would be sheer prostitution not to use those chances to the full.

Ah, I thought that you would be with me. "But," say you, "how are we to put over that 'big idea,' so that folk will listen to it? They loathe the least hint of any education."

## THE REASON FOR THIS ARTICLE.

In a recent article we published a notice of a booklet by Mr. A. Corbett Smith, who at one time was station director at Cardiff, entitled "Our Radio Programmes—What is Wrong, and Why." The review was not a favourable one; in short, we rebuked the author for his remarks concerning certain B.B.C. officials and their work, and suggested that it would have been better if he had never written the book at all. In the course of certain correspondence which resulted, between the Author and the Editor of "Popular Wireless," the latter invited Mr. Corbett-Smith to reply to the Query "How Would YOU Run the B.B.C.?" The invitation was accepted; the article was written—and here it is, published in "P.W." We ourselves make no comment—but invite our readers to express their views on the ideas contained in Mr. Corbett-Smith's article—The Editor.

Why, my dear sir, have you not thought that every single thing in the world that has beauty and humanity is, by that fact, "education"? A help to the formation of character. What an educationist was



Mr. A. Corbett-Smith.

Marie Lloyd! And Albert Chevalier! There is no shadow of a dividing line between radio work for children or schools in the afternoon and grown-ups at night. Given the knowledge, inventiveness and imagination and you may interest and amuse all alike.

Who are the "best sellers" in Britain to-day in home and school?—Rudyard

Kipling and Charles Dickens. Two mighty entertainers. Has Kipling ever written a story or poem which is not "education"? I do not know it. And Dickens, the greatest popular educator we have ever had, won hands down with the great masses because he spoke not for the people but with the voice of the people.

There, then, is your answer. And since I am involved in this, may I give just one personal example to back it up? Ten years ago I wrote a book solely to "educate" boys and girls in one particular phase of the Great War. Being a novelty form of entertainment it was refused by fifteen publishers. (The old story.) The book has now run through some thirty editions, and only last week (as I write) 10,000 copies of it were sold within six days. Ten years later. And a war book! You have only to apply that same principle to every phase of radio entertainment and success is yours.

"Of Course, It Is Difficult."

How do we set about it? Of course, it is difficult. There is nothing in the world more delicate and difficult than catering in entertainment for the general public. Not in giving them what they want, but in making them want what you want them to want. And when you add in the "big idea," and the very peculiar and restricted radio medium upon which we have to rely, the task becomes a very serious one.

Well, I have another "queer" prejudice in favour of selecting for any particular job the man or woman who, by inclination, experience and training, is best fitted for that job. Further, having satisfied myself that he is the right man, I have another odd method of leaving him alone to "carry on" and to pull his weight to the utmost. If, after chances, he fails, then he has to go. (You will understand, of course, that this is just my own idea about "running the B.B.C." It does not commend itself to everyone.)

I have, then, to find chiefs for a dozen different departments—drama, orchestra, Children's Hour, song, light comedy, etc. I comb Britain through for the best men. But, mark this: Each man or woman chief must be an expert in gripping the heart of the great public with his own subject. He must know, in effect, how to "put it across." I want, not first-class scholars but first-class advertisers. For example, to name one of my lieutenants, if he will but honour me, I appoint Mr. H. Plunket Greene as chief of the Song department. It is interpretation I want. And Mr. Plunket Greene is, I should say, the greatest living master of

(Continued on next page.)

## "HOW I WOULD RUN THE B.B.C."

(Continued from previous page.)

*Interpretation in Song.* So with the other departments, each self-contained and working on its own lines.

Now I draw all the threads together to a central, general, elastic control. It is like guiding a team of sensitive Arabs upon the lightest of snaffle reins. Or, shall we say, like fighting a fleet in action. Each ship's captain may know the general objective, and will fight his ship to the last gasp, but only the admiral commanding can so combine and manoeuvre as to secure the maximum concentration and effect and thus win the battle. And, please note, the admiral is in the firing line; an army general is not. The admiral supplies the needed "personal touch"; the general, miles away behind, cannot give this.



Lord Gainford, Vice-Chairman of the new B.B.C.

### "My Own Individuality."

There is, very broadly, my foundation. That is how I should set to work. I do not assert that it is the only way, or even the best way. I only say that it is my way. My own individuality as an artiste. Joshua Reynolds, Gainsborough and Lawrence each painted the famous Siddons as he saw her. Which is the best portrait? Who shall say? Yet, in popular entertainment certain golden, basic rules must be observed.

But if you ask me how I should fight the fleet, or guide my spirited team to victory, I cannot answer. Ask Richard Strauss how he composed the "Rosenkavalier," or John Masefield how he wrote "Reynard the Fox," or G. B. Cochrane how he produced "The Miracle, and he would be equally at a loss. For the direction of radio entertainment is, every whit, as creative an art as any of these. You have to go on creating every day that passes. Every single programme, every successive Children's Hour must be a new, vital, human creation. That is the mighty task of it. Habit is fatal.

### "Radio is a Fireside Comedy."

Certainly I could name off-hand a score of "features" which I should like to see introduced in London. There is nothing in that. Anybody can offer that criticism and pretend that it is constructive. The creative art lies in the working out and presentation. That I cannot explain. Any more than I can instruct or "advise" a friend or pupil how to do it. It is the personality and sincerity of the artiste himself which counts. That cannot be duplicated. And only the artiste himself can work out his own ideas.

And, given that man, he cannot be controlled, except within a broad policy. It is the essence of the artiste to be free, like Shelley's skylark. Interfere with him, and he will promptly resign. For myself, I do

not think that I should ever go near the microphone except, perhaps, for a short, bi-weekly, friendly, fireside chat over our doings in general. But the whole entertainment would carry the "personal touch," and its atmosphere be impregnated with that feeling of "home" which, before all else, appeals to all of our race.

The human touch is the keynote. Given that and the battle is far to the winning. Charles Dickens, Albert Chevalier, Balzac, Marie Lloyd, Nelson, Dan Leno, Shakespeare—you smile at the medley, but they had that divine gift in common, and so they held the masses. And nothing in the world has ever happened where the human touch is more essential. For radio is a fireside comedy in millions of homes. It should still be cheerfully burning when the fire is out and the cupboard is bare. Does it do that to-day?

### "Honest Men are Not Popular."

The B.B.C. say that I am too aggressive for them. I prefer to think myself merely an honest man who is in the habit of speaking his mind. And honest men are not popular with bureaucrats. Just as originality never yet led to preferment, so is mediocrity and lip-salve the road to honour. They put Nelson on half-pay for five weary years because he was too honest for Whitehall. Any man who would "run the B.B.C." with success must be prepared for a like fate. But he will have the people with him. And that is all that matters.

Were I in artistic command at Savoy Hill I should strive to practise, so far as they lay in me, four factors—self-reliance, fearlessness of responsibility, fertility of resource, power of initiative. In the highest degree those attributes were

Nelson's. I would add a fifth, which I should like to have earned for my epitaph—"The common people heard him gladly." And if the Evangelist could say that of Christ it is good enough for the B.B.C. to aim for.



Mr. J. G. W. Reith, who is now Director-General of the new B.B.C.

A "three years' agreement," did I say? Nonsense! Cut it down by half. Nothing bores me so much as success. The work itself is all that matters. Eighteen months should be ample.

## A CRYSTAL DETECTOR TIP.

IN a conventional crystal circuit the crystal detector is always connected between the telephone receiver and the aerial terminal.

The 'phones are at low potential and do not carry H.F. current.

But this condition obtains only when the detector is rectifying in the direction from the aerial. Thus it is always well worth while changing a crystal detector's connections round experimentally.

It is frequently found that in one position results are superior to that obtainable when the current is passing in the reverse direction through the crystal.

## A SIMPLE LIGHTNING ARRESTER.

By E. W. CLAXTON.

A LITTLE gadget may be made from a few oddments which usually adorn the experimenter's bench. The parts required are as follows: Two large terminals, an old fixed condenser case, ebonite 1½ in. by 2½ in., two small pieces of copper sheet, two soldering tags. The

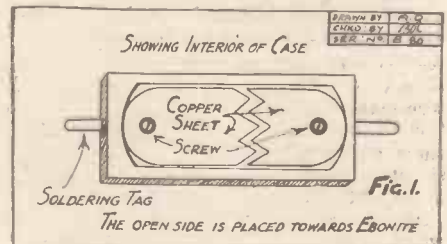

terminals are mounted on the ebonite at 2-in. centres, then the foil is cut to fit inside the condenser case, with an ¼-in. space between them (Fig. 1), two small screws are placed through the foil and case, the soldering tags being fastened one on each screw at either end on the outside of the case.

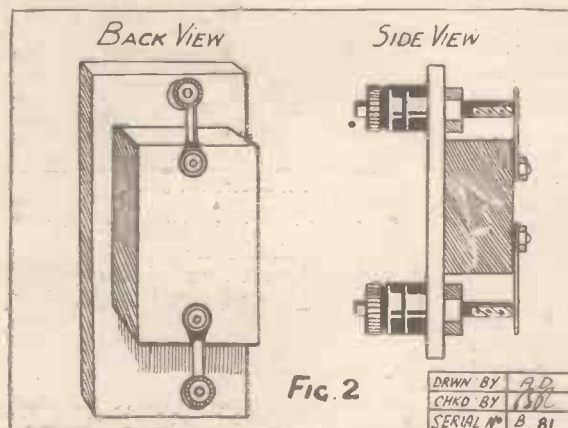

The case should then be laid on the ebonite and the tags soldered to the terminal shank-ends, the soldered joints making the case fast behind the ebonite. Fixed in a small box and placed beneath the aerial lead-in, one terminal being connected to aerial lead-in before it enters the house, and the other to earth, we have a small air gap in the aerial-earth system which, in the event of lightning or heavy X's striking the aerial, would probably save considerable damage inside the house.



# THE MUSICAL BOX

This set has been specially designed to give pure loud-speaker reproduction from the local station.  
By PERCY W. HARRIS,  
M.I.R.E.

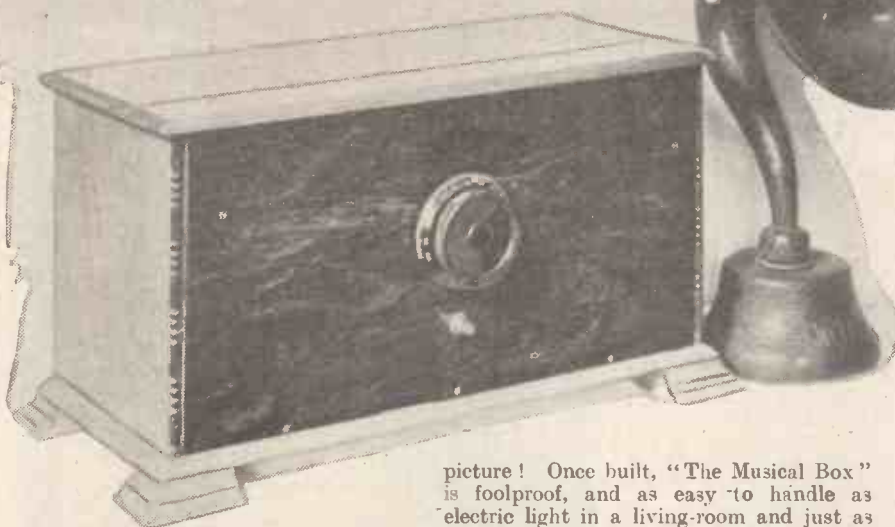

is the best obtainable with our present knowledge of the art, and provided you use a good loud speaker you will have the satisfaction of knowing that you are right up to date in sound reproduction. Thousands of people with musical tastes and musical education are still under the impression that wireless reproduction is crude and distorted. Build this set for yourself and at the same time invite your  
(Continued on next page.)

WHENEVER I am asked for advice on the choice of a wireless receiver, I reply at once, "Where is it to be used?" To many inquirers this seems a strange question, for, unconsciously, they are liable to compare a wireless receiver with a gramophone, and, in the latter case, what does it matter where the instrument is used? Surely a good gramophone is a good gramophone in London or in Leeds!

The great difference between the gramophone and the wireless set is that with the first the reproduction is controlled entirely at the instrument, whereas with the wireless receiver the distance from the transmitting station will largely determine how much energy we have available at the input terminals of our set. "But," you will say, "if the signals are weak, we can magnify them by means of valves. That is surely simple enough."

Unfortunately this is just our difficulty. True, in a well-designed set we can magnify weak signals, and obtain results similar to those given by strong signals from a nearer station, but the set which will do this is more complicated, more expensive, and slightly more difficult to manage.

### Pure Reproduction.

The man who lives near a wireless station has many advantages. He has plenty of energy available, the set to utilise and reproduce this energy can be simple to manufacture, low in cost and delightfully easy to control. Furthermore, the perfect purity, for which most of us now aim, is far more easy to obtain.

"The Musical Box" described in the present article is designed for one purpose—good reproduction—and for one station, the local, and, to indicate its limitations first of all, the local station should be not more than ten miles away. "The Musical Box" is not a set for indoor aerials, and I am quite willing to admit that in a different circuit three valves can be made to bring a dozen or more stations, many on the loud speaker instead of the solitary station to which I have referred.

But, now, look at the other side of the

picture! Once built, "The Musical Box" is foolproof, and as easy to handle as electric light in a living-room and just as reliable. Nicely fitting into its cabinet, with the batteries concealed in some convenient position, "The Musical Box" will give you, each day and every day, bad weather and good, a quality of reproduction unbeaten by the most expensive set you can purchase. As you will see from the photographs, the panel carries just one dial and an on-and-off switch. You will find that your local station will come in at best strength at one position only on this dial, and, once this tuning position has been found, it will only alter with a change of aerial or a change of the local wave-length. If at any time the strength is too great—as frequently may be the case—you simply turn the dial a few degrees to reduce the strength to something more suited to your taste.

I say, without hesitation, that the quality of reproduction given by this set

### LIST OF COMPONENTS.

- One panel, 16 x 8 in.
- One cabinet with baseboard to take panel.
- One .0005 mfd. variable condenser.
- One pair of brackets to support panel.
- Three valve sockets, anti-vibratory type.
- One potentiometer for baseboard mounting.
- Three fixed resistors to suit valves chosen.
- One fixed condenser, .002 mfd., of good type.
- Two fixed condensers, .015 mfd.
- Two grid-leak holders each with  $\frac{1}{4}$  megohm grid leak.
- One fixed condenser, .0003 mfd., with 2 megohm grid leak.
- Two wire-wound anode resistances with bases.
- Two fixed condensers, Mansbridge pattern, 1 mfd. each.
- One audio-frequency choke of good make.
- One board mounting coil socket.
- Two terminals and one small piece of ebonite for mounting same.
- One on-and-off switch.

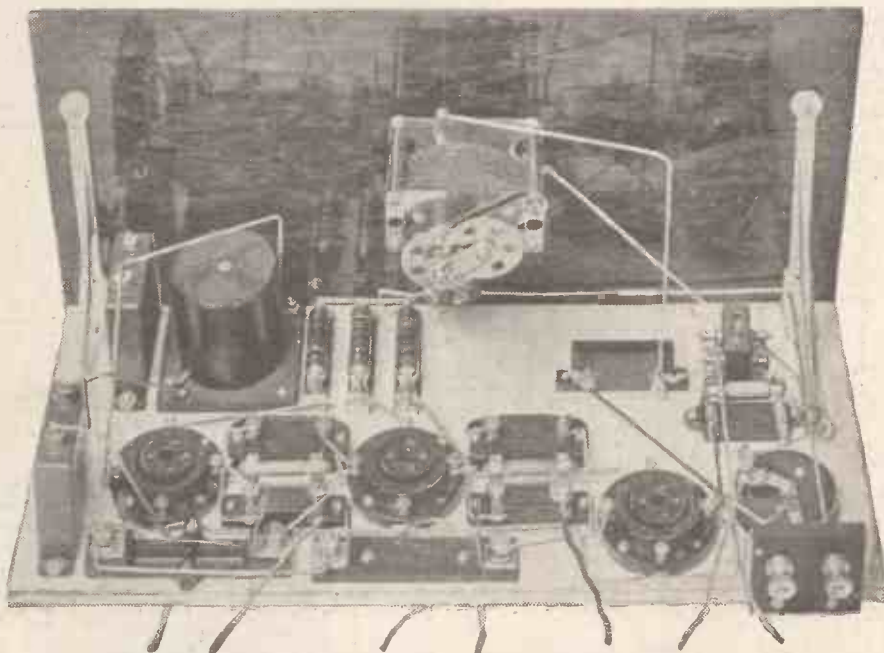

It will be seen from the above photograph that pigtail connections are used instead of terminals, and several of the leads are taken through the baseboard before reaching the back of the set.

“THE MUSICAL BOX.”

(Continued from previous page.)

musical friends to hear it. I wager you will make dozens of converts.

And now for a little more technical information about “The Musical Box.” The circuit has a valve detector without reaction, followed by two resistance-coupled note magnifiers. Admittedly the absence of reaction considerably reduces the sensitiveness of the set, but at the same time it ensures a quality not generally obtainable when reaction amplification is used, and the operation is much simplified. Provision is made for the use of either anode bend rectification—this is recommended for the greatest purity of reproduction when signals are good—or the more commonly used grid leak and condenser method. The additional cost of providing both forms of rectification is small—only a few shillings—but the ability to make the change will be appreciated by those who are experimentally inclined and who wish to make direct comparisons. Now that we have a number of really excellent valves designed specifically for resistance-capacity amplification, the efficiency of the note magnifiers will be found to be very high, while by using in the last socket one of the modern “super-power” valves with adequate grid bias, full volume, without distortion, is easily obtained.

Moderate Cost.

Examining the set in detail, you will find that the front panel need not necessarily be of insulating material. I have used mahogany-finished ebonite in the set for the sake of a good appearance. This panel carries a variable condenser and an on-and-off switch. Behind the panel you will find a socket with a tuning coil and the various other parts of the apparatus symmetrically disposed. Fortunately, in this design it is possible to use the very best components throughout, while yet retaining the advantage of very low cost, as the resistance capacity method of amplification is appreciably cheaper than the

transformer method, if the best transformers are used.

Without valves and batteries or loud speaker, the set, as shown, will not cost you more than about £7. Three valves, 120-volts high tension battery, and an accumulator, will cost about £5 more. The loud speaker can be chosen from one of the recognised makes, according to your taste and the price you are prepared to pay. Personally, if you want the very finest reproduction of the lowest tones, one of the modern cone types of loud speaker would be my recommendation, although the horn type gives slightly greater volume and, in the best models, is really exceedingly good.

The front panel, carrying just the variable condenser and the on-and-off switch, is a very simple affair, and when the holes for these two components have been drilled, I suggest that you next mount the two brackets on the baseboard and, with the panel held against them, mark off on the back of the panel the positions of the holes for the securing screws. These can then be drilled, together with three small holes along the bottom front edge of the panel, to take the wood screws for holding it against the baseboard.

Having made this progress, lay the panel aside, and proceed to place the various components in their positions on the baseboard, as indicated in the wiring diagram. Practically all the wiring up can now be carried out before the front panel is placed in position.

Only Two Terminals.

You will notice that I am following a modern practice by avoiding as far as possible the use of terminals, the leads for the batteries and loud speaker being taken direct from the points to which these con-

nections have to be made. A small advance in design is to drill holes in the baseboard (there are three in this case), so that flexible leads can be taken through the baseboard and along the under side to prevent fouling any of the component parts. This makes for neatness and efficiency.

The Battery Connections.

Note particularly in the set, as in the diagrams, that there are two grid bias positives and three grid bias negatives. The detector valve will require a separate grid bias battery when anode rectification is used, but one large grid bias battery can

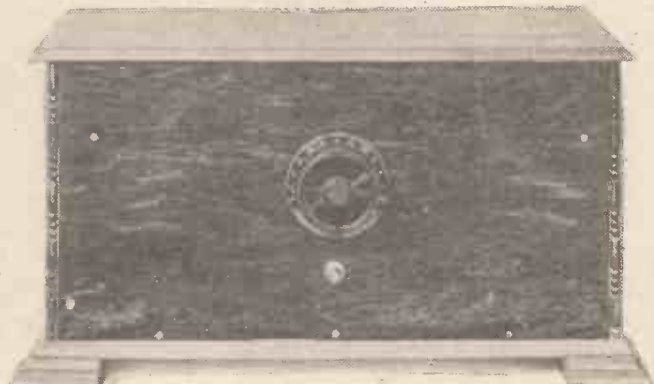

The front of the panel has an extremely neat and business-like appearance.

be used for the two note magnifying valves.

You will notice that the grid bias positive for the detector is taken to the slider of a potentiometer, while the grid bias negative is taken to the earth terminal. The grid bias positive for the L.F. valves is taken to the L.T. terminal of the accumulator. The two grid bias negatives of the L.F. valves are tapped in the grid battery in a manner to be described.

Other connections to which I would like to draw your attention are the H.T. negative, which goes straight from the H.T. battery to the positive terminal of the accumulator, and is not joined to the set at all; the L.T. positive which comes through the baseboard to the on-and-off switch, and

(Continued on next page.)

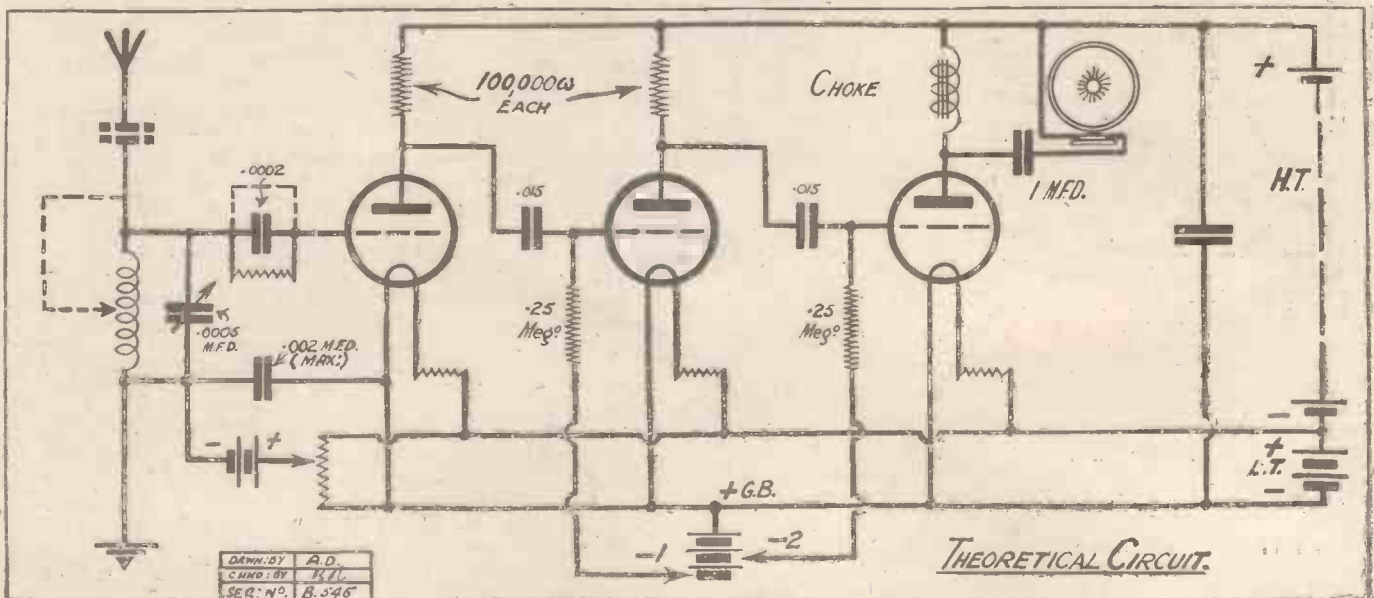

**"THE MUSICAL BOX."**

(Continued from previous page.)

the L.T. negative which goes to a convenient point on the connection running to the filament lugs of the valve sockets. As we are using a super-power valve in the last socket with a high voltage, it is not advisable that the loud speaker should be connected directly in circuit with it, as too much strain would be imposed upon the windings of the speaker, thus increasing the liability

of breakdown, and, incidentally, tending to overload the loud speaker. A filter circuit has therefore been incorporated, which allows the passage of the L.F. pulses which we desire to pass through the loud speaker, but by-passes the direct H.T. supply. The loud speaker leads, therefore, do not carry the anode current of the last valve, which may be quite heavy.

**Suitable Valves.**

The loud-speaker leads are taken to one terminal of the Mansbridge shunting condenser (in this way to the positive H.T.)

and to one terminal of the filter Mansbridge condenser. If you trace out the circuit, you will find that there is no direct current through the loud speaker, and that the anode supply for the last valve goes through the L.F. choke. The connections to the loud speaker are clearly shown in the diagram.

For the first two valve sockets I suggest that you use valves of a type specially designed for resistance capacity amplification. Unless you use valves of this type the volume given by the set will be very considerably reduced. All makers make

(Continued on next page.)

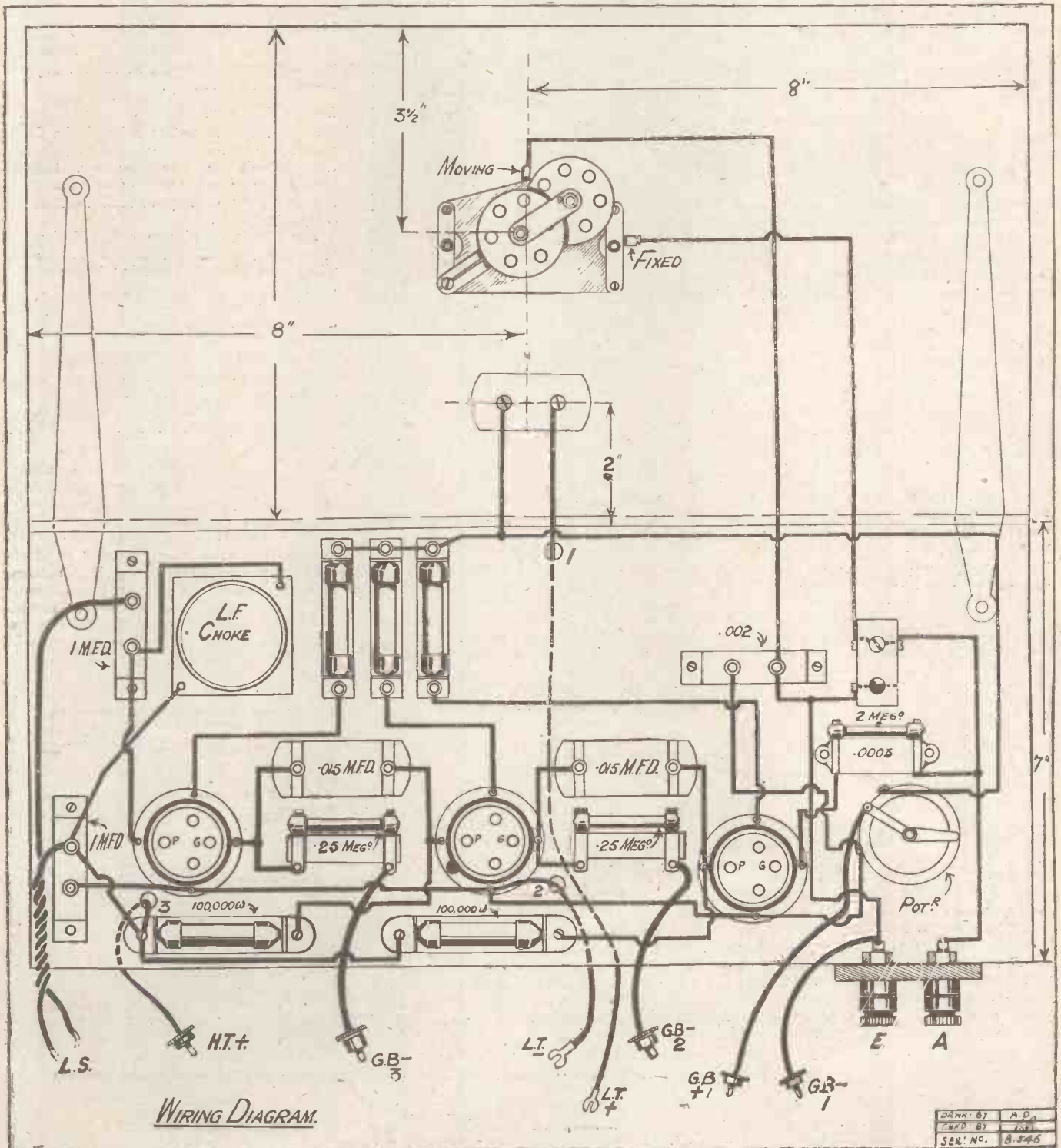

*WIRING DIAGRAM.*

DRAWN BY	A.D.
CHECKED BY	J.S.
SER. NO.	8-346

## "THE MUSICAL BOX."

(Continued from previous page.)

suitable valves in the 2, 4 and 6 volt varieties. Marconi, Oesram, Mullard, Cossor and the new S.T. valves have all been tried out in this set with good results.

If you are to obtain the really first-class quality for which this set has been designed,

This illustration shows the interior of the "Musical Box" with valves and coil in position.

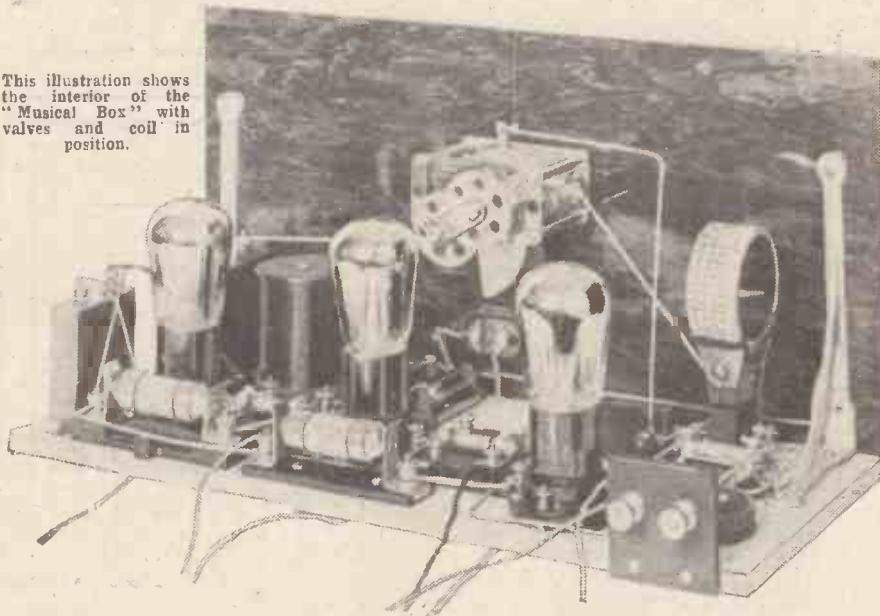

it is essential that you should use in the last stage one of the special loud-speaker valves of the super-power variety. Good results will be obtained with any L.F. valves, but for pure undistorted volume you must use a super-power valve. There is a wide choice of these in the 2, 4 and 6 volt varieties, and if you have not used such valves before, you will be surprised at the improvement in loud passages. All too frequently loud speakers and transformers have been blamed for distortion and overloading, when the real fault was the use in the last stage of a valve quite incapable of handling the large amount of energy already available.

### Operation.

Let me now tell you how to use the set.

To use grid leak and condenser rectification (this does not require any special grid bias battery) take the negative grid bias lead which is joined to the earth terminal, and connect it directly to the slider of the potentiometer, disconnecting for this purpose the grid bias positive lead already in position. With the 2 megohm leak in position across the clips of a .0003 mfd. condenser set the slider of the potentiometer at about a half-way position. Now place the positive wander plug of the grid bias battery for the L.F. valves in the positive socket of this battery, grid bias negative 2 in the second socket from positive, and grid bias negative 3 at a voltage recommended by the maker for the particular type of super-power valve you are using.

If, for example, you are using an S.T.43 or an S.T.63, with 120 volts as recommended for this set, you will probably try

about 12 to 15 volts negative. You may think this a very big figure for grid bias, but when this grid bias is used very large, "grid swings" are possible without the grid becoming positive.

Again, with suitable grid bias the H.T. demand made by a power valve is not necessarily exorbitant, and as a matter of fact the total H.T. requirements of this set, using 120 volts throughout, and with a Burndept LL 525 valve in the last stage, will not exceed about seven or eight milliamperes,

in the wiring diagram, place the grid bias positive in the separate battery and grid bias negative at about six or seven and a half volts.

Take out the grid leak from the clip, and short-circuit this condenser by winding a piece of bare wire around the two clips in place of the grid leak. Connect up the L.T. and H.T. batteries as before, and use the same grid bias positive on the note magnifying valve.

Tune in the station, and then try different positions on the potentiometer slider until the loudest signals are obtained. If they steadily become louder towards one end of the potentiometer, try altering the grid bias battery one tapping, until you find a position that loudest signals are procured at, say, half or two-thirds the way round the potentiometer. Once this position has been found no further adjustment will be necessary.

### Local or Daventry.

So far, I have not mentioned the fixed resistors; but, obviously, you will choose these to suit the valves you buy. Choose your make of valve first of all and then, having chosen, order your fixed resistors to suit these valves.

The choice of plug-in coil will depend upon the wave-length of the station to which you wish to listen, but it will either be a 25, a 35, or a 50, depending upon the wave-length of the station and the particular aerial you are using.

The set is easily changed from the local station to Daventry by substituting a 150 coil for that previously indicated, but as no reaction is used in this set, Daventry will not usually be received at really full loud-speaker strength unless it is well within 100 miles.

which is not too much to take from a reasonable size of H.T. battery. This plate current will, of course, vary according to the H.T., grid bias and the type of valve used.

So far as the first note magnifying valve is concerned, you will generally find that about three volts is the maximum needed, as when the high resistance is in the anode circuit of the note magnifying valve, the actual voltage applied to the valve itself is cut down considerably. In any case you will not go wrong if you stick to three volts for grid bias negative 2 and fix your grid bias, at least to begin with, on grid bias negative 3 at about 16.

As the filter is used with the loud speaker it does not matter whether you connect the negative or positive loud speaker lead to the H.T. positive connection indicated, as no direct current will be flowing through the windings.

As described, the set will be used with grid leak and condenser rectification, but as mentioned previously I do not recommend this, save when the signals are weak. To change the set over to the recommended form of anode, bend detection, replace the grid bias positive 1, and grid bias negative 1 leads, in the positions shown

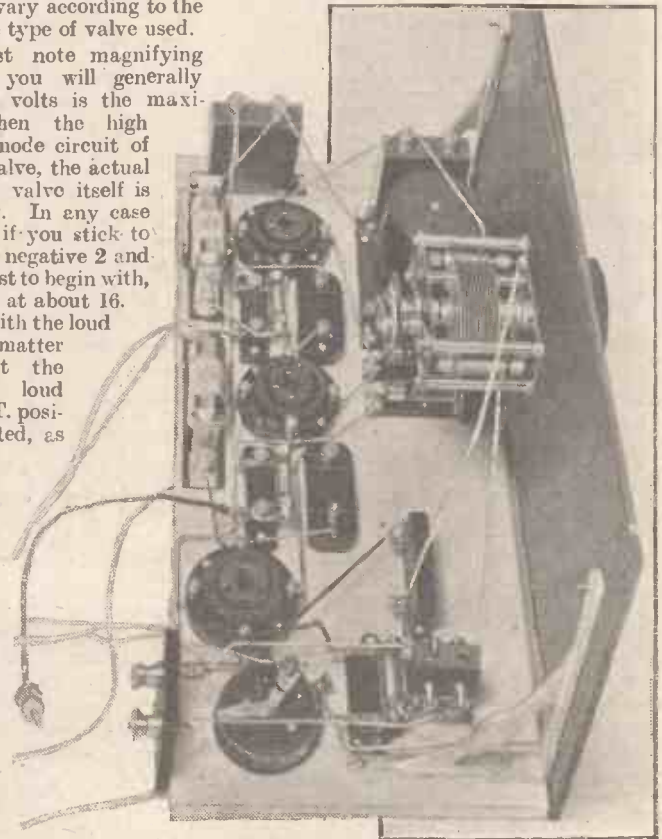

An unusual aspect. This illustration clearly shows the lay out of the various components.

# A Wavetraps That Works



The wavetraps made up in vertical form makes a neat accessory to any valve set built on the American pattern.

One of the most successful wavetraps ever devised was that described in No 193 of this Journal. Further practical details are given in this article and will be of interest to all listeners who cannot cut out the local station.

By G. V. COLLE  
(Experimental Staff)

every confidence. While acting as a wavetraps or "H.F. drainage system" on the local station, it is also capable of dealing with other types of interference (except perhaps X's and heterodyning), and, unlike other eliminators, it does not cut down the volume of the station received.

Before describing its action, it would be well to point out some simple precautions that one should take to make the set itself as selective as possible, as this will facilitate the work of the eliminator.

Raise the aerial as high as possible (the higher the better up to 60 feet). It should be noted that the nearer the ground the "flatter" the tuning. An aerial that is not longer than 90 feet,

gauge of wire as the aerial lead. After due regard has been paid to the above points, the construction of the "Complete Eliminator" can be commenced. As a theoretical circuit, a wiring diagram, a panel layout and some photographs are shown; no description of the actual construction, which is simple and straightforward, need be given.

**What It Will Do:**

Claims by the originator for this wavetraps are:

- (a) It will cut out the local station;
- (b) Cut out 5 X X so as to bring in Radio-Paris;
- (c) Cut out or reduce 300 metres ship jamming;
- (d) Cut out or reduce jamming by ships on 600 metres.

(Continued on next page.)

It would not be incorrect to state that the problem of cutting out the local station at short distances for the reception of others has yet to be solved.

There are doubtless several rather costly sets capable of doing this, such as the superhet. and the neutrodyne, but there must be many who cannot afford these and have to be content with a modest two or three-valver at the most. While these may give

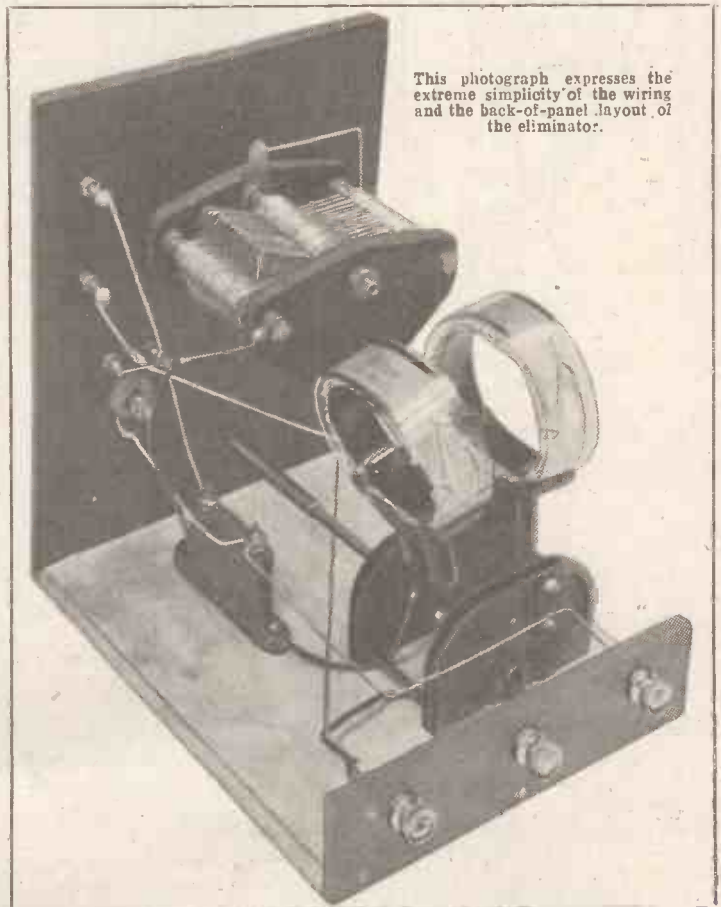
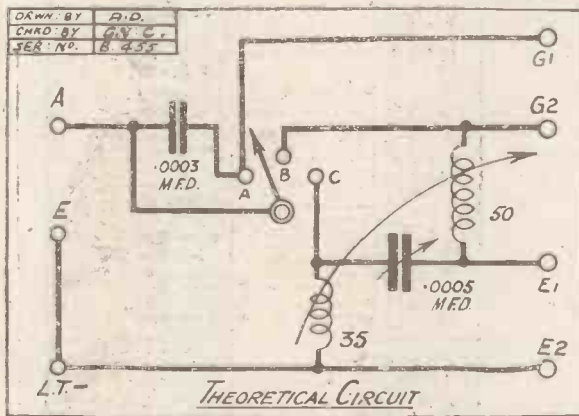

This photograph expresses the extreme simplicity of the wiring and the back-of-panel layout of the eliminator.

excellent loud-speaker results on local transmissions, they are usually unable to receive further afield owing to that "coming-in-all-round-the-dials" effect. There is no doubt that some really selective and sensitive tuning arrangement is required to cut out the local station effectively. It is for the amateur that needs such a selective tuning circuit that the "Complete Eliminator" has been reintroduced.

This wave-traps was first described in POPULAR WIRELESS, No. 193, by Mr. L. Manning, A.M.I.R.E., and many readers of POPULAR WIRELESS obtained the desired results with it. It can be recommended with

including the lead-in wire, is preferable. Keep the latter as short as conditions will allow, and avoid running it parallel with walls or near ceilings. Use a short earth wire, preferably of the same

# A WAVE-TRAP THAT WORKS.

(Continued from previous page.)

One great asset possessed is that it will actually increase the volume of the station received, although this might not be done until the action of the circuit is understood fully, as the results with it are a matter of personal experiment.

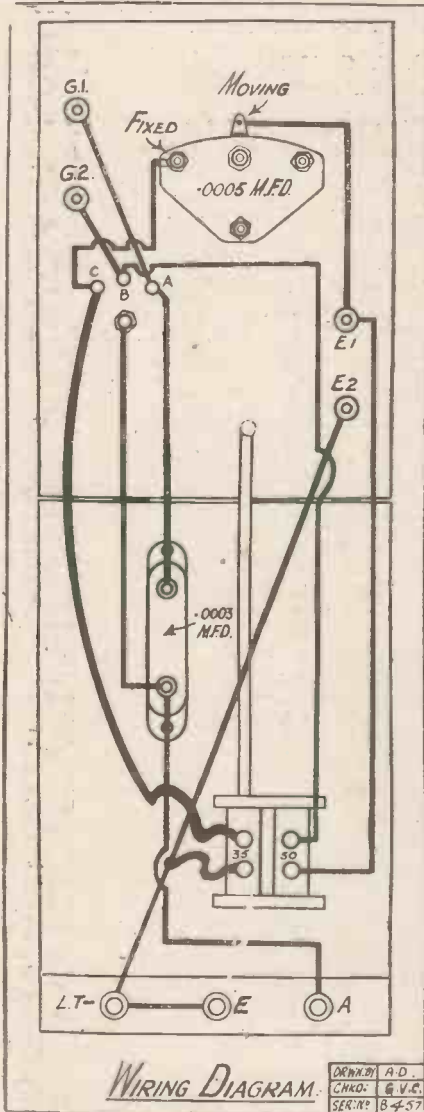

To connect it to the set, it is necessary to remove the aerial and earth leads from the latter and join them to their respective terminals on the eliminator. The terminal on the eliminator marked L.T. is then connected to the earth terminal on the set, and the one marked G.1 is joined to the aerial terminal.

### Series-Parallel Tuning.

As many readers have a three-terminal system of series or parallel for the aerial condenser, it would be well to point out that in such a case the variable condenser on the set must be joined in parallel, and the G.1 terminal on the eliminator connected to the parallel terminal. For the various

forms of interference experienced, the eliminator will be arranged as follows:

Interference under (a): Turn three stud switch to A position, tune in interfering station at loudest strength on the set, then switch to B stud and turn condenser on eliminator until it is at minimum strength or has entirely vanished. The terminals on the front of the panel marked G.2, and E.1 and E.2 must be left unconnected. When turning the condenser it is advisable to manipulate the coils in the eliminator at the same time. When the interfering station has been cut out, the controls on this unit can be left set and all further tuning done with the condensers, etc., on the set itself.

### Operation.

Interference under (b): Connect G.2 to the aerial terminal on the set, in place of G.1, join E.1 and E.2 together, plug in two 150-turn coils and tune as in (a). Leave G.1 unconnected. This arrangement also holds good for interference under (d), except that the 35 and 50 turn coils must be used in place of the two 150's.

For interference as under (c): Several arrangements can be tried, as best results will be a matter of experiment. As the author of this novel wave-trap pointed out in his article, many difficult tuning feats can be carried out with the aid of it, especially when G.1 is joined to the aerial terminal on the set, in place of G.2 and the stud switch is placed at C. Using this arrangement, the effect can be tried on connecting G.1 and G.2 together, E.1 to E.2 and so on.

Personal results with the Complete Eliminator were distinctly encouraging. When connected as under (a) it was found possible to cut out the local station at a distance of five miles on a 4-valve set and tune in stations very near its wave-length.

Finally, a word of warning would not be out of place. Do not make the mistake of attempting to cut out the local station on its own wave-length—concentrate on cutting it out on all those frequencies above and below its own.

A careful study will make this clear. If the local station is not receivable at all, it means that all other signals have been literally "damped out of existence."

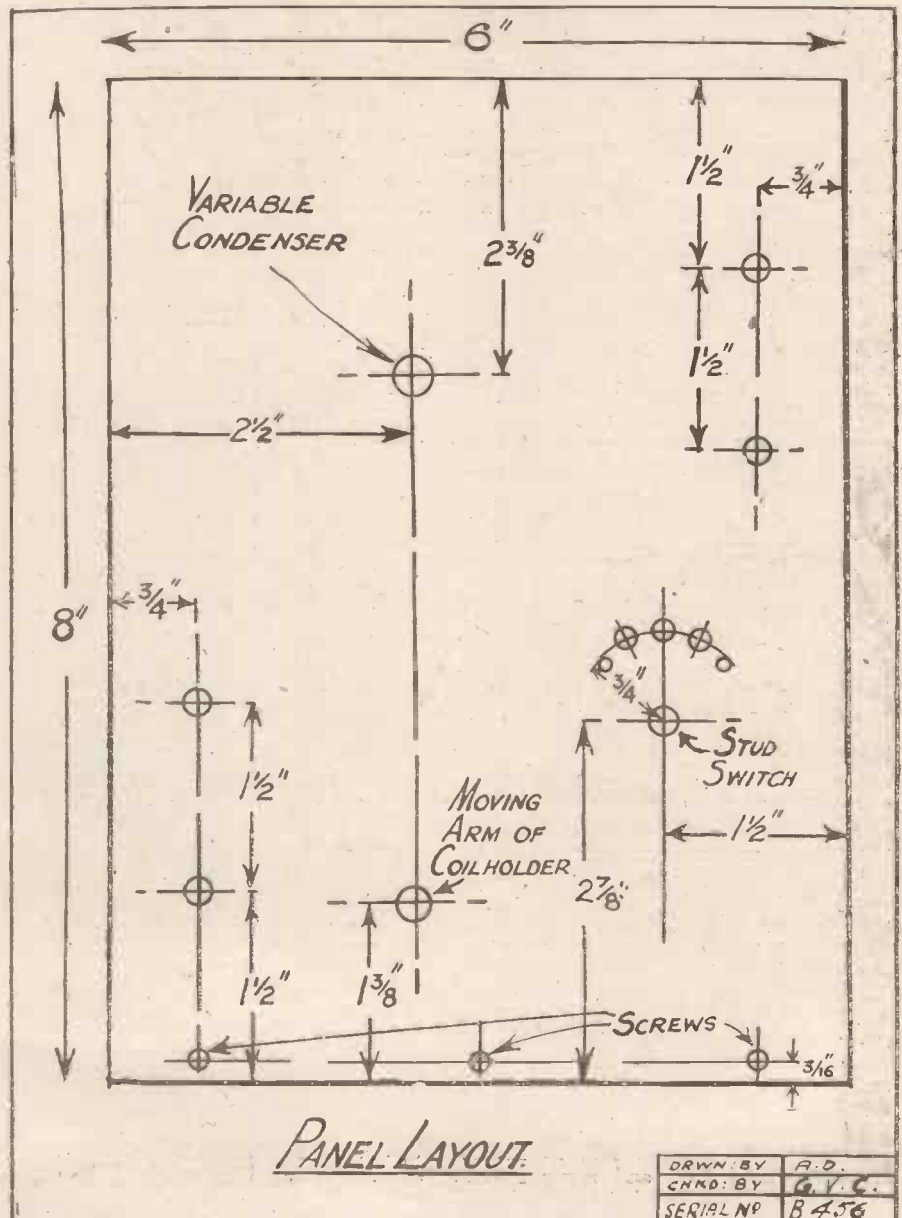

# A TRANSFORMER WITHOUT A PRECEDENT—



## A GREAT CHOKE as well as a GREAT TRANSFORMER!

Transformer and Choke coupled amplifiers give greater and better volume per stage than resistance capacity coupled amplifiers (popularly referred to as r.c. sets). Practically no skill is required to balance a transformer or choke-coupled circuit to suit the valves used, but in an r.c. set that is a very important point which requires careful watching. No special high tension voltage is necessary for transformer and choke couplings, either. Transformers and Chokes are widely used, therefore, for excellent reasons. The advantage of being able to use a Transformer also as a Choke is obvious. And **NOT ONLY IS THE NEW LISSEN A GREAT TRANSFORMER**, but by the simple act of connecting two of its four terminals together, we have found it to be **A GREAT CHOKE** also.

LISSEN has therefore given you a radio part that saves you buying two parts—for a single LISSEN Transformer now enables you to make use of the two most used methods of low frequency amplification.

### FOR USE AS A CHOKE :

All you have to do is to connect together the terminal marked O.P. to the terminal marked I.S. Then take a connection from the remaining two terminals, and you have a **HIGHLY EFFICIENT CHOKE**. Your dealer will show you how easily you can do this if you do not already know. Ask him.

Test this new LISSEN as a transformer against the most expensive transformer you know of—test it as a Choke against the most expensive Choke you know of. If, within seven days, you find a better Transformer or a better Choke, no matter how high its price, then take the new LISSEN back to your dealer. It is significant that LISSEN has unhesitatingly withdrawn in favour of this new LISSEN all the previous expensive LISSEN transformers which have been on the market for several years.

**USE IT AS A TRANSFORMER—USE IT AS A CHOKE**, either way it **AMPLIFIES FULLY EVERY NOTE, EVERY TONE, EVERY HARMONIC, EVERY OVERTONE.** Never again pay a high price for a transformer—this new LISSEN will replace any transformer mentioned or used in any circuit. Choose your own transformer, and your own parts. Remember there are many advertising manufacturers, and that they expect a share of the use and mention of their products in any circuit published in periodicals. You can gain in performance and in economy if you choose your own transformer and other parts, for LISSEN now gives you keen prices as well as LISSEN quality.

# 8/6

**GUARANTEED FOR 12 MONTHS**

Turns ratio 3 to 1. Resistance ratio 4 to 1.

Use it for 1, 2, or 3 stages L.F.

It is suitable for all circuits and all valves you will want to use.

## USE LISSEN FIXED CONDENSERS, TOO, Mica & Mansbridge Type LISSEN Mica Type CONDENSERS

Small energy-conserving condensers—note the new case which enables the condenser to be used upright or flat. At present the new case is available only in the most used capacities, but will quickly become a LISSEN standard.



Capacities—  
 .0001 to .001 1/- each (much reduced).  
 .002 to .006 1/8 each (much reduced).  
 Accurate to 5%—they never leak—they will never vary.

## LISSEN Mansbridge Type CONDENSERS

To a fine LISSEN quality condenser is added the specially moulded case—the condenser cannot short circuit on to its case. The new LISSEN case protects you if the condenser is used in any circuit connected straight on to the electric light mains. And due to our new policy of direct-to-dealer distribution this LISSEN Condenser costs no more than the ordinary type.



.01 to .05	2/4
.1	2/6
.2	2/8
.25	3/-
.5	3/4
1.0	3/10
2.0	4/8

## LISSEN FIXED GRID LEAKS

A case of these was left on our factory roof during the summer of 1925, soaked in rain, baked by sun, and the resistance value of these leaks never altered.

All capacities, previously 1/8. Now 1/- each.



Improve every circuit by using LISSEN parts wherever you can—save money, too—for now you get keen prices as well as fine quality.

**LISSEN LIMITED,**  
 8-16, FRIARS LANE,  
 RICHMOND, SURREY.

(Marketing Director: Thos. N. Cole)

L.185

# Write Five words for

# £105

Nothing to buy — no entrance fee—no annoying rules. Just write a phrase of five words about EDISWAN Valves and comply with conditions given on the right.



- First prize . . . £105
- Second prize . . . £55
- Third prize . . . £25
- Fourth prize . . . £15
- Fifth prize . . . £10
- Fifty prizes of . . . £5
- Fifty R.C. Threesome Receiving Sets with royalties paid.

### ALL YOU HAVE TO DO:

Read the simple conditions. Fill in \*Entry Form. Write on a sheet of paper the names and addresses of five friends who own wireless sets. Write a simple phrase of five words, which expresses the superiority of EDISWAN Valves. Your wireless dealer will tell you all about them and give you literature. Pin together the slogan, entry form, and list of five names; seal the envelope. Use 1½d. postage stamp. Post to Ediswan.

**R.C.  
THREESOME.**

*If you have already received the R.C. Threesome Instruction Book strike out the "Threesome" paragraph in the Entry Form.*

### RULES & CONDITIONS.

- 1.—Prizes will be awarded, in order of merit, for what in the opinion of the Judging Committee are the best slogans received.
- 2.—In order to qualify, the competitor must complete the accompanying Entry Form, and send with it the names and addresses of five wireless users.
- 3.—The Judging Committee's decision on any matter arising in connection with this competition must be accepted as final and legally binding in all respects, and acceptance of this rule is an express condition of entry.
- 4.—Proof of posting will not be accepted as proof of delivery.
- 5.—No correspondence can be entered into with regard to this competition.
- 6.—Employees of The Edison Swan Electric Co., Ltd., are not eligible to compete.
- 7.—All entries must bear a post-mark not later than Monday, January 10th, 1927.
- 8.—Results will be published in the "DAILY MAIL" on Monday, 31st January, 1927.

FILL IN ENTRY FORM — TEAR OUT and ENTER THIS SIMPLE COMPETITION TO-DAY!

# EDISWAN

**\*ENTRY FORM.**

P.W. 8-1-1927

To the EDISON SWAN ELECTRIC CO., LTD.  
(Publicity), 123/5, Queen Victoria Street, E.C.4.

Name \_\_\_\_\_

I agree to enter this Competition in accordance with the conditions announced in this advertisement.

Address \_\_\_\_\_

Please send copy of R. C. Threesome Instruction Book, and Blue-print.



THE B.B.C. have been in receipt of quite a number of complimentary letters, and quite a number of complimentary articles in the Press, concerning their Christmas programmes, and it is only hoped that the very fine show they did provide over Christmas marks a new era in improved programmes now that the new B.B.C. has taken over.

We understand that no drastic alterations are contemplated in the programmes, but it is anticipated that the opening weeks of the new regime will be marked by one or two new developments. Possibly the first will be the introduction of a first-class orchestral concert into the Saturday afternoon programmes, and more variety items will also figure rather prominently. The latter have been decided on, we understand, in view of the fact of their widespread popularity as revealed in the many thousands of letters sent by listeners to 2, Savoy Hill.

**Wireless For the Blind.**

It is quite likely that the nightly classical recitals will be reorganised into two distinct recitals for each weeknight. The first will probably be devoted to keyboard music at about 7.15 each evening, and at 8.15 a recital somewhat on the lines of the present 9.45 recitals will be given; but in the second recitals the entertainment side will be emphasised, and the average listener will have a programme which, it is thought, will appeal to him.

While on the subject of general broadcasting, we would point out to readers that the Ministry of Health has sent out a circular to all County and County Borough Councils drawing attention to the provisions of the Wireless Telegraphy Blind Persons Facilities Act (1926), under which free wireless licences are granted to blind persons. It appears that it is the duty of the Council to arrange for the issue of the necessary licences for blind people who wish to instal wireless sets free of charge.

This very great boon to blind people, it must be remembered, has been primarily due to the energy and unselfishness of Captain Ian Fraser, M.P., the blind Chairman of St. Dunstan's, who, to our certain knowledge, is a devotee of wireless technique.

**A Broadcasting Review.**

POPULAR WIRELESS wishes to inform any of its readers who may have blind friends interested in wireless that every possible advice and help will be given to them if their friends will write in and put their problems before us. This service is offered free of charge.

Our readers will have noticed in the Press lately that a considerable amount of space has been devoted to an invention of Mr. J. L. Baird, in connection with an invisible light ray for use in his television apparatus. One of our special scientific correspondents, who has investigated this matter, has, we are pleased to say, written a very important article dealing with the subject, and this will shortly be published in these pages.

# CURRENT TOPICS.

BY THE EDITOR.

**B.B.C. Alterations—Mr. Baird's Latest—An Amusing Review of Radio Progress—Little Things Which Make a Big Difference.**

We have hitherto refrained from commenting on Mr. Baird's latest developments in order that certain inquiries might be made. These have now been completed, and the article has been sent to the printers. It will probably appear in our next issue, and we should advise all readers interested in this particular branch of radio to make a point of reading this article, which will be the most comprehensive criticism of the subject yet published.

Now that 1927 is with us, it is interesting to note a rather amusing review of broadcasting in 1926 which appeared recently in the "Yorkshire Weekly Post." The writer of the article states that there have been few alterations in principle in the past year, but, he remarks:



"Samson—The Powerful Twin"—is the name given to Mr. Harris's latest receiver, which will be fully described in the Wireless Constructor on sale January 15th. Order your copy now—Price 6d.

"Of course, we have had the usual glut of 'new' circuits every week—The Ether Master, The Ebony Four, the Fancy Three, and so on—circuits that really differ very little from the ordinary straight circuit, but they have been nothing of moment. The Neutrodyne and the Super-heterodyne have become popular deservedly, but their initial cost and high running expenses are a serious handicap to anything like general use. The Neutrodyne, however, is being widely used in sets of moderate power.

We do not quarrel with the writer of the above when he refers to the growing popularity of the Neutrodyne, although we are inclined to doubt the popularity of the Super-heterodyne in the wider sense. And when our critic, who does not sign his article, by the way, refers to the "usual glut of new circuits every week," and suggests that they really differ very little

from the ordinary straight circuit, we are inclined to suggest that he does not know what he is talking about.

A study of the circuits published not only in this journal but in other wireless journals, too, reveals the fact that there has

been, during the last twelve months, a considerable amount of ingenuity and technical progress made in the designing of new circuits, and although some of these circuits are admittedly only a variation of the old straight circuit, a considerable number of them have been of a distinctly original kind, and well worthy of the attention of the amateur experimenter.

**"Fancy" Names.**

It is true, also, that these circuits have been given what our friend the critic refers to as "fancy names," but because a set has a fancy name it must not be assumed by the reader who is likely to be influenced by anonymous criticisms that the circuits incorporated in the sets baptised with "fancy names" are necessarily of a kind which vary very little indeed from the ordinary straight circuit.

It would be a waste of time to fill these columns with a list of the circuits which have appeared during the last twelve months which are distinctly original, although perhaps in the eyes of less experienced technicians than the writer of the criticism we have quoted from, their distinctive features may be less apparent on the surface.

There has been, of course, a great deal of criticism lately about circuits, and some wireless papers have been accused of rehashing old circuits under new names and in other words, trying to "swing the lead" on readers with receivers which have been touched up, but which, in essentials, are more or less straight circuits.

This criticism is easily met when one deals with an intelligent amateur or with an intelligent critic, but we would remind readers that many of the most important circuits in use to-day vary very little indeed on the surface from the straight circuit; what variation there is, however, is extremely essential and very important in the improved working of the receiver.

Possibly, if we produced a set with the valves upside down, the H.T. battery shorted, six or seven grid leaks in parallel, and one or two other distinctly original features, some critics would regard the set as extremely novel, and boost it sky high, irrespective of the fact that it would probably give no results at all.

**An Example.**

A good example of a circuit which has very little variation, but which marks an extremely important development in reflex receivers, is the "Hale." Any reader who cares to take the trouble to compare an ordinary reflex circuit with the "Hale" circuit, will realise how even a small alteration will make a vast difference in the operation of a reflex receiver. And although the variation may seem very slight, and apparently of no consequence, in actual practice the difference is often very important.

THOSE experimenters who use a frame aerial should try mounting the same upon a wall bracket in a corner of the room, so that it will swing like a door. Putting it against the wall in a corner of the room keeps it well out of the way, and as everyone knows, one of the principal drawbacks to a frame aerial is its size and its general ungainly appearance. A loop mounted upon a central pivot, in the usual way, can, of course, be completely rotated, but the same result may be obtained with a frame mounted against the wall (if this be capable of swinging through 180 degrees, or two right angles) by the use of a reversing switch. The switch gives two equivalent positions for every actual position of the frame, and thus the 180 degrees becomes equivalent to 360 degrees.

#### A Useful Connector.

A very simple form of connector strip, for general purposes, may be made by taking a length of copper or (preferably) brass strip, say about 30 to 40 gauge (although this depends upon the use to which the connector is to be put), and drilling a hole about  $\frac{1}{4}$  or  $\frac{3}{8}$  inch from each end (this distance again depends upon the diameter of the hole, and the latter depends upon the size of the pillar—for example, battery terminal—upon which the connector is to be placed). The part of the strip extending beyond the hole is then turned back almost flat against the main strip, and the dimensions and positions must be so arranged that the end of the strip, when turned over in this way, just butts over the rim of the hole. It will be found, on pushing the strip upon a screw or pillar, or other object of about the appropriate size for the hole, that the turned-up end will bear against the screw or pillar, making good contact, and that it will tend to lock if you attempt to pull the connector off from the pillar. The strip is, of course, treated similarly at both ends. Strips of this kind will be found very convenient as battery connectors and for such-like purposes.

#### Handling Solder.

When soldering you often find that the strip of solder you are using lies hard against the bench, and when you apply the iron to it, in order to take up the necessary "blob" of solder, apart from burning the bench (which may not or may matter, according to whether the "bench" happens to be a bench or a valuable table), you generally get a larger quantity of solder than is desired.

A simple and convenient way of holding the solder strip is to make a holder for it out of an ordinary wooden reel, held in a vertical position by means of a screw or nail and the top end of the bobbin. A hole should be drilled in the cylindrical part of the bobbin, and the end of the solder strip inserted firmly into this hole, the strip being then wound around the bobbin, with the free end being left projecting just sufficiently to permit the soldering iron being placed into contact with it. In this way, the free end is always clear of the bench,

## TECHNICAL NOTES.

A Weekly Feature  
Conducted by

Dr. J. H. T. ROBERTS, F.Inst.P.  
(Staff Consultant.)

which will be found much better. When it gets short, the solder strip may be "unwound" from the bobbin a little more.

#### Use of Grid Bias.

When discussing the question of anode current, I omitted to mention (although it is hardly necessary, as I have mentioned it before in these columns) that a great economy can frequently be effected by the use of a proper grid-bias battery. This

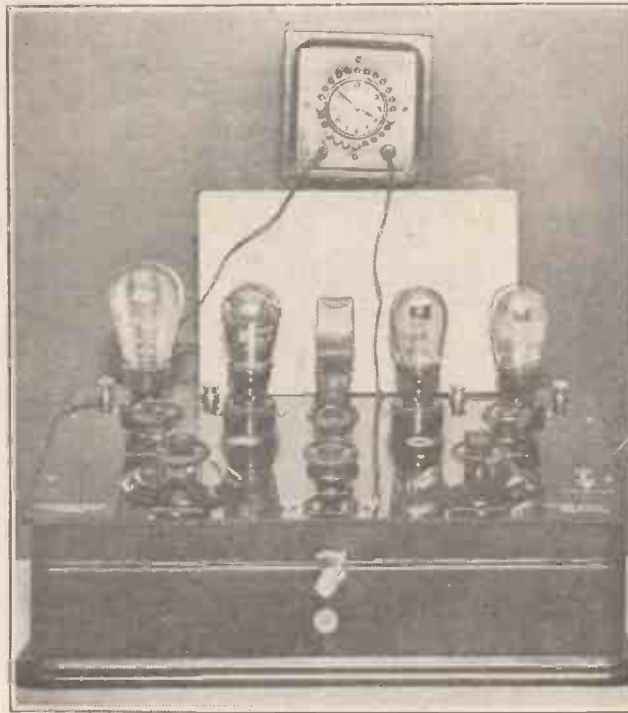

The "Selecton e," a novel device which automatically switches a set on and off at prearranged times.

latter battery costs practically nothing in upkeep, and yet it may have the effect of reducing the anode current to half or one-third the value it would otherwise have, and this not only without distortion, but usually with improvement in quality of reproduction.

#### "Sensitivity" of Loud Speakers.

Another matter which arises in the same connection is the question of the efficiency of the loud speaker; I am using the term "efficiency" here in the scientific sense, namely of the relation of output to input; perhaps a more readily understood term would be "sensitivity."

After all, the power which has to be delivered from the last valve of the set, to produce a given volume, depends upon the

sensitivity of the loud speaker; if the sensitivity be high, the power required will be correspondingly small and vice versa.

This question arises more particularly in relation to the cone type of loud speaker, where the sensitivity is generally much lower than in the case of the trumpet type. Many listeners prefer the cone type of speaker, notwithstanding the extra power input required, owing to its tonal qualities and the more even distribution of the reproduced sound.

To get really good volume from a cone speaker, I should say it was generally necessary to use a set giving a good power output, and a power valve in the last stage, with, of course, proper grid bias—the latter very important.

#### Effecting Reproductions.

I wonder how many amateurs have ever tried systematically the effect of placing the loud speaker in different positions in the room. If you have not done so, the simple experiment is one which is well worth trying. It should be remembered that the trumpet or "sound amplifier," as it is sometimes wrongly called, consists not merely of the actual metal or wood "horn" of the instrument itself, but also of the adjacent walls of the room, and it takes in further the surrounding objects near to the loud speaker. If the loud speaker be placed close in to a corner of the room, especially if the walls in the immediate vicinity are bare, it will generally be found that a much better reproduction (or at any rate a much better volume of reproduction) will be obtained.

Probably many readers have noticed also that the reproduction from the speaker varies from time to time, and varies again if the speaker be taken (with the set) to a neighbour's house. The latter effect simply bears out the statement made above with regard to the influence of the walls and surrounding objects.

The variation of the reproduction from time to time may, of course, be due to a great variety of causes. It is most likely to be due to variations in the voltage of the low and high-tension batteries, and may be due to variations in the valves and so on.

But it may be due, also, other things being equal, to variations in the temperature and humidity of the room. Everyone knows, for example, how different speech may sound in a church or large hall when empty and when filled with an audience. The difference is due partly to the fact that the audience prevents the sound from being reflected from the floor of the hall, partly to the fact that the sound is broken up in a special way by the large number of more or less regular-sized objects (the bodies of the members of the audience), and partly to the influence of the audience upon the temperature and (by their exhalations) upon the humidity of the air.

You will probably notice a difference even between the reproduction obtained during the evening, if there are several persons in the room, and the room is kept

(Continued on page 1171.)

**BROADCASTS BY 'TONE' & 'POWER'**  
*The 'Boon' Companions of Osram Valves*



**'TONE' & 'POWER'**  
**meet an Old Friend**

"Good evening, you two boys—you've been making a lot of noise lately," was LONG-LIFE'S greeting when he met our two inseparables the other evening.

"Hallo—LONG-LIFE!"—shouted POWER. "Why we'd almost forgotten all about you"—murmured TONE.

"Never forget old friends," said LONG-LIFE, perhaps a little hurt. "Remember, I gave my blessing to the first OSRAM VALVE made, and it's been with them ever since. That's just why you two chaps can keep going so long." And the three walked on together, plug in socket.

Invite the inseparables to your home to-night by buying

**Osram**  
**Valves**  
*for TONE & POWER*

*The G.E.C.—your guarantee*



**BRITISH  
MADE**

—  
For  
**2-v., 4-v. & 6-v.  
Accumulators  
and Dry Cells**

**CRYSTAL & 1-VALVE AMPLIFIER (L.F.)** In handsome polished cabinet, tested for use, 22/6; post 1/6. (With D.E. Valve, 30/-)

**OR COMPLETE SET:** Valve, H.T., L.F. Units, Aerial Equipment, 2X Coil, 45/11; post 2/-

**ASTOUNDING 2 Valve Amplifier in L.F. pillar, 25/11.** Amplifiers in or complete handsome cabinet with valves, polished box, H.T. and L.F. valve, 16/11. Units, 44/6. Carriage 1/6. Carriage 2/-

**KAY-RAY**

**S.L.F. CONDENSERS**  
LATEST MODEL  
READY.  
6/11  
OST 6d.

0003 6/11 each  
0005 7/11 each  
With 4 in. dial 7/11

**LOW LOSS SQUARE LAW**  
this variable Condenser is simply marvellous value. It cannot be equalled in price or quality.

0003 4/11 each  
0005 5/11 each  
By Post 5/11.

With **VERNIER** 1/- extra.  
**L.F. TRANSFORMERS.** Ferranti A.F.3, 25/-; A.F.4, 17/6; Eureka Concert, 25/-; Success (Black), 21/-; Royal 20/-; Ormond newest model, 15/6; Wates' Supra, 10/6. Croix 5-1, 3-1, 4/6. Marconi 'Ideal', all stages, 25/- each. G.A.V., 15/-; Pye, 22/6. Gambrell, 2 stages, 25/6. Ideal Junior, 18/6. R.I., 25/- Multi-Ratio, 25/-.

**FAILS IN STOCK FOR THE** LESTREE SIX, SOLODYNE, MEWFLIX, ELSTREEFIX, 1927 FIVE and ALL THE CHIEF CIRCUITS.

**CHOKES**—Cosmos H.F. 6/6; Lissen H.F. or L.F. 10/- each; Success L.F. or H.F. 10/- each; Bowyer Lowe H.F. with base, 9/-

**ORMOND SQUARE LAW LOW-LOSS.** 0005, 9/6; 0003, 8/6 (1/6 each less no vernier); Friction Geared, 0005, 15/-; 0003, 14/6; 00025, 13/6. Straght Line Frequency Friction Geared, 0005, 20/-; 00035, 19/6. S.L.F. 0005, 12/-; 00025, 11/-.

**D.E. VALVES.** Power, 2 volts, 9/11; 06, 2 volts, 6/11. Post 6d.

**RADIO MICRO VALVES.** 06, 3-v., 6/11; 25, 2-v., 6/11; Power, 3, 8/6; Power, 1, 9/11 (Power are 3.4 volts), Phillips, 4. Electrode, 4-pin for Underdyne, 8/11. Post 6d. each.

**ACCUMULATORS.** 2-v. 40, 7/11; 2-v. 60, 9/6; 2-v. 80, 12/6; 2-v. 100, 14/6; 4-v. 40, 13/11; 4-v. 60, 17/11; 4-v. 80, 26/6; 6-v. 60, 26/6; 6-v. 80, 35/6. ALSO another good make, 1/6 extra on each of above. Post 1/- each.

**CALL HERE FOR LISSÉN, BENJAMIN, RADIO-MICRO, COSMOS, MULLARD, EDISWAN, MARCONI, COSSOR, OSRAM, JACKSON'S (J.B.), DUBILIER, McMICHAEL, SUCCESS, BEARD & FITCH, BLUYER-LOWE, LEWCOCK, IGRANIC, EUREKA, ORMOND, UTILITY, FORMO, EDISON BELL, FERRANTI, R.I., POLAR, NEWEY, P.M., MAGNUM.** WE HAVE THE GOODS! CALL AND SEE US. ALL LINES IN DEMAND STOCKED. SPECIAL TERMS RADIO CLUBS, GENUINE EXPERIMENTERS. BE SURE YOU ARE AT RAYMOND'S!

**THIS MAGNIFICENT 2-VALVE SET (D.S.L.F.)** AS SHOWN, IN HANDSOME POLISHED AMERICAN TYPE CABINET, WITH 2 DULL EMITTER VALVES, TUNING COILS, 100V. H.T. L.T. AERIAL EQUIPMENT, LEADS, AND 25/- LOUD SPEAKER, TAX PAID. THE LOT **£5.5.0** Carr. and packing 5/-.

**GALLER'S COLUMN**  
NOT SENT BY POST.  
Terminals with N. and W. 1d.; Nickel, 1d.; Spade Tags, 6 a 1d. Soldering, 3d. doz. 156 Bushes, 1d. Screw Winder Plugs, 2d. 3d. 4d. pair. Plug and Socket, R. or B. 3d. Staples, 4 a 1d. Valve Pins, 2 a 1d. 4 or 2 B.A. Rods, 3d. 1b. Earth Tubes—Copper, 2/3; Climax, 5/-; Fine 7/22 Aerial, 100 ft., 1/11; Special Heavy weight, 2/3. Phosphor Bronze, 49 strands, 100 ft., 1/- (dimpled), Twin Flex R. & B., 12 yds., 1/4, 1/6, 2/-; Miniature Silk Twin Flex, 6 yds., 6d. Maroon Lighting Flex, 6 yds., 1d. Insulators, 2 for 1d. Tinned Copper, 1/16th sq. 1d. 2 ft. D.C.C. Wire, 1 lb. reel, 20s. 9d., 22g., 10d., 24g., 11d., 26g., 1/2, 28g., 1/11. Ebonite Grade 3/16th is 1d. sq. inch; 1 in. is 1d. sq. in. Stock sizes cheaper: 7 x 5, 1/3; 8 x 5, 1/3; 8 x 6, 1/3; 9 x 6, 1/11; 10 x 8, 3/-; 12 x 9, 4/-. Also cheaper quality for crystal sets. Special offer in Crystal Sets, 6/11, 7/6, 8/11, 9/6, 12/6. Also in enclosed cabinet, wonderful value, 18/11. AMERICAN Type Oak Cabinets, with base-board, take 12 x 5 ebonite, 10/6; 12 x 8, 11/6; 16 x 8, 16/11, 18/11. Any size in 3 days. Handsome panel switches, DPDT, 1/6; SPDT, 1/- (highest quality). Lightning Arrestors, 1/6. Wave length Permanent Det., 6d. Red Diamond Perm. Detector, 2/-; Liberty, 3/6; Brownie, 3/-; R.I. 6/-; Crystals, Shaw's Genuine Hermit, sealed 8d.; Neutron Wyray, 1/6; Dayzite, 2/6; Splendid enclosed Crystal Detectors on base, 1/-, 1/3, 1/6. Micro-meter, 1/9; Service do, 2/9 (with crystal), P. & E. Switches, 1/- Non-micro-phonous V.H. 1/3. Solid Rod Eb., 1/- Baseboard, 6d. 2-way Geared Coil Holders, 2/11, 3/11. Penton, Lotus, Polar, Newey stocked. Back of panel, W.L.L., 4/11; Kay Ray, 3/11. drills for 1-h. filing, 1/3. Phone Cords, 1/-, 1/3. L.S. do., 1/6. 1/9. H.T. and L.T. Leads, 4-way, 1/11. Our old friends ADICO Batteries, 60-volt (not one in a 1,000 has to be returned. I will change any faulty). Price 6/11; Adico, Eveready, Siemens, Hecsons, 60-v. and 100-v., all 1.5 Batteries here. (Columbia always stocked). Dr. Nesper L.S. Unit, Nickel, 14/11. Dr. Nesper De-Luxe Senior, 4,000 ohm Loud Speaker, 35/- Radio Micro "Safir," fine value, 22/6.

**STOCK IN JUSTIFIABLE 4,000 ohm Headphones (Nesper pattern), double leather headbands, 7/11 pr.**

**CALLERS: MAKE OUT YOUR LIST FOR A SPECIAL QUOTATION**



# The Tide of Progress Must be Served

As with King Canute, who of course failed utterly to stem the mighty tides, so will you sooner or later be unable to resist the tide of wireless progress represented by the substitution of "HART" "RAY" type High Tension Accumulators for Dry Batteries.

Actually more economical to operate than dry batteries over prolonged periods, "HART" "RAY" type High Tension Accumulators also effect an increase in volume and improvement in tone which are a revelation to new users.

# HART

THE BATTERY OF QUALITY

'RAY' TYPE H.T. ACCUMULATOR  
20-volt, 14/8 : 30-volt, 22/-

Any reasonable number of the above units can be utilised to build up the particular voltage desired.

## The Accumulator which makes Dry Batteries things of the Past

Write to Dept. "P.W." for full particulars and FREE illustrated booklet, "The Right Way to Use your Wireless Batteries"

**HART ACCUMULATOR Co., Ltd.**  
STRATFORD, LONDON, E.15.



Good!! Ad.

**K. RAYMOND**  
HOURS .. 9.15 to 7.45  
SATURDAY .. 9 to 8.45  
SUNDAY .. 11 to 1

**27 & 28a, LISLE STREET, LEICESTER SQUARE, W.C.2**  
Back of Daly's Theatre.  
Nearest Tube, Leicester Square.  
'Phone : Gerrard 4637.

# BROADCAST NOTES.

By OUR BROADCASTING CORRESPONDENTS.

Australia Day Programme—Glasgow Still Agitated—A Relaxed Censorship—Television and the B.B.C.—The Corporation and Patents.

## "My Programme." By the Super-Gipsy.

ON January 27th, Birmingham is likely to provide an S.B. novelty of unusual interest. This will take the form of a "My Programme" by a "super-gipsy," well-known in the Midlands and in Cornwall.

## Australia Day Programme.

Mr. Harold Williams and Miss Madge Titheradge will appear in the special Australia Day programme at London Station on January 26th.

## The Time-Signal Fuss.

The Glasgow agitation continues with greater and greater fury because of the intermittent character of the Greenwich time-signal service through London at 10 p.m. The B.B.C. has rightly declined to give way to such an irrational and artificial agitation, but has decided to put out the six dots regularly on London at 6.30 after the New Year. It will also put out Big Ben when possible at 9 p.m. But Glasgow has declined to accept the changes. Plans are in hand for a big campaign to stretch over the whole of next year if, in the interval, the six dots are not restored at 10 p.m. But the attempt to make the campaign nationally Scottish is failing. Other Scottish centres are not a bit interested, so Glasgow will be left to continue the struggle unaided.

## Yiddish Songs and Music.

In March there is to be a broadcast festival of Yiddish songs and music. The occasion will be one of the My Programme series by a Jew, possibly Jack Waller.

## Conrad's "Lord Jim."

An adaptation of this work for broadcasting by Cecil Lewis will be put out in February, S.B. from London. It is likely to be the first broadcast play to be accompanied by a libretto.

## National Anthem Complaints.

It is understood that there have been some complaints that the national anthem is not broadcast with sufficient frequency, and particularly that it is not the practice of the B.B.C. to put it out after operas. The practice followed is in line with that of the concert industry generally, and there is to be no change at present.

## A Relaxed Censorship.

A B.B.C. interview in a Sunday newspaper makes it clear for the first time that the people at Favoy Hill propose to do a great deal more of their own censorship, both of subjects and of matter, than has been the custom hitherto. It would not be possible to read this extension of authority into either the Charter or the new Licence; but it is possible to read it into statements made by the Postmaster-General in the House during the debate on the new Constitution of Broadcasting in this country. Sir William Mitchell Thompson declared that while he was not allowing the new authority

to begin any new talks policy at once, he was allowing them to interpret his general ruling, and that if this were successful, he would consider afresh the whole question of controversy and broadcasting in six months time. The new B.B.C. are no doubt alive to the extreme danger and delicacy of their position in this regard. Any mistakes, however trivial, will be exploited against them to the maximum. Interested parties will see to it that all possible objections to revision at the end of six months are pressed both in Parliament and in the country. It would appear probable, however, that a measure of controversy will be introduced into the programmes to the general satisfaction of the majority of listeners.

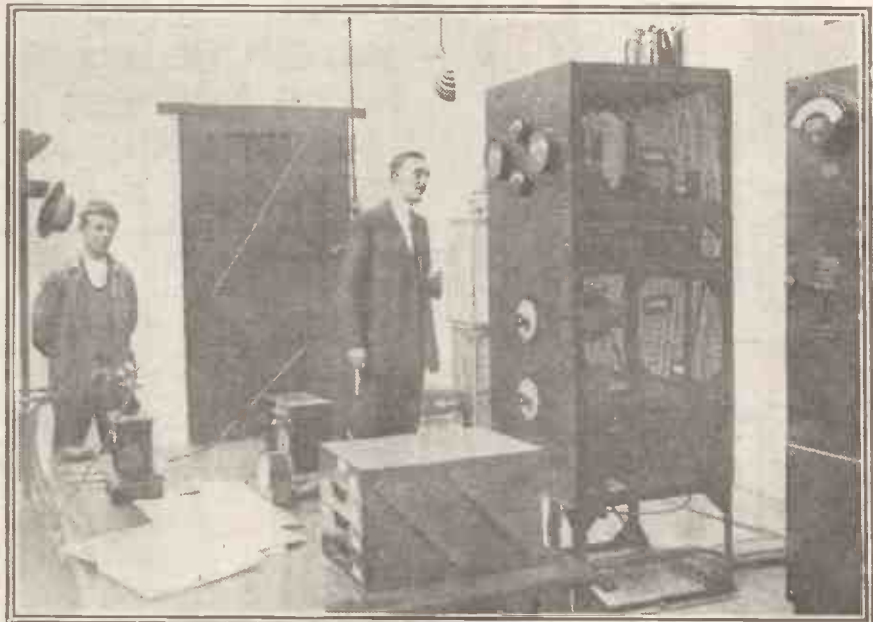

The control panels at the Summer Lane Power Station, Birmingham, where the broadcasting station is situated.

## Television and the B.B.C.

Some of the promoters of television have been nursing a grievance against the old B.B.C. for its apparent reluctance to cooperate with them. This was due to instructions from the Post Office, which took the view that the new B.B.C. should be left to determine the brand of television it wished to exploit, and that any prior commitment by the expiring Company might be regretted. It follows, therefore, that one of the first problems to be solved under the new regime is that of television. To what extent will the new B.B.C. cooperate, and with which particular system of television? It is understood that there are six applicants, each of which claims the ascendancy over his competitors. Two of these are from Germany, and one from Austria. Naturally the television company that gets B.B.C. backing will gain enormously in prestige and credit. The task of settling this problem is by no means an easy one. There is always the danger

of the introduction of an undue proportion of the purely commercial element without regard for the merits of the invention. It may well be that the Corporation will find itself unable to take on any of the existing methods and will evolve something new on its own. There is a good deal to be said for independent effort as long as patents are safeguarded.

## The Corporations and Patents.

Under the Broadcasting Company the manufacturers waived their rights to patent royalties in transmitting apparatus. This was only natural in view of the fact that the Company was made up of manufacturers. With the change over to the Corporation the position is different. The manufacturers no longer have any voice on the Board of the Broadcasting Authority. Then again, it is generally known that the new B.B.C. is to have a good deal more licence revenue than its predecessor was allowed. Consideration of this kind induced one section of trade opinion to advocate a policy of applying the screw to the new authority in the matter of patent royalties and fees. After some anxious moments, counsels of moderation

prevailed, and a reasonable compromise has been reached. It is believed, however, that, by a curious paradox, the trade will get more direct return from the B.B.C. under the Corporation on which they are not represented than under the Company which they constituted. This means simply that the fees to be paid by the Corporation for royalties on patents will be considerably in excess of the guaranteed dividend of the old Company. Then again, the Corporation will be free to help the trade much more substantially than was possible before. But, of course, the basic fact is that with more funds and greater authority the Corporation can go on developing programmes, and making the service more and more attractive. This means more listeners, and therefore an expanding market for wireless goods and accessories. It is generally agreed among those who are best qualified to know that there will be a tremendous boom in wireless next autumn and winter.

# BROADCAST 'HUMOUR'



← JOKE McCRACK'EM  
 THE FAMOUS  
 MUSIC HALL COMEDIAN  
 - WHO FOR THE LAST TWENTY YEARS HAS BEEN  
 FACING AUDIENCES CONVULSED WITH LAUGHTER  
 AND APPLAUDING HIS "GAGS" — FACES THE  
 MICROPHONE FOR THE FIRST TIME.

STOCK  
 JOKE OF  
 BROADCASTING  
 HUMOURISTS

YOU'RE ALL  
 LOOKING  
 WELL THIS  
 EVENING

AFTER SPRINGING  
 HIS BEST GAG

S'MATTER WITH YOU?  
 -ALL SITTING ON YOUR  
 HANDS?



NAH THEN! KEEP  
 YOUR EGGS TO  
 YOURSELF !!!



CON SHAW.



# What Dynamic Curves Mean

By JOHN SCOTT-TAGGART, M.C., F.Inst.P., A.M.I.E.E.

It is several years now since we last published an article from the pen of Mr. Scott-Taggart in "Popular Wireless," and we take this opportunity of welcoming back an old and valued contributor. As our readers know, Mr. Scott-Taggart was recently chairman and managing director of Radio Press, Ltd., but with the sale of "Modern Wireless," "Wireless," and the "Wireless Constructor" to the Amalgamated Press, Ltd. (proprietors of "Popular Wireless"), Mr. Scott-Taggart entered the radio market as a valve manufacturer, and in his new sphere of activity we feel sure our readers will join with us in wishing him good luck and continued success.—The EDITOR.

THIS is, I believe, the first article published in any wireless paper dealing with the subject of dynamic characteristic curves. This is all the more difficult to understand when one appreciates that the word "dynamic" implies operating conditions as distinct from the sort of conditions one has been accustomed to arrange in a physical laboratory. After all, is it too much to ask that wireless apparatus should be designed, thought about, and tested under the actual conditions which exist in a wireless receiver?

Who would judge a motor-car merely by looking at it standing still? It is perfectly true, of course, that you could measure the bore of the cylinders and the length of the stroke and work out an h.p. figure, which would certainly be some guide to what the car could do, but if this were the only test of a motor-car all 12-h.p. cars would give the same results, whereas it is well known that there are no two engines alike.

In 1917, when I wrote what I believe was the first complete analysis of all the various kinds of characteristic curves which could be obtained from valves, there was practically no data available. Wireless, however, is now drifting from a mystery science into ordinary engineering, and while we once went by rule of thumb we now design scientifically and with absolute precision.

### The Usual Method.

The great mistake which we have tended to make in considering the three-electrode valve is that we have been inclined to forget that there is a loud speaker, a transformer, a choke, a resistance or other apparatus having "impedance," in the anode circuit. When we draw a characteristic curve of a valve we use an arrangement something like that shown in Fig. 1. The valve has been connected in its anode circuit a milliammeter M, of negligible resistance, and a high-tension battery B2, which may be adjusted from zero to, say, 120 volts. The grid circuit of the valve contains a battery B3 and a high resistance R2, the middle of which is connected to the grid G of the valve. A sliding contact Y is connected to the negative side of the filament

accumulator B1. By moving Y above or below the middle point X, we can give the grid of the valve any positive or negative voltage which we may desire.

The usual way of taking a characteristic curve is to adjust the high-tension voltage to the right value, and then to regulate the sliding contact Y until the grid is so negative that it cuts off the anode current as indicated by the milliammeter M. The sliding contact Y is then gradually moved one volt at a time, and the rise in anode current is measured.

It is not nowadays customary to carry the grid potential more than a few volts positive, be-

An airship designer might speak of an airship of the non-dirigible type (called "blimps" during the war) as having a certain static shape. If, however, the shape of the airship were taken when it was travelling at 60 miles an hour it would be found that it was considerably different, owing to the air pressure and the new strains set up by its movement. Its new shape might be called its "dynamic" shape, although if the airship were brought down to ground it would once more resume its static shape. It must be obvious that the designer of the airship would have to have regard to what happened in the air when the airship was travelling at its maximum speed.

Much the same thing applies to valves, and I would like to ask the beginner who is reading this to answer the following questions:

Look at the curve ABCD. Suppose we give the grid a negative potential of -8 volts, so that we are now working the valve at the point C. What would happen if the grid of the valve were influenced by a very strong signal which varied the grid potential above and below



A recent photograph of John Scott-Taggart. Further articles by him will appear from time to time in "Popular Wireless."

cause in actual practice we do not use valves with a large positive grid bias. Nevertheless, even to this day it is quite common to find characteristic curves being given by valve manufacturers which show the conditions when the grid is perhaps as much as 10 volts positive. The majority of valve makers, however, realise that the only part of the characteristic curve which is of much interest is that lying to the left of what we call the grid zero ordinate—i.e. the straight vertical line which passes through zero grid volts.

### What Happens in Practice.

I have drawn in Fig. 2 the kind of curve which you get with a super-power valve, as is used in the last stage of a receiver to give pure and, if necessary, very loud reproduction. This curve ABCD is what is called a static curve; the word static implies that it is obtained by the means illustrated in

- 8 volts by an amount of 12 volts? You will probably say that the anode current would vary during the positive half-cycle from 12 milliamperes up to 27 milliamperes and back again to 12 milliamperes. You would also probably say that the negative half-cycle would change the anode current from 12 milliamperes down to 1 milliamperes and back again to 12.

As a matter of fact this does not happen at all in practice in an actual set. While the normal anode current is 12 milliamperes, the 12-volt positive half-cycle may only increase the anode current to 14 milliamperes, while the negative half-cycle at the maximum may only decrease the anode current to 10 milliamperes.

This may seem very astounding to the student who has been accustomed to look at the characteristic curve of the valve as being the relationship between anode current and grid volts on the static basis.

(Continued on next page.)

# WHAT DYNAMIC CURVES MEAN.

(Continued from previous page.)

While Fig. 2 shows the characteristic curve of the three-electrode valve containing a simple measuring instrument, such as the milliammeter, in the anode circuit, yet the Fig. 3 curve shows the dynamic characteristic curve of the valve under certain actual operating conditions.

### Surprising Results.

The example I have given is one where a loud speaker of 20,000 ohms impedance (not

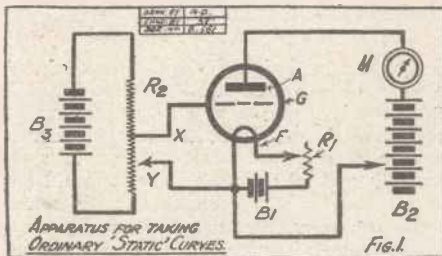

20,000 ohms resistance) is included in the anode circuit of the valve, and it will be seen that the fluctuation in anode current around the normal value 12 milliamperes is only about 1/7th of that which you would expect by looking at the characteristic curve.

Let me ask you another question. If signals applied to the grid of a valve were

very strong, say 18 volts (and in point of fact, the Elstree Laboratories have recently shown that an 18-volt grid swing is by no means extraordinary), you will probably think that the 18 volts negative added to the existing negative 8 volts on the grid will bring the operating point on the curve ABCD beyond the point A. In other words, you would expect the anode current to fall to zero, and that as you are working beyond the bend of the characteristic curve, and therefore no longer on what is generally known as the steep straight portion, distortion would result.

You would be wrong. As a matter of fact, if we assume that the loud speaker has an impedance of 20,000 ohms, then far from the anode current falling to zero as one would expect from the curve ABCD, the anode current at -26 volts, which is the -18 added to the existing -8 volts, will produce an anode current of as much as 9 milliamperes, and, instead of distortion, perfectly good reproduction will be obtained.

### Ordinary Characteristic Curves.

These are extraordinary facts to the student who does not appreciate dynamic curves, and shows how utterly fallacious it is to judge of how a valve will operate by looking at its static characteristic curve. Far from an additional 18 volts negative cutting off the anode current, even 28 volts negative would not cut off the current passing between filament and anode, which even at this voltage would be higher than 8 milliamperes.

Why is it, then, that the ordinary published characteristic curves of valves are so unreliable? The reason is that the ordinary characteristic curve, while valuable as showing the theoretical possible amplification; ignores the fact that a piece of apparatus possessing impedance is in the anode circuit. In other words, a static characteristic curve is taken with a fixed anode voltage, and is so labelled—e.g. 100 volts. In the case of the dynamic curve, however, and in the case of an actual wireless receiving set, the anode voltage is never constant. The only thing which remains steady is the high tension voltage, which is a very different matter.

### The Dynamic Effect.

In practice, the grid potentials are fluctuating—due to the incoming signals. These produce variations of anode current which pass through the anode impedance (e.g., loud-speaker) and set up varying

potentials across it, thus causing continual changes in anode voltage.

Perhaps I can explain the dynamic effect better by referring the reader to Fig. 4, which shows a simple detector and note magnifier, in which a milliammeter M is included in the anode circuit of the second valve. This milliammeter should have a negligible resistance and impedance. We can, therefore, ignore any voltages which may be set up across the milliammeter, due to fluctuations in anode current produced by the incoming signals. We can regard the anode as being kept at the voltage of the high tension battery, B<sub>2</sub>, say 100 volts.

In a circuit of this kind, the anode current changes will be represented by the static characteristic curves of the valve, and the answer to the questions I gave will be what the average reader would expect, but who would even use a milliammeter in actual practice as a receiving device for wireless signals, even if it would respond quickly enough? Instead of the milliammeter, we

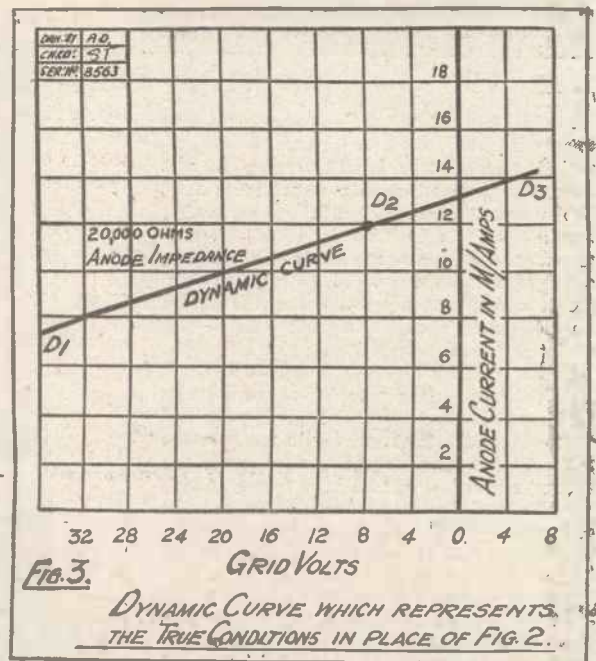
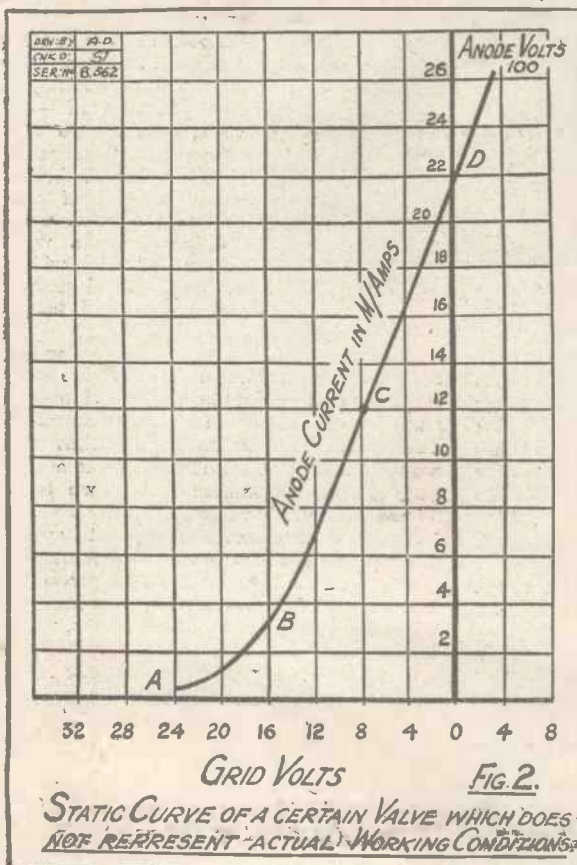

would, in practice, use a loud speaker, but this immediately introduces the question of impedance.

### Meaning of "Impedance."

Some readers may not be quite sure of the meaning of the word "impedance." A good rough and ready explanation is to say that it is the property of a circuit or piece of apparatus through which an alternating or fluctuating current is flowing, which corresponds to "resistance" to a direct current. If you pass a direct current through a resistance—e.g. an anode resistance of 100,000 ohms, a potential difference will be set up across this resistance and any change in the current flowing through it will set up changes in the potentials across the resistance. If, now, we take an inductance coil having negligible resistance, and pass a direct current through it, there will be no appreciable voltage set up across that inductance coil.

If, however, we pass an alternating current, such as the high-frequency signals from a broadcasting station, varying

(Continued on page 1152.)



## There has come a new battery to improve Radio

—resulting in a new power, a new smoothness in loud speaker reproduction, a new freshness of tone, a new naturalness, a new clearness, all at this moment uniting to give a new enjoyment of radio to the many thousands who have bought it.

A LISSEN New Process Battery—made as no other battery, with a secret in each which many battery makers would give much to know—jealously guarded and exclusive to LISSEN. All who use it are finding a new delight in their loud speakers because of a new and better utterance.

And it is not dear. LISSEN has put into operation a new direct-to-dealer policy of distribution which cuts out all wholesale profits and ensures, too, that every LISSEN battery is brimful of new energy when you put it into your set.

Your dealer sells this LISSEN battery. Ask him for "LISSEN New Process," and take no other.

LISSEN NEW PROCESS Battery is rated at 60 volts, but goes considerably over.

# 10/6

(Price would have been 13/- but for new policy.)



Hear your LISSENOLA working off this LISSEN battery to know what a good loud speaker and a good battery can do together.

LISSEN LTD., 8-16, FRIARS LANE,  
RICHMOND, SURREY.

Managing Director: Thomas N. Cole.

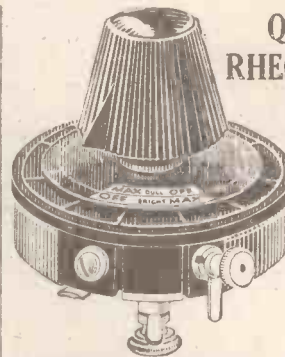

### QUALITY RHEOSTATS

Previously 4/-  
NOW 2/6

LISSEN quality—look how they are made—the wires cannot move and short circuit—the contact brush rides firmly yet smoothly—the heat-resisting former cannot soften—there are accessible terminals—and the combined knob and pointer will fit flush with the neat photo-engraved dial when mounted. Lastly, note the irresistible appeal of the price, made possible by our big production programme backed by our new direct-to-dealer distribution policy which cuts out all wholesale profits.

	Previously	NOW
LISSEN 7 ohms rheostat, patented	4/-	2/6
" 35 " " "	4/-	2/6
" Dual " " "	6/-	4/6
" Potentiometer, 400 ohms	4/6	2/6

Every One LISSEN One-Hole Fixing, of Course.  
Baseboard mounting type same prices as above.

### QUICK TO FIX AND HANDY TO USE

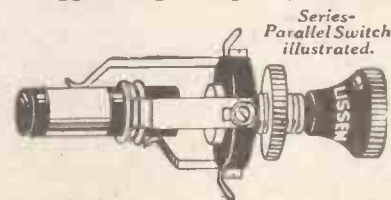

There is a LISSEN switch for everything you want a switch to do. Ask your dealer for the appropriate LISSEN switch, and you will get a real radio switch. LISSEN one-hole fixing explains itself.

	Previously	NOW
LISSEN 2-way	2/9	1/6
Series-parallel	3/9	2/6
Double Po'e, Double Throw	4/-	2/6
Key Switch	2/3	1/6

### A VALVE HOLDER FOR CLEARER, BETTER SIGNALS

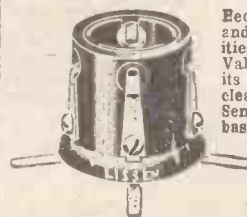

Because of its low loss and low capacity qualities, the LISSEN Valve Holder plays its part in getting clearer, louder signals. Sent out ready for baseboard mounting, as shown, it can also be used for panel mounting by bending the springs straight.

LISSEN VALVE HOLDER (Patented).  
Previously 1/8 NOW 1/- Each

IMPORTANT TO THE TRADE.—Retailers who have not already been notified of our new direct-to-dealer policy of distribution should, in their own interests, communicate with us without delay. All orders must now be sent to us at Richmond, and not to usual wholesale factor.

## WHAT DYNAMIC CURVES MEAN.

(Continued from page 1150.)

potentials will be set up across the inductance. Anything which has inductance, such as a loud speaker, an iron-core transformer primary, a choke coil, a tuned anode circuit, a high-frequency transformer, etc., also has impedance. This impedance is measured in ohms just in the same way as is resistance, but the impedance of, say, a loud speaker is very much greater than its D.C. (direct current) resistance. The great point I would like you to note is that when you have a varying current, whether

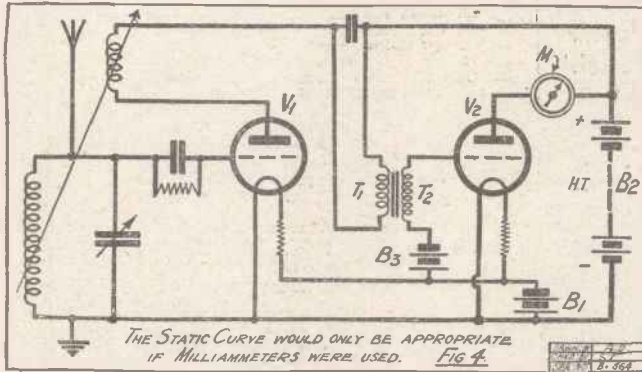

of high or low frequency, passing through an impedance, no matter what the nature of that impedance may be, you will get voltages set up across it.

To compare the effects of a milliammeter as against a loud speaker in the anode circuit of a low-frequency amplifying valve, I have drawn Figs. 5 and 6. Fig. 5, the milliammeter M, if suitably designed, will respond to any alternating signals of low frequency applied to the grid of the valve. It would, of course, only follow the anode current variations if the latter are of very low frequency. The milliammeter can be taken as having to all intents and purposes no impedance, so that the anode voltage of the valve remains the same as that of the high-tension battery. Under these conditions, although the anode voltage remains constant, the anode current may be fluctuating widely as the low-frequency potentials are applied to the grid of the valve. The anode current variations will now follow exactly what you would expect to get from the static characteristic curve. You would know exactly what was going to happen.

### Momentary Voltage Increases.

Now, instead of the milliammeter, let us put what we would actually use, for example, a loud speaker. In Fig. 6 I have shown the loud speaker represented by a choke coil because, after all, a loud speaker consists of an iron or steel core around which a large number of turns of wire are wound. It, therefore, acts electrically in the same way as a choke coil. When no signals are being received, the voltage of the anode will be the same as the voltage of the high-tension battery B<sub>2</sub>,

because the loud speaker may have a relatively small resistance compared to that of the valve. The moment signals, however, are applied to the grid of the valve, large anode current variations will take place, and since these are flowing through the "choking" loud speaker, varying potentials will be obtained across the loud speaker, and these may attain very high values. Let any amateur who is getting powerful signals on his get wet his fingers and place them across the terminals of the loud speaker. He will get strong shocks, indicating that big voltages are set up across the windings of his loud speaker. These shocks do not come from the high-tension battery. If you de-tune your signals so that practically nothing is heard in the loud speaker, you will get no shock at all. Tune in the signals again, and you may readily get as much as 50 volts set up across the loud-speaker windings.

This brings me to the point I wish to explain, namely, that under operating conditions, the anode voltage, instead of stopping at, say, 100 volts, is actually fluctuating all the time the signals are received; a sudden negative half cycle of the low-frequency current applied to the grid of the valve will cause an equally sudden decrease in anode current. This sudden change in the current flowing through the loud speaker will set up a potential difference across the loud speaker, causing the anode end of the loud speaker to be positive with respect to the bottom end, and the total potentials momentarily set up across the loud speaker may be, say, 5 volts, 10 volts or 15 volts, according to the voltage applied to the grid.

### A Predominating Factor.

Let us suppose that 15 volts has been set up across the loud speaker. This 15 volts will add itself to the 100 volts of the high-tension battery B<sub>2</sub>, and the anode will consequently momentarily increase its voltage to 115. It is consequently not a bit of use looking up on the static characteristic curve to see what effect the negative grid voltage would have on the anode current, because as we see in actual practice, the anode voltage does not remain steady, but increases by 15 volts.

The static characteristic curve would certainly show a drop in anode current due to the momentary negative potential on the grid, but in actual practice the drop in anode current would be very much less because while the grid is being made negative and thus tending to reduce the anode current, the anode voltage is actually rising and tends to increase the anode current. The effect of the negative potential on the grid always wins in the end and causes a decrease of anode current, but the rise and fall of anode current in the average receiver is negligible as compared with what the average student thinks when he looks at the static characteristic curve of a valve.

Now, let us suppose that instead of the

grid being given a negative potential, the incoming signal tends to add a positive potential to the existing negative bias on the grid of the valve. There will be an immediate tendency for the anode current to increase and the sudden increase of current through the loud speaker will this time

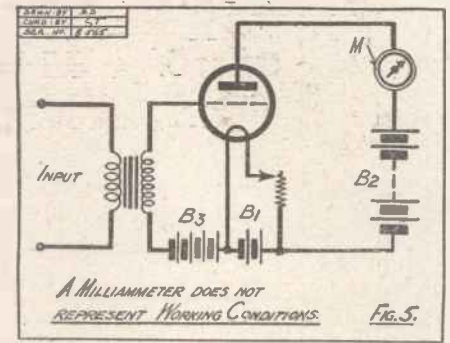

also set up a potential of, say, 15 volts across loud speaker, but this time the top end of loud speaker will be negative, and the bottom end will be positive.

### Momentary Decrease in Voltage.

This means that the high-tension battery will momentarily have in series with it what is equivalent to a 15-volt battery acting in the opposite direction. The effect, therefore, is to reduce the anode voltage to 85 volts. If the anode voltage had remained at its ordinary value of 100 volts, we would get quite a substantial increase of anode current, when the grid was made more positive, but since the anode voltage drops simultaneously, the increase of anode current is much less than one would expect. To find out the effect of a certain applied grid potential, we would have to look up not the static curve for 100 volts, but the static curve for 85 volts. If at another part of the incoming music, the grid voltage increased still more, the anode voltage would drop still lower to perhaps, say, 60 volts, and you would have to look up the 60 volt static curve and see what the anode current was.

### Changing the Operating Point.

If, however, you look at my dynamic curve of Fig. 3, I can tell you immediately what the anode current will be, assuming

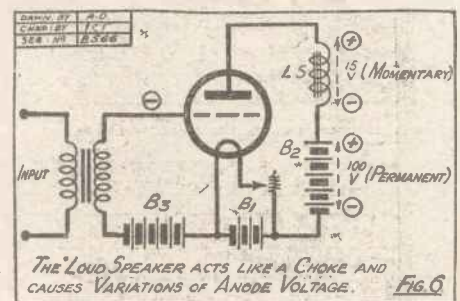

the loud speaker has an impedance of 20,000 ohms (the value being taken at a given frequency). This dynamic curve, it should be noted, only holds good for the definite conditions specified, namely, the anode voltage, the impedance and grid voltage. If you change the operating point, the dynamic curve will take up a different position.

In designing a valve for a given purpose, (Continued on page 1172.)



**I save 15/- in the £1  
by using 2-volt S.T.'s  
and these batteries.**

Do you want glorious volume and vivid clear-cut music? Of course you do, but why spend more on your valves and four times as much on upkeep expenses by using 6-volt valves? The S.T. 2-volt valves work better than most 6-volt valves, although they only take one-tenth of an ampere filament current, and will work excellently on only 60 volts high tension. All the arguments which have been brought forward in favour of point one valves apply to S.T.'s. All the arguments in favour of glowless filaments apply to the torodium filament common to all S.T. valves. But the real secret of the efficiency of the S.T.'s lies, as the laboratories of the "Wireless World" have stated, in the high amplification combined with the low impedance of the valve. The dynamic curves of the S.T. 2-volt valves explain what everyone finds in practice, that they give wonderful signal strength with smaller batteries than any other valve, and, of course, each valve is tested under the personal supervision of John Scott-Taggart, and its life is insured at Lloyds.

- S.T. 21 (H.F.) 0.1 amp. . . . . 14/-
- S.T. 22 (L.F. and Det.) 0.1 amp. 14/-
- S.T. 23 (Power) 0.15 amp. . . . . 18.6

S.T. Ltd., 2, Melbourne Place,  
Aldwych, London, W.C.2. (next  
to Australia House).



**L**OUND SPEAKERS are legion, their sponsors have been apt to write abundantly of qualities supreme. So-called mellowness, sweetness, clarity, wonderful depth, fidelity, etc., etc., are insufficient to truly describe the reception experienced by users of the Claritone.

*It is sufficient for them to know that they can sit back and enjoy*

*Ashley Radio*

Ashley Wireless Telephone Co. (1925), Ltd., 17, Finch Place, Falkland Street, Liverpool.

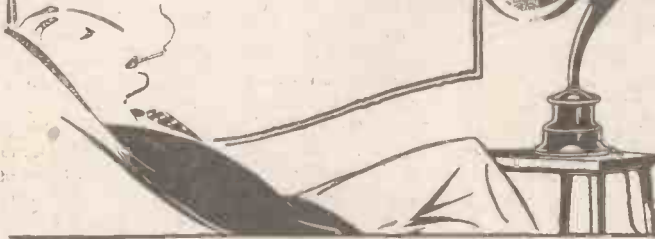

- W265 £5 0 0
- W267 £2 15 0
- W299 £12 10 0
- W287 £4 10 0
- W275 £6 0 0
- W277 £4 0 0

Described and illustrated in Booklet No. 71 obtainable from all dealers.

# CLARITONE

LOUD SPEAKERS & HEAD PHONES

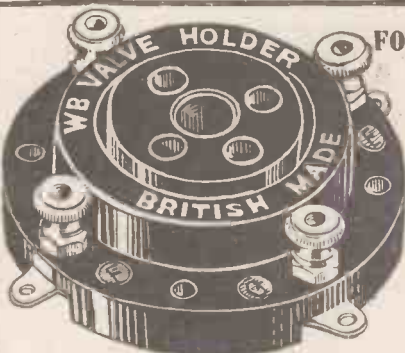

**FOR BEST RESULTS USE W.B. ANTI-PHONIC LOW LOSS VALVE HOLDERS**

PRICE Complete with Terminals

**2/3**

If unable to obtain from your dealer write direct. Manufactured by **WHITELEY, BONEHAM & CO., LTD.**, Duke Street, MANSFIELD, NOTTS.

## Geared Skeleton Coil Holder

Designed for maximum efficiency with a minimum of material at an astonishing price yet giving the same satisfaction as one at four times the cost.

The gear ratio of 4 to 1 permits 360 degrees of the knob and 90 degrees of the coil and enables a dial or pointer to be used in conjunction with the knob.

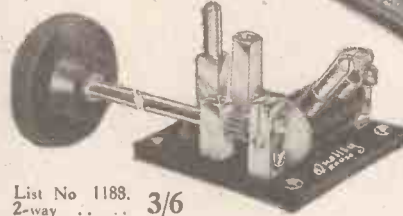

- List No 1188. 3/6
  - 2-way . . . . . 3/6
  - List No. 1198. 6/-
  - 3-way . . . . . 6/-
- Swings the Coil to and from the knob.  
Postage 3d. each.

- List No. 1186. 3/-
  - 2-way . . . . . 3/-
  - List No. 1196. 5/6
  - 3-way . . . . . 5/6
- Swings the Coil at right angles to the axis of handle.  
Postage 3d. each

## Quality RADIO

**GOSWELL ENGINEERING CO. LTD.**, 95-98, White Lion Street, London, N.1

*A statement of fact!*  
**DULIVAC VALVES**  
ARE THE BEST IN THE WORLD

They give greater power, purer tone, and more economical consumption at a lower cost.

- 1.8 volt, general purpose, 0.2 amps, 7/-
- 1.8 volt, Power, 0.3 amps, 13/-
- 4 volt, general purpose, .06 amps, 7/-
- 4 volt, Power, .25 amps, 13/-

From your dealer, or direct from **M. & A. WOLFF**, 9-15, Whitecross St., E.C.1. **7/- each**

**FORMO**  
EXPERIMENTAL CONDENSERS

**ULTRA LOW-LOSS**  
Straight Line Frequency Condenser  
Cone Bearings. Braced Vanes. Positive Collector. A real precision job. **7/6**  
Condenser only, 0003uf., .0005uf . . . . . **6/-**  
New Vernier Dial  
Reduction Ratio 16-1, No Backlash. **6/-**

**THE FORMO COMPANY**,  
Crown Works, Cricklewood, N.W.2  
Phone: Hampstead 1787.  
Manchester: Mr. J. B. Levee,  
23, Hartley St., Levenshulme.  
\*Phone: Heaton Moor 475

**"POPULAR WIRELESS" ADVERTISEMENT RATES**

WHOLE PAGE £40    QUARTER PAGE £10  
HALF PAGE - £20    EIGHTH PAGE - £5

Narrow Column Advts. (3 columns to page) per inch 30/-  
Minimum Space accepted - - - - half inch 15/-

NO SERIES DISCOUNTS. ALL COPY AND BLOCKS MUST BE IN HAND 11 DAYS BEFORE DATE OF ISSUE TO ENSURE PROOFS  
ADVERTISMENT COPY SUBJECT TO EDITORIAL APPROVAL

*All Communications respecting advertising must be made to*

**JOHN H. LILE LTD.**, 4, Ludgate Circus, London, E.C.4.  
Phone: City 7261.

# Facts and Fallacies About Condensers



Though one of the most familiar components in the construction of wireless sets, the variable condenser is often looked upon as more or less foolproof and chosen without any thought as to its suitability for the task it has to perform. In this article some of the chief misapprehensions concerning variable condensers are dispelled.

By G. P. KENDALL, B.Sc. (Assistant Technical Editor.)

NOT once but several times have I heard the question "Can I make my set more selective by using larger condensers?" It seems that this question of the relation between critical adjustment and true selectivity is one apt to confuse the comparative beginner, and it is in hopes of clearing up this point and certain other similar ones that this article is being written.

## What is Selectivity?

Let us first try and get a clear idea of what we really mean by selectivity. Now, it is a very common mistake indeed to imagine that to estimate the selectivity of a set it is only necessary to note by how many degrees it has to be detuned before the local station is cut out, and one often hears proud constructors boast that they can "cut out 2 L O in five degrees."

The next moment, however, one may hear the same person confess that the set is rather critical to operate, because the stations are somewhat bunched together on the dials!

What that really means, of course, is that he is using large condensers with which a small movement of the dials causes a relatively great change of capacity, and hence of tuning. Consequently, when he detunes by five degrees he is really altering the tuning by quite a large amount, and it is no great credit to the set that the local station should disappear.

Evidently, we need some standard of comparison of selectivity which does not depend upon a purely arbitrary criterion, such as the meaningless graduations on a condenser. All this may sound a "twice-told tale" to some of my readers, but I must crave their patience for a while, with the assurance that the point really deserves a certain emphasis.

We shall probably achieve something nearer to what we want by thinking of a change of wave-length rather than a change of dial reading. For example, if we discovered by means of a wave-meter that one set had to be detuned by fifteen metres before the local station disappeared, whereas another only required a change of tuning of ten metres to achieve the same result, then it would at once be obvious which was truly the more selective receiver.

Evidently, then, it is useless to pay much attention to the change in dial readings required to cut out the local station, because the true guide to the selectivity of the set is the change of wave-length (more correctly, frequency) required to produce that effect. Now, a given change of wave-length will

require quite different alterations of dial reading according to circumstances. For example, a bigger condenser means smaller changes of reading, yet the apparent increase in sharpness of tuning thereby obtained is entirely illusory, and the set is not really more selective than before. Again, with the old straight-line-capacity condenser small changes of dial reading meant large changes of tuning at the lower end of the scale, while the opposite was true at the upper end of the scale.

Finally, we have the confusing effect of the nature of the circuit in which the condenser is used. Thus, if two exactly similar

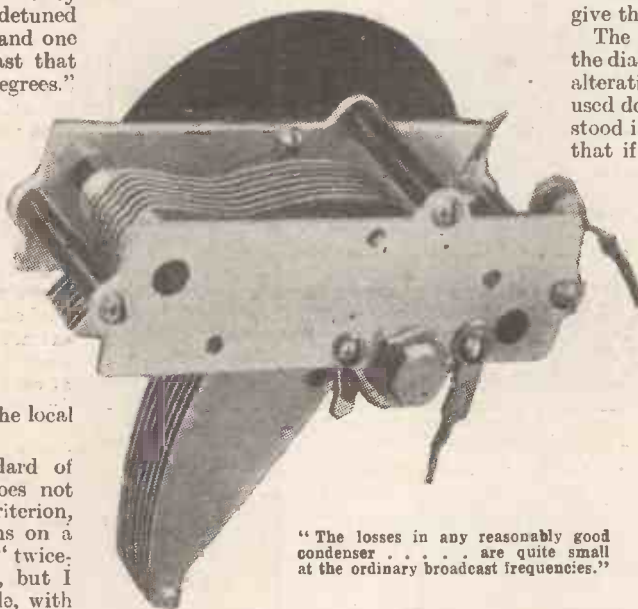

"The losses in any reasonably good condenser . . . are quite small at the ordinary broadcast frequencies."

condensers are employed in different circuits (e.g. one in the aerial circuit and the other in a tuned anode) to produce the same wave-length change quite different alterations of dial reading will be needed.

## Size and Selectivity.

I have not exhausted the list of factors which make dial-reading changes an unsatisfactory guide to selectivity, but I think the reader will now agree that they are entirely untrustworthy, and further will see that the actual size of tuning condenser employed has no effect upon real selectivity, but merely makes adjustment more or less critical.

Probably more nonsense has been written in advertisements and elsewhere about the square-law condenser than about any other wireless component except the L.F.

transformer. I have even seen it stated that a certain condenser would "eliminate interference between stations"—a truly extraordinary example of confused thinking!

What the square-law condenser really does, of course, is to give a more uniform variation of tuning for equal alterations of dial readings at any point on the scale, so that the set does not become very critical and difficult to operate at the lower readings. It may or may not give a uniform spacing out of stations round the dial, depending upon whether the stations are allocated waves equally spaced in metres or kilocycles. If the latter, of course, as at present, the straight-line-frequency condenser will give the more equal spacing-out.

The exact nature of the relation between the dial reading variation and the equivalent alteration in tuning when a square-law is used does not seem to be very clearly understood in some cases. I have heard it argued that if the alleged relation between metres and degrees holds good, then doubling the dial reading should double also the wave-length. For example, if a wave of 300 metres is received at 35 degrees, then at 70 degrees stations on 600 metres should be heard.

## The True Relation.

This is not the case, as everyone who has used such a condenser knows, and the fact is sometimes cited as an argument against the possibility of producing a true square-law condenser.

Such a contention, of course, indicates a lack of true understanding of the relationship involved, which is really only the simple one that equal changes of dial reading produce equal changes of wave-length. Thus, in practice it may be found that the change from 35 degrees to 70 degrees just quoted produces a wave-length change of, say, 80 metres. In this case, we should also find that an addition of a further 35 degrees to the dial reading, increasing it to 105 degrees, would add another 80 metres to the wave-length being received, and so on all round the dial with only slight discrepancies at certain points, notably at the extreme lower end of the scale.

When the low-loss craze first started the variable condenser was one of the principal components to be attacked, and we heard a great deal about the importance of reducing as much as possible the amount of dielectric material in the static field, and so on and so forth. Everyone got the

(Continued on page 1171.)

IT is a commonplace to repeat that it is bad policy in wireless matters to buy cheap and inferior articles. Anyone who has had experience, for example, of foreign valves of unknown characteristics, knows that he will get only a fraction of the value out of a thing of that kind that he will get out of a standard British article. But that is not the only way in which an attempt to save pence may result in the loss of pounds or shillings. Using components after they are worn out is no less foolish a practice.

#### Old Wire.

It is surprising, to take one instance, how often an experimenter will make shift with frayed flex, or with badly-fitting valve

## FALSE ECONOMY.

It does not often pay to use unguaranteed apparatus: the cheapest is rarely the best.

By HUMPHREY PURCELL.

condensers, too, should be examined very critically before being built into a set where tuning is a matter of delicacy. It is a hopeless task to catch elusive stations if there is any backlash about the movement of the spindle, or if the design of the condenser is such that hand-capacity effects are bad. A variable condenser in which there is risk of the moving vanes touching the fixed vanes may cause a lot of damage if used to control reaction in a circuit of the Reinartz type.

time and patience have any value at all, it will be found economical to renew them when they become blunt with wear or lose their temper.

## A NEW YEAR'S CAT'S-WHISKER.

By J. F. C.

WASN'T it Shakespeare who sagely remarked that there are sermons in stones, books in every brook, or something of that sort? What is more to the point, however, is that in many households at this time of the year there are innumerable potential cat's-whiskers, every one of them merely waiting patiently to be applied for that purpose.

Where, you ask? Look round. You remember those rows and festoons of tinsel decorations? Well, each one of those contains hundreds of small metallic strips, each nicely curved, and with just the small requisite amount of springiness in it which is demanded from any self-respecting cat's-whisker.

#### An Efficient Contact.

Carefully, therefore, and surreptitiously—that's a good word for the New Year—get hold of some of the aforesaid decorations and extract one of the small tinsel strips from among the multitude. Nip off a tiny piece at each end of the tinsel strip in order to remove any traces of varnish, and then cut each end into a V-shape. One end of the strip is now inserted into the cat's-whisker holder of the detector, the other making contact with the crystal, as seen in the accompanying illustration.

One further word, and this in the nature of a warning! If anybody misses the one single fragment of tinsel which you have thus surreptitiously extracted from the festive decorative property, don't blame me. I have merely suggested the idea after personal trial of its efficiency. It's for you to take the risk!



Mr. R. W. Emerson, of St. John's Wood, London, who recently won the world's championship for Radio construction at the Amsterdam Exhibition.

pins instead of wander plugs, although new articles would cost only a few coppers. A stray strand from a frayed wire may easily cause a short in the H.T., or may find its way to a stray strand from some other wire and result in burnt-out valves. One hates to throw away wire that seems to be still usable, but it is not a good policy to save up odd lengths of tinned copper from previous sets for use when next constructing a hook-up. Unless such wire is very carefully cleaned, good soldered connections will be almost impossible, and for the sake of sixpence the efficiency of the new set, as well as its appearance, may be spoiled.

#### Faulty Condensers.

Old fixed condensers, particularly those with paper dielectric, and old grid leaks should always be used with caution. They may be all right, but on the other hand they may not. A faulty condenser across the H.T. battery will speedily account for several times the cost of a new one, and a grid leak in which the resistance has increased by a few megohms will ruin the working of any set. Old variable

Worn-out rheostats will usually announce their faults for themselves, but it should be made a rule never to attempt to use an old compression-type rheostat with valves of the 3-volt class. Wire-wound rheostats are essential for valves of this kind.

#### Use Fresh Flux.

Another direction in which it is easy to be penny wise and pound foolish is in regard to tools. An old soldering iron, in which the copper bit has worn away to half its proper size, will not serve the constructor as well as a new tool. The chances of dry joints are considerably lessened if a large soldering iron is used, because the small bit is more liable to cool off in the middle of making a joint. Old and dirty flux, too, will not work as well as new flux.

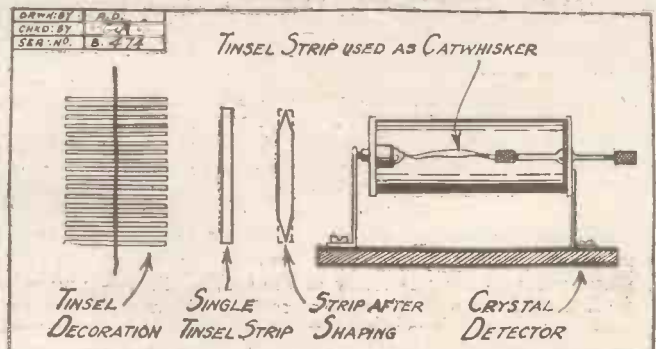



## THE **MH** SUPERSONIC BLOCK UNIT

The **MH** Supersonic Block Unit, "The Heart of the Super-Het," is designed by skilled radio engineers, and represents the entire supersonic part of the receiver. The ease with which a set can be built is remarkable.

Enthusiasts who purchase this block unit will be able to listen-in to far distant broadcast within half-an-hour of reaching home with their purchase.

Price **£6 : 6 : 0**

This price includes a five point Auto Oscillator from 275-600 metres, and also 1 **MH** H.F. Damper for controlling strength of local frequency.  
5 point Auto Oscillator from 550-2,000 metres 12/6 extra.

### SUPERSONIC RECEPTION ON SHORT WAVES

*A few points:—*

1. Simple Control.
2. Enormous H.F. Amplification.
3. Adaptable to any waves between 25 metres and 2,000 metres.

Detailed instructions and Blue Print of S.W. arrangement for reception of K D K A can be had on application.

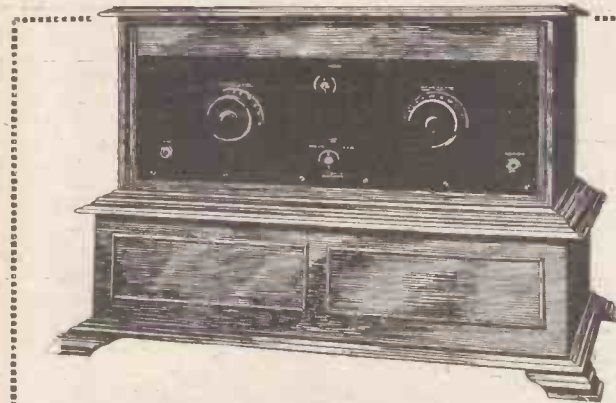

## THE **MH** 'DIMIC' FOUR

A highly efficient receiver, comprising 1 H.F. with Balancing Reactor, Detector, and 2 L.F., with a normal tuning range of 300 to 600, and 900 to 2,000 metres.

It is fitted with slow-motion condensers and is adaptable to wave-lengths outside its normal range by merely substituting suitable "Dimic" Coils.

*Particulars on application.*

Price **£15 : 15 : 0** (Royalties £2 : 10 : 0 extra.)

Demand of your Dealer **MH** Components. British, Best and Cheapest in the Long Run.

Telephone:  
SLOUGH  
441/442

# L.M<sup>c</sup> MICHAEL<sup>LTD</sup>

Manufacturers of Wireless and Scientific Apparatus  
WEXHAM ROAD, SLOUGH, BUCKS

IRISH AGENTS: B.N.B. WIRELESS, LTD., DUBLIN and BELFAST.

Telegrams:  
Radiether  
Slough.



THE "POPULAR WIRELESS" VALVE GUIDE—continued.

2-VOLT DETECTOR VALVES—continued.

Make of Valve	Type	Fil. Volts	Fil. Amp.	Anode Volts	Grid Bias	Impedance	Amp. Fac.	Price	Remarks
RADVACO.— Blitz Bros., 3, Lynton Rd., W.3.	S.B.8 S.B.6	1.0 1.8	0.06 0.15	30-100 30-100	—	22,500 40,000	9 10	4 3 2 10	General purpose General purpose
RATRACO.— Blitz Bros., 3, Lynton Rd., Horn Lane, Acton, W.3.	6 8	1.8 1.0	0.15 0.06	30-100 30-100	—	40,000 22,500	—	4 6 7 6	General purpose For portable sets
SEX-SIXTY.— Electron Co., Triumph Hse., Regent St., W.1.	S.S.21F. S.S.2A L.F.	2 1.8	0.3 0.1	30-80 30-80	—	60,000 18,000	17 8.5	14 0 14 0	High imp. det. Also general L.F.
S.T.— S.T. Ld., 2, Melbourne Place, W.C.2.	S.T.21 S.T.22	1.8 1.8	0.1 0.1	40-120 40-120	—	26,000 16,000	16 10	14 0 14 0	Det. foll. by res. comp. Also L.F. det. foll. by transformer
STANDARD.— Standard Telephones Co., Connaught Hse., Aldwych, W.C.2.	G.125 G.125A	1 1	0.25 0.25	60 50	—	25,000 25,000	6 8	14 0 14 0	G.P. (4-pth base) G.P. (bayonet fixing)

2-VOLT L.F. VALVES—including Power Valves.

Make of Valve	Type	Fil. Volts	Fil. Amp.	Anode Volts	Grid Bias	Impedance	Amp. Fac.	Price	Remarks
AMPLION.— A. Graham & Co., 25, Saville Row, W.1.	A.M.G. A.L. A.2/30L.	1.6-1.8 1.6-1.8 1.6-1.8	0.25 0.3 0.3	120 max. 120 max. 120	1½-0 1½-0 0-1½	18,000 7,500 70,000	9 7 8.5	14 0 14 0 14 0	General purpose L.S. valve High amp. for res. comp.
A.P.A.— Stephens & Well, 55, St. Eastern St., E.C.2.	13 9	1.8-2 1.8-2	0.08 0.25	30-90 50-160	0-7½	15,000 12,800	2 7	— —	General purpose L.F. valve
BRAM.— Lester & Marjms, 15-16, Theatres Inn, E.C.1.	D.E.2	1.8-2	0.12	20-90	1½-0	—	—	9 0	General purpose
BENJAMIN.— Benjamin Electric Co., Broadwood Works, Tottenham, N.17.	S.P.18G S.P.18B L.240	1.6-1.8 1.6-1.8 1.6-1.8	0.3 0.09 0.3	20-80 80-120 60-120	0-3 Nil 0-0	17,000 70,000 7,000-8,000	1.5-0 3.5-0 7.0	14 0 14 0 14 0	All stages except last Res. comp. (250,000-500,000 ohms) Last stage L.F.
B.T.H.— British Thomson-Houston Ltd., Crown Hse., Aldwych, W.C.2.	R.3	1.8	0.35	20-80	0-3	27,000	7.5	14 0	General purpose
B.S.A.— B.S.A. Radio Ltd., Small Heath, Birmingham.	C.125 G.125A G.225	0.85-1.1 0.85-1.1 1.7-2.2	0.25 0.25 0.28	30-60 30-60 30-60	0-3 0-3 1.5-7.5	25,000 25,000 15,000-19,000	5-6.5 5-6.5 8.5	14 0 14 0 14 0	General purpose General purpose Bayonet fixing General purpose valve
BURNEDEPT.— Burnside Wireless Ltd., Bedford St., W.C.2.	H.L.213 L.240	2.0 2.0	0.13 0.40	45-90 90-120	1.5-3 1.5-7.5	25,000 6,500	6.5 6.0	14 0 18 6	General purpose Power valve for last stage
C.A.C.— C.A.C. Valve Distrib. Co., 10, Ranginon St., E.C.3.	D.E.2 L.F.	1.05 2.0	0.25 0.4	40-90 60-120	0-1.5 0-0	18,500 10,000	5.25 5.75	7 6 15 0	Average L.F. Last stage power
CLEARTRON.— Cleartron Radio Co., Charing Cross, W.C.	C.T.15 C.T.15+ C.T.15	1.8-2.0 2.0 2.0	0.15 0.3 0.3	30-100 30-100 30-100	0-6 4-21 4-21	18,000 5,000 5,000	7.5 3.5 3.5	14 0 18 6 18 6	General purpose Last stage power
COMOS.— Metro-Vick Supplies Ltd., 155, Charing Cross Rd., W.C.2.	S.P.18G S.P.18B S.P.18H	1.6-1.8 1.6-1.8 1.6-1.8	0.3 0.09 0.09	20-80 80-120 80-120	0-3 Nil 0-0	17,000 70,000 7,000-8,000	15.0 35.0 7.0	14 0 14 0 14 0	All stages except last Res. comp. (250,000-500,000 ohms) Last stage L.F.
CONSOR.— A.C. Gossor Ltd., Aberdeenshire, Highbury Grove, N.	W.1 W.2 W.3 W.R.1 W.R.2 P.T.1 (B) P.T.1 (C) P.T.1 (E) Stentor 2 C.11 C.X.12	1.6-1.8 1.6-1.8 1.6-1.8 1.6-4.0 1.8 1.8 1.8 1.8 1.1 1.1	0.3 0.3 0.3 0.3 0.1 0.1 0.15 0.15 0.25 0.25	30-120 30-120 30-150 30-120 30-120 170-120 60-150 — — —	0-3 0-3 0-4.5 0-3 0-4.5 0-4.5 0-6 0-6 — — —	19,000 30,000 13,000 30,000 22,000 44,000 6,000 — — —	6.6 10.0 8.0 7.5 9.0 2.0 2.0 — — —	14 0 14 0 18 6 14 0 14 0 18 6 18 6 — — —	L.F. and det. Res. or choke coupl. Power L.F. and Det. res. cpl. (special res. in base) L.F. and det. Res. and choke L.F. Power amplification General purpose
CUNNINGHAM U.S.A.— Rothermel Comp. Ltd., 24-26, Maddox St., W.	C.11 C.X.12	1.1 1.1	0.25 0.25	— —	— —	— —	— —	10 0 10 0	General purpose

To be continued.



**The Truth,  
the whole  
Truth and  
nothing but  
the Truth.**



**I**F your set gives you poor quality, it is telling lies about the Broadcast Station. If it fails to transmit the low bass notes, it is concealing part of the truth. You want true reception, you are entitled to it. So is your family. There is a way to get the truth in wireless reception—

# FERRANTI

Ferranti Transformers can probably modernize that old set of yours or improve the reception of even a new one. Your dealer can help to install one or two. If you want to make the best of the power valve feeding the loud speaker, use Ferranti Transformers.

**TYPE A.F.3.**

**25/-** (In Irish Free State 32/6)

**TYPE A.F.4.**

**17/6** (In Irish Free State 23/-)

**FERRANTI, Ltd., Hollinwood, Lancashire.**

Ferranti, Ltd.,  
Bush House,  
London, W.C.2

Ferranti Electric, Limited,  
Toronto,  
Canada.

Ferranti, Incorporated,  
130 W. 42nd Street,  
New York.

**EVERY LOUDSPEAKER  
DESERVES  
MULLARD  
MASTER  
VALVES**

— Ask for —  
**Mullard P. M. Power Valves.**



Traders and manufacturers are invited to submit wireless sets and components to the "P.W." Technical Dept. for test. All tests are carried out with strict impartiality in the "P.W." Test room under the supervision of the Technical Editor, and the general reader is asked to note that this weekly article is also intended to provide a reliable and unbiased guide as to what to buy and what to avoid.—EDITOR.

**REPAIRS**

Headphones and loudspeakers rewound and remagnetized, H.F. and L.F. Transformers rewound and repaired **EQUAL TO NEW** by skilled mechanics on the latest automatic coil winding machines.

From **2/6**

**B. KIMBER, ALLEN & COY.,**  
39, BARGERY RD., CATFORD, LONDON, S.E.6.  
TRADE ENQUIRIES SOLICITED.

**EASY PAYMENTS**

Finest 2-valve amplifier set, including loud speaker, 120 H.T., D.E. valves, £7 10s.; or 18/9 down and 11 instalments of 15/-.

**CASH BARGAINS.**

Amplifiers, 17/6 and 21/-. 'Phones, Telefunken type, 7/9; Fr. T. Houston, 11/- Good H.T., 60-v., 5/9; Best 66-v., 6/9; or 41-v. (laboratory test), 4/- doz. Famous Metal Valves (French), 2-v. .2, 4/-; 2-v. .06, 6/9; 2-v. .5, Power, 8/9; 4-v. .06, 5/6. Straight line Condensers, 5/9; Ditto, 4" dial, 7/3. Transformers: Habana, 3/6; Radolys, 3/8; Fr. T. Houston, 8/3; Brunet, 2/9. Also Ferranti, Eureka, Forno, etc. Postage extra. Everything in Wireless reliable and cheap. Satisfaction or cash refunded.—Music Roll & Gramophone Records Exchange, 29, High St., Clapham, London, S.W.4.

**S.T. VALVES.**

**WE** are now able to supplement our preliminary remarks concerning S.T. valves by giving a detailed report. We will deal with the full range, taking each valve separately.

**S.T. 21:** Fil. volts, 1.8; fil. amps., .1; anode volts, 40-120; impedance, 26,000 ohms; amplification factor, 16; Price 14/-.

This is undoubtedly one of the best two-volt H.F. valves we have tested. It operates excellently with practically all methods of coupling, including the resistance-capacity system. And, as claimed, it also functions well as a detector, although for this we prefer the S.T. 22 in most receivers.

**S.T. 22:** Fil. volts, 1.8; fil. amps., .1; anode volts, 40-120; impedance, 16,000 ohms; amplification factor, 10. Price 14/-.

The characteristics of this economical little valve were, in our opinion, very

happily chosen, and enable it to work well in a "general purpose" capacity. Primarily it is, of course, a detector, and as such we have found it very good indeed. But its amplification factor and medium impedance render it most suitable for "first" L.F. stages, while yet leaving it quite happy in H.F. positions. In fact, it is most versatile, and in all its capacities gives a very good account of itself.

**S.T. 23:** Fil. volts, 1.8; fil. amps., .15; anode volts, 80-120; impedance, 6,000 ohms; amplification factor, 6. Price 18/6.

There is something about a little power valve like this that cannot fail to command admiration, even among those well versed in the potentialities of the modern "tube." Remembering that the S.T. 23 consumes but a trifle over one quarter of a watt it is indeed surprising that it can handle fairly hefty inputs and can deliver a volume

(Continued on page 1162.)



## Explore the Ether on Short Waves

**T**HE New Short Wave Receiver (20 to 200 meters) designed by Bowyer-Lowe for compactness, ease of operation and stability is without equal.

This remarkable production is another instance of the advancement in Radio by Bowyer-Lowe. The name guarantees its quality and perfect operation and its price is low because production is simplified and each component is standard. Send 1/- now for your copy of booklet with constructional details and blue print—and explore the ether from your arm chair.

Made by the Makers of the "Popular" Condenser.



Announcement  
by the Bowyer-Lowe Co.,

Ltd., Letchworth, Herts.

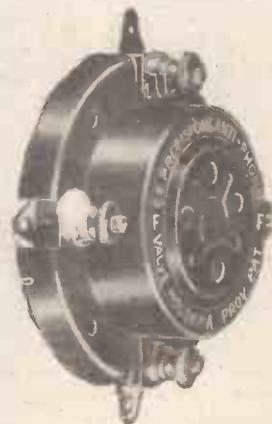

### a new and better valve holder!

**W**HEN we introduced the C.E. PRECISION RHEOSTAT, we thought that in quality, in efficiency and in price, this Component could not be beaten. Now that we have added the C.E. PRECISION FLOATING VALVE HOLDER, we find it even excels the former in these respects to such an extent, that the demand has been amazing and we are working to maximum capacity to keep pace with the orders.

Before purchasing other makes, just ask your dealer to show you ours. We are confident that after comparison they will have the preference.

**C.E. PRECISION FLOATING VALVE HOLDERS** anti-capacity, non-microphonic,

2/3 each  
**C.E. PRECISION RHEOSTATS**, efficient and velvety,  
50 and 30 ohms 3/- each,  
7 and 15 ohms 2/9 each.

Dual Rheostats and Potentiometers, 3/9 each.

**C.E. PRECISION GRID-LEAK**, an entirely original and accurate component, 2/- each.



**FOR UTMOST  
C.E. PRECISION  
EFFICIENCY**

**C. EDE & CO., LTD., BYFLEET, SURREY**  
Telephone: Byfleet 226.      Telegrams: "Ceprecise, Byfleet."



**The name does not rotate**

The head does not come off.

The slot and nut eliminate soldering.

The finish is perfect throughout.

*Complete patent No. 248,921, 4th March, 1925, and registered designs.*

Standard Large Insulated Model (polished black bakelite), Type B, 9d. each. Popular Model (non-insulated), Type M, 6d. each.

28 different engravings stocked. Catalogue free on request.

# BELLING-LEE TERMINALS

Advt. of BELLING & LEE, Ltd., Queensway Works, Ponders End, Middlesex. E.P.S.14.

Gain satisfaction by using

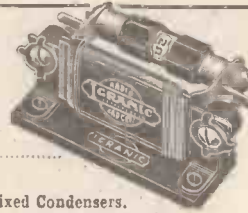

**IGRANIC FIXED CONDENSER AND GRID LEAK**

Made with scrupulous care which ensures accuracy and constancy in operation, Igranic Fixed Condensers are light in weight and can be supported on the wiring of a receiver. Igranic Fixed Grid Leaks are supplied with spring clips which permit of mounting in various ways.

**PRICES :**  
 Igranic Fixed Condensers.  
 .0001 to .002 mfd. Price 1 6 each.  
 .003 to .006 " " 2 - each.  
 Igranic Fixed Grid Leaks. Price 2/3 each. Insulated Mounting Base, as illustrated, 9d.

**IGRANIC VARIABLE GRID LEAK**

The Igranic Variable Grid Leak has a special resistance element and the smooth running contact ensures silent control and accurate resistance. Moulded Bakelite cover protects the resistance element and contact from dust and damage. Price, as illustrated 6/6, with plain knob 5/6.



WRITE FOR THE NEW IGRANIC CATALOGUE. LIST NO. R.42.

**IGRANIC ELECTRIC CO LTD**  
 149, QUEEN VICTORIA STREET, LONDON.  
 Works : BEDFORD.

"Money saved is Money earned—  
 So when your 'VALVES' get old or burned  
 Send them to us—and we, to you,  
 Will send them back 'MADE GOOD AS NEW.'"

Manufacturers of Auto-  
 veyors Thermionic Re-  
 lays, and new valves of  
 all types. Write for par-  
 ticulars and list price.

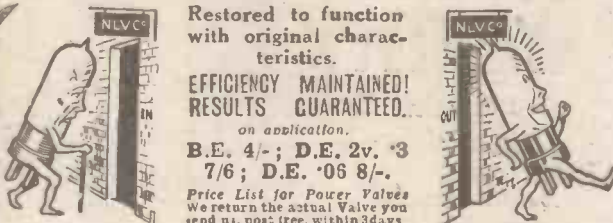

Restored to function with original characteristics.

**EFFICIENCY MAINTAINED! RESULTS GUARANTEED.**  
*on application.*

B.E. 4/-; D.E. 2v. 3/7/6; D.E. .06 8/-.

Price List for Power Valves  
 We return the actual Valve you send us, post free, within 3 days.

**THE NORTH LONDON VALVE CO., LTD.,**  
 22 1/2, Cazenove Road : Stoke Newington, N.16.  
 Liberal Discounts to Wireless Agents

# Weak Joints need Strong Treatment

An imperfect joint . . . a tiny leakage . . . gone are the chances of good, long-distance reception.

The Fluxite Soldering Set will fix all joints quickly, and for ever. No trouble . . . no mess . . . and so simple.

**FLUXITE SOLDERING SET—Complete 7/6**

All Hardware and Ironmongery Stores sell FLUXITE in tins, price 8d., 1/4 and 2/8. Another use for Fluxite—Hardening Tools and Case Hardening. Ask for leaflet on improved methods.

FLUXITE, Ltd. (Dept. 324), Rotherhithe, S.E.16.

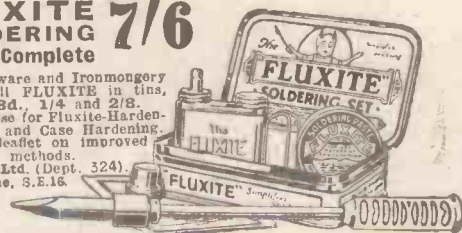

# FLUXITE

**CHEAPER THAN USING THE MAINS**

## WESTAM EVERLASTING H.T. ACCUMULATORS

Requires re-charging twice a year only.

Mr. Biggleswade, writes: "I have had one of your batteries in constant service on a four-valve set (including power valve) since the Wireless Exhibition, and it has stood up to it really well. They are the finest value possible at the price."

**6<sup>d</sup>. a Volt. 2 Amps.**

**ENTIRELY BRITISH. FULLY GUARANTEED.**

60 Volt Model - 30/-  
 20v. 10/6, 30v. 16/6, 90v. 45/-,  
 100v. 50/-, 120v. 60/-.

**SCRAP YOUR DRY BATTERY.**

All models, catalogues and spare parts from any dealer, or

Pat. No. 1008323

**WESTAM ACCUMULATORS, Clements Road, London, E.6.**

**IMPORTANT SALE OF  
HIGH-CLASS WIRELESS GOODS**

**GEORGE R. LIGHTFOOT**  
is instructed to **SELL BY AUCTION**  
(in lots to suit Private and Trade Buyers) on  
**THURSDAY, JANUARY 20th**  
at 11 a.m. precisely, at  
**No. 13, HIGH HOLBORN, W.C.**

A huge consignment of **NEW WIRELESS SETS** and **COMPONENTS**, consisting of Crystal Sets, 1, 2, 3 & 4 Valve "Anodon" Sets, 1 & 2 Valve Amplifiers, 2 & 3 Valve "Power Amplifiers," Threeflex Sets with Frame Aerials, "Amplivox" Combined Loud Speaker & Valve Amplifiers, 4 Valve "Drawing Room Cabinet" Receiver fitted Primax Loud Speaker.

All the above sets are manufactured by **THE STERLING TELEPHONE CO., LTD.**, in solid walnut cabinets.

600 "Sterling" Square Law Condensers (Laboratory Type) "Sterling" Frame Aerials, 50 Amplion Loud Speakers, 1000 "Igranite" Rheostats, "Igranite" Variometers, Coils, Unitune Couplers, L.F. & H.F. Transformers, Vernier Knobs and Dials. "Polar" 2, 3, 4 & 7 Valve Sets, Polar "Blok" Sets, 1000 "Polar" Micrometer & Variable Condensers, 2000 "Polar" Crystal Detectors, 600 "Violins" Loud Speaker Cabinets in mahogany, 3000 Coils Enamelled Bronze Aerial Wire, large quantities of Lead-in & Earth Wire, Single and Twin Flexibles, etc.

2000 New Accumulators (Plate & Block Type) by Fullers, Peto & Radford, Premier, etc., High Tension Accumulators, and a large Assortment of other Wireless Components. **CATALOGUES** from the Auctioneer, "Planet House," 5, ST. GEORGE'S RD., LONDON, S.E.1. Phone: Reliance 1777.

\*-----\*  
**APPARATUS TESTED.**  
(Continued from page 1160.)  
\*-----\*

that necessitates the use of a fairly large speaker. Used with S.T. 22's in detector and first L.F. stages, the S.T. 23, with a full 120 volts H.T. on its plate, can handle a six-volt grid swing (with at least six volts grid bias). This represents excellent volume, and, as our tests proved, this volume is obtainable with excellent "fullness" and purity. In cases we obtained very good results with the S.T.23 in detector positions.

S.T. 41: Fil. volts, 3-7; fil. amps., .1; anode volts, 40-120; impedance, 16,000 ohms; amplification factor, 13. Price 14/-.

The first of the four-volt range, we have found this valve to be very efficient in detector stages and good in first L.F. positions, but, although it is supposed to be suitable for H.F. work, we do not find it as good as the two-volt and six-volt S.T. 1's in this respect. Nevertheless, it is, in our opinion, well up to many that are on the market.

S.T. 42: fil. volts, 3-8; fil. amps., .1; anode volts, 40-120; impedance, 6,000 ohms; amplification factor, 6. Price 18/6.

An excellent power valve from every point of view. We have used the S.T. 42 in several sets for both first and second stages of L.F. amplification, and, with carefully adjusted grid bias and H.T., it "carried its weight" in every case without faltering.

S.T. 43: Fil volts, 3-8; fil. amps., .25; anode volts, 120; impedance, 4,000 ohms; amplification factor, 33-3. Price 22/6.

It is claimed that this is the only standard four-volt valve in the "super-power" valve class, and with the long "straight" section to its curve capable of accommodating a 12-volt "swing," it can truly be placed in that category. It can handle enormous inputs without the slightest roughness, and is an outstanding valve in an outstanding range.

S.T. 61: Fil. volts, 5-6; fil. amps., .1; anode volts, 50-120; impedance, 20,000 ohms; amplification factor, 20. Price 18/6.

This is an excellent H.F. and detector valve. It is sensitive and stable and, in our opinion, one of the most successful valves on the market for use with modern neutrodyne stages of H.F. amplification. But it is versatile, and can be used with equal success in resistance-capacity and other stages.

S.T. 62: Fil. volts, 5-6; fil. amps., .1; anode volts, 80-120; impedance, 6,000 ohms; amplification factor, 8-3. Price 18/6.

As the makers claim, this is a good all-round power valve, capable of handling respectable inputs.

S.T. 63: Fil. volts, 5-6; fil. amps., .25; anode volts, 120; impedance, 4,000 ohms; amplification factor, 3-33. Price 22/6.

Here we have a "super-power" valve which can occupy with credit the "last" valve-holder of a really large and powerful receiver. In a practical test we used an S.T. 63 in the last stage of the L.F. amplifier used with our 14-valve super-het. Usually two paralleled valves are employed, but the S.T. 63 was able to handle the entire input without distortion occurring. It is

(Continued on page 1164.)

**"Two in One"**  
**VALVE**

**MEANS DOUBLE POWER**  
For use in both H.T.-less and ordinary circuits, B.E., D.E. and '05, 10/6 to 14/-

Send card for Radio press reports and booklet. This valve can be used in any set without alteration and will give 50% to 150% increase in power.

**ANBLOY PRODUCTS,**  
Eton Works, East Dulwich, London, S.E.22.  
CALLERS: 36a, Forest Hill Road, East Dulwich.

**Safety**  **First!**

**BE PREPARED FOR -TORMS-  
WINTER and SUMMER-by**

**FIXING THE "EELEX" SAFETY SWITCH**

Comprising: Switch, Lightning Arrestor, Lead-in Tube and Weatherproof Cover.

The Eelex safety switch, the latest development in Safety First devices, enables the operator to earth the aerial outside the house. By pushing the knob the set is at once connected to the aerial. A pull instantly disconnects the set from the aerial system, automatically earthing the aerial. The spark gap provides ample means of by-passing any electrical discharge which may occur while set is in operation.



6 in. Tube  
PRICE  
**5/6**

12 in. tube 6/6. 18 in. tube, 7/6.

**KNIFE SWITCHES**

D.P.C./9 2/6 each.  
S.P.C./o 1/6 each.



S.P.C./o 1/- each



S.P.S.T. 1/- each.



Please Write for Entire List of Switches.

**MINIATURE KNIFE SWITCHES** for Panel Mounting as illustrated 1/6. S.P.C./o 1/-.

Write for New Eelex Catalogue P.W. 10

**J. J. EASTICK & SONS**

**EELEX HOUSE, 118, BUNHILL ROW, E.C.**  
Phone: Clerkenwell 9282/9283.

**Cut out the WORRY**

of uncertain High Tension Batteries.

Install one of

**CLARKE'S "ATLAS"**

**"B" BATTERY ELIMINATORS**

and lead the way to Brighter Radio

Models for A.C. & D.C. Current. Variable Voltages. Grid Bias. Full wave rectification.



Upkeep negligible. Silent and Efficient.

WE GUARANTEE every instrument.

We make them good Good judges make them famous

Manufacturers of the famous "Atlas" Plug-in Coils and Fixed and Variable Condensers; also sole manufacturers of the Super Selective-Reactor Formers.

H. Clarke & Co. (Mer.) Ltd., "Atlas" Works, Old Trafford, Manchester

# "EKCO" H.T. UNITS

## SCRAP DRY BATTERIES!

By obtaining H.T. Current from Electric Supply Mains (D.C. & A.C.) by just attaching Adaptor to Electric Light Lampholder!



12" X 6" X 7"  
MODEL V2A-A.C.

**SAFE!  
SILENT!  
SOUND!**

# "EKCO"

The  
"QUALITY"  
Unit



SIZE 6" X 6" X 3 1/2"  
MODEL V2A-D.C.

Illustrated Folder FREE.

UNITS TO SUIT } FROM **42/6**  
ALL SETS - - -

Obtainable from all the leading Wireless Stores or direct from:—

**E.K. COLE LTD.** (DEPT. A), 513, LONDON RD,  
WESTCLIFF ON-SEA.

<b>JACKS 4-POINT</b>  1-Hole Fixing 1/9	<b>S.L.F. CONDENSER</b>  With 4-in. dial. '0003 7/- '0005 7/3	<b>RELIABILITY CONDENSERS</b>  Mansbridge Mids. Type. '25, 1/6 1 mfs. 2/6 '5, 1/3 2 mfs. 3/6	<b>WIRELESS CABINETS</b> For Panels 7 in. High Width 8 in. Hinged Lid Oak 12 in. 17/-, 14 in. 17/5, 18 in. 18/6. Mahogany 1/- extra.	<b>DEWAR SWITCH</b>  12-Contact 2/6
---	---	--	---	---

**READ THIS LIST AND SAVE MONEY ON COMPONENTS**  
 RECENT REDUCTIONS.—Sterling '0005 Square Law Condensers with Vernier, 9/6; Geared 12/-; Minifloss, 15/-; '0025, 8/6; Geared, 10/6; Minifloss, 14/-; Marconi Automatic Detector, 2/6; Series Parallel Variometer, 10/6; Eddystone Absorbos Free, set of 3, 2/3; Benjamin S.P. Switch, 1/3; N.P. Clix Plug & Insulator, 2/4; Adaptor, 1/4; Socket, 2d.  
 LATEST COMPONENTS.—6-Way Coil Stand, 2/8; Colvern Low Loss Inductance Former, 5/-; Formo Straight Line '0005 Condenser, 7/6; Success, 18/6; Eureka, 15/6; Cylidon, 15/6; Lissen 60 v. H.T. New Process Battery, 10/6; Valve Vibrating Springs, 6d. set of 4.  
 EBONITE.—Any size cut; Clayton Brand, 1/4 in., 1d. sq. in.; 9 in. by 8, 2/2 1/2 in. by 9, 4/6; 15 in. by 9, 5/6; 3/16 in. 25 per cent. less. Paragon and Radion, 1d. per sq. in.  
 TERMINALS & ACCESSORIES.—Single W. Orms N.P. or Pol. Brass with nut and washer, 1/4; Phone and Castle type, 1d.; Double Mark, 3, 2d.; 4-way Phone Connector, 6d.; Pole-finding paper, 3d.; Fluxite, 8d.; Black Tape, 6d. per coil; 1/4 in. Empire Tape, 6d. dozen yards; Insulating tube, 3d. yard; Glazite, 1/2, 10 ft. coil; Shellac Varnish, 6d.; Mica 2 in. x 1 1/4 in. 4d. dozen; Chatterton's Compound, 9d.; Hand Drill, 3/6; Drill, 1/-.  
 INSULATORS.—Large Shell, 3d.; Reel or Ekr. id., Climax, 6d.; Ditto, with shock absorbers, 3/- pr.; Gal. Pulleys, 4d.; 100 ft. Gal. Straining Wire, 1/6; Straining Poles, 6d.  
 ACCUMULATORS.—Exide, D.T.G., 4/6; D.F.G., 8/6; W.J., 20 v., H.T. type, 18/-; Oldham H.T., 10d. per volt, complete; Duros, 20 v., 11/-; 10 v., 5/6; Repairing Outfit, 1/6.  
 BATTERIES.—Reliability, 90 v., 11/-; 60 v., 7/6; 36 v., 4/6; 15 v., 1/10; Ever Ready, Siemens, Hellesen, 100 v., 21/-; 66 v., 12/5; 36 v., 7/6; Flashlight Battery Cases for 14 Batts., 3/6; 41 v. Batts., 4d.; 60 v. Unequalled, 6/6; Wan. Plugs, 1/4; Clix Type, 2d.  
 CONDENSERS.—Low Loss, Square Law, with knob and dial, '0005, 8/6; with Vernier Blade, 1/- extra; Twin '0005, for Ectree Six, unequalled valve, 5/6; Cylidon Twin for ditto, 2/1/6; Ormond, J.B. Utility, Sterling, Polar, Formo, Igranite, G.E.C., Var. in all capacities. Neutrodyne type, Ormond, 2/-; Colvern 3/6; Gambriel, 5/6.  
 FIXED CONDENSERS.—Dubilier, Edison Bell, Lissen, Watmel, Mullard, McMichael, at advertised prices. Special Reliability Fallon—'0003 m.d. 2mg. Leak, 1/3; Cases only, 4d.  
 L.F. TRANSFORMERS.—R.I. Multi-Ratio, 25/-; Marconi Ideal, 25/-; Junior, 18/6; Peranti A.F.3, 25/-; A.F.4, 17/6; Formo, 10/6; H.T.O. Empire, 7/6; Croix 5 to 1, 6/-; Lissen new type, 8/6; Igranite, 16/-; Eureka Concert Grand, 25/-; No. 2, 21/-; Baby Grand, 15/-; Ormond, 15/-; Royal, 20/-; Success, All Black, 21/-; Silvertown, 21/-; G.R.C. 15/-; Brandes, 17/6; Burndept, 16/6; Special Value, 7/6; Modulation, 7/6.  
 HEADPHONES.—S.T.B., 15/-; Brown's "Type, 20/-; Reliability, 7/6; Adjustable, 8/-; Dr. Nesper, 12/11; T.M.C., 17/6; Western Electric, 20/-; all 4,000 ohms, Sullivan, 120 ohm Double Ex-Govt., New, 4/-; 120 ohm Single Phone, 2/6; Long Phone Cord, 1/-.  
 AERIALS.—100 ft. 1/4 in. copper tape, 1/9; 7/22's Bright, 2/3; Enamelled, 3/3; Electron, 1/2; Superior, 2/6; Mars, 9/6; Ashton Spreaders, 12/- per pair; O.V. complete, 2/6.  
 VALVE HOLDERS.—Anti-Phonic Benjamin, 2/9; Lotus, 2/3; with terminals, 2/6; Burndept, 2/9; Harle, 1/6; Reliability, unequalled, 2/-; all baseboard types, ord. ditto, 6d.; N.P. Valve Sockets, flush fitting, 1d.; Superior Panel Type, 6d.; All Ebonite, 10d.  
 VALVES.—"Radion" all types, Freila 2 volt, 3 amp., 4/11. All advertised makes stocked.  
 EXPERIMENTERS' PARCELS.—Accessories of Various Types, worth 20/-, post paid, 5/6.

Send for New RELIABILITY WIRELESS GUIDE No. 9. Free on Request Trade Supplied.

**J.H. TAYLOR & Co.**  
 4, RADIO HOUSE,  
 MACAULAY ST., HUDDERSFIELD.  
 Tel. 541. Grams: "THOROUGH" HUDDERSFIELD.

Orders 5/6 Value Carriage Paid. Under 5/6 2d. per 1/- for Packing, etc.

## YOUR set is not protected

HAVE YOU EVER FORGOTTEN TO SWITCH OFF?

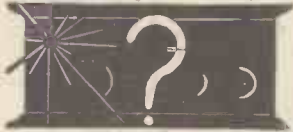

HAVE YOU EVER LEFT YOUR SET SWITCHED ON OVERNIGHT?

HAVE YOU EVER EXHAUSTED OR RUINED YOUR BATTERIES? THE "777" LUMINOUS (red) INDICATOR will prevent these costly mistakes. It is the Guardian of the Listener-in—The Sentinel of the Set.

A De-Luxe Component—Invaluable and Strikingly Effective. One-hole fixing. Fully enclosed. No alteration to existing wiring.

Model "A," Front of Panel Mount, 4 and 6 volt, 4/-  
 Model "B," Rear of Panel Mount, 4 and 6 volt, 5/-  
 Dimming Resistance. 61: State Voltage.

"777" RADIO COMPONENTS (SANDRIDGE),  
 Eastfield Road, Western Park, LEICESTER.

# VALCO MAGIC!

WILL MAKE YOUR BROKEN VALVE AS GOOD AS NEW.

ALL TYPES OF VALVES REPAIRED AT HALF LIST PRICES (minimum charge 5/-).

Satisfaction Guaranteed or Money Refunded.

An unsolicited testimonial from one of our many satisfied users will appear each week.

E. DEREHAM. 16/10/26.—"The Valves you repaired recently are working very satisfactorily, as you state, as good as new."—G.G.C.

Weco, S.P.'s and low capacity types not repairable. Minimum D.E. current 0.15 amps when repaired.

**VALCO LTD.,** Dept. "P.W.," TABOR GROVE,  
 WIMBLEDON, S.W.19.

**SECTION**

This diagram is a magnified section of the Watmel windings. Spotted area—interwoven cotton. Striped area—enamel insulation. Black area—wire. Expensive new machines have been installed to wind the WATMEL Auto Choke this way.

**Watmel**  
**AUTO-CHOKE**  
 18/6

THE WATMEL WIRELESS CO. LTD., 332a, Goswell Road, London, E.C.1. Telephone: Clerk-well 7990. Lancs, Yorks, and Cheshire Representative: Mr. J.B. Levea, 23, Hartley Street, Levenshulme, Manchester. Telephone: 476 Heaton Moor.

**CUT THIS OUT FOR CABINETS**

and post to us for FREE list illustrating Cabinets as shown in "Popular Wireless," etc., etc., and for our additional Bulletin No. 1.

NAME .....

ADDRESS .....

(Write in block letters, please.)

**CARRINGTON Mfg. Co., Ltd.**  
 18-20, Normans Buildings,  
 Mitchell St., Central St., E.C.1.  
 Telephone: Clerkenwell 6903.  
 Trade enquiries especially invited.

EXPERTS IN RADIO

SEE FOR YOURSELF

See and hear for yourself. Go to a Brandes Dealer and look over the Brandes range. Get him to demonstrate and make your own comparisons. Not many instruments of such good class are so reasonably priced. Observe that the cost of the Brandola is considerably reduced



THE BRANDOLA

Specially built to bring greater volume with minimum current input and exceptional clarity over the full frequency range. A large diaphragm gives new rounded fullness to the low registers, and new clarified lightness to the high. Reproduction controlled by a thumb screw on the base. Polished walnut plinth with electro-plated fittings. Height 26 ins., bell 12 ins. **75/-**



THE TABLE-TALKER

The new goose-neck design is the result of research in radio acoustics, which definitely establishes its value in relation to the diaphragm fitted. Patent material used in the construction of the horn eliminates metallic harshness. Volume and sensitivity controlled with small lever located at the rear of the base. Elegantly shaped, tasteful neutral brown finish, felt-padded base. Height 18 ins., bell 10 ins. **30/-**

Brandes

From any reputable Dealer

Brandes Limited, 296 Regent Street, London, W1

ACOUSTICS SINCE 1908

APPARATUS TESTED.

(Continued from page 1162.)

undoubtedly an excellent valve, and one that should appeal strongly to all owners of multi-valve receivers.

In conclusion, just a few general remarks. None of the S.T. valves is microphonic, and all are very robust in construction. We particularly like the absence of visible connections to their pins, these being cleanly mounted in well-polished and distinctive bases. The characteristics of the whole range were checked, and found to be as stated.

A further feature that deserves commendation is the uniformity of the S.T. range. Messrs. S. T. have started off with a comprehensive assembly, which in its regularity of classification cannot cause the slightest confusion in the mind of the veriest tyro.

The range is more comprehensive than it would appear to be at first sight, and with nine valves practically every possible receiving set requirement can be covered.

The result is that throughout all three voltage ranges a team of S.T.'s can be chosen that will operate with excellent results in almost every type of set, from a "stunt" two-valver to a big "multi."

We have no hesitation whatever in recommending S.T. valves to our readers. They are economical, reliable, and, judging by the several samples of each type we have tested, absolutely consistent.

BECO ROSE-BOWL LOUD SPEAKER.

We recently received a Beco Rose-bowl loud speaker for test. It is a handsome instrument, and actually can be used as a rose-bowl. In the appropriate part it holds the necessary water, while the conventional "grid" is provided to support the



The artistic loud speaker described in this column.

flowers. The reproducing element is situated in the base.

With or without water in the bowl this Beco gives very good results. Reproduction is full and mellow, and there is no directional effect in the sound projection or any tendency towards "blanketing." Although it is quite sensitive, the instrument can handle large inputs without signs of resonance.

In appearance, it is distinctly pleasing and forms a refreshing contrast to the conventional horn or disc type. This Beco is available in three styles of "finish": nickel-plate at £5 5s., antique bronze or oxidised silver at £5 17s. 6d. For an "art" production these prices are, in our opinion, very reasonable.

GRAVES  
2-VALVE  
LOUD SPEAKER BARGAIN.

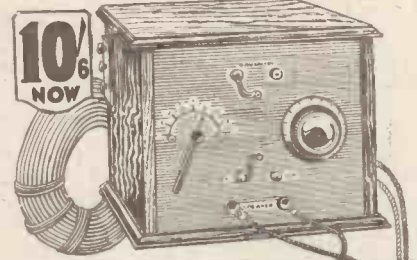

This highly efficient 2-Valve Loud-Speaker Set is the finest wireless value ever offered.

It gives a volume and quality of tone unattained by any instrument of a similar price and is the essence of simplicity. Fitted with coils covering all the British wave-lengths, including Daventry.

THE CABINET is of beautifully polished Oak, & all components are of the highest quality. Full Emitter Valves with patent valve holders, 6c. H.T. Battery, 2-volt accumulator and complete Aerial Outfit. LOUD SPEAKER of exclusive design with unique magnetic system and improved mica diaphragm. Price £7:17:6

TERMS: Our Bargain Price is for deferred payments. Send 10/6 now, & complete purchase in 14 monthly payments of 10/6. If you wish to pay cash, 5 per cent discount is allowed. Catalogue Post Free. Up-to-date Crystal & Valve sets at keenest prices. J. G. Graves Ltd. Sheffield

Fulllest Approval



PICKETT'S CABINETS

FOR BRITAIN'S BEST  
E. H. Anspach, 1st Prize Chicago, writes: "Was greatly helped by your splendid cabinet."  
R. W. Emerson, International Gold Medallist: "The workmanship and finish was all that could be desired."  
"Elstree Solodyne," "Drawing Room Five," and "All British Six," from 45/-.  
For every Receiver or your OWN sizes. Envelope of Cabinet Designs No. 23 FREE. Pickett's Cabinet (F.W.) Works, Bexleyheath.



WET H.T. BATTERIES  
BUY BRITISH. Complete Units 3/6 per doz. All goods BRITISH MADE by BRITISH LABOUR. Jars 1/3, Zincs 1/2, Sacs 1/6 per doz. Carriage and Packing extra. Trade inquiries invited.—Demon Battery Co., 59, Badlis Rd., Walthamstow, E. 17

REPAIRS

Headphones, Loudspeakers, and Transformers re-wound & reconditioned equal to new. AN UNSOLICITED TESTIMONIAL

"Thanks to the excellent manner in which it was reconditioned, the results achieved have been astounding. It is very gratifying to find a firm that really turns out a first-class job, as I have had very disappointing experiences with firms who have advertised as experts, and whose workmanship has been far from good."

Varley Magnet Co., Proprietors. Repairs Dept., Silver Bell Control, Woolwich, S. E. 18. Ltd.



Use the  
**CōPEX "POPULAR MODEL"**



**Copper Coil  
Screen and Base.**

THIS screen and base is made from high-grade copper—the best metal for screening coils. Terminals are arranged in such a manner that it is impossible to "short" them when replacing screen. Perfect electrical and self-cleaning contact. Screen and interchangeable 6-pin base (Patent No. 259,459). The "De-Luxe" (original model) is still available at 15/- 9/6

**BUILD THE "P.W."  
SAVOY THREE for  
£3 : 17 : 6**

This set, described in last week's issue, has been included in the famous PILOT Service, which definitely guarantees you good results. This service is fully described in the Pilot Manual (see below). Complete set of parts **£3 : 8 : 0**

Panel of Polished Ebonite, drilled **9 : 6**  
Polished Mahogany Cabinet and baseboard **£1 : 7 : 6**

**N.B.**—When complete set of parts and panels are purchased together, a Marconi Royalty of 12s. 6d. per valve must be remitted.

**KEYSTONE NEUTRALISING  
CONDENSERS**

Used by all the famous designers of modern sets. Beautifully made and thoroughly tested and guaranteed, these condensers are far superior to the many imitations now on the market.

Board Mounting Type 5/-  
Panel Mounting **6 3**  
Balancing Condenser similar to illustration but having 2 sets of fixed vanes **7 6**

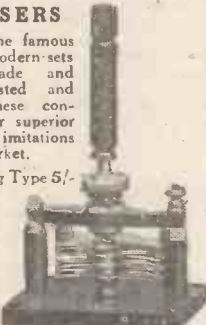

**NOTE.**—Send to-day for our fully illustrated catalogue of components and accessories. 44 pages of bargains. Post free 3d.

THE PILOT MANUAL contains illustrated details of a number of up-to-date sets which we thoroughly recommend. Much useful information on soldering, assembling, testing, etc., is also included. Post free **6d.**

**PETO-SCOTT Co., Ltd.,  
77, City Road, London, E.C.1**

Branches—LONDON: 62, High Holborn, W.C.1.  
WALTHAMSTOW: 230, Wood St. PLYMOUTH:  
4, Bank of England Place. LIVERPOOL: 4, Manchester St. P.S. 6962.

**BECOL**

Makers of the  
**ORIGINAL world-famous  
BECOL LOW LOSS FORMER**

Registered Trade Mark.



As used in sets that took the first four prizes at the 1926 "Manchester Evening Chronicle" Wireless Exhibition and the set that won the Gold Medal at the 1926 Amsterdam Exhibition.

Size: 3 inches diameter to outside of wings. Prices:  
6 inch lengths, 3/- (Postage 9d.);  
4 inch lengths, 2/- (Postage 6d.);  
3 inch lengths, 1/6 (Postage 6d.);  
Up to 36 in. lengths.

**NOTICE** :—Do not be put off with an imitation. Ask for BECOL and use the Former with a reputation.

Ebonite Rods, Tubes and Sheets. Panels guaranteed free from surface leakage.

Write for List "C."

**THE BRITISH EBONITE Co., Ltd., Hanwell, London, W.7.**

Don't forget to use

**GLAZITE**  
BRITISH MADE REGD.

**COLOURED CONNECTING WIRE**  
[ RED YELLOW BLUE BLACK WHITE and GREEN ]

Write for descriptive leaflet to  
The LONDON ELECTRIC WIRE CO & SMITHS LTD  
Playhouse Yard, Golden Lane, London, E.C.1.

Makers of Electric Wire  for over 40 years

JUDD.

For  
**NON-METALLIC  
LEAK-FREE  
SURFACE  
BRILLIANTLY  
POLISHED  
BLACK AND  
MAHOGANY  
DEAD TRUE  
STANDARD SIZES**  
**Ebonart**  
**RADIO PANELS  
STAND SUPREME**

PRICE LIST D 262 FROM  
REDFERN'S RUBBER WORKS,  
HYDE, CHESHIRE.

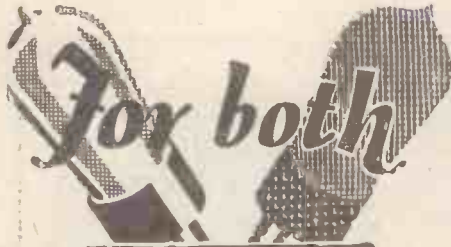

## bright & dull emitter valves

There are two windings on this one Rheostat—one of a resistance of 6 ohms and a continuation of this on to a 30 ohm strip winding. This has been specially made to meet the demand for a thoroughly reliable Rheostat covering needs of both bright and dull emitter valves. The resistance wire is wound on hard fibre strip under great tension and is immune from damage. The popular one-hole fixing method is provided and the terminals are conveniently placed. Contact arm has a smooth silky action. All metal parts nickel plated. Complete with ebonite combined knob and dial.

### The 'PEERLESS' DUAL RHEOSTAT

PRICE 3/9 EACH

From all dealers or direct from—

The Bedford Electrical & Radio Co Ltd  
22, Campbell Road, Bedford.



## RADIOTORIAL.

All Editorial Communications to be addressed to The Editor, POPULAR WIRELESS, The Fleetway House, Farringdon Street, London, E.C.4.

Editor:  
NORMAN EDWARDS, M.Inst.R.E., M.R.S.L., F.R.G.S.

Technical Editor:  
G. V. DOWDING, Grad.I.E.E.

Assistant Technical Editors:  
K. D. ROGERS. P. R. BIRD.

G. P. KENDALL, B.Sc.

Scientific Adviser:  
Sir OLIVER LODGE, F.R.S.

Staff Consultants:  
Dr. J. H. T. ROBERTS, F.Inst.P.; J. F. CORRIGAN, M.Sc., A.I.C.; C. E. FIELD, B.Sc.; E. J. SIMMONDS, M.I.R.E., F.R.S.A.

Foreign Correspondents:  
F. M. DELANO, Paris; Dr. ALFRED GRADENWITZ, Berlin; L. W. CORBETT, New York; P. F. MARTIN, Italy; W. PEETERS, Holland.

The Editor will be pleased to consider articles and photographs dealing with all subjects appertaining to wireless work. The Editor cannot accept responsibility for manuscripts and photos. Every care will be taken to return MSS. not accepted for publication. A stamped and addressed envelope must be sent with every article. All inquiries concerning advertising rates, etc., to be addressed to the Sole Agents, Messrs. John H. Lee, Ltd., 4, Ludgate Circus, London, E.C.4. As much of the information given in the columns of this paper concerns the most recent developments in the Radio world, some of the arrangements and specialities described may be the subject of Letters Patent, and the amateur and the trader would be well advised to obtain permission of the patentees to use the patents before doing so.

Readers' letters dealing with patent questions, if sent to the Editor, will be forwarded to our own patent advisers, where every facility and help will be afforded to readers. The envelope should be clearly marked. "Patent Advice."

### TECHNICAL QUERIES.

Letters should be addressed to: Technical Query Dept., "Popular Wireless," The Fleetway House, Farringdon Street, London, E.C.4.

They should be written on one side of the paper only, and MUST be accompanied by a stamped addressed envelope.

Queries should be asked in the form of the numbered questions: (1), (2), (3), etc., but may be accompanied by a short letter giving any necessary additional particulars as briefly as possible.

For every question asked a fee of 6d. should be enclosed. A copy of the numbered questions should be kept, so that the replies may be given under the numbers. (It is not possible to reproduce the question in the answer.)

Details of the "P.W." BLUEPRINTS are published fortnightly in the advertisement pages of "P.W."

BACK OF PANEL DIAGRAMS can be specially drawn up to suit the requirements of individual readers at the following rates: Crystal Sets, 6d.; One-Valve Sets, 6d.; One-Valve and Crystal (Reflex), 1s.; Two-Valve and Crystal (Reflex), 1s.; Two-Valve Sets, 1s.; Three-Valve Sets, 1s.; Three-Valve and Crystal (Reflex), 1s. 6d.; Four-Valve Sets, 1s. 6d.; Multi-Valve Sets (straight Circuits), 1s. 6d. Except SUPER-HETERODYNE DIAGRAMS, all of which, irrespective of number of Valves used, are 2s. 6d.

If a panel lay-out or list of point-to-point connections is required an additional fee of 1s. must be enclosed. Wiring diagrams of commercial apparatus, such as sets of any particular manufacture, etc., cannot be supplied. (Such particulars can only be obtained from the makers.) Readers may submit their own diagrams, etc., for correction or for criticism. The fee is 1s. per diagram, and these should be large, and as clear as possible.

No questions can be answered by 'phone. Remittances should be in the form of Postal Orders.

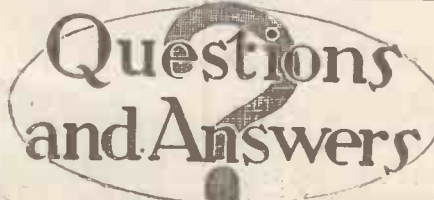

### LOOSE COUPLING.

"IGNORAMUS" (St. Mary Cray, Kent).—What is meant by loose coupling; and has

(Continued on page 1168.)

## "Swinging the lead in Soldering"

Easier soldering! No longer any need for the novice of novices to be troubled by a soldering job! With a tin of "Flusolda" anybody can make an expert clean joint. Just apply heat—and it's ready for active service!

## FLUSOLDA

(Patent Applied For) *Legit*  
Means:—"Soldering with Ease"

Try it—it needs no fluxes or acids, and can be used for every purpose for which ordinary Tinman's Solder is used. Quick, clean and economical.

In tins at 1/3 from Wireless Dealers and Ironmongers.

Trade enquiries to the Sole Manufacturers:

THE TRANSPORT SUPPLY CO., LTD., WARRINGTON.

(Telephone: Warrington 459.)



## VALVES · BATTERIES

Radio Micro 3-v. '06, each 7/-	Fama 2-v. '06, each 6/3
Radio Micro Power, 3-v. '1, each 10/9	.. 2-v. '2, each 4/-
Fama 4-v. '06, each 5/9	.. Power 4-v. each 8/6
	60-v. Batteries, guaranteed.
	60-v. Tappings, each 7/6

TRADE ENQUIRIES INVITED. WHITE FOR LISTS.

ALL Goods sent post free.  
BISHOPSGATE ELECTRIC SUPPLY CO., 180, Bishopsgate, London, E.C.2.

## BUILD A LOUDSPEAKER

### THE SEAMLESS CONE

(Prov. Patent 25069/26)  
and a Brown A Earpiece, or Lissenola with Reed, will enable you to construct a CONE LOUDSPEAKER, which will give you unsurpassable results. These Cones are unequalled for purity of reproduction, the high and lower registers being equally rendered.

Do not be put off with the ORDINARY PAROCHMENT CONE, having a Seam Joint. EXTRACTS from UNSOLICITED TESTIMONIALS: FIBERIGHT, SUREBY: "It is an excellent article and gives very good results." SPALDING, LINCS: "I am more than satisfied with the results." SHEFFIELD: "I have had one of the £7/7/0 Loudspeakers, and have no hesitation in saying that for tone your Seamless Cone is much better." BRISTOL: "The Seamless Conical Diaphragm received yesterday works fine."

Illustrated Lists and particulars for Stamp. GOODMANS, 27, Farringdon Street, E.C.4. Also obtainable from Spence & Sons, 45, Abchurch Lane, E.C.3.

WHEN replying to advertisements please mention "Popular Wireless" to ensure prompt attention. THANKS!

H.F. ST.21(0-1A) 14/-  
L.F. ST.22(0-1A) 14/-  
POWER ST.23(0-13A) 18/6

POINT ONES WHICH GIVE THE HIGHEST EFFICIENCY ON THE LOWEST H.T. (60 VOLTS AMPLE)

BUILT LIKE THE PYRAMIDS - TO LAST



WHY PAY MORE THAN DOUBLE for other amplifiers  
 or for a valve set, when you can get as good results with THE  
**MAGNETIC MICROPHONE BAR AMPLIFIER**

"NO CRYSTAL SET IS COMPLETE WITHOUT THIS WONDERFUL ATTACHMENT."  
(Patent No. 245331/25.)

Not only will this marvellous device give really good LOUD-SPEAKER RESULTS from CRYSTAL RECEPTION of average strength, but it is absolutely the ONLY means of increasing the strength of weak signals in HEADPHONES without using valves.

Works perfectly on one or two dry cells.

**A BOON TO DEAF PERSONS**

EQUALLY EFFICIENT ON VALVE SETS

IF YOUR DEALER CANNOT SUPPLY ORDER DIRECT FROM SOLE MANUFACTURERS AND PATENTEES:



NOT a Microphone Button.

**NO** Valves, Accumulators or H.T. Batteries. Fragile parts. Distortion.

Simple as ABC.

MICROPHONE AND OTHER PARTS OF AMPLIFIER SUPPLIED SEPARATELY

FULLY ILLUSTRATED LISTS FREE

COMPLETE AMPLIFIER as shown PRICE post free **38/-**  
 3-volt DRY BATTERY lasting over three months 4/- extra.  
 No other accessories required.

DELIVERY BY RETURN FROM STOCK. EVERY AMPLIFIER GUARANTEED.

**NEW WILSON ELECTRICAL MANUFACTURING CO., LTD.,** 13, FITZROY STREET, EUSTON ROAD, LONDON, W.1. Phone: Museum 8974.

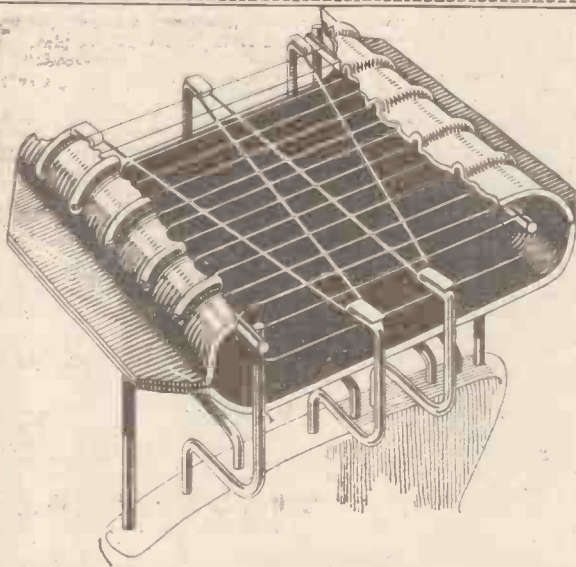

The above sectional view of the P.M. 5 shows the original design and construction of the valve with the wonderful P.M. filament. The patents covering this unique filament are owned and controlled by the Mullard Radio Valve Co. Ltd.

Be safe when you buy valves.  
 Demand Mullard P.M. Valves with  
**THE WONDERFUL P.M. FILAMENT.**

**Mullard**  
 THE MASTER VALVE

To All  
Listeners!



You know those delightful little yarns

**A. J. ALAN**

tells from 2 LO from time to time ?

Mr. Alan has at last been persuaded to let his millions of admirers read him in print. These stories will appear exclusively in the LONDON MAGAZINE. The first of them, "My Adventure in Jermyn Street," appears in the issue on sale to-day.

**LONDON**  
 MAGAZINE ..... 1/-

Now on Sale.

Buy a Copy NOW!

## RADIOTORIAL QUESTIONS AND ANSWERS

(Continued from page 1166.)

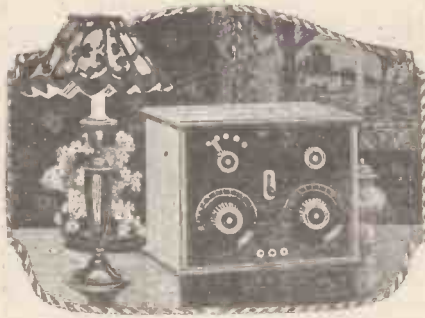

free—  
details for building four unique  
Receivers

HERE'S an invaluable book for constructors. The "Radion Book." It's a practical manual which tells you how to build four unique Receivers. The explicit working drawings and complete illustrated descriptions make it possible for the most unskilled to build a One-Valve Receiver (which has a 250-400 mile range on headphones), a two-valve Amplifier, a self-contained Loud Speaker Set and a Five-Valve Neutrodyne.

Anyone could follow the easy instructions, and build a Set as good as a professionally-made one. In addition, the Radion Book contains useful information on Aerial erection and Set installation and gives easy-to-follow tool hints for "working" panels.

Send the coupon below for the Radion Book and an interesting booklet called "The Gentle Art of Choosing One's Panel." It tells you all about the superb panels, Radion and Resiston, which increase the appearance and efficiency of your Set a hundredfold. Write to-night

—Send for the "Radion Book"—  
Please send, free, the "Radion Book" (which describes four unique Sets) and, also, "The Gentle Art of Choosing One's Panel."  
Name .....  
Address .....



American Hard Rubber Co., Ltd., 13a Fore St., E.C.2  
G.A., 7000

the word "coupling" the same meaning in wireless as when it is used in mechanics (such as for the coupling between railway trucks)?

Essentially, the word coupling means the same in both instances—i.e. the linking together, or connecting.

In wireless, however, the connecting-link is magnetic in nature and it is, of course, invisible.

To understand how different circuits in a wireless set can be linked together, or coupled, it is necessary to remember that whenever electricity is moving (i.e., current is flowing), a magnetic field extends around the conductor carrying the current.

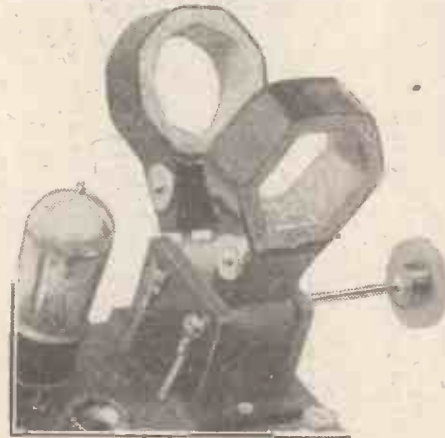

In the photograph two coils are shown (aerial and reaction), and when the set is in use each coil has its own magnetic field around it, due to the current flowing within it.

If the coils are brought close together (by means of the handle), the two different magnetic fields become interlinked, and this in turn affects the currents flowing.

In this way, without any visible link, the circuits are "coupled," strong interaction between them being styled "tight coupling." When kept well apart the interaction is comparatively slight, and the circuits are said to be "loosely coupled."

### FAULT IN A FLEWELLING.

F. S. D. (Meriden, Warwickshire).—I have been troubled by a mysterious fault in a one-valve modified Flewelling (very much like the one described in "P.W." No. 227).

The trouble is that the set is erratic in behaviour, occasionally giving quite good results for a time, and then going off, so that I can hardly pick up 5 X X.

What makes it all the more puzzling is that the set has a switch (S.P.D.T.), so that the '06 "Flewelling" condenser can be shorted, converting it into a straight one-valve receiver. Even arranged like this the set gives varying results, and I cannot trace where the trouble lies. (I am sure the trouble is in the set itself, because my other set works splendidly upon the same valve, batteries, aerial, etc.)

What is likely to cause my signals to come and go at different times? I have replaced practically everything upon the set, and still it sulks, so if you can help me I shall be very glad, for otherwise I must scrap it.

From your description we feel sure that the trouble is due to the '06 coupling condenser being faulty. Probably there is a leak across the insulation of this, which allows a high potential to leak to the grid of the valve. A charge of this kind upon the grid would account for the set's erratic behaviour, though it should work well as a one-valver if you do not alter the switch-adjustment.

Try disconnecting the coupling condenser, and see if the set works as a one-valver should. If not, the insulation of the grid condenser is probably at fault.

If it seems all right when the '06 is disconnected, replace this condenser with a new one, and you will probably find it will work well in the "Flewelling" position also.

(Continued on next page.)



FRANKLIN  
NELSON  
RODNEY  
GRENVILLE

NAMES that are the personification of action. In war and peace the need has always found the man, and today in the radio world the name Mullard implies decisive progress.

Radio appeals to the million. Mullard has brought radio within reach of the million. The Franklin, Rodney, Nelson and Grenville P.M. Receivers are the result of the remarkable success achieved by the Mullard P.M. Valves, and the research, construction and organisation which has made the finest valve is the basis of the Mullard Ever-Rest Wire Wound Anode Resistance.

A Resistance wound on a textile fibre core, perfectly covered and interlaid with the same material, eliminating all self capacity, and also renders the fine metallic wire free from every particle of mechanical shock.

The temperature coefficient is negligible, since the resistance is not set in wax, but only covered by a thin layer of wax allowing perfect dissipation of heat.

MULLARD EVER-REST Wire Wound Anode Resistance (80,000 and 100,000 ohms)	5/-
Complete with Holder	6/6
Other Values to Specification.	
Mullard Grid Leaks and Condensers, Type Grid B 0.5 to 5.0 megohms	2/6
Type Grid B combined with .0003 mfd. Condenser Type MA	5/-
Type MA Condenser .0001 to .0009 mfd.	2/6
Type MB Condenser .001 to .01 mfd.	3/-



WIRE WOUND ANODE RESISTANCE

The MULLARD WIRELESS SERVICE Co., Ltd.  
Mullard House, Denmark St., London, W.C.2

## RADIOTORIAL QUESTIONS AND ANSWERS

(Continued from previous page.)

### TERMINALS.

S. T. G. (Abingdon, Berks).—Are the new big engraved terminals really worth their extra cost?

So far as efficiency in contact goes there is probably not much to choose, but the chief advantage of the large, well-finished terminals is their enhanced appearance, as compared with the cheap brassy ones.

A good-looking set deserves good-looking terminals, but if the constructor cannot afford these he has the satisfaction of knowing that the cheaper ones are quite efficient.

### NOISY RECEPTION.

"MUSICIAN" (Leigh-on-Sea).—What are the commonest causes of extraneous noises during reception when using a crystal set with two-valve amplifier?

This is rather a big question, as a great deal will depend upon the actual type of amplifier in use—i.e. whether it is transformer-coupled, resistance-capacity coupled, or choke-coupled. As you omit to mention this we are tabulating the commonest faults in all the types.

(A) *Transformer-Coupled Amplifier.*—Defective windings in the transformer itself cause clicks. If one of the windings develops a break in continuity signals become very weak, or disappear altogether, and there is an almost constant frying, frizzling sound. (See also C.)

(B) *Resistance-Capacity Coupled Amplifier.*—A defect in the anode resistance will result in voltage variations, causing irregular amplification. If the coupling condenser is leaky, the plate potential of the preceding valve is partially applied to the grid of the following valve, and may stop signals altogether, or cause fluctuations. A defect in the grid leak also will cause noisy and irregular reception.

(C) *L.F. Choke Amplifier.*—Faults in choke amplifiers may resemble those in either (A) or (B), and the following defects also will affect all three types:

Variations in the filament current supply, due to imperfect connections, such as a loose connecting-bar on the accumulator. (This, of course, results in variations in the electronic emission, causing signal-strength to rise and fall.)

Imperfect contact in the H.T. battery circuit. Imperfect contact in the grid bias battery circuit. Either of these latter defects may arise within the battery itself, as well as in the external leads.

### WHICH STATION WAS THAT?

"DX HOUND" (Stapleford Abbots).—Which Italian station is it that calls "Pronto," and uses a "ticker" between the items? The wave-length is about 330 metres, and sometimes the announcer is a man, sometimes a woman.

So many changes have been, and are being made in call signs, wave-lengths, etc., that it is almost impossible to identify stations except by their own announcements. However, in this particular instance, you probably picked up Naples, which has been working on 333.3 metres, call sign 1 N A. Between the intervals the ticking of a metronome is transmitted from this station.

### MORSE INTERFERENCE.

J. D. (Caister-on-Sea).—Morse interference is the bugbear of this neighbourhood, and I am anxious to know if there is a good prospect of ships giving up their antiquated spark transmitters some day, and using continuous waves instead?

The prospects of this are hardly "good," though probably something of the kind will come about within the next ten years.

At present a large number of ships are using transmitters that were designed to give quite broad bands, so that in the event of a distress call being made it would be heard not only upon its own wave-length, but upon the neighbouring ones also.

In time, as more and more sensitive receivers are used, the necessity for such transmitters becomes less. Moreover, apart from improvements in the instruments themselves, there will doubtless be further attempts ere long to regulate non-urgent Morse transmissions, when they are likely to interfere with broadcasting.

### COILS FOR CONTINENTAL STATIONS.

"NEW ONE-VALVE SET" (Maidenhead).—Having listened to London, Daventry, and (on one occasion) to Bournemouth, I should

(Continued on next page.)

## THE BRANDES AUDIO TRANSFORMER

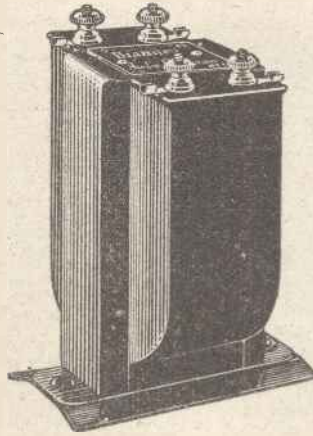

CONNECTIONS FOR ONE STAGE OF L.F. AMPLIFICATION

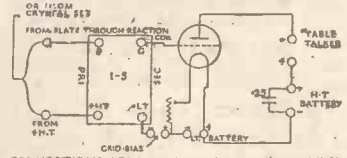

CONNECTIONS FOR TWO STAGES L.F. AMPLIFICATION

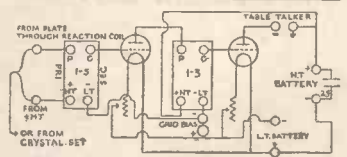

- (1) Connect Pri. P. to plate of det. valve through reaction coil or direct to plate if 2nd stage L.F. connection is being made.
- (2) Pri. + H.T. to + terminal of H.T. Battery.
- (3) Terminal marked G. Sec. to grid of next valve.
- (4) Terminal - L.T. Sec. to - of grid batt.
- (5) + of grid batt. to - terminal of L.T. batt.

Connect it as above.

## HIGH AMPLIFICATION OF APPLIED VOLTAGE AND A STRAIGHT LINE AMPLIFICATION FREQUENCY CURVE

For many years Brandes specialised in acoustical research and the improvement of the audio circuit of the receiving set which so essentially determines the quality of reception.

One result is the Brandes Audio Transformer. Developed along sound engineering lines, the main object in view is a high constant voltage amplification-frequency curve. That is to say, for a given input voltage the amplification is constant over a wide band of frequencies, thus eliminating resonance. The inductance of the primary winding is much larger than usual, giving good amplification at low frequencies, and bringing beautiful reproduction, more particularly in the lower registers.

The unit is well protected mechanically, and the shielding is such that transformers may be placed close together without interaction. The insulation between primary and secondary coils and also from these to laminations is very high. Each transformer is tested against a Standard before leaving the factory at 200, 600, 1,600 and 4,000 cycles per second. The ratio of turns between secondary and primary is 1 to 5 for the First Stage Transformer and 1 to 3 for Second Stage Transformer. They are ideal in first and second stage work respectively.

As well as ordinary terminals for connection, soldering tags are provided, giving the user a decided advantage.

No condenser need be shunted across the primary winding. When used, it may be found necessary to use grid cells for biasing purposes to obtain purest results. To use grid bias all that is necessary is to insert cells between L.F. Sec. and the negative terminal of the L.T. Battery such that the L.T. Sec. terminal is connected to negative terminal of cell and the negative terminal of L.T. Battery is joined to positive terminal of cell. Cells from 1.5 volts to 8 volts should be tried.

G. P. Kendall, B.Sc., writing in the WIRELESS CONSTRUCTOR on the building of the "Spanspace Three" recommends the inclusion of the Brandes L.F. Transformer.

Ratio 1-5  
17/6  
(Black case)

# Brandes

AUDIO TRANSFORMERS.

Ratio 1-3  
17/6  
(Brown case)

BRANDES LTD., 296, REGENT ST., W.1

WORKS: SLOUGH, BUCKS.



**The TANGENT TOUCHSTONE Loudspeaker**

This loud-speaker is designed on quite new and original acoustic lines. It is possible on this to get the lowest bass notes as well as the highest treble notes in a perfect form of reproduction.



For distinction of design and construction it stands alone, the attractive cabinet harmonises with any furniture. Over four feet of curving flute lies in the Touchstone cabinet to preserve the overtones of perfect rendering.

Price in Oak . . . . . £6 : 6 : 0  
 „ „ Mahogany . . . . . £7 : 0 : 0

Write for full illustrated leaflet 141 giving all particulars.

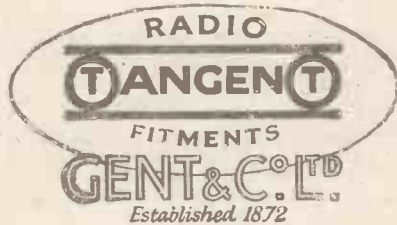

LONDON :  
 25, Victoria Street, S.W.1.  
 NEWCASTLE-ON-TYNE :  
 Tangent House, Blackett Street.

**GENT & CO., LTD., FARADAY WORKS, LEICESTER**

**RADIOTORIAL QUESTIONS AND ANSWERS**

(Continued from previous page.)

like to try for foreign broadcasting. What coils shall I get for the Continental stations?

You are wrong in assuming that different coils will be required. Those you have will "tune" to both the long and the lower broadcasting wave-lengths.

Notice, however, that because they will "tune" to dozens of Continental stations, you may not be able to hear these stations broadcasting programmes.

The reason is that although your receiver may be tuned to the correct wave-length of a foreign station, its signals are so weak over the long distance intervening, that it is inaudible.

To overcome this, extra amplifying valves have to be used. But even with a one-valve set you will probably be able to hear Radio-Paris, working near the Daventry wave-length, when you are accustomed to handling the set.

At present you are probably using reaction wrongly, which generally spoils your own reception, and very often that of other people as well.

Why not write to the B.B.C., 2, Savoy Hill, W.C.2, for their free booklet, "Anti-Oscillation" (enclosing a stamp for postage)? This booklet explains how to use reaction properly, and once that is learned you stand quite a good chance of picking up distant stations.

**WAVE-LENGTH CALCULATIONS.**

"HOME-WORK" (Petworth).—I have noticed that the formula for wave-length is generally quoted as:

$$\lambda = 1885 \times \sqrt{C \& L}$$

where  $\lambda$  = wave-length in metres,  
 $C$  = capacity in mfd.,  
 and  $L$  = inductance in mhs.

Does this formula apply to an ordinary receiving aerial?

Yes. The natural wave-length of an aerial can be found easily, if the capacity and inductance of the aerial are known. Assuming these are, say, .00032 mfd. and 16 mhs. respectively—these are values that might easily occur in an aerial erected to comply with the P.M.G.'s regulations—the formula becomes:

$$\lambda = 1885 \times \sqrt{.00032 \times 16}$$

$$= 1885 \times .018 \times 4$$

$$= 133.7 \text{ metres.}$$

This, then, is about the natural wave-length of the receiving aerial.

**GRID BIAS FOR SUPER POWER VALVE.**

"POWER AMPLIFIER."—What is the maximum grid bias needed for powerful L.F. amplification?

This depends upon the valve, and the valve-maker's instructions should be adhered to, as correct bias will effect a considerable saving in H.T. current.

Generally speaking, the higher the H.T. voltage, the higher will be the bias required. Using an L.S. 5, for instance, with a plate voltage from 60 up to 400, grid bias will vary from 6 to 20 volts.

**IMPORTANCE OF A GOOD AERIAL.**

"CRYSTAL" (Belfast).—Why is it more important to use a good aerial with a crystal set than it is with a valve set?

Because the energy available for working the 'phones of a crystal set is always less than the energy picked up by the receiving aerial, owing to unavoidable losses in resistance, etc.

On the other hand, by taking advantage of the amplifying powers of valves, the energy available for the output may be hundreds of times greater than the initial energy in the receiving aerial! For this reason the crystal set owner should always try for maximum aerial efficiency.

**COST OF MAKING AN H.T. BATTERY ELIMINATOR.**

"FED-UP WITH H.T." (Redlands, Bristol).—How much does it cost and what parts are necessary to make an H.T. Battery Eliminator? (For use with A.C. mains, 200 volts, 50 cycles.)

To make the Eliminator described recently in "P.W." (No. 227), the following parts were used: One Climax transformer, to suit voltage of mains; two 4-mfd. fixed condensers; one Climax special choke; one potential divider (Climax); one filament rheostat, 35 ohms; two valve holders; one panel, 13 by 10; in baseboard, and cabinet to match; eleven flush mounting valve sockets; and some 12-gauge Glazite wire; the total cost being 25 8s.



Little things which matter.  
**Don't Waste Time!**

Keep a record of the dial readings for every station you log.

No searching each time you want to listen to one of those hard to tune stations.

This RADIO STATION LOG screws on cabinet or panel. Handsome appearance.

Supplied in Nickel-Copper or Silver finish. Size 5 1/2 x 3 1/2. Price 2/- each. Complete with 3 Cards.

Refill Cards 6d. per dozen.  
 Our New Catalogues are now ready, Free. Obtainable from Best Dealers or—



**ADANA AUTOMATIC SELF-INKING PRINTING MACHINE**

**45/-**  
 Complete Plant

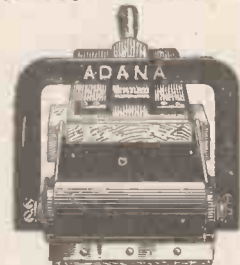

THIS massively constructed Printing Machine is the most wonderful of its kind. There are now over 10,000 users of these plants, many saving enormously in their own work, others making an excellent living.

Will print any class of matter from a CHEMIST'S LABEL to an ILLUSTRATED MAGAZINE including Perforating, Creasing and Box-making. The finest malleable iron and mild steel used in construction. Simplicity to the extreme. No special skill required. Large numbers of boys are producing their School and Scout Magazines. Printers' metal type, case, complete accessories, and excellently illustrated instructional book included. Illus. particulars in two coloured and samples of work, sent on receipt of stamped addressed envelope. Also sold by small weekly instalments. Ask for Terms. The "ADANA" AGENCY (Dept. P.W.6), 34, King Street, Twickenham, Middlesex.

Printers should write for particulars of new system of supplying First-Class Founders' Type.

**TRANSFORMERS REWOUND**

Transformers, Phones, Loudspeakers, Rewound and Repaired to Maximum Efficiency. All One Price 4/- each. Don't discard if burnt out. All work guaranteed for 12 months. Write for trade terms. TRANSFORM CO., 116 LINKS RD., Tooting, London, S.W.17

**VALVES, BATTERIES**

RADIO MICRO D.E. 3-v. .06, 7/- each. RADIO MICRO BIVOLT, 2-v. .2, 6/8 each. RADIO MICRO POWER, 3-v. .1 amp, 10/9 each. Ditto, 2-v. .2 amp, 11/6 each. TUNGSRAM, 3-v. .05, 5/6 each. PHILAT Type K, 2-v. .3 amp, 4/11 each. PHILAT Type D.K.P., 2-v. .3. Power, 8/6 each. SILVER STAR, 4-v. .06, 7/- each. HIGH TENSION BATTERIES, guaranteed 3-volt tapping, 7/6 each. ALL GOODS SENT POST FREE. TRADE INQUIRIES INVITED. WRITE FOR TRADE LISTS. W. SEGAL, 53, Russell St., London, E.C.1.

**EASY PAYMENTS**

LOUD-SPEAKERS, HEADPHONES, H.T. ACCUMULATORS. Anything Wireless.

Send a list of the parts you are requiring, and we will send you a quotation on monthly payments.

H. W. HOLMES, 29, FOLEY STREET, Phone Museum 1414. Gt. Portland St., W.1

**LIFE LONG H.T.**

Tromba units are constructed of the finest quality sacs, zincs, jars, etc., and creeping of the electrolyte and other troubles usual to Leclanche cells eliminated. In units of any size battery to order in Mahogany Case with glass cover Amalgamated zincs 6d. doz. extra. Sample unit and sample large capacity Sac, post free 1/-. Send to-day for free descriptive folder, etc.



TROMBA ELECTRICAL CO. 17, WHITE HART LANE, TOTTENHAM, N.17.



**TECHNICAL NOTES**

(Continued from page 1144.)

fairly hot by means of a fire, and that obtained when the room is cool and practically empty of people.

These observations, although perhaps not individually important, go to show upon how great a variety of conditions the reproduction of sound may depend, and therefore how desirable it is to ascertain that the loud speaker is being given the best possible chance.

**New Capacity Unit.**

Some discussion has taken place recently amongst the experimenters, more particularly transmitting experimenters, in the United States, on the choice of a substitute for the clumsy term "micro-micro" with reference to condensers. The microfarad, as every reader knows, is the one-millionth part of a farad, and the micro-micro farad is the one-millionth part of a microfarad. Owing to the fact that the capacities used in variable condensers for ordinary wireless receiving purposes are usually exceedingly small fractions of a farad, it is more convenient to take the microfarad as the unit for such purposes and to express the capacity of a condenser as a decimal of a microfarad.

Another way, however, would be to take a millionth of a microfarad, that is a micro-microfarad, and to express the capacity as so many micro-microfarads. A suggested name for this latter unit is the "pico"; thus a capacity of 0.0005, which is 500 micro-microfarads, would be expressed as

(Continued on next page.)

# Wasting Money on a Make-Shift

Materials used in Dry Batteries are SELF-DESTRUCTIVE and must and do continuously eat themselves away.

Gradual destruction is constantly reducing capacity.

Amp. hour is the only vital and absolute essential factor in a battery.

Makers never state and cannot give any amp. hour capacity.

Makers cannot test for amp. hour capacity.

Makers' voltage statements absolutely unreliable.

Average working value is 1 volt only.

Voltage drops haphazardly and uncontrollably.

Crackling noises caused by decaying material and cannot be stopped.

**Five Dry Batteries of 100 Volts each cost more than a Tungstone—which will last the lives of many persons.**

## Reliable Service Remembered

**TUNGSTONE 60 Volt 3 a.h. Actual and Guaranteed is more efficient than a 100 Volt Dry Battery. Will outlive Hundreds of Dry Batteries.**

**NO CRACKLING OR PARASITICAL NOISES ON WIRELESS PHONES OR LOUDSPEAKER. NO FROTHING, FOAMING, HEAT AND OTHER TROUBLES.**

Tungstone (Patented) Tapping-Off Cell-Connector. By means of the Wander Plug supplied free, Tappings can be taken off as required at any two-volt cell or any varying series of cells.

**CHARGING HIGH TENSION on LOW TENSION CHARGING PLANT**

**All H.T. Tungstone Accumulators are fitted with a Patent Equipment whereby each series of 12 Volts can be coupled in parallel so that these H.T. Batteries of whatever voltage can be charged at local Garages and Charging Stations on a 12-16 Volt Low Tension Charging Plant.**

TUNGSTONE High Tension 60 Volt Battery 3 a.h. is sold in the United Kingdom on monthly payments over extended period. Apply for particulars. Further interesting information on points of this advertisement are to be found on pages 58, 59, and 67 to 73 of the Illustrated Booklet "Photography tells the Story" which will be sent free on application to—

T.A.59

TUNGSTONE ACCUMULATOR CO., LTD., St. Bride's House, Salisbury Square, London, E.C.4

**FACTS AND FALLACIES ABOUT CONDENSERS.**

(Continued from page 1155.)

impression that condenser losses were of tremendous importance, and some of us went so far as to scrap perfectly good pre-loss instruments and put some of the very latest in their places. Since the latter were generally greatly improved components as regards mechanical features, smooth motion, and so on, we did not regret the change, but it must be confessed that there did not seem much improvement in signal strength!

As a matter of plain fact, the losses which take place in any reasonably good condenser, whether labelled "low-loss" or not, are quite small at the ordinary broadcast frequencies, and hardly seem worth taking into account in comparison with those taking place in the average tuning coil. The losses can be expressed as an equivalent resistance in the circuit, and those produced by the condenser will usually be less than one ohm, whereas quite a fair coil will have a high-frequency resistance of eight or ten ohms. (The ordinary plug-in multi-layer coil runs a good deal higher as a rule.)

I have not attempted in these notes to cover all the points about variable condensers which crop up in the post-bag at intervals, but I think I have quoted enough of the common fallacies to show that the condenser is a much-misunderstood instrument!

**WIRELESS.**—Capable, trustworthy men with spare time who wish to substantially increase income, required where we are not fully represented. Applicants must have practical knowledge of installation of Set and Aerial, be a householder or live with parents, and be able to give references: state age and experience. Address: Dept. 10, General Radio Company, Limited, Radio House, Regent Street, London, W.1.

**HEADPHONES REPAIRED**  
Re-wound and re-magnetised 5/- per pair. Loud Speakers repaired 5/-. Transformers re-wound 5/- each. All work guaranteed and tested before delivery. Write for Trade Prices. Phone: Clerk, 1795. MASON & CO., 44, East Road, City Road, N.1.

**2-VALVE AMPLIFIER, 35/-**  
1-Valve Amplifier, 20/-, as new; Valves, D.E. .06, 7/-; Headphones, 8/6 pair; new 4-Volt Accumulators, 13/-; New 60-Volt H.T., guaranteed 7/-; 2-Valve All-Station Set, £4. Approval willingly. Write for free bargain list. P. Taylor, 57, Studley Rd., Stockwell, London.

EVERY WIRELESS COMPONENT IN STOCK

GET IT BY POST FROM

Young's Glasgow Ltd. 40 Stockwell St Glasgow

100-PAGE CATALOGUE FREE WRITE N.W.!



**Best and Permanent Results at Low Cost by using WET H.T. (Leclanche Type) BATTERIES.**

Suitable for 1, 2, 3 and 4-valve sets. The Cells give 14 volts each and comprise Sac Element, Zinc, Jar, and a solution of Salammoniac. No particular skill required to construct.

Price per dozen Cells complete, giving 16 volts 3/6  
Price of component parts per dozen: Sacs, 1/6; Zincs, 1/2; Jars, 1/3 (carr. extra).  
Full instructions for assembling sent with each order. Send 1d. stamp for full particulars.

**WET H.T. BATTERY Co., 23, Coldharbour Lane, Camberwell Green, S.E.5.**

Size: 2 3/4" high, 1 1/2" sq.

## BARGAINS No. 209

**ELECTRIC IMMERSION HEATERS.** Brand new, nickel-plated, with flex and plug. Boils water, eggs. 110 volts. Two in series 220 volts. 5/-.

**HOTPLATES.** 100 volts large, 200 volts small size. Aluminium frame. Brand new. List, 35/- and 45/- Sale, 7/6.

**ELECTRIC MASSAGE VIBRATOR SETS.** Nickel finish, with 5 applicators for muscular treatment. All in leatherette padded case. 110 volts. Work off 220 volts with lamp. List 24 5s. Sale price, 21/6. 100 volts or 220 volts Electric Irons. List, 21/-; Sale, 10/- . All the above guaranteed for A.C. or D.C., and brand new. Soldering Irons, 110 volts and 220 volts, 10/- . Geared 110 and 220-volt light Drills, 50/- .

**LOW LOSS SHORT-WAVE COILS,** as used by Marconi. Air-wound copper strip Helices 25 to 250 metres, ebonite mounted, 4/- .

**C.A.C. H.T. ACCUMULATORS,** 6d. per volt brand new, 80 volts, in ebonite cases, 40/- .

**H.T. FROM THE MAINS. D.C. UNITS, SMALL SIZE** for 200/220 volt supply, 3 taps, any ranges 50 to 120 volt, 35/-, mahogany case, ebonite panel. The finest ever made.

**A.C. MAIN UNITS, 25.10.0.** Kit 23.10.0. Six-tap 1.5 m/a. Rectifying Transformer, 25/-; 50 m/a, 37/6; Condensers, 4 mid., 6/6; 10 mid., 15/-; Power Chokes, 1,000, 1,400, 3,000 ohms, 4/6; 2 Electrode Rectif. Valves 15 m/a 7/6; 30 m/a, 10/6. Valve-holders, 8d. Cabinet, 2/6.

**DIXON DISTANT CONTROL FOR FILAMENT.** Auto switch. On and off, any distance. Finely made. In polished oak case, 15/- .

**INSTRUMENTS.** All ranges in stock.

**THE DIX-ONEMETER** is an entirely new production of wonderful precision. Measures microamps to 20 amps, milli-volts to 2,000 volts. 50 ohms to 50 meg-ohms. Mirror Double Scale. Sensitivity 500 ohms per volt. Instrument only, 55/- Multipliers, each, 6/6. "Onemeter" 16-page descriptive Booklet. Why buy several instruments when the "ONE-METER" with 55 ranges does everything?



**LABORATORY EQUIPMENT.** Inductometer, Valve Control, Fork, Paul Bridge, Weston Cells, Standard Mid. and Res. Units, 1 ohm. to 10,000 ohms, Sullivan's Spot Galvo with shunts, Tinsley Micro-ammeters, M.B.T. Direction Finder, Ohm-meter, Valve Test Panels. All cheap.

**LOUD-SPEAKER BARGAINS.** Bargain Western Electric 2,000 ohm famous 35/- Table Talkers, offered while they last at 17/6. Sterling Magnavox, 50/-; New Design Texas Cone Speakers, 40/- . L.S. Parts stocked.

**DYNAMOS.** You are looking for a cheap Charger. We offer the Government stock of 6 and 12 volt new ball-bearing type 45 Dynamos.

Type.	Volts.	Amps.	Speed.	Price.	Maker.
45	6/12	8/10	3,000	£2 10 0	Lucas
A	12	20	3,000	£5 0 0	Mackie
V/47	20	10/12	2,000	£6 0 0	Vaucas
129	30	15	3,000	£6 10 0	Crompton
S	50	38	2,200	£12 10 0	E.M.Co.

**Polar Surplus, All New.** Precision Condensers. .0003 list, 12/6. Sale, 4/6. Polar Panel 2-way Coil Holders, 3/- Polar Varia H.F. Transformers 300/500, 3/6. L.F. Inter-valve, 7/6. Dubilier Anode Res., all sizes, 3/6. Holders on ebonite, 1/- . Polar Semi-fixed Detectors, 2/- . Polar Variometer on panel, scale and dial. List, 21/- . Sale, 8/6. Efesca Tapped H.F. Transformers with switch for 150-2,500. Fits in valve-holder, 15/- .

**Plugs and Jacks, 2/6 pair.** One hole, 3/- pair Switches—Dewars 1-way, 1/6; 3-way, 2/6; 4-pin Lucas Plug and Sockets, 4/-; Panel 2-pin Base and Plug, 8d.; Electric Plug Adapters, 5d. Torpedo Gyroscopes, 15/- .

**Insulators.** Transmit and H.T. Buldix bell-strain, 1/6; Porcelain Ribbed Ped. brass stems, 2/-; Marconi 4 ft. Rubber Cord strain Insulators for Mast Stays and Aerials, 2/-; Cows for Down-lead or Lead-in, 1/- .

**Chokes.** L.F. 200, 600 or 1,000 ohms, 1/6; Power, 4/6 & 10/-; H.F., small, 1/6 & 2/6; 1,000 ohms, 4/6; Marconi 100 milhenries, 7/6.

Do you realise that we have produced the most unique Radio Catalogue in the world. Send 4d. stamps for our Winter Edition. It saves you Pounds.

**ELECTRADIX RADIOS,**  
218, UPPER THAMES ST., E.C.4

## TECHNICAL NOTES.

(Continued from previous page.)

"500 picos." Balancing condensers would run from 10 to 50 picos, short-wave tuning condensers say from 50 to 150 picos; and ordinary broadcast tuning condensers say from 250 to 1,000 picos. Bypass condensers would run from 250 to 5,000, and blocking condensers (as used in resistance coupling) might run to the order of 100,000 picos. Filter condensers would be expressed as 1, 2, 3, 5 and 10 million picos. Thus, the phrase "three million picos" would take the place of "three microfarads."

### HOME-MADE H.T. BATTERY.

A reader sends me an account of his special H.T. storage batteries which he has made up in a very simple way. Each cell consists of a test tube about 2 in. high and 1/2 in. in diameter. At the bottom of this is placed a small quantity of mercury, about 1/2 in. deep, and a piece of copper wire, covered with rubber or enclosed in a narrow glass tube just slipping over it, is introduced, the bare copper tip at the lower end passing into the mercury. It is important that the copper should be covered with the glass or rubber sleeve at every part except the very tip, which is beneath the surface of the mercury. The test tube is then filled to a little less than half its depth with a mixture of mercurous and zinc sulphates in solution, and on the top of this is poured about an equal depth of a saturated solution of zinc sulphate. The mercury with its insulated leading-in wire forms one electrode, and the other electrode consists of a small strip of zinc which passes into the upper solution (that is, the saturated zinc sulphate solution), but does not reach quite down to the surface of separation between the zinc sulphate solution and the lower mixed solution of zinc and mercurous sulphates.

To prevent evaporation, about 1/2 in. depth of oil may be poured on the surface.

### WHAT DYNAMIC CURVES MEAN.

(Continued from page 1152.)

one has to see that this dynamic characteristic curve is dead straight, so as to give perfectly pure reproduction. The dynamic characteristic curve, moreover, has to be of adequate length to handle the grid voltage of signals of the varying strength which is likely to be met with in actual reception.

From the above explanation it will be seen that the dynamic curve conveys an extraordinary amount of information which the ordinary static characteristic curve does not show. The latter curve does not represent any energy output from the valve at all; all the energy is wasted in heating up the anode of the valve. To test a man's physical condition, it would not do to watch him free-wheeling on a bicycle down a steep hill.

Make the same man ride up the hill and then judge him by his speed and general performance. The ordinary characteristic curve of a valve is the free-wheel curve, while the dynamic curve on which the design of all valves should really be based, represents the valve doing not only work, but the actual work which it does in practice.

Britain's Best RADIO in Radio

LAMPLUGH PRODUCTS

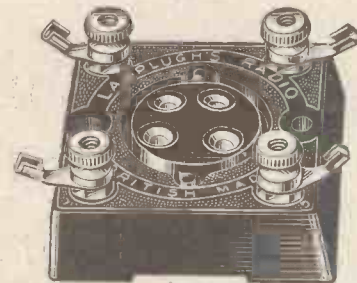

### SILENT VALVE HOLDER

Anti-Microphonic

Fitted with Heavy Terminals & Grip Tags. PRICE 2/6

Obtainable from all leading Wireless Dealers

SEND FOR LISTS.

### S. A. LAMPLUGH LTD.

King's Road, Tyseley, BIRMINGHAM.

Sole Distributors for London and Southern Counties: The Empire Electric Co., 303, Fuston Road, London, N.W.

Scottish Depot: 38, Montrose Street, Glasgow.

## GAMBRELL

### NEUTROVERNIA CONDENSER

Is obviously the best, because:

It cannot short—has ebonite dielectric. It is ideal not only as a balancing condenser, but as capacity reaction control and vernier condenser. It has the widest capacity range, approximately 2/38 micro microfarads. It is all enclosed, making it dust and damp proof. It is a precision job throughout. It can be fitted with direct reading dial (price 1s. 8d.) As now supplied is adaptable for either panel or base-board mounting without extra charge.

The price is 5/6 only

Obtainable from Leading Dealers.

GAMBRELL BROS. LTD.  
76, Victoria Street, London, S.W.1

PATENTS, TRADE MARKS. Inventions Advice Handbook & Consultations FREE.—B. T. KING, C.I.M.E., Regd. Patent Agent (G.B., U.S. & Canada), 146a, Queen Victoria Street, London, E.C.4. 40 years' references. Phone: Cent. 682

### VALVES REPAIRED

WHY WASTE MONEY?

Let us RE-MAKE your old ones as good or BETTER than NEW D.E. 4/6 ea. Power 8/- ea. Postage 6d. extra.

All work thoroughly TESTED, GUARANTEED and promptly dispatched by Post C.O.D. "NuVal," 64, Mill Hill Road, London, W.3.



STOCKED BY ALL THE BEST DEALERS TRELLEBORGS EBONITE WORKS Ltd. Audrey House. E.C.1.

### 4-ELECTRODE VALVES

We are the suppliers of the genuine U.O. and Thorpe valves, as specially tested and recommended by the "United" inventors and "Popular Wireless" U.C.S. and Thorpe K.4 (both 4-electrode 5-pin valves), each, post free, 10/6

Order direct from—Cash with Order  
LUDGATE RADIO CO.,  
56, LUDGATE HILL, LONDON, E.C.4



The difference between a good half-crown and a bad one is not brought home to you till your coin is challenged.

When you buy an *ordinary* valve you may get a bad filament and you will not be aware of it until it lets you down.

The wonderful P.M. Filament cannot let you down. It has stood apart for genuine value since it was first produced by the Mullard Laboratories in Sept., 1925.

*Valve users protect yourself against loss.*

Turn to page 1167 for details of the  
**WONDERFUL P.M. FILAMENT.**



# TUNING IN HALF THE TIME



INSTEAD of finding the right wavelength somewhere about the time for "Good Night! Everybody, Good Night!" get in right at the start of the concert.

You only need the R.I. Retroactive Tuner to make your tuning such plain sailing. It cuts out all the bother of plug-in-coils, and at the same time operates far more efficiently, for it ensures correct aerial reaction over the whole range of wavelengths covered, that is, 175 to 4,000 metres.

In addition, the R.I. Retroactive Tuner costs appreciably less than a set of plug-in-coils with coil holder to cover the same range.

Price **39/6**

Write for the R.I. Catalogue.

**THE MARK OF  BETTER RADIO**

Advt. R.I. Ltd., 12, Hyde St., New Oxford St., London, W.C.1

Printed and Published every Thursday by the Proprietors, The Amalgamated Press (1922), Ltd., The Fleetway House, Farringdon Street, London, E.C.4. Advertisement Offices, Messrs. J. H. Lile, Ltd., 4, Ludgate Circus, London, E.C.4. Registered as a newspaper and for transmission by Canadian Magazine Post. Subscription rates: Inland, 17/4 per annum, 8/8 for six months; Abroad, 19/6 per annum, 9/9 for six months. Sole agents for South Africa: Central News Agency, Ltd.; Sole agents for Australia and New Zealand: Messrs. Gordon & Gotch, Ltd.; and for Canada: The Imperial News Co. (Canada), Ltd. Saturday, January 8th, 1927.

All applications for Advertisement Space in POPULAR WIRELESS to be made to JOHN H. LILE, LTD. (Sole Agents), 4, Ludgate Circus, London, E.C.4. Phone: City 7251.



ADDING H.F. TO THE HALE.—By P. W. HARRIS

# Popular Wireless

Every Thursday  
PRICE  
3d.

No. 241. Vol. X.

INCORPORATING "WIRELESS"

January 15th, 1927.



### CONTENTS

- Is "Push-Pull" Worth While?
- Experiments with the Filadyne Circuit
- How to Make the "Q and A" Set
- An Interesting Reinartz Variation.
- Reaching Out with the Crystal
- 7000 Diagrams in Four Years
- Etc. etc., etc.

Our cover photograph shows a number of R.A.F. mechanics receiving instruction in wireless transmission.

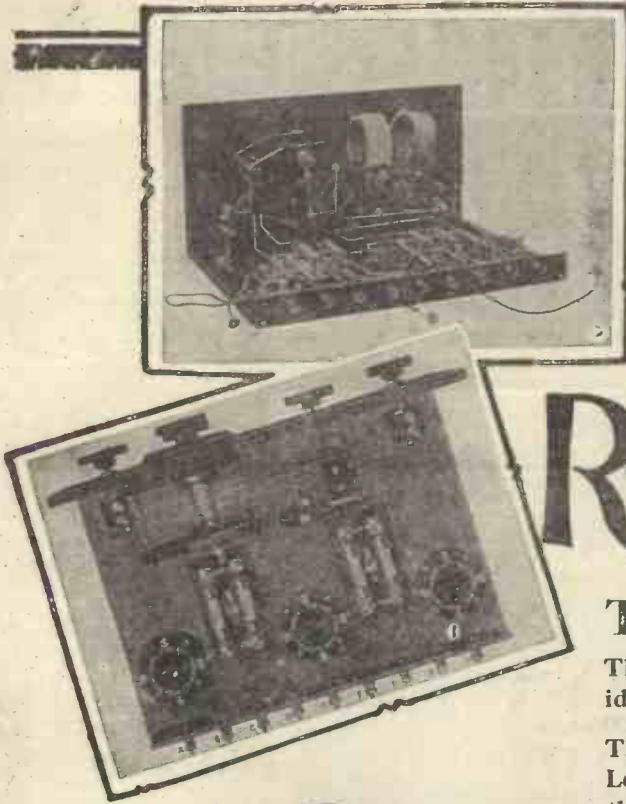

# Are you making the famous R.C. Threesome?

TO get the wonderful results obtained with the original R.C. Threesome Set, you should use identical components.

The Coil Holder used is a "Lotus" Left-Hand Two-Way Coil Holder; the three Valve Holders are "Lotus" Buoyancy Valve Holders, with Terminals.

Wireless experts decided that these were best for a very important experiment; that they would get most out of the set on which depended the very high reputation of the famous Ediswan Valves.

They were not disappointed. YOU will be more than pleased with the R.C. Threesome's performance if you fit "Lotus" Valve Holders and Coil Holder.

Lotus Two-way  
Coil Holder. In-  
side mounting.  
Left-  
hand. 7/-  
Patent No. 244251.

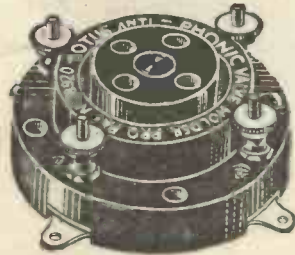
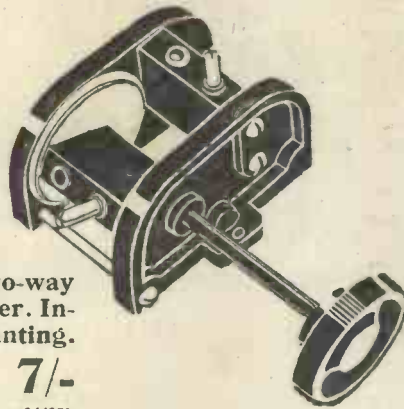

Lotus Buoyancy  
Valve Holder  
with Ter-  
minals. 2/6  
Patent No. 256833.

From all Radio Dealers

## LOTUS COMPONENTS

# A SIMPLE CIRCUIT FOR H.T. SUPPLY FROM A.C. MAINS

THIS circuit enables anyone with an electric light supply to dispense entirely with H.T. batteries, thus avoiding the expense of renewals, which frequently become necessary when using sets with three or more valves. The running cost is extremely low, more than compensating for the slight extra initial expense, whereas a reliable and constant H.T. supply is always available.

## Marconiphone and STERLING Radio Components

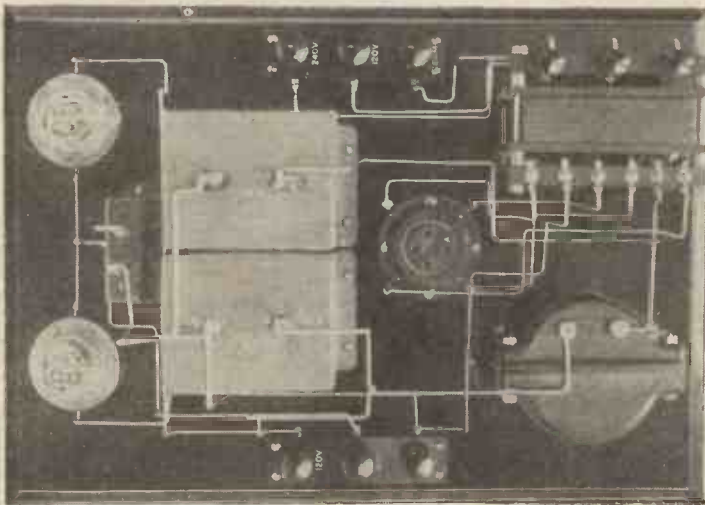

CIRCUIT DIAGRAM

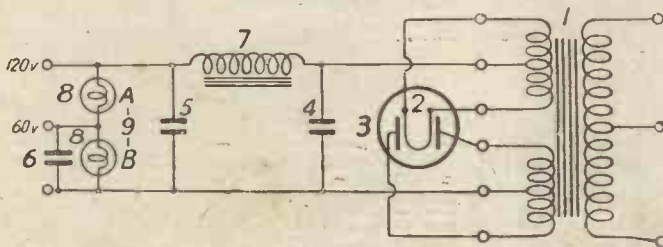

Publication No. 446, "Circuits for Building Radio Receivers," contains full particulars of the construction of this unit, together with a circuit for D.C. mains. Write for a copy to-day.

**THE MARCONIPHONE COMPANY LIMITED**  
(Sole Agents for Sterling Telephone & Electric Co. Ltd.)

Head Office:  
210-212, Tottenham Court Road, W.1

Registered Office:  
Marconi House, Strand, W.C.2

### Some of the Required Components



#### MARCONIPHONE POWER TRANSFORMER

For use with Marconi U.5. Rectifying Valve. Designed for experimenters who wish to make their own rectifiers for H.T. Supply from A.C. Mains.

Price 35/-

#### STERLING MANSBRIDGE CONDENSER

For use where large values of capacity are required, i.e., to stand pressures up to 1,000 volts. Supplied in capacities ranging from .1 mfd. to 10 mfd.

Prices:

.2 mfd. 2/8    10 mfd. 20/-



STERLING NON-PONG Valve Holder, 2/9  
Adapter 3/6

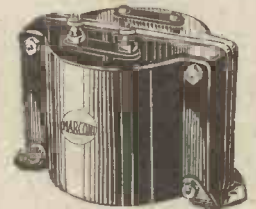

#### MARCONIPHONE IDEAL CHOKE

For use in the smoothing devices of H.T. supply units to eliminate noisiness of the mains. Guaranteed for one year against breakdown.



Price 30/-

#### MARCONI U.5 Rectifying Valve

For use in all types of smoothing circuits. Incorporates a double electrode system in one bulb, thus providing rectification of both halves of the A.C. wave.

## "SAMSON"—The Powerful Twin

A "Hale" Receiver for Frame Reception

Designed by  
**PERCY W.  
HARRIS, M.I.R.E.**

Not everyone can arrange for the erection of a good outdoor aerial. This set will give good loud-speaking results, using only two valves, on either frame or outdoor aerial—up to ten miles in the case of the frame and greater distances with an outdoor aerial.

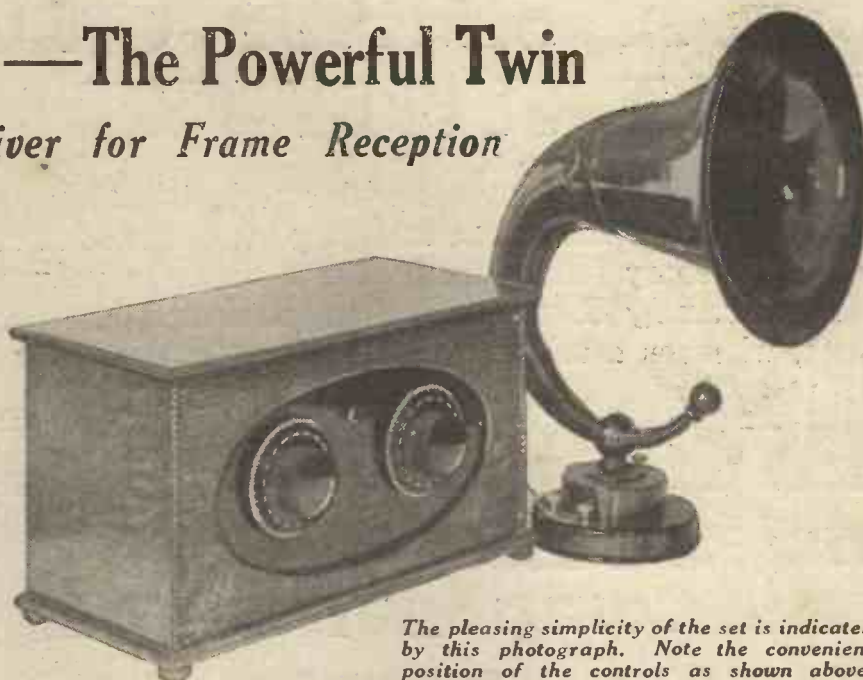

*The pleasing simplicity of the set is indicated by this photograph. Note the convenient position of the controls as shown above.*

**T**HIS reliable two valver is fully described by Mr. Percy Harris in the February issue of the **WIRELESS CONSTRUCTOR** (on sale everywhere on Saturday, Jan. 15th). The constructional diagrams and photographs make it a particularly fascinating set to build. Other notable features in this fine issue include:—

The Home Built Basket Aerial, a Reinartz One Valver; the Truth about High-Frequency Valves; the "Change-over"—a novel and simple crystal receiver described by Mr. A. S. Clark—a Simple Three Valver, Rectifier Problems, Time-Saving Tips, etc., etc.

# *The* **Wireless Constructor**

Edited by Percy W. HARRIS, M.I.R.E.

At all Newsagents and Bookstalls. Out on Saturday, Jan. 15th.

6<sup>D.</sup>

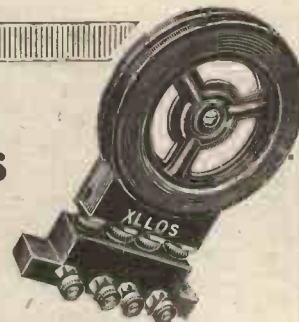
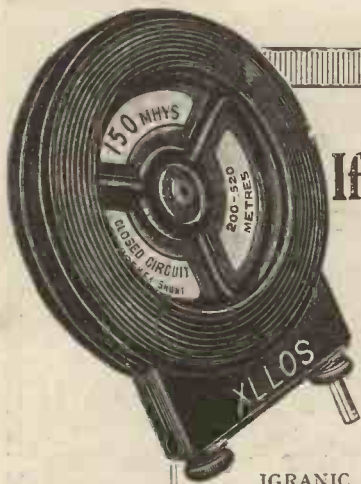

If it's a modern circuit it needs these modern components

**IGRANIC "XLLOS" (Extra Low Loss) COILS.**

IGRANIC "XLLOS" (Extra Low Loss COILS) are wound in a special manner which makes the self capacity and losses extremely low. The windings are enclosed in a sealed Bakelite shell which excludes dust and moisture and prevents the coil being damaged, thus preserving constancy in operation. Pin and socket are separated by an air space and the spacing between them is adjustable from 9/16" up to 2". Made in 10 sizes for wave-lengths from 220 to 3200 metres. Prices from 3/9 each

**IGRANIC CENTRE TAPPED "XLLOS" (Extra Low Loss) COILS.**

Igranic Centre Tapped "XLLOS" Coils are particularly suitable for modern circuits and have a number of uses. Each coil actually contains two inductances which may be used separately or may be joined in series to form a single coil to which a centre tapping may be taken. Similar in external shape and size to the standard "XLLOS" coils, to which they can be coupled. Made in five sizes, Igranic Centre Tapped "XLLOS" Coils cover a wave-length range of approximately 110 to 3350 metres. Prices from 7/- each. Mounting Base, as shown, 4/6.

**IGRANIC INDIGRAPH VERNIER KNOB AND DIAL.**



The Igranic Indigraph Vernier Knob and Dial is a handsome slow motion dial which greatly facilitates fine adjustment. Two scales of 0 to 100 each are provided reading in opposite directions making the Indigraph suitable for different types of condensers. Space is provided opposite the scale for recording station settings. The metal dial acts as a shield against hand capacity effects. Price 7/6 each.

**IGRANIC-PACENT S.L.F. CONDENSERS.**

Tune by frequencies according to the Geneva Plan with Igranic-Pacent Straight Line Frequency Condensers. Plates are of brass riveted together and soldered. Minimum capacity is extremely low and losses are negligible. Substantial bearing gives smooth turning movement.

PRICES : '00035 mfd. 14/6.  
'0005 " 18/6.

Also made as Square Law Condensers.

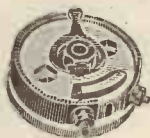
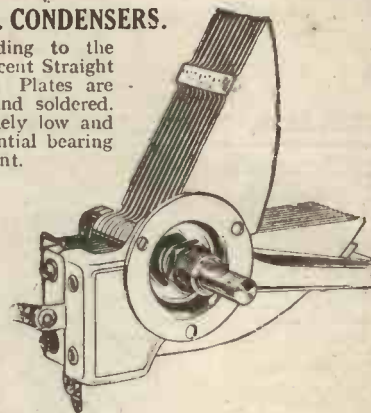

Igranic-Pacent "PRE SET" Resistors have all the uses of Fixed Resistors, and yet are as variable as rheostats. Their use instead of rheostats lessens the cost of a receiver, and prevents over-running the valves. They are suitable for all types of valves, and the position of the contact finger is easily altered. Made with resistances of 6, 10, 20, 30 and 50 ohms, 1/8 each.

WRITE FOR THE IGRANIC CATALOGUE LIST No. R.43.

**IGRANIC ELECTRIC CO LTD**

149, Queen Victoria Street, LONDON.

Works : Elstow Road, BEDFORD.

For all tuning use the IGRANIC INDI-GRAPH VERNIER KNOB AND DIAL—the ideal slow-motion control - Price 7/6.

**New Machinery**

Expensive new machinery winds Watmel Chokes far better—each turn of wire exactly parallel with cotton between each layer. Remember Watmel Auto-Chokes have transformer volume with Choke purity.



The Watmel Wireless Co., Ltd., 332a, Goswell Rd., London, E.C.1. Telephone : Clerkenwell 7990. Representative for Lancs., Yorks. and Cheshire. Mr. J. B. Levee, 23, Hartley St., Levenshulme, Manchester.

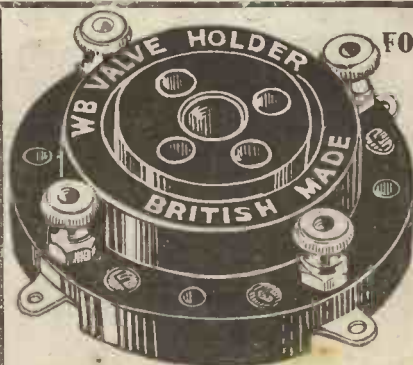

FOR BEST RESULTS

USE **W.B. ANTI-PHONIC LOW LOSS VALVE HOLDERS**

PRICE With Terminals 2/3 With Tinned Soldering Tags 2/-

If unable to obtain from your dealer write direct.

Manufactured by **WHITELEY, BONEHAM & CO., LTD.**, Duke Street, MANSFIELD, NOTTS.

WHY PAY MORE THAN DOUBLE for other amplifiers  
or for a valve set, when you can get as good results with THE  
**MAGNETIC MICROPHONE BAR AMPLIFIER**

(Patent No. 243581/25.)

"NO CRYSTAL SET IS COMPLETE WITHOUT THIS WONDERFUL ATTACHMENT."

Not only will this marvellous device give really good LOUD-SPEAKER RESULTS from CRYSTAL RECEPTION of average strength, but it is absolutely the ONLY means of increasing the strength of weak signals in HEADPHONES without using valves.

Works perfectly on one or two dry cells.

A BOON TO DEAF PERSONS

EQUALLY EFFICIENT ON VALVE SETS

IF YOUR DEALER CANNOT SUPPLY ORDER DIRECT FROM SOLE MANUFACTURERS AND PATENTEES.



(Two-thirds actual size.)

NOT a Microphone Button.

**NO** Valves, Accumulators or H.T. Batteries. Fragile parts. Distortion.

Simple as A B C.

MICROPHONE AND OTHER PARTS OF AMPLIFIER SUPPLIED SEPARATELY FULLY ILLUSTRATED LISTS FREE

COMPLETE AMPLIFIER as shown PRICE post free **38/-** 3-volt DRY BATTERY lasting over three months 4/- extra. No other accessories required.

DELIVERY BY RETURN FROM STOCK. EVERY AMPLIFIER GUARANTEED.

NEW WILSON ELECTRICAL MANUFACTURING CO., LTD., 18, FITZROY STREET, EUSTON ROAD, LONDON, W.1. Phone: Museum 8974.



YOUR REQUIREMENTS fully met by the **EELEX**

Treble Duty Terminal and Standardised Plugs and Sockets System

INVESTIGATE for yourself by writing for List P.W.10.

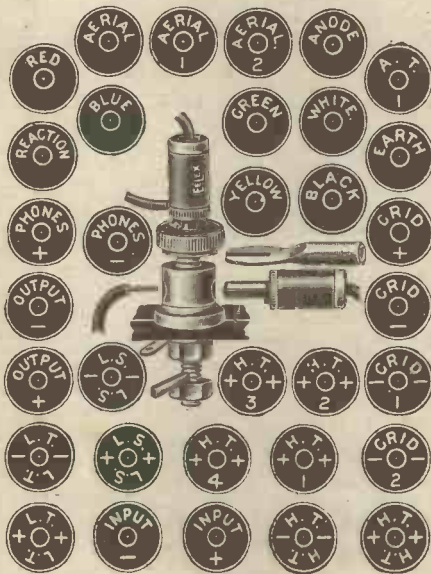

This System is used and advised by all the Leading Wireless Journals.



Phone: Clerkenwell 9282.



Read what an Army Wireless Expert says of this wonderful Loud Speaker!

"I HAVE been making a comparative test of the 'Allhall Loud Speaker' against a famous five-guinea model. I find the 'Allhall' compares very favourably with it; so much so, in fact, that from the next room it was impossible to tell when a change-over was made."

MONEY BACK GUARANTEE

Buy one, try it, and if you are not satisfied send it back within 7 days and your money is returned without any questions being asked.

Obtainable from all Radio Dealers.

READ THIS DESCRIPTION  
The Allhall Loud Speaker stands 21 ins. high and has a depth of 14 ins. from back to front; the base is 6 1/2 ins. overall and is finished in lead black lacquer, relieved by a nickel plated diaphragm control, and supplied complete with long plug-in cords. The neck is of lead black lacquer, and 3 nickel screws secure the horn which is finished in matt black and has a flare of 14 ins., ensuring resonance and volume.

**27'6**  
**L. K. Remner**  
Radio Engineers  
49a, Shudehill, Manchester.



**"He certainly sold us  
the right Loud Speaker"**

THAT is what you will probably say, and certainly think, after you have bought a B.T.H. C.2. Loud Speaker. It is right in tone, right in volume, right in appearance, and especially right in price.

It is a full-sized instrument, 24" high with a 14" flare, giving an ample volume of sound for any living room of average dimensions.

**TYPE  
C 2**

The *only*  
full sized  
full toned  
instrument  
for  
**£3:0:0**



**LOUDSPEAKERS**

BRITISH MADE

2608A

The British Thomson-Houston Co. Ltd.



Centre:  
Capt. Barnard and the  
assistant editor of  
"Amateur Wireless."

Above:  
The "Wireless World"  
man retrieves one of the  
dropped Cossor Valves.

# Crash!

"The world's most sensational Valve test"  
—vide the Press.

## Cossor Kalenised filaments unharmd after 500 feet drop from aeroplane

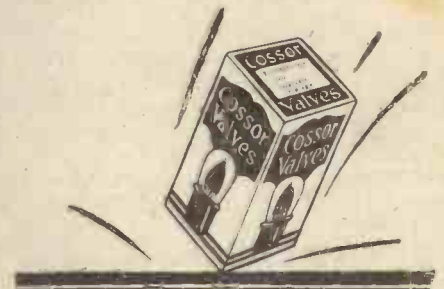

**EXTRAVAGANT** claims and bombast have never found a place in Cossor advertising. To demonstrate the immense strength of the new Cossor Kalenised filament we looked for deeds—not words. We determined to convince the public that through recent improvements the Kalenised filament is now practically indestructible. And so we asked for the co-operation of "Amateur Wireless," "Popular Wireless" and "Wireless World."

When we told them our plan of dropping twelve Cossor Valves from a height of 500 feet they were frankly incredulous. "It can't be done," they exclaimed, "no valve in the world could stand such a drastic test." But, knowing the vast strides made by our chemists during the last few months, we had confidence that the new Cossor Kalenised filament would withstand even this amazing abuse.

On December 20th at Stag Lane aerodrome this epoch-making test took place. Twelve Stentor Two Valves—previously sealed within their boxes without cotton wool or corrugated paper—were dropped from an aeroplane at a height of over 500 feet. One valve was lost owing to the high wind but in each of the remaining 11 valves the Cossor Kalenised filament was unbroken. One of the valves hit the tail plane with terrific force and was smashed. But even this filament was found to be intact. This remarkable test from start to finish was directly supervised by the Technical Press and the sealed valves were afterwards opened and tested by them at our Highbury Works.

**This test was carried out under the direct supervision of 'Amateur Wireless' 'Popular Wireless' 'Wireless World'**

### What this test means to you

Here is unanswerable proof of the tremendous strength of the new Cossor Kalenised filament—proof that every Cossor Dull Emitter will give long and enduring service. Of equal importance is the fact that the Cossor Kalenised filament never becomes brittle in use. This is because it gives off a terrific electron emission without visible glow. Heat has been practically eliminated. The Kalenised filament never loses its emission through over-running—any Cossor Dull Emitter can be operated from a fully charged accumulator without a rheostat without harm. Remember the wonderful Kalenised filament is to be found only in Cossor Dull Emitters—no other valve has it. Do not accept a substitute—no other valve is so strong or can give such economical service.

#### TYPES & PRICES

<b>Cossor Point One</b>		
210H for H.F. use	...	14/-
210D for Detector	...	14/-
(2 volts '1 ampere)		
<b>Cossor Power Valves</b>		
Stentor Two	...	18/6
(2 volts '15 ampere)		
Stentor Four	...	18/6
(4 volts '1 ampere)		

All above Valves fitted with Cossor Kalenised Filaments

# Cossor

—the Valve which serves you longest



# Popular Wireless

Scientific Adviser:  
**Sir OLIVER LODGE, F.R.S.**  
 Technical Editor:  
**G. V. DOWDING,**  
 Grad.I.E.E.  
 Assistant Technical  
 Editors:  
**K. D. ROGERS**  
**P. R. BIRD**  
**G. P. KENDALL, B.Sc.**



Incorporating "Wireless."

Consultants:  
**Dr. J. H. T. ROBERTS,**  
 F. Inst.P.  
**J. F. CORRIGAN, M.Sc.,**  
 A.I.C.  
**C. E. FIELD, B.Sc.,**  
**E. J. SIMMONDS,**  
 M.I.R.E., F.R.S.A.

Editor: **NORMAN EDWARDS, M.Inst.R.E., M.R.S.L., F.R.G.S.**

## RADIO NOTES AND NEWS.

Rugby Opens the Ball—The Auto Back-patters—A Zad Ztory—The Public Mind—Dublin Calling—A Mystery Solved—Cheerio, Pharaoh!—That Next War—"Over There."

### Rugby Opens the Ball.

I SAID 1927 would be a "bumper," and sure enough the young year opens in promising style with a telephone service to the States at £15 a touch! They tell me the speech obtained compares favourably with many a long-distance wire performance. But I do not understand the secrecy claimed for the service, and doubt whether the claim is official; if it is, I should like to know how secrecy is obtained in broadcast telephony. Well, there you are! Get out your fifteen Treasury notes, work them well down the slot—and you can have a chat with Henry Ford or Harold Lloyd.

### The Auto Back-patters.

THE Second Report of the Wireless Telegraphy Commission could be reasonably described as the camouflage on a white elephant, for it is a canticle in honour of Rugby, and as two—and perhaps three—of the four signatories were intimately concerned with the design and/or construction of the station and the remaining one is the P.M.G. himself, I don't think "auto back-patters" is at all an inapt title.

### What Are the Long Waves Saying?

ACCORDING to the Report they are saying that Rugby's signals have been heard "all over the globe." So have Mr. Marcuse's, but Rugby has twelve 820 ft. masts (or 2,400 tons of steel), 27 miles of aerial, 120 miles of "earth" wire, a three-storey building (103 ft. by 42 ft. by 60 ft. high) for the wireless plant alone, and can push 500 kilowatts into the aerial. All this, my brothers, at the beginning of the era of short-wave wireless, with the income-tax weighing like lead and the penny post costing us three ha'pence. Hence the Report—to gloss over the fact that except for the Beam stations the Post Office has got a slightly *passé* white elephant in its W/T Dept.

### Have You Heard These?

**THIS Week's Optimist:** The beginner who bought a crystal set—and a Maori dictionary.

**This Week's Careful Body:** The man who asked the P.M.G. whether, if he plugged one ear with cotton wool, he could have a licence for five shillings.

**This Week's Grandma:** The dear old lady who, on being subjected to a bad demonstration of the Croyland Abbey bells by her grandson's 10-valve distorter, said she could distinctly hear the bats in the belfry.

she had enjoyed the wireless, "especially them Zincoplated Orphans playing a bit of *Sandow and Eliza!*"

### The Public Mind.

TALKING about B.B.C. programmes—and I do a lot of it—what about that item on New Year's Eve? (It's harking back, I know, but not far.) Do you remember the wordy duel between "The Spirit of the Public Mind" and the Discontented Listener, John Somebody? Wasn't it rich? And didn't the Listener rag the Spirit beautifully? Of course, the whole item was an attempt on the part of the B.B.C. to smite all its critics one final, crushing blow. But I am positive the majority of those who heard it would give the cigar (or nuts) to the Listener—"on points." He was no fool, that lad. Oh, and I observed that amongst all the star turns served up in order to show John Somebody what a gratuitous gronser he was, *there was no Chamber music!* Good enough!

### Dirty Work.

THE first blot on my New Year was dropped by one of the "P.W." technical staff, who hid himself behind an experimental model of

a super-Anodyne and inquired whether now that the managing director of the old B.B.C. has been publicly honoured he might be called a Laurel Reith!

### Another One "On the Air."

MR. C. R. GREEN, 32, Aldridge Road Villas, London, W.11, having received permission to oscillate on purpose, proposes to shake up the Antia (Continued on next page.)



Mr. E. H. Shaughnessy, M.I.E.E., of the P.O., who was largely responsible for the inauguration of the recent transatlantic telephone service.

### A Zad Ztory.

THE writer of a letter to a daily newspaper said he was pierced to the marrow the other day because a Wicked Uncle announced a song as "Old Lang Zync." How zilly! Being a B.B.C. man he should have said "Old Long Since." But, I say, it doesn't take much to horrify some people, does it? I wonder what our sensitive friend would do if he heard our "daily" saying (as she did recently) that

## NOTES AND NEWS.

(Continued from previous page.)

podean ether, using the call letters 5 GN. No wave-length or other details of transmission given. So you may come across his signals by chance.

## Dublin Calling.

THE Editor of "The Irish Radio and Musical Review" (179, Great Brunswick Street, Dublin) reminds me that the Dublin station (2 RN) now works on a wave-length of 319.1 metres, and asks listeners for reports on its transmissions. Now then, knights of the cat's-whisker, there's your meat. By the way, after having heard so much of recent months about the great gulf which is fixed between "radio" and "music," it is refreshing to see the two wedded together in one publication. Evidently in Ireland there is an *entente* between the "fans" and the fiddlers and pianers.

## A Mystery Solved.

HA! the game is up and the mystery of Daventry is solved. We knew quite well that Daventry is pronounced "Daintry"; so did the B.B.C. And yet they continued to say "Dav-en-try," to our astonishment. We wondered what the B.B.C. Advisory Committee on spoken English would do about it. But the secretary of the committee has now explained that had "Daintry" been adopted it would have been impossible for French and German people to identify "Daintry" with "Daventry." Bless us! What a reason! As weak as seven days! Well, of course, if that is the criterion of the committee, we shall be hearing some queer sounds from the announcers, such as "Aperteen," "Ool," and "Blimmuss." Awfully kind of the British B.C. to tamper with "spoken English" for the sake of Gauls and Teutons—what?

## "Farewell, Romance."

THE old wind-jammers are disappearing from the face of the seven seas, and with them Romance—for those who never sailed in one. Now the old romance of whaling has had its death-blow, for the whaling vessels are being fitted with radio. Marconi sets of ½ kw. power, specially designed for being worked by a harpoon-gunner in full kit, have been fitted to all the ships of the Southern Whaling and Sealing Co., Ltd. They are operated by stout levers which are easily manipulated by heavily gloved



Sir Alexander Roger, Chairman of the Telephone Development Assoc. who was one of the first to speak to New York by means of the new telephone service.

hands, and reception is by loud speaker. The "C. A. Larsen" has been heard 2,000 miles away by the "Sir James Clark Ross," on telephony, with a wave-length of 400 metres. Well, by the time they get to bagging the whales with a death-ray I guess the bottom will be out of fishing as a fine art.

## Piracy a Back Number.

YES, sport ain't what it was, as the fox said when they fitted the hounds with direction-finders. Even piracy has gone phut, for radio broadcasting being

now a mere sub-section of the wireless sub-section of the telegraphy section of the engineering branch of the Post Office, the collection of the licence fees becomes as dull and deadly a process as that of "stinging for income-tax." The radio "pirates" have little hope now, for it is mooted that special machinery has been devised unto their undoing. So all that remains to the "something-for-nowt" brigade is to drop radio and collect stamps—or bang twenty sixpences every annum. I believe some of 'em would rather emigrate to Greece, where there is no broadcasting.



Sir W. Mitchell Thomson, the P.M.G. under whose auspices the new wireless telephone system has been inaugurated.

## Good News from Mexico.

IT is reported that the Mexican Government is about to spend 8,000,000 dollars on the improvement of its telegraph and wireless systems. Doubtless they are going to make the windows of the offices shot-proof, and to employ some living operators in place of the late perforated staff. (R.I.P.)

## Cheerio, Pharaoh!

THE Marconi Co. is going to brisk up the land of Tut. It has bought the Post-Office station at Abu Zabal, and is going to shove a "Beam" in the Sphinx's eye. So mote it be. It is also going to

## SHORT WAVES

"I should like to make it clear that I am not objecting generally to this remarkable invention."—(Sir Thomas Beecham, on "Wireless"—Evening Standard.)

—We understand that the B.B.C. is overjoyed.

Wagging of the ears is being recommended as an aid to beauty. It is a useful accomplishment, too, if wireless headphones are found to be a trifle tight.—(London Opinion.)

Headline in Daily Paper: "Wireless Works." A correspondent wrote the other day to ask us when.

Radio comedy will never be really popular until somebody invents a method of broadcasting a custard pie.—(Ideas.)

The wireless pirate sits alone,  
A furtive soul is he.  
His horrid deeds must not be known,  
And though he listens free  
To song and jazz, the fellow has  
Moments of agony.

But though a sob that tears his heart,  
He possibly may fetch,  
He still pursues his wicked part  
Till the abandoned wretch  
On some sad day is led away  
To do his seven stretch.  
(“Touchstone,” Morning Post.)

A reader who wishes to build a set for use in India has written to us as follows:

"Notes on the following would be useful: Mitigation of atmospheric; DX's are awful out there."

Many other readers are not so reserved in their descriptions!

Radio shrinks the earth!—(Headline, Provincial Paper.)

The country amateur who had to walk six miles to get his battery recharged said this was a fallacy.

Listeners without licences never hear any good of themselves.

give the "Gippies" a real wireless telegraph service. And doubtless the Sphinx will go on smiling as it broods over the sight of the descendants of the Pharaohs listening in to a ukelele-saxophone fox-trot or a talk on excavation in the Valley of the Kings.

## That Next War.

DON'T say I didn't warn you. If you want to have peace in the next war go to Andorra in the Pyrenees and keep goats. Mr. Elmer Ambrose Sperry has been awarded the John Fritz gold medal, which is the highest award in the United States engineering profession. Why? Because he can control aerial torpedoes by wireless. And for a distance of thirty-five miles he can direct them unerringly against the target. Gollies! I'll have to invent a wirelessly controlled target—which can dodge Elmer's bombs. (Don't Trouble: Ed.)

## Kindness to Aerials.

THE 45-kilowatts broadcasting station which the Marconi Company is building at Lake Vattern, some miles south-west of Stockholm, is a model of kindness. Even the electrons are to be kept warm. The facts are that in winter there is a pest called "silver thaw," which coats the aerial with ice to such an extent that the wire would break with the added weight unless some means of melting the ice were provided. So arrangements had to be made whereby a current is sent through the aerial wire sufficiently strong to cause the wire to become hot. This was, I believe, first done when the Glace Bay (Nova Scotia) station was built, many years ago, after Senatore Marconi had proved the possibility of wireless across the Atlantic. Cold and "silver thaw" were then unforeseen enemies of radio.

## "Over There."

A FRIEND of mine has just returned from those Yewnited States, where he went to find out what they are doing over there in radio. You will be interested to know that crystal sets are obsolete, and that there is not much doing in any sets with less than four valves. The whole country is divided between super-hets and neutrodynes. "All mains" sets are common, thanks to the general prevalence of uniform A.C. mains supplies. Valves are sold at about 8/- apiece. Cabinet multi-valve sets, with all-mains drive, enclosed loud speaker, and special power-amplification stage, can be got for about £100. There are two picture theatres in New York playing to crowded houses which feature wireless-synchronised films—a five-year advance on us, I calculate. But then, we are verging on television. Portable sets are a drug on their market, and a six-valve set can be got for £6. Thinking it all over, I *druther* be a blooming Britisher, nevertheless.



Mr. J. C. Stobart, who broadcast the much discussed "Grand Good Night" on Christmas Eve.

# Adding H.F. to the Hale

By PERCY W. HARRIS M.I.R.E.



In response to a large number of requests from readers Mr. Harris has specially designed an H.F. amplifier for attachment to the Hale receiver.

THE Hale circuit, which was first introduced to readers of this journal in November last, has proved so immensely successful that many constructors

broadcast band), and this is coupled inductively to the grid coil (which for the lower broadcast band can be a No. 60 or 75). For convenience in experimental work, I have placed these coils in a coil holder which, in the photograph, happens to be a

the grid and the other end to a neutralising condenser. The centre tapping of the coil is taken to the negative filament leg of the valve, and the plate of this valve besides being connected to the neutralising condenser, goes to a radio-frequency choke (through it to positive H.T.), and to one terminal of a .0003 mfd. fixed condenser. The second terminal of this condenser carries a flexible wire for connection to any set to which it is desired that the H.F. stage should be joined.

### Neutralised Circuit.

The circuit used is that known as the Rice "bridge" circuit, and can be adjusted for complete stability. The object of the radio-frequency choke and the fixed condenser is to enable the output side of the amplifier to be connected to the aerial terminal of the Hale or other set without the necessity of any high-tension current flowing through its normal aerial windings. If, however, the aerial of the set to which this H.F. unit is joined is tuned and inductively coupled to the grid of the next valve, and there is no direct connection between the earth terminal and the battery of the second set, the radio-frequency choke and the fixed condenser can be dispensed with. The plate of the H.F. valve is then taken to the aerial terminal of the set, the earth terminal of which is connected to H.T. positive. However, many sets have the aerial directly connected to the grid, and the earth to the filament, and if we were to use the direct

three-coil form, although the third socket is not used. It is not necessary, however, that the coils should be movable in relation to one another, and the two sockets can be of the ordinary fixed board-mounting type, placed fairly close to one another.

The aerial coil is of the ordinary type, while the grid coil is of the centre-tapped variety, obtainable from several makers, including Lissen and

Gambrell. The variable condenser is connected across the whole of this tapped coil, one end of this coil being taken directly to

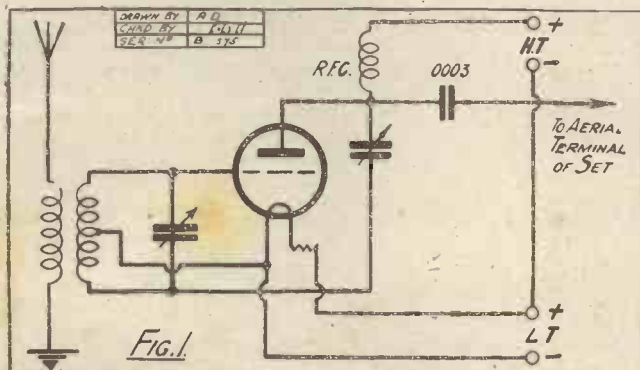

have wondered what additional efficiency can be gained by adding a stage of H.F. In response to a very large number of letters asking for particulars of how to add such a stage, I have carried out a number of experiments, the results of which are given below.

At first thought, it might appear a very simple matter to add one of the conventional H.F. stages to the Hale circuit, but in practice, as many readers have found, difficulties occur. Some of these difficulties vanish on close investigation, and when we realise that the adjustments of the original Hale circuit no longer hold good when the aerial is removed.

### The H.F. Stage.

Incidentally, the H.F. stage which I have built up to precede my experimental Hale receiver is applicable at once to any other set, without any alterations to its wiring, for the output terminals of the amplifier are connected directly to the receiver in place of the usual aerial and earth wires. Let us first of all examine the theoretical diagram.

Fig. 1 shows the theoretical circuit in conventional form. The aerial is connected to a plug-in coil (25, 35 or 50, according to your aerial, when used on the ordinary

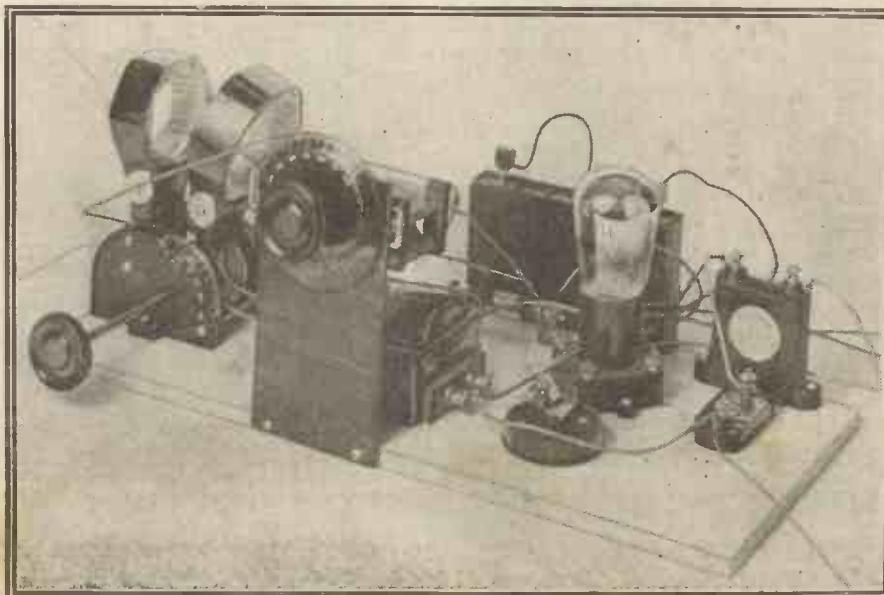

The experimental Hale receiver with valve coils and grid bias battery in position.

(Continued on next page.)

## ADDING H.F. TO THE HALE.

(Continued from previous page.)

arrangement just referred to the H.T. battery would be shorted to earth. The use of the radio-frequency choke feed, together with a fixed condenser as shown, obviates this trouble.

From a large correspondence it would appear that POPULAR WIRELESS has recently added many readers to its already very large circle, and a number of these have not seen the original Hale circuit, as published last November. In order to carry out my experiments, I have fixed up a very simple single-valve "Hale" on a baseboard, the circuit for which is shown in Fig. 2. Here again we have a coil holder with the aerial directly connected to the

the filament. From the plate terminal of the valve a lead goes to the reaction coil, and from this last to the telephones or loud speaker. A .001 mfd. fixed condenser is joined from one terminal of the telephones to the negative L.T., the other telephone or loud-speaker terminal being taken to positive H.T., which in its turn is shunted by a 1 mfd. condenser taken from positive H.T. to negative L.T., thus shunting both H.T. and L.T. batteries.

Many readers will already be well acquainted with the operation of the Hale circuit, but for those new readers to whom this is the first introduction, the following practical points will be of interest.

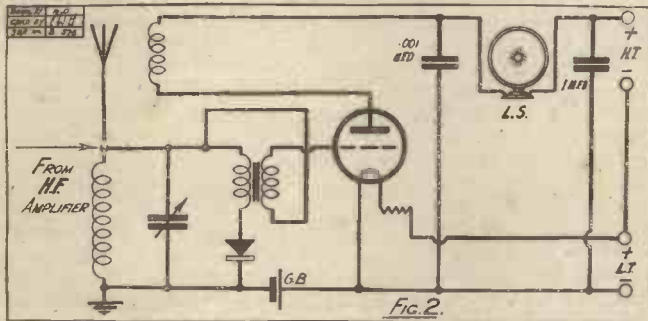

grid coil, the reaction coil being placed in the movable socket. The circuit, as readers will see, is the same as that recently published in POPULAR WIRELESS, and as the make-up is of an experimental nature, a board is used with the greatest simplicity.

### The Hale Connections.

Notice that the L.F. transformer connections are unusual in the Hale circuit, the I.S. being connected to O.P. and to the aerial coil, while I.P. goes to one terminal of the crystal detector, the other terminal of which is joined to earth. A grid-bias battery is interposed between the tuning coil and the filament of the valve, negative being connected to earth and positive to

The valve used with the Hale circuit should preferably be of the power-valve type, as the set is capable of giving very strong signals from the nearest station, and unless a suitable valve is used, distortion will occur. A voltage of from 100 to 120 is recommended and I have found best results are given by one of the semi-permanent types of detector, rather than with the cat-whisker type. However, a wide variety of apparatus is possible with this set, and the excellent results with many different components have already been published in this journal.

To operate the Hale circuit, proceed as

follows: Open out the reaction coil so that it is well away from the aerial coil (having joined aerial and earth as usual) and join the telephones or loud speaker to the ter-

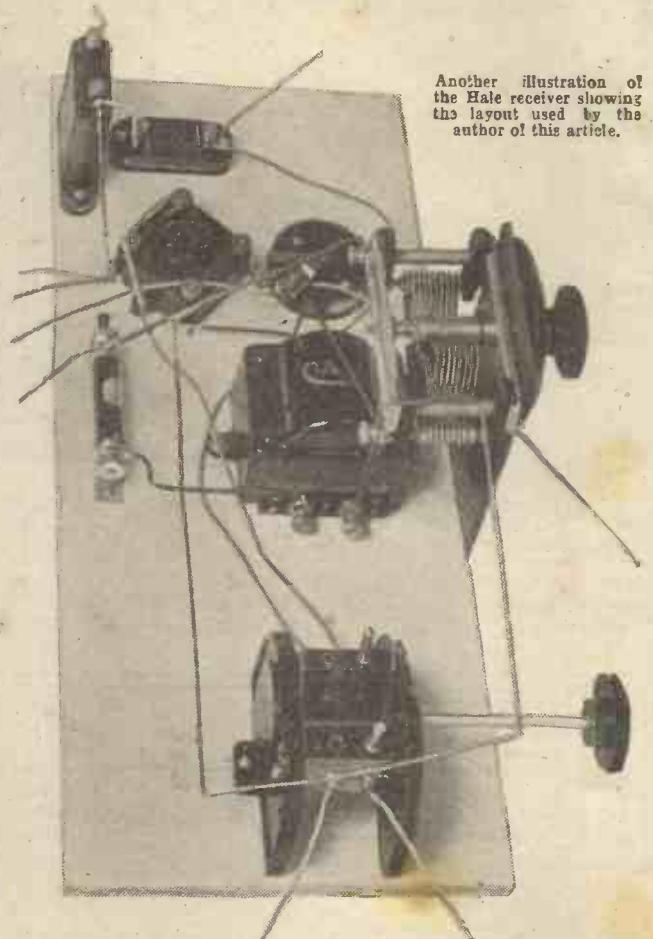

Another illustration of the Hale receiver showing the layout used by the author of this article.

minals marked in the diagram. Join up your batteries and set the filament resistance to a suitable value for the particular valve you are using. If this is a small power valve with 120 volts on the plate, join up the grid-bias battery with about 4½ or 6 volts, for the time being, and make sure that your two crystals are in contact. Tune in the nearest station in the usual way by means of the variable condenser, and gradually bring up the reaction coil against the aerial coil to see whether the signals increase, as they should do. A point should be reached when the set begins to oscillate, when you will, of course, slack off at once. It is preferable, by the way, to undertake these tests on the test signals which are often given after the normal service has closed down. For example, test signals are regularly sent out every Friday night from 2 L O after "closing-time."

### Careful Crystal Setting.

If you do not succeed in getting oscillation, or if oscillation control is not smooth, try resetting your crystal. A careful setting of the crystal is an important part of the operation of the Hale receiver, and, once a good position has been found, it will be retained for a considerable time. A little practice in setting the crystal of the Hale receiver will soon show you that marvellous results can be obtained with this set, which, incidentally, should work a loud speaker at

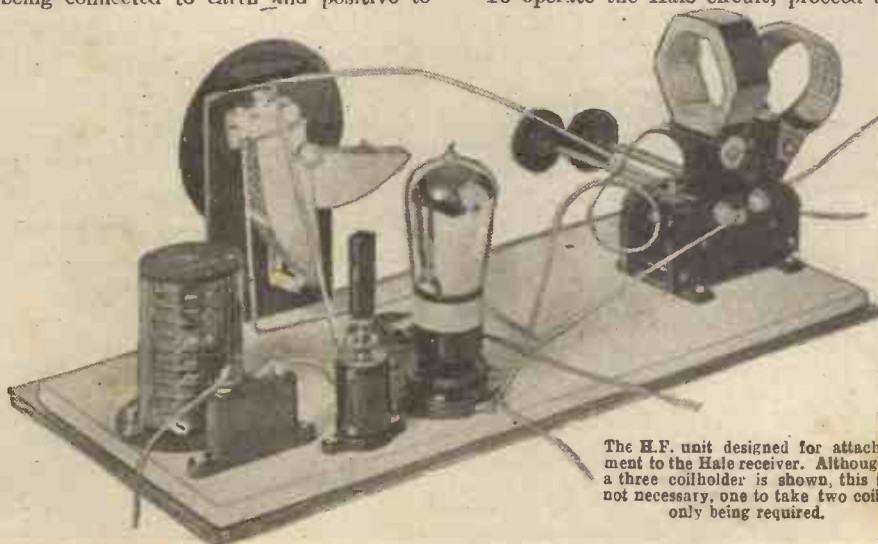

The H.F. unit designed for attachment to the Hale receiver. Although a three coilholder is shown, this is not necessary, one to take two coils only being required.

(Continued on next page.)

## ADDING H.F. TO THE HALE.

(Continued from previous page.)

good strength up to quite twenty miles from a main B.B.C. station, using an average aerial.

We will now consider the attachment of the H.F. unit. Having satisfied yourself that the ordinary Hale receiver is working properly, remove the aerial and earth leads from this and connect them to the aerial and earth terminals of the H.F. unit. Take the flexible lead from the fixed condenser of the H.F. unit to the aerial terminal of the Hale, and leave the earth terminal free. It is necessary in this case to use the same accumulator for both sets; the same H.T. battery can also be used.

### Connecting the H.F. Unit.

As the aerial and earth are no longer connected to the original Hale receiver, you will have to place a larger coil (say a 60) in the grid-coil socket of the Hale. Set the

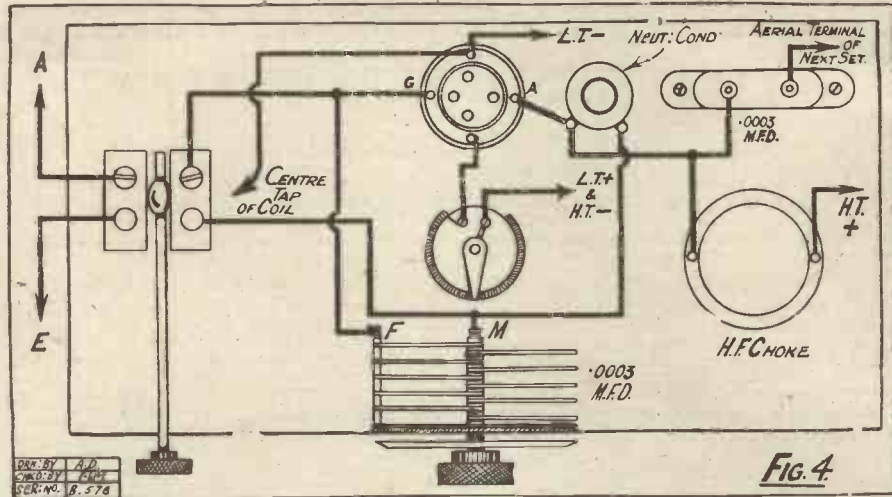

FIG. 4

violent self-oscillation may take place. While the Hale circuit will introduce considerable damping, it is not wise to rely upon this, and it is very difficult indeed to obtain satisfactory working with such an arrangement.

Although for convenience of experimental work the H.F. unit has been made up without a panel, readers will see that a very slight change is necessary in order to make up this set in the conventional form. If such a type of receiver is desired I would suggest that the coil sockets be both fixed in the H.F. amplifier, thus cutting out one adjustment and that the condenser be mounted centrally on the panel in the usual way. The general

lay-out of the parts inside the box can be as shown in the present receiver.

In order to show readers the theoretical connections of the anode circuit of the H.F. valve and the grid circuit of the Hale receiver when they are coupled, I have

shown in Fig. 5 the essential parts of these two circuits, from which it will be seen that the path of the H.F. oscillations from the H.F. valve is through the grid coil of the Hale receiver, through the grid-bias battery, and thus back to the common negative filament. This will explain why no earth connection is necessary on the Hale receiver when the H.F. valve is placed in front of it.

### Remarkable Increase of Strength.

As previously indicated, this H.F. unit can be placed in front of any existing receiver, providing a common L.T. battery is used, and it will be found to give a very appreciable increase of signal strength on distant stations. When this H.F. stage is added to the Hale, the increase of strength on distant stations is very remarkable. For example, a quick change over showed me that on a night when Madrid was just audible close to the loud speaker with a single-valve Hale on a good aerial, the addition of the H.F. amplifier brought it up to quite reasonable loud-speaker strength for the ordinary room.

For long-distance work the great advantage of the H.F. stage in front of the Hale is that it is not necessary to use much reaction amplification to get these distant stations, and for this reason the quality is greatly improved. When the limit of

(Continued on next page.)

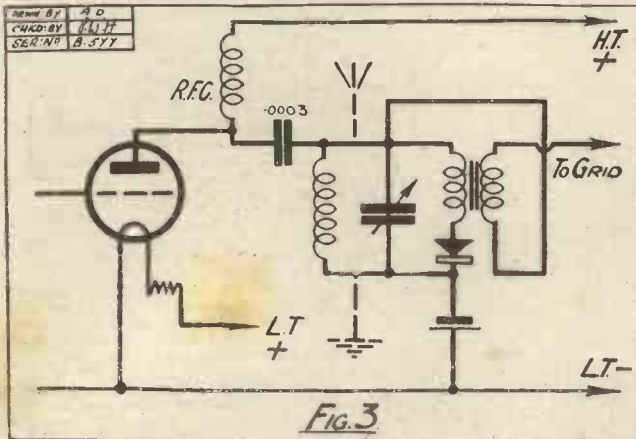

FIG. 3

aerial coil of the H.F. unit fairly close to the grid coil, and by manipulating the tuning condenser again tune in your nearest station. The set will probably be very prone to oscillation, so carefully adjust the neutralising condenser turn by turn until the set becomes stable again. When this neutralising condenser has been properly adjusted the original reaction setting of the Hale set will be the best, and you will get no self-oscillation in the H.F. unit.

My experiments have shown that the ordinary small power valve (not necessarily the H.F. type) works excellently as the H.F. amplifier, and about 80 volts will be found to be suitable for H.T. Remember that the tuning with this combination is exceedingly sharp and that alteration of the coupling between the aerial and the grid coil of the H.F. amplifier may cause you to lose a station until you retune.

### In Conventional Form.

Most trouble found in adding a stage of H.F. to the Hale receiver has been due to the fact that unless the H.F. unit is of the neutralised type great difficulty is found in getting stability in the Hale, as the grid-coil circuit of the Hale acts as if it were in the plate circuit of the H.F. valve, and when in tune with the grid circuit of this latter valve

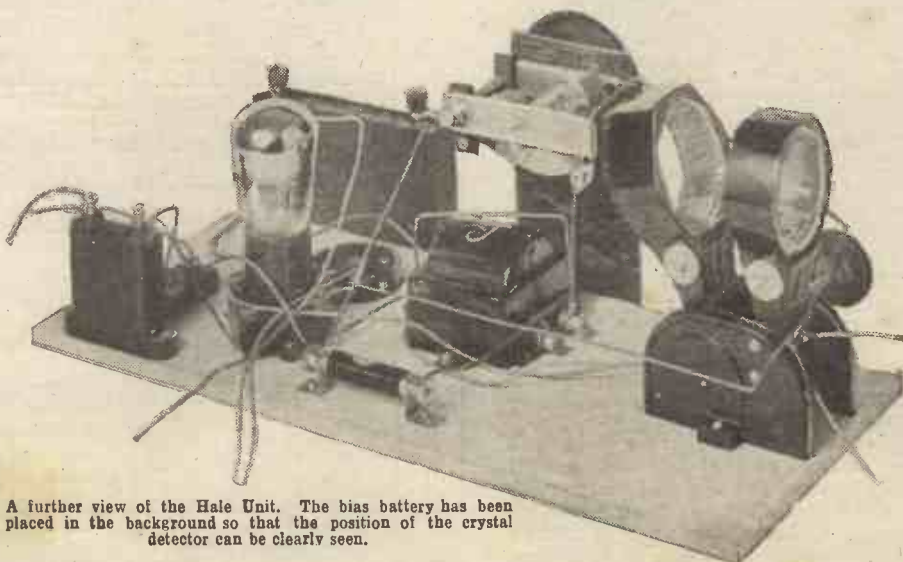

A further view of the Hale Unit. The bias battery has been placed in the background so that the position of the crystal detector can be clearly seen.

# CORRESPONDENCE

Letters from readers discussing interesting and topical wireless events, or recording unusual experiences, are always welcomed; but it must be clearly understood that the publication of such does in no way indicate that we associate ourselves with the views expressed by our correspondents, and we cannot accept any responsibility for information given.—Editor.

## A QUESTION ANSWERED.

The Editor, POPULAR WIRELESS.

Dear Sir,—Re Mr. Manly's enquiry in the correspondence column of your December 18th issue, the station in question is KDKA of the Westinghouse Electric Co., East Pittsburgh. This station has been working on 84 metres for some time, and is a very useful help in calibrating a short-wave set, as its wave-length is kept remarkably constant.

Mr. Manly would be well advised to try for 2 X A F of the G.E.C. on 32.7 metres on Saturdays and Tuesdays from 11 p.m., G.M.T., onwards.

This station is remarkably easy to pick up, and considerably louder, generally, than KDKA.

Hoping to see more of "P.W." devoted to short-wave work and amateur research work.

Yours faithfully,

R. MACKLEY.

84, Torrington Street, Grimsby.

## RE LECLANCHÉ WET H.T. BATTERIES.

The Editor, POPULAR WIRELESS.

Dear Sir,—Probably a lot of your readers who have constructed "Wet H.T." have found that they get considerable trouble from electrolyte creeping, thereby shorting the battery and, of course, lowering the insulation of the unit. Sugar has been suggested as a remedy, but I have never found this very effective. I therefore suggest that they pour a little THIN lubricating oil on top of the electrolyte. This will be found to stop all creeping.

Only a very thin film of oil is needed. Trusting this will help many, and wishing "P.W." all good wishes.

Yours faithfully,

CYRIL E. CATER, A.M.I.R.E.

123, Newland Avenue, Hull, E. Yorks.

## SOME COMMON FAULTS.

The Editor, POPULAR WIRELESS.

Dear Sir,—An article which appeared in last Thursday's issue of POPULAR WIRELESS, entitled "Some Common Faults" calls, I think, for comment.

The article is apparently intended for new recruits to wireless, to whom it might be somewhat misleading on one or two points.

Your contributor begins by stating that an H.T. dry battery should be tested with a flashlamp, and faulty cells should be shorted. A flashlamp obviously cannot give any useful indication of the state of an H.T. battery for wireless reception, as, although some three-volt tappings may give little or no visible glow in a flashlamp, they may give a perfectly steady current at the rate demanded by a receiving set. I suggest that a voltmeter test would be much more satisfactory, especially if the voltmeter has a fairly high resistance. The really defective cells can be shorted, but I think that the addition of a large Mansbridge condenser across the H.T. battery will sometimes effect a considerable improvement.

He next deals with the accumulator. In this respect I, of course, agree with him, but a clearer way of expressing it would be that the voltmeter will not give a reliable reading unless it is connected across the battery whilst the battery is delivering normal current to the set.

As regards the paragraph dealing with fading, I do not see how this can be caused by geographical conditions, which, I take it, means one's location. One may be in a more or less "blind spot," but I should imagine that only atmospheric conditions affect actual fading.

He advises that valve pins should be scraped,

and I suggest that the valve holders occasionally need similar treatment in order to obtain good contact with the valve pins.

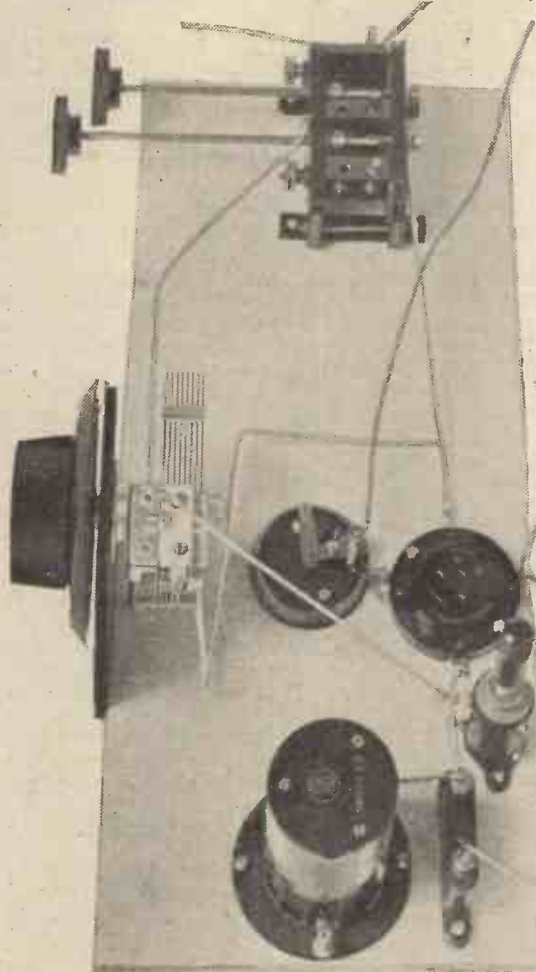

Another photograph of the Hale H.F. Unit.

The anode voltage of the L.F. valve should, your contributor states, be "100 volts or so." This, I submit, depends upon the type of valve used, and, if there is more than one L.F. stage, also upon its position in the set. Instructions on this point, however, frequently appear in your excellent periodical, of which I am a regular reader.

Other common sources of trouble which I have encountered are the external aerial-earth switch, which at times gets wet and dirty, and should be periodically cleaned; and extension wires, which cause a capacity or leakage to earth, thus throwing the set out of adjustment or causing a drop in volume when plugged in. I have found that a way out of the latter difficulty is to use loose-coupled or aperiodic aerial tuning.

I cannot conclude without saying that the contents of POPULAR WIRELESS are usually of the highest order, and I hope that the progressive policy of "P.W." will be continued.

Yours faithfully,

ERNEST H. J. KEW.

9, Charles Street, Barnes, S.W.13.

## D.C. ELIMINATORS.

The Editor, POPULAR WIRELESS.

Dear Sir,—As your paper has recently given some prominence to H.T. Battery Eliminators, perhaps my experiences with one of these instruments on D.C. Mains may be of interest.

Prior to the installation of the Eliminator, clicks could be heard in the loud speaker every time a house switch was turned on or off.

Since fixing the Eliminator these clicks are slightly louder, but when listening to Daventry the reception is marred by a number of similar noises occurring every few seconds.

My conclusion is that these latter noises are due to the switching on or off of electric lights in the neighbourhood, and that the natural wave-length of the local electric lighting circuit must be approximately 1,600 metres, since the noises are not heard on the lower B.B.C. wave-lengths. This theory is further strengthened by the fact that this evening, before the Daventry transmission commenced, the set was tuned to approximately 1,600 metres, and noises were heard which correspond to those usually caused by an electric motor. Increasing or decreasing the wave-length by means of the variable condenser resulted in a decrease in the volume of the interference.

Have any of your readers had a similar experience, and if so have they found a cure?

Yours faithfully,

"E. ELIMINATOR."

3, Wilmer Drive, Redburn Road, Shipley, Yorks.

## MORSE INTERFERENCE.

The Editor, POPULAR WIRELESS.

Dear Sir,—Perhaps my locality is rather bad for Morse interference, but it is evident that something must quickly be done to effectively prevent its transmission on 250-400 metres. I possess a powerful

(Continued on page 1226.)

## ADDING H.F. TO THE HALE.

(Continued from previous page.)

sensitiveness is required, the use of the H.F. stage in front of the Hale with careful reaction setting on the Halo gives remarkable results, and the two-valve combination so produced has distance-getting powers which few people would credit if they have not tried it.

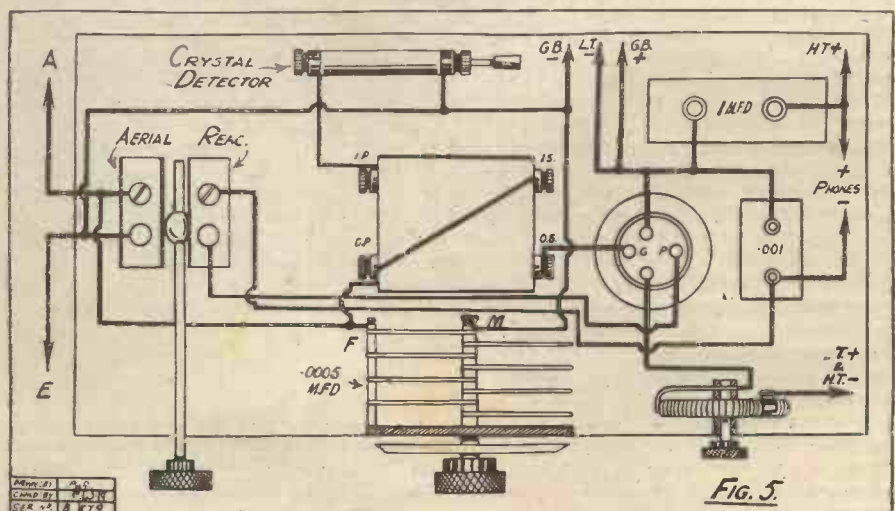

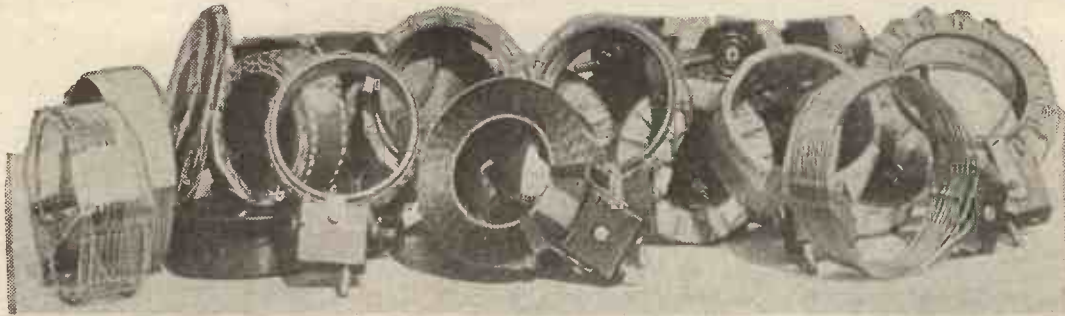

# An Interesting Reinartz Variation

THE reason why circuits employing capacity reaction control have become so popular is chiefly because the use of a variable condenser as the reaction control permits of a very delicate and smooth adjustment of the receiver's sensitivity. This tends to make it all the easier for the amateur to get good DX results.

Of the various circuits perhaps the Reinartz and its modifications have met with most success. This type of circuit in its more simplified form is certainly a fine one for the DX enthusiast who does not wish to bother with H.F. amplification.

Fig. 1 depicts a well-known version of the Reinartz which is quite selective and remarkably efficient. C1 and C2 are respectively the tuning and reaction control condensers, while the two coils are coupled at a fixed distance from one another. In operation, especially when receiving weak signals, it is often found that each adjustment of the reaction condenser necessitates a slight retuning of the grid circuit, L1 C1. Where a large anode coil has to be used to get sufficient reaction, a correspondingly bigger variation in tuning is caused by reaction adjustments.

Now this in itself is not a great disadvantage because, with a suitable reaction coil, the amateur skilled in tuning can bring in station after station quite easily and quickly. However, where it is necessary to use a large reaction coil, and where the operator has not the necessary skill in tuning, especially of weak signals, this variation in tuning is of more importance.

### The Ideal Condition.

Thus it would be a decided advantage if some form of reaction control could be introduced into this circuit so that reaction adjustments made no difference to the tuning of the grid circuit. Given such a modified circuit, tuning would obviously be easier, and occupy less time, for, with the receiver just oscillating, we could tune to the silent point of a carrier wave and then decrease reaction until oscillation just ceased. It would then be possible to hang on to a weak station without fear of losing it while making the necessary reaction adjustments. Even the beginner could operate such a receiver successfully, and adjust reaction sufficiently quickly to cause the minimum of interference.

Now in Fig. 1 the reason why reaction adjustments detune the grid circuit is because any alteration in the capacity of C2 changes very slightly the mutual inductance of L1 and L2, so that C1 has to be reset to make up for the decrease or increase of the

\*-----\*  
 A modification of one of the most popular wireless receiving circuits.  
 By J. ENGLISH.  
 \*-----\*

inductance of L1. Other forms of capacity control upset even more the tuning of the grid circuit.

Obviously the only modification of Fig. 1 which will bring about the desired condition of things is some form of reaction control which does not change either the capacity of C2 or the mutual inductance of the coils.

Before describing this modification let us consider a little more fully the effect of vary-

ing between zero and several thousands of ohms, is inserted in the earth to filament lead, with the reaction coil at the earth end of the tuning coil. Since a properly made variable resistance has negligible inductance and capacity, its use as a reaction control will not detune the grid circuit. Besides this advantage, the circuit of Fig. 2 retains all the good points of the original.

### Adding the Resistance.

The fixed reaction condenser C2 (.0002 mfd.) is large enough to make the receiver oscillate at any setting of the tuning condenser with R at maximum and using the coils indicated in Fig. 2. Then, as the resistance of R is reduced, oscillation gradually decreases until the set is just off

oscillation, this being the correct adjustment for the loudest signals. Further reduction of R reduces signal strength correspondingly. This wide variation in the degree of reaction causes no detuning of the grid circuit, so that when the set is tuned to the silent point of a carrier wave and then oscillation reduced to "just off," there is no fear of losing the signal, however weak. This modification therefore enables us to obtain the desired results anticipated above, giving a sensitive receiver that is remarkably easy to handle.

Any existing set similar to Fig. 1 can be modified quite easily by inserting a variable

resistance in the earth to filament lead as in Fig. 2. The success of this circuit, however, depends entirely upon the choice of the variable resistance, which must be continuously variable from zero to maximum, constant in use and of good design mechanically. A resistance of the graphite type is best, and a very satisfactory component is the Marconiphone variable resistance (0 to 40,000 ohms). I have also used successfully a home-made variable resistance of similar value, details of which were recently given in "P. W."

### Preliminary Adjustments.

In making the preliminary adjustments, R is set at zero and the coupling of L1 and L2 weakened so that the set does not oscillate at any setting of the tuning condenser. Turning R towards maximum

(Continued on next page.)

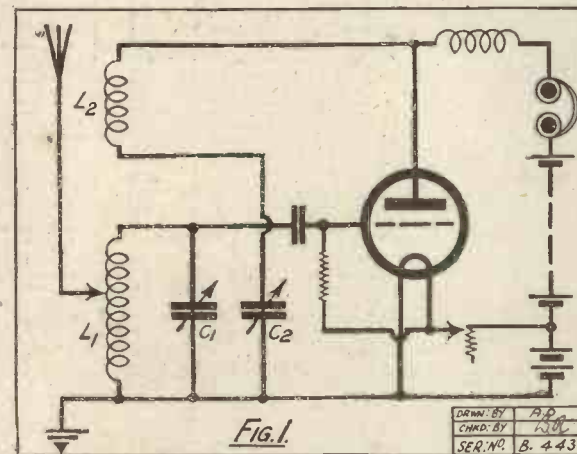

ing degrees of reaction in Fig. 1. Here the full sensitivity of the receiver is only obtained when sufficient reaction is used to counteract, almost but not quite, the fixed damping of the grid circuit. This damping, of course, is due to the H.F. resistance of the aerial system and of the coils and tuning condenser. Therefore, if we substitute for this state of affairs a fixed degree of reaction and then vary the damping, we shall obtain just the same control of the receiver's sensitivity, but with one important difference. The damping of the grid circuit can be varied in such a way that no detuning of the grid circuit takes place, whatever the degree of reaction. This will give us the required modification of Fig. 1.

Now there are several ways of varying the damping of the grid circuit, but the method which I have found most successful is shown in Fig. 2. Here a resistance R, variable

## GRID BIAS AND H.T. BATTERIES.

Some Useful Hints upon the Treatment of Dry Batteries.

BY A CORRESPONDENT.

A GRID bias battery is not called upon to supply current. If it were capable of providing a definite voltage value without any current flow whatever, it would still be doing its duty. But no battery can be connected in any complete circuit without some current flowing, although in cases this may be almost negligible.

Now, simply because of this fact, it has become a habit among many amateurs to use otherwise useless batteries for grid bias purposes—old H.T. battery units which have served their purpose, and which

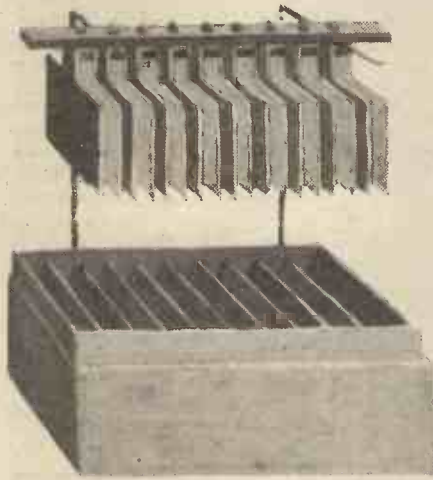

An early form of wet H.T. battery, where the plates have to be removed from the electrolyte when the battery is out of use to prevent unnecessary action taking place.

give just three or four volts where once they were able to record twelve or fifteen, and so on.

But it should be remembered that such a battery as this may fluctuate considerably. One day it may give a three-reading, and another eight or so, or even nothing at all. Needless to say, a grid bias battery that gives no grid biasing voltage is merely a useless resistance in circuit, while one that fluctuates is bound to have a detrimental effect upon reception.

### Watch the Bias Battery.

And it should not be forgotten that a dry battery standing on "open circuit," or one that is called upon to deliver negligible current, will still deteriorate. Therefore the practice of connecting up a grid bias battery inside a receiver, and then forgetting about it after its initial adjustment, is strongly to be deprecated. We have even known amateurs to solder "dash-lamp" batteries up inside sets, just as they would solder into circuit a fixed condenser or other component.

As a matter of fact, the health of a grid bias battery is just as important as that of an H.T. battery. A very little thought and study of an average characteristic valve curve will show that a two-volt depreciation in a grid bias battery of nine volts is as serious as a ten-volt or so H.T. battery depreciation.

Grid bias batteries should be as carefully watched as H.T. or L.T. batteries. In the first instance they should be new batteries of sturdy construction, and not derelicts or tiny batteries with infinitesimal capacities; such will rapidly depreciate. In use they should be tested from time to time, and should be replaced when they show the inevitable signs of old age.

### H.T. Faults.

When, after a period of successful work, a receiver begins to emit loud crackling noises, such are most frequently due to a faulty H.T. battery. If the noises are due to "atmospherics," they will cease when the aerial and earth leads are removed.

A faulty H.T. battery will cause such a commotion in a loud speaker that broadcasting is practically drowned. It is interesting to test a faulty H.T. battery with a high-resistance low-reading volt-meter. The sections of three or six volts should be tested separately.

Frequently it will be found that it is only one section that is causing the trouble. This section may not give any reading at all, but more often it will give a "shaky" reading. The test should be carried out while the set is working, and it will probably be found that the faulty H.T. battery section (it may be situated between 12 and 15 volts, or any other of the plugs) varies as much as half a volt; and the flicking of the voltmeter needle will indicate how the noises occur.

This section can be shorted out of circuit with a piece of wire, and clear reception once again enjoyed. H.T. batteries with shorted sections sometimes give lengthy extensions of service, whereas with the faulty section in circuit they are perfectly useless.

An H.T. battery should always be tested whilst in operation. It is waste of time to remove it from the set and test it, for such a test will provide no true indication of its condition.

## AN INTERESTING REINARTZ VARIATION.

(Continued from previous page.)

will then increase reaction smoothly and evenly.

As a matter of fact, this form of resistance control is slightly superior to capacity control as the adjustment of the resistance is not nearly so critical when reaching the point of maximum sensitivity just before oscillation commences. A point worthy of notice is that the resistance in the filament-

earth lead does not give rise to howling when one or more L.F. stages are added to the detector valve.

To those who are interested in the theoretical side of reaction control this circuit will seem rather peculiar in its behaviour. On the face of it, the receiver should oscillate with R at zero and reaction decrease as R is increased. Actually, it works in the opposite way, as we have seen above. With R at zero the circuit is just a modification of the Reinartz and the fixed degree of reaction is not strong enough to cause oscillation or even to make the receiver sensitive. But as R is increased, the earth end of the tuning circuit can be considered as being gradually separated from the filament, so that a smaller proportion of the fixed H.F. back coupling is required to make the receiver sensitive. Eventually when R is big enough the receiver oscillates. If R is made infinitely large, that is, removed altogether, the circuit, in a disguised form, becomes our old friend the Ultra-audion. This can easily be seen by re-drawing Fig. 2 without R, and inverting

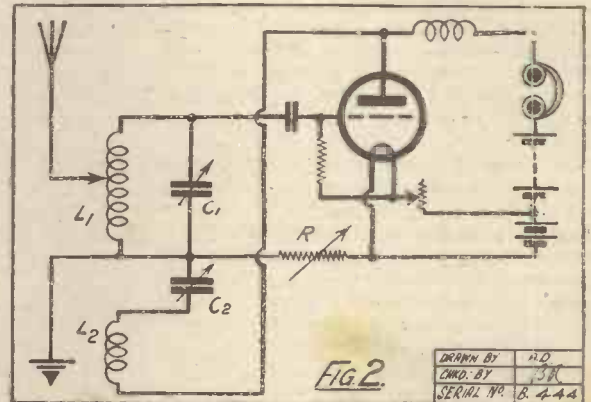

the coils. In this form the fixed degree of reaction causes full oscillation. This explains why the variation of R controls reaction as it does.

## SLATE PANELS

ALTHOUGH widely used in the electrical world for power switch-boards, instrument bases, etc., slate has not found favour in the eyes of the wireless enthusiast. At the present time, when substitutes for the conventional ebonite are being eagerly sought, it is surprising to find that the merits of this most useful material are not given so much as a thought.

Slate is a good insulator, vastly superior to wood; it does not become discoloured, and will not warp. It is, moreover, much cheaper than ebonite or glass. The only disadvantage, which is probably the reason for the lack of enthusiasm, is the difficulty in drilling. A sharp drill and a little oil reduce this considerably.

A steady pressure is essential if the expenditure of energy is to be minimised; but this must not be taken to mean a heavy pressure, which will cause "chipped" holes. To keep the drill sharp, give it a rub on the oil-stone after drilling two or three holes, as it will naturally be slightly blunted.



# REACHING OUT WITH THE CRYSTAL

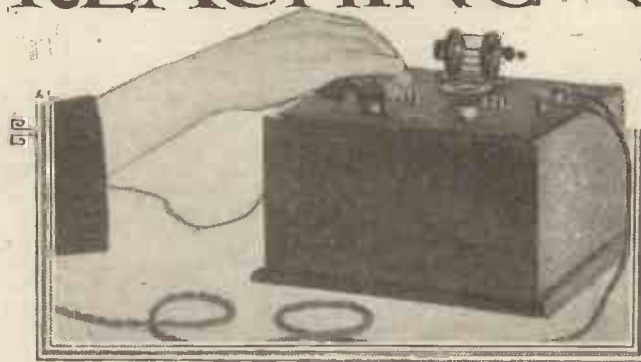

Many reports have reached us from crystal users claiming DX results, and this article should be of interest and value to other crystal enthusiasts wishing to emulate the successes already recorded.

By J. F. CORRIGAN, M.Sc., A.I.C.  
(Staff Consultant.)

IT is on occasion remarked that long-distance reception with a crystal set is more a matter of luck and good fortune than one of skilled management. And, in some respects, such a remark is not at all an untrue one, for there is no doubt that a crystal set which suddenly begins to excel itself and to give long-distance results for no apparent reason—as many such receivers sometimes do—is really behaving in a very mysterious manner. As a general rule, a crystal set of good make can be relied upon to provide good and loud reception within a range of ten miles from a main broadcasting station. Beyond this limit the reception qualities of the set begin to get uncertain. For instance, at a range of fifteen miles, such a set might provide good reception one evening, and then on the following night it might probably refuse to give any intelligible result at all.

At twenty miles' range the average crystal set becomes so inefficient that it can no longer be considered to constitute a practical means of receiving radio broadcast. That is, I repeat, as a general rule. But there are, of course, exceptions to this rule.

### Results Achieved.

For instance, it is an authenticated fact that reception from the Aberdeen station has been obtained in the London area by means of a crystal set alone. Northern crystal enthusiasts have from time to time reported the reception of Madrid, Paris, Brussels, and other Continental stations. Now, although the re-radiation question may enter into the matter in some instances, it cannot be implied that such long-distance crystal reception is due in every case to the effects of radiation from a neighbouring aerial. Nor are such long-distance results due to the employment of what we may call "stunt" circuits, or out-of-the-way crystal rectifying combinations. The man who gets long distance crystal results generally achieves them through the agency of a thoroughly efficient aerial-earth system, an ordinary crystal set of careful but nevertheless quite straightforward design and construction, and a crystal of the usual cat's-whisker type.

Thus it is that a high degree of all-round efficiency in the receiving set and the aerial-earth system with which it is operated seem to constitute the main factors which make for success in attempts at crystal long-distance work. Of course, we have all

had brought to our notice from time to time special circuits which are claimed to give exceptionally good crystal reception over considerable ranges. Some of these stunt circuits may be effective. The majority of them, however, give but disappointing results.

Given any one of the usual types of crystal set of good design and thoroughly efficient construction, the factors which make for success in long-distance reception are the following:

1. Thorough efficiency of the aerial-earth system.
2. The use of a highly sensitive rectifying contact.
3. The employment of suitable 'phones.



Fig. 1. An efficient type of earth plate.

The careful consideration and application of these factors not only enable the town-dweller to reach out with his crystal set, but perhaps what is of greater practical importance, they enable the would-be crystal set user who is situated on the fringe of crystal reception (say, at about fifteen miles distance from the broadcasting station) to reach in, as it were, to transmissions from the neighbouring town, and to obtain reliable reception from that source by means of the crystal receiver alone.

Considering the factors of success in long-distance crystal work outlined above, let us begin with the aerial-earth system, and the conditions which make for its utmost efficiency for this type of reception. It has been proved by actual test that for long-distance crystal work the height of the aerial is of more vital importance than its length. Thus, in designing a crystal receiving installation for long-distance work the height of the aerial should never be sacrificed. The higher the aerial, the better.

### Importance of Aerial Efficiency.

The aerial, also, must not be subjected to any appreciable screening influences. And still further, the aerial should not pass over the roof of a house or any other building for any great portion of its length. This is not a very well recognised fact, but the reason for it lies in the fact that a crystal receiver works more efficiently at comparatively long distances when its earth is situated directly under the aerial, and thus when the aerial is stretched between two house chimney-pots this requirement respecting the earthing system becomes practically impossible.

The aerial must, of course, be efficiently insulated, not only against direct electrical leakage, but also against capacity leakages. For this latter reason, it is essential to have the aerial down lead as far distant from neighbouring walls as possible. Soot and grime-laden insulators are conducive to current leakages. This fact should also be borne in mind when working a crystal set for long-distance results.

For DX crystal work, earth efficiency is of almost as vital importance as that of the aerial system. For ordinary crystal results almost any type of earth connection to the set will afford suitable reception. In long-distance work, however, much greater care must be given to the earthing of the receiver. Assuming that the aerial runs the length of a garden or neighbouring space, the most efficient earthing system is to be formed by burying a series of galvanised iron plates, edgewise in the ground, directly under the aerial. Each of these plates may conveniently be about four feet long and approximately a foot and a half wide. A plate of this description will be seen in the illustration, Fig. 1.

It is best to use a series of four or five of these plates. The plates may be connected together by means of metal strips. There is no necessity to solder the connecting strips to the plates.

(Continued on next page.)

## REACHING OUT WITH THE CRYSTAL

(Continued from previous page.)

Fig. 2 indicates the actual arrangement of the earthing system advised above. Note that the plates are buried edgewise, and on the slope, the plate nearest the earth lead being buried at a depth of four feet, whilst the final plate of the series is below the ground at a depth of seven to eight feet.

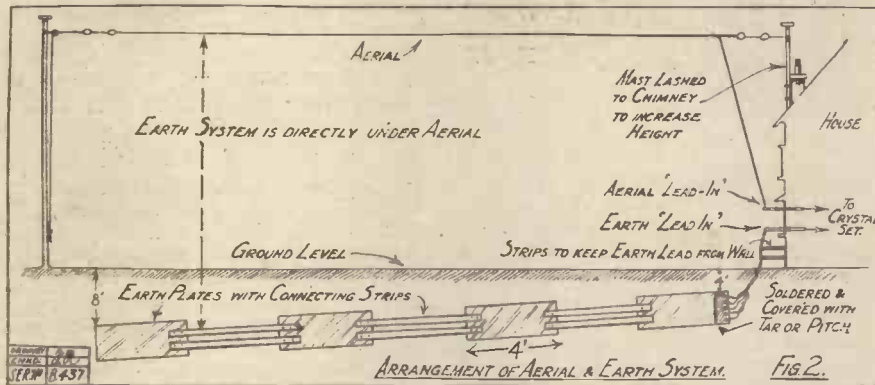

The earth lead to the set should preferably consist of a length of 7/22 enamelled wire, each separate strand of which is well soldered to the first earth plate of the series. If the soldered portions are subsequently covered with tar, and also the portion of the earth lead which runs into the ground, no corrosion effects will be set up.

### The Best Circuit.

The earth lead, in addition to possessing its enamel insulation, must also be kept well away from neighbouring walls by means of projecting strips in the manner shown in the diagram, Fig. 2.

Turning now to the actual type of set which is best used for long-distance crystal results, it is only possible from an essentially practical point of view to lay down general rules of efficiency, because, given these

enough a wire to use. Self-capacity in the circuit must be kept down to a minimum by means of avoiding all unnecessary insulative coatings for the coils, and dead-end losses must be guarded against. Naturally, all rubbing surfaces, such as contact arms and rotating spindles, must be efficiently constructed so as to give rise to the minimum possible electrical loss.

Capacity in a crystal set does not make for long-distance reception. Amateurs who are endeavouring to carry out distance work with their crystal sets should do without the use of capacity in their circuits

and rely upon inductance tuning only. Such is the general rule, but, on the other hand, in the case of crystal sets employing inductively coupled circuits (which are often of great value for crystal DX work) the employment of small and very definitely controllable amounts of capacity may be advantageous. For instance, in the circuit given at Fig. 3—a circuit which, by the way, is an excellent one for getting distance results—only vernier condensers should be employed to tune the aerial and the detector circuits, the coils themselves being of the widely spaced plug-in variety, the exact number of turns on each coil being a matter for practical experiment.

All important in the getting of long-distance crystal reception is the precise nature of the rectifying contact. There is no doubt that, despite its one fundamental disadvantage of instability, a rectifying contact consisting of a fine cat's-whisker, carefully adjusted upon the surface of a natural galena crystal of medium coarse grain, is the most productive of long-distance results. Fine grain galena crystals do not seem to be as sensitive in this respect as the coarser grained ones.

### A Sensitive Detector.

A still more sensitive rectifier may be constructed by attaching a minute fragment of lead pencil (BB grade) on to the end of the cat's-whisker by means of a tiny blob of plastic metallic cement. The contact thus created, whilst being relatively unstable and difficult to adjust, is often extraordinarily sensitive. In a similar manner, very small fragments of metallic antimony, bismuth, and cadmium may be attached to the end of the cat's-whisker. All these contacts are of high sensitivity. So also is a galena-magnesium contact, but its efficiency very rapidly decreases owing to the surface oxidation of the metal. A convenient method of fixing these various contact materials on the end of the cat's-whisker will be seen at Fig. 4. It should be noted, in passing, that the detector in which such contacts are used should be one in

which the cat's-whisker is maintained in a vertical position, otherwise the extra weight of the cat's-whisker would tend to disturb the sensitive adjustment of the detector.

Long-distance crystal workers often overlook the undoubted fact that the manner of connecting the detector in the circuit can influence the results obtained. If, therefore, the reception obtained with the detector arranged in the circuit with the crystal directly connected to the 'phones is not satisfactory, experiments should be conducted with the detector arranged the opposite way—i.e., with the cat's-whisker in series with the 'phones. In many cases, a simple rearrangement of this nature will bring surprisingly improved results.

### Reed-type 'Phones.

Although long-distance reception with crystal sets may be obtained through the medium of ordinary headphones of the 4,000-ohm type, the employment of reed 'phones greatly facilitates the ease of such reception. The reed 'phones, of course, do not affect the intrinsic sensitivity of the set. They merely give louder results when operated by extremely small currents. Hence, 'phones of the reed type have a distinct superiority over those of the ordinary variety when employed for long-range crystal reception.

Finally, let it be said that it is of little use for the crystal-set owner who is situated near to a broadcasting station to attempt to cut out the local transmissions by means of any wave-trap device, and, having done so, to endeavour to bring in more distant signals by means of his crystal receiver. The employment of wave-traps will, of

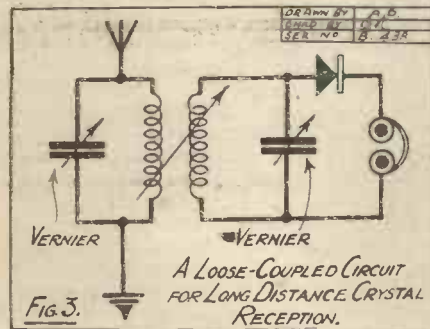

efficiency conditions, any set of average design will afford long-distance results when used under the conditions described in this article.

Crystal sets of the so-called low-loss type, with widely spaced air-insulated coils, are necessary for the best results, so far as distance goes. It is not necessary to employ excessively thick wire for the coils or other portions of the set, however. No. 20 wire, well spaced, and not impregnated with insulating varnishes, is quite thick

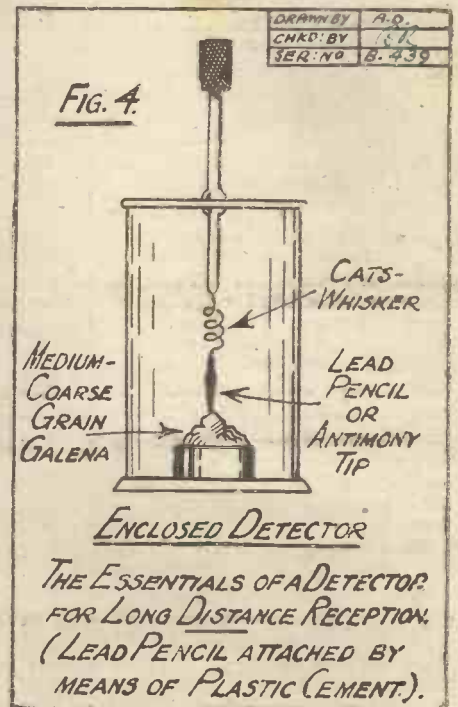

course, have the desired result of cutting out the local station, but these devices usually introduce so much damping into the circuit that it is almost hopeless under such circumstances to pick up the feeble currents from the more distant stations by means of the crystal detector alone.



By the Chief Draughtsman of "Popular Wireless."

**7,000** IN four years! That is approximately the number of diagrams completed to the Editor's orders since the first number of POPULAR WIRELESS appeared in 1922.

As may be imagined, there is a considerable difference between the earlier illustrations and those appearing in the current number of the paper.

I do not refer to the actual diagram as a drawing, but to the type and design of instrument or circuit illustrated. For obvious reasons, the earlier numbers of POPULAR WIRELESS dealt more with the elementary principles of wireless reception, much of the information given applying to the theoretical rather than the practical side of wireless telephony. The illustrations were, therefore, correspondingly simple, and the work of the draughtsman comparatively light.

**Growth of Wireless.**

Publicity, however, quickly led to a better understanding of the science among the thousands of eager enthusiasts who adopted wireless as a hobby, with the inevitable result that from wanting to know "how it was done," readers determined to "go and do." Constructional articles made their appearance; crystal sets, one-valve receivers, two-valve receivers, reflex receivers, etc., terminating in the neutrodyne and superheterodyne.

This gradual, but easily perceptible, advance naturally resulted in a corresponding increase in the amount of work required from the draughtsmen. This can, perhaps, be better understood by going to the two extremes and comparing the wiring diagram applicable to a simple crystal detector set, and a diagram portraying the layout of a superheterodyne receiver; to draw and check the latter illustration would just about equal the time taken to complete all of the diagrams which appeared in three early numbers of "P.W."

The majority of diagrams appearing in

"P.W." fall, of course, between those two extremes, and are generally prepared from "roughs" submitted by contributors with their manuscript.

Unfortunately, certain writers construe

This does not imply that good drawing is required, but simply that the "rough" is capable of intelligent interpretation by the draughtsman.

**Simple Mistakes.**

Where mistakes occur they are usually of a simple kind. The most common error, perhaps, is the connecting of the high tension battery (positive) direct on to the filament of the valves. I refer, of course, to theoretical circuits, and this mistake may be due to the American practice of showing a short thick stroke for the positive sign, and a longer thinner line for the negative. The English method is, of course, the reverse. In theoretical diagrams, also, the iron core in low-frequency transformers is often omitted. This, in most diagrams, makes little difference, the omission being obvious. When it is remembered, however, that the "sign" may then stand for a high-frequency transformer, or even two coils, the necessity for being accurate in compiling theoretical diagrams is apparent. There is, of course, a great deal of difference between diagrams as submitted, some being prepared with meticulous care, and others so bad as to present just a meaningless jumble of lines. It is a fact that the best rough drawings are received from men who are authorities on the science and whose names are known to every wireless enthusiast. In case I should be accused of pointing a moral, I hasten to add that the worst explanatory diagrams I have ever seen have been submitted by their equally eminent confrères. There is also a humorous side, even to an essentially practical thing like a wiring diagram.

In the early days of broadcasting, before 2 LO had "taken the air" with an official programme, I was engaged in answering a voluminous post-bag, from all classes of the community thirsting for wireless knowledge.

One extremely indignant gentleman wrote to say that he had "purchased a wireless from Messrs. \_\_\_\_\_, which, upon being connected to my aerial and earth will not work the music. Why not?" The letter was accompanied by a drawing showing a well-known loud speaker, one terminal of which was connected to the aerial and the other to a gushing water tap! That particular gentleman is, no doubt, wiser to-day, but at that time many queries of a similar character were being received continually.

**Never Built a Set.**

I have, personally, drawn some thousands of diagrams for POPULAR WIRELESS, but I have, however, never actually constructed a broadcast receiver, either crystal or valve, and I am fully convinced that should the attempt ever be made the result would approximate very nearly, in appearance, to some of the drawings submitted to me, which represent, in pictorial illustration, the appearance of their particular receivers.

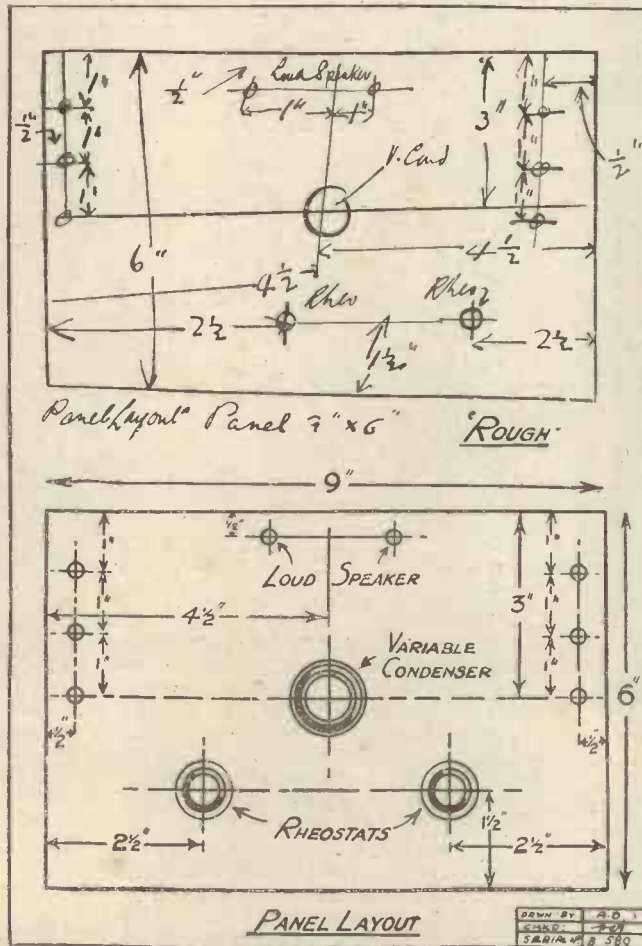

Showing the value of figures on rough diagrams, which should, of course, be as clearly drawn as possible.

the word "rough" too literally, and the crude drawings submitted are practically undecipherable. In some cases of this description the draughtsman completes and checks his drawing from the text of the article, but the liability to error is greater, and the time taken longer, and it is therefore advisable to make sure that all drawings submitted are clear and accurate.

# TECHNICAL NOTES.

A Weekly Feature Conducted by

Dr. J. H. T. ROBERTS, F.Inst.P.

VARIOUS attempts have been made to provide safeguards in the shape of fuses in the H.T. and L.T. supply circuits to the valves, but it would seem that only a small percentage of set users take advantage of these safety devices. It is commonly assumed that valves are generally burnt out owing to accidental application of the H.T. voltage to the filament, and, although all kinds of precautions are taken to avoid this, I think it is a mistaken notion that any considerable percentage of valve burn-outs is due to this cause. My own opinion would be that most valves end their days either owing to a gradual deterioration of the filament, with the inevitable result of a burning out at some particular spot, or to the application of too high a voltage from the L.T. battery—not from the H.T. battery at all. It seems, therefore, that a safety device in the L.T. battery circuit is more called for than the corresponding device in the H.T. circuit.

Probably the reason why safety devices for the H.T. circuit are more common than those for the L.T. circuit is because a safety device for the H.T. circuit is a much simpler device to provide. An ordinary pea-lamp will serve the purpose perfectly well, since it has a comparatively low resistance of about 10 to 15 ohms, which is immaterial in the H.T. circuit, and it burns out at a current of about 0.2 to 0.3 of an

ampere; furthermore, whilst it is carrying the H.T. current its temperature is very far below the fusing temperature.

In the case of a fuse for the L.T. circuit, however, the fuse has to carry a normal current which is not very much below that at which it is required to fuse, and consequently the margin, so to speak, is very much narrower. When we consider that modern dull-emitter valves frequently operate at a filament current of 0.06 to 0.1 ampere, it will be seen that it is by no means a simple matter to provide a fuse which will have a resistance small compared to the resistance of the filament and yet which will carry a current of 0.06 ampere without fusing, and will fuse if the current goes up to say 0.08 or 0.09 ampere. Many attempts have been made to manufacture such a fuse, but, so far as I am aware, no really satisfactory result has ever been attained.

## A New Fuse Unit.

Whilst on the subject of fuses, I see that the Belden Wire Manufacturing Company, of Illinois, U.S.A., have brought out a very

useful novelty in this connection. This consists of a double fuse, one for the low tension circuit and the other for the H.T. circuit, these two fuses being enclosed in a small bakelite two-part container which is fitted over the battery cord, the latter being a multiple cable carrying the H.T. and L.T. leads. In the event of either of the fuses being blown it is only necessary to unscrew the two halves of the bakelite cover and draw these apart, when the two fuses attached to the cord are exposed and the spent fuse can readily be replaced. This device strikes me as being a very convenient one, arranged in a very convenient way. I have not actually seen the "Belden Fused Radio Battery Cord," so I cannot say anything with regard to the L.T. fuse which is employed in it.

## Doubtful "Revivers."

Battery "revivers" come in for a good deal of criticism in a recent article in one of



Women workers in Radio Research—Miss G. Hazen testing out a new invention at the American Bureau of Standards.

the American journals. These products do not seem to have been introduced very seriously on the English market, or, if they have been, they have never become popular, although I can recollect having had two or three different types of chemical reviver submitted to me for examination and report during the past couple of years.

The battery "reviver" usually consists of a carton of a powder soluble in the battery acid. Various claims are made for these powders. One claim which has been made is that as soon as the powder is put into the accumulators the reproduction of the loud speaker is immediately improved. Another claim is that when the battery is run down it can be charged up again in a fraction of the time required when using ordinary battery acid alone. In fact, here is a list of claims which were made in respect of one particular type of reviver: "Keeps your battery always fully charged; preserves and lengthens the life of your battery; removes and prevents sulphation; will recharge any make of battery; prevents corrosion and shedding

of plates; prevents plates warping, cracking, and buckling; preserves plates and insulators; prevents muddy and soft positives; gives better reproduction, better ignition, better lighting; gives more power; will not overcharge; will not freeze at any temperature; batteries filled with this reviver need not be stored in winter; will more than double the life of the battery.

A certain business concern communicated with the proprietors of this battery reviver, asking to be enlightened as to how the material could perform apparent violations of some of the laws of electro-chemistry, but received an unconvincing answer.

The product referred to was analysed by a well-known institution and was found to consist essentially of commercial magnesium sulphate (Epsom salts) to which some potassium-aluminium sulphate had been added.

It is hardly necessary to add that on a careful test the claims made were proved to be quite unfounded. In fact, it was found, that in some respects the addition of these so-called revivers was actually harmful.

## Slip-shod Methods.

It is surprising what a great deal of unnecessary trouble is undertaken by the average experimenter in utilising spare pieces of wire for various connecting purposes. I have often watched amateurs—in a great hurry, owing to their zeal for the experiment in progress—picking up and using anything that comes to hand, hastily baring the ends of large pieces of wire, and in the process getting sharp needles of copper wire embedded in their fingers. It is very much simpler to set aside an hour or so on some suitable occasion to prepare a number of fixed connectors which will be found very handy for a variety of purposes. These may be of various lengths, from 6 in. (for connecting together battery cells) up to perhaps two or three feet. The ends should be carefully cleaned of insulation, and it is much preferable to fit to each end a proper terminal or tag.

## Unnecessary Waste of Time.

Although it may seem, perhaps, to some, a little unnecessary or elaborate to prepare a set of fixed connectors in this way, it will be found much more economical and much more satisfactory in the long run to do the job properly. If an experiment is worth doing at all, it is worth doing well, and if you are delayed in the middle of it by having to fiddle with unsuitable pieces of wire, your patience and interest are severely tried and, furthermore, you are apt to introduce elements of uncertainty into the experiment which it is particularly desirable to avoid. If you could estimate the time spent on doing any part of the operations in a shoddy and extemporised fashion, you would find that it was, in fact, considerably longer than the time which you would spend in preparing the parts beforehand.

(Continued on page 1228.)



# GIVE US A BETTER TRANSFORMER

—and Lissen has responded with a lower-priced, too

A boyish treble, mellow and clear just like a boy's treble in song is—rich low notes with all the feeling of the singer in them—amplification of the kind you can listen to for hours, enjoying every minute. To all these things is due the great success which the new Lissen Transformer has gained, and we believe deservedly gained. Users who have tried this new Lissen Transformer now understand why we withdrew in its favour all our own expensive transformers, which we had largely sold for several years past. **THIS NEW LISSEN IS A BETTER TRANSFORMER THAN ANY BEFORE IT.** It is also far lower in price.

This has been made possible in part by our new direct-to-dealer policy of distribution (which cuts out all wholesale profits), in part to our huge production, and the special plant we have installed. **WE HAVE GIVEN THE USER EVERY ADVANTAGE IN A TRANSFORMER WHICH ANY USER COULD POSSIBLY HAVE.** And we hope no one will now pay a high price for a transformer. Compare this new LISSEN against any for **TONE PURITY AND POWER**—you will find it fully amplifies every note, every tone, every harmonic, every overtone. Read the 7 days' test offer.

Obtainable at every good dealer's, or direct from factory if any difficulty, post free, but please mention dealer's name and address.

**8/6** GUARANTEED FOR 12 MONTHS  
 TURNS RATIO 3 to 1. RESISTANCE RATIO 4 to 1.  
 Use it for 1, 2 or 3 stages L.F. It is suitable for every circuit and every valve you will want to use.

**TEST IT FOR 7 DAYS**—then take it back to your dealer's or send it back to us if you are not satisfied.

**TO THE TRADE:** Orders for all LISSEN products must now be sent direct to factory, and not to usual wholesale dealer.

**"GIVE US A BETTER TRANSFORMER"**—and LISSEN has responded with a lower price, too.

## USE LISSEN FIXED CONDENSERS, TOO, Mica & Mansbridge Type LISSEN Mica Type CONDENSERS

Small energy-conserving condensers—note the new case which enables the condenser to be used upright or flat. At present the new case is available only in the most used capacities, but will quickly become a LISSEN standard.



Capacities—  
 .001 to .001 1/- each (much reduced).  
 .002 to .006 1/6 each (much reduced).  
 Accurate to 5%—they never leak—they never vary.

## LISSEN Mansbridge Type CONDENSERS

To a fine LISSEN quality condenser is added the specially moulded case—the condenser cannot short circuit on to its case. The new LISSEN case protects you if the condenser is used in any circuit connected straight on to the electric light mains. And due to our new policy of direct-to-dealer distribution this LISSEN Condenser costs no more than the ordinary type.



.01 to .09	2/4
.1	2/8
.2	2/8
.25	3/-
.5	3/4
1.0	3/10
2.0	4/8

## LISSEN FIXED GRID LEAKS

A case of these was left on our factory roof during the summer of 1925, soaked in rain, baked by sun, and the resistance value of these leaks never altered. All capacities, previously 1/8. Now 1/- each.



Improve every circuit by using LISSEN parts wherever you can—save money, too—for now you get keen prices as well as fine quality.

**LISSEN LIMITED,**  
**8-16, FRIARS LANE,**  
**RICHMOND, SURREY.**

(Managing Director: Thos. N. Cole.)

**BROADCASTS BY 'TONE' & 'POWER'**  
*The 'Boon' Companions of Osram Valves*



**'POWER' becomes  
 a 'Special'**

POWER is very proud. He has risen to a new dignity. He has, in fact, been appointed to the final valve socket as a special—and he's making no end of a success of it.

TONE stands by just to keep POWER in check and to help impart that purity which is essentially associated with all members of the OSRAM VALVE family.

POWER in his 'Special' capacity does yeoman service when large volumes have to be handled.

Bring POWER and TONE into your set by using

**Osram  
 Valves**

*for* TONE & POWER

*The G.E.C. - your guarantee*





WHEN details of the Filadyne circuit were first published I was struck by the distinct originality of the system. A brief trial fully confirmed the results claimed for the circuit, particularly as regards the purity and volume of local reception. In the course of experimenting with various Filadyne "hook-ups" much interesting information was accumulated, revealing in a better light certain obscure facts about this novel system.

An unusual feature of the Filadyne circuit, which must have intrigued those who have tried it out, is that up to the present but one or two types of valves, such as the

\*-----\*  
 \* The first part of an exceedingly interesting and informative article on the Filadyne system of reception recently described in "P.W." \*  
 \* By J. ENGLISH. \*  
 \*-----\*

effect of anode bias would throw some light on the operation of the valve, whatever its type, and perhaps explain why the B.5 and the D.E.R. work best in the original circuit.

Now the only way to get reliable inside information about a valve is to study its internal workings, that is, its characteristic curves. While it is known that such curves do not portray sufficiently exactly the actual operation of the valve, they do enable us to observe certain facts and, by analogy, to draw conclusions which are very near to the real working conditions.

However, a valve panel was fitted up and a fixed value of H.T. applied to the grid, as in the actual circuit, with a milliammeter in series to indicate the variations in grid current. A bias battery was connected so that the anode could be given a continuously variable negative or positive potential. From the

remarkable for the steepness of its slope and the sharp upper and lower bends. These features, in conjunction with the greatly increased "anode" current for quite a moderate H.T. voltage, suggest the remarkable transition of an ordinary general purpose valve into a power valve giving large amplification and good rectification.

To return to the question of anode bias, theory under normal conditions states that we shall get the loudest signals when grid bias is adjusted so that the working point is on or near either of the bends. This is the well-known method of anode-bend rectification. Now, if this theory is to hold good for the Filadyne circuit, the loudest signals will be heard only when anode bias is adjusted at 1.5 or 6 volts positive, using a D.E.3 valve under the conditions of curve A.

**Anode-bend Rectification.**

Now this is actually the case, other values of anode bias giving either poor results or none at all. Likewise with other valves, the correct anode bias, as ascertained from their new curves, gives in each case the loudest signals. These facts prove almost conclusively that the usual theory of anode-bend rectification does hold good for the Filadyne. There are exceptions, however, of which I shall have more to say later.

So far, then, the examination of grid current-anode bias curves has proved that certain definite values of anode bias give the best results, while making it possible to use all available types of valve in the Filadyne circuit. Incidentally, this also

(Continued on next page.)

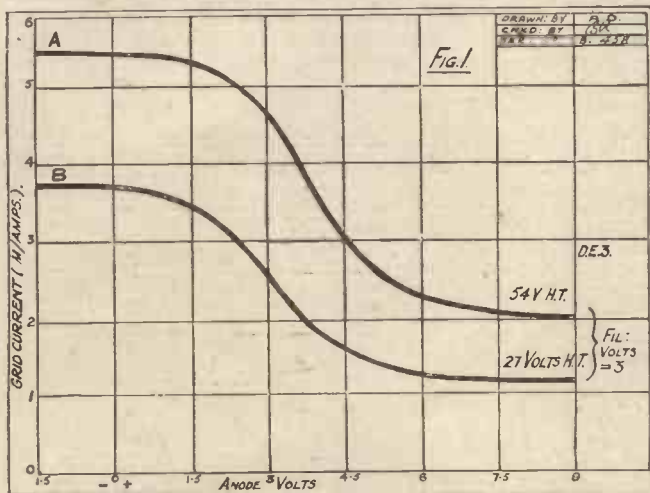

B.5 and the D.E.R., have been found to give the most satisfactory results. Other valves give either very poor signals or none at all. It would therefore be interesting to know why the Filadyne receiver is so particular about its valve.

**Positive Bias.**

For instance, using a D.E.3 only very faint sounds could be heard from the powerful local station. A lucky guess led me to try the effect of anode bias, and, when this was adjusted to about 1.5 volts positive, signals came in remarkably strong and clear, quality being extraordinarily good. Several other valves at hand were treated in a similar way to small doses of positive anode bias, and in no case did I fail to get good strong signals, some valves, of course, working better than others. These results seemed to indicate that examination of the

negative or positive potential. From the readings of grid current and anode bias voltage curves were plotted for various valves, curve A in Fig. 1 being representative of the D.E.3.

These curves are quite different in form from the normal anode current-grid bias characteristics, but if we turn the valve inside out we must not grumble if our curves are upside down! Other curves both for the D.E.3 and other types of valve showed that increasing either H.T. or filament current shifted the curve upwards with increasing steepness of slope. Curve A

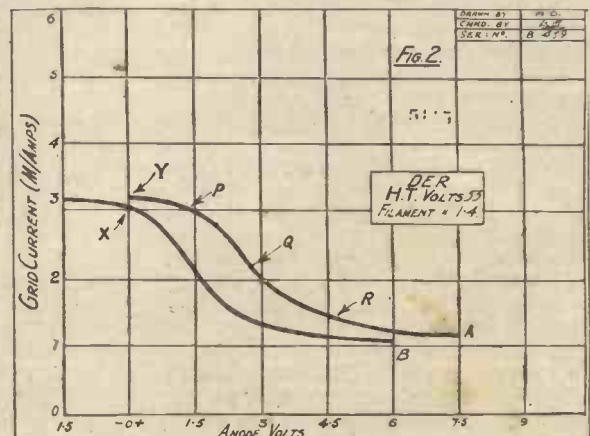

## EXPERIMENTS WITH THE FILADYNE CIRCUIT

(Continued from previous page.)

shows that the conclusions drawn from the new curves were not far from the truth.

Now comes the question of polarity of battery connections, analysis of which brings to light several interesting facts. When taking readings of grid current for the curves given above, no apparent difference was made whether the negative H.T. lead reached eventually positive or negative L.T. However, the connection of the negative end of the bias battery has a pronounced effect upon the characteristic curve, and upon the operation of the circuit.

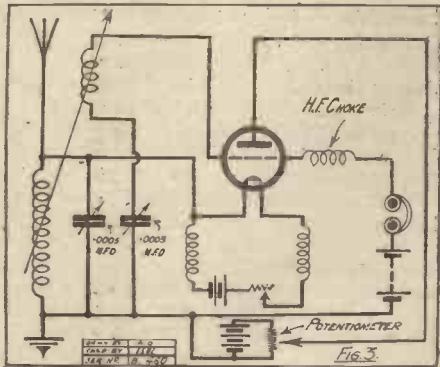

Take, for instance, curve A in Fig. 2. This was plotted for a D.E.R. valve with the negative bias lead to earth reaching the negative side of the filament via the tuning coil. On changing the aerial lead to the positive end of the filament, curve B was obtained for the same conditions of H.T. voltage, filament current, etc. Note that B is essentially the same in form as A, but shifted to the left by an amount corresponding to an alteration in anode bias of 1.4 volts. This, of course, is the voltage difference across the filament, so that when we connect the negative bias lead to positive filament we are actually starting off with a positive anode bias of 1.4 volts.

### Effect of L.T. Connections.

If the connections of the original Filadyne are traced out it will be seen that the anode is really connected to L.T. positive. Now, in curve B, corresponding to no external anode bias and anode to L.T. positive, as in the actual circuit, the working point X is just on the upper bend so that we get strong rectification. On changing L.T. battery connections, the operating point, still without external bias, becomes Y (curve A) on the flat part of curves where no rectification can take place. This explains why reversing the filament connections in the Filadyne results in a loss of signals.

Now, if we apply a positive anode bias of 1.4 volts when the filament connections have been reversed, the working point is shifted back to P on curve A, corresponding to X, so that excellent rectification once more takes place.

We can now see why other valves do not work as well as the D.E.R., since either of the filament connections puts an incorrect bias on the anode for proper rectification.

This bias must be such that the working point is adjusted on or near either the upper (X and P) or lower bends.

On the whole, valves having an impedance between 20,000 and 40,000 work best in the Filadyne circuit. Low impedance valves like the P.M.4 and S.P.18 Red Spot give very poor results, their new characteristic curves being rather flat without pronounced upper or lower bends.

We have now sufficient data to understand more fully how the valve works in the Filadyne circuit. It is just a happy coincidence that, with the Osram D.E.R. in the original circuit, the working point is at the right spot on the curve to give such good rectification. Hence the loudspeaker results. All that we have considered above shows us how to get on the same effective spot for any valve and under different conditions of battery connections, etc. Therefore, if you have not a D.E.R. and you want to get good results with the Filadyne, just insert a grid bias battery in the anode lead, carefully adjusting anode bias and filament current until you hear the loudest signals.

### Potentiometer Advisable.

A much better method is to use a potentiometer, as in Fig. 3. As the slider is moved from negative to positive you can almost hear the working point slide down the characteristic curve! With the anode just positive, signals are heard increasing gradually as the bend (P) is reached, then decreasing as the working-point gets on to the middle of the curve (Q). Here the circuit oscillates very easily. As the anode becomes more positive, signals get better again and eventually come in loud and strong when the working-point reaches the lower bend (R). More positive anode bias results in no signals, because the working-point is shifted on to the flat part at the bottom of the curve where the valve cannot rectify at all.

At this juncture it may occur to you, that, since the anode has such a good control of the grid current, louder signals would be heard if the tuning coil leads were reversed so that the H.F. signals voltages were applied directly to the anode. Actually this reversal of connections gives strong signals from the local station provided more reaction is used, but the circuit is hardly as efficient or as good for DX work as the correct circuit. Moreover, it does not appear to function in the same way.

Now it is a peculiarity of the Filadyne circuit that, whatever valve is used, with or without anode bias, an increase in filament current beyond a certain critical value results in no signals at all. With the usual one-valve circuit one would expect an increase in signal strength, but not so the Filadyne.

Curves for a D.E.R. valve were plotted for a fixed H.T. voltage and increasing values of filament voltage. Under these conditions signals ceased when the filament voltage reached about 1.6. But the curves both for this and higher voltages are very much the same as the lower ones, complete with nice sharp bends. The

curves therefore offer no clue to this mysterious loss of signals, so we can only guess at what happens.

I have a shrewd suspicion, partly confirmed by facts mentioned later, that in the Filadyne circuit the valve functions somewhat like a four-electrode valve. It seems that placing chokes in the filament leads is equivalent to inserting another grid. This phantom grid handles the incoming H.F. energy. The application of positive anode bias makes the valve most sensitive for rectification, while the phantom grid controls the electron stream at its source.

### The "Phantom" Grid.

But this imaginary grid, in my opinion, has only a limited control of this electron stream, which overpowers it when the filament current is increased beyond the critical value. Moreover, no juggling of anode bias will bring back the original volume of signals. It may be that beyond this critical value of filament current a space charge of electrons begins to form, thus paralysing the phantom grid. Increasing the H.T. voltage brings back the original strength of signals probably because the greater attraction of the grid once more disperses the space charge.

Now although the hypothesis of an imaginary second grid helps to explain the working of the Filadyne circuit, there is another interesting fact that illustrates the remarkable similarity to an actual four-electrode valve circuit. This is the relation of grid current to anode current. In Fig. 4 a curve is plotted for each current curve, X being similar to A in Fig. 2. Other valves give similar curves. Notice that as the grid current drops the anode current Y rises, X being almost the same as Y turned upside down.

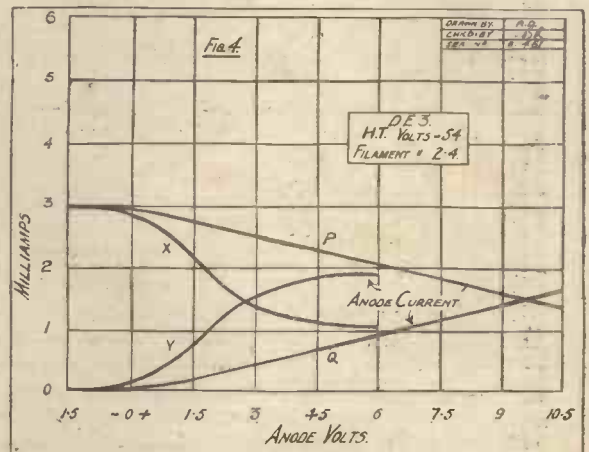

Actually, nearly as loud signals are heard if a pair of 'phones are inserted in the anode circuit instead of the grid circuit! The slight loss in volume is satisfactorily explained by reference to Fig. 4.

The curves P and Q represent grid and anode currents when a pair of 'phones (4,000 ohms) were inserted in the anode lead. This shows the remarkable effect of resistance in the anode circuit flattening the two curves, and thus lowering amplification. Therefore the smaller the resistance of the anode circuit, the sharper the upper and lower bends with corresponding better rectification and louder signals. Adding

(Continued on page 1224.)



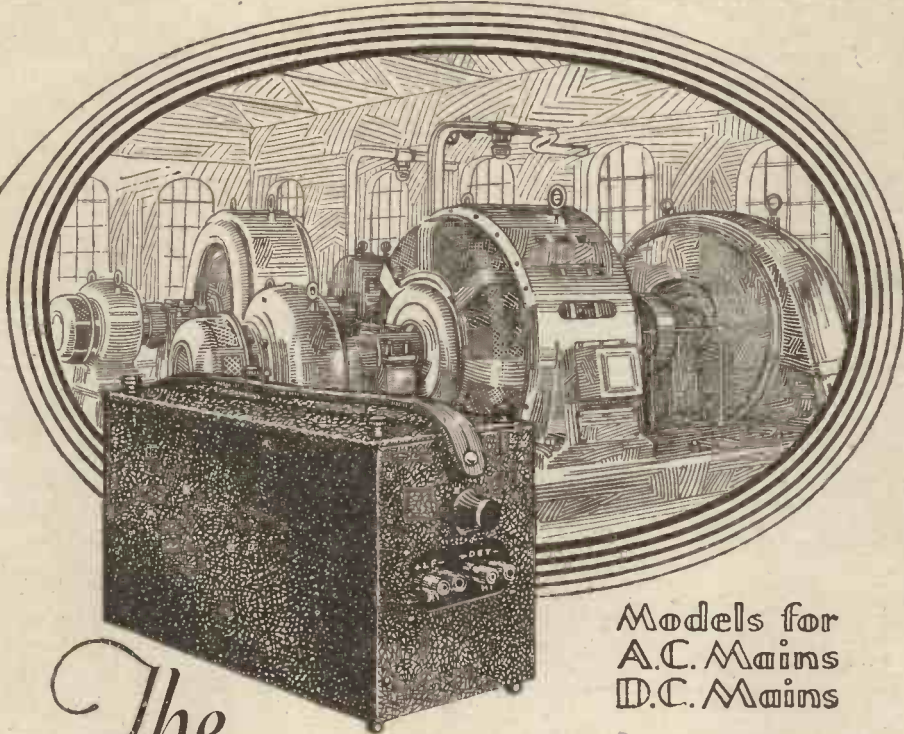

Models for  
A.C. Mains  
D.C. Mains

The  
**POWER**  
behind your wireless set  
-safe- silent- sure

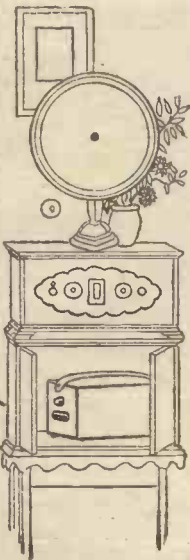

In the electric current you use for lighting and heating, you have available the most efficient and reliable source of High Tension supply that can be devised, and which can be harnessed and fed with extreme accuracy by the GECOPHONE HIGH TENSION BATTERY ELIMINATOR.

This eliminator is as simple and safe to use as any domestic electric appliance; permits your set to operate at 100% efficiency, and for the reason that it reduces H.T. supply costs to practically nothing, pays for itself over and over again.

Write for illustrated Folder B.C.4352.

**GECOPHONE**

REGISTERED TRADE MARK

**H.T. BATTERY  
ELIMINATORS**

*The G.E.C. - your guarantee*

USE  
**Osram  
Valves**  
for TONE & POWER

Sold by all leading  
Wireless Dealers,  
Electrical Con-  
tractors and Stores

*The greatest of Loud-speaker problems now solved by*

# The MARBLOID SALON CONCERT SPEAKER

*First hear the MARBLOID!*

It is absolutely non-resonant, and has unequalled purity of tone. Its perfect reproductions will delight you.



Prices :

MARBLOID "JUNIOR" £3 15s.

MARBLOID "SENIOR" £5 10s.

SUB-AGENTS :

For the Midland Counties :—  
Foster-Boynnton Co., Ltd.,  
70, Lombard Street,  
Birmingham.

For South Wales :—  
Watson Bros.,  
48, Dock Street,  
Newport.

For Lancashire and Cheshire :  
F. A. Hughes & Co., Ltd.,  
6, Booth Street East,  
Chorlton-on-Medlock,  
Manchester.

THE discordant resonant tones caused by the vibration of the old-type loud speaker are abolished. The metal horn loud speaker and its attendant unnatural and displeasing tones have been superseded.

The problem of dispensing with the impure gramophone-like reproduction of speech and music is at last entirely overcome—by the "Blue Spot" MARBLOID Concert Speaker. Made from artificial marble by a patent process, and having a perfectly balanced tone-reflector, designed with strict adherence to the rigorous laws of acoustics, this instrument is immune from the slightest vibration, even under the stress of the greatest volume of sound. Its remarkable sound capacity, combined with purity of tone and realistic reproductions, surprises the most exacting critics.

If you want a loud speaker, hear the MARBLOID first!

Ask your Dealer, or write for List "F.I." of "Blue-Spot" Specialities.

**F. A. HUGHES & CO., LIMITED**

Head Office: 204-6, Gt. Portland Street, London, W.1



Telephone :  
Museum 8630.  
Telegrams :  
"Distancing,"  
Wesdo, London."

# CURRENT TOPICS.

BY THE EDITOR.

Sir John Reith—"Science and Miracles"—The Last Forty Years, and the Next—Television—The Heroic Age of Science.

THE honour of Knighthood conferred upon the Director-General of the British Broadcasting Corporation is one which every amateur and listener will learn about with pleasure. Sir J. C. W. Reith is a Scot who hails from Aberdeen, and he is only thirty-seven years of age. He worked as an apprentice at one time at the North British Locomotive Works, and in 1914, when he was twenty-four, he enlisted in the Scottish Rifles, and was wounded at the battle of Loos. In 1915 he went to America to supervise the production of munitions, and had his headquarters at Philadelphia with a staff of six hundred.

He is a Master of Science and so, as well as a great organising ability, he also possesses a technical knowledge of wireless—a fact which is not generally known.

Everybody will wish Sir John Reith continued success in his new position as Director-General of the British Broadcasting Corporation, where his extraordinary organising abilities, together with his forceful personality, will, we feel sure, enhance the great reputation which he has already built for himself, and incidentally, for the B.B.C.

Mr. J. L. Garvin, the editor of the "Observer," writing in a recent issue of that journal an article entitled "Science and Miracles," takes a very optimistic view of Britain in this scientific age. Mr. Garvin, although somewhat inclined to look upon the coming of television with excessive optimism, writes in a very interesting way about the progress of world telephony. He suggests that before another Imperial Conference assembles, British Prime Ministers will be able to talk direct to any Dominion Premier, or to ring up the Viceroy of India, or speak to them all in turn on the same day.

"This," he says, "is not romancing, but a thing that is surely and rapidly approaching the sphere of practice. With all the cabinets and administrations in immediate touch, the Governments of the new Empire may be carried on as a whole by consent and co-ordination as though an Imperial Conference were in perpetual session. In a decade or so after that statesmen talking to each other across continents and oceans may see each other while they are speaking.

When a physical meeting is desired aviation will bring it about in a few days."

Schiller is credited with the somewhat dogmatic statement that: "Alas, the age of miracles is past!" Thomas Carlyle, on the other hand, although possessing all the canny caution of a Scot, once said: "The age of miracles is for ever here." Carlyle's dictum is intensely true these days, for during the last thirty odd years the age of miracles would seem to have been revived, and one may be excused the extravagance of exclaiming: "Nothing is impossible."

Of all the younger sciences, perhaps wireless has made the most rapid progress. Less than forty years ago, science was in something of a stagnant calm, and it was



Two of the specially trained telephone girls at the London Trunk Exchange at which English subscribers can be plugged straight through to New York.

said that civilisation was slowing down, and that the heroic age of discovery was past. It seemed to be the general impression then that no further great advances would startle the world; at least, not for many years to come. That was about 1890; but almost immediately there dawned a new era of scientific progress. The discovery in 1898 of the electron by Sir J. J. Thomson, of X-rays by Sir William Crookes and his experiments with the Crookes tube; the epoch-making deductions of Clerk-Maxwell, followed up by the practical proofs of electro-magnetic waves by Hertz and their application to and working out in radio practice by Sir Oliver Lodge, also their practical application to business and commerce by Senator Marconi; the development of the motor car, the aeroplane, electrical power—all these things have dawned and developed during the last forty years. What will dawn and develop during the next forty years would

stretch the imagination of Jules Verne and H. G. Wells combined; but just as history repeats itself, so does science repeat itself, not in a redundant and futile way, but branching out into new spheres of activity and discovery and enriching civilisation by its labours and researches.

Every reader of POPULAR WIRELESS who is a keen experimenter and who aims at something above building himself new receivers to pick up new and distant stations must realise that wireless still offers illimitable possibilities for those who will devote themselves faithfully and untiringly to the extraction of further secrets from Dame Nature's store.

The case of Mr. J. L. Baird is an excellent one. This young Scotch inventor has devoted himself with untiring energy to the problem of television, and already his researches have borne fruit in the development of this latest wonder in a way which has inclined even the most sceptical of scientists to the opinion that television may now be regarded, definitely, as a practical possibility.

But let us be under no misapprehension about television. There is still a tremendous amount to be done before it can be applied to everyday use as broadcasting is now applied to everyday use. The day when we shall have apparatus which will enable us to see the broadcasting artist as clearly as we can see an artist on a cinema film may be a very long way off, although, on the other hand, developments may follow each other so rapidly that the day will come, perhaps in the next few years. No one can tell. One can only say that at the moment the prospect of further developments of a revolutionary nature is good.

It has always been the dream of many experimenters in wireless work to design a "cold" valve, that is to say, a valve which will require neither L.T. nor H.T. battery.

Many eminent men are working on this problem to-day, and students of physics and chemistry realise that, theoretically at least, such a valve is possible.

It is, indeed, a revival of the heroic age of science which we are now experiencing, and, as we have already pointed out in our columns, it is a source of gratification to know that many of the greatest scientific pioneers of the age are still with us. It cannot but be a source of inspiration to the young inventor and to the young research worker to know that men like Edison, Fleming, Lodge, Thomson and others, are still working and still helping in that great work of furthering and benefiting the progress of scientific research and, incidentally, modern civilisation.

# America appreciates Lewcos Screened Coils

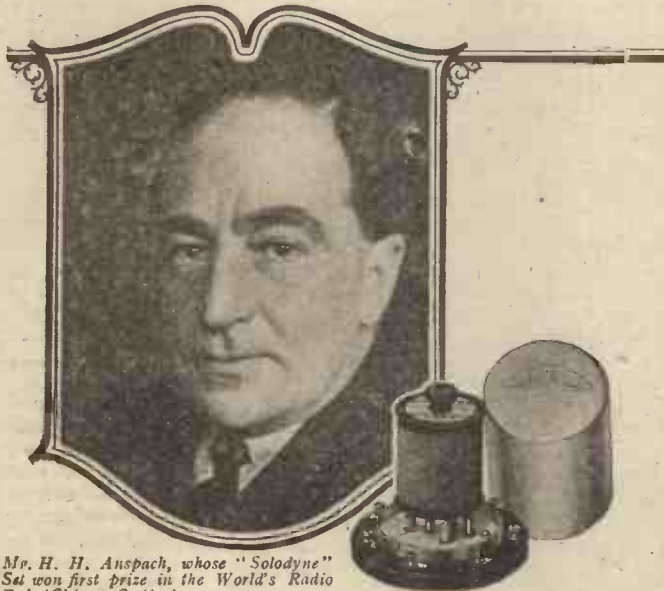

Mr. H. H. Anspach, whose "Solodyne" set won first prize in the World's Radio Fair (Chicago Section).

Mr. Anspach, winner of the first prize in the New York World's Radio Fair (Chicago Section), writes:—

Dear Sirs,—

May I offer you a word of congratulation on the wonderful coils produced by you which must have certainly helped in obtaining for me first prize at the Chicago Exhibition for my "Solodyne."

I sincerely hope your sales will be very good, and wishing you every success, which you thoroughly deserve.

Yours very truly,

(Signed) H. H. ANSPACH.

P.S.—I hope you will not hesitate to make what use you like of this.

Comparative tests prove that LEWCOS Screened Coils and Transformers have a lower H.F. Resistance within their screens than any other coil on the market.

Use LEWCOS Screened Coils in your set. Obtainable from all wireless dealers. Full particulars and prices sent on request to

The  
LONDON ELECTRIC WIRE  
COMPANY & SMITHS, LTD.  
Playhouse Yard, Golden Lane, London, E.C.1

# LEWCOS

Screened Coils

JUDD

The Condenser which gives a separate station to every degree.



- 1 Absolute rigidity of fixed plates ensured by unit construction.
- 2 Moving plates clamped together to permit fine spacing with absolute security.
- 3 Special method of construction eliminates the possibility of fixed and moving plates short circuiting.
- 4 Ball-bearings ensure smooth silken action under all conditions.
- 5 Dual connections (cone and pigtail) guarantee continuously silent performance.
- 6 Electrical losses so low as to be quite negligible. An invaluable feature for short-wave use.
- 7 Generous and readily accessible soldering tags.
- 8 Equipped for panel mounting as one-hole or four-hole, whichever preferred.
- 9 Positive stops at both ends of scale.
- 10 Compact design permits a panel depth when closed of less than two inches. The '0005 mfd. Orthocyclic takes up much less room than most '0003 mfd. condensers.
- 11 Highly polished and beautifully finished throughout—a perfect example of British craftsmanship.

Where else will you find these Eleven Features of Condenser Superiority?

Advt. Portable Utilities Co., Ltd., Fisher St., W.C.1.

G.A. 7093

## 9 FINE DESIGNS 25 SIZES ARTCRAFT CABINETS

MADE IN OAK AND MAHOGANY

"Artcraft Popular Type" Cabinets

Panel Size	Depth	Price in Oak	Price in Mahog.
10 x 8	6	8/0	12/0
12 x 10	8	12/0	16/0
14 x 10	8	14/0	19/0
16 x 8	8	14/0	19/0
18 x 12	9	21/0	29/0

Baseboards Free. Hinged Lids 1/6 extra.

CARRIAGE PAID England & Wales-Scotland 1/- extra.

Radion. Resistor and Ebonart Panels Supplied.

THE ARTCRAFT COMPANY,  
156, Cherry Orchard Rd., Croydon.

Parr's Ad.

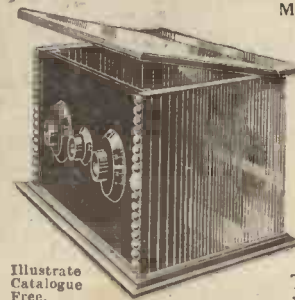

Illustrate Catalogue Free.

## VALCO MAGIC!

WILL MAKE YOUR BROKEN VALVE AS GOOD AS NEW.  
ALL TYPES OF VALVES REPAIRED AT HALF LIST PRICES (minimum charge 5/-).

Satisfaction Guaranteed or Money Refunded.

An unsolicited testimonial from one of our many satisfied users will appear each week.

CAMPDEN. 18/10/26.—Very many thanks for two repaired Valves arrived O.K. I am astounded with the results.—M. F. W.

Waco, S.P.'s and low capacity types not repairable. Minimum D.E. current 0.15 amps when repaired.

VALCO LTD., Dept. "P.W.," TABOR GROVE, WIMBLEDON, S.W.19.

# IS "PUSH-PULL" WORTH WHILE?

A great deal of nonsense has been written about this method of L.F. amplification, especially in certain journals which fill some of their columns with wireless matters, supposedly for the interest of their motoring readers, but in this special article the subject is dealt with in a sane and really unbiased manner.

By G. P. KENDALL, B.Sc.  
(Assistant Technical Editor.)

IT is rather strange that, although perfect quality of reproduction does not appear to have been sought after with any special enthusiasm by the average American experimenter until fairly recently, yet there is a type of L.F. circuit expressly designed to achieve that end which has been far more extensively exploited across the Atlantic than in this country.

When the "Push-Pull" L.F. amplifying circuit first appeared, it at once achieved quite a vogue in the States, and there have been signs of late that it has gained a certain degree of popularity over here. There appears to be some uncertainty as to the exact purpose of this type of circuit and its real capabilities, and there is a risk of disappointment if it is blindly used as a specific for all the distortion troubles which most of us now spend so much time trying to eliminate from our note-magnifiers.

### How It Is Done.

At this point it will be well to refer to the skeleton diagram of a push-pull amplifying circuit reproduced on this page, and gain an idea of the working of the arrangement. It will be seen that three valves are shown here, and of these  $V_1$  is the detector valve of the set, while  $V_2$  and  $V_3$  are two L.F. valves wired up in the special parallel scheme which is the essential feature of the circuit.

This latter is the whole point of the push-pull arrangement, since it does *not* merely consist in the placing of two valves in parallel, but in so dividing the signals applied to them that one half goes to each, is amplified separately, and then, after amplification, is recombined with the other magnified half in a special output circuit before being passed to the loud speaker.

Just how it is done can be followed from the circuit diagram. In the anode circuit of the detector valve is the primary of a special L.F. transformer,  $T_1$ ,  $T_2$ , and it will be seen that the secondary of this transformer is provided with a centre tap which is connected to the filament circuit *via* a grid-bias battery. The ends of the secondary go to the grids of the two L.F. valves, and it will be understood that in this way just half the signal is applied to each.

### Re-Combining the Impulses.

Furthermore, the halves so produced are of opposite sign—i.e. at any given instant the grid of  $V_2$  may be made positive and the grid of  $V_3$  negative, and a moment later conditions will be reversed. Thus, when the anode current of  $V_2$  is increasing, that of  $V_3$  is decreasing, and so on; hence the name, "push-pull."

Since the two amplified halves of the signal are of opposite sign, it is evident that they must be combined in a special manner before being passed to the loud speaker.

### The Main Claim.

This is done by means of another transformer with a centre-tapped winding, this time the primary. This is the output transformer,  $T_3$ ,  $T_4$ , and the diagram shows how the signals are fed in opposite directions through the two halves of the primary. Since they are of opposite sign at any given instant, the fact that they pass in opposite directions through the primary means that they will induce voltages in the *same* direction in the secondary, and thus will be properly added together before being applied to the terminals of the loud speaker.

Possessing now a fairly clear idea of how the push-pull system works, we are in a position to decide whether it possesses so many advantages as popular opinion is inclined to attribute to it, and whether

of the push-pull circuit, because the correct characteristics for a last-stage valve were not clearly understood by the average experimenter, and all sorts of really unsuitable "tubes" were used, especially since valves of the right type were few in number, were expensive, and often required very high anode voltages.

The remedy for such overloading is now known to most people to lie in the use of a power or super-power valve having a very long straight portion upon its characteristic curve, and the number of such valves on the market is now very large. They are no longer unduly costly, and all the later ones work well with anode voltages of the order of 120 volts. Provided that proper grid bias is used, there is very little risk of overloading such valves when reproducing signals of adequate volume for any normal domestic purpose.

### Not Worth While.

Since there is no longer the same urgent need to reduce the load on the last valve by dividing it between two, it would seem that the only real justification for the push-pull circuit is gone. It is sometimes argued, however, that it is still worth using by experimenters who have a large stock of the older L.F. valves and *small* power valves on hand which they wish to use up. This seems to me to be false reasoning, however, because to use the circuit two special transformers must be bought, and it is surely cheaper to buy *one* special valve!

Just one sound argument in favour of the push-pull circuit remains, and this should receive due consideration before reaching our final conclusion. The types of valve capable of handling really strong signals without risk of overloading are necessarily valves with a rather low amplification factor, and thus one does not obtain quite so much magnification from a "super-power" stage as from a push-pull stage employing two valves, each separately capable of handling only moderate signals, but of higher amplification factor. Against this, however, must be set the corresponding drawback that for *one* stage of push-pull *two* valves are needed, with their attendant adjuncts and filament current. This does not seem to me a sufficiently weighty advantage to justify the unquestionable complication and expense of the circuit.

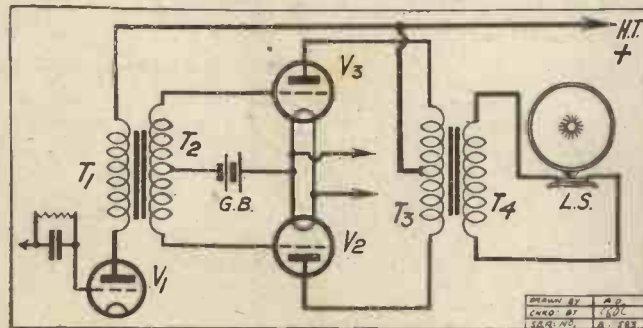

those advantages outweigh its obvious drawbacks. The main claim made for the system is purity of reproduction, and its possibilities in this direction are principally due to the fact that only half the voltage of the signals is applied to each valve. Since they thus are called upon to deal with relatively small voltages, the risk of distortion being produced by overloading is practically eliminated, and this risk was a very real one at the time of the introduction of the push-pull circuit.

### Now Out-of-date.

Overloading, as applied to valves, is perhaps a term requiring explanation. What we mean by saying that an L.F. valve is overloaded is simply that the voltage swings produced by the signals across its grid and filament are too large to be accommodated on the available straight portion of the characteristic curve of that particular valve. When this happens, of course, distortion is bound to take place, and there is no doubt it *did* occur quite frequently at the time of the introduction

### NEXT WEEK :

## "Modernising the P.W. Continental"

By Percy W. Harris, M.I.R.E.

Order Your Copy of P.W. NOW.



Captain Eckersley Runs Another "Howler" to Earth.

# The "Q and A" SET

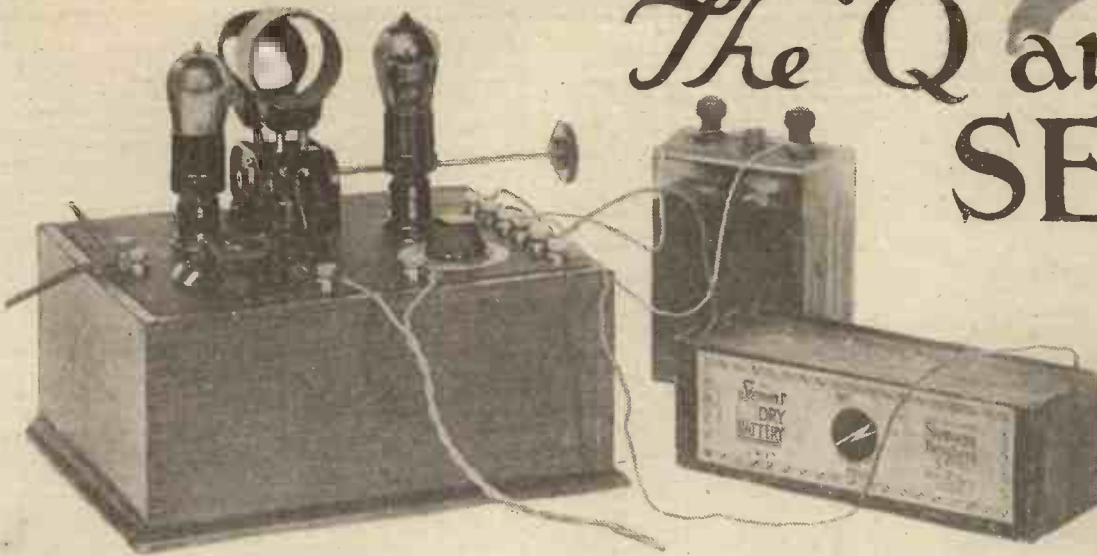

Could I use this instead?

A. Oh, yes, providing it is of suitable ratio, and is designed for coupling a first stage of L.F.

Q. Good! What else shall I need?

A. Besides the transformer, you will require a grid leak and condenser, some stiff wire of about No. 16 gauge, and about a couple of feet of flexible wire for the coil connections.

Q. I am going to have a shot at building a wireless set. How should I set about it?

A. Have you made up your mind whether you will listen on 'phones or loud speaker?

Q. Well, I am about eight miles from 2 L O, and I would like to work a loud speaker from there, and from Daventry. If possible, I should like to tune in other stations sometimes, but it's really the local station and 5 X X that I shall depend on. I don't want the set to be too expensive, though; say, up to three pounds, without the valves, coils, 'phones, and batteries.

A. It need not cost more than that, and you should get excellent results on two valves from 2 L O, and quite fair volume from 5 X X.

Designed and described by a member of the "P.W." Queries Staff.

A straightforward chat about set building, discussing the various needs of the average listener and fully describing the construction of a general purpose 2-valve receiver.

Q. What parts shall I need?

A. Well, I have here a set of the kind you require, and we will look over it together. Suppose you make a note of the prices as I take the various components. As you will see, you'll want a box not less than 4 1/2 in. deep, big enough to take an ebonite panel measuring 10 by 8 in.

Q. Would it be possible to make the box at home, or would it be just as cheap to purchase one ready-made?

A. If you are skilled at that sort of thing, you can certainly make it for yourself, but otherwise it is hardly worth while.

Q. By the way, I presume the components you are now mentioning are those that have to be bought, and cannot be substituted by anything else or cut down in number?

A. Yes, all these are necessary, though, of course, you need not buy exactly the same makes provided you get

components which answer the same purpose as those I have here. Let's take those on the panel first. There is a one two-way coil holder (Lotus), two valve holders (Lissen), one variable condenser (0005 mfd.), one filament resistance (30 ohms), and ten terminals.

### Suitable Transformer.

Q. I notice the coil holder has an exceptionally long handle. Is this a necessity?

A. No; but the long handle is a great convenience, as you will find that if your hand is approached too close to the set it affects the tuning.

Q. What extra components are on the reverse of the panel?

A. The chief one is the Lissen L.F. transformer.

Q. A friend of mine has offered me a transformer of another make.

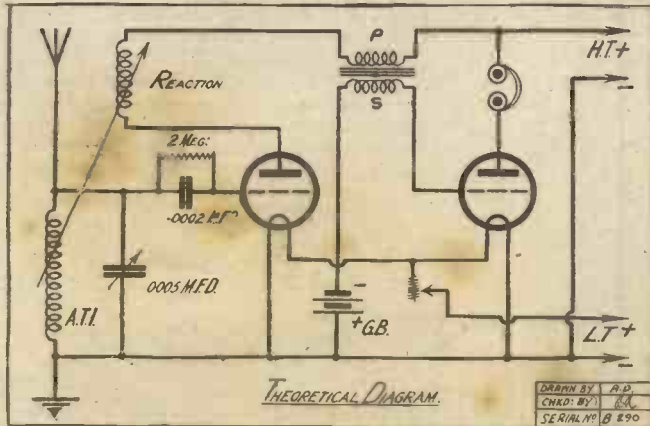

Q. What about the foreign stations? Should I stand any chance of getting them occasionally?

A. Oh, yes, when you have attained a little skill in handling it, the set I have in mind would probably bring in quite a nice sprinkling of foreigners as well. But that is only when conditions are good, and if you put up a decent aerial.

Q. Out-of-doors aerial, I suppose?

A. Yes, out of doors. The higher it is, the better; and I am assuming it would not be shut in too badly by surrounding houses, trees, etc.

### The Necessary Components.

Q. Well, I can put up a 30-ft. pole, and my garden backs on to another garden, so I suppose it's an average sort of situation?

A. That should be all right, I think.

Q. What sort of set would be suitable?

A. A "straight" two-valver, in which the first valve is a detector and the second valve the L.F. amplifier. As you haven't built a set before, I should recommend an easy-to-make flat-panel set.

Q. I suppose I shall need a few odd screws for fixing the components to the panel?

A. Yes; the screws for the coil holder are supplied with it, and, in addition, you will require about half-a-dozen counter-sinking bolts and nuts (4 B.A. gauge) of half-inch and three-quarter sizes.

Q. As I cannot carry accurately in my mind the way you have arranged the parts in your set, can you give me a sketch showing where the various components should be placed?

A. Here is one that shows all the essential measurements, which you can vary slightly if the components you finally decide upon are not exactly the same size as those I have used. (See drilling layout.)

### Inexpensive Receiver.

Q. What are the approximate costs of the parts? I don't believe you mentioned them.

A. I bought the panel and cabinet together at an inclusive cost of 12s. 6d.; the L.F. transformer costs only 8s. 6d.; the coil holder is 8s.; and the variable condenser is retailed at 10s. 6d. The other components are quite inexpensive, the rheostat costing 6s., the grid leak and condenser, complete, 2s.; the terminals, 1s. 3d.; the valve holders, 2s. Odd screws and wire will cost you about 1s. 6d.

Q. Having got all the parts, is there any special procedure I should adopt for building the set? I mean, can the components be mounted in any order, or should some be put on before the others?

A. First of all, you should mark the panel for drilling. The sketch I have given you indicates the positions of the various components. The exact location of the coil holder holes can be found from

(Continued on next page.)



The two-valve receiver discussed in the article. All the components are mounted either above or below the panel.

## THE "Q AND A" SET.

(Continued from previous page.)

the template which is supplied with that component. The valve-leg spacing must be very accurate, so I should advise you to use a template. The particular valve holders which I have used have a template supplied with them, but if ordinary valve holders or valve sockets are employed the spacing can be accurately found by one of the little metal templates obtainable from your dealer.

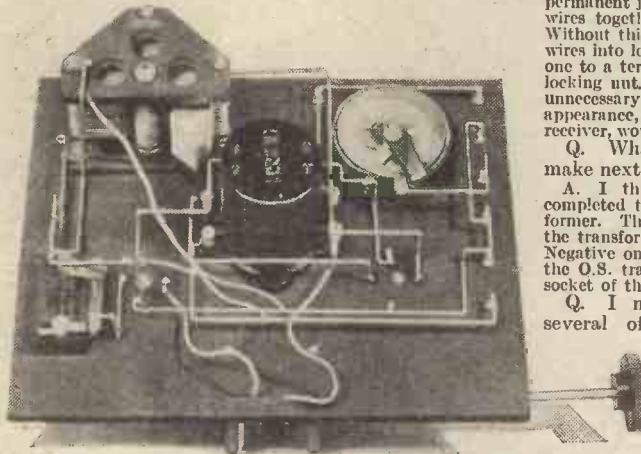

Together with the other under-panel photographs, this illustration should be of assistance during the wiring-up process.

Q. I presume that all the components should be mounted before I commence wiring up? Or should I wire up some of them (for instance, those wires nearest the panel) before putting on the larger components, such as the transformer?

A. The best method is to mount the terminals first, and file the ends ready for soldering. Then mount the rest of the components, and you will be ready to commence the wiring.

Q. Where shall I start on the wiring?

A. The usual plan is to wire the filament circuit first, and I think I had better give you a sketch of the wiring (see wiring diagram). You will notice that the wire joining the grid bias plus and L.T. negative terminals to the filaments of the two valves is low down close to the panel. Having put on this wire, join the remaining filament connections of the valve holders together and connect them to one side of the rheostat. The remaining rheostat terminal is joined to the L.T. plus terminal, and then the filament wiring is complete.

Q. I notice that other wires join those you have mentioned. Should these be taken next?

A. Yes; though with a little ingenuity I could have continued the wire that joins L.T. negative and G.B. plus to the H.T. negative terminal as well. The exact order of wiring up and the exact position of the various wires is not very particular providing you follow the sketch in its essentials, and leave adequate space between those wires that are not connected together.

### Concerning the Wiring.

Q. I notice that all the wires on your set have right-angle bends in them. Is this an essential feature, or would it be better to take them direct to the various points they have to reach?

A. The idea of bending them at right-angles is to keep them as well-spaced from each other as possible and, at the same time, give the set a neat appearance. As regards the next wires that you put on, I should take the following in the order I mention them: One joining the aerial terminal to one side of the grid leak and condenser, and to the fixed plates of the variable condenser; one from the earth terminal to the moving plates and to the filament wire coming from the L.T. minus and G.B. plus; then the lead connecting the remaining side of the condenser and leak to the grid socket of the right-hand valve holder (looking at the back of panel all the time, of course, with the variable condenser and rheostat towards you).

Q. Should the flexible leads, which come through the panel from the coil holder and are connected to the leads from aerial and earth terminals, be fixed in position now?

A. No; I think it would be best to leave those until a later stage, though you might fix the flexible lead from the plate of the first valve to the socket of the moving section of the coil holder in position. The other terminal on that portion of the coil holder can be connected by a flexible lead to the terminal marked O.P. on the transformer. The terminal marked I.P. should then be connected by a piece of stiff wire to the left-hand telephone terminal and the terminal marked H.T. plus.

Q. I notice, in your set, that all the connections are soldered. Is that an essential feature, or could I do away with the necessity of soldering?

A. It is much better to solder the connections if you possibly can, as this makes for a much more permanent job and enables you to connect wires together at any points you wish. Without this you would have to bend the wires into loops at the ends and take each one to a terminal, fixing it by means of a locking nut. In this way a great deal of unnecessary wire would be used, and the appearance, if not the efficiency of the receiver, would be impaired.

Q. What connections should I make next?

A. I think it would be best if you completed those going to the L.F. transformer. That is, join the I.S. terminal on the transformer to that marked Grid Bias Negative on the left of the panel, and join the O.S. transformer terminal to the grid socket of the second valve holder.

Q. I notice that at this stage several of the wires seem to be running close together.

Should they be kept any definite distance apart, or is that immaterial?

A. There is no definite distance at which they should be kept apart, but they should not be allowed to go too close, or slight bending of the wires might cause them to touch, which would certainly prevent the set from working properly, and might possibly damage your valves if the voltage from the high-tension battery, by any chance, was placed across the filament circuit. There are very few wires now to be put on, viz., the one from the right-hand phone terminal to the plate socket of the second valve holder, and those two flexible leads from the fixed portion of the coil holder through the panel that you mentioned before, one going from the plug of the coil holder to the lead attached to the earth terminal and the other one from the socket of the coil holder to the wire joining the fixed vanes of the variable condenser to the aerial terminal.

### The Accessories.

Q. Now that the set is wired up, I conclude it is ready for testing?

A. Before connecting up, you had better check over the connections.

Q. What shall I need in the way of accessories before the set will be ready to use?

A. Apart from the aerial and earth leads you will require the L.T. battery, H.T. battery, and grid bias battery. Also a pair of phones or loud speaker, the two valves, and a set of coils.

Q. Is there any special size or voltage of accumulator that will be required, or is this immaterial?

A. Your requirements in this direction are entirely governed by the valves chosen. Whatever kind of valves you decide upon, you will find that the makers recommend a suitable L.T. and H.T. battery and grid bias values, and if you keep within the limits recommended by the valve maker you can be sure of obtaining the best results from them.

Q. I understand that the valves can be divided roughly into three classes according to the voltage they require. Is any one class more suitable for my use than another?

A. No, they are equally suitable, except for the fact that if you choose two-volt valves the L.T. battery is smaller than with the other types and, consequently, the problem of recharging it is simplified.

### Choosing the Valves.

Q. I presume the efficiency of the various classes is about the same, but as there are so many valves from which to choose, I should be glad if you would give me some idea of what I shall require, as it is a difficult matter for a novice to make a choice from all the valves at his disposal.

A. I should recommend you to use valves with a low current consumption, so that your accumulator will need recharging at infrequent intervals only. We shall have to mention figures here for a moment, I am afraid, but as they are very easily understood I think you will follow exactly what I mean.

The current consumed by any valve is measured in amps., and the lowest current consumption you can obtain will be with valves taking .06 amp. There is another class taking .1 amp. others taking .25 amp., and so on. Either of these would give excellent service, and really there is very little to choose between them.

Q. I suppose if I take the middle course I shall not be going far wrong, but I am told that the number of times I have to have my accumulator recharged will depend on the size of the accumulator as well as on the valves I use. Is that correct?

A. Yes. If you choose the .1 valves the total current consumption of the set will be .2 amp. This total consumption will have to be divided into the actual ampere-hour capacity of your accumulator, to find out how many hours it will last before it needs recharging.

Suppose, for instance, you purchase a twenty actual ampere-hour accumulator. Divide this twenty by the .2 which is the total current consumption of the set, and the answer is 100—that is, you can use your set for about 100 hours before the accumulator will need recharging.

Q. If I exceed this number of hours, will any damage be done to the set or will it merely cease to work? In any case, if I should lose count of the number of hours, is there any indication which would tell me when the battery wants recharging?

A. It is particularly important that the battery should not rub right down for the first two or three

(Continued on page 1205.)

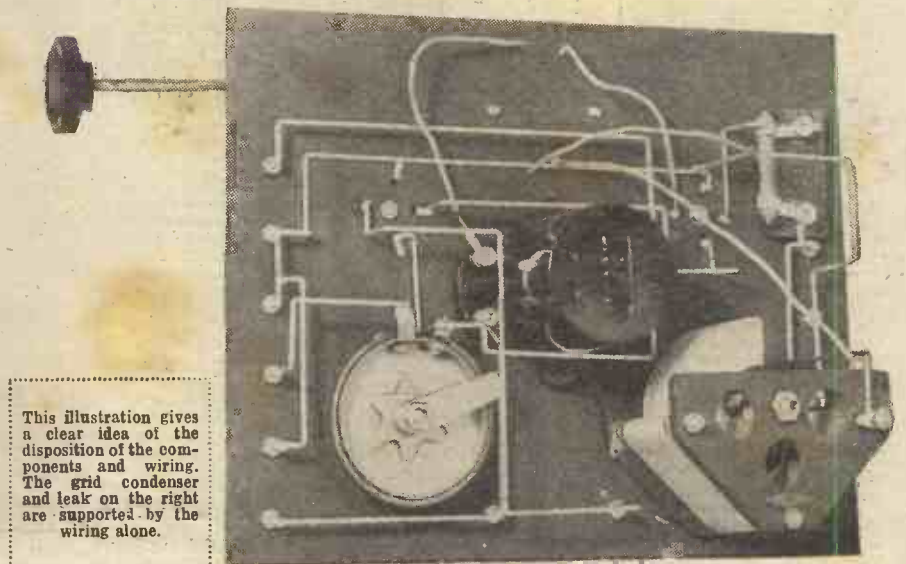

This illustration gives a clear idea of the disposition of the components and wiring. The grid condenser and leak on the right are supported by the wiring alone.



# THE NEED FOR A BETTER BATTERY IS FILLED

There was a need for a better battery for loud speaker work—long programmes imposing a tremendous strain on batteries proved that the ordinary H.T. Battery could not stand it as well as was desirable. Deterioration in reproduction during every long programme took place, but so gradually did it occur that the ear almost got accustomed to the change, but that did not mean that the reproduction was not as good as it could be.

The unique new process and chemical combination employed in the making of the LISSEN new process battery has introduced a new power smoothness into the loud speaker reproduction. The tones are more natural than has ever been known before. Volume is clearer and bigger, and the LISSEN battery will keep this up hour after hour, never varying, never altering throughout the longest evening.

All who are using it are finding a new delight in their loud speakers because of a new and better battery utterance.

A LISSEN battery is always fresh, always brimful of new energy when you get it.

It is not dear, for the LISSEN new direct-to-dealer policy of distribution cuts out all the wholesale profits for your benefit. Your dealer sells this LISSEN battery. Ask him for LISSEN new process and take no other. Rated at 60 volts but goes considerably over. If any difficulty send to factory—no postage charged, but please mention dealer's name and address.

## 10/6

(Price would have been 13/- but for new policy.)



Hear your LISSENOLA working off this LISSEN battery to know what a good loud speaker and a good battery can do together.

LISSEN LTD., 8-16, FRIARS LANE,  
RICHMOND, SURREY.

Managing Director: Thomas N. Cole.

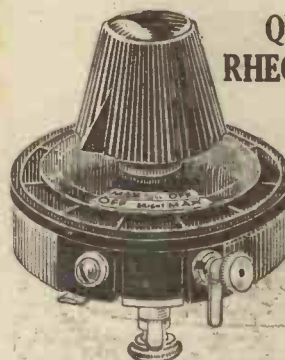

QUALITY  
RHEOSTATS

Previously  
4/-  
NOW  
**2/6**

LISSEN quality—look how they are made—the wires cannot move and short circuit—the contact brush rides firmly yet smoothly—the heat-resisting former cannot soften—there are accessible terminals—and the combined knob and pointer will fit flush with the neat photo-engraved dial when mounted. Lastly, note the irresistible appeal of the price, made possible by our big production programme backed by our new direct-to-dealer distribution policy which cuts out all wholesale profits.

	Previously	NOW
LISSEN 7 ohms rheostat, patented	4/-	2/6
" 35 " " "	4/-	2/6
" Dual " " "	6/-	4/6
" Potentiometer, 400 ohms	4/8	2/6

Every One LISSEN One-Hole Fixing,  
of Course.

Baseboard mounting type same prices as above.

## QUICK TO FIX AND HANDY TO USE

2-way  
Switch

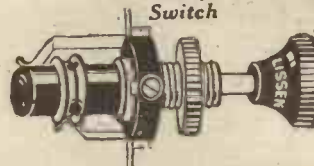

There is a LISSEN switch for everything you want a switch to do. Ask your dealer for the appropriate LISSEN switch, and you will get a real radio switch. LISSEN one-hole fixing explains itself.

	Previously	NOW
LISSEN 2-way	2/9	1/6
Series-parallel	3/9	2/6
Double Pole, Double Throw	4/-	2/6
Key Switch	2/6	1/6

## A VALVE HOLDER FOR CLEARER, BETTER SIGNALS



Because of its low loss and low capacity qualities, the LISSEN Valve Holder plays its part in getting clearer, louder signals. Sent out ready for baseboard mounting, as shown, it can also be used for panel mounting by bending the springs straight.

LISSEN VALVE HOLDER  
(Patented)  
Previously 1/8 NOW 1/- Each

# The Duvarileak



## Perfection in Variable Grid Leaks!

Fit your receiver with a Duvarileak Variable Grid Leak.

It enables you to increase the selectivity and the purity of your reception by applying to the grid the exact resistance demanded by your particular detector valve.

The Duvarileak eliminates all the failings often associated with variable grid leaks in the past.

The resistance material, which it has taken us years to evolve, has a hard surface. It retains its resistance value indefinitely, and the rolling ball contact (see inset) reduces wear to a negligible quantity. The result is that the Duvarileak remains variable and gives a constant value for any given setting of the dial. It carries the Dubilier Guarantee to give complete satisfaction, and is obtainable of all Dealers, Price 7/6.

The *Duvalcon* for Loud Speaker volume control is the same in appearance and price as the Duvarileak. Suitable for use with any Loud Speaker.

May we send you our new Catalogue in which these and all other Dubilier Products are fully described?

Price 7/6 each



ADVT. OF THE DUBILIER CONDENSER CO. (1925) LTD.  
 DUCON WORKS, VICTORIA ROAD, N. ACTON, W.3  
 TELEPHONE: CHISWICK 2241-2-3. H. 9, 249

## COMPONENTS OF REPUTE

All the components described below are used and recommended by leading set designers everywhere, and they will considerably improve reception on your set. Each of them is covered by our usual guarantee.

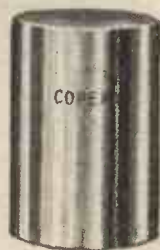

**CŌPEX**  
**"POPULAR MODEL"**  
 Copper Coil Screen and Interchangeable 6-pin Base.  
 (Pat. No. 259,459.)

**9/6**

Made from best quality copper, these screens give perfect electrical and self-cleaning contact on the base. The novel arrangement of

the terminals renders accidental "shorting" impossible. Beautifully finished, with all brass parts heavily nickel-plated.

### Special Six-pin Base

To replace the more expensive standard screened coil base in sets where the actual screen is not required. Standard spacing with terminals arranged for easy accessibility. . . . . **2/9**



### Keystone Fixed Resistors



No. 4 for .25 amp. valves with 6-volt. accumulator. No. 17 for .06 amp. valves with 4-volt. accumulator.

Price **2/6**

We can supply all the components and panels ready drilled for Mullard Receivers described in "Radio for the Million."

### S.L.F. Condenser

As used in the "P.W. SAVOY THREE." The condenser which gives a dead straight line frequency curve, the effect of which is to prevent the usual crowding of wave-lengths on the lower portion of the scale as is the case with other types of condensers, and to allow the various stations to come in at regular intervals round the dial, thereby greatly facilitating tuning. Beautifully finished, with a spiral contact which eliminates noise, wear-proof bearings giving smooth, easy movement, and a handsome 4 in. dial. Very rigidly constructed.

.0005 mfd. . . . . **15/-** .0003 mfd. . . . . **14/-**

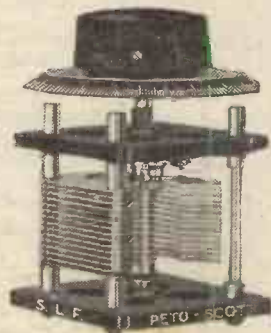

### Keystone Neutralising and Balancing Condensers

Used in all the popular circuits this season. These condensers have been designed by experts, and they are suitable for neutralising the electrode capacities of all type of valves. Very low minimum capacity. The wide spacing of the vanes renders accidental "shorting" impossible. Very well made from best quality material and beautifully finished.

Board mounting **5/-** Panel mounting **6/3**

Balancing Condenser, similar to the illustration, but having two sets of fixed vanes instead of one. **7/6**  
 Equally well finished. . . . .

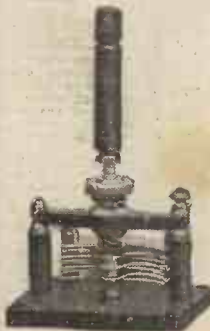

### REAL SERVICE FOR HOME CONSTRUCTORS

If you are building a set, you cannot do better than avail yourself of the famous Pilot Service. Under this Scheme you are absolutely guaranteed success, and our Technical and Service Departments are ready to help you at all times, should you encounter any small difficulties. Do not attempt to build a set without this guarantee of technical assistance.

Send 6d. in stamps for a copy of the "Pilot Manual," which gives full particulars of this Service, and illustrated details of the latest and most popular receiving sets.



### THE PILOT MANUAL

## PETO-SCOTT CO., LTD.,

Regd. Office: 77, CITY ROAD, LONDON, E.C.1.  
 BRANCHES:—82, High Holborn, London, W.C.1. 4, Manchester Street, Liverpool. 4, Bank of England Place, Plymouth. 230, Wood Street, Walthamstow, London, E.

# THE "Q AND A" SET.

(Continued from page 1202.)

charges, so if I were you I should take it to be recharged after it has had about a fortnight's use, for the first four or five times. After this, you will find that it

A. By never bringing the reaction coil too near to the aerial coil. The important thing to remember is that too much reaction spoils your own signals as well as other people's, whilst too little reaction has no detrimental effect whatever except that signals are not quite as strong as they might be. This will hardly affect the reception of London and Daventry, but when you are conversant with the receiver and try for foreign stations you will have to get skilful enough in the use of reaction to use it as much as possible without carrying it to excess.

Q. When varying the distance between

following. By the way, this method should be tried outside broadcasting hours, preferably early in the morning, when no one is trying to listen to distant stations. You proceed as follows: Put on the 'phones or listen carefully with the loud speaker, and then gradually bring the reaction coil towards the aerial coil. Whilst you are doing this, wet your finger, and tap the aerial terminal with it. With each tap you will hear a click, and these clicks will probably get louder and louder when the coil is at an angle of about 45 degrees from the aerial coil. At first the increase is not very noticeable, but at a certain point it suddenly gets very much louder, and this is often accompanied by a slight hissing or breathing sound, or else by a whistle.

The very loud clicks or the whistle are due to oscillation, so it is before this point that the correct reaction position is found. With a little practice you will soon discover a position where reaction is making the clicks louder than before, but the set is just not oscillating. This is the position for maximum reaction, when the set is in its most sensitive condition.

### Picking Up Distant Stations.

Q. You mentioned just now that I might have to change the coil over. Will the size of coil have an effect on the oscillating powers of the set?

A. Yes, the larger the coil the greater the reaction effect (within limits). By the way, I forgot to mention that sometimes it happens that when trying to increase reaction it is found that apparently the opposite effect is being obtained. Signals do not get stronger as the coils get closer together, and they may indeed get weaker.

Q. What should I do then?

A. All that is necessary is to reverse the two leads to the reaction coil. It is partly for this reason that flexible leads are being used, as they enable the relative positions of the coil wiring to be altered easily.

Q. I have been told that best results are obtained from what are known as power valves. Are these expensive to run, and should I be able to use them?

A. They are a little more expensive, both in first cost and upkeep, but, as a matter of fact, their performance is generally greatly in advance of the ordinary valves, and if you can do so I should certainly purchase those of the power type. Alternatively, one power valve in the last stage would give better results than two of the ordinary valves.

Q. What is the best procedure for tuning in a station?

A. Simply rotate the aerial condenser until maximum signals are received, with the reaction coil well out. Later on, when picking up distant stations, this coil will have to be advanced closer to the aerial coil, as already explained, but just at first you will be well advised not to attempt long-distance reception.

(Continued on next page.)

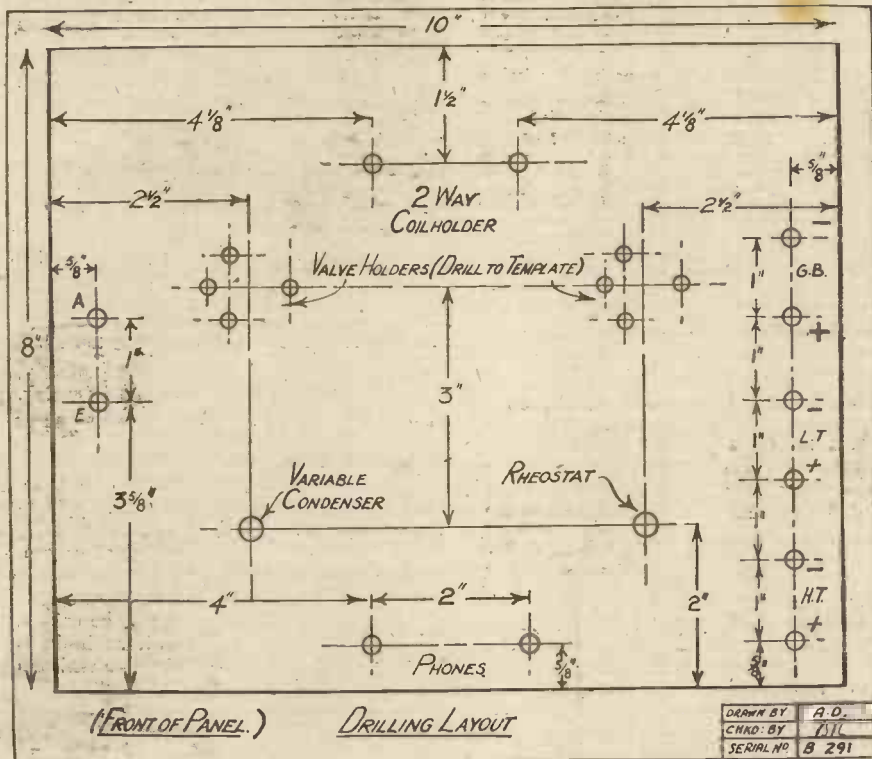

you leave the battery too long before taking it to the charging station it will give out in use and your results will more or less suddenly fade away. This is when the battery is fully discharged, and in such a condition it should be taken to the charging station as soon as possible for recharging.

You can obtain a good idea of the condition of the battery from its voltage, which is measured by an instrument called the voltmeter. When the battery has been recharged, you will find its voltage is just over 2, and by the time it has run completely down this will only measure about 1.8 volts. The decline in voltage is fairly steady, so that this forms a good indication of the condition of the battery.

Q. The H.T. battery, I understand, is of a different type and cannot be recharged. How long should this last and how big should it be?

A. For two valves, one of the ordinary size 66 volt H.T. accumulators will probably meet the requirements of the valve maker, and this should last you several months before needing a renewal.

Q. What coils shall I need?

A. For London you will need a 40 and 50 coil, and for Daventry a 150 and 200. Probably the smaller coil will go best in the fixed holder, and the larger one in the moving, though you might try experimenting with these by changing them over to see if better results are obtained the other way.

### Hints on Operation.

Q. I assume that in connecting up I put the aerial lead on the aerial terminal, and earth lead on the earth terminal; that leaves me with six more terminals to connect up. What are the correct connections for these?

A. The drilling layout is marked to show how the respective batteries should be connected, and you must be very careful with the leads, or you may do some damage either to the batteries themselves, or to the valves. If I were you I should connect the leads to the set itself first, and then, making sure that they are the right leads, connect each pair to its battery as marked.

Q. I understand that reaction is employed in this set and that when mishandled this is liable to upset neighbouring receivers. How can I guard against this?

the coils, how shall I know when I am causing interference by using too much reaction?

A. Too much reaction causes a set to oscillate, and a good method of finding out how this happens is the

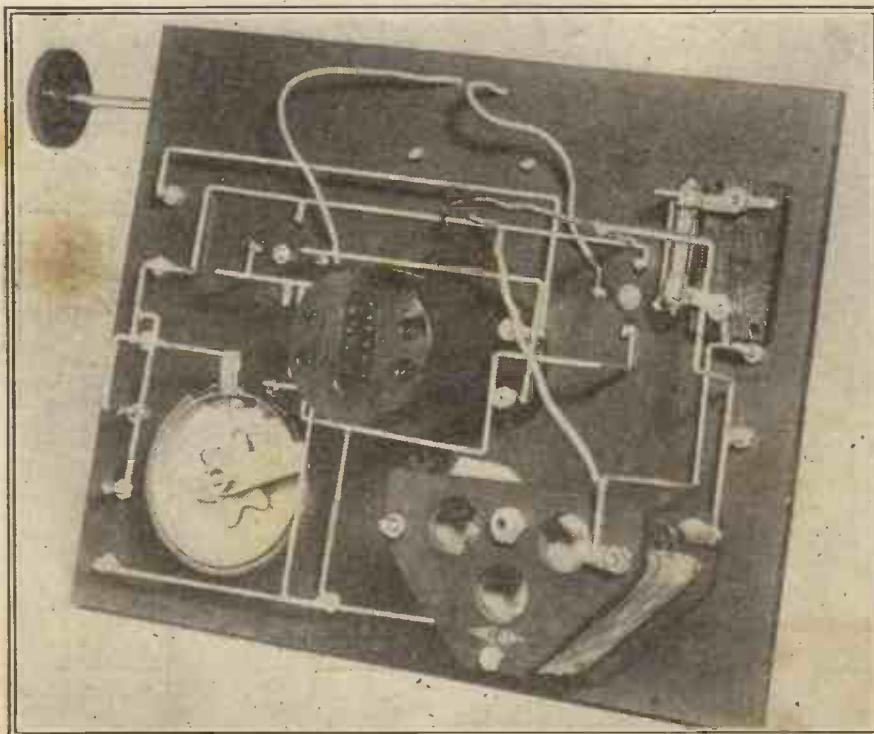

The connections made by the flexible leads are clearly indicated in the above photograph.

## THE "Q AND A" SET.

(Continued from previous page.)

**Q.** There is one other query I should like to raise now, and that is as to whether it will be possible to use the set away from the window through which the lead-in will be taken, or whether it must be placed in that part of the room?

**A.** That all depends how far away from the window you want to have the set. A few feet will not matter, but we do not advise you to let your lead-in wander all round the room before reaching the receiver, as this will entail serious losses and a corresponding decrease in efficiency.

**Q.** Supposing I place the set in a corner of the room about six feet away from the window, shall I need to take any special precautions with regard to the lead-in wire?

**A.** In that case you should keep your aerial well away from the wall and run it as direct to the set as possible. Under no circumstances must the aerial and earth leads be made of twisted flex, or even allowed to run close to each other, if you want to get the best from your set.

**Q.** Well, that reminds me that I shall want to run a lead upstairs sometimes, so that one can listen in the bedroom on 'phones. Will there be any need for precautions with the lead in this case, as it will be rather difficult to keep it right away from the walls and floor?

**A.** No. Provided well-insulated wire is used, a couple of leads from the 'phone terminals of the set can be run anywhere in the house and can be placed quite close together. Under these circumstances, it would be better to place a .003 or .005 fixed condenser across the 'phone terminals, so that extension leads shall not have any marked effect upon the tuning.

**Q.** Shall I build the fixed condenser into the set, or would you test the set without it first?

**A.** You might just as well build it into the set while you are about it, as in any case it will tend to improve the tone of your reception, especially if a loud speaker is used at any time.

**Q.** As there are several types of loud speakers, would you mind telling me which is

most likely to be satisfactory on a small set of this kind?

**A.** It is rather difficult to advise any particular make of loud speaker, because so much depends upon the individual taste of the listener. I would advise you to hear several makes at some demonstration before finally deciding, but in any case I do not think that one of the hornless type, having a large composition diaphragm, would be suitable for your purpose. As a rule these take rather a little more energy than some of the smaller models, and I doubt whether your set would be capable of operating them so as to give sufficient volume for your purpose. Something about the order of three guineas, and a well-known make, should meet your requirements. This should have an ohmic resistance of about 2,000 ohms, as you will be using an average-type power valve in the L.F. stage.

**Q.** I presume that sometimes wireless receivers go wrong, and if mine fails to function at any time, what is the best way of finding out what the trouble is likely to be?

**A.** Probably any wireless enthusiast you may happen to know who possesses sufficient knowledge will be glad to give you a hand with the set, or advise as to what is wrong with it. But remembering the wide differences in sets, I think your safest plan in the event of difficulty is to write to the "P.W." Technical Queries Dept. The full rules governing the answering of queries are given in the Radiatorial columns of POPULAR WIRELESS every week, and this dept. will be only too glad to put you right.

because it is always difficult to obtain efficient electrical contact by such means.

For making wire connections of a purely temporary nature there is no implement more useful than an ordinary paper clip, or, alternatively, one of the small clips which are used by shopkeepers for hanging up showcards in their windows.

Both these varieties of clips generally possess steel jaws which are made to come

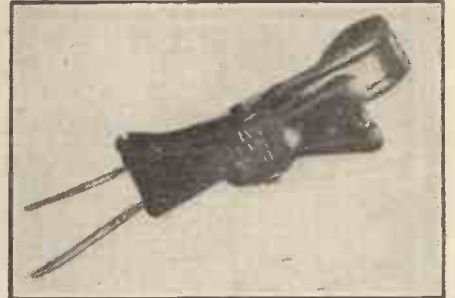

Making use of a tie-clip for connecting two wires.

together firmly by means of a strong spring. A number of such articles can be of great use to the busy wireless amateur. If wires are placed between their jaws, the former will be held tightly, provided, of course, that the two wires are of the same approximate diameter.

It is necessary to make sure, of course, that the gripping portions of the jaws of the clip are perfectly clean and free from rust, otherwise bad contact areas would be set up.

The accompanying illustrations indicate the manner in which the above two varieties

## TWO IMPROVED CONNECTORS.

By J. F. C.

IT is often very convenient to be able to make use of some very temporary means of connecting two or more wires together, and with the least possible loss of time and expenditure of trouble.

Naturally, one can make temporary connections by holding the two wires together, or by tying them together. Such connections are not satisfactory, however,

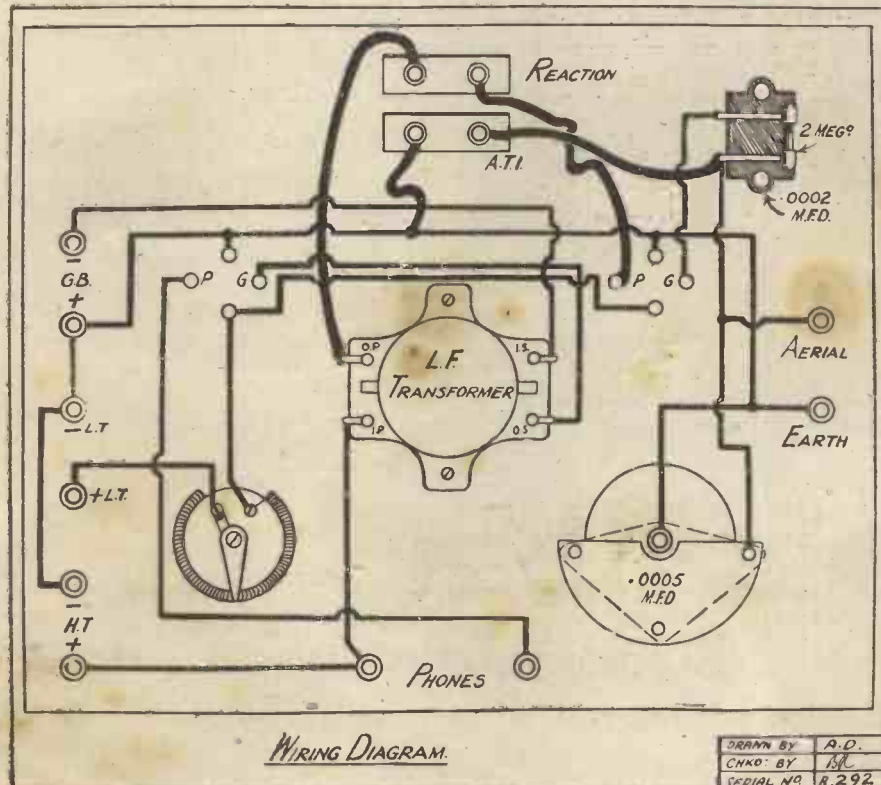

WIRING DIAGRAM.

DRAWN BY	A.D.
CHECKED BY	ISL
SERIAL NO.	8,292

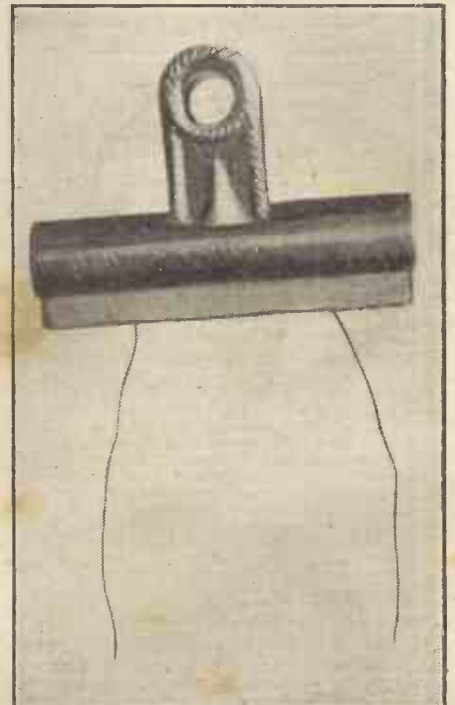

A supply of small paper-clips often greatly assists when rapid changing of connections has to be carried out.

of clips may be used. Needless to say, this mode of making wire connections is not an elegant one, but it is decidedly convenient, and on that account it will recommend itself as a good practical tip to the radio worker whose time is not unlimited.



## 30 PER CENT MORE ELECTRICITY PRODUCING MATERIAL

Improvement on top of improvement has been the history of COLUMBIA Radio Batteries. Here, in the radically different COLUMBIA Layerbilt, is the H.T. Battery which tops them all. The ability of this battery to give unrivalled service and economy is due to its unique internal design. Instead of the usual assembly of round cells, it is built of flat layers of current-

producing materials pressed firmly together. This construction makes use of the spaces now wasted between the round-type cells and avoids the usual soldered wire connections. COLUMBIA Layerbilt is every inch a battery. This exclusive COLUMBIA development packs more active chemicals in a given space, produces more current from them and gives longer life.

### HIGH TENSION

The ordinary H.T. Battery is composed of cylindrical cells. The new COLUMBIA Layerbilt H.T. Battery is made of flat layers of electricity-producing material. In this way every available cubic inch produces power. This not only means greater efficiency but longer life.



### BATTERY No. 4486

The illustration shows the unique internal construction of the Layerbilt Battery. This exclusive feature makes it the most economical of all H.T. Batteries. It will be available after JANUARY 1, 1927, from any good dealer.

“Layerbilt”

**Columbia**  
Radio Batteries  
*they last longer.*

Manufactured and  
guaranteed by:  
NATIONAL CARBON CO.

© © ©  
Scotland:

John T. Cartwright,  
3, Cadogan Street,  
Glasgow.

For full particulars  
apply to:

J. R. MORRIS,  
Imperial House,  
Kingsway, W.C.

Telephone: Gerrard 3038.  
Telegrams: "Colcarprod, London."

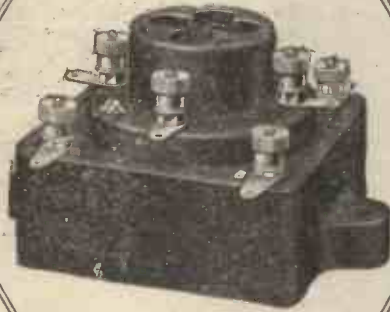

The **Cosmos**  
Resistance  
Coupling Unit

Real purity of reproduction can only be obtained with resistance capacity coupling. The Cosmos Coupling Unit with a suitable valve is as effective as an ordinary transformer coupled stage. It avoids all distortion and effects considerable economies in first and operating costs. Designed primarily for use with the "Cosmos" S.P. Blue Spot Valves, it can be used successfully with any valve having an amplification factor of 30 or more. Special attention is directed to the following advantages of the Cosmos Coupling Unit:—

1. It takes up little space in a set.
2. It is not liable to be broken.
3. It has permanent resistance values.
4. It allows for simplified wiring.
5. It is economical in L.T. current (S.P. Blue Spot Valves consume 0.9 amps).
6. It is economical in H.T. Battery consumption (less than 1/20 normal).

And lastly its use results in purity of reproduction without loss in volume.

Ask your dealer for copy of folder 4117/7.

**METRO-VICK SUPPLIES LTD.**  
Metro-Vick House, 155, Charing Cross Rd., London, W.C.2

Type "O." The unit alone. Price 8/6

Type "V." The unit incorporating the "Cosmos" Spring Valve Holder. As illustrated. Price 10/6

Suitable Valves for use with this unit are:

For 2-volt "Cosmos" SP18/B.

For 6-volt "Cosmos" SP55/B.

**L**OUND SPEAKERS are legion, their sponsors have been apt to write abundantly of qualities supreme. So-called mellowness, sweetness, clarity, wonderful depth, fidelity, etc., etc., are insufficient to truly describe the reception experienced by users of the Claritone.

*It is sufficient for them to know that they can sit back and enjoy*

*Ashley Radio*

Ashley Wireless Telephone Co. (1925), Ltd., 17, Finch Place, Falkland Street, Liverpool.

- W265 £5 0 0
- W267 £2 15 0
- W299 £12 10 0
- W287 £4 10 0
- W275 £6 0 0
- W277 £4 0 0

Described and illustrated in Booklet No. 71 obtainable from all dealers.



**CLARITONE**  
LOUD SPEAKERS & HEAD PHONES

> **"EKCO" H.T. UNITS** <

**SCRAP DRY BATTERIES!**

By obtaining H.T. Current from Electric Supply Mains (D.C. & A.C.) by just attaching Adaptor to Electric Light Lampholder!

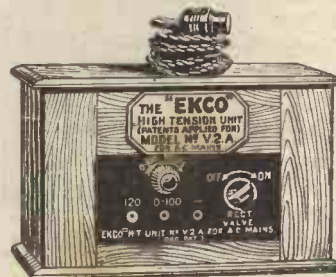

12" X 6" X 7"  
MODEL V2A-A.C.

**"EKCO"**

The **"QUALITY"** Unit

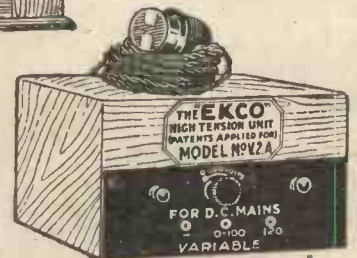

FOR D.C. MAINS  
0-100  
VARIABLE  
SIZE 6" X 6" X 3 1/2"  
MODEL V2A-D.C.

Illustrated Folder FREE.

UNITS TO SUIT } FROM **42/6**  
ALL SETS - - - }

Obtainable from all the leading Wireless Stores or direct from:—

**E.K. COLE LTD.** (DEPT. A), 513, LONDON RD., WESTCLIFF ON-SEA.

# BROADCAST NOTES.

By OUR BROADCASTING CORRESPONDENTS.

"Menace of the Leisured Woman"—"Peer Gynt" from Liverpool—An O.U.D.S. Broadcast—The A.A. Talks—Flotsam and Jetsam—The Extra Money—The Governors at Work—Sir John Reith—B.B.C. Publicity—Long Plays Preferred—The Danger of Dignity.

## "Menace of the Leisured Woman."

THE debate on this subject at the Kingsway Hall on January 22nd is likely to be broadcast from London and Daventry. Mr. George Bernard Shaw is to preside, and the principal speakers are to be Lady Rhondda and Mr. G. K. Chesterton. This should be of exceptional interest to most listeners.

## "Peer Gynt" from Liverpool.

It is definitely "one-up" to the Liverpool Station that their recent local performance of "Peer Gynt" was so successful that they are to repeat it for the benefit of London and Daventry listeners. The date has not yet been fixed, but will probably be early in February.

## An O.U.D.S. Broadcast.

Arrangements are being made for the broadcasting of an excerpt from the O. U. D. S. performance of "King Lear" on February 15th.

## The A.A. Talks.

A violent controversy is raging round the A.A. Talks, broadcast regularly. Mr. Stenson Cooke, the popular and able executive chief of the A.A., does the talks in his own inimitable direct and incisive manner. One section of opinion at Savoy Hill takes the view that in their present form these talks do no good either to the A.A. or the B.B.C. But the other view is still prevailing, to the general advantage of the programmes. Those who are in a position to gauge public opinion are agreed that there should be more talks of the kind given by Mr. Stenson Cooke. They point out that dignity and platitude do not compensate for dullness and lack of personal appeal.

## Flotsam and Jetsam.

It will be welcome news to all radio fans that Flotsam and Jetsam are to appear for three separate but whole weeks during 1927. They will appear in the weeks commencing February 7th, June 6th, and October 3rd. Next only to George Grossmith's special "My Programme" in December, Flotsam and Jetsam's broadcast week in November last year was quite the most popular and successful broadcast of the year. Some Press commentators in surveying broadcasting for 1926 put the national concerts and the chamber concerts at the head of the list. This was perhaps true of the minority; but for the overwhelming majority, G.G.'s programme was

first, Flotsam and Jetsam second, Harry Lauder third, and Kitesh fourth. It is to be hoped that the engagement of Flotsam and Jetsam for the three periods is indicative of a new and more decisive policy in dealing with features whose merit and popularity are proved.

## The Extra Money.

There is some speculation as to the distribution of the additional funds which the B.B.C. will have this year. It is presumed that programmes and engineering will get the whole of it. The old B.B.C. had established its administrative charges as long ago as June, 1925, and the proportion of revenue allotted thereto is understood to have remained stabilised during the past eighteen months. The salaries and expenses of the new Board will cost an item of about £7,000. But the introduction of the new system of distribution, accom-



The interesting test of dropping a number of valves out of an aeroplane was recently carried out by Messrs. Cossors. This photograph shows the valves being handed to the pilot.

panied by a reduction of staff, should see at least an equivalent saving on salaries. Thus the Corporation is in the fortunate position of being able to devote all its extra money to programmes and technical improvements.

## The Governors at Work.

The extreme pressure on the available space at Savoy Hill makes it impossible for each of the new Governors to have an office, at least for the present. As to the actual detail of how the new Board will work, no final decision has been taken. It is understood, however, that for the first few weeks they will content themselves with examining carefully what is being done. Subsequently they will signify their approval or disapproval of general methods, and will then split up the work of supervising between them. Thus each Governor will accept responsibility for the working of one or more departments, as is done in many successful businesses. In the event of the adoption of this scheme, each Departmental Chief at Savoy Hill will be attached to a Governor whose office normally would adjoin his. It will be interesting to see if

this plan is adopted, and, if so, how it will work.

## Sir John Reith.

This honour is so long overdue that it has been taken for granted. It is perhaps typical of the attitude of a section of the "official mind" towards Broadcasting that it should have received only a knighthood. If the matter had been left to the twelve million listeners throughout the country they would have spontaneously given Mr. Reith the choice between a high title and the Order of Merit. Nor will they be satisfied until due reparation has been made.

## B.B.C. Publicity.

No step has been taken as yet to apply the proposal to demobilise the B.B.C. publicity machine, and "farm-out" their publications either to a publisher or to a new concessionaire company. It is understood that this is one of the early problems for the attention of the Governors. Apparently, however, there is less desire now at the Post Office to be rid of the B.B.C. publicists.

## Long Plays Preferred.

Up until recently it was generally assumed even at Savoy Hill that with one main set of programmes available, listeners would prefer short plays to long ones. It has now been discovered, however, that the longer plays are actually more popular. This indicates two things—first of all, that the B.B.C. dramatic work is vastly improved; and secondly, that sustained listening is becoming more customary. Now that the error of the previous view is recognised, it is certain that the dramatic side of broadcasting will be more en-

couraged by the Corporation than it was by the Company.

## The Danger of Dignity.

Just as the new B.B.C. has more power, independence, and resources, so it will be subject to correspondingly more acute and exacting criticism. And one of the first points likely to be criticised is the new-found dignity of our Broadcasting service arising from the fact of the Royal Charter and new status generally.

Unless the greatest care is taken, it will not be to the advantage of the programmes that Broadcasting is at last regarded as thoroughly respectable, and as one of the normal institutions of British life. Recognition and dignity are of value only to the extent in which they open up new fields of programme material. They will be a positive hindrance if their chief manifestation is in red tape and bumbledom.

If the executive people at Savoy Hill are really wise they will omit no opportunity to show that there is not to be any intrusion, however slight and innocuous, of the "Departmental manner."





# LLOYD'S POLICY



*(Subscribed only by Underwriting Members of Lloyd's who have complied in all respects with the requirements of the Assurance Companies Act of 1909 as to security and otherwise.)*

Whereas Messrs. S.T. Ltd., of 2/3 Melbourne Place, W.C.2, hereinafter called the Assured, have paid the necessary Premium or Consideration to Us, who have hereunto subscribed our names to Insure against loss as follows, viz. :—

To indemnify the Assured against loss incurred consequent on their Wireless Valves being returned as faulty due to failure to give long life or otherwise.

Now know ye, that we the Insurers do hereby bind ourselves, each for his own part, and not one for Another, our Heirs, Executors, and Administrators, to pay or make good to the Assured or to the Assured's Executors, Administrators, and Assigns, all such Loss or Damage as aforesaid as may happen to the subject matter of this Insurance, or any part thereof during the continuance of this Policy.

In witness whereof we, Underwriting Members of Lloyd's, have subscribed our Names and Sums of Money by us insured.

Dated in London, the Thirteenth day of December One Thousand Nine Hundred and Twenty Six.

N.B.—The above is an extract from the first life insurance policy ever granted for a valve. The S.T. is the only valve in twenty-two years, the life of which has been considered sufficiently certain to warrant the issue of such a policy, and this is due primarily to the introduction of the new torodium filament and the Barguet process which produces the highest vacuum known to science. Buy your S.T. to-day. If it should fail to give long and faithful service it will be instantly replaced by S.T. Ltd. Our obligation does not end when the valve is sold; it only begins.

<b>2-VOLT.</b>		<b>4-VOLT.</b>	
S.T.21 (H.F.) 0'1 amp	14/-	S.T.41 (H.F. and Det.)	0'1 amp. . . . . 14/-
S.T.22 (L.F. and Det.)	0'1 amp. . . . . 14/-	S.T.42 (Power) 0'1 amp.	18/6
S.T.23 (Power) 0'15 amp.	18/6	S.T.43 (Super Power)	0'25 amp. . . . . 22/6

<b>6-VOLT.</b>	
S.T.61 (H.F. and Det.)	0'1 amp. 18/6
S.T.62 (Power)	0'1 amp. 18/6
S.T.63 (Super Power)	0'25 amp. 22/6

S. T. Ltd., 2 Melbourne Place,  
Aldwych, London,  
W.C.2.

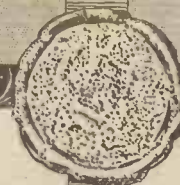



# Apparatus Tested

Traders and manufacturers are invited to submit wireless sets and components to the "P.W." Technical Dept. for test. All tests are carried out with strict impartiality in the "P.W." Test room under the supervision of the Technical Editor, and the general reader is asked to note that this weekly article is also intended to provide a reliable and unbiased guide as to what to buy and what to avoid.—EDITOR.

## A NEW COSSOR "STENTOR."

WE are rather surprised that Messrs. Cossor did not follow up their undoubted success with the now well-known little Stentor Two with a power valve or two of the six-volt type. It was our impression that the order of popularity was 2-6-4, with the four-volters a rather bad third. However, it is possible that by the time these words are in print we will have some six-volt Cossors on the market. Such would undoubtedly be welcomed very heartily.

Perhaps the Stentor Four, samples of which were recently sent us, is merely the precursor of a wider Cossor range. Anyway, it is a really good valve and a worthy member of the Stentor fraternity. Operating at 3.8 volts and taking the low current of .1 amps., it is a power valve in the strictest sense of the word. It hasn't double the "punch" of its smaller brother, for

unfortunately amplification is not proportional to filament volts, but, in its class, it is just as successful and can handle pretty large inputs very capably.

Cossor enthusiasts will find this new Stentor all that they would expect it to be.

## A WELL DESIGNED L.F. TRANSFORMER.

We recently received a "Puradyne" L.F. transformer from the manufacturers, The Puradyne Manufacturing Company, 27, Elgin Road, Seven Kings, Essex. It embodies several novel features. For instance, the terminal bars, of which there are two each carrying two terminals, are moulded integrally with the bobbin, and the terminal screws have hexagonal heads which fit into specially shaped slots in the terminal bars. Therefore the terminals cannot possibly turn and break their connections.

The transformer is very heavily built, and its many core laminations are held together securely without screws passing through them. An earthing tag is provided on the metal frame.

On test the "Puradyne" gave very good results—results that place it immediately out of and above the so-called "cheap" class. Three ratios are available, viz. 1-27; 1-4 and 1-6, all at the standard price of 13s.

## A DISTANT CONTROL SWITCH.

Messrs. Electradix Radios recently submitted one of their Electradix control switches to us for test. It is a very substantial piece of apparatus, and operates in a very definite manner. Placed in series with a small dry battery and a "button" switch, it controls the filament circuit by "making" and "breaking" it as desired. It embodies a novel clockwork mechanism, and this provides it with the power to operate very heavy contact points. One winding will suffice for 350 switchings. It is a control switch which we should hardly think could fail to work, and in our opinion it is decidedly cheap at 15s.

## NEW AMPLION LOUD SPEAKER.

In producing their new "Cabinette" loud speaker, the Amplion people state that they are endeavouring to meet a demand from listeners who do not approve of the horn type instrument, and at the same time are not prepared to invest in one of the rather more expensive "Radiolux" models. But although the "Cabinette" costs but £3 3s., it has not a

(Continued on page 1214.)

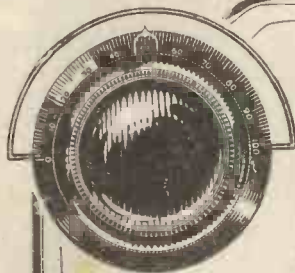

No. 1151. ETHOVERNIER complete with ETHOLOG and card scales 9/-.

No. 1152. ETHOVERNIER alone 8/-.

No. 1162. ETHOLOG only, with spare card scales 2/-.

## ETHOVERNIER DIAL

Swift or Slow yet Sure to find that most elusive Station

The Burndept Ethovertier dial gives you easier, finer tuning adjustments than ordinary condenser dials and knobs. It is free from backlash, silent, fits practically any type condenser and has a reduction ratio of 18:1. Fit the Ethovertier dial and that most elusive station can be brought in again and again. BURNDDEPT "ETHOLOG" obviates further exploration once a station has been 'logged.' It is a unique feature which, kept snugly in position round the dial by spring pressure, contains a changeable card on which you can mark the position of any station or various wave-lengths.

## NEW TYPE FIXED RESISTORS

Fit these to your set, one in series with each valve, you can then adapt your receiver for use with any valve you choose, with any accumulator within practical limits.

Write to us or ask your local Dealer for the

## BURNDDEPT RESISTOR CHART,

which shows you the correct value of Resistor to use with every well-known make of Valve in conjunction with either a 2, 4 or 6-volt accumulator.

LONDON SHOWROOMS:  
15, BEDFORD STREET,  
STRAND,  
W.C.2.

# BURNDDEPT

## WIRELESS LIMITED

AGENTS AND BRANCHES EVERYWHERE.

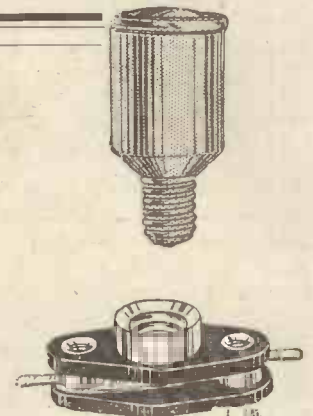

Supplied in 18 different values from 0.5 ohms to 50 ohms, 1/8 each. Screw holders in cartons containing two, 2/-.

HEAD OFFICE:  
BLACKHEATH,  
LONDON,  
S.E.3.

# EASY MOUNTING~SMOOTH WORKING

## Ormond Filament Rheostats

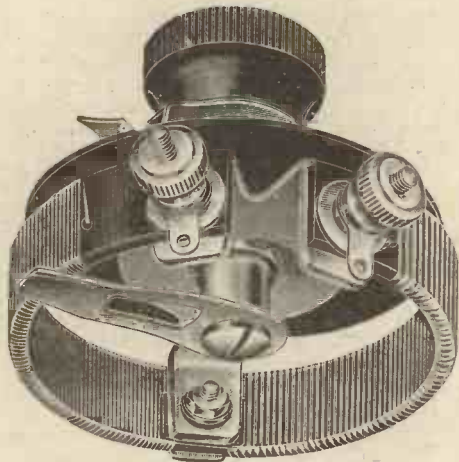

Dual Rheostat.

These rheostats and potentiometer are of the open type. The resistance wire is wound on an insulating former, supported on a metal frame, well ventilated.

The movement of the contact arm is smooth and silent, giving a firm, sure electrical contact.

The Dual Rheostat is wound in two sections with different-gauged wire continuously variable from maximum to zero. It may be used for Bright or Dull-Emitter valves.

ORMOND would not trouble your attention with a component unless they could make it better than others on the market. Here, for instance, are rheostats and a potentiometer in which, if you examine them at your dealers, you will notice several real improvements. The two main results are silent, silky-smooth movement and a rigid, reliable contact.

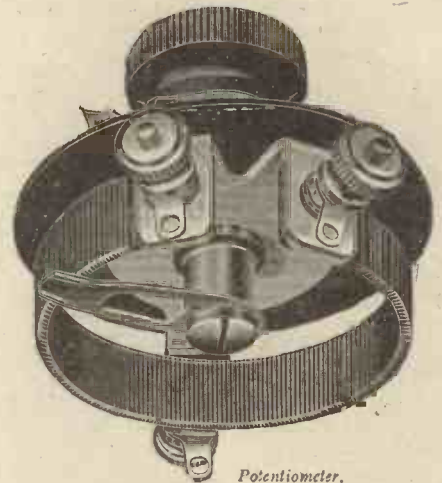

Potentiometer.

The 6 ohm and Dual Rheostats may be used as Master Rheostats; they will control three bright emitters without undue heating.

### "ONE HOLE" FIXING.

For Baseboard mounting an additional bracket is supplied. Complete with Knob, Pointer, and suitably engraved dial.

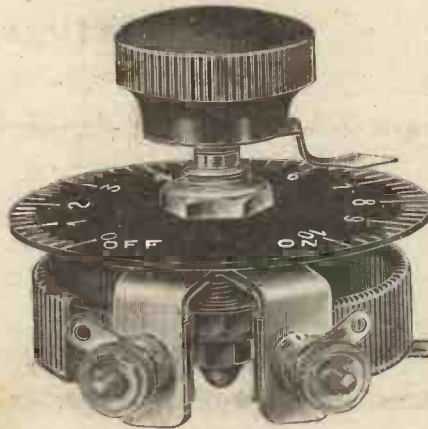

No. 5 Rheostat.

### PRICES :—

No. 5 Rheostat, 6-15-30 ohms 2/-  
 Dual Rheostat, 5-30 ohms ... 2/6  
 Potentiometer, 400 ohms ... 2/6



199-205, PENTONVILLE ROAD, KING'S CROSS, LONDON, N.1

Telephone: CLERKENWELL 9344-5-6.

Telegrams: "ORMONDENGI, KINCROSS."

Factories: WHISKIN STREET AND HARDWICK STREET, CLERKENWELL, E.C.1

Continental Agents: Messrs. PETTIGREW & MERRIMAN, LTD., "Phonos House," 2 & 4, Bucknall Street, New Oxford Street. W.C.1

## APPARATUS TESTED.

(Continued from page 1212.)

"cheap" appearance, in fact, it looks quite an expensive instrument.

It is finished in dark Jacobean oak, and is of a handsome design and is very nicely made. And this speaker gives good results, too; reproduction is full and mellow, and the projection factor of the instrument is very high. A hinged door at one end provides access to the unit and its adjustment screw. This new Amplion model should prove to be one of the most popular of all speakers this year.

### A MICROPHONE AMPLIFIER.

We have had a Wilson Microphone Bar Amplifier on test for some few weeks in different localities and under varying conditions. The device is manufactured by the New Wilson Electric Manufacturing Co., of 18, Fitzroy Street, Fitzroy Square, London, W.1. Through the medium of our advertising columns most of our readers will be familiar with the appearance of this instrument and will know that it operates on the usual microphone amplifier principle, although the application of this is decidedly a novel one.

The Wilson amplifier is a very neat little instrument, and is carefully made and assembled. Two small dry cells are all that is required in the way of a local energy supply. The current consumption is of a markedly low order.

It gives good results, too, and is less affected by external vibration than most

other instruments of the same nature. It is perfectly stable in operation, and once adjusted (a very simple operation) it functions for very long periods without the slightest attention.

Reproduction is good, and the sensitivity of the amplifier deserves special commendation in the circumstances. When fairly strong 'phone signals are receivable on a crystal set it will amplify them sufficiently to operate a medium-sized loudspeaker.

The price of the instrument is 38s. complete. Crystal enthusiasts desirous of operating a speaker and not wanting to use valves should endeavour to hear one of these amplifiers at work.

### A USEFUL FITTING.

Messrs. A. F. Bulgin & Co., of Cursitor Street, London, E.C.4, seem to specialise in novel and useful gadgets. Their latest is the "Deckorem" wall mounting telephone extension or loud speaker socket. It bears resemblance to an ordinary ceiling rose, and it can be supplied with covers finished

in oxidized silver, nickel plate, or oxidized copper to match existing room fittings. The wooden bases can also be obtained in various finishes. The socket will take standard telephone plugs, or by means of special terminals fitted inside, ordinary wire. Types suitable for either series or parallel wiring. The price of this handy little article is 3s. 9d.

### A D.C. MAINS UNIT.

We recently received a Micromain Super D.C. unit for test from the Micromain Unit Service, 46, Artillery Lane, London, E.1. It is a very neat little instrument; one of the most compact we have seen, and is enclosed in a solid, polished aluminium case. By means of conventional sockets the unit enables ten voltages of H.T. to be obtained, these ranging from approximately 12 to 154 volts on 220 volt mains.

This Micromain Unit was tested in three different localities in one of which the supply is notoriously "rough." In all cases the device operated well, although in two, "hum" was experienced. This "hum" was not noticeable during the reception of music and speech of normal intensity, but could be discerned during quiet passages. Practically all traces of "hum" could be eliminated by using an additional choke-condenser smoothing attachment.

On the whole, the "Micromain" is well up to the average D.C. unit, as it is found that but few will function with complete "silence" without employing additional smoothing devices.

The price of the "Micromain" Super, complete with plugs, flex and standard adapter, is £2 8s. 6d.

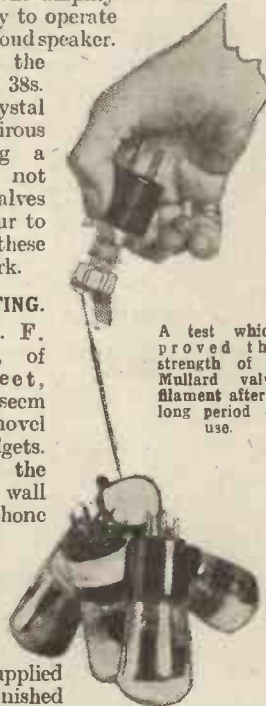

A test which proved the strength of a Mullard valve filament after a long period of use.

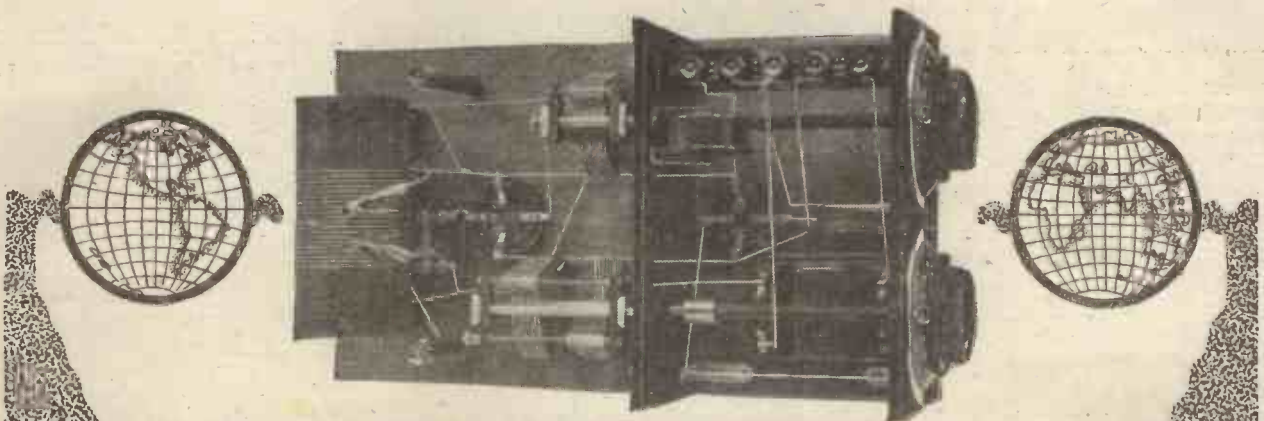

## Explore the Ether on Short Waves

THE New Short Wave receiver (20 to 200 metres) designed by Bowyer-Lowe for compactness, ease of operation and stability is without equal.

This remarkable production is another instance of the advancement in Radio by Bowyer-Lowe. The name guarantees its quality and perfect operation and its price is low because production is simplified and each component is standard.

Send 1/- now for your copy of booklet with constructional details and blue print—and explore the ether from your

Made by the Makers of the

"Popular" Condenser.

**BOWYER-LOWE**

**Another Reason** why you should use



**BRETWOOD  
S.L.F. CONDENSERS**

**The Elimination of Hand  
and Body Capacities.**

THESE are eliminated by setting the thin edge of vanes to face panel, which gives 70 to 90 per cent. less surface area exposed to body or hand than any other condenser on the market. Again, no interference is caused by stray field effects with other components in your set, because the vanes move away from the panel instead of across it, as in all other designs of S.L.F. Condensers.

The Bretwood design gives a great saving of back-of-panel space and enables inductances to be placed immediately behind the condenser, causing a close magnetic field, which produces an increase of selectivity.

PRICES:—0005 .. 17/6; 0003 .. 14/9; 00025 .. 14/-; 00015 .. 13/6

**Another Component** that will greatly help in securing selectivity and ease in distant station tuning.

**THE BRETWOOD  
GRID LEAK DE LUXE**

Constant—Silent—Efficient

This improved type has a syphon container which prevents all possible leakage of resistance element and guarantees the even distribution of it.



Prices :  
Grid Leak de Luxe .. 3/6  
Grid Leak (with Condenser) .. 4/6  
Anode Resistance .. 3/6

For accuracy of readings (50,000 ohms to 10 megohms) it is on a par with those of our straight-line frequency condenser.

A special mount is now available for baseboard mounting .. Price 3d.

Obtainable from all dealers or direct from Sole Manufacturers:

**BRETWOOD LTD.,**

16, London Mews, Maple Street, London, W.1.

Parr's Ad.

**YOUR  
OPPORTUNITY!!!**

Write NOW for Our Special Bargain List of Components.

MEANWHILE

**GUARANTEED COMPONENT PARTS** for ELSTREE SIX, SOLODYNE, or other Circuits can be supplied for CASH or EXTENDED PAYMENTS  
ELSTREE SOLODYNE.—Components including Bowyer-Lowe Condensers, Lewcos Coils and Screens, Peto-Scott Neutralising Condensers, Cydon Resistors, Lissen H.F. Chokes, Cabinet, Ebonite Panel, Glazite Wire, etc. **£20**

Or deposit £4 and the Balance payable over 6 or 12 months.

Wireless Specialists



"SERVICE—Our Name and Aim."

Wireless Dept.—

273-274, HIGH HOLBORN, LONDON, W.C.1

**FORMO**  
A MONUMENT IN THE MARCH OF PROGRESS  
The Formo Shrouded Transformer is the universal favourite.  
Made in Ratios 1-1, 1-2, 1-3, 1-4 and 1-5  
10/6 1-3 and 1-5 for 1st and 2nd stages  
Send for Catalogue and Descriptive Literature of Complete Formo Range  
**THE FORMO COMPANY**  
Crown Works, Cricklewood, N.W.2  
Phone: Hampstead 1787.  
Manchester: Mr. J. B. Levee, 23, Hartley St., Levenshulme.  
Phone: Heaton Moor 475.

**NOTICE  
TO  
BENNETT COLLEGE  
STUDENTS.**

Dear Student,

The Year 1926 has come and gone. For many (owing to Bolshie-made labour troubles) it has not been a very good year, but the men who make progress in this world are not permanently stopped by a temporary check. Obstacles are things made by circumstance to be overcome by determination.

You will be pleased to hear that although we also have suffered through the Labour trouble, yet our record of successes stands higher than ever, and I am writing this letter to thank you for the assiduity with which you have attended to your studies; that alone has helped us to achieve this gratifying result.

1927 is here. Where do you stand now? Where does The Bennett College stand? Let us both make a mark and then set off with the determination that next year at this time we shall be able to make another mark still higher. I want to help you and I want you to help me to make 1927 a record year. Work is the only way to achieve success, so let us work together for it.

Yours faithfully,  
*J. B. Bennett*  
F.R.S.A., M.I.M.A.R.E., A.I.Struct.E., etc.,  
Governor of  
**THE BENNETT COLLEGE,  
SHEFFIELD.**

**BECOL** Makers of the ORIGINAL world-famous BECOL LOW LOSS FORMER

As used in sets that took the first four prizes at the 1926 "Manchester Evening Chronicle" Wireless Exhibition and the set that won the Gold Medal at the 1926 Amsterdam Exhibition.

Registered Trade Mark.

Size: 3 inches diameter to outside of wings. Prices:  
6 inch lengths, 3/- (Postage 6d.);  
4 inch lengths, 2/- (Postage 6d.);  
3 inch lengths, 1/6 (Postage 6d.);  
Up to 36 in. lengths.

**NOTICE:—Do not be put off with an imitation. Ask for BECOL and use the Former with a reputation.**

Ebonite Rods, Tubes and Sheets. Panels guaranteed free from surface leakage.  
Write for List "C."  
**THE BRITISH EBONITE CO., Ltd., Hanwell, London, W.7.**

# RADIOTORIAL

All Editorial Communications to be addressed to The Editor POPULAR WIRELESS, The Fleetway House, Farringdon Street, London, E.C.4.

Editor.  
NORMAN EDWARDS, M.Inst.R.E., M.R.S.L.,  
F.R.G.S.

Technical Editor:  
G. V. DOWDING, Grad.I.E.E.

Assistant Technical Editors:  
K. D. ROGERS. P. R. BIRD.  
G. P. KENDALL, B.Sc.

Scientific Adviser:  
Sir OLIVER LODGE, F.R.S.

Staff Consultants:  
Dr. J. H. T. ROBERTS, F.Inst.P.; J. F.  
CORRIGAN, M.Sc., A.I.C.; C. E. FIELD,  
B.Sc.; E. J. SIMMONDS, M.I.R.E., F.R.S.A.

Foreign Correspondents:  
F. M. DELANO, Paris; Dr. ALFRED  
GRADENWITZ, Berlin; L. W. CORBETT,  
New York; P. F. MARTIN, Italy; W.  
PEETERS, Holland.

The Editor will be pleased to consider articles and photographs dealing with all subjects appertaining to wireless work. The Editor cannot accept responsibility for manuscripts and photos. Every care will be taken to return MSS. not accepted for publication. A stamped and addressed envelope must be sent with every article. All inquiries concerning advertising rates, etc., to be addressed to the Sole Agents, Messrs. John H. Lile, Ltd., 4, Ludgate Circus, London, E.C.4.

As much of the information given in the columns of this paper concerns the most recent developments in the Radio world, some of the arrangements and specialities described may be the subject of Letters Patent, and the amateur and the trader would be well advised to obtain permission of the patentees to use the patents before doing so.

Readers' letters dealing with patent questions, if sent to the Editor, will be forwarded to our own patent advisers, where every facility and help will be afforded to readers. The envelope should be clearly marked "Patent Advice."

## TECHNICAL QUERIES.

Letters should be addressed to: Technical Query Dept., "Popular Wireless," The Fleetway House, Farringdon Street, London, E.C.4.

They should be written on one side of the paper only, and MUST be accompanied by a stamped addressed envelope.

Queries should be asked in the form of the numbered questions: (1), (2), (3), etc., but may be accompanied by a short letter giving any necessary additional particulars as briefly as possible.

For every question asked a fee of 6d. should be enclosed. A copy of the numbered questions should be kept, so that the replies may be given under the numbers. (It is not possible to reproduce the question in the answer.)

Details of the "P.W." BLUEPRINTS are published fortnightly in the advertisement pages of "P.W." BACK OF PANEL DIAGRAMS can be specially

drawn up to suit the requirements of individual readers at the following rates: Crystal Sets, 6d.; One-Valve Sets, 6d.; One-Valve and Crystal (Reflex), 1s. Two-Valve and Crystal (Reflex), 1s.; Two-Valve Sets, 1s.; Three-Valve Sets, 1s.; Three-Valve and Crystal (Reflex), 1s. 6d.; Four-Valve Sets, 1s. 6d.; Multi-Valve Sets (straight Circuits), 1s. 6d. Except SUPER-HETERODYNE DIAGRAMS, all of which, irrespective of number of Valves used, are 2s. 6d.

If a panel lay-out or list of point-to-point connections is required an additional fee of 1s. must be enclosed. Wiring diagrams of commercial apparatus, such as sets of any particular manufacture, etc., cannot be supplied. (Such particulars can only be obtained from the makers.) Readers may submit their own diagrams, etc., for correction or for criticism. The fee is 1s. per diagram, and these should be large, and as clear as possible.

No questions can be answered by 'phone.

Remittances should be in the form of Postal Orders.

## Questions and Answers

### ON-OFF SWITCH.

"PUSH-PULL" (Camberley, Surrey) —What is the best position in the circuit to insert one of those little make-and-break push-pull switches, for putting the battery on and off? It is a straight one-valve set, with H.T. negative and L.T. negative joined together.

You cannot put both batteries on or off with a one-pole make-and-break switch. If you have a rheostat, this will make or break the filament circuit, and the new switch, when inserted between H.T. negative and L.T. negative, will break the H.T. battery lead, thus safeguarding the valves against an accidental short.

If, however, the control must be worked by someone unaccustomed to a set, you can insert

(Continued on page 1218.)

# Why you should use CYLDON Temprytes

Certain advertisers are claiming that "Variable Fixed Resistors" are more efficient than fixed resistors, but all that can honestly be claimed for variable resistors (a new name for the old fashioned rheostat) is that they are more variable. A resistor can have no greater fault than this.

A resistor must never vary. If it does, either your valve is not yielding maximum results or else the filament is overheated. A CYLDON TEMPRYTE never varies, because it is scientifically designed to suit the particular valve you are using. With a CYLDON TEMPRYTE your filament is kept at the exact temperature calculated from the valve-maker's data.

A further disadvantage in the carbon mixture type of variable fixed resistor is that their chemical combinations set up home-made atmospherics.

CYLDON TEMPRYTES, being WIRE WOUND, operate against a background of dead silence.

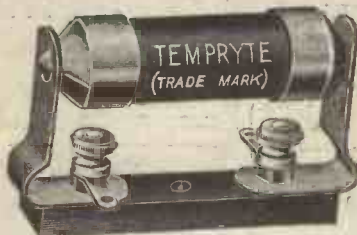

CYLDON TEMPRYTES are thoroughly tested before leaving our works, and are definitely guaranteed to function perfectly with the type of valve for which they are designed.

We issue a very comprehensive valve chart which shows the correct resistance for every valve in existence, and is free for the asking.

The cost of 2/6 for a "TEMPRYTE" is much less than 15/- to 22/6 for a ruined valve, through starting with an unknown resistance which may only be approximately right.

CYLDON TEMPRYTES - 2/6 ea.

HOLDER MOUNTINGS - 1/6 ea.

Get full particulars of the range of famous CYLDON Condensers—Square Law, Straight Line Frequency, Dual, 2-Gang, Triple Gang and 4-Gang.

CYLDON Condensers are as faultless in design as in finish, and once you use a CYLDON you will never go back to other makes.

If unable to obtain CYLDON Products locally write direct to:

SYDNEY S. BIRD & SONS, CYLDON WORKS, SARNESFIELD ROAD, ENFIELD TOWN, MIDDLESEX.

Telephone:  
ENFIELD 0672

# The Best Form of H.T. Supply.



DIMENSIONS (including lid), 8½ × 5½ × 9½ ins. high.  
 MAXIMUM ECONOMICAL DISCHARGE RATE,  
 20 milliamperes. WEIGHT, 20 lbs. 50 volts.

WHEN purchasing a H.T. accumulator, one also purchases certain disadvantages, such as the possibility of damage by sulphating, impure acid, leakage of acid, damage due to inexpert charging, overdischarging, inconvenience caused by the necessity of recharging, etc., etc.

All these disadvantages are eliminated by using a Siemens Super-Radio Dry Battery, which has a capacity several times larger than that of the ordinary H.T. accumulator. It is, in addition, more economical in first cost, more reliable, requires no attention whatsoever, and is made in a convenient size.

A copy of our Catalogue 650, giving full particulars of the correct size and type of battery to use for any radio purpose, will be sent, post free, on application.

**SIEMENS BROTHERS & CO., LTD., WOOLWICH, S.E.18.**



## The Magic Box

THERE'S a little box which some think is almost magical in its powers. Like the Tinderbox of the fairy tale! The Magic Box of 1927 is the **Brown** Crystal Amplifier. You couple it to your Crystal Set and a Loud Speaker. Then presto! full, pure loudspeaker reproduction will be yours! Without valves. No Accumulators. If you are within 15 miles of a broadcasting station (or 80 miles Daventry) these results are yours. Hear it at your Dealer's. Price

**£4 4s.**

**Brown**  
 Crystal Amplifier

**S. G. BROWN, LTD.,**  
 Western Ave., North Acton,  
 W.3.

Retail Showrooms: 19, Mortimer St., W.1.; 15, Moorfields, Liverpool; 67, High St., Southampton

Wholesale Depots: 2, Landsdown Place West, Bath; 120, Wellington St., Glasgow; 5-7, Godwin St., Bradford; Cross House, Westgate Rd., Newcastle; Howard S. Cooke & Co., 59, Caroline St., Birmingham; Robert Garmany, Union Chambers, 1, Union St., Belfast.

**Important 2 Days' Auction Sale**  
**WED. and THURS. JANUARY 26 and 27**  
 at 11 a.m. each day.

31, CAMDEN STREET, CAMDEN TOWN, N.W.  
 (Close to Camden Town Tube Stn. & on Bus Routes)  
**VERYARD & YATES** will sell by auction (in lots to suit large and small buyers). Valuable New and S.H.

**WIRELESS, ELECTRICAL, MEDICAL**  
 AND GENERAL SURPLUS STORES, including: 1,000 Frame Aerials, 500 Pairs Headphones, 7 Tons 3" and 4" Ebonite, 10,000 Microphone Buttons, 100 Tuners, 100 1 K.W. Transformers, 200 Large Volt and Ammeters, 1,000 2 M.F. Condensers, 50 Testing Sets, 200 Hand Generators, 50 3-Valve Amplifiers, 2,000 Choke Coils, 500 Telephone Cords, 1,000 Dull Emitter Cells, 250 X-Ray Valves, 60 Dial Sights, 100 Ships' Variometers, 50 Ships' Variable Condensers, together with Large Quantities Accumulators, Wave-meters, Valve and Crystal Sets, Transmitters, and Wireless Accessories and material of Every Description; also 200 Brass Fire Extinguishers, 500 Picks and Heives, 5,000 Hand Painted and Decorative Tiles, 20,000 Pins and Bends, Platform Weighing Machines, etc. On view 2 days prior. Catalogues from the Auctioneers, 365, Norwood Road, S.E.27.  
 ('Phone: 0346 Streatham.)

**WIRELESS.**—Capable, trustworthy men with spare time who wish to substantially increase income, required where we are not fully represented. Applicants must have practical knowledge of installation of Set and Aerial, be a householder or live with parents, and be able to give references: state age and experience. Address: Dept. 10, General Radio Company, Limited, Radio House, Regent Street, London, W.1.

**JARS ZINGS SACS**  
 Waxed, Special, High Capacity.  
**1/6 DOZ. 1/- DOZ. 1/6 DOZ.**  
 For making Wet H.T. Batteries, post free on 3 doz. and over. Packed in special carton with division for each cell. This can be used as a container for the battery when made up. Send 6d. for sample complete unit, particulars and instructions. Build a Loud Speaker of the latest type with the Seamless Moulded Cone for the most perfect reception. Easily assembled. All the necessary parts stocked. Call, inspect and hear.  
**SPENCER'S STORES, LTD.,**  
 4-5 Mason's Avenue, Coleman Street, London, E.C.2.  
 'Phone: London Wall 2292. (Nr. Bank.)

**RADIOTORIAL**  
**QUESTIONS AND ANSWERS**

(Continued from page 1216.)

the on-off switch in series with the rheostat, and then the set can be brought into action by the push-pull switch only. In this case, however, H.T. negative has to be left connected to the L.T. lead.

**WIRING UP.**

F. W. B. (St. Leonards-on-Sea).—When making up a set, from a "How to Make" article, I have found that some of the wiring

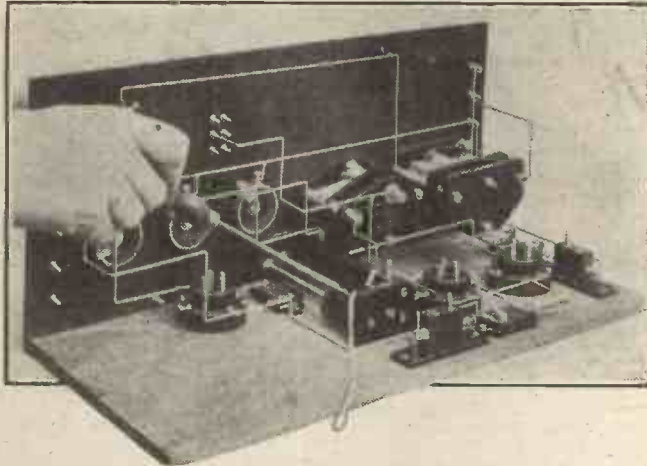

is best carried out before all the components are mounted. Ought everything to be in position first, or is it a good plan to leave large components unmounted until their own wiring is ready to go on?

It is essential in wiring up multi-valve sets, without explicit bit-by-bit instructions, to mount all the components first, and mentally plan how the various wires will run. When it has been ascertained that all the positions are O.K., the larger components are then best removed from the baseboard, to leave as much room as possible, whilst the first part of the wiring is carried out.

The accompanying photograph shows a set being constructed, and it will be noted that L.F. transformers, etc., have all been removed and put aside until the H.F. portion of the set is wired up.

**THE SAVOY THREE.**

D. K. (Portsmouth).—I have built the "Savoy Three" (using 2 Cosmos resistance-coupling units), and, though it is giving very good results, I am puzzled by the wiring diagram, which shows G.B.+ joined to the rheostat lead from L.T.+ . Would it be an advantage to take the G.B.+ lead to L.T. neg.?

Theoretically, the G.B.+ lead should be connected to the L.T. neg. lead, but, if desired, the wiring can be shortened by connecting it to L.T.+ . In practice it will be found that this procedure means that when adjusting grid bias a little more negative bias is required than would be the case if G.B.+ were connected to L.T. neg.

If the wiring diagram has been followed exactly, and it appears that a little more negative grid bias than the G.B. battery gives would be beneficial, the lead can easily be changed over.

The only modification to the wiring diagram (page 1103) is that the flexible lead from G.B.+ should be disconnected from the rheostat lead, and taken instead to a point on the wire that joins the aerial coil and condenser to the earth terminal and L.T. neg.

(Continued on page 1221.)



**REACH OUT**

—and your biggest aids are Clarke's "ATLAS" low-loss coils. Not only will you get the distant stations with greater ease, but the home station reception will be a revelation.

The specially-spaced patented twin-wire winding makes a neat and compact coil—a coil that gives real meaning to phrases like "low-loss," "maximum inductance," and "minimum self-capacity."

**PRICES**

No.	Each
25-59	2/6
65	3/-
75-150	3/6
175-300	4/6
400	5/6
500	7/6
600	9/6
750	10/6
1000	12/6
1250	14/-
1500	15/6

**CLARKE'S "ATLAS"**

**RADIO SPECIALITIES.**

**H. CLARKE & CO. (Mc.), LTD., Radio Engineers, "Atlas" Works, Old Trafford, MANCHESTER.**  
 Telephones: 683 & 793 Trafford Park. Telegrams: "Pirtoid, Manchester."

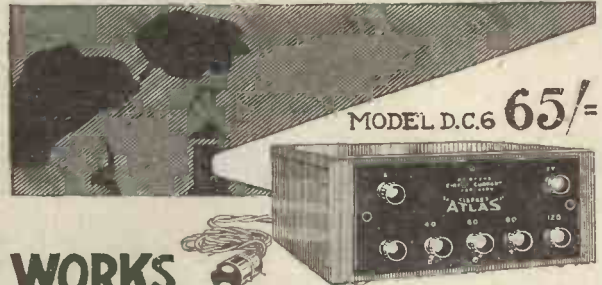

**WORKS WITHOUT NOISE OR FUSS**

Clarke's "ATLAS" H.T. Battery Eliminator is the one thing needed to make wireless all pleasure. Turns the old H.T. dry battery, with its annoying troubles and costly replacement, into an interesting museum relic. A real economy and a justifiable luxury combined. Simply plug into an electric-light socket. Models for direct or alternating current; direct current models from 65/-, as illustrated.

Ask any good dealer's opinion!

Send for descriptive folders 17, 18 and 20. They tell the whole story of the most efficient method yet devised for the supply of H.T. current up to 120 volts.



## IMPORTANT NOTICE. WIRELESS VALVES.

### *Injunction and Damages*

On the 9th December, 1926, in the High Court of Justice Chancery Division in the case of Marconi's Wireless Telegraph Company Limited against Midland Valves Limited the Defendants having paid agreed sums for damages and costs amounting to £75 consented to an order for an Injunction restraining them from infringing Letters Patent 184,446 and for delivery up to the Plaintiffs of all '06 Ampere Valves in their possession or power.

## WARNING to DEALERS and USERS

*NOTICE IS HEREBY GIVEN by Marconi's Wireless Telegraph Company Limited, both on their own behalf and on behalf of the British Thomson Houston Company Limited and the General Electric Company Limited, that legal proceedings will be taken against any Company firm or person selling or using valves which infringe any patents owned or controlled by them.*

M.W.035.

# “Silvertown”

## WIRELESS ACCESSORIES

Quality guaranteed by over 50 years' electrical manufacturing experience.



### ANTI-MICROPHONIC VALVE HOLDERS

*(Registered design No. 723272)  
(Patent applied for).*

The Silvertown Anti-Microphonic Valve Holder is built to stand the heaviest vibrations. Manufactured from best-quality ebonite, with metal parts nickel finished. Superfluous metal work is eliminated, thereby reducing capacity effects to a minimum. These Valve Holders are light and strong, and take up very little room on the baseboard, to which they are fixed by two screws. Diameter at Base, 2 ins., Height, 1½ ins.

Price 2/9 each

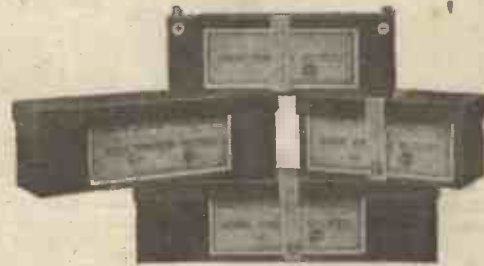

### HIGH TENSION PRIMARY BATTERIES

*(Dry Cells)*

No. 1720	.. .. .	15 volt,	9½" x 7" x 2½" high,	3/6
No. 1721	.. .. .	30 "	6½" x 2½" x 3½" "	7/6
No. 1722	.. .. .	50 "	10½" x 2½" x 3½" "	10/6
No. 1723	.. .. .	60 "	12½" x 2½" x 3½" "	13/6
No. 1724	.. .. .	100 "	10½" x 5" x 3½" "	21/6

The 15-volt Battery forms one unit, but the larger batteries can be tapped every 4½ volts, and are provided with two "wander" plugs to each.

#### AN AID TO ENTHUSIASTS.

We have prepared a logging chart for recording wavelengths, condenser settings, etc., of those stations which require careful calibration to tune in. A copy of this chart, printed on stiff card, with hanger, can be obtained free of charge at any of our Branches or from any high-class dealer.

*Makers:*

## THE SILVERTOWN COMPANY,

106, Cannon St., London, E.C.4.

Works: Silvertown, E.16

BELFAST.  
BIRMINGHAM.  
BRISTOL.  
CARDIFF.

DUBLIN.  
GLASGOW.  
LEEDS.  
LIVERPOOL.

LONDON.  
MANCHESTER.  
NEWCASTLE-ON-TYNE.  
PORTSMOUTH.  
SHEFFIELD.



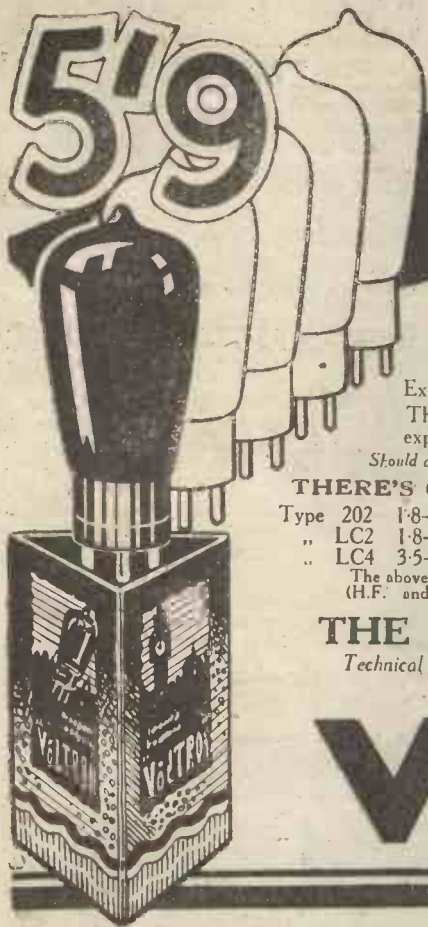

# NOW BUYS A BRITISH GUARANTEED VALVE

## "VOLTRON" Three Pumpings and Nine Tests

YOU can pay more than the price of a "Voltron," but you cannot buy a better filament more strongly mounted on low loss, anti-microphonic principles, in so complete a vacuum.

Every "Voltron" Valve is exhausted by three separate pumpings.

Exactng tests at every important stage of manufacture—nine in all—are applied to every "Voltron."

The high vacuum of the "Voltron" means longer life and greater uniform sensitivity. That is why serious experimenters choose it for the Super Heterodyne circuit. "Voltron" Valves improve any set!

*Should any "Voltron" Valve fail to give satisfaction owing to faulty workmanship it will be replaced on request provided filament is intact.*

### THERE'S ONE FOR EVERY STAGE.

Type 202	1.8-2 volt	2 amp.	5/9
LC2	1.8-2	06	7/6
LC4	3.5-4	06	7/6

The above types are in two classes: RED STAR (H.F. and Detector), GREEN STAR (L.F.)

### DULL EMITTER POWER VALVES.

Type LS2 (P2)	1.8-2 volt	9/-
P4	3-4	10/9
P6	5-6	12/-

Get "Voltrons" from your dealer or direct from

**THE VOLTRON CO., 169, City Road, E.C.1.**

Technical folder on request.

Phone: Clerkenwell 1081.

BRITISH MADE DULL EMITTER from 5/9.

# VOLTRON

#### COIL SCREEN & BASE



Only 5/6

#### S.L.F. CONDENSER



With 4-in. dial.  
0003 .. 7/3  
0005 .. 7/3

#### RELIABILITY CONDENSERS



Mansbridge  
Mids. Type  
25, 1/8 1 mfd. 2/6  
5, 1/9 2 mfd. 3/6

#### WIRELESS CABINETS

For Panels 7 in. high  
Width 8 in. Hinged Lid  
Oak 12 in. 17/-, 15 in.,  
17/6, 18 in. 18/6.  
Mahogany 1/- extra.

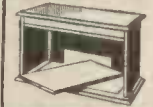

#### DEWAR SWITCH



12-Contact  
2/6

### READ THIS LIST AND SAVE MONEY ON COMPONENTS

RECENT REDUCTIONS.—Sterling 0005 Square Law Condensers with Vernier, 9/6; Geared 12/-; Miniloss, 15/-; 00025, 8/6; Geared, 10/6; Miniloss, 13/-; Marconi Automatic Detector, 2/6; Series Parallel Variometer, 10/6; Eddy stone Absorbos Feet, set of 4, 2/3; Benjamin S.P. Switch, 1/3; N.P. Clip Plug & Insulator, 2/4; Adaptor, 1/4; Socket, 2/4.

LATEST COMPONENTS.—8-Way Coil Stand, 2/9; Colvern Low Loss Inductance Former, 5/-; Formo Straight Line 0005 Condenser, 7/6; Success, 18/6; Eureka, 15/6; Cyldon, 15/6; Lissen 60 v. H.T. New Process Battery, 10/6; Valve Vibrating Springs, 6d. set of 4.

ESONITE.—Any size cut; Claytonbrand, 1 in., 4d. sq. in.; 9 in. by 6, 2/2; 12 in. by 9, 4/6; 15 in. by 9, 5/6; 3/16 in. 25 cent. less. Faragon and Radion, 1d. per sq. in.

TERMINAL WELDS & ACCESSORIES.—Single W. Office N.P. or Pol. Brass with an washer, 1/4; Phone and Castle type, 1d.; Double Mark, 3, 2d.; 4-way Phone Connector, 6d.; Pole-binding paper, 3d.; Fluxite, 8d.; Black Tape, 6d. per coil; 1 in. Empire Tape, 6d. dozen yards; Insulating tube, 3d. yard; Glazite, 1/2, 10 ft. coil; Shellac Varnish, 6d.; Mica 2 in. x 1 1/4 in. 4d. dozen; Chatterton's Compound, 9d.; Hand Drill, 3/6; Drill, 1/-.

INSULATORS.—Large Shell, 3d.; Reel or Egg, 1d.; Climax, 6d.; Ditto, with shock absorbers 3/- pr.; Gal. Pulleys, 4d.; 100 ft. Gal. Straining Wire, 1/6; Straining Bolts, 6d.

ACCUMULATORS.—Evide, D.T.G., 4/6; D.F.G., 8/6; W.J., 20 v., H.T. type, 15/-; Oldham H.T., 10d. per volt. complete; Duros, 20 v., 11/-; 10 v., 5/6; Repairing Outfit, 1/6.

BATTERIES.—Reliability, 90 v., 11/-; 60 v., 7/6; 36 v., 4/6; 15 v., 1/10; Ever Ready, Siemens, Hellesen, 100 v., 21/-; 66 v., 12/6; 36 v., 7/6; Flashlight Battery Cases for 14 Batts., 3/6; 41 v. Batts., 6d.; 60 v. Unequalled, 6/6; Wan. Plug, 1d.; Clix Type, 2d.

CONDENSERS.—Low Loss Square Law, with knob and dial, 0005, 5/-; 0003, 4/6; with Vernier Blade, 1/- extra; Twin 0005, for Elstree Six, unequalled value, 9/6; Cyldon Twin for ditto, 27/6; Ormond, J.B. Utility, Sterling, Polar, Formo, Igranite, G.E.C., Var. in all capacities. Neutrodyne type, Ormond, 2/-; Colvern 3/6; Gambriel, 5/6.

FIXED CONDENSERS.—Dubilier, Edison Bell, Lissen, Watmel, Mullard, McMichael, at advertised prices. Special Reliability Fallon—0003 and 2 meg. Leak, 1/3; Cases only 4d.

L.F. TRANSFORMERS.—E.I. Multi-Ratio, 25/-; Marconi Ideal, 25/-; Junior, 18/6; Ferranti A.P.3, 25/-; A.F.4, 17/6; Formo, 10/6; H.T.C. Empire, 7/6; Uroix 5 to 1, 6/-; Lissen new type, 8/6; Igranite, 16/-; Eureka Concert Grand, 25/-; No. 2, 21/-; Baby Grand, 15/-; Ormond, 15/-; Royal, 20/-; Success, All Black, 21/-; Silvertown, 21/-; G.R.C., 15/-; Brandes, 17/6; Burndept, 15/6; Special Value, 7/6; Modulation, 7/6.

HEADPHONES.—E.T.H., 15/-; Brown's "F" Type, 20/-; Reliability, 7/6; Adjustable, 3/-; Dr. Nesper, 12/11; T.M.G., 17/6; Western Electric, 20/-; all 4,000 ohms; Sullivan, 120 ohm Double Ex-Govt., New, 4/-; 120 ohm Single Phone, 2/6; Long Phone Cord, 1/-.

AERIALS.—100 ft. 3 in. copper tape, 1/9; 7/22's Bright, 2/3; Enamelled, 3/3; Electron, 1/2; Superlat, 2/6; Mars, 3/6; Ashton Spreaders, 12/- per pair; O.V. complete, 2/6.

VALVE HOLDERS.—Anti-Phonic Benjamin, 2/9; Lotus, 2/3; with terminals, 2/6; Burndept, 2/9; Hurtle, 1/6; Reliability, unequalled, 2/-; all baseboard types, ord. ditto, 6d.; N.P. Valve Sockets, flush fitting, 1d.; Superior Panel Type, 6d.; All Ebonite, 10d.

VALVES.—"Radion" all types, Frelat, 2 volt 8 amp., 4/11. All advertised makes stocked. EXPERIMENTERS' PARCELS.—Accessories of Various Types, worth 20/-, post paid, 5/6.

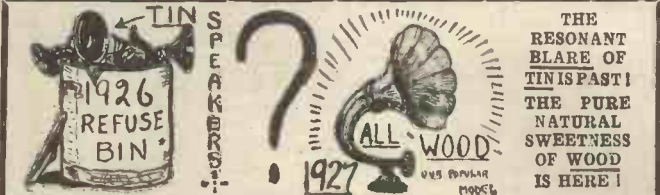

## THE NEW W.B. "ALL-WOOD" LOUD SPEAKERS AND HORNS.

Special Distributors:—  
LONDON: Messrs. Will Day, Ltd., Lisle St. Gamage, Ltd., Holborn. London Elec. Co., 1, Sherborne Lane.  
BRISTOL & WEST: Bristol Wireless Co., Queens Rd.  
BRIGHTON: Carters Stores, Western Rd.  
WILTSHIRE: Wilts Wholesale Co., The Parade, Trowbridge.

Ask to hear one at once!  
A revelation in tone!  
Or write to Manufacturers:  
**WALKER BROS.,**  
St. Joseph's Works, Bramley, GUILDFORD.



**SAFE AT LAST!**  
THE  
**SPEEKABRAK**  
LOUD SPEAKER HOLDER  
(Patent Applied For)  
"HANG IT ANYWHERE—  
LIKE A PICTURE"  
TAKES ANY BASE, 4 in. to 8 1/2 in. diameter.  
BEAUTIFULLY FINISHED  
IN OXIDISED COPPER  
Price 10/6 Post Free  
STEPHEN HEATH & Co.,  
Metropolitan Chambers,  
Wolverhampton.

Send for New RELIABILITY WIRELESS GUIDE No. 9. Free on Request. Trade Supplied.

**J. H. TAYLOR & Co.**  
4. RADIO HOUSE,  
MACAULAY ST., HUDDERSFIELD.

Orders 5/6 Value Carriage Paid. Under 5/6 2d. per 1/- for Packing, etc.

# RADIOTORIAL QUESTIONS AND ANSWERS

(Continued from page 1218.)

Will Mr. Arnold, who wrote to the Queries Department regarding a portable super-heterodyne receiver, send his address in full as soon as possible? (The reply sent to him in his own stamped, addressed envelope has been returned undelivered by the G.P.O.)

When sending inquiries to the Technical Queries Department, readers can expedite the replies by carefully observing the rules of the department (as set out under the heading "Radiotorial").

Remember it is essential to send a stamped, addressed envelope.

Write your name in block letters.

If, for any reason, reference is made to a previous communication from the Query Department, the letter in question must be returned for reference.

### DISCONNECTING H.T. & L.T.

M. J. D. (Llwydcoed).—I have constructed a 3-valve loud-speaker set from your Blue Print series No. 20 which works very satisfactorily. I am anxious to insert a switch so that I can cut out both H.T. and L.T. to save disconnecting the leads. Will you give me the wiring for a switch suitable for fixing on side of cabinet?

To completely disconnect both the batteries, a make-and-break switch, having two poles, is required. The L.T. neg. terminal is connected direct to one pole, and the H.T. neg. terminal direct to the other. The rheostat lead goes to the switch contact corresponding to L.T. neg., and when the switch is in the "on" position the connections are completed exactly as shown in the Blue Print. When the switch is "off," the negative leads of the two batteries are joined only to their respective switch contacts.

### SCREENING.

C. W. R. (East Ham, London, E.).—How do metal screens prevent interference?

Interference is caused by electro-magnetic fields, such as exist around conductors carrying current. This interference occurs in concentrated form around inductive apparatus such as motors, generators, transformers, or choke coils.

In the case of a transformer, for instance, its electro-magnetic field may extend over a considerable distance, setting up interference in neighbouring conductors.

If, however, the transformer is completely enclosed in an iron box, no interference from it will be experienced outside this box, because the transformers' external varying field dissipates its energy in setting up eddy currents in the iron.

Similarly, if a tuning coil is to have complete protection from stray electro-magnetic fields, all that is necessary is to place it inside a suitable metal screen, which then automatically excludes all external fields that could set up interference in it.

### SET'S FAILURE TO WORK.

"INEXPERIENCED" (Halesworth, Suffolk). My 1-valve set suddenly ceased to work, apparently without cause. Where should I look for the fault?

You will get no signals if the aerial or the earth lead becomes disconnected, or if the lead-in wire gets caught upon the roof, iron gutter-pipe, etc.

If H.T., L.T., or 'phones are not connected correctly the same trouble will occur, and a faulty connection at one of the plug-in contacts (valve or coil, for instance) may account for the failure to hear anything.

Apart from the external leads and the accessories, any break in the wiring of the set itself, or in one of the components, would cause the trouble you complain of.

### A GOOD STRAIGHT 3-VALVER.

J. W. N. (Stansted, Essex).—Please give the circuit for a straight 3-valve set, with simple switching, so that the valves light up when the

(Continued on next page.)

# GAXTON WIRELESS CABINETS

All Polished with new enamel that gives a glass hard surface that cannot be soiled or scratched. Ebonite or Radion Panels Supplied and Perfectly Fitted at low extra cost. SENT FREE.—Catalogue of Standard Wireless Cabinets in various sizes and woods.

## THOUSANDS OF SATISFIED CUSTOMERS.

**ELSTREE SOLODYNE.** Panel 21" x 7" fitted 16" Baseboard, drop down Beaded Front Door. Fumed Oak 61/-, Dark Oak 65/-, Mahogany polished 68/6. Raised Panel 5/- extra. Packing Case 5/- extra.

**ELSTREE SIX.** Panel 42" x 9" fitted 13 1/2" Baseboard. Open Type. Fumed or Dark Oak 80/-, Mahogany polished 90/-, Packing Case 7/6 extra.

**MONODIAL.** Panel 14" x 7" fitted 14" Baseboard. Fumed Oak 33/6, Dark Oak 35/-, Mahogany polished 39/6. Packing Case 6/- extra.

**NIGHT HAWK.** Panel 16" x 8" fitted 14" Baseboard. Open Type. Fumed Oak 33/6, Dark Oak 35/-, Mahogany polished 39/6. Packing Case 7/- extra.

**FIVE FIFTEEN.** Panel 24" x 7" fitted 8 1/2" Baseboard two Front Doors. Fumed Oak 40/-, Dark Oak 42/6, Mahogany polished 48/-. Packing Case 7/6 extra.

**THE 1927 FIVE.** Panel 27 1/2" x 7" Sloping Front, as originally described. Fumed or Dark Oak 38/-, Mahogany polished 48/-. Packing Case 7/6 extra.

**EVERYMAN THREE.** Panel 20" x 8" fitted 8" Baseboard. Fumed Oak 33/6, Dark Oak 35/-, Mahogany polished 39/6. Packing Case 6/- extra.

**EVERYMAN FOUR.** Panel 26" x 8" fitted 8" Baseboard. Fumed Oak 35/6, Dark Oak 37/6, Mahogany polished 41/6. Packing Case 7/- extra.

**CASH WITH ORDER. CARRIAGE PAID U.K. PROMPT DELIVERY.**

Packing Case Money repaid if Case returned within 14 days  
Carriage paid to Works.

## GAXTON WOOD TURNERY CO., MARKET HARBOROUGH

### The Polytechnic, Regent Street, W.1.

Four popular lectures entitled "SIDELIGHTS ON BROADCASTING" will be given by Capt. Jack Frost, M.I.R.E. (late of the B.B.C.), on Fridays from 6 to 7.30 p.m., commencing 21st January. 4 lectures 5/-, For further particulars apply to Director of Education.

### EVERY LOUDSPEAKER

## DESERVES MULLARD MASTER VALVES

— Ask for —  
Mullard P. M. Power Valves.

### A CHEAP AMPLIFIER

The "Varex" (Pro. Pat.) Amplifier fills your room with music by amplifying crystal (or valve) sets three to five times, without valves or buttons, etc. Anyone can make it CHEAPLY from our full-size plans, instructions and diagrams, with reed, "Carbex" electrode material and special filling, 2/6 post free. Operated by two 1.5 volt dry cells.

Debenham & Co., 28, Castlands Rd., London, S.E.6.



### WET H.T. (Leclanche Type) BATTERIES.

Do not require re-charging. The cost and upkeep is less than with Accumulators or any other kind of H.T. Battery.

Send 1d. for full particulars.

Price per dozen cells complete, giving 16 volts  
Separate Components. Zincs, 1/-; Sacs, 1/6; Jars (waxed), 1/3 (carriage extra).  
Full instructions for assembling sent with each order.

WET H.T. BATTERY Co., 23, Coldharbour Lane, Camberwell Green, S.E.5.  
Phone: Brixton 2539.



With Plated Tweezers and Cat's-whisker.  
THE THEPA CO., 256, Brearley St., B'HAM.

### TRANSFORMERS REWOUND

Transformers, Phones, Loudspeakers, Rewound and Repaired to Maximum Efficiency. All One Price 4/- each. Don't discard if burnt out. All work guaranteed for 12 months. Write for trade terms. TRANSFORM CO., 115, LINKS RD., TOTTING, LONDON, S.W.17.

### BUILD A LOUDSPEAKER

THE SEAMLESS CONE  
(Prov. Patent 25069/26)

and a Brown A Earpiece, or Lissenola with Reed, will enable you to construct a CONE LOUDSPEAKER, which will give you unsurpassable results. These Cones are unequalled for purity of reproduction, the high and lower registers being equally rendered.

Do not be put off with the ORDINARY PARCHMENT CONE, having a Seam Join. EXTRACTS from UNSOLICITED TESTIMONIALS: PIRBRIGHT, SURREY: "It is an excellent article and gives very good results." SPALDING, LINDS: "I am more than satisfied with the results." SHEFFIELD: "I have had one of the 2 1/2" Loudspeakers, and have no hesitation in saying that for one your Seamless Cone is much better." BRISTOL: "The Seamless Conical Diaphragm received yesterday works fine."

Illustrated Lists and particulars for Stamp. GOODMANS, 27, Farringdon Street, E.C.4. Also obtainable in Mr. Spencer's St. res. 45 Mason's Av., E.C.2

**Better Reception**

The New

**Varley Varley**

Tapped Resistance

It's Bi-duplex Wire-wound

Another example of the progressive policy of the Varley Magnet Company. The new Varley Tapped Resistance possesses all the advantages of the original famous Varley Bi-Duplex Wire-Wound Anode Resistance with the added advantage of having four different values of resistance in one component.

Wireless enthusiasts will at once appreciate the value of the Varley Tapped Resistance for

- Tone Control**
- Volume Control**
- H.T. Eliminators**
- Voltage Dividers,**

and knowing it to be Varley Bi-Duplex wire-wound they can rest assured of perfect purity of tone, absolute constancy under all conditions, and complete freedom from shorted or leaking turns.

This is only the beginning. We are marketing in the near future a special resistance with 6 tapplings, in addition to other Bi-Duplex wire-wound components, particulars of which will be announced in the Wireless Press.

The Varley Bi-Duplex Wire-Wound Tapped Resistance .. complete 15/-  
 Varley Bi-Duplex Wire-Wound Anode Resistances are made in a complete range of sizes up to 500,000 ohms, prices from 4/- to 16/-.

Full particulars on application.

The Varley Multi-cellular H.F. Choke .. complete 9/6

The Varley Multi-cellular H.F. Choke for circuits of the SPLIT COIL Type .. complete 12/6

**MAKE SURE IT'S VARLEY BI-DUPLEX WIRE-WOUND**



**THE VARLEY MAGNET Co.**  
 (Proprietors: Oliver Pell Control, Ltd.) Phone: City 3393  
 Granville House, Arundel Street, London, W.C.2.

V-17.

**RADIOTORIAL QUESTIONS AND ANSWERS**

(Continued from previous page.)

loud speaker is plugged in. I have the following components on hand—1 H.F. and 1 L.F. transformer, 3 rheostats, grid leak and con-

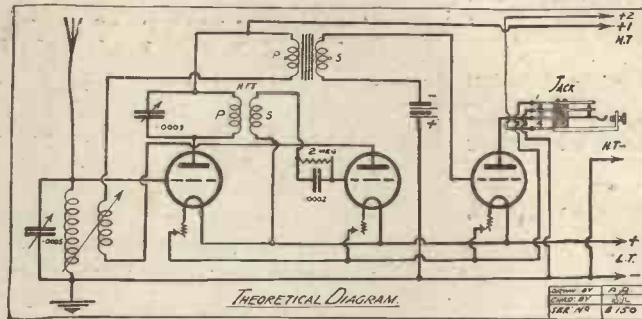

denser, and .0005 variable condenser. What others will be required?

A set of this kind was fully described in "P.W." No. 226. The circuit is given herewith, and is perfectly straightforward.

If your L.F. transformer does not incorporate a fixed condenser across its primary winding, this may be added as a separate component to assist smooth reaction (.001 is the usual capacity).

The additional components required are: 1 panel, 16 ins. by 8 ins., with cabinet to fit; 1 .0003 variable condenser; 1 2-way coil-holder; 3 valve-holders; single filament jack and plug (Bowler Lowe, 239 type); terminals, strips, wire transfers, etc.

**THE GUARANTEED REFLEX.**

As large numbers of readers have asked for the layout of the "Guaranteed Reflex" (Hale circuit, with additional L.F. amplifier),

Earth terminal to moving plates of condenser crystal, and flexible lead for coil-holder; also flexible lead for G.B. negative and stiff wire to I.S. of second transformer.

S2 to grid of first valve. Join one filament terminal of both valve sockets to bottom of filament rheostat. Join other filament terminal of both sockets to one terminal of Mansbridge condenser and to one terminal of .0003 fixed condenser. Join flexible lead for G.B. to this last point.

Join flexible leads of L.T. +, H.T. - to top terminal of filament rheostat. Take flexible leads for coil-holder from anode of first valve and from terminal of .0003 fixed condenser. Join same terminal to I.P. of second transformer. Join O.P. to Mansbridge terminal. Join crystal to P2 of first transformer and to .0001 fixed condenser.

H.T. flexible leads to Mansbridge. L.T. negative flexible lead to other Mansbridge terminal. Join .002 fixed condenser to Mansbridge. Other terminal of .002 condenser to anode of second valve-holder. Grid of second holder to O.S. of second transformer. Flexible leads for loud speaker taken from terminals of .002 condenser. Thread coil-holder leads through holes in side of cabinet.

**CRYSTAL AND 2 L.F.**

E. J. N. (Wellingboro', Northants).—I have two good L.F. transformers on hand, and should like to use these in conjunction with a crystal for loud-speaker work. Please recommend a suitable circuit for a set to be used about 11 miles from the Birmingham station, on a good outdoor aerial.

Only the local and Daventry stations' programmes are required, so I should like a "straight" set instead of one using a reflex or similar circuit.

Switching for 1 or 2 valves would be an

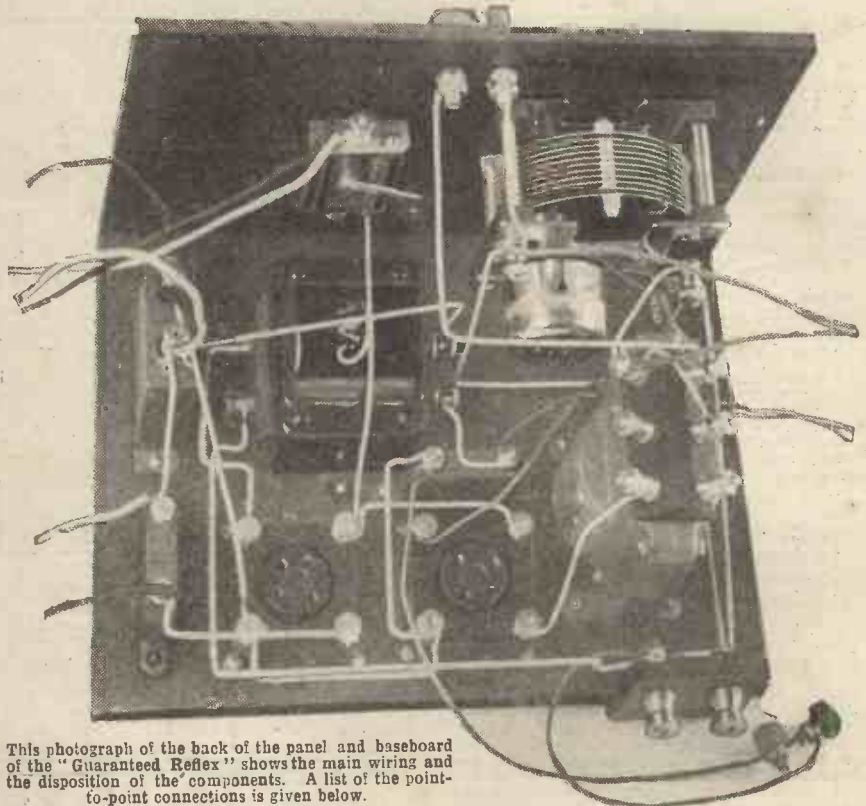

This photograph of the back of the panel and baseboard of the "Guaranteed Reflex" shows the main wiring and the disposition of the components. A list of the point-to-point connections is given below.

the back-of-panel photograph of the receiver is reproduced herewith, together with a list of the point-to-point connections.

(The theoretical diagram was published in "P.W." No. 232.)

Aerial terminal to fixed vanes of condenser, to .0001 fixed condenser, and to S.O. and P1 of R.I. transformer. Attach flexible lead to S.O.

advantage, as sometimes only one loud speaker (or even 'phones) may be required. Would such a set be difficult to build?

For your purpose the best circuit is undoubtedly one in which the valves act as straightforward L.F. amplifiers, to increase the volume given by the crystal detector.

(Continued on page 1224.)

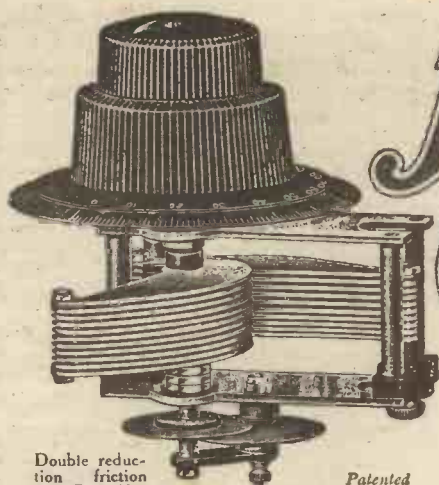

Double reduction friction drive Ratio 60-1

Patented

# JACKSON CONDENSERS



Recommended for the P.M. Receivers.

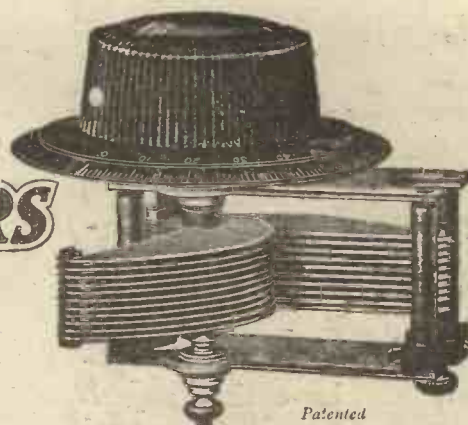

Patented

The J.B. True Tuning S.L.F., complete with 4" Bakelite Dial.  
 '0005 mfd. - 16/6  
 '0003 mfd. - 15/6  
 '00025 mfd. - 15/-

The J.B. '0005 mfd. Dual Gang Control Condenser, complete with 4" Bakelite Dial - 33/-

**J.B. Condensers are ideal for every circuit, and their perfect design and construction, resulting in a remarkable degree of efficiency, has ensured their being used in all the P.M. Circuits.**

The J.B. True Tuning S.L.F.—the final Condenser—embodies new and vitally important improvements and solves for ever the tuning evils of the past. This Condenser is provided with a 4 inch Bakelite Dial for coarse tuning, in addition to a smaller Bakelite Knob for slow motion control which enables stations to be logged with a real degree of accuracy. Friction surfaces are machined to a fine limit of accuracy preventing all possibility of lost motion; in short, the complete Condenser is built like a precision instrument to last a life-time.

A combination of the three essentials—precision, efficiency and finish—makes the J.B. S.L.F., the foremost condenser on the market to-day. In both this type and the J.B. True Tuning S.L.F. the vanes are designed on a new principle which obviates crowding at any part of the scale. The vanes are supported at the tips to ensure accuracy of spacing; special bearings ensure wonderfully smooth control, and render side and end play in the centre spindle impossible. Beautifully finished throughout.

The J.B. S.L.F., complete with 4" Bakelite Dial.

'0005 mfd. - 11/6  
 '0003 mfd. - 10/6  
 '00025 mfd. - 10/-

The J.B. '0005 mfd. Triple Gang Control Condenser, complete unit, less dial, £2 : 7 : 6

The J.B. '0005 mfd. Twin Low-Loss Condenser, complete with 4" Bakelite Dial, each 21/-

**JACKSON BROS.**  
 8, POLAND ST-OXFORD ST LONDON - W.1  
 Telephone - GERRARD 7414

**KINGSWAY RADIO, LTD.**  
 92, CANNON STREET, LONDON, E.C.4.  
 CITY 9158.  
*The City Firm for Wireless.*

The Edison Swan R.C. Threesome, Constructional Booklet Free. Cabinets for above in stock, 12/6. Terminal strips engraved, 2/-, R.C. Units, 7/-, R.C.2 and P.V. 2 Valves in stock.

**LOUD SPEAKERS** in stock: Amplion, Priory, Beco, Brown, B.T.H. and G.E.C. Special Demonstration Room.

**SPECIAL LINE:** Var. Condensers Straight Line '0005 6/-, '0003 5/9  
 CYLOND, ORMOND & IGRANIC Triple Condensers in Stock.

**HEADPHONES:** Sterling, Ericsson, G.E.C., Brown, 20/-; B.T.H. 15/-; Telefunken 17/6; Ericsson Continental 12/6; Special French 8/6.

**BATTERIES:** Ever-Ready, Siemens, Hellesen, 100 v, 21/-; Adico, 13/6; Ever-Ready, Siemens, 60 v, 12/6; Lissen 60 v, 10/6 and 7/11; Adico 7/6. Ever-Ready Flash Lamp, 6d.; Adico, 4½". Battery boxes to hold 14, 2/9. H.T. Accumulators, Exide 20-volt units, 15/-; Ever-Ready ditto, 15/-.

**BATTERY ELIMINATORS:** ECKO D.C., 55/-; A.C., 130/-, plus Royalty, 12/6; H.T.C. A.C., £6 6s.

**L.T. ACCUMULATORS:** 2 v. 40, 10/-; 4 v. 40, 17/6; 6 v. 40, 17/6; 2 v. 60, 12/6; 4 v. 60, 21/-; 6 v. 60, 33/-; Exide D.T.G., 4/6; D.F.G., 8/6.

**VALVES:** Scott Taggart, Osram, Marconi, Cossor, Mullard, all in stock. Special Line: Micro Radio Valves, D.E. '06 4 volt, 6/6; 2 volt, 6/6; power 4 volt, 10/6.

**CABINETS:** Over 50 sizes and types in stock. Any type made to order.

**EBONITE:** Machine cut with ground edges to any size. Radion Resiston panels in stock.

**Crossonla Panels:** Every size in stock ¼d. per square inch. (Postage extra on all above items.)

We keep in stock all components for Modern Wireless, and Wireless World sets, as well as Coil Formers, D.C.C. wire, Coils by Igranic, Edison Bell, Lewcos, Condensers by Igranic, G.E.C., Ormond, McMichael, Peto-Scott, Gambrell, etc.

We also stock a range of special tools and material for amateur constructors.

**CATALOGUE SENT ON REQUEST.**

**H.T. MONOBLOCKS**

IT IS BETTER TO KEEP YOUR MONEY IN YOUR POCKET THAN TO BUY A MONOBLOCK H.T. ACCUMULATOR OF INFERIOR QUALITY, DESIGN AND WORKMANSHIP

THEREFORE INSIST ON "VARTA" THE ORIGINAL H.T. MONOBLOCK

Advt. A.F.A. Accumulators, Ltd., 9a, Diana Place, Euston Rd., London, N.W.1.

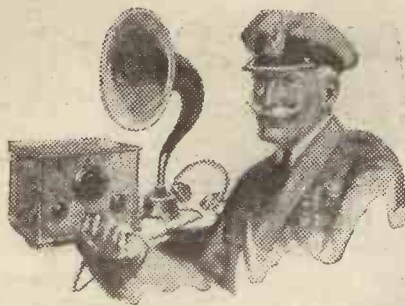

**For £1 down**  
you can have this superb  
**TWO-VALVE General**  
Radio set installed in your  
house . . . . .

**NOTHING ELSE TO BUY.**—The set is complete with **LOUD SPEAKER, HEADPHONES, Dull Emitter Valves, Accumulator, Battery, complete aerial equipment, all cords and plugs, etc., and the Royalty is paid.**

Every set and every part is guaranteed. The price of the complete set is £1 down and 20/- a month for twelve months only, or £12 cash.

**FREE INSTALLATION.**—On receipt of the first payment of 20/- one of our own Installation Engineers will come to your house *anywhere in the country* and will erect, instal, demonstrate and leave the set playing for you—free of charge. It is only necessary to provide an aerial pole if trees, etc., are not available.

By having the set installed by our own Engineers we ensure that you cannot buy a General Radio set that does not give you perfect satisfaction. No other wireless firm gives you this service and this safeguard.

Send a P.C. to-day for our new illustrated catalogue No. 7W and full particulars of this unique offer.



GENERAL RADIO CO. LTD.  
RADIO HOUSE, 235 Regent St., W. 1



**2-VALVE AMPLIFIER. 35**  
1-Valve Amplifier, 20/-. as new; Valves, D.E. 06, 7/-; Headphones, 8/6 pair; new 4-Volt Accumulators, 13/-; new 60-Volt H.T., guaranteed, 7/-; 2-Valve All-Station Set, £24. Approval willingly. Write for free bargain list.  
**P. Taylor, 57, Studley Rd., Stockwell, London.**

**EBONITE BUSHES**  
FOR MOUNTING ON WOOD.  
Orders under 1/- send 1/- post free.  
PERFECT INSULATION Two required for each hole.  
NUMBER 0 1 2 3 4 5 6  
Hole in Bush... 6BA, 4BA, 2BA, 1/4", 5/16", 3/8", 7/16"  
Price each: 1d. 1d. 1d. 1d. 2d. 2d. 2d.  
**DAREX RADIO CO.,**  
Waldram Road, Forest Hill, London, S.E. 23  
TRADE SUPPLIED

**GAMBRELL**

**NEUTROVERNIA CONDENSER**  
Is obviously the best, because:  
It cannot short—has ebonite dielectric.  
It is ideal not only as a balancing condenser, but as a capacity reaction control and vernier condenser.  
It has the widest capacity range, approximately 2/38 micro microfarads.  
It is all enclosed, making it dust and damp proof.  
It is a precision job throughout.  
It can be fitted with direct reading dial (price 1s. 8d.)  
As now supplied is adaptable for either panel or base-board mounting without extra charge.  
The price is only **5/6** Obtainable from Leading Dealers.

**GAMBRELL BROS. LTD.**  
76, Victoria Street, London, S.W. 1

**RADIOTORIAL**  
**QUESTIONS AND ANSWERS**

(Continued from page 1222.)

A circuit of this kind is given on the "P.W." Blue Print No. 17, which is obtainable from the Query Dept. for 6d., and a stamped addressed envelope. Suitable switching is incorporated, and by means of one S.P.D.T. and one D.P.D.T. switch it is possible to listen on crystal only, crystal and one L.F., or on crystal and two L.F.

The set is equally suitable for 5 X X or for 5 I T, and is shown arranged on a flat panel. (If desired, it could easily be built in the totally enclosed form, as pictorial and theoretical diagrams are given upon the blue print.)

**A CORRECTION.**

We regret that, owing to a printer's error, the price of a Brunet transformer was given incorrectly on page 1169 of "P.W." No. 240 (Jan. 8th issue).

Instead of 2/9 as shown, the price should have been 7/9.

IF there is anything in this or any other issue of "Popular Wireless" that you do not like, please let us know what it is when you write.

**EXPERIMENTS WITH THE FILADYNE CIRCUIT.**  
(Continued from page 1194.)

together the value of X and Y for any particular value of bias gives a constant figure which is the saturation current for the particular grid and filament voltages used.

This interesting relation between grid and anode current suggests other possibilities of the Filadyne circuit. This has led to the development of other circuits, which will be described in the second part of this article.

**Grid Circuit Resistance.**

Resistance in the grid circuit also affects the operation of the Filadyne valve. When the 'phones are shorted, this resistance is low and grid current then increases to abnormal figures. For instance, using a D.E.R., grid current reaches 15 milliamperes for normal filament current and 50 volts H.T.! This is more than twelve times the value of anode current when the valve is used normally with the same H.T. voltage. Accordingly better results are obtained by using lower resistance 'phones, but there does not seem to be much advantage in using 'phones of less than 2,000 ohms resistance.

So far I have considered chiefly the purely theoretical side of the Filadyne circuit, but in the next article I shall show how this knowledge may be used to obtain even greater efficiency from an already highly efficient circuit. The circuit of Fig. 4 is certainly a fine one both for local and long-distance work on the one-valve. Careful adjustment of anode bias brings in distant stations at excellent strength. This circuit also embodies capacity reaction control, the advantages of which are too well known to need further description.

Fit It and Forget It

**EXCEL PERMANENT DETECTOR.**  
**WHY?** Because it has the finest combination of crystals it is possible to produce, and is **ABSOLUTELY PERMANENT**. Think of it. No more adjusting knobs or fiddling with cat's whiskers.  
**NO ADJUSTMENT WHATSOEVER** is necessary. When once fitted it can be forgotten. Powerful as a valve, more reliable, and needs less attention. Get one to-day, direct from the actual manufacturers.  
**POST FREE. 2/6** Trade Inquiries Fully guaranteed. Invited.  
**EXCEL RADIO COMPONENTS.**  
65, Abington St., NORTHAMPTON.

**WET H.T. BATTERIES**  
BUY BRITISH Complete Units 3/6 per doz. All goods BRITISH MADE BY BRITISH LABOUR.  
Jars 1/3, Zincs 1/-. Sacs 1/6 per doz. Carriage and Packing extra. Trade inquiries invited.—**Demon Battery Co., 59, Badlis Rd., Walthamstow, E. 17**

**WIRELESS WAREHOUSE**  
The Largest Wireless House outside London.  
**PARTS FOR**  
Elstree Six Solodyne  
Everyman's 3 & 4 Monodial  
Magic Five Nighthawk  
and all other Popular Circuits.  
Do not fail to write for it—it is sure to be in stock.  
**"ANSIL" SCREEN AND BASE**  
Copper, 7/6 :: Aluminium, 6/-  
Guaranteed and post free over 5/-  
**SEND NOW FOR LIST.**  
**BUSH HOUSE**  
(Established in the Electrical Trade since 1900).  
35, SHUDEHILL, MANCHESTER.

**MORE No. 314**  
**BARGAINS**  
See our full column advertisement on page 1228 of this issue.  
**POLAR SURPLUS, ALL NEW.** Precision Condensers, 0003, list, 12/6. Sale, 4/8. Polar Varia H.F. Transformers, 300/500, 3/6. Polar Cosmos Variometer on panel, scale and dial, list, 21/-. Sale, 8/6. Polar Panel 2-way Vernier Coil Holders, 3/9. Fil. Rheos., with knob, 1/3. Polar L.F. Transformers, 7/6. Everest Polar Detectors, 1/6.  
**ELECTRIC HEATERS.** Immersion, 4/-; Hot-plates, 7/6; Irons, 10/-; Massage Vibrator Sets, list, £4. Sale, 21/6.  
**45-METRE MARCONI SETS,** with 2-valve Tele. Transmitters and 6-valve Receiver. Transformers, Tuning Coils, Condensers, etc. Siemens' Telephony Microphone on arm. Weston combined Amp. and Milliammeter 0-6 amp., 0-120 milliamms. Instrument alone is worth £4. We offer the 6-valve Receiver and 2-valve Transmitter, in mahogany case, complete, tested. These sets cost £45. Our price, £5; carriage, 3/6.  
**MASTS.** R.A.F. Steel Tube, 15 ft., 7/8; 20 ft., 10/-; 30 ft., 14/-, in 2 ft. 8 1/2 in. by 1 1/2 in. sections. Heavy Mast Sections, 4 ft. 3 in. by 2 1/2 in., 5/- each.  
**ELECTRADIX RADIOS,**  
218, Upper Thames Street, E.C. 4.

**44 STATIONS IN 50 MINUTES**

You may duplicate this performance on the MONO-TUNE 3, designed by C. P. Allinson, A.M.I.R.E., late of RADIO PRESS and ELSTREE LABORATORIES. The use of the recently developed C.A.R. circuit gives greatest range and power.  
Features:—One tuning control—constant reaction—no hand capacity—ease of handling and cheap to build. Only three valves (det. and 2 L.F.).  
You can't go wrong in building this successful set. 15 diagrams, photos, drawings and plans given in Constructone No. 1 leave nothing unexplained.  
**PRICE 2/6**  
Don't delay—Get it to-day  
from Post Free.

**The Constructone Publishing Co.,**  
Dept. A, 37, Drury Lane, London, W.C. 2

# FREE BOOK OF WORKING DIAGRAMS

## of the wonderful new CARBORUNDUM CIRCUIT FOR ONE, TWO OR THREE VALVES.

The CARBORUNDUM CIRCUIT is a simple ONE CONTROL CIRCUIT which will give you the maximum RANGE, SELECTIVITY, VOLUME, and, above all, PURITY.

The book shows you how your set can be converted by a small rearrangement of the wiring.

Send postcard for Free copy of Book W 13!

THE CARBORUNDUM COMPANY, LTD., TRAFFORD PARK . . . . . MANCHESTER



## Why Pay More?

YOU cannot buy a better valve than Frelat, even tho' the others cost twice as much. The proof lies with you! Send to-day for a trial valve. The D.E. type K, Detector or Amplifier, costs only 4/11, the new 2-volt power valve 8/6, and they give the best in Radio in tonal purity and volume.

**DE TYPE K**  
2-volt 3amp  
**4/11**  
**2-Volt Power Valve**  
**8/6**

CONTINENTAL RADIO IMPORT CO. LTD.  
8, Spital Square, Bishopsgate, London, E.C.1



For C.O.D. terms add 4d. - postage free.

If your dealer cannot supply send direct.

**CRYSTAL & 1-VALVE AMPLIFIER (L.F.)**  
In handsome polished cabinet, tested for use, 22/6; post 1/6. (With D.E. Valve, 30/-)  
**OR COMPLETE SET:** Valve, H.T., L.T. Units, Aerial Equipment, 5 XX Coil, 45/11; post 2/-.  
**ASTOUNDING 2-VALVE AMPLIFIER** in L.F. plifier, 25/11. Amplifiers in or COMPLETE handsome with valves, polished box, H.T. and L.T. Valve, 16/11. Units, 4/6. Carriage 1/6. Carriage, 2/-.  
Above are supplied with L.F. Transformer. In American Type Cabinets, all parts enclosed, 4/- extra on each.  
**BURKE-JONES, LEWCO'S, ETC.-SCOTT BOWER LOWE COLVERN SCREENED COILS, BASES & SCREENS**

**IGRANIC'S BIG PRICE REDUCTIONS.**  
**IGRANIC TRIPLE HONEY-JOMB INDUCTANCE COILS.** Indigraph Vernier Knob and Dial, 7/6. Microvern, 8/6. "B" Type L.F. Transformers, latest shrouded model 3/-, 15/-; 5-1, 16/-.  
**LISSON.**—Lissena, 13/6. L.F. Transformer, 6/6. 35 ohm Rheostat, 2/6. H.P. or L.F. Choke, 10/-. Fieldless Coils, 13/6. Grid Leaks, 5/-, 1/-; Ditto, variable, 2/6. All parts available.  
**VARLEY.**—Anoder, 7/6; 250,000 ohm, 9/6. H.P. Choke, 9/6, 12/6.  
**SEARD & FITZ (Success).**—I.F. and L.F. Chokes, each, 0/6. Midget Net. Condenser 1/6. "Black" L.F. Transformer, 2/1.  
**McMICHAEL.**—Bal. Condenser, 4/9. All Fixed Condensers. H.F. Transformers, each 10/-. Dimic Coils, 10/-. Bases, 2/6.  
**BENJAMIN.**—Battery Switch, 1/3. Valve Holder, 2/9; with Grid Leak, 5/3. With Condenser and Leak, 7/- Rheostat, 2/9.  
**PERLESS.**—6 or 30 ohm Rheostat, 2/6. Fixed Resistors (Star Values), 1/2. JACKSON BROS. (J.B.) S.L.F. '0005, 11/6; '00035, 10/6. Brass Vanes, -in. dial, Geared, Sq. Law, Twin Gears stocked.

**ALL CIRCUITS, PARTS, COILS & SETS STOCKED.**  
**FORMO** Low Loss S.L.F. Condenser, '0003 or '0005, 7/6. Formo L.F. shrouded, 10/6. Micro Dial, 5/-.  
**GREEN & BASE.** 8/6. H.F.T. 7/6. A.C. 5/6. Jacks, 1/3, 1/6, 2/3. Plugs, 1/6.  
**HEADPHONES,** all 4,000 ohms. N. & K. Standard Pattern, 7/11 pair. N. & K. Genuine, new light weights, 11/6, 13/6. Dr. Nesper, 10/6 and 12/11. Telefunken, adjustable, genuine (50 model) 14/11. Brunet, 11/9, 12/11, 14/6. 3 models.  
**ERICSSON (Continental) E.V.** 7/11 pr. (Post 6d.)  
**EDISWAN E.C.** Three-sons, E.C.R. 2 units, 3 valve holders, 2 R.C. valves, 1 p.v., 2 Do., 3 rheostats 9-v. G. Bias. '0005 Tuning Condenser, 2-way L.H. wire terminals. The lot 84.  
**THORP H4 9/6 VALVES,** 5-pin  
**WEST END DEPOT FOR "MAGNUM" (Burne-Jones) INSTON SCREENED COILS.** B.B.C. Aerial Coil, 5/6. Split Primary H.F. Transformer, with reaction, 7/6. S.S. H.F.T., 7/6. Helmarz 7/6. 5XX above, 5/6, 7/6, 11/- Screen and 6-pin Base, 9/-.  
**FIXED CONDENSERS.** Dubilier, '0001, 2, 3, 4, 5, each 2/6. '001, 2, 3, 4, 5, 6 each 3/- Grid Leak, 2/6. Edison Bell, '001, '0001, 2, 3, 4, 5, 1/-; '002, 3, 4, 5, 6, 1/6. '0005 and grid leak, 2/6. McMichael with clips, '001 to '0005, 2/6 each. '001 to '006, 3/- each.  
**MONODIAL RECEIVER COMPONENTS** 28: 8: 0. All as specified.

**World's Most Wonderful Crystal "WYRAY" 1/6**

## KAY S.L.F. CONDENSERS LATEST MODEL NOW READY.



6/11 POST 6d.  
'0003 .. 6/11 each  
'0005 .. 6/11 each  
With 4 in. dial 7/6

## LOW LOSS SQUARE LAW

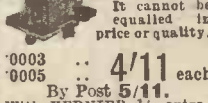

This variable Condenser is simply marvellous value. It cannot be equalled in price or quality.  
'0003 .. 4/11 each  
'0005 .. 4/11 each  
By Post 5/11.  
With VERNIER 1/- extra.  
**L.F. TRANSFORMERS.** Ferranti A.F.3, 25/-; A.F.4, 17/6; Eureka Concert, 25/-; 2nd Stage, 21/-; Baby 1st or 2nd, 15/-; Flex, 15/-; Formo shrouded, 10/6; Success (Black), 21/-; Royal 20/-; Ormond newest model, 15/6; Water's Supra, 10/6. Croix 5-1, 3-1, 4/6. Max coil "Ideal," all stages, 25/- each. C.A.V., 15/-; Pye, 22/6. Gambrell, 2 stages, 25/6. Ideal Junior, 18/6. R.L., 25/- Multi-Ratio 25/-.

## FATS IN STOCK FOR THE ELSTREE SIX, SOLODNE, MEWFLEX, ELSTREEPLEX, 1927 FIVE AND ALL THE CHIEF CIRCUITS.

**CHOKES.**—Cosmos H.P., 6/6; Lissan H.F. or L.F., 10/6 each; Success L.F. or H.F. 10/- each; Bower Low H.F., with base, 9/-.

## ORMOND SQUARE LAW LOW-LOSS.

'0005, 9/6; '0003, 8/6 (1/6 each less no vernier); Friction Geared, '0005, 15/-; '0003, 14/6; '00026 13/6. Straight Lines Frequency Friction Geared, '0005, 20/-; '00035, 19/6. S.L.F. '0005, 12/-; '00025, 11/6. **SO-LAW LOW-LOSS DUAL.** '0005, for Elstree Six, 16/11 each. **Ormond Friction Dial.** 10/-. Filament Rheostats Dual, 2/6; 6 ohms or 30 ohms, 2/-; Potentiometer, 400 ohms, 2/6. L.F. Shrouded, latest model, 15/-.

## D.E. VALVES.

Power, 2 volts.....9/11  
'06, 2 volts.....6/11

## RADIO MICRO VALVES.

'06, 3-v., 6/11; '25, 2-v., 6/11; Power, '3, 8/6; Power, '1, 9/11 Powe are 3.4 volts. Phillips' 4 Electrode, 4-pin for Uni-dyne, 8/11. Post 6d. each.

## ACCUMULATORS.

2-v. 40, 7/11; 2-v. 60, 9/6; 2-v. 80, 12/6; 2-v. 100, 14/6; 4-v. 40, 13/11; 4-v. 60, 17/11; 4-v. 80, 26/6; 6-v. 60, 26/6; 6-v. 80, 35/6. ALSO another good make, 1/6 extra on each of above. Post 1/- each.  
**HART'S OLDHAM STOCKED GANG CONDENSERS,** Dual '0005.  
**ORMOND,** with dial, 32/  
**CYLDON** no dial, 50/- Triple '0005, 50/-  
**ORMOND,** with dial, 40/  
**CYLDON,** no dial, 70/-  
**IGRANIC,** no dial, 75/-  
Grand Value in NON-MICROPHONIC VALVE HOLDERS, Roan outline, 1/6.

## VALVES.

S.F. 12, Red or Green, 14/-  
New Blue Spot, 14/-  
All Mullard, Ediswan, Osram, Marconi, Cosmor, Bright, D.E. and Power, 9/-, 14/-, 18/6, 22/6, 24/6, 30/-, 22. Mullard PM 1. 2. 3. 4. 5. 6 stocked.  
S.T. Valves stocked.

## This MAGNIFICENT 2-VALVE SET (D.&L.F.).

As shown, in handsome Polished American Type CABINET, with 2 DULL LEATHER VALVES, TUNING COILS, H.T. L.T. BATTERIES, AERIAL EQUIPMENT, LEADS, AND LOUDSPEAKER. FAX PAID. **£4.19.6**  
THE LOT  
Carr. and packing 5/-  
**3-VALVE SET (D. & 2 L.F.)** Coils and Valves, **£5.15.0** (carr. & packing, 7/6).

## CALLER'S COLUMN NOT SENT BY POST.

Terminals with N. and W. 1d.; Nickel, 1 1/4d. Spade Tags, 3d. Phosphor Bronze, 3d. doz. E6 Bushes, 1d. Screw Winder Plugs, 2d., 3d., 4d. pair. Plug and Socket, R. or B., 3d. Staples, a 1d. Pins, 2d. 2 a 1d. 4 B.A. Rod, 3d. ft. Earth Tubes - Copper, 2/3; Climax, 5/-; Fine 7/22 Aerial, 100 ft., 1/1; Special Heavyweight, 2/1; Phosphor Bronze, 49 strands, 100 ft., 1/- (dim. limited). Twin Flex, R. & B., 12 yds, 1/4, 1/6, 2/-; Miniature Silk Twin Tex, 6 yds., 6d.; Marine Lighting Flex, 6 yds., 9d.; Insulators, 2 for 1d.; Tinned Copper, 1/16th sq., 1d., 2 ft. D.C. Wire, 1 lb. reel, 20G; 8d.; 25, 10d.; 24, 11d.; 26, 11d.; 28g, 1/1. Ebonite, Gradd "A," cut white you want, 5/16th ls 4d. sq. inch; 1 in. ls 4d. sq. inch. Stock sizes of ebonite: 7 x 3/8; 6 x 6, 1/3; 8 x 6, 1/9; 9 x 6, 1/11; 10 x 8, 3/-; 12 x 9, 4/-. Also cheaper quality for crystal sets. Special offer in Crystal Sets, 6/11, 7/6, 8/11, 9/6, 12/6. Also in enclosed cabinet, wonderful value, 18/11. AMERICAN Type Oak Cabinets, with base-board, take 12 x 8 ebonite, 10/6; 12 x 9, 11/9; 16 x 8, 16/11, 18/11. Any size in 3 days. Handsome panel switches, DPDT, 1/6; SPDT, 1/- (Highest quality). Lightning Arrestors, 1/- Wave-length Permanent Det., 6d. Red Diamond Perm. Detector, 2/-; Liberty, 3/6; Browne, 3/-; R.L. '0005, Crystals, Shaw's Genuine Hertzite, sealed, 8d.; Neutron Wyray, 1/6; Dayzite, 2/6; Splendid enclosed Crystal Detectors, on or base, 1/-, 1/6. Micro-meter, 1/9; Service do, 2/9 (with crystal). P. & P. Switches, 1/- Non-micro-phonous V.H. 1/3. Solid Red Eb., 1/- Baseboard, 8d. 2-way Geared Coil Holders, 2/11, 3/11. Penton, Lotus, Polar, Newey stocked. Back of panel, W.L.L., 4/11. Ray, 3/11; drills for 1 in. dia. ing, 1/3. "Phone Cords, 1/-, 1/3. L.S. do, 1/6. 1/9. H.F. and L.T. Leads, 4-way, 1/1. O.C. old friends: ADICO Batteries, 60-volt (not one in a 1,000 has to be returned. I will change any faulty). Free 6/11. Adico, Eveready, Siemens, Helleskus, 60-v. and 100-v., all 15 Batteries here. (Columbia always stocked.)

## CALLER'S MAKE OUT YOUR LIST FOR A SPECIAL QUOTATION.

CALL HERE FOR LISSON, BENJAMIN, RADIO-MICRO, COSMOS, MULLARD, EDISWAN, MARCONI, COSSOR, JSRAM, JACKSON'S (J.B.), DUBILIER, McMICHAEL, SUCCESS, BEARD & FITZ, BOWER-LOWE, LEWCO'S, ORMOND, EUREKA, ORMOND, UTILITY, FORMO, EDISON BELL, FERRANTI, R.L. POLAR, NEWEY, P. & M. MAGNUM. WE HAVE THE GOODS! CALL AND SEE US, ALL LINES IN DEMAND STOCKED. SPECIAL TERMS RADIO CLUBS. GENUINE EXPERIMENTERS. BE SURE YOU ARE AT RAYMOND'S,

**K. RAYMOND** 27 & 28a, LISLE STREET, LEICESTER SQUARE, W.C.2  
HOURS .. 9.15 to 7.45 .. Back of Daly's Theatre.  
SATURDAY .. 9 to 8.45 .. Nearest Tube, Leicester Square.  
SUNDAY .. 11 to 1 .. 'Phone: Gerrard 4637.

# PEERLESS FIXED RESISTOR



1/3

## Efficient, Neat and Cheap

YOU can see from the illustration what a neat job this "Peerless" Fixed Resistor is. The Base is solid insulation and the former a strong impregnated material that atmospheric conditions will not affect. The wire is wound evenly and firmly and terminals and soldering tags are fitted. One hole fixing. A very thoroughly assembled and finely finished unit in all.

### OTHER BEDFORD PRODUCTS :

- "Peerless" Dual Rheostat ... 3/9
- "Peerless" Junior Rheostat ... 2/6  
(already over half a million sold)
- "Peerless" Resicon Variable Condenser, from ... 15/- to 18/-  
(Dial and Vernier 2/6 extra)
- "Peerless" Master Switch ... 2/9
- "Peerless" Valve Switch ... 3/-

From all good dealers or direct.

**BEDFORD ELECTRICAL & RADIO CO. LTD**  
22 CAMPBELL RD. BEDFORD

## CORRESPONDENCE

(Continued from page 1184.)

4-valver, and if I wish to use it, I am compelled to tolerate a hubbub of Morse as a background. I quite realise that Morse is a necessity, but it must be confined to a definite wave-band. My set is quite useless five days out of seven, and my sympathies go with those who have struggled, perhaps a little beyond their means, to purchase a decent receiver, and have been sorely disappointed with this disgusting bugbear.

I was demonstrating my set last week to a musician who was considering purchasing a set. When his enquiry of the reason of the continual tap-tap-tap was answered, he decided to stick to his gramophone, and thanked me for the warning.

Yours truly,  
JOHN W. COLLINS.

P.S.—My tuning is sharp, and I find the worst interference is on about 350 metres.  
"Lea Hurst," Esplanade Gardens,  
Westcliff-on-Sea.

### IMPROVED LOUD SPEAKER.

The Editor, POPULAR WIRELESS.  
With reference to your article on an improvised loud speaker, I think you may be interested in one that will cost—nothing. Simply unscrew the cap off one of the headphone earpieces and bring the magnets into contact with the clean bottom of a tin similar to a Cerebos salt container. The results are remarkable in a small room. The tin bottom is the diaphragm, and, if the headphone is any good, it will hang on by its own magnetism.

Yours sincerely,  
W. N. MAWBY.

The Cottage, Quenborough Lodge,  
Syston, Leicestershire.

### THE "RANGE" OF A CRYSTAL SET.

The Editor, POPULAR WIRELESS.  
Dear Sir,—I can hear London (80 miles) on a crystal set at any time, including when Daventry is doing another programme, thus proving it to be 2 L O.

I hear Birmingham (50 miles) at any time and have heard Hamburg several times.  
London, on my 30-foot-high aerial, is faint, but on a friend's aerial (50 feet high) it is at comfortable strength.

On this latter aerial I have heard Hamburg at 3.30 p.m. I know German and identified the station from the published programme.

In this district it is extremely unlikely that any valve user would be listening to a long German talk at such a time; all would be at work.

In any case, re-radiation must be ruled out as regards 2 L O. It is impossible to believe that someone or other is always listening to London at all the times I have tried it.

I can generally hear Nottingham (38 miles), only a relay, and have occasionally heard Bournemouth; all the above on a crystal set.

Yours faithfully,  
CHAS. D. ROCHESTER.

4, High Street, Rothwell,  
Kettering.

### SPARK JAMMING.

The Editor, POPULAR WIRELESS.  
Sir,—May I, if I am not too late, make one or two comments on Mr. J. L. Maitland's letter in your issue of December 4th, in which he puts forward the sea-going operator's point of view on spark jamming.

Firstly, as regards broad tuning: Granting that it would not be desirable or even practicable to carry on commercial work with razor-sharp tuning or strict adherence to the 600-metre wave for ordinary work, particularly when traffic is heavy, there still remains the fact that "there's measure in all things made," and when one finds the whole band of wave-lengths from 250 metres upwards freely used by shipping, there does seem legitimate cause for grumbling.

May I remind Mr. Maitland of a fact which so many operators seem to forget, and that is that even with the old type of 14 kw. and 5 kw. sets, which probably cause a large percentage of the interference, reasonably sharp tuning may be obtained with a loose aerial coupling; and that a coupling which may be justifiable and necessary when well clear of the land and great range is required is both unnecessary and undesirable when in wireless company with, say, the Channel shipping. Imagine a dinner-party where everyone used "full power and a tight coupling" when speaking! Conversation would not be easier.

Secondly, is not the distress signal plea rather overdone? There are two ends to a signal, to put it crudely, and receiving gear, so far as I am aware, has not yet reached such a state of selectivity that a reasonably sharply tuned transmission will not be picked up even if slightly off the expected wave-length.

Do not think that this is a flippant treatment of a serious argument, as having been at sea for over 20 years myself, I know how urgent a distress signal may be.

Another small point—almost trivial—the "selfish minority" referred to at the end of Mr. Maitland's "Point 2": Is it a minority? If it is now (with

(Continued on next page.)

# GRAVES

## 2-VALVE LOUD SPEAKER BARGAIN.

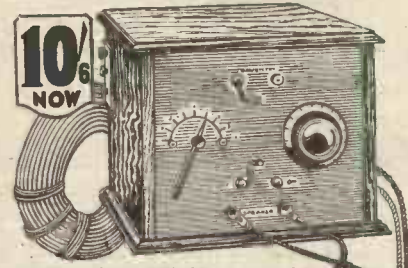

This highly efficient 2-Valve Loud-Speaker Set is the finest wireless value ever offered.

It gives a volume and quality of tone unattained by any instrument of a similar price and is the essence of simplicity. Fitted with coils covering all the British wave-lengths, including Daventry.

THE CABINET is of beautifully polished Oak, & all components are of the highest quality. Dual Emitter Valves with patent valve holders, &c.; H.T. Battery, 2-volt accumulator and complete Aerial Outfit. **LOUD SPEAKER** of exclusive design with unique magnetic system and £7:17:6 improved mica diaphragm. Price

**TERMS:** Our Bargain Price is for deferred payments. Send 10/6 now, & complete purchase in 14 monthly payments of 10/6. If you wish to pay cash, 5 per cent discount is allowed. Catalogue Post Free. Up-to-date Crystal & Valve sets at keener prices.

J. G. Graves Ltd. Sheffield  
Of proved efficiency



### HEADPHONES REPAIRED

Re-wound and re-magnetised 5/- per pair. Loud Speakers repaired 5/-. Transformers re-wound 5/- each. All work guaranteed and tested before delivery. Write for Price Lists. Phone: Clerk, 1795. **MASON & CO., 44, East Road, City Road, N.1.**

### RADIO REGISTERED PANELS

Inches	Inches
7 x 5 1/4	6 x 6 1/4
7 x 6 1/8	8 x 5 1/2
8 x 6 1/4	9 x 6 1/7
10 x 8 2/1	11 x 8 2/3
10 x 9 2/4	12 x 8 2/6
12 x 10 3/4	12 x 9 2/10
14 x 12 4/7	14 x 10 3/5
	5 in. thick
	Post Free.

Money back guarantee that each and all Panels are free from surface leakage. Megger test Infinity. Callers cut any size. Quotations by post, or phone Clerkenwell 7853. Samples and prices post free to the Trade.

**CROXSONIA CO., 10, South St., MOORGATE, E.C.2**

## ACCUMULATORS ON EASY PAYMENTS

High-Tension Accumulators built up from 20-volt sections (15/- each). Example: 60-Volt H.T. 45/- OASH or 12/6 DOWN and 6 monthly payments of 6/-. Carriage Paid. Satisfaction or money back. Write for Lists to DEPT. 11, COVENTRY

DIRECT SUPPLIES LTD., 27, Warwick Row, COVENTRY. Any Wireless Goods supplied on easy payments.

### LIFE LONG H.T.

Tromba units are constructed of the finest quality zincs, zincs, jars, etc., and creeping of the electrolyte and other troubles usual to Leclanche cells eliminated. In units or any size battery to order in Mahogany Case with glass cover. Amalgamated zincs 6d. doz. extra. Sample unit and sample large capacity set, post free

1/- Send to-day for free descriptive folder, etc.  
**TROMBA ELECTRICAL CO**  
17, WHITE HART LANE, TOTTENHAM, N.17.



OF ALL DEALERS OR DIRECT 6D PER UNIT



**CORRESPONDENCE**

(Continued from previous page.)

which I do not agree), this state of affairs would soon be altered, given reasonable freedom from interference round the coast.

Finally, may I say that I entirely agree with Mr. Maitland in the third "Point" of his letter, and wholeheartedly sympathise with those who have to receive signals through the pandemonium which exists at present. I suggest again that the situation could be eased for all by the more frequent use of a loose coupling in narrow waters—though how those who begin the good work will ever get their signals through the shoutings of the remainder, goodness only knows!

Yours etc.  
E. G. HALLEWELL.

"Home Croft"  
Mullion, Cornwall.

**3-VALVE DX RESULTS.**

The Editor, POPULAR WIRELESS.

Sir,—On seeing some of the results of POPULAR WIRELESS readers, I thought I would write and let you know of my list of Main Stations and Amateurs received on a 3-valve—detector and 2 L F. Those stations in heavier type I require addresses. Could any readers oblige me with same?

**AMATEURS.**

2 QR, 2 PL, 2 MD, 6 AH, 2 NR, 2 AD, 2 RU, 2 PS, 2 VS, 2 HX, 2 AD, 2 E, 2 SY, 2 RY, 2 PB, 2 OW, 2 BP, 2 YN, 2 WB, 6 HU, 5 NU, 2 IS, 2 YX, 2 WD, 2 QI, 5 ZX, 2 KD, 2 YZ, 2 WS, 2 YK, 2 QR, 2 KO, 5 YS, 5 LK, 2 NK, 2 WX, 2 KR, 2 RF, 5 RI, 2 PD, 2 SE, 2 NY, 2 DU, 2 ARF, 6 MK, 5 WO, 2 MD, 2 FR, 6 YZ, 2 LS, 2 BMM, 2 OP, 2 HF, 2 XE, 2 SK, 2 AE, 2 OQ, 1 X, 5 KD, 2 AK, 2 NU, 2 PI, 2 YI, 2 VI, 2 FI, 5 IY, 5 MD, 2 HS, 2 VR, 6 MJ, 2 YC, K A R G (Germany), 6 ID, 6 KR G, 5 K D, 2 B P P, 2 A X R, 2 A K L, 2 A F T, 5 Y X I (4 A F (New Zealand), 5 P I, 33 A Z, 1 J W, 6 U U, 2 Y D, 6 F U, 6 F F W, 2 B B P, 6 R E, 6 S W, 2 B P M, 2 R E, 2 X I, 2 B F, 2 S T, 6 H W, 6 H T, 3 T C K, 2 Y V, 1 J W (Italy), 2 B S L, 2 B S O, 6 U C, 5 E W, 6 F R, 6 S R, 3 B M V, 3 B M P, K I G (Germany), 6 V D, 6 C Y, 6 C L, 5 I Y, 6 E Y, 2 M Z, 5 K Y, 5 J I, 6 X O, 6 R S, 5 P X, 2 B K, 6 N A, 5 A J, 2 O J, 6 N T, 5 A D K, 6 S L, 5 S X, 2 A R E, 6 P C, 6 P H.

**MAIN B.B.C. STATIONS**—London, Birmingham, Bournemouth, Glasgow, Newcastle, Liverpool, Cardiff, Aberdeen, Manchester, Edinburgh, Dublin, Daventry, Nottingham, Stoke, Plymouth, E A J I. **FOREIGN**—Paris C F R, Paris F P T T, Paris P T T, Riga, Hilversum, Vienna, Lyons La Doua, Barcelona, Prague, Seville, Brussels, Belgrade, Berne, Toulouse, Munster, Draz, Hamburg, Madrid E A J G, Madrid E A J T, Oslo, Copenhagen, San Sebastian, Breslau.

New York, America. Rugby, England. I have just made the 2-valve Male receiver, which has proved of great satisfaction. It is a "wonderful receiver." I get 2 LO, 5 IT, 5 X X, Rugby, New York, on loud speaker.

Some foreigners are just audible in the loud speaker. Signals from Rugby can be heard at full loud-speaker strength. On Sunday I can hear the conversation between Rugby and New York very loud in the 'phones. On this set I am using a P.M. Mullard P.M.6 dull-emitter power valve, followed by a P.M.5 Mullard dull emitter valve, using 120 volts H.T. and 1½ volts grid bias and R.I. transformer, first stage, followed by a Telsen second stage.

I must congratulate POPULAR WIRELESS on such a fine, sensitive, selective, long-distance receiver.

Hoping this will interest you and POPULAR WIRELESS readers.

Yours faithfully,  
ALBERT HORTON;

270, Rookery Road,  
Handsworth, Birmingham.

**WET H.T. BATTERIES.**

The Editor, POPULAR WIRELESS.

Dear Sir,—I have just read the letter of Mr. Alfred Timson in "P.W." and as he appears to have experienced some trouble with the zinc sheet in his wet H.T. I thought perhaps the following hint might possibly help him. It may possibly help other readers as well.

In place of sheet zinc he should obtain some commercial Leclanché zincs and cut them into 1½ in. lengths and use these, and as they are very solid they will last for years. I have had some in use for over eighteen months and have had no trouble yet. They can be soldered to the carbons with a short strip of bare copper wire (about 22 gauge), and the joints smeared with either oil or vaseline to prevent salts creeping. I feel certain your reader will then get his battery to work O.K. May I just add that I am a regular reader of P.W., and have tried a good many of your circuits, the latest being the Hale 2-valver, and I must say I am truly surprised at this circuit as the stations fall over each other to get to the 'phones, the only drawback being its lack of selectivity.

Wishing you and "P.W." every success in the future.

Yours faithfully,  
H. C. BUTTER.

Myrtle House,  
North Drink, Wisbech.

# THERE ARE OTHERS

You can get other anti-microphonic valve holders besides BENJAMIN—just as you can get inferior substitutes for every first-class article made. But it is a poor policy.

BENJAMIN Anti-Microphonic Valve Holders—the first and the finest on the market—have built up their enormous popularity chiefly through the following five exclusive and essential features:—

- 1 Valve sockets and springs are stamped in one piece: there are no riveted, soldered or clamped joints to work loose and create microphonic noises.
- 2 The springs allow the valve to float in any direction.
- 3 Stops controlling spring movement enable valves to be inserted without damage to valves or springs.
- 4 Valve legs, however far pushed home, cannot foul baseboard.
- 5 Terminals and soldering tags are fitted for easy wiring-up.

The BENJAMIN Anti-Microphonic Valve Holder again was the first to incorporate a grid-leak or condenser and grid-leak attachment, already mounted for your convenience—and there is still no better combination to be obtained.

Price of valve holder alone:

## 2/9

# BENJAMIN

**Clearer-Tone Anti-Microphonic VALVE HOLDERS**

From all radio shops or direct:  
**THE BENJAMIN ELECTRIC LTD.,**  
Brantwood Works, Tottenham,  
London, N.17.

5/3



Valve Holder & Grid-Leak.  
A Dubilier Dumet-ohm 2 meg. Grid-Leak is fixed on to a rigid insulating bar by means of nickel-plated copper clips.

7/-



Valve Holder Grid-Leak & Condenser.  
Nickel-plated copper clips carry a Dubilier fixed Condenser (1000) in addition to the Grid-Leak. Series or parallel.

**BARGAINS No. 314**

The Dix-Ometer has become the acknowledged Radio Standard. Why? Because it is a 55 Range Instrument of exact precision, Double Scale and Mirror Edge needle, Front zero adj. and 50,000 ohms per 100 volts. Reads 20 micro to 20 amps., 2 milli- to 2,000 volts and measures 50 ohms to 50 megohms with ease. Low Price. High value. Instrument, 55/-. Multipliers, 6/6 each. Radio Test Booklet free.

**WAVEMETERS.** Reduced prices. Calibrated Sullivans to N.P.L. standard. S.W. "Forward," cost £10, 40/100 metres, 35/-; B. 1,000/2,000 Townsend, 35/-; B.B.C. "Townsend," 280/1,600 metres, 50/-; LR Townsend, 120/4,000 metres, £4; Ondia Wavemeter (for 60/4,000 metres), £3 10s. Heterodynes, with calibr. valve, 150/3,000 metres, £4 10s. Original cost £15, and all guaranteed.

**H.T. GENERATORS,** all sizes from 2 K.W. Newton 2,500 volts on bedplate, £45, to Evershed belt drive Megger 800 volt 60 m/a Generator, £8. H.T. Megger Hand, 600/1,000 volt, in wood case, £3 10s.; 100 m/a 350 volt Westinghouse M.G. off 25 volts to 35 volts L.T., £4.

**INSULATORS.** R.A.F., Ebonite Aerial, 9 for 6d. Marconi Strop Strain, 4 ft., 2/-; Egg and Shell, 2 for 13d. Buldix Bell, porcelain, 1/6. Ribbed Pedestal, H.T., 2/-; Large Transmit, 4/6.

**LAB. EQUIPMENT.** Inductometer, 4/6 10s. Valve Tuning Fork, 50/-; Paul's Bridge and Galvo, £7 10s. Weston Clark Cells, 30/-; Standard Mfd. Units, from 8/-; Wheatstone Bridges, £2 5s. and £6 10s.; New Sullivan Spot Galvo Scale and Shunt, £15; 3-range Tinsley Micro. Ammeter, 60/-; Capacity Bridge, .000 to 10 mfd., £8; Bellini-Tosi Direct Feeder, £5 10s.; 3-set Valve Test Cabinet, £5 10s., etc. Megger Conductivity Tester, £15. Get the Best out of your set by using a Dix-Ometer and a Wavemeter.

**SPARK SETS.** 10" Marconi Coils, £7; Cox X-ray, £10; 2" Sterling, 15/-; 1" Coils, 6/-; Diathermy 1 K.W. 100 v. D.C. to 10,000 v. A.C., £15; 250 watt 500 v. Alternators, 70/-.

**MORSE WIRELESS RECORDERS,** £7 10s. Magnificent British work solid brass case, fine finish. Mahogany case with drawer for tape reel. Cost £30.

**PRECISION INSTRUMENTS.** 2,000 to select from. Mov. Coils to 500 m/a, etc. 3-range Milliammeters, 37/6; 2-range Voltmeters, 6/120, 11/8; 0-30 volts, 10/-; 120 volts, 20/-; 600 volts, 55/-; 0-1,000 volts, £3; 1,500 volts, £4 10s.; 2,500 volts, £6; 50" Mov. Coil Siemens Cell Testers, 15/-; 250 m/a or 500 m/a Thermo Meters, 15/-.

**DIXON DISTANT CONTROL** for Valves. On and off any distance. Uses no current. Polished Oak Case, 15/-; Bronze Watertight, 17/6.

**MAINS UNITS.** The DIX D.C. size of 60-volt Battery gives any voltage from D.C. mains; 3 taps, 30/-; A.C. Rectifying H.T. Unit with Control Knob and 3 Taps, £5 10s.

**POWER TRANSFORMERS.** 220 volts to 3, 5, or 8 volts, 12/6. To 20 volts, 14/6. Double wound for H.T., from A.C. mains, 220 volts, two centre tap secondaries for H.T., 20 m/a, 25/- each; 50 m/a, 37/6 each.

**PARTS FOR MAINS UNITS.** Condensers, 2 mfd., 4/3; 4 mid., 8/6; 10 mid., 15/-; Fullertype Chokes, 200, 600, 1,000 ohms, 1/6. Power Chokes, 1,000, 1,400, 3,000 ohms, 4/6. 2 Electrode Rectif. Valves, 15 m/a, 7/6. Complete A.C. Kit, £3 10s.

**SURPLUS MARCONI B10 CRYSTAL AND 1-VALVE AMPLIFIER SETS.** Straight from maker. Closed Cabinet, engraved ebonite panel, nickel fittings, 2-spade tuning Range Block and Verniers, M.S.1 and T.C.C. fixed Condensers, 2 H.F. Chokes, Detector, Marconi Transformer, Valve-holder and Terminals, L. and S. wave Switch, Wiring diagram. All new, aerial tested, and complete as above, with Osram Valve. A £7 10s. set for 27/6.

**SWITCHES.** Lucas panel 3-lever flush, 1/3, quarter price. Plugs and Jacks, 2/6 pair; 4-pin plug and socket with switch, 4/6. Earth Aerial, 1/-; Arresters, 9d.

**TRANSFORMERS.** Intervolve Marconi, 10/-; Dix. Ironclad, 10/-; Microphone, 5/-; 220 volt to 3, 5 and 8 volt, 12/6. Dixon H.T. for Receivers, 220 to 150 volt Rectifying, 25/-.

**GYROSCOPES.** Navy Torpedo, in mahogany case, cost £25. Sale, 15/-.

**AERIALS.** R.A.F., 110 ft. 7-strand bronze pocket, 1/3. Navy 8-strand ename, 3/-; 100 ft. Indoor, Special Aerial, 22-gauge, 1/- per 100 ft.

**ACCUMULATOR SALE.** Fuller "BJX24," 2 volt 24 amp, 6/-; 4 volt 24 amp, 11/-; 6 volt 24 amp, 16/-; "BJX30" 2 volt 30 amp, 8/6; 4 volt 30 amp, 12/-; 6 volt 30 amp, 17/-; Fuller—2 volt 45 amp, 10/-; 4 volt 50 amp, 20/-; 2 volt 80 amp, 13/-.

**HIGH TENSION ACCUMULATORS.** C.A.C. 80 volt 1 amp, with taps, ebonite case and lid, glass cells, new, 40/4.

**ELECTRADIX RADIOS,**  
218, UPPER THAMES ST., E.C.4  
St. Paul's and Blackfriars Stn. Phone City 0191.

**TECHNICAL NOTES**

(Continued from page 1190.)

This applies in quite a general way to experimental work, and you will always find that the most successful experimenters in any branch of science adopt a tidy and business-like method in their manipulations.

**A Necessary Accessory.**

Talking about experimental work, I wonder how many readers, when carrying out experiments, take the trouble to keep what might be called a "laboratory notebook," and to write down all their observations at the moment that they are made. This I place as one of the most important of all factors to success in scientific investigations. You may feel it a little bothersome to have to write down patiently your various observations as they are made, and you may feel that your memory is quite sufficiently trustworthy. But after you will have made a few observations you will very quickly find that they have become hopelessly confused if carried only in the memory, and the net result will be that there will be, at the least, a degree of uncertainty as to what it was you have really found out. The moment there is any degree of uncertainty whatsoever as to the results of your observations, you may as well forget the matter and start all over again and do the thing right. Thus it is easy to see that time and trouble would, in fact, have been economised had the work been done properly in the first instance.

Always keep a written record of any observations which you make when carrying out experimental work and, as soon as you have finished an experiment, sit down and consider very carefully the interpretation which is to be placed upon the observations which you have made. Do not, for example, leave the records until the next day, but consider them whilst the whole matter is fresh in your mind, as such consideration will indicate to you the direction which the next day's experiments should take.

"THE Wireless Trader' Year Book & Diary" for 1927 (published by the proprietors of "The Wireless Trader," 139-140, Fleet Street, E.C.4), contains nearly 400 pages of trade facts and information, readily supplying answers to the innumerable problems met with by Wireless Traders in the course of business.

Revised and thoroughly up to date, the new edition, beside providing a useful interleaved Diary, contains an Alphabetical List of Trade and Professional Addresses of Manufacturers, Agents, Associations, and Publishers; a comprehensive Guide to Goods Supplied and Services Rendered; a List of Factors (arranged territorially); an Alphabetical List of Proprietary Names of Wireless Sets and Components; data on Technical and Broadcasting matters, and a wealth of other trade information. The price is 5s. 6d. (7s. 6d. Overseas).

**WOOD-HORNS**

The Manufacturer is  
H. MADDISON, 28, RONALDS ROAD,  
HOLLOWAY ROAD, HIGHBURY, N.5.  
There's only one best.  
"The ALLWOODORN" is that one.  
Send for list.  
Lissenola—Amplion—T.M.C. units supplied  
complete with horn if desired.

**LAMPLUGH**

**VARIABLE VOLUME CONTROL** (Max. Resistance 500,000 ohms.)

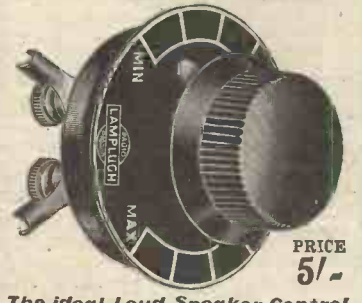

The ideal Loud Speaker Control.

**VARO-FIX FILAMENT RHEOSTAT**

Interchangeable elements and each one adjustable. More positive than automatic devices.  
6 ohm, 2/3; 15 ohm, 2/6; 30 ohm, 2/9  
**S. A. LAMPLUGH LTD.,**  
King's Road, Tyseley, BIRMINGHAM.  
Our high-grade components are obtainable from all first-class Radio Dealers

**3/9 'PHONES 3/9**

These 'phones are of British manufacture and were made specially for broadcast reception; they are 4000 ohms, and are complete with 7 ft. cord and light aluminium adjustable headbands. These 'phones may be had on approval against cash, and if you are not satisfied your cash will be refunded if you return the 'phones.

Price 3/9 post free and immediate delivery from:  
**C. WILDE, WILLESBOROUGH, ASHFORD, KENT.**

**EASY PAYMENTS**

Finest 2-valve amplifier set, including loud speaker, 120 H.T., D.E. valves, £7 10s.; or 18/9 down and 11 instalments of 15/-.

**CASH BARGAINS.**

Amplifiers, 37/6 and 21/-. 'Phones, Telefunken type, 7/9; Fr. T. Houston, 11/-. Good H.T. 60-v. 5/6. Best 66-v., 6/6; or 21-v. (laboratory test) 4/- doz. Famous Metal Valves (French), 2-v., 2/5; 2-v., .06, 6/9; 2-v., 5, power, 8/9; 4-v., .06, 5/6. Straight-line Condensers, 5/9. Ditto, 4 in. dial, 7/3. Transformers: Habana, 3/6; Radiolya, 3/6. Brunet, 7/9. Also Ferranti, Eureka, Formo, etc. Postage extra. Everything in wireless reliable and cheap. Satisfaction or cash refunded.—Music Roll & Gramophone Records Exchange, 29, High St., Clapham, London, S.W.4.

**A HOME FOR YOUR WIRELESS SET**

**OUR STANDARD CABINETS** are **DUST PROOF** and house the whole apparatus, leaving no parts to be interfered with. All you do is **UNLOCK & TUNE IN.** Made on mass production lines, hence the low price. Provision is made to take panels from 16 x 7 up to 30 x 18 in.  
From £4 15 0  
Write to-day for descriptive pamphlet and suggestions for adapting your receiver or panel in our Standard Cabinets.  
Carriage paid and packed free England and Wales. Thousands supplied with full satisfaction.  
Immediate Delivery.  
Dept. 5, Melville Chambers, 50a, Lord St., LIVERPOOL.  
**MAKERIMPORT Co.**

**Trelleborgs**  
GENUINE EBONITE  
Experts choose it - its Choice!  
STOCKED BY ALL THE BEST DEALERS  
**TRELLEBORGS EBONITE WORKS** 14, Audrey House, E.C.4

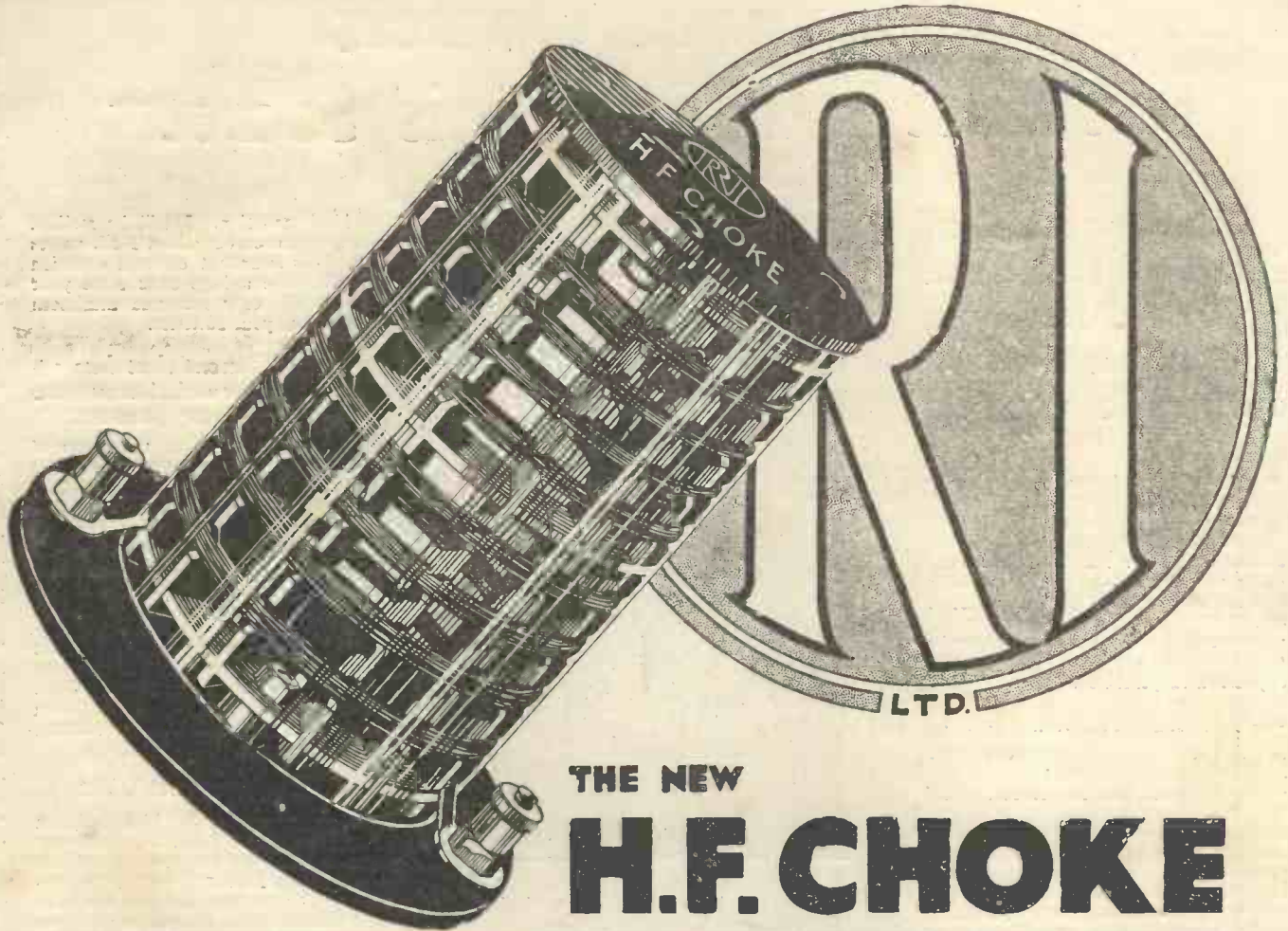

**THE R.I. MULTI-RATIO TRANSFORMER**

with its seven ratios and three impedance values is undoubtedly the perfect L.F. coupling unit. The design is recognised as an advance on any previous transformer for interval coupling. Suitable for use in any circuit and with any valve, it gives a degree of pure powerful amplification under any conditions impossible to obtain with the usual single ratio instrument.

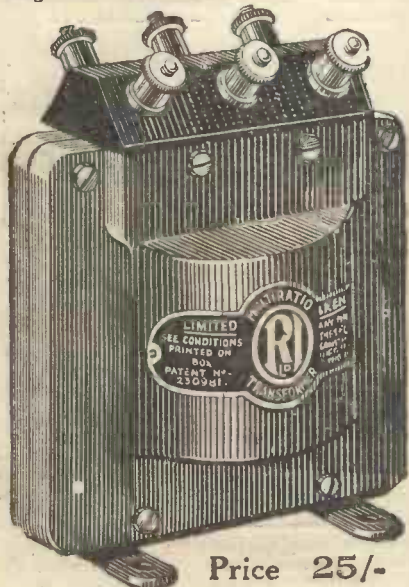

Price 25/-

**THE NEW  
H.F. CHOKE  
WILL BE THE BIGGEST  
FEATURE THIS YEAR**

Here is another remarkable R.I. component designed for circuits where a tuned-grid circuit is employed.

Being an R.I. product it has all the features necessary to give improved working of this circuit, for, as it is used virtually in parallel with the tuned circuit it is important that the high-frequency resistance and self-capacity are negligible in order to maintain selectivity and efficiency.

Hence the New R.I. H.F. Choke possesses a high impedance value and is wound in well-spaced sections on a low-loss skeleton former. For wavelengths of from 50 to 4,000 metres it is quite suitable and no observable increase in the H.F. resistance of the parallel tuned circuit will result.

It is a precision instrument well in keeping with the sound engineering tradition of R.I. Ltd. Perfect in design and workmanship it is an outstanding example of the dominating influence of this progressive company in the wireless field.

PRICE 12/6

Write for the R.I. Catalogus.

THE MARK OF BETTER RADIO



Advt. R.I. Ltd., 12, Hyde St., New Oxford St., London, W.C.1.

# Valve Set Owners Are Fast Learning This Secret★

★ the secret of increased range and greater economy in the operation of their radio receivers

*It must have struck you at one time or the other that the radio results of certain of your friends who have sets based on the same circuit and the same number of valves, were better than those from your own receiver. The answer to the following question will give you the key to the secret of improved reception:*

*"How copious is the emission given by the filaments of your valves over a range of filament temperatures?"*

It may seem strange to you that the emission of a valve filament can make a marked difference in the way your receiver operates and in the cost of its upkeep.

If, for example, your set is "all out" when receiving a station, say 100 miles away, you have small hope of securing weaker distant stations as your friends may do, moreover, your battery consumption is naturally at its highest under these conditions.

## Why great emission makes all the difference

When a valve filament gives a copious and sustained emission at the correct filament temperature, a rich field of power is placed under your control which enables the best conditions to be secured to deal with the incoming signals, so that your



receiver is adjusted to suit the particular circumstances existing at the time.

The local station may be tuned in purely and strongly with the minimum of energy expended because valves that possess a huge emission are able to function perfectly at considerably less than their full capacity.

Then, as you reach out for more distant stations or weaker signals, you are able to adjust the operating energy of your high emission valves, particularly in the detector stage, to suit the exact demands

for ideal reception. It will be realised that by the use of Mullard P.M. valves with their abundant electron emission you will save upkeep costs since your receiver will only consume minimum energy from your batteries.

## A valve filament that has up to 5½ times the emission surface of an ordinary filament

To no one so much as the owner of Mullard P.M. Valves is the truth of this boon of great emission so apparent. The wonderful P.M. Filament—the foundation of the famous series of Mullard P.M. Valves—is so generous in its dimensions that the emission surface is immense. This remarkable fact is due to the length of the P.M. Filament being up to 3 times that of an ordinary filament, and its greater diameter. These two factors are responsible for the supreme efficiency of the Mullard P.M. Filament which possesses an emission surface 5½ times more effective than an ordinary filament.

## A Government Test

Convincing proof of the high emission of the wonderful P.M. Filament was recently given by the 1000 hours' test report of the National Physical Laboratory. This proved that the emission of Mullard P.M. Filaments was so abundant and consistent that an 18/6 Mullard P.M. Valve was still worth 18/- after 1000 hours' continuous life test, equivalent to a year's broadcasting service.

Bring your radio receiver up to the highest pitch of efficiency by installing Mullard P.M. Valves with the wonderful P.M. Filament and remember they consume absolutely minimum current. Ask any radio dealer for full information.

INSTALL MULLARD P.M. VALVES WITH THE WONDERFUL P.M. FILAMENT

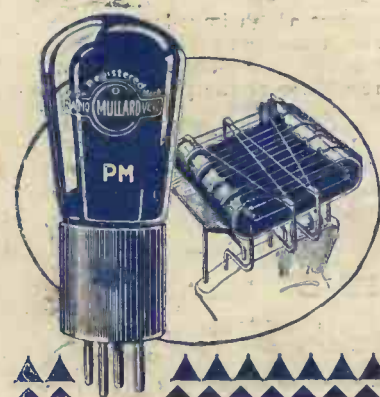

Sectional view of P.M.5 showing generous proportions of P.M. Filament

# Mullard

## THE MASTER VALVE

For 2-volt accumulator  
 THE P.M.1 H.F. 0.1 amp. 14/-  
 THE P.M.1 L.F. 0.1 amp. 14/-  
 THE P.M.2 (Power) 0.15 amp. 18/6  
 For 4-volt accumulator or 3 dry cells  
 THE P.M.3 (General Purpose) 0.1 amp. 14/-  
 THE P.M.4 (Power) 0.1 amp. 18/6  
 For 6-volt accumulator or 4 dry cells  
 THE P.M.5 (General Purpose) 0.1 amp. 18/6  
 THE P.M.6 (Power) 0.1 amp. 18/6  
 Super power valves for last L.F. stage  
 THE P.M.254 (4 volts, 0.25 amp) 22/6  
 THE P.M.256 (6 volts, 0.25 amp) 22/6

ADVT. THE MULLARD WIRELESS SERVICE CO. LTD., MULLARD HOUSE, DENMARK STREET, LONDON, W.C.2

MODERNISING the "P.W." CONTINENTAL RECEIVER

# Popular Wireless

Every Thursday  
PRICE  
3d.

No. 242. Vol. X.

INCORPORATING "WIRELESS"

January 22nd, 1927.

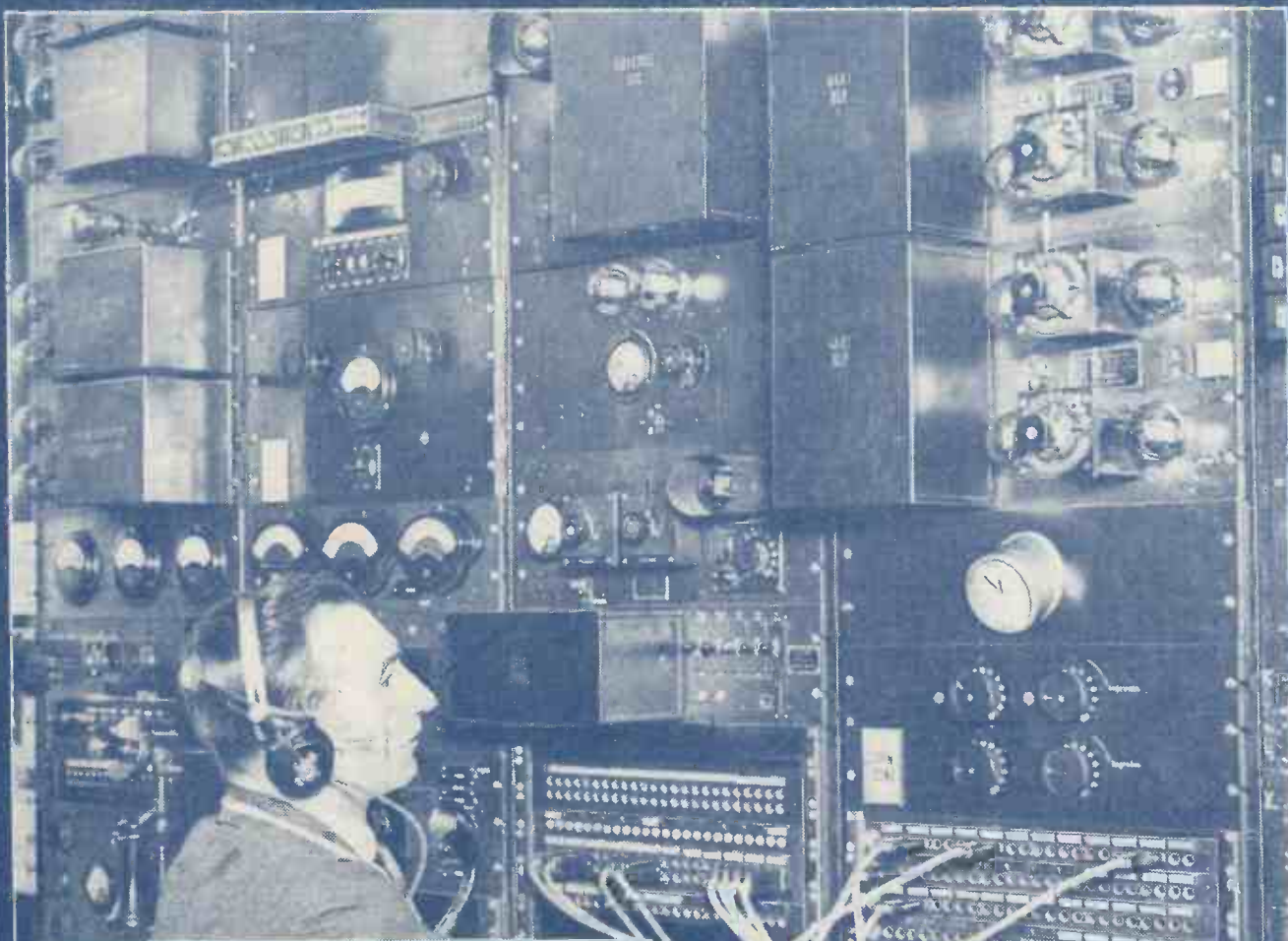

*Special Features In This Issue.*

- Beam Interference    Making Up H.T. Batteries
- Experiments with the Filadyne Circuit
- Low Loss Aerials    Colloidal Detector Experiments
- How to Make the "Coastal" Crystal Set

Our cover photograph this week shows a P.O. operator controlling the amplifiers employed in the new transatlantic telephone system.

Two new 6-volt General Purpose Valves, extremely economical in current consumption.

# MARCONI



Types

**D.E.H.612**  
and  
**D.E.L.612**

Price

**14/-**

# VALVES



THE SWEETEST, richest, truest radio you have ever listened to is at your command by means of these new Marconi valves. Both types are extremely economical—the filament consumption is only 12 ampères—thus your accumulator charge will last twice or three times as long, and you will get better results from your receiving set.

	Type D.E.H.612	Type D.E.L.612
Filament Volts	5.6 - 6	5.6 - 6
Filament Amps.	.12	.12
Anode Volts	40-150	80 max
Amp. Factor	20	7
Impedance(ohms)	33,000	9,000

Type D.E.H.612 is a highly efficient detector valve, suitable for resistance or choke-capacity coupling and all forms of high frequency amplification. Type D.E.L.612 is designed for transformer-coupled sets, and is also an excellent amplifying valve in the second stage.

# THE GREATEST NAME IN RADIO

Ask your radio dealer for full particulars, or send postcard for Valve Publication No. 443B, mentioning "Popular Wireless," to:—

THE MARCONIPHONE COMPANY, LTD..

Head Office :  
210-212, Tottenham Court Road, W.1.  
[M.P.O. 812B.]

Registered Office :  
Marconi House, Strand, W.C.2.

# THE AMPLION

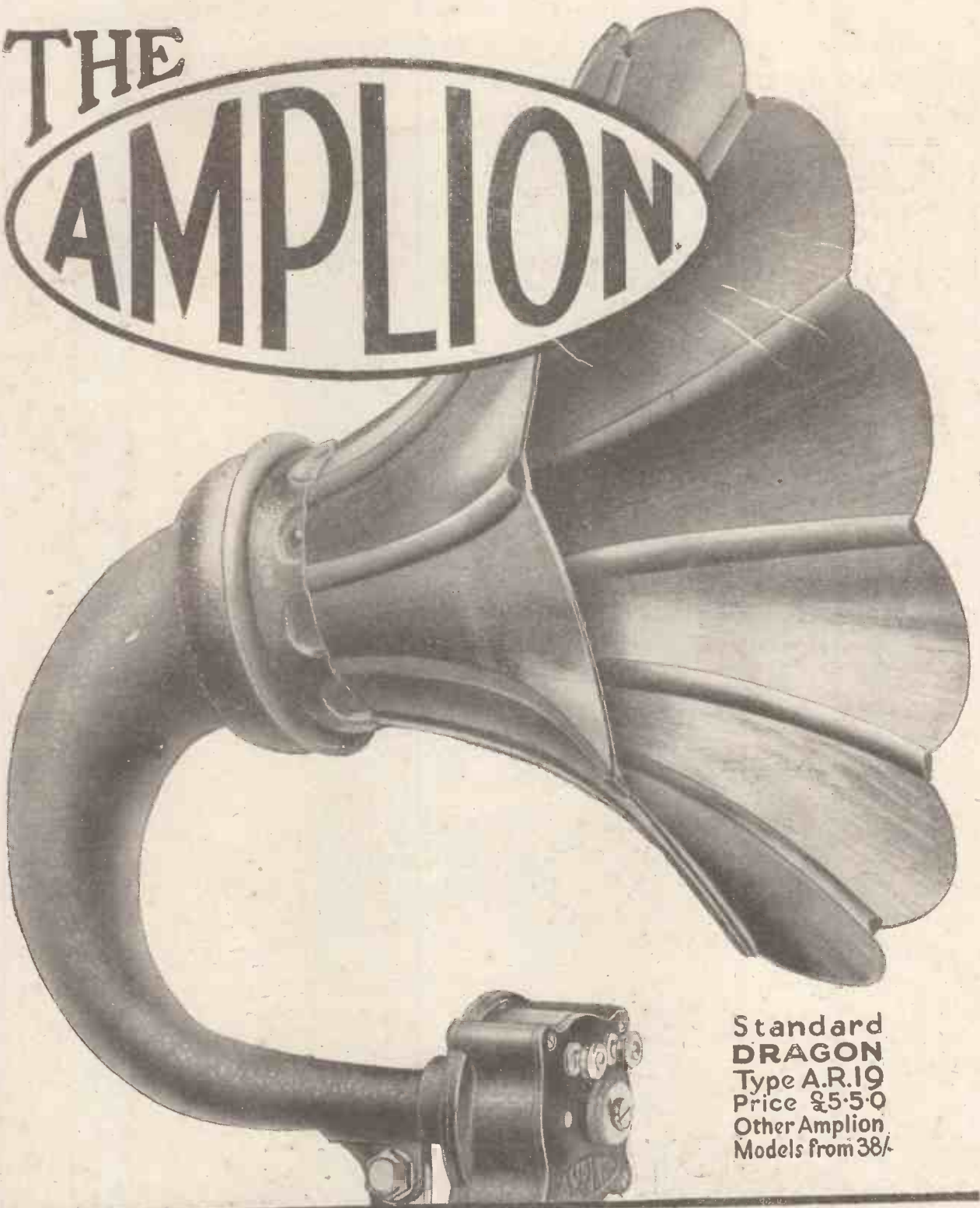

Standard  
**DRAGON**  
Type A.R.19  
Price £5.5.0  
Other Amplion  
Models from 38/-

---

*The World's Standard Wireless Loud Speaker*

---

PLAYER'S MEDIUM NAVY CUT CIGARETTES, WITH OR WITHOUT CORK TIPS.

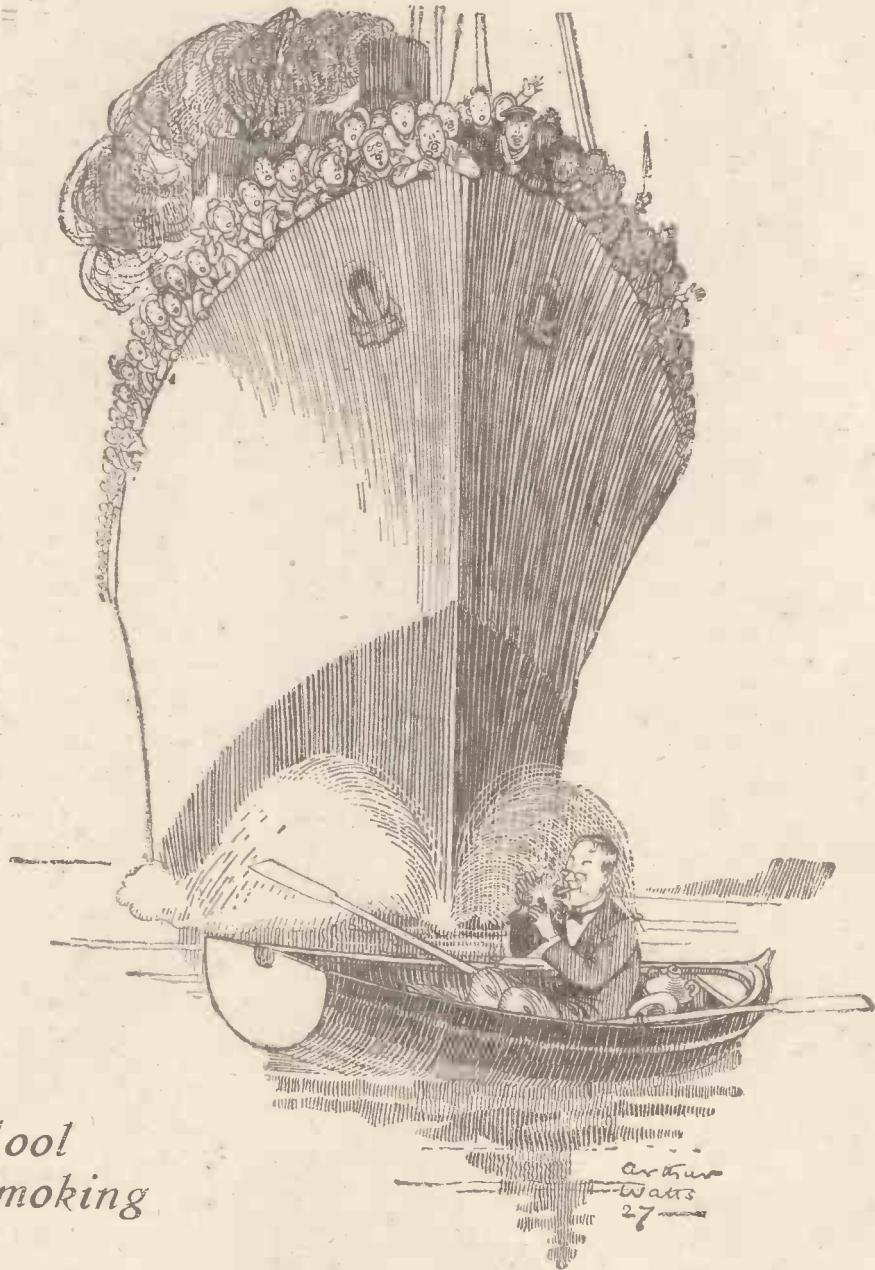

for Cool  
Smoking



# PLAYER'S

Navy Cut

# CIGARETTES

10 for 6d.    20 for 11½d.

50 for 2/5    100 for 4/8





The famous B4 valve  
now has its complement



The B.4.H. Valve has been produced, after long research, as a companion to the B.4., the finest power amplifier ever designed. Both these valves take 6 volts 0.25 ampere on the filament and can be used without resistance on a 6 volt accumulator. In a multi-valve set, the B.4.H. should be used in the H.F., detector and

early L.F. stages, and the B.4. in the final L.F. stage. For those who use 6 volt accumulators, the B.4.—B.4.H. is the most efficient combination of valves, giving a large volume of undistorted sound at a low current consumption. If you have a B.4. buy a B.4.H. If you haven't, buy both. Ask your dealer to-day.

Filament Volts.....6  
Filament Current 0.25 amp.  
Anode Volts .....60 to 120  
Amplification Factor .....20  
Impedance .....28,000 ohms

PRICE  
**18/6**

(OUTSIDE THE  
IRISH FREE STATE)

**B  
T-H**  
**VALVES**

*Sold by all Good Radio Dealers*

# "SAMSON"—The Powerful Twin

A "Hale" Receiver for Frame Reception

Designed by  
**PERCY W.  
HARRIS, M.I.R.E.**

Not everyone can arrange for the erection of a good outdoor aerial. This set will give good loud-speaking results, using only two valves, on either frame or outdoor aerial—up to ten miles in the case of the frame and greater distances with an outdoor aerial.

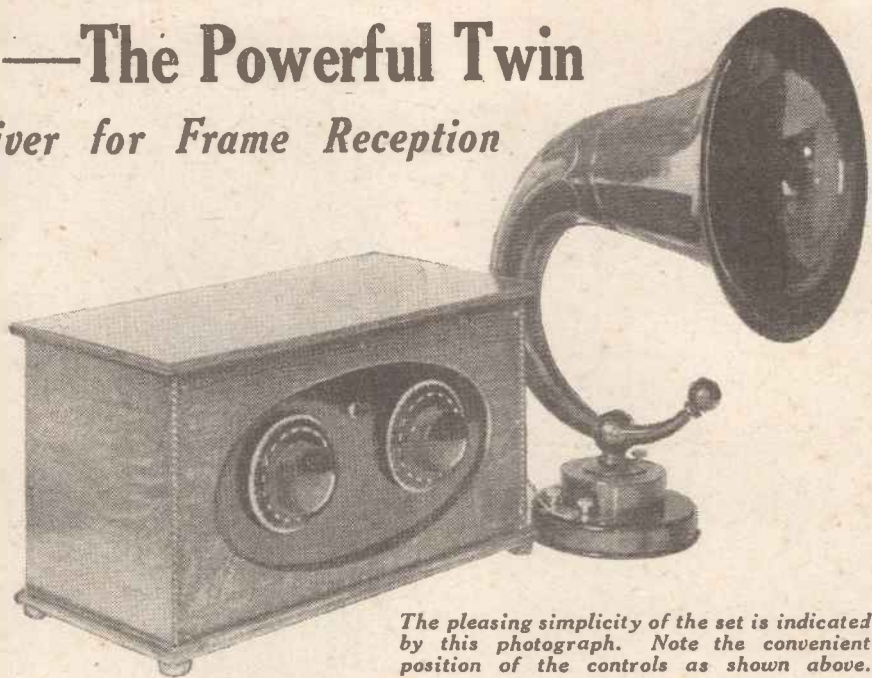

*The pleasing simplicity of the set is indicated by this photograph. Note the convenient position of the controls as shown above.*

**T**HIS reliable two valver is fully described by Mr. Percy Harris in the February issue of the WIRELESS CONSTRUCTOR (now on sale everywhere). The constructional diagrams and photographs make it a particularly fascinating set to build. Other notable features in this fine issue include:—

The Home Built Basket Aerial, a Reinartz One Valver; the Truth about High-Frequency Valves; the "Change-over"—a novel and simple crystal receiver described by Mr. A. S. Clark—a Simple Three Valver, Rectifier Problems, Time-Saving Tips, etc., etc.

# *The* **Wireless Constructor**

Edited by Percy W. HARRIS, M.I.R.E.

*At all Newsagents and Bookstalls: Buy Your Copy To-day.*

**6<sup>D.</sup>**

# A Real Advance in Battery Design for HIGH TENSION

## Exide TYPE WJ

### Some unique features

The ordinary type of accumulator plate loses its charge and becomes sulphated, so that its full capacity cannot be utilised, if the cells be left for any considerable time, especially if they are already partially run down.

This is exactly what a high tension battery has to put up with, so that the ordinary plate is obviously unable to do itself justice, and the problem demands a new and special type of cell not subject to sulphation or loss of charge when standing partially run down.

Exide High Tension Batteries, type WJ, comprise cells of new and special design specifically developed for this duty, which they fulfil with a degree of success which has surpassed the most sanguine hopes of their designers, is the admiration of the whole electrical industry, and has not been approached by any other make of battery.

Their plates are of a special nature, differentiating them entirely from all other types or makes.

They will stand for six months at least without detriment or loss of charge, even when partially run down, so that their full capacity is available though the discharge be spread over such periods. They can then be recharged, and, reasonably cared for, will last for years.

Their discharge is steady, free from fluctuations, and ensures pure reception against a silent background that is a revelation.

They provide the most satisfactory source of H.T. in existence, superior to any other H.T. battery, definitely superior to any battery eliminator, and infinitely superior to dry batteries, which give an uneven and noisy discharge, deteriorate rapidly, and then need complete renewal. In spite of their advanced design, their price is low, and they are cheaper than dry batteries in the long run.

BEWARE OF IMITATIONS

Type WJ  
2,500 milli-amp. hrs.  
**15/-** per 20-volt  
unit.

Dry Batteries are  
out of date

Type WJ  
2,500 milli-amp. hrs.  
**9d.** per  
volt.

# Exide

## THE LONG-LIFE BATTERY

TYPE WJ  
20 Volts.

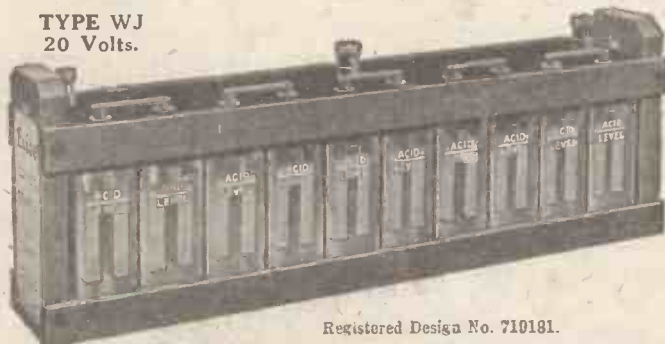

The Sign  
of  
Skilled Service.

OBTAINABLE  
FROM ALL  
REPUTABLE  
DEALERS

Registered Design No. 710181.



Above: One of the Valves being picked up after its 500 feet drop.

Below: The "Wireless World" man hands the Valves to Pilot.



Below: A Stentor Two Valve used for this test.



# The most daring test ever conceived

→Cossor valves dropped from an aeroplane at 500 feet to prove toughness of filament

THERE took place on Monday, December 20th, 1926, the most astonishing test to which any wireless valves have ever been subjected. Twelve Cossor Valves were chosen at random from stock by editorial representatives from "Amateur Wireless," "Popular Wireless" and "Wireless World." These valves were numbered and packed in the ordinary cardboard carton without cotton wool, corrugated paper or other absorbent material. They were taken direct to Stag Lane Aerodrome and handed to Capt. Barnard, the pilot of a "Moth" aeroplane, with instructions to drop them overboard one at a time at a height of over 500 feet.

The assistant Editor of "Amateur Wireless" accompanied the pilot.

Out of the 12 Cossor Power Valves which were thrown overboard the following were the startling results:

- 5 Valves were found to be in perfect condition (one landed on a corrugated iron roof and another on some wooden blocks).
- 5 Valves suffered from an internal derangement of the electrode system but the filaments were unharmed.
- 1 Valve was smashed to pieces through hitting the tail plane in flight (even in this case the filament was intact).
- 1 Valve fell out of range and was lost.

But in spite of the terrific drop and a 35 m.p.h. wind the filaments were intact in all valves.

This proves beyond question that the new Kalenised filament is the world's strongest filament. But only Cossor has the Kalenised filament—if you want long life, low current consumption and superb results see that your next valve is a Cossor.

Test carried out under supervision of "Amateur Wireless" "Popular Wireless" "Wireless World"

**TYPES AND PRICES.**

**Cossor Point One**  
 210H For H.F. use ... 14/-  
 210D For Detector ... 14/-  
 (2 volts 1 ampere)

**Cossor Power Valves**  
 Stentor Two ... 18/6  
 (2 volts 15 ampere)  
 Stentor Four ... 18/6  
 (4 volts 1 ampere)

All above Valves fitted with Cossor Kalenised Filaments

# Cossor — the Valve which serves you longest

# Popular Wireless

Scientific Adviser:  
 Sir OLIVER LODGE, F.R.S.  
 Technical Editor:  
 G. V. DOWDING,  
 Grad. I.E.E.  
 Assistant Technical  
 Editors:  
 K. D. ROGERS  
 P. R. BIRD  
 G. P. KENDALL, B.Sc.



Incorporating "Wireless."

Consultants  
 Dr. J. H. T. ROBERTS,  
 F. Inst.P.  
 J. F. CORRIGAN, M.Sc.,  
 A.I.C.  
 C. E. FIELD, B.Sc.,  
 E. J. SIMMONDS,  
 M.I.R.E., F.R.S.A.

Editor: NORMAN EDWARDS, M.Inst.R.E., M.R.S.L., F.R.G.S.

## RADIO NOTES AND NEWS.

An Important Discovery—Wireless Notes (Collected)—A Generous Reader—A Thousand and One (K)nights—The Wave Shuffle—Success of B.B.C.'s "S.O.S."—Have You Heard Japan?

### Birds of a Feather.

UNLESS it be a freak of my imagination, a certain sedateness has characterised the B.B.C.'s public radiations since January 1st, and they tell me that the number of bowler hats hung up at Savoy Hill has increased by forty per cent. Spats are on the increase, too, and the Third Oboe has stopped calling the hall-porter "Alce." I doubt whether they will ever let Sir Harry Lauder smile aloud in the studio any more. Well, let's hope I'm wrong. But, somehow, I can't get rid of the feeling that the C.S. tradition has begun its insidious work, and that already they think of the programmes as "agenda."

### An Important Discovery.

TURNING hastily to thoughts of brighter things, let us ponder on the speed of light. For some time past we have all felt comfortable about this, because we imagined it was settled, and we counted implicitly upon light and wireless waves being propagated at 186,326 miles per second. Now this is all upset, for, after three years' work Professor A. E. Michelson finds the correct figure to be 186,284. So, you see, light isn't so fast as we thought; it positively *crawls*. Very sad, too, about those three years, for we would have made the professor a present of the odd 42 miles a second if only he had told us what he was after.

### Wireless Notes (Collected.)

"THE U.S.A. is the only important country where 'listening' is free." Free from what? That's the important point. Minor poets, possibly—and distortion. I don't think.

"Austria, having issued 250,000 licences, is, considering the size of its population, the second country in broadcasting in Europe." Monaco is organising a Day of National Teeth-gnashing about this, thirteen of its citizens having allowed their licences to lapse.

"An amateur picked up the P.O. Transatlantic telephony on the day the service opened." The poor fellow thought it was a trunk call that he had put through the day before, and died of shock.

"A blue tit has built its nest in a loud speaker." The owner of the L.S. is doubtless still trying to find the sensitive spot on the valve, but the cat's-whisker keeps slipping off.

less brittle jaw—I would sing the praises of—er—that place I mentioned above.

### Lectures at the "Poly."

AN old friend to listeners, Capt. Jack Frost (late of the B.B.C.), begins on January 21st a series of four Friday evening lectures, entitled "Sidelights on Broadcasting," at the Regent Street Polytechnic. Time, 6 p.m. to 7.30 p.m. I judge from the synopsis of these lectures that they will be of great interest and utility to "fans," and also to the non-technical listener who is interested in the *modus operandi* of broadcasting.

### Technical Hint.

AN article appearing in the provincial press has touched me on a sore spot. It is entitled, "Getting the Most Out of the Accumulator." The most I ever got out was the electrolyte and all the plates, and therein lies a horrible warning. Once I had a battery—a cheap one—and it was enshrined in a celluloid case. I told an assistant to charge it all night and all the next day, but the scurvy knave, being full of theory about connecting things up, "pos. to neg. to pos., etc.," put the "pos. to neg." mains on to the "neg. to pos." terminals. When I arrived I found that the battery had sulphated itself up to the eyebrows, and the container had just opened out like a bud in spring; so the "most" had been got out of it. I don't use batteries now. I am getting the most

out of the mains.

### They Don't Do It.

BY the way, I don't know how you find it, but my experience is that oscillation has decreased splendidly, largely due, no doubt, to the enlightening influence of "P.W." But have you noticed the trouble in the ether when someone nearby gets a new set, and has to "twiddle"

(Continued on next page.)



The station director at the Helsingfors broadcasting station reading the news bulletin.

### A Generous Reader.

MY journalist's heart warms towards Mr. R. O. Williams. He is the sort of reader editors dream about, for he has a complete set of "P.W." and, excepting those issues covering the last six months, he is kind enough to offer them gratis to his fellow-readers. Address: "Siriol Fan," Llanfairfechan, N. Wales. If I had the Welsh gift of melody—and a

## NOTES AND NEWS.

(Continued from previous page.)

for a night or two before settling down? Just before Christmas my set was absolutely "spifficated." It leaked howls like a Yankee's luggage leaks alcohol. It screamed at me on every possible adjustment and, after I had overhauled it inside and out, changed the valves, glared at the aerial, and re-interred the "earth," I decided to close down rather than jam the whole of London. The next evening the results were similar, but two days later all was as before, and has so continued. I know for a fact that my next-door neighbour has installed a new receiver, and I believe I know the culprit now.

## Standardised Poles.

YOU will agree with me, I am sure, that the most sensible resolution ever passed by a city corporation—except the classic instance of that of Hamelin, where the Pied Piper got the contract—is the one whereby the Housing Committee of the Hull Corporation will provide wireless poles, brackets, and pulleys for the houses it is building; one pole to every four tenants, at 10s. per tenant. On the other hand, council houses don't generally look very pretty, seen in the lump, and I vote rather for better-looking houses, leaving the poles to improve with the growth of the æsthetic bumps of the tenants.

## A Thousand and One (K) nights.

I WAS aware that there are many crystal users; but, honestly, I thought most of them "crystallised" from force of circumstances (i.e. lack of means), rather than from choice. I am wiser now. There is a distinct cult, a well-defined school of thought, which holds that "little and good" is better than "bigger and worse." The Knights of the C.'s Whisker have made me requisition an extra letter-basket, besides reviving my love for the twopenny-ha'penny crystal set I chucked on to a top shelf many years ago.

## Another Convert.

MR. A. H. IVES (Oxford), like me, is going to reinstate Uncle Hertzite in his favour; or perhaps he prefers Aunt Carborundum. In the presence and with the aural confirmation of his neighbour, he has received on a crystal set Daventry, London, Manchester, Birmingham, Newcastle, Aberdeen, Glasgow, Cardiff, Bournemouth, and Radio-Paris. And five pairs of telephones on Radio-Paris. You pass, Mr. Ives; and thanks for your kind remarks about "P.W." I like to see an old hand like you enthusing about crystal work.

## More Evidence.

MR. H. J. BARNES (Enfield) thrusts his lance well and truly at the re-radiators and scores freely. He is none of your stay-at-home crystallographers, but plunges boldly across the Channel, ay! and across the Bay. His modest list is: Birmingham, Bournemouth, Radio-Paris, Madrid (ho!), Hanover (ha!), Stuttgart (gee!), Hamburg (hoch!), and our old friends Frankfort and Leipzig; these last two being quite regular "pick-ups" of good strength. Yes! for people who have not tender ears (like me) the crystal seems to be all that is necessary. Personally speaking, however, telephones are the

## Germany—His Ethereal Home.

MR. C. D. ROCHESTER (Desborough) in a fierce attack on the re-radiators, purposely chose to reach out for Frankfort and Hamburg at a time when those stations were delivering "long and solid talks." He is evidently a psychologist, for he argues that it would be an unlikely time for neighbouring valve-owners to be tuned-in to those stations, especially perhaps for five consecutive nights. Pretty convincing, though people perhaps tune-in not to see *what* they can get but to see *whether* they can get. Nevertheless, I admit his argument is weighty, but he should note that other Knights *have* received Paris and Barcelona.

## A Merlin Appears.

MY Round Table would not feel comfortable without a Merlin around, and Merlin has appeared in the shape of Mr. Butler (Stoke-on-Trent). He has proved conclusively that his reception of Frankfort, Hamburg, and Stuttgart was not due to re-radiation. Like the real Merlin of old, he does not reveal his secret, but I live in hopes of hearing from him. A proof "beyond doubt" is far above rubies and commoner crystals.

## Advance, South Africa.

JUDGING by what I hear from South Africa, they have advanced considerably in reception, for it is said that they have heard America on their crystal sets. That's a flip of about 8,000 miles. Well, as this startling announcement was made to Belfast Rotarians I suppose it is O.K. But it is

## SHORT WAVES

As a last request, a negro convicted of murder at Sing Sing, was allowed to listen to an entire radio programme broadcast from New York. After that the unfortunate fellow was probably very glad to die.—"Judge."

It is possible to understand Sir Thomas Beecham's dislike of the broadcasting of music; but it is difficult to understand that dislike of it should send him to—America. (Time and Tide.) It is suggested that he has taken his cue from Shakespeare's "Coriolanus": "Poor gentleman, take up some other station; here's no place for you."

"... Like several other men, I myself was once a small boy, and I can only say that an invention which has brought headphones into well-nigh every home, thereby rendering it less necessary than ever to wash behind the ears, is deserving of every encouragement."—"Passing Show."

"Plato on the Wireless," says a heading. This will B.B.C. with a vengeance.—"Star."

Apropos of a scheme under attention, the object of which is the equipping of lighthouses and lightships of Britain with wireless receiving sets, a cynical correspondent regrets that one by one the remaining places of refuge are being diminished.—"News of the World."

Wireless sets that will operate under water have been invented. This will be quite useful to those who intend spending their next summer holidays on houseboats.

They call him Mike because he broadcasts so much.—"Judge."

"Real Music by Wireless" (Headline, Morning Paper). Another remarkable era in radio.

A Brixton amateur claims to have broken all records; he says he ate a Neapolitan ice and got Chilli.

Francis Mistress: "Jane, Jane! Come quickly and take the parrot away—the master's just dropped his valve set."

certainly calculated to make one rotate, and it pushes my Frankfort and Madrid reports somewhat far towards the threepenny seats. Knights, it's your move.

## The Wave Shuffle.

A READER writes to say that since the new wave-lengths came into operation he has been unable to tune-in any English station except 5 X X, but, strange to say, has been getting Berlin, Prague and Radio-Paris better than ever. Looks like a conspiracy, doesn't it?

## Success of B.B.C.'s "S.O.S."

IT is gratifying to learn that on both occasions when the B.B.C. appealed for ass's milk, someone milked the donkey and saved the life of a baby. On the last of these occasions the mother had the milk *within twenty minutes*. Who would have thought it possible? It reminds me of the story of the wag who tried to baffle a great store by ordering a pint of fleas. The order was booked and later in the day the humorist was presented with a bill for the goods and a credit note for seven fleas. They had got nearly a pint, but were short by seven! So they said!

## Have You Heard Japan?

NO doubt this will be a common question in future, for Japan has ordered a wireless station sufficiently powerful for communication with Western Europe. It is, however, curious to note the confusion of terms and thought in the following sentence, taken from a well-known newspaper: "Current capacity at the transmitting towers will be between 550 and 600 kilowatts." Current is usually expressed in amperes, capacity in farads (or microfarads) and "kilowatts" refers to power. Moreover, the power is expected to be in the aerial, not in the towers.

## Radio on the Red Spots.

NO, Archibald, not scarlet fever, but those little red dabs on the map which indicate that the British flag is there. It cannot be said of the Briton that he becomes any less keen on "what people are doing" because he is stuck away on some two by four island five weeks steam from civilisation. On the other hand, the boot is on the other foot, so to speak, and he is really keener than ever. For instance, radio is all to the fore in British North Borneo—not that Borneo is a little island—and the Savoy Band is heard there, which is rather good reception, methinks.

## Amateur Empire Radio Chain.

THERE is another perspiring but enthusiastic gang of juice-wasters in Singapore who are keeping the Malaysian ether well strained. It occurs to me that it would be a fine thing if amateur transmitters were to form an Empire Chain of their own, and pass the glad word right round the empire once every time the sun (never) sets upon it. How it would buck up the lonely lads in the back blocks of Beyond if they could get a daily word or two from some kindly soul at home. To think of a cheery British slogan buzzing round the empire from one amateur's aerial to another's is rather jolly, I think, if you get into the right frame of mind. Now then, some of you organisers!

ARIEL.

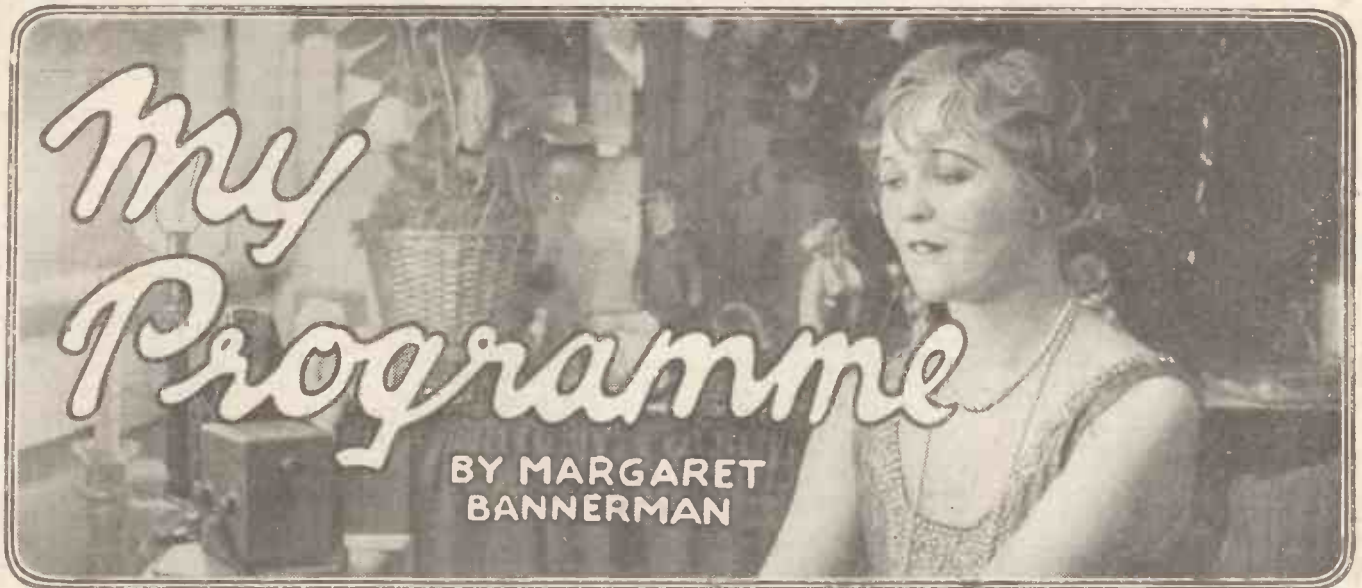

AS I sat on a small, rickety chair in a draughty corner late one night recently, bemoaning the fate of all those unhappy people who have to sit, if only for a while, on rickety chairs in draughty corners, I heard a voice like the tinkle of bells.

Behind the scenes of the Globe Theatre, Margaret Bannerman advanced, all smiles, and with hand outstretched.

"Do believe me when I say I'm so sorry to have kept you waiting, won't you?" she said.

**"I Love Wireless."**

We sat down next to a lime. Then we talked and talked of wireless and things in general.

"I love wireless and everything the word means," said Margaret Bannerman, with that beautiful smile that has charmed thousands of theatregoers. "I have a nice set at my home, and whenever I get the chance I try to listen-in, and believe me, I enjoy it very much.

"You can imagine my surprise and delight when the B.B.C. came to me and asked if I were willing to compose a radio programme all by myself.

"I was too thrilled for words. Wireless has always held me in awe, and the invitation to be connected with this marvellous invention left me somewhat dazed. However, I decided to accept, and the result was that one evening a few weeks ago I had the wonderful experience of presenting my very own programme from the London station, and what was an even greater thrill—I was my own announcer."

**A Difficult Task.**

I asked Miss Bannerman how she went about the not-too-easy task of composing a wireless programme likely to suit every taste.

"I racked my brains for hours on end, and I thought of all the things I liked in radio. I often read your articles on what the public likes and dislikes, and I thought, maybe, that my task would be an easy one. Alas, it was quite difficult.

"However, in the end, I managed quite well and my programme included, among musical selections, 'Decameron Nights,

\*-----\*

In this exclusive interview with "Ariel" Miss Bannerman expresses her views on broadcasting and tells her experiences when she broadcast her own programme.

\*-----\*

'The Mastersingers' and, as a change, an excerpt from 'Tip-Toes,' by Gershwin. I also included a song dedicated to Canada.

"I really felt very frightened," she went on, "but everyone was so charming that in a minute I was completely at ease."

Miss Margaret Bannerman's programme was one of the most successful in the interesting "My Programme" series, and



This handsome multi-valve cabinet set was entirely home-made by one of "P.W.'s" earliest readers.

it has proved one of the most popular heard for a long time.

Miss Bannerman is a great lover of music, but, on the whole, prefers serious to jazz music.

"I think, however, that modern dance bands are a welcome relaxation to the

somewhat heavy music one hears now and again," she remarked.

"I like dancing and I suppose I like jazz, but I like best of all beautiful music of the dreamy, sentimental kind. I think that good music loses nothing by being broadcast.

**Improved Broadcasting.**

"As a matter of fact, broadcasting has improved so much lately that I rather look forward to the programmes of good music. I think that violin solos and string music sound very well through the loud speaker.

"I have always realised the great advantages of wireless in out-of-the-way places, where people are not in a position to see much of everyday life and civilisation. I have travelled a great deal, and in small villages where I have been wireless is treated almost as a god.

"Broadcasting in hospitals is a great boon to the poor patients who are deprived of the sunshine of normal lives. I have often visited hospitals where I have been told that wireless is the greatest contribution to the happiness of the inmates."

**Letters of Appreciation.**

And, before leaving, Miss Bannerman added:

"Will you, through your admirable journal, tell your readers that I thank them from the bottom of my heart for the sweet letters they have sent me on the occasion of my first broadcast performance. I only hope that the B.B.C. will ask me again to do something, as I greatly enjoyed my experience at Savoy Hill.

"Now that I know more about it I follow the development of wireless broadcasting with even more interest, and I am sure it is blessed with a brilliant future."

And then, in her beautiful jade-green crinoline, Margaret Bannerman returned, amid applause, to the glare of the foot-lights.

As I threaded my way in and out of the "props" at the back of the theatre I wondered what the future would hold for broadcasting, how the Corporation would carry on, and whether the improvements we have all looked forward to for so long would materialise.

Some Useful  
Hints for the  
Constructor.

By

F. H. NEWRICK.

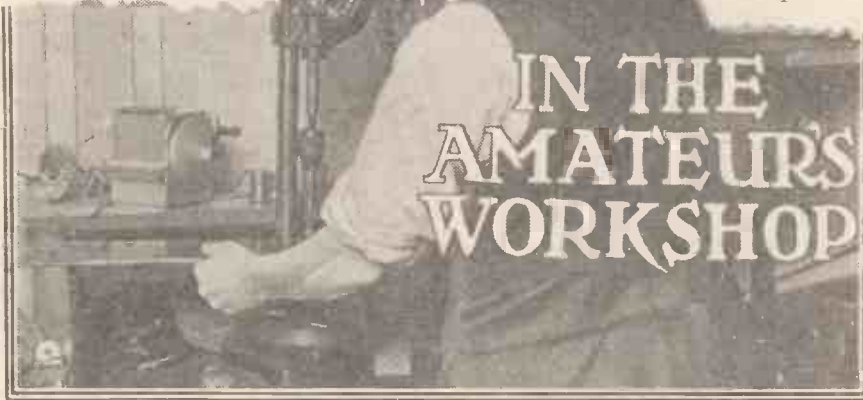

taken or a smooth, flat file and emery cloth; if a vice is used thin layers of soft wood should be placed over the metal jaws to prevent dents being made in the panel.

For marking the positions of holes, etc., a lead-pencil must

eight fluid ounces of methylated spirit. It will keep indefinitely in a corked bottle, the article of brasswork should be cleaned, slightly warmed and have the lacquer applied with a camel-hair mop.

Panel transfers are usually fixed by means of a hot cloth or iron, but a cleaner and quicker method is to moisten the transfer with methylated spirit, press it firmly on to the panel and when dry remove the backing paper with water in the usual manner.

A handy workshop cement possessing good insulating properties and great tenacity may be made by melting together equal parts by weight of resin and bees-wax, moulding it into sticks and using in the same manner as ceiling wax. It is useful for scores of purposes.

#### Some Soldering Tips.

For wireless work the author prefers to use a miniature copper bit weighing about 1 oz. and of the "hatchet" type, as this is a universally handy tool for small and accurate work. It should be kept hot in a small bunsen gas or spirit lamp flame in between times of use. The bit is the correct heat for use when the flame of the heating medium is evenly tinged with green and the bit must be kept well tinned and free from a pitted surface by means of a small file kept for the job.

A good non-acid flux should be used, such as "Baker's Fluid," a bare sufficiency only being applied to the points to be soldered to prevent "splashing" in places from which it would be difficult to remove it afterwards.

Most commercial brands of flux may be removed by means of a camel-hair mop saturated with methylated spirits, which is a wonderfully useful fluid to keep in a wireless "den."

A useful all-round medium for wiring-up is 16 S.W.G. tinned copper wire, and will be found much easier to use by the amateur than the square section busbar now principally sold for the job. It should be well stretched and cut into lengths of about 2 feet for handiness.

All wires should be cut and shaped to put into position before being soldered—that is, do not solder one end of the wire to a point and then try to bend the remainder to shape and solder the other end.

After the soldered joint is made and whilst still hot give it a clean-up with a rag containing a trace of clean tallow to remove surplus flux and charred dirt, if any.

Before passing a completed set on to the testing bench, all traces of dirt, grease, dust, etc., must be removed, the plates of variable condensers cleaned out with a clean feather or pipe cleaner and any lacquer removed from the contact surfaces of terminals, etc.

#### Preventing Rust.

All steel tools should be periodically cleaned with a greasy rag and edged tools such as chisels should be kept in racks with the cutting edges hanging down. Planes should have the irons knocked back to preserve the blades.

Saws used for ebonite should often be resharpened and set as they very quickly lose their edge and set if left for any time. Files should be thoroughly cleaned with a wire brush after use as if left they soon become badly choked and useless.

THERE is undoubtedly much good material spoilt every year by amateur constructors who have not gained the rudiments of constructional knowledge before commencing the construction of anything from the cheapest crystal set to the most expensive nine-valve super-het!

It is an old saying that we must all buy experience, but surely it were better to profit from the experiences already paid for by some other unfortunate, should opportunity occur.

The author—who has paid a considerable amount in this manner—proposes to pass on a few of the tips so acquired for the enlightenment of the beginners.

Use only the better-known grades of guaranteed ebonite; it has a clean black fracture, cuts easily with a tenon-saw or hack-saw blade—leaving a brown dust with a strong smell of indiarubber—drills without binding, and may be bent, within reasonable limits, if previously heated in scalding-hot water.

If guaranteed ebonite cannot be obtained the surface skin of both sides of that used must be removed with coarse emery cloth rubbed with a circular motion and finished off with fine-grained emery cloth and oil—it will not be worth while for the amateur to attempt a really glossy surface as this entails a most tedious operation, trying even to the patience of an ardent fisherman, either wireless or fresh-water.

#### Drilling Ebonite.

When drilling ebonite use engineers' twist drills with an ordinary joiner's brace—this is easier to use and control than a geared hand-drill—the panel being laid on a perfectly flat piece of soft wood to prevent the back edges of the holes chipping away under the pressure of the brace.

The use of turpentine is sometimes advocated as a lubricant when cutting and drilling, but the better method is to keep the drills sharp and the saw well set.

Panels should be marked off dead square with a scratched line and cut with a tenon saw or hack saw blade, being afterwards trimmed up with a small plane—ebonite planes quite easily if only fine cuts are

on no account be used as the graphite is exceedingly difficult to remove and may subsequently form undesirable leakage paths over the surface of the ebonite panel. The best method, in the opinion of the writer, is to draw a full size template on thin drawing paper and attach this to the front of the panel by means of a pop of gum at each corner, the centres of all holes then being "popped" through the paper on to the panel by means of a sharp centre punch and light hammer, the panel being perfectly flat on the bench or else a cracked panel may be the result.

#### A Useful Lacquer.

Where large holes are required, as for valve windows, a row of small holes may be drilled round the inside edge of the circumference and the centre piece removed, the raggy edges being cleaned with a medium-cut half-round file and if slots are required, as for a "Utility" switch, a row of holes are first drilled and then run together into a slot with the aid of a suitable flat file.

Now that soldered joints are the standard practice it is better to tap all terminal holes and screw the terminals tightly into the panel before tightening up the nut, securing same at back of panel; this system gives in effect a lock-nut and obviates the tendency of the terminal to become slack after soldering.

Before inserting screws into hardwood drill a guide hole with a suitable brad-awl, apply a trace of pale soap to the thread of the screw, and so obviate jammed or sheared-off screws.

It is often necessary to drive a small nail or brad near to the end grain of wood, when making a box, for instance, and if the point of the nail is first flattened slightly with a hammer no fear of cracking the wood need be experienced—this is a tip well worth taking note of apart from wireless construction.

Brass work which is near ebonite will quickly tarnish—owing to the sulphur fumes given off by ebonite, if not lacquered; a lacquer having a good body and colour may be made by mixing together ¼ oz. each of shellac, seedlac and turmeric in





IN the first part of this article some of the theoretical aspects of the Filadync circuit were considered. The importance of anode bias and the effect of battery connections were mentioned, together with the peculiarity of filament control and the similarity of the Filadync to a four-electrode valve circuit.

Coming now to practical details, there is a modification of the original circuit in which reaction can be obtained without either reaction coil or coupling condenser. This circuit works so well, and is so unlike any straight circuit, that a brief description may be of interest.

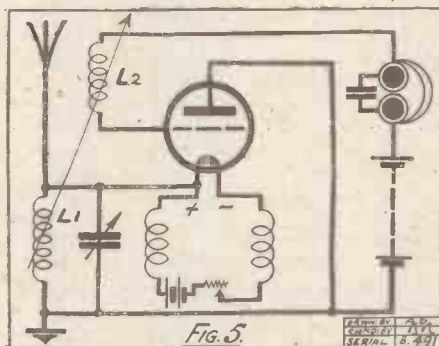

If the anode and grid circuits of Fig. 5 are traced out, it will be seen that the currents in both circuits flow through the tuning coil to the filament. Now Fig. 4 demonstrated quite clearly that every variation of grid current gave rise to an equal, but opposite, variation of anode current. Therefore, in Fig. 5 these two currents cancel out and actually no current flows through the tuning coil.

**An Improvement.**

Now the two currents can be separated if the H.T. negative lead is disconnected from earth and taken direct to the filament battery. The anode current alone then flows through the tuning coil. It so happens that the pulsations of this current are in just the right phase and direction to assist the incoming signals. This is actually equivalent to reaction, and when the anode is given a certain positive bias this boosting up is sufficient even to cause oscillation. This curious state of affairs is made use of in the modification

**PART II.**  
Some interesting practical details following on the theoretical aspects of the Filadync circuits discussed in last week's issue of "Popular Wireless."  
By J. ENGLISH.

mentioned above and shown diagrammatically in Fig. 6.

Anode bias is first of all adjusted to a suitable value for the valve in use. About 1.5 volts positive is a good value for both the D.E.3 and the D.E.R. When the local station is tuned in, it will be found that as the filament rheostat is turned towards maximum, signals become gradually louder and louder. Further increase in filament brilliancy causes the circuit to squeal. The receiver is then oscillating and, on slightly reducing filament current, signals come in remarkably strong and clear.

**Easy to Operate.**

The circuit of Fig. 6 is thus very simple to operate. The single condenser C1 tunes the set, while all reaction control is effected with the rheostat. For the reception of weak signals, reducing H.T. to about 20 or 25 volts gives better control.

Another circuit that yields some interesting results is obtained from Fig. 6 by connecting the negative bias lead to the negative side of the accumulator, and inserting a coil between the grid and the phones. This coil, when coupled to the

aerial coil, provides the necessary amount of reaction. For the best results, filament current should not be too high.

Now both the original and the modified circuits described above, while giving excellent results, suffer from certain disadvantages. The L.T. accumulator not being connected to earth is rather a disturbing factor, since a "floating" filament battery does not ensure the

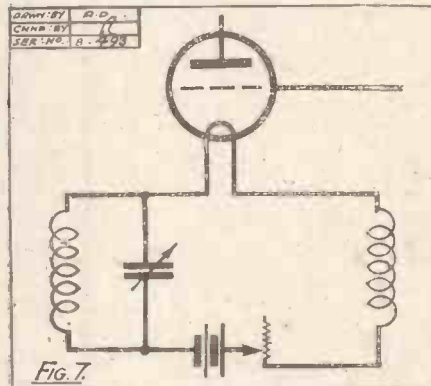

greatest stability. The filament battery cannot very well be earthed, because the H.F. impedance of the chokes in the filament leads is not high enough. Also, these chokes do not give a maximum efficiency on all wave-lengths. While two 250-turn chokes are quite satisfactory for the usual broadcast wave-band, they are almost useless above 1,000 metres. Any attempt, therefore, to overcome the disadvantages of the previous circuits resolves itself into an onslaught upon the H.F. chokes. Make these more perfect and the circuit will be greatly improved.

**Tuned Chokes.**

If I may be permitted for a moment to wander off into theory once more, it will be easier to show how and why this improvement in the choking system can be accomplished. The business of an H.F. choke is to stop the passage of H.F. currents, hence its name; and the more it resists these currents, the more nearly is it a perfect choke. Actually the nearest approach to the ideal is a coil tuned by a variable condenser. If the H.F. losses of

(Continued on next page.)

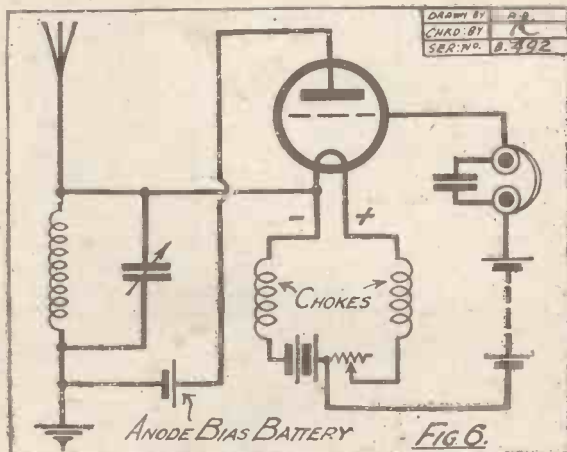

\*-----\*  
**EXPERIMENTS WITH THE  
 FILADYNE CIRCUIT**  
 (Continued from previous page.)  
 \*-----\*

both are small, then the impedance, choking effect, of the combination is extremely high when tuned to the same frequency as the H.F. currents. With a perfect coil and condenser the value of this impedance in ohms would be infinitely large. This is actually the principle of tuning with a condenser in parallel with the aerial coil, and of "tuned anode" H.F. coupling.

absolutely stable and well-behaved, while its exceptional efficiency as a one-valve receiver must be experienced to be believed. As would be expected, the improvement in the filament choking system results in an appreciable increase in the volume of signals. This is especially noticeable when receiving weak signals. Stations that are difficult to tune in on the other circuits are comfortably audible on this receiver, because the better H.F. isolation of the filament improves the working of the phantom grid.

**Anode Bias Adjustment.**

The two tuning coils should be wound, for preference, with 22 D.C.C. wire, so that the minimum of extra D.C. resistance is introduced into the filament circuit. In any case, with 2-volt valves it is better to use a 4-volt accumulator with a large rheostat. Sixty turns on a 4-inch former for each coil is suitable for a band of 250 to 550 metres. Alternatively, the two coils can be wound as one, using insulated twin bell wire, putting about 50 turns on the same size former. This type of double coil, while ideal in some respects, does not permit tappings to be taken when it is desired to use an auto-coupled aerial circuit. It can be used, however, with marked economy of space in the circuit of Fig. 9 described below.

In operation, anode bias plays an important part, filament control not being quite so critical as in the previous circuits. Fig. 2 helped us to visualise why the best results were obtained when anode bias was adjusted to bring the working-point on to one of the bends of the curve. Similar conditions apply in this circuit for reception of strong signals such as the local station, but when we go farther afield more reaction must be used to bring in the distant stations.

It is here we find a distinct relation between anode bias and reaction control. Backlash or unstable reaction adjustments are very noticeable when anode bias is adjusted for maximum rectification. This instability disappears, however, when bias is adjusted to bring the working-point more on to the straight sloping part of the curve, usually about 3 or 4½ volts positive. A potentiometer is very useful for fine adjustment of bias, but it is not absolutely essential. Working near the lower bend appears to be the best for most types of valves when receiving weak signals. Filament current should not be too low, but increase beyond a critical value results in the loss of signals as in the other circuits.

**Adding an L.F. Stage.**

For the reception of the local station only, it is an extremely simple matter to adjust anode bias and filament current for loudest signals, but in DX work a little more care is necessary. Experiment will soon find the best adjustments for both, and then distant stations will be received in a most pleasing manner. A little practice makes this one-valve receiver an excellent one for touring the Continent on the 'phones.

The addition of a low-frequency stage to the Filadyne one-valver raises interesting points, because we have here a detector valve of low internal impedance. Actually the D.E.R. under usual Filadyne conditions has an impedance of only 17,000 ohms, which is half the normal value. If a transformer is used between the Filadyne and the L.F. valve, a high ratio instrument with a small primary gives excellent amplification. In fact, the Filadyne, when adding L.F. amplification, should be treated as a medium impedance (Continued on page 1287.)

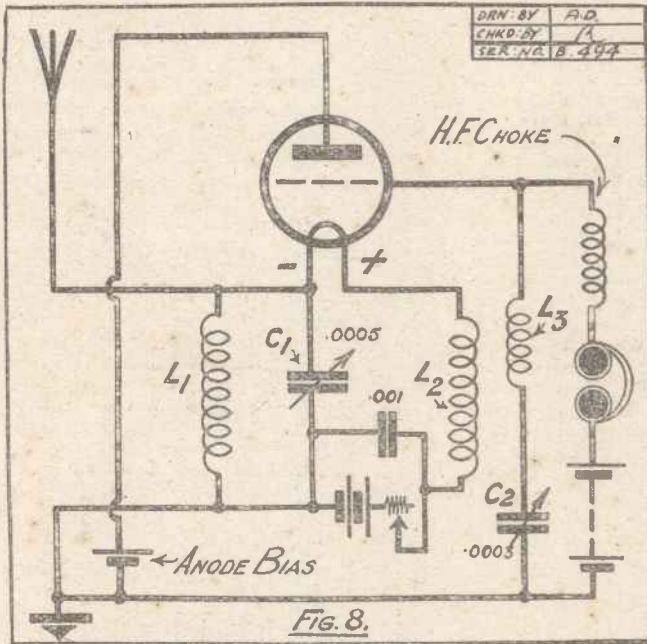

Fig. 8.

Reverting once more to the Filadyne circuit, it occurred to me that this principle might be applied to this circuit in the following manner. Two aerial coils of the same size connected in parallel with a tuning condenser also in parallel are, for tuning purposes, the same as a single coil with a condenser in parallel. Actually, two coils are better. However, both coils can be tuned to the same frequency by the one condenser, so that if we send the filament current up through these coils, one for the negative and the other for the positive lead, we shall have an exceptionally efficient choking system. The tuned coil in each filament lead now constitutes the nearest approach to the perfect choke that it is possible to have.

**The Best Circuit.**

The proposed filament connections are shown in Fig. 7, from which the principle of the thing will be more apparent. Since both inductances are aerial coils and choke coils, the very act of tuning automatically makes the impedance of both chokes a maximum for H.F. currents, whatever the wave-length. The filament battery can now be earthed without in any way upsetting the circuit. On making the remaining connections as usual, the circuit of Fig. 8 is obtained.

This is far and away the best Filadyne circuit that I have yet handled; it is

so useful for DX work. The magnetic form of reaction coupling can be used if desired by removing L3 and C2 and replacing the H.F. choke by a coil which is then coupled to L2 for reaction effects.

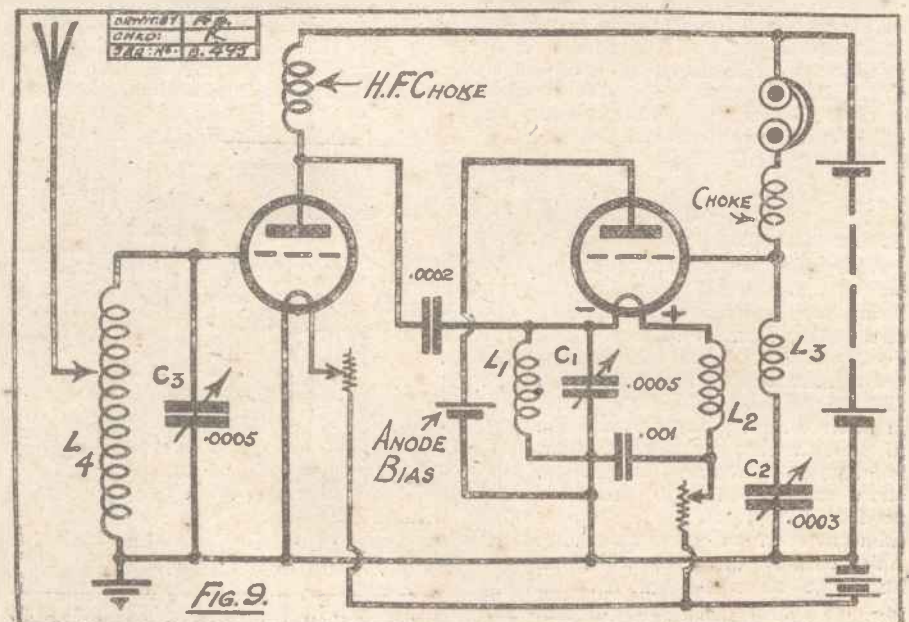
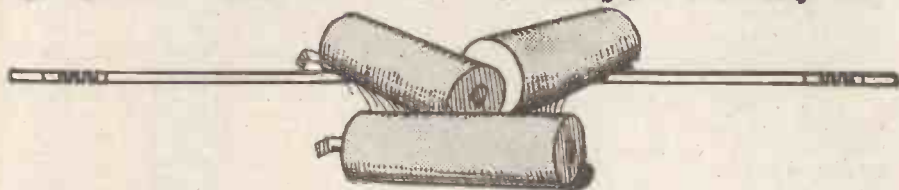

Fig. 9.

# MAKING UP H.T. BATTERIES



With the advent of the super-power valve and its accompanying heavy drain on the H.T. supply, the advantages of the wet type of high-tension battery are rapidly being realised. In this article our contributor explains how a reliable H.T. unit can be made up by the home-constructor with a minimum of expense.

BY A CORRESPONDENT.

QUITE a number of amateurs are now making up H.T. batteries from small wet cells of the Leclanché type. This system of H.T. supply is rapidly increasing in popularity owing to its relative cheapness and the good results obtainable. In fact, a wet battery properly constructed is almost as good as an H.T. accumulator, for it is silent in discharge, will provide quite a considerable anode current, and will

The larger the cell, of course, the longer its life, with a correspondingly bigger current capacity. Therefore, the bigger the cells you can make up the better, but where economy has to be studied, a cell equivalent in size to that of the standard flash-lamp battery is quite satisfactory. The choice of this size enables us to use the carbon elements obtainable from old H.T. dry batteries, etc.

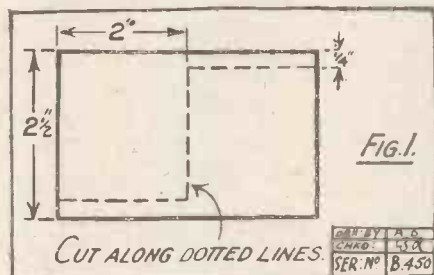

last for a very long period. The great thing is that it is cheaper than an accumulator in initial outlay and recharging costs.

Another attractive feature of this type of battery is that the positive and negative elements, together with suitable glass jars, are now widely retailed, and this makes it easier for the amateur to assemble quickly an H.T. battery of any desired voltage.

### Important Details.

Now, when making up this type of wet battery careful attention to certain constructional details will avoid much disappointment. Too often poor results are due to the neglect of such details, which, although apparently of minor significance, are nevertheless of vital importance in obtaining the best results. Therefore, it is hoped that the methods outlined in this article, based entirely on the writer's past experiences, will assist other amateurs in avoiding the pitfalls that await the unwary.

Raw materials are naturally the first consideration, and the choice of these will depend upon the size of cells to be used.

### Utilising Old Batteries.

Provided you are handy with the simpler tools, all that need be purchased are the glass jars, for your friends will be only too glad to get rid of their dud H.T. batteries, which will furnish an ample supply of carbon (positive) elements. Sufficient zinc (negative) elements to make up a 60-volt unit can be cut from two-shillingsworth of zinc.

Of course, better results would be possible if fresh positive elements were purchased, but in these hard times economy must be

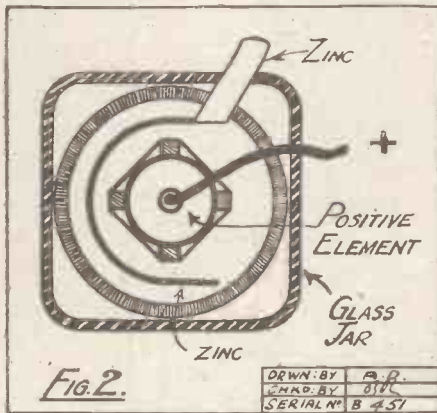

practised. Let us therefore be content with our reclaimed positives. Now, the zinc elements for these should have a large area in contact with the active fluid (electrolyte). It is quite a common mistake to use too small a zinc insufficiently close to the

carbon element. For use with the reclaimed positives you will require pieces of zinc equal in height to the thickest part of the latter, and about 2 1/2 in. wide, these being the minimum dimensions for this size of cell. The ideal shape for the zinc element would be a cylinder surrounding the positive as closely as possible. Now, it is rather a difficult job to make zinc cylinders without special apparatus, so that we have to effect a compromise by using U-shaped or three-sided box-shaped pieces of zinc. These will give the necessary large area and close proximity to the positive elements, these being vital factors for the best results.

### Opening the Cells.

The necessary number of negative elements can be cut in pairs without waste from pieces of zinc, as in Fig. 1. This will leave a nice long soldering tag on each. After cutting out, each zinc can easily be bent with pliers to the desired shape. If you use stout sheet zinc not less than 1/16 in.

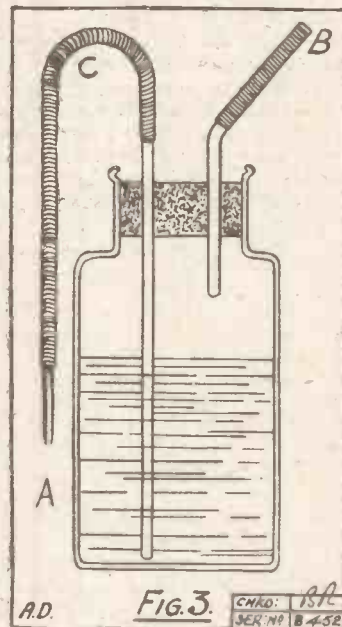

thick, the battery can be recharged several times before you need worry about fresh zincs.

The first step in reclaiming the positive elements from exhausted batteries is to separate the individual cells.

Each cell is then broken up by slitting the zinc casing with a chisel, taking care not to cut too deeply, or the cotton covering of the positive element inside will be injured.

Each positive consists of a small carbon rod surrounded for three-quarters of its length by a cylindrical mass of the depolarising compound, the whole being bound up in a cotton bag or covering.

For our purpose it is necessary to salve these positives intact, without either destroying the cotton coverings or pulling off the brass caps on the tops of the projecting carbon rods. When all the cells have been broken up, choose only those positives which have sound and clean brass caps.

The positive elements so reclaimed from exhausted batteries need a thorough wash and brush up and a chemical "monkey gland" before they are ready for assembly

(Continued on next page.)

## MAKING UP H.T. BATTERIES.

(Continued from previous page.)

They will generally be covered with a more or less hard white deposit, and the best way to remove this is to stand them all in a dish (not metal) and pour in a weak solution of sal-ammoniac, just up to, but not covering, the brass caps. After standing for a day or so the white deposit will have become sufficiently soft to be easily scraped and washed off.

The "monkey gland" process consists of standing the elements once more in the empty dish and pouring in a strong solution of potassium permanganate (Condy's crystals) to the same level as before and allowing to stand for twenty-four hours. This operation will partly restore the depolarising element to its original freshness. After rewashing, the rejuvenated positives should be dried, especially the brass caps, and set aside for the next operation.

### Assembling the Units.

This consists of so treating the positive that it cannot possibly touch the negative in the same jar. This is a most important point, and a little extra care here will amply repay you for your trouble. An effective and simple method is to take four match-sticks, place them lengthways at equal distances round the fat part of the positive, and secure top and bottom with a small rubber band (Perry & Co., No. 8). Don't forget to cut off the match heads or all kinds of queer chemical reactions will be set up when the active liquid is put in!

The next step is to join together the positive and negative elements in pairs, which is best done before assembly. It is a bad plan to solder the projecting strip of zinc direct to the brass cap on the carbons, as, when assembled in the glass jars, it is a difficult job to get the proper alignment so that all the elements are nicely spaced and all standing upright. The best way is first of all to tin carefully the brass caps and projecting zinc strips and then join a positive to a negative with a 2-in. length of tinned wire not thicker than 22 S.W.G. The pairs of elements are then sufficiently flexible to be waxed into their correct positions in the jars. (Fig. 2.)

### Preventing Corrosion.

After soldering up the elements in pairs, leaving one of each for the beginning and end cells, the tops of each pair must be treated to prevent creeping and corrosion.

If this is not done you would find that after a month's use the exposed metal parts of the battery would all be covered with beautiful white, green, and blue growths, the metal parts falling to pieces at a touch. Then good-bye to the battery so carefully constructed! Therefore, this insulation of exposed metal surfaces must be very thoroughly carried out, using a coating of either vasoline or paraffin wax. The latter is more permanent and durable, provided that the tops of each pair of elements are dipped in very hot wax so that the whole of the brass cap, connecting wire and projecting zinc strip are well covered. An even better, though slightly more tedious method, is to use sealing-wax dissolved in methylated spirit as a coating. One or two pairs before coating may have a

length of wire soldered on to provide a tapping point.

The constructional steps outlined above may sound more complicated than they really are, but if you have progressed satisfactorily so far the rest is plain sailing. As a container for the battery you will require a wooden box big enough to accommodate all the cells and deep enough to allow an inch or two above their tops. A close-fitting lid will then retard evaporation of the electrolyte. A good plan is to paint the bottom of the box with hot paraffin wax and then put in your glass jars. Then the elements can be carefully assembled. A useful size of jar is one 2½ in. deep inside, and having a mouth 1½ in. in diameter. The positive, negative, and tapping leads should be soldered to the shanks of valve sockets or terminals mounted on a strip of ebonite screwed over a slot cut in the front of the box.

The final stage of construction is to fill each glass jar with the electrolyte. Now, the strength of this is important, as too strong a solution of sal-ammoniac tends to give rise to the formation of numerous crystals of a double chloride of zinc and ammonia. This is not really harmful, but is best avoided if possible. Also, if the solution is too weak, each cell will not give its full voltage. A satisfactory strength of solution is obtained by adding powdered sal-ammoniac to, say, a pint of water until no more will dissolve, and then add an equal quantity, that is one pint, of water.

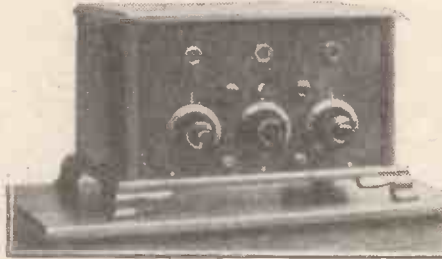

A neat three valve receiver constructed by one of our Somerset readers.

Now comes the delicate operation of filling each cell. If this is done with a small jug or such-like receptacle the chances are that you will pour more solution into the box than into the cells. The only satisfactory method is to use what chemists call a wash bottle. This can be made up quite easily from a bottle with a well-fitting cork and a few pieces of glass and rubber tubing, as shown in Fig. 3. By inserting the end A into the cell, and blowing down B, the cell can be filled without spilling any liquid, the flow of which can be stopped instantly by pinching the rubber tubing at C. The level of the electrolyte in each cell should be just above the top of the zinc element. This will be well below the level of the brass cap on the positive element.

### Concerning Maintenance.

Now that the battery is finished you may be anxious to see what its voltage is. This should not be done, however, until the cells have stood for a few hours. It can then be tested with a voltmeter, but a cheap instrument must not be used or you will get very misleading results. If properly constructed each cell should read about 1.4, so that 45 cells will give just over 60 volts. When you use the battery with your receiver, its superiority over the dry cell type will soon become apparent.

Regarding maintenance, the drop in the level of the electrolyte due to evaporation should be made up every month by means of the wash bottle, using either distilled or boiled water. Recharging at a future date can be done quite easily. First remove the exhausted electrolyte by working the useful old wash bottle in the opposite way—that is, sucking out air at B. This will draw all the liquid out of the cells, which can then be refilled with a fresh solution of sal-ammoniac, as in the first instance.

## B.B.C. EPITAPHS.

### The "Evening News" Competition.

THE London "Evening News" competition for the best B.B.C. "epitaphs" produced some very clever and amusing efforts. The following is an extract from the "Evening News," which we print with due acknowledgments to our contemporary, and with compliments on the success of a most amusing and novel competition:

The shortest and neatest of all comprised only 11 letters, and was sent by Mr. Peter Baxter, 27, Dorset Square, N.W.1. His epitaph was simply, "Well Earthed."

Another epitaph was sent in by Mr. Henry Carver, of Claremount House, St. Mary Cray, Kent. His epitaph runs: "It began well, did its best; but the suburbs won."

### An Unkind Comment.

An excellent, unkind comment from Miss Gladys Peor, 7, Elmhall Gardens, Wanstead, was: "Laid in your right place, and I hope you'll never be 'relayed.'"

A good many quotations were submitted, but most of them were too familiar, and lacked any special reference to the deceased. But Mr. R. T. Warner, of 4, Collingham Road, S.W.5, found a good one in Shakespeare's "Tempest," Act I, Scene 2: "Thou hast done well, fine Ariel."

Of many epitaphs built up on the lines of an acrostic, the one sent by Mr. L. J. Martin, 3, Waterloo Road, S.E.1, certainly deserves publication. It runs:

Being	But	Can
Religiously	Retribution	Officialdom
Inclined	Overtakes	Mercy
They	All	Provide
Intensified	December	Amusement
Sunday's	Came,	Next
Horrors.	And	Year?
	Saw	
	Their	
	Ignominious	
	Nullification.	
	Good!	

Of those in verse, the following was sent by Miss Eleanor Farjeon, 137, Fellows Road, N.W.3:

To that last Inn at last you've come  
Wherein all Sojourners are dumb.  
Lie down, Tired Guest, and hush your din;  
You, too, have joined the Listeners' Inn.

And here is another good four-line epitaph, from Mr. P. Simpson, of 16, Dumbarton Road, S.W.2:

Here lies our B.B.C., deceased,  
"Shut down"—bereft of breath.  
In life, he was too eloquent,  
And talked himself to death.

IT was my lot, at Christmas, whilst on a visit to Cornwall, to experience a particularly bad case of beam interference.

The station, situated in very open country, was five and a half miles south of Bude, N. Cornwall, and about thirty miles north of Bodmin. Perfect reception of Daventry was maintained until November last, when the set, a 1-valve straight reaction, refused to function. No attempt was made to ascertain the cause of the failure at the time, as the user preferred to await my visit at Christmas to put it right again.

On my arrival I tested the set, and found all in order except the H.T. battery, which I promptly replaced with a new one. Full of hope, I tuned in Daventry as before. The reception could only be described as awful. A sort of rhythmic sound of dynamos running at high speed, plus a peculiar "choppy" effect on the reception of music, etc., which vainly strove to come through, together made such a tantalising sound as made one want to tear out one's hair by the roots.

When the announcer said the usual "Good-evening, everybody," the words came through as if they had been passed through a mincing machine and sounded like "Go-oo-od-ev-ev-en-en-ing-ing ev-ev-ry-ry-bod-bod-y." Sometimes perfectly clear reception would come through for about fifteen seconds, then cease entirely for another fifteen seconds, and end up with a lengthy period of the staccato effect exemplified.

Changing the coils to 300-500 metres had no effect on the interference, which was maintained, all day long, on all wavelengths. For two days I wrestled with the trouble, substituting new batteries, phones, valve, etc., etc. I had luckily brought with me two new sets, a 2-valve 0-v-1 and a 3-valve 1-v-1, together with ample spare equipment of every kind. I replaced the 1-valver with the 2 valver, and also the 3-valver, and although the latter had given perfect reception in London a few days previously, the results in each case were as bad or even worse.

#### An Earth "Skin" Effect.

Obviously the fault did not lie in the set, as it would be a million to one chance that three sets should be equally faulty in the same respect, although any one might conceivably be faulty in some respect. I therefore turned my attention to the aerial and earth, as it was clear that the fault was there somewhere.

The aerial was poor, the earth good, so I concentrated on the former first. At the far end it was supported by a pole 25 ft. high, but the receiving end ran down to a short bamboo pole strapped to the wooden upright of a galvanised iron verandah, 12 ft. high. This aerial ran almost due north and south.

Without touching it in any way, I erected a new aerial running east and west from a pole on the top of the chimney of another

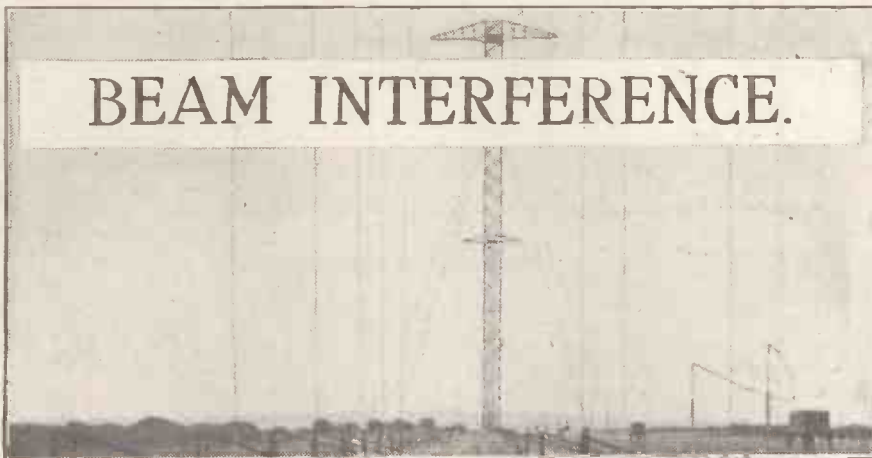

## BEAM INTERFERENCE.

This article describes an interesting example of beam interference in Cornwall and how it was successfully overcome.

By C. G. PHILP.

house to a pole 35 ft. high behind the house. This aerial was practically 35 ft. high at both ends, and might be classed as a good aerial. Reception was made in the house as before, but in a room 15 ft. west on the same level. Reception was perfect!

The set, which was completely self-contained, was at once disconnected and taken to the original aerial. Reception, as before, was awful. Back again to the new aerial—reception perfect. And so, to and fro, the sets were tried, always with the same result on all three sets.

Clearly the trouble lay either in the direction or altitude of the original aerial. Accordingly, the receiving end was lifted from the verandah to a pole fastened round the chimney of the house, so that the original height of 12 ft. was increased to 25 ft. As a result, reception was now perfect on either aerial with all three sets, and has been consistently maintained.

I am of opinion that the interference was an earth "skin" effect, radiating from the earthing system of the Bodmin beam station, and acting with capacity effect on the low end of the original aerial. This would account for the sound like the hum of dynamos. As Bodmin is transmitting regularly to Canada only on about 26 metres, it is extremely unlikely that this low wavelength would interfere with Daventry on 1,600 metres. Moreover, no trouble was ever experienced on the 35-ft. aerial.

There is the possibility that the galvanised verandah was having a capacity effect on the original aerial; but I prefer the earth "skin" effect theory.

I may say that, despite thirteen years' experience with wireless sets of all kinds, I should certainly have given up the job as hopeless, had I not the good fortune to have other and more powerful sets I could substitute. In this way the trouble was clearly and definitely located to the aerial of the earth system.

#### Eliminating the Trouble.

To all Cornish listeners who are troubled by interference of the kind I have described, I recommend the following "cure."

1. Substitute the existing set for another and more powerful set, after making quite certain that the batteries are in order, and that the valve is functioning properly. This will locate the trouble as in the aerial or earth.

2. Raise both ends of the aerial to at least 25 ft., and higher if possible.

3. If this fails, erect an entirely new aerial at right angles to the existing one, and instal a new "earth."

4. See that the aerial nowhere passes over galvanised roofing, wire fencing, etc.

Based on my experience, the result should be perfect reception judging by that previously obtained.

Readers who have experienced similar forms of interference to that described by our contributor, will be rendering a service to other amateurs if they will forward full details to us for publication in our correspondence columns—Ed.

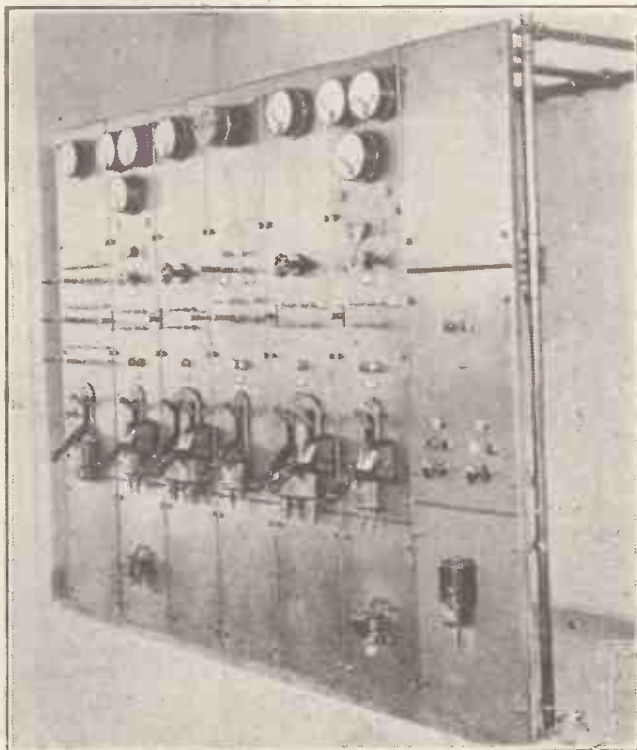

The main control panel at the WJZ station, Boundbrook, N.J., America.

# TECHNICAL NOTES.

A Weekly Feature Conducted by

Dr. J. H. T. ROBERTS, F.Inst.P.

I SUPPOSE one of the most popular crystals used as a detector is galena, the reason for its popularity being its sensitiveness, together with the fact that it does not require any applied potential difference across the contact. On the other hand, galena has the drawback—which it shares with many other crystals—that it is not particularly stable.

## A Stable Detector.

For stability, the carborundum crystal holds its own, and in this connection it should be mentioned that, although it is usual to apply a voltage across the contact of a carborundum crystal by means of a small battery and potentiometer, this is not absolutely necessary, and, in the case of strong signals, it may be quite unnecessary. If a carborundum crystal detector is used on signals from the local station at comparatively short range—in other words, if the signals are quite strong when applied to the detector—it will be found that the carborundum works perfectly well when used in exactly the same way as the galena crystal, a steel contact being, of course, used with the carborundum.

There is a great deal to be said in favour of the carborundum detector, since it has the advantage of stability, and yet is not, in these circumstances, much below the galena detector in sensitivity.

by lightning and atmospheric, but also in respect of their "distance-getting" qualities. My experience of underground aerials, however, has always led me to believe that their advantages are limited to the former, and that in regard to their sensitivity they are much surpassed by a reasonably efficient overhead extended antenna.

Underground aerials are usually provided with loading coils, and sometimes with condensers, which have the effect of improving their efficiency over that of an ordinary insulated conductor under the same conditions.

Another point to bear in mind with regard to underground aerials generally is that hand-capacity effects will, as a rule,

proverb applies particularly to the wireless receiver and the loud speaker. If the output on the low-frequency amplifying side is already distorted, the loud speaker, however efficient it may be, can do no more than reproduce what is supplied to it.

Some manufacturers are now taking steps to assist users of their products to standardise the last output stage. One manufacturer has supplied valves specially suited to be employed with his loud speakers, whilst another company have placed upon the market an elaborate loud speaker complete with low-frequency valve-amplifying system.

## The Rice-Kellog.

Probably the most complete, and certainly one of the most perfect, loud-speaker equipments ever produced—at any rate, for amateur purposes—is the Rice-Kellog. The low-frequency amplifying system is contained in an attractive cabinet, and may be supplied with a unit which enables the current necessary for operating the device to be drawn from the electric-light mains, whether these be of the A.C. or D.C. variety.

For actual reception an ordinary receiving circuit may be used, the output of this being supplied into the low-frequency amplifying system contained in the cabinet as mentioned.

The loud speaker unit itself has many special features, and is the result of long experiments by Messrs. C. W. Rice and E. W. Kellog, of the research laboratory of the General Electric Company at Schenectady. An account of this experimental work is published in the journal of the American Institute of Electrical Engineers for September, 1925.

A system of permanent magnets is used, and the actual vibrating element, which is of the cone type, is provided with a small coil which is located in the strong magnetic field created by the arrangement of permanent magnets mentioned above. The speech currents, which, of course, are very considerably amplified by the L.F. amplifying system, are passed through this coil, which thus has a vibratory motion imparted to it, owing to its presence in the magnetic field, corresponding to the variations in the speech current. It is claimed that the natural frequency of vibration of the diaphragm system is below the lower limit of the operating range, so that for all practical purposes the system may be considered to be aperiodic.

One very interesting point in the design of the sound reproducing part of the apparatus is that the sound from one side of the diaphragm is retarded to the extent of a quarter wave-length (of the longest sound wave dealt with) behind the sound from the other side of the diaphragm.

(Continued on page 1287.)



Examining one of the Super-hets. on view in the radio section of the South Kensington Museum.

be considerably increased, and means may have to be employed for counteracting these.

## Better Loud Speakers.

Great improvements have been made in loud-speaker design during the past three or four years. I suppose it is only about four years ago since it was almost impossible to obtain a loud speaker in this country. I recollect distinctly requiring some loud speakers in connection with a series of lectures, and having the greatest difficulty in securing them.

Although immense improvements have been made, and the loud speaker of to-day is really a fine example of an efficient mass-produced article, it is now coming to be realised more and more that it is little use having an efficient loud speaker unless the receiving set, and particularly the output stage, is correspondingly efficient. It is said that the strength of a chain is that of its weakest link, and this

It is interesting to try the effect of disconnecting the set from the aerial and earth, and connecting the earth to the aerial terminal, leaving the earth terminal idle; in other words, using the earth lead as an aerial and doing without any earth. This arrangement may sometimes be found useful in cases of thunderstorms or severe atmospheric; but, of course, the reception range is apt to be considerably reduced, and consequently the method will usually be limited in its application to the local station. Moreover, it may be necessary to use a somewhat larger aerial coil.

As you are no doubt well aware, underground aerials have been put on the market at various times, and great claims have been made for them, not only with regard to their freedom from interference

# NOW A Brandes CONDENSER

STRAIGHT LINE FREQUENCY SLOW MOTION LOW LOSS

It will be obvious from the table of new B.B.C. wave lengths given below that a condenser in which the dial reading varies directly as the frequency will give a more uniform separation of stations than one in which the dial reading varies directly as the wave length. This is particularly apparent in the lower wave lengths.

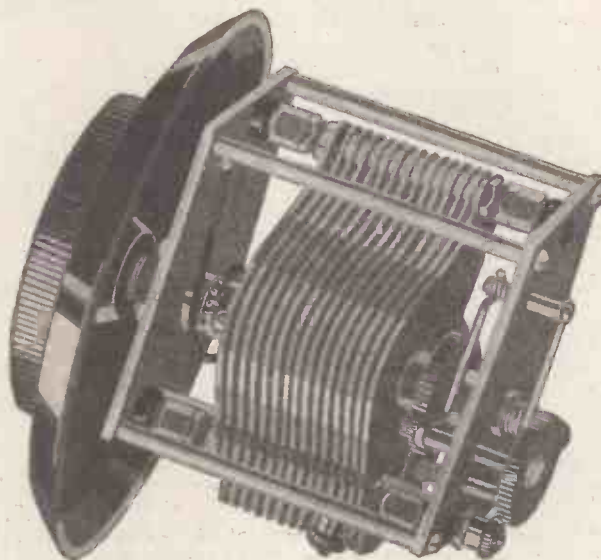

Brandes Straight Line Frequency Slow Motion Low Loss Condenser has been specially designed to provide a straight Line Frequency tuning characteristic and to bring in the B.B.C. Stations well spaced out over the major portion of the dial, whilst at the same time maintaining the compact form which is so very essential in the back-of-panel instrument.

A typical tuning curve is shown below ;—

With this condenser a positive movement for approximate setting is obtained by turning the 4" diameter dial which is provided with finger grips for this purpose. The final critical setting is obtained by turning the 2½" knob which actuates the slow motion mechanism.

Low dielectric losses and the complete absence of backlash are ensured.

Price '0005 = 18/6  
'0003 = 18/-

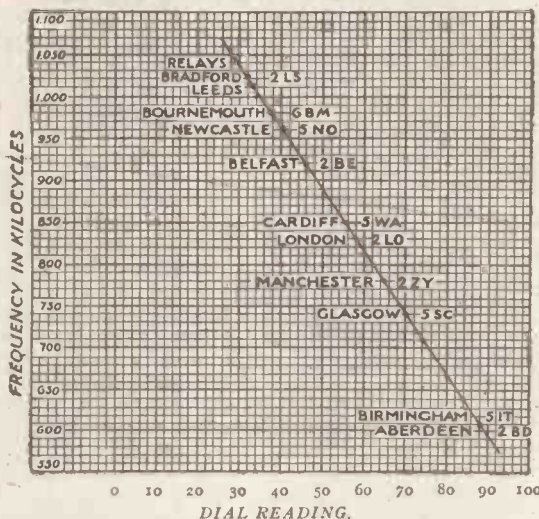

Actual curve of Brandes '0005 mfd. S. L. F. Slow Motion Condenser used with a loose-coupled circuit comprising No. 35 untuned aerial coil and No. 50 tuned secondary coil.

The following table shows the new wave lengths of the B.B.C. stations with their corresponding frequencies :—

Call Sign	Station	Wave Length	Frequency
2 BD	Aberdeen	491.8 metres	610 k.c.
5 IT	Birmingham		
5 SC	Glasgow	405.4	740 "
2 ZY	Manchester	384.6	780 "
2 LO	London	361.4	830 "
5 WA	Cardiff	353	850 "
2 BE	Belfast	326.1	920 "
5 NO	Newcastle	312.5	960 "
6 BM	Bournem'th	306.1	980 "
2 LS	Leeds	297	1,010 "
	Bradford	294.1	1,020 "
	Other Relays	288.5	1,040 "

### Numerous Advantages :—

1. A handsome 4" dial engraved with clearly marked divisions and provided with finger grips for the approximate setting of the condenser.
2. The large knurled knob 2½" diameter operates the patent vernier mechanism for fine or critical tuning.
3. A minimum quantity of highest quality ebonite ensures low dielectric losses.
4. The single hole fixing bush has a knurled face to ensure a firm grip on the panel.
5. Ball bearings fitted into cone shaped races prevent shake and backlash.
6. A pigtail flexible connection ensures perfect

- contact between the frame and the moving vane system.
7. Brass vanes and spacing collars chemically cleaned ensure perfect contact.
8. Conical bearings at base prevent shake and backlash.
9. The Slow Motion is transmitted to the moving vanes through a carefully designed friction clutch by means of a train of wheels having a finely knurled surface which ensures a very smooth reduction movement without jump or slip.
10. Specially designed spring bearings keep the

train of wheels in intimate contact and by exerting a gentle pressure on all the moving parts entirely eliminate backlash. This Condenser will provide a Straight-Line-Frequency tuning characteristic with the stations within the B.B.C. frequency range well spaced over the dial. The shape of the moving vane is designed to provide a small compact condenser having a straight-line-frequency tuning characteristic without taking up a large back-of-panel space. Most other S.L.F. Condensers have a long narrow vane with a very wide swing, taking up a lot of valuable space at the back of the panel.

# NEGATIVE RESISTANCE.

It is sometimes stated that the correct way of expressing the electrical effect of regeneration is to say that it introduces negative resistance into the circuit concerned. This article clearly explains what this apparently contradictory term signifies.

By A CORRESPONDENT.

WHILST the term "negative resistance" is one which is continually cropping up in technical wireless literature, the expression is nevertheless one upon which all radio amateurs are not altogether clear, and therefore it is proposed in this article to give a brief but concise exposition of the subject, and in entirely non-mathematical language.

### What Resistance Is.

In the first place, however, it is necessary for us to obtain a clear conception of the meaning of the term "resistance" itself. It is rather loose thinking to be satisfied with the idea that the resistance of a circuit is represented by the amount of impedance

which it offers to a current flowing through it. Of course, if we make a statement such as that, the implied facts are right, but, all the same, they have not been put into what the

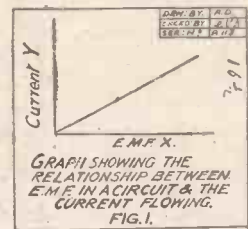

philosophical highbrows would call "scientific phraseology."

It is better, therefore, to say that the resistance of a circuit is that ratio of the applied potential to the current flowing through it. If the circuit is an inductive one, an extra amount of E.M.F. will be set up in it, and therefore, very strictly speaking, we ought to define resistance as the ratio of an electro-motive force acting upon a circuit to the resultant current flowing. That is the definition of resistance pure and simple, and we may call such a resistance a positive one.

### An Opposite Effect.

The graph, Fig. 1, indicates the relation between the E.M.F. acting upon an ordinary electrical circuit and the current which flows through it in consequence. X is the E.M.F., whilst Y represents the current flowing. It will be noticed that the graph is a straight line, and thus the current flowing is directly proportional to the E.M.F. in the circuit.

Suppose now we take the case of the resistance set up in a circuit by an ordinary carbon arc junction. In this case it is found that in the graph obtained by plotting the E.M.F. against the current a straight line is not obtained. A curve results instead, and has a shape something like that indicated in Fig. 2. Thus, in the case of an arc, an increase in E.M.F. in the circuit results in a decrease of current flowing. Or, if you prefer it the other way about, an increase of current requires a decrease of E.M.F. Within limits, this is a characteristic of an arc, and it should be noted that as the current flows across the arc from the direc-

tion of high potential in the direction of low potential, the resistance which is set up is a positive one.

However, if we superimpose an oscillatory current upon the steady one in the arc circuit, we shall then have a direct potential difference across the arc junction, and also an oscillatory or alternating potential difference.

Under these circumstances the alternating current will pass through the arc in the opposite direction to that in which the steady current flows, the reason for this being that when the oscillatory or alternating potential difference of E.M.F. is across the arc in the same direction as the steady E.M.F. the total potential difference across the junction is increased.

### Negative Resistance.

However, the resultant total current flowing will be less, because part of the oscillatory current will be flowing in the reverse direction. Thus, although the ratio of the total current to the total E.M.F. is positive, the ratio of a part of the current to a part of the E.M.F. will be negative. The circuit, therefore, is said to offer a negative resistance to the oscillatory current.

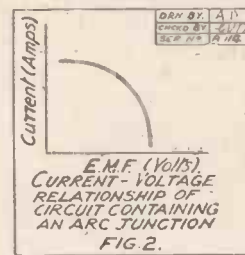

A valve has two potentials acting upon it, viz., a direct and an oscillatory potential, the latter, of course, being supplied by the incoming impulses on the grid. Thus it can have a positive and a negative resistance. If the negative resistance of the valve circuit is greater than its positive resistance, the oscillatory current flowing will not tend to die out in the ordinary way.

### The Building-up Process.

On the other hand, because the negative resistance helps in maintaining the oscillatory current, such a current, if the valve is connected up in a suitable circuit, will tend to increase in amplitude. The oscillatory current will build itself up, as it were. This building up of the current from very small beginnings would, under ideal circumstances, go on practically for ever.

Such theoretical circumstances, however, are not attainable, for, in practice, the negative resistance of the valve to the oscillatory currents is found to decrease as the amplitude of the oscillations increases, so that eventually the negative resistance becomes equal to the positive one. Under these conditions there is no more increase

in the amplitude of the oscillations which the valve generates, but they are maintained constantly at that amplitude.

### Effect of Reaction.

The commonest method of producing a condition of negative resistance in a valve circuit is to couple the grid and anode circuits inductively; that is to say, to use an ordinary inductive coupling, as indicated in the diagram, Fig. 3. Here an increase in the coupling between the two circuits lowers the positive resistance of the circuit, and increases its negative resistance to oscillatory currents. When the negative resistance is greater than the positive one, the valve begins to oscillate. These oscillations, as has been indicated above, tend to increase in amplitude, but, as their amplitude in-

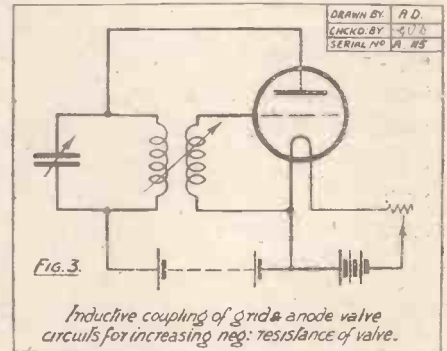

creases, the negative resistance of the circuit decreases, so that when the total effective resistance in the circuit resulting from the presence of the positive and negative resistances is equal to zero, the amplitude of the oscillation is maintained constant.

This property of the valve when employed under these conditions is practically applied in the well-known Armstrong super-regenerative circuit by means of giving a positive potential to the original valve in the set, and applying the incoming aerial oscillations to it. One half of the cycle of incoming oscillations is stopped by the positive potential of the grid, the other half is built up when the valve is in a state of negative resistance.

### Limited in Practice.

It should be remembered that a valve does not possess negative resistance in itself. It is only made to acquire that property by being specially constructed or by being arranged in suitable circuits. Valves which are specially intended for negative resistance working are known under several names, among which the terms "Negatron" and "Pliotron" are the more common.

The subject of negative resistance is of interest, not only on practical grounds, but also on account of the theoretical possibilities which its application seems to allow. Of course, in the very strictest sense of the term, a true condition of negative resistance would result in an applied steady potential in the one direction giving rise to a similar and equally steady potential in the other direction. This is, however, merely a theoretical conclusion, and, like many other speculations of that nature, its practical demonstration has certainly not been accomplished. If it is ever carried out, a new and startling working principle will be established in electricity.



# GIVE YOUR VALVES THIS ENERGY—

You can tell at once that your valves like this LISSEN New Process Battery because of the bigger volume, the smoother power through the loud speaker.

Here is energy in a battery which is unadulterated—its fine characteristics are uniform, too, right through the battery.

There is a deep capacity and such a reserve that this LISSEN battery does its work effortlessly night after night—standing up to long continuous programmes in a way no ordinary battery does. The secret of the new process is jealously guarded and exclusive to LISSEN.

Your dealer sells this battery. Ask him for LISSEN New Process and take no other. If any difficulty send direct to factory.

The LISSEN New Process Battery is rated at 60 volts, but goes considerably higher.

## 10/6

(Price would have been 13/- but for our new distribution policy.)



Hear your LISSENOLA working off this LISSEN battery to know what a good loud speaker and a good battery can do together.

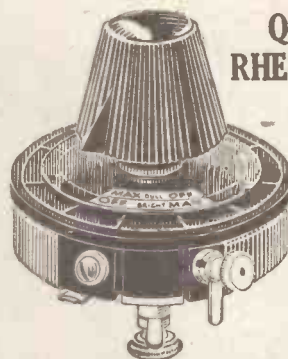

## QUALITY RHEOSTATS

Previously 4/-

NOW  
**2/6**

LISSEN quality—look how they are made—the wires cannot move and short circuit—the contact brush rides firmly yet smoothly—the heat-resisting former cannot soften—there are accessible terminals—and the combined knob and pointer will fit flush with the neat photo-engraved dial when mounted. Lastly, note the irresistible appeal of the price, made possible by our big production programme backed by our new direct-to-dealer distribution policy, which cuts out all wholesale profits.

LISSEN 7 ohms rheostat, patented	Previously	NOW
" 35 " " "	4/-	2/6
" Dual " " "	4/-	2/6
" Potentiometer, 400 ohms	8/-	4/6
	4/8	2/6

Every One LISSEN One-Hole Fixing, of Course.

Baseboard mounting type same prices as above.  
**QUICK TO FIX AND  
HANDY TO USE**

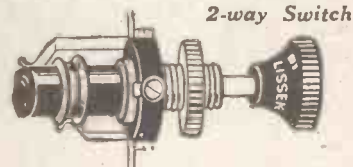

2-way Switch

There is a LISSEN switch for everything you want a switch to do. Ask your dealer for the appropriate LISSEN switch, and you will get a real radio switch. LISSEN one-hole fixing explains itself.

LISSEN 2-way	Previously	NOW
Series-parallel	2/9	1/6
Double Pole, Double Throw	3/9	2/6
Key Switch	4/-	2/6
	2/6	1/6

## A VALVE HOLDER FOR CLEARER, BETTER SIGNALS

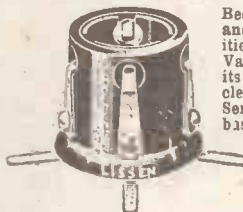

Because of its low loss and low capacity qualities, the LISSEN Valve Holder plays its part in getting clearer, louder signals. Sent out ready for baseboard mounting, as shown, it can also be used for panel mounting by bending the springs straight.

**LISSEN VALVE HOLDER**  
(Patented),  
Previously 1/8 NOW 1/ Each

**LISSEN LIMITED,**  
8-16, FRIARS LANE,  
RICHMOND, SURREY

BROADCASTS BY 'TONE' & 'POWER'  
*The 'Boon' Companions of Osram Valves*



**And Here's  
 Another  
 Masterpiece!**

A NEW OSRAM VALVE

**D.E.L.612**

(Dull Emitter, Low Impedance, 6-volt, 0.12 amp.)

"Now we've got it," exclaimed "TONE" excitedly. "Absolutely," replied "POWER" with emphasis. "A new 6-volt dull emitter that will take the place of the extravagant bright emitter, that consumes less than one-sixth the current hitherto necessary, and is sold at the remarkably low price of 14/-."

"What pleases me most," added "TONE," "is the fact that the OSRAM DEL.612 gives all the benefits of a 6-volt valve for purity and greatest volume with low upkeep cost at the same time."

"But don't forget," said "POWER," "that we've done just as well for listeners who use RESISTANCE COUPLING with our other new valve, the DEH.612, and this one also only costs 14/-."

Price 14/- each

from all Wireless Dealers.

**Osram  
 Valves**

for TONE & POWER

*The G.E.C. - your guarantee*

# Some Colloidal Detector Experiments

By J. F. CORRIGAN, M.Sc., A.I.C. (Staff Consultant.)

THE ranks of wireless enthusiasts are not devoid of individuals who, from continual use of the present-day methods of crystal and valve rectification, have come to regard these modes of radio reception as being more or less fundamentally final. The crystal and the valve, in their different spheres, imagine the above individuals are so efficient and productive of satisfactory practical results that it is difficult to imagine how they may be improved upon.

Well, the answer to that sort of reasoning is this. Science, and applied science in all its branches, seldom admits the word "final" to be used in conjunction with it. There is always room for improvement, no matter how good and efficient anything may be, and, as for pure scientific know-

ledge, the greater the amount of knowledge we obtain, the more numerous the array of scientific advances and practical discoveries which are made, the more thoroughly we realise the illimitable vista of unknown things which lie in front of us.

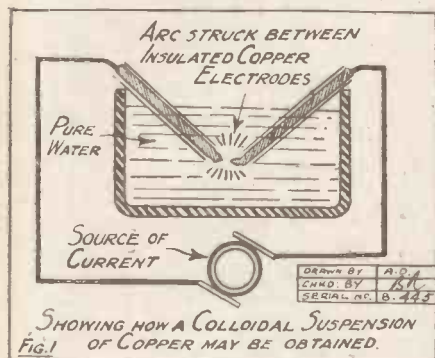

SHOWING HOW A COLLOIDAL SUSPENSION OF COPPER MAY BE OBTAINED. FIG. 1

but it cannot be very well related here. However, during recent years much work has been carried out in this country, in France, and in the United States on colloid physics, and one of the results of this research has been the construction of experimental colloid rectifiers and amplifiers which can be used in connection with radio reception. So successful have some of these rectifiers been that a number of them seem to be in a very fair way of being utilised in actual radio practice.

The colloid rectifiers and amplifiers do away with the use of valves, and as they are liquid in nature, they have most naturally been termed "liquid valves."

However, before dealing with the experiments which have been conducted with these interesting devices, perhaps it would be best, for the benefit of my non-technical readers, if I give a brief explanation of the meaning of the word "colloid."

### Radio-Sensitive Suspensions.

If we dissolve a quantity of pure salt in warm water, the salt entirely disappears during the process. It has, in fact, "gone into solution," and by that we mean, in a general way, that the molecules of salt have given up their solid form and are held in combination in some manner between the molecules of the liquid. You may, in fact, take a drop or two of the salt solution prepared as above, and place it under the most powerful microscope, but, nevertheless, no particles of salt will you see.

Now, there is a very large class of substances which behave very differently when they are treated in this manner. These substances, known generically as "colloids," include such things as starch, glue, gums, resins, finely divided particles of sulphur, selenium, metals, and other elements. If we attempt to dissolve a colloidal substance in water, what happens is this: the particles of the substance appear to absorb the liquid, and they are ultimately held in suspension in the liquid. Thus, the substance is not actually dissolved by the liquid, although the state of suspension of the substance in the liquid may be so fine that the liquid itself may appear perfectly clear and transparent when held up to the light.

### Interesting Electrical Properties.

They both have their attendant disadvantages, and, very naturally, scientists have not been lacking who have attempted to seek new modes of rectification and amplification. Several years ago, however, it was shown that colloidal solutions, or "colloidal suspensions," as they should more correctly be called, possess some very interesting electrical properties, and this discovery turned the attention of several scientists towards a closer study of these interesting bodies.

The history of colloid physics, especially on its electrical side, is an interesting one,

There is another class of colloids known as *suspensoids*, these being the colloids which are of interest in connection with the possibility of using them as amplifiers and detectors. A suspensoid does not absorb water like an emulsoid does; its particles merely entangle themselves with the liquid, and retain their solid nature.

Suspensoids are usually completely insoluble in water, and they include such substances as finely divided metals, sulphur, and other similar elements, and inorganic materials.

### Preparing the "Solution."

Colloids of the suspensoid class are readily made. For instance, a sulphur colloidal suspension may be made by adding small amounts of acid to ordinary hypo solution until the solution takes upon itself a milky appearance. This milkiness is really due to particles of sulphur which have been precipitated in an extremely fine state of division. Each individual particle of sulphur is perfectly solid, but it is so fine that it does not sink down to the bottom of the liquid, but remains in suspension.

Similarly, one may prepare colloidal suspension of almost any known metal by chemical means. Another method of preparing a colloidal suspension of a metal consists in striking an arc under water between electrodes of that metal. For instance, as in Fig. 1, if an arc be struck under water between two copper electrodes, extremely fine particles of copper will be torn away from the electrodes and held in suspension by the liquid, thus forming a copper colloid.

The technique of colloid preparation forms a big subject in itself, and therefore we can only merely refer to it in a very general outline, as above.

When a colloidal suspension of, say, a metal, is examined under the ultra-microscope, the particles of the metal suspended in the liquid are seen to possess a continual rapid motion. A similar motion to this was discovered by Brown, as far back as 1828, and the motion is generally known as "Brownian motion." Now, the causes of this motion are electrical in nature. Each particle carries a negative or a positive

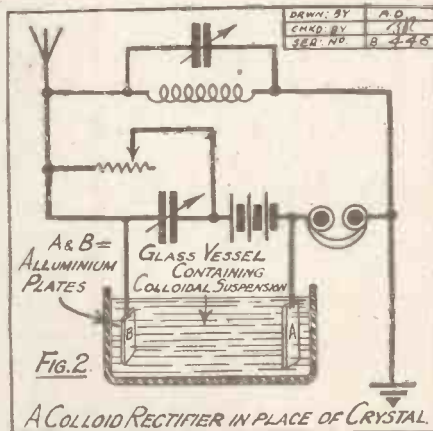

A COLLOID RECTIFIER IN PLACE OF CRYSTAL

charge, and the motion is usually understood to be the result of the mutual repulsion of these charges.

The idea which inventors of colloid rectifiers and liquid valves have been working at will now be straightforward for the reader to grasp. If these extremely fine particles are continually in motion, they may be

(Continued on next page.)

## SOME COLLOIDAL DETECTOR EXPERIMENTS

(Continued from previous page.)

considered to be analogous to the heated filament of a valve. And, therefore, it is reasonable to suppose that if two electrodes charged up to different potentials are placed in the colloidal suspension, the colloid particles will take upon themselves the task of transporting the radio impulses of current in a manner similar to that in which the thermionic valve exercises its function.

In fact, there is really no element of supposition in this statement. The thing actually works out in practice, despite the fact that the colloidal particles are enormously bigger in size than the electrons which are emitted from the filament of a valve.

### French Success.

The French experimenters have been the most successful in their efforts to devise a liquid valve of this nature. They have employed many varying kinds of colloidal suspensions, but the ones which give the most favourable results are colloidal preparations of silver, sulphur, selenium, gold, copper, iron, and nickel. Sulphur colloid, however, appears to have been the one which has been the most used.

Fig. 2 illustrates the manner in which sulphur colloid has been employed for the rectification of radio signals. Two aluminium sheets are immersed in a glass vessel containing a quantity of the sulphur colloid. The sheet A is four times as big as sheet B, and it is arranged in the circuit in such a manner that it replaces the crystal of an ordinary crystal detector, sheet B replacing the cat's-whisker. A potential from a local battery is given to the plates. Under these conditions radio reception is said to come in

A method of employing a colloid cell as an amplifier is illustrated at Fig. 3. This method, originally due to the German experimenter, Herr Niemhold, is illustrated in Fig. 3. In the diagram it will be noted that the colloid cell is placed across a circuit consisting of the secondary of an L.F. transformer, a source of current supply, a large capacity condenser, and the primary of a telephone (step-down) transformer.

Still another circuit of this nature will be seen at Fig. 4. In this circuit, something analogous to the grid of a valve is employed. It is a controlling electrode which is placed in the colloid between the positive and negative electrodes. Here, whilst the two

placed a doubly wound electro-magnet. One of the windings of the magnet carries a small steady current, provided by one or two cells, so that a constant electro-magnetic field is set up around the colloid cell. The other winding of the electro-magnet carries the impulses of radio current to be amplified.

Now, when a radio impulse comes along, it momentarily increases the strength of the magnetic field. This acts inductively upon the conductivity of the colloid cell, and the result is that a small additional amount of current from the batteries in the cell circuit passes into the headphones.

In this manner a considerable amplification effect is obtained. Like many other colloid rectifiers and amplifiers, however, the cell soon wears out, owing to the coagulation and increase in size of its particles. Reversing the cell current and the local magnet current diminishes this tendency to wear out to some extent, but, despite these precautions, the cell will not run for many hours without complete deterioration.

### Research Required.

The subject of colloid rectifiers and amplifiers is still being investigated, as a reference to the recent publications of the French Academy of Sciences and other journals will show. In fact, several patents have been taken out for such devices. It is unfortunate, however, that most of these papers omit many important details which are necessary to the experimenter. For instance, it is difficult to learn the exact manner in which the colloidal suspensions employed in the experiments are prepared. There are many different modes of preparing colloids, and it is only to be expected that colloids prepared by a certain process will

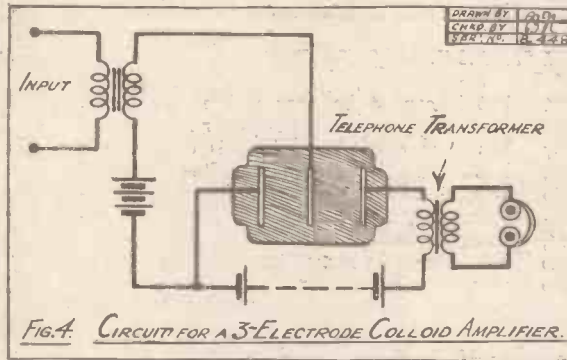

FIG. 4. CIRCUIT FOR A 3-ELECTRODE COLLOID AMPLIFIER.

latter electrodes are charged up to a differing potential, the third (middle) electrode conveys the impulses of radio current to the cell. These act on the colloidal particles electrostatically, increases in the strength of the incoming radio current impulses creating corresponding increases in the conductivity of the cell, and vice versa.

### Magnetic Effects.

Moreover, by the use of this circuit the cell can be run over considerably lengthy periods, provided the direction of the H.T. current is frequently changed. The circuit acts best as an amplifier pure and simple; and increases in the amplification ratio may be obtained by arranging a number of these cells so that the current is amplified by progressive stages, as in a cascade series of amplifying valves.

One remarkable property of these colloid cells is that many of them can be influenced in their conductive properties by a magnetic field. Such a property has been taken advantage of in another form of colloid amplifier of liquid valve.

The circuit for the above purpose is shown in all its essentials in Fig. 5. The electrodes

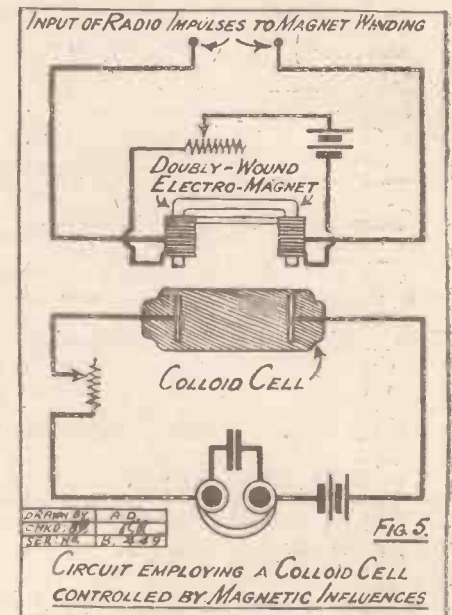

CIRCUIT EMPLOYING A COLLOID CELL CONTROLLED BY MAGNETIC INFLUENCES

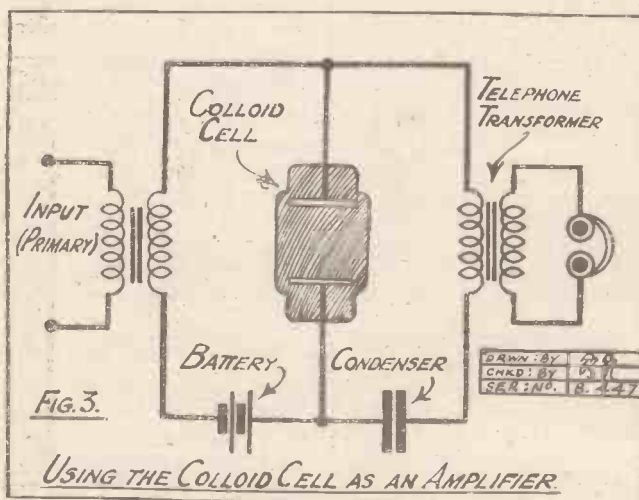

FIG. 3. USING THE COLLOID CELL AS AN AMPLIFIER

well over distances of up to 12-15 miles from a station of average power.

The great trouble with this colloid detector, and indeed with all of them so far, is that it rapidly loses its rectifying power after use. This effect is due to the increase in the size of the colloid particles, thus making it impossible for them to transport the radio charges.

of the colloid cell are connected in series with a supply of current, a regulating resistance, and a pair of headphones. In the most refined apparatus there exists a device for minutely varying the distance of the electrodes apart. This, however, for the purpose of simplicity is not indicated in the diagram, Fig. 5.

In close proximity to the colloid cell is

afford better results in this class of work than colloids made by other methods.

Naturally, this article is only intended to give the reader a brief outline of the work which has been and is at present being conducted in this field of radio research. The possibilities involved in the work are considerable, and experimental investigations are well worthy of consideration.



# SOLITARY AND SUPREME—

You may think there can be no better transformer for the circuit than the one specified in the booklet or publication whose instructions you are building to—until you remind yourself that there are many advertising manufacturers, each of whom you will find obtains a share of use and mention of his products. Then you will understand that the best transformer and other parts have not necessarily been specified.

You may think you have to pay a high price before you can get a transformer capable of yielding amplification of the kind that will please you. This may have been so before the new LISSEN came, but now it is so no longer.

You may have an expensive transformer which has broken down, and might have decided to have it re-wound. Do not do so—get a new LISSEN.

You may think it impossible to get a good transformer for the price this new LISSEN is sold at—but this new LISSEN transformer bears a name which stands for the better things in radio.

**TO ALL AND EVERY OBJECTION WE HAVE ONE ANSWER—TRY THE NEW LISSEN.**

**WE GIVE YOU A 7 DAYS' TEST.**

If within that time you do not prefer the new LISSEN Transformer for tone, purity and power to any other transformer, irrespective of price, against which you may test it, return it within a week of purchase and your money will be refunded.

**8/6** GUARANTEED FOR 12 MONTHS  
 TURNS RATIO 3 to 1. RESISTANCE RATIO 4 to 1.  
 Use it for 1, 2 or 3 stages L.F. It is suitable for all circuits and valves you will want to use.

In its conception, in its price, in its popularity, this new LISSEN is solitary and supreme. It is saving set builders £30,000 a month in the purchase of their transformers alone.

It will save you money, and **MORE THAN SATISFY YOU.**  
**RELY ON YOUR OWN JUDGMENT IN BUYING—CHOOSE YOUR OWN TRANSFORMER—LET IT BE A NEW LISSEN—remember the 7 days' test offer.**

## USE LISSEN FIXED CONDENSERS, TOO (Mica and Mansbridge Types).

### Lissen Mica Type Condensers

Small energy-conserving condensers—note the new case which enables the condenser to be used upright or flat. At present the new case is available only in the most used capacities, but will quickly become a LISSEN standard.



Capacities—  
 .001 to .001 1/- each (much reduced).  
 .002 to .006 1/6 each (much reduced).  
 Accurate to 5%—they never leak—they never vary.

### Lissen Mansbridge Type Condensers

To a fine LISSEN quality condenser is added the specially moulded case—the condenser cannot short circuit on to its case. The new LISSEN case protects you if the condenser is used in any circuit connected straight on to the electric light mains. And due to our new policy of direct-to-dealer distribution this LISSEN Condenser costs no more than the ordinary type.



.01 to .09	2/4
.1	2/6
.2	2/8
.25	3/-
.5	3/4
1.0	3/10
2.0	4/8

### LISSEN FIXED GRID LEAKS

A case of these was left on our factory roof during the summer of 1925, soaked in rain, baked by sun, and the resistance value of these leaks never altered.

All capacities, previously 1/8. Now 1/- each.



Improve every circuit by using LISSEN parts wherever you can—save money, too—for now you get keen prices as well as fine quality.

**LISSEN LIMITED,**  
**8-16, FRIARS LANE,**  
**RICHMOND, SURREY.**  
 (Managing Director: Thos. N. Cole.)

READ THESE  
OPINIONS  
FROM USERS  
OF THE  
R.C. THREESOME

"... I am truly astonished at the results. It is indeed all you claim for it. It is at present reproducing on a — Cone Loud Speaker which, as you are aware, requires considerable volume to work it efficiently..."

W. J. B., Croydon.

"... it is an extremely fine circuit. There is absolutely no 'mush,' and the musical instruments come through perfectly..."

A. J. H., Farnworth.

"... I am delighted with it, the reception is really a treat..."

R. H. B., Manchester.

"... my friends and myself are absolutely astounded at the results. 'Beautiful, mellow, natural reproduction, with an abundance of volume,' are the words of your advertisement and it cannot be emphasized too much..."

H. J. R., Wolverhampton.

"... am delighted with it..."

G. S. B., Richmond, Surrey.

"... I have now made the set, never having done anything of the sort before. It really is excellent, very clear and true... I picked up Newcastle and Swansea and some French station on the London coils, on 'phones (London closed), and I got Paris on Daventry coils quite loud on loudspeaker..."

R. G. M., Tunbridge Wells.

"... The tone is absolutely real... This is a champion..."

"... It is a £20 set for half... BEST OF ALL..."

T. R. H., Coventry.

"... entirely satisfactory and surpasses my expectations..."

H. O. E., Brockley, London.

"... a wonderful set and simplicity itself in operation..."

K. B., Ollerton.

THIS REMARKABLE SET HAS  
DELIGHTED THOUSANDS  
THE R.C. THREESOME

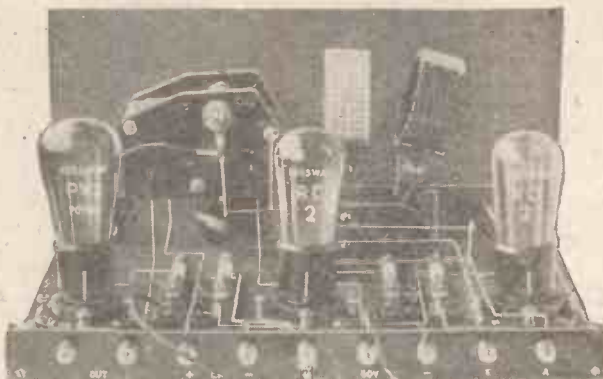

THE fine performance of the R.C. Threesome Resistance-Coupled Receiver has resulted in many glowing tributes being received.

Builders of this remarkable receiver now enjoy wireless reception of a standard hitherto unknown, yet the R.C. Threesome is so simple in design that it can be built in an evening.

Its tone is wonderfully mellow... its volume is abundant and free from blare and distortion. One dial control for both local station and Daventry reception.

The two new EDISWAN Valves—R.C.2. and P.V.2.—are the secret of the success of the R.C. Threesome.

Every user of valves should seriously consider the merits of the new EDISWAN Quarter-watt POINT ONE ECONOMY Valves, the types which have won the enthusiastic endorsement of the public. Ask your dealer about them.

**FREE BLUE-PRINT & INSTRUCTIONS**

If you can use a screwdriver YOU can make this ultra-modern receiver. You can do it in an evening for £3, or less. The Instruction Book, is FREE, with BLUE PRINT.

**FILL IN COUPON—NOW!**

**EDISWAN**

V. 17.

To THE EDISON SWAN ELECTRIC CO. Ltd.  
(Publicity) 123/5 QUEEN VICTORIA STREET, LONDON, E.C.4.

Name .....

P.W. 22/1/27.

Address .....

PLEASE USE  
BLOCK LETTERS .....

Please send, post free, presentation copies of the "R.C. Threesome" Instruction Book and Blue-print.

# CURRENT TOPICS.

BY THE EDITOR.

Atlantic Telephony—"Radio Listening Toms"—High Power Broadcasting—100 kw. Stations.

THE inauguration of the London-New York Radiophone Service seems to have created among the lay public an extraordinary amount of interest—far more interest, indeed, than has ever been occasioned when Mr. E. J. Simmonds, for instance, succeeded in radiophoning to Australia on a far smaller power than that employed by Rugby.

It was interesting to note that two or three days after the inauguration of the service many of the London newspapers

investigated by the Post Office experts. We have, from time to time, published many articles in POPULAR WIRELESS dealing with secret wireless systems, but as our readers know nearly all of such systems are complicated and, in fact, not always practicable.

However, in view of the interest created in the inauguration of the London-New York Radiophone Service and the importance of the question of secrecy, we shall shortly be publishing a special article devoted to

the question of secret methods of radio communication. This article will be published in an early issue of POPULAR WIRELESS.

More and more evidence is being accumulated to show the necessity for the erection of high power wireless broadcasting stations in this country and in the Dominions. The successes obtained with high power plants of this nature cannot be ignored. German broadcasting stations are, as it is well-known, heard much better in this country than British stations are heard in Germany, and two of the very finest German stations broadcast on high power.

Again, the records achieved by amateur experimenters using short waves of forty metres and less make a point in the favour of a scheme for the erection of short-wave broadcasting transmitters and short-wave broadcasting stations; and further, a powerful short-wave broadcasting transmitter in this country could be heard in most parts of the world and would, incidentally, constitute a valuable instrument for British propaganda. Broadcast concerts have been relayed to amateurs twelve thousand miles away by experimenters in this country, using only a fraction of the power employed by some of our main broadcasting stations.

### Casual Reception.

To-day, listeners in Australia, Canada, New Zealand and other distant parts of the Empire can only receive British broadcasting in a casual way, and then it is chiefly by good luck and suitable atmospheric conditions.

The fallacy of the low-power station has, in the minds of many experts, long been established, and it is to be hoped that the British Broadcasting Corporation, the Postmaster-General, and other authorities concerned, will give very careful considera-

tion indeed—when they come down to bedrock discussion with regard to the new regional broadcasting scheme—as to whether or not high power broadcasting stations would not in the long run prove far more useful and satisfactory than the modern low-power station as at present in use.

It is generally known that a scheme involving the complete re-organisation of the B.B.C. stations is under consideration by the chiefs of the British Broadcasting Corporation and the Postmaster-General.

This new scheme provides for the substitution of a number of medium high-power stations for the present broadcast stations, each of which will transmit simultaneously on two wave-lengths.

The idea is that every crystal set user would have an alternative programme to listen to, and, in fact, he might be able to hear more than one station, even on a crystal set. But the minimum power should be 100 kw.

### Two Programmes.

This scheme was drawn up some time ago by the old B.B.C., but it was not proceeded with in view of the change-over which took place in the New Year. The scheme cannot, of course, be carried out without the authority of the Post Office, but we understand that the Postmaster-General looks with favour on it inasmuch as it involves fewer but more powerful broadcasting stations.

It has been pointed out that the double wave-length idea has its merits, as it would be possible to transmit what we may term "high-brow" and "low-brow" programmes at the same time.

### 100 kw. Stations.

This change would, it is stated, only result in a very slight re-adjustment of listeners' receiving sets, and the chief advantage would be that they would be able to switch over from one programme to another, and consequently continued complaints with regard to the lack of variety in programmes would be met.

In theory the scheme is certainly interesting, but we hope that when the new broadcasting chiefs at their next meeting discuss the scheme in detail they will give consideration to the idea that, instead of medium-power stations, or even moderately high-power stations, the question of building 100 kw. broadcasters will be considered.

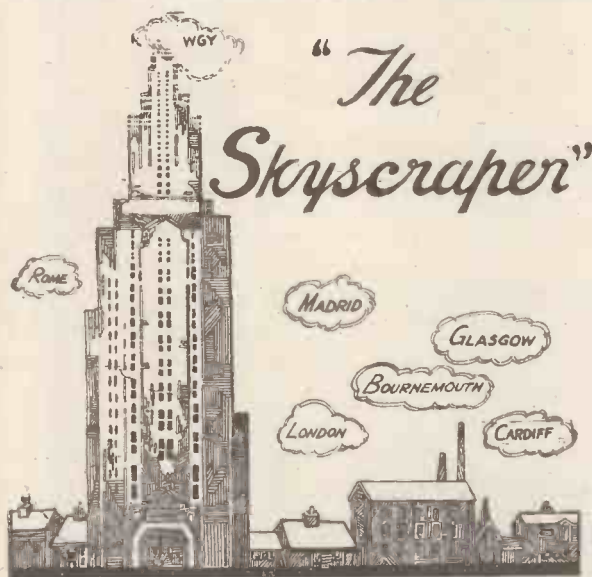

The issue of "Modern Wireless" on sale March 1st will give full constructional details of "The Skyscraper," a really up-to-date and efficient D.X. 2-valver.

suddenly became aware of the fact that telephoning to New York, although rather a wonderful accomplishment, had one serious drawback, viz. that secrecy was impossible.

### £15 a Call.

It had been suggested in many quarters that business men would find the wireless telephone between New York and London a great boon and, at £15 a call, it was considered that the service would do good business. But it is hard to imagine really important business being carried on by wireless telephone when thousands and thousands of people in this country and in America, and for that matter, in other parts of the world, can, in the simplest way possible, adjust their receiving sets, tune to Rugby's wave-length, and listen in to the conversations.

Radio "Peeping Toms"—or perhaps we had better call them Radio "Listening Toms"—constitute a very serious drawback to the utility of long distance wireless telephony between this country, New York, and other countries.

An official of the Post Office stated in an interview that secret methods of conversing between New York and London were being

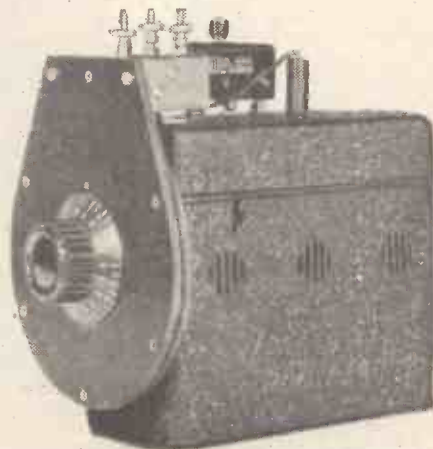

An example of modern radio design in Germany. The case contains a detector and three valve amplifiers.

# BROADCAST NOTES.

By OUR BROADCASTING CORRESPONDENTS.

Permanent Concert Party—Eisteddfod Difficulty Again—Increased Resources—"The Red Pen"—Seventh National Concert—A Fox-Trot Singer—Puccini from Glasgow—Tubby Edlin Coming—Catholic Choir for Dundee—Burns Nights at Aberdeen—An Important Broadcast Sermon—Wireless Engineers Slighted—The Status of the Announcer.

## Permanent Concert Party.

THE new B.B.C. has decided to accept the recommendation of the old B.B.C. that it should proceed at once to form a permanent concert party. It is believed that the party will be organised in time to make its microphone debut on February 11th.

## Eisteddfod Difficulty Again.

The hardy perennial problem of the Royal National Eisteddfod has arisen again. Readers of POPULAR WIRELESS may recall that last year an endeavour was made to get from the B.B.C. more than the £100 offered for this broadcast, with the result that there was no broadcast. Last year's Eisteddfod was at Swansea. At the time these negotiations were falling through the representatives of the 1927 Eisteddfod, which is to be held in North Wales, declared their desire that their show should not miss the microphone. It was understood that this had been duly arranged on the £100 basis. But now the 1927 people have come along with a demand for £60 in addition to the £100 offered. If this demand is maintained there will be no broadcast of the 1927 Eisteddfod. The B.B.C. are quite right to resent and resist such hold-up tactics. Moreover, if the negotiations fall through this time, it is unlikely that the Eisteddfod will be heard on the ether for ten years or so. Its blacklisting at Savoy Hill will be hailed with relief by the vast majority of listeners, including a great many in Wales, both North and South. It is of doubtful entertainment value at best. In the event of permanent deadlock being reached, it is presumed that the B.B.C. official who is a "Druid" will find an opportunity of resigning this position.

## Increased Resources.

An early sign of the new power and increased resources of our broadcasters is their decision to reply to the difficult attitude of theatre, music-hall, and concert agents by cutting them out in certain contracts. Thus it is understood that several eminent artists from abroad will be brought to England by the B.B.C. and "farmed out" for the times they are not broadcasting. The new B.B.C. will probably send their own representatives to

the States and the Continent with a view to annexing likely talent and saving the fees and difficulties of third-party negotiations hampered by barring clauses.

## "The Red Pen."

A. P. Herbert ("A. P. H." of "Punch"), the author of "The Red Pen," describes it as "sort of opera." It will be broadcast S.B. from London on Monday, February 7th, with Mr. Geoffrey Toye conducting. This should prove a special treat for listeners.

## Seventh National Concert.

Hermann Scherchen, conductor of the Frankfurt Museum Concerts, will be in charge of the seventh of the series of National Concerts organised by the B.B.C. at the Albert Hall. This will be given on Thursday, February 3rd. Hermann Scher-



A scene in the early days of broadcasting when the carbon microphone was still employed.

chen is regarded as the most eminent of the younger school of German musicians. He was a prisoner of war in Russia for some years. Beethoven's Eroica Symphony will be included in the programme at the Albert Hall on February 3rd.

## A Fox-Trot Singer.

Eddie Sheldon, who has an international reputation as a fox-trot singer, and immortaliser of the apostrophising of "My Baby," has joined the London Radio Dance Band.

## Puccini from Glasgow.

"Le Villi," Puccini's first opera, will be relayed by London from Glasgow on Thursday, February 10th.

## Tubby Edlin Coming.

The well-known burlesque comedian, Tubby Edlin, will be heard by wireless for the first time from London on Monday, January 31st, when he will include in his performance a burlesque news bulletin.

## Catholic Choir for Dundee.

The Dundee Catholic Choir, under the Rev. Father Noonan, will lead in an operatic programme at Dundee on the evening of Wednesday, January 26th.

## Burns Nights at Aberdeen.

Aberdeen will broadcast Burns features on January 25th and January 28th. On the former evening, the Aberdeen Burns Club Choir, under Mr. E. D. M. Walker, will be heard in five of Burns' songs. The other part of this programme will be specially arranged and "compèred" by Provost Donald Munro and Colonel Rorie. The other Burns night programme, on the 28th, will consist of a special concert by the Aberdeen Choral Union, under Mr. Irvine S. Cooper.

## An Important Broadcast Sermon.

It is understood that the address of the Archbishop of Liverpool, to be taken from Liverpool Studio by London on February 6th, will be of special importance in Church politics.

## Wireless Engineers Slighted.

There is a good deal of bitterness among wireless engineers generally at the way in which they are consistently overlooked in the honours lists. It is pointed out that people like Dr. Fleming, Captain Eckersley, and Captain Round have really made broadcasting possible, yet they are invariably ignored on occasions of public recognition. No blame attaches to their colleagues or administrative chiefs, who always put forward their names; but apparently the Government disregards the recommendations and still looks upon them as "super-mechanics." This is unfortunate, because it lowers the morale of technicians generally. The financial rewards of engineering are not attractive; therefore, if research is to go

forward, there should be some public recognition of outstanding success. More will be heard about this in Parliament when it reassembles.

## The Status of the Announcer.

A movement has been started in broadcasting circles to secure an improvement in the status of the broadcasting announcer. The old B.B.C. regarded the announcer as a comparatively junior and lowly paid official. This was perhaps a natural reaction from the original tendency of the public to exalt him into the position of a kind of national hero. But now that broadcasting is settling down it is important that something be done to make the job of announcing attractive to the right kind of young men. The actual voice of the B.B.C. should be considered very important, and the announcers rewarded liberally. There should be promotion as announcers. Promotion should not involve passing away from the microphone.



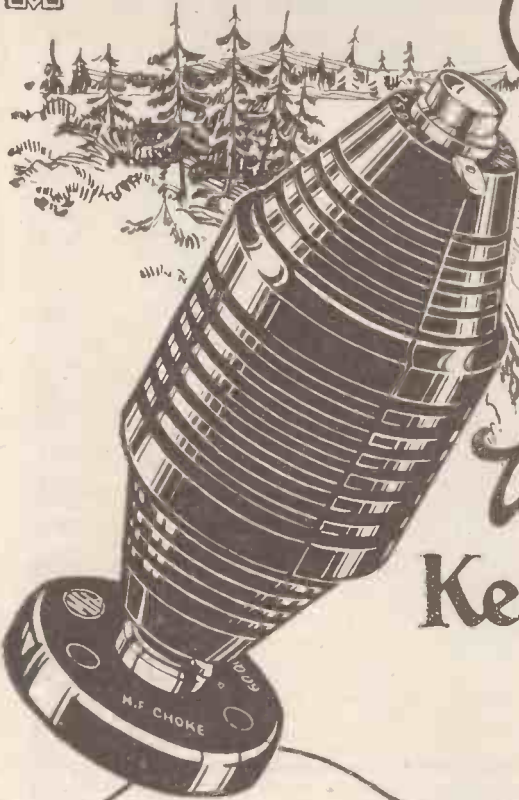

# Why Waste Energy? Keep Your H.F. in its Place

As most experimenters know, it is necessary, in certain circuits, to restrict the high-frequency current to certain paths.

This restriction is effected by interposing a H.F. Choke, but this unit must fulfil certain technical conditions.

It must have a high inductance, a low self-capacity, and must efficiently deal with "long" or "short" wave frequencies.

## Try this REACTION CIRCUIT

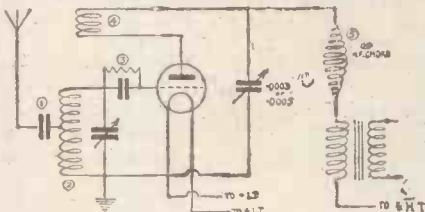

With reaction condenser set at about 90 degrees, adjust the reaction coil so that the set is just off oscillation point. Leave the Coil in this position, and thereafter control reaction by the condenser.

1. MH '0003 Condenser.
2. MH Dimic Coil No. 1.
3. MH Grid Leak and Condenser.
4. MH Unimic Coil. No. 50.
5. MH H.F. Choke.

## The NEW MH H.F. CHOKE

scientifically designed to meet these conditions, is a genuine advance on all existing types. The reduction in diameter of the end windings deals in a graduated manner with the higher frequencies and the central portion with the lower frequencies. With an inductance of 60,000 microhenries, a self-capacity of negligible value, and a D.C. resistance of 130 ohms, it is the ideal Choke for all purposes.

PRICE 9/- EACH

Demand of your Dealer MH components.

BRITISH, BEST AND CHEAPEST IN THE LONG RUN.

Telephone: Slough 441-442. **L. M. MICHAEL LTD** Telegrams: Radiether, Slough.  
Manufacturers of Wireless and Scientific Apparatus  
**WEXHAM ROAD, SLOUGH, BUCKS.**

IRISH AGENTS: B. N. B. WIRELESS LTD. DUBLIN AND BELFAST.

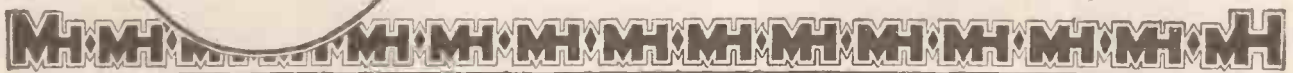

# Although it had no name you *knew* it referred to the Eureka Ortho-Cyclic Condenser

On page 1198 of last week's "Popular Wireless" there appeared the advertisement you see here on the right. It had no name. But if you read it you would *know* it referred to the Eureka Ortho-cyclic Condenser. For in no other Condenser will you find eleven such points of Condenser superiority. No other Condenser gives such razor-sharp tuning—a separate station to every degree. Only the Eureka so simplifies tuning that the veriest amateur can separate any station he chooses from the overcrowded ether. Only the Eureka Ortho-cyclic gives you the same even separation of stations throughout the whole of the dial. In short—only the Eureka will satisfy you, the discriminating Amateur.

14/6 '0003 mfd. and '0005 mfd. New Eureka Dial. Fits any Condenser 4/6. 15/6



Advt. Portable Utilities Co., Ltd., Fisher Street, W.C.I.

The Condenser which gives a separate station to every degree.



- 1 Absolute rigidity of fixed plates ensured by unit construction.
- 2 Moving plates clamped together to permit fine spacing with absolute security.
- 3 Special method of construction eliminates the possibility of fixed and moving plates short circuiting.
- 4 Ball-bearings ensure smooth silken action under all conditions.
- 5 Dual connections (cone and pigtail) guarantee continuously silent performance.
- 6 Electrical losses so low as to be quite negligible. An invaluable feature for short-wave use.
- 7 Generous and readily accessible soldering tags.
- 8 Equipped for panel mounting as one-hole or four-hole, whichever preferred.
- 9 Positive stops at both ends of scale.
- 10 Compact design permits a panel depth when closed of less than two inches. The '0005 mfd. Ortho-cyclic takes up much less room than most '0003 mfd. condensers.
- 11 Highly polished and beautifully finished throughout—a perfect example of British craftsmanship.

Where else will you find these **Eleven Features of Condenser Superiority?**

G.A. 7343



## Makers of the ORIGINAL world-famous BECOL LOW LOSS FORMER

As used in sets that took the first four prizes at the 1926 "Manchester Evening Chronicle" Wireless Exhibition and the set that won the Gold Medal at the 1926 Amsterdam Exhibition.



Registered Trade Mark.  
Size: 3 inches diameter to outside of wings. Prices: 6 in. lengths 3/- (postage 9d.) 4 in. lengths 2/- (postage 6d.) 3 in. lengths 1/6 (postage 6d.) Up to 36 in. lengths.

NOTICE:—Do not be put off with an imitation. Ask for BECOL and use the Former with a reputation. Write for List "C."

THE BRITISH EBONITE COMPANY LIMITED, Harwell, London, W.7. Ebonite Rods, Tubes and Sheets. Panels guaranteed free from surface leakage.

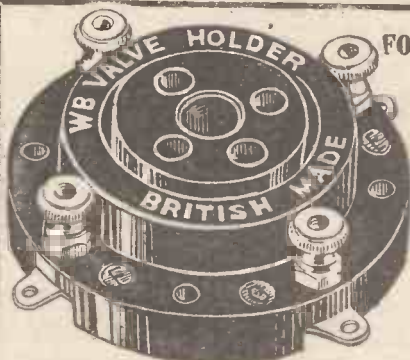

### FOR BEST RESULTS USE W.B. ANTI-PHONIC LOW LOSS VALVE HOLDERS

PRICE With Terminals 2/3 With Tinned Soldering Tags 2/-

If unable to obtain from your dealer write direct.

Manufactured by WHITELEY, BONEHAM & CO., LTD., Duke Street, MANSFIELD, NOTTS.

## H.B.H. REMOTE CONTROL SWITCH



The MASTER SWITCH

At last, real armchair control of your set. This switch gives absolute control over the set from any distance, and from any number of points simply with ordinary bell-pushes and flex. Wherever you have the loud speaker, you can have a bell-push controlling your set.

The switch is inserted between the L.T. supply and the set, and close handy to the set. Bell flex is extended as required. To start or stop the set simply press one of the bell-pushes. A small lever on the control switch gives local control of the set independent of the bell-pushes.

The secret lies in the ingenious arrangement of the magnetically controlled contacts contained in the switch. Invaluable to those wishing to hear the last few items of the programme in bed, whence they are able to turn their set on or off.

Fully guaranteed for one year, provided the switch has not been tampered with.

Price 21/- post free from the makers. A novel form of grip contact, to be used in place of bell-pushes; can also be supplied at 10d. each in Black, or 1/- each coloured.

GOSWELL ENGINEERING CO., LTD., 95/98, WHITE LION STREET - LONDON, N.1

Telephone: North 3057.

# LOW LOSS AERIALS

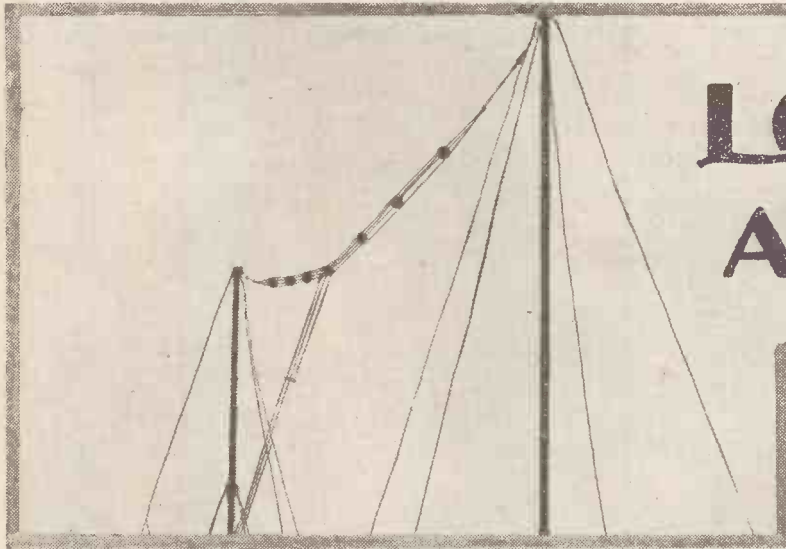

In spite of endless precautions taken by some constructors to ensure the utmost efficiency in their wireless sets, in nine cases out of ten the aerial system is totally ignored and is often a very mediocre affair. If you want really good results the aerial must be properly designed and erected.

By G. V. DOWDING, Grad.I.E.E.  
(Technical Editor.)

To all intents and purposes the strength of the rectified signals in a 1-valve set is proportional to the square of the strength of the signals as they oscillate in the form of high-frequency currents in the aerial. That is to say, if we double their initial strength we obtain signals in the telephone receivers four times as loud. Therefore, a little loss of energy from the

very necessary evils. But we are jumping ahead too fast. First of all the high-frequency energy generated in our aerials by the other waves due to the various broadcasting stations can be lost in part either by absorption or by leakage. And there are two kinds of leaks to deal with: capacity leaks and conductive leaks. In a sense, absorption is leakage, but we are going to differentiate between the two in this article. Our capacity leaks are going to be purely "series condenser" effects, and our conductive leaks direct leaks through conductive paths.

ends are 40 feet from the ground. It has a 40-foot span from insulator to insulator. (See Fig. 1.)

### Protection Against Wiring.

If the insulators are allowed to accumulate a layer of dust, leakage may occur, especially during damp weather. Therefore, the insulators must be clean and must be kept clean. Each insulator must have a long leakage path, but must not be bulky. We are going to suggest nine-inch insulators made of high-class, well-glazed non-metallic porcelain shaped like two cups held together by means of a rod. (See Fig. 2.) With these we can always have partially dry insulators during the heaviest rain whatever way the wind blows, and also partially dry halyards, which is equally important seeing that these latter will offer the leakage path to earth which we wish to eliminate.

The lead-in must be through the centre of a window pane. There is nothing else for it if we wish to obtain the highest possible degree of efficiency. The window pane

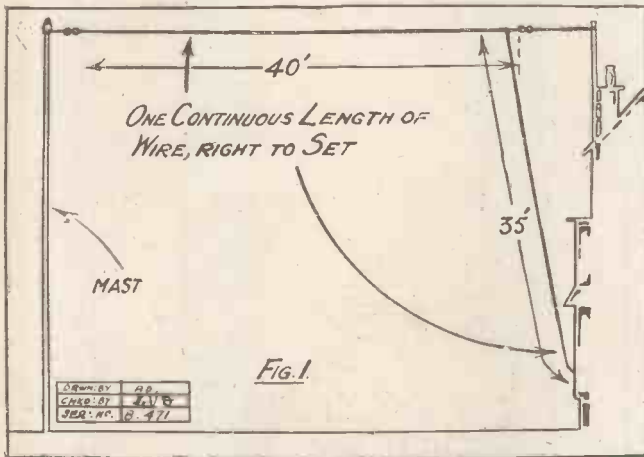

### Ordinary Rules.

There will be absorption losses if the aerial is very close to and parallel to another aerial, or if it is run along close to metal guttering, etc. But by now practically every

aerial becomes a correspondingly greater loss in the 'phones. On the other hand, a comparatively slight increase in the intensity of the energy we manage to guide on to the grid of the valve might mean a really noticeable increase in volume.

These are proved facts, not theories, so it would appear to be high time that the "low-loss" cult was extended to aerials in real earnest. We have our low-loss variable condensers, coil holders, coils, valve holders, and what-not, but if these are used with "high-loss" aerials we are merely "stream-lining" the superstructure before we tackle the barge-shaped hull!

### Very Necessary Evils.

The ideal aerial for broadcast reception would be one of 75 feet in length, including the down lead, with plenty of height, and suspended in space touching nothing but the aerial terminal of the set, and being yards away from anything else. But an aerial wire will not float in air, so it must be held up by some means. Insulators are

listener, let alone the amateur, will know that an aerial must be kept well away from walls, roofs, trees, and other such objects, and we will take it for granted that it is unnecessary for us to go over all the elementary requirements of an efficient aerial. We are dealing with the "low-loss" aerial, and this spells super efficiency.

Therefore, we will take as an example an aerial reckoned by all ordinary rules and regulations to be an efficient one, and endeavour to bring it into the "super" category. It consists of a single length of 7/22 stranded copper wire (bare), 75 feet in length from the farthest insulator to the lead-in point, and suspended from a 40-foot mast. It stretches from this mast to a short mast fixed to the roof of the house so that both

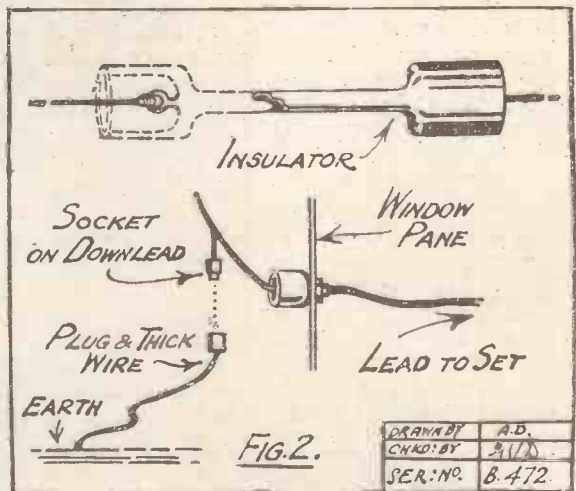

itself will provide ample insulation, but we suggest that a light "cup" type arrangement consisting mainly of the same high-  
(Continued on page 1288.)

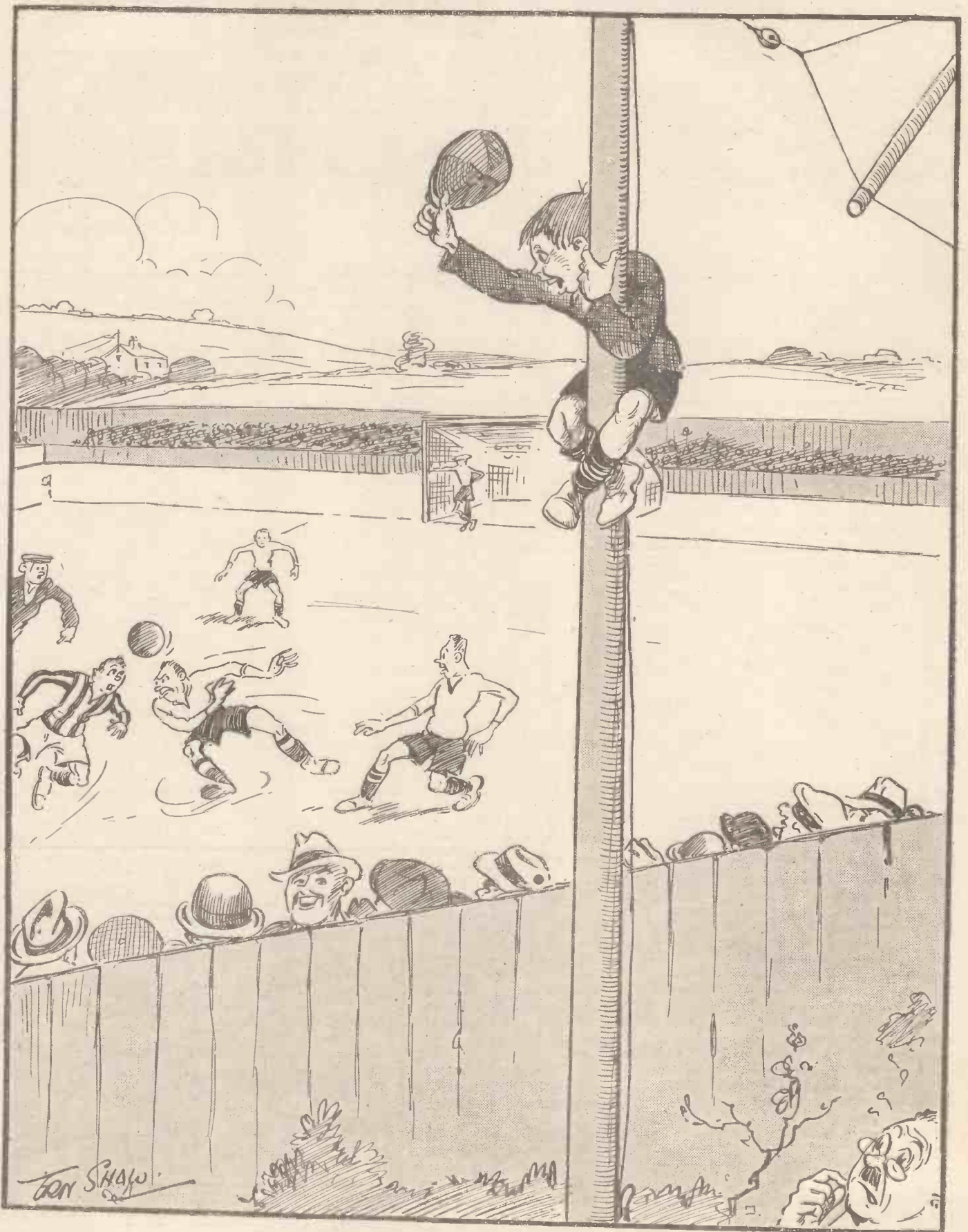

One of our junior amateurs solves the problem of seeing by wireless.

# Modernising the "P.W." Continental Set

BRINGING  
A POPULAR  
RECEIVER  
UP TO DATE

THE "P.W." Continental Set, first published in POPULAR WIRELESS on February 21st, 1925, has proved one of the most popular ever published in this journal. Not only have a very large number of readers obtained successful long-distance results with it, but a steady flow of letters shows that on the recommendation of their friends readers are still building it in large numbers.

An examination of the original design and circuit revealed several reasons for its popularity and success. The circuit is a

Published in "P.W." No. 143, the Continental two-valver has always been popular with constructors. In this article Mr. Harris shows how to modify the set in order to incorporate many of the improvements evolved since the receiver was first described.

By P. W. HARRIS, M.I.R.E.

in a movable coil holder, enables variable reaction to be obtained.

violently without any special reaction coupling. A closer examination shows that the earth end of the aerial coil is connected to the positive leg of the valve filament. As the grid of the H.F. valve is connected through the aerial coil to this point, it is easy to see that the grid of the valve will normally have a positive potential, the value of which will depend upon the voltage of the valve. So long as the grid of a valve is appreciably positive, grid current will flow. This, when made large enough, will introduce damping quite sufficient to prevent oscillation in such a set unless we use specially applied reaction.

### Reducing H.T. Current.

While the damping so introduced reduces the efficiency of the set, both in signal strength and selectivity, it must not be forgotten that a considerable amount of the loss so introduced can be made up by reaction amplification, and so the efficiency of such an arrangement is not so low as might appear at first sight. Indeed, a long experience of such circuits has shown me that they can be remarkably sensitive. At the same time there are several disadvantages in the arrangement, although at the time the set was designed this method of obtaining stability was, on the whole, the best, as the modern neutralising methods had not then been sufficiently developed to be of practical use to the home constructor.

(Continued on next page.)

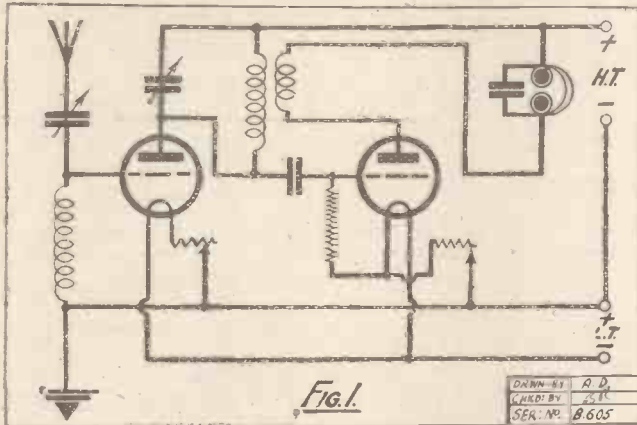

thoroughly tried and tested one, the controls are not too numerous, full stability is obtainable with any class of aerial and reaction control is simple. Furthermore, the lay-out of the set itself is of a form which lends itself to easy handling, and the whole design is thoroughly practical.

### Recent Improvements.

At the same time we must remember that the set was built nearly two years ago, and thus lacks many of the improvements which have come into use in the last year or so. Having this in mind, an examination of the "P.W." Continental Set shows that with a very small expenditure of time and money it can be considerably improved and brought up to date. The purpose of this article is to show just what can be done and how easy it is to do it.

Fig. 1 shows the original theoretical circuit of the "P.W." Continental, from which it will be seen that the aerial circuit is tuned by a series condenser, a plug-in coil forming the aerial inductance. In the anode or plate circuit we have another plug-in coil shunted by a variable condenser of .0003 mfd., the coupling taking the form of the conventional tuned anode system. In the plate circuit of the second valve we have a reaction coil coupled to the tuned anode, and this reaction coil, being located

Now, when the grid and anode circuits of a valve are in tune with one another, the inter-electrode capacity of the valve and the stray fields from the coils and wiring, together give sufficient "feed-back" to cause self-oscillation in the set without any specially applied reaction unless some form of damping is introduced. "Series tuning" of the aerial has invariably a greater tendency to cause self-oscillation in such circumstances, and it might

be expected from a cursory glance at the theoretical circuit that the set shown would not only be unstable but would oscillate

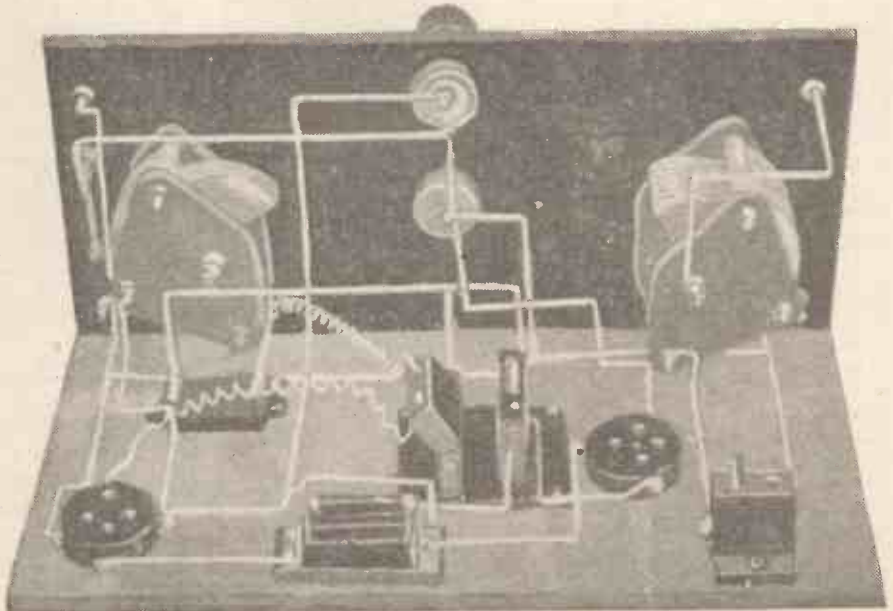

The positions of the various components and connections mentioned by Mr. Harris are clearly indicated in this photograph of the original receiver.

## MODERNISING THE "P.W." CONTINENTAL SET.

(Continued from previous page.)

Another disadvantage of "positivising" the grid is the large increase of H.T. current which accompanies it. To give you a practical example, I have just tested the

from which you will see that there are but three new components used—an additional coil socket, a neutralising condenser, and a Mansbridge condenser of 1 mfd. In addition, you will require, if you do not already possess one, a centre-tapped coil of a size that will be explained a little later. Neutralising condensers vary in price, but average about 5s. Coil sockets are obtainable for a few pence, and the 1 mfd. Mansbridge type condenser costs about 4s. A centre-

condenser in the set itself is not strictly necessary, and if you are using one across your H.T. battery outside the set, you need not make any change, although if you are not at present using the Mansbridge condenser you will be wise to place it in the position shown. The circuit now becomes one stage of H.F. amplification, neutralised by the "Rice" method followed by a detector, while in place of the original direct coupled aerial we have an arrangement of inductive coupling which appreciably adds to the selectivity obtainable.

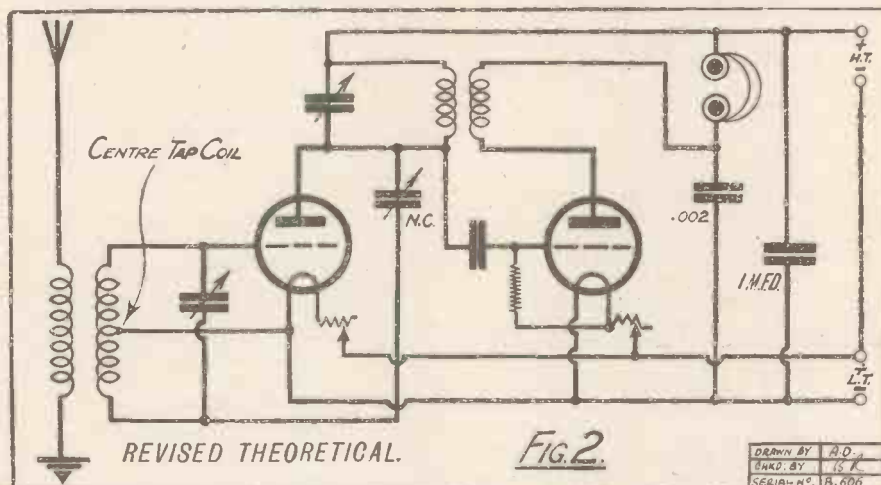

FIG. 2

H.T. consumption of an H.F. type of bright emitter very popular at the time when this set was first published. Used as shown in the original theoretical diagram, with 70 volts on the plate, the H.T. consumption is exactly two and a half milliamperes. When the grid is brought to zero voltage, that is to say, connected to the negative leg of the valve (thus being held at the same potential as this point), the plate consumption is immediately reduced to one milliampere, so that by positivising the grid you increase the H.T. consumption of the valve to two and a half times normal.

Now, two and a half, or three milliamperes is not a great deal to take from an H.T. battery, but with modern valves the problem is much more important. Take, for example, one of the modern dull emitter valves of the tenth of an ampere type. Used in the same circuit, with the same H.T. voltage, the positivised grid brings the consumption up to no less than nine milliamperes (this, by the way, is with a valve designed for H.F. amplification). By connecting the grid return to the negative leg of the valve the H.T. is immediately reduced to two milliamperes.

### Few Additional Items.

For the expenditure of a very few shillings the "P.W." Continental Set can be converted into a modern neutralised arrangement which will have the advantage of enabling you to use modern H.F. valves at their greatest efficiency, yet without any abnormal demand upon your H.T. battery. Furthermore, both H.F. amplification and selectivity of the set will be greatly improved. By using a proper neutralised arrangement, the set will also be rendered non-radiating, so that you need not fear that you are causing disturbance to your neighbours when hunting the distant stations.

Fig. 2 shows the theoretical diagram of the modernised "P.W." Continental Set,

tapped coil for the ordinary broadcast band costs very little more than the same size coil without the tap.

The inclusion of the Mansbridge con-

### Easily Modified.

Fortunately the "P.W." Continental Set lends itself admirably to modernising with a minimum amount of work. In order that matters may be as simple as possible, I have arranged the wiring diagram to show all the original wires as dotted lines, and the new wiring as full lines. For additional clarity the new components are shaded.

The first constructional step is to take your three new components—the board mounting coil socket, the neutralising condenser and the Mansbridge condenser—and with coils and valves in place see whether there is room for them in the positions shown. If not, it may be necessary to make a slight alteration in the position of the first valve socket or perhaps the original coil socket. The exact position of the Mansbridge condenser is not important. You will find plenty of room near the H.T. terminals.

If, as is probably the case, you can place  
(Continued on page 1263.)

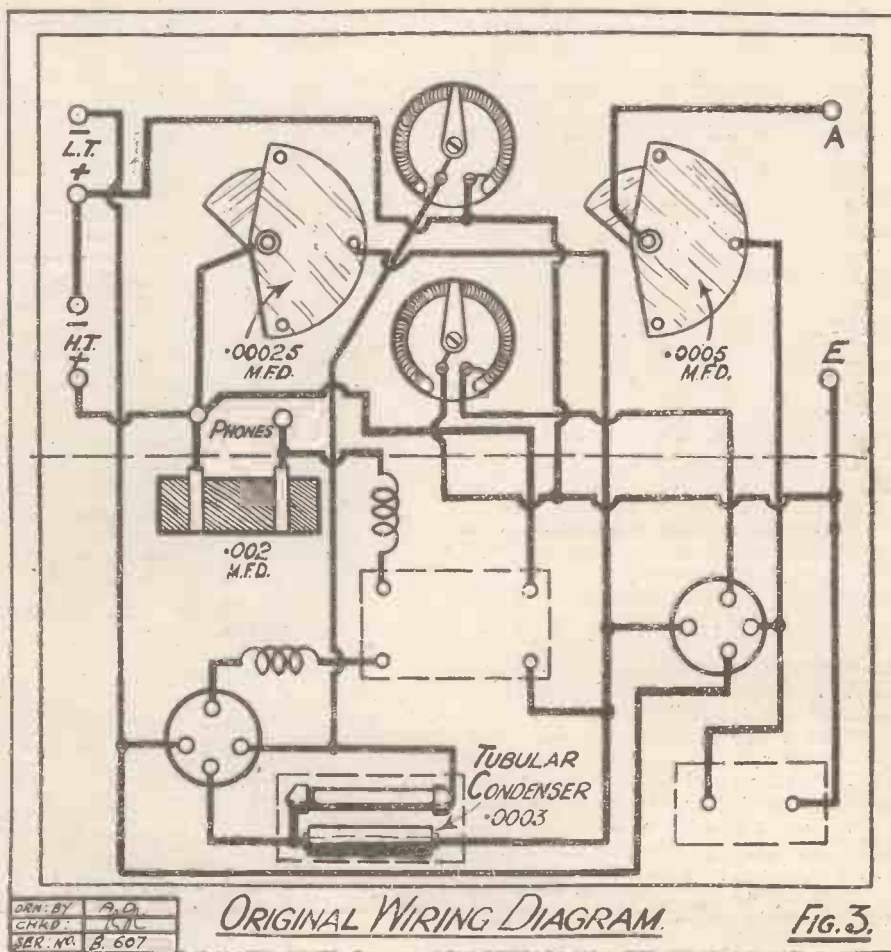

ORIGINAL WIRING DIAGRAM

FIG. 3

# Look what S.T. "Twos" have saved me!

I save 15/- in the £ in accumulator upkeep costs alone, apart from initial expenses:

I live in the country, so, to avoid the fag of lugging heavy batteries to be charged I bought a set of S.T.2's. I can go weeks without recharging, because these valves, with their glowless torodium filaments take one-tenth of an ampere. As for high tension, I get magnificent results on a 60-volt dry battery.

It's nice to know, also, that if any of my three valves fails to give long and faithful service it will instantly be replaced by S.T. Ltd., who insure the lives of their valves at Lloyd's.

*That's why S.T. "Twos" are the Valves to use!*

S.T. LTD.,



2, Melbourne Place, Aldwych, London, W.C.2

(Next to Australia House.)

What "Popular Wireless" says about S.T. 2's.—

**S.T.21** (0.1 amp.) H.F. 14/-

*"Undoubtedly one of the best 2-volt H.F. valves we have tested. It operates excellently."*

**S.T.22** (0.1 amp.) L.F. and Detector .. 14/-

*"We found it very good indeed. In all its capacities it gives a very good account of itself."*

**S.T.23** (0.15 amp.) Power .. 18/6

*"It cannot fail to command admiration. Gives excellent volume with excellent fullness and purity. We obtained very good results!"*



# Watmel

## H.F. CHOKE

Double silk-covered wire wound in four accurately balanced sections. Ensures required constant impedance, very low capacity, small external field. Transparent case. Ebonite base. A British product well up to the "Watmel" standard .. **7/6**



## AUTO-CHOKE

(Illustrated above.) A famous "Watmel" product. Coils wound in special manner with over a mile of wire. Transformer volume with Choke purity. Totally enclosed winding. Splendid finish. Complete with fixed condenser and resistance mounted **18/6**

## TAPPED L.F. CHOKE

Same in appearance and method of winding as Auto Choke, but without Condenser and Grid Leak. Winding connected to 3 terminals, giving 3 wiring combinations. For filtered circuits, L.F. circuits, and smoothing circuits in H.T. eliminators .. **15/6**

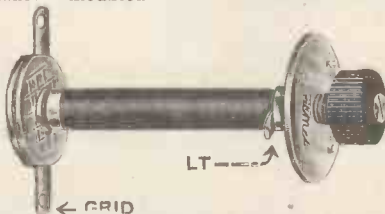

Variable Grid Leak and Anode Resistance. Resistance continuously variable. Dust-proof case. Elements not affected by changes of temperature. Perfect electrical contact with adjusting screw. Tested before leaving factory. One-hole fixing. Variable Grid Leaks, 5 to 3 megohms, 2/3 each. With low loss grid condenser, mounted as illustration, 3/-.

## FIXED CONDENSERS

Most efficient shape—round. Best ruby mica and finest Bakelite. Accurate to within 5% in all capacities, 2/- and 2/6. Grid Condenser with fixed grid leak incorporated (parallel or to filament) As illustration .. **2/6**



# COMPONENTS

From your dealer or direct from—  
**THE WATMEL WIRELESS Co. Ltd**  
832a, Goswell Road, London, E.C.1.  
Telephone: Clerkenwell 7990.

Lancs., Yorks. and Chesire  
Representative,  
Mr J. B. Levee, 13, Hartley Street  
Levenshawe, Manchester.  
Telephone: 475 Heaton Moor.

# FRELAT

## D.E. VALVES

## Why Pay More?

YOU cannot buy a better valve than Frelat, even though the others cost twice as much. The proof lies with you! Send to-day for a trial valve. The D.E. type K Detector or Amplifier, costs only 4/11, the new 2-volt power valve 8/6, and they give the best in Radio in tonal purity and volume.

**D E**  
**TYP K**  
2-volt 3amp  
**4/11**  
**2-Volt**  
**Power**  
**Valve**  
**8/6**

## CONTINENTAL RADIO IMPORT CO. LTD.

8, Spital Square, Bishopsgate, London, E.C.1

or C.O.D.  
terms  
dd sd.—  
ostage  
rec.

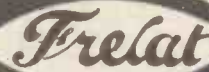

If you  
dealer  
anno-  
uppl-  
send  
direct

<b>COIL SCREEN &amp; BASE</b>  Only 5/6	<b>S.L.F. CONDENSER</b>  With 4-in. dial. '0003 .. 7/- '0005 .. 7/8	<b>RELIABILITY CONDENSER</b>  Mansbridge In. us. Type. '20, 1/6 1 mfs., 2/6 '5, 1/9 2 mfs., 3/6	<b>WIRELESS CABINETS</b> for panels: 4 in. high Width in. Hinged Lid Oak 12 in. 17/-, 14 in. 17/6, 18 in. 18/6 Mahogany 1/- extra.	<b>DEWAR SWITCH</b>  2-Contact 2/6
---	---	--	---	---

**READ THIS LIST AND SAVE MONEY ON COMPONENTS**

**CONDENSERS**.—Any size cut; Clayton brand, 1 in. dia., 9 in. by 2, 12 in. by 9, 4/6, 15 in. by 9, 5/6 3/8 in. 25 per cent. less Paragon and Radion, 1d. per sq. in.

**INSULATORS**.—Large Shell, 3d., Reel or Egg, 1d., Climax, 6d.; Ditto, with shock absorbers, 3/- pr. Gal. Pulleys, 4d., 100 ft. Gal. Strainline Wire, 1/6; Strainline Bolts, 6d.

**TERMINALS & ACCESSORIES**.—Single W. D.C. N.F. or Pol. Brass with nut and washer, 1d.; Phone and Castle type, 1d.; Double Mark, 3, 2d., 4-way Phone Connector, 6d.; Pole-riding paper, 3d.; Fluxite, 8d.; Black Tape, 6d. per coil, 1/4 in. Empire Tape, 6d. dozen yards; Insulating tube, 3d. yard. Glazite, 1/2, 10 ft. coil; Shellac Varnish, 6d.; Mica 2 in. x 1 1/2 in. 1d. dozen; Chatterton's Compound, 3d.; Hand Drill, 3/6; Drill, 1/-.

**RELAYS**.—100 ft. 1/4 in. copper tape, 1/9; 7/22's Bright, 2/3; Enamelled, 3/3; Electron, 1/8; Super, 2/6; Marx, 3/6; Galton Speakers, 12/- per pair; O.V. complete, 2/6.

**HEADPHONES**.—E.T.H., 15/-; Brown's "E" Type, 20/-; Reliability, 7/6; Adjustable, 8/-; Dr. Nesper, 12/11; T.M.C., 17/6; Western Electric, 20/- all 4,000 ohms; Sullivan, 120 ohm Double Ex-Govt., New, 4/-; 120 ohm Single Phone, 2/8 Long Phone Cord, 1/-.

**LATEST COMPONENTS**.—6-Way Coil Stand, 2/9; Colvern Low Loss inductance Former, 5/-; Formo Straight Line '0005 Condenser, 7/6; Success, 15/6; Eureka, 15/6; Cydon, 15/6; Lissen 50 v. H.T. New Process Battery, 10/6; Valve Vibrating Springs, 1d. set of 4.

**BATTERIES**.—Reliability, 90 v., 11/-; 60 v., 7/6; 36 v., 4/6; 15 v., 1/10; Ever Ready, Siemens, Hellesen, 100 v., 21/-; 66 v., 12/6; 36 v., 7/6; Flashlight Battery Cases for 14 Batts., 4/6 4 v. Batts., 4d.; 60 v. Unequalled, 8/6; Wan. Plugs, 1d.; Olix Type, 2d.

**ACCUMULATORS**.—Exide, D.T.G., 4/6; D.F.G., 8/6; W.J., 20 v., H.T. type, 15/-; Oldham E.T., 10d. per volt, complete; Duros, 20 v., 11/-; 10 v., 5/6; Repairing Outfit, 1/6.

**CONDENSERS**.—Low Loss, Square Law, with knob and dial, '0005, 5/-; '0003, 4/6; with Vernier Blade, 1/- extra; Twin '0005, for Elctree 8lx. unequalled value, 9/6; Cydon Twin for ditto, 27/6; Ormond, J.B. Utility, Sterling, Polar, Formo, Igranic, G.E.C. Var. in all capacities, Neutrodyne types, Ormond, 2/-; Colvern 3/6; Gabriel, 5/6.

**FIXED CONDENSERS**.—Dubilier, Edison Bell, Lissen, Watmel, Mullard, McMichael, at advertised prices. Special Reliability Fallon—'0003 mid. 2 meg. Leak, 1/3. Cases only 4d.

**L.F. TRANSFORMERS**.—E.T. Multi-Ratio, 25/-; Marconi Ideal, 25/-; Junior, 15/6; Ferranti A.F.3, 25/-; A.F.4, 17/6; Formo, 10/6; H.T.C. Empire, 1/6; Groix 5 to 1, 6/-; Lissen new type, 8/6; Igranic, 16/-; Eureka Concert Grand, 25/-; No. 2, 21/-; Eaby Grand, 15/-; Ormond, 15/-; Royal, 20/-; Success, All Black, 21/-; Silvertown, 21/-; G.R.C., 15/-; Brandes, 17/6; Burndept, 16/6; Special Value, 7/6; Modulation, 7/6.

**VALVE HOLDERS**.—Anti-Phonic Benjamin, 2/9; Lotus, 2/3; with terminals, 2/6; Burndept, 2/9; Harlie, 1/6; Reliability, unequalled, 2/-; all baseboard types, ord. ditto.

**SA. N.P. Valve Sockets**, rush fittings, 1d.; Superior Panel Type, 4d.; All Ebonite, 10d.

**VALVES**.—"Radion" all type, Frelat 2 volt, 3 amp., 4/11. All advertised makes stocked.

**RECENT REDUCTIONS**.—Sterling '0005 Square Law Condensers with Vernier, 9/6; Geared 12/-; Minifloss, 15/-; '00025, 8/6; Geared, 10/6; Minifloss, 14/-; Marconi Automatic Detector 2/6; Series Parallel Variometer, 10/6; Edystone Absorbos Feet, set of 4, 2/3; Benjamin P. Switch, 1/3; N.P. Olix Plug & Insulator, 2/4; Adaptor, 1d.; Socket, 2d.

**EXPERIMENTERS' PARCELS**.—Accessories of Various Types, worth 20/- post paid, 5/6.

Send for New **RELIABILITY WIRELESS GUIDE No. 9**. Free on Request. Trade supplied.

**J.H. TAYLOR & CO.**  
4, RADIO HOUSE,  
MACAULAY ST., HUDDERSFIELD  
Tel. 341. Grams: THOROUGH HUDDERSFIELD

Orders 5/6 Value Arrriage Paid. Under 5/- 2d. per U for Packing etc.



**MODERNISING THE "P.W." CONTINENTAL SET.**

(Continued from page 1260.)

the new components in the positions shown without altering the disposition of the other parts, screw them in position and carefully study the new wiring diagram. Heat up your soldering iron and, first of all, remove the original lead going from the aerial terminal to the first variable condenser and from this condenser to the coil holder. Next disconnect the wire going from the earth terminal to the original coil socket.

nections which are very simply joined up. The first lead will go from the aerial terminal to one terminal of the new coil socket and the second lead is taken from the other terminal of the coil socket to the earth terminal. We must now take one lead from the variable condenser to the grid of the first valve, and from the grid to one terminal of the original coil socket. The remaining terminal of this socket goes to the other side of the variable condenser and to one terminal of the neutralising condenser (it does not matter which). The second terminal of the neutralising condenser is joined by a short lead to the original wire running from the plate of the first valve to the grid condenser.

suit, the better of the two being found by trial, as much depends upon your aerial. With a very large aerial a 25 might give better results.

**Choice of Coils.**

For the grid coil you will need a centre tapped specimen obtainable from several makers, including Gambrell, and Lissen. As there are many stations below 300 metres, which you may desire to hear on this set (they will be very easily audible) I would suggest you obtain for the grid coil socket a centre-tapped C and a centre-tapped B if you are purchasing Gambrell coils, and a centre-tapped 75 and a centre-tapped 80 if you buy the Lissen variety. The 60, or the B, will enable you to bring in many stations which are below the minimum of the 75 and the C respectively. If you have wound your own coils it is only necessary to tap the centre of an existing coil which is giving satisfactory service, taking a wire from this centre tap to a suitable terminal fixed on your coil socket. Coils in the tuned anode circuit and for reaction respectively will be as before. If you are listening to a station in the Daventry range, a centre-tap F in the Gambrell series, or 250 in the Lissen series, will suit for the grid circuit. A No. 100 or 150 will be required for the aerial socket. The tuned anode coil will be of the same size as the grid coil, and the reaction coil about the same size, or perhaps a size larger.

There is no need to buy a new valve for the detector socket, but I would strongly recommend you to purchase, if you have not already one, a special H.F. valve of one of the leading makes, as these are a very great improvement over the older types for this work. Such valves are obtainable in the two, four and six-volt series, so that you need not change your present accumulator. You will probably gain some advantage by using a higher H.T. voltage than you have previously used, say 72 or even 80, as in my experience the H.F. valve in a neutralised circuit works better with higher voltage than we were accustomed to use with the older methods of control.

**Adjusting the Set.**

As there is only one stage of H.F. to be neutralised, the adjustment of the set is quite simple. Join up your batteries, place your valves in the sockets, and connect the telephones as usual. Do not join up aerial or earth, or, for that matter, place any coil in the aerial socket. Place a suitable centre-tapped coil in the grid socket and join a flexible lead from the negative terminal of your valve socket to the centre tap of the coil. Place a suitable coil in the tuned-anode socket and for the moment short-circuit the reaction coil socket with a piece of wire, or a shorting plug. Set your anode tuning condenser at some intermediate position (say 30°) and rotate the grid tuning condenser (on the left of the panel looking from the front). You will soon find that the set will oscillate very freely over quite a wide band. I am assuming that before making this test you have set the neutralising condenser at the minimum position, which, in the great majority of models, means screwing the adjusting handle in an anti-clockwise direction (or outwards) as far as it will go. When you have found that the set will oscillate freely, as it should do, owing to the fact that the

(Continued on page 1286.)

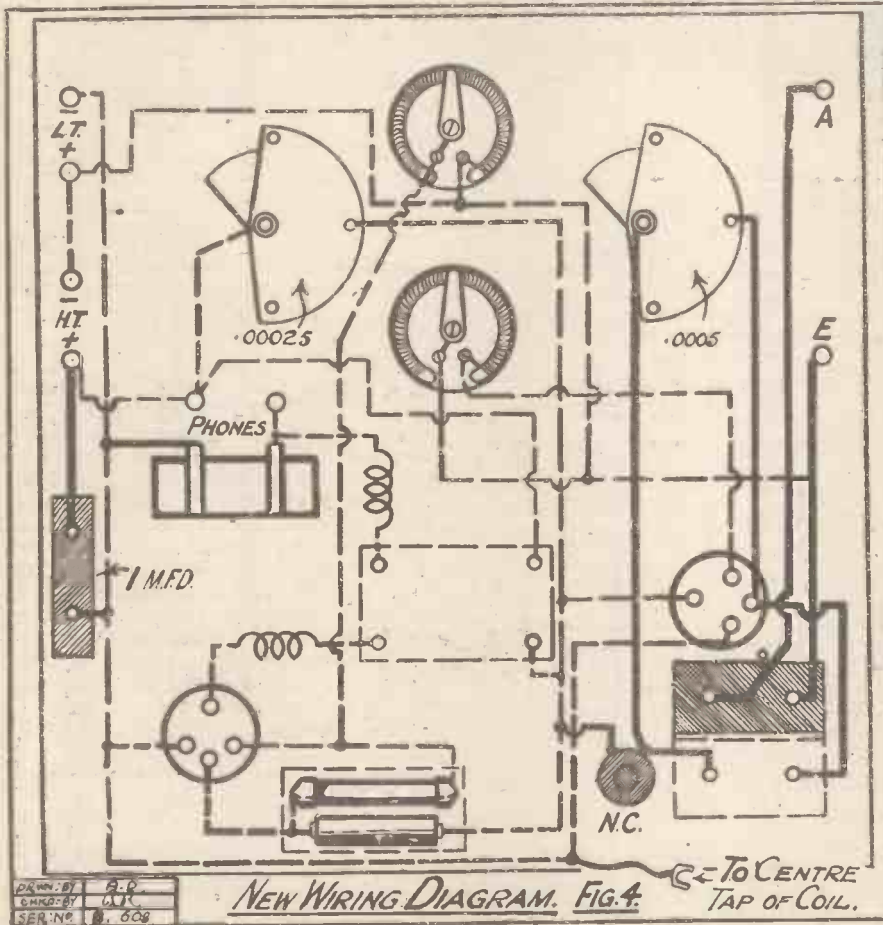

NEW WIRING DIAGRAM, FIG. 4

TO CENTRE TAP OF COIL.

The wire going from the coil socket to the grid of the first valve must also be removed. The small lead going from one side of the telephone condenser to one of the telephone terminals is next taken off, and we are ready for new wiring up.

**Anti-Microphonic Valve Holders.**

While you are making improvements in this set I would strongly recommend you to remove the original valve sockets, which were designed for the old bright emitter valves which were not particularly microphonic, and substitute for them a pair of one of the modern anti-vibratory types. Many valves which you may like to try in this set are slightly microphonic, and the spring suspension of the new sockets will add considerably to the comfort of operating, by cutting out the "ponging" noises set up by vibration of the set.

We are now ready to make the new con-

A flexible lead should now be soldered to the negative terminal of the first valve socket for connection subsequently to the centre tap of the grid coil.

Only two further connections remain to be made. The first is a short wire from the telephone condenser terminal from which the original wire was removed, to the lead coming from the L.T. negative terminal. To this same lead is joined one terminal of the Mansbridge condenser, the other terminal being joined directly to the positive H.T. terminal.

You will see that these changes can be made in a very short time with a minimum of labour and without making any alteration to the front panel of the set.

You will need a coil for the aerial socket, the size of which will depend upon your particular aerial and the band of wavelengths you desire to cover. For the ordinary broadcast band a 35 or 50 will generally

# The "COASTAL" CRYSTAL SET



MANY listeners living near a coastal broadcasting station are beset by the problem of Morsc interference and its elimination, which is not as a rule easily solved. An external wave-trap connected to a crystal set, or even a built-in "eliminator," has its disadvantages as it

Sensitivity and selectivity are not easily combined, especially when one is dealing with the design of crystal receivers, but in this circuit a remarkable degree of the latter has been obtained without in any way detracting from the sensitivity of the set.

By C. A. J. MEADOWS.  
(Experimental Staff.)

signal strength to considerably above normal by careful adjustment of the tuner dial.

The crystal detector employed is of the type which uses a combination of two crystals; once the most sensitive spot has been found, it can be left set indefinitely.

### Variometer Construction.

A set of parts for building a variometer can be purchased for a very low sum, or if desired the whole instrument may be home-constructed. The stator must not be less than 3 in. in diameter and 2 in. long; a ball type rotor is preferable, and should only have about 1/4 in. clearance all round. The gauge of the wire employed is not important, but that used in the original set was No. 26, double cotton-covered. If the dimensions for the tuner given above are adhered to, it will be found that the windings are easily accommodated. Details of the tuner construction are given in the accompanying diagrams and photographs, which show the internal connections, method of fixing, etc.

(Continued on page 1267.)

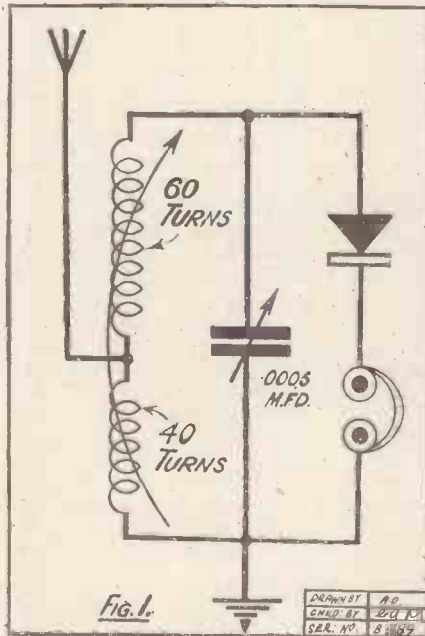

joined in series with the aerial connected to the junction. The complete 100 turns are tuned by a .0005 variable condenser, and connected to the crystal detector, phones and earth in the usual way.

Tuning is quite simple, although sharp; the station which it is desired to receive should be tuned in on the condenser, with the tuner dial at about 90 degs. Final adjustment of the condenser will be necessary after the tuner adjustment has been made. Another advantage possessed by this set is that if it is not tuned to reduce interference, it will be possible to increase

costs as much as (or even more than) the set itself, and causes the set to become unnecessarily complicated

The set described herewith is not expensive, and is neither complicated nor difficult to control. Near the Thames estuary, where interference from land stations and ships entering the estuary is both strong and persistent, it functioned perfectly. London was received at fair strength, and without a trace of the usual "background."

### Easy Tuning.

Reference to the theoretical circuit will show the reason for the selectivity of this set. Two coils, one of 60, the other of 40 turns, are mounted in the form of a variometer; the 60-turn coil as rotor, and the 40-turn as stator. The windings are

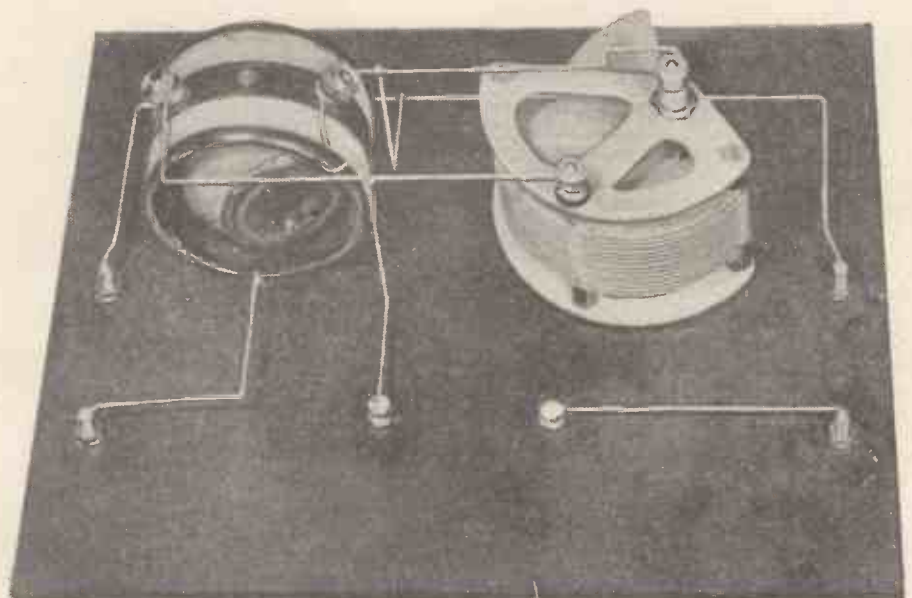

The wiring of the "Coasta." Crystal Set is not in any way difficult, as will be seen from the above.

# USE "GOLTONE" COMPONENTS SUPERIOR QUALITY IS THE MAIN REASON

## CONSTRUCT YOUR OWN H.T. ELIMINATOR UNIT



### "Goltone" H.T. ELIMINATOR KITS

Made in 3 Models. Each Kit is complete with prints and full constructional details.

**ALTERNATING CURRENT KIT.** Type "A" £4 2s. including valve.

**DIRECT CURRENT TYPES.**  
As Model "D" .. £2 3 9 As Model "DJ" .. £1 10 0  
For fuller particulars see next column.

## "Goltone" (Regd.) HIGH TENSION BATTERY ELIMINATOR

Entirely eliminates the troubles, worries and uncertainties associated with high tension dry batteries and accumulators. The constant voltage adds considerably to the volume and purity of reception. Saves its first cost in a short time. Connect to any convenient lampholder. Current consumed negligible.

Complete with Adaptor and Connecting Cords.

### DIRECT CURRENT MODELS.

Type "D.J." Approx. tappings, 45 and 100 volts. Price 35/.

Type "D." Approx. tappings, 30, 50 and 120 volts. £3.

Type "D.N." Possesses the latest refinements. Perfectly silent. Suitable for voltages from 200/250 volts. Voltage tappings as Model "D." £3/12/6.

**ALTERNATING CURRENT MODEL.**  
Type "A." Approx. tappings, 30, 60, 90 and 130 volts. Dual tappings are taken from each voltage, thus providing eight separate tappings. £5/10/0, including valve.

State voltage and frequency of Lighting Mains when ordering. See List No. ELM/10 for full particulars and appreciations from delighted users.



## EASIFIX

"COURT" RADIO ASSEMBLIES.  
Overall size, 33 ins.  
Eliminates ugly, loose wiring, and adds to the neatness of the Receiver. As a precaution against wrong connections, each conductor is distinctively coloured and enclosed within a strong outer braiding. Complete, fitted with Spade Terminals and Wander Plugs.  
4-ways, 2/-      5-ways, 2/3  
6-ways, 2/9      7-ways, 3/6  
Refuse substitutes.

TO HIGH & LOW PANEL TERMINALS.

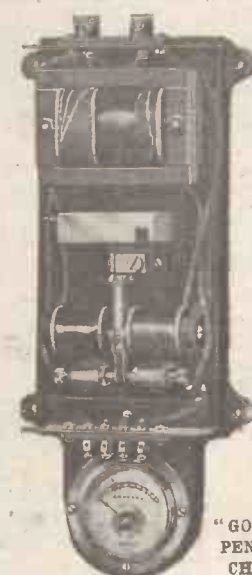

"GOLTONE" PENDELTON CHARGER

## ACCUMULATOR CHARGING SETS for Home Service. NO TECHNICAL KNOWLEDGE OR ATTENTION REQUIRED.

CLEAN, ECONOMICAL AND EFFICIENT. Plug-in to any Convenient Lampholder. Supplied complete with Adaptor, Flexible Cords and full instructions. The "ALTERNO" (as illustrated).

Charges 4hr High Tension Accumulator at negligible cost. Price 21/.

The "INDISENSO," Direct Current. Charges the High Tension Accumulator at no extra cost when light is in use. Price 6/.

GOLTONE "PENDELTON," (Patent App.) Alternating Current.

Charges the Low Tension 2, 4 or 6 volt Accumulator economically and effectively. No Valves or renewals. Charging Rate approx. 2 Amps. Price £2/12/6.

Fitted with Ammeter for ascertaining rate of charge (as illustrated) Price £3/7/6.

State voltage and frequency of Lighting Main when ordering.



"ALTERNO"

## "Goltone" Micrometer RHEOSTAT

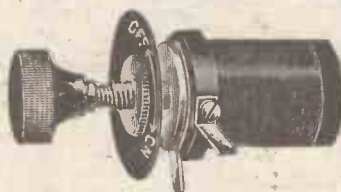

Smooth velvety action, permitting noiseless and critical adjustments. Ball contact. Takes minimum space. One hole fixing complete with knob and dial.

12 ohms .. 2/9 each  
6 ohms .. 2/8 each  
30 ohms .. 3/6 each

**GOLTONE** REC'D  
"LITZ" WIRE

Super efficient in Coil and Variometer windings. Specially recommended by the leading technical papers.  
Silk Covered.  
Size, 27/42s.  
50 ft. — 2/-  
100 ft. — 3/6  
200 ft. — 6/-  
Per lb. — 18/-  
Subject Trade Discount Prices for other sizes on request.

**RADIO LIST "P.W." No. 116 WILL BE SENT POST FREE ON REQUEST.**

"GOLTONE" Specialties are stocked by all First Class Radio Stores.

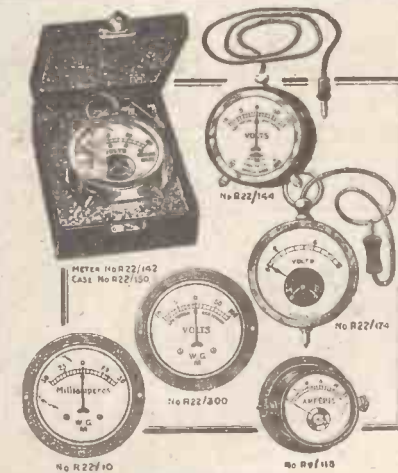

## BRITISH MADE RADIO METERS

ACCURATELY CALIBRATED  
ABSOLUTELY DEPENDABLE

### POCKET TYPE DOUBLE READING VOLTMETERS

Reading to 12 volts and 120 volts. Side Reading No. R22/142 .. 8/6

Centre Zero Reading (Pat. App.) R22/144 .. 10/6

Strong Lined Cases .. 1/6 extra

### PANEL MOUNTING DOUBLE READING FLUSH TYPE VOLTMETERS.

Pat. App. Diam. of Dial, 1 1/2 in. Centre Zero Reading 12 and 120 volts. .. 12/9

No. R22/300 each .. 12/9  
Panel Mounting Push Buttons, pair .. 1/6

### POCKET VOLTMETERS, ORDINARY TYPE.

Reading 0-3, 5-6, 0-12 or 0-16 volts, 5/- each

### SWITCH BOARD VOLTMETERS and AMMETERS

3 in. Base. Reading to 3, 6 or 10 volts or amps, 9/6 each.

### PANEL MOUNTING FLUSH TYPE MILLIAMPEREMETER.

Centre Zero. Diam. of Dial, 1 1/2 in. Reading 0-20, 0-50 or 0-100 .. 12/- each

See List R/116 for full details.



WHY PAY MORE THAN DOUBLE for other amplifiers  
or for a valve set, when you can get as good results with THE  
**MAGNETIC MICROPHONE BAR AMPLIFIER**

(Patent No. 24351/25.)

"NO CRYSTAL SET IS COMPLETE WITHOUT THIS WONDERFUL ATTACHMENT."

Not only will this marvellous device give really good LOUD-SPEAKER RESULTS from CRYSTAL RECEPTION of average strength, but it is absolutely the ONLY means of increasing the strength of weak signals in HEADPHONES without using valves.

Works perfectly on one or two dry cells.

A BOON TO DEAF PERSONS

EQUALLY EFFICIENT ON VALVE SETS

IF YOUR DEALER CANNOT SUPPLY ORDER DIRECT FROM SOLE MANUFACTURERS AND PATENTEES:



(Two-thirds actual size.)

NOT a Microphone Button.

NO Valves, Accumulators or H.T. Batteries. Fragile parts. Distortion.

Simple as A.B.C.

MICROPHONE AND OTHER PARTS OF AMPLIFIER SUPPLIED SEPARATELY FULLY ILLUSTRATED LISTS FREE

COMPLETE AMPLIFIER as shown PRICE post free 38/- 3-volt DRY BATTERY lasting over three months 4/- extra. No other accessories required.

DELIVERY BY RETURN FROM STOCK EVERY AMPLIFIER GUARANTEED

NEW WILSON ELECTRICAL MANUFACTURING CO., LTD., 18, FITZROY STREET, EUSTON ROAD, LONDON. W.1. Phone: Museum 5974.

WIRELESS PICTURES AND TELEVISION

By T. THORNE BAKER, F.C.S., F.R.P.S.

At All Booksellers: Fully Illustrated, 6/6 net.

Mr. T. Thorne Baker will control the transmission of wireless photographs from the Paris broadcasting station "Radiola."

Read the book and see how it is done and learn how, yourself, to receive wireless pictures.

Constable & Co., Ltd., 10-12, Orange Street, W.C.2.

USE A WAVE TRAP THAT WORKS!

In "P.W." January 8th, 1927, appears a description of the working of a wonderfully efficient Wave Trap. Easy to build, costs very little, and is an excellent opportunity for you to acquire an invaluable adjunct to your set.

Here is a list of the parts required:

Standard Square Law Condenser '0005 m.f.d.	7 0
T.C.C. Mica Condenser '0003 m.f.d.	2 4
B. M. Two Coil Holder	5 6
Miniature Rotary Switch complete with studs and stops	1 9
7 Nickel-plated Terminals, connecting wire, etc.	1 8
Terminal Strip, drilled	9
"Red Triangle" Panel, drilled and engraved	19 0
Polished Mahogany Cabinet	12 6

If you build this Wave Trap under the famous Pilot Service you are definitely assured good results. We have an expert Technical and Service Department ready to assist you free of charge, so that your efforts cannot fail. The Wave Trap can also be supplied as a finished instrument, fitted in a polished cabinet and complete with the necessary coils for eliminating your local station, price £2:10:0

Send to-day for a copy of the Pilot Manual, which gives full particulars and illustrated details of the latest receivers. Every listener should have it. Post free: 6d.

Catalogue of Wireless Components and Accessories, 44 pp. fully illustrated. Post free: 3d.

PETO-SCOTT CO., LTD., 77, City Road, London, E.C.1.  
Branches: 62, High Holborn, W.C.1; 4, Manchester Street, Liverpool; 4, Bank of England Place, Plymouth; 230, Wood Street, Walthamstow.

P.S. 9233.

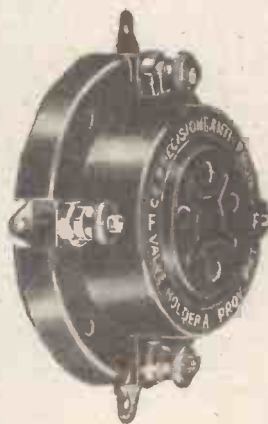

a new and better valve holder!

WHEN we introduced the C.E. PRECISION RHEOSTAT, we thought that in quality, in efficiency and in price, this Component could not be beaten. Now that we have added the C.E. PRECISION FLOATING VALVE HOLDER, we find it even exceeds the former in these respects to such an extent that the demand has been amazing, and we are working to maximum capacity to keep pace with the orders.

Before purchasing other makes, just ask your dealer to show you ours. We are confident that after comparison they will have the preference.

C.E. PRECISION FLOATING VALVE HOLDERS anti-capacity. non-microphonic

2/3 each  
C.E. PRECISION RHEOSTAT efficient and velvety  
50 and 30 ohms 3/- each,  
7 and 15 ohms 2/9 each.  
Dual Rheostats and Potentiometers 3/9 each.

C.E. PRECISION GRID-LEAK, an entirely original and accurate component. 2/- each.



FOR UTMOST EFFICIENCY  
C.E. PRECISION

C. EDE & CO., LTD., BYFLEET, SURREY

Telephone: Byfleet 226.

Telegrams: "Cetprecis, Byfleet."

# THE "COASTAL" CRYSTAL SET.

(Continued from page 1264.)

The next operation is the preparation of the panel, which should be marked for drilling in accordance with the panel drilling

otherwise the moving plates will foul the side of the cabinet. The other is caused by the small projection under the terminals, for which a niche at the base of the hole is necessary; this should be made with a small three-cornered file, and it is essential that it is at the exact base of the hole, otherwise the engraving on the terminal will be out of line, and spoil the appearance of the panel.

to which the lead from the aerial terminal is to be connected towards the top of the panel.

All is now ready for wiring, and if the set is to be efficient, it is essential that this final stage in its construction should be carried out with the utmost care. "Make haste slowly" is the best advice that could be given where wiring is concerned.

Every joint should receive careful attention, as otherwise dry joints may result, causing a reduction of signal strength, crackling noises, and probably in the end a frenzied letter to a long-suffering Technical Queries department. Joints in which pressure is the medium through which contact is made, such as between a wire and terminal, must be tightened with a pair of pliers to ensure "safe" connections.

### Soldering Hints.

Soldered joints need more initial attention, but given that, last indefinitely. It should be remembered that the idea of soldering is not simply to get a blob of solder covering the end of the wire and the terminal head; a good joint will only result when the solder is properly amalgamated with the other metals. Further, fluxes are intended to prevent a film of oxide forming on the heated metals—not to run down and form pools on the surface of the panel.

Never use liquid fluxes, as although very efficient, they splash over the panel, and provide leakage paths for the H.F. currents, which, by the way, such are not slow to take. No difficulty need be experienced when soldering wires to terminals or small joints of that nature, if the following points are kept in mind.

Use a clean iron, keep it clean, and keep it hot. Use good quality solder. Use a little flux on a joint, not a spoonful. The lightest smear will suffice to make a good, firm joint, and is at the same time economical.

Before testing the set, check the wiring (Continued on next page.)

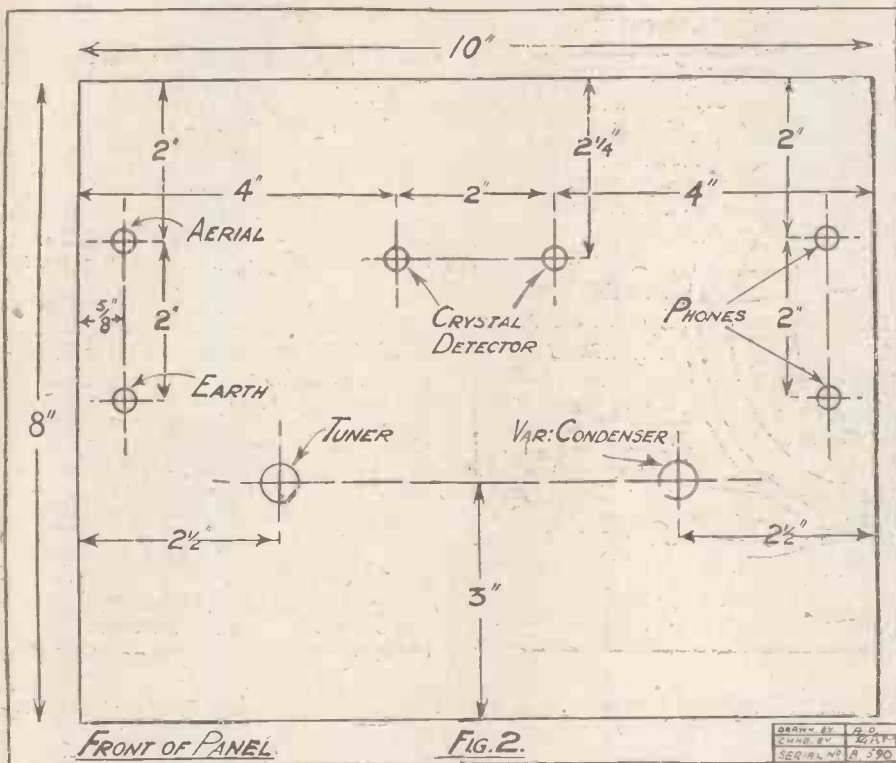

diagram. Do not draw lines across the panel with a pencil in the usual way, but if a large pair of dividers is available, use them for the job instead.

For instance, the holes for the crystal detector are 2 1/4 in. down from the top of the panel; stretch the divider points out that distance and place a rule 2 1/2 in. or so down the panel to act as a guide. Allow one point of the dividers to drop just below the top edge of the panel, then make two fine lines 2 in. apart. The remainder of the marking if carried out in this fashion will not take five minutes, and there will be no pencil lines to clean off afterwards.

### Drilling the Panel.

The actual drilling is not a difficult matter, and should soon be finished. Four twist drills are necessary, one 3/8 in. for the tuner and condenser holes, one 1/4 in. for the terminal holes, one 1/8 in. for the crystal detector fixing screws, and one 5/32 in. for the holes through which the wood screws pass. When drilling ebonite a fairly light pressure and high speed are best for making clean, smooth holes; heavy pressure and low speed cause chipped and ragged holes, and also soon blunt the drills.

Having drilled the panel, the mounting of the components may be proceeded with. This is the most straightforward operation of all, and really needs no comment, but it is as well to point out that there are two small snags.

The first is that the variable condenser must be mounted in the position shown,

The crystal detector screws should be turned as far home as possible, and the nuts then tightened up against the panel.

Mount the tuner with the copper strip

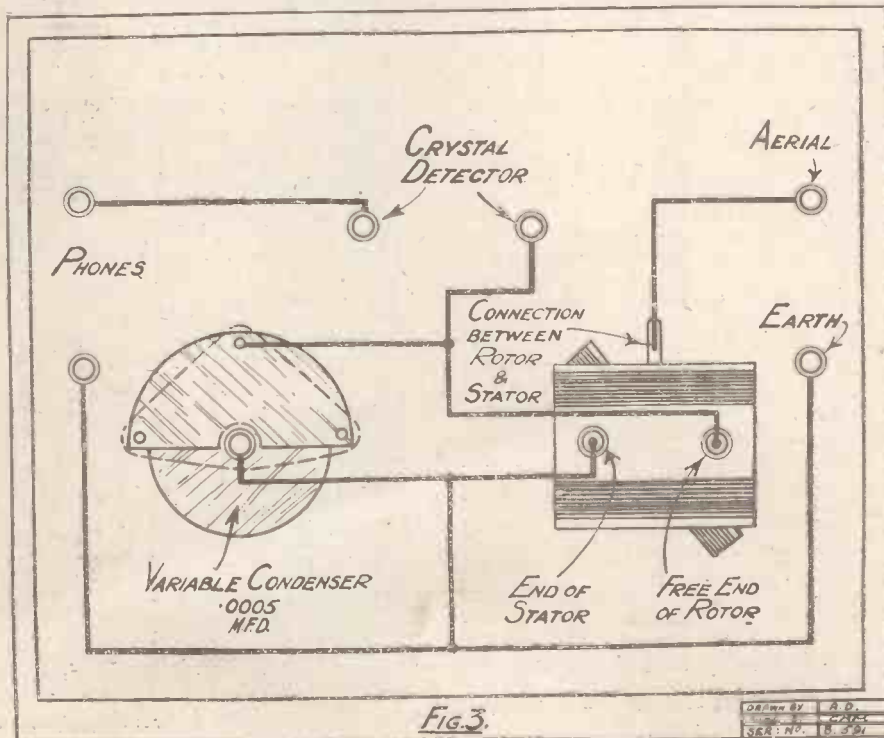

## THE "COASTAL" CRYSTAL SET.

(Continued from previous page.)

from the point-to-point connections. If possible, get someone else to check them also. This being accomplished satisfactorily, connect the aerial, earth, and 'phones to their appropriate terminals; and, after

### POINT-TO-POINT CONNECTIONS.

Aerial terminal to connection between rotor and stator of tuner. Earth terminal to other end of stator, to moving plates of variable condenser, and to bottom 'phone terminal. Other 'phone terminal to one side of crystal detector. Other side of crystal detector to other end of rotor, and to fixed plates of variable condenser.

## SOME VALVE DEFECTS

By HUMPHREY PURCELL.

IT is not often that one finds a defect in a newly-purchased valve of standard British manufacture, but the writer has had the bad luck to buy no less than three valves within the past few months which were unsatisfactory, although the filament was intact in each case. A note of the symptoms may be of interest, but it must be added that the valves were promptly replaced by the manufacturers. All the valves were of "general purpose" type.

The first valve gave very poor results when used in the H.F. position, and when tried as detector or L.F. amplifier, the set was silent. The trouble was that the fine wire from the "pinch" was broken at the point where it should have been soldered to the valve leg connecting with the plate.

### Peculiar Faults.

The second valve worked satisfactorily in the L.F. position, but atmospherics seemed to be unusually bad. When the set was switched off, however, the loud speaker continued to emit the noise of atmospherics! When another valve was substituted for the new one, the noises ceased. A test of the insulation between the anode leg and the other legs of the new valve (made by means of a small battery and a pair of telephones) revealed a distinct leakage.

In the third case the valve worked quite satisfactorily in any position until the rheostat was turned so as to give the filament the full voltage permitted by the manufacturers. Then "atmospherics" developed, and a slight further turn of the rheostat caused signals to disappear. The writer's theory is that the heating of the filament caused it to expand and touch the grid, but unfortunately the filament was broken in transit when it was returned to the factory, and the exact cause of the trouble remains a mystery.

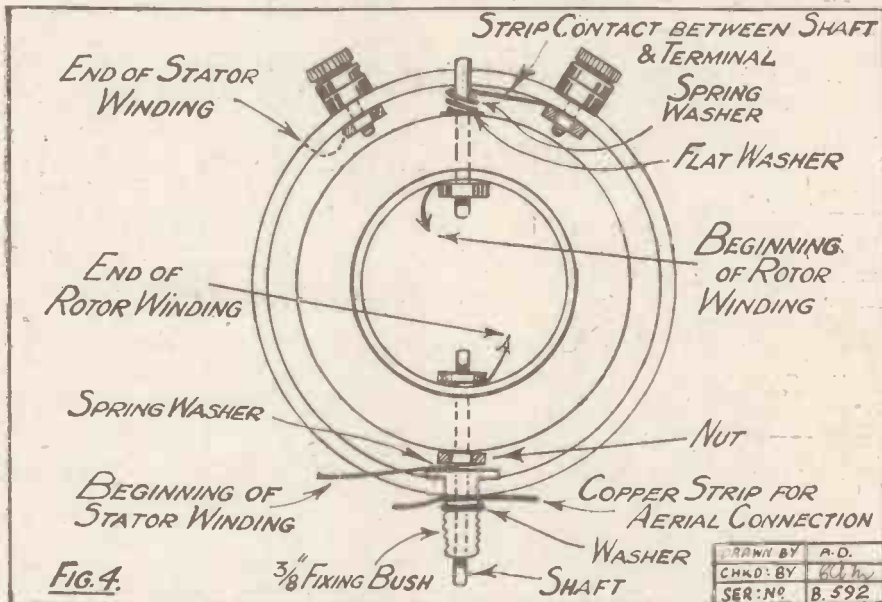

making certain that the local station is working, don the 'phones and tune in as described previously.

Adjust the crystal detector to its most sensitive point and leave it set. Rotate the tuner dial slowly through the 180 degrees of the scale to ascertain whether the internal contacts of the tuner are in good order, or otherwise. A sudden cessation of signals, followed by an equally sudden resumption as the dial is turned a few more degrees, indicate a faulty contact between these two points.

### Tracing Faults.

This will mean that the nuts on the rotor shafts must be tightened, and it will probably be discovered that a pair of pliers are an extremely awkward means to that end. The best thing for such a case is one of those little sets of flat spanners which are now produced especially for wireless work in standard B.A. sizes. This handy little tool enables an otherwise tricky job to be done with comparative ease.

No results whatever indicates a break in one of the windings, or a total lack of contact between the rotor and stator, or even a fault in the crystal detector. Forgetting to open the earthing switch has the same effect.

It may as well be mentioned that, when on test in the POPULAR WIRELESS test-room, this set worked a large loud speaker with sufficient volume to be heard at the other side of the room. Do not assume that it was loud enough for dancing, or anything of that kind, but the announcements could be followed easily and without straining the ears.

Although only two miles from 2 L O, this is certainly good for a crystal set, isn't it?

### LIST OF COMPONENTS.

- 1 Ebonite panel, 10 x 8 x 1/4 in.
- 1 Cabinet to fit.
- 1 '0005 variable condenser (of any good make).
- 1 Crystal detector.
- 1 Set variometer parts (Stator, 3 in. dia., 2 in. long).
- 2 oz. 26 S.W.G. D.C.C. wire.
- 4 Indicating terminals.
- Transfers, screws, etc.

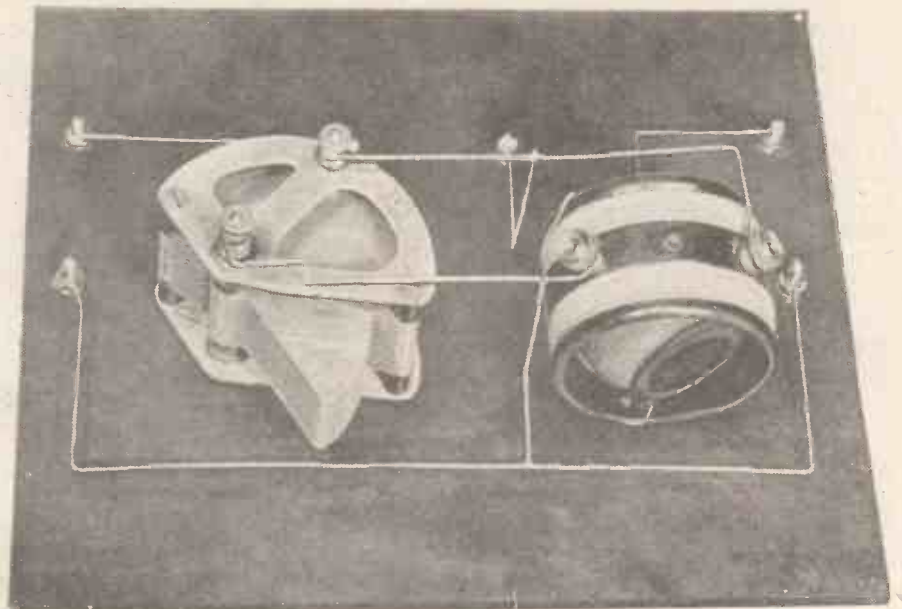

Another photograph of the wiring of the receiver, which should be used in conjunction with the wiring diagram when the connections are made.

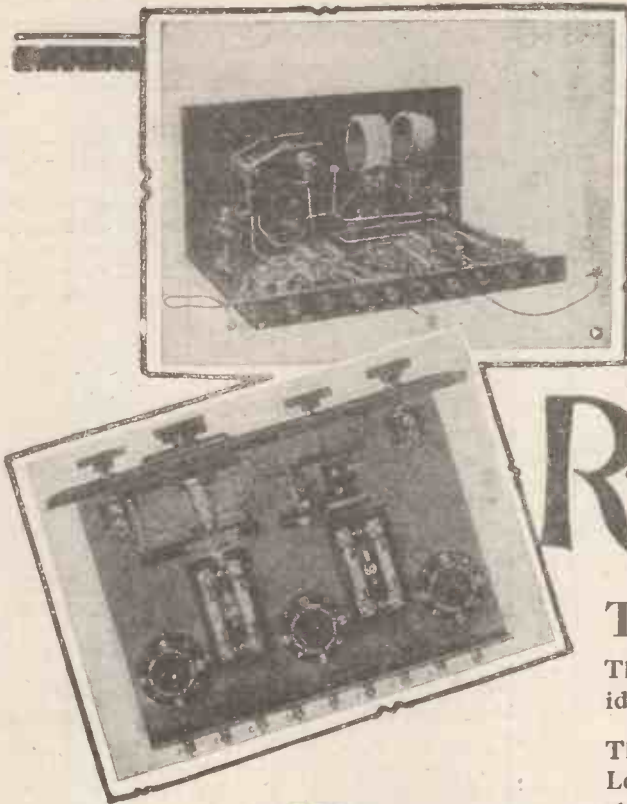

# Are you making the famous R.C. Threesome?

TO get the wonderful results obtained with the original R.C. Threesome Set, you should use identical components.

The Coil Holder used is a "Lotus" Left-Hand Two-Way Coil Holder; the three Valve Holders are "Lotus" Buoyancy Valve Holders, with Terminals.

Wireless experts decided that these were best for a very important experiment; that they would get most out of the set on which depended the very high reputation of the famous Ediswan Valves.

They were not disappointed. YOU will be more than pleased with the R.C. Threesome's performance if you fit "Lotus" Valve Holders and Coil Holder.

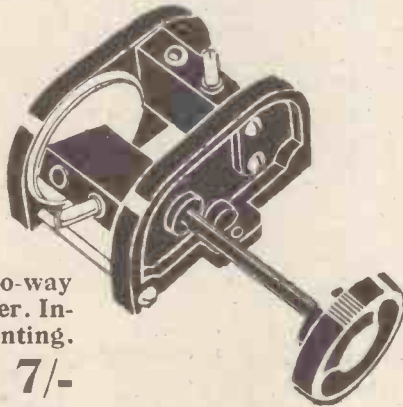

Lotus Two-way Coil Holder. Inside mounting. Left-hand. 7/-  
Patent No. 244251.

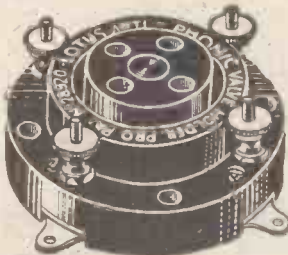

Lotus Buoyancy Valve Holder with Terminals. 2/6  
Patent No. 256833.

From all Radio Dealers

## LOTUS COMPONENTS

*Invaluable to  
EVERY Amateur  
and Constructor.*

The "POPULAR WIRELESS"

**BLUE PRINTS**  
of TESTED CIRCUITS

Every wireless amateur and every wireless constructor will find these "POPULAR WIRELESS" Blue Prints absolutely reliable. They have been most accurately drawn, and every circuit has been tested under normal broadcasting conditions by the technical staff of "Popular Wireless." It will be seen from the complete list given below that the series covers a very wide field. The veriest tyro will find each print most straightforward to follow and the receivers most easy to construct.

P.W. BLUE PRINT  
Number

1. DETECTOR VALVE WITH REACTION.
2. UNIDYNE DETECTOR VALVE WITH REACTION.
3. 1-VALVE L.F. AMPLIFIER.
4. CRYSTAL DETECTOR WITH L.F. AMPLIFIER.
5. H.F. (Tuned Anode) AND CRYSTAL, WITH REACTION.
6. H.F. AND CRYSTAL. (Transformer Coupled, without Reaction).
7. 1-VALVE REFLEX WITH CRYSTAL DETECTOR (Tuned Anode).
8. 1-VALVE REFLEX AND CRYSTAL DETECTOR (Employing H.F. Transformer, without Reaction).
9. H.F. AND DETECTOR (Tuned Anode Coupling, with Reaction on Anode).
10. H.F. AND DETECTOR. (Transformer Coupled, with Reaction).
11. DETECTOR AND L.F. (With Switch to Cut Out L.F. Valve).
12. DETECTOR AND L.F. UNIDYNE (With Switch to Cut Out L.F. Valve).
13. 2-VALVE REFLEX (Employing Valve Detector).
14. 2-VALVE L.F. AMPLIFIER (Transformer Coupled with Switch to Cut Out Last Valve).
15. 2-VALVE L.F. AMPLIFIER (Transformer-Resistance Coupled with Switch for Cutting Out Last Valve).
16. H.F. (Tuned Anode), CRYSTAL DETECTOR AND L.F. (with Switch for Last Valve).
17. CRYSTAL DETECTOR WITH TWO L.F. AMPLIFIERS (with Switching)
18. 1-VALVE REFLEX AND CRYSTAL DETECTOR, with 1-VALVE L.F. AMPLIFIER, Controlled by Switch.
19. H.F. DETECTOR AND L.F. (with Switch to Cut Out the Last Valve).
20. DETECTOR AND 2 L.F. AMPLIFIERS (with Switches for 1, 2, or 3 Valves).

ALL "POPULAR WIRELESS"  
BLUE PRINTS—6d. EACH

All orders for these Blue Prints should be sent direct to the "Popular Wireless" Queries Department, Fleetway House, Farringdon Street, London, E.C.4, enclosing a stamped addressed envelope and a postal order for 6d. for each Blue Print Ordered.

> "EKCO" H.T. UNITS <

SCRAP DRY BATTERIES!

By obtaining H.T. Current from Electric Supply Mains (D.C. & A.C.) by just attaching Adaptor to Electric Light Lampholder!



12" X 6" X 7"  
MODEL V2A-A.C.

"EKCO"

The  
"QUALITY"  
Unit

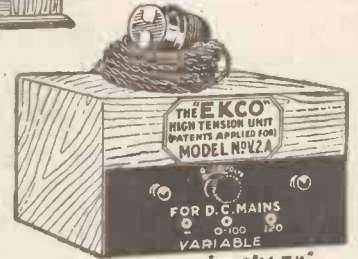

FOR D.C. MAINS  
0-100 120  
VARIABLE  
SIZE 6" X 6" X 3 1/2"  
MODEL V2A-D.O.

Illustrated Folder FREE.

UNITS TO SUIT } FROM 42/6  
ALL SETS - - }

Obtainable from all the leading Wireless Stores or direct from:—

**F.K. COLE LTD** (DEPT. A), 513, LONDON RD.,  
WESTCLIFF-ON-SEA.

RADIAX Super LOW LOSS COILS

The high efficiency, splendid finish, and precision characteristics of Radiax Coils make them essential if you want the best.

**SPLIT SINGLE COILS** for anode tuning and a variety of purposes.  
150/400 ... 6/8 300/600 ... 6/9 130/400 10/6 300/600 10/6  
600-1200 ... 8/- 1200/3000 9/- 600/2200 11/- 1200/3000 12/6  
Three-leg Base ... 2/3. Six-leg Base ... 2/6.

A variety of types is standardised, and we make any special coils required. List stamp.

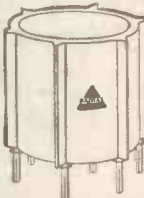

**LOW LOSS FORMERS.**—We now supply our Standard Low Loss Formers ready for winding any coil, transformer, oscillator, etc. Plain or fitted holding bar; 6 nickel pins and nuts.

Length	Former Only	Former Fitted
2 1/2"	1/3	3/3
3"	1/4	3/3
3 1/2"	1/6	3/6

6-pin Base, nickel fittings, 2/6.

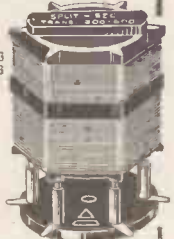

**H.F. CHOKES.** Use the Radiax Chokes and ensure effective reaction control. Not merely a bunch of wire, but a low-capacity, high resistance, sectionised winding designed for its job. Price 8/-. Send two stamps for Catalogue of all Radiax Guaranteed Components and all wireless requirements.

**RADIAX, LTD.,** 10, ACCESSORY HOUSE,  
Palmer Place, London, N.7.

From Radio  
Dealers Everywhere



"almost  
the same as  
an added  
stage of L.F."

**LEWCO'S** Inductance  
Coils



THE "POPULAR WIRELESS" VALVE GUIDE—continued.

4-VOLT H.F. VALVES—continued.

Make of Valve	Type	Fil. Volts	Fil. Amp.	Anode Volts	Grid Bias	Impedance	Amp. Fac.	Price	Remarks	Make of Valve	Type	Fil. Volts	Fil. Amp.	Anode Volts	Grid Bias	Impedance	Amp. Fac.	Price	Remarks		
FRELAT— L. Kreier, 49a, Shude- hill, Manchester.	H.V.L.	3.8-4.0	0.5	30-100	—	—	—	s. d. 4 11	General purpose	RADION— Radion, Ltd., Bolling- ton, nr. Macclesfield.	D.E.-06 4-06 H.F.	2.7	0.06	40-120	—	59,000	16.8	10 6	H.F. and res. coup- ling		
LOUWEN— Fellows Mag. Co., Cun- berland Ave., Park Royal	L.A.74	3.0	0.6	50-100	—	—	—	9 6	General purpose	RADIO-MICRO— H. D. Zealander, 121- Minories, E.I.	H.V.L. D.E.-06 M.K.3 D.E.-AV. H.	3.8-4.0 3.0-3.5 3.0-3.5 3.5-4.0 3.8-4.0	0.5 0.06 0.06 0.06 0.5	30-100 40-80 40-80 30-100 20-60	—	60,000	20.0	10 6	H.F. and res. coup- ling		
LUSTROUX— Lustroux Ltd., Bolling- ton, nr. Macclesfield.	F.E.R.2	4.0	0.1	40-100	—	24,000	12	8 0	Also res. coupling	RADVACO— Blitz Bros., Lynton Rd., Horn Lane, Acton, W.3.	S.B.1 S.B.3 S.B.4	3.0 3.5 4.0	0.06 0.5 0.7	30-100 25-75 50-200	—	25,000 40,000 25,000	10 10 10	—	General purpose General purpose General purpose		
MARCONI— Marconi Co., Mar- con House, Strand, W.C.2.	R. D.E.3B. D.E.V. F.E.3	4.0 2.8-3.0 3.8-4.0 3.8-4.0	0.7 0.06 0.06 0.7	30-100 20 max. 20-0 6-15	— — +6 +15	40,000 50,000 24,000 20,000-8,000	9.0 17.0 6.0 4.5	8 0 14 0 25 0 15 6	General purpose Also res. H.F. valve Special H.F. valve 4-electrode, G.P.	RATRACO— Blitz Bros., Lynton Rd., Horn Lane, Acton, W.3.	R. B.E.	4.0 3.5	0.7 0.5	50-200 50-100	—	25,000 40,000	10 10	2 4 2 4	General purpose General purpose		
METAL— J. Rae, Ltd., 60, Black- friars Rd., S.E.1.	T.M. 6/100	4.0 4.0	0.37 0.06	40-80 20-80	—	19,000 19,000	8.5 8.5	— 9 6	General purpose General purpose	S.T.— Ltd., Melbourne S. Place, W.C.2.	S.T.41	3.7	0.1	40-120	—	16,000	13	14 0	H.F. valve		
MULLARD— Mullard Wireless Service Co., Ltd., Denmark St., W.C.2.	P.M.3 S.6 S.4 R.H.F.	3.0-3.7 3.0 3.0 3.8	0.1 0.2 0.2 0.65	50-100 20-160 20-60 50-100	—	16,000 100,000 14,000 59,000	13.5 22 6 15.5	14 0 22 6 22 6 8 0	General purpose Res. coupling General purpose H.F. and det.	STANDARD— Standard Telephones & Cables Ltd., Connaught Hse., Aldwych, W.C.2.	S.S.3 S.S.1 S.S.8	3.0 3.7 3.0-4.0	0.06 0.66 0.1	50-125 50-100 30-125	—	60,000 28,000 18,500	17.0 8.5 13.0	14 0 8 0 14 0	H.F. valve General purpose General purpose		
NELSON— Nelson Electric Ltd., 138, Kingsford Rd., S.W.19.	G.306 G.410	3.0 3.8	0.06 0.1	— —	—	25,000 20,000	7.0 7.0	11 0 11 0	General purpose General purpose	TELA-RADIO— Monowatt Lamp Co. . .	G.P. D.E.3 D.R.4	3.5-4.0 3.0 4.0	— 0.06 0.6	— — —	—	— — —	— — —	— — —	— — —		
NEUTRON— Neutron Distrib. Co., Sartanel Hse., South- ampton Row, W.C.1.	H.406	3.5-4.0	0.06	20-100	—	22,000	9.0	12 6	H.F. and det.	TRIOTRON— Electric Lamp Service Co., 6, Red Lion Yard, High Holborn, W.C.1.	D.E.3 D.R.4	3.5-4.0 3.0 4.0	— 0.06 0.6	— — —	—	—	—	—	—	—	—
OCTRON— H. S. Electric Ltd., 32, Charlotte St., Bir- mingham.	H.R.408 H.408	3.7 3.7	0.08 0.08	30-80 30-80	—	50,000 25,000	18.0 11.0	12 6 12 6	H.F. and res. L.F. H.F. valve	"TWO GRID"— Anodyl Products, Eton Works, E. Dulwich, S.E.22.	H.F. & det. B.E.	3.5 3.5	0.06 0.55	20-25 50-100	+8- +12 +20- +40	—	—	—	—	H.F. and det. General purpose	
OSRAM— G. E. Co., Magnet Hse., Kingsway, W.C.2.	R. D.E.3B. D.E.V. F.E.3	4.0 2.8 3.0 4.0	0.7 0.06 0.2 0.7	30-100 20-120 20-60 6-15	— — +0 +15	40,000 50,000 20,000-8,000	9.0 17.0 4.5	8 0 13 0 25 0 15 6	General purpose Also res. L.F. valve Special H.F. valve 4-electrode, G.P.	VITA— Peter Curtis Ltd. . . VOLTRON— Voltron Co., 75, City Rd., E.C.1.	T.P.3 L.C.4 (red)	2.5-3.0 4.0	0.06 0.06	40-100 30-100	—	17,000 25,000	— —	9 0	—	H.F. and det.	
QUIKKO— J. W. Pickavant & Co., Quikko Works, Lon- bard St., Birmingham.	D.E.-2 B.E.H.F.	3.0-4.0 3.5	0.2 0.5	40-120 30-120	—	45,000 52,000	14.0 18.0	8 0 4 3	H.F. valve H.F. valve	VITA— Peter Curtis Ltd. . . VOLTRON— Voltron Co., 75, City Rd., E.C.1.	L.C.4 (red)	4.0	0.06	30-100	—	25,000	—	9 0	—	H.F. and det.	

4-VOLT DETECTOR VALVES—(Many Power Valves prove excellent Detectors).

Make of Valve	Type	Fil. Volts	Fil. Amp.	Anode Volts	Grid Bias	Impedance	Amp. Fac.	Price	Remarks	Make of Valve	Type	Fil. Volts	Fil. Amp.	Anode Volts	Grid Bias	Impedance	Amp. Fac.	Price	Remarks
AMPLION— A. Grabam & Co. 25, Savile Row, W.1.	—	—	—	—	—	—	—	s. d.	—	BURNDIPT— Burndip Wireless Ltd., Bedford St., W.C.2.	H.L.425 H.L.310	4.0 3.0	0.25 0.1	40-50 30-45	—	10,000 20,000	9.0 6.5	18 6 14 0	General purpose General purpose
A.B.A.— Stephens & Well, 55 Gt. Eastern St., E.C.2.	Ara 1 Ara 6	3.8-4.0 3.5-4.0	0.6 0.06	30-80 30-80	—	—	13.0 5.0	—	General purpose General purpose	G.A.C.— Valve Distrib. Co., Ltd., 10, Raugoon St., E.C.3.	B.E.H.F.	3.5	0.5	—	—	52,000	18.0	6 0	H.F. and det.
B.E.A.M.— Lester & Marquis, 15-16, Thevia Inn, E.C.1.	D.E.-06	3.0-4.0	0.06	20-90	—	—	—	0 6	General purpose	CLEAFTRON— Cleatron Radio Co., Ltd., 1, Charing Cross, W.	C.T.-08 C.T.-4	3.0 3.5-4.0	0.08 0.1	30-100 30-50	—	18,000	7.5	14 0 18 6	General purpose Spec. det.
B.J.H.— The British Thomson- Houston Co., Crown Hse., Aldwych, W.C.2.	R. B.5H.	4.0 2.8 2.8	0.7 0.06 0.06	40-100 20-80 40-120	—	27,000 17,000 55,000	7.5 7.0 17.5	8 0 14 0 14 0	General purpose General purpose High imp. detector	COSMOS— Metro-Vick. Supplies Ltd., 155, Charing Cross Rd., W.	—	—	—	—	—	—	—	—	—
B.S.A.— Radio Ltd., Small Heath, Birmingham.	—	—	—	—	—	—	—	—	—	A. C. Gossor Ltd., Aber- deen Lane, Highbury Grove, N.	W.R.1	1.0-6.0	0.3	30-120	—	19,000	9.8	16 0	Det. and L.F.

To be continued.

**Sing a Song of Sixpence,  
Pocket full of rye,  
If you're wanting RAYMOND S,  
Pass the others by.**

**MULLARD P.M. VALVES**  
For 4-v. accu. or 3 dry cells.  
P.M.3 (G.P.), 0-1 amp, 14/-  
P.M.4 (Power) 1-amp, 18/6  
For 6-v. accu. or 4 dry cells.  
P.M.5 (G.P.), 0-1 amp, 18/6  
P.M.6 (Power) 1-amp, 18/6  
For 2-v. accu.  
P.M.1 H.F., 0-1 amp, 14/-  
P.M.1 L.F., 0-1 amp, 14/-  
P.M.2 (Power) 0-15 amp, 18/6  
4-v. accu., 22/6  
P.M.5A, H.F.A. and H.C.C., 18/6  
P.M.256, 0-6 v. accu., 22/6

**RADIO FOR THE MILLION**  
(Mullard Receivers).  
FRANKLIN P.M.  
RODNEY P.M.  
NEELSON P.M.  
GRENVILLE P.M.  
All parts in Stock.

Set of 4 Blue Prints, with Book of Instructions, Free to customers (callers only).

**MULLARD Ever-Rest Wire Wound Anode**  
Resistance, 180,000 and 100,000 ohms; 5/-; complete with Holder, 6/6.  
**MULLARD Grid Leaks and Condensers:** Type Grid B 0-5 to 5-0 ohms, 2/6. Type Grid B combined with '0005 mid. Condenser Type MA, 5/-. Type MA Condenser, '0001 to '0009 mid., 2/6. Type MB Condenser, '001 to '01 mid., 3/-.  
**STOP PRESS!**  
J. B. Condensers.—True tuning, S.L.F. Friction Vernier, '0005, 16/6; '00035, 15/6.  
Copey Copper Screen and 6-pin Interchangeable Base, 9/6.  
Keystone Binocular Coils, 10/6. 5-pin Base, 2/-.  
Keystone Neutralising B.B., 5/-. Panel, 6/3.  
Balancing, 7/6.  
Lampugh S.L.T. Condensers.—'0005, 13/-. '0003, 12/6. Triple Gang, 50/-.  
**STILL THEY COME!**  
McMICHAEL H.F. CHOKE, 9/-.  
**BURNETT ETHER VERNIER DIAL** (with Ethlog Station Indicator, 15/-, 9/-).

**WEARITE**, 2-way geared, 5/-, B. of Panel, 7/6.  
**BRUNET L.F. TRANSFORMER**—Highly strong, 3-1/2, 5/- each, 7/11. Post 6d.  
**DUBILIER 'Uniwave' Variable Condenser**, 25/-.  
**RAYMOND ANTI-MICROPHONIC VALVE HOLDER**. Board Mounting, 1/6.  
**BROWNIE No. 2. Latest model**, 10/6. Complete with pair of high-class phones, 4,000 ohms, value 8/11. Aerial wire, lead-in, Daventry Coil, the lot, 18/11. Post 1/6.  
**GOLSTONE (Ward & Goldstone)**.—Anti-cap Valve Holder, 1/-. Multiple Phone Block, 8/11, 2/6. Acc. Carriers, 2/-, Voltmeters, d'ble r'dg., 0-10, 0-20, 8/6. Centre Zero pattern, Ins. Body, L.T. 0-10; H.T., 0-20, 10/6. L.F. Transformer, 1/6. 2-way Coil Stand, 6/6. 3-way, 9/-. B.B. 'Easifix' Assembly, 2 H.T. and 2 L.T. leads, 2/-; 5-way, 2/3; 6-way, 2/9; 7-way, 2/6. 100 H. Stranded Conductor for Frame Aerials, 5/-. D.C.H.T. Battery Eliminator, 63/-.  
**COSMOS R.C. Unit**. Type "O". The unit alone. Price 8/6.  
Type "V". The unit incorporating the "Cosmos" Spring Valve Holder. Price 10/6.  
Suitable Valves for use with this unit are: For 2-volt "Cosmos" 5S18/B. For 6-volt "Cosmos" 5P55/B.

**FIXED CONDENSERS.**  
Dubblier, '0001, 2, 3, 4, 5, each 2/6. '001, 2, 3, 4, 5, 6, each 3/-. Grid Leak, 2/6. Edison Bell, '001, '0001, 2, 3, 4, 5, 1/-; '002, 3, 4, 5, 6, 1/6. '0005 and grid leak, 2/-. McMichael with clips, '0001 to '0005, 2/6 each. '001 to '0005, 3/- each.

**GRAHAM-FARISH WEST END DEPOT**  
Sold on Money Back Guarantee  
Fixed Condensers, 1/-, 1/6; '0003 and Grid Leak, 2/-; for Series and Parallel; Grid Leak, 1/3 each.

**R.T. AERIAL TUNING INDUCTANCE.**—With variable reactance. A new unit for panel mounting, covering the wave-lengths from 175-4,000 metres. With efficient aerial reaction over the whole range, £3/18/6ea.  
R.T. Permanent Detector, 6/-; 1-Hole Fixing, 6/6. Multi Ratio L.F., 25/- Standard Ratio, 25/- Reactive Anode Unit, 25/- New H.F. Choke, 12/6.

**VALVE HOLDERS**  
(R.B. Non-microphonic).  
1/6; 2/6. Key Ray, 1/6; 1/6. Lotus, 2/3; with Terminals, 2/6. Benjamin, 2/9. Burnet, 2/9.

**MAGNETIC MICROPHONIC BAR AMPLIFIER.** No Valves. No Batteries. No fragile parts or distortion. Complete Amplifier, 38/-.  
**VERY SPECIAL!**  
Post Free over 10/-.  
L.F. Transformers, 5/11, 6/11, 6 or 30 ohm Rheo., 1/10, 2/- Non-Microphonic V.H., 1/6, 1/9, 2-way Geared (B.B. or P.), 3/6, 3/11, '0005 Sq. Law Variable, 5/11, 6/11. Handsome Cabinets, American type, 12 x 8, hinged lid, and baseboard, 12/- Panels, 12 x 8, 3/6, 4/3.

**BROWNIE**  
No. 2 Crystal Set, 10/6. 2-Valve Amplifier, 63/-. 4-way 'Phone Boards, 3/-.  
**EDISWAN VALVES.**  
R.O.2, 14/- ea. P.V.2, 18/6. R.C. Units, 7/- ea. Post 6d.

**CABINETS.** Large stocks of really useful Cabinets kept, or made to order. Polished mahogany colour or oak. American type, hinged lid, baseboard, 8" x 8" deep, 8/3, 6/11 (By post, 8/3) 10" x 8" x 8" deep, 8/11 (By post, 10/3) 12" x 8" x 8" deep, 10/6 (By post, 12/6) 14" x 7" deep, 12/6 (By post, 14/-) 16" x 8" deep, 16/11 (By post, 17/11)

**EDISWAN R.C. THREESOME**  
Set of Parts: Pr. 2 Valve, 18/6; 2 R.O.2 at 14/-; 3 Lotus V.H. at 2/6; 3 Fil. Rheostats at 2/6; 9-v. Grid Bias, 2/-; Lotus 2-way L.H., 7/-; '0005 Tuning Condenser, 6/11. The lot, post free, £3/19/6. With cheaper (but good) rheostats, valve holder, and 2-way. The above lot, 72/6.

**RADIO MICRO**  
(Guaranteed genuine).  
3-5-v. '06-a. G.P., 6/11  
1-8-v. '2-a. G.P., 6/11  
3-5-v. '3-a. Power, 8/6  
3-5-v. '1-a., " " 9/6  
1-8-v. '2-a., " " 10/6  
The lot, post free, £3/19/6. Undine or other circuits.  
3-5-v. '06, A.T.5 to 20-v., 10/6.  
Beware of infringements.

**VERNIER DIALS.**—Formo, 6/-. Indigraph (Igranico), 7/6. Detex, 5/9. Detex Vermo, 4/6. Ormond, 10/-, etc., etc. Igranico 4 in. Dial, and Knob, 2/6. RAY RAY, 1/6. Tritile, 1/9. Standard Ebonite Dials, 10d. and 1/-.  
**BRETWOOD.**—Grid Leak do Lux, 3/6; with condenser, 4/6. Anode, 3/6.

**HEADPHONES**  
(All 4,000 ohms).

**N. & K. STANDARD PATTERN 'PHONES,** large size ebonite earcaps, double leather earbands, Super Tone, 4,000 ohms, Special Price, 7/11 per pair.  
**N. & K. GENUINE.** See name in full on outside cases. New lightweight, 1/6. Extra quality do., 2/6.  
**DR. NESPER,** 13/6. Unapproachable value, adjustable, wonderful tone, 10/6.  
**DO. TELEFUNKEN** (20" model) limited number at 14/11. Adjustable, genuine BRUNET, stood the test of years, need no boosting, 10/6 & 12/6.  
**ERICSSON EV CONTINENTAL**, still as good as ever, 10/6 (tone, sample pair, 8/1).  
**BRITISH HEADPHONES.—BROWN'S FEATHERWEIGHT**, 20".  
**BROWN'S 'A' TYPE** (Reed), 30/-  
**B.T.H., 15/- STERLING,** 20/- 22/6. Post Extra.

**COMPONENTS FOR ELSTRELEX TWO.**  
'0005 dual condenser (Ormond); '0005 single condenser (Ormond) fitted with slow-motion device (indispensable); 2 special bases (six-pin); 2 split-secondary transformers (any standard make); 2 non-microphonic valve-holders; L.F. transformer, ratio 5 to 1 (Igranico); L.F. transformer, ratio 3 to 1; 30-ohm rheostat; P.M. crystal detector; '002 fixed condenser; neutralising condenser; strip of ebonite, 8 in. by 1 1/2 in. by 1/2 in.; 12 terminals; wire, £4 12 6, post free.

**ORMOND**

**SQUARE LAW LOW-LOSS.**  
'0005, 9/6; '0003, 8/6; (1/6 each less, no vernier); Friction Geared, '0005, 15/-; '0003, 14/6; '00025, 13/6. Straight, Friction Geared, '0005, 20/-; '00035, 19/6. S.L.F., '0005, 12/-; '00025, 11/-.  
**SQ. LAW LOW LOSS DUAL**—'0005 for Elstrelux, 8/- each. Ormond Friction Dial, 10/-  
**Filament Rheostats,** Dual, 2/6; 6 ohms or 50 ohms, 2/6. Potentiometer, 400 ohms, 2/6. L.F. Shrouded, latest model, 15/-.

**GANG CONDENSERS.**  
Dual '0005.  
**ORMOND**, with dial, 32/-  
**CYLDON**, no dial, 50/- Triple '0005.  
**ORMOND**, with dial, 40/-  
**CYLDON**, no dial, 70/-  
**IGRANIC**, no dial, 75/-  
**BOUYER-LOWE**, no dial, 70/-

**MARCONIPHONE**  
Sterling Non Pong V.H., 2/9. Ideal L.F. Transformers, 25/- (2-7-1, 4-1-6, 1-B-1). Ideal Junior L.F. P.B. Var. Res. 40,000 ohms, 8/6. H.F. Choke up to 4,000 metres, 10/6. Sterling Baby L.S. 50/- Sterling Dinkie, 30/- Melloxox, 48/-.

**COLVERN SCREENED COILS, BASES AND SCREENS.**  
Former and Base, 5/-, 6-pin Base, 1/6. Former only, 4/- Screen and Base, 8/6. R.P.H.T., 9/6. S.S. do., 9/6. 2 Monodial Coils, 19/-.  
**LEWCO'S, BOUYER-LOWE, MAGNUM SCREENED COILS.**  
BBC 250/550 metres. Tapped Primary Aerial Coils, 6/- H.F. Transformers (Split Primary and Resonant), 10/- Split Secondary H.F. Transformers, 10/- Reinforcing Transformers, 10/- 5XX same prices with exception of Reinartz and S. Secondary; these are 14/- each. 6-pin base with standard spacing and cross-formation, with screen, 15/-.

**WEST END DEPOT FOR "MAGNUM"** (Burne-Jones)

**IGRANIC'S**

**BIG PRICE REDUCTIONS.**  
**IGRANIC TRIPLE-HONEY-COMB INDUCTANCE COILS.**  
30, 2/6; 40, 2/9; 50, 2/3; 60, 3/-; 75, 3/3; 100, 3/6; 150, 3/9; 200, 4/-; 250, 4/6; 300, 4/9; 400, 5/6; 500, 7/-; 750, 9/6; 1,250, 14/-; 1,500, 16/-.  
**Wattmeter Amplifier,** 250/500 M., 4/6. Patent S.L.F., '0003, 14/6; '0005, 18/6. Low Loss Dual, '0005, 27/6. Micro Condenser, '0004, 5/6. Dial, 12/- extra. Vernier Balancing Do., 5/6. Indigraph Vernier Knob and Dial, 7/6. Microvern, 8/6. "E" Type L.F. Transformers, latest shrouded model, 3-1, 15/-; 5-1, 16/- Fil. Rheo. and Potentiometers stocked. On and Off Switch, 2/9; Radios, 3/6; Earring Switch, 3/-; Jacks from 2/- Plugs from 1/6. All parts available stocked. Short-wave Coils: No. 2, 2/6; 4, 2/7; 6, 2/8; 8, 2/9. Set of 4, 10/- Honey-comb H.F. Transformers, with tapped primary, B.B.C. 6/9; 5XX, 10/- Buy IGRANIC Parts. Quality Highest. Prices Lowest.

**L.F. TRANSFORMERS.**  
Ferranti A.F.3, 25/- A.F.4, 17/6; Eureka Concert, 25/- 2nd Stage, 21/-; Baby 1st or 2nd, 15/-; Reflex, 15/-; Formo shrouded, 10/6; Success Black, 21/-; Royal 10/-; Ormond, newest model, 15/6; Wates' Supra, 10/6; Croix 5-1, 3-1, 4/6; Marconi 'Ideal', all stages, 25/- each; O.A.V., 15/-; Eye, 22/6; Gambrel, 2 stages, 25/6; Ideal Junior, 18/6; R.I., 25/-; Multi-Ratio, 25/-.  
**FRANCO.**—Midget B.I. Cond., 3/9. Panel Brackets, pair 1/-.

**LISSEN.—Lisenoia,** 13/6. L.F. Transformer, 8/6. 35 ohm Rheostat, 2/6. H.F. or L.F. Choke, 1/-, H.F. or L.F. Grid Leaks, F. 1/-; Ditto, variable, 2/6. All parts available.  
**VARLEY.—Anode's,** 7/6; 250,000 ohm, 9/6. H.F. Choke, 9/6, 12/6.

**BEARD & FITCH (Successors).**—H.F. & L.F. Chokes, each 10/6. Midget Neut. Condenser, 7/6. "Black" L.F. Transformer, 21/-.

**McMICHAEL.**—Bal. Condenser, 4/9. All Fixed-Condensers, H.F. Transformers, each 10/- Dimic Coils, 10/- Bases, 2/6.

**BENJAMIN.**—Battery Switch, 1/3. Valve Holder, 2/9; with Grid Leak, 5/3. 4-way Condenser and Leak, 7/- Rheostat, 2/9.

**FEERLESS.**—6 or 30 ohm Rheostat, 2/6. Fixed Resistors (State Valves), 1/3.  
**JACKSON BROS. (J.B.) S.L.F.**—'0005, 11/6; '00035, 10/6. Brass Valves, 4-in. dial, Geared, Sq. Law. Twin Gang stocked.

**ALL CIRCUITS, PARTS, COILS & SETS STOCKED.**

**FORMO Low Loss S.L.F. Condenser.** '0003 or '0005, 7/6. Formo L.F. shrouded, 10/6. Micro Dial, 6/-  
**SCREEN & BASE,** 8/6. H.F.T., 7/6. A.C. 5/6. Jacks, 1/3, 1/6, 2/3. Plugs, 1/6.

**World's Most Wonderful Crystal "WYRAY" 1/6**  
The Crystal with the Power of a Valve.  
**BOUYER-LOWE.**—Dual Valve Condensers, 25/- Popular '0005, '0003, 10/6 each. Neutralising Unit, 9/- Triple gang, £3/10/0. H.F. Transformers, 9/- ea. Neutralising condenser, 7/-.

**CLIMAX.**—Potential Divider, 5/6. Special Choke, 10/6. Shock Absorbers, 3/- Earth Tubes, 5/-, L.L. Insulators, 1/- pair.

**Who put the RAY in RADIO? WHY! RAYMOND'S !!**

**Buy IGRANIC Parts If you want the best.**

**FOR A REAL CRYSTAL Try "WYRAY" 1/6**  
The Crystal with the power of a valve.

**A TWO-VALVE D. & L.F. CIRCUIT.**

Set of Parts  
L.F. Transformer, 2 Valve Holders, Fil. Rheostat, 2-way Coil Holder, square wire, Variable Condenser and Dial, '0003 Fixed and Grid Leak, Terminals and WIRING DIAGRAM. 17/11 Post free.

**"SUPER ONE" ONE VALVE RECEIVER.**  
(will also work Loud Speaker)  
**A WONDERFUL INSTRUMENT**  
In American Type Cabinet, all parts enclosed complete with Dull Emitter Valve, 1 Pair 4000 ohms Headphones, Tuning Coils, H.T. and L.T. Batteries, Aerial Equipment. Tax Paid.  
**£3 - 3 - 0** Post 2/6.

**SOLODYNE COMPONENTS as specified - £10. 15. 6**  
Less Panel, Cabinet, Valves.

**PINSTON SCREENED COILS.**  
S.L.F. Aerial Coil, 5/6. Split Primary H.F. Transformer with reaction, 7/6. 88 H.F.T., 7/6. Reinartz, 7/6. 5XX, above, 5/6. 7/6, 11/- Screen and 6-pin Base, 9/- Finston Monodial Coils, 9/- each. Base, 1/6.

**WATES' MICROSTAT 2/9 each.**  
**UTILITY SWITCHES.**  
4 1/2-cap, 2-v., 3/6; 3-w., 4/6; 4-w., 5/-; 5-w., 6/-; Lever Pattern, 2-w., 4/-; 3-w., 5/-; 4-w., 6/6; 6-w., 8/-.  
**UTILITY Variable Condensers stocked.**

**EDISON BELL COILS.**  
25 ... 2/6 100 ... 3/6  
35 ... 2/6 150 ... 3/6  
50 ... 2/6 200 ... 4/6  
75 ... 3/6 250 ... 4/6  
300 ... 4/6

**"TUNEWELL" LOW-LOSS COILS** (Tandco Patent). Accurately calibrated. Standardised Potentiometer, 25, 35, 50, 75, 150, 300, 400, 600, 1000, 1/8 each. 150, 2/3. (5XX 175, 2/6). 200, 2/9. 250, 3/3. 300, 3/9.

**ACCUMULATORS.**  
2-v. 40, 7/11; 2-v. 60, 9/6; 2-v. 80, 12/6; 2-v. 100, 14/6; 4-v. 40, 13/11; 4-v. 60, 17/11; 4-v. 80, 23/6; 6-v. 60, 26/6; 6-v. 80, 35/6. ALSO another good make, 1/6 extra on each of above. Post 1/- each.

**CHOKES**—Cosmos H.F., 4/6; Lissen H.F. or L.F., 10/- each; Success L.F. or H.F., 10/- each; Bewyer-Lowe H.F., with base, 9/-.  
**VOLTMETERS.**—First-class meters for testing high and low tension. Double reading, dead beat, 10/6 and 7/11. Cheaper line, excellent value, 5/11. Post 6d.

**LOTUS.**—V. Holders, 2/3; with Terminals, 2/6. 2-way Coil Stand, 7/-, 8/- 3-way, 10/6, 12/-.

**PARIS IN STOCK FOR THE ELSTRE SIX, SOLODYNE, NEWREX, ELSTRELEX, 1927 FIVE AND ALL THE CHIEF CIRCUITS.**

**VALVES.**—Cosmos S.P.1B, Red or Green, 14/- New Blue Spot, 14/- All Mullard, Ediswan, Osram, Marconi, Cossor, Bright, D.E. and Power, 8/-, 14/-, 18/6, 22/6, 24/6, 30/-, £2.

**EXIDE H.T. ACCUMULATORS.** 20-v. Unit, 15/- (Not sent by post).

**ASHLEY JACKS & PLUGS.** Fit panels at 2 thick, one hole fixing. S.C.O., 1/3. S.C.C., 1/6. D.C., 1/9. F.S.G., 1/9. F.D.C., 2/3. Phone Plugs, 1/6. Post Extra.  
Newly 2-way geared coil stand, 6/6. 4-point condenser, 17/6, 15/-.

**LATE NEWS**  
B.T.H. L.F. 17/6 each.  
EVERYTHING IN Demand Stocked for Wireless.  
**RADION PANELS LIST PRICES**  
BRANDES, AMPLION, B.T.H. STERLING, and ALL LOUD SPEAKERS. T.C.G. MANSBRIDGE, USUAL SIZES.

**CALL HERE FOR LISSEN, BENJAMIN, RADIO-MICRO, COSMOS, MULLARD, EDISWAN, MARCONI, COSSOR, OSRAM, JACKSON'S (J.B.) DUBILIER, McMICHAEL, SUCCESS, BEARD & FITCH, BOUYER-LOWE, LEWCO'S, IGRANIC, EUREKA, ORMOND, UTILITY, FORMO, EDISON BELL, FERRANTI, R. L. POLAR, NEWBY, F. & M. MAGNUM. WE HAVE THE GOODS! CALL AND SEE US. ALL LINES IN DEMAND STOCKED. SPECIAL TERMS. RADIO CLUBS. GENUINE EXPERIMENTERS.**

**BE SURE YOU ARE AT RAYMOND'S!**

**K. RAYMOND 27 & 28a, LISLE STREET, LEICESTER SQUARE, W.C.2**

**HOURS** .. 9.15 to 7.45  
**SATURDAY** .. 9 to 8.45  
**SUNDAY** .. 11 to 1

**Back of Daly's Theatre. Nearest Tube, Leicester Square. Phone: Gerrard 4637.**



# TWO-VALVE SET DE-LUXE

### NOTE THE WONDERFUL VALUE. TRY ONE OF THESE!

This 2-valve receiver is a self-contained instrument. Range of wave-lengths from 65 metres-Under normal conditions and using a P.M.G. standard aerial it gives loud-speaker reception from 25-40 miles for local and up to 100 miles on H.P. station. The receiver is built into a polished American Cabinet. All parts are enclosed, but can be seen by raising the hinged lid. When headphones are used the results are simply wonderful. This receiver, irrespective of price, is an absolutely high-class article. The valves and coils shown in photograph are displayed in order that they may be seen, for photographic purposes only.

# £4.19.6

Carriage and Packing 5/-

## THIS MAGNIFICENT 2 VALVE SET (D. & L.F.)

(As shown above) includes

- HANDSOME POLISHED AMERICAN-TYPE CABINET,
  - 2 DULL EMITTER VALVES,
  - TUNING COILS,
  - H.T. & L.T. BATTERIES,
  - AERIAL EQUIPMENT, LEADS,
  - 25 - LOUD SPEAKER.
- TAX PAID.

## 3-VALVE SET (D. & 2 L.F.)

With Coils and Valves. Tax paid. (Carr. and packing, 7/6) **£5.15.0**

With accessories as mentioned with 2 Valve Set (Carr. and packing 10/-) **£8.18.6**

**LOW LOSS SQUARE LAW.** This variable Condenser is simply marvellous value. It cannot be equalled in price or quality.

0003 .. 4/11 each  
0005 .. 4/11 each  
By Post 5/11.  
With YERNIER 1/- extra.



## KAY-RAY S.I.F. CONDENSERS

LATEST MODEL NOW READY  
**6/11**  
POST 6d.



0003 .. 6/11 each  
0005 .. 6/11 each  
With 4 in. dial 7/11

## VARIABLE CONDENSERS.

- Polar Standard, 10/6.
- Junior, 5/6 each.
- Bowyer Low-Popular, 10/6.
- Granio, 24/-.
- Collinson's Low-Loss, 21/-.
- Utility, 3/6.
- 10/9.
- Vernier, 2/6 extra.
- Utility Low Loss, stocked -0003 and -0005.
- J.B. (Jackson Bros.), Square Law, -001, 9/6; -0005, 8/-.
- 0003, 7/- (with vernier 4/- each extra).
- Gear, -0005, 15/-; -0003, 13/-.
- Low Loss, 10/6, 9/-.

From J. M. HAINES, M.I.E.E., Hackney, E.9., 24th September, 1926.

"I have two of your -0005 Low Loss S.I.F. at present giving excellent results. I put them in my Set in place of two condensers of a very reputable Maker, and increased the selectivity 100 per cent. You may use this testimonial (entirely unsolicited) as you wish."  
"(Signed) J. M. HAINES."

## VOLTMETERS.

First-class meters for testing high and low tension. Double reading, dead bent, 10/6 and 7/11. Cheaper line, excellent value, 5/11. Post 6d.

# K. RAYMOND 27 & 28a, LISLE STREET, LEICESTER SQUARE, W.C.2

HOURS 9.15 to 7.45  
SATURDAY 9 to 8.45  
SUNDAY 11 to 1  
Back of Daly's Theatre.  
Nearest Tube, Leicester Square.  
Phone: GERRARD 4637.

## WATMEL PRODUCTS

0002 or 0003 and Grid Leak, 2/6. Fixed Condenser, all caps, 2/-. Variable G.L. 2/6 (3 to 5 meg.). Anode, 50,000 to 100,000, 3/6. Ditto, 10,000 to 75,000, 3/6. Auto Choke L.F. Coupling, 18/6. Post extra.

## BARGAINS!

Handsome Crystal Set in box with lid. No extra coils for Daventry needed. Simply switch plug over.  
Or, Set only 12/6.  
Or, complete with headphones, 4, 6 ohms, and aerial equipment, 18/11. Post 1/-.

## SPECIAL LINES FOR CALLERS ONLY

**PERMANENT DETECTORS.** Liberty, 3/6. Red Diamond (a topper), 2/-.  
Lion Micro, latest, cannot be equalled, 2/6. Brownie, 3/-.

**CRYSTAL DETECTORS.** Enclosed Kay Ray, 1/-, 1/3. Service Micrometer, with crystal, 2/9. Burnsted, 4/-.  
Mic Met, 4/6.

**CRYSTALS.** Wyray (power of a valve), 1/6. Shaw's genuine Hertzite, 8d. & 1/-. Neutron. All makes stocked. Gold and Silver Whiskers, 2d., 3d. Packets, 4d.

**AERIALS.** -100 ft. 7/22. Hard drawn, 1/11. Extra heavy, 2/2. Phosphor 49 strands, 1/-.  
Special INDOOR Aerials, phosphor, with ebomite separators and rubber rings (12 ft. x 8 strands), total 100 ft. 4/6.  
O.V. 2/6. Rubber Lead-in, highest quality, 10 yds. 1/-; 10 yds. 1/3; 10 yds. 1/6. Extra heavy, 2d. and 3d. yd. R. & B. Twin Flex (best), 6 doz. yds. 10d.; 12 yds. 1/6; 36 yds. 1/2. Ins. Hooks, 2 for 13d. Egg Insulators, 2 for 14d. Ins. Staples, 4 a 1d. Earth Tubes. Copper, extra value, 2/3. Climax, 5/- (also at 2/6).

**SWITCHES.** - On porcelain, DPDT, 1/3; SPDT, 10d. Superior articles. Nickel, Panel, Ebomite handle, DPDT, 1/6; SPDT, 1/-. Push and Pull, 9d. and 1/-. All Lissens stocked.

**TERMINALS, Etc.** - Nickel W.O. Phone, Pillar, 1/- doz. 3 for 4d. Brass do., 10d. doz.; 1d. each. Nickel Valve Legs, 2 for 1 1/2. Stop Pins, 2 a 1d. Spade Tags, 6 a 1d. Soldering, 3c. 3d. Ormond Nuts, 2d. doz. Washers, 12 a 1d. 2 and 4 B.A. Rod, 3d. ft. Only the best sold here. Screw Spades, 2 for 14d. Pins do. Valve Pins, 2 a 1d.

**RED & BLACK WANDER** Plugs, 2d. & 3d. pr. Spades, 3d. pr. Pins, 2d. pr. Plug & Socket, 3d. Clix Wands, 3c. Pins, 2d. Igranite, 3d.

**TANDCO BASKET COILS.** - 4d., 2, 5d., 5, 6d., 7, 7d., 8, 8d., 6, 9d., 7, 10d.; 8, 1/-; 9, 1/2; 10, 1/4; 11, 1/6; 12, 1/8.

**LISSEN H.T. 7/11 & 10/6**  
Belling Lee Terminals stocked.

**SEE K. RAYMOND'S NAME ON PREMISES. THIS WILL ASSURE YOU GETTING THE GOODS I ADVERTISE. PLEASE ASK: "IS THIS RAYMOND'S?"**

**EVERY LOUDSPEAKER DESERVES MULLARD MASTER VALVES**  
- Ask for -  
Kullard P.M. Power Valves

**BECOL LOW LOSS FORMER**  
Size: 3 inches diameter to outside of wings. Price: 6 inch length, 3/-; 4 inch length, 2/-; 3 inch length, 1/6. Up to 36 in. length. Post 6d. piece.

"I was fortunate enough to purchase one of these sets this week, and after very thorough tests it has proved to be perfect in every detail, giving very fine clear results, and I shall be only too pleased to recommend this set to all my friends."  
Yours faithfully,  
JOHN F. DREW.

**BEFORE YOU PURCHASE ELSEWHERE: CALL AND LET ME QUOTE YOU**

**OUR NOTED 1-VALVE and CRYSTAL SET,** in solid polished cabinet, complete with valves, 'phones, H.T. and L.T. Units, Aerial Equipment, Daventry Coil. Extraordinary value **45/11**

Carriage 2/-.

Set only 22/6. Carriage 2/-.

**ASTOUNDING VALUE IN L.F. AMPLIFIERS,** in handsome polished box (Carriage 1/6)

- 1 Valve .. 16/11
- 2 Valve Amplifier .. 25/11
- OR COMPLETE with Valves, H.T. and L.T. Units, Carriage, 2 - 44/6

In American-Type Cabinets, all parts enclosed, 4 - extra on each.

## S.T. VALVES

- S.T. 22: Fil. volts, 1-8; fil. amps., 1; anode volts, 40-120; impedance, 16,000 ohms; amplification factor, 10. Price 14/-.
- S.T. 23: Fil. volts, 1-8; fil. amps., .15; anode volts, 80-120; impedance, 6,000 ohms; amplification factor, 6. Price 13/6.
- S.T. 41: Fil. volts, 3-7; fil. amps., 1; anode volts, 40-120; impedance, 16,000 ohms; amplification factor, 13. Price 14/-.
- S.T. 42: Fil. volts, 3-8; fil. amps., 1; anode volts, 40-120; impedance, 6,000 ohms; amplification factor, 6. Price 18/6.

- S.T. 21: Fil. volts, 1-8; fil. amps., 1; anode volts, 40-120; impedance, 26,000 ohms; amplification factor, 16. Price 14/-.
- S.T. 43: Fil. volts, 3-8; fil. amps., .25; anode volts, 40-120; impedance, 4,000 ohms; amplification factor, 33.3. Price 22/6.
- S.T. 61: Fil. volts, 5-6; fil. amps., 1; anode volts, 50-120; impedance, 20,000 ohms; amplification factor, 20. Price 18/6.
- S.T. 62: Fil. volts, 5-6; fil. amps., 1; anode volts, 80-120; impedance, 6,000 ohms; amplification factor, 8.3. Price 18/6.
- S.T. 63: Fil. volts, 5-6; fil. amps., .25; anode volts, 120; impedance, 4,000 ohms; amplification factor, 3.33. Price 22/6.

## NO EXPENSIVE CATALOGUES ISSUED

We offer the goods we have for sale.

### SO THAT'S THAT!



# Apparatus Tested

Traders and manufacturers are invited to submit wireless sets and components to the "P.W." Technical Dept. for test. All tests are carried out with strict impartiality in the "P.W." Test room under the supervision of the Technical Editor, and the general reader is asked to note that this weekly article is also intended to provide a reliable and unbiased guide as to what to buy and what to avoid.—EDITOR.

## THE "DUVOLCON."

**D**OUBTLESS many amateurs have felt the need of a variable resistance suitable for use as a volume control or for controlling reaction, and in order to meet this demand the Dubilier people have produced the "Duvolcon." This component is identical in appearance to the "Duvarileak" upon which we recently reported. A component of the nature of the "Duvolcon" volume control requires to be used with discrimination. Volume control is not quite as simple as some people think. A variable resistance placed haphazardly across transformer windings or even across a loud speaker can be a source of distortion, especially in a set the components and accessories of which are carefully matched.

The "Duvolcon" gives a very smooth variation of resistance and is very well

made. It is non-inductive and for this reason particularly suitable for the work for which it was designed. The price is 7s. 6d.

## THE "HARTEL" H.T. BATTERY.

Some time ago we reviewed an H.T. battery of the wet Leclanché type, manufactured by a Mr. Birtles, of Sheffield. The right of manufacture of this battery has since been acquired by the Yorkshire Ignition Co., Ltd., of 1 and 3 Broomhill St., Sheffield. This company has considerably improved the product and has renamed it the "Hartel."

The elements have been increased in size and larger jars of Leclanché pattern are now used. This indicates a greater capacity and longer life. We have received a 60-volt "Hartel," and find it to be a very substantial battery. By careful "pitching," creeping is prevented and the "Har-

tel" is capable of providing up to about 22 milliamps for several hours at a time. 25s. for the 60-volter in case would appear to be a very reasonable price indeed, in view of its undoubted advantages over the conventional dry type for multi-valve sets.

## SOME "SILVERTOWN" COMPONENTS.

We recently received a "Silvertown" S.L.F. variable condenser to test. It is a very well designed component and has a sound movement free from backlash. It is provided with metal endplates to which the moving vanes are positively connected by means of a "pigtail." Very little solid dielectric is employed. The vanes are of hard brass and the dial is provided with a large milled knob.

Two values are available: .00025 mfd. at 11s. 6d. and .0005 mfd. at 13s.

We also received a number of "Silvertown" fixed mica tubular condensers. These are somewhat similar in appearance to grid leaks and are held in similar sorts of clips. On test we found that these condensers hold their charges well and are very accurately rated. Prices range from 2s. for values from .0001 mfd. to .001 mfd. to 2s. 6d. for values up to .005 mfd. The clips mounted on a neat base, cost 7s. 6d.

The "Silvertown" two-way coil holder sent to us with the above is a very well made and nicely finished component, but its design is rather out-of-date. But, nevertheless, it is a substantial component and retails at 7s. 6d.

(Continued on page 1276.)



"ETHOVOX" WITH MAHOGANY HORN

All metal parts are finished in mahogany colour to match the 15-in. polished mahogany flare. This model will appeal to those who desire the full round tone given by a wooden horn. — PRICE £5.5.0

"PETER PAN"  
Price 18/6

# "ETHOVOX"

## Loud Speakers for Power and Purity of Reproduction

Link up an "Ethovox" Loud Speaker with your Receiving Set and realise of what your set is really capable. An "Ethovox" will reveal all its latent capabilities.

In musical reproduction "Ethovox" gives you every note in the musical scale from deepest bass to highest treble, each in its proper value and with perfect clarity.

It reproduces speech so distinctly that you would almost believe the person speaking was in the room with you.

Hearing is believing. Get your local Burndept Dealer to demonstrate an "Ethovox" to you to-day.



"ETHOVOX" WITH METAL HORN

Height 26 in. with 15-in. diameter Metal Flare finished in the rich brown, non-dust holding colour exclusive to BURNDDEPT.

PRICE £4.10.0

"ETHOVOX" JUNIOR  
Price £2.2.0

**BURNDDEPT**  
WIRELESS LIMITED

AGENTS AND BRANCHES EVERYWHERE

London Showrooms: 15 Bedford Street, Strand, W.C.2.

Offices and Factory: Blackheath, London, S.E.3.

RF



# Time Tells

USE "HART" Wireless Accumulators in preference to dry batteries—always. You will quickly note the difference, and the longer you use them the greater will be your appreciation of their undoubted merits. There are models for all low and high tension wireless circuits.

# HART

THE BATTERY OF QUALITY

"RAY" HIGH TENSION ACCUMULATOR  
20 VOLT—14/8; 30 VOLT—22/-

"ENDURO" LOW TENSION ACCUMULATOR  
2 VOLT, 10 AMPERE HOURS ACTUAL—6/-

Write to-day to Dept. W.C.5, for full details of all "HART" Batteries and FREE booklet "The Right Way to Use your Wireless Batteries," Post Free.

**HART ACCUMULATOR CO. LTD.**  
MARSHGATE LANE. STRATFORD. LONDON. E. 15

Telephones - Maryland 1361, 1362, 1363 and 1364

Branch Offices and Showrooms - BELFAST, BIRMINGHAM, BRISTOL, CARDIFF, DUBLIN, GLASGOW, MANCHESTER, WESTMINSTER & YORK

## REDFERN'S COIL FORMER

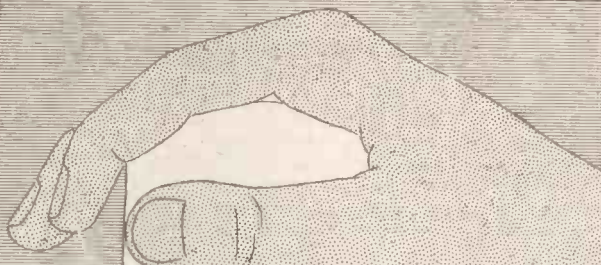

Made by the Makers of

**Ebenart**

In 6 in. lengths.	
A. 2 in. overall diam.	1/8
B. 2 1/2 " " "	1/9
C. 3 " " "	2/1
D. 3 1/2 " " "	2/3

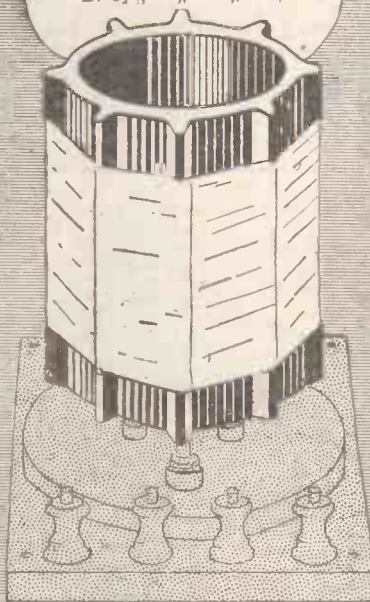

WITH this soundly designed low-loss former you can construct any kind of solenoid coil—coils for screening loose couplers, low-loss single-layer coils, H.F. transformers and other types demanded for the most modern circuits. All except size A have 8 ribs. A will fit B, and B into D (see above).

Write for Folder A262 to  
**REDFERN'S RUBBER WORKS, LTD.,**  
Hyde, Cheshire.

\*-----\*  
**APPARATUS TESTED.**  
 (Continued from page 1274.)  
 \*-----\*

The makers of "Silvertown" wireless components are The India Rubber, Gutta Percha and Telegraph Works, Ltd., of Silvertown, London, E.16

**GECOPHONE L.F. TRANSFORMER.**

We recently received a Gecophone L.F. transformer. It is contained in a metal case of crystalline finish, and is very neat and attractive in appearance. We note that the terminals are taken to the lower part of the case and are well spaced. They are marked so that not only are winding ends shown but circuit connecting points as well—a very sensible modern practice.

The core and windings are hermetically sealed in the case, and are thus absolutely impervious to moisture. In fact the whole assembly is eminently sound in both design and construction. On test we obtained good results with the Gecophone transformer submitted to us. Having a ratio of 4-1, we used it in a second stage of L.F. amplification, following a resistance stage and using a D.E.4. It was also tested in a first L.F. stage, following a crystal and provided even full amplification. It has a primary winding of a high order of inductance and is an efficient component in all respects.

The 2-1 sells at 17s. 6d. and the 4-1 at 22s. 6d. We have no hesitation in recommending this G.E.C. product to our readers.

**A NOVEL DEVICE.**

Many loud-speaker enthusiasts will welcome the "Speakabrak" which has just been placed on the market by Stephen Heath & Co., of Metropolitan Chambers, Lichfield Street, Wolverhampton. It is a loud-speaker bracket which can be hung on a picture rail as easily as a picture, or it can be suspended from a hook fastened at any desired point.

It is a well-made article, and is by no means unsightly. It is provided with rubber buffers to isolate it from the wall, and its

holder is adjustable, so that practically any size or type of loud speaker can be accommodated. The weight of the speaker tends to make the fitment firmer, and the support thus provided is almost equal to that given by a rigidly and permanently fixed shelf.

Undoubtedly the "Speakabrak" is a practical and useful article, and it will be unnecessary for us to detail all its other advantages. The price of the device is 10s. 6d.

**COIL SCREENS.**

Readers who make their own coil bases and coils will be pleased to learn that cylindrical screens can be obtained at reasonable prices from Messrs. R. Simmons and Co., 81, Costa St., South Bank-on-Tees. These screens suit bases of standard dimensions and can be obtained in frosted aluminium at 3s. 3d. or polished at 3s. 6d., post free. They are well made and answer their purpose quite well.

**RUSSELL'S HERTZITE.**

Mr. Leslie G. Russell, of 2, Hill Street, Birmingham, recently sent us a sample of his new Sixpenny Hertzite. That such a well-known crystal is now available at the low price of 6d. per specimen, complete with cat's-whisker and tweezers for handling the crystal, will be good news to crystal enthusiasts. We carefully tested the sample submitted in a standard detector and obtained good results. The crystal is in every way well up to the standard of the previous samples of Russell's Hertzite we have tested and reported upon in these columns in the past.

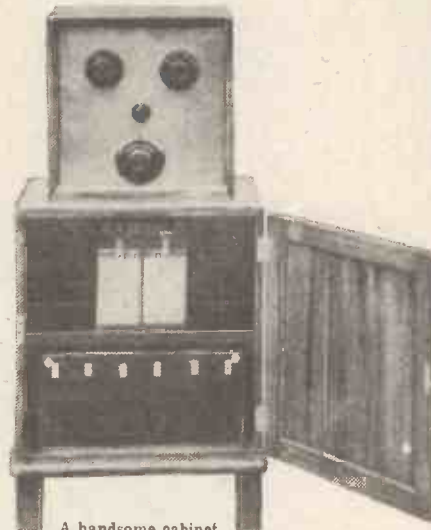

A handsome cabinet receiver that is on the market.



In addition to the H3Q, there are eight other Brown Loud Speakers—a type for everyone from 30/- to £15 15 0.

**T**HE history of the Loud Speaker is the history of the Brown. It is yet another page added to the romance of industry; the story of years of unflagging, unremitting endeavour to reach an ideal. The S. G. Brown, Ltd., it was who, in the days before Broadcasting began, produced the first Loud Speaker ever used in this country for Wireless purposes. The firm which then led the way in making Loud Speaker reproduction possible has ever since set the pace in Loud Speaker design.

The Brown H3Q Loud Speaker marks yet another forward step. For the first time, at the remarkably low price of 65/-, there is available an instrument whose appearance will enhance the setting of any room. All that is best in H3Q acoustical design gives to the H3Q, a remarkable fidelity of reproduction. All that is artistic in design gives it a distinctive and pleasing appearance. For a little over three pounds you can buy a Loud Speaker which will look well in your home and fill it with a faithful rendering of the evening's broadcast. Ask your Dealer.

**S. G. BROWN. LTD., Western Avenue, North Acton, W.3**

Retail Showrooms: 19, Mortimer Street, W.1.; 15, Moorfields, Liverpool; 67, High Street, Southampton. Wholesale Depots: 2, Landsdown Place West, Bath; 120, Wellington Street, Glasgow; 5-7, Godwin Street, Bradford; Cross House, Westgate Road, Newcastle; Howard S. Cooke & Co., 59, Caroline Street, Birmingham. Robert Garmany, Union Chambers, 1, Union Street, Belfast.

# THE "UNIVANE"

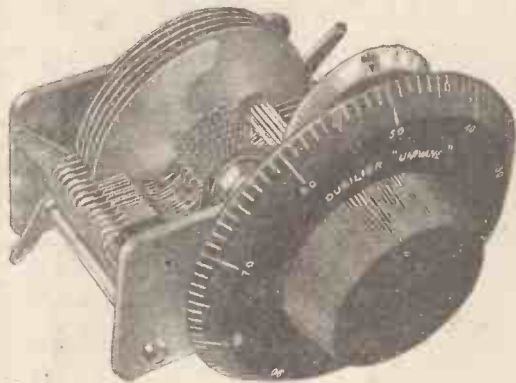

Over 4,600 degrees  
of Vernier Tuning!

The "Univane" gives the equivalent of a continuous Vernier adjustment between minimum capacity and 0.0005 mfd. Rotation of the scale moves one vane at a time, adding it to or subtracting it from those already in opposition.

This enables you to pick up station after station with the greatest accuracy, and the figures on the small dial can be noted to form a permanent log of all stations heard.

The "Univane" is intended for use on every occasion where the ordinary variable condenser is now employed. It is in no sense a condenser for special circuits, and in these days of ultra fine tuning it is a necessity whether you "search the ether" or merely listen to your local station.

It is backed by the full Dubilier guarantee and is further described in our new Catalogue. May we send you a copy?

Price, of all dealers

25/-



ADVT. OF THE DUBILIER CONDENSER CO. (1925) LTD.  
DUCON WORKS, VICTORIA ROAD, N. ACTON, W.3  
TELEPHONE: CHISWICK 2241-2-3. M.C.250.



## Does your radio set rewrite the music?

Supposing you were a musician and listened to radio concerts with the score in your hand . . . how much would you find your radio set had re-written . . . how many notes it had played too *piano*—how many too *forte*?

Fit PYE L.F. Transformers. Then you will get reproduction as it should be . . . clear, pure and lifelike, high and low notes amplified uniformly. The PYE frequency-efficiency curve certified by the National Physical Laboratory is practically a straight line and is unrivalled by any other published authoritative curve. PYE Transformers create no parasitic noises, and voltages up to 300 can be used with perfect safety. Made for horizontal or vertical fitting. Each one tested by an actual measurement of amplification and each one definitely guaranteed.

Ref. No. 651.	Ratio 2.5 : 1	17/6
" " 652.	" 4 : 1	17/6
" " 654.	" 6 : 1	20/-

W. G. PYE & CO.,  
Granta Works, Montague Rd., Cambridge

PYE TRANSFORMERS  
—now reduced in price

BRINGS RECEPTION TO PERFECTION



TRANSFORMERS

# RADIOTORIAL

All Editorial Communications to be addressed to The Editor, POPULAR WIRELESS, The Fleetway House, Farringdon Street, London, E.C.4.

**Editor.**

**NORMAN EDWARDS, M.Inst.R.E., M.R.S.L., F.R.G.S.**

**Technical Editor :**

**G. V. DOWDING, Grad.I.E.E.**

**Assistant Technical Editors :**

**K. D. ROGERS. P. R. BIRD.**

**G. P. KENDALL, B.Sc.**

**Scientific Advisor :**

**Sir OLIVER LODGE, F.R.S.**

**Staff Consultants :**

**Dr. J. H. T. ROBERTS, F.Inst.P.; J. F. CORRIGAN, M.Sc., A.I.C.; C. E. FIELD, B.Sc.; E. J. SIMMONDS, M.I.R.E., F.R.S.A.**

**Foreign Correspondents :**

**F. M. DELANO, Paris; Dr. ALFRED GRADENWITZ, Berlin; L. W. CORBETT, New York; P. F. MARTIN, Italy; W. PEETERS, Holland.**

The Editor will be pleased to consider articles and photographs dealing with all subjects appertaining to wireless work. The Editor cannot accept responsibility for manuscripts and photos. Every care will be taken to return MSS. not accepted for publication. A stamped and addressed envelope must be sent with every article. All inquiries concerning advertising rates, etc., to be addressed to the Sole Agents, Messrs. John H. Lile, Ltd., 4, Ludgate Circus, London, E.C.4.

As much of the information given in the columns of this paper concerns the most recent developments in the Radio world, some of the arrangements and specialities described may be the subject of Letters Patent, and the amateur and the trader would be well advised to obtain permission of the patentees to use the patents before doing so.

Readers' letters dealing with patent questions, if sent to the Editor, will be forwarded to our own patent advisers, where every facility and help will be afforded to readers. The envelope should be clearly marked "Patent Advice."

**TECHNICAL QUERIES.**

Letters should be addressed to: Technical Query Dept., "Popular Wireless," The Fleetway House, Farringdon Street, London, E.C.4.

They should be written on one side of the paper only, and MUST be accompanied by a stamped addressed envelope.

Queries should be asked in the form of the numbered questions: (1), (2), (3), etc., but may be accompanied by a short letter giving any necessary additional particulars as briefly as possible.

For every question asked a fee of 6d. should be enclosed. A copy of the numbered questions should be kept, so that the replies may be given under the numbers. (It is not possible to reproduce the question in the answer.)

Details of the "P.W." BLUEPRINTS are published fortnightly in the advertisement pages of "P.W."

BACK OF PANEL DIAGRAMS can be specially drawn up to suit the requirements of individual readers at the following rates: Crystal Sets, 6d.; One-Valve Sets, 6d.; One-Valve and Crystal (Reflex), 1s.; Two-Valve and Crystal (Reflex), 1s.; Two-Valve Sets, 1s.; Three-Valve Sets, 1s.; Three-Valve and Crystal (Reflex), 1s. 6d.; Four-Valve Sets, 1s. 6d.; Multi-Valve Sets (straight Circuits), 1s. 6d. Except SUPER-HETERODYNE DIAGRAMS, all of which, irrespective of number of Valves used, are 2s. 6d.

If a panel lay-out or list of point-to-point connections is required an additional fee of 1s. must be enclosed. Wiring diagrams of commercial apparatus, such as sets of any particular manufacture, etc., cannot be supplied. (Such particulars can only be obtained from the makers.) Readers may submit their own diagrams, etc., for correction or for criticism. The fee is 1s. per diagram, and these should be large, and as clear as possible.

No questions can be answered by 'phone.

Remittances should be in the form of Postal Orders.

## Questions and Answers

### ADDING H.F. TO THE HALE.

"HALE" (Morecambe, Lancs.).—My Hale 1-valve set has never been quite a success because I've never been able to make it oscillate. I suppose if I add an H.F. stage to it, as described in "P.W." No. 241, this trouble will disappear?

It is fortunate that you wrote, for you are quite wrong. Adding H.F. to an unsatisfactory set, in the hope of making it "go," is like buying a big powerful racing car because you can't drive a little "baby seven." In other words, it is simply asking for trouble.

We should not attempt to complicate the 1-valve set, in any way, until it not only oscillates, but oscillates surely and smoothly, just when required.

(Continued on page 1280.)

Rid your loud-speaker of "Tinnny" Sounds!

— with the —

## "BLUE SPOT" TONE CLARIFIER

Ask your Dealer, or write for List F.2 of 'Blue-Spot' Specialities.

INSTALLED between your receiver and the loud-speaker, this instrument will entirely rid the metal horn of its "tinny" sounds, in an amazing manner. It can easily be fitted to any receiving set, whether a detector set or a valve set. It is accurately adjustable to the finest degree in 6 stages. By turning the adjustment ring, the scale will show the figures 0—6. When set on "0" the clarifier is switched off, whilst the figures 1—6 indicate the degrees of clarification. By very simple adjustments this indispensable accessory will give you reproduction more clear and distinct than you thought possible—at the cost of only 9/6



Wholesale only:

**F. A. HUGHES & CO., LIMITED**  
Head Office: 204-6, Gt. Portland Street, London, W.1

Telephone: Museum 8630.  
Telegrams: "Distancing, Wesdo, London."

SUB-AGENTS:—

For the Midlands: FORSTER-BOYNTON CO. LTD., 70, Lombard Street, BIRMINGHAM.  
For South Wales: WATSON BROS., 48, Dock Street, NEWPORT.  
For Lancs. and Ches.: F. A. HUGHES & Co., Ltd., 6, Booth St. East, C.-on-M., MANCHESTER.





**You can buy  
with your  
eyes shut!**

You'd like to be able to buy components without the trouble of comparing prices & samples. If you could be sure of getting the right instruments at the right price.

Many amateurs buy Bowyer-Lowe Components that way - just say Bowyer-Lowe to the dealer & trust us. The name is synonymous with precision & quality - both are assured by the generous guarantee.

The Bowyer-Lowe Coil Screening Box is a typical example - the sockets are standard, the box is of polished Aluminium and screws into the base screen - thus providing a perfect Electrostatic screen.

**SCREEN & BASE 15/-**

You can confidently specify Bowyer-Lowe-makers of fine Radio Components



ANNOUNCEMENT BY THE BOWYER-LOWE CO. LTD LETCHWORTH HERTS

**MAKES TUNING EASIER  
LAMPLUGH S.L.F. CONDENSERS.**

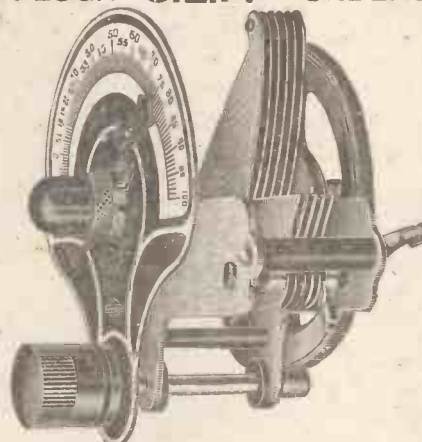

Perfectly designed and beautifully finished, Lamplugh Condensers are unequalled for efficiency and ease of tuning. Built of brass with ball and cone bearing shaft. Copper indicator scale. Lamplugh S.L.F. and S.L.T. Condensers possess a remarkably efficient Slow Motion device. It is absolutely noiseless in operation, has a positive drive and backlash is impossible.

Prices: '0005 mfd. 17/-, '0003 mfd. 16/-, '0002 mfd. 15/6.  
Lamplugh '0005 mfd. Twin Gang S.L.T. Condenser, complete with dial 33/6  
Lamplugh '0005 mfd. Triple Gang S.L.T. Condenser, complete with dial £2 10 0

Particulars of Lamplugh Twin Gang and Triple Gang S.L.F. Condensers on application.

**Economic Electric Ltd** 10, FITZROY Sq. LONDON W.1.

**FERRANTI**

Audio Frequency

**TRANSFORMERS**

WILL DOUBLE THE VALUE OF YOUR SET

TYPE AF3 TYPE AF4

25/- 17/6

(In Irish Free State) 32/6 23/-



**Weak Joints  
need Strong  
Treatment**

An imperfect joint . . . a tiny leakage . . . gone are the chances of good, long-distance reception.

The Fluxite Soldering Set will fix all joints quickly, and for ever. No trouble . . . no mess . . . and so simple.

**FLUXITE SOLDERING SET—Complete 7/6**

All Hardware and Ironmongery Stores sell FLUXITE in tins, price 6d., 1/4 and 2/8. Another use for Fluxite—Hardening Tools and Case Hardening. Ask for leaflet on improved methods.

FLUXITE Ltd. (Dept. 334) Rotherhithe, E.16.

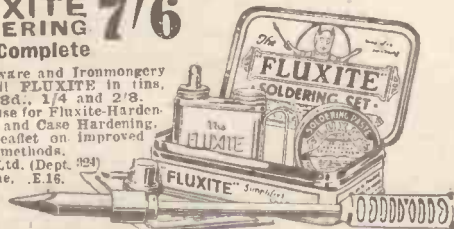

**FLUXITE**

“Money saved is Money earned—  
So when your ‘VALVES’ get old or burned  
Send them to us—and we, to you,  
Will send them back ‘MADE GOOD AS NEW.’”

Manufacturers of Auto-  
revolvers Thermionic Re-  
lays, and new valves of  
all types. Write for par-  
ticulars and list prices.



Restored to function  
with original charac-  
teristics.

**EFFICIENCY MAINTAINED!  
RESULTS GUARANTEED.**  
B.E. 4/-; D.E. 2v. '3  
7/6; D.E. '06 8/-.

Price List for Power Valves  
on application.

We return the actual Valve you  
send us, post free, within 3 days.



**THE NORTH LONDON VALVE CO., LTD.,**

22½, Cazenove Road : Stoke Newington, N.16.

Liberal Discounts to Wireless Agents.

THE WORLD'S SELECTED

# COMPETA

RADIO PRODUCTS.

**THE METERS THAT MATTER.**  
**Don't Overfeed** your valves with L.T. H.T. Put a meter in circuit and get the correct flow as specified by the manufacturers of the valves you use. This means long valve life and pure reproduction.



**MINIATURE PANEL METERS**  
 Specially designed for Radio uses.

<b>VOLTMETERS</b> 0-3, 0-6 and 0-10 Volts.....	7/6
<b>AMMETERS</b> 0-1, 0-3 and 0-6 Amps.....	7/6
<b>MILLI-AMMETERS</b> 0-20, 0-30 and 0-40 M.A. ....	10/6
<b>COMBINED VOLTMETERS</b> 0-6 and 1-20 Volts.....	11/6

Obtainable from all Dealers or—

**A.F. BULGIN & CO**  
 9, H. CURSITOR STREET  
 LONDON, E.C.4. WORKS CHISWICK

TRADE DECKO MARK  
 Patents Ad.

## RADIOTORIAL QUESTIONS AND ANSWERS

(Continued from page 1278.)

If the reaction coil appears to make no difference, try reversing the leads to it.

If still ineffective, try a one-size bigger coil, and reversal of the leads of this. If still obstinate, probably more H.T. is required.

Further improvements can be effected by careful adjustment of the grid bias, in conjunction with the above alterations.

Finally, if the aerial is low or screened, try a .0002 or a .0001 fixed condenser in series with it, to lessen its damping effect.

When oscillation is good and easily controlled, and when plenty of stations are obtainable, you can decide whether it is worth adding the H.F. stage for still greater range.

### "D" COIL CONNECTIONS.

E. J. E. (Feltham, Middlesex).—How are two "D" coils connected together to give a variometer-tuning effect?

The end of one "D" coil is connected to the beginning of another "D" coil, the first one being secured to the panel, with the variometer spindle projecting through a hole in its centre.

The second coil is then laid face downwards upon the first (see photograph), and is secured to the spindle, so that it can be rotated by the control-knob.

In order to prevent breakage of the flexible connection between the two halves of such a variometer, it is usual to arrange a "stop" that prevents the rotating coil from being turned right round continuously.

### ELIMINATOR BLOWS MAIN FUSE.

H. D. (Ilford, Essex).—I have purchased an H.T. battery eliminator, but am unable to use it because it always blows the main fuse (though it is fitted with a large fixed condenser).

Before connecting it to the house lighting (230 volts, direct current) the earth wire of the set was removed, and taken to the unit, the other "E" terminal of this being earthed, according to the printed instructions. Yet, no sooner was the plug connected than the main house fuse was blown. This appeared to me to indicate a direct earth, so I had the unit carefully tested again by the makers. It was passed as O.K., insulation of the condenser being perfect.

(Continued on page 1282.)

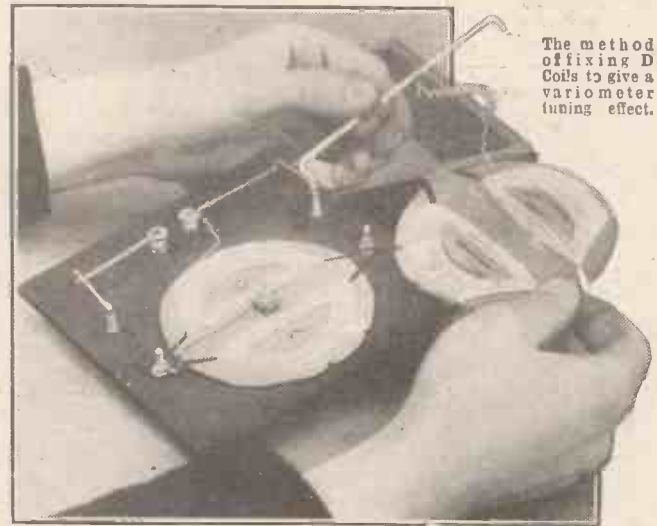

## EASY PAYMENTS

Finest 2-valve amplifier set, including loud speaker, 120 H.T., D.F. valves, £7 10s.; or 18/9 down and 11 instalments of 15/-.

**CASH BARGAINS**

Amplifiers, 17/6 and 21/-; Phones, Telefunken type, 7/9; Fr. T. Houston, 11/-; Good H.T. 60-v. 5/9; Best 66-v., 6/6; or 44-v. (laboratory test) 4/-; doz. Famous Metal Valves (French), 2v. .2, 5/-; 2v. .06, 6/9; 2v. .5, power, 8/9; 4v. .06, 5/6; Straight-line Condensers, 5/9; Ditto, 4 in. dia., 7/3; Transformers: Babina, 3/6; Radiolye, 3/8; Brunet, 7/9. Also Ferranti, Eureka, Formo, etc. Postage extra. Everything in wireless reliable and cheap. Satisfaction or cash refunded.—Musio Coil & Gramophone Records Exchange, 29, High St., Clapham, London, S.W.4.

ARTIC ARTIC ARTIC ARTIC ARTIC ARTIC ARTIC ARTIC ARTIC ARTIC

## The Master Non-Vibratory Valve Holder



**ANTI-MICROPHONIC**  
**-VIBRATION**  
**-SHOCK**  
**-CAPACITY**

**WORLD PATENTS.**

SPRUNG-YET THERE ARE NO SPRINGS OR RUBBER SUSPENSION

## YOU WOULD LAUGH

If you saw a man using a heap of sand as a spring board. WHY, because he would not bounce in sand, his bounce is immediately damped out. You cannot eliminate microphonic noises, distortion, and obtain purer and more distant reception by bouncing your Valves on spring boards. WHY, because springs and rubber accentuate bounce shock and vibration—this is indisputable. The Artic Valve Holder is like the heap of sand, being dead to vibration and shock, a De Luxe Holder which can be obtained at small extra cost. The suspending medium is used by the Admiralty, large Industrial Concerns, etc., for protecting metallic filaments.

**HAVE THE BEST AND ORDER NOW!**

THE ULTRA SENSITIVE VALVE HOLDER

FROM YOUR DEALER OR DIRECT

# ARTIC

FUSE & ELECTRICAL MFG. CO. LTD.  
 BIRTLEY, Co. Durham

**3/9 EACH**

POST FREE

## Safety EELEX First!

BE PREPARED FOR STORMS—WINTER and SUMMER—by

## FIXING THE "EELEX" SAFETY SWITCH

Comprising: Switch, Lightning Arrester, Lead-in Tube and Weatherproof Cover.

The Eelex safety switch, the latest development in Safety First devices, enables the operator to earth the aerial OUTSIDE the house. By PUSHING the knob the set is at once connected to the aerial. A PULL instantly disconnects the set from the aerial system, automatically earthing the aerial.

The spark gap provides ample means of by-passing any electrical discharge which may occur while set is in operation.

6 in. Tube] PRICE 5/6

12 in. tube, 6/6. 18 in. tube, 7/6.

## MULTIPLE CONNECTOR 5/6 Complete



Non-reversible. Detachable name plates. Built with Eelex standardised Plugs and Sockets. All parts are standard, detachable and interchangeable. Coloured flexibles can be supplied in the following colours: red, blue, green, yellow, black, white, and maroon at 1 1/4d. per yard. If at any time sets change so that multiple connectors are no longer required, then the parts can be put to other uses. It will pay you to adopt the Eelex Standardised system of Connections.

Write for fully Illustrated List Q.W.A.

**J. J. EASTICK & SONS**

**EELEX HOUSE, 118, BUNHILL ROW, E.C.1**

Satisfaction comes through using

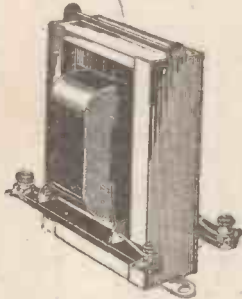

**IGRANIC-PACENT SUPER "AUDIOFORMER."**

The Igranic-Pacent Super "Audioformer" has a remarkable amplification curve, making it quite different from all other low frequency transformers, and giving uniformity of amplification which results in superlative tone qualities. A particular feature of the Igranic-Pacent Super "Audioformer" is the massive iron circuit built up with a special quality of iron. The ratio is 1:3 and the Igranic-Pacent Super "Audioformer" can be used for first or second stages. Price 24/6.

**IGRANIC "INDIGRAPH" VERNIER KNOB AND DIAL.**

The Igranic "Indigraph" Vernier Knob and Dial is a handsome slow motion Dial which greatly facilitates fine adjustment. Two scales of 0 to 100 each are provided, reading in opposite directions, making the "Indigraph" suitable for different types of condensers. Space is provided opposite the scale for recording station settings. The metal dial acts as a shield against hand-capacity effects. Price 7/6 each.



Write for the New Igranic Catalogue R44.

**IGRANIC ELECTRIC CO. LTD**

149, QUEEN VICTORIA STREET, LONDON

Works: BEDFORD.



**The name does not rotate**

The head does not come off.

The slot and nut eliminate soldering.

The finish is perfect throughout.

Complete patent No. 248,921, 4th March, 1925, and registered designs.

Standard Large Insulated Model (polished black bakelite), Type B, 9d. each. Popular Model (non-insulated), Type M, 6d. each.

28 different engravings stocked. Catalogue free on request.

**BELLING-LEE TERMINALS**

Advt. of BELLING & LEE, Ltd., Queensway Works, Ponders End, Middlesex. M.C.14.



**FORMO**  
ARTHUR POLLEN & CO. LTD.

**ULTRA LOW-LOSS**

Straight Line Frequency Condenser  
Cone Bearings. Braced Vanes. Positive Collector. A real precision job. **7/6**  
Condenser only, .0003uF., .0005 uF.  
New Vernier Dial **6/-**  
Reduction Ratio 16-1. No Backlash

**THE FORMO COMPANY,**  
Crown Works, Cricklewood, N.W.2.  
Phone: Hampstead 1787.  
Manchester: Mr. J. B. Levee.  
23, Hartley St., Levenshulme.  
Phone: Heaton Moor 475.

*A statement of fact!*

**DULIVAC VALVES**

ARE THE BEST IN THE WORLD  
and give greater volume, purer tone  
and low consumption at a low cost.

1.8 volts general purpose .2 amps. 7/- each

4 volts general purpose .06 amps. 7/- each

4 volts power .25 amps. 13/- each

From all others and from M. & A. WOLFF, 9-15, Whitecross St., London, E.C.1



**VALCO MAGIC!**

WILL MAKE YOUR BROKEN VALVE AS GOOD AS NEW.

ALL TYPES OF VALVES REPAIRED AT HALF LIST PRICES (minimum charge 5/-).

*Satisfaction Guaranteed or Money Refunded.*

An unsolicited testimonial from one of our many satisfied users will appear each week.

PEMBROKE DOCK. 23/11/26.—The valve you repaired last week for me is giving every satisfaction and I will certainly recommend your firm to any of my friends who want any valve repaired.—J. D. H.

Weeco, S.P.'s and low capacity types not repairable. Minimum D.E. current 0.15 amps when repaired.

**VALCO LTD.,** Dept. "P.W.," TABOR GROVE, WIMBLEDON, S.W.19.

**CUT THIS OUT FOR CABINETS**

and post to us for FREE list illustrating Cabinets as shown in "Popular Wireless," etc., etc., and for our additional Bulletin No. 1.

NAME.....

ADDRESS.....

(Write in block letters, please.)

**CARRINGTON Mfg. Co., Ltd.**  
18-20, Normans Buildings,  
Mitchell St., Central St., E.C.1.  
Telephone: Clerkenwell 6903.  
Trade enquiries especially invited.





Panel Talks: No. 5.

## Here is a Panel that will not split or break or crack

DO you know how it feels to split your panel just when you have almost completed your drilling? No, you don't—if your choice fell on Resiston.

For Resiston Panels (like Radion) are made throughout from nothing but pure rubber. Because of this they are tough yet not brittle. They are strong. They will not break. Or split. Or crack. They can be sawn with ease and with safety. They can be drilled without difficulty and, when tapped, will take a good thread.

Thus, when the home constructor buys a Radion or Resiston Panel, in one of its 17 sizes, he knows that even though he is not quite an expert with the drill or the saw, he is in very little danger of ruining his panel. Its very constitution facilitates easy working.

If, in the past, your experience of ebonite has been discouraging you'll appreciate the worth of Resiston. Its perfect insulation. Its superfine surface (which no hand has touched, since it left the factory). Its colour permanence and its strength.

For the sake, perhaps, of a few pence, will you court failure and disappointment by choosing an unnamed panel in preference to one bearing such a name as Radion or Resiston—names which give you positive assurance of lasting satisfaction?

## Send for the Radion Book

In its twenty-four fully illustrated pages are details for building four unique Receivers together with many useful wireless hints

Please send me, free, the 'Radion Book,' together with the booklet, 'The Gentle Art of choosing one's Panel.' P.W. January, 22

Name.....

Address.....



American Hard Rubber Co., Ltd., 13a, Fore St., E.C.2

## RADIOTORIAL QUESTIONS AND ANSWERS

(Continued from page 1280.)

The set is a 3-valver, and it gave normal results with ordinary H.T. battery. Everything upon it after careful examination seems perfectly normal, except for the fact that it is impossible to get H.T. from the mains without blowing the fuse. As one of my neighbours is already using an eliminator of the same type with great success, I should be glad to know what can possibly be preventing my own set from doing ditto. (His house-lighting and mine are precisely alike, the houses having been built and fitted at the same time.)

Yours is an unusual and interesting case, because if the eliminator itself has been found O.K. there is no doubt that the fault lies in your set, or in the insulation of something connected to it.

One fault that might cause such a failure is the use of an external earthing switch, by means of which the aerial is joined to earth outside the house, whether the eliminator "fixed" condenser is joined in series with the earth lead indoors or not. Naturally, if the set is earthed in two places, like this, it is necessary to break both the earth leads, to prevent a short to earth and the blowing of the main fuse.

In your own case, as you have made a careful examination and failed to find anything wrong, the fault is probably a subtle variation of the above. You may not have an earth via a switch, but we have no doubt that if you trace all the leads very carefully you will find a place where the voltage of the mains can cause an earth-spark. Even with the eliminator in series with the D.C., a voltage of 230 may cause the breakdown of insulation, which hitherto was quite sound, and this in effect will short the mains to earth, thus blowing the fuse.

For instance, if you employ an earth arrester, we should take this to pieces and examine it internally. Very often there is a very small air-gap in an instrument of this type, such as might break down if subjected to a high voltage. We have no doubt but that such a short is causing the failure to get the eliminator properly installed.

### MODERNIZING THE FAMILY FOUR.

G. G. H. (Purley, Surrey).—With reference to "Modernizing the Family Four," in "P.W." dated December 11th, I have seen no mention made of the coils required for conversion. What make, number of turns, etc., should be used?

A 60-turn coil with centre-tapped secondary is required. It need not be of any special make.

"STUDENT" (Bishops Stortford).—Please give an example of the method of finding the total ohmic resistance in a circuit having resistances in parallel with each other.

The total resistance of resistances in parallel is given by the formula

$$\frac{1}{R} = \frac{1}{r_1} + \frac{1}{r_2} + \frac{1}{r_3} \text{ etc.}$$

Where R is the total resistance, and r<sub>1</sub>, r<sub>2</sub>, r<sub>3</sub>, the separate resistances.

As an example, let us take the case of the three resistances shown in the accompanying diagram.

Assuming that the resistance between the points E B is 3 ohms, between F C 12 ohms, and between G D 6 ohms, the total resistance across the two leads

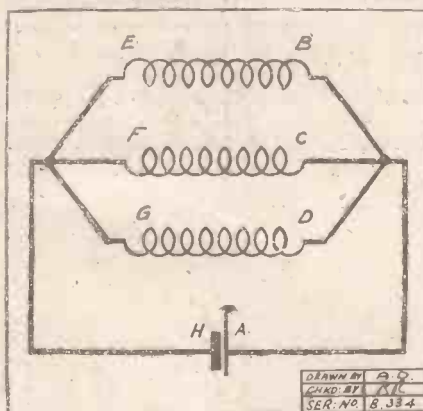

DRAWN BY A.D.  
CHECKED BY K.L.  
SER. NO. 8,334

from the battery is found as follows: The reciprocals of 3, 12, and 6 are respectively  $\frac{1}{3}$ ,  $\frac{1}{12}$ , and  $\frac{1}{6}$ . The

(Continued on next page.)

## GRAVES 2-VALVE LOUD SPEAKER BARGAIN.

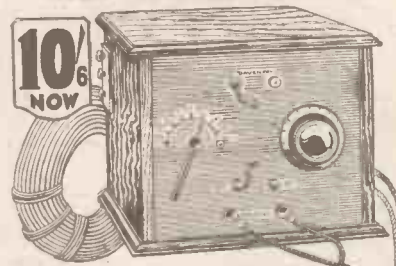

This highly efficient 2-Valve Loud-Speaker Set is the finest wireless value ever offered.

It gives a volume and quality of tone unattained by any instrument of a similar price and is the essence of simplicity. Fitted with coils covering all the British wave-lengths, including Davent

THE CABINET is of beautifully polished Oak, and all components are of the highest quality. Dual Emitter Valves with patent valve holders, &c. H.T. Battery, 2-volt accumulator and complete Aerial Outfit. LOUD SPEAKER of exclusive design with unique magnetic system and improved mica diaphragm. Price £7:17:6

TERMS: Our Bargain Price is for deferred payments. Send 10/6 now, & complete purchase in 14 monthly payments of 10/6. If you wish to pay cash, 5 per cent discount is allowed. Catalogue Post Free. Up-to-date Crystal & Valve sets at keenest prices.

J. G. Graves Ltd. Sheffield

Fullest Approval



WET H.T. BATTERIES  
BUY BRITISH. Complete Units 3/6 per doz. All goods BRITISH MADE by BRITISH LABORERS. Jars 1/3, Zincs 1/-, Sacs 1/6 per doz. Carriage and Packing extra. Trade inquiries invited.—Demon Battery Co., 59, Badlis Rd., Walthamstow, E. 17



## AERMONIC

VALVE 1/9 HOLDER  
DON'T PAY MORE

AERMONIC cost a shilling less—and they're better. Air-spaced. Anti-phonics. Beautifully sprung. High insulation. Splendid new design. So don't pay more than 1/9. List of Aermonic Specialities Free. If your dealer does not stock, apply to:

JAMES CHRISTIE & SONS, Ltd.  
246, West Street, SHEFFIELD.

London Agents:  
A. F. BULGIN & Co.,  
10, Cursitor St., London, E.C.4

## USE C.A.R. CIRCUIT FOR SUPER-EFFICIENCY

44 European Stations on Loudspeaker. The MONOTUNE 3 gives results on three valves (det. & 2 L.F.) unequalled by any 4-valve set. You may duplicate these remarkable results—even on a poor aerial. This wonderful performance is only possible when you use the C.A.R. circuit recently developed by C. P. Allinson, A.M.I.R.E., late of RADIO PRESS and ELSTREE LABORATORIES. Begin making this highly-efficient receiver to-day—the No. 1 Constructone tells you how. Fullest constructional details and 15 photos, diagrams and plans leave nothing unexplained.

PRICE  
2/6

DON'T DELAY—GET IT TO-DAY from Post Free

The Constructone Publishing Co.,  
Dept. B, 37, Drury Lane, London, W.C.2  
Money returned if not satisfied.

## RADIOTORIAL QUESTIONS AND ANSWERS

(Continued from previous page.)

The sum of these (common denominator 12) is given by  $\frac{1}{3} + \frac{1}{3} + \frac{1}{3} = 1$ .  
The total resistance will be the reciprocal of this figure,

$$\text{i.e. } \frac{1 \times 12}{7} = 1.71 \text{ ohms (approx.)}$$

It will be noted that the total resistance (just over 1½ ohms) is less than the least of the separate resistances. This, of course, is only to be expected, since not only is the low resistance in circuit, but the other resistances also offer paths to the current from the battery.

The more alternative paths that are offered the lower will the total resistance be, so it will always be of some value less than the lowest separate resistance.

### INSULATED WIRE FOR AERIALS.

S. C. (Charlton, Kent).—Why is it that insulated wire can be used for aerials, just as well as bare wire? Doesn't the insulation

## For the Constructor.

### WHAT TO DO WITH SPARE APPARATUS.

#### COILS.

(a) Large tuning coils of approximately 250 turns or more may be used in the place of H.F. chokes. Coils having a low self-capacity are best for the purpose, the number of turns required for the "H.F. choke" of this type depending upon the wave-length to which the receiver is to be tuned. Often a 200-turn coil will prove large enough to be a very effective H.F. choke in a Reinartz-type circuit, used for broadcasting wave-lengths.

(b) A small tuning coil—say, 25 turns or so—connected to aerial and earth leads, and placed near to the original "aerial" coil, will often improve selectivity to a very marked degree. (The coil thus used gives an aperiodic aerial coupling effect.)

(c) One coil placed in parallel with another, without mutual coupling, will decrease the tuning range, in the same way that a reduction in the size of the tuning condenser would.

(d) A coil of about 50 turns, placed near the aerial coil, and tuned carefully with a small variable condenser, will act as an absorption wave-trap, to reduce interference from the local station. In this case the distance (coupling) between the extra coil and the aerial coil must be adjusted carefully for best results.

keep the electricity broadcast out of the wire in the same way as it would keep any current in the wire from escaping?

You have hit upon an interesting point here, "S.C.". The reason that aerial insulation is powerless to stop the incoming "currents" is that they are not currents at all until they are actually in the aerial wire itself.

In all the space around your aerial, and in the insulation of the aerial, the broadcasting exists in the form of electro-magnetic disturbances, not in the form of electric currents.

This electro-magnetic strain is not stopped by insulation, so it reaches the aerial wire, even if the latter is well covered. Having reached an aerial suitably tuned, it sets up currents in the wire, and if this wire were not insulated these currents would leak away to earth.

So the effect is that ordinary electrical insulation is powerless to keep out wireless, but it may be very useful in keeping it in!

### SMOOTHING D.C. MAINS.

E. B. (Morningside Crescent, London, N.W.).—Is it really necessary to use "smoothing" condensers in conjunction with direct current H.T. eliminators; and if so what are the connections?

Smoothing condensers are essential because, although the supply is "direct" current—i.e. current flowing continuously in one direction, it is subject to fluctuations and "ripples." These are unimportant for ordinary electrical purposes, but when such a current is applied to wireless, a loud hum is caused in the receiver.

This can be eliminated by the use of a suitable smoothing unit, such as that shown by the accompanying diagram.

(Continued on next page.)

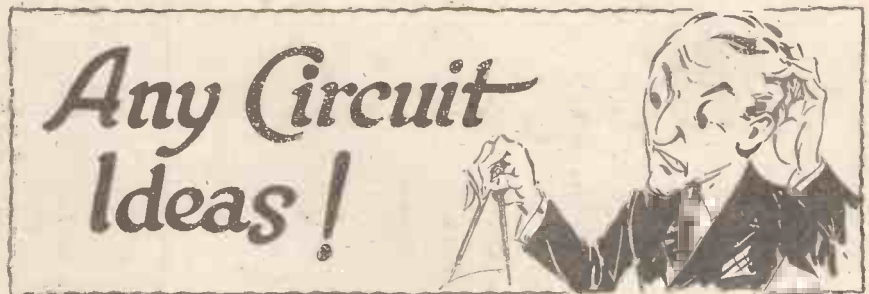

Somebody's two-some, three or multi-valver, may have smitten you to try this—or that circuit. Deep cogitation—cost!!! Conclusion—all a catch—too darned expensive! Very probably too, with the designer's specification before you—to him Resistances, Jacks, Plugs, Anti-microphonic Valves Sockets, etc., might grow on trees; so they might, but summer's a long way off.

**Any Circuit Ideas** are capable of improvement, in operation, in economy of construction, and in appearance, by incorporating Ashley Radio Jacks, Plugs, and Resistances—the **Best British at Continental Prices.**

## JACKS

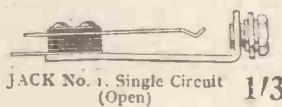

JACK No. 1. Single Circuit (Open) 1/3

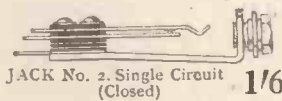

JACK No. 2. Single Circuit (Closed) 1/6

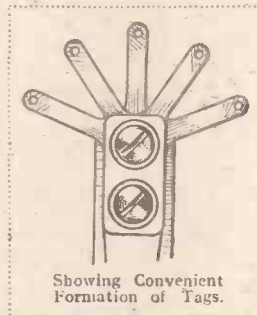

Showing Convenient Formation of Tags.

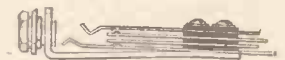

JACK No. 3. Double Circuit 1/9



JACK No. 4. Filament Single Control 1/9



JACK No. 5. Filament Double Control 2/3

Jacks at the above prices, besides materially increasing the effectiveness and appearance of any circuit, reduce the amount of work involved when experimenting, aiding both construction and dismantling. The Jack itself helps towards this end, the tags being spread fanwise for ready soldering. Non-ferrous metal nickel-plated springs (recognised best by leading Wireless and Telephone Engineers) insulated throughout with genuine bakelite. Solid Silver Contacts. Single hole fixing to standard size panels.

**Positive in Action.**

## STANDARD PLUG



PRICE 1/6

Will fit all standard Radio Jacks and take any form of connection Spade or Pin tags, rigid wire or ordinary flex, with equal facility and minimum trouble. Pin tags and rigid wire leads firmly connect when pushed home. Spade tags and flex connect to simple adaptors provided for insertion similar ly. Genuine bakelite neatly moulded with mirror finished metal work.

## RESISTANCE CAPACITY COUPLING



The most vital component in any circuit on this principle is the anode resistance. Many an otherwise satisfactory circuit has proved inefficient and noisy in operation due to the Resistance employed depending on some principle now proved fundamentally unsound. Freedom from disturbing noises is assured with the Ashley-Ledward Resistance, the base of which differs from all others.

Exhaustive tests by famous laboratories have produced eminently satisfactory reports, and each Resistance on completion is subjected to a 48 hour test during which it is continuously under pressure at a minimum of 230 volts.

ALL STANDARD VALUES

PRICE (Complete with Clips) 2/6 each

ASHLEY WIRELESS TELEPHONE CO. (1925), LTD.,  
17, FINCH PLACE, LONDON ROAD, LIVERPOOL



## RADIOTORIAL QUESTIONS AND ANSWERS

(Continued from previous page.)

It will be seen that not only are large smoothing condensers connected across the mains, but L.F.

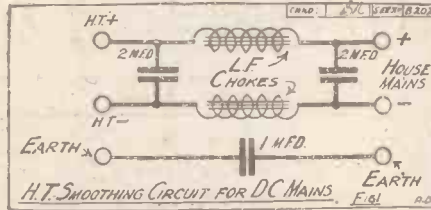

chokes are placed in series. The extra 1 mfd. condenser is usually incorporated with a smoothing unit, so that the earth terminal of the set is not connected direct to earth, but is joined through this condenser, thus preventing the mains from being earthed direct through the set.

### FADING AND CRACKLING NOISES.

"PUZZLED" (Walton-on-the-Naze).—My set has suddenly started crackling noises, and although it is a 4-valver, I can sometimes hardly hear any broadcasting even on 'phones. (Before it was loud enough to work two small "speakers," wired in series across a choke-coupled output.) A friend who had exactly the same kind of fault traced it to a burnt-out transformer, but all my valves are resistance-coupled, so it cannot be this in my case. What is the cause?

Although you have no L.F. transformers you have a very similar component in the L.F. choke, which is across the output of your set. A failure in this would cause noises of the kind described, and loss of strength, so probably the replacement of the choke will cure the trouble.

We suggest that you test this by removing the choke temporarily, and connect one of the loud speakers in its place. If the latter works well in this position, this will indicate that the choke is the cause of the trouble.

### SUDDEN WEAKNESS OF SIGNALS.

P. T. E. G. (Salisbury).—What causes a sudden weakness, so bad that two or three sentences are missed, the set then coming right again suddenly?

Many causes will account for such a fault, and in the absence of particulars of your set, we have set out the likeliest of these below.

- (A). Aerial or lead-in wire touching an obstruction.
- (B). L.T. Battery connecting bars loose.
- (C). Break in the earth lead, or partial disconnection.
- (D). 'Phones or loud speaker leads making intermittent contact at a "weak place" in the lead, or making poor contact at one of the terminals.
- (E). Plug of the H.T. battery loose, or H.T. lead faulty.
- (F). A very powerful set situated close to your own can "wipe out" the programme if tuned to the same wave-length.

### "WHY ARE VALVES SILVERED?"

"SILVERSIDE" (New Barnet, Herts).—Are valves silvered inside to strengthen them?

No. The silvering is a more-or-less accidental accompaniment to the high vacuum which is required of the modern valve.

After the bulb has been exhausted by mercury pumps, the valve is subjected to an H.F. induction furnace, which makes the electrodes red hot, and volatilises a small piece of magnesium previously inserted in the bulb.

The vaporised magnesium spreads over the glass, absorbing or combining with the last particles of residual gas. The cloud of magnesium vapour deposits itself as a metallic film on the inside surface of the bulb, thus "silvering" the bulb.



The **'PEERLESS'**  
Junior  
**RHEOSTAT**

Sales  
now over  
 $\frac{1}{2}$   
MILLION

Study the life of your valves and fit only the components that will function properly. In the "Peerless" Junior Rheostat are found features which make it exceedingly popular—its sales figures are now well over the half million. This Rheostat has an OFF position provided, while definite stops make short circuit impossible. The resistance element is immune from damage. Will safely carry current of two valves.

Complete with nickelled dial and one hole fixing. Three types. Size, 1 1/2" dia. 1 1/2" high, 6, 15 or 30 ohms.

2/6

From all dealers or direct

The Bedford  
Electrical & Radio Co Ltd  
22, Campbell Road, Bedford.

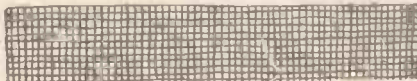

Size: 2 1/2" high, 1 1/2" sq.

### WET H.T. (Leclanche Type) BATTERIES.

Do not require re-charging. The cost and upkeep is less than with Accumulators or any other kind of H.T. Battery.

Send 1/6 for full particulars.

Price per dozen cells complete, giving 16 volts  
Separate Components. Zincs, 1/-; Sacs, 1/6; Jars (waxed), 1/3 (carriage extra).  
Full instructions for assembling sent with each order.

WET H.T. BATTERY Co., 23, Coldharbour Lane, Camberwell Green, S.E.5.  
Phone: Brixton 2539.

Put on a little ~  
**FLUSOLDA** (Resd.)  
(Patent Applied For)  
~and Heat it~ That's All

### The Secret of Simple Soldering

One clean handy fluid—no tinning, no flux—now enables expert or novice to handle any soldering job with complete confidence.  
"Flusolda" has made soldering simple at last. Just apply "Flusolda" and then apply heat and a perfect joint must result.  
In tins at 1/3 from Wireless Dealers and Ironmongers.

Trade Enquiries to the Sole Manufacturers:—  
**THE TRANSPORT SUPPLY CO., LTD.,**  
Warrington.  
(Telephone: Warrington 459.)

FLUID TINMAN'S SOLDER  
CAN BE USED FOR EVERY PURPOSE FOR WHICH  
FLUSOLDA IS USED  
FOR GENERAL USE

WIRELESS.—Capable, trustworthy men with spare time who wish to substantially increase income, required where we are not fully represented. Applicants must have practical knowledge of installation of Set and Aerial, be a householder or live with parents, and be able to give references: state age and experience. Address: Dept. 10, General Radio Company, Limited, Radio House, Regent Street, London, W.1.

**EVERY LOUDSPEAKER  
DESERVES  
MULLARD  
MASTER  
VALVES**

— Ask for —  
**Mullard P. M. Power Valves.**

2-VALVE AMPLIFIER, 35  
1-Valve Amplifier, 20/-, as new; Valves, D.E. .06,  
7/-; Headphones, 8/6 pair; new 4-Volt Accumulators, 13/-; new 60-Volt H.T., guaranteed, 7/-;  
2-Valve All-Station Set, 24/. Approval willingly.  
Write for free bargain list.  
P. Taylor, 57, Studley Rd., Stockwell, London.

**WOOD-HORNS**  
The Manufacturer is  
**H. MADDISON, 2a, RONALDS ROAD,  
HOLLOWAY ROAD HIGHBURY, N.5.**  
There's only one best.  
"The ALLWOODORN" is that one.  
Send for list.  
Lissencola—A mplion—T.M.O. units supplied  
complete with horn if desired.

**CORRESPONDENCE.**

Letters from readers discussing interesting and topical wireless events, or recording unusual experiences, are always welcomed; but it must be clearly understood that the publication of such does in no way indicate that we associate ourselves with the views expressed by our correspondents, and we cannot accept any responsibility for information given.—Editor.

**BUY BRITISH GOODS.**

The Editor, POPULAR WIRELESS.  
Dear Sir,—I am writing in answer to the letter of David Fullelove and for his information quote the following. I purchased a Cossor 2-volt power valve a few months ago and after very little use the same ceased to function.

I sent the valve back to the makers, who immediately sent a new valve post free, and by their kind action I think it only fair to say they proved beyond doubt the best thing to do is to buy British made goods every time.

Yours faithfully,  
H. PURKISS.

6, Old Road, Linslade,  
Bucks.

The Editor, POPULAR WIRELESS.  
Dear Sir,—I note in this week's POPULAR WIRELESS a correspondent has a lot to say against buying British goods. What interested me most was his statement that a small charge was payable for the repair of loud-speaker bases.

My Amplion speaker, after a year's constant service, was handed in at the Glasgow branch of the firm, and it was sent to the works and returned to me as good as new at no cost whatever.

With regard to valves, there are many British makes on sale whose prices compare favourably with the "foreigner" as can be seen in the advertisement columns of "P.W."

I was favourably treated in this line also, as I sent a Radion valve, which I had had for some months, and had developed a fault, to the makers, and it was replaced by a new valve of a later type without cost or question. Surely, if these facts were more widely known, there would be no need for controversy?

I am, etc.,  
ROBERT BROWN.

146, Rottenrow,  
Glasgow, C.4.

The Editor, POPULAR WIRELESS.  
Dear Sir,—May I, through the columns of your most excellent paper, prove the value of buying British goods. I recently returned a pair of 'phones which I purchased 10 months ago, to the makers, General Radio Company, for repair. When returned the firm had fitted new diaphragms, new cords, and given them a general tune up. The charge was nil. Why patronise foreign firms, when our own offer such valuable service free of charge?

Yours faithfully,  
E. REDDOW.

C/o W. Ashton, Esq.,  
Brockhurst,  
Nr. Wem, Shropshire.

**IT PAYS TO BUY BRITISH.**

The Editor, POPULAR WIRELESS.  
Dear Sir,—Mr. Fullelove seems to imagine that foreign components are best, and in the matter of some components, he is perhaps right.

Taken as a whole, however, foreign components are not dependable, and if Mr. Fullelove has, or can obtain a milliammeter, a voltmeter, and a megger, he can easily perform a few tests on valves and other foreign components that will convince him that British goods are best.

It is very seldom that two foreign valves of the same type show the same characteristics and the average filament of the foreign valve is fragile and easily ruined by even a slight overload.

Foreign 'phones and loud speakers should be treated with a certain amount of suspicion, as in many cases the stated resistance is not produced by the number of turns but by the quality of the wire, which in some cases is resistance wire and not copper wire of high conductivity. This explains the poor results obtained with some foreign 'phones marked 4,000 ohms, as compared with the results obtainable on British 'phones of a similar ohmage or resistance.

It is highly probable that if Mr. Fullelove cannot fix a lock-nut on so simple a component as a grid leak, he will obtain poor results from other British components, while other amateurs who really are constructors will obtain the best results from these same British goods.

I wish Mr. Fullelove the best of luck in his choice of his foreign components, as I am sure he will need it.

Yours faithfully,  
WM. R. CUMMING.

10, Holburn Road, Aberdeen.

(Continued on next page.)

**Vibration-distant shocks - they are always here**

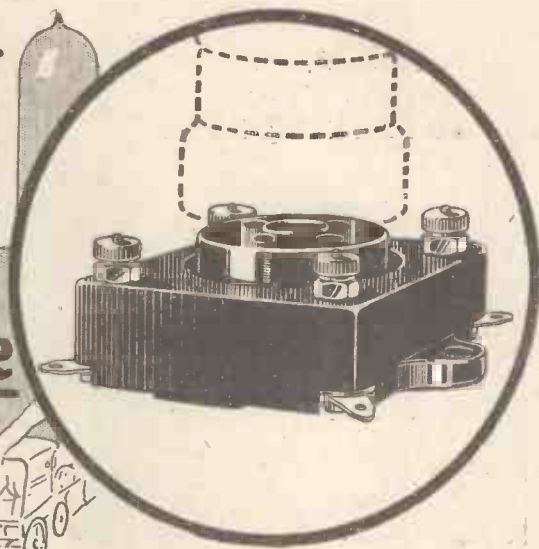

**Protect your valves - float them on springs and kill noise in the filament!**

The simplest, most efficient method of accomplishing this is to use a Benjamin Clearer Tone Valve Holder. This new shock-absorbing device prevents the transmission of outside noises to the filament. Outside vibrations (often inaudible to the ear, yet invariably destroying pure tone) are completely dissipated. The secret lies in the four delicately adjusted springs, cushioning the valve against all external shocks. Though responding to the slightest vibration these springs are immeasurably strong, permitting the tightest valve to be inserted without fear of damage. EACH SPRING HAS ONE TURN ONLY. High insulation, low capacity and great mechanical strength is assured by using Bakelite for the body of the holder.

There are terminal connections for the experimenter and soldering tags for the permanent set. The Benjamin Clearer Tone Valve Holder is easily cleaned—little or no dust can collect in the sockets. The springs themselves, as shown in the lower of the two diagrams, form the valve pin sockets. No soldered

joints—all one solid metal piece from tag to valve leg. No flexible wire connections. The spring supports are not affected by stiff bus bar wiring. For Good Reception with Dull Emitter Valves Benjamin Clearer Tone Anti-Microphonic Valve Holders are absolutely essential.

2/9  
Each.

Sectional View of Holder

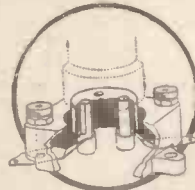

Detail of Spring Feature

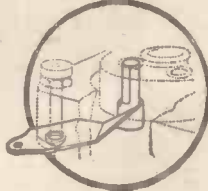

**BRITISH BENJAMIN MADE CLEARER TONE VALVE HOLDER**

Patent No. 250431. (ANTI-MICROPHONIC) Regd. Design No. 714847

From your Dealer or direct from:

**THE BENJAMIN ELECTRIC LIMITED**  
Brantwood Works, Tariff Road, Tottenham, N.17.

The Benjamin Battery Switch gives perfect current control, 1/3 each.

Britain's Best in Radio

**LAMPLUGH  
RHEOSTAT AND  
POTENTIOMETER**

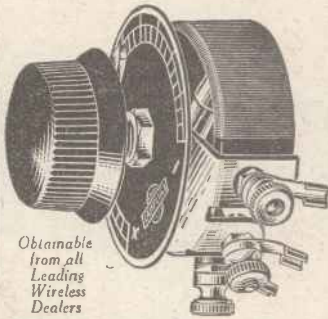

Obtainable from all Leading Wireless Dealers

RHEOSTAT, the choice of the expert. 3 ohm, 3/2; 15 ohm, 3/3; 30 ohm, 3/6 each.  
POTENTIOMETER, using the famous Lamplugh Buffer Contact ensures absolutely silent operation. Resistance 500ohms. 4/6 each.

S. A. LAMPLUGH, LTD.  
King's Road, Tyseley, BIRMINGHAM.

Send for **RADIO** Lists.



This Mark is our Guarantee.

**THE FINEST VALVE CONTROL**  
Can be assured by using only the

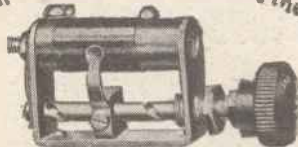

**NEW TCB GUARANTEED RESISTANCE**

(Illustration is three-fifths actual size.)  
Perfect contact; smooth and dead silent; stops for "off" and "full on"; total travel two turns of knob; easy to fit. British throughout. Send p.c. for descriptive folder. **Every one carries three months' written guarantee**

Resistance, 6, 13 or 30 ohms, 2/6; 50 ohms, 3/-  
Potentiometer, 300 ohms 3/6  
Of all dealers or direct, post free, from sole makers. State whether one- or two-hole fixing desired.

**Wavio Ltd**

DEPT. P., QUEEN STREET, HITCHIN.

**VOLTRON ENGLISH MADE D.E. VALVES.**

**EVERY VALVE GUARANTEED.**

2-v. 2-a. H.F. & L.F. 5/9 2-v. .06-a. H.F. & L.F. 7/6  
2-v. .35-a. Power..... 9/- 4-v. .06-a. H.F. & L.F. 7/6  
4-v. .35-a. Power..... 10/9 6-v. .25-a. Power..... 12/-

POST FREE.

EVILASIO DISTRIBUTING AGENCY,  
43, Leswin Rd., Stoke Newington, London, N. 16.

**CORRESPONDENCE** (Continued from previous page.)

**CONCERNING K D K A.**

The Editor, POPULAR WIRELESS.  
Dear Sir,—I have read with interest the letter of your correspondent, Mr. G. B. Manby in a recent issue of POPULAR WIRELESS. The station that Mr. Manby received was, I think, that of the Westinghouse Electric Co., K D K A; broadcasting on 63.7 metres.

K D K A has always been received well on the high-frequency at my station, and during the last two or three weeks has been remarkably free from atmospheric. On the morning of a Friday, in December the "Old Time Favourites" programme—consisting of songs by the Cosmopolitan Quartette—"That Old-fashioned Mother of Mine," "Little Grey Home in the West," "Drink to Me Only With Thine Eyes," etc. The last being very appropriate from the land of Prohibition. The Westinghouse Symphony Orchestra in various numbers, including "In a Persian Market." I can always tune in on K D K A as soon as they commence their dinner-hour programme (11.15 p.m. G.M.T.).

Their programme generally lasts until 4.15 a.m. G.M.T., but on Tuesdays and Thursdays until 5.30 a.m. G.M.T.

Trusting that this information will be of interest to your correspondent.

Yours faithfully,

JOHN H. BEST.

402, Brincliffe Edge Road, Sheffield.

**MODERNISING THE "P.W." CONTINENTAL SET.**

(Continued from page 1263.)

plate circuit is in tune with the grid circuit, make a few turns on the knob of the neutralising condenser and you will find that the band over which the whole set will oscillate will be reduced. Go on adjusting with this condenser and turning the grid tuning condenser backwards and forwards continually until an adjustment is found on the neutralising condenser at which you cannot get oscillation at any position on either of the condensers. If you screw the neutralising condenser too far down, you will probably pass beyond this optimum point and the set will again oscillate.

**The Reaction Coil.**

Remove the short circuiting wire from the reaction coil socket and insert a reaction coil, leaving the neutralising condenser as originally adjusted. I may say, in passing, that once you have found the best position on this condenser for a particular valve, it will remain the same for all further work and will only be altered when you change the valve. With the reaction coil in place, try the reaction adjustment and you will find that the set will pass in and out of oscillation with perfect smoothness and without overlap. If there is any tendency to be "ploppy," the reason will probably be that you have chosen too large a reaction coil. In order to get the finest adjustments, choose a size of reaction coil which, when the anode condenser is "all in," will just make the set oscillate when the two coils are fairly close to one another. Remember that if the set will oscillate with all the capacity in circuit it will oscillate still more freely as you go down the scale towards the position of minimum capacity.

After adjusting the reaction coil for minimum reaction, you can now place a suitable coil in the aerial socket and join up your aerial and earth leads. The set will now be found to be very much more sensitive than previously, and will tune much sharper. A further point of interest and value is that once you have properly neutralised the set you can use your reaction freely, with the full knowledge that even when the set is oscillating you will not be radiating energy from your aerial and thus disturbing your neighbours.



**DO YOU KNOW?**

That you can have this wonderful TWO-VALVE General Radio set installed in your house for £1 down?

**NOTHING ELSE TO BUY.**—The set is complete with LOUD SPEAKER, HEADPHONES, Dull Emitter Valves, Accumulator, Battery, complete aerial equipment, all cords and plugs, etc., and the Royalty is paid.

Every set and every part is guaranteed. The price of the complete set is £1 down and 20/- a month for twelve months only, or £12 cash.

**FREE INSTALLATION.**—On receipt of the first payment of 20/- one of our own Installation Engineers will come to your house anywhere in the country and will erect, instal, demonstrate and leave the set playing for you—free of charge. It is only necessary to provide an aerial pole if trees, etc., are not available.

By having the set installed by our own Engineers we ensure that you cannot buy a General Radio set that does not give you perfect satisfaction. No other wireless firm gives you this service and this safeguard.

Send a P.C. to-day for our new illustrated catalogue No. 8W, and full particulars of this unique offer.



GENERAL RADIO CO. LTD.

RADIO HOUSE, 235 Regent St., W. 1

**JARS ZINGS SACS**

Waxed, Special, High Capacity.  
1/6 DOZ. 1/- DOZ. 1/6 DOZ.

For making Wet H.T. Batteries, post free on 3 doz. and over. Packed in special carton with division for each cell. This can be used as a container for the battery when made up. Send 6d for sample complete unit, particulars and instructions. Build a Loud Speaker of the latest type with the Seamless Moulded Cone for the most perfect reception. Easily assembled. All the necessary parts stocked. Call, inspect and hear.

SPENCER'S STORES, LTD.

4-5 Mason's Avenue, Coleman Street, London, E.C.2.  
Phone: London Wall 2292. (Nr. Bank)

**REPAIRS**

to HEADPHONES TRANSFORMERS LOUDSPEAKERS COILS

First class workmanship only. That is just the vital difference. We are specialists with almost 30 years' experience in every form of intricate and accurate coil winding, and we guarantee that work entrusted to us will be returned to you as good as new, if not better. This is no idle claim, but the unsolicited opinion of scores of satisfied clients.

THE VARLEY MAGNET COMPANY

(Proprietors: Oliver Bell Central, Ltd.)  
BLOOMFIELD ROAD, WOOLWICH, S.E.18.  
Telephone: Woolwich 0888.



**RADIO REGISTERED PANELS**

Inches	Inches
7 x 5.1/2	6 x 6.1/2
7 x 6.1/8	8 x 5.1/2
8 x 6.1/4	9 x 6.1/7
10 x 8.2/1	11 x 8.2/3
10 x 9.2/4	12 x 8.2/6
12 x 10.3/4	12 x 9.2/10
14 x 12.4/1	14 x 10.3/5
	3/8 in. thick
	Post Free.

Money back guarantee that each and all Panels are free from surface leakage. Megger test Infinity. Callers cut any size. Quotations by post, or phone Clerkenwell 7853. Samples and prices post free to the Trade.

CROXSONIA CO., 10, South St., MOORGATE, E.C.2



**TECHNICAL NOTES**  
(Continued from page 1244.)

It is argued that by this means the sound output is more concentrated, and what is particularly important is that this effect is obtained without the use of any trumpet or corresponding device.

The reproduction from this outfit is certainly a revelation, and would appear to justify the cost of the apparatus for those who desire the best.

**Amplification.**

Valve users are often desirous of ascertaining the degree of amplification which  
(Continued on next page.)

**EXPERIMENTS WITH THE FILADYNE CIRCUIT.**  
(Continued from page 1240.)

power valve. It may be mentioned here that the D.E.3 has a lower impedance than the D.E.R., an average valve being 8,000 to 10,000 ohms—real power-valve figures!

With the Filadyne circuit the efficiency of rectification, as with the normal anode bend method of detection, is proportional to the H.F. voltage input. This, when receiving the local station, is quite large. Hence the loud-speaker results on one valve, a notable feature of the Filadyne circuits.

Therefore a stage of H.F. amplification preceding the circuit of Fig. 8, by magnifying the incoming signal voltage and thereby increasing the efficiency of the Filadyne valve as a detector, should give considerably stronger signals from distant stations. Actually this is the case, and I have found the circuit of Fig. 9 wonderfully good for DX work. This is one of the circuits where the H.F. valve does "earn its keep."

To avoid extra tuning controls and maintain stability in the H.F. stage, choke coupling is used, the two tuning condensers being C1 and C3. With careful balancing a twin condenser could be used to tune both circuits simultaneously, as introduced with such success in the well-known "Spider" receiver. The variable condenser C2 controls reaction as before. Instead of choke coupling, tuned anode or transformer coupling could be used.

In Fig. 9 the success of the H.F. stage depends largely upon the design of the choke, which should have a large inductance with small self-capacity. There are well-known components on the market which possess these desirable features. Alternatively a 1,500-turn coil may be used.

**Remarkable DX Receiver.**

After a few trials, the handling of this receiver will become quite easy. As a DX receiver it has given very excellent 'phone reception of a considerable number of European stations, while the local station, of course, comes in at full loud-speaker strength.

In conclusion, I hope that this article, while dealing but briefly with the many interesting features of the Filadyne circuit, will provide ample material for experiment. In breaking away from convention, the origination of the Filadyne certainly provided us with a receiving system of great fascination, and the possibilities of this novel system are by no means yet exhausted.

**IMPORTANCE OF HYDROMETER Sp. G. ACID TEST.**

The only true test of the efficiency of any battery is by testing the acid specific gravity by Hydrometer. "Tungstone," superior to any other Accumulator, uses a higher specific gravity of acid, namely, 1300 when fully charged, always giving more amp. hour capacity.



Voltage is only pressure or force and is the worst form of testing a battery, as you can have 6 or 12 volts and yet only have a few amps. capacity.

Tungstone plates are always kept in best condition by maintaining a full charge. Tungstone plates being heavier and stronger than any other makers plates, we recommend that the battery be kept overcharged in preference to being undercharged.

We accept no responsibility for damage to plates caused by "Undercharging" or by "Discharging" any cell below 1.8 voltage.

To maintain high amp. hour the plates must always be well "topped up" with distilled water, not rain or tap water, which immediately starts a damage that will certainly and quickly kill the plates.

The amp. hour capacity of the plate will gradually grow less under the following conditions:—

(a) As it grows older in working by cycles, of charge and discharge. Until fatigue of metal sets in, when plates will be required to be replaced. The best results out of the plates are economically secured by using a PURE BRIMSTONE ACID.

(b) Never let your battery run down; and never let your plates be uncovered by Acid solution. A little thought and care will repay by the securing of higher amp. hour efficiency and longer life.

To encourage users to make their tests regularly by Hydrometer, we offer the "Tungstone" Hydrometer at the low price of 5/6, with 6d. extra for postage for "cash with order."

T.A.70

TUNGSTONE ACCUMULATOR CO., LTD., St. Bride's House, Salisbury Square, London, E.C.4

**WIRELESS**  
Save Money by buying from us.  
RADIO MICRO BIVOLT, 2 v. 2, 6/- each.  
RADIO MICRO D.E., 3 v. .06, 6/8 each.  
RADIO MICRO POWER, 3 v. 1 amp., 10/- each.  
Ditto, 2 v. .2 amp., 10/8 ea. Tunggram, 3 v. .06, 5/- ea.  
LOUD SPEAKER (Cone), wonderful receptn., 25/- ea.  
HEADPHONES, ADJ. or non-ADJ., best qlty., 8/- pr.  
SILVER STAR, 4 v. .06, 6/8 ea. Ditto, 2 v. .2, 8/- ea.  
H.T. BATTERIES, best qlty. only, tapped every 3, 7/- each. ALL GOODS SENT POST FREE.  
WRITE FOR TRADE LISTS.  
**THE IMPERIAL WIRELESS CO.,**  
253, Hoe Street, Walthamstow, London.  
Please mention "Popular Wireless" when replying to advertisers.

**LIFE LONG H.T.**  
Tromba units are constructed of the finest quality zinc, zincs, jars, etc., and creeping of the electrolyte and other troubles usual to Leclanche cells eliminated. In units or any size battery to order in Mahogany Case with glass cover. Amalgamated zincs 6d. doz. extra. Sample unit and sample large capacity Sac., post free 1/-. Send to-day for free descriptive folder, etc.  
**TROMBA ELECTRICAL CO.**  
17, WHITE HART LANE, TOTTENHAM, N.17.  
OF ALL DEALERS OR DIRECT 6

**HEADPHONES REPAIRED**  
Re-wound and re-magnetised 5/- per pair. Loud Speakers repaired 5/- Transformers re-wound 5/- each  
All work guaranteed and tested before delivery.  
Write for Trade Prices. Phone: Clerk. 1795.  
**MASON & CO., 44, East Road, City Road, N.1.**

**BUILD A LOUDSPEAKER**  
**THE SEAMLESS CONE**  
(Prov. Patent 25069/26)  
and a Brown A Earpiece, or Lissenola with Reed, will enable you to construct a **CONE LOUDSPEAKER**, which will give you unsurpassable results. These Cones are unequalled for purity of reproduction, the high and lower registers being equally rendered.  
Do not be put off with the ORDINARY PARCHEMENT CONE, having a Seam John. EXTRACTS from UNSOLICITED TESTIMONIALS:  
FIBRHIGH, SURREY: "It is an excellent article and gives very good results." SPALDING, LINOS: "I am more than satisfied with the results." SHEFFIELD: "I have had one of the £7/10 Loudspeakers, and have no hesitation in saying that for long your Seamless Cone is much better." BRISTOL: "The Seamless Conical Diaphragm received yesterday works fine."  
Illustrated Lists and particulars for Stamp.  
**GOODMANS, 27, Farringdon Street, E.C.4.**  
Also obtainable from Spencer's Stores, 4-8 Abchurch Lane, E.C.4

# BARGAINS—No. 308

**ACCUMULATOR SALE.**—Fuller "BJX21," 2 volt 24 amp, 6/-; 4 volt 24 amp, 11/-; 6 volt 24 amp, 16/-; "BJX30," 2 volt 30 amp, 6/6; 4 volt 30 amp, 12/-; 6 volt 30 amp, 17/-; Premier—2 volt 40 amp, 10/-; 4 volt 50 amp, 20/-; 2 volt 80 amp, 13/-; H.T., 80 volt 1 amp, with taps, ebonite case and lid, glass cells, new, 20/-.

**A 55 RANGER, THE DIX-ONEMETER,** is a Radio Standard Instrument, 55/-; Multipliers, 6/6.

**STAMPINGS FOR TRANSFORMERS AND CHOKES.**—E or L, 6d. per doz. Hedgehog wire for Transformers or Chokes, 1/- lb.

**COVERED WOOD CABINETS,** with lid and handle, for portable sets, 12 in. by 8 in.; depth, 6½ in. Cases, only, 7/6. With ebonite panel, 10/6.

**POLAR-SURPLUS ALL NEW.**—Precision Condensers, .0003. Sale, 4/6. 3-gang Varia. Triple, 10/-; Polar Varia H.F. Trans. 300/500, 3/6. L.F. Trans., 7/6. Polar Cosmos Variometer, on panel, scale and dial. List, 21/-. Sale, 3/6. Polar Panel 2-way Vernier Coil Holder, 3/-; Polar Filament Rheostats, 10d. Polar Everest Detectors, 1/6.

**EEFSCA.** Aeroflex, 49 strand, 1/6 100 ft. Fine Aerial. H.F. tapped plug-in Transformers, 200 to 2,000, 15/-; Benbow Crystal Sets, 10/-; H.F. 3,000 ohm. Hendon Chokes, 4/6. L.F. Ironclad, 1/6.

**SIGNALLING LAMPS (War Stock).** Metal case, 3-lens-lamps, red, green and white, with focus cover, 3 keys, and main switch, to clear at 6/6 each. Post 9d. All new. Complete with 3 Tungsten lamps and battery, 8/6.

**AMPLIFIERS.**—r-valve, 32/6; R.A.F. 2-valve T.B., 35/-; Marconi 3-valve L.F. with Selector Switch for 1, 2, or 3, 22/10s. Tested and guaranteed H.F. Amplifiers for Super Hets., 3-valve, 40/-; 7-valve, 25/-; 7-valve Marconi Straight D.55, with valves, 28/-; Pol. Mahog. Case, £10. G.P.O. 2-RANGE No. 146 TESTERS.—250 m/a and 2-3 volts, 5/6 each. 3-range Milliammeter, 37/6. Capacity .0001 to 10 mfd. Testers, 27/10s., £12. Have you ordered your "DIX-ONEMETER" yet? You must have one instrument, 55/-; Multipliers, 6/6. Get The Best Out of Your Set.

**SWITCHES.**—Lucas panel 3-lever flush, 1/3, quarter price, 8-way, 4/6. Plugs and Jacks, 2/6 pair; 4-pin plug and socket with switch, 4/6. Barth Aerial, 1/-; Arresters, 9d. Dewars, 1/6 and 2/6.

**COIL HOLDERS.**—Geared 2-way, 4/6. 2-Way Quantity, back of panel, 5/-; 3 Way "Hava," 6/6. Long Handles, 4d. H. & B., back of panel, 3-coil, 7/6. Polar Panel 2-way 2/-.

**TRANSFORMERS.**—Intervalve Marconi, 10/-; Ironclad, 10/-; Microphone, 5/-; 220 volt to 3, 5 and 8 volt, 12/6. Dixon H.T. for Receivers, 220 to 150 volt, tapped for Rectifying, 25/-; Fuller type Chokes, 200 to 1,000 ohms, 1/6. 2 mfd. W.D. Condensers, 2/6. New, 4/6. 4 mfd., 6/6.

**GYROSCOPES.**—In Mahog. Case, Navy, cost £25. Sale, 15/-.

**AERIALS.**—R.A.F., 110 ft. 7-strand bronze pocket, 1/3. Navy 7/23-strand enam., 3/- 100 ft. In-door Special Aerial, 1/- 100 ft. Govt. frame Aerials, Bakelite Arms, 10/-.

**INSULATORS.**—R.A.F. Drip-proof, 1d. Bulldix, 1/-; Porcelain Tubes, 8d. and 9d. Egg and Shell, 1d. Mica, 2 in. by 2 in. by .002, 1/- doz.

**EARTH MATS.**—Galv. with Electron wire, 2/6. Copper Mesh, 2/6. Earth Spikes, 1/3.

**MASTS.**—R.A.F. Steel Tube, 15 ft., 7/6; 20 ft., 10/-; 30 ft., 14/-; 4 ft. 3 in. by 1½ in. sections. Heavy Sections, 4 ft. 3 in. by 2½ in., 5/- each.

**D.C. H.T. MAINS UNITS.**—220 volt to 60 volt, 80 volt and 120 volt, 35/-; DIX L.T. and H.T. from Mains, 23/10s. H.T. from A.C. Mains, 25/-.

**ELECTRIC HEATERS.** Nickel-Plated.—Immersion, 4/-; Hotplates, 7/6; Flat Irons, 10/-; Soldering Irons, 10/-; Massage Vibrator Sets, list £4. Sale, 21/8. Violet Ray Sets, 50/-.

**NEW 45-METRE MARCONI SETS,** 2-valve Telephone Transmitters, with 6-valve Receiver, Siemens' Microphone on arm, Weston 0.5 amp., 0-120 milliamps. Alone is worth £3. We offer the whole of above, 6-valve Receiver and 2-valve Transmitter, in mahogany case, complete, tested. These sets cost £45. Our price 25/10s.; carriage 2/6. Trans. Valves, 10/- and 15/- each.

**PHONES.**—West and Ericsson, with Brown's Alumin. swivel, 8/6. Marconi, 12/-; B.T.H., 12/-; Heath's, 11/-; New Mello, 7/6 pair. Single receivers, H.R., 3/9. Sullivan's L.R., 3/6 pair. All parts for Paper Loud Speakers, Brown's "A" 12/6, 12 in. Twin Brass Rings, 5/- pair. Stays, 3 for 1/9. Machine Pleat Parch-Paper for Diaphragms, 2/3. Cone Texas Parts: Stand, 7/6; Cone, 14/-; Reproducer, 15/6; Violinas, 10/-; Complete with Reed Reproducer, 25/-; Western Speakers, 17/6.

**MARCONI RB 10 CRYSTAL DET. and 1-VALVE L.F. AMPLIFIERS.**—Engraved Ebonite Panel, Spade Variable Vernier Condenser, T.C.C. Condenser, 2 high-freq. Chokes, Crystal Detector, L.F. Transformer, Valve Holder, Terminals, L. and S-wave Switch, Range Block. In lidded covered case. New and Aerial Tested. With diagram and 1 Osram Valve. Our price 27/6.

**SENSITIVE MICROPHONE BUTTONS.**—For amplifying gramophone, speech, detectaphone, &c. List, 8/-, Sale, 1/-, post 2d.

**ELECTRADIX RADIOS,**  
218, Upper Thames St., E.C.  
Blackfriars Sta., Met. Rly. City 0191.

# TECHNICAL NOTES.

(Continued from previous page.)

is obtained per valve per stage, and as this is a subject on which many conflicting opinions are expressed, it will no doubt be useful if I point out one or two considerations in connection with it which should be borne in mind. In the first place, as no doubt you are well aware, the amplification obtained by a single stage depends not only upon the valve, but upon the way in which it is used—as, for example, the type of coupling which is employed.

It is generally agreed that transformer coupling (I am speaking now of L.F. amplification) gives the highest degree of amplification per stage; and, similarly, it has always been accepted that the resistance-coupled arrangement, although inferior in amplification, is superior in quality of reproduction.

## Transformer Coupling.

I ought to say, however, before passing over this point, that it is not now generally accepted that the transformer-coupled arrangement is necessarily inferior in quality to the resistance-coupled arrangement, and some of the better known transformer makers would be the first to assert—indeed, to prove—that the transformer method has nothing to yield to any other method, either in quantity or quality of reproduction.

# LOW LOSS AERIALS.

(Continued from page 1257.)

class porcelain as the aerial insulators should be provided and fitted as per Fig. 2.

Some means of earthing the aerial is essential for protection against lightning, but we must eschew practically all of the usual "earthing switches" for what of these that do not operate as fixed condensers out of place, provide sufficient numbers of faulty contacts, conductive leaks, and what-not to drive respectable H.F. currents straight away to earth!

## A Logical Development!

Therefore, we suggest a non-oxidisable socket of solid dimensions soldered firmly and directly on to the aerial lead-in as in Fig. 2, and a ditto socket securely fixed to the end of a nice stout earth lead which goes directly down below to a nice efficient buried earth.

The lead and socket (or similar device) can hang on a nail beneath the aerial lead-in until required. When these are in use, the aerial lead-in, of which there are only a few inches behind the window pane, is pulled through and left hanging down, gently twined round the earth lead.

The window pane cup device is quickly unscrewed, a small rubber washer neatly and automatically covering the hole so that the rain and wind shall not blow through it!

And that is our ideal, and we calmly and hopefully await the announcements of the manufacturers who logically follow up the low-loss component movement with "Complete Equipments for Low-loss Aerials."

**TO MAKE A GOOD SET you must have well-made components. TRY THESE!**

**J.J.R. Patent No. 250014/25.** All illustrations actual size.

**FIG. 51.** Why blow your valves? Our safety plug will save them, costs nothing to renew (use renewal instructions with each). Will last a lifetime. Blows at 4 amp. Each 1/-

**FIG. 52.** The only wander plug on the market that will not pull to pieces when withdrawn from the batteries. Made in eight colours. Ea. 30d.

**FIG. 54.** The J.J.R. patent non-rotating inducting terminal. Made in eight colours and all markings on insulated tops. Each 6d.

If your dealer does not stock them write us direct. Illustrated Catalogue on request.

Trade please apply for terms. Phone: Sutton 2511

**J.J.R. LTD.** Manufacturers 7a, ROSS PARADE, and Patentees, WALLINGTON, SURREY.

**TRANSFORMERS REWOUND**  
Transformers, Phones, Loudspeakers, Rewound and Repaired to Maximum Efficiency. All One Price 4/- each. Don't discard if burnt out. All work guaranteed for 12 months. Write for trade terms.

**TRANSFORM CO.** 115 LINKS RD., TOOTING, LONDON, S.W.17

**VALVES · BATTERIES**

Radio Micro 3-v. '06, ea. 7/-	Fama 2-v. '06, each 6/3
Loud Speaker, Excellent value. (One), each 25/6	2-v. '2, each 4/-
Radio Micro Power, 3-v. '1, each 10/9	Power 4-v. each 8/8
Fama 4-v. '06, each 5/9	60-v. Batteries, guaranteed.

3-v. '1, each 10/9  
60-v. Batteries, guaranteed.  
Fama 4-v. '06, each 5/9  
3-v. tappings, each 7/8

TRADE ENQUIRIES INVITED. WRITE FOR LISTS.  
ALL Goods sent post free.

**BISHOPSGATE ELECTRIC SUPPLY CO.,**  
180, Bishopsgate, London, E.C.2

**FULLER PLATE ACCUMULATORS**  
6 volt 20 A.H. 14/6 post free.  
**A. & F. GARNETT, 29, New Kent Rd., London, S.E.**  
Write for list of other radio bargains.

**GAMBRELL**

**B and E**  
Both Centre Tapped  
ARE WAITING FOR YOU.

We have ample supplies of the coils, centre tapped coils and Nentreovernias for use in the

**MULLARD P.M. CIRCUITS.**

Insist on your dealer supplying these.

If any difficulty write us.  
Apply for Free descriptive booklet.

**GAMBRELL BROS. LTD.**  
76, Victoria Street, London, S.W.1

**Trelleborgs**  
GENUINE EBONITE  
Experts choose it—its Choice!

STOCKED BY ALL THE BEST DEALERS  
**TRELLEBORGS EBONITE WORKS Ltd. Audrey House, E.C.1.**

**4-ELECTRODE VALVES**

We are the suppliers of the genuine U.C. and Thorpe valves, as specially tested and recommended by the "Undyne" inventors and "Popular Wireless." U.C.5 and Thorpe K.4 (both 4-electrode 5-pin valves), each, post free, 8/11

Order direct from—  
**LUDGATE RADIO CO.,**  
56, LUDGATE HILL, LONDON, E.C.4

# Valve Set Owners Are Fast Learning This Secret★

★ the secret of increased range and greater economy in the operation of their radio receivers

*It must have struck you at one time or the other that the radio results of certain of your friends who have sets based on the same circuit and the same number of valves, were better than those from your own receiver. The answer to the following question will give you the key to the secret of improved reception:*

*"How copious is the emission given by the filaments of your valves over a range of filament temperatures?"*

It may seem strange to you that the emission of a valve filament can make a marked difference in the way your receiver operates and in the cost of its upkeep.

If, for example, your set is "all out" when receiving a station, say 100 miles away, you have small hope of securing weaker distant stations as your friends may do, moreover, your battery consumption is naturally at its highest under these conditions.

### Why great emission makes all the difference

When a valve filament gives a copious and sustained emission at the correct filament temperature, a rich field of power is placed under your control which enables the best conditions to be secured to deal with the incoming signals, so that your



receiver is adjusted to suit the particular circumstances existing at the time.

The local station may be tuned in purely and strongly with the minimum of energy expended because valves that possess a huge emission are able to function perfectly at considerably less than their full capacity.

Then, as you reach out for more distant stations or weaker signals, you are able to adjust the operating energy of your high emission valves, particularly in the detector stage, to suit the exact demands

for ideal reception. It will be realised that by the use of Mullard P.M. valves with their abundant electron emission you will save upkeep costs since your receiver will only consume minimum energy from your batteries.

**A valve filament that has up to 5½ times the emission surface of an ordinary filament**

To no one so much as the owner of Mullard P.M. Valves is the truth of this boon of great emission so apparent. The wonderful P.M. Filament—the foundation of the famous series of Mullard P.M. Valves—is so generous in its dimensions that the emission surface is immense. This remarkable fact is due to the length of the P.M. Filament being up to 3 times that of an ordinary filament, and its greater diameter. These two factors are responsible for the supreme efficiency of the Mullard P.M. Filament which possesses an emission surface 5½ times more effective than an ordinary filament.

### A Government Test

Convincing proof of the high emission of the wonderful P.M. Filament was recently given by the 1000 hours' test report of the National Physical Laboratory. This proved that the emission of Mullard P.M. Filaments was so abundant and consistent that an 18/6 Mullard P.M. Valve was still worth 18/- after 1000 hours' continuous life test, equivalent to a year's broadcasting service.

Bring your radio receiver up to the highest pitch of efficiency by installing Mullard P.M. Valves with the wonderful P.M. Filament and remember they consume absolutely minimum current. Ask any radio dealer for full information.

INSTALL MULLARD P.M. VALVES WITH THE WONDERFUL P.M. FILAMENT

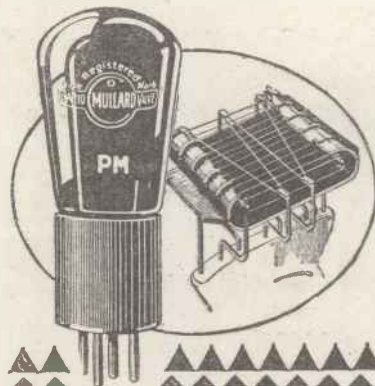

# Mullard

## THE MASTER VALVE

Sectional view of P.M.5 showing generous proportions of P.M. Filament

- For 2-volt accumulator
- THE P.M.1 H.F. 0.1 amp. 14/-
- THE P.M.1 L.F. 0.1 amp. 14/-
- THE P.M.2 (Power) 0.15 amp. 18/6
- For 4-volt accumulator or 3 dry cells
- THE P.M.3 (General Purpose) 0.1 amp. 14/-
- THE P.M.4 (Power) 0.1 amp. 18/6
- For 6-volt accumulator or 4 dry cells
- THE P.M.5x (General Purpose) 0.1 amp. 14/-
- THE P.M.6 (Power) 0.1 amp. 18/6
- Super power valves for last L.F. stage
- THE P.M.254 (4 volts, 0.25 amp) 22/6
- THE P.M.256 (6 volts, 0.25 amp) 22/6

*These prices do not apply in Irish Free State*

ADVT. THE MULLARD WIRELESS SERVICE CO. LTD., MULLARD HOUSE, DENMARK STREET, LONDON, W.C.2



# Down to 18 Micro- Microfarads.

Seven ratios—three impedance values—a self-capacity of only 18 micro-microfarads—these are the three reasons why the R.I. Multi-Ratio Transformer means perfect audio-frequency amplification.

A glance at the diagram here will show you the special method of sectionalising the primary and secondary windings to give this amazingly low self-capacity.

The result of this unique construction is an instrument that minimises the likelihood of distortion in your L.F. stages.

It is only by using a transformer with a range of ratios and impedance values allowing of its use in any circuit and with any valve, plus a minimum self-capacity, that you can hope to obtain the kind of reproduction which will please you.

Fit the R.I. Multi-Ratio Transformer to your set to-day and notice how immediately the reproduction reaches so closely the distinctness and quality of tone of the original.

**Price 25/-**

Write for the R.I. Green and Gold Catalogue.

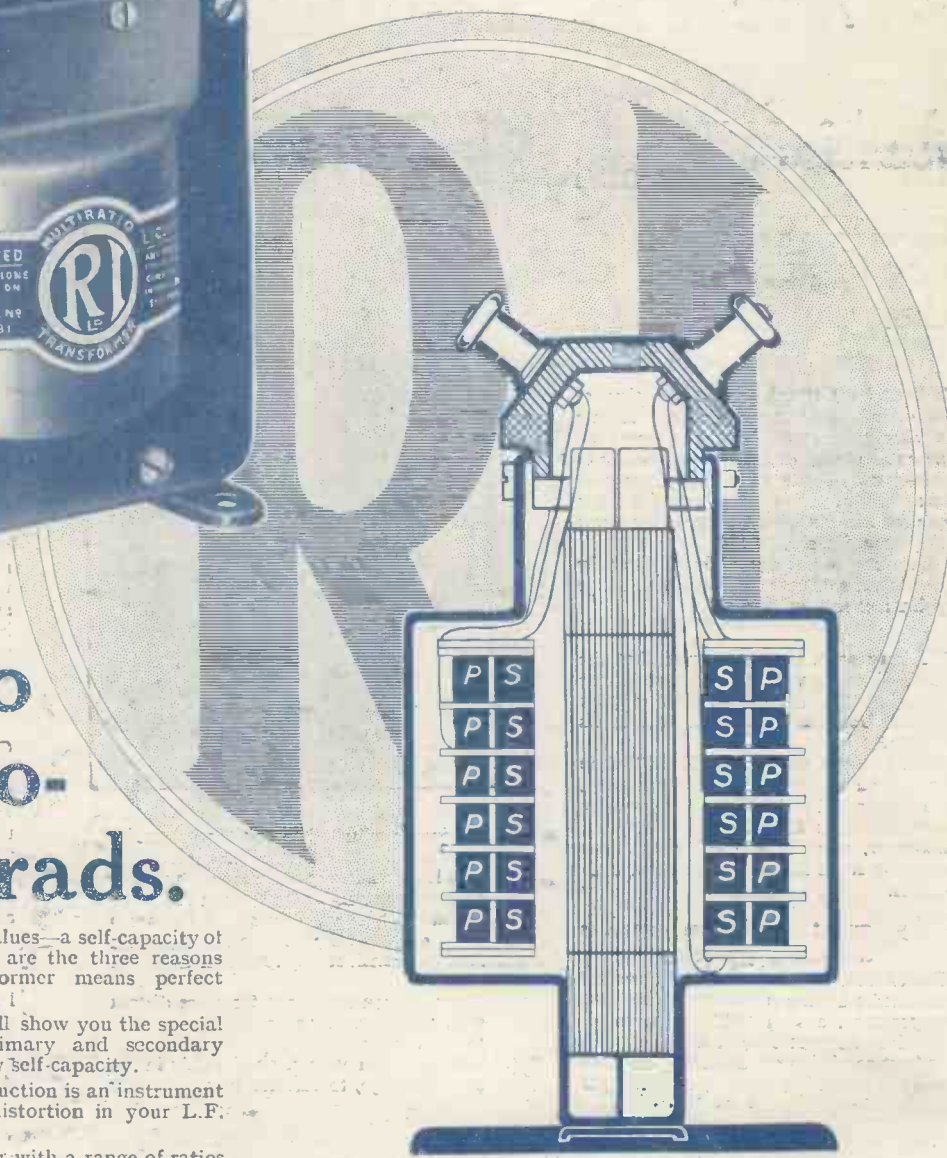

**THE MARK OF BETTER RADIO**



Advt. R.I. Ltd., 12, Hyde St., New Oxford St., London, W.C.1.

All applications for Advertisement Space in POPULAR WIRELESS to be made to JOHN H. LILE, LTD. (Sole Agents), 4, Ludgate Circus, London, E.C.4. Phone: City 7261.

# HOW TO MAKE THE "PROGRAMME COLLECTOR"

7

# Popular Wireless

Every Thursday  
PRICE  
3d.

No. 243. Vol. X.

INCORPORATING "WIRELESS"

January 29th, 1927.

### Contents

- Repressing the Rheostat
- More About the Four-Valve Family Receiver
- Your Aerial
- Crystal-Valve Operation
- An Economical A.C. Rectifier
- Etc., etc., etc.

Controlling the transmitter at Rugby during a transatlantic telephone conversation.

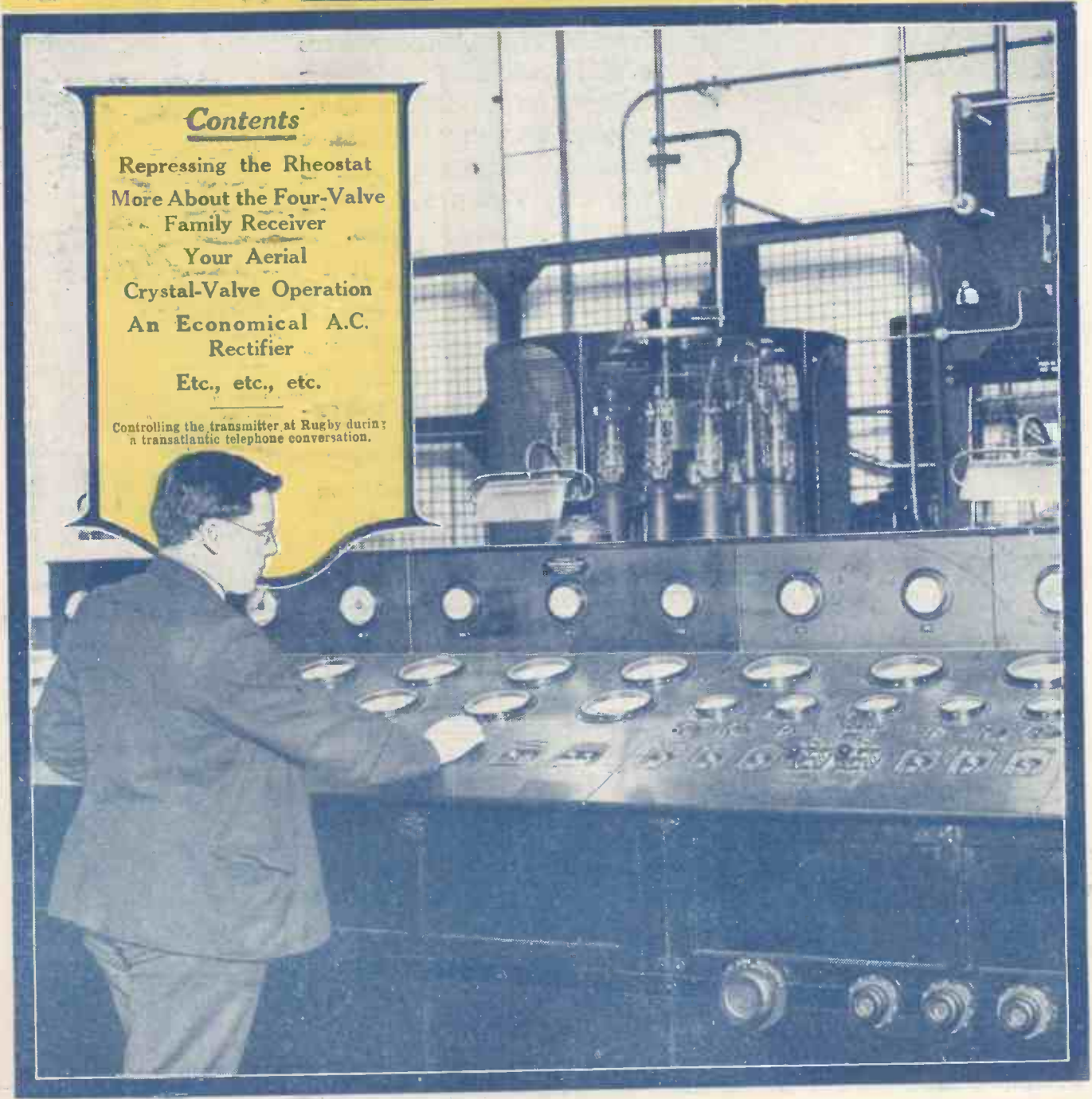

# LOTUS

## THE "MASTER" VALVE HOLDER

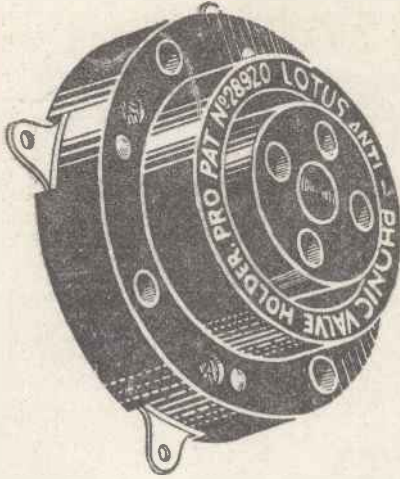

RECOMMENDED BY  
**Mullard**  
 THE MASTER VALVE

IN evolving the skilful circuits described in "Radio for the Million," the makers of the famous Mullard Master Valves had to choose components that would do justice to their reputation. That is why they recommend Lotus Buoyancy Valve Holders.

Made with every care of the best materials, they can be relied on under any conditions to absorb shock, protect the valves and eliminate microphonic noises.

The Lotus Single Coil Holder

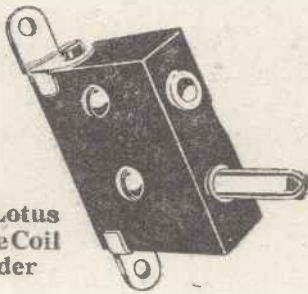

*Fit them on any set you make and get the best possible results.*

Valve sockets and springs locked together by a mechanical process, making a definite and permanent connection.

Bakelite mouldings, nickel silver springs, and phosphor bronze valve sockets, nickel plated.

PRICES:

VALVE HOLDER without terminals	2/3
VALVE HOLDER with terminals	2/6
Combination Grid Leak and Terminal Valve Holder	3/9

# LOTUS

BUOYANCY

## VALVE HOLDER

ANTI-MICROPHONIC

Made by the makers of the famous Lotus Vernier Coil Holder  
 GARNETT, WHITELEY & CO., LTD.,  
 Lotus Works, Broadgreen Road, Liverpool.

# Marconiphone and STERLING Radio Components

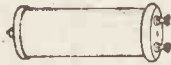

MARCONIPHONE  
H.F. CHOKE  
10/6



MARCONIPHONE  
IDEAL  
SUPERSONIC  
TRANSFORMER  
20/-

MARCONIPHONE  
VARIABLE  
RESISTANCE  
8/6



MARCONIPHONE  
GRID LEAK  
1/3  
Mounted 2.3

MARCONIPHONE  
HIGH & LOW  
TENSION  
SWITCH 3/6



EASE in tuning, quietness, selectivity, sensitiveness to distant signals, plus tonal quality, are only possible when every component in the circuit is of the highest efficiency.

The accuracy and reliability of Marconiphone and Sterling components are beyond question—they are used by the most successful constructors and experimenters.

Specify a complete range for your next circuit; the results from the unit will exceed your expectations.

STERLING TRIPLE  
COIL HOLDER 20/- and 22/6



STERLING SQUARE  
LAW CONDENSER  
(with Vernier)  
.00025 mfd. . . . . 8/6  
.0005 " . . . . . 9/6  
.001 " . . . . . 10/6

STERLING  
MANSBRIDGE  
CONDENSERS 1 to  
10 mfd. 2/6 to 20/-



STERLING FIXED  
CONDENSERS  
.001 to .00005 mfd. 1/6



STERLING  
ROTARY  
FILAMENT  
RESISTANCE  
4'5 and 30 ohms 4/6



STERLING  
'NON-FONG'  
VALVE  
HOLDER  
2/9



**This 48 page Book  
of tested Circuits  
sent on request**

CONTENTS:  
CIRCUIT DIAGRAMS AND  
ILLUSTRATIONS OF 1, 2, 3,  
4 AND 8-VALVE RECEIVERS,  
H.T. SUPPLY SETS AND  
FULL RANGE OF COM-  
PONENTS.

To:  
THE  
MARCONIPHONE  
COMPANY, LTD.,  
210-212, Tottenham  
Court Road, London, W.1

Please send, post free, copy  
of 48-pp. Book of Circuits.

Name .....

Address .....

("Popular Wireless.") USE BLOCK LETTERS

Fill in Coupon and  
post in 1d. (unsealed)  
envelope to Head  
Office.

CIRCUITS  
for Building  
RADIO  
RECEIVERS

The finest Inter-  
Valve Transformer  
human ingenuity has  
yet devised.

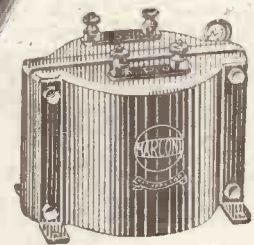

THE  
MARCONIPHONE 'IDEAL'  
TRANSFORMER  
Ratios: 2'7-1, 4-1, 6-1, 8-1.  
Price 25/- each.

THE MARCONIPHONE COMPANY, LTD.  
(Sole Agents for Sterling Telephone & Electric Co., Ltd.)

Head Office: 210-212, Tottenham Court Rd., London, W.1  
Registered Office: Marconi House, Strand, London, W.C.2



NEXT WEEK'S GREAT GIFT  
number of "P.W." will contain a

*2-Set of Blue Prints*  
**FREE**

**These Blue Prints contain complete details for building FOUR of the MOST POPULAR CIRCUITS EVER DESIGNED.**

*Another Set  
of  
Blue Prints  
FREE  
with the issue  
dated Feb. 12th*

With every copy of "POPULAR WIRELESS" next Thursday a Set of Blue Prints will be given FREE. These Blue Prints will contain explanatory Pictorial Circuits, Wiring Diagrams, lists of Components and other constructional details for the following modern receivers:—

### **TWO-VALVE LODGE "N"**

SIR OLIVER LODGE'S famous non-radiating receiver.

### **THE GUARANTEED REFLEX**

Embodying the well-known Hale Circuit with which amateurs have been getting most remarkable results.

### **ONE-VALVE CHITOS**

Probably the most popular one-valve set ever designed.

### **SPAN SPACE THREE**

A modern and highly efficient receiver for long-distance and loud-speaker reception, designed by G. P. KENDALL, B.Sc.

**ORDER**  
**Next Week's**  
**"P.W." NOW**

So clear and complete are the drawings that it is almost impossible to make a mistake. Whether you want a circuit for listening to the local station or for long-distance reception, you should make sure of the "P.W." Blue Prints. They describe four of the most popular and efficient circuits ever designed. Both amateurs and experts are loud in their praise of the results obtained from them. The FOUR Blue Prints are given with "POPULAR WIRELESS" next week. The demand for this issue of "P.W." will be enormous—you are strongly advised to order your copy at once.





**"He certainly sold us  
the right Loud Speaker"**

THAT is what you will probably say, and certainly think, after you have bought a B.T.H. C.2. Loud Speaker. It is right in tone, right in volume, right in appearance, and especially right in price.

It is a full-sized instrument, 24" high with a 14" flare, giving an ample volume of sound for any living room of average dimensions.

**T Y P E  
C 2**

The only  
full sized  
full toned  
instrument  
for  
**£ 3 : 0 : 0**

(This price does not apply  
in Irish Free State.)



**LOUDSPEAKERS**

**BRITISH MADE**

2608A

The British Thomson-Houston Co. Ltd.

WHY PAY MORE THAN DOUBLE for other amplifiers  
or for a valve set, when you can get as good results with THE  
**MAGNETIC MICROPHONE BAR AMPLIFIER**

(Patent No. 248951/25.)

"NO CRYSTAL SET IS COMPLETE WITHOUT THIS WONDERFUL ATTACHMENT."

Not only will this marvellous device give really good LOUD-SPEAKER RESULTS from CRYSTAL RECEPTION of average strength, but it is absolutely the ONLY means of increasing the strength of weak signals in HEADPHONES without using valves.

Works perfectly on one or two dry cells.

**A BOON TO DEAF PERSONS**

EQUALLY EFFICIENT ON VALVE SETS

IF YOUR DEALER CANNOT SUPPLY ORDER DIRECT FROM SOLE MANUFACTURERS AND PATENTEES:



(Two-thirds actual size.)

NOT a Microphone Button.

**NO** Valves, Accumulators or H.T. Batteries. Fragile parts. Distortion.

Simple as ABC.

MICROPHONE AND OTHER PARTS OF AMPLIFIER SUPPLIED SEPARATELY  
FULLY ILLUSTRATED LISTS FREE

COMPLETE AMPLIFIER as shown PRICE post free **38/-**  
3-volt DRY BATTERY lasting over three months 4/- extra. No other accessories required.

DELIVERY BY RETURN FROM STOCK EVERY AMPLIFIER GUARANTEED.

**NEW WILSON ELECTRICAL MANUFACTURING CO., LTD.,** 18, FITZROY STREET, EUSTON ROAD, LONDON. W.1 Phone: Museum 8974.

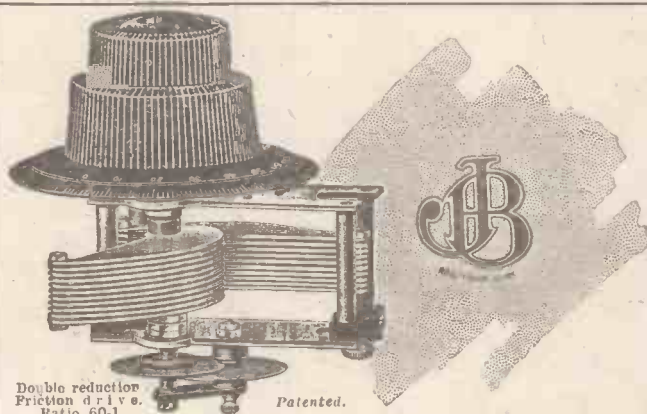

Double reductor Friction drive. Ratio 60-1. Patented.

**The Final Condenser**

The J.B. True Tuning S.L.F. embodies new and vitally important improvements, and solves for ever the tuning evils of the past. The J.B. True Tuning S.L.F. spreads stations so evenly over the dial that all stations on all wave-lengths can be quickly and easily tuned in or out, and accurately logged. Ball-bearings ensure a wonderfully smooth control, and the beautiful finish of the complete condenser forms a perfect parallel to its real efficiency in tuning.

**The J.B. True Tuning S.L.F.**  
PRICES, complete with 4-inch Bakelite Dial { '0005 mfd. 16/6. '00035 mfd. 15/6.  
'00025 mfd. 15/-.

**The J.B. S.L.F.**  
PRICES, complete with 4-inch Bakelite Dial { '0005 mfd. 11/6. '00035 mfd. 10/6.  
'00025 mfd. 10/-.

**JACKSON BROS.**  
8, POLAND ST- OXFORD ST LONDON - W.1 Telephone: GERRARD 7414

**The Topical Illustrated Sports Weekly**

ALL SPORTS is *the* paper for all who love sport for sport's sake or for those who specialise in Boxing, Football, Tennis, Racing, Hockey, etc.

Readers of ALL SPORTS *always* have the very latest inside information on every movement in the realm of sport, for the articles are always up to date and written by the biggest authorities.

Buy a copy of this fine paper to-day. Ask for—

**ALL SPORTS**

Every Thursday, 2d.

# FOR RELIABILITY

## Exide

### THE LONG-LIFE BATTERY

Alike for the highest possible quality of tone, and for tuning in weak signals from distant stations, the batteries, both High and Low Tension, must be capable of supplying absolutely steady, unfluctuating current.

Further, the High Tension Batteries should be capable of lasting for long periods on one charge and should take no harm from standing in a partially run down condition.

This means that the batteries must be constructed of first-class material to sound and up-to-date designs.

Exide Batteries in the opinion of those most qualified to judge, occupy the leading position throughout the world. They are made at the largest battery works in the British Empire by the people who have been manufacturing batteries and nothing else for 35 years.

Type DTG

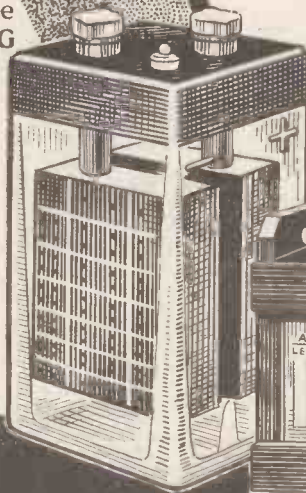

Type HZ

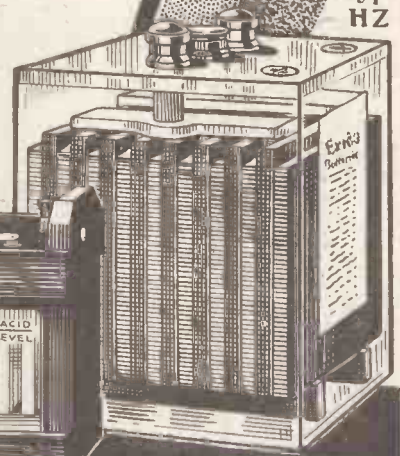

The Sign of



Skilled Service

Type WJ



#### Types DTG & DFG

Specially designed for small discharge currents, and to hold their charge, when not in use, for long periods. Suitable for small Dull Emitter valve sets.

Capacity.

DTG	DFG
20 amp. hrs.	45 amp. hrs.
Price 4/6.	Price 8/6.

#### Type WJ

These batteries are the most satisfactory source of high tension in existence. They will hold their charge, when standing, and even if partially run down, for six months at least with no injury or detriment. They give a steady, even discharge free from fluctuations, ensuring purity of reception against a dead silent background that is a revelation. Exide H.T. Batteries are standardised by The Marconiphone Company.

#### Type HZ

Combines the advantages of the DTG and the CZ.—a De Luxe battery suitable for all types of receiving sets. Capacities 40 to 80 amp. hrs. Prices from 17/6 per 2-volt unit.

**EXIDE HIGH TENSION BATTERIES SUPERSEDE ALL OTHER FORMS OF H.T. SUPPLY**

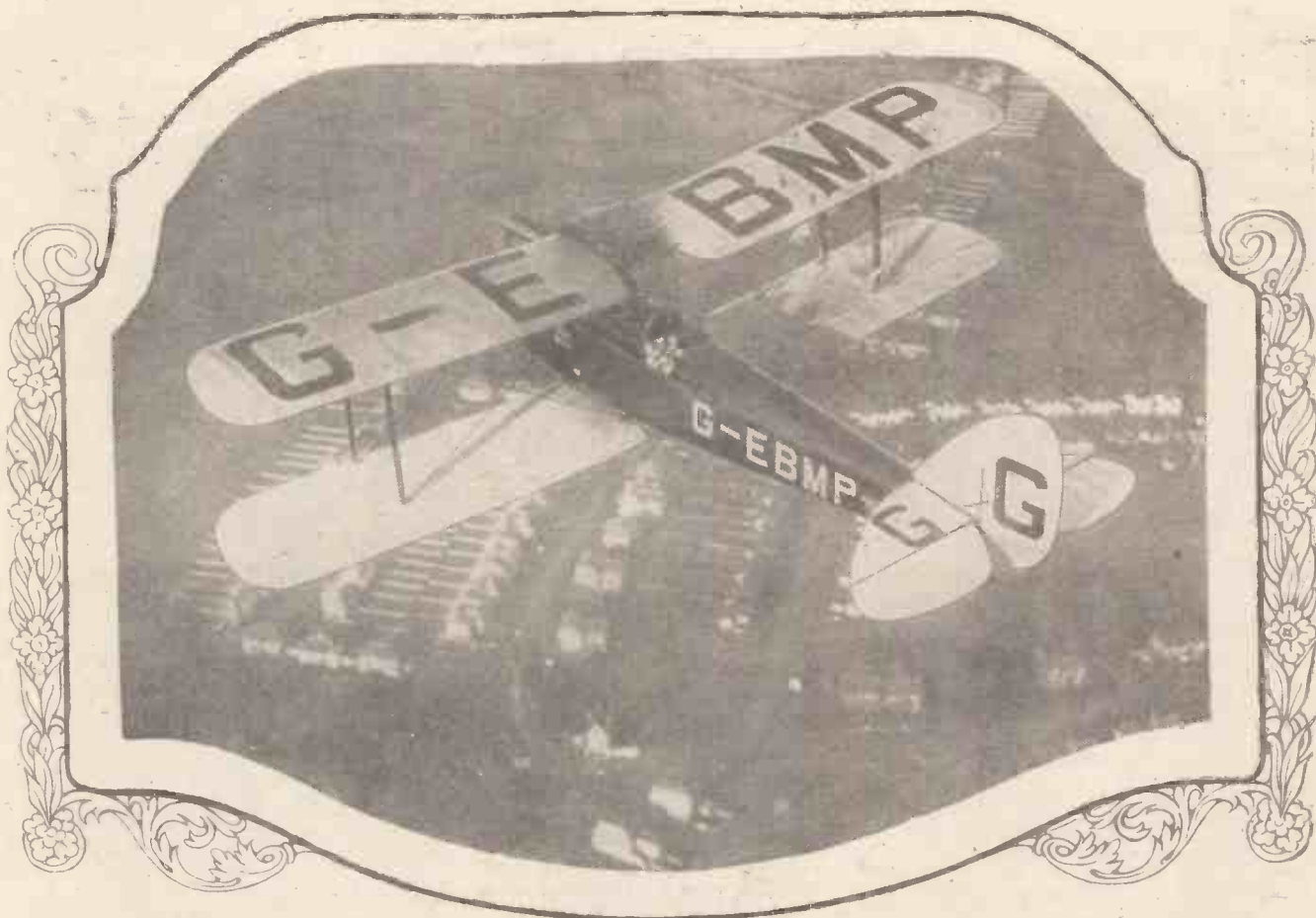

## The World's greatest Valve Test

THE most remarkable valve test ever conceived has just taken place at Stag Lane Aerodrome, London, when twelve Cossor Valves were hurled from an aeroplane 500 feet up to prove the strength of the wonderful new Cossor Kalenised filament.

In view of the almost incredible severity of this test we sought the co-operation of the Wireless press and requested the presence of qualified technical men to supervise it and to remove every element of doubt or suspicion.

The Valves—selected at random from stock by Mr. Sissons Relph (Amateur Wireless), Mr. Wheatley (Popular Wireless) and Mr. Thom-

*Cossor Kalenised filaments unharmed after 500 feet drop from aeroplane*

son (Wireless World)—were inserted into ordinary cartons without corrugated paper, cotton wool or other absorbent material. All cartons were sealed, numbered, and taken to the Aerodrome in the custody of Mr. Thompson.

At the Aerodrome the valves were handed to the pilot, Capt. Barnard, with instructions that they should be dropped overboard at a height of 500 feet.

Of the twelve Cossor Valves thrown overboard, eleven only were actually retrieved—one being lost. And these were the astound-

ing results:—Five valves were in perfect condition, five others suffered from an internal derangement of the electrode system and one valve was smashed through hitting the tail plane in flight. *But in all valves the Kalenised filament was absolutely intact and unharmed.* Several valves fell on a concrete road, and one bounced from a corrugated roof on to the ground, but even these tremendous impacts failed to shatter the kalenised filaments. Never before has such a daring test been carried out—its results prove conclusively that the new Cossor Kalenised filament is practically unbreakable. But only Cossor has it—do not accept a substitute.

### TYPES & PRICES

210H for H.F. use, 2 volts '1 ampere ...	14/-
210D for Detector, 2 volts '1 ampere ...	14/-
Stentor Two Power Valve, 2 v. '15 amp.	18/6
Stentor Four Power Valve, 4 v. '1 amp.	18/6

All above Valves fitted with Cossor Kalenised Filaments

# Cossor —the Valve which serves you longest

# Popular Wireless

Scientific Adviser:  
Sir OLIVER LODGE, F.R.S.  
Technical Editor:  
G. V. DOWDING,  
Grad.I.E.E.  
Assistant Technical  
Editors:  
K. D. ROGERS  
P. R. BIRD  
G. P. KENDALL, B.Sc.



Incorporating "Wireless."

Consultants:  
Dr. J. H. T. ROBERTS,  
F. Inst.P.  
J. F. CORRIGAN, M.Sc.,  
A.I.O.  
O. E. FIELD, B.Sc.  
E. J. SIMMONDS,  
M.I.R.E., F.R.S.A.

Editor: NORMAN EDWARDS, M.Inst.R.E.E., M.R.S.L., F.R.Q.S.

## RADIO NOTES AND NEWS.

The Amende Honourable—"Cheops Calling"—Crystal DX—Valve Baronets—Listeners' Paradise—Radio Drama—Large Benjamin—Strange Effect of the Beam.

### The Amende Honourable.

IN an article entitled "How I Would Run the B.C.G.," published a few weeks ago in "P.W.," Mr. A. Corbett-Smith used the word "artist," meaning player or performer. We printed the word as "artiste." Now Mr. Corbett-Smith asks us to announce that "artiste" is a "horrible hybrid term," which he does not countenance. I am delighted to have this opportunity of making it clear that the fault was entirely ours. Nevertheless, according to my dictionary, "artiste" is a common French noun meaning player or performer, and I lack evidence that it is horrible and hybrid. But if it is any comfort to our esteemed contributor I am ready to confess that I think it much better to call a man a handbell-ringer or cellar-flap dancer than an artist.

### News from Gurnigel.

MR. WM. LE QUEUX, well known as a writer of fiction about spies and of truth about wireless, writes to me from Gurnigel, Switzerland, where his caravan-balloon has rested, 3,800 feet above the level of Margate beach. He relates a tale of high jinks in the high Alps, and tells me that not long ago the visitors at his hotel, having arranged a specially hectic evening, had the honour of being broadcast from the Berne station. Knowing the famous novelist I know quite well that he was one of the chief conspirators. Did anyone pick up this transmission on 411 metres, between 8 p.m. and midnight, January 8th?

### "Cheops Calling."

DURING the present year the first broadcasting station in Egypt is to be erected, and, it is expected, will join in the chorus on November 1st. This provides opportunities not only for ambitious amateurs but for British traders. I am reliably advised that French, German and Austrian firms are making a dead set for the piastres, but I hope that the British exporter will get the most. He ought by now to be studying local conditions and planning his campaign.

### Crystal DX.

I HAVE had a corking letter from a reader of Mawnam, near Falmouth, who is hereby dubbed a genuine, stainless, Knight of the C.W. He has been working

with crystals for fifteen years and speaks with authority, though (I am bound to remark) he writes with a fearful nib. Once he was an unbeliever and thought crystals were prehistoric implements compared with valves. So he built a crystal receiver and was converted within the hour, for he got 5 X X (300 miles away). A ghastly blow! Then he got London. A shrewd thrust!



The new radio vicar, Rev. Canon "Pat" McCormick of St. Martin-in-the-Fields.

Since then he has been knocked out repeatedly, by both English and Continental stations. Re-radiation, he says, is ruled out, because he lives miles from anywhere. That accounts for his nib. But he's right, I think.

### Valve Baronets.

I DON'T want the valve users to be debarred from recounting their prowess; in fact, I know that many of them are getting results which seem as incredible

as the deeds of the K's of the C.W. In dubbing them Bazonets I don't mean to imply that they belong to a higher order of the Round Table than the Knights, but I must have some distinguishing title, or I shall get muddled. Now—what is the most distant broadcasting station heard on a loud-speaker by a Valve Bart? You can use as many valves as you like, but please don't pull my leg by instancing a B.B.C. relay. And don't forget that the re-radiation test applies to you as well as to the Knights.

### Listeners' Paradise.

THAT'S us, according to Mr. H. Belcher, of Waterloo, Ontario, who writes to say that the vast spaces of Canada are lonely enough until you begin to listen-in, when the numerous stations on the American continent successfully compete with the coyotes in howling. He says Chicago has over thirty stations, with twenty more to come—and they all choose their own wave-length. I don't wonder that "over there" they are strong on selectivity, do you? Anyway, I believe he is right when he says that some of us don't know when we are well off with broadcasting. Too much freedom is tantamount to license, and, by the Great Horn Spoon, those United States have found it out with a vengeance.

### Is the Ether a Drug?

AS you know, most of the hospitals have now been fitted with wireless sets. A caustic writer in the "Sporting Times" suggests that, "Judging by the dullness of some of the B.B.C. programmes, they might almost be used instead of an anaesthetic!"

### A Radio Coil Finder?

EXPERIMENTS recently carried out at Cannock, Staffs, suggest that eventually wireless will be used to discover the direction of new seams of coal. At present mine surveying is expensive and somewhat uncertain, and a radio coal-finder would effect a considerable saving of money and time. The Cannock experiments have been carried out by Dr. Hancock on behalf of the mining Research Board of the Birmingham University.

(Continued on next page.)

## NOTES AND NEWS.

(Continued from previous page.)

### Lowly Microphones.

THE microphone used by the Japanese broadcasting stations is mounted upon a rubber pad, like 2 L O's used to be, but it is placed upon a stand at a height of only two or three ft. from the floor. The reason for this is that the native performers generally prefer to sit upon the floor to play, so the microphone also occupies a lowly position, to get the best effect.

### The Four Just Men.

I BORROW this title from Edgar Wallace to describe (as I hope) the four critics who this month began to give fortnightly talks on Literature, the Drama, the Cinema and Music, namely, Mr. Desmond MacCarthy, Mr. James Agate, Mr. G. A. Atkinson and Mr. Percy Scholes. Just four men! But worth the expenditure of a few watts, for they know what's what.

### Radio Drama.

I HAVE received from Messrs. George Allen & Unwin, Ltd., a little book which I believe is the first book ever written on a subject which in ten years' time may have its special shelf in the public libraries, namely, "Radio Drama, and How to Write It." For those of you who aspire to fame and money those baubles are yours if only you will produce a radio play the aural equivalent of a play by Shakespeare as presented by the late Sir H. B. Tree. Get this book (2s.) and try your luck.

### Noise.

IF it is true that a noisy noise annoys an oyster, I wonder what passion imitation noises would excite in the bosom of that bivalve—oyster, not I det., 1 L.F. Mr. Gordon Lea, the author of "Radio Drama," banks a lot more than I would on the possibilities of conveying the dramatic scene to the mind by sound. Half the appeal of the stage is *form* and *colour*, but radio drama employs much lower frequencies. I would rather see an imitation moon than hear radio wind made by that absurd wind-machine so dear to the B.B.C. noise artistes. But the book is courageously written—and, anyway, radio drama will continue.

### A Good Eighteen-Pennyworth.

"PITMAN'S Radio Year Book for 1927" is one of those books you take home and never get hold of again till the rest of the family has devoured its contents. It is chockful of photographs of celebrities at the microphone, aunts and uncles, and so forth. Contributors to this book include Dr. J. A. Fleming, Captain Eckersley, Mr. Norman Edwards (Editor of "P.W."), and Mr. J. L. Baird, the tele-visionary.

### Time Signals.

GLASGOW is disturbed about the changes in the time-signals and a number of letters have reached me from that fair birthplace of (inter alia) marine engineers. Scots who hae written, please accept this intimation that these matters are not (thank goodness!) controlled by 'P.W.' Just to remove ambiguity, however, as to the B.B.C.'s

intentions, let me say that, effective January 1st, the Greenwich six-dots signal will be withdrawn from London at 10 p.m., and will be radiated from all stations at 6.30 p.m. on weekdays.

### Large Benjamin.

BIG BEN is broadcast from London and all stations at 11 a.m., 1 p.m. and 7 p.m., and from London and all stations at 9 p.m. whenever possible. When it is not possible to broadcast Ben the Big at 9 p.m., the announcers will give the correct time in a dulcet voice and correct "spoken English," as closely to 9 p.m. as possible. On Sundays Big Ben will boom broadcastwise at 3.30 p.m., if the programme begins then (I hope the Sunday programme will soon be shifted to 3 p.m.) and at 9 p.m. if possible. And that (as Shakespeare might have said but, unfortunately, omitted) is that.

### A 2/- GIFT FOR READERS!

Next week four Sixpenny Blue Prints will be given away with every copy of "POPULAR WIRELESS."

### ORDER YOUR COPY NOW!

### The Ideal Receiver.

A WRITER in the provincial press states that there is no ideal receiver. I don't think we can admit him to the select company of "P.W."-ites until he is converted from that belief. I will repeat, for his benefit, the general specification of the ideal receiver. It has one control. It has a wave-length range of 1 to 30,000 metres. It will receive all wireless stations at good loud-speaker strength. It can be built for the price of a pound of baccy. Great Scott! What more do some people want? A television attachment for half a crown?

### SHORT WAVES

"Mixed-grill wireless" says a heading. One reader said he thought it was a hash.

"Asked why he refused to broadcast from the London Station, a famous artiste said because the fee offered was 2L0. I asked the B.B.C. how much they offered him, but they said that was a B.B.C.-cret!"—"Radio Digest."

We hear that a new type of loud speaker with extraordinarily clear notes has now come on the market; this depends for its efficiency on the use of real diamonds.

They usually DO speak louder than words.

"Wireless and the telephone are now linked. The operators, having used up all the wrong numbers in this country, are jubilant at the chance of tapping-into America."—"Sunday Pictorial."

"It is calculated that 2L0 has broadcast altogether 10,000 hours' entertainment during the regime of the British Broadcasting Company."—"News of the World."

Entertainment?

"Wireless set in a motor car."

(Headline, Provincial Paper). He must have swallowed his whisker.

Which county in Scotland should make the most musical broadcasting centre? Fife; but there is also a charming Ayr.

Inspector: "It has been reported that you possess no wireless licence, and yet have a loud speaker working on your premises. Is that so?"

Householder: "Alas, yes!"

Inspector: "I wish to inspect it."

Householder: "Sorry, you can't—she's having a bath."—"The People."

### Tele-Blizzards.

MR. A. DINSDALE, who has recently published a book about television, says that "howling" appears on the television screen as snowstorms and "atmospherics" as white flashes. I am wondering what "In a Monastery Garden" would look like. But, joking aside, it would be rather awkward to have snowstorms whirling round the devoted head of the Sheik as he larrups his jolly old camel across the burning desert in the television film of the near future. And during bad periods of "atmospheric" disturbance we shall have to avoid pictures of dark nights on lonely heaths, or else those "white flashes" will make the thing look like a Brock's benefit.

### Strange Effect of the Beam.

SENATORE MARCONI says that engineers standing near a short-wave transmitter sometimes become exceedingly warm on that side of the body nearest the apparatus. The same may be said of that side of little Johnny which is nearest the oscillating slipper. This new discovery ought to give a tremendous fillip to amateur short-wave transmission. A coal strike means absolutely nothing to a man like Mr. Marcuse; he just sits in front of his set, talks to New Zealand, and toasts his toes in comfort.

### A Fair Offer.

I HAVE had a letter from a coloured gentleman resident in the loyal colony of the Gold Coast. He is highly educated and has a nose for business. He says: "Having heard of your loving-kindness tords all men I am very bold gentleman and praying you despatch f.o.b., one reliable wireless receiver and assisting bits such as badteries and insetera. In return I will sending my likeness and faithfully reporting all heard here on receler aforesaid and may God Almighty ever bless."

Yep. The response is one lemon, f.o.b., and lots of loving-kindness.

### French Broadcasting Control.

THE French Minister of Commerce is considering the advisability of bringing all French broadcasting under the State. Just see how contagious the complaint is. First us, then Jacques. And it is at the instigation of the postal and telegraph workers that the Minister is revolving the great idea. Just like us, too. It cannot be long, surely, before post-offices turn into limited companies, and train postmen to sell rabbit-skins or clothes-props on their rounds. "Hark, George! there's the postman bringing the laundry. Just ask him if he's got any soft-roed bloaters, will you?"

### Problem of the Indoor Aerial.

I NOTICE that in a letter to the daily Press someone asks whether the use of an indoor aerial demands that the front door and windows must be kept open during reception. Evidently the inquirer is not a reader of "P.W." How many times more have the technical staff to explain that the set should be kept outside on the window-sill, under an umbrella, and fed with groundsel? Any readers who fail to induce it to sing under such circumstances should write to ARIEL.

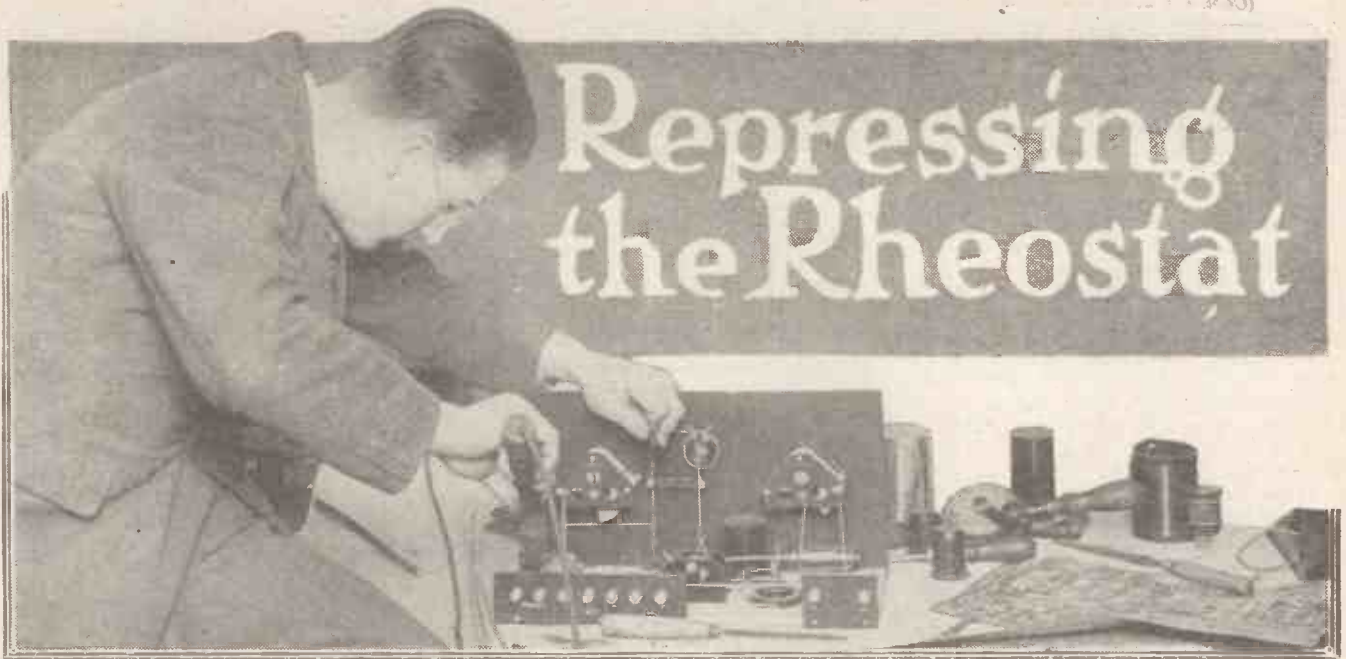

IN the days when ".06" valves were very popular it was a usual practice to employ 30-ohm filament resistances. Most of the .06 valves were designed to operate with dry batteries. Now a dry battery gives the awkward voltage of  $1\frac{1}{2}$  volts per cell, and not a nice even 2 volts per cell like an accumulator. And, therefore, most of the .06's were rated at 2-8 to 3 volts so that they could be used with two dry cells.

But the accumulator was always (and is still!) more popular than the dry battery, and in order to supply a safe margin when a 4-volt accumulator was used with one or

\*-----\*  
 An article of great interest to all  
 home constructors.  
 By G. V. DOWDING, Grad.I.E.E.  
 (Technical Editor).  
 \*-----\*

high-resistance filament rheostats are no longer the essential articles that they have been in the past.

And a high-resistance filament rheostat does not provide an efficient control of a modern valve. No doubt there are many amateurs who are of the opinion that variable rheostats themselves are obsolete and that fixed resistors should be used in every case; but fixed resistors cannot replace filament rheostats in many circuits which are still extremely popular (those using anode bend rectifiers, for instance), and a fixed resistor naturally demands a fixed type and make of valve!

But the point at issue is that there must be very many amateurs using sets which incorporate high-resistance filament rheostats who realise that these do not provide ideal controls, but yet who do not consider it worth while having a change over. Actually it would be worth while to do this in many cases, even although it did mean spending money on buying new rheostats and time on making the alteration.

**Gives an Inefficient Control.**

A maximum of 5 ohms might be all that is required instead of 30. The control in the case of the former will be spread over the whole dial of the instrument (0-5 ohms), but with the former the control is narrowed down to one-sixth of the available adjustment. A "hair's-breadth" movement, perhaps, makes all the difference between maximum signals and no signals. But that is not control at all in the true

sense of the word. What is required is a smooth variation between "max" and "min."

Therefore, if you have to turn your rheostats right round till points are reached where tiny movements one way or the other seem to turn the valves on or off, then your filament rheostats are not "rheostating" as they should. What you want are rheostats which commence to "bring in sigs." when they are about one-third of the way round, and continue smoothly to bring the valves up to their ideal filament heat just before reaching the "maximum" points which indicate resistances nearly all out of circuit.

**Better Results Obtainable.**

Such control is necessary if the best results are to be obtained from many of the interesting 1-valves and other circuits published in "P.W.," and which so many amateurs use. We could instance the Lodge "N," Chitos, and many others.

It will be "real news" to many amateurs, however, that by means of very simple  
 (Continued on next page.)



Fig. 1—A ten-ohm resistance element. Photograph is reproducal full size.

more .06 valves it was necessary to have a filament rheostat capable of providing a fairly high maximum resistance.

Also, a year or two ago the choice of valves was restricted, and many amateurs had to employ valves chosen from .06, 2-volt, 4-volt, and 6-volt ranges in multi-valve sets if they desired to satisfy their personal requirements in respect of impedances and other operating characteristics.

Thus it was no uncommon thing for an H.F. valve to be chosen from a 2-volt range, the detector and L.F. valves being 4-volters or even 6-volters, or vice versa. In these circumstances, too, high-resistance filament rheostats were essential.

**The High-Resistance Rheostat.**

But now each range is absolutely comprehensive, and there are 2-volters available to suit every conceivable purpose, and the same applies to 4- and 6-volters. Therefore

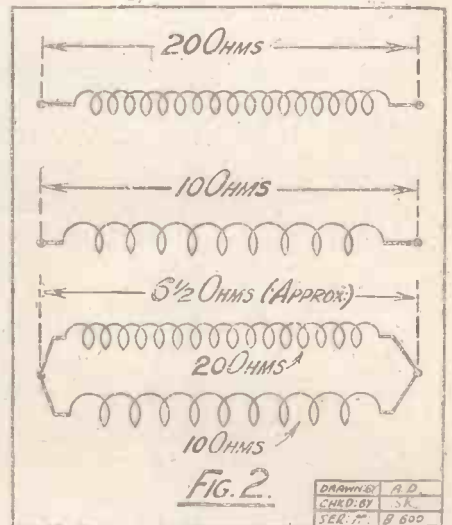

## REPRESSING THE RHEOSTAT.

(Continued from previous page.)

additions this ideal condition can be realised, using 15, 20, or 30 ohm rheostats with ordinary modern valves.

No alterations to existing components or wiring are called for, but just merely the addition of simple little resistance elements which can be made by anyone who can assemble a wireless set. These resistance elements are really fixed resistors, although they are not going to be used as such. They can consist merely of short lengths of resistance wire wound around small slips of hard wood or ebonite (see Fig. 1). But of these more anon.

The scheme, in brief, is based on the fact that the value of the combined resistance of two separate resistances placed in parallel

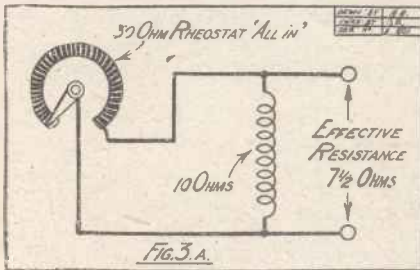

with each other will always be something less than the value of the smaller resistance of the two. Just as an example, if two resistances, one of 20 ohms and the other of 10 ohms, are connected in parallel, the joint resistance is about 6 2/3 ohms (six point six recurring, to be exact!).

### By Quite a Simple Addition.

Therefore, if a 10-ohm resistance element is connected across the two leads which go to a 20-ohm filament rheostat, the effective resistance across those two points will be reduced, and at whatever point the rheostat is "set" the maximum resistance now obtainable is that of 6 1/3 or so ohms. (See Fig. 2.)

Now, supposing we were using a valve rated at 5 to 6 volts .25 amp. with a 6-volt accumulator. The least voltage that valve will operate on is 5 volts. Our filament rheostat is therefore called upon to enable a variation from 5 volts upwards to be obtained. For this a 5-ohm rheostat would be ample; 25 ohms, or five-sixths of a 30-ohm rheostat, would be absolutely wasted.

If we have a 30-ohm rheostat and we

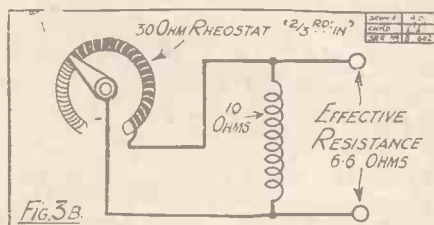

wish to reduce the maximum of this to 7 1/2 ohms, a resistance element of 10 ohms should be connected across it. Then when the rheostat was "all in" the maximum of

7 1/2 ohms would be obtained (Fig. 3A) two-thirds in, or when the knob was turned round a distance equivalent to one-third of its movement from "zero" 6.6 ohms would

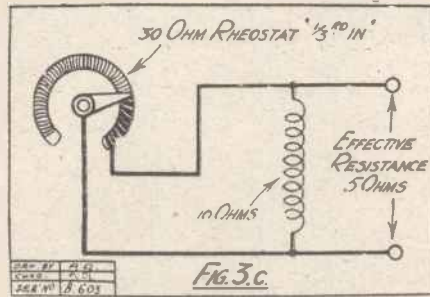

be recorded (Fig. 3B), a further one-third of the scale movement, and the resistance would drop to 5 ohms (Fig. 3C).

And a 2 1/2-ohm variation spread over two-thirds of the "dial" would provide a keener, smoother control than were it spread over a mere one-twelfth, wouldn't it?

We can almost hear hundreds of readers exclaiming at this point, "But how can we work at the necessary resistances involved in this 'wangle'?"

It is all very simple, and the following figures need not frighten even those amateurs who have forgotten that Mr. Algebra ever existed. Elementary addition, multiplication and division only are involved.

Most valve makers now recommend filament rheostat values for their various valves, but even where this is not done the figure can be easily worked out. Take the minimum operating voltage of the valve (it would be 1.8 out of "1.8 to 2.0 volts"), subtract this from the maximum (2.0 volts in our example) and divide this by the figures quoted as "filament consumption." This last might be .1, so, pursuing our example, we have to divide .2 by .1, which is 2, as our youngest amateur will see. And this 2 is the number of ohms required to ensure that with an accumulator recording 2 volts, the voltage across the valve can be dropped to 1.8 volts.

### Some Practical Examples.

Were we to work on 2 volts all the time obviously no filament rheostat at all would be required. At most this component would seem to need only to provide 2 ohms or a variation between zero (none at all) and 2. But sometimes accumulators give more than 2 volts per cell; immediately after charging it might be 2.2 volts, so we must allow 2 or 3 ohms in addition to cope with such "liveliness." Therefore a 4 or 5-ohm rheostat would be advisable.

Knowing the maximum resistance of the rheostat and the maximum that is necessary, it is very easy to work out the resistance required in parallel with the rheostat to arrive at this desired figure. Quite a simple little formula will cover it.

$$\frac{1}{x} = \frac{1}{A} - \frac{1}{B}$$

When A = the desired maximum resistance,

B = the present maximum resistance of the rheostat,

and x = the necessary additional resistance that must be connected across the terminals of the filament rheostat.

Let us take an easy example. We have a rheostat of 30 ohms which will be more useful with a 10-ohm maximum:

$$\frac{1}{x} = \frac{1}{10} - \frac{1}{30}$$

Now these can be treated as quite ordinary fractions, and we have merely to subtract one-thirtieth from one-tenth—which is three-thirtieths. The result is two-thirtieths or one-fifteenths. Our 1/x is resolved into 1/15 and all that remains is to reverse the answer. Therefore we reverse this

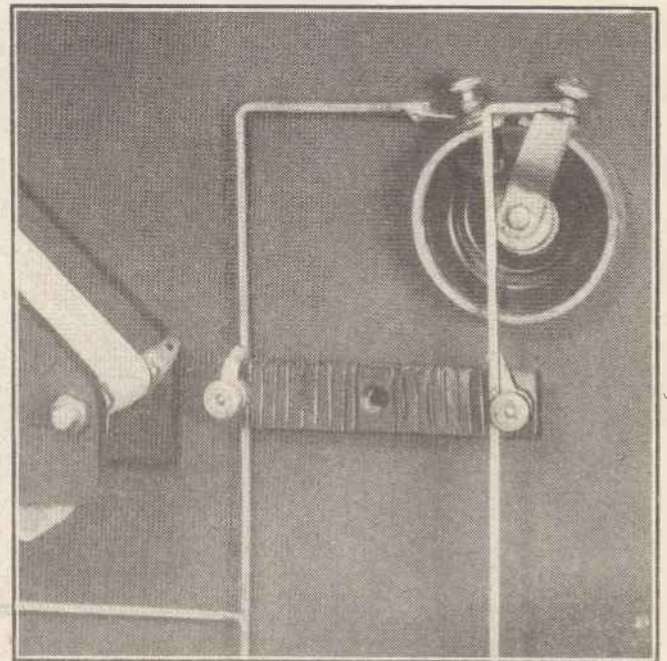

Showing how the 10-ohm resistance element was connected across the leads going to a 30-ohm rheostat. The result of this is indicated in the diagrams on this page.

(15/1) and our x is 15; 15 ohms will therefore do the trick.

A further example. A rheostat provides a maximum of 15 ohms, whereas a maximum of 5 only is required, what value of resistance should we place in parallel to produce this reduction?

$$\frac{1}{x} = \frac{1}{5} - \frac{1}{15}$$

We must have a common denominator, so  $\frac{1}{x} = \frac{3}{15} - \frac{1}{15}$

$$\therefore \frac{1}{x} = \frac{2}{15}$$

We reverse this figure and make it 15/2 which is 7 1/2. So our x in this case is 7 1/2 ohms.

(Continued on page 1333.)



IN the issue for November 27th of POPULAR WIRELESS I described how to modernise the Four-Valve Family Receiver, converting it into neutralised receiver and incorporating a number of improvements such as jack-switching and the provision of additional high-tension tappings and grid bias. Semi-aperiodic aerial coupling was also provided, and in regard to this I have received a number of letters from readers asking for the correct coils to use.

The coil for the aerial socket must be chosen to suit the individual aerial, but it generally will be a 25 or 35, or even in some cases a 50. It is best to try the coils you possess, starting with a 35. If the coil used in the aerial should happen to tune to the actual wave-length you desire to receive the results will not be satisfactory, because the coupling will then become so tight as to give extremely flat tuning and diminution of signal strength.

**The Grid Coil.**

The coil for the grid socket must be, as previously mentioned, of the centre-tapped variety. A Gambrell centre-tapped C or a Lissen centre-tapped 60 will cover the lower broadcast band adequately. If you are anxious to search the bottom end of the broadcast band for some of the continental stations that are working on very low waves, I would suggest you get a centre-tapped 50 or a centre-tapped B. For the Daventry range a 75 or a 100 in the aerial will generally suit, and a 250, centre tapped, in the grid socket. In the lettered series, either an E or F will suit here.

For the tuned anode there is no change to be made. You will use the same coils as before, as this part of the circuit is not affected by the changes so far as tuning is concerned. You will probably find, however, that it is necessary to use a larger coil in the reaction socket, due to the neutralising of the "feed-back" which previously tended to make the set oscillate.

Some correspondents have written to

## MORE ABOUT THE FOUR-VALVE FAMILY RECEIVER.

In this short article Mr. Harris gives some further details concerning one of his most popular receivers.

By PERCY W. HARRIS.

ask how the set should be neutralised and the procedure to adopt. Neutralising is quite simple and should be carried out as follows.

Remove the reaction coil and short-circuit the socket by a piece of wire. Remove aerial and earth wires from their terminals, and set the left-hand tuning condenser at some intermediate value, say 30 degrees. Now, with the right hand twist the anode condenser backwards and forwards, whereupon you should find that the set will oscillate over quite a wide band.

**How to Neutralise.**

I am presuming that you have set the neutralising condenser at the minimum position—i.e. if it is of the inter-leaving plate type with the plates separated from one another, or if it is of the screw-down type, at a position found by turning the adjusting knob in an anti-clockwise direction as far as it will go.

We will assume that the set now oscillates with the anode condenser set anywhere between 20 and 40 degrees. Turn the neutralising condenser knob downwards for a few turns and again move the anode condenser backwards and forwards. If there is no difference, give a few more turns to the neutralising condenser. By adjustment of the neutralising condenser you should find a position where the band of oscillation is narrowed—i.e. instead of oscillating between 20 and 40 degrees, it will only oscillate between, say, 25 and 35 degrees. Continue making careful adjustments of the neutralising condenser until a point is reached where you cannot make the set oscillate at any setting of the condensers. Repeat the process by setting the first tuning condenser at 50 or 60 degrees

so as to "make" sure.

The set should now be correctly neutralised, and it should be only necessary to put a reaction coil in the socket and join up aerial and earth. It is sometimes an advantage to adjust the neutralising

condenser slightly "off" the best position, giving a slight feed-back effect into the first circuit. This feed-back effect should not be sufficient to make the set oscillate when the aerial is connected, but will give a certain reaction and sharpen the tuning in the first circuit.

If the tuning should prove to be very flat it is probable that the coil you are using in the aerial socket is of the wrong size. Try a size larger or smaller. In connection with the modernising of the Four-Valve Family Receiver, readers should peruse the previous articles on bringing sets up to date in the issues for October 30th and November 6th. They will find a number of hints and explanations in these articles which may be of assistance to them.

**Further Tests.**

The actual instrument modernised for the purpose of this description has now been given a prolonged test, not only in my laboratory at Wimbledon, but at the hands of friends who have tested it out in different localities, notably at Chichester (two different parts) and Woking. It has also been tested side by side with sets made from the original design, and in all cases has shown a very considerable increase in selectivity and sensitiveness.

Readers who are experimentally inclined may care to try the addition of the H.F. amplifying unit described in POPULAR WIRELESS recently for use with the "Hale" receiver. This unit is equally suited to the "Four-Valve Family" set, and will still further increase its sensitivity, although, of course, if a permanent set incorporating two stages of high frequency is desired, it is better to follow a complete design for such a receiver.

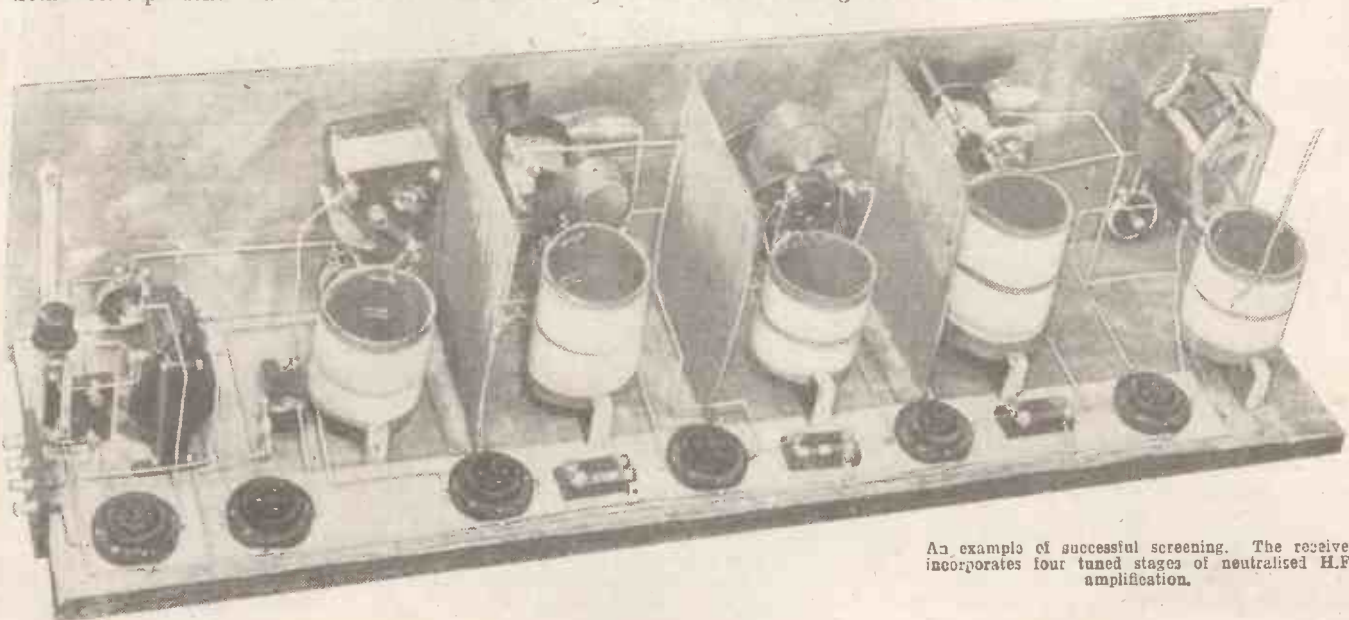

An example of successful screening. The receiver incorporates four tuned stages of neutralised H.F. amplification.

It is not commonly realised how useful the base of a discarded valve may be.

This little component with its four pins and leading-out wires may be applied to a variety of useful purposes. It may, for example, be used for the mounting of home-made coils, the four pins providing connections for two coils, or if the holder is used for a single coil two of the pins may remain idle.

Another purpose to which such a valve base may be applied is the making of experimental H.F. transformers.

In order to obtain the valve base it is only necessary to remove the glass bulb from the sealing compound by which it is secured into the base. These sealing compounds vary with different manufactures, but as a rule they contain shellac as an essential constituent and are therefore partly soluble in alcohol or methylated spirit. If the valve base be soaked in the spirit for a few hours it will usually be quite a simple matter to remove the valve from the base.

#### Condensers for Eliminators.

In the making of an H.F. transformer the simplest way is to attach a short length of ebonite or cardboard tube to the valve base, the tube then acting as a "former" for the windings of the H.F. transformer. The ebonite or cardboard tube may be readily secured into the valve base by means of shellac, but in order to obtain a good joint it is preferable to make the tube a fairly tight fit into the base before the adhesive is applied.

Quite a number of readers are now experimenting with home-made battery eliminators, and I receive a considerable amount of correspondence connected directly or indirectly with this subject. One of the principal items of cost in the making of a device of this kind is the smoothing condenser (or condensers, as usually more condensers than one are required). The choke coils can, as a rule, be made by the constructor himself, and the rectifier, unless it is of the valve type, may be made very inexpensively. The condensers, however, are often beyond the constructional means of the experimenter and consequently there is in such a case no alternative but to purchase the commercial article.

#### A "Variable-Fixed" Condenser.

As the condensers required for smoothing purposes are of a comparatively high capacity, their price is apt to be rather considerable, but since paper condensers are quite suitable for the purpose, there would seem to be no great reason why special cheap paper condensers should not be made, particularly intended for the home constructor who desires to make up his own eliminator. As a matter of fact, it is possible to obtain imported paper condensers which may be quite satisfactory up to the voltages commonly used on electric light supply mains, but naturally there is always a certain degree of uncertainty about apparatus of this kind, and the constructor would be much better satisfied with a British article if he could obtain it at the right price.

Although the manufacture of a compact condenser is a matter of some difficulty, the constructor who desires to make his own condensers can perfectly well do so provided he does not object to their being somewhat bulky when completed. If sheets of thoroughly waxed paper be used, interleaved with sheets of tinfoil, the sheets

## TECHNICAL NOTES.

A Weekly Feature  
Conducted by

Dr. J. H. T. ROBERTS, F.Inst.P.  
(Staff Consultant.)

being, say, of foolscap size, a condenser of the required capacity can soon be built up, and if this is housed below the baseboard of the apparatus, it is out of the way and its somewhat large area is not a matter of much inconvenience. Large area condensers arranged somewhat in this way are often used in the bases of induction coils, so that there is good precedent for the practice.

A very interesting and useful little component which has been introduced by the X.L. Radio Laboratories of Chicago is a "variable fixed" condenser, that is to say, a condenser which is to all appearances and for practical purposes an ordinary small fixed condenser, but which is nevertheless capable of being very simply adjusted or set to a particular value. In outward appearance the condenser, as just mentioned, resembles a small fixed condenser in a moulded case, but passing through the centre is an adjusting screw which is turned by means of

exhibited recently at the Manchester Show. This condenser consists of two series of co-axial cylinders equally spaced apart and arranged so that one set can slide into or mesh with the other set without contact between individual cylinders. The capacity of the condenser increases, of course, as the one set of cylinders is pushed further into the other, and for the control of the condenser capacity a quick-acting screw is provided, which regulates the relative positions of the two sets of cylinders. This form of construction lends itself readily to the die-casting process and thus uniformity as well as economy in production may be secured.

#### One H.F. Stage.

One of the important advantages of this design is that the condenser occupies a small amount of projected panel space as compared with the ordinary type of condenser, which requires space to be left for the swing of the movable set of vanes. The usual range of capacities is obtainable in this type of condenser and, by suitably arranging the cross-sectional shape of the cylindrical walls, the usual straight-line readings may be obtained.

I think we have discussed in these columns once or twice the question as to whether a single stage of H.F. amplification is worth while, and my own opinion, which has been amply supported by the opinions of numerous correspondents, is that, generally speaking, one stage of H.F. amplification does not give in practice the results which might theoretically be expected. It is

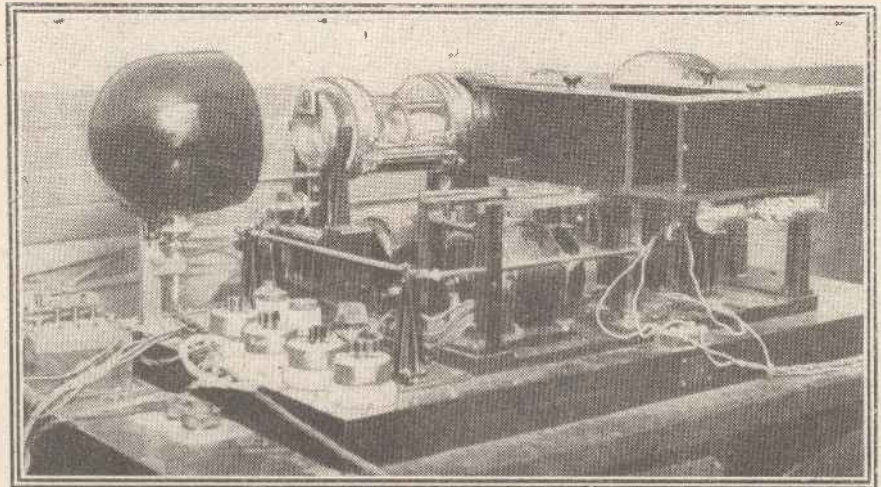

The apparatus used at Radio House for the transmission of photographs by wireless to New York.

a screwdriver. This screw has the effect of tightening or releasing the "plates" or leaves of the condenser and so of adjusting the capacity. In one model the capacity range is from about 0.002 to 0.02 microfarads, and in other models the capacity ranges are from 0.00016 to 0.0005 and 0.0003 to 0.001.

#### A Cylindrical Type.

This condenser has the great advantage that it enables the capacity to be adjusted whilst the condenser is actually in circuit and so obviates the necessity for condenser clips and a range of different capacity fixed condensers.

I notice that the co-axial cylindrical plate condensers are coming into fashion again, an excellent example having been

interesting to note that this question formed the subject of a debate at a meeting of one of the London Wireless Societies recently and, although some arguments in favour of the single stage of H.F. amplification were brought forward, the general opinion appeared to be that the answer to the question as to whether the single H.F. stage was worth while was, to use a Parliamentary phrase, "in the negative." It was maintained that just as good results could be obtained from the proper use of reaction as from the addition of one H.F. valve with its accompanying damping devices.

My readers will remember that a week or two back I was referring to the fact that the amplification per stage, whether H.F. or L.F., was in practice usually considerably

(Continued on page 1340)

IN an article entitled "Into the Earth," published in POPULAR WIRELESS, No. 231, Vol. X., dated November 6th, 1926, I singled out one particular portion of an aerial system, viz., the earth lead, for discussion, so attention will now be focused on the aerial and down lead, reserving the analysis of "earths" to a future date. It is really remarkable how efficiency is at a premium in so many cases as far as the aerial is concerned, no regard being paid to the close relationship which should exist between all parts of the erected system in order to ensure that efficient reception is the rule and not the exception.

Of course it may be argued that signals can generally be heard with the poorest of aeri- als—the wire bedstead has been known to function as a collector of energy when circumstances demanded, while even a wire fence will serve as a fairly good aerial for reception in the country, but this is rather begging the question. An aerial system should consist of the efficient orientation of one or more elevated wires for the express purpose of receiving or transmitting electromagnetic waves, and to this end it is essential to keep uppermost in one's mind a few fundamental principles to observe when an aerial is to be erected or the alteration of an existing one is contemplated.

**Single or Double?**

The question of environment is perhaps the most deciding factor with the majority of wireless enthusiasts, but even in poor situations improvements can be effected if due attention is paid to details and nothing left to chance. I am often asked whether it is preferable to employ a single or multi-wire antenna, so it will serve a useful purpose to settle this point before proceeding with the others. There are many factors which could be included in the answer to this question, but other things being equal, it is best approached from the standpoint of the method employed for coupling up the receiving set to the aerial.

When a direct or auto-coupled arrangement is desired the loading coil or A.T.I. must be of adequate size, and consequently the aerial capacity must not be unduly large. This is provided by the single wire type, but when magnetic or inductive coupling is preferred (and with the present need for selectivity this method of coupling has many points in its favour) a large capacity is permissible, and a twin or multi-wire aerial can be erected. In the majority of cases, however, an orthodox single-wire aerial, suitably designed, will meet the demands, and from the point of view of erection presents less difficulty than the other type.

Viewing the whole problem from a general standpoint before attempting to particularise, it can be shown that amongst other factors, which are all beyond the control of

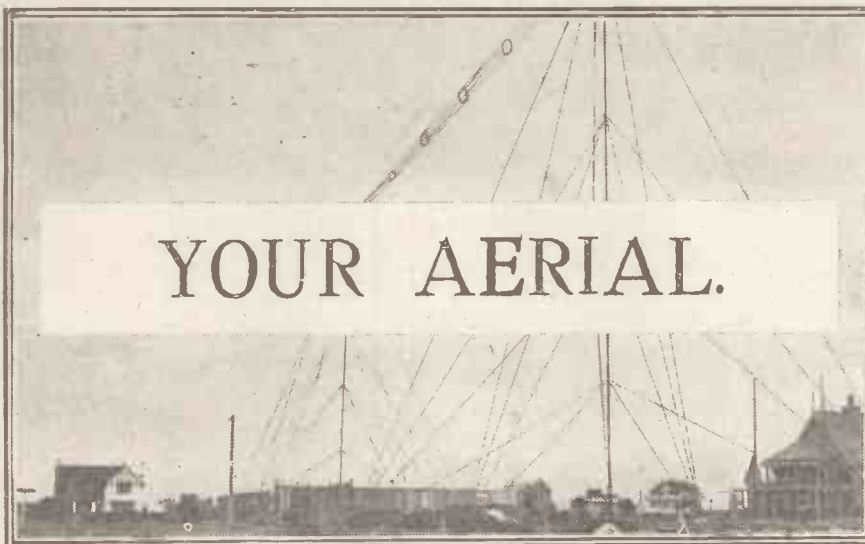

**YOUR AERIAL.**

A great many listeners would obtain better results if they paid more attention to the actual design and position of their aeri- als. This article will be of vital interest to all owners of wireless sets.

By H. J. BARTON CHAPPLE, Wh.Sch., B.Sc. (Hons.), A.C.G.I., D.I.C., A.M.I.E.E.

the amateur and hence do not concern us, the actual current in an aerial due to the received signal is proportional to the effective height of the aerial, and inversely proportional to the total resistance. That being the case, an increase in aerial height will result in an increase in the voltage produced in it by the incoming signal, and we thus automatically increase that fraction of the power transmitted which becomes available for the detector. It is the failure to appreciate the importance of the length of the down lead and its correct positioning that has made so many amateur aeri- als inefficient.

**Selectivity Essential.**

At first sight then it would appear advantageous to bring about the largest signal voltage increase, but there are, however, two distinct reasons why such a procedure is often of no practical advantage. In the first place, readers will have realised from their own experiences that reception often fails not as a direct result of the weakness of the incoming signal, but from the presence of some form of strong interference. This can take the form of "strays" or atmospheric conditions which vary according to certain conditions of nature, the proximity of the local broadcasting or some commercial transmitting station, induced electrical disturbances from railways or tramcars, etc.

We have a parallel case with low-frequency amplifiers—i.e. beyond a certain point nothing is gained by increasing together the volume of the signals and the inherent disturbances. Thus with the particularly sensitive receivers which can now be designed we may consider that in a large percentage of

cases reception fails as a result of inter- ferences rather than by any intrinsic weakness of the incoming signal itself. This fact re-emphasises the need for discrimination between signal and disturbance—i.e. an improvement in selectivity rather than the large increase in sensitivity which would be given by undue elevation of the aerial system.

The second reason to be borne in mind is that with the present-day use of retro-action, or the feeding back of energy for further

amplification, thus making it possible to reduce the resistance of a circuit to a considerable extent, has effected a large modification in the conditions governing the design of the receiving aerial. It was stated in an earlier paragraph that the aerial current was inversely proportional to the aerial resistance, so that by making this last quantity small by the application of retro-action the current can be increased. It is this fact that has enabled very high receiving aeri- als to be dispensed with, and has also led to the successful employment of loop or frame aeri- als, but this principle cannot be pushed too far owing to the practical difficulties encountered in maintaining an absolutely steady reaction adjust- ment.

Having appreciated the foregoing, the reader must not imagine that the possession of a sensitive receiver is an excuse for neglecting the aerial problems, for the maximum pleasure from a broadcast programme can only be derived if attention is paid to the receiving station as a whole—i.e. aerial system, receiver and attendant apparatus, and the points enun- ciated merely show that it is not necessary to go to extremes.

Where a choice of site is possible, an open situation  
(Continued on next page.)

The first of a series of radio beacon towers to be erected in America for the benefit of aircraft. Similar beacons are to be erected along the airway lines across the Continent.

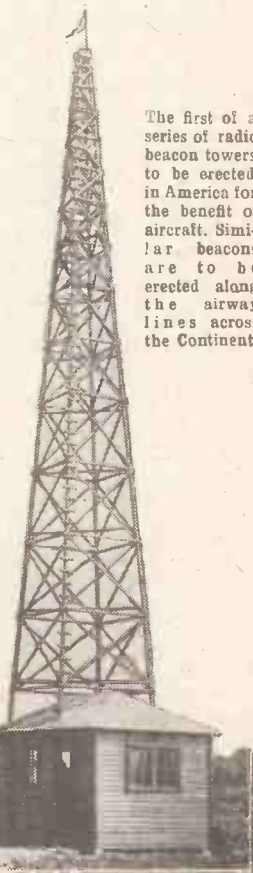

## YOUR AERIAL.

(Continued from previous page.)

free from screening of any sort is a very desirable feature. Under these conditions the horizontal portion of the aerial wire should be about 30 to 40 ft. high. When any screening is present, then an increase in height may be desirable so as to keep the effective height the same—i.e. the height above any earthed objects. For example, if an aerial is erected between two chimney-stacks on a roof, then the effective height will be approximately the distance above the roof and not the distance from the ground.

From considerations of selectivity, the ratio of the horizontal portion to the vertical portion of an aerial should not be made unduly large and, under normal conditions, the horizontal portion should not exceed 40 to 50 ft., with a corresponding height of 30 to 40 ft for the down-lead. While bearing in mind, however, that with the simple inverted L aerial, a short horizontal and a long vertical is preferable to a long horizontal and short vertical, considerations of screening may preclude the former and make the latter a necessity.

### Multi-strand Wire.

Let us for a moment examine the factors which contribute to the aerial resistance, for we have observed that any decrease in this quantity results in an increase in signal current. We have the actual resistance of the aerial itself, and, added to this, the equivalent resistance brought about by the power lost on the poor dielectrics in the neighbourhood of the aerial, the resistance of the earth, or counterpoise, eddy currents in nearby conductors, and the leakage over the insulators.

All the remarks made in the previously mentioned article concerning the type of wire for the earth lead apply with equal force to the aerial. Multi-stranded wire with a coating of enamel over each strand is the best, but good results are secured with the popular 7-22's. The presence of wood, concrete, masonry, trees, etc., should be avoided, as these reduce efficiency, due to what is known as hysteresis loss.

### The Down Lead.

In arranging the down-lead, see that it is kept as far as possible away from the wall, and not run close to rain-water pipes. Hence the house end of the aerial should be clear of any lead roofing and, if circumstances permit, should run transverse to the guttering. This will obviously reduce any losses introduced through eddy currents being induced in the metallic conductors. For the same reason, metal stay wires must be kept outside the "field" of the aerial, and insulators introduced into their length at each end.

It is not necessary to incorporate several large insulators in the aerial, for, after all, the voltages dealt with are quite small, and the provision of a pair of egg-shaped insulators at each end of the horizontal wire should prove quite satisfactory. They should preferably be of good quality porcelain, with the outside surface smooth-

glazed and free from flaws; and, of course, it is necessary to bear in mind that these insulators should be in a state of compression when in position, or results will be disappointing from the point of view of mechanical strength. When circumstances permit, make the aerial and down-lead one continuous length, for soldered or braided joints are a source of loss; and a detail worth noting in this connection is the method of passing the aerial wire round the channel in the shell insulator.

### Attaching the Insulators.

If the wire is brought over the top and looped round from underneath, then, since one wire is bearing down on the other, the strain and friction brought about by the wind, etc., will cause the wire to snap.

A better method is for the aerial wire to be brought into the under channel and, after passing round the insulator, continued down for the vertical lead. Where the wires touch one another binding wire can, with advantage, be added to prevent any slipping.

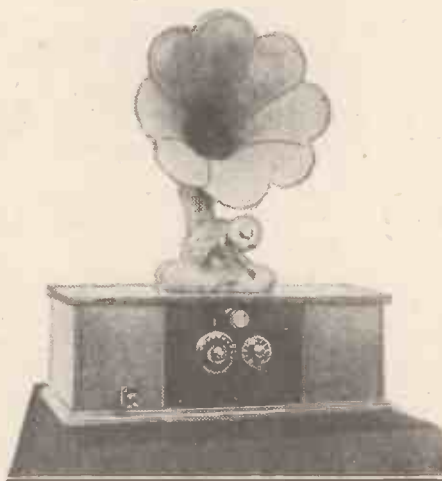

A handsome Hale two-valver constructed by Mr. F. W. Youngman, of 25 Sutherland Road, Croydon.

If the strain lead—i.e., the portion situated between the insulators and the house—is rope, see that provision is made for the continual shrinkage and expansion brought about by climatic changes, and, to facilitate frequent overhaul (a much neglected feature), adequate provision must be made at the mast end. A continuous rope passed round the pulley and held in position round a metal cleat will meet the needs. Many constructors prefer to retain the continuity of their down-lead right to the receiver, and this is good practice, being carried out quite easily by bringing the lead through an open tube inserted in the window-frame or other suitable position. If an aerial-earth switch is preferred, see that it performs its function efficiently, and one that earths the aerial outside the building is admirable, provided the switch contacts are housed in a protecting cover to prevent corrosion—the forerunner of weak signals.

Due regard paid to these few remarks, when attention is next turned to the aerial, will more than compensate the reader for the time and labour expended, and result in improved signal reception, which, after all, is the aim and ambition of all amateurs.

## H.T. BATTERY ECONOMY.

IT sometimes happens that an H.T. battery is not asked to provide its full voltage. For instance, its maximum reading may be 108 volts, while 90 or so volts suffice for the valve requiring the highest H.T. Thus, 18 volts are standing by idle. Nine or so of these will be useful to provide compensation for the drop in voltage which inevitably accompanies the latter days of a battery's life.

The remaining 9 volts can be used for grid bias purposes, thus saving the complication and additional expense of a separate grid bias battery.

The negative wander plug of the H.T. battery should be moved up to "9 volts," and the positive plugs moved up correspondingly at the other end. The grid bias negative plug can then be inserted in any one of the H.T. battery sockets between 0 and 9 volts.

### Varying the Load.

It should always be remembered that the first group of cells in an H.T. battery, used with a multi-valve set, has to do the most work. They have to provide current for the valve or valves taking the least H.T. voltage, as well as those which take most. For instance, supposing there are three valves, each with separate H.T. plus tapplings, taking 45, 60, and 90 volts. The cells between 60 and 90 volts have to supply current for only one valve, those between 45 and 60 for two, and those between 0 and 45 have to supply current for all three.

The work can be evened up a little by shifting all the wander plugs up for periods, viz., that one in 90 up to 108, the 60 up to 78, the 45 up to 63, and the negative plug to 18. Then the probability is that a cell or cells between 18 and 45 will be the first to "pack up." Such can be short-circuited, and the battery used until all the cells between 18 and 90 are hors-de-combat, shortages in voltage being made up by additional 12 or so volt units.

The cells between 90 and 108 should be the last to go. A 108-volt battery, so handled, has given 16 volts of useful energy after a period of nearly eighteen months' work. It provided the last 16 volts out of a total 88 necessary for a three-valve Det.-2 L.F. set, 72 in the form of a complete unit, used for the detector and first L.F. valve.

## NEXT WEEK

A  
SPECIALLY ENLARGED NUMBER

of  
"POPULAR WIRELESS"

containing

FOUR FREE BLUE PRINTS

Will be on Sale on February 3rd

Price 3d. as usual

ORDER YOUR COPY NOW

# Crystal Valve Operation

A consideration of the practical points that have to be taken into account in crystal-valve sets in order to ensure satisfactory results.

By "AMEC,"

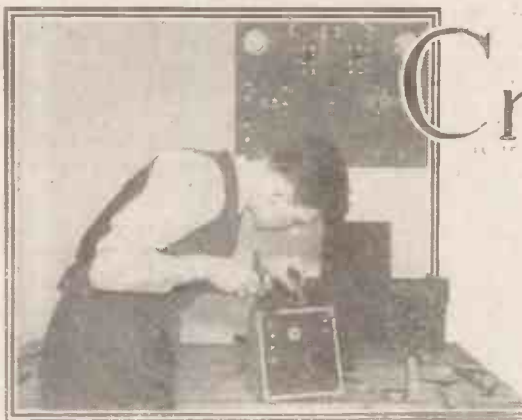

IN this article I am not going to enter into any very detailed discussion of the merits and demerits of various crystal-valve circuits. Such a subject has been repeatedly dealt with in these pages, and therefore I think the question would rather savour of monotony if it was brought up again at the present time.

It has always seemed to me, however, to be a strange fact that even the most able writers on the subject of crystal-valve reception very seldom give more than a few lines at the most to the consideration of the working qualities which must be looked for in the crystals of such sets in order that a reasonable measure of efficiency may be obtained by their use. It is, therefore, in view of facts such as these that I propose in this article to enter into a consideration of the practical points of attention which must be given to the matter of selecting the right type of crystal for the crystal-valve receiver, and to ensure also that the rectifying contact is performing its allotted function to the best of its ability.

## A Simple Circuit.

It is probable that the majority of crystal-valve sets which are in use in this country comprise receivers in which the valve portion of the circuit undertakes the rôle of note magnifier, pure and simple; although, of course, quite a considerable number of crystal-valve sets are built upon a reflex principle. "Straight" crystal-valve sets of the valve-H.F. amplification type are rather at a discount, the reason for this fact being that such sets are often

tricky to operate, and also that the results obtained by their use are never anything extraordinary.

Let us, however, come back to the question of the crystal in crystal-valve sets. Consider, first of all, a very common crystal-valve circuit, to wit, that in which an amplifying valve is tacked on to the crystal rectifying portion of the set through the medium of an L.F. transformer. An example of this type of circuit will be seen at Fig. 1.

Now, in this circuit, as even the beginner will be aware, the pulsations of rectified current from the crystal detector, after being stepped up by the transformer, are impressed upon the grid of the valve. These are reproduced in the plate circuit, and thus the original aerial current which the detector rectifies undergoes a considerable degree of amplification, so much so that with the use of a simple circuit of this nature it is often a feasible matter to work a loud speaker satisfactorily on a nearby broadcasting station.

Simple as this circuit is, however, there are several points of attention which should be given to it if results of the utmost efficiency are expected. In the average plain crystal set it matters very little which way the detector is wired up. That is to say, the crystal side of the detector can be connected to the aerial tuner, and the cat's-whisker to the 'phones, or the opposite arrangement

can be employed with, in nearly every case no appreciable difference to the strength of reception. Not so in the case of crystal-L.F. valve sets; however. In this instance, the wiring of the detector in the above respect does very often make a good deal of difference to the strength of the reception obtained. Unfortunately, however, it is impossible to lay down a general rule for the guidance of the amateur in this respect, for crystals, even although they be of exactly the same variety and manufacture,

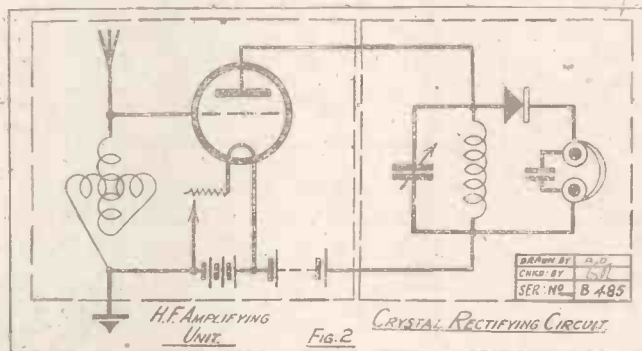

vary greatly in their individual characteristics. When dealing with crystal-L.F. valve amplification, therefore, it always pays to try out the capabilities of the set with the detector connected both ways, for, in most cases, quite an appreciable amount of difference will be made in the reception strength.

This fact is true also of the crystal detector employed in reflex sets. And, in fact, in this latter instance even a greater amount of difference in the reception efficiency may be found to depend upon such a simple trial.

## An Interesting Fact.

The best type of crystal to use in a crystal-valve set of the ordinary L.F. amplification breed is a vexed question. Certainly the ordinary galena or "ite" crystals with their cat's-whisker accompaniments are very convenient articles to use. But do they always give the most satisfactory results? It is a moot point, and, personally, I think they don't.

Let us consider the subject more closely. The resistance of a galena-cat's-whisker contact depends mainly upon the pressure of the cat's-whisker's contact and the exact spot on the crystal at which contact is made. Thus, to a more or less extent, the amount of rectified current (in microamps) getting through the crystal is dependent upon the above two highly variable factors. Now, it is a fact, the reason for which is very obscure, that the signal strength given by a

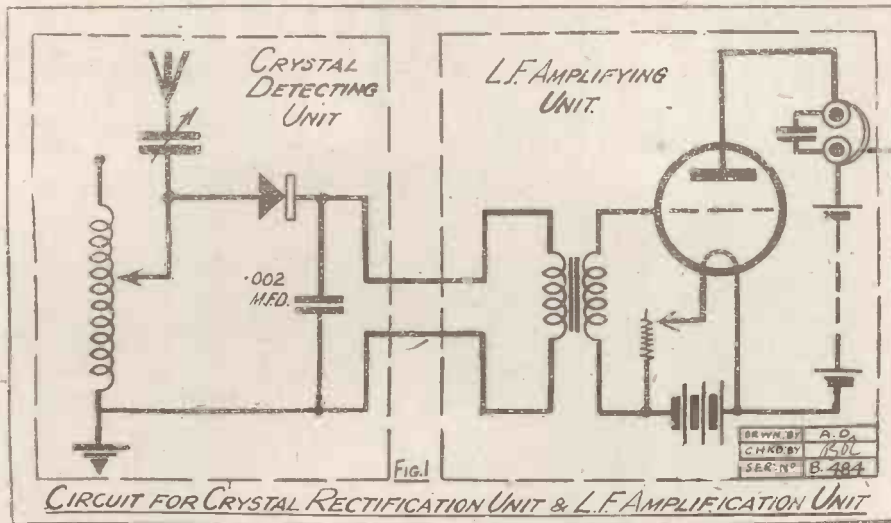

(Continued on next page.)

## CRYSTAL-VALVE OPERATION.

(Continued from previous page.)

plain crystal set is not altogether dependent upon the amount of current (microamps) getting through the contact. Some crystal sets which give a microamperage of 40 will

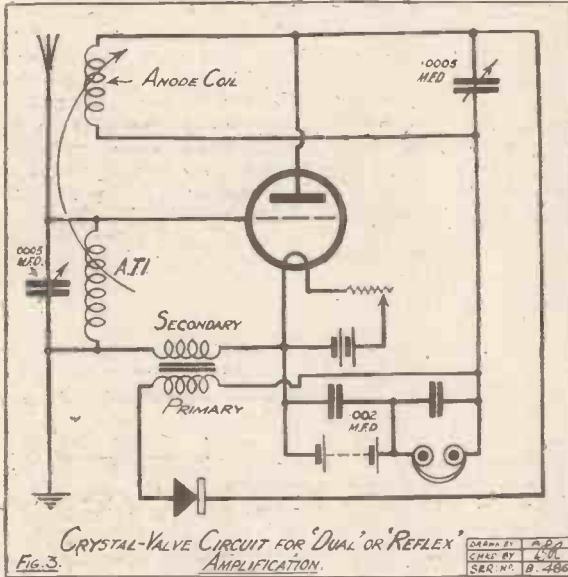

very often give louder and clearer signals than a crystal set producing, say, a microamperage of 65. The subject is a very interesting one, but, nevertheless, it is not possible to enter into any attempt at an explanation of it at the present moment.

The signal strength given by a valve must, of course, be determined (other factors being equal) by the strength of the current impressed upon its grid. Thus, although slight variations in rectification contact conditions will not very greatly influence reception in a plain crystal set, such variations will very easily greatly affect the working of a crystal-L.F. valve amplifying set. Hence it is that the ordinary galena-cat's-whisker contact detector in which the crystal setting has constantly to be adjusted is not the best type of rectifier to employ in conjunction with a valve amplifier.

### Stable Detectors.

A detector of more stable propensities is more advisable for the above purpose. Carborundum detectors are, of course, characteristically stable affairs, but they work under the disability of requiring the employment of a local dry battery and a potentiometer, and further they are not exceptionally sensitive in most cases. A good perikon detector is hard to beat for crystal-L.F. amplification work. The most effective type of this detector is that formed by the contact of a piece of tellurium with a fragment of natural zincite or zincite of the artificial variety. Such a contact may be adjusted to its most sensitive extent, and it will retain its adjustment over long periods, despite the fact that the set may possibly be carried about from room to room during the period. Thus, having obtained a good and fairly permanent

setting to the crystal detector, the valve controls (i.e. the amount of L.T. and H.T. current) can be so adjusted in order to effect the valve working at its best, and, once adjusted, the supply of L.T. and H.T. current to the valve may be allowed to remain fairly constant.

This is a great convenience, for, with the general run of amplifying valves, careful trial will show that the precise amounts of L.T. and H.T. current needed to effect the working of the valve at its best are often enormously dependent upon the strength of the rectified impulses of current from the detector, and therefore upon the setting of the detector. Thus, if a galena crystal is employed in the set, every time the cat's-whisker is adjusted the operator will probably find that some readjustment of the L.T. and H.T. supply of the valve may make a difference in reception. A perikon detector, however, once set, remains set, and thus the above tedious process of re-adjustment making is very greatly obviated.

A crystal-valve set which is apt to be noisy can often be cured by using for the crystal rectifier a good specimen of iron pyrites in conjunction with an ordinary pin as the contact. The

contact is fairly stable, but, of course, not so stable as a contact of the perikon type. Iron pyrites, however, even when used in a plain crystal set, gives signals of unsurpassed tonal purity. Hence its great usefulness for playing the part of crystal rectifier in a valve receiver.

### A Cause of Self-Oscillation.

Turning now for the moment to crystal-H.F. valve amplification receivers, such as those of the type illustrated by the circuit diagram, Fig. 2, such receivers, as I have remarked previously, very often give results which are disappointing in the extreme. In such sets, the greatest measure of efficiency is obtained by the employment of the tuned anode method of coupling the valve, the crystal rectifier circuit being placed across the tuned anode. Even in such cases, despite the damping effect of the crystal rectifier, such a circuit may very frequently evince a persistent tendency to set itself into a state of self-oscillation. That tendency is perhaps one of the great failings of crystal-H.F. amplifying sets. It is, of course, possible to eradicate the trouble to some extent by neutrodyne methods, but the amateur will have to be very keen on the subject of crystal-H.F. valve amplifying sets before he will put himself to the trouble of incorporating neutrodyne circuits into the receiver.

For any crystal-valve circuit in which the valve acts as an H.F. amplifier, there is no doubt that the stability of the circuit is best assured by the use of the carborundum

(Continued on page 1338.)

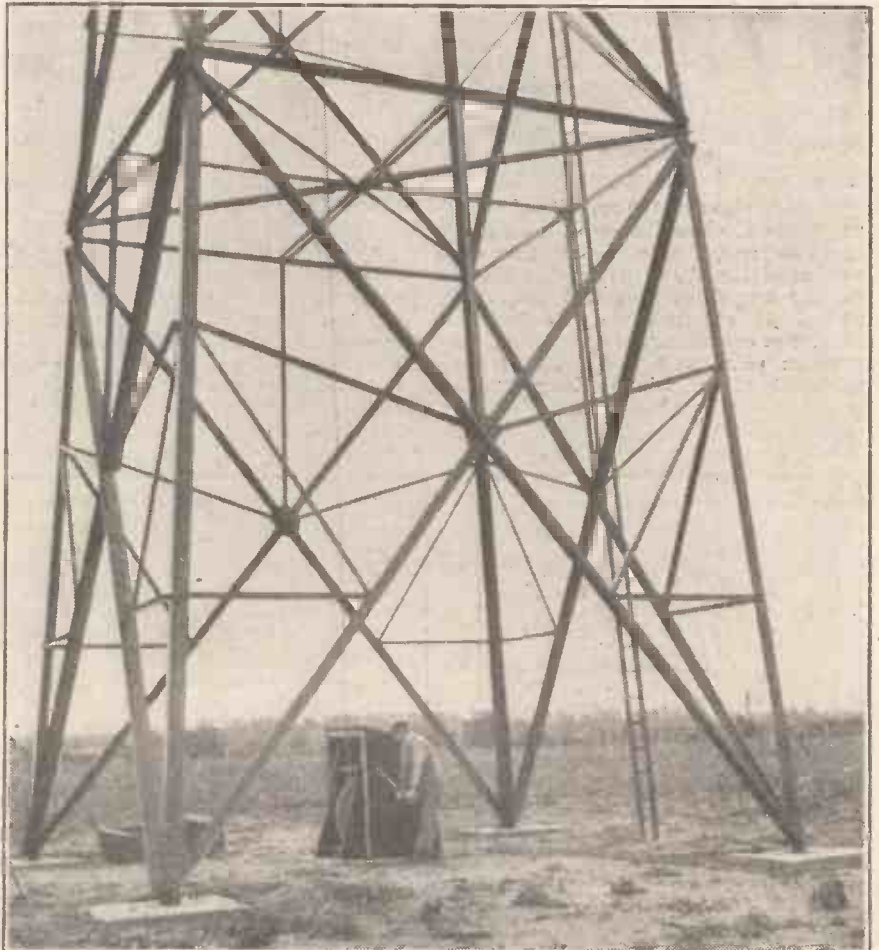

The base of one of the 200 ft. masts at the St. Albans Post Office Wireless Station.

# CRYSTAL COLORATIONS.

An Interesting Sidelight on Radio Mineralogy.

FROM A SPECIAL CORRESPONDENT.

EVERY experimenter in the sphere of crystal rectification knows, of course, that one of the essential characteristics of minerals and crystals is the colour which they exhibit, and that by this property alone they are generally very readily distinguishable from one another. For instance, apart from any other physical characteristics of the minerals, one could single out a piece of zincite from an assortment of rectifying minerals and crystals merely on account of its peculiar ruby-red colour alone.

All this information will very naturally appear at first sight to be very commonplace

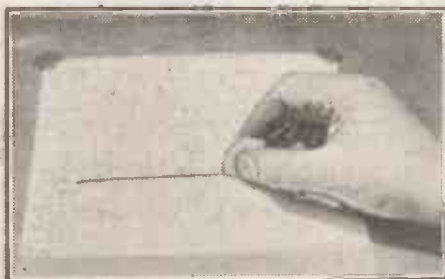

Fig. 1. The "streak" test.

and uninteresting, but it is necessary to state the above facts in order that the essentially characteristic nature of crystal coloration may be fully grasped.

The colour which is exhibited by any mineral or crystal is either an "intrinsic" property of the material, or else it is "accidental" in nature. For instance, cinnabar, a native ore of mercury consisting of the sulphide of that metal, possesses a vermilion-red colour, and, no matter how much the mineral may be purified, its colour will always remain the same. Thus, cinnabar has an "intrinsic" vermilion-red coloration.

On the other hand, the colour of native zincite is "accidental." By the "accidental" coloration of a mineral is meant the colour which the mineral acquires owing to the admixture with it of traces of impurities.

### "Accidental" Colours.

Now, zincite is a naturally-occurring oxide of zinc. But, as every crystal experimenter knows, zinc oxide in itself is cream-white in colour. Moreover; if, by certain processes, the ruby-red zincite is purified, its colour will disappear, leaving merely the colourless substance which forms almost the entire bulk of the mineral, viz., zinc oxide.

How, then, does the native zinc oxide, which we call zincite, obtain its ruby-like appearance? The answer to this question lies in the fact that zincite contains slight traces of the metal manganese, and it is this metal, existing as an impurity in the zincite, which, in some mysterious way, imparts to the mineral the deep-red colour with which every crystal user is so well acquainted. The red colour of native zincite, therefore,

is not an intrinsic characteristic of the mineral. The colour is an accidental one, and it is a noteworthy fact that many of the synthetic zincites which are now being produced very closely approximate in colour to the creamy whiteness of pure zinc oxide.

The colours of most of the precious stones which are so much sought after and admired for their great beauty and brilliance are, for the most part, accidental to the mineral, and, in very many instances, precious stones are only more or less common minerals in which a trace of some metallic colouring impurity has been deposited. Take away, for instance, the very small traces of metallic impurities which impart the deep blue colour to the sapphire, and you are left with a lump of almost valueless alumina, or aluminium oxide.

So far, we have been considering the reasons why minerals exhibit their distinctive colours. Let us now dwell for a short time upon the methods by means of which the true intrinsic colours of mineral substances are determined.

The real colours of minerals are very often extremely deceptive, for, in the finely powdered condition, nearly all crystals and minerals exhibit quite a different colour to that which is shown by them when they are in the mass state.

### Difficult to Determine.

Take, for instance, haematite, an oxide of iron which sometimes finds a limited use for the purpose of crystal rectification. Haematite has a very deep-brown colour when it is viewed in the lump condition, but when the mineral is broken up and powdered, its real colour is seen to be cherry-red.

Again, it is sometimes very difficult for the inexperienced crystal user to distinguish between a specimen of galena and a fragment of molybdenite. Both these minerals possess a dull or a bright bluish-black appearance and lustre, and their crystalline structure has also many points of resemblance. If, however, the mineral specimens are finely powdered, the molybdenite will be found to exhibit a decidedly greenish cast, whilst the galena powder will be more or less bluish-black in colour.

Of course, such a test would be a very drastic one, for it would necessitate the complete sacrifice of the crystals. Fortunately, however, there is a very good test for determining the true colours of minerals and thus elucidating their nature, and without at the same time having to bring about their disintegration. This

test, which is known as the "streak" test, is illustrated at Fig. 1, and it simply consists in drawing a fragment of the mineral of crystal to be tested across a piece of unglazed porcelain or rough paper.

A mark will be left on the white sheet, and its colour will correspond to the true colour of the mineral itself. For instance, the dull greyish molybdenite will leave a greenish streak when drawn across the white sheet, whilst bornite, which varies in apparent colour from a reddish-purple to a deep iridescent bluish-brown, will impart a greyish streak to the plate.

If the mineral is a fairly soft one, such as, for instance, galena, molybdenite, or graphite, the test may be carried out with a white sheet of paper. If, however, a hard mineral, such as iron pyrites, or zincite is used for the test, a piece of unglazed pot will be required for the purpose of obtaining the true crystal streak.

The accompanying table gives a list of some of the minerals and crystals which are, or have been, used for the purpose of effecting crystal rectification. In the table will be seen the colour which the mineral exhibits when it is viewed in the lump form, and also the characteristic or "true" colour of the mineral when it is caused to make a streak upon a rough white surface. This true colour of the mineral never varies, and, as we have seen above, it may be accidental or intrinsic in nature according to whether the mineral or crystal is coloured in its pure state, or whether the colour merely results through the admixture of some impurity with it.

Table showing the mass and streak coloration of some common minerals:—

MINERAL.	COLOUR IN LUMP FORM.	TRUE COLOUR (As determined by 'streak test'.)
Bornite ..	Dark reddish-purple	Greyish-black
Cinnabar ..	Dull red	Bright scarlet
Copper pyrites ..	"Old gold" colour	Greenish-black
Galena ..	Bluish-black	Lead-grey
Graphite ..	Black	Black
Haematite ..	Dark brown	Cherry-red
Iron Pyrites ..	Lemon yellow	Brownish-black
Malachite ..	Bright green	Pale yellowish-green
Molybdenite ..	Lead grey	Greenish-blue
Psilomelane ..	Black	Brownish-black
Tellurium ..	Silver grey	"Tin-white"
Zincite ..	Ruby-red	Orange-yellow

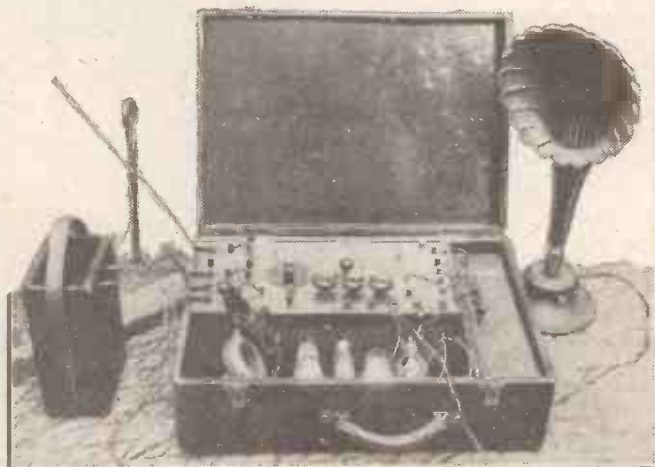

A four-valve portable set constructed by one of our readers.

# "SPORTS NEWS"

THE THREE O'clock  
 1. ACCUMULATOR  
 2. CONDENSER  
 3. GRID BIAS

I READ THAT HOURS AGO

HITHERTO THE SPORTS NEWS - BROADCAST FROM 2.L.O. HAS SIMPLY CONSISTED OF A LIST OF RESULTS. IN THE NEAR FUTURE WE ARE PROMISED DESCRIPTIVE REPORTS OF CERTAIN EVENTS - WITH RUNNING COMMENTS ON THE VARIOUS INCIDENTS TAKING PLACE.

THIS WILL BE MUCH MORE EXCITING

THE FIRST RACE ON THE PROGRAMME IS FOR THE VALVE PLATE. THE WIRE IS UP - THEY'RE OFF!

THE CROWD IS AT HIGH-TENSION. "ACCUMULATOR" MAKING A SHORT-CIRCUIT ON THE RAILS - IS GAINING GROUND

WITH A DETERMINED LOOK ON HIS DIAL - "EBONITE'S" JOCKEY IS CHARGING "ACCUMULATOR" WHO LOOKS LIKE GETTING RUN DOWN

-THE LONG DISTANCE IS BEGINNING TO TELL ON THE FILLY "CRYSTAL" AND ONE CAN DETECT 'ER SHOWING SIGNALS OF DISTRESS-

"CONDENSER'S" CAPACITY TO WIN IS FADING AND LOOKS LIKE BEING POSITIVELY NEGATED. "AERIAL" HAS'NT AN EARTH-LY!

COMING UP THE STRAIGHT "ACCUMULATOR" AMID A VOLUME OF CHEERING- AND HOWLS HAS TAKEN THE LEAD - AND WON!!!



CON SHAW



# A NEW AND MOMENTOUS STEP BY LISSEN

—unparalleled in the annals of British Battery making

LISSEN has always known that if the price of the LISSEN New Process Battery could be reduced it would result in enormously increased Sales. AND LISSEN HAS NOW DECIDED TO GIVE THE USER THE ADVANTAGE OF PRICE AS WELL AS QUALITY IN BATTERIES WHICH NOTICEABLY IMPROVES LOUD SPEAKER REPRODUCTION, and to sell the LISSEN New Process Battery at a price which places it within the reach of all. Unfortunately, this has only been possible by drastically reducing the profit to the retail trader

as well as taking much less ourselves. It is only by the co-operation of our retail friends that we can make LISSEN Batteries available to you at so many thousands of shops throughout the country, and we feel it is only fair that it should be known that the sacrifice in profit which makes the new price possible is being made by our retail friends as well as by ourselves. We shall consider it well justified, however, by knowing that every user can now obtain a battery better than he has ever had before.

PREVIOUSLY 10/6

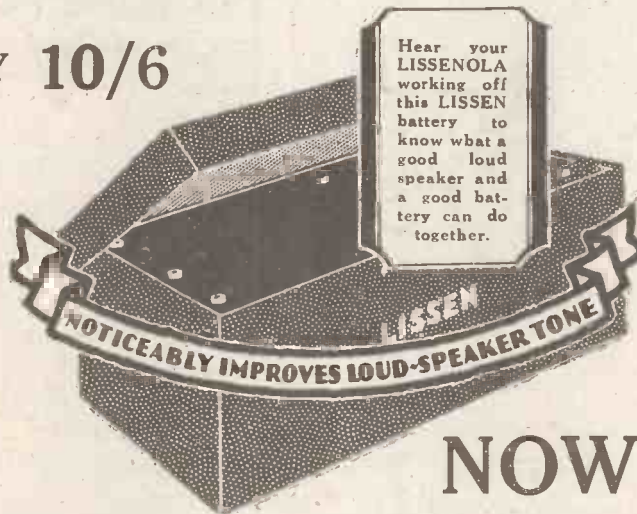

NOW 7/11

### A Word about the Lissen Battery.

Do not limit the use of the LISSEN New Process Battery to 1 or 2 valve sets. Use it on a 4-valve set or more if you like. At the new price the LISSEN battery is identical in every way with the battery previously sold by LISSEN at the higher price. Each battery has at one end four—1½-volt tappings for grid-bi s u e.

### The History of the Battery.

This LISSEN battery is made by a process with chemical combination known to no other battery-maker. The success of this process is now a definitely established fact. The battery would have been sold for 13/- but for a new direct-to-dealer policy of distribution instituted by LISSEN which cuts out wholesale profits. It saved the user 2/6 when LISSEN made the price 10/6. Now this fine battery is obtainable at your dealer's for 7/11. Be sure to ask for "LISSEN New Process." Let it be your next battery. Get one for the next fine programme if you want to hear it at its best. Take nothing else. Then notice the smoothness of your loud-speaker reproduction—the fine, lastingly clear utterance.

### To Our Retail Friends.

We were loth to lower the discount, but we think the new price is going to be justified. Full credits on existing stock will be made to stockists who have obtained supplies direct from us, whose claims are in our hands by January 31st, 1927, for any LISSEN New Process Batteries in stock on January 18th which were invoiced in January. Invoice numbers should be quoted when claiming. Since January 18th batteries have been invoiced to the trade at the new trade price.

### To the User.

There is no substitute for a LISSEN New Process Battery. Ask for "LISSEN New Process" and see you get it. There is a LISSEN dealer close to you who will be glad to sell it to you. But if any difficulty send direct to factory. No postage charged, but please mention dealer's name and address, or can be sent C.O.D. Connect two batteries in series when more than 66 volts required. Rated at 60 volts, this LISSEN New Process Battery goes considerably over. Its size is 9½ in. x 4½ in.—IT IS PACKED FULL OF NEW ENERGY.

BUY IT, Not Merely Because You Prefer British, But BECAUSE IT IS THE BEST MONEY'S WORTH  
LISSEN LTD., 8-16, FRIARS LANE, RICHMOND, SURREY

Managing Director : THOMAS N. COLE.

BROADCASTS BY 'TONE' & 'POWER'  
*The 'Boon' Companions of Osram Valves*



# A Wonderful Advance of 'Tone' & 'Power'

THE NEW OSRAM 6-VOLT VALVE  
**D.E.H. 612**

*Dull Emitter, High "Amplification Factor,"  
 6-volt, 0.12 amp.*

FOR RESISTANCE CAPACITY COUPLED CIRCUITS

**Price 14/- only**

"No wonder you take a special pride, 'TONE,' in the new D.E.H.612 OSRAM VALVE. Used in amplifiers where Resistance-Capacity Coupling is employed, or for use as a Detector valve, particularly for anode bend rectification, it gives amazing volume," remarked "POWER."

"And wonderful purity, too!" replied "TONE." "For use with 6-volt accumulators it consumes less than one-sixth of the filament current of the extravagant bright emitter which it will replace. At 14/- it is certainly a wonderful valve."

"It makes a splendid companion to our new General Purpose 6-volt dull-emitter (D.E.L.612)," added "POWER." "Two valves that set a new and higher standard of reception."

# Osram Valves

for TONE & POWER

*The G.E.C. - your guarantee*



# Economical A.C. Rectifier

THE following notes have been compiled for the benefit of amateur constructors who may be led to believe that the problem of charging an accumulator from A.C. mains presents many difficulties, and that the saving effected by home charging is absorbed by the resistance, usually a cluster of carbon filament lamps kept specially for the purpose. The D.C. mains charger is, of course, an extremely simple affair, the most important part of such a device being the resistance; the A.C. mains charger must be provided with a *rectifier*, as

\* Some useful details of a simple battery charger suitable for A.C. mains of any voltage. \*  
By O. J. RANKIN. \*

the simplest, cheapest, and most stable rectifier for A.C. current. But in any case, having rectified A.C. into D.C. by this or any other method, you might ask: what about the waste of current—the heat dissipated by the resistance, which usually cannot be avoided? This brings me to my point. If the outfit is properly arranged—i.e. if the idea suggested in this article is closely followed, and the features therein embodied in the design of the outfit, there will be very little waste of current.

Briefly, the accumulator is charged for nothing, the resistance unit being made to serve a double purpose. There is no "snag." The scheme is simply this, the rectifier is *portable* so that it can be moved about from one room to another. The resistance may be an electric radiator occupying its usual place in the house, an electric iron, a suitable electric cooking utensil in the kitchen, or an illuminating ceiling cluster or a radiator in the workshop, the idea being to avoid waste by simply plugging the rectifier in series with any suitable device which happens to be in domestic use.

Fig. 1 shows the orthodox circuit arrangement of a Noden valve rectifier, and Fig. 2 shows the same circuit modified to suit the present scheme. For the moment we

dispense with the ammeter, this being quite unnecessary as a permanent fixture. We then provide two terminals for the accumulator connections, and in place of the unsightly lamp resistance which usually forms an integral part of the outfit, we provide an ordinary porcelain wall socket, another socket being fitted in place of the two terminals for the A.C. mains. It is now only necessary to arrange the four cells, the sockets, and the terminals in a compact form, so that the device may be easily moved about, and not permanently fitted to the wall of any particular room.

### Constructing the Cells.

The construction of the cells will present no difficulty; for the aluminium plates take four pieces of heavy-gauge aluminium tubing each 2 in. long by about 1 in. in diameter, and 4 4-in. lengths of  $\frac{1}{8}$  in. diameter aluminium rod. File a flat on one end of each rod and drill same to take small rivets. At the opposite ends run a  $\frac{1}{8}$  in. Whitworth thread, then firmly rivet the rods to the tubes in the manner shown at A in Fig. 3. For the lead plates take four pieces of lead tubing each about 6 in. long by 3 in. in diameter, drill a few circu-

(Continued on next page.)

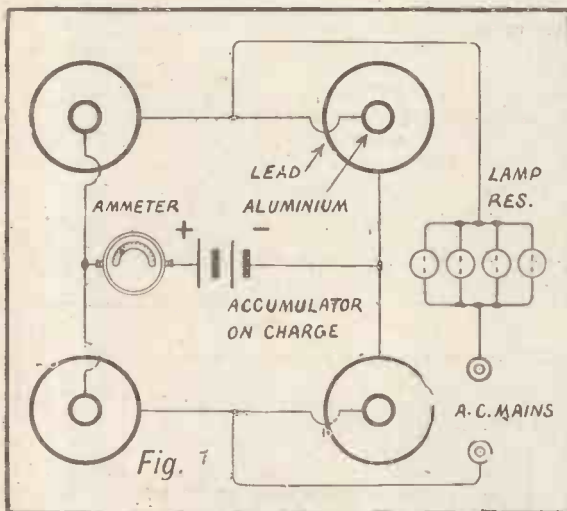

Fig. 1

well as a resistance, and it is this part of the unit which appears to discourage so many would-be enthusiasts.

### "Charged For Nothing."

Leaving special valves and transformers out of the question—these give good results in the hands of experts, but so far there are no suitable models available for amateurs—the next best thing is undoubtedly the ordinary Noden valve, a form of wet cell consisting of two plates, lead and aluminium, immersed in a mixture of ammonium phosphate and ordinary tap water.

The most efficient unit comprises four complete cells, such an outfit then being

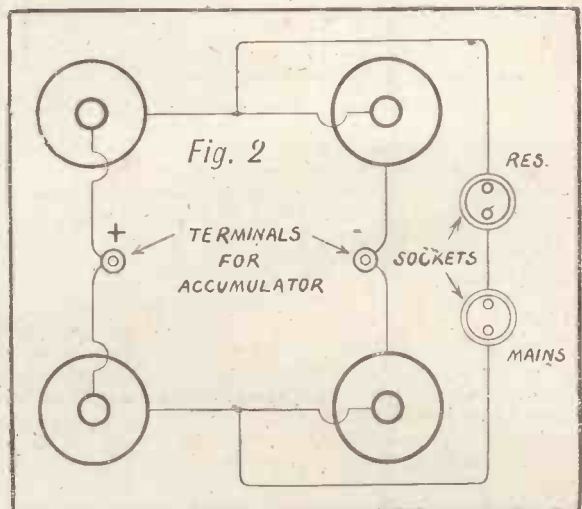

Fig. 2

## ECONOMICAL A.C. RECTIFIER.

(Continued from previous page.)

lation holes in each, and rivet on short lengths of  $\frac{1}{8}$  in. threaded brass rod, as shown at B. Here one will encounter a little difficulty in making a firm joint, owing to the lead being softer than the rivets; the easiest way out of the difficulty is, of course, to rivet and solder.

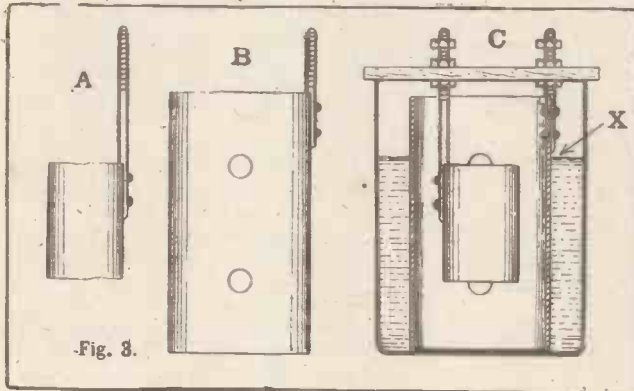

Fig. 3.

Now arrange each pair of "plates," as shown at C, clamping the rods very firmly to a strip of hard wood previously boiled in paraffin wax, and drop each element into a 3-pint glass jar containing  $\frac{1}{4}$  lb. of chemically pure ammonium phosphate dissolved

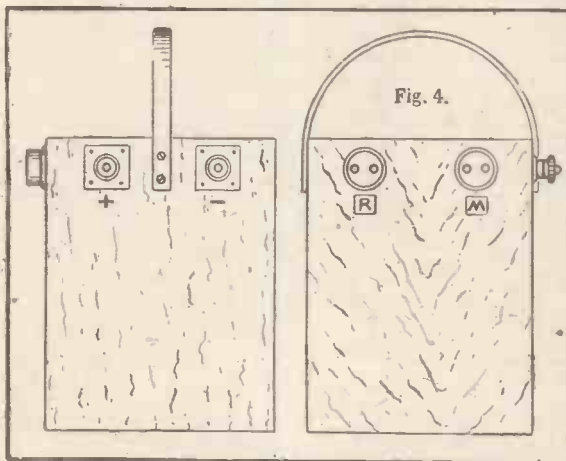

Fig. 4.

in enough tap water to reach the level, X. The wooden strips should rest over the tops of the jars, and do not forget to use  $\frac{1}{4}$  lb. of phosphate for each jar. Connect up the cells as shown in the diagram, Fig. 2, and the rectifier is complete, no "forming" process being necessary.

### The Case.

It now only remains to construct a square wooden box, preferably with a separate compartment for each cell, and arrange this so that there is sufficient space at the top for the two porcelain sockets, the two terminals, and the wiring. (See Fig. 4.) Fit the box with a strong leather handle, take a length of twin lighting flex with a

standard two-pin plug fitted to each end, borrow an ammeter, and all is ready for use, it being assumed that the house is wired with several convenient "points." If there is no point in the workshop, then the amateur alone is to blame.

Fig. 5 shows the device in use. D represents the rectifier-charger which is first connected to the accumulator, E, care being taken to see that the positive terminal goes to aluminium, and the negative terminal to lead. (See diagrams Figs. 1 and 2.) The terminals on the box, which are mounted on small pieces of ebonite, should, of course, be plainly marked. The sockets also should be marked "R" (resistance) and "M" (mains). The next step is to disconnect either one of the accumulator leads and insert the ammeter in series with same; connect the instrument temporarily, plug in the selected resistance (this is represented by a cluster of lamps, F, in the sketch), and finally connect the mains socket, M, to the point, X, in the house or workshop.

Carefully observe the ammeter; if this reads about 2 amperes all is O.K., but if the current passed is considerably lower, or higher, try another form of resistance—a radiator, G; an electric iron, H; or an electric cooking utensil. Should the cluster be particularly desired, try varying the number of lamps. These, of course, should all be connected in parallel. Experiment until the ammeter reads 1.75 to 2.5 amperes, leave the outfit until the reading is constant, then remove the ammeter and connect the accumulator direct, and always use the plug and point X as a master switch. It will be seen that the selected resistance unit is plugged into the socket, R, on the box, and that the twin flex-

ible lead between M—X takes its original place. I have assumed the average 4-volt accumulator rated at 20 to 30 actual ampere hours. In such a case 2 amperes may be usually taken as the normal charging rate, a slight variation either way making no material difference. For the most common supply of 200 volts four 250-watt carbon lamps in parallel will pass about 2.5 amperes.

Such lamps are of the "sausage" type, as used in "glowlamp" radiators. Similarly, for a supply of 220 volts four ordinary 120-watt carbon lamps will pass about 2 amperes. In any case the amateur must be prepared to carry out a few simple experiments,

### Question of Costs.

The current consumption of electric irons, wire-wound radiators, cooking utensils, etc., is usually marked on the apparatus, so that one may select and insert a suitable resistance unit without running the risk of damaging the accumulator when taking readings of the charging rate. Of course, it is always wise to be cautious, but at the same time do not be afraid to "pump in" a little extra current if you have confidence in the accumulator you possess.

## NEXT WEEK

Four 6d. Blue Prints FREE  
with every copy of "P.W."

**Order Your Copy Now!**

The advantage of the portable rectifier and charger described above should be obvious. Using, say, an electric radiator as the charging resistance during the daytime, or in the evening, the heat is utilised in the usual way, in any room wired with a point, so that if we count the cost of this heat, as domestic heat, we can totally ignore the cost of running same as a charging resistance. On the other hand, the cost may be marked against the resistance, in which case the room is heated free of charge, our shirts are ironed for nothing, or we get a free lighting cluster in the workshop, as the case may be.

Success will depend on the workmanship put into the job; the question of available domestic appliances having suitable resistance values must also be considered. The outfit is portable, therefore the various parts must not wobble about every time it is moved. After carefully fitting each cell into its compartment the ends of the hardwood strips should be screwed to the box. In Fig. 5 these strips and the connections to the sockets and terminals, have been omitted, in order to avoid confusion, and to clearly indicate the cell connections.

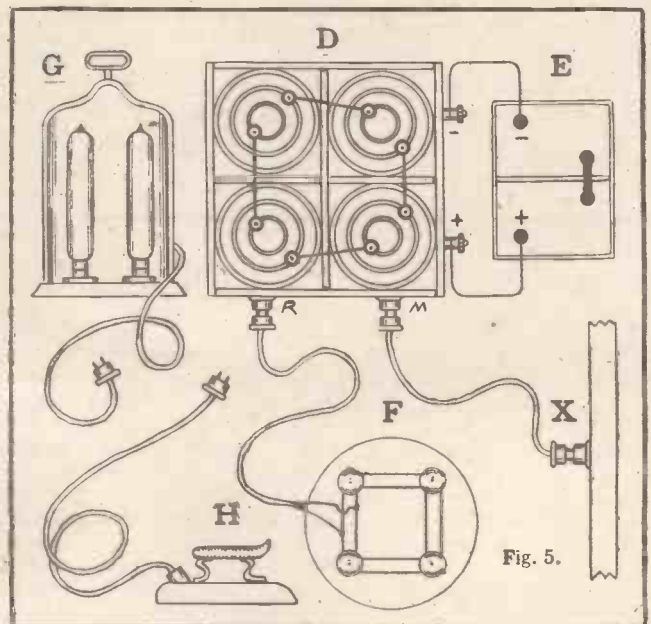
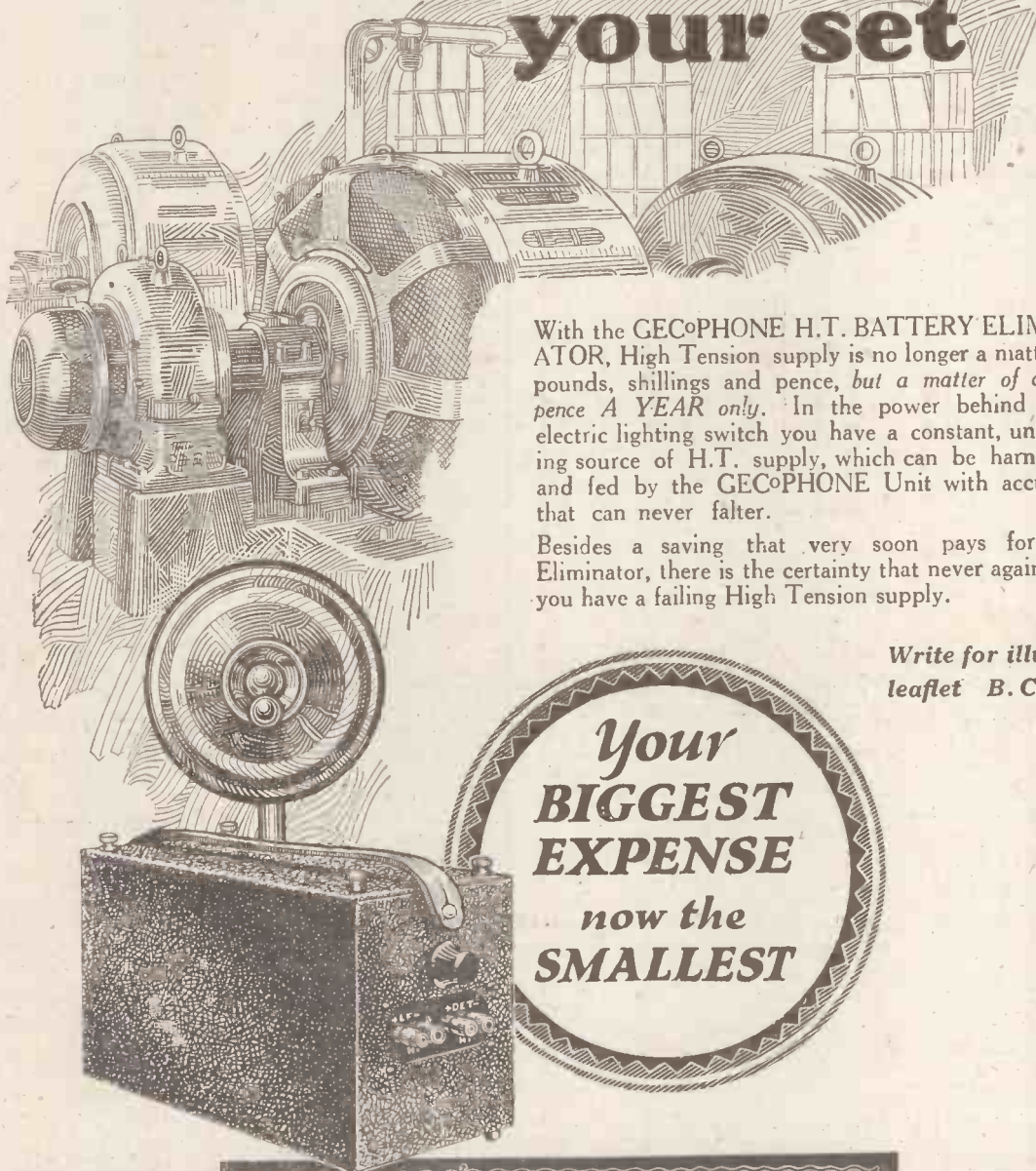

Fig. 5.

# Let the switch work your set



With the GECophone H.T. BATTERY ELIMINATOR, High Tension supply is no longer a matter of pounds, shillings and pence, *but a matter of a few pence A YEAR only.* In the power behind your electric lighting switch you have a constant, unvarying source of H.T. supply, which can be harnessed and fed by the GECophone Unit with accuracy that can never falter.

Besides a saving that very soon pays for the Eliminator, there is the certainty that never again will you have a failing High Tension supply.

Write for illustrated leaflet B.C. 4352.

*Your  
BIGGEST  
EXPENSE  
now the  
SMALLEST*

Models for  
A.C. Mains  
D.C. Mains

**GECOPHONE**  
(REGISTERED TRADE MARK)

Sold by all leading  
Wireless Dealers,  
Electrical Contractors  
and Stores.

**H.T. BATTERY ELIMINATORS**

*The G.E.C. - your guarantee*

# Let's Look the Facts in the Face.

We don't believe you or anyone else swallows half of what they read in any advertisements. S.T.'s say their valves give the best performance. Don't believe such a statement—without investigation, anyway. They'd probably say the same if they had a rotten valve. Is that libellous? Well, I'm only going by the fact that all valve manufacturers say their own valves are much better than others, and you know perfectly well that some valves are much worse than others. Well, to be fair to S.T.'s, let's see what responsible and independent people say about them in print or in letters.

## Is the S.T. a good valve ?

1. "Cannot fail to command admiration . . . an outstanding range. . . Through all three voltages, S.T.'s will operate with excellent results. . . We have no hesitation in recommending S.T. valves to our readers."—*Popular Wireless*.

2. "A remarkably good one."—*Wireless World*.

3. "We looked for something really good and were not disappointed, as every valve in the series came up to the maker's claims. The quality and volume are as near perfection as one could imagine."—*Manchester Evening Chronicle*.

4. "Find them very satisfactory indeed. . . We shall have no hesitation whatever in recommending these valves. It is very satisfactory to us to know that such excellent components are available."—*Ferranti, Ltd.*

5. "Really better than is indicated by the rating."—*Wireless Trader*.

6. "They are of very high efficiency."—*The Broadcaster and Wireless Retailer*.

7. "Amongst the best we have tested. They gave great volume and exceptional purity of tone. Particularly efficient, and bring in the distant stations with surprising volume."—*Amateur Wireless*.

8. "We have tried it with excellent results. Gives remarkably good reproduction on strong signals."—*P. W. Harris, in Wireless Constructor*.

## Are S.T. valves uniformly good ?

1. A published statutory declaration made by John Scott-Taggart, F.Inst.P., A.M.I.E.E., before a commissioner of oaths (19th November, 1926), states that each valve is tested electrically on three occasions and once on actual broadcasting. Two of the electrical tests are the same, but are carried out by different test engineers, and each includes at least nine electrical measurements.

2. Anyone can inspect the testing work in progress at 2, Melbourne Place, London, W.C.2, and check any valves in stock against the standards.

*Advt. of S.T., Ltd., Melbourne Place, Aldwych, London, W.C.2.*

3. The declaration states that every single valve has been thus tested, and after satisfying himself that it comes within the specification, John Scott-Taggart personally initials the certificate on every valve box.

4. "When using the H.F. valves in a superheterodyne it was noticed they were all perfectly matched, showing the extreme care the inspection department must have taken with the testing."—*H. E. Hassall, winner of the European Championship at the New York Exhibition*.

5. "As a further check, we visited S.T., Ltd., and ourselves picked specimens of the valves at random from stock. Again all were better than published characteristics."—*P. W. Harris, in Wireless Constructor*.

6. "They are, judging by the several samples of each type we have tested, absolutely consistent."—*Popular Wireless*.

## Are the advertised characteristics of S.T.'s correct ?

1. "Every S.T. has proved to be highly efficient, and to have characteristics as stated in advertisements. The whole range was checked and found to be as stated."—*Popular Wireless*.

2. "Every valve in the series came up to the maker's claims."—*Manchester Evening Chronicle*.

3. "The performance to be expected from the characteristic curves and technical data was obtained."—*Ferranti, Ltd.*

4. "The valve is really better than is indicated by the rating."—*Wireless Trader*.

5. "The individual specimens have shown themselves well up to published characteristics. In practically every case they have been distinctly superior."—*P. W. Harris, in Wireless Constructor*.

## Are S.T.'s really built like the pyramids, to last ?

1. The life of every S.T. is insured at Lloyd's. The S.T. is the only valve in 22 years, the life of which has been considered sufficiently certain to warrant the issue of such a policy. This is due to the torodium filament and Barguet vacuum.

2. No ravages of heat shorten the life of the S.T. filament—the coldest filament in the world. "No glow can be seen."—*Wireless World*.

3. If your S.T. valve should fail to give long and faithful service it will be instantly replaced by S.T., Ltd., without fuss or quibble. You can at any time send or bring your S.T. for a free "medical" report, if in any doubt.

4. A second statutory declaration has been made by John Scott-Taggart before a commissioner for oaths stating that the number of valves returned is negligible, and that there has not been a single case where replacement has been refused.

## Are S.T.'s robust and non-microphonic ?

1. "The valve is non-microphonic."—*Wireless Trader*.

2. "Herewith remains of an S.T. 41 valve. An accumulator was accidentally dropped on it whilst it was laid on the bench. The glass, you will notice, was smashed to fragments, but the filament is still intact."—*J. Grimshaw*.

3. "Sound and robust."—*Wireless Constructor*.

4. "None of the S.T. valves are microphonic, and all are robust in construction."—*Popular Wireless*.

## Are S.T.'s economical ?

1. "They are economical."—*Popular Wireless*.

2. "Their main features are economy in both filament and anode current, (the readings in each case being extremely low), a high standard of efficiency, and they are inexpensive."—*J. H. E. Black, Silver Cup winner at the New York International Show*.

3. "In spite of the very low filament consumption, the value of A.C. resistance for a given amplification factor is remarkably low."—*Wireless World*.

(This implies that less H.T. voltage is needed while maintaining high efficiency.)

## CHEAPER SIX-VOLT VALVES !

The S.T. Six-volt Valves are now sold at 14/- and 18/6 (except the super-power valve) and it is consequently as cheap to buy 6-volt as 2-volt valves.

The S.T.61 H.F. valve is now replaced by S.T.61 B. at 4/6 cheaper, although the two valves are similar in characteristics.

S.T.61 A. This is just out, and is a remarkably fine valve as a detector, when resistance capacity coupling is used, and also as the first stage of resistance capacity coupling. It is also an excellent H.F. valve and gives very high selectivity. The amplification factor is extraordinarily high and the valve is unique as regards being non-microphonic and having a long life.

Amplification Factor : 37.

Price 14/-.

S.T.61 B.—This valve has identical characteristics to the S.T.61, which is withdrawn as a type number.

Price 14/-.

## OTHER S.T. SIX-VOLT VALVES !

S.T.62. Power Valve for L.F. - 18/6

S.T.63. Super-Power "The valve with the golden voice" 22/6

## FOUR-VOLT VALVES.

S.T.41. H.F. Detector & 1st L.F. 14/-

S.T.42. Power - - - 18/6

S.T.43. Super-Power - - - 22/6

# BROADCAST NOTES.

By OUR BROADCASTING CORRESPONDENTS.

Attacks on the New B.B.C.—Running Commentaries—Community Singing—  
The Civil Service Dinner—An Interesting Talk—Empire Day Programme  
—Rex Palmer's Return to the Microphone—"Heterodyned History"—  
Bernardino Molinari—£1,000 for a Cornish Home.

## Attacks on the New B.B.C.

WITHIN a fortnight the B.B.C. programmes passed from their maximum of popularity to the lowest point they have ever occupied in public esteem. Curiously enough, a careful analysis of the actual programmes broadcast during the first two weeks of the New Year shows that they were appreciably lighter than the programmes broadcast during the last fortnight of the Old Year. Of course the real explanation is psychological.

People dislike the idea of Government controlled amusement; and as soon as the Broadcasting Service passed from the control of a company to that of a public corporation, the most innocuous programme items began to take on a sinister significance. In other words, the listening public were prepared to accept much more serious pabulum from the company than they will from the corporation.

If the corporation is ever to get a "good Press," or to get within reasonable distance of the popularity of the company it must baffle on the side of lightness and frivolity. The paradox is that an increased opportunity of public service can only be taken advantage of at the expense of goodwill. It is rumoured that the Governors are not altogether happy with their "curtain," and that they may be expected to try to retrieve the position by some striking appointment.

George Grossmith's name is mentioned as a new full-time entertainment expert for the B.B.C. This would meet with wide approval. Grossmith has already proved his mastery of the wireless medium, and his position in the theatre world is unassailable. But he would have to be offered a very big figure indeed to draw him away from the stage even temporarily. It is believed that a salary of the order of £6,000 tax free might attract him. This would not be disproportionate to his value to broadcasting. To the objection that it would not be in line with the other salaries paid at Savoy Hill, the answer is that these salaries are ridiculously low and should be revised upward at once.

## Running Commentaries.

It is too early yet to assess the degree in which these will attract the interest of listeners. The success of the first experiment at Twickenham is generally admitted. Both Captain Wakefield and Charles Lapworth did well. Perhaps the former was somewhat over-interested in the game himself; but the latter's graphic yet calm local colour descriptions were reminiscent of some of the best that has been done in America on this line.

It is to be hoped that Charles Lapworth is secured for the Broadcasting Service. His experience and idealism should prove

invaluable in the present difficult circumstances. The Oxford and Cambridge Boat Race broadcast should be of special general interest.

## Community Singing.

The "Daily Express" Community Singing movement has now spread to outside occasions. When the B.B.C. is doing running commentaries on sporting events where community singing has been organised excerpts of the singing will be broadcast as well.

## The Civil Service Dinner.

Now that the occasions of the broadcasting of public dinners are so curtailed,



Though deprived of their avuncular titles under the new B.B.C., these members of the Glasgow Station still remain the same at heart, as is shown by this photograph taken at a recent toy distribution in Glasgow.

special interest attaches to the prospective broadcast of some of the speeches at the Civil Service Dinner on February 11th. The Bench, Bar and politics will be liberally represented, and the flow of eloquence should be of variety and quality.

## An Interesting Talk.

A talk that is now in preparation promises to overcome the prejudice against most talks. This one is on the subject of the history of cabaret, and is to be given by Leoni, with musical background illustrations by Yvonne Arnaud. No date has been fixed as yet.

## Empire Day Programme.

The Empire Day movement is co-operating with the B.B.C. to organise a special programme for Empire Day, May 24th. It is hoped to secure some royal recognition of the occasion. An attempt will be made to reach the whole Empire with messages of greeting.

## Rex Palmer's Return to the Microphone.

It is rumoured that the Governors of the new B.B.C. have decided to invite Rex Palmer to return to the microphone. He has been engaged in administrative work for the past eighteen months, and has appeared before the "mike" very rarely. Listeners, however, have always missed Uncle Rex's voice from the programmes, and his forthcoming return will be generally welcomed. It is believed that this move represents a new policy with regard to announcers at Savoy Hill. Hitherto their status has been altogether too low in relation to the importance of their work. They are now to be given the distinction and consideration they deserve.

## "Heterodyned History."

Mr. L. du Garde Peach, of "Punch," is to give a talk with the above title from London at 7.45 on Saturday, February 12th. This will be a "scream" of fun from start to finish, especially the debate between Shakespeare and Bacon.

## Bernardino Molinari.

Bernardino Molinari, who will conduct the B.B.C. eighth national concert at the Albert Hall on February 17th, has been since 1912 in charge at the Augusto, Rome. His programme at the Albert Hall will

include Beethoven's Fifth Symphony in C Minor; "La Giara" by Casella; and Respighi's "The Pines of Rome," a symphonic poem, relayed with great success from the last Hallé season at Manchester. The Fascists are understood to be providing a special guard to protect Molinari from Communists during his stay in London.

## £1,000 for a Cornish Home.

The appeal on behalf of the St. Hilary Cornish Home for London children on the occasion of the Christmas broadcast of "Bethlehem" has brought in 3,000 letters, representing a total of just over £1,000 in cash for this highly deserving cause.

## A Recital Dropped.

It is understood that early in February the B.B.C. will drop the second evening educational musical recital. This decision was taken before the Press campaign broke out; but its application will be welcomed. Thus the 8.45 recital will give way to light music or idle banter.

# A CO-OPTIMISTIC VIEW ON BROADCASTING.

Dave Burnaby, the famous Compère of the "Co-Ops.," gives his opinions on Wireless in an exclusive interview with "Ariel."

I CAUGHT Dave Burnaby in his dressing-room at His Majesty's Theatre in the interval of the evening performance. Attired in bright yellow trousers, he was engaged in kneeling on a chair, his head bent attentively over something I could not see. Then the dressing-room was filled by a raucous voice that spoke about various things. Dave Burnaby shut off the loud speaker. If there is one thing in a B.B.C. programme that he hates it is talks.

"Do you know what is wrong with British broadcasting?" he asked me, handing over a glass of refreshment and a cigarette. "No? Well, I'll tell you. I think the greatest mistake is the policy of continuous broadcasting. I mean to say that just now it goes on without a stop from three-thirty onwards until almost midnight.

"There should be intervals in a broadcasting programme. There are so many thousands of people who would like to try and get various other stations at certain hours of the day, and in the majority of cases their sets do not allow them to cut out the London station. I suggest an interval round about six o'clock. Say six to seven. I am sure it would be a very welcome innovation."

## A "DX" Enthusiast.

Mr. Burnaby told me that his enthusiasm in wireless does not lie in listening to any wireless programme, but more in the scientific possibilities of the great invention, its progress, and the greatest thrill of all, picking out all the different stations.

"I have a nine-valve super-het. at my home," he went on, "and my enjoyment lies in the fact that I can go all over Europe with it. I never listen to any station for more than a minute or two, and then just to ascertain what station I've got, and instantly I'm off to another station. In this way I never get tired."

Mr. Burnaby, however, does enjoy the London station programmes, or rather certain parts of it. The item he likes best of all is the Variety Programme.

"I must say that the broadcasts in the variety hour are sometimes full of originality and include really good entertainment. For instance, a turn I thoroughly enjoy is Clapham and Dwyer, the cross-talk comedians. Their performance from beginning to end is a joy. Then there are turns like The Revellers, the famous singing quintette from America.

"But probably the turn I enjoy the most is The Children's Hour. Instantly my two children hear this come on, they say:

'Oh, daddy, please shut it off!' and of course, there is nothing doing, because I like it immensely.

"What amuses me tremendously is Uncle Alf playing the piano. What tickles me hugely is the fact that I know it's an automatic piano; but not a word."

## Continental Stations Preferred.

Mr. Dave Burnaby prefers, however, the Birmingham Children's Hour to the London programme, as they often broadcast coon songs, and the famous Co-Optimist has a great fancy for them.

"I prefer every time jazz to symphonic music. And it is my belief that the great radio audience is the same. I personally could not listen for two-minutes to a concert of pure symphony; I think they are the most boring items in any broadcasting programme.

"What I do enjoy, however, in good music are solos of any kind. I like to hear

programme provides very excellent entertainment."

On the other hand, Mr. Burnaby prefers Continental programmes to those relayed from the English stations. One station in particular is a great favourite of his. That is Rome. The other evening he listened to almost a complete opera, and it was so very fine he told me afterwards that it must have been relayed from The Scala, Milan. As I later ascertained, he was correct.

I asked Mr. Burnaby if he thought that broadcasting as an advertising medium was an aid to the theatre.

"Broadcasting can make or mar a play," was his reply. "If excerpts of a bad play are broadcast it will do it any amount of harm, but if the excerpts are from a good play the result will be excellent. I know of countless examples of broadcasts of good plays having increased the business a hundred per cent, and I also know of one or two cases where the show has been inferior, and the broadcast has absolutely killed it."

## Cut Out the Talks.

Great care should be taken as to what portion of the show should be broadcast, Mr. Burnaby says, otherwise the result might be disastrous. In some plays there are parts which are quite unsuitable for wireless, and as the whole success of the broadcast depends on the piece that the listener hears, it can be imagined that here again the task is not an easy one.

Other suggestions for the perfecting of B.B.C. programmes, according to the views of Mr. Dave Burnaby, are that the talks should be considerably curtailed.

"Broadcasting should be a very bright affair, and the majority of talks are not. Again I think that the news items are of no use whatever. They are full of banality, and quite out of place.

"The average broadcasting programme is full of originality, and constitutes quite an amiable entertainment," he told me in conclusion, "but it should be drawn up to be a happier, free-er, brighter nature. Like jazz it should be full of go all the way through.

"Brighter Broadcasting Programmes should be the motto at Savoy Hill. During the last months I have noticed the programmes improve, and I am certain they will go on doing so until the time when even I will be satisfied."

And with a cheery smile he left me.

A minute later I heard a huge roar of laughter. Dave Burnaby was in front of the footlights!



Dave Burnaby adjusting a wireless receiving set in his dressing-room at His Majesty's Theatre.

a good piano solo, a violin solo, or a cornet solo. But the complete orchestra leaves me cold.

"I will say, however, that I think the B.B.C. are performing their arduous task of composing good programmes wonderfully well. Items that suit each and every listener are almost impossible to find, and yet on the whole a broadcasting

## A 2/- GIFT FREE TO ALL READERS

Four 6d. Blue Prints will be included in every copy of "Popular Wireless," dated February 5th, and on sale next Thursday, February 3rd. These will be new Blue Prints (full details are given elsewhere in this issue) and will form an addition to the present range. There will be no increase in the price of "Popular Wireless"—the Blue Prints will be absolutely free gifts.

ORDER YOUR COPY OF NEXT WEEK'S "POPULAR WIRELESS" NOW.



# The Programme Collector

IN spite of recent advances in the design of multi-valve receivers, loud-speaker reception of distant stations is still an expensive pastime. The initial outlay and the cost of maintenance are stumbling blocks to many. This delays the full measure of popularity that such receivers undoubtedly deserve.

Chiefly because of the expense of loud-speaker reception, there is a wide demand for simple and inexpensive sets capable of good 'phone reception from many British and European stations. The would-be possessor of such a receiver, in the desire to roam the ether at his leisure, looks for a set that is easy to tune, sufficiently selective to cut out the local station, and both inexpensive and economical in upkeep.

### LIST OF COMPONENTS.

- 2 ·0005 variable condensers (Polar cam vernier)
- 1 ·0003 variable condenser (Ormond square law)
- 1 ·0002 fixed condenser (Dubilier)
- 3 ·0003 fixed condenser
- 1 ·001 fixed condenser
- 1 2 mfd. condenser
- 2 H.F. chokes of any reliable make
- 2 Valve holders
- 1 Rheostat
- 1 Single coil holder
- 1 Ebonite former (6 x 3 in.) (Ebonart)
- 1 2 meg. leak (Dubilier)
- 5 terminals, 8 sockets, 6 plugs (Ealex)
- 1 Three-ply panel
- 1 Baseboard
- 1 Coil (Gambrell B1)
- Perforated zinc, 15 x 5 in.
- Tinned wire, 18 S.W.G.
- Sundries (wire, screws, etc.)

I had in mind these broad requirements when designing this two-valve receiver, the chief considerations being a reasonable first cost and full sensitivity with ease of control. The cost of the "Programme Collector," without accessories, is under five pounds, while maintenance charges are very small.

### Stable Operation.

The receiver is perfectly stable over the whole tuning range of approximately 200 to 600 metres. The incorporation in the H.F. stage of a special device, of which I shall have more to say later, maintains a high degree of sensitivity over the whole tuning range on one setting of the reaction condenser. Actually, when in operation, the receiver reminds one of a neutrodyned H.F. stage. All tuning can be carried out on two condensers, once the reaction control has been correctly adjusted.

Given a moderately good aerial system, this receiver will, after dark, pick up the

An efficient two-valver specially designed, constructed and described for "Popular Wireless."

By J. ENGLISH.

principal British and foreign stations. On several evenings recently I have heard on each occasion between thirty-five and forty different transmissions, more than fifty per cent. of these being loud enough to listen to for a lengthy period. Barring fading and atmospheric, each item could be clearly followed. All this did not involve any gymnastics in tuning, just the manipulation of two dials. On the one occasion when I troubled to burn the midnight oil in listening for American stations, WBZ was received quite well. Fading was apparent, but for an hour or so this station was at no time inaudible.

As to the circuit used in this receiver, we have to bear in mind the fact that satisfactory long-distance reception is only possible when at least one stage of H.F. amplification is used. Even one stage ensures a good measure of selectivity, besides making it easier to pick up those weaker stations.

As you will see from the circuit diagram, a single H.F. stage precedes the detector valve, with capacity control of reaction. Provision is made in the aerial circuit for the inclusion of a series condenser,  $C_3$ , useful if the aerial is a large one. The aerial inductance,  $L_1$ , is a tapped coil, useful for obtaining greater selectivity.

This coil, as you will see from the photographs of the rear of the set, is a plug-in one mounted behind the first condenser. It should be noted that there is no necessity to use either an ultra-low loss coil or a special "straightline" condenser in the aerial circuit. The damping and capacity of the aerial system nullify the advantages of such components.

The H.F. valve is choke-coupled to the detector, the parallel feed system being used. Notice that the grid coil  $L_2$  of the detector valve is tapped at three points.



The panel of the "Programme Collector" presents a very neat and business-like appearance.

In the photographs of the rear of the receiver, this coil is seen in the centre of the baseboard, with  $C_2$  behind it. The lower the H.F. tap—that is, the smaller the number of turns in the H.F. input circuit—the greater the selectivity of the receiver. The higher the tap, the greater the strength of signals with a corresponding sacrifice in selectivity. The three tapping points provided allow for variation in selectivity and volume according to the local conditions.

At this juncture I would once more draw your attention to the special H.F. coupling device mentioned above. This consists of

(Continued on next page.)

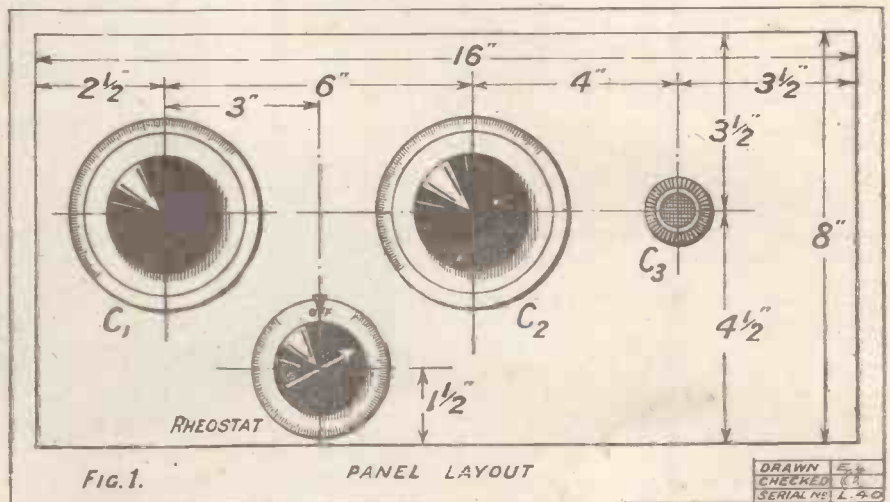

Fig. 1.

PANEL LAYOUT

DRAWN  
CHECKED  
SERIAL NO. L. 50

## THE PROGRAMME COLLECTOR.

(Continued from previous page.)

a fixed condenser ( $C_4$ , .0003 mfd.) connected across the first ten turns of the low-loss coil nearest the filament end. While not affecting appreciably the tuning range of  $C_2$ , this device secures a more even H.F. amplification over the band of frequencies covered by the tuning system.

Coming now to the actual construction of the receiver, there is nothing that is not quite straightforward. The components should first of all be assembled, those used in the original set being listed herein. If you want to use other components, choose those having as far as possible identical characteristics. The resistance of the rheostat winding should be chosen according to the filament rating of the valves to be used.

The three-ply panel, after drilling in accordance with the relative diagram, may be stained, polished, or otherwise treated as you desire. A satisfactory plan is to

make good contact with the shield, and that no part of the fixed vane portion comes within one-eighth of an inch of the perforated zinc. The latter should be fixed about one inch above the rear panel portion of the rheostat. If a larger component is used here, it may be necessary to cut away part of the shield so that it just clears the rheostat.

All components except the low-loss coil can now be mounted, and it is advisable to follow as closely as possible the original layout. The spacing of the holes in the terminal strip at the back of the panel is indicated in the wiring diagram.

### The Low-loss Coil.

There is only one component requiring special construction and that is the low-loss coil. This is really easier to wind than the conventional cylindrical type of coil, and the actual operations are much easier than they sound. A special low-loss coil is incorporated, not to give you trouble in making it up, but simply because a low-loss inductance can be utilised here to the fullest advantage in obtaining high selectivity and big signals. You may, if you wish, substitute a screened coil having similar windings, but in my opinion the extra expense is hardly justified.

The foundation of this coil is the ribbed ebonite former. The full six inches of this are not really necessary, but if it is used as purchased, it stands up well on the base-board. Actually the coil windings are all the better for being "up in the air." Four  $\frac{1}{8}$ -in. holes are drilled in one of the ribs, spaced as shown in the accompanying diagram. In the receiver illustrated, each hole is drilled in a different rib, but there is no need to do this. A 6 B.A. bolt and nut in each hole holds in position a soldering tag to which are connected later the ends of the windings.

The top winding for the reaction coil ( $L_3$ ) consists of twenty turns of 30 D.C.C. Beneath this, at a distance of a good quarter of an inch, is the grid coil ( $L_2$ ), consisting of fifty-five turns of 24 D.C.C. wound in the same direction as the top coil. When you have wound on the first 25 turns, starting at the end nearest the top winding, twist a

(Continued on page 1319.)

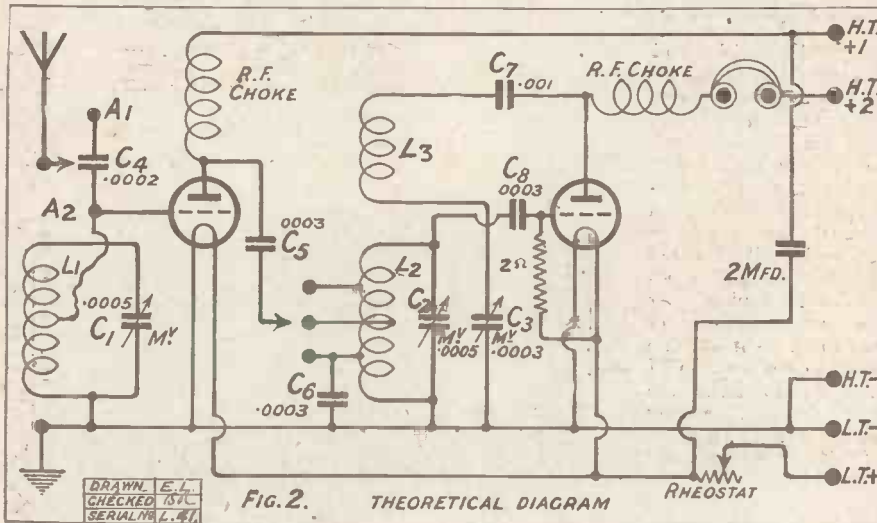

What is more important, the setting of the reaction condenser is maintained practically constant, which makes searching much easier.

This quasi-fixed reaction is a decided advantage, as in a usual three-dial receiver tuning is not an easy matter if all three dials have to be varied simultaneously. In the case of this receiver all the tuning can be done chiefly on the condensers  $C_1$  and  $C_2$ . Having one hand for each, you will find the operation of tuning quite a simple matter.

### Wooden Panel Used.

The design of the receiver follows the usual practice, but there is one point of special interest. This is the shielding of the three tuning condensers, which completely eliminates all hand-capacity effects. The advantages of this will be appreciated by those who have attempted long-distance work with a sensitive receiver. As you will see from the circuit diagram, one side of each of the three variable condensers is at earth potential, so that all the moving vanes can be connected to a sheet of metal. This effectively shields the condensers from hand-capacity effects. We could actually use a metal panel, but as this is not a material easily available, I have used a wooden panel, with a capacity screen of perforated zinc mounted behind it. Since there is no need for the panel to have any insulating properties, an ebonite panel is an unnecessary luxury. In modern receivers of this description ebonite panels are an anachronism. The wooden panel of three-ply, as used in this receiver, is just as satisfactory as an ebonite one, while its cost is but a few pence.

sandpaper down and give two coats of some dark spirit stain.

The capacity shield secured between the angle brackets and the panel is a piece of perforated zinc measuring 15 in. by 5 in. This material is more familiar to us in meat safes than wireless sets! However, it answers its purpose excellently, and you will find that the necessary three holes can easily be punched out with a small chisel or a screwdriver. These holes should be just large enough to clear the fixing bushes of the condensers. When mounting these, see that the fixing bushes (moving vanes)

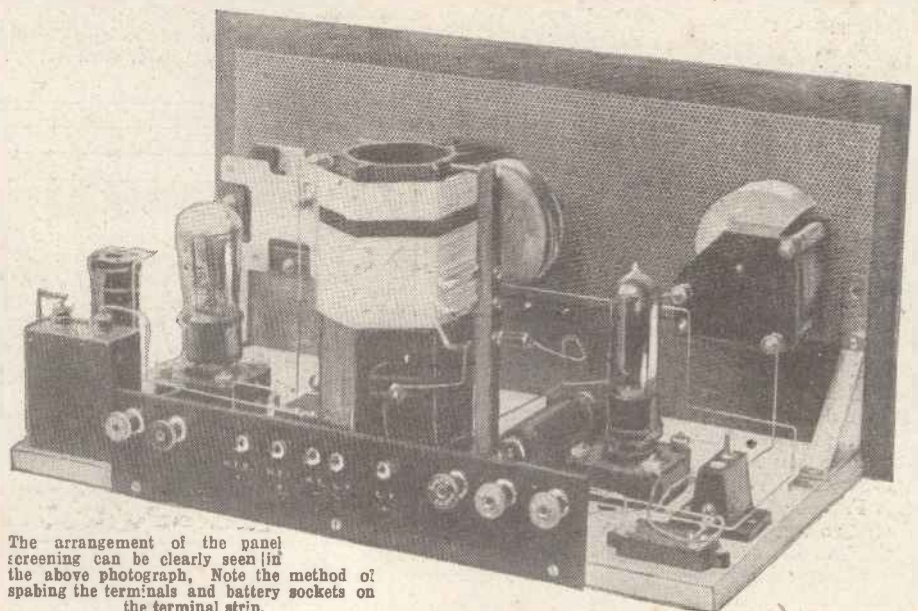

The arrangement of the panel screening can be clearly seen in the above photograph. Note the method of spacing the terminals and battery sockets on the terminal strip.

# WE COULD HAVE SOLD THIS TRANSFORMER FOR 23/6



but decided we would give radio users everywhere this wonderful new transformer at only one-third of that price in order to gain supremacy among transformer makers of the world. The price of good radio transformers has been high—LISSEN only has made it low.

When users who have tried it write and say that it is far better in performance than the expensive transformers which have broken down in their sets, and which the new LISSEN has replaced—and when the trade use it largely in their own built-up sets because they prefer it to any other transformer in their stock—when tens of thousands of users acclaim it as the greatest amplifying transformer of their experience—when LISSEN knows it to be good—when LISSEN has withdrawn in its favour all the previous expensive LISSEN transformers which have been on the market and largely sold for several years past—that surely is striking proof of supremacy in a transformer and a gratifying justification of the LISSEN policy of huge production and direct-to-dealer distribution which cuts out all wholesale profits.

AND IT IS A GREAT CHOKE AS WELL AS A GREAT TRANSFORMER : by the simple act of connecting two of its four terminals together we have found it to be a great choke. Your dealer will tell you how easily it can be used as a Choke.

Obtainable at every good dealer's, or direct from factory if any difficulty, post free, but please mention dealer's name and address.

**8/6** GUARANTEED FOR 12 MONTHS  
 TURNS RATIO 3 to 1. RESISTANCE RATIO 4 to 1.  
 Use it for 1, 2 or 3 stages L.F. It is suitable for every circuit and every valve you will want to use.

TEST IT FOR 7 DAYS—then take it back to your dealer's or send it back to us if you are not satisfied.

TO THE TRADE: Orders for all LISSEN products must now be sent direct to factory, and not to usual wholesale dealer.

"GIVE US A BETTER TRANSFORMER"—and LISSEN has responded with a lower price, too.

## USE LISSEN FIXED CONDENSERS, TOO (Mica and Mansbridge Types).

### Lissen Mica Type Condensers

Small energy-conserving condensers—note the new case which enables the condenser to be used upright or flat. At present the new case is available only in the most used capacities, but will quickly become a LISSEN standard.



Capacities—  
 .001 to .001 1/- each (much reduced).  
 .002 to .006 1/6 each (much reduced).  
 Accurate to 5%—they never leak—they never vary.

### Lissen Mansbridge Type Condensers

To a fine LISSEN quality condenser is added the specially moulded case—the condenser cannot short circuit on to its case. The new LISSEN case protects you if the condenser is used in any circuit connected straight on to the electric light mains. And due to our new policy of direct-to-dealer distribution this LISSEN Condenser costs no more than the ordinary type.



.01 to .09	2/4
.1	2/6
.2	2/8
.25	3/-
.5	3/4
1.0	3/10
2.0	4/8

### LISSEN FIXED GRID LEAKS

A case of these was left on our factory roof during the summer of 1925, soaked in rain, baked by sun, and the resistance value of these leaks never altered. All capacities, previously 1/8. Now 1/- each.



Improve every circuit by using LISSEN parts wherever you can—save money, too—for now you get keen prices as well as fine quality.

LISSEN LIMITED,  
 8-16, FRIARS LANE,  
 RICHMOND, SURREY.

(Managing Director - Thos. N. Cole.)

# The Duvarileak



## Perfection in Variable Grid Leaks!

Fit your receiver with a Duvarileak Variable Grid Leak.

It enables you to increase the selectivity and the purity of your reception by applying to the grid the exact resistance demanded by your particular detector valve. The Duvarileak eliminates all the failings often associated with variable grid leaks in the past.

The resistance material, which it has taken us years to evolve, has a hard surface. It retains its resistance value indefinitely, and the rolling ball contact (see inset) reduces wear to a negligible quantity. The result is that the Duvarileak *remains* variable and gives a constant value for any given setting of the dial. It carries the Dubilier Guarantee to give complete satisfaction, and is obtainable of all Dealers, Price 7/6. The *Duivolcon* for Loud Speaker volume control is the same in appearance and price as the Duvarileak. Suitable for use with any Loud Speaker.

May we send you our new Catalogue in which these and all other Dubilier Products are fully described?

Price 7/6 each



ADVT. OF THE DUBILIER CONDENSER CO. (1925) LTD.  
DUCON WORKS, VICTORIA ROAD, N. ACTON, W.3  
TELEPHONE: CHISWICK 2241-2'3. M.C. 249

National Physical Laboratory figures *prove* the LEWCOS Coil best

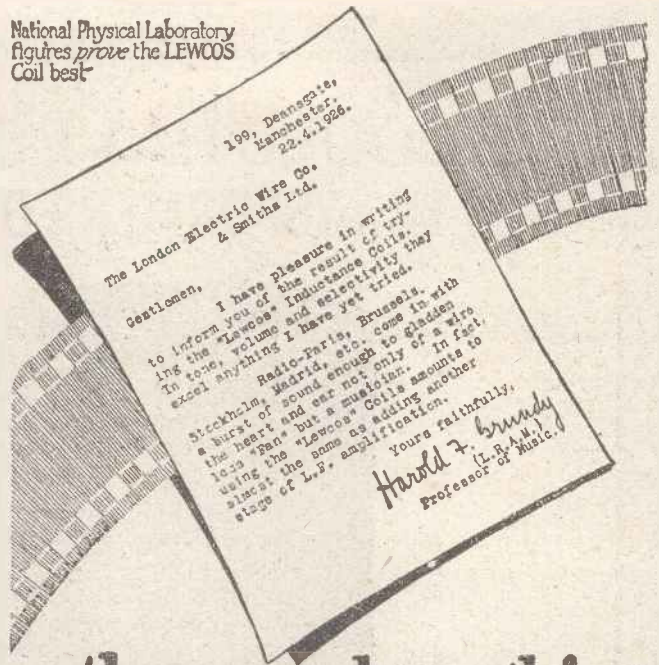

## ...they excel anything I have yet tried...

You, too, will be delighted at the increase in selectivity and signal strength when you plug-in a LEWCOS Coil.

Independent National Physical Laboratory tests prove the superiority of the LEWCOS Coil—the most efficient commercial coil produced. Strongly constructed. Neat appearance.

Try a LEWCOS Coil in your set—it makes all the difference! Your dealer stocks or can obtain LEWCOS Coils. Descriptive leaflet gladly sent on request.

No.	25	35	40	50	60	75	100	150	200	250	300
Reduced Prices	4/-	4/-	4/-	4/6	4/9	4/9	5/9	6/3	6/9	7/-	7/6

The LONDON ELECTRIC WIRE COMPANY & SMITHS, LTD.  
Playhouse Yard, Golden Lane, London, E.C.1



All enquiries for LEWCOS RADIO PRODUCTS should be made to your local dealer.

# LEWCOS Inductance Coil

# THE PROGRAMME COLLECTOR.

(Continued from page 1316.)

loop about  $1\frac{1}{2}$  inches long, continue winding to the 35th turn and twist another loop. Repeat the operation at the 45th turn and then wind on the remaining ten turns. The beginning and end wires of each winding are bared and twisted round the nearest soldering tag, to which they are eventually to be soldered.

The arrangement for tapping the H.F. input on to the coil consists of a narrow

strip of  $\frac{1}{4}$ -in. ebonite carrying three sockets, one for each tapping on the coil. The H.F. lead from the coupling condenser ( $C_5$ ) is a short length of flex terminating in a wander plug so that it can be plugged into any of these three sockets. The ebonite strip is secured to the former after winding by means of two  $1\frac{1}{2}$ -in. lengths of 6 B.A. screwed rod bolted to both coil and strip at top and bottom. Three  $\frac{1}{4}$ -in. holes spaced half an inch are drilled in this strip for the sockets. Under the lock nut of each socket is secured a soldering tag to which the respective tapping loop is soldered. The general construction will be apparent from the photograph of the receiver.

You will doubtless find that it makes things easier if you wire up as much of the

set as possible before mounting the low-loss coil. This can be secured afterwards to the baseboard by one or two brackets. The actual wiring up is quite simple.

## The Battery Plug.

Before putting the receiver into operation there is one small accessory to be made up. This is the battery plug, a useful feature saving much bother of fiddling about with terminals at the back of the cabinet when the set is in use. A piece of  $\frac{1}{4}$ -in. ebonite measuring 4 in. by  $\frac{1}{2}$  in. has drilled in it five holes spaced exactly the same as the holes for the five sockets on the terminal strip.

A suitable length of flex is fastened to the wander plug in each hole. When inserted, (Continued on next page.)

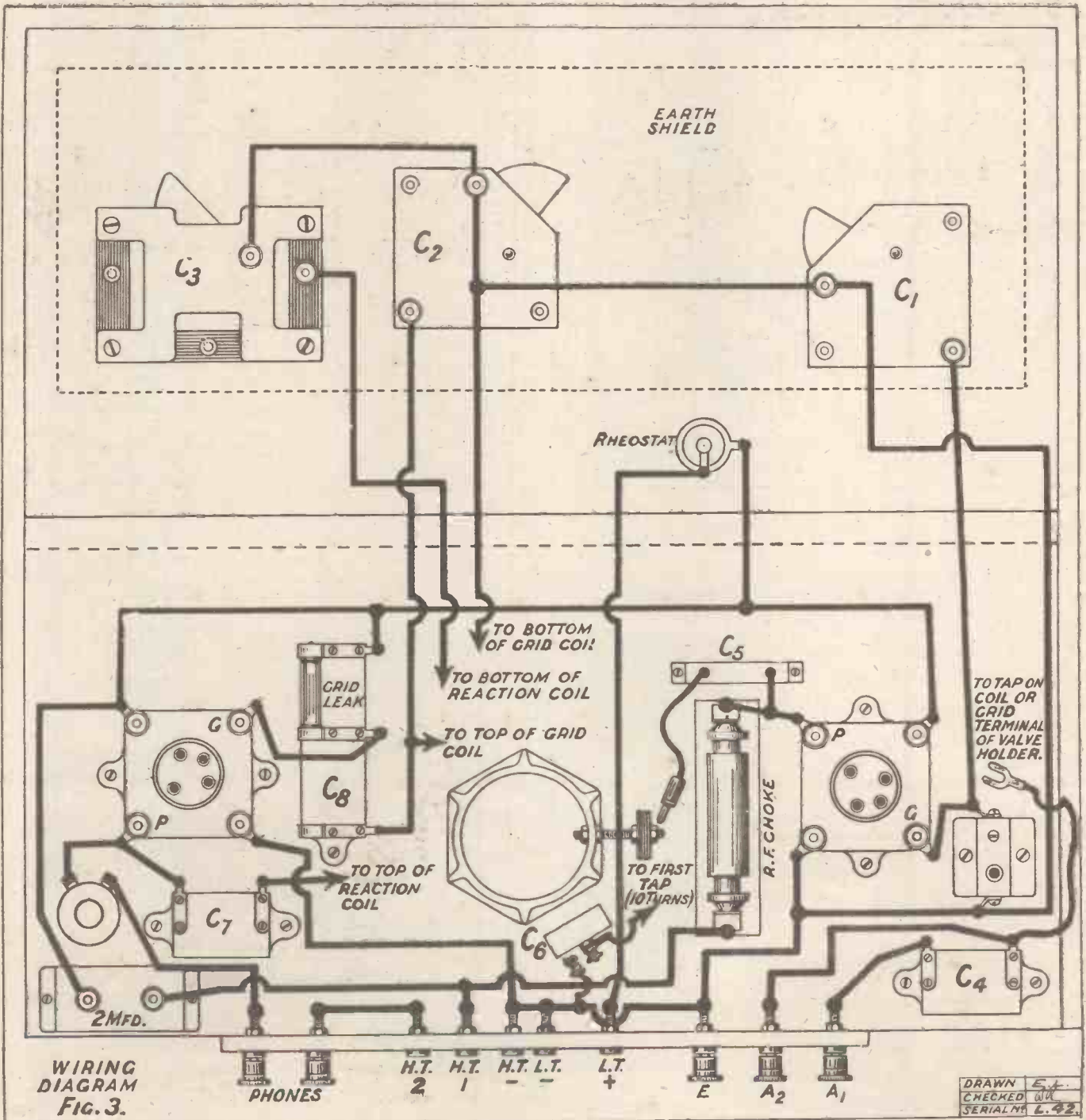

WIRING DIAGRAM FIG. 3.

DRAWN S.J.  
CHECKED W.W.  
SERIALS L. 42.

## THE PROGRAMME COLLECTOR.

(Continued from previous page.)

this battery plug automatically connects up both anode and filament batteries, while the irregular spacing of the holes prevents incorrect insertion.

After a further brief examination of the wiring to see that all is in order, the receiver

adjusted until the receiver is near the point of oscillation, both  $C_1$  and  $C_2$  being in tune. Signals from other stations should now be picked up when slowly rotating the first two dials, maintaining both circuits as nearly as possible in tune. Tuning with  $C_2$  is sharper than with  $C_1$ , and the latter should be adjusted last of all once a station is picked up with  $C_2$ . Full sensitivity is only obtained with both circuits in tune, and if too much reaction is used the set will oscillate when they do come into resonance. There is no need to work the set right on the point of oscillation. With the receiver connected as above a number of stations should be received simply by varying together the settings of the two larger dials.

Suitable valves for both H.F. and detector positions are those having an impedance of between 20,000 and 30,000 ohms in either 2-, 4- or 6-volt ranges. A high impedance, high-magnification valve such as the S.P.18 Blue Spot can be used with advantage in the first stage. General-purpose valves in both positions also give very good results. The first valve requires from 60 to 80 anode volts, while the anode voltage on the second valve need not exceed 45. Lower voltages here will often give smoother control of reaction. I would

recommend a 5 meg. leak for the reception of weak signals.

There is no reason why any constructor of this receiver should not duplicate the results that I have obtained under similar

conditions, and he will then be in the possession of a very useful long-distance receiver. At any future time a one or two stage L.F. amplifier for loud-speaker work can be added quite easily.

### POINT-TO-POINT CONNECTIONS.

L.T.+ to one side of rheostat.

Other side of rheostat to one filament socket on each valve holder, to one side of grid leak, and to one side of 2 mfd. condenser.

Other filament sockets of valve holders joined together and connected to H.T.— L.T.—, to E, to one side of aerial coil, to one side of  $C_1$ ,  $C_2$  and  $C_3$  (moving vanes), and to bottom of grid coil, and to one side of  $C_6$ .

A2 to one side of  $C_4$  and to flexible lead. A1 to remaining side of  $C_4$ .

Remaining side of aerial coil holder to grid of 1st valve and remaining side of  $C_1$ . Plate of 1st valve to one side of  $C_5$  and to one side of 1st H.F. choke.

Other side of  $C_5$  to flexible lead and plug.

Other side of  $C_8$  to 1st tap on grid coil. Remaining side of 1st H.F. choke to H.T.+1, and remaining side of 2 mfd. condenser.

Fixed vanes of  $C_2$  to top of grid coil and one side of  $C_8$ .

Other side of  $C_8$  to remaining side of grid leak and grid of 2nd valve.

Fixed vanes of  $C_3$  to bottom of reaction coil.

Top of reaction coil to one side of  $C_7$ .

Other side of  $C_7$  to plate of 2nd valve and one side of 2nd H.F. choke.

Other side of 2nd H.F. choke to one 'phone terminal.

Other 'phone terminal to H.T.+2.

This completes the wiring.

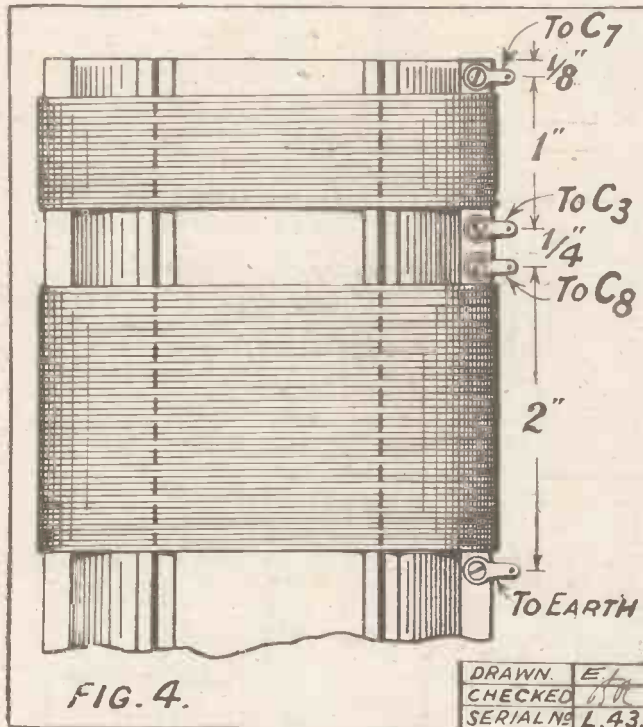

FIG. 4.

can be set up for testing. First insert the battery plug, connect up and make the usual tests for correctness of filament and H.T. wiring. Then insert the valves and a suitable plug-in coil for the aerial circuit. The correct size of this coil will vary according to the dimensions of the aerial system. A Gambrell B1, B, or similar coils, centre tapped, should be suitable in the majority of cases.

### Operating the Receiver.

For full selectivity and also if the aerial is large, connect the lead-in to A1 and the flex lead from the condenser ( $C_4$ ) to the terminal on the coil. Louder signals with a sacrifice in selectivity can be obtained by connecting the aerial to A2 and/or the flex lead to the grid terminal of the first valve holder. After a little experimenting with these connections you will soon find the combination giving best results.

After switching on, place the H.F. wander-plug in the top socket on the coil former, set the reaction condenser at zero, and adjust the other two condensers until the local station is heard. Then place the H.F. plug in the lowest socket and retune. The volume of signals will now be somewhat less, and, with moderate reaction, tuning much sharper, so that the local station is easily lost after turning  $C_1$  and  $C_2$  through a few degrees.

The reaction condenser can now be

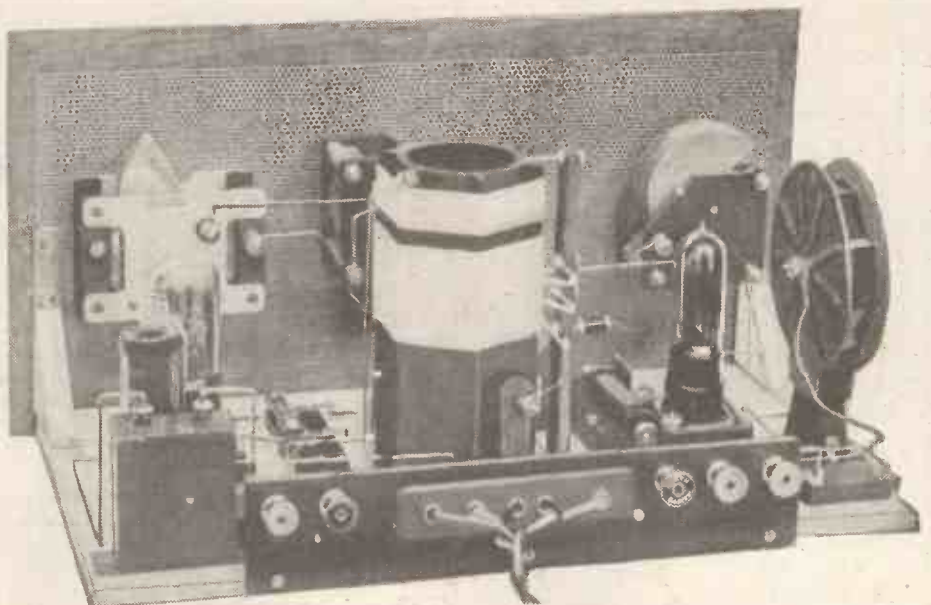

The "Programme Collector" with coils and valves in position ready for test. Note the centre-tapped aerial coil.

No replace a whole set of coils



fit

PRICE:  
**13/6**

Ask your Dealer, or write to-day for List "F.3" of "Blue-Spot" Specialities.

## the "Blue-Spot" MULTIDYNE ALL-WAVE COIL



A UNIVERSAL coil in the truest sense of the word, the "Blue-Spot" Multidyne Coil covers all wavelengths from 160 to 4,300 metres. This wonderful new coil replaces a whole set of ordinary coils, and is equally suitable for use on either crystal or valve sets as a primary, secondary or reaction coil. No other coil can separate Stations so sharply as does the Multidyne All-wave Coil. It can be used in every circuit and is perfectly simple to operate. As a reaction coil it offers quite unique advantages; the difficulty so often experienced in obtaining the correct ratios between reaction coils being entirely eliminated. The carrier wave is kept free from distortion through adjustments easily effected by means of a single lever. Why have the trouble of obsolete sets of coils? Get a "Blue-Spot" Multidyne All-wave Coil at once.

**SUB-AGENTS:**  
For the Midland Counties:  
Foster-Boynston Co., Ltd.,  
70, Lombard Street,  
Birmingham.

For South Wales:—  
Watson Bros.,  
48, Dock Street,  
Newport.

For Lancashire and  
Cheshire:—  
F. A. Hughes & Co., Ltd.,  
6, Booth Street East,  
Chorlton-on-Medlock,  
Manchester.

Wholesale only:—

# F. A. HUGHES & CO., LIMITED

Head Offices: 204-6, GREAT PORTLAND STREET, LONDON, W.1



Telephones:  
Museum 8630.

Telegrams:  
"Distancing, Wesda.  
London."

# IGRANIC RADIO DEVICES

## put LIFE into a circuit

Life—in the zest and virility they give to results—life—in the extraordinary length of time they continue to give such complete satisfaction.



### IGRANIC TAPPED H. F. TRANSFORMERS

are wound with the same honeycomb formation which makes Igranic coils so wonderfully efficient. This method of winding and the air spacing between the two coils results in the maximum transfer of energy and a very great selectivity.

One winding is centre tapped and can be used as primary or secondary.

Four sizes. - Prices from 6/- each.

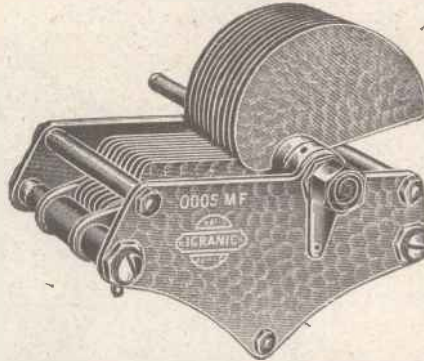

For the efficient tuning of all circuits use **IGRANIC LOW LOSS SQUARE LAW VARIABLE CONDENSERS**. Made as single and dual types. Prices from 17/- each. **IGRANIC-PACENT TRIPLE GANG CONDENSER £3-10-0**

WRITE FOR THE NEW  
IGRANIC CATALOGUE LIST No. R.45



### IGRANIC TRIPLE HONEYCOMB COILS

Igranic Triple Honeycomb Coils are wound in three sections, each separated by a small air space. All the original advantages which made Igranic Honeycomb Coils famous are retained, but the new method of winding results in the coils having much lower self-capacity and H. F. resistance. Igranic Triple Honeycomb Coils are made in 17 sizes covering a wavelength range of approximately 100 to 25,000 metres. From 2/9 each.

## IGRANIC ELECTRIC CO. LTD

149, QUEEN VICTORIA STREET, LONDON.

Works: Elstow Road, Bedford.

# FRELAT

## D.E. VALVES

### Why Pay More?

YOU cannot buy a better valve than Frelat, even though the others cost twice as much. The proof lies with you! Send to-day for a trial valve. The D.E. type K, Detector or Amplifier, costs only 4/11, the new 2-volt power valve 8/6, and they give the best in Radio in tonal purity and volume.

D E  
TYPE K  
2-volt 3amp

4/11

2-Volt  
Power  
Valve

8/6

CONTINENTAL RADIO IMPORT CO. LTD.  
8, Spital Square, Bishopsgate, London, E.C.1

For C.O.D.  
terms  
add 4d.—  
costage  
free.



If your  
dealer  
cannot  
supply  
send  
direct.

# WHY IS TROLITE

Known as the Radio Panel de Luxe?

## BECAUSE

1. Its Electrical Properties are excellent.
2. Highly polished but no surface leakage.
3. Wavy and cube designs do not show scratches or finger marks.
4. Does not warp or discolour.
5. Competitive in price.

## THEREFORE

Combine Efficiency and Elegance with Economy.

### PRICES

Polished Black

3/8" — 5d.

1/4" — 7d.

Mahogany

Walnut

Cubic Wavy

3/8" — 7d.

1/4" — 1 1/2d.

per square inch



Illustration Wavy design.

5 Finishes:

Polished Black

Polished Mahogany

Polished Walnut

Wavy Etched Black

Cube Design Etched

Standard Panels stocked by leading dealers.

F. A. HUGHES & CO., LIMITED,  
204-6, GT. PORTLAND STREET, LONDON, W.1

Telephone . . . . . Museum 3630-1-2.  
Telegrams—"Distancing, Wesdo, London."



THE "POPULAR WIRELESS" VALVE GUIDE—continued.

4-VOLT DETECTOR VALVES—continued.

Make of Valve	Type	Fil. Volts	Fil. Amp.	Anode Volts	Grid Bias	Impedance	Amp. Fac.	Price	Remarks	Make of Valve	Type	Fil. Volts	Fil. Amp.	Anode Volts	Grid Bias	Impedance	Amp. Fac.	Price	Remarks	
GUNNINGHAM—U.S.A. (Rothermel Corporation)	C.299	3.0	0.06	—	—	—	—	10 0	General purpose	OSRAM—G.E.C. Ltd., Magnet Hse., Kingsway, W.C.	R.	4.0	0.7	30-100	—	40,000	9.0	8 0	General purpose	
DEKTRAUDION—E.E. Co., Ltd., Fitzroy Square, W.1.	306	2.8-3.0	0.06	40-75	—	20,000	—	12 6	General purpose	OSRAM—G.E.C. Ltd., Magnet Hse., Kingsway, W.C.	D.E.3	2.8	0.06	50-80	—	22,000	7.0	14 0	General purpose	
EDISWAN—Edison Swan Electric Ltd., Queen Victoria St., E.C.2.	406	3.8-4.0	0.06	40-75	—	21,000	—	12 6	General purpose	OSRAM—G.E.C. Ltd., Magnet Hse., Kingsway, W.C.	D.E.Q.	3.0	0.2	20-50	—	100,000	20.0	25 0	Spec. det. for anode bend	
BLKA—L. Kremmer, 49a, Shadwell, Manchester.	A.R.06	2.5-3.0	0.06	20-100	—	14,000	5.0	14 0	Det. and L.F.	QUIKKO—J. W. Pickavaat & Co., Ltd., Quikko Works, Birmingham.	F.E.3	4.0	0.7	6-15 (grid)	—	20,000-8,000	4.5	16 6	4-electrode general purpose	
FRELAF—L. Kremmer, 49a, Shadwell, Manchester.	G.P.1	3.5-4.0	0.15	60-120	—	22,000	12.0	14 0	General purpose	QUIKKO—J. W. Pickavaat & Co., Ltd., Quikko Works, Birmingham.	B.E.L.F.	4.0	0.5	30-60	—	12,000	6.0	4 8	Det. foll. by trans.	
LOEWE AUDION—Audion Radio Co., 52, Dorset St., W.1.	A.R.L.F.	4.0	0.75	30-80	—	15,000	6.0	8 0	Det. and L.F.	QUIKKO—J. W. Pickavaat & Co., Ltd., Quikko Works, Birmingham.	B.E.H.F.	4.0	0.5	40-80	—	52,000	18.0	4 8	Det. foll. by res. or choke	
LOUDEN—Fellows Mag. Co., Cumberland Ave., Park Royal, W.	R.	3.5-4.0	0.15	20-100	—	25,000	7.5	8 0	General purpose	QUIKKO—J. W. Pickavaat & Co., Ltd., Quikko Works, Birmingham.	D.E.22	3.8	0.2	30-80	—	14,000	5.0	8 0	Det. foll. by trans.	
LUSTROLUX—Lustrolux Ltd., Bollington, nr. Macclesfield.	L.A.74	3.0	0.06	50-100	—	35,000	10	9 6	General purpose	RADION—Radion Ltd., Bollington, nr. Macclesfield.	L.F.	3.7	0.06	80-120	—	18,000	7.2	10 0	Det. and L.F.	
MARCONI—Marconiphone Co., Marconi House, Strand, W.C.2.	F.E.R.1	4.0	0.1	40-100	—	13,000	6.0	8 0	Det. and L.F.	RADION—Radion Ltd., Bollington, nr. Macclesfield.	Spec. det.	3.8-4.0	0.7	20-100	—	27,000	8.0	6 6	Special detector	
METAL—J. Rac Ltd., 60, Blackfriars Rd., S.E.1.	306 L.F.	2.8-3.0	0.06	80 max.	—	25,000	—	9 0	Det. and L.F.	RADIO-MICRO—H. D. Zeilander & Co., 124-7, Minorities, E.1.	Special	3.5	0.06	40-80	—	30,000	—	8 6	General purpose	
MULLARD—Mullard Wireless Service Co., Ltd., Mullard House, Denmark St., W.C.2.	312 P.V.	3.8-4.0	0.06	80 max.	—	18,000	—	15 0	Det. and power	RADYACO—Blitz Bros., Lynton Rd., Horn Lane, Acton, W.3.	S.B.1	3.0	0.06	20-100	—	25,000	10	7 6	General purpose	
NEUTRON—Neutron Distributors, Sentinel Hse., Southampton Row, W.C.1.	412 P.V.	3.8-4.0	0.12	120 max.	—	12,000	—	15 0	Det. and power	RADYACO—Blitz Bros., Lynton Rd., Horn Lane, Acton, W.3.	S.B.3	3.5	0.5	10	—	40,000	10	3 6	General purpose	
NETLSON—Nelson Electric Co., Ltd., 138, Kingston Road, S.W.19.	434 P.V.	3.8-4.0	0.34	120 max.	—	12,000	—	15 0	Det. and power	RADYACO—Blitz Bros., Lynton Rd., Horn Lane, Acton, W.3.	S.B.4	4.0	0.7	50-200	—	25,000	10	3 6	General purpose	
OUTRON—H. S. Electric Ltd., 32, Charlotte St., Birmingham.	470 B.E.	3.8-4.0	0.7	80 max.	—	25,000	—	7 0	General purpose	RADYACO—Blitz Bros., Lynton Rd., Horn Lane, Acton, W.3.	the "Ratrac"	4.0	0.7	will be known as the "Radyaco"	—	as the "Radyaco"	—	—	—	General purpose
AMPLION—Alfred Gramham & Co., 25, Savile Row, W.1.	R.	4.0	0.7	30-100	—	40,000	9.0	8 0	General purpose	SIX-SIXTY—Electric Lamp Co., Triumph Hse., Regent St., W.1.	S.S.1	3.7	0.06	50-100	—	28,000	8.5	8 0	General purpose	
AREA—Stephens & Vell, 55, Gt. Eastern St., E.C.2.	D.E.3	2.8	0.06	20-80	—	22,000	7.0	14 0	General purpose	SIX-SIXTY—Electric Lamp Co., Triumph Hse., Regent St., W.1.	S.S.8	4	0.1	50-125	—	18,500	13.0	14 0	General purpose	
	D.E.Q.	3.0	0.2	50-60	—	100,000	20.0	25 0	Spec. anode bend det.	SIX-SIXTY—Electric Lamp Co., Triumph Hse., Regent St., W.1.	S.T.1	3.7	0.1	40-120	—	16,000	13	14 0	H.F. and det.	
	F.E.3	4.0	0.7	6-15 (grid)	—	20,000-8,000	4.5	16 6	4-electrode general purpose	SIX-SIXTY—Electric Lamp Co., Triumph Hse., Regent St., W.1.	S.T.11	3.7	0.1	40-120	—	16,000	13	14 0	H.F. and det.	
	T.M.4	4	0.7	40-160	—	19,000	8.5	—	General purpose	TELETRON—Standard Cables and Telephones Ltd., Connaught Hse., W.C.2.	G.P.	3.5-4.0	0.06	—	—	—	—	—	—	General purpose
	P.M.3	3.4	0.1	50-100	—	16,000	13.5	14 0	Det. H.F. and L.F.	TELETRON—Standard Cables and Telephones Ltd., Connaught Hse., W.C.2.	D.E.3	3.0	0.06	—	—	—	—	—	—	General purpose
	R.H.F.	3.8	0.65	20-75	—	100,000	22	22 6	Anode bend, det., res.	TELETRON—Standard Cables and Telephones Ltd., Connaught Hse., W.C.2.	D.E.4	4	0.56	—	—	—	—	—	—	General purpose
	R.L.F.	3.8	0.65	50-100	—	59,000	16.5	8 0	General purpose (amp)	TELETRON—Standard Cables and Telephones Ltd., Connaught Hse., W.C.2.	D.E.4	4	0.34	—	—	—	—	—	—	General purpose
	G.306	3	0.06	30-80	—	25,000	7	11 0	General purpose	TELETRON—Standard Cables and Telephones Ltd., Connaught Hse., W.C.2.	H.F. & Det.	3.5	0.06	20-25	+8	—	—	—	—	4-electrode valves, general purpose
	H.406	3.5-4.0	0.06	20-100	—	22,000	9	12 6	H.F. and detector	TELETRON—Standard Cables and Telephones Ltd., Connaught Hse., W.C.2.	B.E.	3.5	0.55	50-100	20-40	—	—	—	—	4-electrode valves, general purpose
	H.R.408	3.7	0.08	30-80	—	59,000	18	12 6	High imped. det.	VITA—Vita-Curtis Ltd., Voluton Co., Ltd., 75, City Rd., E.C.1.	T.P.3	2.5-3	0.06	40-100	—	17,000	—	—	—	For unidyne, 4 or 5 pin
	H.408	3.7	0.08	30-60	—	25,000	7.5	12 6	Det. and L.F.	VITA—Vita-Curtis Ltd., Voluton Co., Ltd., 75, City Rd., E.C.1.	L.C.4	3.5-4.0	0.06	30-100	—	13,500	—	9 0	—	General purpose

4-VOLT L.F. VALVES—including Power Valves.

Make of Valve	Type	Fil. Volts	Fil. Amp.	Anode Volts	Grid Bias	Impedance	Amp. Fac.	Price	Remarks	Make of Valve	Type	Fil. Volts	Fil. Amp.	Anode Volts	Grid Bias	Impedance	Amp. Fac.	Price	Remarks	
AMPLION—Alfred Gramham & Co., 25, Savile Row, W.1.	No. 1	3.8-4.0	0.06	30-80	0-6	—	—	—	General purpose	BEAM—Lester & Marquis, 15-16, Thavica Inn, E.C.1.	D.E.06	3-4.0	0.06	20-90	—	—	—	8 6	—	General purpose
AREA—Stephens & Vell, 55, Gt. Eastern St., E.C.2.	No. 6	3.5-4.0	0.06	30-80	0-6	—	13	—	General purpose	BEAM—Lester & Marquis, 15-16, Thavica Inn, E.C.1.	D.E.06	3-4.0	0.06	20-90	—	—	—	8 6	—	General purpose
	No. 8	3.8-4.0	0.6	30-80	0-6	—	11	—	Initial L.F.	BEAM—Lester & Marquis, 15-16, Thavica Inn, E.C.1.	D.E.06	3-4.0	0.06	20-90	—	—	—	8 6	—	General purpose
	No. 8	3.5-4.0	0.25	30-150	3-12	—	4	—	Power valve	BENJ AMIN—Benjamin Electric Ltd., Bramwood Works, Tottenham, N.1.	D.E.06	3-4.0	0.06	20-90	—	—	—	8 6	—	General purpose
	No. 17	3.5-4.0	0.25	40-200	3-15	8,000	7	—	Power valve	BENJ AMIN—Benjamin Electric Ltd., Bramwood Works, Tottenham, N.1.	D.E.06	3-4.0	0.06	20-90	—	—	—	8 6	—	General purpose

To be continued.



Traders and manufacturers are invited to submit wireless sets and components to the "P.W." Technical Dept. for test. All tests are carried out with strict impartiality in the "P.W." Test room under the supervision of the Technical Editor, and the general reader is asked to note that this weekly article is also intended to provide a reliable and unbiased guide as to what to buy and what to avoid.—EDITOR.

#### THE "DUCO" STUD SWITCH.

FOR a time stud switches seemed to go out of fashion, but of late they appear to have been subject to a revival. And undoubtedly a carefully mounted stud switch can be both efficient and pleasing in appearance. Switching can be carried to extremes, but discreetly applied it can be most useful.

Messrs. Brown Bros., of Great Eastern Street, London, E.C.2, recently sent us a sample of their "Duco" Stud Switch for panel mounting. It is supplied in parts, of course, but a metal template is provided which makes the necessary panel drilling a very simple operation. The "Duco" switch is, therefore, easy to mount and additionally it has a smooth action and provides position contacts. The contact studs fit nearly flush on the panel. It can be obtained in either nickel-plated or brass

finish. Prices range from 1s. 9d. (two-way in brass) to 2s. 3d. (10-way, nickel-plated).

#### ANOTHER MULLARD VALVE.

To the already very wide and comprehensive Mullard range of valves has recently been added another type, the P.M.5.B. This valve has a very high amplification factor, no less than 37, although its impedance, 74,000 ohms, is, in the circumstances, quite low. Operating on 5 to 6 volts, it consumes but 1 amp.

In view of the above characteristics the P.M.5.B. should make a very efficient and economical valve for use in resistance-capacity stages. And, on test, we found that it does do this, and its high "mu" is well evinced by the manner in which it amplifies. Signal strength, using but one stage of resistance-capacity coupling with

this P.M.5.B. and a P.M.6 in the last position, nearly approached that obtainable with an efficient stage of transformer coupling.

One hundred and fifty volts of H.T. was employed, and there was a commendable absence of frequency distortion. The P.M.5.B. makes a most excellent detector when employed in the correct manner; in fact, in this capacity, it is one of the best valves we have ever tested. †

#### THE "P.W." VALVE GUIDE.

In the section of our valve guide published in "P.W." of January 1st, the two-volt Radio Micro Bivolt valve is incorrectly priced at 5s. 3d., instead of correctly at 7s. 6d.

#### TWO CHEAP SIX-VOLTERS.

Two new Osram valves have just come to hand, the D.E.H. 612 and the D.E.L. 612. The following are their characteristics and prices:

D.E.H. 612: Fil. volts, 5.6-6; fil. current,

(Continued on page 1326.)

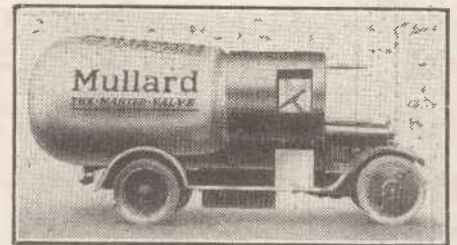

A novel radio van which forms a striking advertisement.

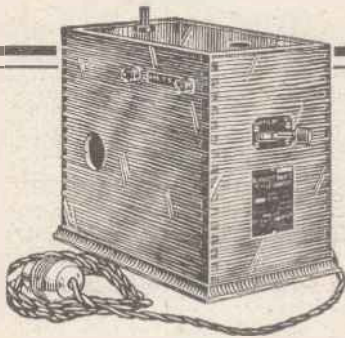

No. 484 Balkite Trickle Charger, 100-120 volts, 50-80 cycles with filler and gauge. Price £2 : 18 : 0

No. 489 Balkite Trickle Charger, 200-215 volts, 50-80 cycles, with filler and gauge. Price £2 : 18 : 0

No. 483 200-240 volts, 50-80 cycles. Price £2 : 18 : 0

Write or ask your local Dealer for Catalogue which fully describes this and other Burndeft Wireless Apparatus.

## Keep Your Accumulator up to full strength with the "BALKITE" TRICKLE CHARGER

and save yourself the frequent trouble of carrying a heavy accumulator to your re-charging station.

Balkite Trickle Charger charges your accumulator, by means of A.C. electric light supply. Connected up to the main by means of any convenient plug or lamp socket, it charges your accumulator from the moment your set is switched off until it is switched on again. All the while your receiver is not in use your low-tension battery is being brought up to its full strength and you need never be without the use of your set. Suitable for charging either a two-, four- or six volt accumulator.

# BURNDEFT

## WIRELESS LIMITED

AGENTS EVERYWHERE



The "Cosmos" Rheostat.

# Cosmos

RADIO COMPONENTS

ensure reliable sets

Constructors who desire smooth working and efficient sets use "Cosmos" Precision Components.

The "Cosmos" Rheostat. The principal features of the "Cosmos" Filament Rheostat are its sturdy construction and reliable, smooth movement. The contact arm cannot easily be damaged, having its movement on the inner side of a porcelain bobbin which carries the windings. Other pleasing features of this Precision Rheostat are the handsome knob and dial. ONE HOLE fixing, and the small space it occupies.

Made in four types, two of which are double-wound for DULL or BRIGHT VALVES and one a Potentiometer.

Description	Ohms.	Current.	Price.
Single Wound ..	6.0	1.0 amp.	s. d. 4 8
Double " ..	20	" 4 "	5 0
" " ..	34	" 2 "	5 0
Potentiometer ..	300	---	6 0

The "Cosmos" Permacon is an ideal fixed condenser, being light in weight, of guaranteed accurate capacity, and having the lowest possible losses.

The dielectric is mica and each condenser is tested at 500 volts during inspection. Nickel-plated cases give them a particularly neat appearance.

.0001 mfd. ..	1/8	.001 mfd. ..	1 8
.0002 " ..	1/8	.002 " ..	1 10
.0005 " ..	1/8	.005 " ..	2 8
.0003 " (with clips for grid leak)	1/8	.01 " ..	3 9

The "Cosmos" Resistance Coupling Unit.—Real purity of reproduction can only be obtained with resistance capacity coupling. The "Cosmos" Coupling Unit with a suitable valve is as effective as an ordinary transformer coupled stage. It avoids all distortion and effects considerable economies in first and operating costs. Designed primarily for use with the "Cosmos" S.P. Blue Spot Valves, it can be used successfully with any valve having an amplification factor of 30 or more. Special attention is directed to the following advantages of the "Cosmos" Coupling Unit:

- (1) It takes up little space in a set.
- (2) It is not liable to be broken.
- (3) It has permanent resistance values.
- (4) It allows for simplified wiring.
- (5) It is economical in L.T. current (S.P. Blue Spot Valves consume 0.09 amps.).
- (6) It is economical in H.T. Battery consumption (less than 1/20 normal).

And lastly its use results in purity of reproduction without loss in volume.

Type "O" the Unit alone .. 8/6  
 Type "V," the Unit incorporating spring valve holder (as illustrated), 10 6.  
 Suitable valves for use with this unit are "Cosmos" S.P. 18, B at 14/-,  
 and "Cosmos" S.P. 55/B at 18/6.

## METRO-VICK SUPPLIES LTD.

(Proprietors: Metropolitan-Vickers Electrical Co., Ltd.)

Metro-Vick House, 155, Charing Cross Road, LONDON, W.C.2

R  
P6J



The "Cosmos" Permacon.

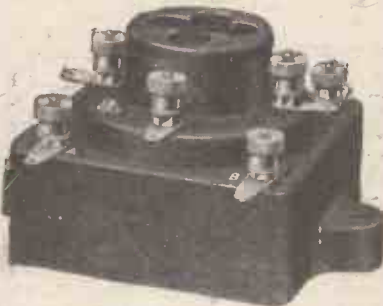

The "Cosmos" Coupling Unit and spring valve holder.



Ask your dealer for these attractive Folders on "Cosmos" Valves, Sets and Components.

## APPARATUS TESTED.

(Continued from page 1324.)

0-12 amps. ; anode volts, 150 max. ; amplification factor, 20 ; impedance, 33,000 ohms. Price 14s.

D.E.L. 612 : Fil. volts, 5-6-6 ; fil. current, 0-12 amps. ; anode volts, 80 max. ; amplification factor, 7 ; impedance, 9,000 ohms. Price 14s.

It will be noted that both of these valves follow the new Osram style of nomenclature and that their prices are, in comparison with many of the other economical six-volters, very low indeed. In fact, they represent, in a sense, a reduction in price in six-volters, for they will operate with efficiency equal in very many cases to 18s. 6d. six volters.

The D.E.H. 612 operates very well indeed in those positions for which it is designed. In detector and resistance-capacity coupled stages, it functions as well as the D.E.5 B, although it takes but half the filament current. With  $1\frac{1}{2}$  volts grid bias and 50 to 70 volts H.T. it makes an excellent anode bend detector.

The D.E.L. 612 is of a more "general purpose" character, and can be used with advantage in all three stages. As an H.F. amplifier, it requires stabilising, but when properly used it is sensitive and generally efficient. We obtained very excellent results indeed with this valve when it was tested in both the detector and first L.F. positions of a straightforward four-valver

employing one stage of transformer and one stage of choke L.F. coupling. In fact, there can be but few six volters of any type on the market that would give equal performances in such circumstances.

A feature, that particularly appeals to us in the Osram valve is the prominent ridge down its base in line with its anode pin. This makes it very easy indeed to cope with awkwardly placed valve holders.

In conclusion, we trust that these new Osrams are the precursors of a comprehensive range of six volters of low consumption and reasonable prices. No two or four volter can hope to equal a good six volter, and at even prices all discriminating amateurs would reckon two extra accumulator cells to be a very excellent investment.

### AN IMPROVED SOLDERING IRON.

Probably most amateurs find that one of the greatest difficulties encountered in soldering is keeping the copper bit of the "iron" clean and well tinned, more especially when the source of heat is a coal fire. Recently we carried out some tests with a most ingenious appliance designed to surmount this trouble. It is a soldering iron conventionally shaped which

has a thin copper cap which fits closely over the main and solid copper bit. This copper cap is controlled by a long metal arm which is operated (the movement is very simple) by a small lever fitted with a non-conductive knob. When the iron is being heated the copper cap is eight or nine inches away from the fire, and cannot get dirty. When the iron is hot a simple one-handed movement brings the cap into position, bright and well tinned to obtain its heat by conduction from the solid bit. This iron works very well, although we'd like it to have a slightly larger bit and a larger adjusting knob. But these are mere details. It is a most excellent scheme, and should rapidly gain popularity among both professional craftsmen and amateurs. The Rexo Engineering Co., 2, Ravenscroft Square, W.6.

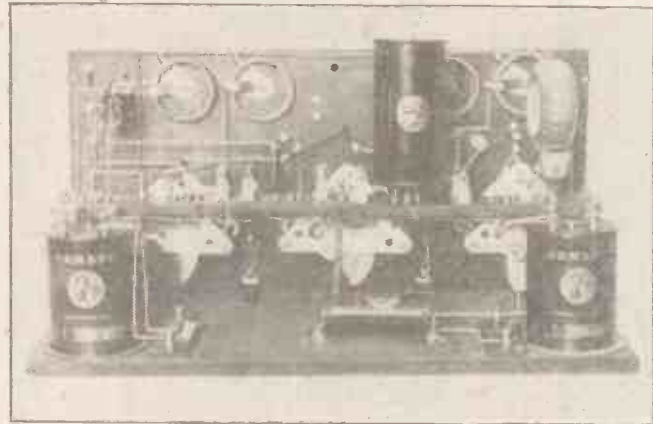

A rear view of the Crmsby four-valve long-range receiver.

# THERE IS NO BETTER CONDENSER AT DOUBLE THE PRICE!

The Bowyer-Lowe Popular Condenser is acclaimed by amateurs everywhere as being the best condenser of its kind. It is perfectly made of sound materials and generously guaranteed.

Increase the efficiency of reception through the perfect control provided by the Popular Condenser.

"THERE IS NO BETTER CONDENSER AT DOUBLE THE PRICE!"

WITH DIAL  
•0003 M.F.  
**10'6**

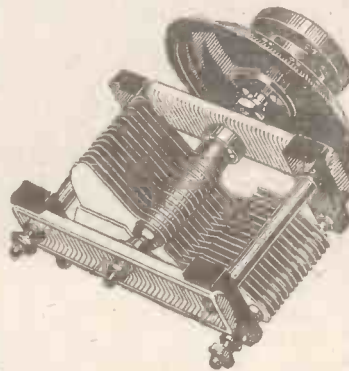

ANOTHER CONVINCING TESTIMONY TO THE QUALITY OF BOWYER-LOWE RADIO APPARATUS.

Mr. H. H. Anspach used the Bowyer-Lowe Gang Control Condenser in his "Solodyne" Set, which secured FIRST PRIZE at the CHICAGO EXHIBITION, U.S.A.

WITH DIAL  
•0005 M.F.  
**10'6**

TESTED RADIO APPARATUS  
**Bowyer-Lowe**

ANNOUNCEMENT BY THE BOWYER-LOWE CO. LTD. LETCHWORTH, HERTS.

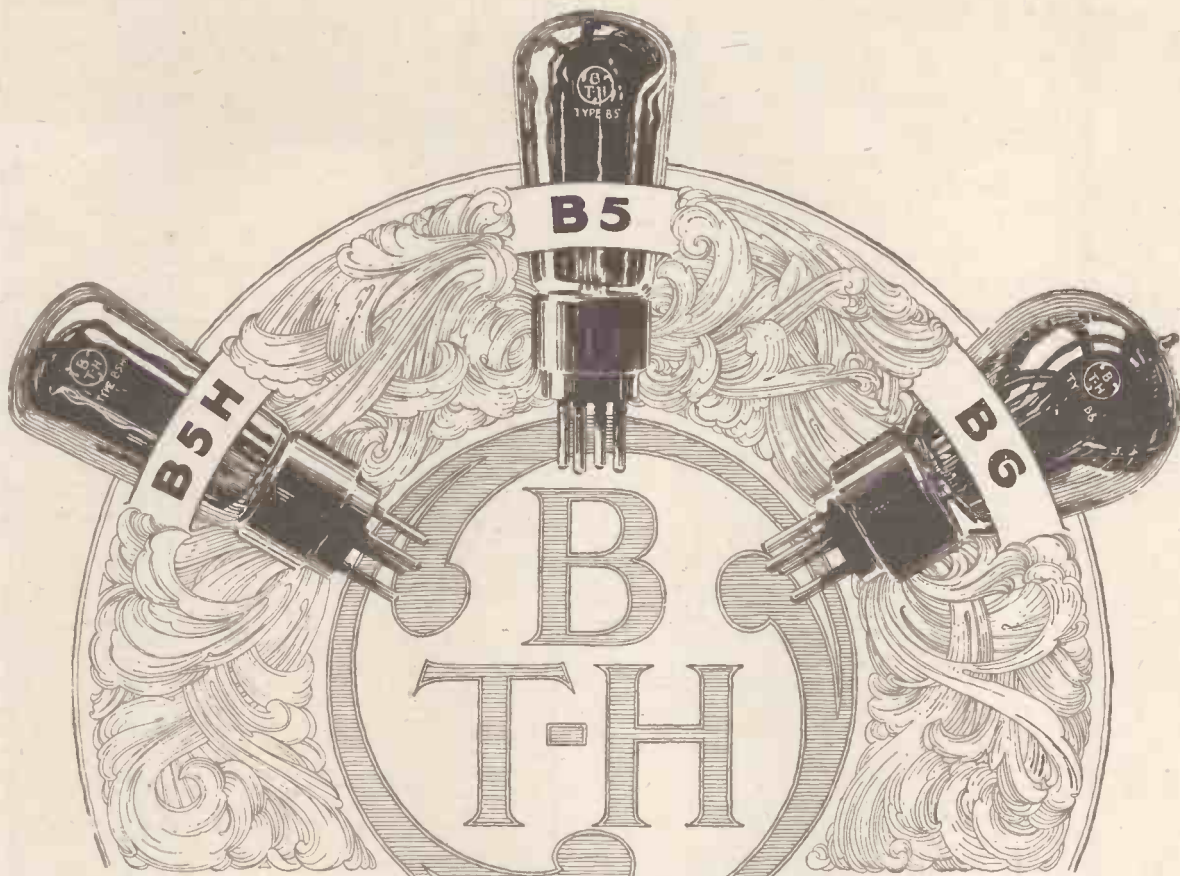

**These three valves are designed to work perfectly together on a small 4v. accumulator or dry battery.**

<b>B.5 H.</b> .....	14/-
Filament Volts.....	2.8
Filament Current.....	0.06 amp
Anode Volts.....	40 to 120
Amplification Factor.....	17.5
Impedance.....	55,000 ohms
<b>B. 5.</b> .....	14/-
Filament Volts.....	2.8
Filament Current.....	0.06 amp
Anode Volts.....	20 to 80
Amplification Factor.....	7
Impedance.....	17,000 ohms
<b>B. 6.</b> .....	18/6
Filament Volts.....	2.8
Filament Current.....	0.12 amp
Anode Volts.....	40 to 120
Amplification Factor.....	8
Impedance.....	12,000 ohms

With the introduction of the new B.5.H. Valve, there is now available a complete range of super-efficient valves for 4 volt batteries. The B.5.H. Valve is intended for the H.F. stages, the B.5 for detector and early L.F. stages, and the B.6 for the final L.F. stage.

These three valves provide a combination of incomparable

efficiency and economy for multi-valve sets using 4 volt accumulators or dry batteries. A 3 valve set for example, equipped with one of each of the three types would require a total filament current of only 0.24 of an ampere, and could be operated for over 80 hours for a single charge on a 4-volt 20 ampere-hour accumulator.

*If you use, or wish to use, a 4-volt battery you will get the finest possible reception at the lowest possible running cost by equipping your set with one or more of the valves illustrated above.*

# B.T.H. VALVES

# RADIOTORIAL

All Editorial Communications to be addressed to The Editor, POPULAR WIRELESS, The Fleetway House, Farringdon Street, London, E.C.4.

Editor:  
NORMAN EDWARDS, M.Inst.R.E., M.R.S.L.,  
F.R.G.S.

Technical Editor:  
G. V. DOWDING, Grad.I.E.E.

Assistant Technical Editors:  
R. D. ROGERS. P. R. BIRD.  
G. P. KENDALL, B.Sc.

Scientific Adviser:  
Sir OLIVER LODGE, F.R.S.

Staff Consultants:  
Dr. J. H. T. ROBERTS, F.Inst.P.; J. F. CORRIGAN, M.Sc., A.I.C.; G. E. FIELD, B.Sc.; E. J. SIMMONDS, M.I.R.E., F.R.S.A.

Foreign Correspondents:  
F. M. DELANO, Paris; Dr. ALFRED GRADENWITZ, Berlin; L. W. CORBETT, New York; P. F. MARTIN, Italy; W. PEETERS, Holland.

The Editor will be pleased to consider articles and photographs dealing with all subjects appertaining to wireless work. The Editor cannot accept responsibility for manuscripts and photos. Every care will be taken to return MSS. not accepted for publication. A stamped and addressed envelope must be sent with every article. All inquiries concerning advertising rates, etc., to be addressed to the Sole Agents, Messrs. John H. Lile, Ltd., 4, Ludgate Circus, London, E.C.4.

As much of the information given in the columns of this paper concerns the most recent developments in the Radio world, some of the arrangements and specialities described may be the subject of Letters Patent, and the amateur and the trader would be well advised to obtain permission of the patentees to use the patents before doing so.

Readers' letters dealing with patent questions, if sent to the Editor, will be forwarded to our own patent advisers, where every facility and help will be afforded to readers. The envelope should be clearly marked: "Patent Advice."

### TECHNICAL QUERIES.

Letters should be addressed to: Technical Query Dept., "Popular Wireless," The Fleetway House, Farringdon Street, London, E.C.4.

They should be written on one side of the paper only, and MUST be accompanied by a stamped addressed envelope.

Queries should be asked in the form of the numbered questions: (1), (2), (3), etc., but may be accompanied by a short letter giving any necessary additional particulars as briefly as possible.

For every question asked a fee of 6d. should be enclosed. A copy of the numbered questions should be kept, so that the replies may be given under the numbers. (It is not possible to reproduce the question in the answer.)

Details of the "P.W." BLUEPRINTS are published fortnightly in the advertisement pages of "P.W."

BACK OF PANEL DIAGRAMS can be specially drawn up to suit the requirements of individual readers at the following rates: Crystal Sets, 6d.; One-Valve Sets, 6d.; One-Valve and Crystal (Reflex), 1s.; Two-Valve and Crystal (Reflex), 1s.; Two-Valve Sets, 1s.; Three-Valve Sets, 1s.; Three-Valve and Crystal (Reflex), 1s. 6d.; Four-Valve Sets, 1s. 6d.; Multi-Valve Sets (straight Circuits), 1s. 6d. Except SUPER-HETERODYNE DIAGRAMS, all of which, irrespective of number of Valves used, are 2s. 6d.

If a panel lay-out or list of point-to-point connections is required an additional fee of 1s. must be enclosed. Wiring diagrams of commercial apparatus, such as sets of any particular manufacture, etc., cannot be supplied. (Such particulars can only be obtained from the makers.) Readers may submit their own diagrams, etc., for correction or for criticism. The fee is 1s. per diagram, and these should be large, and as clear as possible.

No questions can be answered by 'phone.

Remittances should be in the form of Postal Orders.

## Questions and Answers

### CUTTING OUT 2 L O.

F. S. (East Ham, London, E.).—As I am not handy with tools, I do not wish to alter my set inside, but I should like to make it more selective if possible. Can I do this without interfering with wires that I do not understand?

At present I could often hear foreign stations if only I could get rid of a constant background of 2 L O.

Flat tuning is often caused by factors outside the set itself, so there is no reason why you should not try to improve matters.

The likeliest cause of the fault, apart from the set itself, is an inefficient aerial. At your distance from

(Continued on page 1330.)

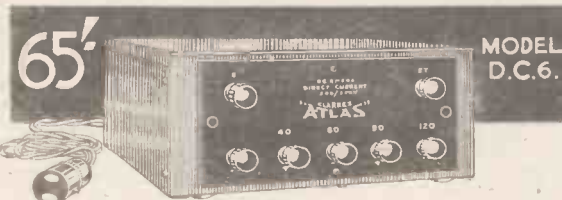

Saves £1 a year for sure, / for twenty years, or even more!

Clarke's "ATLAS" H.T. Battery Eliminator is an economical luxury—the one perfect solution to the problem of H.T. supply, whether yours is a one or a thirteen valver.

Simply plug into an electric light socket, and forget H.T. worries for the rest of your life!

The model shown is the D.C.6. It works from a direct current supply of 200-250 volts, gives 40, 60, 90 or 120 volts H.T. as desired. Fully described in leaflet No. 20.

Other models are the D.C.3 —also for direct current— and the A.C.1 and 2 for alternating current. Folders 17 and 18 tell the whole story.

Ask your dealer or write direct.



Completely change the 'listening look'

No more groping for the distant stations, or grumbling at poor reception from the local one. Clarke's "ATLAS" low-loss Coils bring in more stations—easier and louder! The patent twin-wire winding is the chief secret of a coil which meets every demand of the keenest critic. For Distance, Selectivity and Volume, Clarke's "ATLAS" low-loss Coils are the recognised leaders.

### PRICES

No.	Each.
25-50	2/6
65	3/-
75-150	3/6
175-300	4/6
400	5/6
500	7/6
600	9/6
750	10/6
1,000	12/6
1,250	14/-
1,500	15/6

## CLARKE'S "ATLAS" RADIO SPECIALITIES

We have vacancies in various districts for first-class Service Agents. Replies should be addressed to us, stating full qualifications.

H. CLARKE & CO. [MCR.] LTD., Radio Engineers, Atlas Works, OLD TRAFFORD MANCHESTER

Telephones: 683 and 793 Trafford Park.

Telegrams: "Pirtoid, Manchester."

So handy

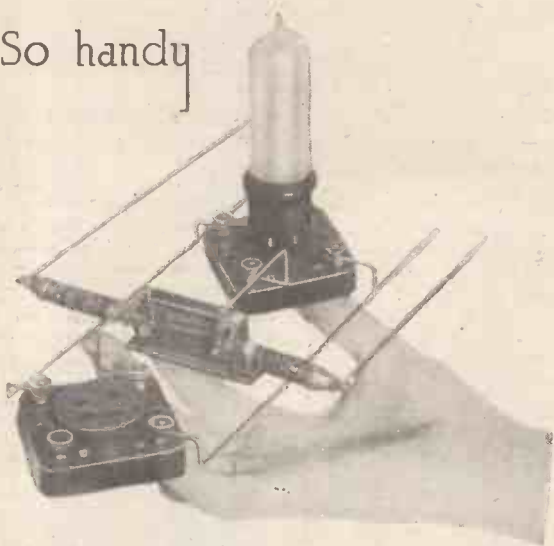

**WHATEVER** your set remember that only Resistance Capacity can give you *true and faithful amplification throughout the entire scale.*

Every note will ring pure and true, as if the artist were performing just to you alone in the very room.

Your set will run so sweetly that it almost seems glad to keep on telling you how absolutely right your Dealer was when he advised

**GRAHAM-FARISH**

PATENT BAKELITE

**R**ESISTANCE  
**C**APACITY  
**U**NITS

DESIGN  
REGD.

THE UNIT DEALERS RECOMMEND

Because it is:—

- Guaranteed absolutely accurate.
- The simplest and most practical.
- Wired in a moment with straight Battery leads.
- Able to stand overloading.
- Certain to give satisfaction.

But the PRICE will astonish you.

TYPE A **The Graham-Farish Mfg. Co.,**  
17, Masons' Hill,  
**BROMLEY,**  
Kent.

TYPE B  
**3/6**

for Special High Impedance R.C. Valves.

ASK YOUR DEALER ABOUT OUR OTHER RADIO GOODS.

WE DO NOT TALK ABOUT SUCCESS—WE GUARANTEE IT.

# Guarantee.

I hereby guarantee that I will provide each Student of The Bennett College with tuition until he has passed the examination for which he has enrolled.

I further guarantee to provide all the necessary books free of charge and undertake that no further fees will be required other than those stated on the form of enrolment.

WE GIVE A WRITTEN COPY OF THIS GUARANTEE TO EVERY STUDENT.

*J. Bennett*

F.R.S.A. M.I.Mar.E., A.I.Struct.E., etc. (GOVERNOR), THE BENNETT COLLEGE, SHEFFIELD.

Having helped thousands of others to achieve success and advancement, it may be possible that we can help YOU.

I am assisted by a large and expert staff, and the advice we give is sound. If we cannot help you we will say so; if we can we will tell you how.

We have FREE booklets setting out the possibilities in connection with each of the subjects shown in the lists; send for the one in which you are interested, or ask for MY PRIVATE ADVICE, which also is free. You incur no obligation.



Most Moderate Charges, Payable Monthly.

**EXPERT TUTORS FOR EVERY DEPARTMENT.**

Have You ANY Ambition?

WE TEACH ALL THE FOLLOWING SUBJECTS:

**COMMERCIAL.**

- Accountancy
- Advert. Writing
- Salesmanship
- Army Certif. Courses
- Auctioneering and Estate Agency
- Auditing
- Banking
- Book-keeping
- Commercial Arithmetic
- Commercial Law
- Company Law
- Costing
- Economics
- English and French
- Executorship Law
- Foreign Exchange
- General Education
- Modern Business Methods
- Police Entrance and Promotion Courses

**COMMERCIAL—Con.**

- Secretaryship
- Workshop Organisation

**TECHNICAL.**

- Applied Mechanics
- Architectural Drawing
- Building Construction
- Clerk of Works' Duties
- Boiler Engineering
- Boiler Making
- Chemistry
- Civil Engineering
- Concrete and Steel
- Draughtsmanship
- Electricity
- Engineering
- Engineering Costing, Quantities and Specifications
- Foundry Work
- Heat Engines

**TECHNICAL—Con.**

- Internal Combustion Engines
- Marine Eng. B.O.T.
- Mathematics
- Matriculation
- Metallurgy
- Mining
- Mine Surveying
- Motor Engineering
- Naval Architecture
- Pattern Making
- Post Office Examinations
- Quantity Surveying
- Sanitation
- Shinbuilding
- Structural Engineering
- Surveying and Levelling
- Telegraphy and Telephony
- Town Planning
- Wireless Telegraphy
- Works Managers' Course

WE SPECIALISE IN PREPARATION FOR ALL EXAMINATIONS.

WE TEACH BY POST IN ALL PARTS OF THE WORLD.

Note THE BENNETT COLLEGE, Address: Dept. 106 SHEFFIELD.



## VALCO MAGIC!

WILL MAKE YOUR BROKEN VALVE AS GOOD AS NEW. ALL TYPES OF VALVES REPAIRED AT HALF LIST PRICES (minimum charge 5/-).

Satisfaction Guaranteed or Money Refunded.

An unsolicited testimonial from one of our many satisfied users will appear each week.

WORKING. 26/11/26.—I am pleased to say the two valves I had repaired are giving every satisfaction, I almost think better volume and tonal quality than when new, and it gives me great pleasure to recommend such good workmanship.—F. T. F.

Wecc, S.P.'s and low capacity types not repairable. Minimum D.E. current 0.15 amps when repaired.

VALCO LTD., Dept. "P.W." TABOR GROVE, WIMBLEDON, S.W.19.

**TO MAKE A GOOD SET  
you must have well-made components.  
TRY THESE!**

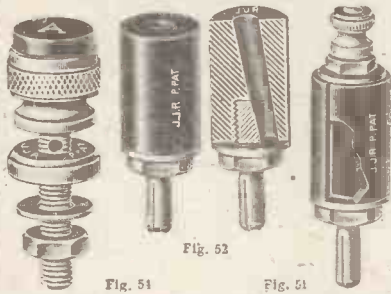

J.J.R. Patent No. 259614/25. All illustrations actual size.

FIG. 51. Why blow your valves? Our safety plug will save them, costs nothing to renew fuse (renewal instructions with each). Will last a lifetime. 1/- Blows at 4 amp. Each

FIG. 52. The only wander plug on the market that will not pull to pieces when withdrawn from the batteries. Made in eight colours. Each 3d.

FIG. 53. The J.J.R. patent non-rotating indicating terminal. Made in eight colours and all markings on insulated tops. Each 6d.

If your dealer does not stock them write us direct. Illustrated Catalogue on request. Trade please apply for terms. Phone: Sutton 2511

J.J.R. LTD. Manufacturers in ROSS PARADE, and Patentees, WALLINGTON, SURREY



**LIFE LONG H.T.**  
Troms units are constructed of the finest quality zinc, zinc, iron, etc., and creeping of the electrolyte and other troubles usual to Leclanche cells eliminated. In units of any size battery to order in Mahogany Case with glass cover. Amalgamated zincs 6d doz. extra. Example unit and sample large capacity Sac, post free descriptive folder, etc.

SEND TO DAY FOR FREE DESCRIPTIVE FOLDER, ETC.

**TROMS ELECTRICAL CO.**  
17, WHITE HART LANE, TOTTENHAM, N.17

IF ALL DEALERS OR DIRECT ORDER 6

**RADIOTORIAL  
QUESTIONS AND ANSWERS**

(Continued from page-1328.)

the local station we should recommend a single wire aerial, bare wire or enamelled, of not more than 65 feet, including the lead-in. It must be kept right away from roofs, trees, etc.

The earth lead should be of thick wire. It must be as short as possible, connected to a good buried earth (in damp soil), or else close to a main water-pipe.

If you are unable to improve the aerial or earth sufficiently in these respects, try disconnecting the aerial lead from the set; and joining it to a '0001 or '0002 fixed condenser. The other side of this condenser being connected to the set's aerial terminal. This should sharpen up the tuning and enable you to keep 2 L.O.'s broadcasting to within more reasonable limits.

**BASEBOARD LAY-OUT.**

"SPACER" (St. Helens).

—Why is it that sets often look neat outside, but the parts are arranged higgledy-piggledy on the base-board—crowded together in places and not in others?

Correct arrangement of the parts on the baseboard is very difficult, owing to the fact that some parts of the set can be placed side by side with impunity, while others must have large air spaces all round.

The accompanying photograph shows a baseboard layout with comparatively wide spacing between wires, etc., in the foreground, and apparent crowding at the other end of the board.

This has been done advisedly by the designer of the set, and though the reasons cannot be entered into in

detail here, it should be noted that especial care has been taken with the spacing of the H.F. wiring, as it is here that inadequate spacing would be most detrimental.

**VOLUME CONTROL.**

"Too Good Now" (Denny, Stirlingshire)—Since improving my set (H.F., Det. and L.F.) as suggested, it has become too loud on certain musical items! Is there an easy method of cutting down the volume a little without any necessity for altering the tuning? (The set is transformer coupled.)

A simple and effective volume control is provided by connecting a good variable grid leak across the secondary of the L.F. transformer, and we think that in the circumstances this will be your best method.

(Continued on page 1333.)

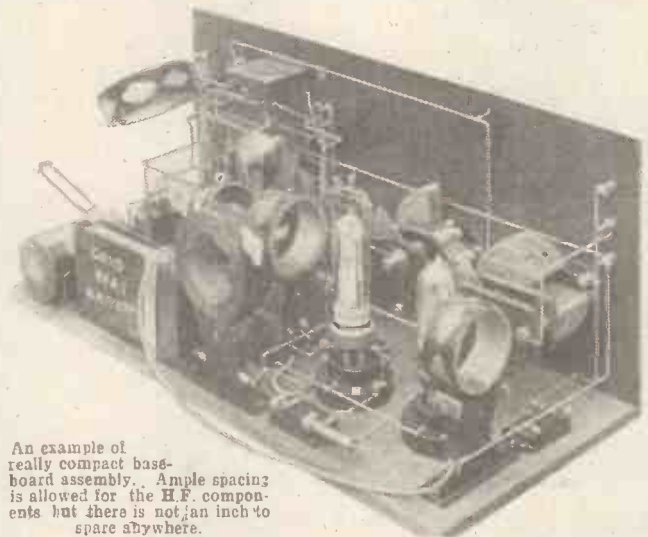

An example of really compact base-board assembly. Ample spacing is allowed for the H.F. components but there is not an inch to spare anywhere.

Only a Brown user knows how really lifelike Loud Speaker reproduction can be

**L**ISTEN, in rapt wonder, to Shubert's Unfinished Symphony on a Brown Loud Speaker. Hear the violins rising and falling; pick out the harp's piping notes; the cellos deep, resonant chords. Hear the wind instruments; distinguish the cornets, the trombones, the oboes and the flutes. Then hear it as one whole, wondrous masterpiece. The work of a Master superbly rendered, and faithfully interpreted as only a Brown Loud Speaker can.

Then later, listen to the dance music from one of London's famous hotels. What a difference! Hear on your Brown,

too, the droll humour of John Henry and the quaint sayings of Mrs. Harris (you can almost hear the aitches drop!) Then the announcer's clear voice reading the evening's news. You marvel at the natural way in which the Brown Loud Speaker reproduces them all. There there are nine Brown Loud Speakers, but from the greatest to the least, there is a tone which cannot be found in any other range of instruments. The music you hear in your room is identical with that in the studio—if your Set is right and your Loud Speaker bears the name BROWN. Above is the H4—2000 ohms, 30/- and on the left the Q— all resistances £15 15s.

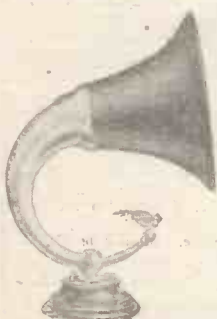

**S. G. BROWN, Ltd., Western Ave., N. Acton, W.3.**

Retail Showrooms: 19, Mortimer Street, W.1; 15, Moorfields, Liverpool; 67, High Street, Southampton. Wholesale Depots: 2, Lansdown Place West, Bath; 120, Wellington Street, Glasgow; 5-7, Godwin Street, Bradford; Cross House, Westgate Road, Newcastle; Howard S. Cooke & Co., 59, Caroline Street, Birmingham; Robert Garmany, Union Chambers, Union Street, Belfast, Northern Ireland.



# HOW CAN A FIXED RESISTOR BE VARIABLE?

—an open letter to the Wireless Public

Gentlemen,

Certain advertisers are making extravagant claims and state that the Fixed Resistor is fast becoming obsolete! This is entirely wrong.

The Fixed Resistor is guaranteed 100 per cent. efficient. It cannot be otherwise if manufactured the "Cyldon" way—that is Wire Wound, therefore absolutely noiseless. Carbon mixtures or chemical combinations change their characteristics as often as the English climate and cause home-made atmospherics.

Supposing your valve requires a resistance of 4 ohms to run it at the correct temperature. With

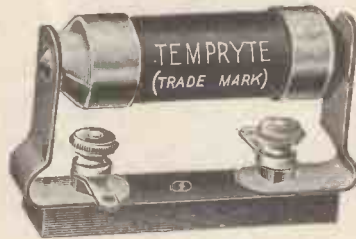

**TEMPRYTES**  
2/6 each.

**HOLDER MOUNTINGS**  
1/6 each.

Cyldon Works,  
Sarnesfield Road,  
ENFIELD TOWN, Middx.

a variable resistor (glorified filament rheostat) you start off with an unknown resistance, maybe too high or too low. If it is too low, your valve will probably be ruined for the rest of its life.

With "Cyldon" Temprytes you *must* be right because they are definitely designed to suit the particular valve you are using, and it is impossible to run that valve at anything but its correct temperature.

We issue a very comprehensive valve chart which shows the correct resistance for practically every valve in existence. It is free for the asking.

The cost of 2/6 for a "Tempryte" is much less than 15/- to 22/6 for a ruined valve through starting with an unknown resistance which may only be approximately right.

Yours faithfully,

*Sydney S Bird*

Get full particulars of the famous range of CYLDON CONDENSORS.

If unable to obtain CYLDON PRODUCTS locally, write direct to—

SYDNEY S. BIRD & Sons, Cyldon Works, Sarnesfield Rd., Enfield Town, Middx. Telephone: Enfield 0372

## 9 FINE DESIGNS 25 SIZES ARTCRAFT CABINETS

MADE IN OAK AND MAHOGANY

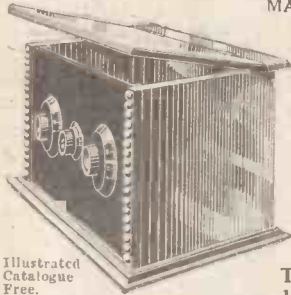

"Artcraft Popular Type" Cabinets

Panel Size	Depth	Price in Oak	Price in Mahog.
10 x 8	6	8/0	12/0
12 x 10	8	12/0	18/0
14 x 10	8	14/0	19/0
16 x 8	8	14/0	19/0
18 x 12	0	21/0	29/0

Baseboards Free. Hinged Lids 1/6 extra.

CARRIAGE PAID England & Wales. Scotland 1/- extra.

Radion, Resiston and Ebonart Panels Supplied.

THE ARTCRAFT COMPANY,  
156, Cherry Orchard Rd., Croydon.

Parv's Ad.

Illustrated Catalogue Free.

## STOP!!!

## CONSIDER

BEFORE BUYING ELSEWHERE!  
Then send for full particulars of Special Sets we have for disposal at Considerably Reduced Prices.

OUR BARGAINS!

Marconi Straight Eight, complete with Valves, H.T. Batteries and Accumulator, B.B.C. £50  
Coils and High Wave Coils. Been very little used. Cash Price £70 5s.

Elwell 4 Valve Receiver, Band 300-4,000 metres, Mahogany Case, Plug and Jack switching, complete with Valves, H.T. Batteries and Accumulator. Shop sealed only. ... Cash Price £33  
List Price £43 3s.

And numerous others; also a large assortment of Components and Loud Speakers by the best Manufacturers. Extended Payments Arranged.

Wireless Specialists



"SERVICE —Our Name and Aim."

Wireless Dept.—

273-274, HIGH HOLBORN, LONDON, W.C.1

## SECTION

This diagram is a magnified section of the Watmel windings. Spotted area—interwoven cotton. Striped area—enamel insulation. Black area—wire. Expensive new machines have been installed to wind the WATMEL Auto Choke this way.

## Watmel

### AUTO-CHOKE

THE WATMEL WIRELESS CO LTD., 332a, Goswell Road London, E.C.1. Telephone: CRYSTAL 7996. LANCY, YORKS, and Cheshire Representative: Mr. J. H. Levee, 23, Hartley Street, Levenshulme, Manchester. Telephone: 478 Heaton Moor.

18'6

## BECOL

Registered Trade Mark.

Size: 3 inches diameter to outside of wings. Prices: 6 in. lengths 3/- (postage 9d.) 4 in. lengths 2/- (postage 6d.) 3 in. lengths 1/6 (postage 6d.) Up to 36 in. lengths.

NOTICE:—Do not be put off with an imitation. Ask for BECOL and use the Former with a reputation. Write for List "O."

Makers of the ORIGINAL world-famous BECOL LOW LOSS FORMER

As used in sets that took the first four prizes at the 1926 "Manchester Evening Chronicle" Wireless Exhibition and the set that won the Gold Medal at the 1926 Amsterdam Exhibition.

THE BRITISH EBONITE COMPANY LIMITED, Ebonite Rods, Tubes and Sheets. Panels guaranteed free from surface leakage. Hanwell, London, W.7.



**YOUR REQUIREMENTS**  
fully met  
by the  
**EELEX**  
Treble Duty Terminal  
and  
Standardised Plugs  
and  
Sockets System



**INVESTIGATE**  
for yourself by  
writing for  
**List P.W. 13**

*This System is used and advised by all the Leading Wireless Journals*

**J. J. EASTICK & SONS**  
EELEX HOUSE  
118, Bunhill Row, E.C.  
Phone: Clerkenwell 9282-9283.

**COIL SCREEN & BASE**



Only 5/6

**RELIABILITY GANG CONDENSERS**



Two Gang 18/-  
Three Gang 25/-

**RELIABILITY CONDENSERS**



Manbridge  
Mids. 25, 1/6 1 mts. 2/6  
5, 1/9 2 mts. 3/6

**WIRELESS CABINETS**  
For Panels 7 in. high  
Width 8 in. Hinged Lid  
Oak 12 in. 17, 14 in.,  
17 1/2, 18 in. 18/6.  
Mahogany 1/- extra



**READ THIS LIST AND SAVE MONEY ON COMPONENTS**

**BATTERIES.**—Reliability, 90 v., 11/-; 60 v., 7/6; 36 v., 3/6; 15 v., 1/10; Ever Ready, Siemens, Hellesen, 100 v., 21/-; 66 v., 12/6; 36 v., 7/6; Flashlight Battery Cases for 14 Batts., 3/6; 4 v. Batts., 4d.; 60 v. Unequalled, 6/6; Wan. Plugs, 1d.; Clix Type, 2d.

**ACCUMULATORS.**—Evide, D.T.G., 4/8; D.F.G., 8/6; W.J., 20 v., H.T. type, 15/-; Oldham H.T. 10d. per volt, complete, Durac, 20 v., 11/-; 10 v., 5/8; Repairing Outfit, 1/6

**CONDENSERS.**—Low Loss, Square Law, with knob and dial, 0005 5/-; 0003, 4/6; with Vernier Blade, 1/- extra. Twin 0005, for Elstra Six, unequalled value, 9/6; Cyclon Twin for ditto, 2/7; Ormond, J.B. Utility, Sterling, Polar, Formo, Igranic, G.E.C. Var. in all capacities. Neutrodyne types, Ormond, 2/-; Colvern, 3/6; Gmbriel, 5/6.

**FIXED CONDENSERS.**—Dubilier, Edson Bell Lissen, Watmel, Mullard, McMichael, at advertised prices. Special Reliability Fallon—0003 mid. 2 meg. Leak, 1/3; Casco only, 5d.

**L.F. TRANSFORMERS.**—P.I. Multi-Ratio, 25/-; Marconi Ideal, 25/-; Junior, 18/6; Ferranti A.F.3.25/-; A.F.4, 17/6; Formo, 10/6; H.T.C. Empire, 7/6; Croix 5 to 1, 6/-; Lissen new type, 8/6; Igranic 10/-; Eureka Concert Grand, 25/-; No. 2, 21/-; Paby Grand, 15/-; Ormond, 15/-; Royal, 20/-; Success, All-Black, 21/-; Silvertown, 21/-; G.R.C., 15/-; Brandes, 17/6; Burndep, 16/6; Special Value, 7/6; Modulation, 7/6.

**LATEST COMPONENTS.**—6-Way Coil Stand, 2/9; Colvern Low Loss Inductance Former, 5/-; Formo Straight Line, 0005 Condenser, 7/6; Success, 18/6; Eureka, 15/6; Cyclon, 15/6; Lissen 60 v. H.T. New Process Battery, 10/6; Valve Vibrating Springs, 6d. set of 4.

**RECENT REDUCTIONS.**—Sterling 0005 Square Law Condensers with Vernier, 9/6; Geared 12/-; Minilos, 15/-; 00025, 8/6; Geared 10/6; Minilos, 14/-; Marconi Automatic Detector, 2/6; Series Parallel Variometer, 10/6; Eddystone Absorbs Feet, set of 4, 2/3; Benjamin S.P. Switch, 1/3; N.P. Clix Plug & Insulator, 2d.; Adaptor, 1d.; Socket, 2d.

**EPONITE.**—Any size cut; Clayton Brand, 1 in., 1d. a sq. in.; 9 in. by 5, 2/3; 12 in. by 9, 4/6; 16 in. by 9, 6/6; 3/16 in. 25 per cent. less. Paragon and Radion, 1d. per sq. in.

**INSULATORS.**—Large Shell, 3d.; Reel or Egg 1d.; Ohmax 6d.; Ditto, with shock absorbers, 3/- pr. Gal. Pulleys, 1d.; 100 ft. Gal. Straining Wire, 1/6; Straining Bolts, 6d.

**TERMINALS & ACCESSORIES.**—Single W. Office N.E. or Pol. Brass with nut and washer, 1d.; Phone and Castle type, 1d.; Double Mark, 3, 2d.; 4-way Phone Connector, 6d.; Pole-binding paper, 3d.; Flaxite, 8d.; Black Tape, 6d. per coil; 1 in. Empire Tape, 6d. dozen yards; Insulating tube, 3d. yard; Glazite, 1/2, 10 ft. coil; Shellac Varnish, 6d.; Mica 2 in. x 1 1/2 in., 4d. dozen; Chatterton's Compound, 9d.; Hand Drill, 3/6; Drill 1/-.

**AERIALS.**—100 ft., 1 in. copper tape, 1/9; 7/22's Bright, 2/3; Enamelled, 3/6; Electron, 1/8; Superal, 2/6; Mars, 9/6; Ashton Spreaders, 12/- per pair; O.V. complete, 2/6.

**HEADPHONES.**—E.T.H., 15/-; Brown's "F" Type, 20/-; Reliability, 7/6; Adjustable, 8/-; Dr. Nesper, 12/11; T.M.C., 11/6; Western Electric, 20/-; all 4,000 ohms; Sullivan, 120-ohm Double Ex-Govt., New, 4/-; 120 ohm Single Phone, 2/6; Long Phone Cord, 1/-.

**VALVES.**—"Radion" all types, Frelat 2 volt, 3 amp., 4/11. All advertised makes stocked.

**VALVE HOLDERS.**—Anti-Phonic Benjamin, 2/9; Lotus, 2/3; with terminals, 2/6; Burndep, 2/9; Harlie, 1/6; Reliability, unequalled 2/-; all baseboard types, ord. 10d., 6d.; N.P. Valve Sockets, flush fitting, 1d.; Superior Panel Type, 6d.; All Ebonite, 1d.

**EXPERIMENTERS' PARCEL.**—Accessories of Various Types, worth 20/-, post paid, 5/6.

Send for New  
RELIABILITY  
WIRELESS  
GUIDE No. 9.  
Free on Request.  
Trade Supplied.

**J. H. TAYLOR & CO.**  
4, RADIO HOUSE,  
MACAULLY ST., HUDDERSFIELD  
Tel. 341. Grams: THOROUGH HUDDERSFIELD.

Orders 5/6 Value  
Carriage Paid.  
Under 5/6  
2d. per 1/-  
for Packing, etc.

**A NEW BATTERY CHARGE INDICATOR CHASLYN VENT TYPE HYDROMETER**  
(Pat. applied for.)

For high and low tension accumulators which is left permanently on the battery during discharge.

Always on View. No Mess. Checks Faulty Charging. Increases Life of Battery. Easy to see. Simple to read. No bothersome scales No burden on memory.

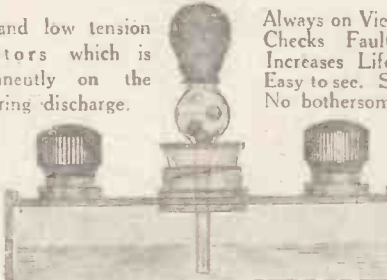

**PRICE 1/6 EACH Post Free.**

Full-Size CHASLYN HYDROMETERS Price Each 3/- Post Free.

**J. H. COLLIE & Co., 10, Canning Place, LIVERPOOL**

**ELECTRIC SOLDERING IRON**

For constructing your New Set -

In Various Sizes

Send PO for 10/- and the Iron will be forwarded Post Free State Voltage

**S. WOLF & CO., LTD.,**  
Specialists in Electric Tools for over 20 Years  
115 SOUTHWARK ST., S.E.1.,  
Telephone - Central 5172 and Hop 2734.



**"YPLAT" Low-Loss Aerial Wire.**

How many New Year resolutions have you broken!!! What about that aerial? You can't go wrong if you order "YPLAT." Every complete turn in aerial wire consisting of a number of twisted wires offers a small induction resistance. By plating together a number of wires, as in "YPLAT," this is done away with, making the resistance very low.

"YPLAT" consists of 16 strands 28 S.W.G. plated, plated copper wire, and it is sold in boxes of 110 feet, price 5/-.

If your wireless dealer can't supply you send 5/- to:—  
**LANG & SQUIRE Ltd., Dynamo & Motor Manufacturers, ACTON, W.3.**

**FORMO**

**A MONUMENT IN THE MARCH OF PROGRESS**  
The Formo Shrouded Transformer is the universal favourite.  
Made in Ratios 1-1, 1-2, 1-3, 1-4 and 1-5  
10/6 1-3 and 1-5 for 1st and 2nd stages

Send for Catalogue and Descriptive Literature of Complete Formo Range  
**THE FORMO COMPANY**  
Crown Works, Cricklewood, N.W.2  
Phone: Hampstead 1787.  
Manchester: Mr. J. B. Levee, 23, Harry St., Levenshulme.  
Phone: Heaton Moor 475.



**\*RADIOTORIAL  
QUESTIONS AND ANSWERS**

(Continued from page 1330.)

**WAVE-LENGTHS OF ANODE COIL.**

"CALIBRATE" (Smethwick).—What are the maximum and minimum wave-lengths to which a 50-turn and a 100-turn basket coil will reach when tuned by a .0003 condenser? (For tuned anode.)

The 50-turn coil will tune from approximately 175 metres to 475 metres in the anode circuit. The corresponding figures for the 100-turn coil will be approximately 365 and 1,040 metres.

**H.T. BATTERY ELIMINATOR FOR A.C. MAINS.**

"JUICE" (Sunderland).—I recently purchased a copy of "P.W." (No. 240), and found in it a list of the parts necessary to make up a good H.T. Battery Eliminator, for use on A.C. mains.

I should like to make this up and so once and for all get rid of the trouble and expense of H.T. Battery renewal.

How are the various parts named in the list connected together, and do you think I could make the special transformer and the potential divider at home, with a good chance of success?

The connections for this H.T. Eliminator for A.C. mains were given in a diagram, published in the "Radiatorial" column of "P.W.", No. 239. (If this issue is unobtainable locally, application should be made to The Amalgamated Press, Ltd., Back Number Dept., Bear Alley, Farringdon Street, London, E.C.4, enclosing 4d. in stamps.)

We do not recommend you to attempt to make the transformer or the potential divider at home. The former, especially, is really a factory job, and the components used in the original Eliminator, described in "P.W." No. 227, were very satisfactory, and would probably have cost quite as much if made at home. (Both the potential divider and transformer used in the original model were "Climax" products.)

**RESTORING AN '06 VALVE.**

"ACCIDENT" (Liverpool).—The other day I dropped a basket coil into my set by accident and its ends fell across the leads, causing one of my '06 valves to light up like a bright emitter. Now the valve won't work, but I hear it can be brought to life again. Is this correct?

Yes, it often happens that a valve of the '06 type, which has been subjected to too much filament voltage, can be restored to service.

The method is to light the valve, at its correct filament voltage (for a period of from half an hour to three hours) with no H.T. connected to the set. Very often this simple procedure effects a complete cure.

**H.F. TRANSFORMER CONNECTIONS.**

S. I. D. (Rotherham, Yorks).—Recently my plug-in barrel-type H.F. transformer "went west," and I bought another, marked like the first (300/600 metres) but of different make. The new one is not half as good as the old. Why is that?

Probably its windings are arranged differently, and you are not getting the best from it with your present wiring. Try the effect of changing over your leads to the transformer primary (and for the secondary) sockets. When the correct relations of input and output connections have been found, you will probably get much better results.

**COUNTING THE NUMBER OF TURNS IN SPIDER-WEB COILS.**

"PUZZLED" (Framlingham, Suffolk).—How do you count the "number of turns" in a home-made spider-web coil? They only seem about half the number of actual turns that are wound on.

Once round the former constitutes one turn. In the ordinary spider-web coil the completed turns are arranged half on one side of the former, and half on the other at any given section of the coil. So if you lie the coil flat, and count the wires down from the outer diameter to the centre of the coil, multiplying this number by two, you will get the correct number of turns in the coil.

**GAXTON WIRELESS CABINETS**

All Polished with new enamel that gives a glass hard surface that cannot be soiled or scratched. Ebonite or Radion Panels Supplied and Perfectly Fitted at low extra cost. SENT FREE.—Catalogue of Standard Wireless Cabinets in various sizes and woods.

**THOUSANDS OF SATISFIED CUSTOMERS.**

**ELSTREE SOLODYNE.** Panel 21" x 7" fitted 16" Baseboard, drop down Beaded Front Door. Fumed Oak 61/-, Dark Oak 65/-, Mahogany polished 68/6. Raised Panel 5/- extra. Packing Case 5/- extra.

**ELSTREE SIX.** Panel 42" x 9" fitted 13 1/2" Baseboard. Open Type. Fumed or Dark Oak 80/-, Mahogany polished 90/-, Packing Case 7/6 extra.

**MONODIAL.** Panel 14" x 7" fitted 14" Baseboard. Fumed Oak 33/6, Dark Oak 35/-, Mahogany polished 39/6. Packing Case 6/- extra.

**NIGHT HAWK.** Panel 16" x 8" fitted 14" Baseboard. Open Type. Fumed Oak 33/6, Dark Oak 35/-, Mahogany polished 39/6. Packing Case 7/- extra.

**FIVE FIFTEEN.** Panel 24" x 7" fitted 8 3/4" Baseboard two Front Doors. Fumed Oak 40/-, Dark Oak 42/6, Mahogany polished 48/-, Packing Case 7/6 extra.

**THE 1927 FIVE.** Panel 27 3/4" x 7" Sloping Front, as originally described. Fumed or Dark Oak 38/-, Mahogany polished 48/-, Packing Case 7/6 extra.

**EVERYMAN THREE.** Panel 20" x 8" fitted 8" Baseboard. Fumed Oak 33/6, Dark Oak 35/-, Mahogany polished 39/6. Packing Case 6/- extra.

**EVERYMAN FOUR.** Panel 26" x 8" fitted 8" Baseboard. Fumed Oak 35/6, Dark Oak 37/6, Mahogany polished 41/6. Packing Case 7/- extra.

**CASH WITH ORDER. CARRIAGE PAID U.K. PROMPT DELIVERY.**

Packing Case Money repaid if Case returned within 14 days  
Carriage paid to Works.

**CAXTON WOOD TURNERY CO., MARKET HARBOROUGH**

**GAMBRELL**

**B and E**

Both Centre Tapped

ARE WAITING FOR YOU.

We have ample supplies of the centre tapped coils and Neutrovernias for use in the

**MULLARD P.M. CIRCUITS.**

Insist on your dealer supplying these.

If any difficulty write us.  
Apply for Free descriptive booklet.

**GAMBRELL BROS. LTD.**  
76, Victoria Street, London, S.W.1

Parr's Ad

**EASY PAYMENTS**

Finest 2-valve amplifier set, including loud speaker, 120 H.T., D.E. valves, £7 10s.; or 18/9 down and 11 instalments of 15/.

**CASH BARGAINS**

Amplifiers, 17/6 and 21/-. 'Phones, Telefunken type, 7/9; Fr. T. Houston, 11/-. H.T.: 'Reliance', 65-v., 8/6; or 41-v. (laboratory test), 4/- doz. 'Reliance' Dry Cells, 100 amp. hours, 1/8. Famous Metal Valves (French), 2-v. 2, 5/-; 2-v. '06, 5/9; 2-v. '5, Power, 8/9; 4-v. '06, 5/6. Straight Line Condensers, 5/9. Ditto, 4" dial, 7/3. Transformers: Habano, 4/8; Croix, 3/5; Brunet, 7/8. Postage extra. Everything in wireless reliable and cheap. Satisfaction or cash refunded.—Music Roll & Gramophone Records Exchange, 29, High Street, Clapham, London, S.W.4.



Size: 2 1/2" high, 1 1/2" sq.

**WET (Leclanche Type) H.T. BATTERIES.**

**CAPACITY DETAILS:** The Standard Sac Element will give a current of 7 milli-amperes for 6 hours a day; the Large Sac Element will give a current of 14 milli-amperes for 6 hours a day. The first cost of complete cells fitted with Standard Sac Elements, including 9 months upkeep, is under 3d. a volt. With the Large Sac it is 4d. a volt. The construction is simplicity itself. Send 1d. stamp for full particulars. Prices: Jars (waxed).....per doz. 1/3 Standard Sac, with terminals.....per doz. 2/3 Large Sac, with terminals.....per doz. 3/9 Standard Sac.....per doz. 1/6 Large Sac.....per doz. 3/9 Carriage Extra. Full instructions for assembling sent with each order.

**WET H.T. BATTERY Co., 23, Coldharbour Lane, Camberwell Green, S.E.5.**  
Phone: Brixton 2539.

EVERY WIRELESS COMPONENT IN STOCK

GET IT BY POST FROM  
Young's Wireless Ltd  
40 Stockwell St  
Glasgow

100-PAGE CATALOGUE FREE WRITE NOW!

**TRANSFORMERS REWOUND**

Transformers, Phones, Loudspeakers, Rewound and Repaired to Maximum Efficiency. All One Price 4/- each. Don't discard if burnt out. All work guaranteed for 12 months. Write for trade terms. TRANSFORM CO., 115 LINKS RD., TOOTING, LONDON S.W.17



**BUILD A LOUDSPEAKER**

**THE SEAMLESS CONE**

(Prov. Patent 25069/26)

and a Brown A Earpiece, or Lissensola with Reed, will enable you to construct a CONE LOUDSPEAKER, which will give you unsurpassable results. These Cones are unequalled for purity of reproduction, the high and lower registers being equally rendered.

Do not be put off with the ORDINARY PARCHEMENT CONE, having a Seam Join. EXTRACTS from UNSOLICITED TESTIMONIALS: PIRBRIGHT, SURREY: "It is an excellent article and gives very good results." SPALDING, LINDSAY: "I am more than satisfied with the results." SHEFFIELD: "I have had one of the £7/7/0 Loudspeakers, and have no hesitation in saying that for its size its Seamless Cone is much better." BRISTOL: "The Seamless Conical Diaphragm received yesterday works fine."

Illustrated Lists and particulars for Stamp. GOODMANS, 27, Farringdon Street, E.C.4. Also obtainable from Spence's Stores, 43 Nelson's Av., E.C.2

**ALL APPLICATIONS FOR ADVERTISING SPACE IN "POPULAR WIRELESS" MUST BE MADE TO THE SOLE ADVERTISING AGENTS JOHN H. LILE, LTD., 4, LUDGATE CIRCUS, LONDON, E.C.4**

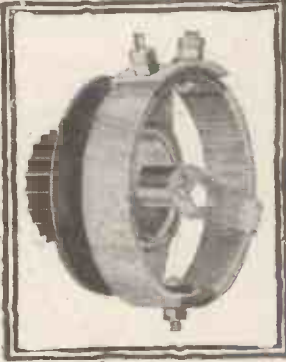

## bright & dull emitter valves

There are two windings on this one Rheostat—one of a 6 ohm resistance and a continuation of this on to a 30 ohm strip winding. This has been specially made to meet the demand for a thoroughly reliable Rheostat covering needs of both bright and dull emitter valves. The resistance wire is wound on hard fibre strip under great tension and is immune from damage. The popular one-hole fixing method is provided and the terminals are conveniently placed. Contact arm has a smooth silky action. All metal parts nickel plated. Complete with ebonite combined knob and dial.

### The 'PEERLESS' DUAL RHEOSTAT

PRICE 3/9 EACH

From all dealers or direct from—

**The Bedford Electrical & Radio Co Ltd**  
22, Campbell Road, Bedford.

## CORRESPONDENCE.

Letters from readers discussing interesting and topical wireless events, or recording unusual experiences, are always welcomed; but it must be clearly understood that the publication of such does in no way indicate that we associate ourselves with the views expressed by our correspondents, and we cannot accept any responsibility for information given.—Editor.

### PURE REPRODUCTION.

The Editor, POPULAR WIRELESS.

Dear Sir.—On page 1,108 of your issue for January 1st, under the above sub-heading, a contributor enquires as to whom has evolved a transformer which will give amplification equal as regards quality to best resistance coupling, and this raises the query as to the existence of resistance coupling which gives straight-line amplification.

The writer has not yet come across any form of commercial resistance coupling which, when used in the manner specified by the makers, does actually give straight-line amplification at all musical frequencies, and, in fact, he knows that the AF3 transformer manufactured by Ferranti, Ltd., is capable of giving musical results not only superior to commercial resistance coupling units but also appreciably greater amplification.

It seems to the writer of this letter about time that the idea that resistance coupling gives the purest possible reproduction was exploded. It was, of course, the case until good transformers became available, and legends of this kind take a long time to die, but if anyone compares two sets, the one resistance-coupled and the other coupled by means of transformers of the type indicated, he will be agreeably surprised at the superior performance exhibited by the transformer-coupled amplifier.

Yours faithfully,

J. BAGGS.

47, Northfield Road,  
New Moston,  
Manchester.

### THE HALE CIRCUIT.

The Editor, POPULAR WIRELESS.

Dear Sir.—Perhaps you will be interested to hear of a curious experience I had with the 2-valve Hale circuit on a Sunday afternoon recently.

I had hooked up this circuit on a panel much used for experimenting, and on trying it out I found that I was unable to pick up any broadcasting. I disconnected the grid-bias battery, and was surprised to hear voices with a distinct American twang. These, I eventually found, were speaking from London and adjusting a telephone circuit, which I afterwards gathered belonged to the Anglo-American Telephone Service. Following the adjustments a lady at the London exchange called New York, and at intervals put various telephone officials in this country in touch with (I believe) officials of the service of New York. I removed the aerial coil and found that reception was not interfered with, and was thus coming in on the reaction coil. Putting the crystal out of action made no difference, and I received equally well on different sized coils.

After spending an interesting hour in this manner, I concluded that something was wrong, and proceeded to investigate. I found that I had omitted to earth the L.T. and reaction condenser.

Yours faithfully,

A. E. IRVING.

Brigham Road,  
Cockermouth,  
Cumberland.

The Editor, POPULAR WIRELESS.

Dear Sir.—After reading so many good accounts of the Hale circuit, I ventured to strip my 3-valver, which was the same circuit as your Suburban Three ("P.W.," June 19th, 1926), and the results from the set were wonderful. Many stations, English and foreign, I have had at good loud-speaker strength, and I was determined not to depart from it. However, the glowing letters of the Hale have led me to make the "Two Valver," and thanks to Mr. Hale I am more than delighted with its performance. In fact, the volume it throws out is really astounding, and very excellent music is obtained and speech wonderfully clear. Last evening I tuned in seven foreign stations in as many minutes, and afterwards got four on the speaker (Amplion Junior) at good strength, quite clear and audible.

I am using the swing reaction coil, but later on shall try Reinartz reaction, which no doubt makes a great improvement. In my "Guaranteed Two-Valver" I have two resistances, and separate H.T.+ for each valve, one R.F. and one Eureka No. 2 transformers, using two Marconi D.E. 3 valves, Q6, and a "Liberty" permanent detector. The fixed condenser across the primary of first transformer makes no difference. The transformers have been in use over two years, the valves about 10 months, and the crystal detector about 2½ years. Radio-Paris came through very clear on the speaker, when Daventry (7 miles from here) was not working.

(Continued on page 1336.)

## BARGAINS No. 315A

WIRES at half prices. Heavy Twin Flex, 2/6 doz. yds., post 3d. Light Twin Flex, 2/- doz. yds., post 3d. 4-way Flex, 3/- doz. yds.; post 4d. Rubber Vul. Lead-in wire, 1/3 per doz. yds., post 3d. 5/36 Single Flex, silk braid covered for Frame Aerial wiring, 1/3 doz. yds., post 3d. Pos. and Neg. col. Flex, 2/6 doz. yds.

POLAR SURPLUS, ALL NEW. Precision Condensers, .003 mf., 4/8. Panel 3-gang Triple, 10/-, Polar Rheos, 1/3. Polar Panel, 2-way Coil Holders, 2/9. Polar Varia H.F. Transformers 300/500, 3/8. I.F. Inter-valve, 7/6. Polar Variometer panel and dial, List 21/-. Sale, 8/6. Polar Detectors Everest, 1/9.

PLUGS AND JACK, 2/6 pair. One hole, 3/- pair. 4-pin Lucas, Plug and Sockets, 4/-; Panel 2-pin Base and Plug, 8d. Switches—D.P.D.T. Panel, 1/-, S.P.D.T. Panel, 9d. On and off Switch, 1/-. Double Switch, 2/-. Tumbler, 1/-. Push and Pull, 1/-. Dewars 1-way, 1/6; 3-way, 2/6; Electric Switch Adaptors, 5d.

VARIOMETERS, B.C.C. Ebonite former, silk, 3/11. Our famous D.C.C., 1/9. Aerial Inductance to taps to plug terminals on Ebonite Panel. Low Loss Plug-in Coils, 35, 50, 100, 150, 200, 1/3 each. Sq. Law Low Loss .0005 at half price, 4/8 Dial and Knob.

ELECTRIC HEATERS, Immersion, 4/-; Hot-plates, 7/8; Irons, 10/-; Massage Vibrator Sets, list £4. Sale, 21/6.

SUNDRIES, Adhesive Tape, 41. Breast Drills, 3/11. Window Shades, 4d. A. Holders, 4d. Basket Coil Holders, 101d., 1/-. 6-ft. Phone Cords, 1/-, 1/3, 1/8. Loud Speaker Cords, 1/8. Fixed Resistors on Mica, 6d. Cabinet door fila. contacts, 1/-. Spade Tags, 6 a 1d. Staples; 5 a 1d. Switch Arms and Studs, 1/-. Wander Plugs, 2d., 3d., 4d. pair. Ins. Hooks or Egg Insulators, 2 for 1d. Bus Bar, 1/- per doz. 2-ft. lengths.

GADGETS A.C. Telephone hand magneto, 50 volts, 6/8. Fixed Mica Dubilier condensers, .005, .02, .03, .05 and .01, 2/6. Dubil. Anode Res., 20,000 to 100,000 ohms, 3/8. Duconette House Aerials, plug in lighting socket, 2/8. Burglar alarms, 1/-. LAMP BATTERY CHARGERS, with pole indicator D.C. No. 1261, price 7/8. A.C. to D.C., £3 10 0. EBONITE "GRADE A," cut while you wait; 3-16 at 1d. per sq. in.; 1/4 in. at 1d.

**ELECTRADIX RADIOS,**  
218, Upper Thames Street, E.C.4.

## A HOME FOR YOUR WIRELESS SET

OUR STANDARD CABINETS

are DUSTPROOF and house the whole apparatus, leaving no parts to be interfered with. All you do is UNLOCK & TUNE IN. Made on mass production lines, hence the low price. Provision is made to take panels from 16 x 7 up to 30 x 18 in.

Carriage paid and packed free England and Wales. Thousands supplied with full satisfaction.

MAKERIMPORT Co.



From £4 15 0. Write to-day for descriptive pamphlet and suggestions for adapting your receiver or panel in our Standard Cabinets. Immediate Delivery. Dept. 5, Melville Chambers, 55a, Lord St., LIVERPOOL.

## "2 for a Bob" (Post Free)

Try this in your Hale Circuits.

The "CLEAR STONE" mineral combination

Refills for all makes of Permanent Detectors. Sufficient for two Detectors. Wood's Metal Free. Positively the Loudest Results on Earth.

S. LYONS, 119, Clerkenwell Road, E.C.1.

## RADIO REGISTERED PANELS

Inches	Inches
7 x 5, 1/-	6 x 6, 1/-
7 x 6, 1/3	8 x 5, 1/2
8 x 6, 1/4	9 x 6, 1/7
10 x 8, 2/1	11 x 3, 2/3
10 x 9, 2/4	12 x 8, 2/6
12 x 10, 3/-	12 x 9, 2/10
14 x 12, 4/-	14 x 10, 3/5
	1 1/2 in. thick
	Post Free.

Money back guarantee that each and all Panels are free from surface leakage. Megger test Infinitely. Callers cut any size. Quotations by post, or phone Clerkenwell 2852. Samples and prices post free to the Trade.

CROXSONIA CO., 10, South St., MOORGATE, E.C.3

# Help British Trade

A LEADING Trade Paper, after remarking on the "excellent results" of "Voltron" valves on test, continues: "These valves are marketed at very reasonable prices—there should be no reason why the public should not have to buy valves of foreign origin.

British valves are the best in the world and no "Voltron" valve leaves the factory until it is worthy of the mark—BRITISH MADE.

"Voltron" high vacuum three-stage pumping ensures the long life and uniformity of results obtained only with the more expensive valves.

Experts choose "Voltron" valves for super-hot work—Voltron Valves will improve any sets. Should any "Voltron" valve fail to give satisfaction, owing to faulty workmanship, it will be replaced on request provided filament is intact.

<b>THERE'S ONE FOR EVERY STAGE.</b>		<b>DULL EMITTER, POWER VALVES.</b>	
Type 202. 1.8-2 volt 2 amp. ....	5/9	Type LS2 (P2) 1.8-2 volt .....	9/-
LC2. 1.8-2 .. 06 ..	7/6	P4 3-4 ..	10/9
LC4. 3.5-4 .. 06 ..	7/6	P6 5-6 ..	12/-

The above types are in two classes: RED STAR (H.F. and Detector); GREEN STAR (L.F.). Get "Voltrons" from your dealer or direct from—

**THE VOLTRON CO., 169, City Road, E.C.1.**

Technical folder on request. Phone: Clerkenwell 1081.

BRITISH MADE DULL EMITTER FROM 5/9



# VOLTRON

## KINGSWAY RADIO, LTD.

92, CANNON STREET, LONDON, E.C.4  
CITY 9158.

**The City Firm for Wireless**  
Officially appointed Dealers and Repairers by the Radio Association.

The Edison & Swan "Threesome" constructional Booklet, Free Units for above, 7/-; Cabinets, 10/6; Terminal Strips, 2/-; Cosmos R.C.C. units in stock, 10/6.

All complete sets of components purchased, wired up free of charge. We stock a complete range of small tools suitable for Wireless work.

**VALVES:** Marconi, Osram, Cosmor, Mullard, Scott-Taggart, and Ediswan in stock. Special line of valves, Micro Radio, .06, 3 1/2 v., 6/6; 2 v., 6/6; Power, 10/6.

**L.F. TRANSFORMERS:** R.I., 25/-; Ferranti, A.F.4, 17/6; A.E.3, 25/-; Igranic, 5-1, 16/-; 3-1, 15/-; Lissen, 3/6; Formo, 10/6; Powerquip, 10/6; Brunet, 7/6; Croix, 3/6; Lissen H.F. and L.F. Chokes, 10/-.

**BATTERIES** (Delivered from works weekly): Ever Ready, Siemens, Hellesen, 100 v., 21/-; Adico, 100 v., 13/6; Ever Ready, Siemens, 12/6 & 9/6; Lissen, 60 v., 7/11 & 10/6; Adico, 7/6; 36 v. Ever Ready, 7/6; Adico, 4/6.

Flash Lamp batteries, Ever Ready, 6d.; Adico, 4/1d.

**H.T. ACCUMULATORS:** Ever Ready and Exide 20 volt dry charged, 15/-.

**L.T. ACCUMULATORS:** 2 v. 40, 10/-; 2 v. 60, 12/6; Exide D.T.G., 4/8; D.F.G., 8/6; 4 v. 40, 17/6; 4 v. 60, 21/-; 6 v. 40, 26/6; 6 v. 60, 33/-.

**BATTERY ELIMINATORS:** Ecko D.C., 42/- & 55/-; D.C., £6 10s.; H.T.C., £6 6s.

**CABINETS:** Over 50 sizes and types in stock, any type made to order.

**EBONITE:** Machine cut, ground edges, to any size. Resistor Panels in stock.

The famous Croxsonia Panels all sizes in stock, 1d. per square inch.

**VAR. CONDENSERS:** G.E.C., Igranic, Sterling, Bowyer-Lowe, Jackson, Ormond.

**CYLDON and ORMOND** triple in stock.

Special line Straight line var. Cond., .0005, 6/-; .0008, 5/9.

**HEADPHONES:** Ericsson, Sterling, G.E.C., Brown's, 20/-; B.T.H., 15/-; Telefunken, 17/6; Ericsson Continental, 12/6. Good 'Phones at 8/6 & 6/6.

**LOUD SPEAKERS:** Amplion A.R. 38, 38/-; A.R. 111, 48/-; A.R. 05, 05/-; Brown H4, 30/-; H3, 60/-; Lissenola, 13/6; also Speakers by Priory, B.T.H. and G.E.C. Cabinet Speakers all in stock.

**COILS:** Igranic, Edison Bell, Lissen, Lewcross and Colvern, Screens and 6 Pin Bases, also Dimic and specially wound Coils.

**CRYSTAL DETECTORS:** R.I., 6/-; Brownie, 3/-; Volso, 2/6.

**VALVE HOLDERS:** Harlie, 1/6; Lotus, 2/3; Benjamin, 2/9; all antiphonic.

**FIXED CONDENSERS:** Edison Bell, .001-.0006, 1/-; .002-.006, 1/8; Grid leaks, 1/-; Dubilier, .0001-.0006, 2/6; .001-.006, 3/-; Grid leaks, 2/6; Lissen, same as Edison Bell.

**VOLT and AMP. METERS:** Many types from 4/6.

Sets rewired, repaired and modernised, lowest prices. Nickel-plated Screws, Terminals, etc. in stock. Aerial Wire, Strainers, Mast Rings, Earth Mats, Earth Tubes, etc., all in stock. Carriage paid on all goods over 2/6, excepting Batteries, Accumulators. Send for Catalogue. We also stock Baby Pathé Projectors, Accessories and Films.

## No Overcrowding!

says this Eureka Ortho-cyclic Condenser

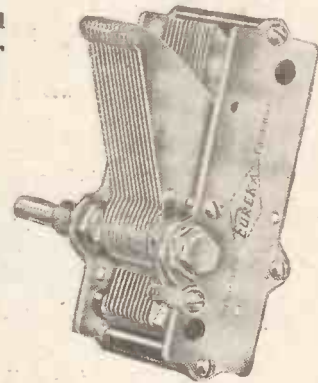

Under the new Geneva wavelength plan, Great Britain receives nine exclusive wavelengths. But there is to be a separation of 10 kilocycles between each wavelength. Metres have been ignored in these calculations. The Eureka Condenser also abandons metres and deals with kilocycles. It gives ortho-cyclic tuning—an even separation between wavelengths no matter where they may appear on the dial—crowding is impossible. With the Eureka Ortho-cyclic 10 degrees cover 10 wavelengths precisely. What a difference from the ordinary Condenser which crowds as many as 39 wavelengths into the same 10 de-

grees. Practically 4 wavelengths to every degree on the dial; while the last 10 degrees will barely span 2 wavelengths. The new conditions of Broadcasting demand the use of a Eureka Ortho-cyclic with its even separation, step by step, all the way up the scale.

FROM ALL DEALERS.

14/6 .0003 mfd. and .0005 mfd. 14/6

# EUREKA

ORTHO-CYCLIC

Advt. Portable Utilities Co., Ltd., Fisher Street, W.C.1.

G. A 7426

**CORRESPONDENCE**

(Continued from page 1334.)

**2 'things  
more useful'**

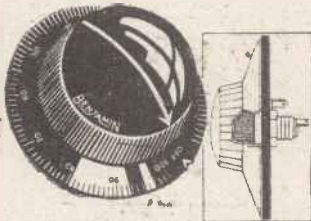

**self contained  
Rheostat**

THE RESISTANCE windings are built inside the 2 1/2" dial of this ingenious BENJAMIN Rheostat. The lock-nut and soldering tags occupy no more than 7/16" space at the back of the panel. So panel space is saved, wiring is made easier and the look of the set improved. Very fine adjustments of current are possible; the nickel-plated pointer and the 0 to 100 markings on the Bakelite dial facilitate this. One hole fixing standardised.

There are 3 types of the BENJAMIN self-contained Rheostat - 6, 15 and 30 ohms. Each **2/9**

**Battery switch**

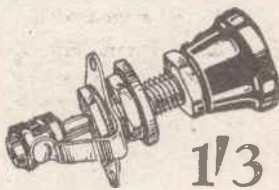

This BENJAMIN off and on Battery Switch is the simplest you can buy. No parts to get out of order. Neat and unobtrusive Bakelite knob. Nickel-plated metal components. Soldering tags. Overall measurement 1 1/8". It's off when it's in

**BENJAMIN**

Makers of things more useful

THE BENJAMIN ELECTRIC LTD.  
Brentwood Works, Tariff Road,  
Tottenham, N.11.

Any readers of "P.W." who may be in doubt as to the "Guaranteed Tuning" performance, can take it from me that their labours in making this set will be greatly rewarded.

The wet battery for H.T. work in the same issue of "P.W." I have made up and it is giving excellent results. Total cost for 5 dozen cells and zincs, 6s. 10d. Each cell giving approximately 1.4 volts.

Thanks to Mr. Hale, and also to POPULAR WIRELESS for being able to give us amateurs such good information. Wishing you all a bright and successful New Year.

Yours faithfully,  
C. GRIFFIN.

7, Colwyn Road,  
Northampton.

**SHORT-WAVE TELEPHONY.**

The Editor, POPULAR WIRELESS.

Dear Sir,—Short-wave telephony on about 45 metres may be heard during the day from R.A.F. portable stations engaged in the training of pilots. The stations use fancy calls, such as Hereford, Nightingale, Buffalo, etc. Koenigs-wusterhausen may be heard daily from 3 p.m. onwards; Simmond's receiver easily separates it from the above stations.

The Mount Valerian station, Paris, mentioned a few weeks ago, has the call O C M V and a wave-length of 39 metres. It can be heard at various times until midnight, usually transmitting gramophone records.

Yours faithfully,  
W. W. WOODMAN.

61, Hanover Road,  
Willesden, N.W.10.

**THE GUARANTEED REFLEX.**

The Editor, POPULAR WIRELESS.

Dear Sir,—It may be of interest to you to give particulars of successful reception on short-wave length, using the "Guaranteed Reflex" based on the Hale circuit. Clear reception at about crystal set strength was obtained on three successive nights from K D K A on 68 metres. I give below particulars of programmes received. The set used was made up on a baseboard with front ebonite panel. Components used: Lissen (new) transformers, Ormond 0005 condenser, Burndy detector with Geocite crystal, Cosmos Redspot valves.

The coils used were Igranite short-wave; instead of using the aerial terminal, the aerial lead was attached by means of a spring clip to the fourth turn of the aerial coil, which was the Igranite six-turn coil, the reaction coil being also an Igranite, 9-turn. The coil holder was a standard swinging coil variety. Two things of importance were evident during operation: viz. the crystal setting, and the fixed condenser value of .002 across phones.

After this successful reception on the roughly wired set, I have converted a standard S.T. 100 set to Hale, and using the same coils as in the original set, have received K D K A on two occasions, so far at not quite such good strength, yet quite clearly.

On the converted set also, I have received a station, possibly W G Y, on 32.79 metres, but distorted with bad fading. Coils used for this were aerial, 4 turns tapped at 3rd turn; reaction, 9 turns.

Yours truly,  
"C.L."

Birmingham.

**WHAT DYNAMIC CURVES MEAN.**

The Editor, POPULAR WIRELESS.

Dear Sir,—I have read with interest the article by Mr. John Scott Taggart in your good paper, and have the following remarks to make in connection with the subject he broaches, entitled "Dynamic Curves."

(1) The dynamic curve shown in Fig. 3 is incorrect. (2) A dynamic curve is an ellipse, whereas the line shown is presumably the axis of the ellipse.

It is therefore fairly obvious that no true dynamic curve has been given, nor any idea how to get one.

Your contributor states that ordinary published valve graphs are unreliable. This is not so. Anyone pretending to any knowledge of dynamic curves is able to picture from the ordinary static curves what the dynamic curves would be like.

In addition, the writer of the article does not attempt to show the ideal dynamic curve. He gives wrong impressions, for, from his figure, one would imagine a much longer grid base than actually exists.

Yours faithfully,  
G. D. ROYDS.

Hill o' Thrane,  
Wray Lane, Reigate.

**BUY BRITISH!**

The Editor, POPULAR WIRELESS.

Dear Sir,—I think it right to let you know of the courteous and considerate treatment it has been my privilege to receive from the Mullard Wireless Service Co., Ltd.

I have, on a few occasions, returned a valve which I did not consider to be quite normal in all respects, and the above company have always given full regard to any report I have made, and in all cases so far have forwarded free replacements without demur.

I think, therefore, one is justified in advocating the support of this firm.

Yours faithfully,  
G. NASH.

Post Office House, Crail, Fife.

**GRAVES  
2-VALVE  
LOUD SPEAKER BARGAIN.**

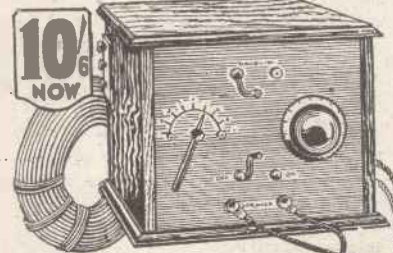

This highly efficient 2-Valve Loud-Speaker set is the finest wireless value ever offered.

It gives a volume and quality of tone unattained by any instrument of a similar price and is the essence of simplicity. Fitted with coils covering all the British wave-lengths, including Daventry

THE CABINET is of beautifully polished Oak, & all components are of the highest quality. Dull Emitter Valves with patent valve holders, &c. H.T. Battery, 2-volt accumulator and complete Aerial Outfit. LOUD SPEAKER of exclusive design with unique magnetic system and improved mica diaphragm. Price **£7:17:6**

TERMS: Our Bargain Price is for deferred payments. Send 10/6 now, & complete purchase in 14 monthly payments of 10/6. If you wish to pay cash, 5 percent discount allowed. Catalogue Post Free. Up-to-date Crystal & Valve sets at keenest prices.

J. G. Graves Ltd. Sheffield

Fullest Approval



Of proved efficiency

WIRELESS.—Capable, trustworthy men with spare time who wish to substantially increase income, required where we are not fully represented. Applicants must have practical knowledge of installation of Set and Aerial, be a householder or live with parents, and be able to give references: state age and experience. Address: Dept. 10, General Radio Company, Limited, Radio House, Regent Street, London, W.1.

**WET H.T. BATTERIES**

BUY BRITISH Complete Units 3/6 per doz. All goods BRITISH MADE BY BRITISH LABOUR. Jars 1/3, Zincs 1/-, Sacs 1/6 per doz. Carriage and Packing extra. Trade inquiries invited.—Deimon Battery Co., 59, Balldis Rd., Walthamstow, E.17

**EBONITE BUSHES**

FOR MOUNTING ON WOOD. PERFECT INSULATION. Orders under 1/- send 1/4d. postage. Two required for each hole.

NUMBER 0 1 2 3 4 5 6  
Hole in Bush... 6BA, 4BA, 2BA, 1/4", 5/16", 3/8", 7/16"  
Price each: 1d. 1d. 1d. 1 1/2d. 2d. 2d. 2d.

DAREX RADIO CO.,  
Waldram Road, Forest Hill, London, S.E.23

TRADE SUPPLIED

**EVERY LOUDSPEAKER**

**DESERVES  
MULLARD  
MASTER  
VALVES**

— Ask for —  
Mullard P. M. Power Valves.

# CLIX

THE PRICE IS SO SMALL



**CLIX PIN TERMINALS**

An exceptionally useful pin for use where terminals are already fitted. **2d.**

**CLIX PARALLEL PLUGS AND SOCKETS**

Designed to combine cheapness with efficiency. Because of their resiliency they can always be relied upon to make perfect contact.

Plugs **2d.** Sockets **1d.**



Both the fittings illustrated are Nickel-plated. They are obtainable with red or black insulators, patent wiring channels, and are typical of the exceptional value and utility offered in all

**CLIX PRODUCTS**

**AUTOVEYORS, LIMITED.**

84, Victoria Street, Westminster, S.W.1.

Phone: Victoria 309.

Telegrams: "Autoveyor," Sowsel, London

**H.B.H. REMOTE CONTROL SWITCH**



*The*  
**MASTER SWITCH**

At last, real armchair control of your set. This switch gives absolute control over the set from any distance, and from any number of points simply with ordinary bell-pushes and flex. Wherever you have the loud speaker, you can have a bell-push controlling your set.

The switch is inserted between the L.T. supply and the set, and close handy to the set. Bell flex is extended as required. To start or stop the set simply press one of the bell-pushes. A small lever on the control switch gives local control of the set independent of the bell-pushes.

The secret lies in the ingenious arrangement of the magnetically controlled contacts contained in the switch. Invaluable to those wishing to hear the last few items of the programme in bed, whence they are able to turn their set on or off.

Fully guaranteed for one year, provided the switch has not been tampered with.

Price 21/- post free from the makers. A novel form of grip contact, to be used in place of bell-pushes; can also be supplied at 10d. each in Black, or 1/- each coloured.

**GOSWELL ENGINEERING CO., LTD.,**  
95/98, WHITE LION STREET . . . LONDON, N.1

Telephone: North 3051.

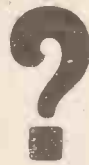

**WHY**

DOES THE ACCUMULATOR EXPERT INSIST ON

**"VARTA"**

THE ORIGINAL H.T. MONOBLOCK

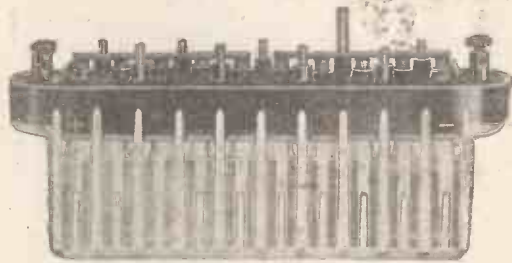

IT IS BECAUSE THE EFFICIENCY OF THE VARTA IS UNSURPASSED.

BEWARE OF INFERIOR IMITATIONS

Advt. A.F.A. Accumulators, Ltd., 9a, Diana Place, Euston Rd., London, N.W.1.

**VARTA**



*Truest to Nature*

Being able to 'forget' that the Ether is the medium and a loudspeaker the reproducer, is as near to the ideal of television as is obtainable to-day.

The Claritone enables one to visualise the very scene, some great mind was inspired to portray in harmony.



W287 Reflex Model  
£4 : 10 : 0



**CLARITONE**

LOUD SPEAKERS & HEAD PHONES

Advt. of Ashley Wireless Telephone Co. (1925) Ltd., Liverpool.

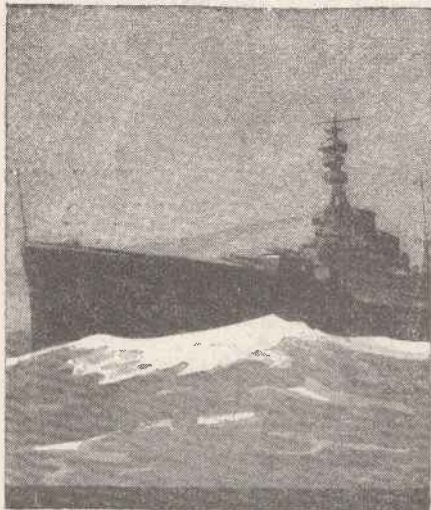

**FRANKLIN  
NELSON  
RODNEY  
GRENVILLE**

**N**AMES that are the personification of action. In war and peace the need has always found the man, and today in the radio world the name Mullard implies decisive progress.

Radio appeals to the million. Mullard has brought radio within reach of the million. The Franklin, Rodney, Nelson and Grenville P.M. Receivers are the result of the remarkable success achieved by the Mullard P.M. Valves, and the research, construction and organisation which has made the finest valve is the basis of the Mullard Ever-Rest Wire Wound Anode Resistance.

A Resistance wound on a textile fibre core, perfectly covered and interlaced with the same material, eliminating all self capacity, and also renders the fine metallic wire free from every particle of mechanical shock.

The temperature coefficient is negligible, since the resistance is not set in wax, but only covered by a thin layer of wax allowing perfect dissipation of heat.

**MULLARD EVER-REST Wire Wound Anode Resistance (80,000 and 100,000 ohms) . . . . . 5/-**  
Complete with Holder 6/6

*Other Values to Specification.*

Mullard Grid Leaks and Condensers,  
Type Grid B 0.5 to 5.0 megohms . . . 2/6  
Type Grid B combined with .0003 mfd.  
Condenser Type MA . . . . . 5/-  
Type MA Condenser .0001 to .0009 mfd. 2/6  
Type MB Condenser .001 to .01 mfd. . . 3/-



**WIRE WOUND ANODE RESISTANCE**

The MULLARD WIRELESS SERVICE Co., Ltd.  
Mullard House, Denmark St., London, W.C.2

**REPRESSING THE RHEOSTAT**  
(Continued from page 1298.)

Don't forget to reverse! We hope this simple calculation is quite clear. We could make it sound much more "highbrow" by talking about "reciprocals" and "conductances," but this is quite unnecessary.

Now how shall we make our resistance element? Well, an excellent article on "Fixed Resistors" by Mr. O. J. Rankin, in "P.W." No. 234, covers this very well indeed, but we will describe in brief one method that could be adopted.

The resistance of any piece of wire is directly proportional to its length. If a piece of wire 100 ft. long has a resistance of 10 ohms, 50 ft. of it will have a resistance of 5 ohms. Halving the length halves the resistance, and so on. If 100 ft. of a resistance wire of a certain type and gauge has a resistance of 18 ohms, and we want a resistance of 6 ohms, which is one-third of this, it can be obtained by cutting off a third of that 100 ft.—i.e. 33 ft. 4 in. A table giving a few wire resistance details is appended. "Eureka" wire is very easily obtainable, and is most suitable for this work.

The resistance wire can be wound on a small piece of hard wood, ebonite or other suitable material, and fastened at its ends to small screws or terminals. (See Fig. 1.)

Of the method of connecting a resistance unit to a rheostat little need be said; we can safely leave this to the ingenuity of our readers.

In conclusion, we trust that many of those amateurs who do not need to adopt the methods detailed in this article will find the calculations interesting. Personally, we consider that the working out of parallel resistances and series condensers and what not is far more intriguing than cross-words.

"EUR KA" RESISTANCE WIRE CAPABLE OF CARRYING THE NECESSARY CURRENT.

S.W.G. No.	Resistance per foot in ohms
24	.59
26	.88
28	1.33
30	1.86
32	2.45
34	3.37
36	4.94

**CRYSTAL - VALVE OPERATION**

(Continued from page 1304.)

detector, with its inevitable accompaniment of potentiometer and battery. Galena crystals are far too capricious in their properties to give really satisfactory results when dealing with H.F. amplified signals. Some perikon detectors (notably a zincite-copper pyrites, but not tellurium zincite combinations) give reasonably effective results in H.F. amplification circuits.

In some degree, the remarks which have been made with regard to the employment of crystal rectifiers in H.F. amplifying circuits apply also to the employment of crystal detectors in reflex circuits, although, very happily, to a very much less detrimental extent. A carborundum detector in a reflex or regenerative set gives the most stable circuit, but it can generally be

(Continued on next page.)



**DO YOU KNOW?**

That you can have this wonderful **TWO-VALVE General Radio set installed in your house for £1 down?**

**NOTHING ELSE TO BUY.**—The set is complete with **LOUD SPEAKER, HEADPHONES, Dull Emitter Valves, Accumulator, Battery, complete aerial equipment, all cords and plugs, etc., and the Royalty is paid.**

Every set and every part is guaranteed. The price of the complete set is £1 down and 20/- a month for twelve months only, or £12 cash.

**FREE INSTALLATION.**—On receipt of the first payment of 20/- one of our own Installation Engineers will come to your house anywhere in the country and will erect, instal, demonstrate and leave the set playing for you—free of charge. It is only necessary to provide an aerial pole if trees, etc., are not available.

By having the set installed by our own Engineers we ensure that you cannot buy a General Radio set that does not give you perfect satisfaction. No other wireless firm gives you this service and this safeguard.

Send a P.C. to-day for our new illustrated catalogue No 9W, and full particulars of this unique offer.



GENERAL RADIO CO. LTD.  
RADIO HOUSE, 235 Regent St., W. 1



**JARS ZINGS SACS**  
Waxed, Special, High Capacity.  
1/6 DOZ. 1/- DOZ. 1/6 DOZ.

Sacs supplied with terminal tops, 9d. doz. extra. Special large, double-size sac, 3/- doz. For Wet H.T. Batteries, Post Free on 3 doz. and over. Packed in special carton with division for each cell. This can be used as a container for battery when made up. Send 6d for sample complete unit, particulars and instructions.

All parts stocked for building the latest type loud-speaker with the Seamless Moulded Cone.

**SPENCER'S STORES, LTD.**  
4-5, Mason's Avenue, Coleman St., London, E.C.2.  
Phone: London Wall 2292. (Nt. Bank.)

**DO YOU KNOW WHAT IS WRONG?**

If not, let our Information Dept. help you. Under the personal supervision of Mr. C. P. Allinson, A.M.I.R.E., late of RADIO PRESS and ELSTREE LABORATORIES, we can help you out of any difficulty.

We specialise in Super-het., Solodyne and Elstree 6 queries, and in all wireless matters we are at your service.

Any 4 questions answered in full for 2/6 post free.

**SOLVE YOUR PROBLEMS NOW**—by writing to

The Information Department, Sect. 5,

**The Constructone Publishing Co., 37, Drury Lane, London, W.C.2**



## CRYSTAL - VALVE OPERATION.

(Continued from previous page.)

replaced by a perikon crystal combination with results very closely equal to it so far as circuit stability goes. Despite these facts, however; galena-cat's-whisker rectifiers are mostly used in crystal reflex sets, and therefore a few remarks concerning their adjustment will not be out of place.

### Effects on Selectivity.

Consider two circuits, the first consisting of H.F. amplifier, valve rectifier, and L.F. amplifier; the second comprising H.F. amplifier, crystal rectifier, and L.F. amplifier. Now, of these two circuits, the one in which valve rectification is used will be the more selective of the two, because although the use of valve rectification introduces damping into the circuit, it does not do so to the same extent as a crystal rectifier does. In "straight" H.F. amplification-crystal rectification-L.F. amplification sets, as well as in reflex or regenerative sets employing crystal rectification, such as the one illustrated in the circuit diagram, Fig. 3, the characteristics of the common galena-cat's-whisker rectifier are such that the greater the pressure of the cat's-whisker on the crystal, the greater the damping introduced by the rectifier into the circuit. This effect must, of course, give rise to diminished selectivity.

A light cat's-whisker contact with a galena crystal will tend to increase the sharpness of the tuning, but, on the other hand, it will tend to reduce the stability of the circuit. Thus, when using galena crystals in crystal reflex sets, one has to attain a happy medium in the adjustment of the crystal so that the circuit is retained in a reasonably stable condition while, at the same time, the selectivity is not seriously interfered with.

Carborundum crystals, and perikon contacts of the zincite-pyrites type, can be used with their required heavy pressures on account of their high resistance, which, of course, reduces the "crystal damping" in the set.

### A Common Fault.

Just one further point concerned with crystal reflex working. There are quite a number of amateurs who suddenly discover that they can obtain better results with the cat's-whisker actually off the crystal than they can do with it on. In such cases we may look for the cause of this effect in two directions. Firstly, in the use of a very poor crystal. If the crystal rectifier is so poor in its properties it may introduce sufficient damping into the circuit to give rise to very greatly decreased signal strength in the 'phones when the cat's-whisker is in the "on" position. Then again, there may be present some stray leakages in the circuit, which, in some complex way, would quite possibly allow the valve to undertake the work of rectification as well as that of amplification. In truth, however, the precise cause of such an effect is really unknown. Nevertheless, the effect ought not to occur in a crystal reflex set which is working efficiently. If it does, the best thing to do is to make a few trials with fresh crystals, and to examine carefully the wiring and components in order to detect any possible sources of leakages.

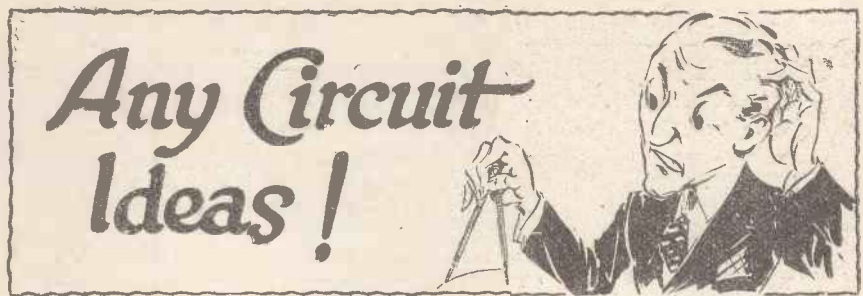

Somebody's two-some, three or multi-valver, may have smitten you to try this—or that circuit. Deep cogitation—cost!!! Conclusion—all a catch—too darned expensive! Very probably too, with the designer's specification before you—to him Resistances, Jacks, Plugs, Anti-microphonic Valves Sockets, etc., might grow on trees; so they might, but summer's a long way off.

**Any Circuit Ideas** are capable of improvement, in operation, in economy of construction, and in appearance, by incorporating Ashley Radio Jacks, Plugs, and Resistances—the **Best British at Continental Prices.**

## JACKS

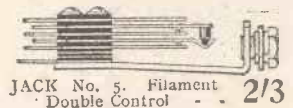
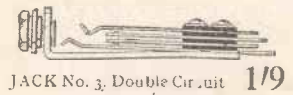
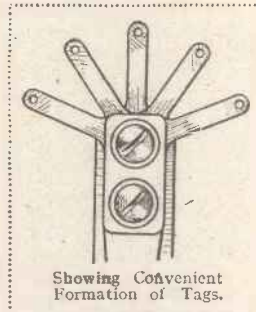
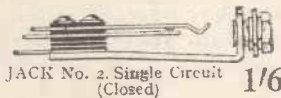

Jacks at the above prices, besides materially increasing the effectiveness and appearance of any circuit, reduce the amount of work involved when experimenting, aiding both construction and dismantling. The Jack itself helps towards the end, the tags being spread fanwise for ready soldering. Non-ferrous metal nickel-plated springs (recognised best by leading Wireless and Telephone Engineers) insulated throughout with genuine bakelite. Solid Silver Contacts. Single hole fixing to standard size panels.

**Positive in Action.**

## STANDARD PLUG

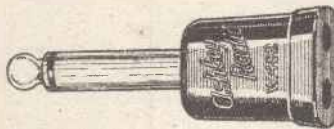

PRICE - - - 1/6

Will fit all standard Radio Jacks and take any form of connection Spade or Pin tags, rigid wire or ordinary flex, with equal facility and minimum trouble. Pin tags and rigid wire leads firmly connect when pushed home. Spade tags and flex connect to simple adaptors provided for insertion similarly.

Genuine bakelite neatly moulded with mirror finished metal work.

## RESISTANCE CAPACITY COUPLING



The most vital component in any circuit on this principle is the anode resistance. Many an otherwise satisfactory circuit has proved inefficient and noisy in operation due to the Resistance employed depending on some principle now proved fundamentally unsound. Freedom from disturbing noises is assured with the Ashley-Ledward Resistance, the base of which differs from all others.

Exhaustive tests by famous laboratories have produced eminently satisfactory reports, and each Resistance on completion is subjected to a 48 hour test during which it is continuously under pressure at a minimum of 250 volts.

ALL STANDARD VALUES

PRICE (Complete with Clips) 2/6 each

ASHLEY WIRELESS TELEPHONE CO. (1925), LTD.,  
17, FINCH PLACE, LONDON ROAD, LIVERPOOL



**BARGAINS No. 315**

**TEXAS CONE**

The 4-Guinea "Speaker With The Golden Voice." With Cord. Sale 30/-



**SALE CLEARANCE.** Western Electric, famous for Tone, 2,000 ohms, 17/6; T.M.C. Loud-speakers, 2,000 ohms, 12/6; Ultra, 26/8. Magnavox moving coil, 10 guin. model, 65/-. Amplion Dragonfly, 20/-. Amplion A.R., 50/-. Laray, 18/-. New Violinas, 5 guin., elegant mahog., 2,000 ohms, with cord, 25/-. Violinas without unit, 10/6.

**SPEAKER PARTS.** Pleated Paper, 2/-. Twin 12 in. nickel rims, 5/-. Texas Cones, 4/6. Stands, 8/-. Reed 'phones, with needle, Brown's "A," 13/6. Lissen, 14/6. Viola Units for Violinas, etc., 15/6.

**LOUD SPEAKER BOBBINS.** 1,000 ohms, wound silk cov. wire, 6d. Unwound 'phone bobbins, 2d.

**WAVEMETERS.** Large stock of all ranges at greatly reduced prices. Townsend's from 35/-. Details in catalogue. You need one with the wave-length changes being made.

**GYROSCOPES.** 525 Navy Torpedo in mahogany cases. Beautiful workmanship. Price 15/-.  
**RELAYS.**—Weston, 20/-; G.P.O., 40/-; Magnetic Relays, 10/-; Dixon Filament Distant Control Switches auto. on and off, in pol. case, 15/-.  
**L.F. AMPLIFIERS.** 1-Valve, 20/-; Marconi 2-Valve, 35/-; 3-Valve L.F. Switch, for 1, 2, or 3 v., etc. in cabinet case, tested, 22 10s. Valves extra. Western Electric i.v. Mahog. Cab., 32/6.

**HIGH-FREQUENCY AMPLIFIERS,** 1,000/5,000 metres, 3-Valve. Complete with Rheostat and Potentiometer. Price 30/-. Vario coupled Inductance, fitted with 10 special tapping sockets, 200/1,800 metres, price 9/6. Sliding Coupler, 5/-.

**DIX-ONEMETER**

The 55 Range Rolls Royce of Radio. An instrument of exact precision reading, 40 micro-amps to 20 amps, 2 milli-volts to 2,000 volts. Measures Crystal Signals or Resistances from 50 ohms to 50 megohms. Instrument De Luxe Model 55/- Multipliers each 6/6 16-page Booklet Free. Whenever you require Special Apparatus, Transmitting, Receiving or Recording, Precision Instruments, etc., "Those Hard to Get Things" not usually stocked elsewhere, write or call on us.



**MAINS UNITS.** The DIX D.C. No bare Terminals. Gives any voltages from D.C. mains; 3 taps, 30/-; A.C. Rectifying H.T. Unit with Control and 3 Taps, 25 10s.

**PARTS FOR Condensers:**—2 mfd., 4/3; 4 mfd., 6/6; 10 mfd., 15/-; Fullertype Chokes, 200, 600, 1,000 ohms, 1/6. Power Chokes, 1,000, 1,400, 3,000 ohms, 4/6. 2 Electrode Rectif. Valves, 15 m/a, 7/6. Transformers, 220 volts to 3, 5, or 8 volts, 12/6. To 20 volts, 14/6. Double wound for H.T. from A.C. mains, 220 volts, two centre tap secondaries for H.T., 20 m/a, 25/- each; 50 m/a, 37/6.

**COMPLETE MARCONI BIO CRYSTAL AND 1-VALVE AMPLIFIER SETS FOR 27/6.** Straight from maker. Closed Cabinet, engraved sponite panel, nickel fittings, 2-spade tuning Range Block and Verniers, M.S.1 and T.C.C. fixed Condensers, 2 H.F. Chokes, Detector, Marconi Transformer, Valve-holder and Terminals, L. and S. wave Switch, Wiring diagram. All new, aerial tested, and complete as above, with Osram Valve. List 27, Sale 27/6.

**RECEIVERS.** 2-Valve No. 33 Marconi in Enclo. case, coil-holders for all wave-lengths, 23. 2-Valve Mark 32, 250 to 1,800, 23. Western Electric 2-Valve, 25. 3-Valve, 26. 3-Valve Aircraft, 24. Polar 4, Pol. Cab., 28 10s. 5-Valve R.A.F. with Valves, 25. 6-Valve Marconi De Luxe, 28. Sterling Surplus Receivers, Anodized, etc., 25 10s.

**ELECTRIC SOLDERING IRON.** Does the work of two. Speeds set construction. Massive copper bit, 110 or 220 v. 7/6 and 10/- Cased. Solder, 3d.

**AERIALS.** Frame Aerials, midtap, 10/-. Pocket R.A.F. 110 ft. stranded cop., 1/2. Aeroflex, 49 strand cop., 10 ft., 1/4. Navy 7/22 Enam. bronze, 3/-; 100 ft. Electronic, 100 ft., 1/3. Maxi, braided cop., 50 ft., 1/3; 100 ft., 2/-. Indoor Aerial wire, 22 gau. 1/- 100 ft. Earth wire, 1/3 doz. yds.

**MASTS.** R.A.F. Steel Tube, 15 ft., 7/6; 20 ft., 10/-; 30 ft., 14/-, in 2 ft. 8 1/2 in. x 1 1/2 in. sections. Heavy Mast Sections, 4 ft. 3 in. long, 2 1/2 in., 5/- each.

**MICROPHONES.** Sensitive Buttons, Mica diaph., amplify without valves, detectaphone tests, etc., 1/- Disc Type in Brass Case, 5/-. Wireless Hand Micros, 15/-. Micro. Transformers, 100—1, 4/6.

**BOXES.** 12 x 8 x 6 1/2 lid and ebonite panel for Portable Sets, 10/6. 11 x 10 x 2 for Coil Storage, etc., 2/-. Teak with ebonite panel, 13 1/2 x 10 1/2 x 5 in., 9/6. Brown's Relay Cabinets, 5/-; 3-Cell Valve box, padded, 1/6. Portable Cabinets Stocked.

**BUZZERS.** Townsend, 2/6. Larger, 3/-. Power, 4/6. D. III., 10/-. Siemens 25 S.A. Signal Sets, 27/-. Sounders, 18/6. Signal Lamps, 3 cols., 3 Tap Keys with 1 1/2 volt Battery, new Army, 7/6. Illustrated Catalogue 1,000 Bargains. 4d. stamp.

**ELECTRADIX RADIOS.** 216, Upper Thames St., E.C.

**TECHNICAL NOTES**

(Continued from page 1300.)

less than the value calculated from a consideration of the characteristics of the valve and the coupling components, and the comparative inefficiency of the single stage of H.F. amplification is, as a matter of fact, rather a good illustration.

A reader has asked me whether it is not possible to use his D.C. electric light mains for supplying the H.T. to his set, the mains being 110 volts, without the need for purchasing an expensive eliminator or going to the trouble of constructing one. The answer to this is that it will in any case be necessary to use the equivalent of an eliminator: the essentials are a choke coil and a condenser. The choke coil should have a fairly high inductive value, say about 25 henries, and this choke is to be introduced into one of the leads from the mains. The other lead runs direct to one of the H.T. terminals and a condenser is bridged across the mains leads before the choke. It is desirable also to bridge another condenser across the leads after the choke or, to put the matter in a different way, two condensers in series with one another may be shunted across the choke and a connection may be taken from the point between the condensers to the other mains lead. These condensers should have a capacity of at least two and preferably four microfarads. It should be noted that the choke, although of a high inductive value, should not have an unduly high ohmic resistance.

This arrangement will usually be found quite satisfactory on most D.C. electric supply mains, although it gives only a single value of H.T.

**A Frequent Fault.**

When using coupled condensers mysterious trouble sometimes arises owing to the readings of the dials suddenly, and for no apparent cause, getting out of step. If stations have been coming in at 20—20.30—30, and so on, this is regarded as something of an accomplishment, since the aerial capacity and other factors often make it difficult, if not impossible, to achieve synchronous tuning.

When the dials get out of step this is often due to nothing more serious than a loose set-screw on one or more of the dials. If the condenser has end-stops, there is often a tendency to jar the dial one way or the other, which means that the dial settings may be changed without changing the actual condenser settings; in other words, the dial shifts in relation to the vanes.

The solution is to re-adjust the "off" dial, so that at zero or at full scale it represents full capacity (according to whether the frequency or wave-length system is used).

Most experimenters prefer, in any case, to have the dial so adjusted that it reads zero when the condenser itself is set to the minimum capacity and should therefore test the dials accordingly.

**2-VALVE AMPLIFIER, 35/-**  
1-Valve Amplifier, 20/-. as new; Valves, D.E. .06, 7/-; Headphones, 8/6 pair; new 4-volt Accumulators, 13/-; new 60-volt H.T., guaranteed, 7/-; 2-Valve All-Station Set, 24/-, approved willingly. Write for free bargain list.  
**P. Taylor, 57, Studley Rd., Stockwell, London.**

**VALVES,** British, 2-volt H.F. or L.F., 5/3; 2-volt Power, 8/-; 3-volt .06, H.F. or L.F., 5/3; 4-volt .06, H.F. or L.F., 5/6; 4-volt Power, 8/-; 5-volt Power (1 amp.), 8/6. We pay postage and guarantee full satisfaction or money refunded.  
**DAWSON BROS., Milton Hall, Deansgate, Manchester.**

Put on a little—  
**FLUSOLDA** (Resd.)  
(Patent Applied For)  
—and Heat it—That's All

**The Secret of Simple Soldering**

One clean handy fluid—no tinning, no flux—now enables expert or novice to handle any soldering job with complete confidence. "Flusolda" has made soldering simple at last. Just apply "Flusolda" and then apply heat and a perfect joint must result. In tins at 1/3 from Wireless Dealers and Ironmongers.

Trade Enquiries to the Sole Manufacturers:—  
**THE TRANSPORT SUPPLY CO., LTD., Warrington.** (Telephone: Warrington 459.)

**WOOD-HORNS**  
The Manufacturer is  
**H. MADDISON, 2a, RONALDS ROAD, HOLLOWAY ROAD, HIGHBURY, N.5.**  
There's only one best.  
**"The ALLWOODORN" is that one.**  
Send for list.  
Lissenola—Amplion—T.M.C. units supplied complete with horn if desired.

**SOLODYNE AND MONODIAL**  
We have a very limited number of the Blueprints of the wiring diagrams for these sets, and they may be obtained from us at the following prices:  
**SOLODYNE BLUE PRINT . 2/-**  
**MONODIAL BLUE PRINT . 1/6**  
Post Free.  
If you wish to make sure of getting one, send your remittance to-day.  
**THE CONSTRUCTONE PUBLISHING CO., 37, Drury Lane, London, W.C.**

**WE CAN SUPPLY ALL COMPONENTS** for any set described in any publication of "Popular Wireless." Let us have your enquiries, and receive prices per return. Any complete set of parts or units despatched same day as ordered.

**—HEADPHONES REPAIRED—**  
Re-wound and re-magnetised 5/- per pair. Loud Speakers repaired 5/-. Transformers re-wound 5/- each. All work guaranteed and tested before delivery. Write for Trade Prices. Phone: Clerk. 1795.  
**MASON & CO., 44, East Rd., City Rd., N.1.**

**"HARTEL" WET H.T. BATTERIES**  
Cannot be equalled for reception, and charge themselves as recommended by "Popular Wireless," Aug. 11th 60 volts, in case with lid 25/- Post 1/- 30 volts 13/6 .. 10d.  
If you wish to build your own—  
Glass Containers 2/- doz. } Send 8/-  
Sacks . . . . . 2/- doz. } stamps for  
Zincs . . . . . 1/6 doz. } Sample Cell.  
**YORKSHIRE IGNITION CO., LTD., 1 & 3, Broomhall Street, SHEFFIELD.**  
Trade and Factory Supplies

**THE VALVE-POWER CRYSTAL**  
Price per set 1/6 & 1/-

OBTAINABLE FROM WIRELESS STORES

**Russell's** OR SEND P.O. LB TO DEPT. P  
T. G. RUSSELL LABORATORIES HILL STREET BIRMINGHAM

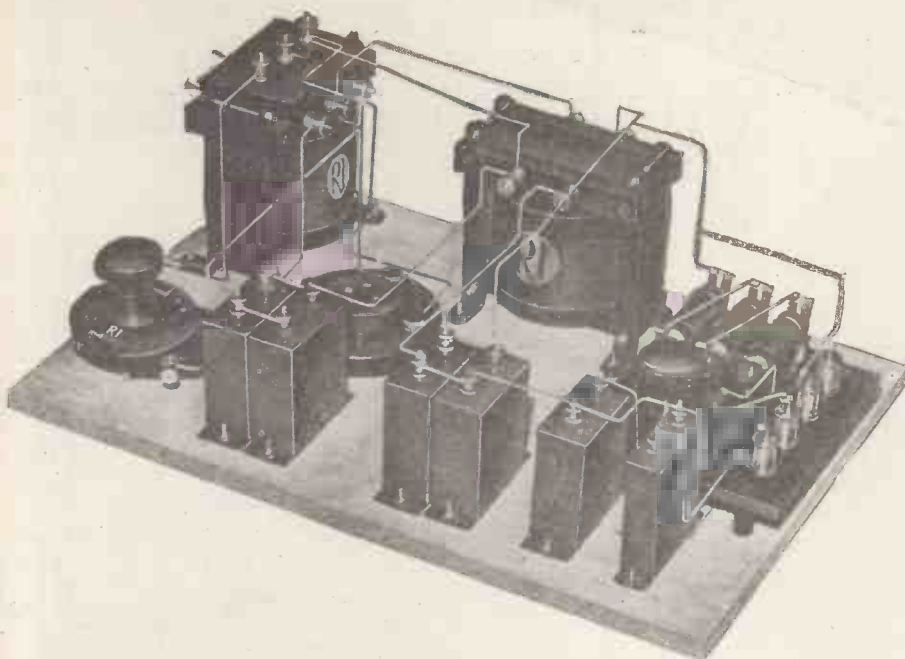

THE MARK OF BETTER RADIO

## How to Build a Simple, Efficient H.T. Supply Unit.

The upkeep and renewal of high tension batteries is now one of the most costly items in modern valve receiving sets, particularly where multi valves of the dull emitter and power-types are employed. The use of batteries is, therefore, now being superseded by obtaining the current from the domestic electric light supply. By mounting up the components indicated below and following the simple wiring diagram, you can soon have a unit that will give you all the high tension current you need for any type of set, no matter how many valves are employed. The running cost is negligible, and the initial cost is quickly saved, to say nothing of the additional efficiency, by the elimination of the usual high tension battery. If the unit is built up as the illustration herewith, the current supply is uniformly smooth, and the system is absolutely safe. Ordinary transformers and chokes are not suitable. Those shown in the illustration are of the very large power type, and have been specially designed to give a wide margin of safety, with the absolute maximum efficiency. The condensers have been built to stand a voltage of 1,000. It is false economy to buy cheap condensers as, although they stand a flash test of a high voltage, deterioration soon sets in with use, and the unit will break down, with possible disastrous results to the receiving set.

The following components are all supplied by R.I. Ltd.:-

### THE R.I. POWER TRANSFORMER

The power transformer is for connection to the A.C. mains, for the supply of high tension and filament current for its own rectifying valve. Everything in this transformer has been designed on the most generous principle. The primary is connected to the alternating electric light mains, of either 100, 110 or 200/240 volts at 50 or 60 cycles. The two secondary coils each supply the high tension current, up to 180 volts: These give the necessary voltage to the anodes of a full wave rectifying valve allowing double rectification in the high tension supply, and ensuring an absence of hum. A third winding supplies the filament current to its own rectifying valve at 6 volts. This is the finest transformer ever designed and built for this purpose, and is sold to the public at the lowest price consistent with efficiency.

### "R.I." 20 HENRY CHOKES

This is a large unit, almost similar in dimensions to the transformer, comprising one large double choke, both coils being mounted on one iron core of very large dimensions. The chokes are designed for an output of 60 to 80 milliamperes permanent loading, and are suitable for the smoothing circuit shown above, and also as described in the "Wireless Magazine." They are wound to an extremely low resistance, so that there is a minute drop in potential when using high current output.

	£	s.	d.
1 Large double choke	1	12	0
1 Transformer	1	19	0
1 Double Rectifying Valve	1	0	0
3 Wire-Wound Anode Resistances, 20,000 ohms each	5	0	
1 R.I. Rectifying Unit Rheostat	7	6	
Bank of Condensers tested to 1000 volts	Prices on application		

Full particulars sent on application.

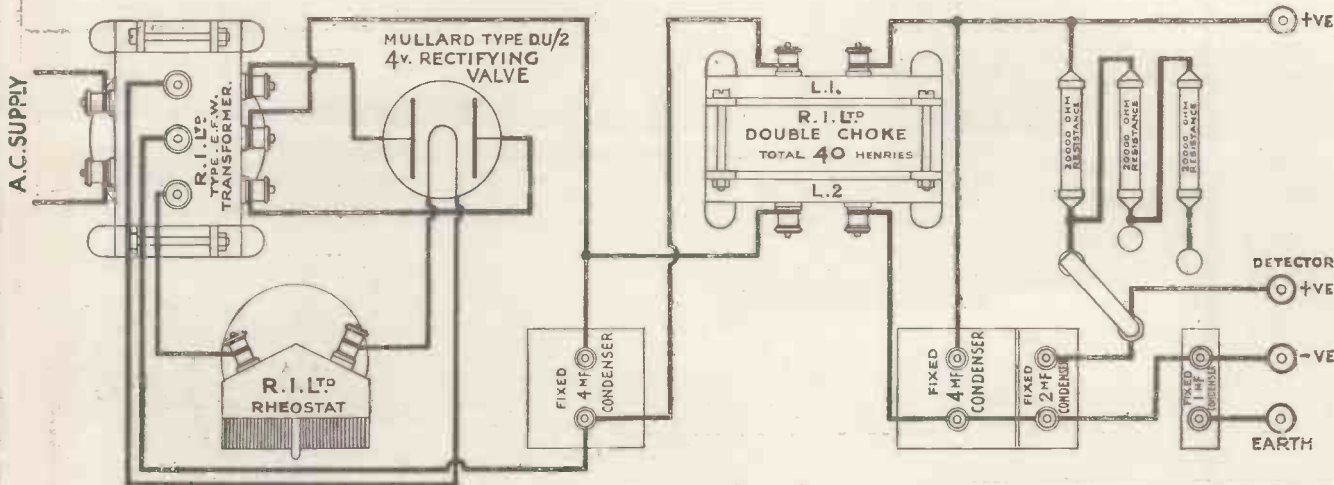

# The Last L.F. Stage Of Your Set Has Something to tell You

★ You can make your set give better results than your loud speaker gives it credit for by using the right valve in the last L.F. stage.

Volume is by no means the final word in the achievement of better reception, for it can so easily be secured by overloading the L.F. valves with the immediate result that distortion destroys the texture of both music and speech. The secret of perfect purity is to use valves that are able to handle strong signals under normal working conditions.

LOUD signals are particularly evident when the receiver is situated close to a broadcasting station or when several stages of L.F. amplification are being used.

It is therefore obvious that with an ordinary L.F. valve in the last stage you are either faced with loud, harsh reception with your receiver properly tuned, or faint, but clear reproduction by the use of slight de-tuning. In the main, the loud-

speaker comes in for a great deal of unjustified criticism, due to the incorrect use of one of the best virtues of your set, namely—to give strong signals.

## Super Power Valves

The immediate enquiry following the above facts is readily answered by the recommendation to use super power valves.

These valves have been specially designed to handle powerful signals without any trace of distortion.

This ability is due to the fact that they are able to give, as a result of the large grid swing, all the fluctuations in anode current that may be required throughout the whole frequency range of broadcasting. This means that the low, sonorous vibrations of the double bass may roll unharmed from your loud-speaker, and the highest trills of a prima donna retain all the pleasure of their original rendering.

## Couple these Qualities with those of the Wonderful P.M. Filament

The remarkable merits of the wonderful P.M. filament when embodied in the design of Mullard P.M. Super Power valves, result in valves that are absolutely without equal for operation in the last L.F. stage of a receiver. The quality of reproduction that can be secured from even the very largest loud-speaker is a revelation of lifelike reality. This ability is the natural result of the gigantic emission surface available in the Mullard P.M. Filament. No comparison can be made with an ordinary



filament without revealing the increased value offered by the unique P.M. Filament.

All the advantages of long, useful life, low current consumption, and majestic volume possessed by Mullard P.M. Valves are available to the highest degree in Mullard P.M. Super Power Valves. Fit your receiver with Mullard P.M. Valves with the wonderful P.M. Filament and enjoy the best results from your loudspeaker.

Obtainable from all dealers.

INSTALL MULLARD P.M. VALVES WITH THE WONDERFUL P.M. FILAMENT

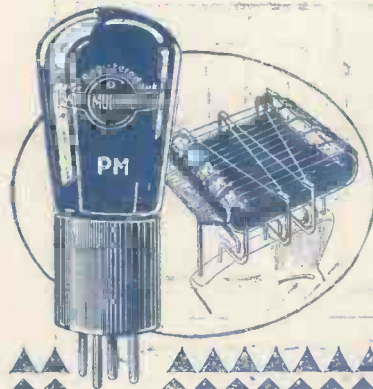

# Mullard

## THE MASTER VALVE

Sectional view of P.M.5 showing generous proportions of P.M. Filament

6-volt resistance capacity valve THE P.M.5B (0.1 amp.) 14/-

- For 2-volt accumulator
  - THE P.M.1 H.F. — 0.1 amp. 14/-
  - THE P.M.1 L.F. — 0.1 amp. 14/-
  - THE P.M.2 (Power) 0.15 amp. 18/6
  - For 4-volt accumulator or 3 dry cells
  - THE P.M.3 (General Purpose) — 0.1 amp. 14/-
  - THE P.M.4 (Power) 0.1 amp. 18/6
  - For 6-volt accumulator or 4 dry cells
  - THE P.M.5x (General Purpose) — 0.1 amp. 14/-
  - THE P.M.6 (Power) 0.1 amp. 18/6
  - Super power valves for last L.F. stage
  - THE P.M.254 (4 volts, 0.25 amp) 22/6
  - THE P.M.256 (6 volts, 0.25 amp) 22/6
- These prices do not apply in Irish Free State

ADVT. THE MULLARD WIRELESS SERVICE CO. LTD., MULLARD HOUSE, DENMARK STREET, LONDON W.C.2

All applications for Advertisement Space in POPULAR WIRELESS to be made to JOHN H. LILE, LTD. (Sole Agents), 4, Ludgate Circus, London, E.C.4. Phone: City 7261.