

## MAKING AN A.C. MAINS H.T. UNIT

# Popular Wireless

Every Thursday  
PRICE  
3d.

No. 227. Vol. X.

and Wireless Review  
*Scientific Adviser: SIR OLIVER LODGE, F.R.S., D.Sc.*

October 9th, 1926.

**64**

PAGES

Price 3d.

as usual.



### *Features In This Issue.*

- A NEW EXTENSION LEAD AERIAL SYSTEM.
- A NEW ONE-VALVE FILADYNE.
- DISTORTION IN REFLEX CIRCUITS.
- NOTES ON THE FLEWELLING.
- HOME-MADE TELEPHONE LEADS.
- THE GERMAN RADIO EXHIBITION.
- HEAT TREATMENT OF CRYSTALS.





## Just as an inferior lens will create distortion so an inefficient Transformer will distort a voice



The new Eureka Concert Grand

ALMOST any kind of lens will serve to produce an image on a sensitive photographic plate. But no one expects that a simple uncorrected achromatic lens will give such faithful reproduction as an anastigmat. Exactly the same principles apply in wireless. Practically any L.F. Transformer will amplify and give some kind of results.

But if you want to hear the rippling notes of the soprano you must use a Transformer scientifically corrected against distortion. Every Eureka has been scientifically designed by specialists in the science of sound reproduction to give an even amplification throughout its entire frequency range. It does not amplify some notes at the

expense of others, but is, in fact, fully corrected against distortion.

And now, through an improved method of "stratum-winding," the efficiency of Eureka Transformers has been still further increased. At no extra cost to you there is now available greater volume and sweeter tone, whilst the possibility of breakdown has been eliminated by the use of interspaced insulation between windings.

These new and exclusive features will place the Eureka again ahead of possible competition. For your next Set, therefore, be sure to use a Eureka—"the Transformer which re-creates the living Artiste."

### Types and Prices

Concert Grand	25/-
Ditto for 2nd stage	21/-
Baby Grand (1st or 2nd)	15/-
Eureka Reflex	15/-
Eureka L.F. Choke Unit	25/-

Re-creates the **EUREKA** Living Artiste



# MARCONI VALVES

for Purity and Volume

the last valve of your Receiver to a Marconi Power Valve. The types illustrated give 50% to 100% louder and clearer reception, provided the correct high tension and grid current is employed—the Marconi Valve Log Book gives full information. Write for a complete set of Marconi Valve literature to THE MARCONIPHONE COMPANY, LTD., Marconi House, Strand, London, W.C.2.

You will obtain more natural tone and vastly increased volume from your broadcast receiver by changing



## Marconiphone Type 41 Four-Valve Receiver



Embodies every modern improvement, is simple and thoroughly reliable in operation. A rejector device is incorporated to make it highly selective. The cabinet is of mahogany with folding doors, and the instrument is unequalled for all round efficiency.

The real test of radio reproduction is simply this—can you forget that it is radio? If you can close your eyes and hear symphony, song and speech in all their natural beauty, then that is perfect reproduction.

The Marconiphone Type 41 Four-Valve Receiving Equipment and the Sterling "Mellovox" Loud Speaker re-create everything that is broadcast with clarity and volume unparalleled in the era of radio.

Full particulars of all models of Marconiphone Receivers are given in Publication No. 364G, sent on request to

## The MARCONIPHONE COMPANY, LIMITED

Head Office : 210, Tottenham Court Rd., London, W.1  
 Regd. Office : Marconi House, Strand, London, W.C.2

Price, inclusive of all Accessories and Marconi Royalty, £27 : 18 : 6  
 Deferred Payment terms may be arranged.

# The Marconiphone

Type 41 FOUR-VALVE RECEIVER

## Sterling "MELLOVOX" Loud Speaker (Hornless)



Black, Brown, Blue or Mauve Finish, 45/-

Reproduction by the "Mellovox" is unmarred by distortion; all tone values being faithfully preserved.



# "BEST WAY"

## GUIDES FOR WIRELESS CONSTRUCTORS

*The Two Latest Numbers  
Now On Sale Everywhere*

### MODERN LOUDSPEAKER SETS

This book contains straightforward, amply illustrated directions for constructing three of the latest valve sets. The first is a two-valve household loudspeaker set. A straightforward set of up-to-date design intended for the reception of quality signals from the local station and from Daventry. The second is a sensitive three-valver incorporating a novel reflex principle which will receive European stations with ease. The third set described is a four-valver including every possible modern refinement.

### PICTORIAL BLUE PRINTS

This book consists of an up-to-date and comprehensive range of blue print diagrams drawn in a simplified pictorial style so that the amateur constructor cannot possibly go wrong when building up a set on the lines of any of the circuits with which the book deals. There are 11 circuits in all.

Price **6<sup>D.</sup>** Each.

*At all Newsagents and Bookstalls*

**CONSTRUCTORS USING THESE  
BOOKS CANNOT GO WRONG.**





ART and Science go hand in hand in the **Brown Cabinet Loud Speaker**. Beautifully finished in rich Mahogany or Oak, it will harmonise with the setting of any room, while in purity of tone and adequacy of volume it stands alone among Loud Speakers of this type. In resistances of 2,000 or 4,000 ohms. **£6.6.0**

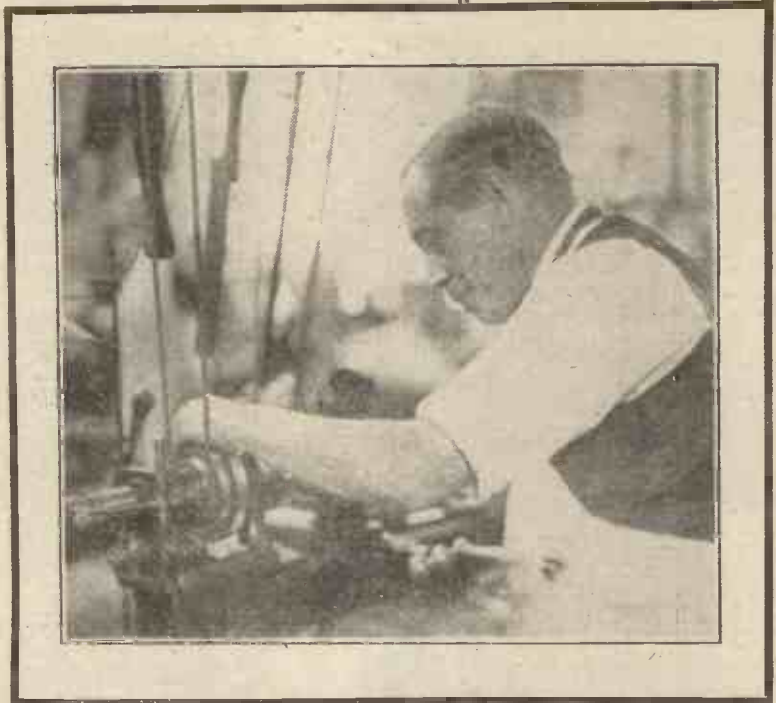

## The brain-made Instrument

A FAMOUS painter, when asked with what he mixed his paints replied, "with brains." Just as the finest quality paints cannot make a masterpiece unless brains and vision control the brush, so are the best materials in the world useless, in the making of Loud Speakers, without wisdom, knowledge and experience to guide the hand which designs and makes them. Telephonic experience gained in the days before Broadcasting began—and after; the brain, imagination

and enthusiasm of the pioneer; the skill of the mechanic allied to discernment in the choice of materials—such is the basis of **Brown** success.

When you choose a **Brown**, you buy—not an instrument hastily assembled to conform more or less to an original "pattern," but a Loud Speaker on which has been bestowed all the individual thought, care and attention of a craftsman loving his work. A brain-made instrument!



# Brown

S. G. BROWN, LTD., Western Avenue, North Acton, W.3

Retail Showrooms: 19, Mortimer Street, W.1; 15, Moorfields, Liverpool; 67, High Street, Southampton.  
Wholesale Depots:—2, Lansdown Place West, Bath; Cross House, Westgate Road, Newcastle; 120, Wellington St., Glasgow; 5-7, Godwin St., Bradford; Howard S. Cooke & Co., 59, Caroline St., Birmingham. N. Ireland: Robert Garmán, Union Chambers, 1, Union Street, Belfast.

Q

In addition to the Cabinet, there are eight other **Brown** Loud Speakers—a type for everyone from 30/- to £15 15 0.



PLAIN OR TIPPED WITH CORK OF PURE NATURAL GROWTH

*The Natural  
Fragrance*  
of  
**Player's  
Medium Navy Cut  
Cigarettes**

is the result of years  
of experience in the  
blending of choice  
old Virginia tobacco

**10**  
for  
**6d.**



REGD. TRADE MARK

**20**  
for  
**11<sup>1</sup>/<sub>2</sub>d.**

*"It's the Tobacco that Counts"*

THE OPINION OF  
AN EXPERT  
CONFIRMS THE CLAIM THAT

**FERRANTI**  
BRITISH MADE - AUDIO FREQUENCY  
TRANSFORMERS

TYPE A.F.3 - 25/-  
ARE NEARLY PERFECT



RADIO RESEARCH  
STATION  
6 NF.

Operator : Alfred D. Gay,  
F.C.S., T. & R.R.S.G.B., A.R.R.L.

Messrs. Ferranti Ltd.,  
Bush House, W.C.2.

Postal Address :  
49, Thornlaw Road,  
West Norwood,  
London, S.E.27,  
England.

September 9, 1926.

Dear Sirs—The writer is pleased to state that excellent reports have been received on transmissions in which the two A.F.3 Transformers supplied last June have been used.

Operators of more than one Station have reported that the re-transmissions of 2 L O by G 6 N F were indistinguishable from the original. Considering that five valves, including the oscillator (a 250 watt power valve), were used, these reports prove the distortionless working of these excellent transformers. The speech quality has always been reported as very good.

Another station has reported the re-transmission of 5 X X to be free from resonance or distortion.

Since the tests were commenced, the writer has received numerous Q S L cards reporting the excellence of the transmissions.

Trusting that this information will be of interest to you, I remain,  
Yours faithfully,  
Alfred D. Gay.

RADIO TRADERS! APPLY FOR ATTRACTIVE LEAFLETS & SHOWCARDS TO  
FERRANTI LTD., HOLLINWOOD, LANCASHIRE.



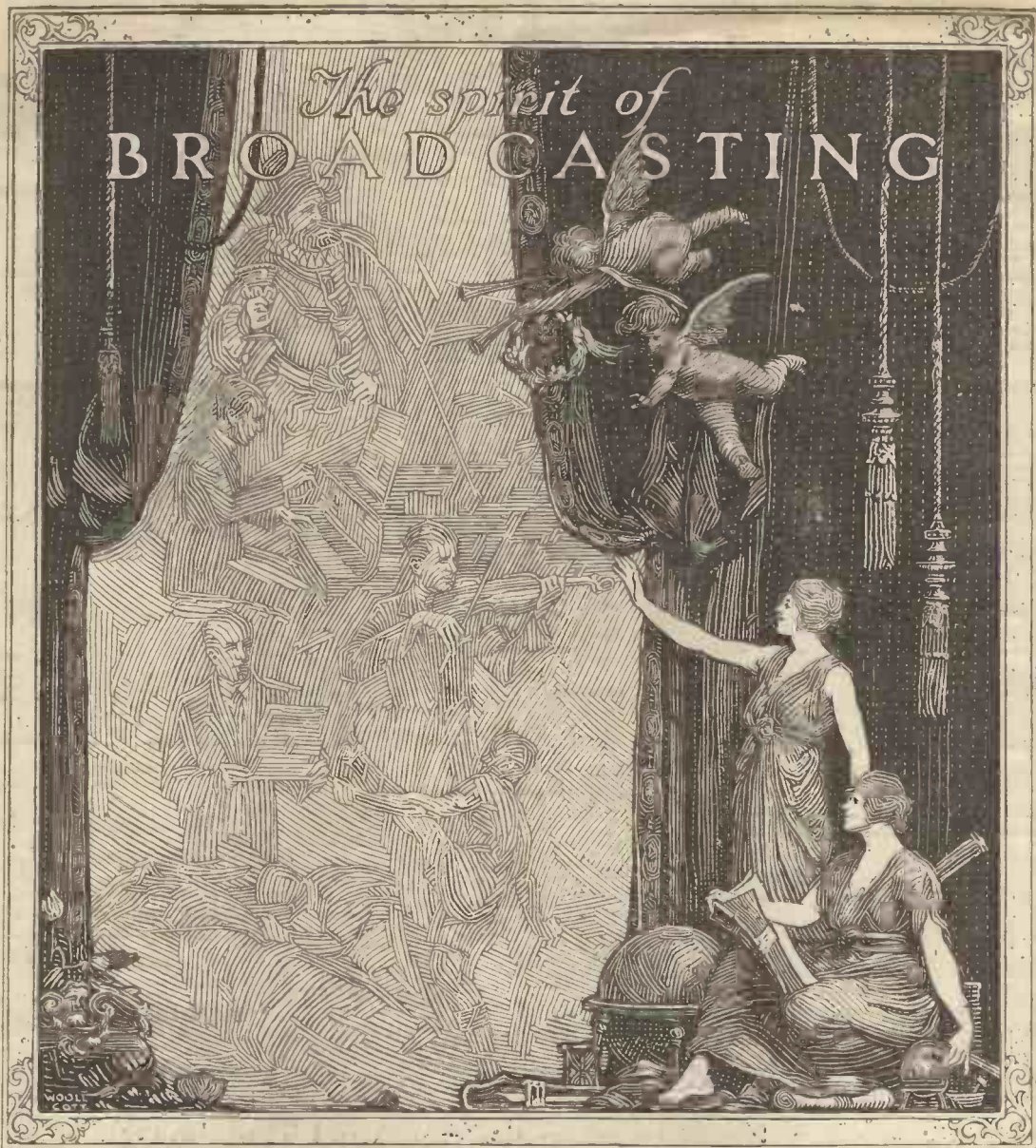

**B**ECAUSE the Science of Radio is so essentially young, great developments are bound to appear unheralded almost overnight. Cossor, ill-content to rest on the international reputation gained through the excellence of the Wuncell Dull Emitter has once again excited considerable comment by introducing a valve incorporating far-reaching improvements. Not only is the new Cossor Point One at least a year ahead in design, but for the first time there is available a filament which is well-nigh proof against the ravages of time. The new Cossor Kalenised filament is the latest step in the search for a process of manufacture

to secure an adequate electronic emission without perceptible glow. And by the almost total elimination of wasteful heat, exceptional robustness has naturally followed. It is a scientific fact that even after a very lengthy period of use, the character of the Cossor Kalenised filament is quite unchanged. It is as pliable as ever. Its electronic emission is just as prolific. While its current consumption continues at a miserly one-tenth of an ampere. For 14/- you can now buy an entirely new type of Dull Emitter which will give you greater satisfaction and more lasting service than you have ever before experienced.

## The new Cossor Point One



# Popular Wireless

Scientific Adviser:  
**Sir OLIVER LODGE, F.R.S.**  
 Technical Editor:  
**G. V. DOWDING,**  
 Grad.I.E.E.  
 Assistant Technical  
 Editors:  
**K. D. ROGERS,**  
**P. R. BIRD.**



Editor: **NORMAN EDWARDS, M.Inst.R.E., F.R.S.A., F.R.Q.S.**

Consultants:  
**Dr. J. H. T. ROBERTS,**  
 F.Inst.P.  
**J. F. CORRIGAN, M.Sc.,**  
 A.I.C.  
**C. E. FIELD, B.Sc.**  
**E. J. SIMMONDS,**  
 M.I.R.E., F.R.S.A.

## RADIO NOTES AND NEWS.

### World's Biggest Set—A Radio Raffles—Cup-Tie Broadcasting?—British Radio Station Destroyed—The Spider.

#### A Radio Raffles.

**D**ID you hear about the raffle swindle at the Radio Exhibition at Olympia?

A persuasive gentleman was going the round of the show selling tickets for a raffle, the draw to take place at 8 p.m. at a well-known stand, and the prize to be a big box of cigarettes.

Eight o'clock came along all right, but it was unaccompanied by this modern Raffles, who at that time was probably "far from the maddened crowd" counting his ill-gotten gains!

#### World's Biggest Set.

**W**HICH is the biggest receiving set in the world? One of the competitors for this honour is the set at North Evington Infirmary, Leicester, which is connected up to work a total of 672 points, viz. 20 loud speakers and 652 pairs of 'phones.

Fourteen valves are used, and the installation cost £1,200. It was paid for by public subscription.

#### Big New Station for Sydney.

**O**NE of the most powerful broadcasting stations south of the Line has just been erected at Sydney, N.S.W. It was officially opened by the Minister of Education, and transmission on the first day was so promising that it is hoped that the station will eventually be picked up in Europe. The wave-length employed is 326 metres.

#### Checking Continental Clocks.

**Y**OU often check your own watch by wireless. Have you ever tried checking a foreign clock by radio? With a bit of careful tuning it is possible to hear the Paris clocks chiming and at the same time pick up in the background the six pips of Greenwich from 5 X X.

Incidentally, I don't think I've ever heard bells—either on the loud speaker or

*au naturel*—with a more delightful tone than that one p.m. chime, broadcast from the Radio-Paris station.

#### Where Do They Go?

**T**HE 1926-1927 session of the Radio Society of Great Britain (R.S.G.B.) opened quite friskily, when Professor W. H. Eccles gave an address upon the "skipping" of short waves.

The professor told

stood for a Poor Poppa set ("He gets nuthin' at all!")

I should like to make it absolutely clear that the secondhand set in question was not, and never had been, anything to do with the well-known "P.P.V." receivers, or with any other product of Press Exclusives, the wireless publishers, of 2, Wine Office Court, Fleet Street, London.

#### "Science and Human Progress."

**T**HIS is the title of a series of six free lectures to be delivered by Sir Oliver Lodge, D.Sc., F.R.S. London readers whose love of wireless is part of a larger interest in science as it affects humanity, should not fail to avail themselves of hearing the great scientist—who is "P.W.'s" Scientific Adviser—lecture upon this fascinating topic.

The first talk will be at the Mansion House to-night (October 7th) at 5.30 p.m. The remaining lectures will be given at the Memorial Hall, Farringdon Street, E.C.4, on October

14th, 21st, 28th, and November 2nd and 11th.

#### The Big Noise.

**L**ISTENERS who recall the Radio Tattoo, broadcast last November, will be interested in the Radio Tournament which is to be put on the ether on Saturday (Oct. 9th). There is to be an artillery drive, an attack from the air, an inter-port field-gun competition by the Royal Navy, and desert warfare.

It's sure to be the biggest noise we've had for a long time, and I expect that the  
 (Continued on next page)



Army manoeuvres in Hampshire. One of the small wireless transmitters in use.

how at night time waves of 40 metres skipped 500 miles, and were then audible at all distances. Waves of 20 metres skipped 7,000 miles, but could be heard everywhere above that distance; whilst waves of 15 metres threw themselves into these midnight follies so heartily that they skipped off the earth for good!

#### "Poor Poppa."

**R**EFERRING recently to the case of a man who couldn't pick up anything with what was said to be a second-hand P.P. set, I suggested that the initials



## NOTES AND NEWS.

(Continued from previous page.)

microphone will be glad when they all fold up their tents like the Arabs and silently steal away.

## Radio at the Ringside.

WHAT with the wireless pictures of the combatants, and the wireless news of the results, radio figured largely in the Tunney-Dempsey fight for the world's championship.

Some of the pictures as reproduced in the newspapers looked as though they had a very rough Atlantic crossing, I thought, but others were really remarkable achievements.

In one newspaper the wireless photographs were every whit as clear as those upon the same page that had been forwarded and reproduced by ordinary means. Without a doubt wireless photographs are now an accomplished success.

## Cup-Tie Broadcasting.

TALKING of the radio fight reminds me that over here we have no equivalent of the ringside announcer, who described the fight to the microphone blow by blow. Listeners over here would like to "attend" a football match by wireless in the same way, and there would be plenty to talk about in a fast game. What does the B.B.C. think about it?

## The Line to Adopt.

"CAN I use a 'clothes'-line' aerial for long distance?" asks a correspondent who signs himself "Aged Reader."

Better ask the wife first, old man!

## Reaching Out to the Rajah.

THAT well-known Essex experimenter, Mr. F. A. Mayer, of Wickford, recently plucked out of the ether a message for the world's most romantic ruler—the Rajah of Sarawak. The present rajah, His Highness Charles Vyner Brooke, is a descendant of that indomitable Englishman, Brooke, who was stranded in Borneo, and who by courage and force of character raised himself from a captive to be King of Sarawak.

The rajah has been visiting this country, and one of his loyal subjects broadcast to him a radio greeting that passed in one step from the station in Borneo to an Essex aerial.

## A Trans-World Maori Message.

ANOTHER interesting message picked up by Mr. Mayer shortly after hearing the Borneo greeting came from Palmerston, New Zealand. Here again two-way communication upon the short waves was easily established, and this time a message was taken down for Mr. Jack Stuart, of the New Zealand Maori Rugby football team, now visiting Europe. Pretty wonderful, the way these experimenters hop all over the globe at one sitting, isn't it?

## J M 3 A B.

SHORT-WAVE workers will be interested to know that the intermediate J M is Johore Malaya. Mr. C. W. Randall, of the Amber Rubber Estate, Johore, advises me that the call sign J M 3 A B has been allotted to him.

## The Week's Radio Phenomenon.

GEORGE BERNARD SHAW has declared himself "an enemy of radio." And yet the sale of broadcasting licences goes on!

## Birmingham's Wireless Exhibition.

BIRMINGHAM'S first all-radio Exhibition was opened at the Thorp Street Drill Hall, in that city, on October 5th. Prizes to the value of £100 are being offered to amateur set-builders, before the show closes its doors on Saturday week, October 16th.

## Right Away.

THE wireless control of a model train, that stopped, reversed, or went forward, according to shouted instructions, was one of the most interesting sights of the Model Engineers' Exhibition, recently held in the Royal Horticultural Hall, Westminster.

The demonstrator was Major Raymond Phillips, the wireless-control expert, whose name will be familiar to readers in connection with his displays at the various "P.W." meetings.

## SHORT WAVES.

Captain Ian Fraser, the blind M.P., is reported to have remarked that he has an eleven valve set and he uses eleven valves. This is a very bad example to set Mr. Baldwin, in view of the absolute necessity for economy in these wasteful days.

Wireless, like books, brings to the home mind-pictures of near and far, and, moreover, brings one in contact with voices one would otherwise never hear.

(Mr. Walter A. Briscoe, F.L.A., in the "Nottingham Journal.")  
And which, probably, one would never want to hear again.

We understand that one exhibitor at Olympia had a stand at which nothing but pictures could be seen, but each picture concealed a loud speaker.

"Every picture tells a story"—especially during the Children's Hour.

"How do you get your set down to those short waves?" That is the question that is often asked me when I am demonstrating my four-valve portable set to a friend. (Provincial Paper.)

By just carrying it down to the beach, of course.

"This policy seems to fit the situation, and if we can but apply it to broadcasting some of us will elect gratefully to live in tents in the sterilized areas if only we may thus be permitted to escape the broadcasting amenities so passively enjoyed by radio-dragged dwellers in the zones."  
("Musical News and Herald.")

We wish some people would live and let live.

There are many listeners who boast that their sets will operate without aerial or earth, but such sets cannot be called selective or efficient. ("Cheltenham Chronicle.")

Alternative words come to one's mind, but they seem hardly polite in print.

Tenants of municipal housing schemes are beginning to demand that their homes should be equipped with the poles necessary for the erection of wireless aerials.

The clothes line (old style) is now definitely out-of-date.

Auntie Ida writes in the "Nottingham Journal and Express": "I shall not be singing quite so often in future during the Children's Hour, as I am asked to sing to the Mummies on Thursday afternoons."

Is Auntie Ida going to the British Museum or all the way to Egypt?

Any reliable wireless dealer will fit a new pair of fords to your headphones at the cost of a few shillings. (Answer to Query, Scottish Paper.)

Those Henries, again!

A headline in the "Glasgow Weekly Herald" reads: "Did Your Panel Once Run About?"  
The one we dropped the other day ran us into about ten shillings!

## Listening to Earthquakes.

WIRELESS experiments are now being conducted in Japan by means of which it is hoped to be able to predict the coming of earthquakes. The usual earthquake-recorder, the seismograph, is sensitive enough to record any big earthquake, but it cannot register the smaller slips and strains that precede an earthquake.

The new radio instrument, listening in to earth's heart, will, it is hoped, enable earthquakes and eruptions to be foretold in time for precautionary measures to be taken.

## British Radio Station Destroyed.

IN the dead of night, supported by the guns of the Battle Cruiser Squadron of the Atlantic Fleet, an invading force of Royal Marines and Black Watch assailed a lonely wireless station on the hills above Cromarty Firth and ruthlessly rushed the radio.

Did the brave wireless men blench when the Red invaders burst upon their wireless objective? Not at all. For it was only naval manoeuvres, with the Atlantic Fleet doing its autumn exercises, and the lonely wireless station was to be destroyed, on paper only!

## A Loss to the Microphone.

THE Rev. H. R. L. Sheppard, vicar of St. Martins-in-the-Fields, Trafalgar Square, London, has had to resign his living because of ill-health.

You probably have your own views about radio religion, just as I have mine, but I think you will have to agree with me when I say that very few other personalities have come to listeners over the ether with the force and charm of this gifted preacher.

## Sixpenny Magazine.

HAVE you seen the Premier this month? No, I don't mean Mr. Stanley Baldwin, but the "Premier Magazine." Hitherto it has cost 1s., but now, in good company with the "Red," the "Merry," and the "Violet" Magazines (that each used to cost 7d.) it is on sale for sixpence!

There's a new magazine, too, the "All-Story," that is going to help set the fashion for sixpenny magazines again; so if they will chatter at home, and prevent you from digesting your "P.W." properly, try taking one of the above new sixpennies home, to quell the tumult.

## Limburger!

DOWN in the Limburg coal-mines they have recently succeeded in sending and receiving intelligible radio signals, says a press report.

I wonder if it really was the wireless talking, that they heard?

## The Spider.

HAVE you ever heard a spider? I hadn't till this week, but happening to be near the "P.W." test room, I was amazed to hear a stentorian voice bawling some foreign language (it sounded like Bashi-Bazouk with a Stamboul accent), so I naturally asked what it was all about, what station, etc.?

All I could find out was that they were testing a Spider! If the bits of foreign conversation that I listened to were anything to go by, it must be a Daddy-Very-Long-Legs!

ARIEL.



In this interesting article is described a novel system whereby loud speaker or telephone extension leads can be used as an efficient indoor aerial.

# NEW EXTENSION LEAD AERIAL SYSTEM

MANY people are unable to erect really satisfactory outdoor aerials and a further great number object to the installation of poles and wires in their gardens. An alternative is to employ a frame aerial, but such has a very poor "pick up," and necessitates the use of a considerable number of valves if it is desired to operate one or more loud speakers. In the case of the local station, it is hardly economic to use more than two valves even for speaker work, and so the result is that there are a large number of extended wire indoor aerials in use. In some cases these

\*-----\*  
 By G. V. DOWDING, Grad. I.E.E.  
 (Technical Editor)  
 \*-----\*

in the drawing-room or dining-room, or better still, in both, although please do not think we hold a brief for the untidy constructor!

However, loud-speaker listeners nearly always start with the set and its speaker in one room, and gradually spread a network of extension leads all around the house. Some day every house may have such leads built in just as the electric lighting system is "built in"; anyway that seems an inevitable development. But there are still, no doubt, many listeners who do not know how easy it is to carry L.F. impulses over rough-and-ready wiring providing some form of H.T. isolation is employed, such as, for instance, the familiar choke and condenser method.

Some time ago we described a simple system of employing loud-speaker extension leads as an aerial without interfering with their normal duties. No internal circuit

alterations to the set were necessary. All that had to be done was to interpose an ordinary telephone transformer between the loud-speaker terminals of the set and the extension wiring and to connect between this latter and the aerial terminal of the set a fixed condenser of the order of .0003 mfd. capacity. Fig. 1 is a theoretical diagram of the circuit of a straightforward Det. L.F. two-valver with these additions.

Quite satisfactory results were obtained up to a point, but it is a fact that these

results were not quite equal to those that could be obtained by using a good indoor aerial. Owing to the aforementioned increasing popularity of loud-speaker extension leads (proof of which was forthcoming in the form of bulky correspondence subsequent to the publication of an article recently dealing with the subject, and in which very brief reference was made to the circuit given in Fig. 1) we decided that it was well worth our while to give the system a little further thought. This we did, and the result was most gratifying. The method was developed in quite a logical sort of way. Frankly, no brilliant research work was at all necessary. A few experiments, and our original scheme was polished up and given just those few refinements necessary to make it really efficient.

### Doing Double Duty

First of all, an ordinarily sized house some eight miles from 2 L.O. was wired up with extension leads running from a study on the top floor in which the set was to be situated, to one other room on the same floor and to three on the ground floor. These leads were well insulated, and were treated, in fact, as though they formed an indoor aerial.

They radiated from a terminal board mounted on the skirting of the operating room so that it would be possible to "plug in" any one room singly, or any number

(Continued on next page.)

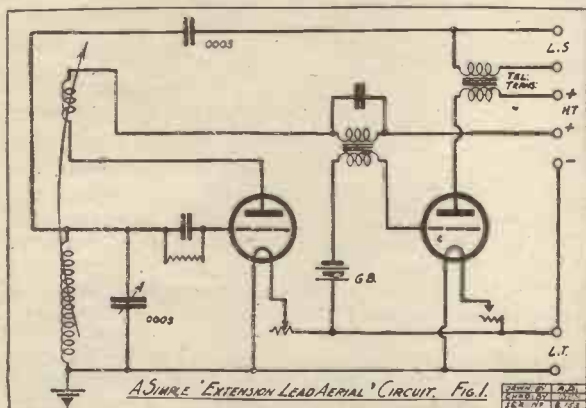

take the form of a number of wires stretched across the room just beneath the ceiling and in others an attempt at concealment is made, and the wires are run around the picture rail of a room, or are hidden away in an attic. In this short article we are going to describe a system which should interest every listener to whom the above applies and others as well.

### Efficient and Convenient

The practice of "wiring the house for wireless" is becoming more and more popular, and with good reason, too. It is certainly very useful to have extension leads running from room to room so that several loud speakers working on the one receiver can be operated simultaneously or singly at different points. The set can be situated in a place convenient for the stowing of batteries and close to a good earth, for there is practically no loss in telephone extension leads. Then again it matters not what the appearance of the receiver is, if only its loud speaker figures

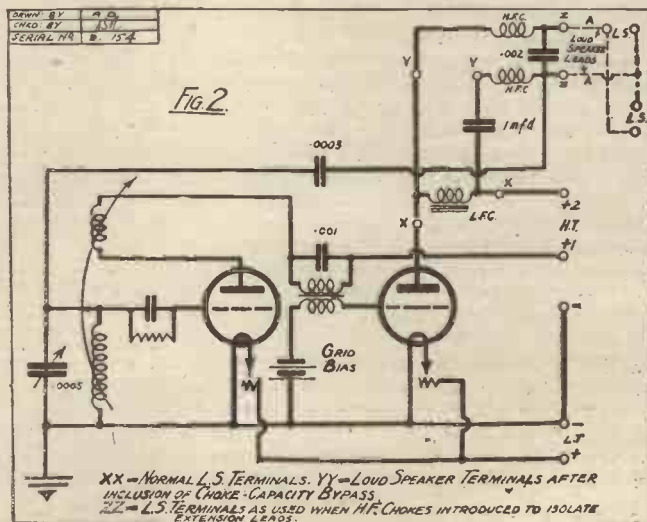



# SIMPLIFIED CONDENSER CALCULATIONS.

FROM A CORRESPONDENT.

EVERY experimenter is familiar with the equation :

$$\frac{1}{C} = \frac{1}{C_1} + \frac{1}{C_2} + \frac{1}{C_3} + \dots \text{etc.},$$

which gives the resultant capacity of a number of condensers in series. The capacities of the most commonly used condensers being small (0.01 microfarad, or less), calculations are usually complicated by the large number of noughts between the decimal point and the first significant figure of each of the individual capacities under consideration. In addition, the exact place of the decimal point has also to be carefully watched. The method described below greatly simplifies these calculations and reduces the risk of arithmetical error.

There are four stages in the process, viz. :

1. If the number of digits following the decimal point is not the same for all the capacities under consideration, add sufficient noughts after the significant figures to effect this.

Thus, if the capacities are 0.0003 and 0.01, then, since there are four figures following the decimal point in the first case and only two in the second, we must add two noughts to the latter, making it read 0.0100.

2. Move the decimal point to the right-hand end, noting the

number of places by which it is moved, and delete all the noughts preceding the significant figures.

In the above example the point is moved four places to the right, the capacities then becoming 3 and 100 respectively. This is simply multiplication (in this case by 10,000), and it will be noted that we have for the moment changed our units; but as we shall revert to microfarads at the end, this is of no importance.

3. Now calculate the resultant capacity, C, from the equation above, thus :

$$\frac{1}{C} = \frac{1}{3} + \frac{1}{100} = \frac{103}{300}$$

$$\therefore C = \frac{300}{103} = 2.91 \text{ approximately.}$$

4. Finally, express the result in microfarads by moving the decimal point as many places to the left as it was previously moved to the right.

In the present case the number of places was four, and so our result is 0.000291 microfarads.

## HAS YOUR SET SETTLED DOWN?

DID you know that a new wireless set always takes a certain time to settle down? Just like a new motor-car, that requires watching for the first 500 miles or so, till it is "run in," so does an intricate wireless set need a little time and use before the parts all pull together properly.

In one of Kipling's most characteristic works, he describes the little give-and-take adjustments that occurred before "The Ship that found Herself" was broken in to the sea. Something of the kind—on a smaller scale, of course—takes place before any large wireless set settles down to give perfect service.

The loud-speaker adjustment, for instance, may need to be advanced or retarded slightly after a week or two's use, or the rheostat reading will almost certainly be slightly different, as the new accumulator plates are formed by charge and discharge. But the puzzled purchaser need not disturb himself over the little discrepancies. His set is merely "settling down."



This efficient receiver was made from "P.W.'s" "Nineteen Pictorial Circuits" by a London reader, Mr. E. J. Elliott, 6, Victoria Terrace, Finsbury Park, N.4.

## NEW EXTENSION LEAD AERIAL SYSTEM.

(Continued from previous page.)

either in series or parallel merely by arranging a few brass straps. Two leads ran from the terminals board to the set. Now this latter was quite a normal two valver. But the loud-speaker extension lead system was isolated from it by two H.F. chokes. These were mounted on the baseboard of the set itself, the circuit of which is shown in Fig. 2. It will be seen that the choke-condenser loud-speaker by-pass is also incorporated.

The inclusion of the two H.F. chokes, which are both clearly shown in Fig. 2, meant that the loud-speaker extension lead system, marked A, completely ended at the loud-speaker terminals of the set from an H.F. point of view, so from one of these terminals a .0003 mfd. fixed condenser was connected to that point in its circuit to which in ordinary circumstances an aerial terminal would be joined. It will be observed that this condenser on its part offers a resistance to L.F. impulses. Thus the L.F. impulses transmitted to the extension leads by the set, and the H.F. impulses picked up by it in its rôle as an antenna,

could both be handled without fear of either one interfering with the other.

An Adaptable Unit.

The leads functioned in their dual rôle with excellent results. "Pick up" equalled that of a good indoor aerial, and reproduction on four loud speakers, operating in series, was excellent.

Those amateurs contemplating the in-

the system can be employed as an addition to an existing aerial with very good results, more especially if the existing aerial is of a rather inefficient nature.

There are one or two points well worth noting. First of all, it must again be emphasised that extension leads should be well insulated—that is, the wire used should be provided with a good insulation covering. Unfortunately, it must be admitted that in

many cases excellent results would be obtained with untidily strung up cheap cotton-covered wire, but in order to ensure success, at least double silk covered should be used. To still further increase the efficiency of the system, the loud speakers may be stood on rubber mats, but this is quite a luxury refinement!

The wiring should be kept well away from the mains wiring, more especially if it is A.C.

Finally, this new system should not be confused with

those in which electric bell wiring, etc., is employed as an aerial merely by placing a fixed condenser in series with it, and connecting this component to the aerial terminal of the set. A comparison of results given would prove to the inquiring why we should, with all due modesty, strongly object to this!

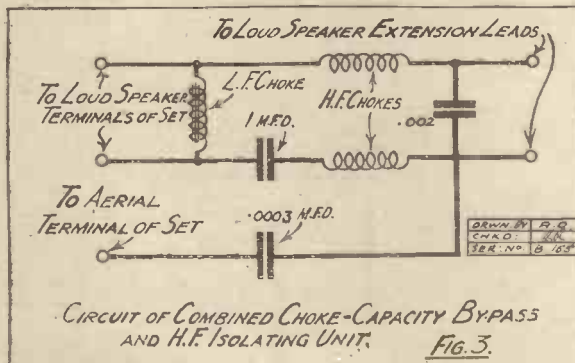

stallation of extension leads, but whose sets do not embody a by-pass system, could construct a unit on the lines of Fig. 3. The addition of two H.F. chokes and one fixed condenser to the usual choke and condenser, would enable them to employ their leads as an aerial additionally, or as a substitute to an ordinary antenna. And, by the way,





# HEAT TREATMENT OF CRYSTALS

IT is one of those assumptions which are more or less generally taken for granted that if you fix an ordinary galena crystal in its cup by means of solder you thereby ruin its sensitive properties. Now, I, personally, not being very favourably impressed with the efficiency of the electrical contact afforded by cementing a crystal to its cup by Wood's metal or similar low-temperature melting alloys, have, probably to my shame, indulged for some considerable time past in the use of ordinary solder for crystal cementing purposes.

And, strange to say, as it would seem, I have never observed any detrimental change in the crystal as a result of a rapid soldering process.

Coupled with the above observation is the fact that some time ago I came across a number of old crystal detectors of the brass point type, the date of whose construction was approximately the year 1908. These detectors functioned excellently when attached to the circuit of a modern crystal receiver. Further, on analysis, most of the metal which held the crystals to their cups proved to be zinc. Thus, these crystals must have been subjected to a temperature of somewhere about the region of 420° Centigrade, yet, so far as I could ascertain, they had suffered no sensible diminution in sensitive properties.

## High Temperature Treatment.

The question which naturally arose, therefore, was this: What exactly is the result of heating up a radio-sensitive crystal to an abnormally high temperature? Does such an operation result in the complete destruction of the crystal's sensitive powers, as is generally assumed, or is it merely some fault in the physical conditions of heating which produces this unwanted effect?

Every crystal possesses a critical voltage upon which it functions most efficiently. A few crystals also have been shown to possess a critical temperature at which they give their best results. For instance, it has long been known that carborundum becomes more sensitive when it is operated at a temperature of 350°-400° C. than at normal temperatures. Zincite, also, very frequently undergoes a change for the better after it has been subjected to a localised high-temperature heat treatment.

Why, therefore, should galena and similar crystals undergo a detrimental change in sensitivity when they are momentarily subjected to a moderate degree of heat during the process of cementing them to their cups with solder?

\*-----\*  
 An Article for the Advanced  
 Experimenter.  
 By J. F. CORRIGAN, M.Sc., A.I.C.  
 (Staff Consultant.)  
 \*-----\*

The experiments described below were made in an endeavour to determine the accuracy of the statements which have been made from time to time concerning the action of heat on crystals, and it is hoped that they may prove interesting to crystal enthusiasts, because, for the most part, they are experiments which can be readily carried out in the amateur's home workshop and laboratory and their accuracy confirmed.

## Crystals that Explode.

To begin with, a crystal of galena placed on an iron tray and rapidly heated, will generally disintegrate into small fragments, with a miniature explosion, long before the mineral becomes red hot. This is due to rapid and unequal expansion of the crystal and to the production of internal strains.

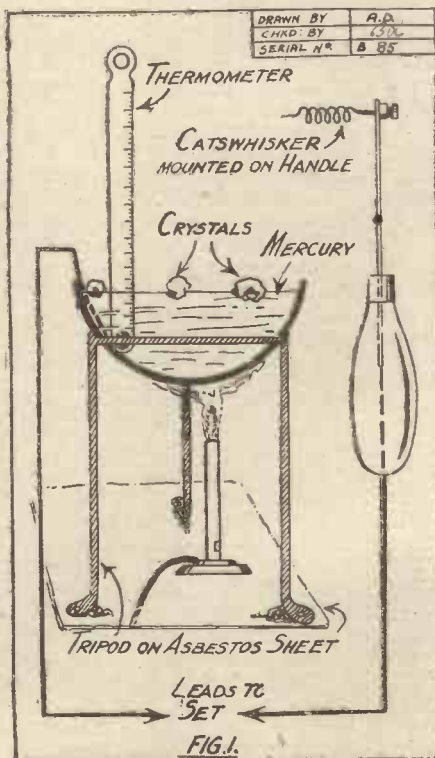

If, however, a galena crystal is carefully confined in a small crucible and rapidly heated to redness, the crystal being then cooled as rapidly as possible (by immersing the crucible in a basin of cold water) subsequent testing will show that the crystal has lost a very large proportion of its former sensitivity.

## The Rate of Heating.

If, on the other hand, a similar crystal is heated up very slowly to a temperature approaching red heat, and then allowed to cool equally as slowly, it will not lose anything in sensitivity. In fact, in some cases the crystal may actually gain in sensitivity. This point, however, is one to which I shall refer again.

Thus it seems that the rate of heating has a lot to do with the resultant sensitivity of the crystal. If the crystal is rapidly heated, the result is a decrease in sensitivity. Very slow heating results either in "no change," or in increased sensitivity.

Now let us turn for a moment to one of the modern theories of crystal rectification—that particular theory which has it that the phenomenon of rectification is due to some inherent peculiar formation in the molecular structure of the crystal surface, resulting either from physical causes or from the presence of traces of chemical impurities in the mass of the crystal.

It is well known that the rapid heating of a body has the effect of disturbing its physical and also, in many cases, its chemical composition. Working on these facts, therefore, is it not reasonable to suppose that the decrease in sensitivity resulting from the rapid heating of a crystal may be due to an alteration in the crystal's physical molecular structure, or to a change in the proportion of impurity present?

During the process of very slow heating, bodies suffer the above physical and chemical changes to a much smaller degree, and, in many instances, any change which is undergone by the substance can be controlled by the operator. This brings us now to our main series of experiments in the very slow heating of galena crystals.

## The Test Apparatus.

In the following experiments, the galena used comprised crystals of a deservedly well-known and well-advertised brand. All the crystals used in the experiments were carefully tested beforehand, and their rectifying properties were excellent.

A small metallic dish containing mercury was supported on an iron tripod, beneath  
 (Continued on next page.)



## HEAT TREATMENT OF CRYSTALS

(Continued from previous page.)

which was an ordinary bunsen burner. Floating on the surface of the mercury were experimental crystals, and dipping below the surface of the liquid metal was a thermometer capable of registering temperatures up to 360° C. The mercury constituted one electrical lead of the detector, an ordinary cat's-whisker mounted on a wooden handle comprising the other. Such a scheme of apparatus will be seen in diagram at Fig. 1.

### Red Hot Reception.

By carefully adjusting the flame of the bunsen burner, the temperature of the mercury was very slowly increased at the

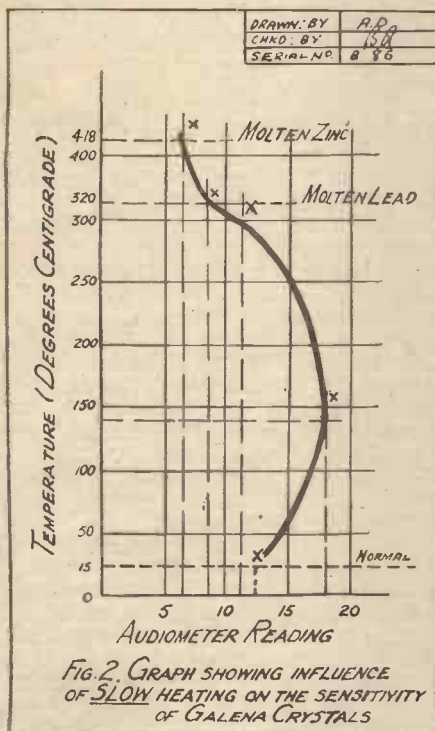

rate of about 10 degrees every five or six minutes. Tests were made upon the crystal's sensitive powers at intervals of 10 degrees rise in temperature, the strength of reception being measured by an audiometer, working on the shunted phones principle, and provided with an arbitrary scale, marked at intervals from 1 to 20.

When a temperature of 300 degrees had been reached in the mercury bath, the crystals were rapidly transferred to a similarly fitted-up dish containing molten lead maintained at a temperature slightly above its melting point (Melting point of lead = 326° C.)

The sensitivity of the crystals was tested in this bath, and, finally, they were transferred to a similar bath containing molten zinc (temperature about 420° C.).

### Effect of Slow Cooling.

The results of these experiments will be seen in the graph, Fig. 2. From the diagram it will be evident that the strength of audibility of reception slowly increased to

a maximum round about a temperature of 140° C., then slowly decreased to 300° C., after which it suffered rather considerable drops when the crystals were immersed in the lead and zinc baths.

However, on allowing the crystals to cool slowly down to normal temperatures, by reversing the order of procedure, almost identical audiometer readings were obtained. Thus, from these experiments, it would follow that careful heating has no effect on the sensitivity of galena crystals.

### Heat Treatment for Crystals.

However, the experiments with the crystals in the mercury bath only were repeated. This time the temperature of the mercury was raised very rapidly up to 340° C., readings being taken at intervals as accurately as the conditions allowed. The results will be seen in the graph Fig. 3. In this instance, it will be evident to the reader that, after becoming slightly improved at a temperature of about 100° C., the strength of reception very considerably decreased. Furthermore, on rapidly cooling down the crystals, their normal sensitivity was not regained, thus indicating that the rapid process of heating had exerted an injurious effect.

There is ample scope for amateurs interested in the subject to extend these experiments, for, even without the use of an audiometer, rough estimates of the strength of reception can readily be obtained by using a sensitive pair of phones. Again, galena formed practically the only mineral tested in any detail in the above experiments, and thus there is a great opportunity for conducting tests with other crystals.

Doubtless, the hard minerals, such as zincite, silicon, and so on, would not be appreciably influenced by any reasonable degree or rate of heating. On the other hand, minerals of the pyrites group, notably iron pyrites, would most likely show a tendency to permanently decrease in sensitive properties as a result of heat treatment.

### Improving Sensitivity.

The experiments described above have not been without their practical applications. In experimenting with inferior grades of galena crystals it was often noticed that, after cooling down, the crystals did not return to their normal sensitivity, but, on the contrary, showed enhanced sensitivity. Evidently, in these cases, the heating had caused some slight chemical or physical change to take place within the crystal, with the consequent improved results. From these observations a method of improving the sensitivity of inferior galena crystals was devised, and I am describing it below for the benefit of readers in general.

Rig up the apparatus depicted in Fig. 1, but without connecting up the leads to the crystal set. Float the inferior grade crystals on the surface of the mercury, and then very gradually heat that liquid up to a temperature of 100° C. The attainment of this temperature should take at least half an hour. Only a very small flame will be required for the purpose, and, if more convenient, a methylated spirit lamp, or even an ordinary candle flame, can be employed for the purpose.

After this temperature has been reached, regulate the size of the flame to such an extent that the temperature of the mercury

bath remains constant between 95° C. and 110° C. On no account allow it to exceed the latter temperature.

Maintain the mercury bath containing the crystals at this temperature for about two hours, after which allow the bath to slowly cool down during a period of half an hour. Inferior crystals of the galena type, treated in this way, will give surprisingly improved results, and in many cases they will become almost as perfect in radio-sensitive properties as the best grade material.

Mercury is, of course, an expensive material to use, and, therefore, if desired, ordinary paraffin wax can be employed instead. In this case, the wax will have to be dissolved off the crystals with a little ether, benzene, or some other suitable solvent. And, needless to say, the greatest care will have to be taken to see that the wax does not catch fire. Water cannot be used for the experiment, for, in most cases, it contains solids in solution which tend to attack the surface of the crystal and to oxidise it.

### Soldering Harmless.

Finally, it may be said that the slow heating of high-grade galena crystals causes no appreciable change in their sensitivity, and that, in fact, the heat treatment is actually beneficial to the inferior qualities of galena. Also, there is very little harm,

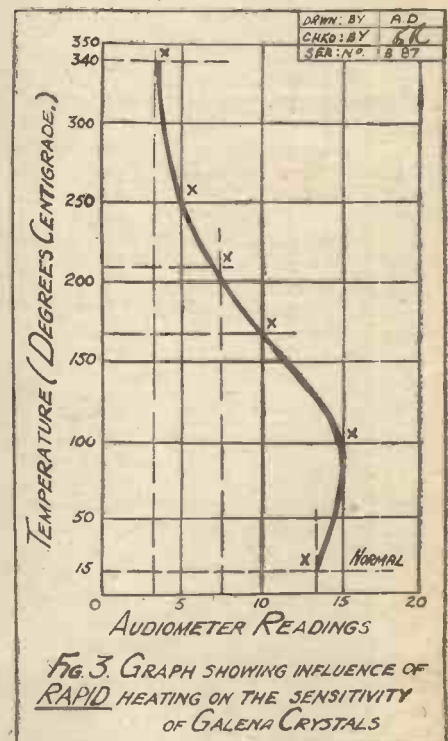

if any, to be done to a galena crystal by affixing it to its cup with ordinary solder, most commercial samples of which melt at a temperature considerably below the melting of lead. Although such a treatment involves the rapid heating of the crystal, the heating is only of momentary duration, and the temperature attained is not high enough to influence the crystal's sensitivity. Whether this point is strictly in accordance with the accepted theory of the subject is another matter, but it is certainly a fact which is born out in actual practice.



# Home-made Telephone Leads

HAVE you ever taken the trouble to work out just how your telephone leads connect up the two earpieces of your telephones? I wonder if you know how many distinct wires there are in those leads, and if you could improvise a set of such leads if the necessity arose?

Like you, I daresay I have always taken my 'phone leads for granted, and it was not until I ran up against trouble with the leads of a new pair of headphones that I bothered to find out anything about such things.

My wireless dealer recently put me on to a good thing in the way of a pair of new headphones at a reduced price, and I took the new 'phones home with me gleefully, for I am a great lover of a wireless bargain. What wireless man isn't?

When I tested the new 'phones, however, I found that there was something sadly wrong with the leads. Just when telephony was coming in well, a slight movement of the leads or a sudden jerk on them would cause the signals to disappear entirely.

Accordingly, I bought a new set of 'phone leads of the usual pattern. As soon as ever I started to think about fitting those leads to my new headphones, I realised my ignorance of the manner in which 'phone leads were connected up. So I set to work to find out all I could about those 'phone leads, and a most interesting piece of work it was.

## The Run of the Wires.

On examining the new 'phone leads, I noticed that, of the two pairs of ends which go to the earpieces, the two wires of one pair were marked one red and one green, whereas the two wires of the other pair were marked one green and one black. The other two ends of the leads—the ends which are attached to the telephone terminals of the receiving set, were not marked in any way.

The two green ends suggested that there might be one wire stretching from green to green. A simple test with a voltmeter and a small dry cell confirmed this suggestion. Further tests with the voltmeter and the dry cell resulted in a precise knowledge of the run of the other wires in



By OLIVER HALL, D.Sc.

the 'phone leads. Fig. 1 shows the run of these wires, and it will be seen from this diagram that there are three distinct wires in a set of 'phone leads. It will also be seen from this diagram that the two earpieces of a set of headphones are connected up in series.

## New Leads for Old.

In order to see where the two wires went to in one of the earpieces of my new 'phones, it was necessary to take off the cap and remove the diaphragm. On doing this, and looking inside the earpiece, it was at once evident that fitting the two wires was going to be no easy task. Each wire had to pass through a hole in the outer rim of the metal case, and then had to be threaded from underneath through a hole in a kind of stiff, waxed cardboard protector, fixed over the magnets. Finally, each wire had to be secured to a small screw which screwed into a small threaded socket. Fig. 2 will, perhaps, make clear the run of the two wires to the inside of an earpiece.

The new 'phone leads I had purchased were rather stiff, and I had to admit that it would be an utter impossibility to push the ends of those stiff 'phone leads through the holes in the earpieces. Accordingly, I gave up the idea of using the new 'phone leads and decided to make a set myself.

For the 'phone leads of my own make, I first cut off a length of five feet of good twin flex and unwound the two leads. I then cut off a length of 18 in. of single flex. Round the two ends of one of the long pieces of flex, I wrapped a little red cotton as a distinguishing mark. The other long piece of flex was then marked in similar fashion with black cotton.

Connections were then made to the first earpiece, the red-marked piece of flex being connected to the positive terminal screw in the earpiece and the short piece of flex to the other terminal screw. I then twisted together these two pieces of flex for a length of 9 in. (see 1 of Fig. 3).

Next I took the black-marked piece of flex and measured off a length from one end equal to the remaining length of the short piece of flex. Then I twisted together this short portion of the black-marked long piece of flex and the untwisted portion of the short piece of flex, starting the twisting at X (see 2, Fig. 3). After this twisting together was done, connections were made to the second earpiece. The unmarked end of the short piece of flex was connected to the positive screw terminal, the black-marked end of the long piece of flex to the negative screw terminal.

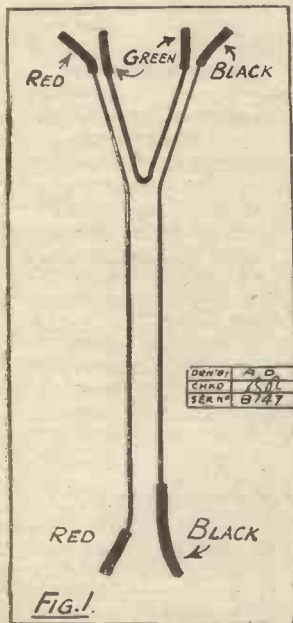

FIG. 1.

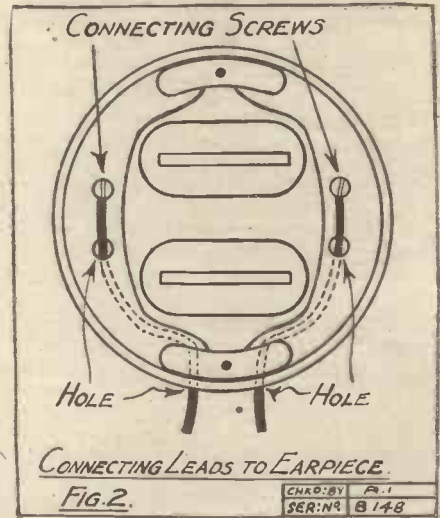

FIG. 2.

Lastly, the two free ends of the long pieces of flex were twisted together, starting again at X (see 3, Fig. 3). Tags were then secured to the ends of these leads, and the 'phone leads were complete.

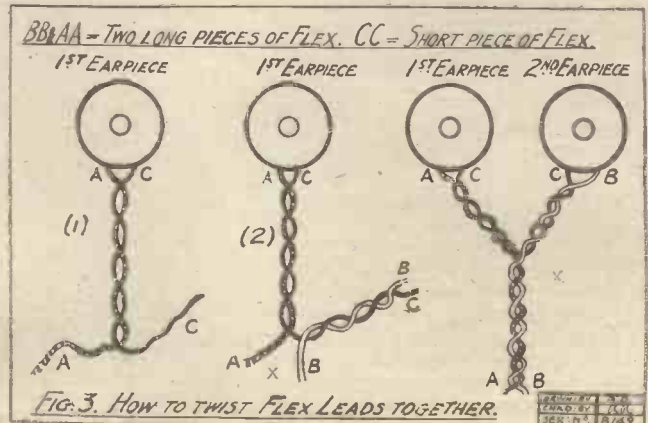

FIG. 3. HOW TO TWIST FLEX LEADS TOGETHER.



THE question of "soft" valves for detecting purposes, which was discussed recently, has brought me a number of inquiries as to the lives of these valves as compared with those of the more conventional "hard" type.

For the sake of readers who may not be familiar with the difference between "hard" and "soft" valves, perhaps I should state that a "hard" valve is one in which the vacuum is taken to a high degree, that is to say, in which there is very little residual air left in the bulb. A "soft" valve, on the other hand, is one which, although in the ordinary sense highly evacuated, nevertheless contains an appreciable quantity of residual gas.

If a large potential difference be applied between the electrodes in a "soft" valve, especially if the filament be alight, some of the gas molecules or atoms will become ionised, that is, they will lose or gain one or more electrons. A molecule or atom which loses an electron will thereby become positively electrified and will constitute what is known as a "positive ion." When the plate of the valve is made positive with respect to the filament, so that the negative electrons from the filament are driven across towards the plate, it is evident that, by the same token, the positive ions in the bulb will be driven in the opposite direction, and as the electrons bombard the plate, so the positive ion will bombard the filament.

#### Filament Bombarded.

Thus, in a soft valve there is a much greater tendency for the filament to be bombarded, and this has the effect of gradually disintegrating or wearing down the filament and so of shortening its life.

It is important to note, however, that the effect just mentioned increases rapidly with the applied potential difference, or rather, to be more accurate, with the potential gradient.

In a "soft" detecting valve it is unnecessary to apply any very high H.T. voltage, and indeed, as will be gathered from the foregoing remarks, it is very undesirable to apply a greater H.T. than is necessary for the efficient functioning of the valve as a detector.

In the case of a "hard" valve, there is so little residual gas in the tube that the proportion of the current that is carried through the valve by the gas ions is insignificant compared with that which is carried by the electrons thermionically emitted from the filament: in other words, the current through the valve may be considered to be carried by a pure electron discharge from the filament. In this case, there is scarcely any bombardment of the filament by gas ions travelling in the opposite direction to the electrons and the filament has a much greater "expectation of life" (to use an insurance phrase).

#### New Soft Valves:

Another important point to bear in mind is that the disintegration of the cathode, owing to this bombardment, depends not only upon the pressure but also upon the nature of the residual gas in the tube.

Most amateurs who have had experience with the earlier types of receiving valve will know that these valves were apt to become soft during use owing largely to the release of gas from the electrodes, particularly the anode, under the bombardment due to the electron stream from the filament. In

## TECHNICAL NOTES.

A Weekly Feature  
Conducted by

Dr. J. H. T. ROBERTS, F.Inst.P.  
(Staff Consultant.)

the modern methods of receiving-valve manufacture particular precautions are taken to free the electrodes, and especially the anode, from gas, so that the valve once completed is unlikely to become soft in use. Once a valve became soft it could be taken as a moral certainty that its filament would have a comparatively short life.

I mention all this by way of explaining that the new soft detector valves, which are specially manufactured as soft valves, are not to be confused with valves which have become soft in the way mentioned above. In the new valves, partly owing to the special method of manufacture, to the nature and pressure of the gas used and to the fact that they operate on a comparatively low value of H.T., the difficulty due to the bombardment and disintegration of the filament, as mentioned in the foregoing remarks, has been overcome.

For the information of those of my readers who have from time to time sent



A section of the Milan Radio School where elaborate technical training is provided.

queries with regard to selenium cells, I would like to mention that I received recently some particulars of a new type of selenium cell which is claimed to be ultra-sensitive. Hitherto, many amateurs who felt inclined to carry on experiments with light-sensitive cells have been deterred from so doing owing to the difficulty and uncertainty of preparing the cells. Selenium or other such-like cells usually form the essential component in television and allied apparatus and there are a great many interesting experiments which may be made with light-sensitive cells of this kind. In fact, it seems probable that there is a great and comparatively unexplored field for research.

#### Photo-electric Cells.

The particular cells to which I have referred above are made by Priorsells Limited, of 65, Cannon Street House, 110, Cannon Street, E.C.4. Amongst the claims which are made for them are the following: They are of great sensitivity and the "lag," or "inertia," which is a pronounced feature in most other types of selenium cell, has been almost entirely eliminated; the cells have a high, dark resistance and a low, light resistance, which gives a greater light-dark ratio than has hitherto been obtainable; they have also long life and constant performance. In addition, the makers guarantee to replace any cell which during the first six months falls below the specified ratio, provided certain simple conditions are carried out.

Some of the uses to which cells of this kind may be put are in connection with television, photo-telegraphy, photo-telephony, amplification of speech currents, synchronising, photometry, automatic lighting, detection of colour, fire alarms, burglar alarms, etc.

To give an idea of the resistance and resistance-variation in a particular cell, the dark resistance was 2,000,000 ohms, whilst the light resistance when at a distance of 40 inches from a 500-candle-power lamp was 300,000 ohms, and at a distance of 12 inches 125,000 ohms. The current passed through the cell when unilluminated was 2 micro-amperes, and when 12 inches from the lamp 33 micro-amperes.

Full particulars of these cells, together with a large amount of most useful and interesting information, may be obtained from the manufacturer whose name is given above.

#### Amplifiers.

In my remark, a week or two back, on the subject of microphone amplifiers, I omitted to mention some experiments which I made lately with the Wilson bar microphone amplifier. This is a very neat unit operating on a novel principle and works  
(Continued on page 334.)



# A NEW ONE VALVE FILADYNE CIRCUIT

In this article Mr. Dowding describes a new development of his Filadyne circuit which has aroused the greatest interest in amateur radio circles.

THERE is no perfect system of coupling either H.F. or L.F. stages together, and, furthermore, there is as yet no perfect valve. The result is that the greater the number of stages a receiver employs the greater will be the degree to which both wave and frequency distortion may impair the purity of the ultimate reproduction.

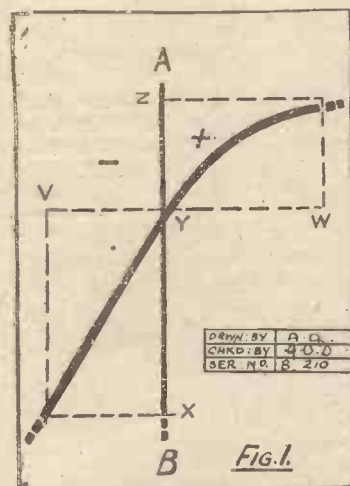

Additionally every stage of magnification must of necessity amplify "background" noises of some kind or another and, in more extreme cases, these "unwanted signals" are brought up to a strength out of all proportion to that of the music and speech from the broadcasting station.

### Loud-speaker Results.

For these reasons it must be granted that, quite apart from any of economy pure and simple, any reduction in the number of valves that can be used to produce a certain result is distinctly advantageous. Therefore, we feel gratified that we are able to publish details concerning a considerably improved one-valve Filadyne circuit. This new hook-up really is worth bringing to the discriminating attention of "P.W." readers. The original one-valve Filadyne was pretty

good, as those of our readers who built it will agree, but the new or improved one-valver described in this article is capable of considerably superior performances.

Further, it has the stability of a straight-forward circuit. The local station can be tuned in on the loud speaker in a few moments even although the adjustments are deliberately thrown out beforehand. Amateurs who have had the nerve-racking experience of attempting this with some of the so-called "one-valve loud speaker circuits" can be forgiven if at this juncture they close their eyes reminiscently and smile a bitter, sceptical smile.

### Anode Bend Rectification.

However, let us proceed with the description of the circuit. It will be remembered that the application of an "input" bias to the original Filadyne was tried with but little success. Had rectification been carried out on one or other of the two bends of the "input volts" — "output current" curve this was not surprising, as the effect of applied voltage would be to throw us off this necessarily somewhat critical point. Now, according to the curve given by the D.E.R. (a suitable valve for the Filadyne), rectification takes place at the upper bend.

Dissecting this curve a description of this means of rectification can be given in quite a few words, and will enable the reader more clearly to follow the development of the circuit.

The point Y in Fig. 1 represents a zero point symbolical of the Filadyne receiver connected up but with no signals coming in. Now, the current received or, rather, induced, in the aerial is an oscillating one. From point Y to point V represents the arrival of

a negative impulse of a certain voltage, and from point Y to point W a positive impulse of an exactly similar voltage (and this is how the energy would arrive).

It will be seen that the negative impulse

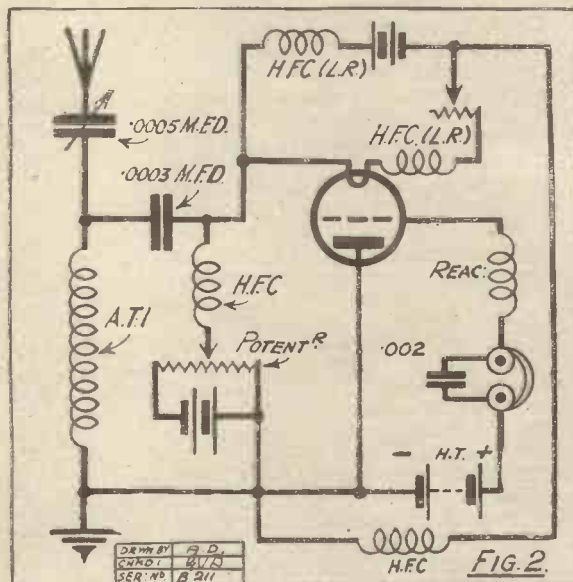
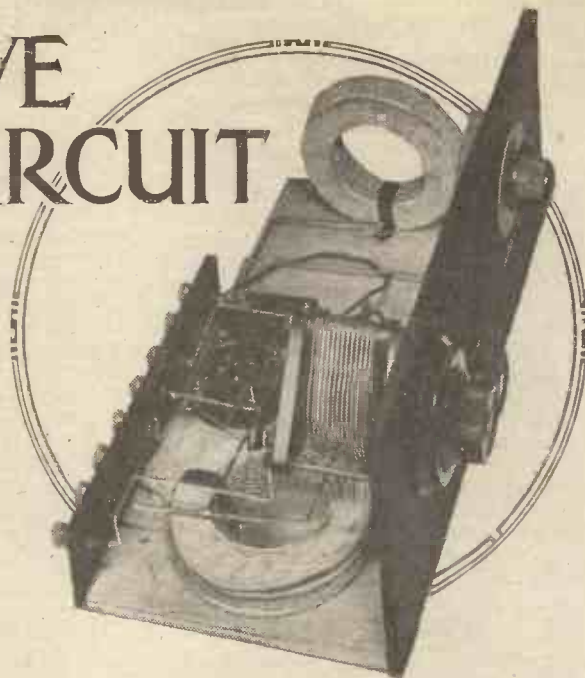

decreases the plate current (A—B) from Y to X, but that the positive impulse increases it only from Y to Z owing to the close approach to the saturation point of the valve. The increase is, therefore, by no means in the same proportion to the decrease, and thus rectification occurs.

### What the Potentiometer Does.

We were not satisfied with this method of rectification because we did not feel that we were controlling the zero point sufficiently closely to give us optimum efficiency. After a considerable number of experiments we were, however, able to introduce a cumulative filament method, and by means

(Continued on next page.)

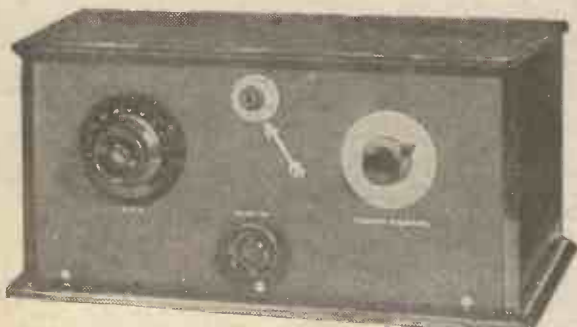

Showing how a potentiometer can be mounted on the panel of the one-valve Filadyne set described in "P.W." No. 215.



## A NEW ONE VALVE FILADYNE CIRCUIT.

(Continued from previous page.)

of specially applied bias, to work on the straight part of the excellently steep curve and thus obtain even greater amplification.

A filament condenser of .0003 mfd. capacity was introduced and an ordinary H.F. choke was connected from the filament to the moving contact of an ordinary potentiometer of 400 ohms resistance. Across this potentiometer was joined a small 4½-volt dry battery tapped at each 1½ volts. The positive pole of this battery was taken to earth. (See Fig. 2.)

Results were excellent, and a very fine control of reaction was provided by the potentiometer, although, of course, its primary function is to bring the operating zero of the curve down to as central a point in the straight as possible in order that the maximum grid swing can be utilised.

### Additional Sensitivity.

Greater stability was given the circuit by earthing the filament battery through another ordinary H.F. choke. In Fig. 2 the filament chokes are suffixed L.R. to denote that they should be of low ohmic resistance, as per previous articles. The other two chokes can be of any good make (Lissen, Marconi, Cosmos, etc.). It is important that the filament battery choke be connected exactly as shown—i.e. to the negative pole, and not to the positive.

We found it possible to eliminate the potentiometer and bias battery and the filament choke, and still obtain results that were far superior to those given by any normal one-valver, but the inclusion of these items is decidedly warranted by the additional sensitivity that they provide.

Readers who have constructed the Filadynes previously described will find it very well worth their while to incorporate these improvements. The extra components can be accommodated quite easily. We reproduce photos of the panels of the one- and two-valve Filadynes detailed in "P.W." constructional articles with potentiometer dials and knobs painted in by our technical artist in positions which render them easy to mount without first of all dismantling existing sets.

The chokes and condenser can be fitted in the most convenient spaces behind the panel or on the baseboard. There will be a little crowding here and there, but as long as the wiring is kept fairly well spaced this will not matter. We advise Metro-Vick. H.F. chokes as these are very small and are quite efficient. They are no larger than anode resistances, and will slip into places where a larger make would be hopelessly cramped.

### Modifying Existing Sets.

As will be seen by Fig. 2 not many alterations to the circuit will be required. The only real alteration is the breaking of a filament lead for the insertion of a fixed condenser, all the rest is merely addition.

Let us detail the actual work necessary, and this will apply both to one- and two-valvers. The connection between one side of the variable condenser and A.T.I. coil holder and a filament socket of the valve holder should be broken and a .0003 mfd.

fixed condenser inserted in a series position. The same filament socket of the valve holder should be connected to one side of an H.F. choke, and the other terminal of this component to the moving arm of a potentiometer. A 4½-volt dry battery should be connected across the two fixed contact terminals of the potentiometer by means of two flexible leads and wander plugs (the small battery being tapped, as should all "grid" bias batteries). The positive terminal of the battery should be taken to the earth terminal or to the nearest lead or other point in direct metallic contact with the earth terminal. Another ordinary H.F. choke should be connected between the negative L.T. terminal and the earth terminal or any lead in direct contact with it. And that is that!

In conclusion, readers will no doubt be interested to learn that details of further developments of the Filadyne principle, as applied to multi-valve receivers of consider-



This two-valve Filadyne, described in "P.W." 218, can easily be modified, and there is ample space for the potentiometer on the panel as indicated by the arrow.

able sensitivity and general effectiveness, very shortly will be ready for publication.

## VARIOMETER ROTOR CONTACTS.

By A. RODGERS.

A METHOD of making contact with the spindles of variometer rotors, which, tried with success, is described below. When the holes in the stator are drilled for the spindles, they should be made a little larger than the spindles, so as to allow a bushing of copper foil to be inserted, as shown in sketch, leaving a tag for soldering external connections. This idea, carried out with a little care, is about the best and simplest method when making variometers

from the wooden or moulded ebonite formers.

It allows a free movement of the rotor in any direction without the restriction of flexible leads. The corner foil bushes must, of course, fit very closely so as to make good contact.

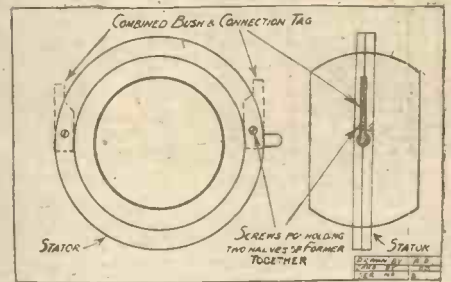

One of the latest army mobile wireless stations together with two of the operators and a driver.



**T**HE Third German Radio Show comprised exhibits by about 250 firms, and while there were one or two novelties of a more sensational kind, the general impression was one of steady and, in spite of adverse circumstances, prosperous development. Many of the firms which formerly were among those constructing radio apparatus have either gone out of existence altogether or have turned their attention to the manufacturing of component parts, and a wise division of labour could be noticed in this connection.

**Increase in Valve Receivers.**

There is a general tendency to substitute efficient valve receivers for the detector apparatus so far used nearly exclusively by the majority of the German listeners-in, prices now being so low as to make a one-valve receiver accessible even to modest purses. Much headway has been made by tuning devices intended to ensure long-distance reception even during the working

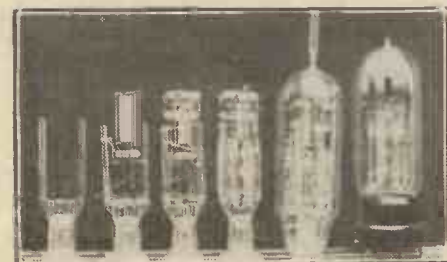

The Loewe triple valve in various stages of manufacture.

hours of the local transmitter. Secondary and tertiary circuits are used in this connection, while in some cases a special selective circuit is provided for disposing of the local station. Practically all these receivers are designed for the whole range of waves between 200 and 2,000 metres. L.F. am-

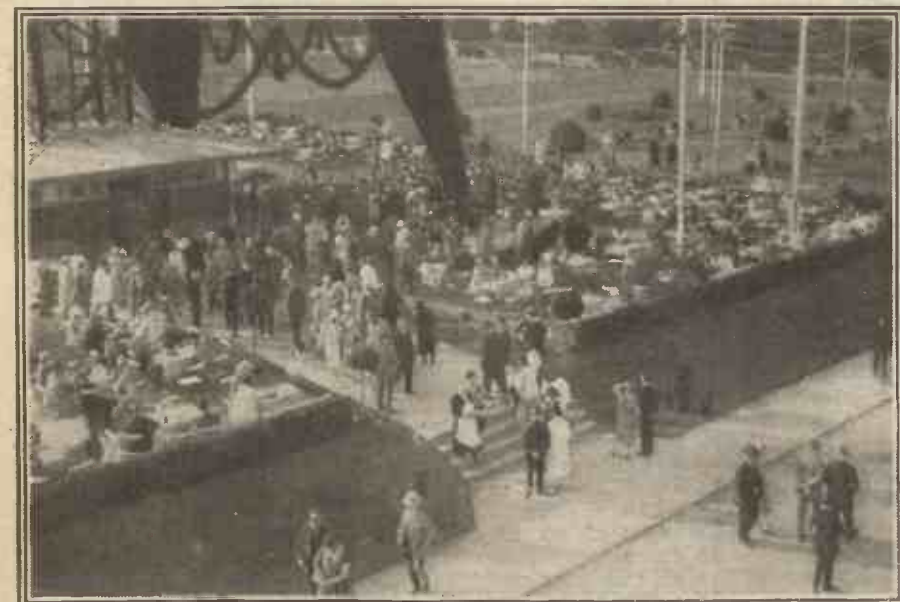

A portion of the crowd that assembled at the foot of the new Radio tower.

# THE GERMAN RADIO EXHIBITION. BERLIN'S BIG BOOM.

By **DR. ALFRED GRADENWITZ.**  
(Our Correspondent in Berlin.)

plifiers were in the last stages often designed as resistance amplifiers. Short-wave transmitters and receivers were likewise on show.

Another tendency everywhere to be noted was a growing demand for apparatus independent of any batteries as source of current and intended to be connected up direct to the light socket. While a marked improve-

condensers, one firm turning out a type of cylindrical condenser claimed to afford constant standardisation, while a sliding condenser made up of two batches of plates sliding within one another likewise met with much interest.

The definite adjustment with hardly one exception is obtained by a special gearing slowly operating a planetary gear.

**An Interesting Exhibit.**

Much headway has been made in connection with the construction of loud speakers, special measuring methods enabling the

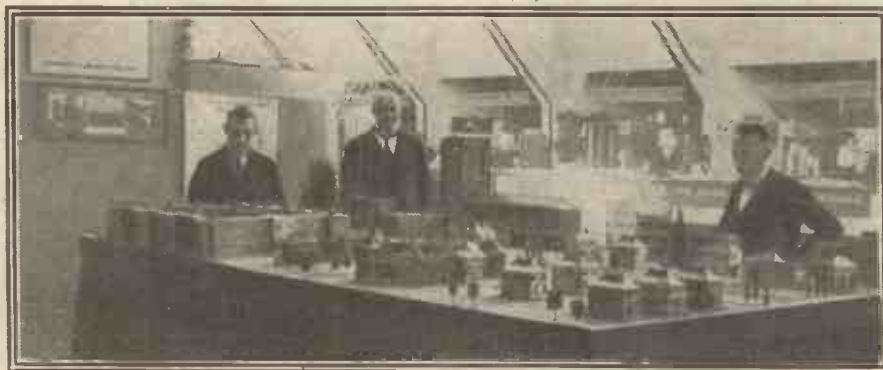

The Stand of the Postal Department, where a model of a complete high-power station was shown.

ment has been made in the manufacture of anode batteries, their use is still more expensive than connection to the mains. In the event of a direct current supply, the pressure in the mains, which in Germany as a rule is 220 volts, cannot be eliminated so completely as to avoid any disturbing effect, while alternating current systems do not afford any insurmountable difficulty.

As regards the manufacture of component parts, particular attention has been given to the designing of more perfect

behaviour of these instruments to be examined and their defects ascertained.

A special show by the German Postal Department afforded particular interest. This comprised on one stand a complete survey of the development of radio receivers in Germany during the last three years—i.e. since the beginning of an authorised broadcasting service. Typical receivers from the various stages of that period were on show, diagrams of connections enabling both the industrial and scientific progress to be gauged. Another stand was set apart for the most modern branch of radio engineering—viz. telephotography, or the wireless transmission of pictures and handwriting. Of the more important types of German apparatus—Korn, Telefunken-Karolus, Dieckmann—only the latter, an outfit for the recording of broadcast weather maps, was shown in actual operation, the others, as well as their foreign competitors, being merely illustrated by instructive pictures and diagrams. A collection comprising all German types of audion and amplifier valves with the characteristics of each particularly appealed to amateurs.

**High-Power Station.**

Another exhibit by the German Postal Department was the model of a high-power receiving station destined for overseas wireless telegram reception with its characteristic antenna arrangement. This was supplemented by a long row of photographs showing the installations of German broadcast transmitters and a collection of house models fitted with antennae of the most varied types.

(Continued on next page.)



## THE GERMAN RADIO EXHIBITION.

(Continued from previous page.)

The Telegraphen-technische Reichsanstalt (Government Laboratory of Telegraph Engineering) exhibited the work of prize-

casting of theatrical performances from the studio, an amusing revue, "As far as the Antenna," made up for the deficiency. The various rooms of the Berlin transmitting station were again on view in the form of reduced imitations.

### The Multiple Valve.

The most remarkable exhibit from a scientific and technical point of view was Dr. Loewe's multiple valves. A triple

headphone reception of most European stations to be obtained.

Dr. Nesper showed his broadcast tele-photographic apparatus, of simple construction, for connecting up to any broadcast receiver. This is mainly intended for broadcasting, along with the text of a lecture, the portrait of the lecturer, and such pictures and diagrams as are indispensable.

The Radio Exhibition coincided with the inauguration of the new Radio Tower, 420 feet high, which contains a restaurant 150 feet up and a further platform 360 feet up.

### Compact Receivers.

On the whole the exhibition has been a great success and it has shown that considerable developments have taken place during the last twelve months. Radio has progressed in all directions and the newcomer to wireless is apt to overlook this fact unless he is confronted with comparisons such as the exhibition provided.

Compactness in receivers is receiving a great deal of attention, as will be seen from the photograph on this page. This set, resistance coupled throughout, makes use of the new triple valve, which contains in itself all the necessary parts, except the filament rheostat and the aerial tuning system.



Radio is extensively used in the German army, as this photograph taken at recent manoeuvres shows.

takers in its Amateur Contest, the results of which were remarkable in many ways.

While the Berlin Broadcasting Company this year had not arranged for any broad-

valve for all wave-lengths, comprising three-valve systems (two amplifier stages and one loud speaker stage), with all the couplings required, ensures loud-speaker reception

of local transmitters with frame or emergency aerials, while headphone reception with outdoor aerials is possible from nearly all places. This valve operates (without back coupling) with resistance coupled amplification on Von Ardenne's system, and can even be run on a 150-volt anode battery to ensure maximum strength. Loewe's distant reception double valve is of a similar arrangement, but comprises two double-grid valve systems and coupling, the filament current being 0.17 amp. at about 4 volts. An anode tension of 90 volts is quite sufficient in connection with this valve and 10-20 volts on the space charge grid. This valve gives an aperiodic H.F. amplification down to waves of less than 200 metres, and with an outdoor aerial enables long-distance



A complete three-valve set, using the new Loewe triple valve.

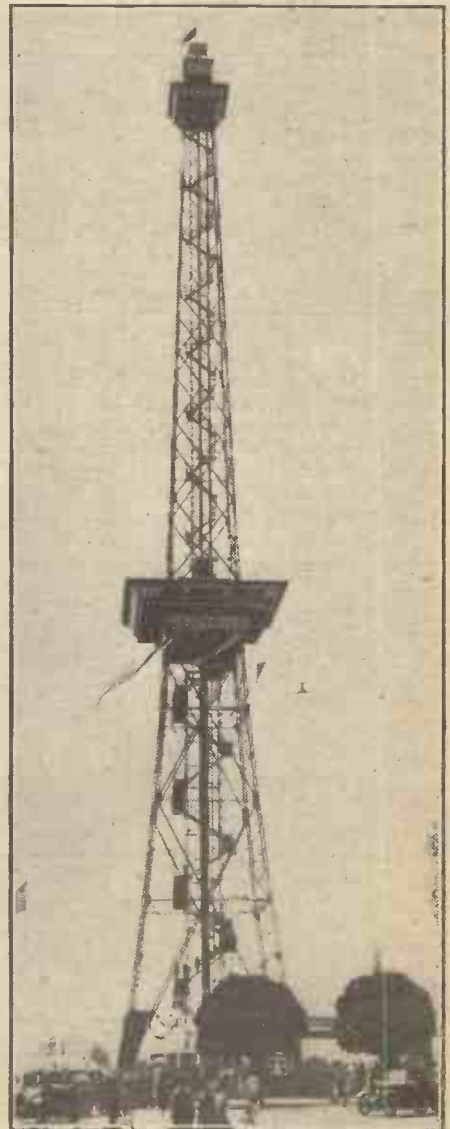

The new Radio tower at Berlin, which has a restaurant on the first platform 150 feet up.





# Now no home need lack a Loud Speaker

The introduction of the "Lissen" Loud Speaking Unit at the amazingly low price of 13/6 has created an unparalleled stir. Unbiased critics, seated behind a screen and asked to distinguish between a thirteen-and-sixpenny "Lissen" and a well-known loud speaker at five guineas have been completely at a loss.

The "Lissen" Loud Speaking Unit is sold exactly as illustrated above, and with every instrument are simple directions telling you how to make a horn of proved efficiency to attach to it. Full sized exact patterns and clear instructions how to put the horn together are given to you with each "Lissen" Unit. If you possess a gramophone horn or any loud speaker horn—or any horn or trumpet—that will serve admirably. Make this test. Go to your nearest dealer—ask him to put on the best loud speaker he has in stock—then use the same horn on the "Lissen" Unit and see if you can notice any difference.

Get a "Lissen" Loud Speaking Unit for *your* home. Anyone who can use a pair of scissors and a paste-pot can turn out in half an hour an instrument of most pleasing appearance, equal in performance to the finest money can buy. The secret is in the "Lissen" Loud Speaking Unit, which possesses an electro-magnetic sound-reproducing mechanism concentrated in the most effective manner achieved, and sold at a record in low prices.

Your dealer will gladly demonstrate and supply—or send postal order direct.

## LISSEN LIMITED

LISSENIUM WORKS, 8-16, FRIARS LANE, RICHMOND, SURREY.

'Phone: RICHMOND 2285 (4 lines).

'Grams: "Lissenium, Phone, London."



The "Lissen" Unit instantly converts any gramophone into a loud speaker.



A cone diaphragm loud speaker can easily be constructed. The illustration shows one method of mounting.



Full directions for making this horn are given with every "Lissen" Unit.

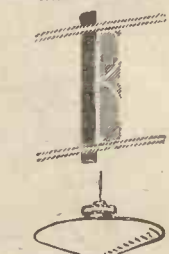

Another way of utilizing the cone diaphragm method of construction.



The "Lissen" Reed Attachment (pat. pending) for use with cone diaphragm loud speaker. Price 1/-.



# Choose your Valves carefully —

For: —  
ONE-CELL ACCUMULATORS

For: —  
THREE-CELL ACCUMULATORS

## "COSMOS" DE.11



The 11-Volt Valve that works well off a Dry Battery  
Filament Current 0.25 Amp.  
Amplification Factor 6.5

14/-

## "COSMOS" SP.18/R SHORTPATH RED SPOT



The real 2-Volt Power Valve  
Filament Current 0.3 Amp.  
Amplification Factor 7

14/-

## "COSMOS" SP.18/G SHORTPATH GREEN SPOT



A 2-Volt High Amplification Valve  
Filament Current 0.3 Amp.  
Amplification Factor 15

14/-

## "COSMOS" SP.18/B SHORTPATH BLUE SPOT



The 2-Volt Resistance Capacity Valve  
Filament Current 0.09 Amp.  
Amplification Factor 35

14/-

A CAREFUL choice of the valves for use in the various positions of a receiving set will often make a wonderful improvement, and the time spent in making the choice is well worth while. The comprehensive range of "Cosmos" Valves shown on this page are shown for convenience under the general heading of the L.T. Supply—2-Volt and 6-Volt respectively—and some brief particulars are given to indicate their chief characteristics.

Particular attention is drawn to the S.P. 18/B and the S.P. 55/B (Blue Spot) Valves, which are specially effective when used with the modern method of Resistance Capacity coupling, equaling the amplification obtained with L.F. Transformers and general purpose valves, with all the recognised advantages of resistance coupling.

Complete details of every valve cannot be given in the space at our disposal, so, in order to assist you in making a careful and satisfactory choice of a valve for each position in your set, the booklet illustrated below has been produced. It gives all the characteristics and features of the entire range of "Cosmos" Valves, and includes an easily understood table showing the best types of valves for use in the different positions or stages in various kinds of circuit.

Your dealer has a supply of these booklets, "The Soul o Music," and would be very pleased to give you a copy.

If by any chance you should have any difficulty in obtaining it write to:—

**METRO-VICK SUPPLIES LTD.**  
Metro-Vick House,  
155, Charing Cross Road,  
LONDON, W.C.2

## A.45 "COSMOS"

A Bright Filament Valve for general purposes for 4.5Volts  
Filament Current 0.65 Amp.  
Amplification Factor 9



8/-

## DE.55 "COSMOS"

A 6-Volt Dull Emitter General Purposes Valve  
Filament Current 0.09 Amp.  
Amplification Factor 9



18/6

## SP.55/R "COSMOS" SHORTPATH RED SPOT

The Loud Speaker Valve Supreme for 6 Volts  
Filament Current 0.25 Amp.  
Amplification Factor 6



22/6

## SP.55/B "COSMOS" SHORTPATH BLUE SPOT

The 6-Volt Resistance Capacity Valve  
Filament Current 0.09 Amp.  
Amplification Factor 35



18/6



A COSMOS VALVE FOR EVERY POSITION



**£200 in Prizes  
for Constructors!**

**NEXT WEEK'S**  
Magnificent Special Number  
Free Supplement

**Order Next Week's  
"P.W." Now.**  
A Gift for Every Reader  
and £200 in Prizes

## THE "P.W." CONSTRUCTORS' GUIDE

The First of Three Fine Gifts for Constructors  
Order Your Copy Now

# Popular Wireless

and Wireless Review

Every Thursday  
PRICE  
3d.

### THE "P.W." CONSTRUCTORS' GUIDE Next Week's Splendid Gift.

Every issue of "P.W." on Sale next Thursday will contain a Special Free Supplement entitled "The 'P.W.' Constructors' Guide." The best paper has been used in order that photos and diagrams shall be printed with the finest clarity with regards detail, and the contents will enable the amateur to build for himself at *minimum cost and with maximum efficiency*—

**A Plug-in Crystal Set and  
A One-Valve L.F. Amplifier**

The two sets have been specially designed by the "P.W." staff so that the two can, if desired, be easily connected together. The veriest novice can follow the instructions given with the greatest of ease.

### TWO MORE GIFT SUPPLEMENTS

Issues of "P.W." on sale week ending October 23rd and 30th will also contain Free Gift Supplements for Constructors

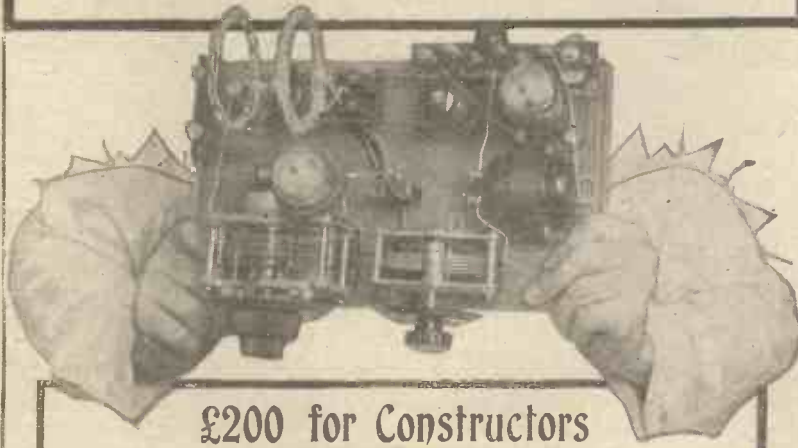

**£200 for Constructors**

Enter  
the  
Great  
"P.W."  
Constructors'  
Competition

Full  
Details  
in  
Next Week's  
Issue

Attractive  
Prizes  
are Offered  
to Readers  
in Next  
Week's Issue

£200 in  
Prizes for  
All Classes  
of  
Amateurs



# BROADCAST NOTES.

BY OUR BROADCASTING CORRESPONDENT.

Potted Operas—Armistice Day—National Wireless Week—Longer Talks?—Continental Relays—Trafalgar Day.

## The Royal Charter.

IT is common knowledge in official circles that the Royal Charter for Broadcasting has been drawn up in agreement between the Post Office and the Treasury, and circulated in Cabinet Papers. There is no sign, however, that the document has as yet been shown to the B.B.C. The natural inference is that there are clauses to which the B.B.C. would take strong objection.

These probably bear upon finance. Even if the Coal situation claims all the time of Parliament for the rest of the year, it should still be possible for the Broadcasting Charter to receive some consideration. One way out of the difficulty would be for the Government to publish a summary of the Charter as a White Paper in advance of the meeting of Parliament in November. This White Paper would naturally outline the financial proposals that the Government would embody in the Charter.

Failing some such action, the chances are that the future constitution of broadcasting will receive no attention from the public or from Parliament before it becomes the law of the land, whatever the consequences. There is, however, a growing movement to extend the B.B.C. licence for six months in order that the Charter may be properly considered.

## Potted Operas.

A controversy is raging round the recently announced intention of the B.B.C. to broadcast a series of "Potted Operas." Some music lovers look upon this as little short of desecration. The problem is, in fact, more one of wise selection than one of general principle. There are some operas that lend themselves to contraction, and are really more attractive as a result. The first of the series will be "Lucia di Lammermoor," to be given in place of "Fidelio," on October 29th.

## "My Programme."

The series of special programmes nominated and organised by representative critics and public men is not making rapid progress. There is an unexpected reluctance on the part of most of those who have been approached. Mr. J. R. Clynes, M.P., will probably put on a programme on October 30th.

## Armistice Day.

This year the broadcast observance of Armistice will be a good deal more solemn than usual. The two minutes' silence and subsequent service will be taken from Canterbury Cathedral. Then in the afternoon a special service will be taken from Westminster Cathedral, and at night there will be a commemorative musical programme from the London studio until 10.30 p.m.

## The National Wireless Week.

Synchronising with the special B.B.C. Birthday Week programmes, November 7th

to 14th, there is to be a National Wireless Week, in which all sections of the industry are co-operating. It is to be hoped that this becomes a permanent institution. It falls just long enough after the September Exhibition to provide another valuable stimulus to the winter season.

## A Stevenson Programme.

A special Robert Louis Stevenson programme is to be given on December 3rd. Sir Edmund Gosse will give the talk, and Mr. Cecil A. Lewis will be in charge of the programme itself. The B.B.C. propose to pay more attention in future to literary anniversaries.

## Threat of Longer Talks.

Mr. J. C. Stobart, Director of Talks at the B.B.C., is reported as having promised the

## New Series of Continental Relays.

One or two of the Continental Relays of last season were of slight entertainment value; the rest were justifiable merely because of their novelty. It is hoped this year to improve the standard of relaying considerably. Unless real programme and entertainment values are secured, the new series will be abandoned.

The first is arranged for October 16th.

## A Russian Programme.

The Russian Programme has been transferred to Wednesday, October 26th, from October 25th. M. Nabokoff will be compère, and a special studio version of Tchekov's "Bear" will replace the poetry reading originally planned.

## Money Prizes.

Money prizes are being offered by the B.B.C. for short choral and orchestral compositions by composers of Scottish birth suitable for microphone transmission. The winning works will be performed at the Symphony Concert in the St. Andrew's Hall, Glasgow, to be broadcast to all stations in Scotland, on March 24th next.

## Bournemouth's Birthday.

Broadcasting flourishes at Bournemouth. A special programme on Saturday, October



A presentation of colours ceremony being broadcast from Prague recently. The microphone is seen on the left of the photograph.

Workers' Educational Association Conference at Cambridge that he would be able, under the Corporation, to make the talks on serious subjects as long as half an hour each, and introduce them into the main part of the programme. Well-wishers of broadcasting will hope that Mr. Stobart has been misunderstood or misquoted.

The chief fault of the B.B.C. now is that all its talks are too long, and that it panders much too much to the educational cranks who cut no ice whatever with the vast body of listeners. Mr. Stobart can extend his talks to six hours each, if and when he is working on a genuinely alternative wave-length, but not before.

It is agreed among those who are in real touch with public opinion, and who are also in reasonable sympathy with the educational side of broadcasting, that five minutes is the outside limit for an effective talk that gets any considerable body of listeners. Longer talks under present conditions defeat their own purpose. They fail to educate; they merely irritate.

13th, will signalise the third birthday of the station. Details are being reserved as a surprise for listeners. Mr. Rose-Troup, who took over this station a few months ago, has done a great work for the B.B.C. in that area. Incidentally, interest in broadcasting is being awakened in Portsmouth as well. There is a desire in the latter place for more attention from Bournemouth than has been the case in the past.

## Trafalgar Day.

The special broadcast on Trafalgar Day, October 21st, will be from H.M.S. "Victory," Nelson's flagship, in Portsmouth Harbour. The transmission will be from six to seven o'clock and will be from all B.B.C. Stations. Some intensely dramatic effects are promised.

## Empire Premiers.

Listeners will probably hear the voice of the Empire Premiers on the occasion of the Empire Press Union Dinner on Wednesday, October 20th.



# DRY CELL USERS

*The Valve that  
has popularised  
Dry Battery Sets*

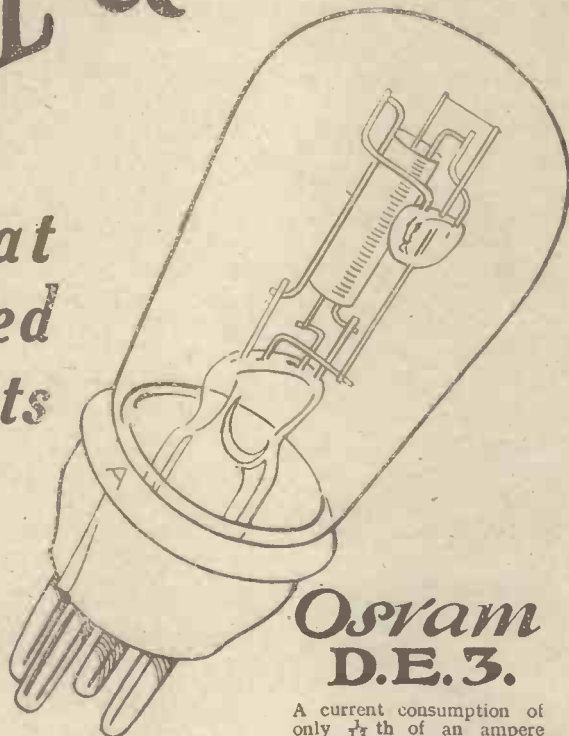

**Osram  
D.E.3.**

The universal popularity,—  
the enormous and constant  
demand for the D.E.3 OSRAM  
VALVE—acclaims the fact  
that it is *the* valve for use  
with dry batteries.

Three ordinary dry cells in  
series will run the OSRAM  
D.E.3 at a cost of *less than*  
*half a farthing an hour.*

A current consumption of  
only  $\frac{1}{4}$  th of an ampere  
renders the D.E.3 OSRAM  
VALVE ideal for operating  
from dry cells or small  
4-volt accumulators. *The  
Valve for Portable Sets.*

**Price 14/- each.**

*This price does not apply to  
Irish Free State.*

# Osram Valves

for Broadcasting

*The G.E.C.-your guarantee*



# Utility

GUARANTEED

## COMPONENTS

The recent National Radio Exhibition fully demonstrated the outstanding supremacy of British design and manufacture in Wireless Components and Instruments—and productions of "Utility" origin there displayed received the highest commendation from Wireless Enthusiasts and Dealers alike for their efficiency, precision and care to detail. Although "Utility" Components have been greatly reduced in price, their high standard of quality and our guarantee to replace or repair defective parts free of charge is maintained.

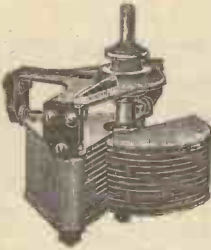

### "Utility"

#### Low Loss Condensers

This famous "Utility" Component has been improved. All brass parts are nickel plated, pigtail connection from moving plates, terminals and soldering tags are fitted, and the centre spindle rotates on ball bearings. The Vernier pattern is fitted with a Micro-Dial as illustrated below.

Prices from 13/-



### "Utility"

#### Push-Pull Switch

A switch of the push-pull type with the advantages of our well-known "Utility" switch. Its extremely low capacity, smooth action and perfect contact ensure highest efficiency. One-hole fixing. Two-pole change-over.

Price 4/6



### "Utility"

#### Micro-Dial

A handsome 4 in. Dial in which is incorporated Slow Motion Mechanism for obtaining the finest tuning of the Condenser. The Dial itself gives coarse adjustment, the Knob fine adjustment and the gear ratio is 70:1. Movement is unlimited. Backlash is entirely eliminated. It can be fitted to all makes of condensers.

Price 7/6



### "Utility"

#### Jack and Plug

A Jack designed on the same principles as our well-known "Utility" Switch, and similar to our Push-Pull Switch in size. Has many advantages over the ordinary type of Jack. Perfect rubbing contact and low self capacity.

Prices: Jack 4/6, Plug 2/6

Your local dealer stocks "Utility" if he is an up-to-date man. Ask him for details.

**WILKINS & WRIGHT LTD**  
KENYON ST. *Utility* BIRMINGHAM

whichever way you look at it —

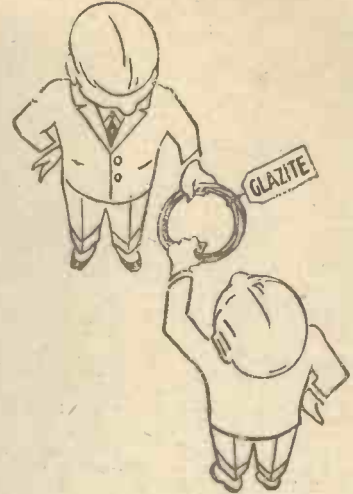

you'll find the  
**GLAZITE** way better!

There isn't a single way in which GLAZITE isn't better. It's easier. It's neater. It gives perfect insulation. It's flameproof. It's damp-proof. It won't deteriorate in use. And it's cheaper!

Next time, use GLAZITE—the better way of wiring!

**GLAZITE**  
BRITISH MADE REGD

COLOURED CONNECTING WIRE

[RED · YELLOW · BLUE · BLACK · WHITE and GREEN]

Obtainable in ten-foot coils, price 1s. 2d. per coil. Or in two-foot lengths—four assorted colours—1s. per packet. Write for interesting descriptive leaflet to

The  
**LONDON ELECTRIC WIRE COMPANY & SMITHS, LTD.**  
Playhouse Yard, Golden Lane, London, E.C.1

Makers of Electric Wire

for over  40 years

THE successful operation of a low-frequency amplifier depends largely upon the correct working of the valves, particularly the last one, which should be a power valve if good loud-speaker results are to be obtained.

When fitting up a circuit for loud-speaker work, therefore, we must first decide upon suitable valves for our purpose, this being determined largely by questions of accumulator voltage and first cost. We must also select a valve for the last stage which is capable of doing the work which will be required of it.

Another point to be considered is the value of the H.T. voltage which is to be

# GRID BIAS.

## How It Is Obtained.

By C. E. FIELD, B.Sc.  
(Staff Consultant).

### PART III.

value of not more than two megohms, one, or even half a megohm being suitable.

In Fig. 1 is shown a circuit consisting of two valves, the first of which is fed from an L.F. transformer and biased with  $1\frac{1}{2}$  volts, the second being resistance-coupled with 4½ volts (3 cells) applied to the grid.

Although grid cells are not called upon to supply any current, it should not be imagined that on that account they will last for ever, or that very small, or inferior cells will be satisfactory. Just as in the case of the H.T. battery, these cells may develop internal faults, or run down within a few months if of inferior quality. It is a good plan, therefore, to renew the grid cells whenever a new H.T. battery is required.

Here it may be mentioned that it is possible to utilise the last few cells of the H.T. battery for biasing a valve grid. When this is carried

out the extreme negative point of the battery is joined to the transformer or grid leak, the H.T. negative lead being connected to a tapping on the battery distant from the negative end by the amount of the bias required (see Fig. 2).

It is, of course, possible that there are not

suitable tappings on the battery, or that, for other reasons, it is desired to join H.T. negative to L.T. positive.

In cases where a bias of only one, or at most two, volts is required, this may be obtained by inserting a suitable resistance in the negative filament lead. This may be a fixed resistance, or may constitute the filament

rheostat. Although in some cases this method is wasteful of power, it would be folly not to employ a necessary voltage drop for the purpose of biasing the grid.

For example, there are probably hundreds of amateurs who have abandoned bright valves in favour of dull emitters, and employ their original 4-volt accumulators for lighting the filaments.

#### Utilising L.T. "Drop."

Let us take the case of a general-purpose dull emitter, requiring 2 volts on the filament and taking a current of 0.4 ampere. Such a valve might be used as a first-stage L.F. amplifier, in which case one or two volts grid bias would probably be required.

If we desire to use a 4-volt accumulator, the total resistance in the circuit must be  $\frac{4}{0.4} = 10$  ohms, to keep the current within the safe value of 0.4 ampere. Since the voltage required for the valve is 2, the resistance of the heated filament is  $\frac{2}{0.4} = 5$  ohms. We, therefore, require an additional five ohms in the filament circuit. This may be a specially wound fixed resistance, or a rheostat, preferably of the "Lissenstat" or "Microstat" type.

By connecting this in the negative lead, and joining the secondary transformer winding directly to the negative L.T. terminal, the two volts which are absorbed in driving the filament current through the

resistance are made to serve the useful purpose of biasing the valve grid. In Fig. 2 is shown a 2-valve L.F. amplifier, comprising a 2-volt dull emitter biased in this manner, followed by a 4-volt power valve, the bias for which is obtained from the last tappings of its own H.T. battery. All fixed condensers have been omitted in order to simplify the diagram.

A little consideration will show us that it is wasteful to employ a 4-volt battery to light a 2-volt valve, even if the surplus is being made use of for biasing the grid.

Why not utilise the same two volts for

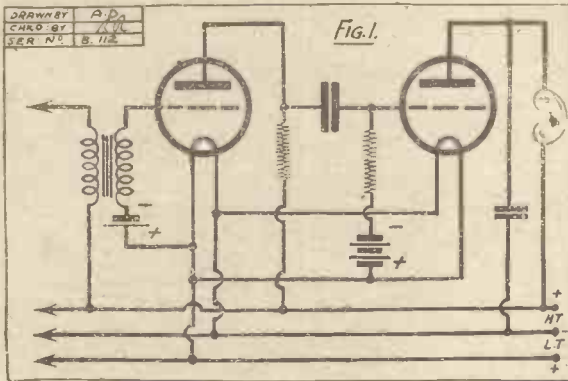

used. In the case of a small power valve, such as should be selected for use in the last stage, the plate voltage employed should be higher than that on the previous valves, and preferably the maximum value recommended by the makers. Having decided these points, we must then turn our attention to the all-important question of grid bias.

#### Correct Value Essential.

The correct value of the voltage to be applied to the grid will probably be given in instructions supplied with the valve, but if this is not the case, information should be obtained from the makers.

It must be remembered, however, that any considerable change in the voltage of the H.T. battery employed should be accompanied by a change in grid bias. For instance, suppose that we were using two sixty-volt batteries, the second one being used simply to bring the voltage up to 120 for the plate of the last valve. It might easily happen that one battery ran down or developed a fault, and we were compelled to carry on with 60 volts only.

We should then have to reduce our grid bias on the last valve, and we should be fairly safe in halving it if the correct figures were not available.

There are several methods of obtaining grid bias, the most popular, and perhaps the simplest, utilising dry cells connected directly in the grid circuit, between the negative end of the filament and the secondary winding of the L.F. transformer.

When resistance-capacity or choke-coil coupling is employed, the grid cells are connected between the filament negative and the grid leak, which should have a



A magnificent set built by an Australian reader, Mr. S. Golding, now in England. Seven valves are employed, 2 neutralised H.F., 1 Det., 2 L.F., and two further stages of push-pull amplification. The lower part of the cabinet contains batteries, wave-meter, and charging system for batteries.

(Continued on next page.)



## GRID BIAS.

(Continued from previous page.)

lighting the filament of a previous valve? This can be carried out quite simply by connecting the valve filaments in series, instead of in parallel, and making use of the voltage lost in the first valve filament for biasing the second valve grid.

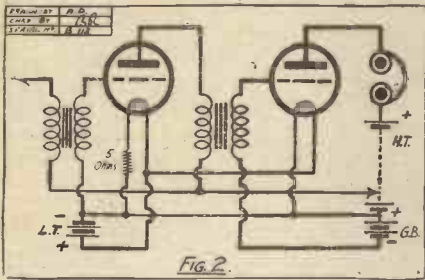

Fig. 2.

This is a method which deserves to be used much more extensively than it is, for it is economical and satisfactory from every point of view. Let us take a practical example.

### A Novel Method.

All leading valve manufacturers now produce a line of valves requiring a filament voltage of 2.5-3, and consuming only .06 ampere, which are excellent for general purpose work, and undoubtedly economical.

For last stage work, dull-emitter power valves with very low filament currents are manufactured, the filament voltage usually being 5-6, and a very economical amplifier, capable of giving strong loud-speaker signals of excellent quality, can be made up of two .06-amp. valves as detector and first-stage L.F. amplifier, followed by one of these power valves.

Now, the chief drawback to the .06 amp. type of valve is the awkward filament voltage required—just too high for two dry cells (unless they are quite new), and too low for use with a 4-volt accumulator, or three cells, without a 30-ohm rheostat in circuit.

Then there is the question of the extra voltage required for a 6-volt power valve. However, by connecting the first two valves in series, with the negative terminal of a

6-volt battery connected to the filament of the detector and to the intervalve transformer secondary winding, a bias of 2½-3 volts is obtained on the second valve grid, there is no risk of burning out the valves, and no power is lost in high-resistance rheostats.

A diagram of connections for this circuit, which can be thoroughly recommended, is shown in Fig. 3.

### Economical Bias.

There is yet another method of obtaining grid bias which does not appear to be generally known, but which has much to recommend it for use on the last stage of a two or three-valve amplifier.

Just as bias can be obtained by means of the drop in voltage across a resistance in the filament circuit, so can a resistance be inserted in the H.T. circuit with the same object.

If the negatives of the H.T. and L.F. batteries are joined, not directly, but through a resistance, the plate current of all the valves will have to pass through this resistance. The H.T. terminal will then be more negative than the filament by the voltage drop across the resistance. This will be clear from a consideration of Fig. 4, which shows an H.F.-crystal-2 L.F. circuit.

Let us suppose, for the sake of argument, that the H.F. and first L.F. valves are an Ediswan A.R. '06, "red line," and a Mullard D '06 L.F. respectively, and that the last valve is a B.T.-H. type B. 7, .06 amp. power valve.

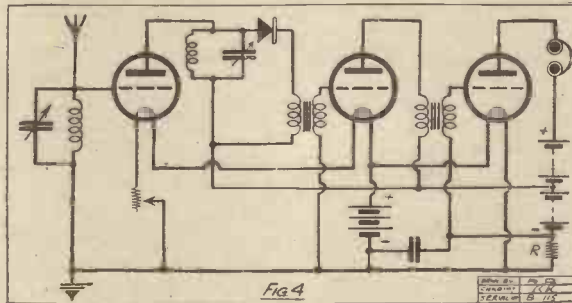

Fig. 4.

The first two valves are connected in series across the 6-volt accumulator. The bias on that used as L.F. amplifier will be the voltage drop in the H.F. valve filament, plus a small drop in the common rheostat, giving about 3½ volts, which is suitable for this valve with a plate voltage of 60. The resistance R supplies the biasing voltage to the last valve grid.

In order to find the resistance required for R, we must consult the curves for the valves concerned, and find the total plate current which will be passing through this resistance.

Characteristics of the valves show us that the currents in the H.F. and first L.F. valves respectively are about 1.2 and 1.6 milliamps.

The H.T. current in the power valve, when supplied with a plate voltage of 100, and biased, as it should be, with 4 volts, is about 3.6 milliamps. The

total current through the resistance R is therefore 1.2 + 1.6 + 3.6 = 6.4 milliamps.

We require a voltage drop of 4 across this resistance when a current of 6.4 milliamps flows through it. Its value is

$$\text{therefore given by } R = \frac{4}{.0064} = 625 \text{ ohms.}$$

A suitable resistance could be constructed by winding 48 yards of No. 36 S.W.G. Manganin wire on a convenient-sized spool. Two lengths of 24 yards should be cut off, soldered together at one end, and run on the spool as a double wire, finishing up with the open ends, to which connection can be made. The winding is then non-inductive.

A condenser of ample capacity (½ or 1 mfd.) should be connected in parallel with the resistance in order to minimise the changes in grid voltage which would be produced by fluctuating currents passing through it, and to prevent the introduction of L.F. reaction.

This method of biasing automatically compensates for changes in the voltage of the H.T. battery, for a reduced voltage means reduced plate current and reduced drop across the resistance, the valve being thus operated always under its best conditions.

Finally, it should be remarked that these more unusual methods of obtaining grid bias are not freak methods, for each is used by one or other wireless manufacturer of repute.

## RHEOSTAT VALUES.

By H. A. POSTLETHWAITE.

NOW that there are so many valves on the market with different consumption ratings, it is necessary always to consider what type of rheostat is most suitable for insertion in a set designed for use with particular valves. Everyone knows that a 30-ohms rheostat should be used when 3-volt valves taking .06 amps. are lit by a 4-volt accumulator, but even dealers are sometimes hazy about the resistance value for, say, a 1.8-volt valve, taking .12 amps., to be run in conjunction with 5-volt valves, off a 6-volt accumulator.

### A Simple Calculation.

Divide the amps. figure into 1, and multiply the result by the maximum number of volts which it is required to cut out. Thus, in the example just given, .12 divided into 1 gives 8½. The number of volts to be cut out is 4.2 (i.e. 6 minus 1.8). The amount of the resistance of the rheostat in use should therefore be 8½ multiplied by 4.2, which equals 35 ohms.

Thus a 3.2-volt valve taking .1 amp., when run off a 4-volt accumulator requires

$$\frac{1}{.1} \times (4 - 3.2) = 8 \text{ ohms resistance.}$$

If run off a 6-volt accumulator, the resistance required would be

$$\frac{1}{.1} \times (6 - 3.2) = 28 \text{ ohms.}$$

It is advisable, however, to allow a few additional ohms, because an accumulator gives rather more than its stated voltage when freshly charged.

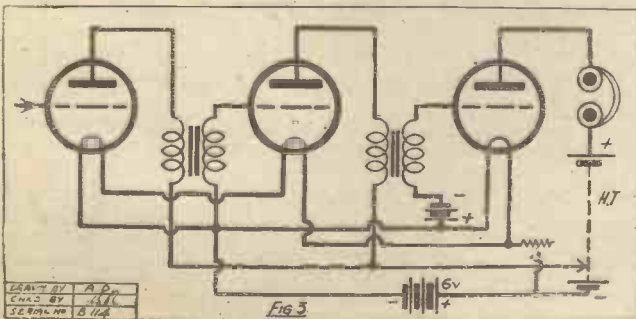

Fig. 3.



Patent Nos. 238003.

223625 and pending.

# IMPORTANT NOTICE



Photo of Sir Oliver Lodge.  
by LAFAYETTE.

Having acquired the World Rights for Sir Oliver Lodge's famous "N" Circuit we desire to state that we assume all responsibility under the CLEARTRON Ironclad Guarantee for the performance of all sets made by us or in accordance with the diagrams furnished with CLEARTRON-Lodge "N" Constructor Kits containing the components selected and approved by the inventors—and royalty paid.

Any sets made up otherwise than in accordance with the foregoing carry no guarantee, and no authorisation of Sir Oliver Lodge. Unless the "Lodge" royalty is paid the manufacture of these Circuits constitutes an infringement of the Lodge Patents owned by "CLEARTRON."

## LODGE 'N' CIRCUIT

### CHIEF FEATURES:

- Non-radiating,
- Non-interfering,
- Great volume,
- Extreme purity,
- Keenly selective,
- Highly sensitive.

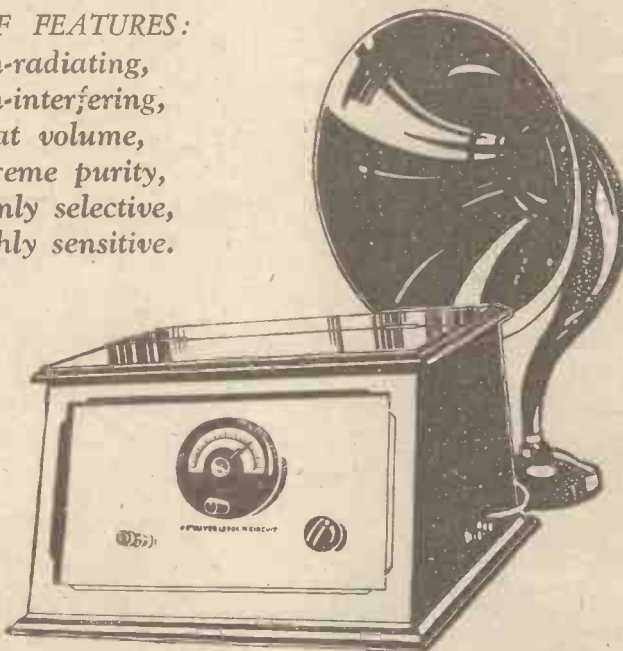

Send for  
Lodge "N"  
Booklet post  
free.

SINGLE  
DIAL  
CONTROL

2-Valve Model complete with all accessories  
£15 15 0

(including all royalties)

3-Valve Model complete with all accessories  
£19 19 0

(including all royalties)

or with  
CLEARTRON'S NOVEL SERVICE PLAN

on Easy Monthly Payments.

Also  
Home Constructor Kits

complete

2-Valve - £6.6.0

3-Valve - £8.8.0

plus Royalties and Valves.

All LODGE "N" CIRCUITS are fitted with  
CLEARTRON <sup>1926/27</sup> NEW MODEL VALVES

and backed by Cleartron's Ironclad Guarantee.

## CLEARTRON RADIO LIMITED

1, CHARING CROSS, LONDON, S.W.1.  
Telephone: Regent 2231-2.

Works: BIRMINGHAM.  
Telegrams: Cleartron, Westrand, London.

C.T. 68a



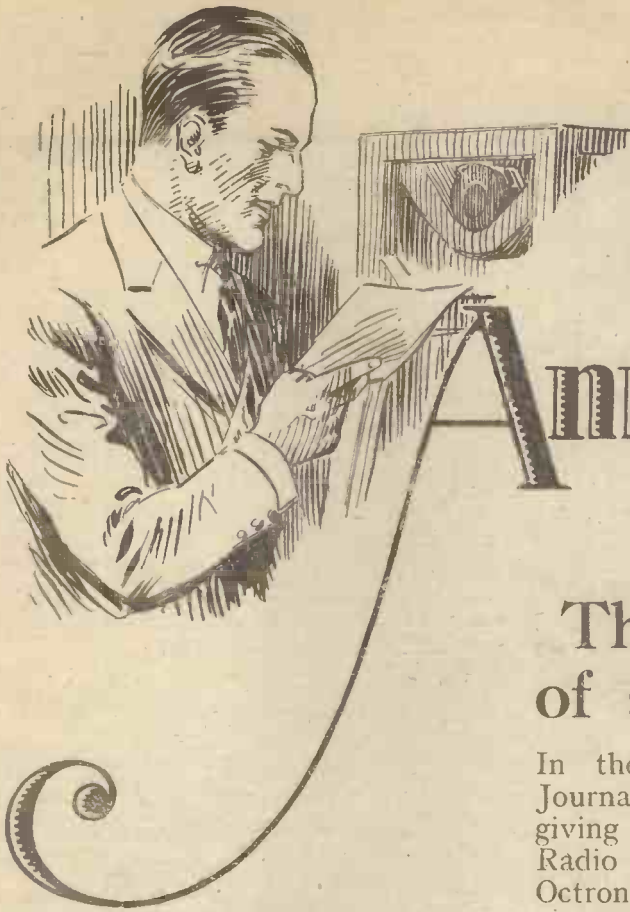

# Announcing

## The Perfection of a New Valve

In the following issues of this Journal we shall have pleasure in giving details of the new Octron Radio Valve. The advent of the Octron will prove of great interest to all Radio users.

Should you desire to learn more of this new advance in valve production, we shall be pleased to forward illustrated descriptive literature immediately this is available. Send us your name and address for this purpose *Now*.

**H.S. ELECTRIC Ltd.,**

*Electrical Engineers,*

**32, Charlotte Street, Birmingham**

Telephone: Central 7460

Telegrams: Hosaval, B'ham.





# DISTORTION IN REFLEX SETS

By G. J. MARCUS.

**A**LTHOUGH reflex sets give such splendid results on very little current it must be admitted that unless precautions are taken they are liable to distortion. This, of course, is due to the fact that the same valve has to perform two entirely different functions. It is a difficult operation to adjust the valve to carry out these two functions satisfactorily.

Then there is the L.F. transformer itself. It is well-known that iron-cored transformers are apt to amplify some frequencies more than others. The result is a most unpleasant harshness and blaring effect.

Distortion is very often produced by the feed-back effect of the reaction coil. In fact, if really good reception is desired it is wiser to do without these reaction coils altogether.

The extra stage of L.F. makes things even worse. The distortion introduced at all the points previously mentioned is handed on to the L.F. valve and amplified still further.

### Eliminating Distortion.

The next thing to do is to discover the best means of eliminating this distortion. The tendency towards "double rectification" can be avoided by keeping the valve on the straight portion of its characteristic

curve; this is done by applying a high voltage of 100 volts or so to the plate with corresponding negative bias of 4-6 volts on the grid (Fig. 2). As the valve has to perform a double duty it is necessary to choose the type of valve which is a good H.F. as well as a good L.F. amplifier. Valves of the D.E.5b type do very well in this capacity.

The grid battery is placed between the H.F. choke and the crystal. A by-pass condenser of 1 mfd. is connected across the terminals of the H.T. battery to ensure smooth running.

### A Satisfactory Circuit.

It is better to cut out the L.F. transformer altogether. The volume is certainly decreased, but this loss in signal strength is more than compensated by increased tonal purity. Any subsequent stages of L.F. must be specially designed to give distortionless amplification. The resistance capacity method of coupling is particularly recommended for this purpose. An amplifier designed on these lines will deal with the heaviest loads without giving rise to distorted reception.

The circuit represented in Fig. 3 may be confidently recommended. This consists of a reflex valve-crystal combination coupled to two stages of L.F. amplification. The L.F. amplifier is on the resistance-capacity principle, and is absolutely dis-

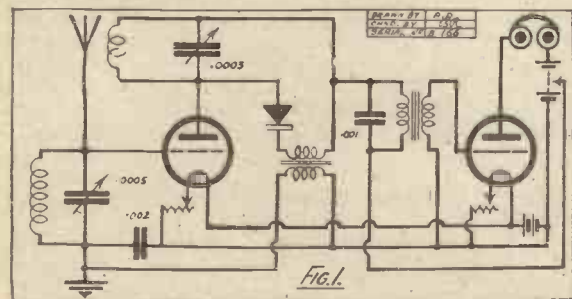

Consider the circuit represented in Fig. 1. The reader will at once notice the points at which distortion can occur. In the first place the valve is liable to rectify on its own account so that signals may be heard in the 'phones even when the cat's-whisker is lifted off the crystal. This double rectification is a very common fault, and produces serious distortion.

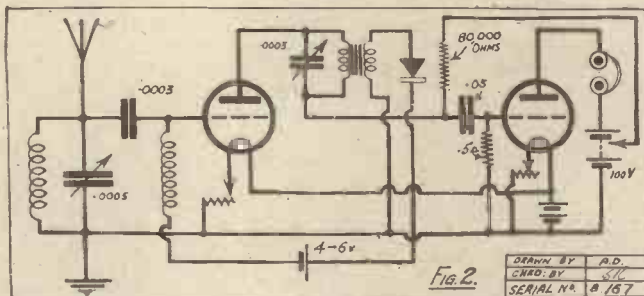

tortionless. There again a large plate potential is required with about 10 volts negative bias on the grids of the L.F. valves. Anode resistances of the wire wound type are recommended because they are more capable of dealing with large currents. Power valves of the D.E.5 or L.S. variety must be used to carry heavy loads without distorted amplification, and the set must on no account be "forced."

It is particularly suitable for long-range reception, since nearly all the main stations of the B.B.C. can be heard on the loud speaker on most nights. The circuit can be recommended to music lovers with every confidence, for it combines sensitivity and faithful reproduction with extremely simple operation.

A little experimenting with the type of crystal and contact will have a useful effect upon the DX properties of the set, and upon the stability of the receiver when strong signals are coming through. The Perikon combination is an ideal one for local loud-speaker work, though one of the galena "ites" will probably be found better when weak transmissions are being picked up. A detector that is rigid in adjustment is an absolute necessity, and the cat's-whisker wire should be of about 32 gauge wire—neither too springy nor too fine—if satisfactory results are to be obtained.

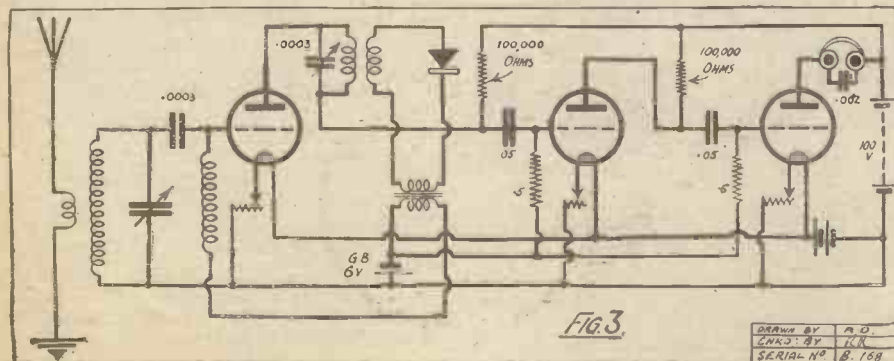



# CURRENT TOPICS.

BY THE EDITOR

A Great Loss—Broadcast Education—Highbrow Cranks—The Broadcasting Commission.

THERE will be widespread regret among thousands of listeners at the news of the resignation of Mr. Sheppard, whose broadcast sermons from St. Martin's-in-the-Fields have achieved such popularity and appreciation. Mr. Sheppard has resigned owing to ill-health, but he has, since the inception of the broadcasts from St. Martin's-in-the-Fields, shown how radio can be brought to the service of the Church in an impartial and exceedingly popular way. Mr. Sheppard might easily have been the cause of endless controversy, but when his sermons were broadcast from St. Martin's he always exercised the most meticulous care, not only in the choice of his text, but in the method of its delivery; and members of all denominations have enjoyed listening to his discourses without in any way having their religious beliefs offended.

Mr. Sheppard.

Mr. Sheppard's connection with the B.B.C. has indeed been a very great success, and we can only hope that other Divines who may, in future, broadcast will adhere to his strictly impartial, common-sense methods, although it is to be doubted whether they will achieve anything like the popularity and the friendly atmosphere which Mr. Sheppard radiated from St. Martin's-in-the-Fields.

We feel sure that every reader of POPULAR WIRELESS will join with us in sincerely hoping that he will soon be restored to health, that he will return to an active career, and that his broadcasts will soon once more be a feature in 2 L O's Sunday programmes.

Mr. J. C. Stobart, the B.B.C. Director of Education, speaking at a Conference of the British Institute of Adult Education at Cambridge, a few days ago, said there was a large demand for adult education up and down the country, and the B.B.C. enabled a man to indulge his desire for tobacco smoke in companionship with high thinking, in comfort by his own fire-side. Broadcasting, said Mr. Stobart, had come to stay, and it would be an end to the educational movement if cheap and vulgar trash were broadcast, and the Adult Education movement could greatly assist in the spreading of knowledge by organising classes to listen to the various lectures and to promote discussion among their pupils afterwards.

There is no doubt that Mr. Stobart is sincere in his advocacy of education by wireless, and few will quarrel with him when he says that the B.B.C. have secured the services of the best brains in the country to deliver lectures. Mr. Stobart thinks, however,

that the reception of a lecture is in itself not enough, but there is a need of stimulating discussion afterwards. Mr. Stobart admitted that the B.B.C. had had to face a lot of unpopularity about their educational talks from certain sections of the public; but this, he said, had happily died down for the present.

Highbrow Cranks.

We question this. There can be no doubt that there is a very large section of the public which resents any form of education by wireless. Broadcasting, in the opinion of many, should be devoted entirely to entertainment and not to the dissemination of education. There are, say these critics, legitimate institutions for "broadcasting" knowledge, and the B.B.C. are exceeding their powers when they spend the money subscribed by listeners on what may be described as "education talks."

We ourselves are of the opinion that a certain amount of educational matter in the B.B.C. programme is not amiss, but we think there is a great danger of it being overdone. The influence of certain high-

brow cranks has already been felt on the B.B.C. programmes, much to the annoyance of many thousands of listeners, and there is no doubt that unless a very tight hand is kept on the activities of these gentlemen, listeners will be subjected to an overdose of highbrow educational matter which they neither pay for nor want.

Welcome Talks.

Bright and stimulating talks of an educational nature, if delivered by competent people in an interesting and suitable manner, would be welcome, but many of the educational talks which have been broadcast during the last few months have not been interesting in delivery or in subject matter.

No doubt many of the authorities who have broadcast such talks have been very eminent people in their own line, but a certain amount of showmanship and a certain amount of artistry in delivery is essential if such talks are to prove popular and worthy of a place in the programmes.

And we hope that Mr. Stobart will see to it that his educational ventures at 2 L O will be carefully watched and that every endeavour will be made not to overdo this important aspect of broadcasting.

We published in our last issue a list of five names of possible candidates for the chairmanship of the new Broadcasting Commission, and we informed readers that on excellent authority we understood that one of those five names was the name of the selected candidate.

We now understand that the salary to be paid to the Chairman of the Broadcasting Commission has, in the opinion of two men to whom it was offered, appeared inadequate, for both of them have declined the position on the grounds that the salary was not sufficiently high for such an important full-time post.

Therefore it will be all the more interesting to note—when the Government decides to throw aside its secrecy—the name of the gentleman who has accepted the chairmanship of the new B.B.C.

There is general relief in the radio industry at the cessation of the quarrels and disagreements which have for so long existed between certain groups of radio manufacturers on the important question of trading policy, and there is a widespread hope expressed that the new Radio Manufacturers' Association will now, once and for all, prevent a repetition of the troubles which have been so prevalent in the radio trade during the last few months.

The Chairman.

There is no suggestion that the new association will be a resurrection of the old N.A.R.M.A.T. under a new title. Up to the moment of going to press we have not been informed of the name of the new chairman of the association, but we understand that there is a body of opinion in favour of the selection of a prominent business man to fill the position—a man not directly connected with the industry.



One of the "De luxe" portable wireless sets that are now on the market.



# AN A.C. MAINS H.T. UNIT

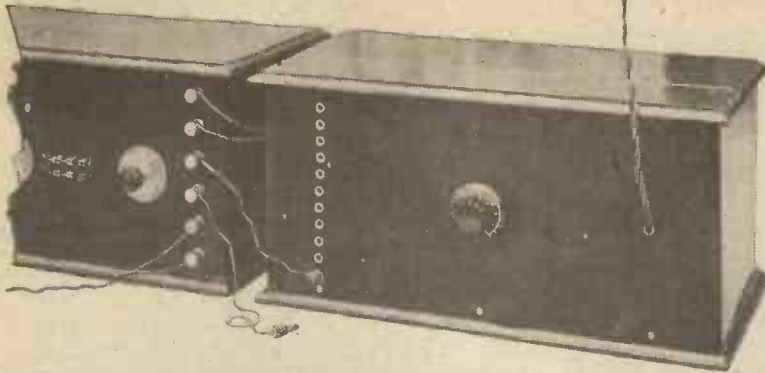

Here is a Unit, specially constructed by the "P.W." Staff Man, which will prove a boon to the reader who has grown weary of H.T. batteries and their attendant disadvantages.

By K. D. ROGERS.  
(Assistant Technical Editor.)

THE use among broadcast listeners of the house electric-light mains for H.T. supply is rapidly gaining in popularity, and rightly so, as there is no more economical or more easy method of obtaining the necessary plate potentials. Such an arrangement as that described (for use with D.C. mains) in "P.W." of Sept. 11th, or the one to be described hereunder, will give an unfailing supply of H.T. without the troubles usually associated with batteries running down, accumulators needing recharging, noisy reception, etc., due to faulty cells.

All the constructor has to do in order to obtain his plate voltage from the mains is to buy the necessary parts and wire them up, after which he can plug into an ordinary electric-light socket, and he has H.T. on tap whenever he requires it.

In the first place, before he can decide upon the particular components he will need, he must make absolutely certain of

markings on an electric light meter were, although not erroneous, very misleading.

LIST OF COMPONENTS.		£	s.	d.
1	Climax Autobat transformer to suit voltage of main:	1	19	6
2	4-mfd. fixed condensers	18	0	
1	Climax special choke	10	6	
1	potential divider (Climax)	5	0	
1	Filament rheostat, 35 ohms	1	9	
2	Valve holders	4	0	
1	Panel, 13 x 6½ in. baseboard, and cabinet to match	1	6	0
11	Peto-Scott flush mounting valve sockets	1	4½	
	18-gauge Glazite wire	2	0	

owing to the fact that the meter was a reconverted one; an old A.C. meter having been altered to act as a D.C. instrument.

Apart from finding out whether his mains are A.C. or D.C. the constructor must ascertain at what voltage he obtains his supply, because the transformer which will be necessary for the construction of the unit has to be specially wound to suit the particular voltage with

or at least intermittent electrical impulses before any energy can be transferred from the primary to the secondary winding. Likewise, owing to the need for rectification, the D.C. unit previously described would be useless if attached to A.C. mains.

### Double Wave Rectification.

The theoretical diagram shows the internal working of the unit. It will be seen that two rectifying valves are employed, being so arranged that what is known as double wave rectification is carried out. This means that both cycles or phases of the current are utilised, being rectified so that each cycle forms an impulse in one direction. Single wave rectification, which would only necessitate the use of one valve, would utilise only one phase out of each two. Although this method of obtaining H.T. supply is fairly efficient, it is found that the filament voltage is rather critical to adjust for good results. A power valve is also required for really successful operation, whereas in the case of the full wave rectification, even H.F. valves will work quite O.K., although naturally L.F. valves give better results.

Full wave or double phase rectification makes use of all the energy supplied by the mains, thus being more economical from that point of view and considerably simplifies the smoothing apparatus necessary for the promotion of a steady H.T. supply.

The transformer incorporated in this unit has a primary and two double wound secondaries so that not only

(Continued on next page.)

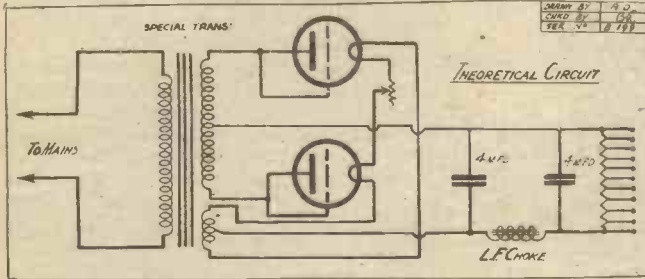

the type of electric main installed in his house. As most readers will know, the electric supply system is of one of two types, either D.C. (direct current) or A.C. (alternating current). In the former case such a unit as the one described here would be totally useless, and the constructor must build one such as was discussed in "P.W.," Sept. 11th.

### Preliminary Considerations.

In order to ascertain which type of mains he has, the reader should apply to the electric power station, as it is not always safe to rely upon outside information or even upon the details marked on the meter itself. This latter can be examined as a matter of interest or as means of verification, but it should not be taken as an absolutely reliable indication of the type of supply system provided.

It will be remembered by those who read the previous article on the D.C. unit that an instance was given where the

wound to suit the particular voltage with which it is to be used. It would be unnecessary to go into the details of why a transformer should have to be so specially constructed but this is an important point, and when ordering the transformer from the makers the constructor must specify the voltage of his mains. We think it should be pointed out once again that this unit described here is totally unsuitable for use with D.C. mains, owing to the fact that such mains will not operate a transformer owing to the physical properties of the current flowing through them; it requires alternating

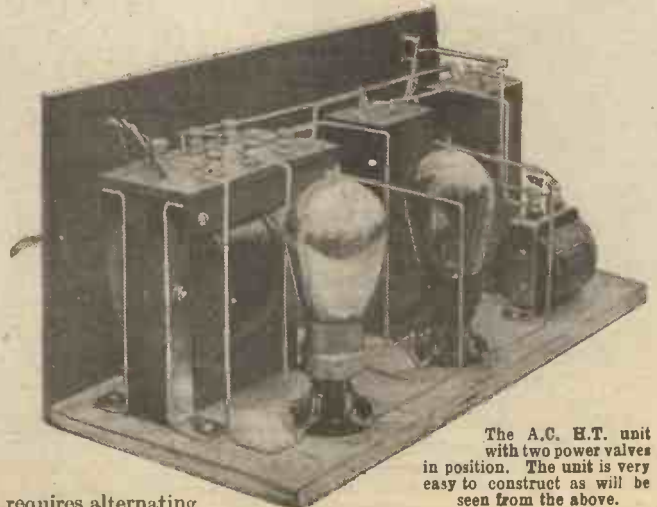

The A.C. H.T. unit with two power valves in position. The unit is very easy to construct as will be seen from the above.



# AN A.C. MAINS H.T. UNIT

(Continued from previous page.)

is full-wave rectification obtained, but also the two valves obtain their filament supply from the mains. In other words, the whole operation of rectification is carried out from energy supplied from the mains themselves.

The output from the unit will depend with regard to its voltage upon the type of valves used as rectifiers. These latter should also determine the milliamp. output of the unit, so that when the constructor has built it he should consider his requirements as regards plate currents as well as plate voltage before he chooses the valves he will use as rectifiers. These valves need not be of the special two-electrode type, as it is found that any ordinary wireless three electrode valve will operate quite efficiently as a rectifier in this unit, and so provision has been made for the use of these valves

### Ordinary Valves Used.

This explains the inclusion of ordinary four-pin valveholders, the plate and grid sockets being joined together so that any valve plugged into them automatically becomes a two-electrode valve, its grid and plate acting as one electrode. On test a large number of ordinary valves were tried and every one acted satisfactorily, though of course the milliamp output varied according to the capabilities of the individual valve—i.e. its filament emission etc

As has been previously mentioned, the constructor should work out from the individual current requirements (plate current is being discussed) of the valves employed in his receiving set the total milliamp. output required from the unit. re-

gardless of the voltage he requires. He should then so arrange his unit that he will obtain at least 30 per cent. more output than he requires. From this he will be able to choose the types of valves he will need in the unit. For his guidance it may be stated that two ordinary bright R type valves, or in general, ordinary bright emitters will provide about 30 milliamps. with a voltage up to about 150 volts. If a larger output is required, power valves such as B.4's can be used provided they are capable of withstanding high plate voltages. The constructor need not worry very much about this point, because the majority of valves, at any rate British ones, are fairly hard



A close-up of one end of the unit showing the 4 mfd. condensers and the wiring to the sockets.

and will withstand up to 160 volts or so. It is preferable to employ valves having low impedances as these require a smaller voltage to operate them, thus leaving more energy to be passed on to the output side of the unit. Both valves should be of the same type. The rheostat which controls the filaments of the valves should have a maximum of not less than 35 ohms and should be wound with a porcelain base to prevent any heat (should it heat up a little) reaching the ebonite panel.

The actual construction of the set is so simple that it does not require any great skill nor a lengthy description. The diagrams and photographs show exactly how the various components are mounted and wired up, and there are no special snags in construction of which the reader should be warned. Everything is perfectly straightforward and no trouble at all will be encountered if the reader makes soldered joints and uses insulated wire. The potential divider, which is mounted close to the panel, should be placed in position and wired up to the H.T. sockets before the two large fixed condensers are mounted. These latter must be of good construction and thoroughly reliable, otherwise they may break down and cause endless trouble, though such an event would not affect the electric mains.

### Final Details.

The capacity of the condensers can vary between 2 mfd. each and 8 mfd., as this will depend upon the mains in which they are used. These condensers are merely smoothing condensers, so that if too much hum is noticeable, larger condensers will be required. In acute cases a second choke in the negative lead may be inserted, but we have found that on the average main one choke and two 4 mfd. condensers were quite sufficient, a smooth H.T. supply being obtained.

A final point worth noting in the construction of this unit is that the input flex of the transformer should be knotted between the transformer and the hole in the panel through which it passes in order that a

(Continued on page 311.)

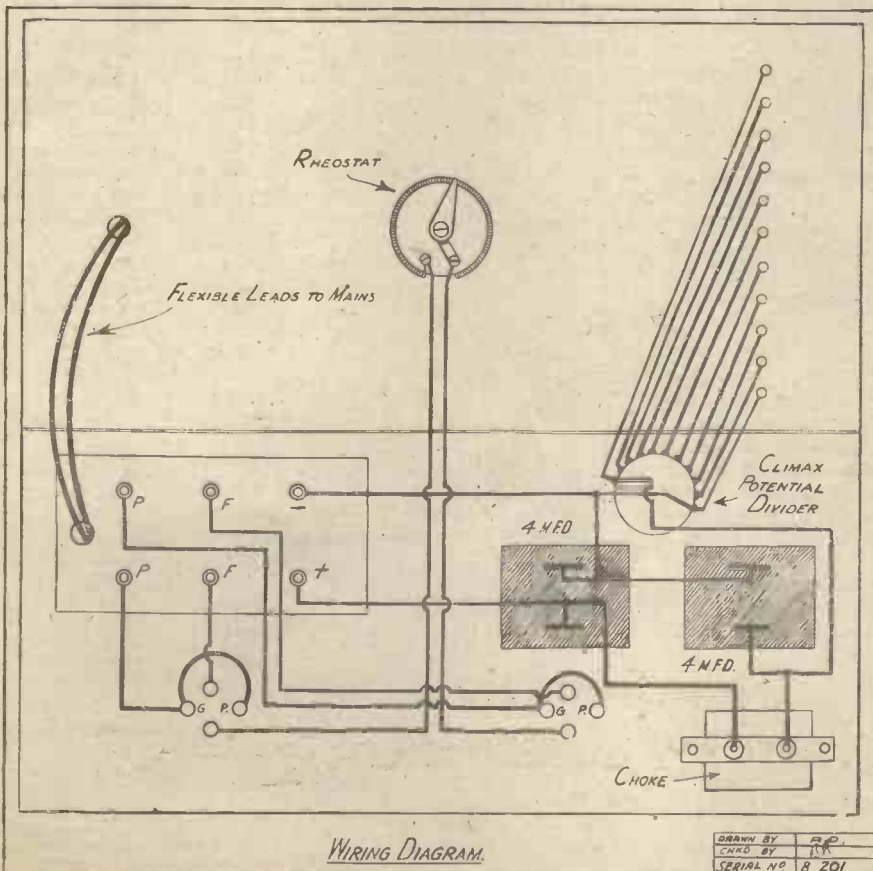

WIRING DIAGRAM.

DRAWN BY R.P.  
 CHKD BY J.R.  
 SERIAL NO 8 201

# CLEARER *and* LOUDER RECEPTION HANDSOME APPEARANCE *and* LOW PRICE - *all embodied in the* NEW 'GECOPHONE' LOUD SPEAKERS

The new GECOPHONE Cabinet Type Loud Speakers represent a remarkable constructional advance. They combine the qualities of a perfect loud speaker with choice, high-grade cabinet work. There are two models, priced to meet the needs of all, and suited in every way to any mahogany or oak furnishing scheme.

Write for  
Illustrated  
Literature

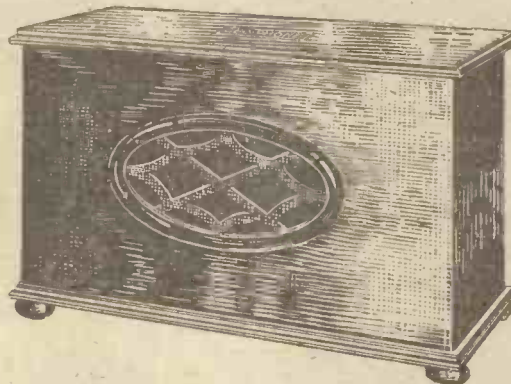
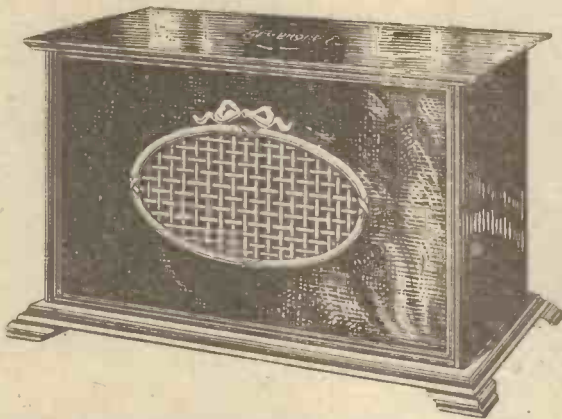

The GECOPHONE Cabinet Loud Speaker type "B" shown above is available either in mahogany or oak. It is made of highest grade materials and a Florentine bronze grill gives it an exceedingly handsome finish. Its rich tonal quality of reproduction of speech, song or music cannot fail to impress, and there is an entire freedom from distortion or undesirable resonance.

GECOPHONE Cabinet Type Loud Speaker "C." The Cabinet work is attractive in design with fine mahogany finish. The clarity and quality should recommend it to all. A wonderful loud speaker at a bargain price.

PRICE £4.4.0

PRICE £2.10.0

## NEW "GECOPHONE" HEADPHONES.

Entirely new in design and specially made for comfort.  
Price, 4,000 ohms resistance, 20/- a pair.



# GECOPHONE

(Registered Trade Mark)

BRITAIN'S BEST BROADCASTING SETS  
and LOUD SPEAKERS

Sold by all  
Wireless Dealers  
and Stores.

*The G.E.C. - your guarantee*

Use  
**Osram**  
Valves  
for Broadcasting  
Your Guarantee  
of Better Wireless



**A Triumph for RELIABILITY**  
 THE WHOLE  
 RINGSIDE  
 TRANSMISSION  
 of the  
**DEMPSEY**  
 v  
**TUNNEY**  
**FIGHT**  
 Received on  
**OSRAM VALVES**

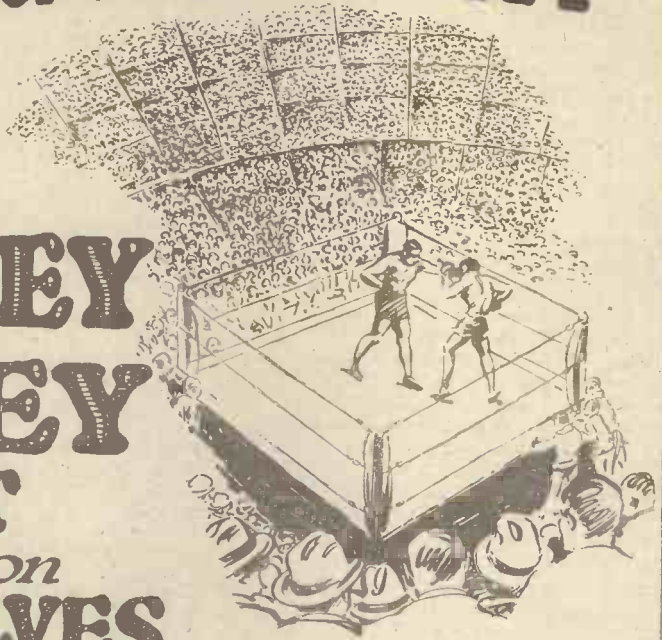

*An unsolicited report from a famous amateur:—*

"Last Thursday night I received the whole ringside transmission of the DEMPSEY-TUNNEY fight through the American station 2 XAF. I was using a short-wave super-heterodyne six-valve set with OSRAM VALVES. The transmission was received remarkably well, and with one amplifier behind the super, was as strong here on a loud speaker as I get 2 L O on a three-valve set. I find that OSRAM VALVES make a wonderful improvement over the previous valves I had used in this set."

*(Signed) F. A. MAYER.*  
*Radio Research Station, G2LZ.*



*The G.E.C.-  
 your guarantee*

**Osram  
 Valves**  
 for Broadcasting

## AN A.C. MAINS H.T. UNIT.

(Continued from page 308.)

certain amount of slack may be present between the knot and the transformer, thus preventing the connections inside the transformer from being strained at any time if this lead is pulled too tight.

It will be noted that eleven sockets for the H.T. tappings are provided, the negative one being at the bottom and the H.T. voltage rising in steps upwards until the top tapping gives the full pressure. This will vary according to the rectifying valves employed.

### Voltages Obtainable.

On test with 200 volt mains the original unit gave just under 160 volts maximum, the tappings giving 136, 112, 88, 64, 56, 48, 40, 32, and 24 volts respectively. These represent definite percentages of the total voltage provided by the potential divider, so that if the initial or maximum voltage across the resistance is known the intermediate tappings can be worked out. It must be remarked that it is useless to attempt to measure the voltages of the tappings with an ordinary voltmeter, owing to the current it consumes, a static instrument being necessary. The above figures, however, will give the constructor some idea as to the efficiency of the instrument.

The unit is connected to the set in the ordinary way, just as if it were an H.T. battery—no special earthing system being necessary as in the case of the D.C. unit.

When operating this unit the filament rheostat should be placed in the off position, and the plug connected to the lamp adaptor. As the winter evenings will soon be here, and the lamp socket will probably be required for other purposes, a double adaptor should be obtained. The cost of this is fairly low and we advise the use of one of these.

The unit may also be connected to a

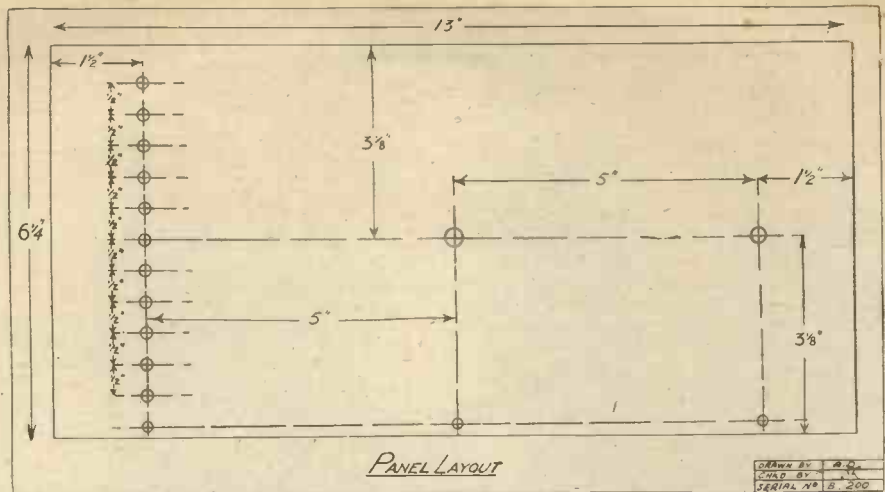

### POINT-TO-POINT CONNECTIONS.

Tappings on potential divider connected to their respective sockets on the panel.

Top socket to one side of one 4-mfd. condenser and one side of choke. Other side of choke to one side of second condenser and plus terminal on transformer.

Other side of each condenser joined together and connected to negative terminal on transformer and bottom socket.

F terminal of transformer on same side as plus terminal to one filament on second valve holder; other F terminal to filament on first valve holder. Remaining filament sockets of the valve holders to opposite sides of rheostat.

Plate and grid sockets of respective valve holders joined together. Grid of first valve holder to one P terminal, other P terminal to grid of second valve holder.

two-pin adaptor socket used for an electric iron or fire, in which case a two-pin adaptor should be connected to the flexible lead from the transformer in place of the

standard adaptor. When the adaptor has been connected to the mains, and the latter switched on, a faint hum will be heard from the autobot transformer. This indicates that the current is passing through the primary winding of the transformer from the mains.

The rheostat on the front of the panel is then carefully rotated, and the valves will be seen to light, do not turn the valves up to their maximum. The H.T. wander-plugs are now placed in the sockets and a click will be heard, if this click is not heard the filament rheostat should be rotated so that the filament brilliancy is slightly increased. After rearranging the H.T. plugs so that maximum results are obtained the filament voltage should be reduced by means of the rheostat until any further decrease causes distortion.

### Using Power Valves.

If it is found that even with the valves at their maximum brilliancy signals are not up to normal, the trouble is probably due to the fact that the valves employed are not suitable. In this case valves having a lower impedance and of the power type should be used. If power valves are used, such as L.S. 5, D.E. 5 or L.S. 5a type, 60-75 milliamperes may be obtained.

A word of warning when using power valves or valves giving a high output. Do not under any circumstances attempt to make any changes in the value of H.T. voltages without first turning out the rectifying valves, or a nasty shock will be received, quite sufficient in fact to make one wonder whether H.T. units are worth while.

If the hum from this unit is pronounced, as it may be on poor mains, as well as connecting additional chokes in series with the negative lead, the two units should be separated approximately two feet. In really bad cases it may be necessary to screen the transformer with copper or tin foil to prevent direct induction from the transformer windings into the wiring of the set. When screening the transformer, care must be taken that the tin or copper sheet is not allowed to touch the terminals of the transformer. Good insulation in this unit is particularly important, and for this reason the valve-holders chosen should be mounted on ebonite or porcelain.

The fixed condensers should also be of a type sufficiently well made, and designed to withstand a maximum voltage of 300 volts.

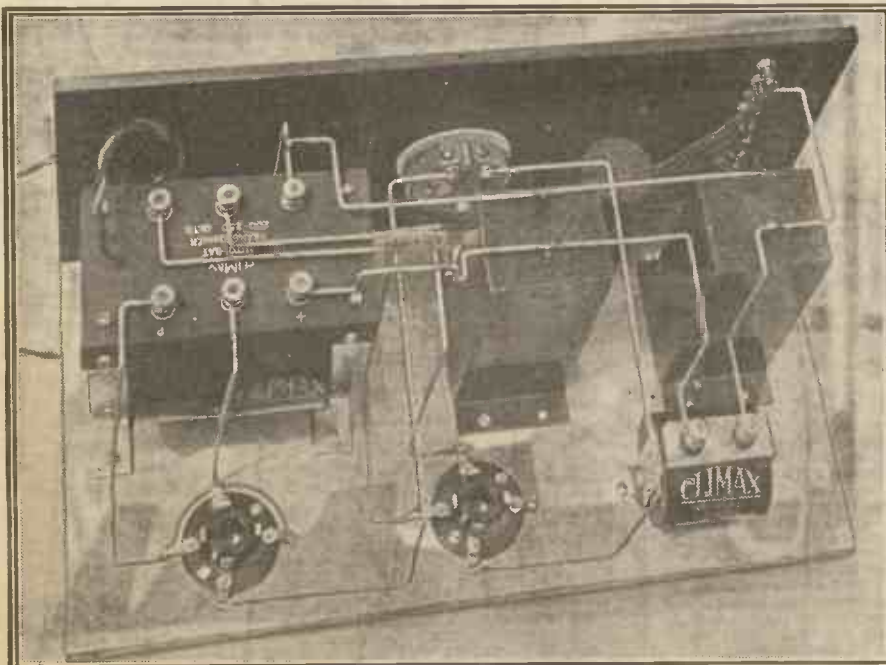

A general view of the lay-out and wiring of the instrument. The potential divider is seen to the right of the rheostat behind the two condensers.



THERE are many indications of a considerable increase in the popularity of capacity reaction now that its advantages are becoming more widely known. One of the chief advantages is that it permits the use of "low-loss" coils of a shape and size which make them unsuitable for mounting in a swinging coil holder. Another advantage is that variations of reaction have very little effect on the tuning, whereas variations of magnetic reaction coupling will affect tuning quite considerably.

There are other minor advantages of capacity reaction; one is possibly appreciated by the makers of commercial sets rather than the experimenter, namely, that the coils can be fitted inside the cabinet, thus enhancing the appearance of the set.

**H.T. Shorted.**

Logging stations is easier with capacity reaction, not only because of the very small effect on tuning, but also because a definite reading can be obtained on the reaction condenser dial.

Capacity reaction is generally used when the detector valve is not preceded by H.F., and it is sometimes used by itself and sometimes in conjunction with magnetic reaction, in which case the reaction coil is at a fixed distance from the grid coil and the reaction is varied with the condenser.

The most popular circuit in which capacity reaction is used is the Reinartz, although there are other circuits in which it can prove equally effective. In most of these circuits, as in the Reinartz, the variable reaction condenser is connected (with or without a coil in series) between the plate of the detector valve and aerial or earth. For convenience of reference a Reinartz circuit is shown herewith.

Many users of such a circuit probably have not realised that a short between the plates of the reaction condenser will have a very undesirable sequel, namely a dead short across the H.T. battery. Assume that the reaction condenser in the diagram is shorted and the .002 condenser is omitted and it will be seen that H.T. positive is connected to H.T. negative, via the primary of the transformer, H.F. choke, reaction and aerial coils and common negative lead. Even if a short does not occur, leakage may, and users who have been mystified by the short life of their H.T. batteries may find in this an explanation.

**Useful Safeguard.**

Fortunately there is a very simple means of guarding against this risk, and it is a remedy which will not affect the efficiency of control of the receiver in any way. It is simply the connection of a fixed condenser, of reliable make, in series with the reaction condenser.

The insertion of this fixed condenser need not materially affect the capacity range of the reaction condenser. The total capacity of condensers in series is found from the law which says "the reciprocal

# CAPACITY REACTION.

FROM A CORRESPONDENT.

of the total capacity is equal to the sum of the reciprocals of the separate capacities."

Thus:

$$\frac{1}{C} = \frac{1}{c_1} + \frac{1}{c_2}$$

If the reaction condenser has a maximum

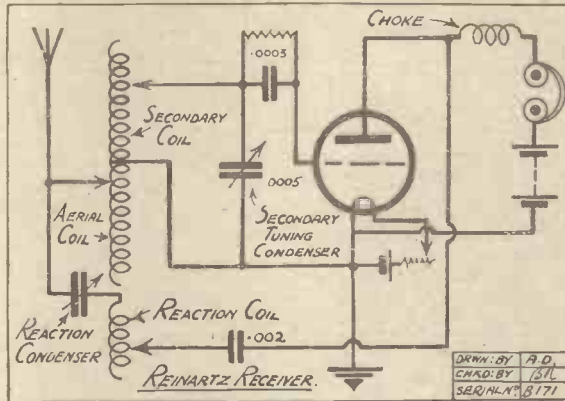

capacity of .0005 mfd. and we connect a fixed condenser of .002 mfd. in series with it, the total capacity, by the above equation, will be .0004, or slightly less than before. Assuming that the minimum capacity of the

variable condenser is one-tenth its maximum, or .00005 mfd., then with the .002 mfd. condenser in series, the minimum capacity will be .000049 mfd., or slightly less than before. With a .001 mfd. fixed condenser, the minimum and maximum capacities will be .000048 and .00033 respectively.

Thus, with this fixed condenser, the Reinartz or other similar circuits become absolutely safe. Of course, the plates of a variable condenser should not short, but such a thing does often happen, and as the above method provides "safety first" at a cost of say, two shillings, it is to be strongly recommended. But on no account use an inferior fixed condenser or its purpose may be defeated.

**The Reaction Condenser.**

For accurate and easy tuning and control, it is always advisable to employ a geared variable condenser for the carrying out of the reaction process. Such an instrument greatly simplifies the handling of the receiver, and if the condenser is of the straight line frequency type as well, it is possible to obtain very accurate adjustment of the reaction with a minimum of operating skill. For ultra long-distance work, such a refinement is almost a necessity, and it is for such reception that the capacity reaction type of receiver excels. A low-loss condenser with long and few leakage paths is also a useful refinement.

## CORRESPONDENCE.

Letters from readers discussing interesting and topical wireless events, or recording unusual experiences, are always welcomed; but it must be clearly understood that the publication of such does in no way indicate that we associate ourselves with the views expressed by our correspondents, and we cannot accept responsibility for information given.—Editor.

**LONG-RANGE TWO-VALVE RECEIVER.**

The Editor, POPULAR WIRELESS.

Dear Sir,—I have just had the opportunity of trying out the above, as described in your issue of November 14th last, but merely as a "hook up," and endorse the author's claims for it as a long-range selective receiver.

As regards signal strength, it is not quite as good as the usual tuned anode circuit, but is much more selective, and less prone to self-oscillation.

Examination of the circuit shows that it is a combination of the usual split-feed H.F. amplifier coupled to the usual straight single-valve circuit, as may be seen by comparison with the enclosed diagram, in which "X" is the split-feed amplifier and "Y" the straight detector valve.

The dotted lines show the only necessary external connections, apart from the battery leads; the Lissen H.F. choke being shown at "B."

When 5 XX was at Chelmsford that station did not interfere with the reception of Radio-Paris here, but since the removal of the former to Daventry, I have been unable to completely separate the French and English stations mentioned with the tuned anode circuit, but with the circuit under review this is easily effected.

I shall be pleased to elucidate any points which may occur to readers to try out this "hook up."

Yours faithfully,  
J. H. COLLINS,  
3, Tyisaf Road,  
Ystrad Rhondda.

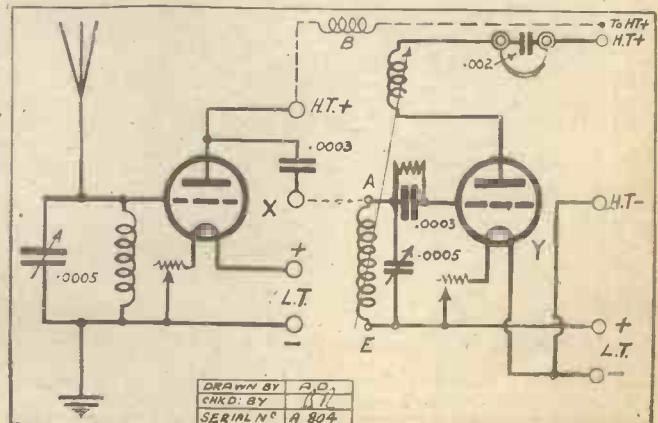

**ACCUMULATOR SULPHATION.**

The Editor, POPULAR WIRELESS.

Dear Sir,—Re the article in a recent issue by Mr. J. F. Corrigan on Accumulator Sulphation. I would like to call attention to the steel-plate accumulators, which are made by Batteries Ltd., under the name of "Nife." In these the plates are made of steel with a perforated outer covering, and the electrolyte used is an alkali. Therefore, there can, of course, be no sulphation whatever.

I have not used one of these batteries yet, but I have studied them in all possible ways at the Wireless Exhibition, and I have little doubt that I shall replace my L.T. accumulator (lead type) and my H.T. battery with these. The weight of the cells is much less than that of the ordinary lead type, and also they would appear to be much more reliable.

I would very strongly advise your readers to study these accumulators very closely, for they are well worth it. As one who has suffered considerably at the hands of careless and inexperienced charging stations, I welcome anything which will effectively relieve me of the continual worry of watching after inexperienced people who take my money and ruin my things.

Yours faithfully,

GERALD O. HOPSON.

27 Merton Hall Road,  
Wimbledon, S.W. 10.

(Continued on page 336.)

KNOB AND DIAL  
FIXED WITH GRUB SCREWS

KNOB & 4" DIAL  
BEAUTIFULLY  
FINISHED

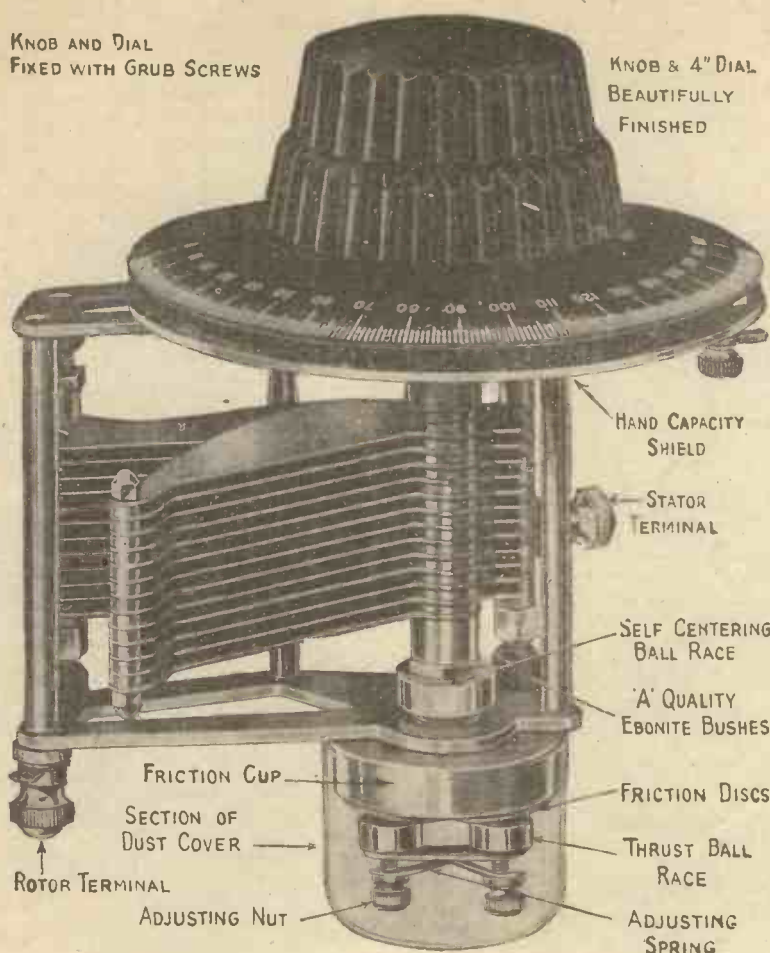

PATENT APPLIED FOR

THIS IS THE WORLD-FAMOUS ORMOND S.L.F. CONDENSER



199-205, PENTONVILLE ROAD, KING'S  
CROSS, LONDON, N.1.

Telephone: Clerkenwell 9344-5-6

Telegrams: "Ormondengi, Kincross"

FACTORIES: WHISKIN ST. AND HARDWICK ST., CLERKENWELL, E.C.1

Continental Agents:

Messrs. PETTIGREW & MERRIMAN Ltd., "Phonos House," 2 and 4, Bucknall Street,  
New Oxford Street, W.C.1

# ORMOND S.L.F. CONDENSERS

RATIO - 55-1

HERE IS YOUR  
FINAL CHOICE OF  
A CONDENSER—  
BUY IT NOW!

The Ormond S.L.F. Condenser is by far the best Condenser to use, and the markings on the dial enable you to pick up any station with the minimum of trouble and without any unnecessary calculations. Precise tuning adjustments with noiseless operation are ensured by the general sound construction of this newest ORMOND product. The famous ORMOND SLOW MOTION FRICTION DRIVE (Ratio 55-1) is incorporated and special ball bearings give liquid-like movement to every turn of the knob. This world-famous ORMOND component is easy to mount, having one and three holes for fixing, with both terminals and soldering tags for connections.

EXTRAORDINARILY  
LOW PRICES

Prices: With 4 inch  
Bakelite Knob:—

·0005 m/f	- -	20/-
·00035 „	- -	19/6
·00025 „	- -	19/-

Prices: With Dual  
Indicator Dial:—

·0005 m/f	- -	21/6
·00035 „	- -	21/-
·00025 „	- -	20/6

Ormond S.L.F. Condensers  
are obtainable from  
all dealers.

ORMOND CONDENSERS ENABLE YOU TO PICK UP STATIONS WITHOUT CALCULATIONS.



# THE NEW COMBINATION LOTUS GRID LEAK and Buoyancy VALVE HOLDER



Pro.  
Pat.  
20339

Pat.  
256833

The Grid Leak is not discernible, being totally enclosed in Bakelite Valve Holder Base.

## Yet Another LOTUS Triumph in Component Design

Like all other LOTUS Components, the new Combination Grid Leak and Valve Holder is guaranteed efficient in construction and design. It eliminates unnecessary wiring and soldering, and makes for economy in cost and space.

Ordinary Terminal Valve Holder 2s. 6d.      **Combination Grid Leak and terminal Valve Holder, 3s. 9d.**  
Without terminals 2s. 3d.

All Anti-Microphonic Type.

# LOTUS

COMBINATION  
GRID LEAK AND BUOYANCY VALVE HOLDER  
Anti-Microphonic

From all Radio Dealers Write for List

## Garnett, Whiteley & Co., Ltd.

Lotus Works, Broadgreen Road, Liverpool.

Makers of the famous "Lotus" Vernier Coil Holders.

# THE Newey "4 Point" Condenser

"The finest engineering production of the year"—an unsolicited testimonial. We reproduce below one of the numerous letters we have had from users of the Newey 4-Point Condenser: in every case there is the same enthusiasm regarding the perfect design and workmanship of this famous Condenser.

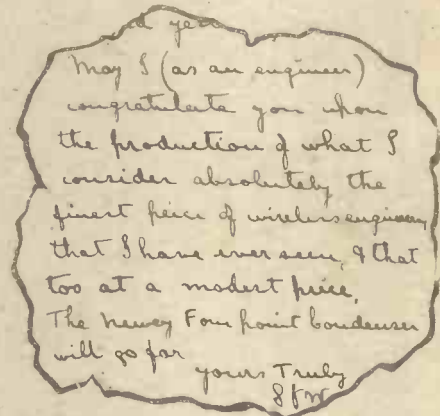

What the Wireless Technical Press thinks of the Newey 4-Point Condenser "Amateur Wireless." "In construction it is of the ultra low-loss type, and in this respect it is one of the finest examples we have seen."

"The Broadcaster." "A noticeable feature is the high-class workmanship throughout, and that all rubbing contacts from vanes to connecting terminals are avoided by the use of soldered flexible wire connections."

"On test we found the maximum capacity very close to the nominal (0005 mfd.), while the minimum was lower than that of the usual vane type of condenser. Tested in critical oscillating circuits, no losses were apparent, while on practical test in a valve receiver tuning the aerial inductance, the actual performance was highly satisfactory."

### THE NEWEY VERNIER COIL HOLDER.



A perfectly constructed coil holder, designed for Back of Panel One-hole fixing, and in addition provided with lugs for fixing in any position on panel. Bakelite moulding throughout. Worm geared by means of metal segment and worm, and fitted with patent stop plate to prevent overwinding in extreme positions—gearing ratio 8-1 giving fine critical tuning and permitting the use of the heaviest coil. Price 7/6.

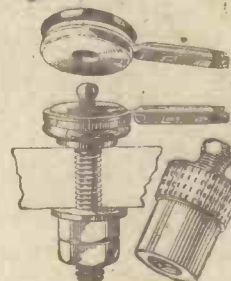

### NEWEY SNAP TERMINALS.

The Terminal with 1,000 uses. No set complete without them. The use of these Snap Terminals, which have been reduced in price and are now only

1d. each; (nickel-plated 1½d) ensures

CONVENIENCE, SIMPLICITY, MULTI-PURPOSE, CERTAIN CONTACT, FINISH.

Experimental Sets in boxes. Brass 1/6. Nickel-plated 2/-.

Adapters supplied in size. No. 2 and No. 4 B.A.

Ask your nearest dealer for the Newey Catalogue of Radio Components. If you have any difficulty, write direct.

Sole Distributors:

**PETTIGREW & MERRIMAN (1925) Ltd., PHONOS HOUSE, 2 & 4, Bucknall St., New Oxford St., London, W.C.2 (and Branches). Telephone: Gerrard 4248-49. Telegrams: Merrigrew, Westcent, London.**



# Notes on the Flewelling

in mind is that it is necessary to acquire a certain knack in the adjustment of this type of receiver before anything like the best possible results will be obtained. However, a little time spent in

ascertaining the best method of operation will be amply rewarded by the truly remarkable performance which the set will ultimately put up.

### The Super "Whistle."

The following fact should be noted carefully. When a Flewelling receiver is functioning as a "super" (as distinct from when reaction is not pressed to the point of oscillation, and it is, therefore, being used as a straight single-valver), a peculiar rushing or high-pitched whistling sound is audible in the phones\*. After a little experience has been gained this is quite

Valuable Notes and Data for the Experimenter.  
By L. P. DUDLEY, Stud.I.E.E.

NOW that winter is once again approaching, the attention of many wireless enthusiasts will, undoubtedly, be devoted mainly to the problems of long-distance work.

This article has been written, firstly, to enable those of moderate means to indulge in this most fascinating branch of the hobby; and, secondly, in an endeavour to clear up some of the misunderstandings which have, as is well known, arisen as to the

Let me explain. A receiving set making use of super-regeneration, such as the Armstrong or Flewelling, is a type of receiver which functions with reaction (or regeneration) pushed to considerably beyond the normal oscillation point, where, in the usual type of circuit, distortion would occur. That is to say, a "super" is a circuit so adapted as to enable satisfactory reception to be carried out under conditions of oscillation which in a plain regenerative receiver would result in nothing but howls and shrieks being heard in the telephones.

### Reaction.

As every amateur is aware, if the coupling between the A.T.I. and the reaction coil of a straight single-valve set is increased (i.e. the distance between the two coils is lessened), the strength of the signals increases to a maximum, after which a very slight increase in the coupling will cause a further great increase in the signal strength for a moment, followed,

almost instantly by the set breaking into violent oscillation. In a "super" circuit, advantage is taken of this great increase in signal strength, to which reference has just been made, and by means of suitable controls the set is caused to operate steadily under those conditions.

It is probable that one of the most outstanding features of circuits of this nature is the tremendous amplification which they give. But a fact which must be borne

unnoticed and does not in any way interfere with reception.

It will, at this stage, be as well to give a brief outline of the theory of the Flewelling circuit, for the proper comprehension of which reference should be made to Fig. 1.

In the plate circuit of the valve shown in Fig. 1 there are three varieties of current flowing. Firstly, there is the unidirectional anode current supplied by the H.F. battery; secondly, a pulsating current, due to the action of the valve in its capacity as rectifier, is present; and thirdly, H.F. oscillations are transferred to the anode circuit from the grid circuit by the magnetic coupling which exists between L<sub>1</sub> and L<sub>2</sub>.

### How It Works.

It is, of course, obvious that the steady anode current will be restricted to the anode circuit, since, being unidirectional, it could not pass through C<sub>2</sub> unless it had sufficient power to break down the dielectric of the

\* This sound is due to the damping action to which reference is made a little further on, and which takes place at audio-frequency.

(Continued on next page.)

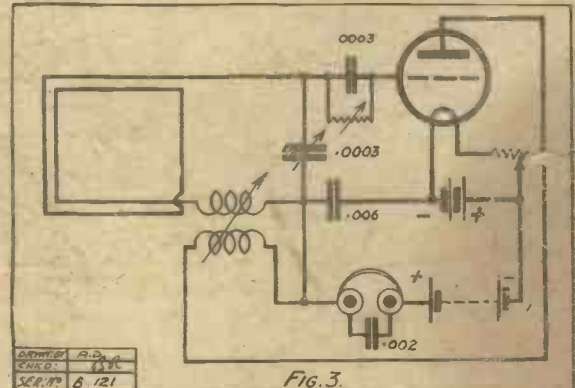
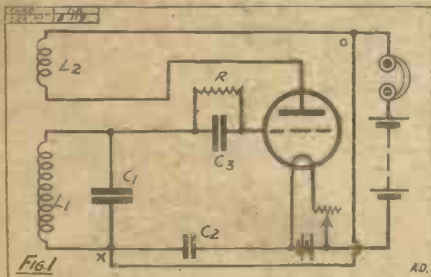

results to be obtained from super-regenerative receivers.

Among all his numerous wireless friends, the writer has not yet encountered a single experimenter who has obtained any measure of success with a Flewelling "super." Moreover, he has frequently heard it stated (and on two occasions has actually seen in print) that the results obtainable with this circuit are no better than those which may be obtained with a "straight" single-valve receiver utilising reaction. The reason for this great mistake is not far to seek. It is simply that the people who make these unwarranted statements have never used a Flewelling "super" as a super (or super-regenerative receiver).

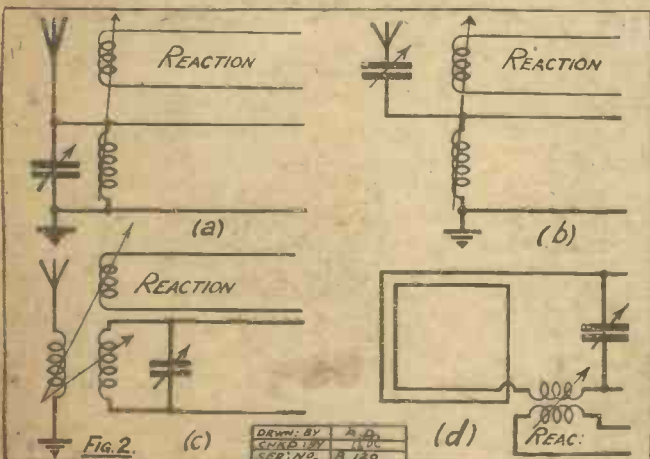



## NOTES ON THE FLEWELLING.

(Continued from previous page.)

latter. The condensers  $C_1$  and  $C_2$  offer too high an impedance to the rectified current, so this is, therefore, restricted in a similar manner.

Now let us see in what way the H.F. currents behave. These, naturally, avoid the high impedance of the telephones and H.T. battery and choose the path of low impedance, O, X. It will be seen that at the point X two paths are presented, one through  $C^2$  and the other through  $C_1$  and  $C_3$ . The condenser  $C_2$  has a definite (though not critical) value, to allow a by-pass through the grid to the filament.

This causes an excess of electrons to accumulate on the grid, thus stopping the valve from oscillating. Directly this occurs, the charge of electrons is dissipated through the grid leak, R. The valve now immediately builds up in oscillations during the



Part of the apparatus to be used at the San Lito Observatory where accurate longitudinal observations are being carried out with the aid of special radio signals.

following positive half-cycle and amplification is, therefore, present to a very large degree. Since, after this, the negative charge is repeated with exactly the same effect as before, a constant cycle is formed.

To obtain the best possible results, the ratio between the incoming H.F. oscillations and the frequency of the damping action on the grid of the valve should be as high as possible. Unfortunately, beyond a certain point distortion will occur.

### Efficient Grid Leak.

It will be realised from the above that the frequency of the damping oscillations should be controllable. This is provided for by using a variable grid leak. The reason why it is possible to control this frequency by means of the grid leak is easily understood. Let us suppose that, while the set is in operation, the resistance of the grid leak is increased. Naturally, this will retard the process of dissipation of the charge of electrons on the grid during each cycle, thus lowering the frequency of the damping action (and, thereby, the pitch of the whistle audible in the telephones). Similarly, if the value of the grid leak is decreased, the frequency will be increased. It is, moreover, desirable to keep the pitch of the whistle as high as possible, since interference from this source when receiving telephony

will then be reduced to a minimum. The grid leak should be chosen with very great care, and should be smoothly variable from, say, one to about ten megohms.

Now since the efficiency of all super-regenerative receivers is proportional to the difference between the frequency of the aerial oscillations and that of the damping oscillations, it follows that receivers of this type are most effective on the shorter wave-lengths (or higher frequencies).

### The Aerial System.

Many readers will, no doubt, be wondering why neither aerial nor earth arrangements are shown in Fig. 1. These have been omitted for two reasons: (1) It is possible to use more than one form of antenna, and these may be connected in different ways. An earth wire is not always used. (2) This diagram is of a purely general nature, illustrating the means by which super-regeneration is secured by the Flewelling principle, and is not that of a complete receiver.

The whole question of the type of aerial to be used, and the method of coupling the latter, is one of the utmost importance. Indeed, it is probably not too much to say that the exact nature of this part of the equipment has more effect on the results obtainable in the case of a "super" than in the case of any other type of receiver. For instance, if the aerial has considerable capacity, and/or is coupled to the set in

not be used, since, as with *a*, the radiation is considerable.

For use on the short wave-lengths (from about 200 metres downwards), the arrangement depicted in *c* can be thoroughly recommended (this is, in fact, the method used by the writer for most of his short-wave reception). A very small indoor aerial is all that is needed. The use of an earth connection is optional. On these short wave-lengths it is not always found an improvement to use one, and its addition will, of course, render it just a little harder to cause the set to super. Once a little experience has been gained in adjusting the receiver, the short-wave transmissions of K D K A and W G Y, and a host of other transmissions, especially amateurs, may readily be received.

For the broadcasting wave-lengths, by far the most satisfactory form of aerial to use is a frame, connected as in *d*. Not only are the directional properties of the frame extremely useful, but, since its damping effect is slight compared with that of the more usual form of antenna, it makes the production of super-regeneration considerably easier. Of course, if it is so desired, a separate frame with fewer turns may be employed for the short waves as well. It is not advisable to take a tapping from the larger frame.

### Broadcast Reception.

Some information regarding the actual receiver used by the writer will probably be of interest. The circuit used for the broadcasting wave-lengths is shown in Fig. 3. It will be seen that this diagram is of the "modified" type of Flewelling. This version is just as efficient as the original one utilising, in place of the single .006 condenser shown, a bank of fixed condensers shunted by a variable high resistance.

The A.T.C., which is of the square law variety, should not be larger than the .0003 specified. If this value is exceeded, the number of degrees through which it is possible to turn the condenser dial and still obtain good super-regeneration will be reduced. Also tuning will, of course, be made more difficult. If, as is advisable, a .0003 square law condenser is used, it will be found possible, on the broadcasting wave-

correctly, it may have too great a damping effect, and thus render the production of super-regeneration impossible.

It is through paying insufficient attention to this subject that so many amateurs have been disappointed with the results which they have obtained with the Flewelling. Naturally, when the set does not super, it functions as a plain regenerative receiver. Hence the criticisms mentioned at the beginning of this article.

Many, in fact most, of the diagrams of the Flewelling super which have appeared show the aerial and earth connected, as shown in *a* (Fig. 2).

This arrangement should on no account be used, for the following reasons: In the first place, unless the aerial is extremely small and the wave-length on which it is desired to carry out reception is suitably short (and several other slightly more complicated conditions are fulfilled), it will be practically if not quite impossible to produce super-regeneration. The other reason is that which caused Captain Ekersley to say: "Please, don't do it!" The method of tuning by means of a series condenser, as shown in *b* will function quite well provided that the damping, due either to the use of too large an aerial, or too much capacity in series with the A.T.I.; is not excessive. However, this type of aerial circuit should

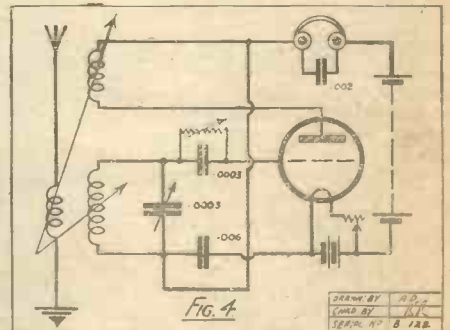

lengths, to turn the dial from  $0^\circ$  to approximately  $90^\circ$  before super-regeneration ceases. This figure naturally varies slightly according to the exact size of the frame, and the coils used.

The frame aerial is 2 ft. square, and is composed of 12 turns spaced  $\frac{1}{4}$  in. But, since the A.T.I. is connected in series with the frame, these figures are not critical. For instance, the frame may contain any-

(Continued on page 319.)





**A MAN WITH HUGE BICEPS**

and a weak chest is not really a healthy man, is he? All-round development is essential to health and strength.

The high efficiency of Ediswan Valves is due to adherence to the policy of **AVOIDANCE OF ECCENTRIC CONSTRUCTION and concentration upon the perfection of every part.**

Ediswan Valves are famous everywhere for their long-life—**they last!—and last!—and last!**

Ask your Dealer for the booklet, "The Ediswan Range."

**RECOMMENDED EDISWAN COMBINATIONS**

Receiving	Accumulator or Battery Volts	Prices	P'w'r	Prices
*A.R.D.E.	1-8-2	14/-	P.V.6	18/6
†R.C. 2	1-8-2	14/-	P.V.6	18/6
†R.C. 2	1-8-2	14/-	P.V.2	18/6
G.P. 2	1-8-2	14/-	P.V.2	18/6
D.R. 2	1-8-2	14/-	P.V.2	18/6
*A.R. '06	3	14/-	P.V.8	18/6
G.P. 4	4	14/-	P.V.4	18/6
*A.R. 4	4	8/-	P.V.4	18/6
R 4	4	8/-	P.V.4	18/6
*A.R. 6	6	8/-	P.V.5	18/6
R 6	6	8/-	P.V.5	18/6

\* Made in L.F. and H.F. Types.  
 † When R.C. 2 is used as detector, anode bend rectification should be employed.  
 ALL DULL EMITTERS except A.R. and R.

**EDISWAN 1/4-WATT VALVES**

Ediswan 2-Volt Range			
H.F.	De-tector	1st L.F.	2nd L.F.
GP.2	D.R.2	G.P.2	P.V.2
	G.P.2	P.V.2	P.V.6 (1-Watt)
Resistance Coupling			
		*R.C.2	P.V.6 (1-Watt)

\* The anode resistance used should not be less than 1-5 megohms.  
 PRICES: G.P. 2, D.R. 2, and R.C. 2, 14/- each; P.V. 2 and P.V. 6, 18/5 each.  
 Fully described in the Booklet "The Ediswan Range." Ask your Dealer for a copy, or write direct.

**FIT**

**EDISWAN VALVES**

**AND NURSE YOUR SET**

THE EDISON SWAN ELECTRIC CO., LTD., 143-5, QUEEN VICTORIA STREET, LONDON, E.C.4.





# THE LISSEN H.T. BATTERY

## 10/6

—and British Made!

Your Loud Speaker needs  
this Better Battery

The LISSEN NEW PROCESS BLOCK TYPE 60 volt H.T. Battery is unlike all previous H.T. batteries—it is both highly efficient and inexpensive.

Its discharge curve shows a stubborn resistance to volt drop—it excels in efficiency because we have discovered a new combination of chemicals not hitherto used in battery making. The unique new process—which naturally is a closely guarded secret—yields far clearer loud speaker reproduction and volume than any previous H.T. Battery and the success of the new process is now a definitely established fact.

Its price would have been 13/- : we could not have sold this new process block type battery at its present price but for our putting into operation a new direct-from-factory-to-dealer policy of distribution which **CUTS OUT ALL WHOLESALE PROFITS**. The price of this LISSEN Battery includes very little trade profit, because our dealer friends have all agreed to take a smaller profit than they get on any other battery, while it is only large quantities that will justify our own narrow margin per battery.

These LISSEN Batteries have another supreme advantage—every battery is absolutely fresh—they are actually on sale less than three days after being made—you cannot get a stale LISSEN Battery because dealers are only supplied at regular short intervals of some days—every LISSEN NEW PROCESS BATTERY is therefore brimful of new energy when you put it into your set.

We are making this new process battery only in the popular block type with socket tappings—an additional advantage are the four one volt tappings provided for grid bias at one end of the battery, while the other usual tappings give any voltage required.

**LISSEN NEW PROCESS BATTERY IS DEFINITELY GUARANTEED—PLOT ITS CURVE AND RECORD ITS SERVICE.**

No block type battery of this size and quality could be sold at the above price but for our new policy.

You can obtain this battery at any dealer's—but if any difficulty send direct to factory. Include nothing for postage but please mention your dealer's name and address.

**LISSEN NEW PROCESS BATTERY is rated at 60 volts, but goes considerably over.**

# 10/6

(Price would have been 13/- but for new policy.)



Hear your LISSEOLA working off this battery to know what a good loud speaker and a good battery can do together.

**LISSEN LIMITED,**  
Lissemum Works, 8-16, Friars Lane,  
Richmond, Surrey.

Managing Director: Thomas N. Co'e.

# DEMPSEY-TUNNEY FIGHT

Clearly received in London

Copy of unsolicited letter received by  
**IGRANIC ELECTRIC CO., LTD.**

Clapham, S.W.11.  
24/9/26.

Dear Sirs,—I think the following may interest you. At the beginning of this month I purchased two sets of your short-wave coils, and having tried innumerable coils for the short waves, both home-made and commercial, I must confess I was amazed at the efficiency of yours. This was so marked that it even tempted me to arise at 2.30 this morning in the hope of hearing the fight broadcast. I tuned in within two minutes to 2 X A F on 32.79 metres and held it without a break until 4 a.m., when I had to close down. There was a certain amount of fading, but not enough to prevent me hearing practically every word from the ringside, and the progress of the whole ten rounds was followed with intense interest. When the fight was finished dance music followed, and on switching on the loud speaker I found that the strength was quite enough to fill the room, although not perhaps full loud speaker strength as some people know it. The set used was a three valve O-V-2 and the circuit similar to the one you publish in the pamphlet describing the coils. Having got the above results, I can only say that the coils exceeded my expectations, for although I have received U.S. transmissions before I have never tuned in with such ease or held them for so long.

Yours faithfully,  
(Sgd.) F. R. RAWLINGS.

USE  
**IGRANIC**  
Short Wave Coils.

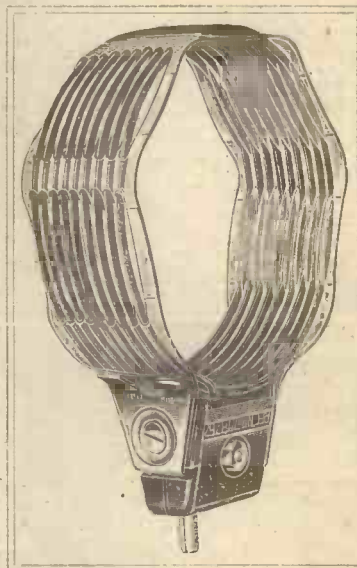

Write for Pamphlet No. R28

**IGRANIC ELECTRIC CO., LTD.**  
149, Queen Victoria Street, LONDON  
Works: Elm Road, BEDFORD.



## NOTES ON THE FLEWELLING.

(Continued from page 316.)

thing from 10 to 15 turns, and still function just as well as the 12-turn loop used by the writer. The turns may be wound either "box" or "pancake" fashion, as desired. This frame will, by the aid of plug-in coils, enable satisfactory reception to be carried out between approximately 300 and 1,000 metres (according to the exact number of turns employed).

### The Fixed Condensers.

The three fixed condensers and the variable grid leak should be the very best obtainable.

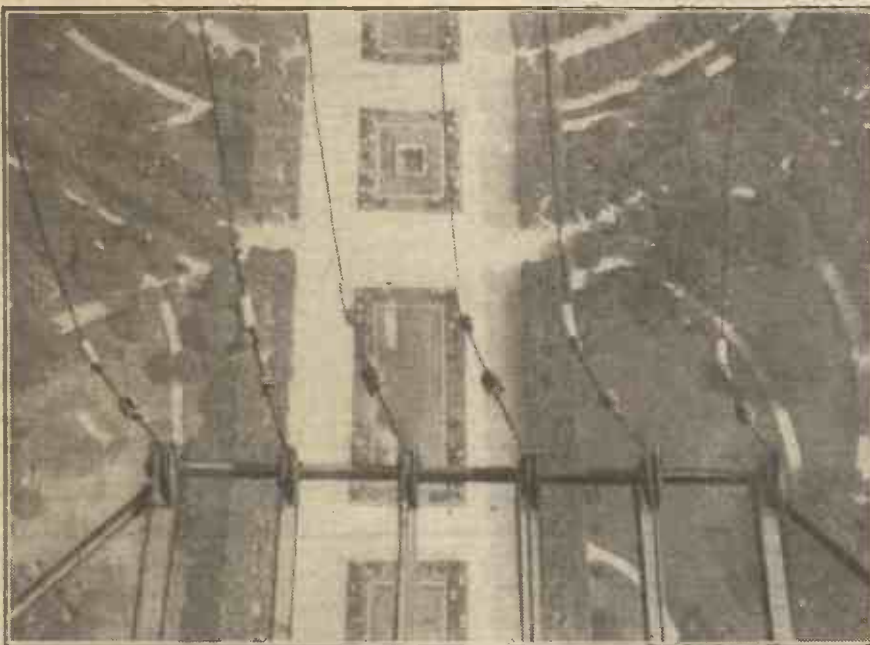

Looking down from the top of the Eiffel Tower, Paris. The six aerial wires and their leads in to the tower are clearly shown.

Any good, hard valve which works well as a rectifier in an ordinary straight circuit will be suitable for use in the Flewelling. The H.T. necessary will be in the neighbourhood of 60 volts.

As regards the coils used. The A.T.I. may be a No. 35 or 50, according to the wave-length of the broadcasting station which it is desired to receive. Both Nos. 75 and 100 should be tried for the reaction. To receive a broadcasting station at a distance of anything less than 15 to 20 miles, it will not be necessary to use the set as a "super." In this case, the reaction coil should be reduced to about 35 turns, so as to stop the receiver not only from "supering," but from oscillating in the ordinary way as well. It is a great advantage to use a coil holder fitted with some fine adjustment device.

No actual constructional details of the set have been given, since the receiver employed by the writer consists merely of the various components connected up in experimental fashion. This need not, however, deter any reader from making up a complete receiver. The writer has done so for several of his friends, and all the sets are giving complete satisfaction.

For short-wave reception the aerial system is changed to that shown in *c* (Fig. 2), so that the circuit of the complete receiver now becomes as shown in Fig. 4.

The dimensions of the coils used will, of course, depend upon the size of the aerial and the magnitude of the stray capacities in the receiver itself. Nevertheless, the following particulars will provide a basis for experiment. Using a 10-ft. indoor aerial, and an earth wire, the short-wave transmissions from W G Y on about 40 metres, and the 63-metre transmissions from K D K A are received excellently with the following coils: Primary 4 turns, secondary 8 turns, reaction 20 turns. These are all basket coils, wound with No. 18 D.C.C. wire on formers (which are afterwards removed) having 1½-in. centres.

For the benefit of those readers who may wish to duplicate exactly the receiver used

are as far apart as possible. The setting of the variable grid leak is, for the moment, unimportant. The H.T. should be set at, say, 60 volts. (The ordinary type of 66-volt H.T. battery will be found amply large enough for use with this circuit, whether a bright or a dull emitter valve is used.) Now set the condenser dial at zero. Switch on the filament current, and steadily increase its value by means of the rheostat. In all probability, a point will be reached at which the set goes into oscillation with a "plop." Should this not occur, leave the valve burning at its maximum temperature, and try the effect of increasing the resistance of the grid leak. This is accomplished, with most makes, by turning the knob in an anti-clockwise direction, so that the plunger moves upwards. If, even when the resistance of the grid leak has been increased to its maximum value, the receiver still fails to oscillate, this trouble will immediately be cured by reversing the leads to the reaction coil.

### Results Obtained.

Having obtained oscillation, still keeping the condenser at zero, gradually increase the coupling between the A.T.I. and the reaction coil. Suddenly, with a slight click, the set will commence to "super," and the quenching whistle will be heard in the 'phones. (If the resistance of the grid leak is too high, the note of the quenching oscillation will be almost a howl instead of a high-pitched whistle. The remedy is obvious.) Next, point the frame aerial in approximately the direction of the station which it is desired to receive. Now, very slowly rotate the condenser dial, at the same time increasing the degree of reaction coupling so as to keep the set in the "supering" condition. When the carrier wave is picked up it will, provided reaction is sufficiently far advanced, be denoted by a series of "squawks" (heterodyne bumps) instead of the more usual squeal. The condenser should then be set at the silent point (although the term "silent point" is used, the whistle is, of course, still present) on either side of which the two loudest squawks are heard. Final adjustments may now be carried out on all the controls, not forgetting the frame aerial. It will be found that very slight adjustments to the reaction coupling will make an enormous difference to the signal strength, this being the more noticeable the greater the distance of the transmitting station; whereas, once all the other controls are properly adjusted, the variable condenser may be turned through several degrees with little effect. This is a characteristic of all super-regenerative receivers. Most probably, if a No. 100 coil is substituted for the No. 75 for reaction it will be found an improvement on all but the lower condenser readings.

Using a two-foot loop on the broadcast wave-lengths, on the ground level, in London, a few of the stations logged by the writer are: 2 L O, clearly audible on a loud speaker without using the set as a "super." Then, with headphones and using super-regeneration—5 W A, 2 Z Y, 6 B M, 5 N O, 5 S C, 5 I T, 2 B D, M S (Münster), R I (Radio Iberica, Madrid), W G Y (Schenectady, New York). Although this list is composed of only a very small fraction of the total number of stations logged, it will serve as a guide as to what may be done with the set once a little experience has been gained in handling it.

by the writer, the following list of the main parts used will be useful: One .0003 square law condenser (Igranic-Pacent), one Lotus three-way coil holder (Garnett, Whiteley & Co., Ltd.), one each .006, .002 and .0003 fixed condensers (Dubilier), one Bretwood variable grid leak, one Lotus valve holder (Garnett, Whiteley & Co., Ltd.), one porcelain filament rheostat (Igranic-Pacent). If it is intended to use a frame aerial only, a two-way coil holder should be substituted for the three-way instrument specified above.

### Operating the Set.

Although the name of the maker of each of the components mentioned is given, it is not necessary to adhere strictly to these makes, since any other corresponding parts, provided they are of good quality, will be equally suitable.

It is assumed that, on completing the receiver, the reader will test it first upon the broadcasting wave-lengths.

Having connected the frame and batteries, etc., place a No. 35 or No. 50 coil in the A.T.I. socket of the coil holder, and a No. 75 in the reaction coil socket. Then adjust the coil holder so that the two coils





# Apparatus Tested

Traders and manufacturers are invited to submit wireless sets and components to the "P.W." Technical Dept. for test. All tests are carried out with strict impartiality in the "P.W." Test room under the supervision of the Technical Editor, and the general reader is asked to note that this weekly article is also intended to provide a reliable and unbiased guide as to what to buy and what to avoid.—EDITOR.

## R.I. PERMANENT MINERAL DETECTOR.

**T**HIS excellent little component now incorporates a specially designed plunger, which makes it impossible to turn the adjusting knob until the crystals have been separated. The new model is, if anything, more sensitive than its predecessor and readers will not need to be informed that it bears the same "scientific instrument" finish and appearance of first-class workmanship that has made the products of Radio Instruments, Ltd., famous. We believe the R.I. Permanent Mineral was the first detector of its type to be placed on the market and, in our opinion, it still retains a premier position in efficiency. The combination of crystals employed is such that its sensitivity is not obtained at the expense of stability and the device will operate with complete satisfaction in reflex and other valve-crystal circuits. We do not think that 6/6 for the panel mount-

ing (single hole) model is, in the circumstances, anything but perfectly reasonable.

## A "QUIKKO" POWER VALVE.

We can only hope that some day valves will be standardised as are electric lamps, for, at present, the arrival of every new type adds to the confusion of a mass of duplicated and overlapping types which is already in existence. The new "Quikko" will stand out of the medley a little more prominently than some in view of its price, and this is a "characteristic" which is of considerable interest to most amateurs. 8/6 is certainly an attractive figure for a dull emitter power valve.

The "Quikko," a product of Messrs. J. W. Pickavant & Co., Ltd., of Lombard Street, Birmingham, is rated at 3.6 volts, 45 amps, 45-120 volts H.T. Its impedance is about 8,500 ohms and its amplification

factor nearly 6, according to our calculations (curves not submitted), and this is pretty good, and indicates that the valve is a very versatile one for L.F. amplification work.

The valve is very well made and has a nicely moulded base with a milled band formed round it to enable it to be handled easily. The bulb is rigidly mounted and is given a distinctive shape. The grid is formed of one stamping of thin metal bent over the filament and the combination of large surfaces and pretty wide openings so provided is a particularly suitable one for this type of valve.

On test, the "Quikko" gave very good results and was able to handle fairly heavy inputs with a commendable absence of frequency distortion. "Watt for watt," there are several valves we can call to mind that are capable of superior performances, but at the above price the "Quikko" is a proposition that will appeal to many amateurs

## A NON-CORROSIVE WANDER PLUG.

Messrs. The Edison Electric Co., Ltd., have produced a special acid-resisting wander plug for use with their Hymeg grid bias and H.T. accumulators. The metal parts of this plug consist of a special alloy which will not corrode when in contact with sulphuric acid, and the insulating material used is also impervious to the effects of this vicious fluid. The plug is not split but is tapered and fits firmly and securely into the sockets of the batteries. It can be obtained with either a red or blue colour to correspond with positive and negative terminals at the reasonable price of 3d.

(Continued on page 322.)



No. 963.  
"ETHOVOX"  
(Type 750) with  
Metal Horn; for  
use direct in the  
plate circuit.  
**PRICE**  
**£4 10 0**

## BURNDEPT TYPE 750 LOUD SPEAKERS

FROM NOTES BY FRANK PHILLIPS, M.I.E.E., CHIEF ENGINEER  
**S**OME months ago I made up my mind that the so-called "high resistance" (2,000 ohm) Loud Speakers were no longer suitable for modern valve sets, because all such sets use a low impedance dull-emitter power valve for the last stage, and the 2,000-ohm Loud Speaker was designed for the obsolete bright "R" valve... it stands to reason that what was right for one cannot be right for the other. Accordingly, I decided that all 1926-27 models of Burndeft Loud Speakers should be of 750 ohms resistance, and I want to explain why they give better results than those of higher resistance. (The detailed explanation is contained in Mr. Phillips' report sent free on request.)

I desire to give you my assurance that with any receiving set using a modern power valve in the last stage, Type 750 Loud Speakers will give better, purer and louder reproduction than is obtainable from 2,000 ohm Loud Speakers, and further, Type 750 can be substituted for 2,000 ohm without any change in wiring, as both go straight in the plate circuit of the last valve, no transformer being required.

Send for a complete copy of Mr. Phillips' notes and for full particulars of Burndeft "Ethovox" and "Etho-Cone" Loud Speakers.

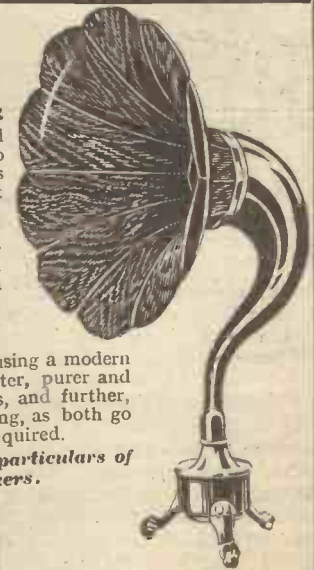

No. 966.  
"ETHOVOX"  
(Type 750) with  
Mahogany Horn;  
for use direct in the  
plate circuit.  
**PRICE**  
**£5 5 0**

## BURNDEPT

Head Office & Factory: Blackheath, London, S.E.3.  
Telephone: Lee Green 2100. Telegrams: Burnacoil, Phone, London.  
London Office & Showrooms: 15, Bedford St., Strand, W.C.2.  
Telephone: Gerrard 9072. Telegrams: Burndept, Westrand, London.

AGENTS AND BRANCHES EVERYWHERE



Motor Car Electrical Equipment Manufacturers  
 by Appointment to  
 H.M. THE KING



# RADIO PRODUCTIONS

Here are some Radio Products which merit your special consideration. They are but briefly described below, but you should make a special point of inspecting them at your local Radio Dealer's.



**MODEL H.T. 3.**  
**H.T. ACCUMULATOR**  
 60 Volts. 1 1/2 Amp. Hrs. (Actual).  
 Size 8 1/2 ins. x 7 ins. x 7 3/4 ins. ht.  
 Weight charged 16 1/2 lbs.  
 The C.A.V. H.T. Accumulator has improved radio reception for hundreds of users, who have wisely scrapped their dry batteries. It will do the same for you. You will get increased volume and purer reception at a consistent signal strength (not varying as with dry batteries) and your H.T. supply will cost less in the long run.  
 Cat. No. 537. Fully charged (first charge free). **60/-**

**"MUSICOLA"**  
 This model, the latest addition to the well-known range of C.A.V. Loud Speakers, is of novel and pleasing design, and is a revelation in both price and performance. It will give ample volume with pure reproduction of all sounds. A demonstration by your local dealer will convince you of its wonderful value.  
 Cat. No. 5050. **£2.2.0**  
 All Brown finish.



**C.A.V. HORN TYPE LOUD SPEAKERS.**  
 Proprietary features in design coupled with excellent workmanship have resulted in an ever-increasing demand for our Horn type speakers.

**"STANDARD."**  
 This model is capable of sufficient volume and pure reproducing characteristics to make it suitable for all outdoor purposes or large halls, where considerable volume is required.  
 Height 22 ins. Dia. of flare 14 ins. Dia. of Base 6 1/2 ins.  
 Black or Brown Satin Enamel, 120 or 2,000 ohms. **£4 10 0**  
 Brown finish with Imitation Tortoiseshell Flare, 120 or 2,000 ohms. **£5 5 0**

**"NEW JUNIOR."**  
 The "New Junior" represents a marked improvement on any Loud Speaker of its class at present on the market.  
 Height 18 ins. Dia. of flare 10 1/2 ins. Dia. of Base 5 1/2 ins.  
 Black or Brown Satin Enamel, 2,000 ohms. **£2 5 0**  
 Brown finish with Imitation Tortoiseshell Flare, 2,000 ohms. **£2 15 0**

**"TOM TIT."**  
 Like the bird whose name it bears, the "Tom-Tit" is the liveliest performer of its size, and is already pleasing thousands. Will give ample volume for average size room.  
 Height 13 1/2 ins. Dia. of Flare 7 1/2 ins. Dia. of Base 4 ins.  
 Black or Brown Crystalline Enamel, 2,000 ohms. **£1 7 6**  
 Brown finish with Imitation Tortoiseshell Flare, 2,000 ohms. **£1 10 0**



**"ALL-PURPOSE" L.F. TRANSFORMER**  
 Height 2 ins. Base 2 1/2 ins. x 3 ins.  
 Fixing Hole Centres 3 1/2 ins.  
 This transformer is designed for use as either a first or second stage amplifier. It is capable of a high degree of amplification, which remains constant over all frequencies.  
 Each transformer is individually tested on broadcasting.  
 Cat. No. 5152. **PRICE 15/-**



**"ACTON" GLASS RANGE L.T. ACCUMULATORS.**  
 The "Acton" Glass accumulators have been designed for use where celluloid containers are objected to. The moulded glass cell container, in addition to being transparent, prevents the risk of fire, eliminates frothing, is clean, and of good appearance.  
 2A. G.60 2 volts 36 Amp. Hrs. (Actual) **13/6**  
 2A. G.80 " 48 " " " **16/0**  
 4 and 6 volt assemblies at practically pro rata prices.

**"ACTON" CELLULOID RANGE L.T. ACCUMULATORS.**  
 Offered at prices, which are strictly competitive with the lowest on the market, the "Acton" Range represents remarkable value. Each is soundly designed and well made, and maintains the high standard of performance for which all C.A.V. Accumulators are well known.  
 2A. 40 2 volts 20 Amp. Hrs. (Actual) **11/0**  
 2A. 60 " 30 " " " **13/6**  
 2A. 80 " 40 " " " **16/0**  
 2A. 100 " 50 " " " **18/6**  
 2A. 120 " 60 " " " **21/0**  
 4 and 6 volt assemblies at practically pro rata prices.



WRITE FOR C.A.V. RADIO CATALOGUE P.W.1.

Telephone: Chiswick 3801  
 (Private Branch Exchange)

**CAVandervell & Co., Ltd.**  
 ACTON, LONDON, W. 3.

Telegrams:  
 VANTERIA-ACT, LONDON

Also Obtainable from all LUCAS-CAV-ROTAX Service Depots:



**APPARATUS TESTED.**

(Continued from page 320.)

**A USEFUL BOOK.**

"First Course in Wireless." By Robert W. Hutchinson, M.Sc., A.M.I.E.E. (University Tutorial Press, 3/6 net). This is one of the most usefully comprehensive radio text books published at a popular price we have seen. An attempt has been made, with considerable success, to deal with the subject right from the beginning of the elementary theory of electricity up to the description of "multi-valvers" of modern design. The receiving side is given the greater prominence, and if the Flewelling simplified is not shown, this and one or two other minor omissions detract but little from the general excellence of the work. Every amateur could number this authoritative book on his shelves with advantage.

**TWO MULLARD VALVES.**

It is a staggering thought, but none the less true, that one could run fifteen Mullard P.M.1 dull emitters on the energy consumed by one average bright emitter of a year or two ago. The P.M.1's take less than one-fifth of a watt. And not only do they reduce "running costs" to proportionately negligible figures from an L.T. point of view, but they "burn" at such low temperatures that their lives may well run into five figures, speaking of hours of actual work. Having long filaments hefty emissions are obtained without the necessity

of going beyond mere warmth! It is stated that a P.M.1 filament can be tied in knots after 1,000 hours of use, and if this is true, and we have no reason at all to doubt it, then here is proof positive of a wonderful toughness and durability.

The P.M.1 H.F. is suitable for H.F. and detector positions and for first stages of L.F. amplification, and the P.M.1 L.F. for detecting and L.F. amplification. The maker's curves of these two Mullard valves are reproduced on this page, together with their full characteristics. Both P.M.1's are retailed at 14/- each.

On test the P.M.1 H.F. gave excellent results, more particularly in a straightforward detector position. As a matter of fact, we are of the opinion that it would take a very good six-volter to equal it in "liveliness."

And as an H.F. amplifier in both transformer and tuned anode stages it operated in a most praiseworthy fashion. Readers need not fear that these "lukewarm-filamented" little tubes lack the punch of those other valves which resemble miniature arcs. The lack of illumination may well be disconcerting to some radio die-hards, but newcomers of the future will learn not to judge a valve's capabilities by the heat of its filament.

The P.M.1 L.F. gave equally good results as a first stage L.F. amplifier

and functioned quite well as a detector, although for this we prefer the H.F. P.M.1. In a two-valve set (actually the "P.W." De Luxe, which was recently described) an H.F. P.M.1 and a P.M.2, which is a two-valve power valve taking but .15 amps, operated a large loud-speaker in a manner that would require something above the average in six-volters to beat.

**"INDURITE" INSULATING MATERIAL.**

Messrs. McCormick & Butler, 121, Victoria Street, London, S.W.1, recently sent us a sample of "Indurite," a new insulating material for which almost startling claims are made. Stated to cost but half the price of high-class ebonite, it appears that it can be just as easily moulded and is as electrically efficient.

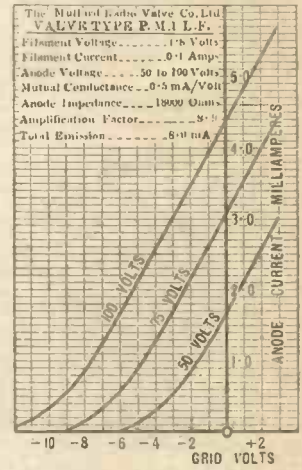
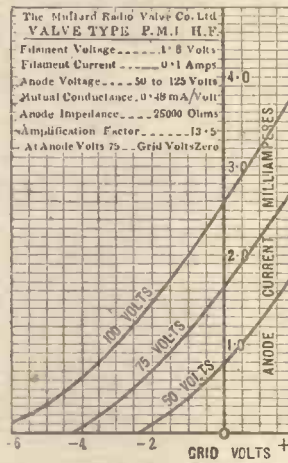

## Tested & Guaranteed Components by Bowyer-Lowe

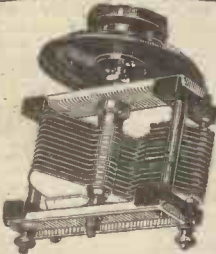

**POPULAR CONDENSER**

The popular price of this new Condenser of unrivalled precision presents to the amateur the ideal instrument for his experimental set. The construction executed for mechanical perfection has been achieved by the use of a ball-bearing rotor, eliminating harshness and unreliability of tuning. Electrical efficiency and exceptional range of wave-length, together with full dial availability for tuning, is combined in its low-loss square law design. If at any time the Bowyer-Lowe Condenser develops a fault during the twelve months after purchase the article will be replaced free of charge.  
•0005 uF., 10/-.  
•0005 uF., 10/6.

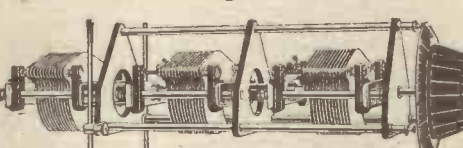

**GANG CONTROL CONDENSER**

This condenser has been designed for use in single control receivers, and is provided with three independent condensers of .0005 u.F. capacity insulated from one another, but controlled by one dial. A simple means is provided for varying the relative positions of the rotors so that the different coils and transformers can be balanced. Each rotor is mounted on ball-bearings, while universal joints are used between them to ensure smooth operation. Two adjustable supports are provided to remove the strain of the weight from the panel.

List 252. With 4 in. dial ..... £3/13/0  
Without dial ..... £3/10/0

Send 1/- in stamps for catalogue of Bowyer-Lowe Components — a handy guide to better reception.



**COIL SCREENING BOXES**

In introducing our new screening box and base for coils, we have achieved an almost perfect electrostatic shield, the whole base and circular screen screwing together, and being earthed by an extra terminal on the base. Six sockets are fitted on the base for coils, together with six terminals for coil connections. List No. 249. Price 15/-.  
Interchangeable coils and transformers for any Radio Set from 4/6.



**Bowyer-Lowe**

Announcement by the Bowyer-Lowe Co., Ltd., Letchworth, Herts.



# IMPORTANT NOTICE

---

# WIRELESS VALVES

---

## INJUNCTION WITH DAMAGES

ON the 26th July, 1926, in the High Court of Justice, Chancery Division, in the case Marconi's Wireless Telegraph Company, Limited, v. S. Kalisky, Limited, by consent an Injunction was granted restraining the Defendants from infringing Letters Patent No. 184446, and the Defendants were ordered to deliver up to the Plaintiffs all TRIOTRON DULL EMITTER '06 AMPERE VALVES and pay DAMAGES and also the costs of the action.

### WARNING

*Dealers in TRIOTRON VALVES are warned that the PATENTEES will take legal proceedings against any person selling or using infringing valves. No license has been granted under the above Patent to any foreign Valve Manufacturer.*

**THE BEST AMPLIFIER** and the **CHEAPEST**  
 both to fix and operate  
**IS THE NEW NON-VALVE**  
 MAGNETIC MICROPHONE  
**BAR AMPLIFIER**

(Patent No. 248581/25).

*Illustrated lists free.*

PRICE  
**38/-**  
 Post Free.

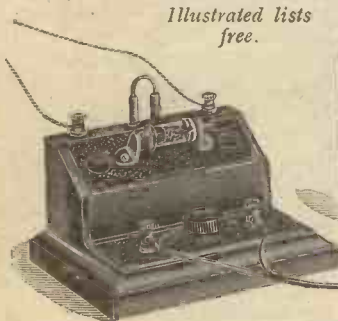

Microphone and other parts of Amplifier also supplied separately.

**REALLY GOOD LOUD-SPEAKER RESULTS** from CRYSTAL RECEPTION of average strength. **WEAK CRYSTAL** or **VALVE RECEPTION** made **STRONG AND CLEAR** on Headphones. **ENABLES** even very **DEAF PERSONS TO HEAR** from Crystal Sets.

Not a Microphone Button. Entirely free from distortion and microphonic noises. No valves, accumulators or H.T. Batteries. No fragile parts. Nothing to get out of order. A child can adjust it. Operates on one or two Dry Cells lasting over 3 months.

**EQUALLY EFFICIENT ON VALVE SETS.**

*Order from your dealer or from Sole Manufacturers and Patentees*

**NEW WILSON ELECTRICAL MANUFACTURING CO., LTD.,**  
 18, Fitzroy Street, Euston Road, London, W.1.

Phone: Museum 2703.



# RADIOTORIAL

All Editorial Communications to be addressed to The Editor, POPULAR WIRELESS, The Fleetway House, Farringdon Street, London, E.C.4.

Editor :  
**NORMAN EDWARDS, M.Inst.R.E., F.R.S.A., F.R.G.S.**

Technical Editor :  
**G. V. DOWDING, Grad.I.E.E.**

Assistant Technical Editors :  
**K. D. ROGERS. P. R. BIRD.**

Scientific Adviser :  
**Sir OLIVER LODGE, F.R.S.**

Staff Consultants :  
**Dr. J. H. T. ROBERTS, F.Inst.P.; J. F. CORRIGAN, M.Sc., A.I.C.; C. E. FIELD, B.Sc., E. J. SIMMONDS, M.I.R.E., F.R.S.A.**

Foreign Correspondents:  
**F. M. DELANO, Paris; Dr. ALFRED GRADENWITZ, Berlin; L. W. CORBETT, New York; P. F. MARTIN, Italy; W. PEETERS, Holland.**

The Editor will be pleased to consider articles and photographs dealing with all subjects appertaining to wireless work. The Editor cannot accept responsibility for manuscripts and photos. Every care will be taken to return MSS. not accepted for publication. A stamped and addressed envelope must be sent with every article. All inquiries concerning advertising rates, etc., to be addressed to the Sole Agents, Messrs. John H. Lile, Ltd., 4, Ludgate Circus, London, E.C.4.

As much of the information given in the columns of this paper concerns the most recent developments in the Radio world, some of the arrangements and specialities described may be the subject of Letters Patent, and the amateur and the trader would be well advised to obtain permission of the patentees to use the patents before doing so.

Readers' letters dealing with patent questions, if sent to the Editor, will be forwarded to our own patent advisers, where every facility and help will be afforded to readers. The envelope should be clearly marked "Patent Advice."

### TECHNICAL QUERIES.

Letters should be addressed to: Technical Query Dept., "Popular Wireless," The Fleetway House, Farringdon Street, London, E.C.4.

They should be written on one side of the paper only, and **MUST** be accompanied by a stamped addressed envelope.

Queries should be asked in the form of the numbered questions: (1), (2), (3), etc., but may be accompanied by a short letter giving any necessary additional particulars as briefly as possible.

For every question asked a fee of 6d. should be enclosed. A copy of the numbered questions should be kept, so that the replies may be given under the numbers. (It is not possible to reproduce the question in the answer.)

**BLUE PRINTS.** A series of 20 Blue Prints can be obtained from the Query Dept. price 6d. per Blue Print.

Only a limited number of circuits are covered in this series, and full details of the circuit arrangements available in Blue-Print form are published fortnightly in the advertisement columns of this journal.

All other back-of-panel diagrams have to be specially drawn up to suit the requirements of individual readers at the following rates: Crystal Sets, 6d.; One-Valve Sets, 6d.; One-Valve and Crystal (Reflex), 1s.; Two-Valve and Crystal (Reflex), 1s.; Two-Valve Sets, 1s.; Three-Valve Sets, 1s.; Three-Valve and Crystal (Reflex), 1s. 6d.; Four-Valve Sets, 1s. 6d.; Multi-Valve Sets (straight circuits), 1s. 6d. Except SUPER-HETERODYNE DIAGRAMS, all of which, irrespective of number of Valves used, are 2s. 6d.

If a panel lay-out or list of point-to-point connections is required an additional fee of 1s. must be enclosed.

Wiring diagrams of commercial apparatus, such as sets of any particular manufacture, etc., cannot be supplied. (Such particulars can only be obtained from the makers.)

Readers may submit their own diagrams, etc., for correction or for criticism. The fee is 1s. per diagram, and these should be large, and as clear as possible.

No questions can be answered by 'phone. Remittances should be in the form of Postal Orders.

## Questions and Answers

### LOADING A FRAME AERIAL.

M. V. B. (Maida Vale, W.)—Can a tapped coil be used to increase the wave-length of a frame aerial in the same way as for an ordinary outdoor aerial? If so, should it be in series or connected across the "aerial" and "earth" terminals?

It is possible to "load" a frame aerial by means of a coil joined in series, but it is not usual to do so. The directional effect of the frame aerial (which is one of its greatest advantages) is reduced by the use

(Continued on page 326.)



## Smooth movement

The principal features of the "Cosmos" Filament Rheostat are its sturdy construction and reliable, smooth movement. The contact arm cannot easily be damaged, having its movement on the inner side of a porcelain bobbin, which carries the windings. Other pleasing features of this Precision Rheostat are the handsome knob and dial, ONE HOLE fixing, and the small space it occupies.

Made in four types, two of which are double wound for DULL or Bright Valves and one a Potentiometer, the prices are given below.

**METRO-VICK SUPPLIES, LTD.**  
 (Proprietors: Metropolitan-Vickers Electrical Co., Ltd.)  
 Metro-Vick House, 155, Charing Cross Rd., London, W.C.2

Description	Ohms	Current	Price
Single Wound	6'0	1'0 amp.	s. d. 4 6
Double "	20	'4 "	5 0
Double "	34	'2 "	5 0
Potentiometer	300	—	6 0

# Cosmos

RADIO COMPONENTS



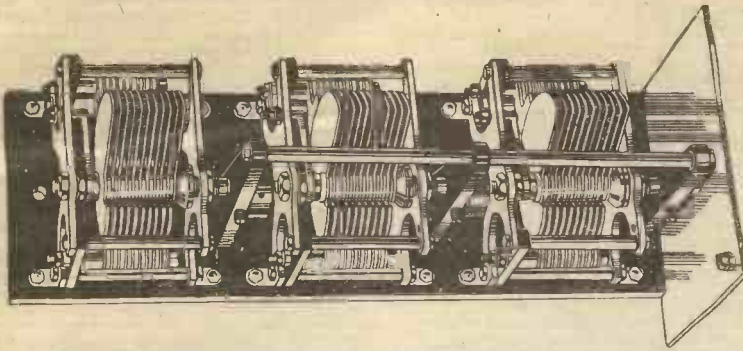

The  
**CYLDON**  
(pronounced SIL-DON).

**TRIPLE GANG  
CONDENSER**

Price **£3-10-0**

2 Gang Condenser **£2-10-0**

4 Gang Condenser **£4-10-0**

Prices without Dial

**C**ONSTRUCTORS are giving this handsome new model a most enthusiastic welcome because of  
(1) Its absolute freedom from whip.  
(2) Independent adjustment of each Condenser by novel means, completely eliminating hand capacity.

**O**ther attractive features are:—Each Condenser electrically separated; anti-capacity plate supplied; operation of all three Condensers as "silky" as if only one was used; whole instrument perfectly rigid; supplied ready for immediate fitting; construction and finish are well up to the fine Cyldon standard.

Send for particulars of the Cyldon **WAVEMETER**—it identifies unknown stations, and makes searching and testing out simplicity itself.



**Cyldon TEMPRYTES**

The best means of valve control. British made and delivered from stock immediately. Can be supplied in correct resistance for any Valve. State resistance (ohms) required when buying, or be sure to give name of Valve and voltage of Accumulator supplying current to the Valve.

Cyldon Temprytes - 2/6 each.  
Holder Mounting - 1/6 "

Get full particulars of all Cyldon Products from your dealer or write direct to the makers. Other Cyldon Condensers comprise Square Law, Square Law Dual Pattern, and the S.L.F. 4 in. Knob Dial supplied free with Square Law and Dual Models, and 2/- extra with S.L.F. or Triple Gang.

**SYDNEY S. BIRD & SONS**

"Cyldon" Works, Sarnesfield Road, Enfield Town, Middlesex.

Telephone - ENFIELD 0672.

**"Almost incredible!"**

"Almost incredible" that was the spontaneous exclamation of a listener at the demonstration last Monday in our Showrooms, less than a mile from 2 L.O. Station after Station had been tuned in. All round Europe we went. First Paris . . . then Rome . . . Madrid . . . Berlin, and so on. All at loud-speaker strength.

But not one trace of 2 L.O., not even when operating within 40 metres of the London Station. The famous Ormsby Long Range Selective Receiver, using exactly the same circuit as on our Home Construction Model, achieves these wonderful results. You can build this remarkable set yourself. There's no difficulty. No fear of failure. Success is certain if you use our patent Home Construction Model. It's simple . . .

easy . . . and cheap. We have letters from Enthusiastic Customers all over the country, and at Olympia literally hundreds called to express their appreciation in person.

Send for this simple model. Make the Receiver yourself. And choose your programmes from the best in Europe.

Catalogue on request. Demonstrations every night from 8 to 10 p.m. at our London Showrooms.



Home Construction Cardboard Model, showing wire connections with coloured strings, complete with instructions and list of components. **3/-** Postage 5d.

**ORMSBY & CO., LTD.,**

1, ORMSBY WORKS, LOWER RICHMOND ROAD, RICHMOND, SURREY.

London Showrooms: 10, NEW OXFORD STREET, W.C.1.

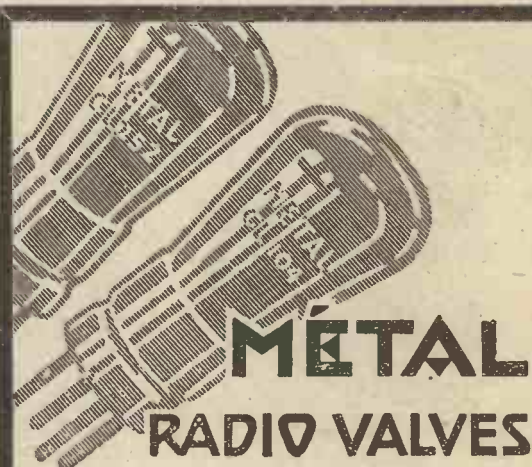

Why pay more for valves when you can obtain "Métal" Radio Valves at the prices quoted. It isn't as if higher priced valves are better than "Métal." They are not, for with "Métal" Valves—one of the oldest makes—you can get results unobtainable with most valves. That is why they are used by the French Government and in countless Continental and U.S.A. sets.

**PRICES:**

Type.	Fil. Volts.	Amps.	Price.
C.L.62	2	0'06	10/6
C.L.202	2	0'2	8/-
6/100	4	0'06	9/6
Power.			
C.L.502	2	0'3	12/-
C.L.104	4	0'10	15/-

Your dealer stocks them. Write for list showing all types.

Sole Distributors:

JOHN RAE, LTD., 60, BLACKFRIARS RD., LONDON, S.E.1



## RADIOTORIAL QUESTIONS AND ANSWERS.

(Continued from page 324.)

of a loading coil, and it is generally quite easy to wind a larger number of turns on the frame and so make its natural wave-length near to the desired wave-length. Or alternatively to use one frame for the long wave-lengths, and another for the short.

If it is necessary to use a small loading coil, it should be connected in series with the frame aerial in order to increase the inductance. If connected in parallel the total inductance will be lessened and the wave-length reduced.

### GRID CONDENSER VALUES.

"GRIDCON" (Banbury).—I am building a circuit which requires a grid condenser of .00025 mfd. Do you suppose that this value is critical, as I already have one of .0003 mfd. on hand?

Generally speaking the value is not so critical as to make a difference if a variation of about .00005 mfd. is made, and we think that you will find the .0003 quite O.K.

### GRATING AND CRACKLING NOISES.

F. A. L. (Newcastle-on-Tyne).—I am troubled with grating and crackling noises. The usual cause I am told is a transformer burn-out or faulty H.T. battery. Both of these have been tested, but the fault persists. What is it likely to be?

Grating and crackling noises are usually produced by a faulty or broken connection. On hearing a grating noise in the headphones, first work the flexible leads about, near where they enter the earpieces. If this affects the noises in any way, the probable cause of the trouble is a loose connection in the back of the earpiece.

Next, check the battery connections. The terminals of the low-tension battery may be so affected by acid fumes that a wire leading to the set has corroded away, and is only attached to the terminal by a crust of sulphate. See that the high-tension battery connections are sound, and that all wander-plugs are clean and a good fit in their sockets.

If the aerial is tuned with a cylindrical coil fitted with a slider, examine the sliding contact, and if it is faulty (which can be easily ascertained by moving the slider a little) clean up the bared portion of the winding with emery or glass-paper, and see that the moving contact is exerting a firm pressure on the wire.

If a variometer is employed, test this. Should the noise show itself when the rotor is turned, there is probably a poor contact in the bearings, which are generally used for making connection between the rotor and stator windings.

Other places to be examined for bad contacts are valve legs, the pins of high-frequency plug-in transformers, and all switch parts, particularly the pivots of switch arms.

If the set has been wired up with flex, a single strand of wire, easily overlooked, may be rubbing on to some other wire or terminal. Examine the underside of the valve-holders and the wires leading through the panel to any moving coils which might be employed for this trouble.

Almost any broken connection in a set may give rise to grating noises, if the ends which have become disconnected are making intermittent contact.

### INCREASING CONDENSER CAPACITY.

R. T. I. (St. Leonards-on-Sea).—In what way can the capacity of variable condensers be increased, apart from alterations to the mechanical structure?

The easiest method is to place another condenser (either fixed or variable) in parallel with the condenser whose capacity it is desired to increase. If desired a switch will be provided so that the additional condenser can be disconnected when required.

To estimate the value of the total capacities when condensers are joined in this way in parallel, all that is necessary is to add together the respective capacities. For instance, if a .0003 mfd. condenser is connected in parallel with a .0005 mfd. condenser the total maximum capacity of the pair will be .0008 mfd.

Another method of increasing the capacity of a variable condenser is to alter the dielectric between the plates (which ordinarily is air) for one of a higher specific inductive capacity.

For instance, the insertion of thin mica between the vanes would increase the capacity, or the whole condenser can be immersed in a hard mineral oil, to obtain the same effect.

### CAUSE OF INTERFERING NOISES.

W. P. R. (Manchester).—What is it that actually causes the noise in neighbours'

receiving sets when excessive reaction is applied to the aerial of a broadcast receiver?

When the reaction coil is brought so close to the aerial coil that the set oscillates, the receiving set acts as a miniature transmitter. The aerial attached to it sends out a continuous wave like the carrier-wave of a broadcasting station.

As the set is tuned for broadcasting wave-lengths this illegal carrier wave will have a wave-length very near to that of the wave used for broadcasting. In itself either of these waves would be inaudible (except when modulated), but when they are present in a receiver simultaneously beats are formed at regular intervals between the two sets of waves. These may occur at audible frequency and if so will in conjunction give rise to a note in the telephones.

If the tuning condenser of the offending set is turned so as to bring the wave-lengths nearer to or farther from one another, the beats will alter in frequency and the received note will rise or fall accordingly. This will give rise to the all too-familiar chirps and whistles that are associated with oscillation.

### BEST TYPE OF VARIOMETER.

F. S. (London, S.W.18).—Why are variometers in general use in the United States for broadcasting, and what is the most efficient type to employ?

The reason that variometers are used to a greater degree in America than in this country is the fact that broadcasting there is carried out on a narrow band of wave-lengths. There is no popular station corresponding with our own 5 X X, that employs a wave-length outside the usual useful range of the ordinary variometer.

The most efficient type of variometer to employ is one with an internally wound stator, and with a very small air space between this stator and the rotor.

### ADVANTAGES OF HONEYCOMB TYPE COILS.

R. A. P. (N. Acton, London, W.3).—What are the advantages of the duolateral or honeycomb winding, as compared with a coil which is wound hank fashion?

The chief advantage of these forms of winding is the fact that they tend to reduce self capacity, which is an undesirable feature of a tuning coil.

(Continued on page 328.)

# The World's Greatest Radio Products

# NEUTRON

TRADE MARK

**NEUTRON DULL  
EMITTER VALVES**  
Extraordinary filament  
emission, unequalled for  
Crystal Clarity of repro-  
duction—absolutely non-  
microphonic British  
made—

4	volt H.F.	.06	amps	12/6
4	"	L.F.	.06	" "
2	"	H.F.	0.2	" "
2	"	L.F.	0.2	" "

**NEUTRON  
H.T. BATTERY**  
Full 60 volt British—  
made Long Life (Sealed  
with special plugs to  
avoid tampering).  
Note new price  
**10/6**

**NEUTRON  
PERMANENT DETECTORS**  
The most sensitive series of  
Permanent Detectors—MAGNUM or  
CRYSTASTAT for panel mounting;  
PANECTOR, one-hole fixing, under  
panel—guaranteed tested on actual  
Broadcast 130 miles from 5 X X.  
Magnum 5/6. Crystastat 4/6. Pantector 3/6.

**NEUTRON  
BASKET COILS**  
The most efficient made—highest  
inductance—maximum capacity—  
rigid construction—95-1,200 metres.  
Faraday House full report with  
each set.  
Set of Five 3/6. Daventry Coil 2/-.

**A WONDERFUL NEW INVENTION  
NEUTRON  
CHEMICAL EARTH**  
Signal strength increased  
50%. Simply dissolve in hot  
water and pour into earth  
tube or around your  
earth connection. **3/6**

All Export enquiries for Continent and Australasia to:  
Pettigrew & Merriman, Ltd.,  
2 & 4, Bucknall Street, Oxford Street, W.1.

Sole Distributors for U.K. and Ireland:  
**NEUTRON DISTRIBUTORS.**  
144, Theobald's Rd., London, W.C.1.





# 7 THE NEW No. 7 RECUPERATING AGENT 7

*Goodnight Everybody!*

You switch off your set and you switch on the No. 7 RECUPERATING AGENT in your HELLESEN H.T. Battery.

This is the secret of the remarkable efficiency and long life of the Helleesen Dry Batteries, and to-day, when radio is just a matter of switching on and off, the H.T. Battery which possesses this power to the greatest degree is absolutely necessary.

You now have the opportunity of buying at a competitive price dry batteries which have always sold on quality—not on price—with quadruple insulation and sealed covers. The GENUINE HELLESEN IS THE GENUINE ARTICLE.

AT HUNT'S NEW PRICES you pay no more but you get the BEST IN THE WORLD.

60 volt "WIRIN" 12/6    99 volt "WIRUP" 21/-  
(Postage Extra)

All types, voltages, etc., in Double and Treble Capacities. Dry Batteries for Low Tension Hand and Pocket Lamps.

From all Radio, Electrical and General Stores, Harrods, Selfridge's, Barker's, Whiteley's, etc., or direct from

**A. H. HUNT, Ltd. (Dept. 12), CROYDON, SURREY**

Write for Leaflet No. 155a



B 31

# For 2, 4, or 6-volt Accumulators



## The New Six-Sixty POINT-ONE VALVES

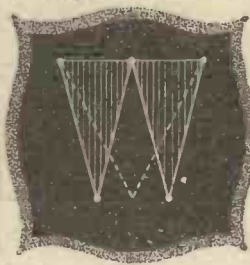

### Duo-triangular filament suspension



WIRELESS enthusiasts can now secure the advantages made possible by Duo-Triangular Filament Suspension whether their L.T. supply be 2, 4 or 6 volts.

It has been the aim of Six-Sixty right from the beginning to produce not just one type of specialised valve with unique characteristics for use with, say, a 4-volt accumulator, but a complete range of valves designed to meet all existing requirements.

After extensive research, Six-Sixty produced a special filament which, when operating at its rated voltage, showed absolutely no sign of "glow," and required barely 1 amp. to give perfect results. The success achieved with this filament led to further research, resulting in the famous Six-Sixty Duo-Triangular system of Suspension. The combination of these two developments ensured increased electronic emission, consistently perfect reception, longer life and lower running costs. Six-Sixty, not content to rest on their laurels, worked incessantly until these advantages were made generally possible to the wireless enthusiast, irrespective of whether his L.T. supply was 2, 4, or 6 volts.

Briefly, this is the story of the new Six-Sixty Point One Valves—valves which bring hitherto undreamed of advantages within the reach of the General Radio Public.

It is interesting to note that Messrs. A. J. Stevens & Co. (1914), Ltd., have decided, after exacting and exhaustive tests, to standardise Six-Sixty Valves in their famous "Symphony" Range of Receivers.

S.S. 2A, H.F. and L.F.  
D.E., 1.8 volts, 1 amp.,  
H.F., L.F. & Detector  
14/-

S.S. 10.  
D.E., 2 volts, 1.5 amp.,  
Power Amplifier 18/6

S.S. 7.  
D.E., 3.7 volts, 1 amp.,  
Power Amplifier 18/6

S.S. 8.  
D.E., 3-4 volts, 1 amp.,  
General Purpose 14/-

These Prices do not apply in the Irish Free State.

## SIX-SIXTY VALVES Better by Six Times Sixty



EXPERTS IN RADIO

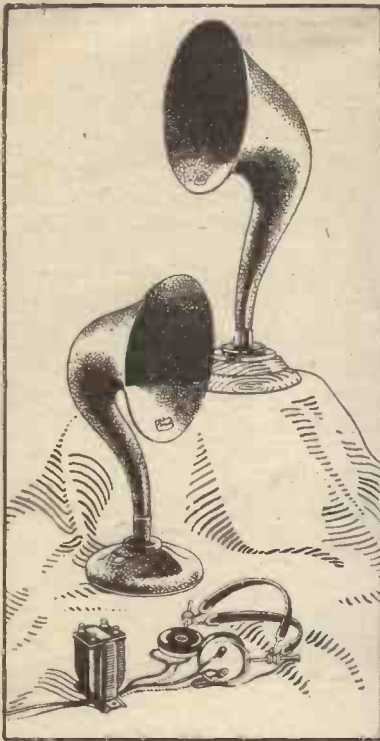

OLD FRIENDS

THE BRANDOLA

Greater volume with minimum current input. Large diaphragm gives fullness to upper and lower registers. Walnut plinth, electro-plated fittings. **75/-**

THE TABLE-TALKER

Material used in the construction of goose-neck horn eliminates metallic harshness. Adjustable. Height 18 ins., neutral brown finish, padded base. **30/-**

THE AUDIO TRANSFORMERS

Ratio 1 to 5. High amplification of applied voltage, together with straight line amplification frequency curve. **17/6**  
Also 2nd stage, 1-3. 1-5 (Black case). 1-3 (Brown case).

MATCHED TONE HEADPHONES

The synchronised effort of both receivers discovers greater sensitivity and volume and truer tone. Light, comfortable and sturdy. **20/-**

Brandes

From any reputable Dealer

BRANDES LIMITED, 296 REGENT ST., W.1

ACOUSTICS SINCE 1908

Service Advertising

RADIOTORIAL QUESTIONS & ANSWERS.

(Continued from page 326.)

COILS FOR BROADCASTING.

M. V. W. (Kensington, London, W.).—What are the best types of coils to use for long and short waves respectively?

For ordinary broadcasting wave-lengths the basket, spider web or single layer solenoid coils will be found very effective, but the duolateral type are preferable for long waves (such as employed by Radio-Paris and Daventry) because of their greater compactness.

ONE-VALVE RESULTS.

B. P. S. (Warrington).—I have constructed a one-valve set. I can hear 6 L V and 2 Z Y quite well, but am unable to hear any other stations. Can you tell me what the trouble is?

You are already getting normal one-valve results. A straightforward one-valve set cannot be credited with possessing a guaranteed range, under all conditions, greater than something between 40 and 100 miles (we would rather not fix this figure).

Anything above this is either due to a good aerial-earth system, abnormal location, or other natural causes, or to operating skill. The latter can be acquired with experience, but a good situation is just pure circumstance. Possibly, as you get to know your set, you may begin to record DX results, but you should regard such as gain, and not expect to accomplish "all B.B.C., etc."

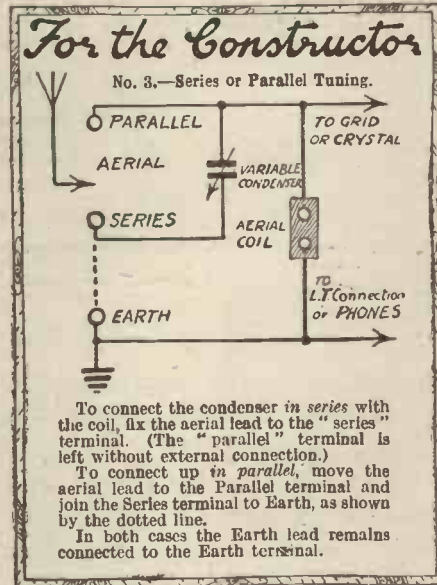

HOW TO SEND IN YOUR QUERIES.

J. F. W. (Abergavenny) and others who have written for advice or diagrams, promising to send a remittance if the charge for diagrams, etc., is stated.

For the benefit of new readers it may not be out of place to draw attention to the rules of the Query Department, as set out under heading "Radiotorial."

The observance of these rules will facilitate the work of the technical staff and assist in getting the replies as quickly as possible.

For instance, if a long rambling letter is sent in there is a difficulty in sorting out the important from unimportant points, but this can be avoided by numbering the questions.

Delay and the possibility of mistakes in names of places, etc., are avoided by the inclusion of the stamped addressed envelope.

If a blue print is required, the number of the Blue Print (as given in the list in "P.W.") must be quoted.

When it is uncertain what type of set will be required it is better to decide this before sending money for the diagram. If the circumstances are outlined, together with a statement of maximum number of valves, or results required, this advice can be given in the form of a single question and answer.

Remember, that the best circuit for your requirements is not necessarily the one that uses up all your old components; a great many readers limit the usefulness of their receivers by insisting that a certain variometer or similar component must be used. It is better to state the desired results and give the list of components on hand, saying they are to be incorporated in the new set if possible, and if this is consistent with good results.

To Electrical and Wireless Goods Merchants, Accumulator Factors, Motor Accessory Dealers, &c.

13, High Holborn, W.C.1.

HENRY J. SHAW

is instructed to SELL by AUCTION

on Thursday, October 14th,

Commencing at 11.0 precisely,

5,000 New Fuller Accumulators in 120 varieties (Including Block and Plate). Celluloid and ebonite cases. 500 New Fuller Sparta Loud Speakers. 150 New High Tension Accumulators in teak boxes. 50 High-Grade Wireless Receiving Sets (in enclosed cabinets, 2, 3, 4, 5, and 6 valves, including Western Electric and Super Het. sets). Large quantity of Polar Accessories, including: Variable and fixed condensers; Coil-holders, Igranic Var. grid leaks, phone distribution boards, headphones, variometers. Marconi and other sets. Complete Crystal Outfits. Large quantities of aerial, earth and lead-in wire. 3,000 Coils New V.I.R. Lighting and Power Cables (all sizes from 1/036 to 37/072, by Fuller and other English makes). 200 Coils Lead Covered Twin and Single Lighting Cables and Bell Wires. 200 Coils Silk and Cotton Covered Twin Flexibles, workshop flexibles, high-tension cables, and flexes. English 5-amp. switches, Holders, Adaptors, I.C. Combined Switches and Fuses, Distribution Boards, etc. All above goods and material are new, clean and perfect, and of recent manufacture. On view day previous and morning of sale. Catalogues upon application to the Auctioneer, 85, Newington Causeway, S.E.1. Phone Hop 3862.

COIL REPAIRS

Headphones & Loud Speakers re-wound & re-magnetised. H.F. & L.F. Transformers re-wound & repaired. All work tested at our experimental station. B. KIMBER & SON, 39, Bargey Rd., Gatford, S.E.6. Phone: Lee Green 2995.

WIRELESS.—Capable, trustworthy men with spare time who wish to substantially increase income required where we are not fully represented. Applicants must have practical knowledge of installation of Set and Aerial, be a householder or live with parents, and be able to give references; state age and experience. Address: Dept. 32, General Radio Company, Limited, Radio House, Regent Street, London, W.1.

PATENTS, TRADE MARKS.

Inventions Advice Handbook & Consultations FREE.—B. T. KING, C.I.M.E., Regd. Patent Agent (G.B., U.S. & Canada), 146a, Queen Victoria Street, London, E.C.4. 40 years' experience. Phone: Cent. 692.

Valves Repaired AS GOOD AS NEW!!

(Except Weco, S.P.'s, and low capacity types). Minimum D.E. Current 0.15 amps when repaired. ALL BRIGHT & DULL EMITTERS Listed at less than 10/6. Minimum charge 5/-. VALCO LTD., Dept. P.W., Labor Grove, Wimbledon, S.W.

WETH.T. BATTERIES

British-made round or square Leclanché Glasa Jars, 21 x 1 1/2 x 1 1/2, for wet H.T. Units, Waxed, 1/3 doz.; plain, 1/2 doz. Carriage and packing extra. Phones and Loud Speakers reconditioned, 4/6 & 5/-. The H.R.F. Co., 1, Cottrill Road, nr. Hackney Downs Station, E.8.

Send card for Radio press reports and booklet explaining how this valve can be used in any set without alteration and will give 50% to 150% increase in power. A new field for the Experimenter. ANELOY PRODUCTS, Eton Works, East Dulwich, London, S.E.22.

ACCUMULATORS ON EASY PAYMENTS

High-Tension Accumulators built up from 20-volt sections (15/- each). Example: 60-Volt H.T. 45/- CASH or 12/6 DOWN and 6 monthly payments of 6/-. Carriage Paid. Satisfaction or money back. Write for Lists to DEPT. 11, COVENTRY DIRECT SUPPLIES LIMITED, 23, Warwick Row, Coventry. Any Wireless Goods supplied on easy payments.



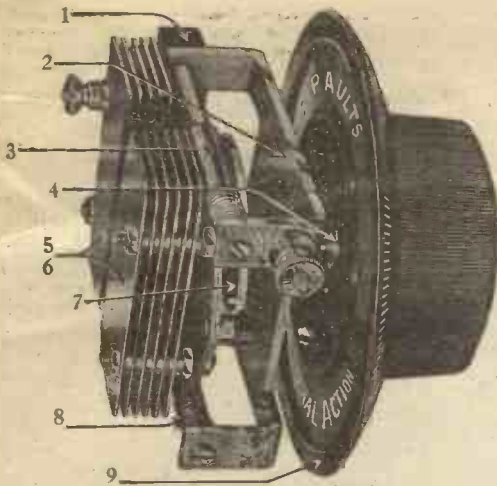

### Special Constructional Features

1. High-grade Ebonite Insulating Bar.
2. Rigid Heavy Gauge Main Frame, placed out of the magnetic field, avoiding eddy current losses.
3. Slider Contact, silent in action and making permanent connection to terminal.
4. One-hole Mounting.
5. Solid Heavy Gauge Brass Plates giving true lateral action.
6. Minimum space occupied at back of panel. 4 in. dial covers whole Condenser.
7. Specially shaped Driving Cam, by which Straight-line frequency characteristic is obtained.
8. Special Compensating Springs, ensuring permanently smooth movement. Backlash cannot develop.
9. 4 in. Dial, divided into 360 degrees for most precise control and easier tuning.

Prices: '0005 - 18/6 '00025 - 17/6  
(Complete with 4 in. Knob and Dial.)

# Revolutionary Design of New Condenser proves Triumph of the Show!

Many advantages must necessarily result from the *revolutionary* design and construction of the Ripaults Lateral Action Condenser. How much these advantages are appreciated has been proved by the enthusiasm the Ripaults Condenser aroused at the show amongst constructors of sets—both amateurs and manufacturers.

The excellent points of design which are so necessary for the efficient operation of a commercial Set make Ripault Lateral Action Condensers ideal for your own purposes.

So study the unique constructional features listed—and ask yourself whether you can really afford to leave the tuning circuits of your Set *minus* the efficiency given by this *triumph* in Condenser design.

# Ripaults

## LATERAL ACTION CONDENSER

(PATENT APPLIED FOR)

MANUFACTURED AND GUARANTEED BY RIPAUTS, LTD., 1, KING'S ROAD, ST. PANCRAS, LONDON, N.W.1;

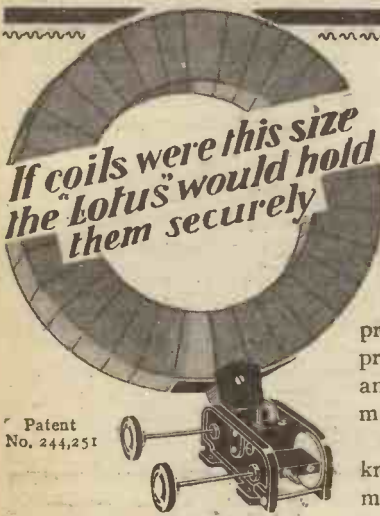

Patent No. 244,251

### The Moving Block Cannot Fall

The vernier movement comprises three sets of enclosed precision machine-cut gears, and reduces the speed of the moving block by eight times.

Side plates, coil blocks, and knobs in artistic bakelite mouldings. All metal parts heavily nickel plated. Made for left as well as right hand.

# LOTUS

VERNIER COIL HOLDERS

#### PRICES:

#### Two Types:

- For outside panel mounting:
- Two-way .. 7/6
  - Three-way .. 10/6
- For inside baseboard mounting, with 6-in. handle:
- Two-way .. 8/6
  - Three-way .. 12/6

Made by the makers of the famous Lotus Buoyancy Valve Holder.

GARNETT, WHITELEY & CO., LTD., Lotus Works, Broadgreen Rd., LIVERPOOL

**The New MAXEL Accumulator**

**GUARANTEED 12 MONTHS.**

AMPERES (Intermittent)				
	44	66	88	110
2-volt	8/-	10/-	12/-	15/-
4-volt	16/-	20/-	24/-	30/-
6-volt	24/-	30/-	36/-	45/-

Packed Free. Carr. Paid.

DO YOU KNOW, we can rebuild your L.T. Battery under 6 months' guarantee, at a low cost. If beyond repair, scrap allowance off price of Maxel Battery. Delivery 3 days.

**SEND IT NOW.**

Phone: MUSEUM 0708.

**MAXEL BATTERY & CO.,** 2, Maxel House, 28, Clipston Street, Gt. Portland Street, W.1

## 3 PERMANENT DETECTORS Partridge RADIALITIES

The B.P. Pro.Pat. ENTIRELY NEW CONSTRUCTION 3/6 each

KLIP ON 2/6 each LITTLE GIANT 2/- each

Push Clips only LIBERAL DISCOUNT Gives loud reception

**PARTRIDGES LTD.**  
140, Northwood St BIRMINGHAM



# The latest in Jacks & Plugs

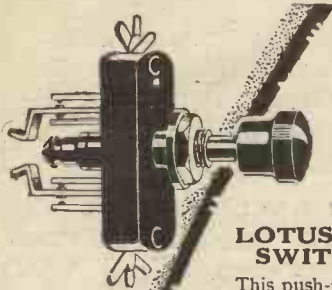

## LOTUS JACK SWITCHES

This push-pull switch is designed to occupy the minimum space, being only 1 1/4 in. deep. Of the finest Bakelite, it has nickel silver springs and contacts of pure silver. Soldering contacts can be made to suit any wiring.

PRICES:  
No. 9, as illustrated .. 4/-  
Others from .. 2/9

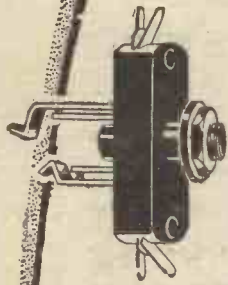

## LOTUS JACK

Designed to take up the least space, the depth back of panel being 1 1/4 in. Made from best Bakelite mouldings with nickel silver springs and pure silver contacts. One-hole fixing. Soldering contacts can be brought into any position.

PRICES:  
No. 3, as illustrated .. 2/6  
Others from 2/- to 3/-



## LOTUS JACK PLUGS

Designed for use with Lotus Jacks. Made from best Bakelite mouldings and nickel-plated brass. To fix, the wires are placed in slots and gripped in position by a turn of the screw cams.

PRICE 2/-

# LOTUS JACKS·SWITCHES·PLUGS

Garnett, Whiteley & Co., Ltd.,  
LOTUS Works, Broadgreen Road, Liverpool.

## WORKSHOP HINTS.

By C. A. J. MEADOWS  
(“P.W.” Staff.)

A PECULIARITY that wireless share with other hobbies is the assortment of used spare parts and oddments of all kinds which accumulate in the receptacle always known as the “junk box.” Despite its name, this step between bench and dustbin is the last resource of every amateur, who flies to it as soon as he needs something in a hurry, yet has to spend some time dismantling, say, a variable condenser to procure a spring washer.

A rainy afternoon might well be spent in sorting out the contents of the “junk box”—re-shuffling them, as it were, and refurbishing up such parts as are really worth it, scrapping, of course, those absolutely useless.

### Polishing and Lacquering.

Take a large sheet of paper and tip everything on to it; now start, for instance, by picking out all the terminals which will, in all probability, have only lost their original brightness. This is quite easily restored by holding the shank firmly in the wheel-brace chuck—the wheel-brace being clamped in the vice—rotating it steadily, and applying a piece of 00 grade blue back emery paper. Screw-heads, valve legs, coil sockets, or any other small brass objects may be treated in the same way.

A really professional appearance may be obtained in two ways, lacquering or tinning; neither process is expensive, and the results justify the time spent to procure them.

Cold lacquer is best for the first attempt, and should, as its name implies, be used cold; a camel hair 1/4 in. flat brush is best to apply the lacquer, which should not be used too freely, as a fine coat sets better and is usually more even. A cardboard box lid, with a number of holes punched in it, makes an excellent drying stand.

### A Method of Tinning

Tinning, the alternative process, gives a finish almost indistinguishable from nickel plating; it is, however, more expensive than lacquering. The ingredients are 1/2 lb. of tin (which may be in stick, grain, or ingot) and 2 ozs. of cream of tartar. The tin should be melted in a suitable crucible, and poured into the receptacle (an enamel saucepan, for instance) which must be three parts full of water. It is best to hold the crucible at arm's length and pour the tin into the saucepan from a height of about four feet, distributing the tin evenly, not as a mound in the centre. Stand the saucepan on the stove and when the water boils drop in all the polished parts and sprinkle in also about 1 oz. of the cream of tartar. Keep the water level above the tin, and in an hour or more the parts may be removed, but can be left longer if a heavier coating is desired, in which case the remaining cream of tartar should be added.

When removed, the parts should be rinsed in cold water and carefully dried. The tin, if washed and dried, may be used again.

(Continued on next page.)

# Build your own H.T. Eliminator

YOU can build for yourself a simple and efficient unit for obtaining all your H.T. requirements from A.C. or D.C. mains. Full instructions for the A.C. unit are given in “P.W.” this week, whilst the D.C. unit was described in the issue of September 11th. Send or call for the parts now.

## A.C. Mains H.T. Unit

	£	s.	d.
1 Climax Auto-Vat Transformer	1	19	6
1 Climax Potential Divider		5	0
1 Climax Choke		10	8
2 Board Mounting Valve Holders		2	8
2 T.C.C. Fixed Condensers 4 mfd.	1	18	0
11 Flush Type Valve Sockets		1	5
1 35-ohm Rheostat		2	8
Wire, Screws, etc.		1	1
“Red Triangle” Ebonite, 13 x 6 1/2 x 3-1/8 in. matted and drilled		6	0
Engraving extra		2	0
Polished Mahogany Cabinet with Baseboard	1	1	0
When the Panel is purchased at the same time as the Kit of Components, a Marconi Royalty of 12/6 per Valve Holder is payable.			
	8	9	6

## D.C. Mains H.T. Unit

	£	s.	d.
1 Ebonite Panel, 7 in. x 5 in. x 1/2 in. matted and drilled		3	0
1 Polished Mahogany Box to fit		3	6
1 Climax Potential Divider		5	0
2 T.C.C. Mansbridge Condensers 2 mfd.		9	4
1 T.C.C. Condenser 5 mfd.		3	4
1 Climax Special Choke		10	6
12 Flush Mounting Valve Sockets		1	6
2 Large Divided Terminals and 4 Telephone Terminals		10	
1 Electric Light Plug and Socket		2	9
1 Electric Light Adapter Plug		1	6
1 Amp. Fuse Wire, 3 yds. flex, screws, nuts, etc.		1	6
		2	2
Extra if required:—			
1 G.E.C. Electric Light Plug Holder with switch		5	9

## Home Constructors!

SEND for the PILOT MANUAL, which gives full details of all latest types of sets. Valuable information on soldering, assembly, etc., is also included. Post free 3d.



Change your  
old 2-Valve  
Set to the  
“N” Circuit

(Described in “P.W.” September 18th).

These are the parts required:—

	£	s.	d.
1 Peto-Scott 3-plate Variable Condenser		3	6
1 Keystone 4-in. dial		2	0
1 Peto-Scott Rheostat 10 ohms.		3	0
1 Silvertown L.F. Transformer	1	1	0
2 B.M. Single Coil Holders		3	0
1 4 1/2-volt Grid Bias Battery		1	6
2 Terminal Strips and 9 Terminals		3	6
Wire, screws, panel transformer, etc.		1	6
1 “Red Triangle” Panel, 13 in. x 6 1/2 in. x 1 in. drilled		6	6
1 Polished Mahogany Cabinet and Baseboard	1	1	0

## Free Service for Amateurs

ALL those who construct their sets under our famous Pilot scheme are entitled to free help and advice from our expert Technical and Service Department. This department is now under the direct control of

Capt. W. A. Tingey, A.M.I.R.E.  
(late of Radio Press Laboratories.)

Remember that whatever Pilot set you build, WE GUARANTEE YOU GOOD RESULTS.

## PETO-SCOTT Co., Ltd.,

Head Office and Works:  
77, City Road, LONDON, E.C.1  
Branches: 62, High Holborn, London, W.C.1  
WALTHAMSTOW—230, Wood St. PLYMOUTH—  
Bank of England Place. LIVERPOOL—4, Manchester Street.

## WORKSHOP HINTS.

(Continued from previous page.)

This should certainly have made a difference in the pile of oddments, and sorting out all the scraps of wire and solder should affect its appearance still further. The wire coiled up and stowed in a separate box will be far more accessible than previously; the before-mentioned crucible will render further service if used to melt the pieces of solder, which may be easily recast by being poured down a piece of sloping angle iron.

A separate box should be found to accommodate small pieces of ebonite, which are always useful, and if kept together a piece of the desired size may be picked up immediately it is wanted. Broken drills and taps should never be thrown away; as, unless broken off short at the shank they can be ground up again without any trouble. Similarly, worn-out files, softened and ground down, form useful additions to the tool-kit as scrapers.

### REDUCING HAND CAPACITY.

**C**IRCUITS which are designed for extreme selectivity are often possessed of one disadvantage, which usually takes the form of either uncontrollability or hand capacity. The former may, as a rule, be to some extent mitigated by changing valves or coils, or by altering the values of the condensers used in different parts of the circuit.

To cure hand capacity is not always so difficult, and in extreme cases can be certainly reduced to an almost negligible proportion by the methods suggested below. Extension handles are rapidly becoming obsolete; screening is now recognised as more efficient and, moreover, tends to enhance the appearance of the receiver.

#### A Screening Plate.

Variable condensers are now almost universally designed with metal end-plates to which the spindle is in direct contact. The fixed vanes are carefully insulated from the end plates and moving vanes, that should be connected to the point of lowest potential, which, if the condenser is to be used as A.T.C. will, of course, be the earth terminal. If it has inadvertently been connected the opposite way and reversing has no effect, a piece of brass or copper about 3½ in. in diameter should be screwed to the panel face and connected to earth. If more than one condenser is used and is at fault, it will be necessary to treat each of them in the same fashion, no matter in what part of the circuit they are connected. Coil holders in which the coils lie close to the back of the panel are sometimes troublesome in this respect, and the same remedy should be used; the screening plate being fixed to the back of the panel. If treating components individually does not procure the desired effect, the panel should be lined with copper foil from which the components must be insulated.

EXPERTS IN RADIO ACOUSTICS SINCE 1908



## OLD FRIENDS

### THE BRANDOLA

Greater volume with minimum current input. Large diaphragm gives fullness to upper and lower registers. Walnut plinth, electro-plated fittings. Reduced from ninety shillings. **75/-**

### THE AUDIO TRANSFORMERS

Ratio 1 to 5. High amplification of applied voltage, together with straight line amplification frequency curve. Also 2nd stage, 1-3. **17/6**  
1-5 (Black case). 1-3 (Brown case).

### THE TABLE-TALKER

Material used in the construction of goose-neck horn eliminates metallic harshness. Adjustable. Height 18 ins., neutral brown finish, padded base. **30/-**

### MATCHED TONE HEADPHONES

The synchronised effort of both receivers discovers greater sensitivity and volume and truer tone. Light, comfortable and sturdy. **20/-**

# Brandes

From any reputable Dealer.

BRANDES LIMITED, 296 REGENT ST., LONDON, W.1

Service Advertising



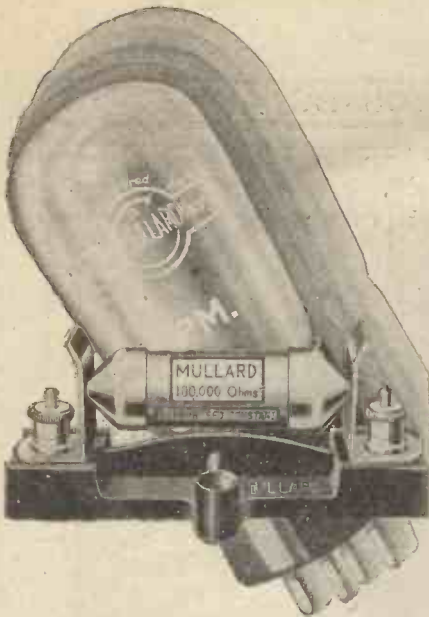

## The Research behind the finest Valve behind a wire wound Anode Resistance

When one research organization controls several products, it follows that the same standard of efficiency must be applicable to each product marketed. The costly patient research which has resulted in the finest valve, lies behind THE MULLARD WIRE WOUND ANODE RESISTANCE, and it is placed on the market with the certain knowledge that its efficiency is the efficiency of the finest valve.

A resistance wound on a textile fibre core perfectly covered, and interlayered with the same material, ensuring the elimination of all self-capacity, and also that the fine metallic wire is rendered absolutely free from every particle of mechanical shock.

The temperature co-efficient is negligible, since the resistance is not set in wax but only covered with a thin layer of wax to allow a perfect dissipation of heat.

**Mullard EVER-REST Wire Wound Anode Resistance (80,000 and 100,000 ohms) - - - 5/-**

**Complete with Holder 6/6**

*Other Values to Specification.*

Mullard Grid Leaks and Condensers,	
Type Grid B 0.5 to 5.0 megohms	2/6
Type Grid B combined with .0003 mfd. Condenser Type MA	5/-
Type MA Condenser .0001 to .0009 mfd.	2/6
Type MB Condenser .001 to .01 mfd.	3/-

*Leaflet P.W. free on request.*



**WIRE WOUND ANODE RESISTANCE**

The MULLARD WIRELESS SERVICE Co., Ltd. Mullard House, Denmark St., London, W.C.2.

## AN EASILY CONSTRUCTED LIGHTNING ARRESTER.

By J. MacINTOSH.

IN days of lightning alarms it is comforting knowledge to know that the aerial is provided for in this respect. A Lodge sparking plug, a large screwed eye-hook, and a washer to fit the threaded portion of the plug are required.

The waterproof type of Lodge plug should be chosen, and the inside diameter of the screwed eye should be such that

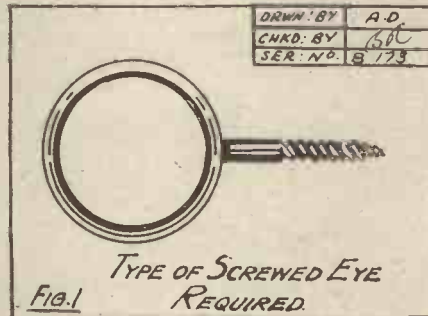

the plain portion of the plug fits it fairly tightly. Thus the eye acts as a holder for the plug.

The eye is screwed into the window-frame, or any convenient position outside the building. The plug is fitted into the eye, which holds it upright. The waterproof

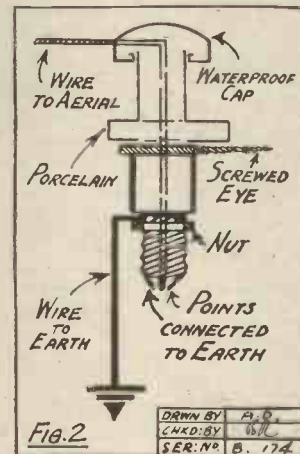

cap on the plug makes contact with the central electrode, and the cable from the cap is connected to the aerial wire at a point prior to it entering the house. By means of the nut a wire is fixed to the frame of the plug, and this wire is earthed. Such an arrangement provides an excellent lightning arrester, and, moreover, is proof against leakage in wet weather.

## The "SPIDER"

Watch "P.W." on Sale October 14th.

The "Spider" will "Get You" — that is certain!

## H.T. ACCUMULATORS

60 volts—Price 32/6

### DO YOU REALISE

that light weight and low cost may be linked up to high efficiency? The inexpensive 60-volt 3-amp. hour ELITE High Tension Accumulator, which actually costs under a 1d. to recharge, will do all that the more expensive types will do and are never done. Therefore, look before you leap at our Descriptive Folders, which will be forwarded per return on application.

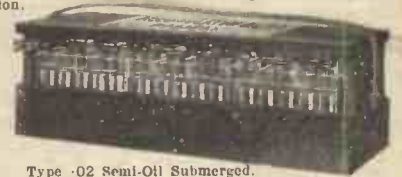

Type .02 Semi-Oil Submerged, 60 volts, complete as illustrated, 32/6, or 5/- per 10-volt Unit.

Obtainable only from—  
**ACCUMULATORS ELITE, 32, King Cross Street, Halifax.**  
Tele.: 1304. Trade Supplied. Telegrams: Elite, Halifax. London Distributor: Cecil Pohlman, 77, Great Portland Street, London, W.1.

**REPAIRS SETS. PHONES. TRANSFORMERS**  
Officially Approved by Radio Association.  
ALL WORK GUARANTEED LOWEST RATES 24 HOUR SERVICE  
Cash on Delivery if Desired.  
**JOHN W. MILLER, 68, Farringdon St., E.C.4**  
Phone: Central 1950.

## CRYSTALS

"5 FOR A BOB"

Comprising  
**HERTZITE, TELLURIUM, BORNITE, IRON PYRITES, SYNTHETIC ZINCITE.**

Plated Tweezers and Silver Whisker.  
Tested by "P.W." Wireless trader.  
Wonderful reports.

ASK YOUR DEALER OR SEND 1/2 TO:  
**THETA CO., 184 Brearley St., BIRMINGHAM.**

**1/9 DONT PAY MORE**

## AERMONIC

VALVE HOLDER.  
Anti-capacity. Anti-phonetic.  
Don't pay more than 1/9.  
If hard to get, drop us a line.  
James Christie & Sons, Ltd.,  
246, West Street, Sheffield.  
London Agents: A.F. BULGIN & Co.,  
10, Cursitor St., London, E.C.4.

## TYPEWRITERS FROM £2.

Every make supplied. All guaranteed. Cash or Easy Payments.  
**SCULTHORPS, LTD.,**  
138, West Nile Street, Glasgow.

**HEADPHONES REPAIRED**  
Re-wound & re-magnetised 5/- per pair. Loud Speakers repaired 5/-. Transformers re-wound 5/- each. All work guaranteed and tested before delivery.  
Write for Trade Prices. Phone Clerk, 1795.  
**MASON & CO., 44, East Road, City Road, N.1.**

## SAVE YOUR VALVES

PRICE complete 2/-

New Bulbs 6d. each

**HUNTS "SAVE IT"**  
SAFETY FUSE COSTS PENCE  
WANDER PLUG SAVES POUNDS  
A. H. HUNT, LTD., (Dept. 12), Groydon, Surrey



**2 VALVE L.F. RECEIVER**  
 The Ideal Loud Speaker Set.  
 Price:- £5.0.0. (without Valves & Batteries)  
 Royalty £1.5.0. extra.

2544-A

*Sold by all good Radio Dealers*

*The British Thomson-Houston Co., Ltd.*

# Hear it!!

"The tone is wonderful." "Reproduction nearly perfect." That is what users of the Ormsby L. F. Transformer say. The Transformer which has helped so much towards the marvellous achievements of the Ormsby Receiver.

The design ensures the entire absence of parasitic disturbances. Materials used are the best. Construction is massive and Primary impedance high. It gives **AMPLIFICATION WITHOUT DISTORTION.** Send for one of these super efficient Transformers. Fit it to your set and notice the difference.

We make them in three ratios 1st and 2nd stages and special No. 1 for Ormsby 4 valve. **15/-**  
 Catalogue on request. Trade enquiries invited. Post 6d.

**ORMSBY & CO., LTD.,**  
 1, Ormsby Works, Lower Richmond Rd., Richmond, Surrey.  
 London Showrooms: 10, New Oxford St., W.C.1

## SPECIAL NOTICE

TO WIRELESS LISTENERS  
 WITHIN 12 MILES OF 2LO

**WHY** be worried with the bother and expense of accumulators or uncertain dry batteries when we will keep you *continuously* supplied with fully charged Rotax L.T. or H.T. ACCUMULATORS for far less than you spend on batteries at present?

*Regular and punctual deliveries* to any address within 12 miles of Charing Cross weekly or fortnightly as desired. Special reduced rates for those with one or more accumulators of their own.

Our service—the largest and most complete of its kind in England—improves reception, saves you money, disappointment and trouble. Write for our price list "H. & L.T.14."

Our Radio Doctor is always at your service for Repairs, Overhauls or Reconstruction.

**THE RADIO SERVICE CO.,**  
 105, TORRIANO AVENUE, LONDON, N.W.5  
 Telephone: North 0623/4/5

## "EKCO" H.T. UNITS

### SCRAP DRY BATTERIES!

by obtaining H.T. current from electric supply mains (D.C. and A.C.) by just attaching adaptor to electric light lampholder.

**SAFE! SILENT! SOUND!**

Illustrated Catalogue **FREE!** Trade Inquiries Invited.

SIZE 6" X 6" X 3 1/2"

Model	Voltage Tappings	D.C.	Price	A.C.
1A	One	.. ..	£2 2 6	—
2A	Two	.. ..	£2 15 0	£8 10 0
3	Three	.. ..	£3 7 6	£7 5 0
V2A	1 Variable, 1 Fixed	.. ..	£4 5 0	£7 15 0
V3	2 Variable, 1 Fixed	.. ..	£5 10 0	£9 0 0
V3A	3 Variable	.. ..	£6 2 6	—
3A	Special "Marconi Straight 8" Model	.. ..	£6 6 0	£9 10 0

**E. K. COLE,**  
 (Dept. A),  
 513, LONDON ROAD,  
 WESTCLIFF-ON-SEA.

## The Improved and Cheaper Coil Plug

**SAVE 25%**

Get your **COIL PLUGS** for 5/6 per doz. (4/6 gross lots.)

Made of best tested materials throughout, these plugs offer the advantages of nickel-plated side plate contacts, having patent lip. Send 6d. to cover postage upon sample dozen orders.

**CECIL RIDLEY**  
 35 & 37 DUNDAS MEWS  
 MIDDLESBROUGH

'Phone: M'bro. 1366



TECHNICAL NOTES.

(Continued from page 290.)



Simpler Wiring

NO NEED any longer to wire up Condenser, Grid-Leak and Valve Holder separately—they can be obtained as complete units. Less space is required, mounting is made easier, troubles arising from faulty connections and spacing are avoided. Also, the cost of Grid-Leak clips and mounting screws is saved.

Remember, too, that the BENJAMIN Anti-Microphonic Valve Holder is not only infinitely superior to all its imitators in design and finish, but in actual performance too.



5/3 Complete

VALVE HOLDER & GRID-LEAK A Dubilier Dumetohm 2 meg. Grid-Leak is fixed on to a rigid insulating bar by means of nickel-plated copper clips.



7/- Complete

VALVE HOLDER, GRID-LEAK & CONDENSER

Nickel-plated copper clips carry a Dubilier fixed Condenser (.0003) in addition to the Grid-Leak. Series or parallel.

BENJAMIN VALVE HOLDER without Leak or Condenser Price 2/9

From all good Dealers

**BENJAMIN**

BRITISH MADE

Clearer-Tone, Anti-Microphonic VALVE HOLDER

THE BENJAMIN ELECTRIC LIMITED  
Tottenham, London, N.17

with a voltage of only 3 volts, which can be supplied by means of two dry cells. This microphone amplifier, unlike many others, may be used not only for the amplification of very weak signals but also for signals which are initially quite strong. In one of these experiments it was used for amplifying speech received on the ordinary line telephone and gave in a loud speaker remarkable volume with great clarity. I should say that the amplification obtained was about equal to that of a 2-valve amplifier. The instrument is very simple and there is nothing to get out of order.

Reaction Variations.

You will probably have noticed with your set that at certain times much closer reaction coupling is necessary than at others and, whilst there are various causes which will influence this effect, it is often due to an earth connection of variable resistance: for example, in case of a buried earthplate the resistance to earth depends on the moisture or dryness of the soil. This is one reason why it is a better plan to take the earth lead to a cold-water pipe, as the extent of the contact with the earth is so great that a thoroughly efficient earth is always obtained irrespective of weather conditions.

It is often recommended to use a bedding of coke, but it should be remarked that chemical action is promoted by the coke, especially in the case of buried copper plates.

In order to obtain a constant reaction effect, it is a good plan to use a loose-coupled tuner in place of the direct aerial reaction system. In this way a smaller reaction coil may be used and the likelihood of re-radiation from the aerial is reduced.

Another condition which may influence the reaction very much is the H.T. voltage applied, particularly to the detector valve. In some circuits the detector H.T. voltage is very critical and a few volts extra may cause the set to oscillate without any adjustment of the reaction coupling. If the reaction coupling is adjusted for a given detector H.T. tapping, and the voltage of the H.T. battery gradually falls off, it is evident that sooner or later a further adjustment of reaction coupling will be necessary to compensate for the change in the applied H.T. voltage.

"Low-Loss" Coils.

Experimenters who invest in so-called "low loss" coils sometimes experience disappointment, and although this is in some cases due to the component not being so "low-loss" as represented, it is in other cases due to the coil being employed in a position where its low-loss character does not avail. For example, if it be employed in the aerial circuit, it is unlikely that any improvement will be noticed, for in this circuit there is the resistance of the aerial and of the earth connection. These will usually be very much greater than that of the coil, so that in reality you are making a small percentage improvement in something which is itself a small percentage of the whole, the result being (as my inathematically-inclined readers will agree) that the improvement is apt to be "of the second order."

AMERICAN VALVES



Why buy them for your Neurodyne or Superhet? Use British Made RADION 5.25 15/- Power Valve They are supplied in both American and British bases. Specially designed for these circuits on the lines of the best American. Satisfaction absolutely guaranteed. Every valve is practically identical. Can be supplied in matched sets. Fil. 5.5 max. 25 amps. Impedance 8,000 ohms. Amplification 7.2. British Base 525B. American Base 525C. Guarantee in every valve box.



Obtainable from BARKERS, BENEFINKS, GAMAGES, WHITELEYS, and most other untied dealers.

If any difficulty write the sole manufacturers: RADIONS LTD., Bollington, Macclesfield, Eng. List Free on Request.

TRANSFORMERS REWOUND

Transformers, Phones, Loudspeakers, Rewound and Repaired to Maximum Efficiency. All One Price 4/- each. Don't discard if burnt out. All work guaranteed for 12 months. Write for trade terms. TRANSFORM CO., 115, LINKS RD., Tooting London, S.W.17



PICKETT'S CABINET WORKS

For Cabinets to improve your Set! To YOUR OWN Panel designs in many Artistic Designs. Write for Latest Designs. Pickett Bros. (P.W.) Works, Bexleyheath.

Bureau Model 3 gns. to 6 gns.

EASY PAYMENTS

Finest 2-valve amplifier set, including loud speaker, 120 H.T., D.E. valves, £7 10s.; or 18/9 down and 11 instalments of 15/-.

CASH BARGAINS.

Good Crystal Sets, 8/3 and 9/3. Amplifiers, 17/6 and 21/-. Phones, Telefunken type, 7/9; Fr. T. Houston, 11/-; U.S. Baldwins, 17/9. Valves, Radio Micro, 5/6; or power, 8/9. Good H.T., 60/-, 5/9; or 4-v. (laboratory test), 3/9 doz. Accumulators, with 12 months' guarantee, 2-v. 40 ignition, 8/3; 4-v. 40, 15/-; 6-v. 60, 29/-. Polished Cabinets, Ebonite, Variometers, Condensers, Coil Holders, and everything in Wireless, reliable and cheap. Satisfaction or cash refunded.

MUSIC ROLL EXCHANGE, 29, High Street, Clapham, London, S.W.4.

TRIUMPH

2-COIL STAND

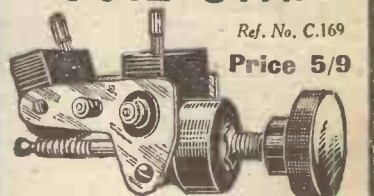

Ref. No. C.169 Price 5/9

THE LATEST SUCCESS VELVET VERNIER ACTION FULLY GUARANTEED. Also TRIUMPH VALVE-HOLDER (Anti-Microphonic) & TRIUMPH RHEOSTAT.

Ask your dealer for illustrated lists, or send p.c. mentioning "Popular Wireless" to

A. H. GLACKSON LTD. WHITE HART WORKS, LONDON, N.22



# IGRANIC CONDENSERS FOR ALL CIRCUITS

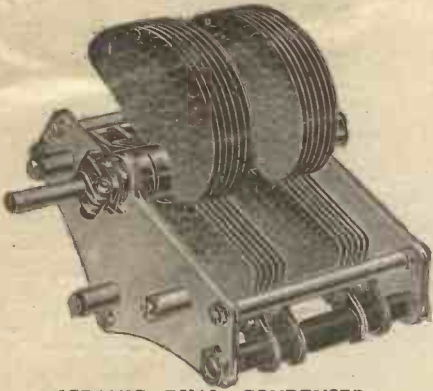

IGRANIC DUAL CONDENSER.

Look through your copies of the leading radio journals—notice the number of receivers in which Igranic condensers have been used with such outstanding success. Profit by the example of experts and use Igranic condensers in all *your* receivers.

**IGRANIC DUAL CONDENSERS.** Extremely low losses, accurate square law characteristic, positive connection to moving plates, combined ball and friction thrust bearings, stout brass plates and highest class workmanship throughout. The two halves are matched.

Dual pattern	..	.0003 mfd. 22/6	.0005 mfd. 27/-
Single pattern	{	.00015 mfd. 17/-	.0005 mfd. 21/6
		.0003 mfd. 18/6	.001 mfd. 25/-

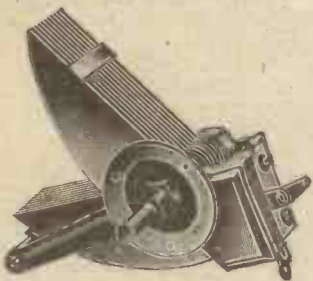

IGRANIC-PACENT STRAIGHT LINE FREQUENCY CONDENSER.

**IGRANIC-PACENT STRAIGHT LINE FREQUENCY CONDENSERS.** Straight line frequency tuning, extremely low losses, brass plates, negligible minimum capacity, smooth action.

Price .. .. .00035 mfd. 14/6 .0005 mfd. 18/6



IGRANIC MICRO CONDENSER and BASE MOUNTING BRACKET.

**IGRANIC-PACENT TRIPLE GANG CONDENSERS.** Built up from three Igranic-Pacent .0005 mfd. condensers. The sections are thoroughly insulated. Flexible couplings between sections. Price £3 10s.

**IGRANIC MICRO CONDENSERS.** Miniature condensers with brass plates of conventional shape. Adequate spacing between moving plates and control knob eliminates hand capacity effects. Moulded cover protects plates. Baseboard or panel mounting. (Single hole fixing.)

Price .. 5/6 Baseboard Bracket 6d.

**IGRANIC FIXED CONDENSERS.** Plates of brass, dielectric of finest Ruby Mica, accurate and constant capacity. Can be mounted in many different ways or supported on the wiring of a receiver.

Prices	..	..	..	..	..	{	.001 mfd., .002 mfd. 1/6 each.
							.003 mfd., .006 mfd. 2/- each.
						Mounting Base	.. .. 9d.



IGRANIC FIXED CONDENSER WITH IGRANIC FIXED GRID LEAK AND MOUNTING BASE.

SEND FOR IGRANIC CATALOGUE No. R27.

## IGRANIC ELECTRIC CO. LTD

149, QUEEN VICTORIA ST., LONDON.

Works: BEDFORD.



### Two in One!

Here's a splendid little component, the Watmel combined Grid Condenser and Fixed Grid Leak. Saves space, time and money. Built to allow the Grid Leak to be connected either across the condenser or direct to the filament of the detector valve.

Price 2/6 each.

Ask your Dealer for full particulars of all Watmel products.

The Watmel Wireless Co., Ltd.,  
332a, Goswell Rd., London, E.C.1  
Telephone, Clerkenwell 7990.

Representative for Lancs, Yorks & Cheshire:  
Mr. J. B. Levee, 23, Hartley Street  
Levenshulme, Manchester.

For trouble-free condenser efficiency always specify the famous round Watmel fixed condenser.

Sizes up to .002 - - 2/-  
Sizes .0025 to .006 - 2/3

TESTED PANEL GUARANTEED FREE FROM SURFACE LEAKAGE

Ready for use

Your Panel  
Size 1 1/2" x 9 1/2"  
Price 6/6

RADIO BECOL PANELS

BRITISH EBNONITE MADE

THE BRITISH EBNONITE CO. LTD. HANWELL LONDON W.7.

STANDARD SIZE PANELS (20 different sizes).  
Packed in cartons and sold by all dealers—everywhere.



## SPLENDID VALUE Bargain Clearance

of famous A.F. Marconi R.B. 10 Crystal Detector and 1-valve L.F. Amplifier Receivers with two new Osram Valves.

Straight from the factory of leading wireless makers. Closed cabinet contains Engraved Ebonite Panel, nickel fittings. 2 Spade Variable Verniers, T.C.C. and M.S.I. Fixed Condenser, 2 H.F. Chokes, Detector Valve-holder, Terminal Plug Sockets, Long and Short Wave Switch, Wiring Diagram, etc. All new and nearly completely wired. New valve fitted and one spare.

**Great Bargain, 12/6. Post, 1/3**

Guaranteed exactly as above. Valves alone worth the money.

**ELECTRADIX RADIOS**  
218, Upper Thames St., London, E.C.4

## VALVES REPAIRED

WHY WASTE MONEY?

Let us RE-MAKE your old ones as good or BETTER than NEW D.E. 4/6 ea. Power 8/- ea.

All work thoroughly TESTED, GUARANTEED and promptly dispatched by Post C.O.D.

"NuVal" 442, Strand, London, W.C.

## Pay while you Listen!

Don't deny yourself the joys of Radio because of the initial cost of a complete Receiver. We can supply the latest "P.W." and other well-known sets, guaranteed Components and Accessories on the Easy Payment System. Technical advice free. Write at once for our comprehensive Catalogue No. 1, and let us know your requirements.

**New Times SALES CO., 77, CITY ROAD, E.C.1.** 5993

PLEASE be sure to mention "POPULAR WIRELESS" when communicating with Advertisers. THANKS!

## 4-ELECTRODE VALVES



We are the suppliers of the genuine U.C. and Thorpe valves, as specially tested and recommended by the "Undyne" inventors and "Popular Wireless" U.O.5 and Thorpe K.4 (both 4-electrode 5-pin valves), each, post free, 10/6

Order direct from—**LUDGATE RADIO CO.,**

56, LUDGATE HILL, LONDON, E.C.4

## CORRESPONDENCE.

(Continued from page 312.)

### LONG DISTANCE CRYSTAL RESULTS.

The Editor, POPULAR WIRELESS.

Dear Sir,—I am enclosing a crystal circuit, which may prove of interest to the readers of "P.W.," and which also gives results superior to any other crystal circuit I have tried out. It will be seen that the variable condenser is connected in parallel with the crystal detector. The fixed condenser across the 'phones is rather larger than is usual, although I am not certain that .005 is the most suitable size. I may say that I am using this circuit for reception of Daventry. London (70 miles) comes in nicely, using No. 50 coil.

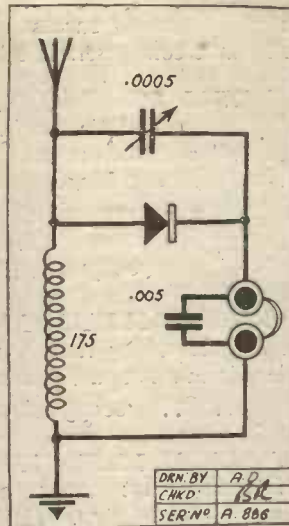

Wishing yourself, staff, and POPULAR WIRELESS every success,  
Yours faithfully,  
E. ASH.

43, Huntingdon Road, Chatteris, Cambs.

### WET H.T. BATTERIES.

The Editor, POPULAR WIRELESS.

Dear Sir,—Permit me to make the following suggestion for the benefit of your readers using the wet H.T. battery. In most cases the brass cap becomes loose or right off. A better method of connection is as follows. Obtain some 18 gauge copper wire and a piece of rod slightly thicker than the carbon rod. The wire should be wound on this very closely, then taken off and cut into 1/2-in. lengths. These will spring tightly on to the carbon, leaving 1/2-in. protruding above, into which the lugs of the zincs will fit nicely. A little toilet paraffin on the top of each spring will safeguard against creeping.

Yours faithfully,  
H. SIMPSON.

7, Shrubbery Road, Southall, Middlesex.

### HOME-MADE H.T. ACCUMULATOR.

The Editor, POPULAR WIRELESS.

Dear Sir,—The following may be interesting for you to publish, of how I made a 60-volt H.T. accumulator out of an old 6-volt accumulator for 3s. 9d. I changed over to dull-emitter valves, and bought

a new 2-volt accumulator, and I daresay there are a large number of your readers who have done the same.

I pulled the old accumulator to pieces, and cut the plates into three strips, as shown by dotted lines in Fig. 1, taking care that the two outside strips were cut so that the paste was retained by the upright section of the grid. If the plates are more than 6 in. long cut across A B.

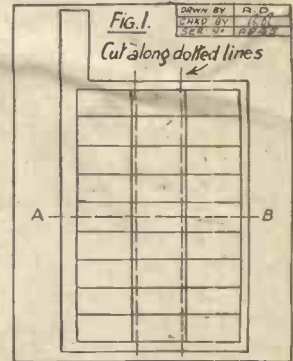

Next, I measured 2 in. up from the bottom, and cut along the horizontal section of the grid, to the thick side foundation of the plate. Then I cut down from the top to meet the horizontal cut, as shown in Fig. 2. The projecting piece is then filed round, and this is done to all pieces, so that there are 30 negative and 30 positive small plates, measuring 2 in. by 1 in., with a 1 in. lug.

I then procured 30 glass tubes (costing 3s. 9d.) and assembled them, placing 1 negative and 1 positive

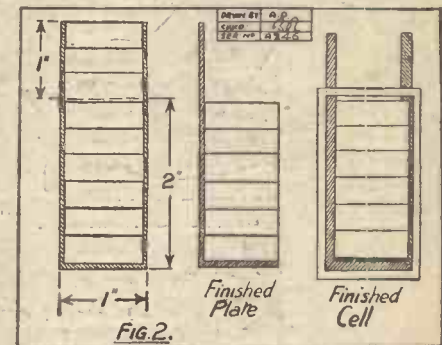

plate in each tube with a piece of separation in between them. I made a rack to hold the 30 tubes by drilling a piece of wood with 5 rows of 6 holes. The cells were connected by fusing a piece of 1/4 lead wire to the positive and negative of each cell with a hot soldering iron. I filled them with acid and put them on charge for eight hours at 1-10th amp. two months ago, and they are still going strong on the first charge. The tubes were obtained from J. Isaacs & Co., 106, Midland Road, St. Pancras, London, N.W.1.

Trusting this will be of interest to you.

Yours faithfully,  
A. E. COURNNELL.  
68, Hampton Road, Ilford, E.



Resiston comes in 17 stock sizes in Black or Mahogany-grained finish. Each Panel is protected by its own stout manilla envelope—your safeguard.

**The Hall Mark**



**of a good Panel**

### Panel Talks: No. 2.

## How can you tell a Panel's insulation qualities?

IT does not take an expert to discern the superiority of one valve over another. Or the inferiority of a variable condenser of one make compared with someone else's. Yet how many amateurs know when they buy a panel whether it is efficient electrically, or whether it will only nullify the many hours spent in building a Set?

In choosing a Panel you cannot go on appearance. Only the most elaborate electrical tests can reveal to you the percentage of its insulation qualities. What then are you to do? There is one safeguard; the Hall Mark borne by every Panel made by the American Hard Rubber Co., (Brit.) Ltd., is your guarantee of perfect, hundred-per-cent insulation—in the twin

names "Radion" and "Resiston" is the key to panel-satisfaction. Resiston—like Radion—Panels are manufactured only from a basis of hard rubber—the most efficient insulating material known to Science. If you, therefore, fit a Resiston Panel to your Set you are certain that not one-per-cent of the incoming currents is lost—your signals will ever be strong and clear.



# It's Right in every base!

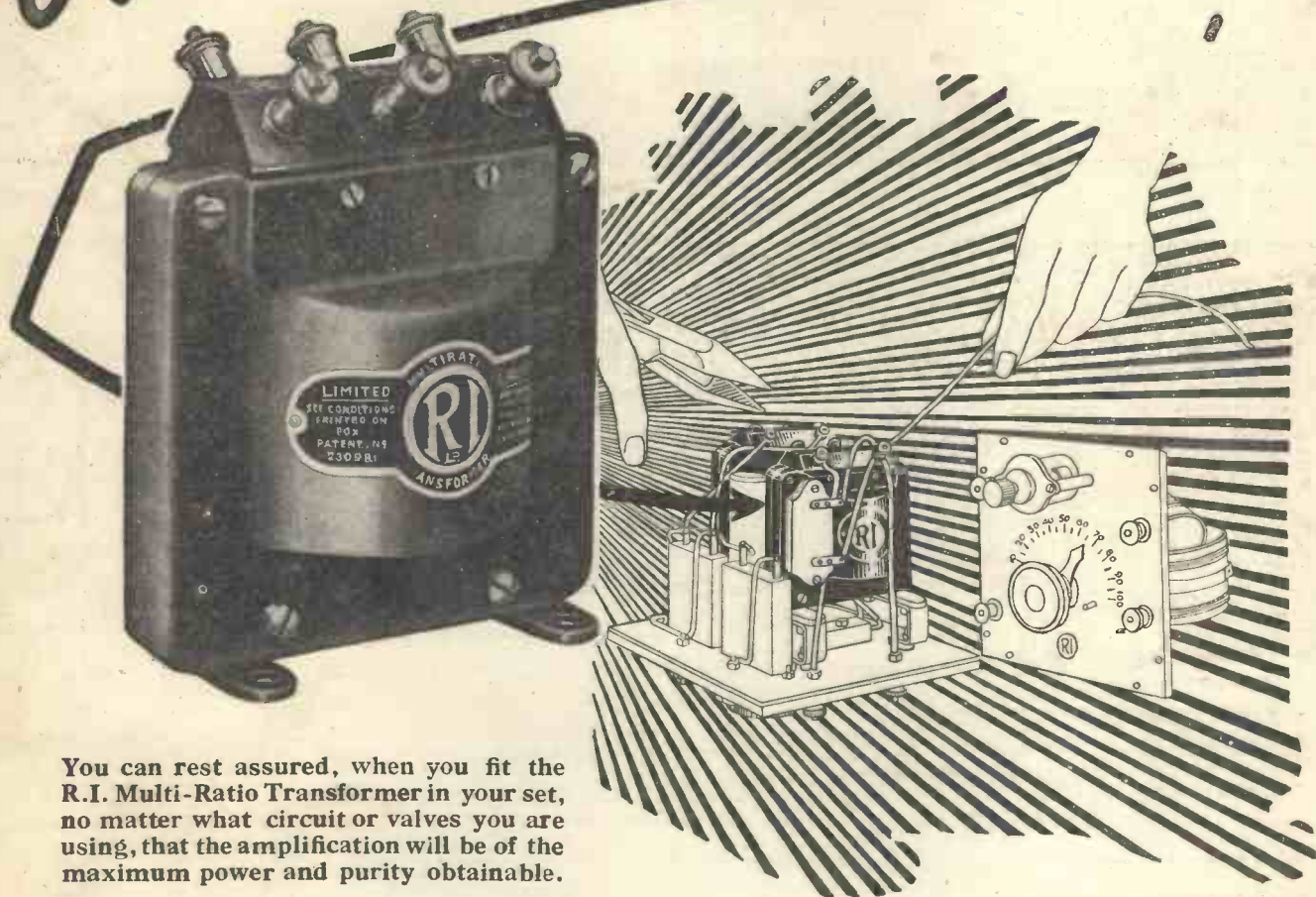

You can rest assured, when you fit the R.I. Multi-Ratio Transformer in your set, no matter what circuit or valves you are using, that the amplification will be of the maximum power and purity obtainable.

You need have no hesitation because the R.I. multi-Ratio Transformer is designed to meet all requirements—7 ratios to give perfect amplification in any stage in any circuit—3 impedance values to operate correctly in conjunction with any valve—all facts to give you complete confidence in the success of your set.

Further than these, you have the knowledge that this instrument is an R.I. Product, that its design and execution are the finest examples of British craftsmanship.

PRICE 27/6

Write for the new R.I. Catalogue.



THE MARK OF



# A win on points



Big events, high honours and mastership are all won on points.

Here are P.M. points that give mastership to your receiver and enable you to reach out when necessary and achieve big results.

For 4-volt accumulator  
or 3 dry cells

THE P.M. 3 (General Purpose) 0.1 amp. 14/-  
THE P.M. 4 (Power) 0.1 amp. 18/6

For 6-volt accumulator  
or 4 dry cells

THE P.M. 5 (General Purpose) 0.1 amp. 13/6  
THE P.M. 6 (Power) 0.1 amp. 18/6

For 3-volt accumulator

THE P.M. 1 H.F. 0.1 amp. 14/-  
THE P.M. 1 L.F. 0.1 amp. 14/-  
THE P.M. 2 (Power) 0.15 amp. 18/6

These prices do not apply in Irish Free State.

**British Made**  
in a  
**British Factory**

(1) EMISSION.

The wonderful P.M. Filament has up to 5½ times the emission surface of an ordinary filament giving greater volume and range.

(2) ECONOMY.

The P.M. Filament consumes only one tenth ampere making your accumulator charges last seven times as long

(3) LONG LIFE.

The operating temperature of the P.M. Filament is as low as 180° below the Pyrometer scale with the result that the life of this filament is vastly increased.

(4) STRENGTH.

Even after 1,000 hours' life the P.M. Filament is so tough that it can be tied in knots and it is so well supported by resilient hooks that it cannot be broken except by the very roughest handling.

(5) VALUE.

The total of all these qualities means 3 times more for your money and better, cheaper-to-run radio reception.



You can join the legions of amateurs who were able to listen to the Tunney-Dempsey fight by installing valves with wonderful P.M. Filament.

ASK YOUR RADIO DEALER FOR P.M. VALVES  
WITH THE WONDERFUL P.M. FILAMENT.

# Mullard

## THE MASTER VALVE

ADVT. THE MULLARD WIRELESS SERVICE CO., LTD., MULLARD HOUSE, DENMARK STREET, LONDON, W.C.2

Printed and published every Thursday by the Proprietors, The Amalgamated Press (1922), Ltd., The Fleetway House, Farringdon Street, London, E.C.4. Advertisement Offices, Messrs. J. H. Lile, Ltd., 4, Ludgate Circus, London, E.C.4. Registered as a newspaper and for transmission by Canadian Magazine Post. Subscription rates: Inland 17/4 per annum, 8/8 for six months; Abroad 19/6 per annum, 9/6 for six months. Sole Agents for South Africa: Central News Agency, Ltd.; Sole Agents for Australia and New Zealand: Messrs. Gordon & Gotch, Ltd.; and for Canada: The Imperial News Co. (Canada), Ltd. Saturday, October 9th, 1928.

R/R

Phone: City 7261.

All applications for Advertisement Space in POPULAR WIRELESS to be made to JOHN H. LILE, LTD. (Sole Agents), 4, Ludgate Circus, London, E.C.4.